

October  
15 Cents

*NOTICE TO READER:* When you finish reading this magazine place a 1-cent stamp on this notice, hand same to any postal employe and it will be placed in the hands of our soldiers or sailors at the front. **NO WRAPPING—NO ADDRESS.** A. S. Burleson, Postmaster General.

# POPULAR MECHANICS MAGAZINE

WRITTEN SO YOU CAN UNDERSTAND IT

REG. U.S. PAT. OFF.





# HARRIS HOMES



**When You Build The Harris Way**—you build to stay, and secure the *utmost possible* in Quality, Economy and Service. Why? Simply because you profit directly—*immediately*—by our 24 years experience. You get the benefit of our practical knowledge as the *originators* of the "Direct to You" Home Building Industry. We were the *first* to sell Lumber and Material direct to Home Builders at one small profit. We were the *first* to reduce vitally important industry to a *perfect system* and extend the benefits uniformly to the people of the nation. *The splendid Harris Home below has 6 rooms, bath, pantry, large living room, etc. The size is 30x26 ft. A thoroughly modern American Home in every respect.*

**"The Harris Way"** has exclusive merits—special advantages for the shrewd and careful Home Builder, possessed by no other plan or method. It is the best, safest and most sensible way to build your ideal home *right* without sacrifice of quality, or the waste of a single penny! Thousands have built "THE HARRIS WAY" with profit and satisfaction.

**Advance in Prices** Our prices are so low that it will be impossible to maintain same for any length of time. They are bound to advance. If you are needing a house, either for investment purposes or for a home, write now. Do not delay another moment if you wish to make a saving.

**The Material** used in building all Harris Homes is prepared by us complete for your use in a way that is instantly and easily understood. It is sensibly cut-to-fit with *absolute accuracy and positive elimination of all waste*. You pay for nothing you do not get—you pay our bed rock low, one-small profit bargain price *only* for what is needed to do the work *right* "THE HARRIS WAY."

**\$10,000,000**

**Capital Stock and Surplus—stands back of our guarantee to every Harris Home Buyer—you cannot lose.**

**Free Book of Plans** Be sure to mail free coupon for the latest edition of the famous \$10,000 HARRIS HOME PLAN BOOK now ready. A golden guide to Quality, Service and Economy in Building. Explains fully and freely, everything about building economy. Contains 100 modern Harris Home Designs, with descriptions, material, specifications, prices, etc., and explains how we save you \$50.00 to \$250.00 on plans and material. Think twice before you pass this opportunity.

**\$1042 Buys The Material To Build This Beautiful Home No. 161**  
—Best Quality Material Throughout—Best Construction — Sensibly Cut-To-Fit.

## CUT OUT AND MAIL

Harris Bros. Co., Dept. FL7  
Chicago

Please send me free—without the slightest obligation—the following books checked.

- Book of Plans
- Plumbing and Heating
- Paints
- Presto-Up Ready Made Sectional Houses & Garages

Name.....

Address.....



**HARRIS BROTHERS CO. CHICAGO** Dept. FL7, 35th and Iron Sts.





To insure Victor quality, always look for the famous trademark, "His Master's Voice." It is on all genuine products of the Victor Talking Machine Company.



CARUSO



MELBA



FARRAR



PADEREWSKI



GALLI-CURCI



GLUCK



MCCORMACK



KREISLER

**The Victrola is the embodiment of all that is best in music**

The excellence of any talking-machine can be safely judged by the artists who make records for it.

Just as there is but one Caruso, one Farrar, one Galli-Curci, one Gluck, one Kreisler, one McCormack, one Melba, one Paderewski, so there is only one instrument able to bring their superb art into your home with absolute fidelity.

The greatest artists themselves have decided that instrument is the Victrola.

Any Victor dealer will gladly play for you the exquisite interpretations of the world's greatest artists who make records exclusively for the Victor. And if desired he will demonstrate the various styles of the Victor and Victrola—\$10 to \$400. Ask to hear the Saenger Voice Culture Records.

**Victor Talking Machine Co., Camden, N. J., U. S. A.**  
 Berliner Gramophone Co., Montreal, Canadian Distributors

**New Victor Records demonstrated at all dealers on the 1st of each month**



Victrola VI, \$25  
 This



Victrola XVII, \$250  
 Victrola XVI, electric, \$300  
 Mahogany or oak



Victrola IX, \$50  
 Mahogany or oak

**Victor Supremacy**

Please Mention Popular Mechanics

This One



QXOP-XNW-B4QX

Copyrighted material



Next time you have to patch the back steps, where the water drips down and rots 'em out, tell the man: "Cypress, the 'Wood Eternal' and no fooling!" (Why not abolish the repair jobs this way? Make each one the last repair job in just that spot

You remember v le-  
 burg said—"H he-  
 leaps, builds for  
 keeps." (N im-  
 mortal.) mortal.) yet?



*A Trade Mark in Every Board and Stick of CYPRESS "the Wood Eternal!"*

Have yo Guess I'd better get some Cypress Books.  
 Or Vol. Guess I'll write the "All-round Helps Dept."  
**SOUTHERN CYPRESS MFRS. ASSN.**  
*All-round Helps Dept.*

## Southern Cypress Mfrs.' Ass'n

1219 Hibernia Bank Building, New Orleans, La.  
 1219 Heard Nat'l Bank Building, Jacksonville, Fla.

**P. S.—Accept none but "Tidewater" Cypress, identified by the Cypress Arrow Trade-mark (shown above) ON EVERY stick or bundle. FOR USES WHICH INVITE DECAY INSIST ON "ALL HEART" GRADE.**



# Popular Mechanics Magazine

6 N. Michigan Avenue, Chicago, U. S. A.

EDITED BY H. H. WINDSOR

England: The International News Co.  
5 Beams Bldg., Chancery Lane, London, E. C.

Australia:  
The Australian News Co.

ISSUED MONTHLY

SUBSCRIPTION:

SINGLE COPY, 15 CENTS

In United States, and its possessions, Cuba and Mexico, per year, postpaid - - - - \$1.50  
To Canada - - - - - 1.75  
To all other countries in the Postal Union - - - - - 2.50

All subscriptions are discontinued at expiration. Please examine the date printed on your wrapper.

Entered as Second Class Matter Sept. 15, 1903, at the Post Office at Chicago, Illinois, under Act of March 3rd, 1879.

Entered as Second Class Matter at the Post Office Department, Canada.

Published monthly by POPULAR MECHANICS CO.

Copyright, 1917, by H. H. WINDSOR.

Copyright, in France.

*Steel Sprocket 587*  
*Non-flammable Glass 497*  
Contents for October, 1917

Accessories for the Home and Its Members.....	524	Concrete Cone Obviates Resetting of Staff.....	576
Accident—Collision, Head On Train, at End of Signal Block.....	522	Concrete Mixing Outfit Has Traveling Tower....	527
Accident—Explosion, Water Heater, Due to Carelessness.....	522	Concrete, Planks of, Used in Seashore Walk....	523
Aeroplane—Battleplane, Big German, Splendidly Designed.....	513	Control, Dual, Motoring Taught in Car with....	553
Aeroplane—Speed Scout Shows War's Effect on Air Craft.....	427	Copper, Claims to Know Secret of Hardening..	518
Air Raids, How Englishmen's Minds Act during Altar, Handsome, Portable, for Coast Artillery.....	521	Cottonwood Posts beside Ditch Become Trees....	530
Aqueduct, Earthquake and Landslide Break....	505	Crawfish, Big Catches of, Made with Mouse-traps.....	512
Army Draft Bowl Placed near Liberty Bell....	518	Cyclometer, New, Measures Freight Car's Trips Deaf, Teaching the, to Hear with Their Eyes, by R. H. Moulton.....	579
Army Ruling, New, Gives Small Men Chance....	528	Death, King's, Scientists Seek to Clear.....	544
Artists Take Vital Part in War's Activities....	524	Doors, Convenient, for a Double Garage.....	545
Automobile, Folding Holder Attaches to Side of Automobile for Alaskan Trails Has Runners in Front.....	522	Draft Shield for Window May be Adjusted....	505
Automobile Lock, New, Has Alarm as an Added Feature.....	522	Drug Herbs, University Cultivates.....	525
Automobile Stalls, Back Yards Transformed into Automobile Tire Rack Provides Place for Tools. Automobile's Load Carried by Horizontal Springs.....	516	Electric Initiation of James Josephus, by Searle Hendee.....	548
Automobiles, New System of Suspending Dissipates Shocks in.....	502	Engine, Little, for Home, Has Original Design..	577
Axle, Special, Increases Sidecar Capacity.....	528	Engine, Powerful Electric, Is Built in East....	525
Bakery, Mobile Army, Equipment Designed..	524	Fashions, Autumn, for Outdoor Activities.....	517
Bamboo Used in Building Railway Bridges....	526	Fire Engine Pumps Water to New Height.....	526
Baseball, Autographed, Brings Big Price.....	574	Fire Pump Unit Carried on Light Trailer.....	558
Bathtubs, Upright, Produced for Japs in America Battleship "Louisiana" Makes Unusual Repair at Sea.....	428	Flag, Use of, War Department's Views Regarding.....	578
Boat, Fast, for Both War and Peace Service....	526	Flower Boxes, Built In, for Apartment House... 529	529
Brake, New Automatic, for Riding Plow.....	528	Fog, Making to Order to Humidify Air.....	525
Brush, Revolving, Cleans Threads in Shells....	578	Fuel Economizer, Motor Appliance Designed as Furnace, Gas, Controlled by Electric Switch... 529	529
Bugle Used to Transmit Military Signals.....	527	Game, Ball Pitching, Wooden Players Used in.. 523	523
Bungalow, Charming, for Small Family.....	540	Game, New, Both Chance and Skill Enter into.. 522	522
Buoy, New Automatic, Makes Own Electricity.. 422	422	Game, New Parlor, Teaches Elements of Music.. 515	515
Bush Two Centuries Old Bought for Garden....	526	Gas, Illuminating, Is Fuel for London Busses.. 515	515
Cableway at Bottom of World's Greatest Gorge.. 573	573	Gauge, Gasoline, Trouble Saving for Motor Car.. 526	526
Caliper, New Universal, for Small Work.....	553	Gear, Flexible, Equalizes Power of Cycle Engine.. 527	527
Camera, Flexible, Unusual Work Executed with Camera, Stereoscopic, Made for Binocular Microscope.....	522	Gear, Friction, Pressure Secured by Magnets... 522	522
Canal, Seattle's Ship, Formally Opened.....	555	Grain Bred for Seed, Device Used in Planting... 554	554
Chair, Invalid's, Leg Guards Improve.....	527	Grease Cup, New, Has Novel and Convenient Points.....	523
Children, Rescues, by Leaping into Blazing Pool Chimney, World's Tallest, Completed in Japan.. 572	572	Gun, the Deadly Machine, by Reginald Trautschold.....	523
"Clocks, Campaign," Speed up Arms Production 512	512	Handless Man Drives Car with Magnetic Control Harness, Improved Lock Snap for.....	522
Coal Bins, Dealer's, Built Like Silos.....	521	Harvester, Fish, Claims to Have Big Capacity.. 522	522
Coal, Why Scandinavians Need, Despite Forests 526	526	Hospital, Model Army Base, Is Built at New York.....	523
		Irrigation Spill Pipe of Ornamental Type.....	527
		Jail, Model, Provided in County Building.....	523
		Jelly Making, Failures in, Are Easily Prevented.. 522	522
		Laundry Apparatus Dries and Irons Hosiery.... 573	573
		Lever, Heavy, Miners Use in Dumping Ore Cars 542	542
		Lift, Worm Gear Traction, Operates at Low Cost 522	522

[Continued on Page 6]

Popular Mechanics offers no premiums; does not join in "clubbing offers," and employs no solicitors to secure subscriptions. It is for sale by nearly every newsdealer in the United States and Canada.

This One



GHWX-P55-PD71

Digitized material



## [Contents—Continued]

"Lion, Awful," Safely Caged while Horrifying	
Actors	527
Log, Fir, Makes Rustic Timepiece	518
Lumber Loads, Big, Carry on Logging Cars	522
Mail, Holiday, Clerks Handle in Extra Cage	567
Map, Military Relief, Has Interchangeable Parts	583
Maps, Mother, Great Help in Estimating Bids	602
Measuring Device, Height, Is Concession Machine	576
Mining, Photos Show Hardships of	583
Monument to Commemorate Brave Promoters	513
Moonshade Camp Accessory for Open Air Outlets	575
Motor, Novel, Utilizes Waste Water Power	575
Navy, Buying Food and Clothes for, a Huge Task	496
Outdoor Outfits and Devices	579
Permits, Camp Fire, Issued in Forest Reservation	560
Photograph, Queer, Shows Puffs Preceding Big Blast	576
Photographs, Fireproof, for Army and Navy	512
Piles, Drivers of Record Height Sink	562
Placards, German, Evidence of Noyon's Oppression	542
Poster Makes Patriotic Appeal to Miners	525
Potash Mine, Abyssinian, being Developed	516
Power, New Discovery of, Big War Secret?	488
Preserving Plant, City, Conserves Food, by O. J. Grimes	507
Printer, Circular Letter, Makes Own Stationery	555
Rafts, Life, Placed Aboard Transatlantic Ships	501
Railroad Cars, Gasoline, Used on Mountain Line	502
Railway is Finally Built to Russian Arctic Port	593
Range, Compact, Electric, Serves Many Purposes	524
Range, Improved, to Make Police Marksmen	538
Reading Course, Popular, for Patriotic Men	522
Regulator, New, for Soil Temperature Test	558
Rheostat, Fool Proof, for Garages	599
Salmon Dressing Machine Works at High Speed	508
Salt Device to Prevent Drain Pipe Freezing	598
School, Opportunity, Denver Educational Feature	509
Seals, Skins of Five Year Old, to be Tested	523
Separators Save Oil in Big Auto Plant	576
Shield, Steel, to Protect Advancing Soldiers	486
Ship—Loaded Transport Rammed in American Port	483
Shoe Repair Shop, Army's, in Truck and Trailer	519
Shrapnel, Counting the Balls in Filling	559
Skating Rink Pipe, over Two Thousand Welds in	545
Sign, Traveling, an Index to Red Cross Drive	523
Sled, Human, Carries Wounded Man to Safety	481
Soldier, Pasteboard, Built to Aid Camouflage	485
Spring Seat, Safety, Made for Farm Implements	597
Statue, War, Washington Politicians Stirred by	499
Stitches, Double Lock and Shuttle, Strength of	488
Swims Many Miles Tied to a Chair	514
Tackle, Simple, Unloading, for Auto Dealers	554
Telephoning from Moving Trains, New Device for	482
Tennis, New Variation of, Played without a Net	574
Tooth, Hinged, Safeguards Against Disease	496
Toyland's Newest and Best Products	600
Tractor, Crippled, Good Makeshift Repair of	486
Tractor, Farm, Four-Footed, Steps Right Along	520
Tractor, Small Farm, Travels on Legs	525
Trade, Foreign, Immense during War Years	528
Traffic Officer Directs from Raised Platform	512
Train Equipped as a Portable Lumber Camp	589
Tree, Big, Children of the Forest	559
Trees, Citrus, Fumigated under Canvas Shelter	591
Truck and Trailer Carry Twenty-One Ton Load	495
Truck, New Military, Is at Home in Water	501
Trunks, Bootlegger's, Sold to Aid Red Cross	526
Turntable, Power Driven, Controlled from Car	522
Turtles, Live "Mock," Ship without Crate	544
Typewriter Eraser Holder, New Office Accessory	588
Tyranny in America, Protesting against	591
Valves, Water Main, Truck Appliance Operates	588
Vessel, Sailing, Light Plant Modernizes	548
War, European:	
Aeroplanes, German, Swift, Swarm over London	537
Britishers after Battle and as Our Guests	534
Efficiency, German, Contrasting Views of	536
Hospital for Damaged Gear, by L. R. Freeman	489
Interesting Side Lights on	528
Legions of Russia and France in Review	535
Nets, Mighty, Weaving to Foil U-Boats	556
Pershing, Major General, in France with	532
Poilus, at the Front in France with	529
Sammies, Special Body will Answer Inquiries about	567
War Time Devices of Odd Character	530
"Yarrowdale" Case, America Forgets	538
Watch, Ring, Is Newest Style of Timepiece	485
Well, Artesian, Bursts from Its Casing	548
Wheelbarrow Isn't a Wheelbarrow at All	559
Windmill, Small Sailboats Form Arms of	584
SHOP NOTES	
Air Pump, Stuffing Box, Repair for	611
Angle Valve, Homemade Low Pressure	606
Automobile, Folding Table, Robe Rack, and Extra Compartment	610
Automobile Foot Brakes, One Man Method of Adjusting	611
Boring Mills, Device for Centering Work on	621
Brackets, Hinged, Insulator, Prevent Breakage of Wires	604
Clamps, Wooden, Refacing Jaws of	614
Commutator, Motor, Turned Up True in Position	616
Concrete Farm Feed and Water Heater	620
Containers, Cleaning Glass Chemical	622
Core, Prints, Simple Method of Making without Lathe	622
Counter, Revolution, Rigged to Determine Travel on Machinery	618
Coupling, Hose, Attaching with a Vulcanized Joint	614
Door, Ventilating on Roof, Opened from Ground Dresser, Emery Wheel, Made of Old Emery Wheel	622
Drier, Clothes, Attached to Kitchen Boiler	621
Drill Press Table Supports Tool Tray	612
Drinking Fountain, Sanitary Concrete	607
Engine, Small Gas, Starting Handle for	612
Floot, Hollow Metal, Stopping a Hole in	612
Furnaces, Automatic Feed Water Pan for	616
Furniture Legs, Band Sawing Cabriole or Curved Gas Cock, Safety, with Ball Valve	610
Gate Adjustable to Heavy Snowfall	613
Goggles, Weight of, Relieved by Rubber Band	606
Grinder, Changing to Left Hand Drive	610
Grinder, Large Wheel Refaced on Lathe Rigged as	613
Grooves, Cutting, in the Edges of Thin Disks	609
Guard, Safety Circular Saw, Prevents Back Thrust	618
Guide for Cutting Triangular Strips on Circular Saw	606
Handcart for Railway Tracks	611
Hood Confines Forge Fire for Intermittent Use	614
Lathe, Back Rest for Supporting Wood in	617
Letters and Designs, Raised, Painted on Roller	605
Lever, Pulley, That Does Not Damage Rims	621
Locker, Foot Rest, Built in Auto Tonneau	614
Machine, Combination Turning, Sawing, and Grinding	616
Mixing Box, Improved, for Mortar or Grouting	608
Motor, Gasoline, Cooled by Air Pumped through Water Jacket	604
Pen, Ruling, Block for Starting Flow of Ink in	622
Piston Ring Grooves, Scraping Dirt from	608
Piston Rings, Gasoline Motor, Fitting Accurately	620
Plates, Slippery Iron Floor, Roughening	605
Posts, Wooden, Renewing with Concrete	617
Rods and Pipes, Stack Racks for, Quickly Devised	609
Rods, Pile of, Protected by Painted Stripe	622
Rubber Goods Kept Pliable by Oil	616
Soldering Furnace, an Improved Charcoal	610
Tool, Adaptable, for Machinery Circular Curves on Lathe	620
Tool for Applying Hose Clamps Handily in Vise	618
Trolley Cable Rides over Guy Wires in Its Path	603
Truck, Roller Skate, Saves Carrying Doors and Sashes	609

[Contents Continued on Page 8]



# Wanted—\$20,000 Men

**T**HIS announcement marks the epoch of a new industry—an industry surpassing in scope that of the automobile, cash register, typewriter, adding machine, talking machine, the farm lighting plant.

The money-making opportunity is, we confidently believe, as great, or greater than any of these. Already sales agencies have been opened in the majority of the principal cities in America, and are *making good*.

An unusual opportunity exists right now for the right man to open a sales agency for this product in a number of live territories throughout the country.

## Electric Refrigeration—the Next Great Industry

Electric—*iceless* refrigeration is colder—cleaner—more economical than ice! No roughshod ice man tracking dirt across your kitchen floor—no swift-melting ice—no need to pay *five times* the cost of *manufacture* for having ice *delivered*

—for FRIDGER—by *electric current*—refrigerates and preserves all food supplies *perfectly*—is far more *sanitary, economical, effective*.

Overnight FRIDGER made

the prevailing means of refrigeration antiquated, clumsy, out-of-date.

And FRIDGER is no *experiment*—but tried, proven, and in use today all over the country. Sales branches already extend from coast to coast. The opportunity to get the sales agency for FRIDGER is a rare opportunity, and one necessitating immediate action; a money-making chance to be had only with a product that supersedes and revolutionizes all previous methods.

## The Men We Want

The primary requisite is *brains*. The men we want must be *big enough* in ability and experience to organize a small sales force, lay out and plan their work intelligently and be strong enough financially to handle such a proposition without the handicap of insufficient capital. The initial capital need not be large; but it should be sufficient to insure stability; the main

requisite being the ability to swing big business fast and hard as you see it opening before you.

FRIDGER has every home for its market—residences, apartments, yachts, country houses.

FRIDGER profits are liberal—the sale of one FRIDGER a day means an income of \$28,600 a year.



Quick action will be necessary; territory is being rapidly allotted. Write today for complete particulars.

**Fred W. Wolf, Manufacturer**  
327 Wells Street **CHICAGO**



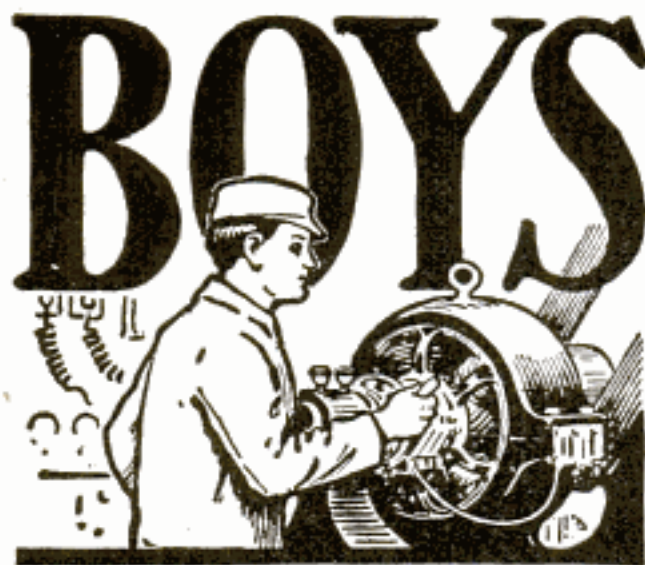

## Big Money in Electricity

The Electrical industries offer wonderful opportunities to boys with a liking for Electricity. The salaries paid to trained men are large, promotion comes rapidly and, best of all, the work is fascinating.

The discovery and development of new lines (such as wireless telegraphy and telephony), from time to time, promise attractive and paying fields to those who wish to specialize. The *will to do* and *Special Training* will bring success to you.

The International Correspondence Schools can help you to become an expert in electrical work, no matter what branch you like best. Thousands of young men have already won success through I. C. S. help. You can do as well as anybody, *if you try*. Everything is made so clear that you can learn in your spare time, regardless of where you live or what your work. No books to buy.

There's big money in Electricity. Get after it by marking and mailing the Coupon today. *Finding out costs you nothing.*

### INTERNATIONAL CORRESPONDENCE SCHOOLS

Box 5610, SCRANTON, PA.

Explain, without obligating me, how I can train for the position below which I mark X.

- |  |  |
|--|--|
| <input type="checkbox"/> ELECTRICAL ENGINEER       | <input type="checkbox"/> ARCHITECT               |
| <input type="checkbox"/> Electrician               | <input type="checkbox"/> Architectural Draftsman |
| <input type="checkbox"/> Electric Wiring           | <input type="checkbox"/> Mill Foreman or Supt.   |
| <input type="checkbox"/> Electric Lighting         | <input type="checkbox"/> Business (Complete)     |
| <input type="checkbox"/> Electric Car Running      | <input type="checkbox"/> Bookkeeper              |
| <input type="checkbox"/> Electric Machine Designer | <input type="checkbox"/> Stenographer            |
| <input type="checkbox"/> Telegraph Engineer        | <input type="checkbox"/> Advertising Man         |
| <input type="checkbox"/> MECHANICAL ENGINEER       | <input type="checkbox"/> Salesmanship            |
| <input type="checkbox"/> Mechanical Draftsman      | <input type="checkbox"/> Window Trimmer          |
| <input type="checkbox"/> STEAM ENGINEER            | <input type="checkbox"/> Civil Service           |
| <input type="checkbox"/> GAS ENGINEER              | <input type="checkbox"/> AGRICULTURE             |
| <input type="checkbox"/> CIVIL ENGINEER            | <input type="checkbox"/> Poultry Raising         |
| <input type="checkbox"/> Structural Engineer       | <input type="checkbox"/> AUTOMOBILES             |
| <input type="checkbox"/> CHEMICAL ENGINEER         | <input type="checkbox"/> Auto Repairing          |

Name \_\_\_\_\_

Present Occupation and Employer \_\_\_\_\_

Street and No. \_\_\_\_\_

City \_\_\_\_\_ State \_\_\_\_\_

If name of Course you want is not in this list, write it below.

Please Mention Popular Mechanics

### (Contents—Continued from Page 6)

Washbasin Faucets, Pedal Controls for.....	605
Whistle Operated by Electric Release Weight..	612
Wrench, Leather, for Tightening Screw Clamps..	610

### AMATEUR MECHANICS

Alarm Bell Warns of Garden Intruders.....	625
Brushes, Cloth Polishing, Made from Bristle Brushes .....	637
Camp Stove, Folding, with Large Hinges as Legs .....	625
Clapper on Bell, Silencing.....	634
Clip, Pencil, Handy Removable Attached to Blank Book .....	639
Cloth, Pressing with Moist Paper Protection.....	634
Coin Mailer Folded from Sheet of Paper.....	631
Ellipses, Machine for Drawing .....	636
Fishpole Tips, Reinforcing Loose.....	630
Fly Book, Fisherman's Homemade.....	632
Fruits and Vegetables, Drying, Homemade Apparatus for.....	635
Games, Card, Trump Indicator for.....	632
Grapes, Water Fed to, from Bottles Keeps Fresh	631
Grinder, Foot Power Emery, Quickly Made.....	636
Heater, Gas, Made of Stovepipe.....	626
Hut, Tree, and Rustic Shelter of Poles and Brushwood .....	623
Kennel, Outdoor, for Cats.....	634
Kitchen Sink Accessories, Holder for.....	637
Match Safe Cut in Frame of Lantern.....	632
Mirror Frame and Hall Rack.....	633
Motorcycle, Enameling Spokes and Worn Rims of .....	638
Photograph Bath Temperature, Uniform, Prevents Blisters .....	630
Pistol, Hitting the Bull's-Eye with.....	627
Sawhorse Weighted by Sawyer Standing on Footstep .....	634
Sewing Box Fitted on Window Stool.....	633
Spot Light, Electric Bulb Used as.....	637
Tablecloths Kept on Rollers in Drawer.....	625
Tacks, Safe Method of Holding.....	632
Target Arrangement for Rifle Sighting Practice..	639
Temperature Regulator, Electric, for Brooder...	631
Time Switch Fitted to a Dollar Watch.....	638
Typewriter Cover, Substantial, made of Wood and Cardboard.....	626

## Mammoth Jubilee Book Free

Picturing 5152 Home Things  
Make your own Credit Terms—1 to 3 years' time,  
SPIEGEL, MAY, STERN CO., 800 W. 35th St., Chicago

## 30 DAY COURSE FREE IN TIRE REPAIRING

Write Today for remarkably low price and particulars about our free course in tire repairing. Let us show you how to make \$3,000 to \$8,000 a year.  
RELIABLE TIRE REPAIR SCHOOL 110 Reliable Bldg. DETROIT, MICH.

## Learn How to WRESTLE

In Your Own Home By Mail

Yes, learn to become an expert wrestler right in your own home, by mail, from the greatest wrestler the world has ever known. Be an athlete, be strong, be healthy. Learn how to throw and handle big men with ease. Learn to defend yourself. All taught in our course of lessons, and illustrated with hundreds of charts and actual photographs by

### Farmer Burns and Frank Gotch

Farmer Burns, "the grand old man of the mat," taught Frank Gotch, the present World's Champion, all he knows about wrestling, so Gotch says. He will now teach you Scientific Wrestling—Physical Culture—Jiu-Jitsu—Self Defense. Every man and boy in America, no difference what age, needs this wonderful course of lessons. Write today—your name, age and address on a postcard or letter brings you our free book absolutely free—no obligations of any kind. A splendid book on wrestling and physical culture. Write today start—your own.

Farmer Burns School of Wrestling, 1197 Range Bldg., Omaha

This Wrestling Book FREE



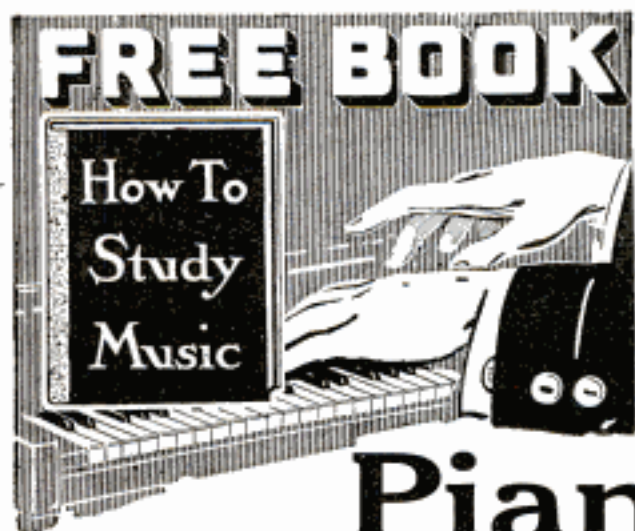

# This Great Book Has Started Thousands to Piano Success

Be sure to write for this 64-page book *today*. It explains the pleasures and social advantages of musical skill. It tells how you can increase your earning power by professional playing or by giving musical instruction to others. It explains the sensible, the scientific, the *economical* way of learning to play piano or organ. It is **FREE** **Short Lesson with Expert Better than a Dozen Other Lessons**

This is the age of **EFFICIENCY**—in music just as much as in any other Art or Science. Now, more than ever before, your teacher must be an **EXPERT**, or you will waste months and years of time practicing in out-of-date ways. Your teacher must possess more than mere playing ability—**much** more. He must know **MUSICAL SCIENCE** as well—and such knowledge is very rare even in the largest cities. The old-fashioned system of studying with a "private teacher" is rapidly being abandoned. And anybody can see why. If you want the **entire** attention of your teacher, but can afford only a dollar or two for each lesson, you can get only **third-rate-instruction**. Whereas, if you join a **class** at a Conservatory, you can secure the services of a **real expert** at **even less cost**—and you learn **correctly** and thus **more rapidly**.

## Learn Right at Home—By Scientific, Guaranteed Method

Dr. Quinn's famous Written Method brings right to your home, **wherever you live**, all the great advantages of Conservatory study. You obtain a complete Course of Music Lessons which has been prepared according to the **latest developments** of scientific teaching and has been successfully used by **thousands** of men and women. **Satisfaction is Guaranteed.**

## Easy to Understand—Music Furnished Free

The Course is fully illustrated with photographs showing every position and movement of the fingers, hands and arms. You can refer to these photographs at any time, day or night. You are **certain** of practicing correctly. Verbal instructions, given by a "private teacher," are unsatisfactory, because, even if correct, it is impossible to remember them **in full** when you practice. Dr. Quinn instructs and guides you at every step. You cannot go wrong, and no matter how far you continue your music you will never have anything to unlearn. All necessary music is included **FREE**. A diploma of internationally-recognized value is granted. Progress as rapidly or as slowly as you wish.

## For Beginners or Experienced Players

The Course is entirely different from any other that you have ever seen or heard of. In thoroughness and in the subjects covered it corresponds to the usual three-year term of study. Yet it can easily be mastered in seventy-five weeks and some students finish it in less than a year. These prompt results are because the Course is systematic, and is carefully planned in advance; **not** because anything is omitted. Not a minute of your time nor an ounce of your effort is wasted. Nothing is forgotten or needlessly covered twice, because errors such as this would have been discovered and corrected long ago. Men and women who have failed by all other methods have quickly and easily attained success when using Dr. Quinn's method. It brings the same surprising results to either beginners or experienced players.

## Endorsed by Distinguished Musicians

Among our graduates are thousands of accomplished amateur players, as well as prominent professional players, successful teachers and leading composers. We have enrolled more students so far in 1917 than in 1916 and 1915 combined. This is due to the remarkable results we have produced. The Course is endorsed by many distinguished musicians, educators and men of affairs who would not recommend any Course but the **best**.

## Investigate Without Cost—Special Offer

Write today, using postcard, letter, or Free Book Coupon, for our new 64-page book, "How to Study Music." It is the most complete explanation of modern teaching methods ever published by a Conservatory. It tells how much the lessons cost, gives the records and opinions of our students and much other valuable information. Our Tuition Fee is greatly reduced just now on account of our Twenty-Fifth Anniversary Offer. Investigate without cost or obligation **NOW**.

**Marcus Lucius Quinn Conservatory of Music**  
Studio KX, Social Union Building, BOSTON, MASS.

## FREE Book Coupon

**QUINN CONSERVATORY**  
Studio KX, Social Union Bldg., Boston, Mass.

You may send me without obligation or expense your 64-page Free Book, "How to Study Music," which describes Dr. Quinn's **WRITTEN METHOD** of teaching piano or organ at home in 142 lessons. Also tell me how much the lessons cost at the reduced Tuition Fee allowed this month as a Twenty-Fifth Anniversary offer.

NAME .....

ADDRESS .....



# Every Electrical Man

Wants These Books

and we ship them **FREE**  
for your inspection



10  
Volumes

3500  
Pages

4700  
Pictures

\$1 Per  
Volume

\$1 Per  
Month

Flexible  
Covers

Handy  
Pocket-  
Size  
Volumes

Just what you need to know to succeed in **ELECTRICITY**



**E**VERY electrician, every engineer, every mechanic should know about these wonderfully helpful instructive books, which give in plain words a complete working knowledge of electrical engineering in all its phases. You run into some new electrical

problem almost every day. It may be some trouble that you can't locate, or some electrical principle that you don't know just how to apply. It's up to you to find the right way out. There's no need to spend hours trying to "dope it out," no need to ask somebody else, or do a makeshift job.

The information you need to help you in your every day work is in

# HAWKINS ELECTRICAL GUIDES

These books place electricity at your finger ends. They cover every imaginable subject, principle, theory, problem, trouble, and way of doing things electrically. Every subject is indexed so that you can turn right to it. They are a study course and a reference guide in one, written in plain every day language—no wasted words—only what you need to know—chock full of up-to-the-minute electrical knowledge. The guides are a complete course in electrical engineering. They will help you in every detail of the day's electrical work. You can't ask an electrical question that Hawkins Guides can't answer.

## Pocket-Size Flexible Covers

The books are small enough to slip into your coat pocket—handsomely bound in flexible black covers. You can carry each volume with you until you have mastered its contents. 3,500 pages of actual information and 4,700 illustrations. Once you see these books and put them into actual use you will never again want to be without them. Try it at our expense.

## SEND NO MONEY

It will cost you nothing to receive these books—to look them over—ask them all the questions you can think of—use them in your work—study them—pick up some information that will increase your earning ability. We will ship you the entire set of 10 volumes entirely FREE. This is a sign of our confidence in the guides. Pure gold does not object to being tested. Keep them for seven days and if you do not decide that you can't get along without them, return them to us and owe us nothing. When you decide to keep them you only have to pay \$1.00 down and remit the balance of \$9.00 on the easy payment of \$1.00 a month till paid for.

Use this coupon to get the books. It will pay you many times over.

**THEO. AUDEL & CO.**  
72 Fifth Ave. New York, N. Y.



### What Electrical Men Say About—

#### Helped Him Make Good

"It is only right for me to recommend highly the Hawkins Guides, for they have been of the greatest assistance to me in placing me in my present position as Superintendent of Construction Department of one of Ohio's largest Electrical Companies. I would like to see every man have a set of Hawkins Guides." *Geo. Knicht, Columbus, Ohio.*

#### The Trouble With Them

"The only trouble I find with the Hawkins Guides is that every body is always borrowing them. My set was even borrowed by a high school instructor for reference work in a physics class." *Carl Haasvinkle, Hattinger, N. D.*

#### First Aid

"Number 10 Guide arrived all O. K. and completes the set, which I am very proud of. I don't think it would be possible to find a better set for either the beginner or the professional electrician." *Elmer A. Stover, Elmer A. Stover, N. Y.*

#### In the Naval Electrical Dept.

"The Hawkins Guides are great help to me in the Naval Electrical Department, which they cover very thoroughly." *U. S. Receiving Ship, Brooklyn, N. Y.*

#### Handy to Carry

"The great beauty of them is that you can carry them in your pocket. That suits me, for I never want to be without them." *F. S. Collins, Richardson Engineering Co., Hartford, Conn.*

#### Saved Him Money

"Hawkins Guides saved me just \$3.50 the first time I looked through No. 10 Book. I had a spark coil played out, and that book showed me how to rewind it; and I made it as good as new. Hawkins Guides are the best ever." *H. F. Ramsey, Fiedmont, Mo.*

#### Superintendent

"I am now superintendent of the Danville Hydro-Electric System, and Hawkins Guides were a great help to me in holding down a responsible position." *W. E. Swartz, Danville, Ontario.*

#### Even in College

"I am attending Cornell University, but I use the Hawkins Guides every day for general information which I cannot get in recitation work or in laboratory experiments. I'll always speak a good word for the every-ready Guides." *J. Windfeld Kurts, Joannas, Berke Co., Pa.*

#### Wireless Operators

"I have worked wireless for ten years—but I wish I had these books years ago, so they have saved me a great deal of trouble." *H. Marshall, Steamer M & B No. 2, Walkersville, Ont.*

### Read This Partial List of Contents

- No. 1** Contains 348 pages, 388 illustrations. Electrical signs and symbols—static and current electricity—primary cells—conductors and insulators—resistance and conductivity—magnetism—induction coils—dynamo principle—classes of dynamos—armatures—windings—commutation—brushes, etc.
- No. 2** Contains 348 pages, 394 illustrations. Motor principles—armature brushes—motor starting—alternations—brake horsepower—selection and installation of dynamometers—resistance measurement—voltmeters—wattmeters—watt hour meters—operation of dynamo—operation of motor, etc.
- No. 3** Contains 330 pages, 423 illustrations. Distribution systems—wires and wire calculations—leads, outside and underground wiring—open flashers—lighting protection—coolers—storage battery systems, etc.
- No. 4** Contains 270 pages, 379 illustrations. Alternating current principle—alternating current diagrams—the power factor—alternator principle—alternator construction—windings, etc.
- No. 5** Contains 320 pages, 614 illustrations. A. C. Motors—synchronous and induction motor principles—A. C. commutator motors—induction motors, transformers, losses, construction, connections, tests—converters—rectifiers, etc.
- No. 6** Contains 268 pages, 473 illustrations. Alternating current systems—switching devices—circuit breakers—relays—lighting protector apparatus—regulating devices—synchronous condensers—indicating devices—meters—power factor indicators—wave form measurement—switch boards, etc.
- No. 7** Contains 316 pages, 379 illustrations. Alternating current, selection, erection, testing, running, care and repair—telephones, etc.
- No. 8** Contains 332 pages, 436 illustrations. Telegraph—simultaneous telegraphy and telephony—wireless—electric bells—electric lighting—photometry, etc.
- No. 9** Contains 323 pages, 657 illustrations. Electric railways—electric locomotives—car lighting—trolley car operation—miscellaneous applications—motion pictures—gas engine ignition—automobile self-starters and lighting apparatus, electric vehicles, etc.
- No. 10** Contains 513 pages, 599 illustrations. Elevators—cranes—pumps—air compressors—electric heat—electric welding—soldering and brazing—industrial electrolyses—electro plating—electro-therapeutics—X-rays, etc.

**THEO. AUDEL & CO.**  
72 Fifth Avenue  
New York, N. Y.

Please submit me for examination Hawkins Electrical Guides (price \$1 each). Ship at once, prepaid, the 10 numbers. If satisfactory I agree to send you \$1 within seven days and to furnish you \$1 each month until paid.

Also a complete 126-page ready reference index of the complete library. This index has been prepared to render easily accessible all the vast information contained in the 10 electrical guides. There are over 19,000 cross references. You find what you want to know instantly.

.....  
**Signature**.....  
 .....  
**Occupation**.....  
 .....  
**Business Address**.....  
 .....  
**Residence**.....  
 (Please write in full the names of business relations with you, we shall appreciate your giving us some of reference on face below.)  
 .....  
 Reference..... P. M. Oct. '17



# Learn El



IN  
**FOUR  
MONTHS**

In the Great  
**CO**  
Trade and Eng

Dept. 1197  
39-51 E. Illinois  
Street

Don't be a slave all your life. Let us train you in this wonderful field of electricity where the demand for skilled men is always far greater than the supply. Many of our graduates

**Earn \$125 to \$300 per Month**

Hundreds of young men come from all parts of this country and many foreign countries each year to be trained in our big shops. Hundreds enter our day school. Hundreds work in the day time and enter our evening school.

Remember, we use no books, have no classes and do not teach by correspondence. You do the actual work here the same as you will later do on the outside only under expert instructors. From the simplest door bell to the mighty generator—motor—electric locomotive, everything is made simple—understandable. Light—power—heat are mastered easily—quickly—surely. And all at small expense.

## Serve Your Country Best

If you want to serve your country best serve it as a **trained** man. Learn one of these big trades **now**, before enlisting and get a higher rating and more money. And, remember, after the war is over the demand for men in these trades will be enormous. Now is the time to act.

### READ THIS

April 10, 1917.  
Mr. B. W. Coyne, Director  
DEAR SIR:—I want to thank you for the interest shown me while at your school. Sorry I could not quite finish my course in plumbing as I have enlisted in the Army as a plumber. Am getting along fine and expect to be made Sergeant Plumber in a short time.

Yours Sincerely,  
J. J. Venzler, Jefferson Barracks, Mo.

Also  
Practical  
Training in  
**Plumbing**  
**Bricklaying**  
**Motion Picture**  
**Operating**

Most complete courses  
in America. Space  
does not permit  
details. Write at  
once for liter-  
ature.

COYNE  
TRADE  
SCHOOL



# U.S. NEEDS



# Electricity



**Shops of**  
**YNE**  
 Engineering Schools

CHICAGO,  
 ILL.

**IN**  
**FOUR**  
**MONTHS**

## Small Cost

Never was such an opportunity open to ambitious men. Even lack of ready money need not stop you. All tools and equipment are furnished Free! There are no extras. The cost is wonderfully low and you pay in easy payments as you go.

## FREE Employment Bureau!

Every worthy, industrious young man receives a welcome at Coyne. If you have no money — our employment bureau will help you get work while you study.

## FREE BOOK OF GOLDEN OPPORTUNITIES

Write for this book at once! Send no money! It's free! Read of the wonderful opportunities for young men in the big trades — Electricity, Plumbing, Bricklaying, Drafting, Motion Picture Operating. Read the wonderful successes of Coyne graduates. No other book in the world is like this. Get it at once! Fill in the coupon and mail it **now!**  
 Address Dept. 1197.

## LEARN DRAFTING

The country is crying for skilled draftsmen in all lines. Thousands of positions open with princely salaries. We have been able to place every graduate in a good position. One firm asked for all our men. Now is the time to get into this big field. Experts train you under practical working conditions, no books and theory go here. Check drafting on the coupon below and mail it at once for full particulars.

**BENNETT WELLINGTON COOKE, Director**

**COYNE TRADE AND ENGINEERING SCHOOLS**  
 Dept. 1197, CHICAGO

Send me at once your big Book of Golden Opportunities. I am especially interested in the trade checked

- Electricity  Drafting  Plumbing  
 Motion Picture Operating  Bricklaying

NAME.....

ADDRESS.....

TOWN..... STATE.....

**TRAINED**  
**MEN**

**MAIL THIS COUPON NOW!**







## Follow Our Boys in France!



WHEN the papers are full of the brave deeds of our boys in France—your boy among them—will you be able to follow each forward drive? When you read "Pershing Gained Laroche" what will it mean to you? How far have we gone from the Meuse? How much more must we gain? Follow the forward drive of the allied troops with your boy at the front. Every village, every ridge, every small stream on the western front will be as clear to you as if you were there, if you have the

## New Geographical Manual and New Atlas

The Story of the  
World in Maps

The wonderful details of the western front form only one phase of this great work. There are 240 pages of maps—Maps Political, Economic, Geographic, Vegetation, Population, Language, Racial, Physical, Historical. There is the Dictionary of Vegetable, Animal and Mineral Commodities. There are Automobile Maps of every state in the Union—Postal and Railroad Guide for the United States—Maps of the Battle Fronts.

This is an Atlas with a new idea—it doesn't only give the locations and boundaries—it shows by colored picture maps the story of this world and the standing today of the nations. Take France, for instance. There are six different and separate maps of France, telling you, at a glance, whether France is rich in coal, and where—what it grows—what races live there—what languages they speak.

With the help of this Atlas you may look beneath the surface actions of this War and realize the basic racial antagonism that caused it. You can answer a thousand and one questions that come up as you read. Here are a few that perhaps you don't know:

What is the hottest place in the world?  
Where is Erzerum?  
What is the Skagerak?

Where is our newest ally—Siam?  
Where does it rain every day?  
What is Russia's new port on the White Sea?

Perhaps you think that Siberia is a cold, frozen place. Perhaps you think the Sahara is an unbroken stretch of thousands of miles of sand. You are wrong. Look at these maps and learn the truth at a glance.

## After the War Maps Free

To you who order this Atlas—maps showing the changes made after this war will be furnished free of charge, just as soon as these changes are settled.

There will be a place in the Atlas to which you can fasten the new maps so that, while you have a complete Atlas of the World now, your Atlas will still be complete and new when the War is over. It will be very interesting to compare your old maps with your new ones.

## Special Low Price on One Edition Only

The great men of the world have always studied maps. Cecil Rhodes drew a red line from the Suez Canal to the Cape of Good Hope where today the Cape to Cairo Railroad grows. Rockefeller drew his oil pipe lines on the map, Harriman dreamed his railroad on the map, and Lord Strathcona built the Canadian Railroad empire on a map. All people who amount to anything read and study maps.

For one edition the price is the price of an ordinary book, yet this is the life of the world in maps such as you never saw before. Send the coupon now. It costs you nothing and brings this big, rich, complete Atlas free for examination. Look it over and find out the true fascination of map hunting—of reading the news with a map at your side—of interpreting history with the help of maps. Send the coupon for your copy of this sumptuous Atlas, now. Send the coupon—now—before the edition is gone.

**Doubleday Page & Co.** GARDEN CITY, NEW YORK



Pop.  
Mech.  
10-17

**Doubleday  
Page & Co.**  
Garden City, N. Y.

Send me, all charges pre-  
paid, Geographical Manual and  
New Atlas, measuring 10 x 12 1/2  
inches—bound in fine silk cloth,  
stamped in gold. If it is not  
satisfactory I will return it within  
10 days, at your expense. Otherwise I  
will send you 35 cents at once and \$1.00 a  
month for 4 months. If you prefer you may  
send \$4.50 with this coupon.

NAME.....

ADDRESS.....

For handsome red limp leather, change coupon to  
8 months instead of 4—\$6.50 cash instead of \$4.50.

Please Mention Popular Mechanics



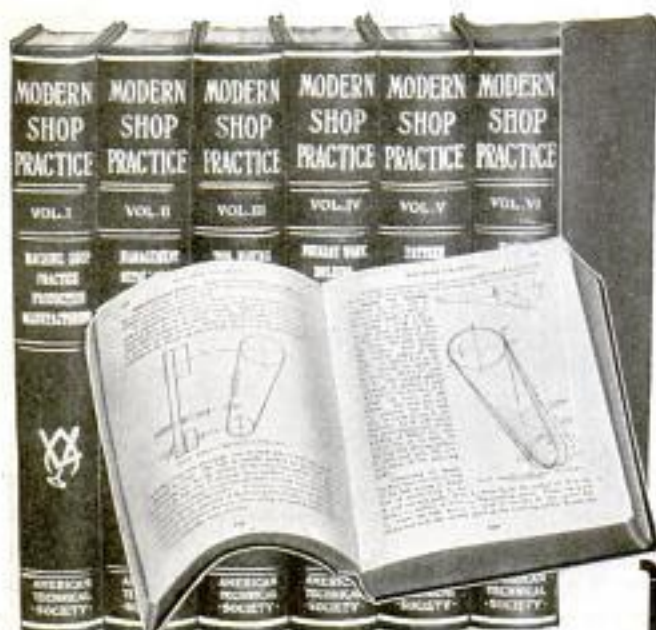

## Everything the Boss Knows

Here, in these new books you have all the knowledge that gave the boss his job. All the problems he had to work out by actual experience are classified and indexed so that you can refer to them instantly. The books are called Modern Shop Practice and every man interested in shop work will find them money makers and money savers.

Just think what it would mean if you knew all shop methods. Think what it would mean to have all the latest machinery described and explained. That is what you have in these six handsome volumes.

## Modern Shop Practice

In these six volumes you have all the information you need to make you an authority on modern shop methods. You can be the man who gives the money saving—time saving methods—and tells how to operate the most complex machinery. They are bound in genuine Bagdad leather, limp covers, 5½x8½ inches, 2300 pages, 2500 illustrations, full page plates, tables and diagrams, all cross-indexed for quick reference. The regular price of the set is \$30.00 but for a limited time we are offering a few sets at \$17.80, about half price. And you can pay this low price at the rate of \$2.00 a month. This offer is made to every man within the boundaries of the United States and Canada.

**Important Subjects Covered**  
 Machine Shop Work—Modern Manufacturing—Machine Shop Management—Metallurgy—Welding—Die Making—Tool Making—Tool Design—Foundry Work (Molding, Casting and Forging)—Pattern Making—Mechanical Drawing—Machine Drawing—Auto Shop Work. Nearly two thousand subjects included.

### Use Them Seven Days

Upon your simple request we will ship you the entire set, express prepaid, for free examination. Use them seven days—just as if they were your own. Don't send us a penny. Just send the coupon and we'll send the books. Use them seven days—and see for yourself what they are going to mean to you. If you think you aren't throwing away a golden opportunity send them back.

### 50c a Week

American Technical Society  
 Dept. M 1197, Chicago, U. S. A.  
 Please send me the set of Modern Shop Practice for seven days' free examination. If I decide to keep them I will send \$2.00 after seven days and \$2.00 a month until the special price of \$17.80 has been paid. Then you will send me a receipt showing the \$30.00 set of books and the \$12.00 consulting membership are mine and fully paid for. Otherwise, I will return them at your expense.

But if you decide to keep them send us \$2.00 after the trial and then \$2.00 a month until you have paid \$17.80. And too, if you order now we will also include free a year's consulting service. This entitles you to the advice of a corps of experts for an entire year. Ask as many questions as you wish.

### Send the Coupon

Just mail us the coupon. Don't send a penny. We will send you the entire set, express prepaid, for your examination. Act quick—before the offer is withdrawn.

American  
 Technical Society  
 Dept. M 1197  
 CHICAGO, U. S. A.

NAME.....

ADDRESS.....

REFERENCE.....

## Automobile Machinist and Machinist Training School



Journeyman courses completed in one year. Elaborately equipped machine shops and garage. Skilled mechanics for teachers. Also twelve weeks' courses in Traction Engine and the Automobile. Trained men in all these courses in great demand at highest wages.

### Also Needed by the U. S. Government

Demand will increase as the war progresses. For years the leading Mechanical Trade School in the country. Enter any time. Winter quarter opens December 4th. Special Winter term opens January 2d. The Garage and Traction Engine courses are also offered by correspondence. Write for catalog and full information. Address

Highland Park College  
 of Mechanical Trades  
 121 Euclid Ave., DES MOINES, IA.



**\$50 for ONE DRAWING PAID**

Illustrators—Cartoonists—Commercial Artists make big money. Learn NOW at home in spare time by our new instruction method. Handsome free booklet explains everything. Write for it today. Get our Special Free Outfit offer. WASHINGTON SCHOOL OF ART  
 1271 H St., N. W. WASHINGTON, D. C.



## ENGINEERING MECHANICAL ELECTRICAL

One Year Practical Courses. Day and Evening classes. Splendid equipment and instruction. Low tuition. For particulars address

DETROIT TECHNICAL INSTITUTE  
 Box 308, Y. M. C. A. Building, DETROIT, MICH.

## FREE BOOK ON BANKING

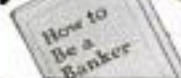

Tells of the great opportunities in this wonderful profession, and how you can learn by mail. Six months' term. Dividends awarded. EDGAR G. ALDRIN Pres., AMERICAN SCHOOL OF BANKING  
 490 East State St., Columbus, Ohio

## STAMMERERS

Our courses of private lessons will correct your impediments. BOSTON STAMMERERS' INSTITUTE  
 Founded 1867. Samuel D. Robbins, Principal.  
 246 Huntington Ave. BOSTON, MASS.

**Stop Eating Poison!** Wrong food combinations are poisonous and destroy health—right combinations build health. Eugene Christian's 24 lessons in Correct Eating tell how to eat for health, strength and efficiency. Send for Free Trial No Money in Advance offer. Write today. Corrective Eating Co., Dept. 50, 443 Fourth Ave., New York City

## 60 BOOKS Bound in Leather \$100 AFTER TRIAL

Balance in small payments each month. Not a penny in advance. The masterpieces of Kipling, De Maupassant, Stevenson, G. Bernard Shaw, Victor Hugo and dozens of others. Each book bound in genuine limp leather, pocket size. Write postal now for offer. LITTLE LEATHER LIBRARY, 150 Marcella Bldg., 23rd St., New York

## Encyclopaedia Britannica "HANDY VOLUME" ISSUE Printed on India Paper

Please Mention Popular Mechanics



Machine Shop  
Practice  
Complete

## Put Your Full Earning Power to Work

You can earn more than you ever dreamed of if you know machinery — if you become an expert machine shop man.

This is an age of mechanics. Whether at the front or at home, a correct knowledge of machine shop work now counts for more than ever before in the world's history.

### Five Men at Home to One in the Field

It is estimated that the services of five men are required at home to keep one properly equipped in the field, in this scientifically fought war. The percentage of citizens called to the front is very small. But the spirit of the nation says prepare. Prepare yourself for the battle of life. Decide on some one profession, and stick to it—master it.

### Earn at Least \$25 to \$50 Per Week

Now is the time to enter the machine industry. Now is the time to enter the industry which is destined to lead all others for the next twenty-five years, war or peace.

**MACHINE  
SHOP  
PRACTICE  
COMPLETE**

The great machine shops of the country are calling for men who are trained. \$25 to \$50 per week is the average salary paid. But with the Machine Shop Library to guide you, you need not stop at that. These books were written by eight men who are probably more widely known than any other expert machinists in the United States—Colvin, Stanley, Goodrich, Logue, Marshall, Palmer, Lake, Haas. They know the essentials of success in the machine industry, and they tell you of these essentials in such plain language that you need not even refer to the dictionary to understand.

### \$16 Worth of Books Sent You Without Deposit

It has been said on good authority that few men today exercise more than one-fifth of their actual earning capacity. Be one of the exceptions. Earn at least \$25 to \$50 per week, and then with the assistance of eight experts go right ahead to the really big positions in the machine field, paying from \$50 to \$100 per week.

### Pay Only 50c Per Week

Return the attached coupon today.

We trust you with the entire Library, weighing sixteen pounds, beautifully and strongly bound. If you are not pleased in every way send them back at our expense. But they will tell you plainly all you want to know about machine shop work, so you will gladly keep them and send us \$2 per month for eight months.

**McGraw-Hill  
BOOK CO., Inc.**

*Publishers of books  
for machinists  
since 1876*

239 W. 39th St.  
New York

Signature .....

Your Address .....

City and State .....

Name of Employer .....

His Address .....

Your Position .....

McGraw-Hill  
Book Co.,  
Inc.,  
239 W. 39th St.,  
New York

Gentlemen:—I am interested in your Machine Shop Library. You may send me the nine volumes, charges paid, for my inspection. If satisfactory I will send \$2 in ten days and \$2 per month until I have paid the price of the books, \$18. If the books are not what I want, I will write you for shipping instructions.

**EXAMINE THE BOOKS AT OUR EXPENSE**

Please Mention Popular Mechanics



# The Men The Navy Needs Now

**D**URING the first few weeks after the United States entered the Great War, many thousands of patriotic young Americans responded to the call of the United States Navy. So many of these fine young men offered their services who had no special qualifications for the work on board ship, that the capacities of the training stations were soon overtaxed. It shortly became necessary to restrict the enlistments of unskilled men by raising the minimum age limit of apprentice seamen, and to suspend enlistments in certain trades which were in excess, such as shipwrights, shipfitters, blacksmiths, boilermakers, plumbers, printers, painters, general electricians and yeomen (or clerks).

**The Navy still needs men, but desires to fill the remaining vacancies in its authorized complement with men who are most needed in the fleet.**

There is a demand now for competent machinists, ages 21 to 35; for cooks and bakers, 21 to 35 (or landsmen for cooks and bakers, 18 to 25); and for radio operators, 18 to 25.

Other ratings which are still open to enlistment are apprentice seamen, musicians, coppersmiths, firemen, hospital apprentices, mess attendants, and men specially qualified for machinists in the Navy Flying Corps.

An attractively illustrated booklet explaining the naval service, together with circulars describing special branches of the Navy, will be sent upon request.

ADDRESS

**RECRUITING DIVISION**  
**NAVY DEPARTMENT**                      **WASHINGTON, D.C.**

*There is a Navy Recruiting Office in every large city*



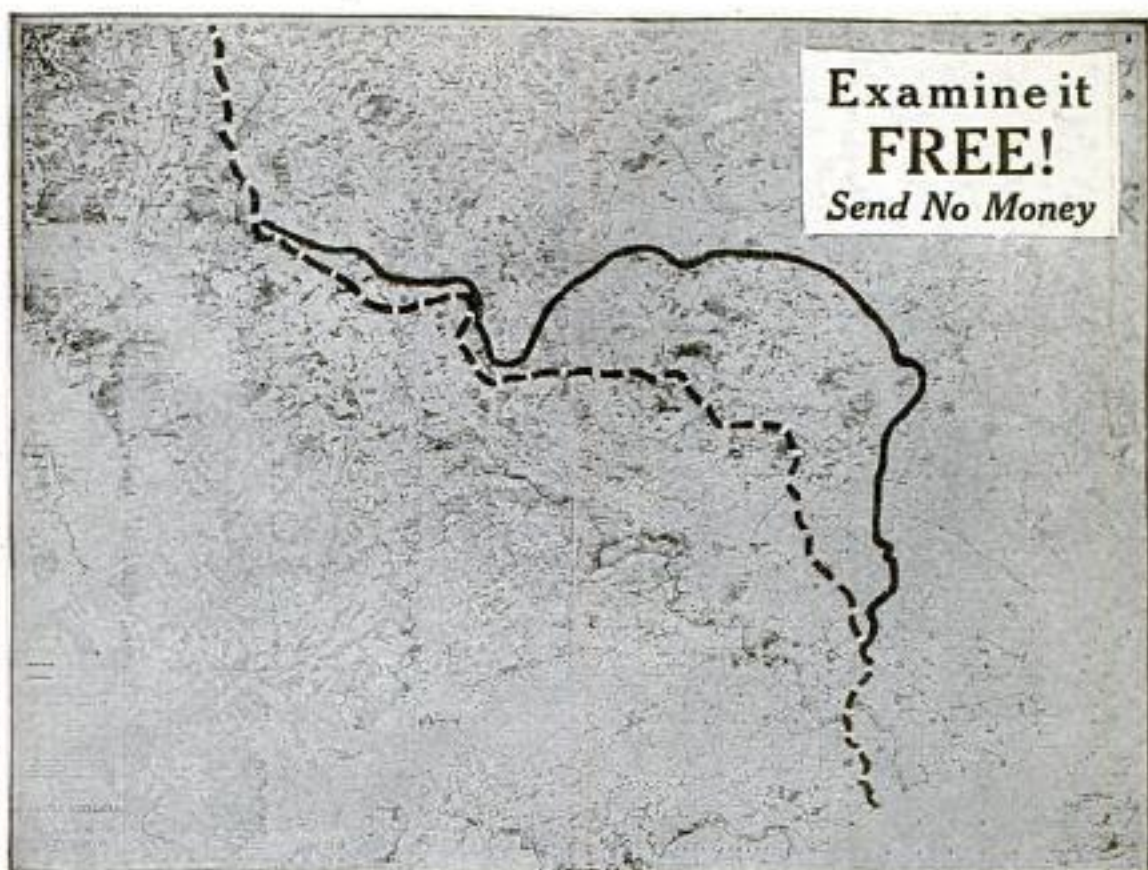

Examine it  
**FREE!**  
Send No Money

**Size**  
**28x36 inches**

This photograph is a reproduction of the most complete single map of the Western Front ever published. It is 28x36 inches in size, but folds into a convenient cover  $5\frac{1}{2} \times 7\frac{1}{2}$  inches, just right to be carried conveniently in the pocket for frequent consultation. It is printed on excellent paper, and can be had mounted on cloth if desired at slight extra cost.

## The Most Complete Single Map of the Western Front!

### More than 7,000 Villages, Towns, and Hamlets

On this map there are shown more than 7,000 places. The State of Illinois contains about the same number of square miles as shown on this map and in Illinois there are less than 1,700 places of 100 or more inhabitants. In addition to this vast number of places it gives all woods, fortresses, fortified towns, naval arsenals, forts, redoubts, batteries, aircraft depots, wireless stations and railways. The forests and woods are indicated in green, giving the map an attractive appearance, and adding a strategical feature of importance. The scale of the map is 10 miles to the inch. It extends west to Ashford, England; north to Antwerp, Belgium; east to Frankfort, Germany; and south to Orleans, France. It shows for comparison the battle line of 1914, when the Germans were almost at the gates of Paris. The ground gained by the Allies therefore, may be plainly seen. It is without exception the most satisfactory map of the Western Front which has been engraved. It has been prepared especially to throw light on movements as they occur. It may be examined with ease, for the type is bold and clean cut:

### A Complete Index Makes Locating Easy

An index of towns and villages accompanying a map of this kind has been proven an absolute necessity. The smaller towns are the ones usually mentioned in the news dispatches. They are not to be found on ordinary maps, and the locations, of

Follow the  
American  
Troops in France

most of them were, and still are, utterly unknown to the general public, but unless their locations are known their strategical importance cannot be grasped.

Nothing is more unsatisfactory than searching all over the map for a small place that may or may not appear upon it. However, this loss

of time and patience is now at an end, for the index which accompanies this map, makes it vastly more useful and valuable. The index contains more than 7,000 names. An idea of the importance of this statement may be gained from the fact that 90 per cent of the war maps available to-day contain less than 500 names. This index is bound in with the map and enables one to locate instantly any one of the 7,000 places mentioned.

### Send No Money

The great value of this map is so apparent that a copy will be sent on approval without a penny in advance. If, after examining this map, you decide to keep it, send only \$1.00 for the plain, or \$2.00 for the cloth-backed map. If not delighted with the map and index, return them and you will owe nothing. Just mail the coupon now.

### Free Examination Coupon

Nelson Doubleday, Dept. 2010, Oyster Bay, N. Y.

Please send me the Large Scale War Map of the Western Front on approval. If it suits me, within five days I will send you \$1.00. Otherwise, I will return it.

Name .....

Address .....

If you want the map mounted on cloth, greatly increasing its durability, at the special price of \$2.00, if it suits you, write "Yes" here.....





FRANK D. HENNESSY  
Pres and Genl Mgr.



## ARE YOU READY

To Fight for Your Country?  
Are You a TRAINED MAN?

Are You Ready for That Job as a Trained Mechanic?  
Are You Ready for the Opportunity That is Knocking at  
the Door of Every Trained Gas Engine Man?

The owners of Gas Engines are clamoring for the men who know how in this business. There are a dozen ways this line can be followed: Shop Owners, Mechanics, Specialists on Starters, Specialists on Storage Batteries, General Repair Work, Garage Operators, Accessory lines, Vulcanizing, Welding, Truck Drivers, Chauffeurs, Tractor Operators, Stationary Engineers, Army or Navy Mechanics.

## Are You Ready?

I am ready to make you ready by my thorough, absolutely practical, systematic, simplified system of instruction for any one or all of these different lines in the short time of six weeks. I can do this because of my thorough equipment and systematic method of teaching. I don't hold you in any department longer than is necessary. You advance as quickly as you master each department, which is so far ahead than the life-long method of serving an apprenticeship that there is no comparison.

and so much quicker

The course, covering every detail, takes six weeks, but carries with it Life Scholarship privileges, meaning that you can stay as much longer as you want or come back at any future time without the payment of another cent; everything covered—Motors, Electric Starters, Storage Batteries, Magneto's, Carburetors, Transmissions, Differentials, Chassis, Welding, Vulcanizing, Machine Shop, General Repair Work. Everything from the four-cylinder to the Twin Six, Electrical Equipment likewise. My system of teaching by practical experience is equal to any in the United States and my price lower. Sioux City is one of the cleanest, best cities of this country. Come to Sioux City. Come to the Iowa State Automobile and Tractor School, a city and a school where you are made to feel at home.

There is a Job Ready for You When You are Ready  
for the Job. Write today for my free book of facts.

## ARE YOU READY?

The Iowa State Automobile and Tractor School

The Biggest and Best School in the Whole Northwest

322 Pearl Street

SIOUX CITY, IOWA

**COUPON**  
Iowa State Automobile and Tractor School  
322 Pearl Street, SIOUX CITY, IOWA  
Please send Free Catalogue.  
Name.....  
Address.....

## Become a Stenographer

**LEARN AT HOME—THE NEW WAY**  
Earn \$25 to \$40 a week. Speed of 80 to 100 words a minute in typewriting and 125 to 150 words a minute in shorthand. Entirely new method. Learn at home in spare time.

**WRITE TODAY FOR AMAZING OFFER**

Entire Course on Trial. Complete business training included. Send today for new descriptive book and special offer. Address: THE TULLOSS SCHOOL, Dept. 135, COLLEGE HILL, SPRINGFIELD, OHIO

## BRAIN ENERGY

Amazing Book of Energy Secrets

**—Free** Swoboda has published for distribution a remarkable book which explains his system of Conscious Evolution and what it has already done. Write for this book—not because Conscious Evolution has meant so much to 200,000 other men and women, not because there is so rarely a prominent family in the country that hasn't at least one member a pupil of Swoboda, including Chas. E. Hughes, Woodrow Wilson, Rockefeller, the Vanderbilts, the Goulds, the Huntingtons, the Armours, the Cudahys, the Swifts—but write for the book because it means so much to you in multiplied living power, curbing power, and resisting power. It is a big book filled from cover to cover with the vital facts about yourself and how you can acquire the degree of perfection in body and mind that you so much desire. It exposes the dangers of excessive deep breathing, excessive exercise, and excessive muscular development. Regardless of how young you may feel, of how efficient you may think you are—regardless of how active, energetic and alert you may consider yourself—regardless of how happy, how contented you may pride yourself on being—regardless of how healthy, wealthy, or successful you may be, you cannot afford, in justice to yourself, to miss the interesting and instructive secrets explained for the first time in this startling new book.

Write NOW. Address ALOS P. SWOBODA, 2065 Aeolian Bldg., NEW YORK CITY



Swoboda  
Creator of  
Conscious  
Evolution

**Taxidermy  
Book  
FREE**



Write Today.

**Stuff Beautiful  
Birds.** Learn by mail to  
stuff and mount

all kinds of birds, animals, fish and game heads, make rugs, tax skins. Mount your own specimens and make money preserving for others. Men, women and boys learn easily and quickly. Success guaranteed or no tuition. Write today for our wonderful FREE book "How to Learn to Mount Birds and Animals. N.W. School of Taxidermy, 9197 Elwood Bldg., Omaha, Neb.

## Folding DOUBLE X-RAY



With this Double X-RAY you can apparently see through cloth or wood, see bones in the body. Makes the flesh look transparent. An optical illusion. By mail 10 cts., three for 25 cts. Postpaid. ARDEE COMPANY, Box 213, STAMFORD, CONN.

## I TEACH Penmanship BY MAIL

I won the World's First Prize for best course in Penmanship. Under my guidance you can become an expert penman. Am placing many of my students as instructors in commercial colleges at high salaries. If you wish to become a better penman, write me. I will send you Free one of my Favorite pens and a copy of the Ransomian Journal. C. W. Ransom, 325 Essex Bldg., Kansas City, Mo.



**WEBSTER'S NEW  
INTERNATIONAL  
DICTIONARY**

G. & C. MERRIAM CO., SPRINGFIELD, MASS.

Whatever your question;—be it the pronunciation of a new term; the spelling of a puzzling word; the location of Nigeria, the meaning of tractor, white coal etc.—this New Creation contains a clear, accurate, final answer.

REGULAR AND INDIA-PAPER EDITIONS



Over  
400,000  
Words Defined  
2700 Pages  
6000 Illustrations

Please send me specimen pages and  
FREE POCKET MAPS

NAME

ADDRESS

Pop. M.



# Are \$2500 to \$10,000 Salesmen Born or Made?

Proof in thousands of cases that salesmanship ability is *developed* in most men; how scientific training is secured; some typical results.

It is thought by many that salesmen are born, that salesmanship is a knack which cannot be acquired. The truth, as has been proved tens of thousands of times, is that we are all salesmen regardless of who we are or what work we are engaged in. If we are physicians we sell our ability to heal and cure disease; if we are lawyers we sell our knowledge of law; if we are office clerks we sell our knowledge of office routine; if we are mechanics we sell our facility in handling tools and machinery; if we are laborers we sell our strength and the sweat of our brow. If we did not possess a spark of salesmanship in us, we would starve. In some of us, however, salesmanship has been *developed*—and developed salesmanship brings rich rewards.



**Earned \$524 in Two Days**  
I had no former experience and never earned more than \$50 a month. Last week I earned \$218 and this week \$218. You have done wonders for me. G. W. KEARNEY, 123 West Jewel St., Salina, Kans.

A man in Boston, who was formerly a mechanic, has received many advances in salary.

A printer in Chicago, decided he would stop trying to get ahead in a crowded field where salary possibilities are limited. He was convinced that salesmen are made—not born—and after studying the principles of scientific salesmanship he launched out and secured a position, paying him \$2500 a year, with every prospect of increased earnings as he goes on.

In Hanford, Cal., is a man who worked at anything he could get to do—and as he says, "was out of work half the time." He turned to salesmanship and has earned as high as \$450 in one month. A man in Kansas City, over 60 years old, decided he would work with his head instead of with his hands. He turned to salesmanship as offering the greatest opportunities for advancement, and earns \$200 a month as a result. An office clerk in Chicago, working at an office clerk's small salary, jumped to earnings of \$3000 a year in a remarkably short time after having studied scientific salesmanship.



**\$300 a Week**  
Don't work for \$25 a week—make that much a day. I made \$300 last week and average high. The day I joined you was a lucky one for me. J. H. FARMER, 2835 Post St., San Francisco, Calif.

men with ability to earn large incomes.

A salesman works in local territory or travels throughout the country. He sees the world and he is broadened by coming in contact with other successful men. He usually works only 5 days a week and only 6 hours a day. He is practically his own boss and his earnings are dependent only upon his own ability.

## How Others Have Succeeded

A young man in San Francisco who was formerly a carpenter, is now in the \$2500 to \$10,000 a year class as a salesman. A former \$15 a week clerk is now selling goods to many of the largest firms in the United States and has earned more than \$100 a day. Last year a man in Dayton, Ohio, earned \$800 as a clerk. This year he has earned \$6300 as a salesman and was recently promoted to sales manager.



**Earns \$375 in a Month**

For ten years I worked for a mill. Was drawing \$25 a month when I left. You secured me my position. I have earned \$375 in a month. Success would have been impossible without your help. R. C. KIMMAN, 2121 Andrews Street, Rockford, Ill.

## Opportunities in Salesmanship

Thousands of men who were earning ordinary salaries in other lines, are earning from \$2500 to \$10,000 a year as salesmen. They are the biggest men in their organization for they produce the business that keeps the entire organization busy. A concern can get along without other help but in order to keep going they must maintain their sales force.

Salesmanship is the power that keeps the wheels of business turning. The salesman is closer to his employer than the man in the office or shop. The salesman has the satisfaction of knowing that he is earning every penny he receives.

Glance through the want columns of any newspaper and you will find that the call for local and traveling salesmen is greater than for men in any other line of endeavor. Business is crying for more salesmen—successful salesmen.

There is no question as to his value, for the results are obvious. The opportunities for promotion are great because it is the men who have been out on the "firing line"—men who have actually sold goods—who are picked for Sales Managers, Executives, and Officers.

## How to Develop Selling Ability

But to learn successful salesmanship without a system of definite instruction is like trying to learn to run an automobile without instruction—it can be done in a way but it takes a long time and is never mastered in the right way.

All of the instances cited above are the result of studying the Course of scientific salesmanship issued by the National Salesmen's Training Association. Instruction, which is of the highest order, is given by mail and the results border on the miraculous. In an amazingly short time, anyone can learn every detail of successfully selling any line of merchandise.

The Course proper consists of 60 lessons contained in 3 copyrighted instruction books, a set of hints on how to study the Course, 60 bulletins or side lights in 3 books, a book of pointers to success, personal instruction, advice, correspondence and examination, and an opportunity to secure a position and get practical experience and earn money while you are studying.

## Amazing Free Book

The National Salesmen's Training Association has issued a remarkable book which will be sent free, on request, to every man who is dissatisfied with his present position. Regardless of how little ability you now have as a salesman, regardless of how impossible you may think it is for you to become a successful salesman, write for this book today. Read how others with no greater advantages than your own, have succeeded in earning salaries of \$2500, \$3000, even up to \$10,000 a year. Read about the thousands of concerns who write in asking for the "National" type of salesmen. Let us tell you about the remarkable employment and service department which not only finds your first position for you but recommends better positions after you have gotten your start.

The Association is now more than 10 years old and has already trained thousands of successful men who never before sold a dollar's worth of goods. In addition, thousands of men who have spent years in selling merchandise have taken the Course with the greatest profit. The salesman is independent. He lives like a gentleman. He earns more money than he could in any other line, and is rated everywhere as a successful business man. Regardless of your present position, you owe it to yourself to write for the 64-page book offered by the Association.

It tells everything you want to know about the opportunities in salesmanship for you, about our amazing system of instruction and what N. S. T. A. Training and Service has meant to thousands of others. Do not wait until tomorrow for you may miss the greatest opportunity of your life. Send in a post-card or the coupon below now. Address National Salesmen's Training Association, Dept. 12R, Chicago, San Francisco, New York.

## National Salesmen's Training Association

Dept. 12R, Chicago, San Francisco or New York

Please send me your Big Free Illustrated Book, and list of lines in which positions are open. No obligation on my part. (Send your request to the office nearest your home.)

NAME.....  
STREET.....  
CITY.....STATE.....



**Earned \$500 This Year**  
Last year I only earned \$500 as a clerk. This year I have earned \$6,000 and have been promoted to Sales Manager. This I accomplished by studying your Course during spare time. Your Employment Bureau offers me many good positions. C. W. BIRMINGHAM, 129 Bank St., Dayton, Ohio.



**Am Earning \$92 a Month**  
After six months of success as a Traveling Salesman in a position secured through your Employment Bureau, I am earning \$92 a week. I am only at the beginning and wonder how the N. S. T. A. can give a man so much for so little money. E. W. BROWN, 68 Benedict Ave., Woodhaven, N. Y.

Please Mention Popular Mechanics



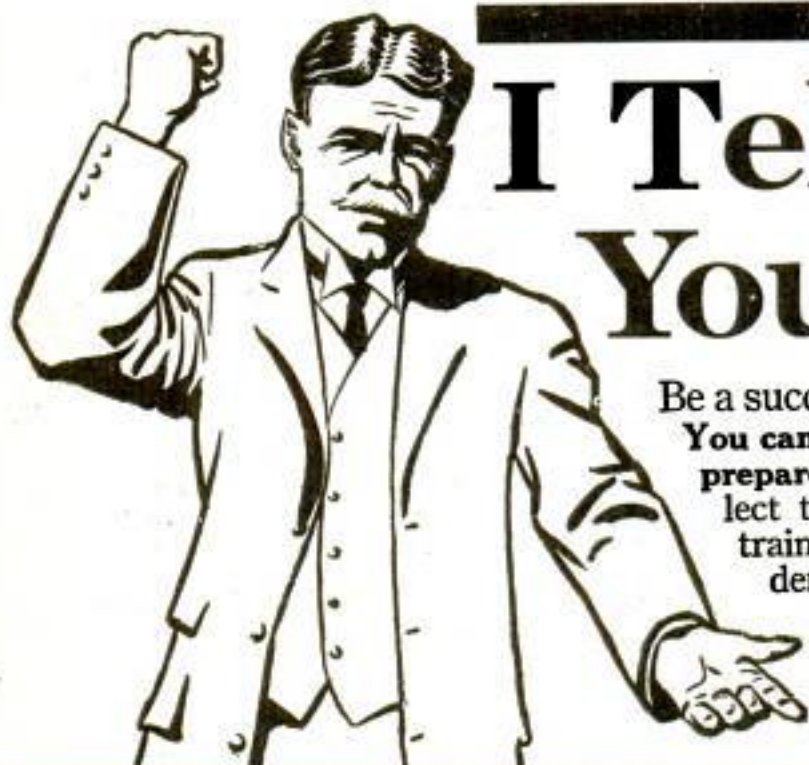

# I Tell You You Can!

Be a success and command big pay. You can easily do it if you will **only prepare yourself!** Why will men neglect to prepare themselves, when trained **electricians** are always in demand at big pay? When employers are **searching** for \$3,000 and \$10,000 men, while this country is crowded with poorly-paid men who could easily qualify for these positions!

## \$50 to \$200 a Week

As a Trained

# ELECTRICIAN

If you have a common school education you can easily qualify at home by my new Course in Electricity, no matter if you know nothing at all about electricity now. My Course, while complete and absolutely scientific, explains everything so clearly that any one can understand it and do the work. But this Course is designed to give you a **real** Electrical education, to help men become **bigger, better men**—men who can command big pay.

And remember, I give every student a **GUARANTEE BOND** which insures you satisfaction or every dollar of your money refunded. We can make such a guarantee because we know our Course and what it does for our students. Send for free illustrated book telling all about it. **PART OF YOUR SPARE TIME** devoted to this interesting work is all that is needed. You will find it most fascinating, and in a short time your earning power will be greatly increased.

## \$17<sup>00</sup> Electrical Outfit Free:

Every student who enrolls with me now gets a \$17.00 outfit of electrical equipment, instruments and material—**FREE**; also my Quick Money-Making Electrical Course **FREE** as soon as enrolled, so that you can earn while learning; you also get **FREE** Employment Service; **FREE** 5-year Advisory Service. And besides all this I have a pleasant and **truly valuable** surprise, for every student who answers this ad. Send in coupon now.

You have one life to live—and time is passing. Make the most of it. Prepare for success. Aim high; you can hit the mark if you will only try. **Do it! Tear off the coupon now!**

### CHIEF ENGINEER

L. L. COOKE

Chicago Engineering Works  
436 Cass Street, CHICAGO, ILL.

**CHIEF ENGINEER**  
Chicago Engineering Works  
436 Cass St.  
Chicago, Illinois

Without obligation on my part kindly send at once, fully prepaid, particulars of your complete Practical Home Study Course in Electricity.

Name .....

Address .....

Town.....State.....

USE THIS FREE "OUTFIT" COUPON



# CLASSIFIED ADVERTISEMENTS

WORLD'S BEST WANT AD MEDIUM

We have records to prove that a classified ad in these columns will find a buyer for almost anything which can be sold. Doubtless you have some article of value to some one else which you no longer need. Why not turn it into money?

Advertisements in this section, 18 cents per word, each insertion, minimum 10 words, payable in advance. To be inserted under proper classification in the November issue, copy should be in our office September 25th.

Millville, N. J.

Popular Mechanics Magazine, 6 N. Michigan Avenue, Chicago.

Gentlemen: I wish to say that the results obtained from my classified advertising in the Popular Mechanics Magazine were more than equal to the combined results from all the other publications in which I advertised. I received replies from New Zealand, Hawaii, Philippine Islands, Cuba, Mexico, Scotland, and all parts of the United States and Canada, which goes to show the universal circulation of your great magazine. I consider Popular Mechanics at the head of the list of publications which do mail order advertising, as my records will prove my assertions.

Very truly yours, M. W. SMITH.

## AUTOMOBILES

\$500.00 STARTS you in the automobile business. We are ready now to place 1918 agencies for our new four-cylinder racer and light delivery car. Money-making proposition for hustlers. Exclusive territory. American Motor Vehicle Co., Lafayette, Ind.

LEGAL Points for Automobile Owners gives Briefly your liability under various circumstances, as when your car is being driven by your friend or a member of your family, by an unlicensed chauffeur, by your chauffeur, with and without your consent; when you lend your auto; defense for speeding, etc. Contains 28 chapters, 55 pages. Cloth bound. Price, 50 cents postpaid. J. S. Ogilvie Publishing Co., 577 Rose St., New York.

INVENT Something; your ideas may bring wealth; free book tells what to invent and how to obtain a patent, through our credit system. Talbert & Parker, 4657 Talbert Bldg., Washington, D. C.

GET into the Automobile business, as salesman, chauffeur, garage manager, mechanic. Automobile instruction in four weeks' residence course. Send for booklet P. M., West Side Y. M. C. A. Auto School, 318 West 57th St., New York.

CYLINDERS reground, new pistons and rings fitted. Restores lost power. Write for prices, giving make and model. The Everts Machine Co., Hartford, Conn.

PATENTS for Automobile Improvements are in great demand. We have special Automobile Department in charge of experts who are in touch with demands of trade. Write for "What To Invent and List of Patent Buyers," sent Free. Victor J. Evans & Co., 158 Ninth, Washington, D. C.

## AUTOMOBILE SUPPLIES

AUTO Motors—4-cylinder, water-cooled, \$35.00 up. Buick 10-24-30 and 17. Mitchell-Everett 30—Hup 20—Flanders 20—Continental and Buick motors all sizes. Johnston, West End, Pittsburgh, Pa.

TIRES—At Wholesale; send at once for our price list of first quality guaranteed tires and tubes. We ship C. O. D. subject to examination without one cent deposit. Overton Tire Co., Box 5, Osceola, Ia.

ONE four cyl. auto. engine with magneto and clutch, \$40. Repairs for 1910 Reo, parts for Oswald motors, axles and transmissions, F. E. Alford, Goshen, Ind.

MAGNETOS—Bosch, all sizes and types, \$10.00 up. Bemy and Splittdorf \$3.50. Coils—Steering Wheels—Auto accessories all kinds. Write for list. Johnston, West End, Pittsburgh, Pa.

AUTOMOBILE Parts for most all makes of cars: Buicks 16, 17, 19, 27, 29, 25 and 30. Maxwells, E. M. F., Flanders, Paige 25 and 36, Overlands 37, 38, 42 and 59, Cadillacs '09 to 1912, Parry, Regals '09 to 1913, Oakland, Jeffery, Mitchells '07 to 1913, Empire, Elmore, Chalmers '09 to 1913, Auburn, Jackson 35, Interstate, Hudson 20 and 33, Hupp 23, Ohio, Staver, Marion, Cole, Mellme, Stearns-Knight, Rambler, Howard, Thomas, Imperial, Lexington and many others. Pistons, connecting rods, cam shafts, crank shafts, cylinders, axles, bearing and gears for most any make of car. Write us your needs. Satisfaction guaranteed. Auto Parts Company, 4116-18 Olive Street, St. Louis, Mo.

MOTORISTS Save Money Using "Gids." After testing, one firm purchased 14,400 cans. There's a reason. It satisfies. "Gids" is not a sell-once proposition. It repeats. Representatives and dealers wanted. Fine protective contract. Write to-day. "Gids" Mfr., Galesburg, Illinois.

BIG Profits HB Battery Charging. City current to operate. Hobarts, Troy, Ohio. Easy Payments.

MAKE \$15 daily profit selling our auto washer and other brush specialties; every car owner buys on sight. This is the best season for big sales. Every sale 100% profit. Puritan Co., Dept. M, 1966 Broadway, N. Y.

NOVICES produce Faultless Vulcanizing using Smooth Edge Pads. Sample 25c. Set \$1.00. J. R. Mfg. Co., Pasadena, Cal.

AUTOMOBILE three flag holder, 25c. Agents wanted. Garfield Supply, 5839 Wissahickon Ave., Philadelphia.

GET into biggest money-making end automobile business—replacing necessary equipment. Lito, ambitious men wanted as special factory representatives; exclusive territory, taking orders for tops, top coverings, seat covers, "Strik-Tite" Windows. No experience necessary. No capital required. No competition. Copyrighted system protects you. Free catalog, samples, full details. Cincinnati Auto Specialty Company, Dept. MA-137, Cincinnati, Ohio.

BARGAINS—Ignition, Coils, Repair Parts and Supplies. Guaranteed Coils, \$3.50 up. Ambu Electric Trouble Shooter cheap. Smythe Ignition Co., 1455 Laurel Ave., St. Louis, Mo.

INSYDE Tyres, inner armor for Automobile tires, double mileage and prevent punctures and blowouts. Quickly applied. Cost little. Demand tremendous. Profits unlimited. Details free. American Automobile Accessories Co., Dept. P2, Cincinnati, O.

VULCANIZE auto tires. Make big money. Learn with our book \$1.00. Vanderpools, Springfield, Ohio.

DOUBLE Service Tires. Guaranteed to give good service. Size, 30 x 3, \$3.50; 30x3½, \$6.00; 32x4, \$8.00; 34x4, \$9.00; 36x4, \$9.50; 36x4½, \$11.00; 36x5, \$12.10; 37x5, \$12.10. Non-skid \$1.00 extra. 10% required on all C. O. D. orders. State if Q. D., straight side or clincher type. 5% discount if cash accompanies order. Also special discount to dealers. I. Jaffess, 1319-5th Ave., New York. Branch—241 West 54th St., New York.

TIRES—Double Tread Guaranteed for good service. Absolutely Puncture-Proof. Big—Strong—Extra heavy, 30x3 tire, \$3.00; 30x3½, \$6.00; 32x4, \$9.00; 34x4, \$9.25; 36x4½, \$12.00; 37x5, \$13.00. Big saving on other sizes and tubes also. Trade in your old tires. Discount to dealers. 10% deposit required on C. O. D. orders. Send for list now! State size and bead of tire. Max Liden & Co., 205B West 48th Street, New York.

AUTO Top Roof Covers Save you two-thirds price of new top; tailored to fit any car; easy to apply; \$6 to \$15, parcel post paid; seat covers \$5 and up; catalog and samples free. S. & H. Top Co., 439 Hunt St., Cincinnati, O.

GEARS for all purposes; transmission gears, bevel-drive gears, sprockets, axles. Special machine work. Must have old parts or drawing. Turley Gear Plant, 1505 N. 16th St., St. Louis, Mo.

VULCANIZE your own tires; save money; full particulars free. Superior Vulcanizer Co., 16B Fulton Ave., Rochester, N. Y.

POWER increased; carbon eliminated; results guaranteed. Write for folder. Automobile Accessories Co., (G.) Baltimore, Md.

## TO FORD OWNERS

WANTED—One responsible Ford owner or dealer for exclusive sale G. and G. Hand-Warmer. Canada patent for sale or manufacture on royalty. Lloyd Garrison, El Paso, Texas.

FORD Top Roof Cover \$6 and up. Easy to apply. You save two-thirds price of new top. Seat covers \$5 and up. Samples and catalog free. S. & H. Top Co., 439 Hunt St., Cincinnati, O.

FORD Electric Lighting systems, \$37.50 complete. Goodlite Company, Indianapolis, Ind.

WRITE for our free offer on the Ford Simplifier. Learn the new way to operate a Ford. Marion Metal Products Company, Marion, Indiana.

BE our agent. Buy a Safety Ford Starter for \$5.00. Retail for \$15.00. Try one, write for particulars. Safety Ford Starter Corporation, Columbia Theatre Bldg., New York.

PEUGEOT type Ford speedster, lifelike patterns, blueprints, instructions, \$5. Photographs 10c. Peugeot-Ford Speedster Pattern Co., Onarga, Ill.

\$1.25 LITTLE Wonder Gas Saver. Agent retails \$2.00 for Ford and Metz; runs 30 miles on gallon; applied one minute. Vandepool's, Los Angeles, Calif.

SUNLIGHT System—Fine night light at all speeds. Complies with dimming law. Connected in five minutes. No holes to drill. Saves tires and car. More speed. Guaranteed \$1. Sunlight System, Box 3, 6900 Lakewood Ave., Chicago.

LOCK your Ford securely for less than One Dollar. Write for circular. Brackbill, 1307 McFerran St., Philadelphia.

SLEEP in your Ford in McMillin Auto Bed, \$8.50. Other small cars \$10. Free booklet on auto camping. Auto Bed Company, Box 0, Bellingham, Wash.

## FORD ACCESSORIES

\$50.00 REWARD paid Ford car owners if car is stolen equipped with B-K Locking Device. Price \$2.00 and \$3.50. Agents wanted. Good territory open. Bee-Kay Motor Lock Co., Atlanta, Ga.

NEW 300-page book on the Ford car for every Ford owner, dealer and repairman. Deals fully with construction, operation and repair. 100 engravings. Best and most complete Ford book published. Price, \$1.00 postpaid. Also Ford Engine Chart, 25x38 in. Location of engine troubles made easy. Price, 25 cents postpaid. Popular Mechanics Book Dept., 6 N. Michigan Ave., Chicago.

DUBOLITE and Dimmer, doubles both lights on Ford car also dimmer that complies with any state law. Price \$4.00. Dealers wanted. Handy Dimmer Co., 15-17 Library St., Grand Rapids, Mich.

## MOTORCYCLES, BICYCLES & SUPPLIES

SUMMER Unloading Sale in second-hand motorcycles. We have an overstock of all makes, such as Indians, Harley-Davidsons, Excelsiors, Peeps, Mericks and 4-cylinder Hendersons. All are in A-1 condition and fully equipped. If interested in buying a motorcycle write for our Bargain Bulletin No. 5 giving description and prices from \$35 up. Gotham Sporting Goods Co., 57 Warren St., New York City.

MOTORCYCLE engines complete, \$9 up. Gregory Fay, 1044 Bellvue Ave., Syracuse, N. Y.



**BEST offer takes 1913 twin Harley, H. W. Krueger, 6024 Princeton Ave., Chicago.**

**USED Motorcycle Bargains—Harley Single \$53, Excelsior Twin \$70, Thor Twin \$30, Harley Twin \$125, Indian 2 Speed \$130, Excelsior, big value, etc. \$220. Many more at exceptionally low prices. Send for Bargain List, C. H. Lang, 1704 Michigan, Chicago, Ill.**

**READING Standard Twin, Two Speed, kick starter, fully equipped, in perfect condition, with sidecar \$150. Dale Clark, 121 N. Franklin Ave., Lima, O.**

**1916 POWERPLUS Indian. Fully equip, three speed. Bargain at \$105. L. E. Fowler, Loudonville, O.**

**MOTORCYCLES from \$25 up—New and second hand—easy terms—large list to choose from—all makes. Send 4 cents stamps for Bulletin "K." Peerless Motorcycle Co., Boston, Mass.**

**BIG bargains in second-hand motorcycles, \$25 up. Indians, Harleys, Thors, Excelsiors and Merks. Write for description. Howard A. French & Co., Baltimore, Md.**

**BIG bargains in good motorcycles we have taken in exchange on new ones. Send for special bargain list. Shaw Mfg. Co., Galesburg, Kansas.**

**BARGAINS in used motorcycles—all machines guaranteed and in A-1 condition ready for use. Write for terms and new bulletin. Photos free. Harley-Davidson Sales Company, Birmingham, Alabama.**

**MOTORCYCLE cylinders reground, fitted with new piston and rings, \$5.00, guaranteed. Muncie Piston Co., Muncie, Ind.**

**SPECIAL Sale. 500 Unguaranteed Inner Tubes, All Sizes, \$1.50 Each. Cash must accompany order. Leo McDaniel, 613 Ohio Street, Cairo, Illinois.**

**EVERY Bicycle rider needs our catalog. Saves you half on tires and shows every article you might need. Champion Bicycles \$26 to \$32.50. Ask for our Catalog No. 536. World Cycle Company, Kansas City, Mo.**

**ATTENTION—Look, 100 used motorcycles we are closing out at a great reduction. Parts, motors, accessories. Indian Twins, \$60; Excelsiors, \$37.50; Harleys, \$40; Merks, \$50; and others. Get our list. 50 motorcycle motors \$20 to \$35. Now and used parts for most any kind of a machine at cut prices. A. Weitzman Cycle Co., 175 Gratiot Ave., Detroit, Mich.**

**LARGE stock of rebuilt motorcycles, new parts for all makes 25% discount; second-hand parts, good as new, 50% discount. Motorcycle Parts Mfg. Co., Chicago.**

**DON'T buy a Bicycle Motor Attachment until you get our catalogue and prices. Shaw Mfg. Co., Dept. 27, Galesburg, Kans.**

**MOTORCYCLES, Side Cars and Cycle-cars. Their Construction, Management and Repair—The only complete work published on this subject. The dealer, mechanic and rider will find this an excellent treatise. 550 pages, cloth, 350 illus. Price, \$1.50 postpaid. Complete description sent upon request. Popular Mechanics Book Dept., 6 N. Michigan Ave., Chicago.**

**WANTED: We pay cash for used motorcycles or take them in on exchange for new machines. Write with complete description. State condition of tires, frame, motor, make and model. Shaw Manufacturing Co., Dept. 157, Galesburg, Kans.**

#### WELDING

**BROKEN Machinery and Auto parts. Aluminum crank cases a specialty. Welders and brazers of all metals. Custom welding for the trade. Let us figure on your requirements. Austin Welding Works, 519 S. Jefferson St., Chicago, Ill.**

**DON'T scrap aluminum parts—trial bar 50c. So-Luminum, new great welding compound for aluminum. Perfect substitute for acetylene welding. 3/4 time and cost. Use gasoline or blow torch. Booklet 1 and directions, \$3.00 per pound, So-Luminum Mfg. Co., 1790 Broadway, New York.**

**BERMO Welding Plants, oxy-acetylene, 13 years' successful record. Guaranteed. Write for Catalog and Easy Terms, \$25 to \$250. Bermo Supply Co., Omaha, Neb.**

**OXY-ACETYLENE Welding and Cutting. Electric and Thermit Welding. Brand new book of practical instruction in this process. The workman will find all necessary information for handling any kind of welding. 215 pages, fully illus. Cloth, \$1.00; Leather, \$1.50 postpaid. Popular Mechanics Book Dept., 6 N. Michigan Ave., Chicago.**

#### AERONAUTICS

**ONLY \$2.00 brings you Hayward's "Practical Aeronautics," including "Building and Flying an Aeroplane." If not satisfactory, return in five days and get your money back. 150 pages (7 by 10 inches), 310 illustrations, construction diagrams, etc. Bound in heavy cloth, gold stamped. American Technical Society, Dept. 1197, Chicago.**

**HEATH Aerial Products and Supplies. Why are they the best and cheapest? It's the old story—quantity production. Aeronautical supply catalogue, 6 red stamps; propeller catalogue, 3 red stamps. Heath Aeroplane Co., formerly Heath Aerial Vehicle Co., Chicago.**

**FOR Sale—Curtiss Aeroplane \$600, Set double covered planes \$150, J. E. Odell, Waterloo, Iowa.**

**7 Ft. AIRPLANE Propeller \$35. 28440 blue print frame. 929 Lawrence St., Denver, Colo.**

**FOR Sale at Bargain. New 50 H. P. Roberts Motor with magneto, carburetor, radiator, gas tank, paragon propeller, new fuselage landing gear, imported shock absorbers. Price \$450. Gus Seyfried, 67 Cook St., San Francisco, Cal.**

**AEROPLANE mechanics wanted; thousands needed right now. Will give thorough, practical training course on modern machines for \$110. No book study, actual work only. U. S. Aero, 38 Park Row, N. Y. C.**

**MEN or Women Learn Aviation. Government or exhibition. Pilot license guaranteed. Actual flights. Ground training device saves time—money—lives. Ideal training camp. A. C. Bosch, Chief Instructor. Write Moler Aviation Instructors, Inc., 105 S. Fifth Ave., Chicago.**

**PATENTS Wanted in Aeronautics—U. S. Government spending millions in this class for Army and Navy. Our Aeronautic Department will give full information on this subject upon inquiry. Write for "What to Invent," sent free. Victor J. Evans & Co., 169 Ninth, Washington, D. C.**

**GET our latest Aeroplane Book containing full information about "Ideal" Model Aeroplanes, parts, plans, etc. 5c postpaid. Ideal Aeroplane Co., 82 1/2 West Broadway, N. Y.**

**AVIATION Motors, all makes, up to 150 H.P., \$250 up. Complete aeroplanes, all types, \$500 up. State your needs. Aero Exchange, 38 Park Row, N. Y. C.**

#### BOOKS AND PERIODICALS

**100,000 SECOND-HAND books for sale, 25c each; costly bindings; some cost \$25.00 new; Medicine, Surgery, Agriculture; Mechanical; chemistry, philosophy, encyclopedias, law; scientific; technical; mathematics; history; fiction; religious; text; school, etc. Send 10c stamps for big catalogues (none free). "M." McCarthy, 1236 Arthur Ave., Chicago, Ill.**

**"VOICE of Death" by request 15c. "Sennan" spirit voice of the Mysterious Hindoo Mystic 25c. Sovereign Pub. Co., 160 Syracuse, Buffalo, N. Y.**

**AUTOMOBILE Repairing Made Easy (Victor Page). 1,040 Pages, 1,000 illustrations, \$2.65. McCarthy, 1236 Arthur, Chicago.**

**ONLY \$2.00 brings you Hayward's "Practical Aeronautics," including "Building and Flying an Aeroplane." If not satisfactory, return in five days and get your money back. 150 pages (7 by 10 inches), 310 illustrations, construction diagrams, etc. Bound in heavy cloth, gold stamped. American Technical Society, Dept. 1197, Chicago.**

**PRACTICAL Bookkeeping and Stenography boiled down, 50c. Marr, R285, Nashville, Tenn.**

**FIND Out for Yourself what to invent and how to procure and sell a patent for the same. My book, "Inventor's Universal Educator," covers the matter from A to Z. 140 pages, elegantly bound. Also contains 600 mechanical movements and 50 perpetual motions. Price \$1.00, postage free. F. G. Dieterich, 651 Ouray Bldg., Washington, D. C.**

**MAGAZINES! Periodicals! Rock bottom prices. Many raising prices Nov. 1. Order now. Catalog free. Hill, Mt. Pleasant, Iowa.**

**U. S. ARMY Infantry Drill Regulations, 58 cents. Field Service Regulations, 80 cents. Cavalry Drill Manual, 80 cents. Small Arms Firing Manual, 80 cents, cloth, postpaid. Also send for complete list of over fifty standard military and naval books. Popular Mechanics Book Dept., 6 N. Michigan Ave., Chicago.**

**ENGINEERS' questions and answers for license by Hobson, for twenty-five cents, postpaid. Send stamps. Kelly's Book Store, Philadelphia, Pa.**

#### EDUCATIONAL AND INSTRUCTION

**ELECTRICAL instruction given by practical engineer. Learn this wonderful profession at home by practical instruction. By my improved method of learning you can become a Certified Electrician in a few months. Satisfaction guaranteed. Electrical outfit of instruments, tools and materials furnished free to each student. Earn money while learning. Write me for Electrical book and full particulars. Everything free if you answer now. Chief Engineer, Chicago Engineering Works, 437 Cass St., Chicago.**

**ARMATURE Rewinding—Learn at home easily by our plain simple course for Automobile Electric Starting Motor and Generator Armatures. We furnish working model, etc. Good armature winders earn big pay. Free literature. S-A Electric Works, 1906 Emmet St., Omaha, Nebraska.**

**"MODERN Foresight," a new book telling how to choose profitable vocation for self or children; choose good salesmen; detect dishonesty and non-efficiency on sight; obtain more salary. Illustrated. Postpaid, \$1. Mellen-Photo-Works, 6911 Times Bldg., Chicago.**

**COMPLETE "Memory Course" 20c. Barry, 2469M Pacific, Atlantic City, N. J.**

**LEARN Show Card Writing and be independent. The Howard System teaches this fascinating profession. Earn \$25 to \$35 weekly or start shop. Particulars free. Lineal Co., Estherville, Iowa.**

**POSTAL Service Examinations. Get your instructions from one who knows. Easy terms. Address, Carl Freeman, 3419 Oregon, St. Louis, Mo.**

**WANTED, draftsmen, everywhere. Practical home drafting course. Circulars telling how others have succeeded, free. J. Edward Goss, 860 President Ave., Fall River, Mass.**

**WANTED—New Ideas. Write for list of Patent Buyers and Inventions Wanted. \$1,000,000 in prizes offered for inventions. Our Four Books sent free upon request. Victor J. Evans & Co., 167 Ninth, Washington, D. C.**

**MOULD making for ornamental casting. Particulars, 200 illustrations, free. Mahler, Woodhaven, N. Y.**

**ARTIFICIAL Marble, sanitary flooring, complete instructions, \$1. Ornamental casting, concrete, plaster, papiermache, decorations, garden furniture, statuary, rubber moulds, electrometallurgy. Particulars, 200 illustrations free. Mahler, D-721 Woodland Ave., Woodhaven, L. I., New York.**

#### FOR MECHANICS

**PATENTS Wanted. Write for list of Patent Buyers who wish to purchase patents and what to invent with list of inventions wanted. \$1,000,000 in prizes offered for inventions. Send sketch for free opinion as to patentability. Write for our four Guide books sent free upon request. Patents advertised free. We assist inventors to sell their inventions. Victor J. Evans & Co., 184 Ninth, Washington, D. C.**

#### TRADE SCHOOLS

**ELECTRICITY, Plumbing, Bricklaying, Mechanical, Architectural and other Drafting Courses, Motion Picture Operating taught by practical work. Largest, best equipped practical trade school in America. Short time to learn. Small cost, easy payments. Write for big illustrated book; it's free. Coyne Trade and Engineering Schools, Dept. 1896, Chicago, Ill.**

**HILL'S Watchmaking and Engraving School, the largest and best equipped school in the West. 717 Market Street, San Francisco, Cal.**

**PRACTICAL Training in Paperhanging, Graining, Sign Painting, Showcard Writing, Chicago Painting School, 131 North Fifth Avenue, Chicago.**



## OPTICAL SUPPLIES

**BROKEN** Lenses duplicated no matter how fitted them. Frames repaired. New ones reasonable. E. G. Pfeiffer, 509 No. Robey St., Chicago.

## TELEGRAPHY

**WIRELESS** Telegraphy—Now taught you at home in Eight Weeks. Golden opportunity for honor and profit. Easy lesson with instruments we furnish free. Open the gates to your ambitions. Instruction by Pioneer Naval Operator. Write for proof of what is open to you thru wireless. Information free. American Radio Institute, 400 Dickason Bldg., Leipsic, Ohio.

**TELEGRAPHIC**—both Morse and Wireless, also Station Agency, taught quickly. Tremendous demand—much greater than supply—permanent positions secured. Big salaries—recently raised. Ideal working conditions—short hours, vacations with pay, sick and death benefits, etc., prevailing. Great opportunities for advancement. Women operators also greatly desired by Railways and Western Union. Tuition reasonable. Cheap living expenses—can be earned. Oldest and largest school—established 43 years. Endorsed by railway, Western Union, and Marconi Telegraph officials. Large illustrated catalogues free. Correspondence courses also. Write today. Enroll immediately. Dodge's Institute, 15th St., Valparaiso, Indiana.

**TELEGRAPHY**—Morse and Wireless—taught at home in half usual time and at trifling cost. Omnigraph Automatic Transmitter will send, on Sounder or buzzer, unlimited messages, any speed just as expert operator would. Adopted by U. S. Govt. and used by leading Universities, Colleges, Technical and Telegraph Schools throughout U. S. Catalog free. Omnigraph Mfg. Co., 41-G Cortlandt St., New York.

## PICTURES, POSTCARDS, PENNANTS

**RECEIVE** views of Newfoundland, trial 12 cents. Order today. Albert Andrews, 47 Bond Street, St. John's, Newfoundland.

**WOULD** you like to exchange postcards, letters, photos, stamps, coins (state which) with some of our 17,500 members in many countries? Membership 15c. Halcyon, Box 133-P, Erie, Pa.

**PRETTY** view cards from everywhere. Membership and 6 pretty cards, 10c. Riverside Club, Knoxville, Md.

## CAMERAS AND PHOTO SUPPLIES

**SAVE** camera money. Deal with specialists. Everything in photography. The greatest camera book ever issued, free for the asking. Write for it today. Every item sold under our liberal ten days' free trial offer. No camera user can afford to be without our famous Bass Book of 1001 bargains. Bass Camera Company, 109 N. Dearborn St., Dept. 57, Chicago, Ill.

**FILMS** Developed 10c roll. Six prints free. Ask for descriptive booklet. Roanoke Photo Finishing Company, 209 Bell Avenue, Roanoke, Virginia.

**PHOTOGRAPHS** copied and printed on postals, or cabinet size, 70c per dozen prepaid. Write Hington, Whitesboro, N. Y.

**WRITE** for our new 1918 Camera Catalog—Remarkably low prices on the highest grade cameras—all standard makes, right from the factory. You save from 10% to 50%. Look at these bargains! No. 2 V-P Anso, F.7.5 Anastigmat lens, extra Speed Bionic shutter, \$15.00. 2½x3½ Eastman Folding Cartridge Premo, Meniscus Achromatic lens, \$3.75. Vest Pocket Autographic Kodak, \$5.00. 5x7 New Improved Seneca View, \$17.50. Every article guaranteed and backed by 10 days' Free Trial. Save money. Get your copy now. See our display advertisement on page 111. David Stern Co., "Everything in Cameras." In Business since 1885. 1018 Davco Bldg., 1047 Madison St., Chicago.

**WANT** to save money? Then send for our free Bargain Book, which lists hundreds of slightly used and new Kodaks, Cameras, Lenses and Supplies. Save 25 to 60%. Free trial of 10 days. Money back if unsatisfactory. Consult us if you desire to trade your Camera or Lens. \$16.00 1A Autographic Kodak, R. R. type, (29.50). No. 1 Anso Vest Pocket Camera, R. R. Lens, \$8.00, new. Our prompt and fair dealing will please you. Central Camera Company, Dept. E-5, 124 S. Wabash Ave., Chicago, Ill.

**FREE.** Send negative for sample print. Film developed 5c per roll; print 2¼x3¼, 3c each; 3¼x4¼, 4c each. 8x10 enlargement, 25c each, from your own negative. Send for price list. M. A. Leese, 611 9th St., Washington, D. C.

**FILMS** Developed Free. High Class work, Perfect Prints. No charge for developing. Prints 3c to 7c. We do the best work in the Photo City. Send us your films and remit with order and get returns same day. Bryans' Drug House, Rochester, N. Y.

**FOR** Sale—Goetz No. 3, F-6.8, in Optimo Shutter, \$50.00. G. G. Menke, Angiola, Calif.

**FILMS** Developed free always. Prints, Post Cards, 2½c. 8x10 Enlargements 25c. Guaranteed. Emil Sprauer, Hamilton, Ohio.

**FILMS** Developed, any size 5c. Any size prints 3c. 8x10 enlargements 25c. Work returned same day received. Address Camera Shop, Box 69, Ann Arbor, Michigan.

**INVENTIONS** Wanted in Motion Pictures and Photography. Special department for these classes of invention. Advice. What to Invent and List of Patent Buyers Sent Free. Victor J. Evans & Co., 139 Ninth, Washington, D. C.

**FILMS** developed, 10c; prints, 3c to 5c. A reputable Incorporated Company conducting largest existing plant. Price list and special offer. Enlargements our specialty. Chicago Photo Finishing Co., 54 W. Lake St., Dept. A, Chicago.

**BIG** Money Saved on Photographic Lenses and Apparatus—goods exchanged; repairing done. Ralph J. Golsen, 5123 Kenmore Ave., Chicago, Department F.

## MOTION PICTURES

**SPECIALTY** Arc Generator Produces current for half. Your engine operates. Easy Payments. Hoberts, Troy, Ohio.

**MAKE** Big Money in moving-picture business. We start you and furnish guaranteed outfit on easy payment plan. Easy to accomplish. Catalog free. Monarch Film Service, 228 Union Ave., Dept. 12-A, Memphis, Tenn.

**MOTION** picture machines bought and sold; bargain lists free. National Equipment Company, Duluth, Minn.

**FOR** Sale—New Edison Kinetoscope, \$60.00. Write F. Russell, Batavia, N. Y.

**PHOTOPLAYS** in demand. Make extra money. We show you how. Details free. Rex Publishers, Box 175 H-14, Chicago.

**HUNDREDS** of people make Big Money writing Photoplays, Stories, etc. Why don't you? Write us for free details. Bookmart Co., Dept. 12, Auburn, N. Y.

**MOVING** Picture Film, most any subject, \$3 reel. Davis Films, Lee Park, Wilkes-Barre, Pa.

**MOTION** Picture Operation, Stage Electric and Illusions—The only practical handbook and guide published for motion picture operators, theater electricians and managers. A thoroughly practical and useful book, covering the subject comprehensively. Pocket size, leather. 393 pages, fully illustrated. Price \$2.00 postpaid. Popular Mechanics Book Dept., 6 N. Michigan Ave., Chicago.

**MAKE** money writing Photo-plays; details free to beginners. No correspondence course. Producers League, 230 Wainwright, St. Louis.

**BIG** Profit Nightly—Moving Picture Business—small capital starts you, easily accomplished. Teach you—furnish everything. Ralph J. Golsen, 5123 Kenmore Ave., Chicago, Dept. M.

## BUSINESS OPPORTUNITIES

**FUR** Farm for Sale, located in fine hunting, fishing and trapping country; equipped with stock. Also mink, skunks, coons, ferrets, pheasants, etc., for sale. B. Tippman, La Crosse, Wis.

**ERECT** chain six-foot Advertising Thermometers in public places. Each nets you \$120 first year; \$170 succeeding years. Valuable "Opportunity" booklet telling how sent for dime. Winslow Cabot Company, 32 Congress Bldg., Boston, Mass.

**PARTNER** wanted in each state. Responsible man with small capital. You handle your own money. We manufacture auto necessary for Ford cars. Big seller. Big profits. Bee-Kay Motor Lock Co., Atlanta, Ga.

**ANYBODY** can make \$5 a day at home, spare time, growing mushrooms in cellars, sheds, barns, boxes. Success guaranteed. Free illustrated booklet. Hiram Barton, 324 West 48th, New York.

**PHOTOPLAYS** in demand. Make extra money. We show you how. Details free. Rex Publishers, Box 175 H-15, Chicago.

**WE** start you in business furnishing everything; men and women make handsome income weekly operating our "New System Specialty Candy Factories" home or small room anywhere; no canvassing. Opportunity lifetime; booklet free. W. Ragsdale Co., East Orange, N. J.

**ENTER** a new business. Earn \$3,000 to \$6,000 yearly in professional fees making and fitting a foot specialty, openings everywhere, with all the trade you can attend to; easily learned by anyone at home in a few weeks, at small expense; no further capital required, no goods to buy, job hunting, soliciting or agency. Address Stephenson Laboratory, 11 Back Bay, Boston, Mass.

**MANUFACTURERS**, Promoters and Patent Buyers are invited to write us stating the line of invention in which they are interested, as we can supply their wants in any class of patents. Victor J. Evans & Co., 162 Ninth St., Washington, D. C.

**MAKE** Big Money Repairing Safes and Setting Combinations. Wayne Strong, Box 1439, Los Angeles, Cal.

**PROFITABLE** formulas, Trade Secrets and money-making plans. Particulars free. Write now. Three "B" Supply Co., Perth Amboy, N. J.

**INVENTORS:** We develop and perfect inventions, make models, dies, tools. Metal stamping and special manufacturing. Gerding Bros., Lion Bldg., Cincinnati, O.

**3,380** FORMULAS, Trade-Secrets, etc., in "Encyclopedia Business Opportunities," 3 volumes. Worth \$3.00. Special offer \$1. "The Ideal," Box 543-W, Chicago.

**ADVERTISERS**—Mail order dealers, increase your business and profits; write for advice and book, "Successful Advertising," free. Warder Advertising Agency, 127 Warder Building, Washington, D. C.

**AUTOMATIC** Advers—\$2.50—\$3.50—\$5. Sell quickly. Excellent profits. Bassett, 5921-U Indiana Ave., Chicago.

**LUMINOUS** Paint—10 formulas, different colors, 25c. "Recharging Dry Batteries"—"Resilvering Mirrors"—"Gas Tonic"—"Puncture Plugger." Carbon Remover, 20c each. Complete collection 50c. "Bestoverall," Box 543-M, Chicago.

**YOU** can make big money in the wall-cleaning business. Let us start you in this profitable business. Write today. C. Swanson Soss, Mankato, Minn.

**MONEY-MAKING** business of your own. We instruct you to manufacture articles that sell rapidly. We teach you how to make: Silverplating Powder, Liquid Courtplaster, Straw-hat Bleach, Resilvering Mirrors, Dressing and Polish for Tan Shoes, Luminous and Oilcloth paints, Toothpaste for Collapsible Tubes, Soap-bubble Liquid. All for 50c. Sidney Specialty Co., 233 E. Fulton St., New York.

**MIRROR** Silvering, \$4.00 Thirty lesson Course, short time, 50c. Box 62, Davenport, Ia.

**BE** Business Broker: Small Capital required. Large Income possible; particulars free. Miss Jack Eydman, 1527 Chemical Bldg., St. Louis, Mo.

**GOOD** Monthly Income Easy in Spare Time, manufacturing letters for signs. Free particulars. J. F. McPherson, 677 Brown Ave., Butler, Pa.

**CONDUCT** a profitable Candy Kitchen; very small capital required; booklet free. Kennon School, 509 Wells St., Dept. A, Chicago.

**500** FORMULAS, including Resilvering Mirrors—Renewing Dry Batteries—Luminous Paint, 25c. "The Ideal," Box 543-K, Chicago.

**RELIABLE** home employment. Particulars for stamp. De Lano Walton, Prairie City, Ill.

**PLASTOGRAPHY:** Make beautiful imitation marble Medallions yourself. Instructions \$2.00. Mould or model of President Wilson or Lincoln sent free with your order. P. B. Spahr, York, Penna.

**ADVERTISERS**, Mail Dealers, Our New Rate Book lists 2,900 Principal Publications, rates, circulation. Includes 30 Mail-Order Plans, Free. Dearborn Advertising Agency, 216 Franklin Bldg., Chicago.

**START** a Vacuum Clothes and Carpet Cleaning business, \$125.00 for machinery required. Write today. General Compressed Air & Vacuum Machinery Co., St. Louis.

**SILVERING** Mirrors! My exclusive French Tartaric method opens enormously profitable business. Booklet Free. H. Barstow, 514 25rd street, Oakland, Calif.



**EXPERT Chemical Service.** Commercial Analysis, Instructions, Formulas, Processes and Trade Secrets. Manufacturing problems solved. Satisfaction guaranteed. Write for Lists and Valuable Information. W. L. Cummings, Ph. D., 127 Standart St., Syracuse, N. Y.

**PATENTABLE Ideas Wanted**—Send for 4 free books. R. B. Owen, 30 Owen Bldg., Washington, D. C.

**BIG money in promoting inventions.** Write Adam Fisher Mfg. Co., 2961D Railway Exchange, St. Louis, Mo.

**LEARN** the real estate business; our enlarged instruction book teaches listing, appraising, management, salesmanship, insurance, brokerage, advertising, renting, agency, estates, titles, rights, forms, etc.; revised edition; 240 indexed subjects; excels \$25 correspondence course; buckeye cover, \$1; silk cloth, \$1.25, postpaid. Realty Book Co., Dept. No. 29, Cleveland, Ohio.

#### MAIL-ORDER SUPPLIES

**WALTHAM Watches**—rebuilt—guaranteed. Sample \$3.77. Alfred Law, Penna Grove, N. J.

**INCREASE** your sales. Place your proposition before the readers of "Cartoons Magazine," 20,000 copies guaranteed every month. Classified rate 5c per word. Mail in a trial ad today. Cartoons Classified Dept., 78 E. Madison St., Chicago.

#### FOR ADVERTISERS

**SPECIAL Notice!!!** 25 word advertisement in 100 Magazines Thrice \$2. Try List, Box 2, Atlantic City.

**20-WORD** advertisement in 100 magazines \$1.00. American System Hollywood, California.

#### ART AND ADVERTISING SERVICE

**ZINC** etchings from tracings. Half-tones, art work, etc. Write for prices. Terre Haute Engraving Company, Terre Haute, Indiana.

#### AGENTS WANTED

**ONE Thousand Dollars Reward** if this is not the greatest money-making house-to-house proposition. N. R. G. Laundry Tablets wash clothes in 10 minutes, without rubbing. Contains no Lime, Lye, Paraffin, Wax or other injurious chemical and cannot possibly injure the clothes or hands. Positively the wonder of the age—sells for 15c, enough for five family washings. We supply Free Samples and guarantee the sale of every package you buy. Just Leave the Free Sample with the housewife and, when you call again, she is eagerly awaiting to become your steady customer. Secure territorial rights at once, or you will regret it. A 1c postal brings sample and full particulars. Farquhar-Moon Mfg. Co., Desk L200, 140 W. Vanburen St., Chicago, Ill.

**"AMERICA and the Great War for Humanity and Freedom"** is having a wild-fire sale. Four hundred pages, one hundred full-page engravings, Cameramen making ten to twenty-five dollars a day. Best terms. Books shipped on credit. Complete outfit mailed on receipt of twenty cents to pay postage, including our large book and Bible, illustrated catalog, showing five hundred books and Bibles. Also Holiday books. Our War book is an unusual proposition at this time. Send 25c at once for outfit and you will make money fast. Do It Now. The F. W. Mead Publishing Co., Dept. 4, Johnson, N. Y.

**YOU** can be your own boss with our Key Check outfit. Good for \$5 a day stamping names on pocket key checks, fobs, etc. Sample check with your name and address, 15 cents. Pease Die Works, Dept. M., Winchester, N. H.

**AGENTS** make 500% profit handling Auto Monograms, Patriotic Pictures, Flag Novelties, Window Letters and Changeable Signs, Catalog free. Hinton Co., 6142 40th Court, Chicago, Ill.

**GOOD** income refinishing chandeliers, brass beds, automobiles by new method, producing amazing results; no capital or experience necessary; particulars free. Gunmetal Co., Ave. H, Decatur, Ill.

**AGENTS**—Even if you were deaf, dumb and blind you could sell our Aluminum Utensil Cleaner. Every housewife grabs it on sight. Steady trade and big money in protected territory. Write quick. Div. Pol. American Aluminum Mfg. Co., Le-mont, Ill.

**CLEANING Preparations:** Dry Cleaner, Rust Remover, Laundry Tablets, Wildfire sellers. Agents earning money. Sales guaranteed. Write for offer—Hurry! Lawrence Chemical Co., Marietta, Ohio.

**\$109.00 MONTHLY**, leaving "Easywash" free with groceries everywhere. Particulars free. Michael D. Riemal, Cutler St., Newark, N. J.

**RUSH** postal for Free Sample "Spik & Span," wonderful new washing tablet. Washes clothes spotless, without rubbing. Tremendous seller. 200% profit. Free samples to boost sales. R. A. Newberry, 202 Peoria, Chicago.

**EVERY** Agent should have a copy of "The Universal," full of opportunities. It's free. The Universal, Box 1743-1, Los Angeles.

**\$61.50 WEEKLY**. Introducing and selling a new gas light burner for kerosene lamps. Beautiful light. No chimney. No mantle. Samples free. Luther Manufacturing Co., Dept. 318, Cincinnati, Ohio.

**1917'S GREATEST** sensation! 11-piece toilet goods combination selling like blazes at \$1.00 with \$1.00 Carving Set Free. Everybody buys. Engle's profit first week \$51.00. Great crew proposition. P. Pierce Co., 802 Lake St., Chicago.

**AGENTS** Wanted—We want 1,000 more men and women agents at once. You can easily earn \$5 to \$10 a day taking orders for our fast selling, attractive line of Soaps, Perfumes, Face Creams and Toilet preparations. Sample case free to workers. Every call a sale. We are an old established firm. Our goods well advertised and well known. You make 100% profit. Get busy—write now for our liberal proposition to agents. Crofts & Reed Co., Dept. C, 167, Chicago, Ill.

**PATENT** Sash Lock for locking windows when open for ventilation. Quick seller, good profits. Price 50 cents. The Stevens Co., North Pryor Place, Atlanta, Ga.

**DISHWASHING** Pans—Fine agent's article. Marvin A. Smith, Cottonwood, Ala.

**MAKE** and Sell Your Own Goods. Machinery unnecessary. Expert Chemists advice. Special attention to beginners. Formula Catalog for Stamp. Blake Mystic Company, Washington, D. C.

**MEN** and women with spare time—whether employed or not employed—can make a lot of extra money with our All Profit offer. No goods to buy or sell. No deliveries. No collections. National, Dept. B-15, 18 W. Lake St., Chicago.

**AGENTS**—Good opportunity to make big money taking orders for Goodyear Raincoats. We deliver and collect. Season just opening. Write for full information. Goodyear Mfg. Co., Dept. 103, Kansas City, Mo.

**MARVELOUS** new winner—the Daylite Mantle Oil Lamp! Different from all others. Better light than electricity. Five times more efficient than common lamps. Uses common kerosene. Burns over 50 hours on 1 gallon. Guaranteed five years. Elegantly finished. To show it is to sell it. Men with rigs and autos making as high as \$325 every month. No money—no experience needed. You can start on our capital. We furnish stock of lamps on credit to reliable men. Sample lamp free. Exclusive territory. Write quick for particulars free. Daylite Company, 603 Daylite Building, Chicago, Illinois.

**WANTED**—An agent in every town to sell our Clamp-On Shock Absorber for Ford Cars. Easy sellers and big profits. Write today. Milwaukee Shock Absorber Co., Milwaukee, Wis.

**WANTED**—Live men and women to organize phonograph clubs by our unique method. \$15 Standard Phonograph for 75c to organizers. Write for interesting proposition. Western Distributing Co., Dept. K, Winfield, Kansas.

**OVER** \$1.45 profit on every \$1.50 job monogramming automobiles, etc., in 10 minutes with Transfer Initials. Samples free. Globe Decalcomanie Co., Dept. 7, Globe Decalcomanie Co., Jersey City, N. J.

**WONDER** Pudding Powder makes the most delicious Chocolate, Raspberry, or Lemon pudding you ever tasted. 5 to 7 large dishes in a jiffy for 10c. Sell it to stores, restaurants, hotels, families. Appoint agents. Big profits, wonderful seller. Package and particulars 10c postpaid. Morrissey Company, 4114 Madison, Chicago, Ill.

**"MAGIC** Gas Lighters" sell quick everywhere. Large profits—No experience necessary. Sample "Lighter," particulars, quantity prices, etc., 25c postpaid. Write at once. "C-m-are" Specialties, Box 51, Goshen, New York.

**DISTRICT** Managers Wanted. Splendid opportunity for growing, permanent income. J. Bunting, 800 Eastwood Ave., Chicago.

**AGENTS**, dealers, join Manufacturers' Syndicate, manufacture what you sell. Brass polish \$1, complexion cream \$1, matches \$1, paint 50c, cologne 25c, shoe dressing 25c. We manufacture Liberty Automobile Polish, Agents wanted. Manufacturing list and particulars 10c. Manufacturers' Syndicate Co., 2123 Madison Ave., New York.

**TAILORING** Agents Wanted—Big complete sample outfit and case, nearly 300 large cloth samples, 3 piece lists and everything needed for canvassing, or use in store, free to live agents, \$25.00 to \$50.00 a week; may make more. Write us today for free elegant outfit to begin, cloth samples, wholesale prices, special offer on a suit for yourself and full information—see our wonderful values beautiful fabrics and styles. Established 28 years. Every garment made to measure—everything guaranteed and express prepaid. Just send a postal. American Woolen Mills Co., Dept. 1014, Chicago.

**RESPONSIBLE** agent wanted in each locality. Side line or full time. If you want to increase your income, or to become independent, write us. Easy sales; big repeater, \$50.00 clear profit per week can be easily made. Address Box 938, Tampa, Fla.

**AGENTS**. Something new; Free sample. Foreign inquiries invited. Famous Products Co., Decatur, Illinois.

**LUMINOUS** Paint! Shines in the dark. Big seller to hotels, garages, etc. Any article can be coated with splendid results, watches, clocks, electric switch plates, crucifixes, match boxes, etc. (Everlasting.) Only 25c a bottle. Luminous Paint Co., B-22, Douglas Park Station, Chicago, Ill.

**NACMA** repeat-order household products are big money-makers. Catchy selling plan gets and holds the business. Free selling helps and samples. Exclusive territory. The Nacma Co., Dept. B-7, 20 W. Lake, Chicago.

**AGENTS**: Biggest moneymaker ever put on the market. "Eggette," the original egg substitute. Takes place of eggs in baking and cooking at less than ten cents per dozen. Sells rapidly to homes, stores, bakers, etc. A Guaranteed pure food product. Good opportunity to build permanent business with big income. No competition. Regular size package 10c equal to 12 eggs. Attractive moneymaking proposition free. Write quick. Bosterer Products Co., B-8 Douglas Park Station, Chicago, Ill.

**EVERY** home on farm, in small town or suburb needs and will buy the wonderful Aladdin kerosene (coal-oil) Mantle Lamp. Five times as bright as electric. Tested and recommended by Government and 34 leading Universities. Awarded Gold Medal. One farmer cleared over \$500 in six weeks. Hundreds with rigs or autos earning \$100 to \$300 per month. No capital required; we furnish goods on time to reliable men. Write quick for distributor's proposition and lamp for free trial. Mantle Lamp Co., 528 Aladdin Bldg., Chicago, Ill.

**AGENTS**: You can make big money taking orders for our fine made-to-measure clothes, so write quick for 60 beautiful cloth samples, 32 smart styles in rich colors, wholesale and retail price lists, lowest prices and best offer to agents, \$5.00 to \$10.00 a day easy. Big outfit, over 250 samples free to live wires. No experience needed—no capital. We furnish everything free—pay postage or express charges—back you, boost you, show you how and clearly explain everything. Costs nothing to try. Let us make you a stylish suit to measure to prove our fine quality and style. Send postal or letter today. Paragon Tailoring Co., Dept. 1014, Chicago.

**DISTRICT** Agents everywhere for wonderful new Automobile Fuel. Good pay and car furnished. Write quick for open territory. L. Ballway, 933 Jefferson St., Louisville, Ky.

**PHOTO** Pillow Tops, Portraits, Frames, Shot Pictures, Medallions, Patriotic Pictures, Pennants. Rejects credited. Prompt shipments; samples and catalogs free to agents; 30 days' credit. Jaa, C. Bailey Co., Desk Z, Chicago.

**STATE** Representatives and Agents—We want men of known ability for best line of Cutlery offered for salesmen. Extremely liberal margins. Dept. P, Aerial Cutlery Manufacturing Company, Marinette, Wisconsin.

**AGENTS**, \$50 a week. Will show you how. Genuine Gold Leaf Window Letters. Chicago Agency Co., 812 Abgeld St., Chicago.



**INSIDE Tyres**, inner armor for Automobile tires, double mileage and prevent punctures and blowouts. Quickly applied. Cost little. Demand tremendous. Profits unlimited. Details free. American Automobile Accessories Co., Dept. P, Cincinnati, O.

**GET Davis' Latest Proposition**, \$15.00 daily a cinch. No matter how many times you have answered my ads in last 20 years, write again. E. M. Davis, Dept. 506, 900 Lake, Chicago.

**233% PROFIT** selling Jubilee Spark Intensifiers to automobile owners, garages. Sure cure for Spark Plug troubles. Sells like wildfire. Brand new. Exclusive territory. Write today. Jubilee Mfg. Co., Dept. M-1, Omaha, Nebraska.

**LARGE Manufacturer** wants representatives to sell shirts, underwear, hosiery, dresses, waists, skirts, direct to homes. Write for free samples. Madison Mills, 503 Broadway, New York City.

**NEW Patriotic War Atlas** Free with my 1917 "Business Guide." Sells everywhere. Beginners clear \$7 daily. 50% commission. Outfit free. Prof. Nichols, Box P. M. 3, Naperville, Ill.

**NINETY Per Cent of Your Calls Turned into Sales!** Wonderful Enthusiasm Follows Every Demonstration! Write at Once for Full Particulars of Our Line of Eradium (Luminous) Articles. Startling! Mysterious! Everlasting! Novel! They Shine in the dark. Crucifixes, House Numbers, Bulbs, Match Boxes, Pictures, Switch Plates. Sole Manufacturers, The Pioneer Corporation, 1239 W. 63rd, Chicago.

**AGENTS—Our gold window letter proposition** beats 'em all. Stahlrite Co., Dept. P, 1115 Second Ave., N. Y. Established 1895.

**DO you want to travel at our expense?** We want good men and women for traveling general agents. Must have fair education and good references. Will make contract for three months, six months or year at salary \$22.50 per week and necessary expenses. Can assign most any territory desired. For full particulars address George G. Clows Company, Philadelphia, Pa., Dept. 4-I.

**BIG Textile Mills** want ambitious men and women everywhere to show latest dress fabrics, neckwear, hosiery, underwear, and sweaters. 400 styles. Easy sales. Values beat stores. Many making over \$30 weekly. All or spare time. Complete sample outfit starts you. Steadfast Mills, 30 Remsen St., Cohoes, N. Y.

**AGENTS—Just out. New Dollar Winner.** One-Hand Speed Wrench. Machinists, autoists, farmers, everybody buy at sight. 100% profit. Make \$30 to \$50 weekly. Toledo Speed Wrench Co., Dept. "M," Toledo, Ohio.

**\$2.50 PER day Salary Paid One Person** in each town to distribute Free circulars, and take orders for White Ribbon Concentrated Flavoring. Non-alcoholic — Big demand, steadily increasing. J. S. Ziegler Co., 71 E. Harrison St., Chicago.

**YOU can earn \$5 to \$10 daily** during the fall season with our Ivory line of Brushes, Mirrors, Combs, etc. One sale helps another. A high grade line of delightful quality. Write now for local agency. Yancoo Ivory Company, Ave. P, Leominster, Mass.

**\$10 A DAY Profit—manufacture Barley Crisp;** new confection; 5c package costs you 1c; machine, instructions complete, \$7.50 prepaid; send 10c for samples. Barley Crisp Company, 1287 Broadway, San Francisco.

**TAILORING Agents—Sell men's suits,** made to order; cheapest and best line made; can sell every man you see; large sample outfit free. Leeds Woolen Mills, Chicago.

**AGENTS to Travel by Automobile** to introduce our fast selling, popular priced household necessities. The greatest line on earth. Make \$10 a day. Complete outfit and automobile furnished free to workers. Write today for exclusive territory. American Products Co., 5339 3rd St., Cincinnati, O.

**AGENTS—Latest invention—a Gas Saver** for Ford cars only—guaranteed to give from 30% to 40% more mileage for each gallon of gasoline. A rapid seller. Big profits. H. S. Pagano & Co., Inc., Albany, N. Y.

**35 HOME Articles.** New, strong Agent's line. Easy sellers. Big money makers. Lustre Mfg. Co., 18 W. Kinzie St., Chicago.

**AGENTS—Make a dollar an hour.** Sell Mendocets, a patent patch for instantly mending leaks in all utensils. Sample package free. Collette Mfg. Co., Dept. 404B Amsterdam, N. Y.

**AGENTS! Everybody buys Triangle Soap** Holder. Big money; 15c brings one and particulars. Triangle Co., Fairbault, Minn.

**\$1.25 LITTLE Wonder Gas Saver.** Agent retails \$2.00 for Ford and Metz; runs 30 miles on gallon; applied one minute. Vanderpool's, Los Angeles, Calif.

**AGENTS—Send for sample "Fretnot"—**the wash day wonder. Be convinced you can do a whirlwind business. You can clear at least \$20 to \$100 weekly, according to spare or whole time. You don't have to talk; if she doesn't buy at sight, leave sample; she will be looking for you long before you are able to make the rounds again. Samples furnished free. Premiums for your customers. Exclusive territory guaranteed to agents who can produce. Credit given. Don't call. P. M. Motter & Sons, 3213 Warren Ave., Chicago.

**AGENTS make 500 per cent profit** selling our Auto Monograms and Initials, Window Sign Letters, Changeable Signs, and Show Cards. 1,000 Varieties. Enormous Demand. Sullivan Co., 1123 Van Buren St., Chicago, Ill.

**GET into biggest money-making** and automobile business—replacing necessary equipment. Live, ambitious men wanted as special factory representatives, exclusive territory, taking orders for tops, top coverings, seat covers, "Stik-Tite" windows. No experience necessary. No capital required. No competition. Copyrighted system protects you. Free catalog, samples, full details. Cincinnati Auto Specialty Company, Dept. MC-137, Cincinnati, Ohio.

**AGENTS: We need men and women** right now to take orders for World's Greatest Raincoat values. Dandy coat \$3.98. Sixty-five fabrics. Dozens of styles. Made to measure and delivered direct from our big factory to your customer. No delivering. Profit in advance. Easy to sell. Cooper making \$300 monthly. Glover \$61.50 first four days. Neally 22 orders in 2 days. Four average orders a day gives you \$2,500 a year profit. Full outfit and sample coat given. Write for wonderful offer. Corner Mfg. Co., Dept. U-11, Dayton, Ohio.

**AGENTS—Something new; patented** sanitary kitchen article; whirlwind seller; big profits; write quick. Valley Supply Co., Grafton, W. Va.

**QUICK snap, this winner.** Brand new, big profits. Sells on sight. Unlimited field. Free particulars. Sunnyside Co., Dept. 8, 614 Sunnyside St., Danville, Va.

**AGENTS wanted for Ford Automobile** gasoline gauges; new invention; sells like wildfire; a gold mine for agents. Exclusive territory. Phillip Ray, General Agent, Blackwell, Oklahoma.

**AGENTS—Sell the patriotic honor** and Unity Shield pictures. Fast sellers. Big profits. Free information, Box AZ 1774, Herman R. Merk, Spokane, Wash.

**AGENTS' repeater, costs 8c, sells for \$1.** Circular free. Dr. Thurber, Ferris, Ill.

**AGENTS, \$60 a week to travel** by automobile and introduce our 300 candle power coal-oil lantern. Write for particulars of our auto offer. Thomas Co., 802 North St., Dayton, Ohio.

**MAN wanted in small town** or on R. F. D.; wear fine sample tailored suit, be agent, make big money; introduce us to friends, take orders for tailoring in spare time. Write for free book of cloth samples, styles, instructions. Knickerbocker Tailoring Co., Dept. 697, Chicago.

**\$15.00 MADE first day** by 13-year-old boy with homescope. Woman made \$8.00 first hour. Particulars Free. Homescope Mfg. Co., 4923 Montgall, Kansas City, Mo.

**AGENTS—Make money** selling Artificial Marble Grave Markers. Write Edward Mease, 918 14th St., Des Moines, Iowa.

**WORLD'S Fastest Selling Auto Accessory.** County distributors wanted. Good profits. Write today. G. L. W. Spring Oiler Co., San Diego, Calif.

**SELL guaranteed made to measure** raincoats. Agent's price \$2.50 delivered. Make \$50 weekly. Outfit free. Standard Raincoat, 305 Broadway, New York.

**DECALCOMANIA Transfer Initials and** Flags: You apply them on automobile while they wait. You can make \$1.38 profit on \$1.50 job; free particulars. Auto Monogram Supply Co., Dept. 1, Niagara Bldg., Newark, N. J.

**AGENTS, sell shirts** direct to consumer. Sample outfit free. Nissen Shirt Co., 4050 3rd Ave., New York.

**AGENTS—200% profit.** Wonderful little article. Something new; sells like wildfire. Carry right in pocket. Write at once for free sample. E. M. Feltman, Mgr., 5239 3rd St., Cincinnati, O.

**AGENTS. New \$2.50 Automatic Adder.** Sell every business man. Big profits. No competition. Does work of high priced machines. Bassett, 5921-S Indiana Ave., Chicago.

**\$300.00 EARNED in 30 days;** by Stewart Bottom, agent, Sheboygan, Wisconsin, selling automatic self opening and closing cuff links. Indispensable to all men. Cuffs may be raised instantly to any position on the arm without unbuttoning. Great convenience and laundry saver. Neat, durable and guaranteed. Energetic high grade representatives wanted everywhere. Master Jewelers Corporation, Sheboygan, Wisconsin.

**EASY Sales! Quick sales.** Repeat sales. Big profits. Likong, takes place of eggs, less than 9c dozen. Hurry, hurry. Merford Co., Dept. P, Chicago.

**AGENTS and Agencies** wanted for Five Minute Vulcanizer, big seller. Auto Devices Company, 305 Parkway Building, Philadelphia.

**AGENTS—50 Calling, or 25 Scout cards,** 10c. F. Shepard, Rome, N. Y.

**DISCOVERED! Extraordinary New Propo-**sition. Supreme Opportunity. \$200 per week Easy. Demonstrating marvelous Adding Machine. Retail \$7.50. Work equals \$300 machine. Subtracts, Multiplies, Divides, automatically. Whirlwind in speed. Guaranteed Five Years. Used by U. S. Government. Sells everywhere. Amazing profits. Write quick for exclusive territory. Calculator Corp., Dept. PM, Grand Rapids, Mich.

**NEW invention, fast seller** to all classes. Popular price, many buy dozens, no competition. Big profit. Dandy mail-order proposition. The Clark Co., Clark Building, Jacksonville, Fla.

**WANTED. General Agent** to represent us in your locality. Exclusive territory. Big inducements. Chicago Agency Co., 840 Alameda St., Chicago.

**WANTED—New Ideas.** Write for list of Patent Buyers and Inventions Wanted. \$1,000,000 in prizes offered for inventions. Our Four Books sent free upon request. Victor J. Evans & Co., 163 Ninth, Washington, D. C.

**AGENTS — Ho-Ro-Co Skin Soap** and Toilet Goods plan beats everything for agents' profits. "Ho-Ro-Co," 112 Locust St., St. Louis, Mo.

**AGENTS: \$50 to \$100 a week.** Free samples. Gold sign letters for Stores and Office Windows. Anyone can do it. Liberal offer to general agents. Metallic Letter Co., 407 N. Clark, Chicago.

**CALIFORNIA Flower** Band Necklaces beat anything for quick sales and profits. Absolutely new. Write for agent's proposition. Mission, 2819 PM, West Pico, Los Angeles, Calif.

**AGENTS, Make Big Money;** fast office seller; particulars and samples free. One Dip Pen Co., Dept. 2, Baltimore, Md.

**AGENTS—\$5 daily** selling our Handy Tool, 12 articles in one. Lightning seller. Sample free. Thomas Mfg. Company, 762 North St., Dayton, Ohio.

**HOSIERY and Underwear Manufacturer** offers permanent position supplying regular customers at mill prices. \$50.00 to \$100.00 monthly. All or spare time. Credit. D. Parker Mills, 2735 No. 12th St., Phila., Pa.

**INVENT Something.** Your ideas may bring wealth. Free book tells what to invent and how to obtain a patent through our credit system. Talbert & Parker, 4683 Talbert Bldg., Washington, D. C.

**HEL-SIT the Kaiser Pin—Latest** war novelty—Biggest Hit Out; oxidized silver; thousands are being sold; simple matter handing them out and taking money; sample with agents' terms, 10 cents. O. Finch, 1002 S. Iowa Ave., Grand Rapids, Mich.

**AGENTS — Sell rich-looking** imported 35x68 rugs, \$1 each. Carter, Tenn., sold 115 in 4 days. Profit, \$57. You can do same. Write for sample offer selling plan; exclusive territory. Sample rug by parcel post prepaid, 98c. E. H. Condon, Importer, Stonington, Maine.

**FEATHER Flowers,** the all-purpose Home flower. Business clean, attractive, profitable. Sample fifteen cents. De Witt Sisters, Route Ten, Battle Creek, Mich.

**DISTRICT and local agents** with Ford cars wanted to demonstrate to Ford owners wonderful Simplex Ford Starter and Simplex Windshield Ventilating Bracket. Both are big selling accessories for good live men. Write today for proposition and exclusive agency. Simplex Mfg. Company, Dept. 443, Anderson, Indiana.



**EASY**, pleasant work for Mechanics, Shop Men, Clerks, during spare hours, will add many dollars to their salaries. Also want persons who can give full time. Big wages assured. Novelty Cutlery Co., 67 Bar St., Canton, Ohio.

**MERCHANTS** Buy at Sight. New changeable letter sign for window advertising. Large metal sign with 270 letters. Sells \$1.50. 300% profit. Greatest seller ever invented. Write for proposition. Changeable Sign Co., E. 102, Cleveland.

**GAS** Fire in any cook stove from common coal oil. Agents coin money. Wonder Burner Company, Columbus, Ohio.

**GASOLINE** Saver for Fords: New Principle; Saves 30% Gasoline; Gives 30% more power. No moving parts; Put on with wrench in ten minutes. Price \$1.50. Guaranteed. 100% proposition to agents. The Little Cyclone Accessories Co., Dayton, Ohio.

**AGENTS** financially responsible who understand heating plants to sell Blasko Fuel-Saving Devices on monthly payment plan. Every heating plant a prospect. Guaranteed to save 20%. Evaporation tests at two universities averaged 25% saving. Wolff Fuel Saver Company, 11 East Jackson, Chicago.

**AGENTS** make \$100.00 monthly selling our 500 Handy Household Articles; Catalogue free. Scheff Company, Desplaines, Ill.

**AGENTS**—Steady Income. Large manufacturer of Handkerchiefs and Dress Goods, etc., wishes representative in each locality. Factory to consumer. Big profits, honest goods. Whole or spare time. Credit given. Send for particulars. Freeport Mfg. Co., 50 Main St., Brooklyn, N. Y.

**GRAB** Territory on our new specialties. Full line samples and terms \$2.00. Money back if wanted. Adam Fisher Mfg. Co., 2061-G, St. Louis, Mo.

**ANY** Man or Woman can make \$35 or more weekly selling Puritan Brushes to every household. Big profits, easy work. Exclusive territory. Special method for making sales easy. Puritan Co., Dept. M, 1966 Broadway, New York.

**MAKE** \$150 a month easy money. Agents and garagemen are clearing as high as \$150 a month selling automobile body polish made from my exclusive formula. Going like wild fire wherever introduced. The formula is yours for only \$5. There is no limit to the profits you can make. For full particulars, address B. Sonntag, Waco, Texas.

**WANTED** Reliable People—Place Eggs in stores and apartment agents. Takes place of eggs in baking and cooking at 2c doz. Large package and particulars 10c postpaid. Morrissey Company, 4403-5 Madison, Chicago.

**1917's GREATEST** Sensation. 11-piece toilet goods combination selling like blazes at \$1.00 with \$1.00 Carving Set Free. Everybody buys. Engle's profit first week \$51.00. Great crew proposition. Pierce Co., Dept. P, 906 Lake St., Chicago.

**AGENTS**, 500% Profit. Sign-Letters for office and store fronts. Samples and particulars free. Inter-States Letter, 2424 N. Halsted St., Chicago.

**AGENTS**—with selling experience—to sell direct to consumer made-to-measure suits and overcoats, \$13.50 and \$17.50. If you want an independent business with Big Money, answer at once before territory is taken. Outfits furnished. Midland Tailors, Dept. 6, 19 So. Fifth Ave., Chicago.

**\$1,000 PER** Man per county. Strange invention startles world—agents amazed. Ten inexperienced men divide \$40,000. Korstad, a farmer, did \$2,200 in 14 days. Schleicher, a minister, \$195 in first 12 hours. \$1,200 cold cash made, paid, banked by Stoneman in 30 days; \$15,000 to date. A hot or cold running water bath equipment for any home at only \$6.50. Self-heating. No plumbing or waterworks required. Investigate. Exclusive sale. Credit given. Send no money. Write letter or postal today. Allen Mfg. Co., 311 Allen Bldg., Toledo, Ohio.

**AGENTS**. We have a good proposition for you. Write for particulars and samples. Chicago Agency Co., 838 Alameda St., Chicago.

**PORTRAIT** Agents, new and old, write us. We know what you want and need. Established 17 years. Pioneer, 1252 W. 63rd St., Chicago.

**AGENTS** Wanted: Sell Polishing Cloths, Rust Remover, Food Flavors, etc. 150 household necessities, guaranteed line, big profits, quick repeater, permanent business. Stuart & Co., 16 Main St., Newark, N. Y.

**AGENTS** sell Reliable Custom-Made Raincoats and Gabardines. Big commission. Complete sample line free. Temple Raincoat Company, Templeton, Mass.

**PORTRAIT** Agents: Our goods will make you big profits. Delivery guaranteed. Refunds credited. Prompt shipments. Send for latest catalogue and prices. Adam J. Kroll & Co., 602 Blue Island Ave., Chicago, Ill.

**HUNDREDS** of Agents are now making goods to sell from Miller's Guaranteed Manufacturers' Formula. Wizard Washing Tablets—no wax, potash, lye. Costs 5c pound. Brings 50c. Eggoline, only pure food substitute for eggs at 2c a dozen. Non-Alcoholic Tube Flavors. Ice Saving Cloths, many new sellers including latest Automobile Specialties. Carbo-Cide, the only recognized Gasoline Intensifier-Decarbonizer—800% profit. Enormous sales. Fibro-Vac Guaranteed Puncture Plugger. Exclusive territory. Particulars for stamp. Miller, Manufacturers' Chemist, Tampa, Florida.

**AGENTS**—Stamping names on Pocket Key Protectors; sample Check with your name and address, 12c. Stamping Outfits, Emblem Checks, Check Fobs, Name Plates. Hart Mfg. Co., Desk 2, 303 Degraw St., Brooklyn, N. Y.

**SIGN** Letter Agents and Painters: 500% Profit Gold and Silver Sign Letters for Stores and Office Windows. Anyone can put on. Big demand. Free samples. Metallic Letter Co., 464 N. Clark St., Chicago.

**HUGE** profits selling Nibco Sanitary Brushes, Auto Washers, Brown Beauty Adjustable Floor Mops, Dustless Dusters, and other specialties. Big line. Fast sellers. Write today. Silver-Chamberlin Company, Department M, Clayton, New Jersey.

**FREE** sample with particulars. No unshaking water strainers. Easy seller. Returns big. Experience unnecessary. Union Filters Co., New York.

**MAN** Wanted in each county community and every small town, to wear beautiful new tailored-to-order suit of clothes and be Agent in spare time among friends, relatives and neighbors. Confidential wholesale prices given, good profit on each order. No experience required, we teach you all you need to know. Write at once and get gorgeous, illustrated book of cloth samples free, and full instructions. Banner Tailoring Co., Dept. 603, Chicago.

**AGENTS**: Big Hit: Our 5-Piece Aluminum Set is all the rage. Cheaper than Enamel Ware. Sells like wildfire. Guaranteed 20 years. Retail value \$5.00. You sell to housewives for only \$1.98. Biggest seller of the age, 9 sure sales out of every 10 shown. Others cleaning up \$10.00 to \$20.00 a day. Answer this quick to secure your territory. Div. GG5, American Aluminum Mfg. Co., Lemont, Ill.

**\$50 WEEKLY** and up selling Mexican Diamonds. Exactly resemble genuine; Same Rainbow Fire; Stand tests; sell at sight; Repeat orders. Write quick for Sample Case offer free. Mexican Diamond Importing Co., S. W. Las Cruces, New Mexico.

**"GOLDINE"** Sign Letters—1,000% profit. Particulars free. Johnston Co., Quincy, Ill.

#### SALESMEN WANTED

**WANTED**—Representatives everywhere. Exclusive territory. Gold sign letters for stores and office windows. Any one can put on. Write today for free sample. Metallic Letter Co., 463 N. Clark St., Chicago.

**FELT** Pennants, caps, hats, school novelties. Attractive side line. Fast sellers. Decorative Co., Box 2, Norwood, O.

**SALESMEN**—Acquainted with grocery trade. Large demand; liberal commission; pocket sample. Wirth Salesbook Co., Dept. P., Chicago.

**WANTED**, Salesman—To sell our new way to operate a Ford. Big money. Universal satisfaction everywhere. Write us. Marion Metal Products Company, Marion, Indiana.

**SALESMEN** Wanted. Owing to draft and enlistment we have a few well worked territories open and will be pleased to hear from interested persons. Applicant must be exempt from draft. McCannan & Company, Dept. G, Winona, Minn.

**TRAVELING** Salesmen Wanted—Expertise unnecessary. Earn while you learn. Hundreds of good positions open. Write today for large list of openings and testimonials from hundreds of members we have placed in positions paying \$100 to \$500 a month. Address nearest office, Dept. 125R, National Salesmen Training Association, Chicago, New York, San Francisco.

**SALESMEN**—Sell Concentrated Food to dealers. Those with automobile preferred. Vegetone, Baldwin, Long Island, N. Y.

**WEEK** You Ever Offered a Grocery Store? Our Proposition is Better. Let us tell you how you can handle Flour, Canned Goods, Provisions, an entire line of groceries, as well as Paints, Roofing, Stock Foods, Automobile and Machinery, Oils and Greases. No rent to pay. No investment in stock. Large orders taken from samples. Goods of guaranteed and proven quality. Selling experience not necessary. Very profitable work for "workers." Address Hitchcock Hill Co., Dept. 200, Chicago, Ill. Reference: Any bank or express company.

**FOUR** sales daily means \$66 weekly. Many make double selling Richmore Wage Computers. Write Bassett, 710 Transportation Bldg., Chicago.

**WANTED**—Live Traveling Salesman calling on Cigar Dealers, Grocers, Hotels, etc.; Regular or side line, \$30-\$40 weekly. Protected territory. Going fast. Write immediately. Carl D. Heyer Co., Laird, Colo.

**SALESMEN** Wanted—Capable organizing and directing sales force for most necessary Ford accessory ever offered. Successfully demonstrated on thousands of cars. One salesman sold 425 in eight days; \$2.50 profit per sale. Direct to user. If looking for a quick seller with fast profits, write Safety First Devices Co., 724 No. 2nd St., St. Louis, Mo.

**AUTOMATIC** Adds—\$2.50—\$3.50—\$5. Sell quickly. Wonderful sideline. Bassett, 5221-V Indiana Ave., Chicago.

**SIDE** Line Men. Do you want a real one that one order a day will pay you \$3.00. No samples to carry. Something new. Write to-day. Canfield Mfg. Co., 208 Sigel St., Chicago, Ill.

**SALESMEN** calling on Manufacturing and Factory Trade to sell High-Grade Legitimate product as a side-line. No samples to carry. Liberal commission proposition. Write North American Linseed Products Co., Cleveland, Ohio.

**EARN** \$5,000 to \$20,000 yearly. New business necessity. Retail \$5. to \$20. 100-200% profit. Purchaser satisfied or money refunded. No competition. Exclusive territory. Free samples. Sayers, 408 Wainwright, St. Louis.

**SALESMEN**—Get our plan for Mono-gramming Automobiles and motorcycles by transfer methods. Very large profits. Motorists' Accessories Co., Mansfield, O.

#### HELP WANTED

**Do you want to learn to be a first-class machinist or molder?** Wanted: Young men 17 years of age and upwards, ambitious to succeed, to learn the trade of machinist in one of the best equipped shops making machine tools in New England. Also to learn the trade of molder in iron foundry connected with machine shop. Machinery manufactured bears the highest reputation and graduate apprentices always command best rates wherever they go. Write for further particulars to The Hendey Machine Co., Torrington, Conn.

**FOREMEN**, Shopmen, and Office men Wanted to work spare time as special representative of large well-known mail-order house, selling Watches, Diamonds and Jewelry on Credit. Liberal commissions and exclusive sales rights granted. No investment or deposit required for outfit or samples. Write at once for details. Address S. D. Miller, Dept. 14, Agency Division, Miller Bldg., Detroit, Mich.

**WANTED**—Gauge and Toolmakers, also Jig and Fixture Makers, for small interchangeable parts. Call or write to Employment Bureau, N. E. Westinghouse Co., Springfield, Mass.

**GOVERNMENT** Positions are easy to get. My free booklet BY-29 tells how. Write today, now. Earl Hopkins, Washington, D. C.

**WANTED** immediately—Thousands men, women, 18 or over, for U. S. Government Jobs. War means many vacancies. \$100 month. Steady work. Life appointment. Write for list positions, Franklin Institute, Dept. G-21, Rochester, N. Y.

**CIVIL** Service Examinations lead to good government positions. Railway mail pays up to \$1,300; postoffice clerk, carrier, \$1,200; customs, \$2,500; internal revenue, \$2,100; bookkeeper, \$2,500; stenographer, \$1,800; clerk, \$1,800; technical, \$4,000; rural carrier, \$1,200; women, \$1,800; guard, \$840 up. I can coach you by mail at small cost and give bond guaranteeing success or money refunded. Particulars free to American citizens over seventeen. Ask for booklet QE-29, naming position wanted. Earl Hopkins, Washington, D. C.



PICK up some easy money gathering butterflies, insects. I buy 750 kinds. Some \$1-\$5. Intensely interesting. 2c stamp brings prospectus. Get posted. Sinclair, Box 214, 190, Los Angeles, Cal.

DO you want a sure job with big pay, easy hours and rapid advance? Write for my big free book, DW-25, which tells you how you can get a good Government position. Earl Hopkins, Washington, D. C.

THOUSANDS Men-Women, 18 or over, wanted immediately for Government positions. \$100 month. No layoffs. Write for list positions open. Franklin Institute, Dept. G-21, Rochester, N. Y.

CIVIL Service Examinations open the way to good Government positions. I can coach you by mail at small cost. Full particulars free to any American citizen of eighteen or over. Write today for Booklet CE-29. Earl Hopkins, Washington, D. C.

PHOTOPLAYS in demand. Make extra money. We show you how. Details free. Rex Publishers, Box 175 H-16, Chicago.

DO you want a position for life, with big pay, short hours and sure advancement? Men work for Uncle Sam. My free illustrated book DK-29 tells how to get an appointment. Earl Hopkins, Washington, D. C.

FIREMEN, Brakemen, Baggage-men, 8 hours, \$148. Colored Porters wanted everywhere. Experience unnecessary. 810 Ry. Bureau, East St. Louis, Ill.

MEN-Women Wanted, \$75 month. U. S. Government Jobs. Vacancies constantly. List positions free. Write immediately. Franklin Institute, Dept. G-21, Rochester, N. Y.

UNCLE Sam has thousands of jobs open this year. I will help you get one. Write for my big free book, DX-29. Earl Hopkins, Washington, D. C.

GOVERNMENT pays \$900 to \$1,800 yearly. Prepare for coming "exams" under former Civil Service Examiner. New Book Free. Write Patterson Civil Service School, Box 3520, Rochester, N. Y.

WANTED. Men and women to qualify for Government positions. Several thousand appointments to be made next few months. Full information about openings, how to prepare, etc., free. Write immediately for booklet CG-29. Earl Hopkins, Washington, D. C.

BE a Draftsman—Big pay; tremendous demand. Our students quickly qualify for good positions. Complete, practical course; drawing instruments free. We help you secure position when qualified. Columbia School of Drafting, 26 McLachlen Bldg., Washington, D. C.

A POSITION is open for you in the Government service after we have helped you qualify. My money back offer guarantees it. Write quick for big free book DA-29. Earl Hopkins, Washington, D. C.

MEN wanted to make Toy Soldiers, War Novelties, Patriotic Emblems. War stopped all importation. Enormous demand. Greatest future in toy industry. Either on small scale, side line, or large scale. We buy everything, all year, 1917, 1918, 1919, 1920, paying from \$3.25 to \$32.00. Tools and experience unnecessary. Castings free. Booklet and information free. Toy Soldier Manufacturing Co., 33 Union Square, New York.

WANTED: Men for the real-estate business who stand well locally. Send references. Cornell Company, Gt. Barrington, Mass.

FREE Illustrated Book tells of about 300,000 protected positions in U. S. service. Thousands of vacancies every year. There is a big chance here for you, sure and generous pay, lifetime employment. Just ask for booklet CS-29. No obligation. Earl Hopkins, Washington, D. C.

GOOD income refinishing chandeliers, brass beds, automobiles by new method, producing amazing results; no capital or experience necessary; particulars free. Gunmetal Co., Ave. G, Decatur, Ill.

GET a Sure Job with big pay, steady work, short hours, regular vacations, rapid advance. Thousands of positions open with Uncle Sam. I will prepare you in a few weeks at small cost. Write immediately for big Free Book DU-29, with special offer. Earl Hopkins, Washington, D. C.

WANTED—Men, 18 or over, as Railway Mail Clerks. Sample examination questions free. Franklin Institute, Dept. G-21, Rochester, N. Y.

WORK for Uncle Sam. He is the best employer. Big pay, sure work, easy hours, long vacations, rapid advance. Thousands of jobs open this year. I will help you get one. Write for my big free book, DY-29, today. Earl Hopkins, Washington, D. C.

\$180 MONTH paid men—women. Government jobs. Write for list positions. Franklin Institute, Dept. G-21, Rochester, N. Y.

THE Way to Get a Government Job is through the Washington Civil Service School. We prepare you and you get a position or we guarantee to refund your money. Write to Earl Hopkins, President, Washington, D. C., for Book PK-39, telling about 292,296 Government Positions with lifetime employment, short hours, sure pay, regular vacations.

MEN and Young Men to prepare for positions as Draftsmen with the Government and private firms; salaries excellent; unusual demand. Personal attention guaranteed. Get particulars promptly. Columbia School of Drafting, McLachlen Building, Washington, D. C.

INVENT Something. Your ideas may bring wealth. Free book tells what to invent and how to obtain a patent through our credit system. Talbert & Parker, 4102 Talbert Bldg., Washington, D. C.

GOVERNMENT Examinations. Most thorough preparation, \$5; returned if not appointed; particulars free. American Civil Service School, Washington, D. C.

MAKE money writing Photo-plays; details free to beginners. No correspondence course. Producers' League, 230 Wainwright, St. Louis.

#### WANTED

GRAFLEX Wanted. Have Grafonola, Winchester Automatic, Typewriter and camera to exchange. Box 210, Ottumwa, Iowa.

I PAY for name and address of successful magazine subscription agents. J. Robbins, Room 11, 31 W. Lake St., Chicago.

#### SALE OR EXCHANGE

SELL or Trade: Printing Press, 11x16, \$60.00; 5x8, \$20.00; Projection lantern, \$15.00; Oliver Typewriter No. 5, \$39.00; 6X, 8X, 10X, 12X, prism binoculars, \$45.00. LaRoy Zehrbach, Dep't PM-1, Leipsic, Ohio.

WANT to Swap? Send 10 cents for "The Market for Exchange" to Pierre Notley, 141 Milk Street, Boston, Mass. It gives a long list of those who have things to trade or sell. Send list of things you have to trade or sell.

#### GUNS, SPORTING GOODS, ETC.

BUY, sell, exchange old-time and modern Fire-arms. Antiques wanted. Stephen Van Rensselaer, 805 Madison Avenue, New York.

#### BLACKSMITHS

BLACKSMITHS. Listen! Prepare for big wages in Navy and Arsenal with Toy's Modern Methods doing hard jobs easy. Forging and making solid welds, hardening and tempering to a standard, with colored tempering charts. All for one dollar. Samples free. W. M. Toy, Sidney, Ohio.

#### MACHINERY, TOOLS AND SUPPLIES

"RED Devil" Mechanics Piler (drop-forged steel); most efficient, 5-inch size, 60c. Style 59. Tool circulars free. Smith & Hemenway Co., 97B Coit Street, Irvington, N. J.

WIRE—all sizes— $\frac{1}{8}$  to No. 16, Coppered, tinned, galvanized and plain steel wire for a-b. Cooley Mfg. Co., 553 W. Monroe St., Chicago, Ill.

15"x6" PRATT-WHITNEY Screw Cutting Lathe. Price \$119 cash. Western Machinery Co., Cincinnati, Ohio.

FOR Sale Cheap—One new 12 bottom Emerson Engine Gang complete, extra shares. Kohlhoff Bros., Stratford, S. D.

MILLING machine, back geared, Lincoln type, with arbor and vise, overhauled, \$90. Photo. Lucas & Son, Bridgeport, Conn.

PULLEYS, Gears, Sprockets, Shafting, Hangers. See page 146. W. A. Jones Foundry & Machine Co., Chicago.

11" WOOD Lathe, Oliver No. 5 wood trimmer, twenty 1" 4 pitch screws 20" long, small elevator drum and shears. \$29 Lawrence St., Denver, Colo.

FOR Sale, Two Stiles & Parker No. 2 old-style presses, one old-style wooden cone pulley power feed milling machine, no countershaft; also one clock wheel gear cutter. The C. J. Root Company, Bristol, Conn.

TOOLS—for shop, factory, garage and home—many high-class tools attractively priced in our "Odds and Ends" pamphlet—which is mailed free on request by Montgomery & Co., Inc., 105 Fulton St., New York City.

#### FLOUR & FEED MILLING MACHINERY

SPECIAL bargains in second hand Attrition mills, burr mills, crushers, corn shellers, bran dusters, dust collectors, purifiers, reels, double, single, 2 and 3-pair high roller mills, sieve bolters, receiving separators, scooters, etc. Write for description and prices. Sprout, Waldron & Co., P. O. Box 429, Muncy, Pa.

#### ENGINES, MOTORS AND DYNAMOS

SMALL Motors and Generators—Quantity  $\frac{1}{4}$  H. P. A. C. Motors—110 volts—slightly used, \$14.00. Small generators—charging—lighting—moving picture Arc machines, \$10 each and up. A. C. Motors 1 and 3 phase up to 5 H. P. for immediate delivery. Write for Bankruptcy Stock sheet. Johnston, West End, Pittsburgh, Pa.

GUARANTEED alternating and direct current rebuilt motor bargains. Fort Wayne, Crocker-Wheeler, Westinghouse, Wagner, Century, General Electric. All sizes and all guaranteed for one year. Moneyworth or Moneyback. Motors bought and repaired. Send for illustrated wholesale catalog supplies and motors. Hyre Electric Co., 633 FB, South Dearborn St., Chicago.

3 H. P. GAS Engine and 2 K. W. compound generator. Sell \$150.00. Buffalo Elec. Co., 555 Wash. St., Buffalo, N. Y.

ENGINE—Gasoline, 8 H. P. Blakeslee, horizontal, complete, \$250.00. S. J. Stewart [Electric], New Orleans.

GENERATORS, Ball-bearing, 32 volt, 11 to 35 amperes, complete with base and pulley. Prompt shipments. Goodlite Company, Indianapolis, Ind.

NEW 3 Horsepower Grey Boat Engine, cheap. Strang, West Unity, Ohio.

ENGINE User Agents Wanted to use, demonstrate and sell "Big Ben," wonderful new  $\frac{1}{4}$  H. P. gasoline engine. Free introductory offer and free details. C. Benninghofen & Sons, Dept. P, Hamilton, Ohio.

REBUILT Engines—We have rebuilt "Buffalo" Engines, guaranteed, at greatly reduced prices. Write for bargain list. Buffalo Gasolene Motor Co., 1293-1305 Niagara Street, Buffalo, N. Y.

#### ELECTRICAL

ILLUSTRATED wholesale catalog. Big reduction in prices. Electrical motors and supplies, including sockets, switches, resistors, inc. knobs, wire cutouts, cleats, plugs, fuses. Hyre Electric Co., 633 TX, South Dearborn St., Chicago.

100 NEW Telephone Condensers, sizes 1 and 2 Microfarad. Exceptionally cheap. Also rebuilt motors, meters, etc., all sizes. Electric Supply Machinery Co., 527 Van Buren, Chicago.

#### STAMP COLLECTING

STAMPS—500 fine foreign incl. Mex. War, Salvador, incl. officials, Guatemala, China, etc., only 10c. Best App. Sheets 60 to 80c dia. We give valuable extra Presents free! Big 120 pg. catal. free. We buy stamps. Hussman Stamp Co., St. Louis, Mo.

SEND 10c for four months of real stamp news in the Illinois Philatelist, 484017, Woodlawn, Chicago.

15 UNUSED Red Cross Stamps \$1.00. James B. Garvin, Sydenham, Ont.

FREE—Choose one, 200 different international stamps, 101 United States, 25 Persia. Remit 25c, six months' subscription McKee's Stamp Weekly, Beverly, Mass.

FREE. Choose one, 25 different queer Persias, 200 different international, 109 United States. Remit 25c six months' subscription McKee's Stamp Weekly, Beverly, Mass.

STAMPS sent on approval at 70% discount. Reference required. Emory Renoll, Hanover, Pa.

WILL exchange 16-size 17-Jewel Howard watch for choice stamp or Indian collection. Curiosity Shop, Kansas City, Mo.

STAMP collections bought. Wholesale list free. Beebe Company, Yonkers, New York.

FREE—60 different stamps, including Newfoundland, China, Japan, Mexico, etc., to applicants for our high-grade approvals. Send 2c stamp for return postage. The Edgewood Stamp Company, Dept. H, Milford, Conn.

FREE! 25 Different British Colonial stamps to applicants for approvals. Postage 2c. Nickles, 122 Florida Ave., Washington, D. C.



**FREE**—25 different United States, with 60% approval. Enclose 2c. Seidenberg, Beecher, Ill.

200 FINE varieties and buying list of U. S. stamps, 25c. Order today. Dakota Specialty Co., Watertown, So. Dak.

**FREE**—20 Different U. S. Revenues to Approval Applicants. Reference required. Murray, Rock Island, Ill.

**STAMPS** on approval at 60% to 90% discount. Leon Cass, Great Bend, Pa.

**TRY** Pauline's 'Provals and improve your purchases. Premiums, Big discounts. Pauline, Townsend, Montana.

100 DIFFERENT stamps 10c. Rubio, 292 East 89 Street, New York City.

500 MIXED U. S. old and new 12c, \$1.00. Parcel Post, 22c. \$1.00, 1908-12-15. Each 13c. Weatherly, Medina, Ohio.

101 DIFFERENT postage stamps from warring nations, 10c. 50 varieties United States, 10c. Borsch & Potter, 490 Widener Building, Philadelphia.

61 ALL Different Foreign Stamps, including Honduras, Mexico, China, Peru, Australia, Egypt, Japan, Chili, Russia, Argentina, Brazil, Cuba, India, Portugal, etc. Only 7 cents. Royal Stamp Company, 48 N. 51st Street, Philadelphia, Penna.

24 VARIETIES Cuban stamps, 10 cents. List of 6,000 low-priced stamps free. Chambers Stamp Co., 111 P. Nassau St., New York City.

**STAMPS**, 75, all different, free. Postage, 2c. Mention paper. Quaker Stamp Co., Toledo, Ohio.

**STAMPS**—12 different from warring nations, 10c; 10 different foreign coins, 15c; 20 Belgian stamps, 10c. Lists free. Toledo Stamp Co., Toledo, Ohio.

**ASSORTMENT** Siamese stamps; satisfaction guaranteed. One Dollar, check or draft. McQuerry, Bangkok, Siam.

**STAMPS**, 58, all different: Malay (tiger), Bolivia, China (junk ship), Mexico, etc.; an album and Perforation Gauge, all for 5c. Interesting List Free. Pays Stamp Co., 138 No. Wellington St., Los Angeles, Calif.

**PACKET "A"** 100 varieties foreign stamps, 20c. F. J. Pope, Charlotte, Vermont.

#### RARE COINS

**CALIFORNIA** gold, quarter size 27c, 1/2 size 53c, dollar size \$1.10. Large cent before 1821, Columbian nickel coin, and catalogue, 10c. Norman Shultz, King City, Mo.

**OLD COINS**, Large Fall Coin Catalogue of Coins for Sale, free. Catalogue quoting prices paid for coins, ten cents. William Hesslein, 101 Tremont St., Boston, Mass.

**VILLA**, Carranza and Infalsifiable; Genuine Paper Money; 2 Cts. a Peso. Rare silver Mexican coins. Details: Luis E. Royen, San Luis Potosi, Mexico.

**TWO** Uncirculated Villa Copper Coins 25c. Moore Coin Company, Commerce, Texas.

**CASH** paid for old money of all kinds; \$5.00 for certain eagle cents; \$7.00 for certain 1853 Quarters, etc. Send 4c. Get Large descriptive Coin Circular. May mean your large profit. Send now. Numismatic Bank, Dept. H, Fort Worth, Texas.

#### GAMES AND ENTERTAINMENTS

**MAGIC**—Tricks, Books and Supplies. For Amateurs as well as the Great Professionals. Any one can learn through our instructions. Feature Acts in Mind Reading, Spiritualism, Rope Ties, etc. Large Illustrated Professional Catalogue, 10c. Chicago Magic Co., Dept. B, 72 West Adams St., Chicago, Illinois.

1,000 STAGE and Parlor tricks, Illustrated Catalog 10c. Small Catalog free. Second-Hand Apparatus bought or exchanged. Hornman Magic Co., Sta. 10, 470 8th Ave., New York.

**TRICKS**, Puzzles, Jokes, Magical Apparatus, Plays, Stage Supplies, Mind-reading Acts, Sensational Escapes, and Illusions. Free large illustrated 1917 catalog. Oaks Magical Co., Dept. 441, Oshkosh, Wis.

**HANDCUFFS**, Escapes, Secrets, Large stock, Lowest prices, Send for list. Box 264, Juneau, Alaska.

#### THEATRICAL GOODS

**SCENERY** supplied. Anywhere. Everywhere. Moderate Rental. Amelia Grain, 819 Springgarden, Philadelphia, Pa.

#### FOR BOYS

25c BUYS 12 beautiful American colored patriotic poems. Sells for 5c. Sovereign Pub. Co., 160 Sycamore, Buffalo, N. Y.

#### FOR MEN

**INTELLIGENT** people everywhere appreciate my invention. Samples, 10c. DeLoof, AG-247 Harmon, Detroit.

#### RAZORS AND BLADES SHARPENED

**SAFETY** razors sharpened; two cents each. Guaranteed. Blade box free. Electro Stropping Co., 134 Shelby St., Detroit, Mich.

#### FOR THE HOME

**"EGGETTE"** (the original egg substitute) takes the place of eggs in all kinds of baking and cooking. Simple to use—always fresh. Guaranteed pure food product. Makes delicious cakes, cookies, puddings, etc. 10c package equals 12 eggs. Send 10c for a package today. (Agents Wanted.) Best-ever Products Co., B-9 Douglas Park Sta., Chicago, Ill.

**PERFUMES**—Wickersham's Concentrated Floral Perfumes. 25 times the strength of common ordinary perfumes; very fine fragrances: Garden Flowers, Lilac, Heliotrope, Violet, Carnation Pink, Orient, Locust, Rose, Romberg, Hyacinth, Lily, Trefle. One bottle 55c, three bottles \$1.45, 12 drop samples 10c. Ora Wickersham, Perfumer, Friendswood, Texas.

**NEW** Invention. Handy household utensil. To introduce sample, 15c. Whitcomb, Mfr., Station C, Detroit, Mich.

**BUSINESS** Cards, 100, 25c; 1,000, \$1.50. Wilson Co., 1108 Locust, Cincinnati, O.

#### DIAMONDS, WATCHES AND JEWELRY

**GUARANTEED** gold filled Waldemar chains 48 cents; Vest chains 75 cents. Watches, Jewelry, prices beat an auction. Write: J. O'Neil, Hammond, Oregon.

#### PIANOS AND MUSICAL INSTRUMENTS

**HENNING'S** Artist Violins. Perfection in tone. Finest workmanship. Ten days' trial free. G. Henning, Miami, Fla.

**BEBE** Violins, deep, mellow tone, easy payments. Colored photo and particulars. 150 Clinton St., Muskegon, Mich.

#### PHONOGRAPHS AND RECORDS

**BUILD** Your Own Phonograph. Any type, Big saving. Patents expired. Profits making and selling them. We furnish parts you can't make. Full instructions, dimension drawings, illustrations, parts—price-list only 25c. Circular Free. Associated Phonograph Co., Dept. P, Cincinnati, O.

#### MUSIC

**FOUR** Latest Song Hits: "Be Prepared," "Mammy's Little Carolina Coons," "I Want to Go Where the Climate Suits My Clothes," "When It's Cotton Time in Dixie-land." 10 cents a copy. Agents wanted everywhere. R. C. Young Music Co., Columbus, O.

#### FORMULAS AND TRADE SECRETS

75 **MANUFACTURING** Secrets 10c. 1,600 Formulas 25c. Luminous Paint; Gas Toner; Mechanics Soap; Renewing Dry Batteries—Resilvering Mirrors, 20c each. Entire collection 50c. Satisfaction guaranteed. "The Ideal," Box 543-K, Chicago.

10 **LUMINOUS** Paint formulas (different colors) 25c. Sneeze Powder—Itch Powder—10c each. "Bestoval," Box 543-F, Chicago.

**INVISIBLE** Ink—Formula 15c. Manufacturing cost under 5c per pint. Frederic Mahon, 9 South Grove Ave., Rockaway Beach, N. Y.

#### ANTIQUES AND RELICS

**INDIAN** curios, baskets, engravings and autograph letters, bought and sold. Helm-muller Art Co., 1307 14th St., Washington, D. C.

**ANCIENT** Indian arrow heads. Send for lists. A. Ruby, Middletown, Pa.

**POMO** Indian Star Baskets. Prices free. Gilham, Highland Springs, Cal.

#### GINSENG

**GINSENG** planting instructions free. Seeds \$1.00 thousand. Specialty Farm, Rockford, Minn.

#### DUPLICATORS AND DEVICES

**"MODERN"** Duplicator—a Business Get-ter. \$1 up. 50 to 75 copies from pen, pencil, typewriter; no glue or gelatine. 35,000 forms use it. 30 days' trial. You need one. Booklet Free. J. E. Durkin & Reeves Company, Pittsburgh, Pa.

#### TYPEWRITERS AND SUPPLIES

**SPECIAL** Sale on High Grade Guaranteed Rebuilt Typewriters, Underwoods, \$30. L. C. Smith's, \$30. Remington's, \$28. Blind Writer's at \$12 and \$14. W. H. Fox, 106 N. La Salle St., established 12 years, Chicago, Ill.

**STARTLING** Values in Typewriters. \$10 to \$15, up. Factory rebuilt. All makes. Shipped on trial. Write for our special offer No. 126-J. Whitehead Typewriter Co., 186 North LaSalle St., Chicago.

**TYPEWRITERS**, all makes factory rebuilt by famous "Young Process." As good as new, look like new, wear like new, guaranteed like new. Our big business permits lowest cash prices, \$10 and up. Also, machines rented—or sold on time. No matter what your needs are we can best serve you. Write and see now. Young Typewriter Co., Dept. 326, Chicago.

**LARGEST** Stock of Typewriters in America. Underwoods, one-fourth to one-half manufacturer's prices; rented anywhere, applying rent on purchase price. Free trial. Installment payments if desired. Write for catalogue No. Typewriter Emporium, estab. 1892, 34-36 W. Lake St., Chicago, Illinois.

**NEW**, Rebuilt and Slightly Used Typewriters, \$8 up. Portable Machines, \$10 up. Write for our catalog 50-N. Beran Typewriter Co., 58 W. Washington St., Chicago.

**WE** have a number of second-hand machines traded in on the new model Victor No. 3. All overhauled and in perfect condition. Like new. Write for list and particulars. Victor Typewriter Sales & Supply Co., 69 W. Washington, Chicago.

#### PRINTING, ENGRAVING AND MULTIGRAPHING

500 **BOND** Letterheads or Envelopes \$1.25. 1,000 \$2.25. 250 of each \$2.00. Circulars, Billheads, Booklets, Imitation typewritten letters. Samples free. Leonard Mfg. Co., Memphis, Tenn.

**MAKE** Money. Print cards, envelopes, letterheads, calendars—easy. Outfit \$35. Fizerman, 110 N. Main, Wilkesbarre, Pa.

**CIRCULARS**—1,000, 3x6, 90c; 4 1/2x6, \$1.15; 6x9, \$1.75. Chas. Walter, Lancaster, Ohio.

**PRINTING**: Then try us first for satisfaction. 500 nice Certificate bond letterheads and envelopes only \$4.00. Peerless Press, Norton, Mass.

100 **VISITING** cards 25c. Hillside Press, 72 Hillside Ave., Newark, N. J.

250 **BOND** Letterheads 80c. Frank Emerson, Brooklyn, Michigan.

**INTRODUCTORY** Offer—100 large letterheads and 100 envelopes, printed; \$1.00. Samples free. Frank Christensen, Moran, Mich.

**INCREASE** your business! Suggestions free. Edward Harrison, "Printing," Baltimore, Maryland.

**CARDS**—Mask, Card Specialist, 84 Detroit Street, Milwaukee, Wisconsin. Samples free.

**PERFECTION** Letter Company, Muncie, Indiana. Multigraphs 500 purple letters with black letter heads. \$2.15. Samples for stamp.

3,000 **GUMMED** Labels for \$1.00—also 1"x2". Circular free. Catalogue 2c Stamp. The Helmers Company, Hoboken, New Jersey.

**PRE-USED** Printing presses, Type, Supplies, cheap. List for stamp. Popular Bargains, Richland, Pa.

**AT** Last! Beautiful Lithography for small users. 1,000 Letterheads, 1,000 Billheads and 1,000 Statements. \$9.99. Engraving Free. Kaylee Lithographing Co., 764 Teutonia, Milwaukee.

**PRINTING** Outfits—Presses, type, supplies, type novelties. Send stamp for catalogue. Model Press, York, Penna.

**GOOD** Printing at low prices. 1,000 good letterheads, envelopes, cards, billheads, labels, circulars, \$2.50. Samples free. Catalogues, booklets and circulars our specialty. Ernest L. Pantus Co., 523 S. Dearborn St., Chicago.

**WE** print anything. Cuts made from photograph. Samples. Commercial Press, Batavia, Ohio.



## PATENT ATTORNEYS

**PATENTS Secured or Fee Returned.** Actual search free. Send sketch or model. 1917 Edition, 90-page patent book free. My patent sales service gets full value for my clients. It should never require more than two days to report upon the patentability of your invention; nor longer than ten days to prepare your application for filing. Longer delay amounts to gross neglect and the jeopardizing of your rights. For prompt personal service write, George P. Kimmel, 212 Barrister Building, Washington, D. C.

**PATENT** applications filed on partial payment plan. We help sell the patent. Trademarks, copyrights, etc. Milo B. Stevens & Co., 655 F St., Washington, 353 Menadock Bldg., Chicago. Estab. 1864.

**THE** Patenteer is free. An education in obtaining patents. Established 1865. Anderson & Son, Attorneys, 707 7th St., Washington, D. C.

**PATENTS.** R. Morgan Elliott & Co., Patent Attorneys, Mechanical, Electrical and Chemical Experts, 713-721 Woodward Bldg., Washington, D. C.

**IDEAS** are Valuable. I help you market them. Write to-day for books and manufacturer's wants. J. R. Kelly, 749-A Woodward Building, Washington, D. C.

**PATENTS** Worth While. No free searches, no free booklets, no premiums, no trading stamps. Samuel Herrick, Master of Patent Laws, Washington, D. C.

**PATENT** Sense—"The book the Inventor Keeps." Worth more than all other patent books combined. Free. Write R. S. & A. B. Lacey, 105 Barrister Bldg., Washington, D. C. Established 1869.

**HIGH-VALUE** Patents. See R. S. & A. B. Lacey's advertisement on page 163.

**PATENTS** Bring Riches; Protect Your Invention. Attorney's Fee payable when patent allowed. Plain advice and "Patent Facts" free. Trade-marks registered. Jaynes & Jaynes, 653 Kellogg, Washington, D. C.

**PATENTS** that protect and pay. Advice and books free. Rates reasonable—highest references; best results. Watson E. Coleman, Patent Lawyer, 624 F St., N. W., Washington, D. C.

**PATENTS**—Herbert Jenner, patent attorney and mechanical expert, 596 F St., Washington, D. C. I report free of charge if a patent can be had and its exact cost. Send for circular.

**H. L. WOODWARD**—Safe methods. Paying patents. Write today, 902 G. St., Washington, D. C.

**INVENTORS:** Let us sell your patent. Send for our liberal proposition. Atlantic Supply Co., Long Branch, N. J.

**PATENT** Your Ideas—\$9,000 offered for certain inventions. Books, "How to Obtain Patent," and "What to Invent," sent free. Send rough sketch for free report as to patentability. Manufacturers constantly writing us for patents we have obtained. We advertise your patent for sale at our expense. Established 20 years. Address Chandler & Chandler, patent attorneys, 1090 F St., Washington, D. C.

**PATENTS** Wanted. Write for list of Patent Buyers who wish to purchase patents and What to Invent, with list of Inventions Wanted. \$1,000,000 in prizes offered for inventions. Send Sketch for free opinion as to patentability. Write for our Four Guide books sent free upon request. Patents advertised Free. We assist inventors to sell their inventions. Victor J. Evans & Co., 166 Ninth, Washington, D. C.

**"PATENTS and Patent Possibilities"** is a 72-page treatise which tells all about patents, what to invent and where to sell it. It gives honest advice to inventors and tells about the successes of some of my clients, also explaining what are frequent causes of failure. Manufacturers are constantly writing for protective patents upon all kinds of sound inventions. Can you help supply their wants? The book is free. Write for it today. H. S. Hill, 995 McLachlin Building, Washington, D. C.

**PATENTS** secured. Write for our booklet; it tells how to protect your ideas and how to proceed with your invention to make money. Featherstonhaugh & Co., 490 Victor Building, Washington, D. C. 35 years' practice in U. S. and Canada.

**DON'T** Lose Your Rights to Patent protection. Before proceeding further send for our blank form "Evidence of Conception." to be signed and witnessed. Book, suggestions and advice free. Lancaster & Altwine, 221 Ouray Building, Washington, D. C.

**PATENT** What You Invent. It may be valuable. Write me. No attorney's fee until patent is allowed. Estab. 1882. "Inventor's Guide" Free. Franklin H. Hough, 522 Loan & Trust Bldg., Washington, D. C.

**KEEP** Up with Progress. Promote your patent. Send \$1.00 for year's subscription to best Inventor's Magazine, "Invention and Manufacturing." United States Patent Corporation, Washington, D. C.

**PATENTS**—Send sketch for free search and report. Books on patents and book of reference letters sent free. John S. Duffie & Co., 610 F St., Washington, D. C.

**INVENTORS:** Write our Patent Dept. Adam Fisher Mfg. Co., 2061 C Railway Exchange, St. Louis, Mo.

**PATENTS** obtained through D. Swift being promptly sold to manufacturers. Write today for free books of "Inventions Needed" and surpassing references. D. Swift, 317 Seventh St., Washington, D. C.

**INVENT** Something. Your ideas may bring wealth. Free book tells what to invent and how to obtain a patent through our credit system. Talbert & Parker, 4280 Talbert Bldg., Washington, D. C.

**PATENTS** on easy payments. Send model or sketch for Free Search and Certified Registration of Your Invention for Your Protection. Free Book Tells What to Invent and How to Obtain a Patent on Easy Payments. C. C. Hines, 591A Loan & Trust Bldg., Washington, D. C.

**PATENTS** without advance attorney's fees. Send sketch for free report. Books free. Frank Fuller, Washington, D. C.

**PATENT** secured or fee returned. Hundreds of inventions sold yearly. We will help you sell yours. Send model or sketch. Books and advice free. Suss & Co., Est. 30 years, 530 7th St., Washington, D. C.

**PROTECTIVE** patents procured promptly. 104-page blue book on patents sent on request. Trade-marks registered. Robb & Robb, 211-215 Southern Bldg., Washington, D. C.

**PATENTABLE** Ideas Wanted—Send for 4 free books. R. B. Owen, 39 Owen Bldg., Washington, D. C.

## FOR INVENTORS

**HAVE** You An Idea? If so, you should protect it by a patent. Send us a model or sketch for free opinion as to patentability. Write for our Four Books sent free to any address. Victor J. Evans & Co., 157 Ninth St., Washington, D. C.

**INVENTORS:** Invent for profit. Write for list of needed inventions. Sanders, 7 Webster Bldg., Chicago.

**CAST** that model! Alloys melt 180F—wet plaster molds—cheap—no machinery—6 formulas sent for \$1. Harris Mallory, Castle Rock, Wash.

**HAVE** you a Patent to sell? You'll be interested in my proposition. Write now for free particulars. Don't call. F. W. Johnson, 6 N. Michigan Ave., Chicago.

**PATENTS, Trade-Marks and Copyrights.** Our handbook on patents will be sent free on request. All patents secured through us are described without cost to the patentee in the Scientific American, Munn & Co., Patent Attorneys, 623 Woolworth Bldg., N. Y. Washington, D. C., office, 625 F St.

**WANTED** — Money-making inventions; send copy for reply. 55E McMillen, Cincinnati, Ohio.

**INVENT** Something. Your ideas may bring wealth. Free book tells what to invent and how to obtain a patent through our credit system. Talbert & Parker, 4280 Talbert Bldg., Washington, D. C.

**INVENTIONS**—Patenting and Promoting. A book containing practical advice and directions for inventors and manufacturers. Book, suggestions and advice free. Lancaster & Altwine, 221 Ouray Bldg., Washington, D. C.

**HIGH-VALUE** Patents. See R. S. & A. B. Lacey's advertisement on page 163.

**NO** Attorney fees until patent allowed. Send sketch for free report. Books free. Frank Fuller, Washington, D. C.

**INVENTORS**—We specialize in manufacturing new patented articles—make models—dies—and do experimental work. Leo J. Gerding Mfg. Co., Dept. D, Opera Place, Cincinnati, O.

**INVENTIONS** commercialized on cash and royalty basis. Patents secured. Models, experimental work and contract manufacturing. Inventors should write at once. Adam Fisher Mfg. Co., 2061A Railway Exchange, St. Louis, Mo.

**INVENT** Something. Your ideas may bring wealth. Free book tells what to invent and how to obtain a patent through our credit system. Talbert & Parker, 4280 Talbert Bldg., Washington, D. C.

**PATENTS** on easy payments. Send model or sketch for Free Search and Certified Registration of Your Invention for Your Protection. Free Book Tells What to Invent and How to Obtain a Patent on Easy Payments. C. C. Hines, 591A Loan & Trust Bldg., Washington, D. C.

**PATENTABLE** Ideas Wanted—Send for 4 free books. R. B. Owen, 39 Owen Bldg., Washington, D. C.

## PATENTS FOR SALE

**PATENTED** Automatic Change Tray. Neatest novelty in years. Low cost. Big profits. Universal sale. T. L. Paine, Milwaukee, Wis.

**OUTRIGHT** Sale or Promotion Basis—Automatic Coin-Operated Shoe-Polishing Machine, polishes both shoes at the same time. Large cash profits every day. Model demonstrating machine. Inventor, 1329 Greenmount Ave., Baltimore, Md.

**U. S. PATENT** No. 1,183,484—Speedy Flying Machine—\$159,000. E. Page, 401 O'Connell's Alley, Charleston, W. Va.

**MANUFACTURERS**—For money-making inventions, call or address Mutual Service Bureau, 55E McMillen, Cincinnati, Ohio.

**WARNING** Signal means for garages. Give warning when automobile approaches door. Permit passers-by to avoid danger. Signal in floor, operated by passing wheels of automobile. T. D. Warner, 112 W. Washington, Jonesboro, Ark.

**U. S. PATENT** 1,212,383 for sale. Automatic shutter operating device for photographic apparatus. Simple device. Low cost of manufacturing. Outright or royalty basis. Write for particulars. S. Nagy, Bay Shore, Long Island, N. Y., Box 202.

**MANUFACTURERS, Capitalists, Railway Supply Dealers,** write us today for particulars of Kelly's patented station indicator for Trains, and City and Suburban Electric Cars. U. S. Patent rights for sale on reasonable terms, cash or royalty. Great possibilities for big money-making in the manufacture and sale of this new invention. Write today if interested in manufacturing or financing this proposition. No triflers need apply. Talbert & Parker, Talbert Building, Washington, D. C.

**FOR** Sale: Patent No. 1,216,142, February 13, 1917, Gang Plow Hitch or equalizer. Simple and efficient, entirely new, eliminates draught. Will consider any reasonable offer. For particulars, write H. O. Lantzer, Aurora, Nebraska.

**FOR** Sale. Potato Harvester, fork digger and sacker. Patent pending. J. Jerome, Battle River, Minn.

**PATENT** No. 1,237,040, twelve in one kitchen utensil. Can be stamped in one piece by one operation. Copies of this patent, five cents each. Address Commissioner of Patents, Look it up and make offer. Geo. E. Henry, 6211 Girard Ave., Philadelphia.

**WONDERFUL** Invention—If you want to get rich in a short time. Investigate, my patent Sewing Device. It is the greatest Pocket Sewing Machine ever invented. I will sell all or part of my foreign Patents. C. A. Myers, 6316 University Ave., Chicago, Ill., U. S. A.

**MOTOR** driven hair-cutting machine. Something like vibrator. Designed for man, horses, etc. Manufacturers, Patent Buyers or promoters' correspondence invited. G. P. Bourdelat, Aberdeen, N. C.

**WILL** take reasonable offer for U. S. Patent, number 1,229,624; on improved Hatchet Wrench. Address Allan Gibson, 16 Honiss Place, Newark, N. J.

**MY** invention an Automobile Fender, Patented United States and Canada, for sale. Strong, durable, simple of construction, inexpensive, badly needed, tremendous market, investigate. Alfred J. State, 2254 Mance Street, Montreal, Canada.

**FOR** Sale—Patented fly trap for screen doors. Ira E. Sager, Box 662, Victor, Colo.

**PATENTS** For Sale or on royalties. Recently patented cigarette roller—can be manufactured very cheap. Instantly rolls any kind of tobacco. Peter Hayn, 1796 Gates Ave., Brooklyn, N. Y.

**FOR** Sale at royalty. Patent on new skirt pin. Holds skirt in place. Miss Frances Rule, Hampton, Iowa.

**SAFETY** First—Elevator safety locks, Canadian patent number 178,332; U. S. pat. pending. Outright or royalty. J. A. Dierst, Modesto, Cal.



**PATENT for Sale.** Apply O. S. Baldwin, Batesville, Ark.

**BID your city of smoke;** perfect invention; by-product pays. Specifications on request. Frank Westbrook, Altonah, Duchesne Co., Utah.

**OUTRIGHT or royalty,** an electric gas stove lighter. A household necessity. Charles A. Lawrence, 4306 Lake St., Omaha, Neb.

**MUST sell patent on very novel and practical commercial specialty.** Write Jno. W. No. 102, Poe Mill, Greenville, S. C.

**PATENT Buyers** are invited to address our sales department for information on any sales of Patents they wish to purchase or lease on a royalty. We have secured a number of valuable patents in all lines of invention. Mail Order, Department Store and Household Novelties a specialty. Victor J. Evans & Co., 169 Ninth St., Washington, D. C.

**FLEXIBLE transparent window panel,** can be rolled up or down, to open or close the entire window. Outright or royalty. J. R., 399 Dolores St., San Francisco, Calif.

**AUTOMATIC Tankless, Packless, Leakless Toilet Flushing Valve.** Simplest invented. Patents pending. Particulars free. Neary, 239 Superior St., Victoria, British Columbia.

**FOR Sale:** U. S. and Canadian Patents on Self-Oiling Floor Mop, different from others. For terms apply to Edwin Nahr, 1050 Elm Ave., Long Beach, California.

**AUTOMATIC controller for Hot Air furnace.** Patented device. Large field for sale. Will consider sale or royalty proposal. E. B. Jones, 413 Opera Block, Lima, Ohio.

**PATENTED Ventilating Smoke Jack.** Economical. For fire protection it's the best. Four largest R. R. Companies bought manufacturing rights for own use. Renstrom, 669 E. 37th, Chicago.

**FOR Sale—Germ-proof milk-bottle cover.** Patent applied for. H. K., Room 925, 78 E. Madison St., Chicago.

**MOTORCYCLE Stand Catch.** Just issued. Works automatically. Quickly attached to any motorcycle without alteration. Cheaply manufactured with good profit. Clyde Schwyler, Pluma, Kans.

**FOR Sale.** Patent. Sugar Beet Harvester. Combined topping and loading mechanism. Thos. McCabe, Maywood, Ill.

**BASIC patent, inexpensive auto accessory,** allowed May, 1917, low manufacturing installation and cost. William C. Koch, St. Paul, Minn.

**PATENT No. 1,197,108 Auxiliary Trolley Device,** removes ice and sleet from trolley wires, much needed, cheaply built, all development work done. Elmer P. Schell, Windfall, Ind.

**GASOLINE gauge for Ford cars.** Can be manufactured cheaply. U. S. Pat. pending. Outright, J. A. Dierst, Modesto, Cal.

**FOR Sale—Toy Motion Pictures; Merry Go Round Toy; Out-door Amusement on Merry Go Round See-Saw; Home-made Stereoscopic Motion Pictures; Combined Safety Window Cleaning Seat and Rocking Chair.** Many others. Apply H. C. Tanabe, Marysville, California.

**AUTOMATIC Faucet for use on water cooler or coffee urn.** Patent for sale for cash or on royalty basis. Thos. Coonan, Alamosa, Colo.

**PATENTS for Sale or Lease, cash or royalty;** our Number 10033 Sawing Apparatus (U. S. and Foreign patents); 10001 Improved Ball Joint; 10464 and 10534 Land Marking Attachment for Planted and Improved Clutch Mechanism. Write for further information. Other patents for sale. Get your name on our list of Patent Buyers. Talbert and Parker, 4687 Talbert Bldg., Washington, D. C.

**PATENTED improved "Article-Carrier."** Cash or royalty basis. Reasonable terms. U. S. Patent No. 1,177,692. Canadian Patent No. 175,789. For full particulars address Joseph Fallis, Gunn, Wyoming.

**WE have some money-making inventions for placing on royalty;** outright sale or trade. Write Adam Fisher Mfg. Co., 2061B Railway Exchange, St. Louis, Mo.

**INVENTOR has ninety inventions.** Will give interest in each to the person who backs me financially. Particulars free. Elmer Paul, Box 497, Greensburg, Pa.

#### MANUFACTURING

**WIRE Goods,** all kinds, made to order. Cooley Mfg. Co., 553 W. Monroe St., Chicago.

**INVENTIONS manufactured under contract.** Write Adam Fisher Mfg. Co., 2061B Railway Exchange, St. Louis, Mo.

#### MODELS AND MODEL SUPPLIES

**WE make working models for inventors;** also dies and stamping of specialties, and carry a complete stock of brass gears and model supplies. Send for catalogue. The Pierce Model Works, 3405 Pierce Ave., Chicago, Ill.

**PERFECT models sell inventions.** We make them. Write Adam Fisher Mfg. Co., 2061B Railway Exchange, St. Louis, Mo.

**MODELS, Punches and Dies.** Patents Perfected. The Sachs-Lawler Co., Inc., Established 1881, 1543 Larimer St., Denver, Colo.

**WANTED—New Ideas.** Write for list of Patent Buyers and Inventions Wanted. \$1,000,000 in prizes offered for inventions. Our Four Books sent free upon request. Victor J. Evans & Co., 165 Ninth, Washington, D. C.

#### REAL ESTATE AND FARM LANDS

**A SMALL farm in California will make you more money with less work.** You will live longer and better. Delightful climate. Rich soil. Hospitable neighbors. Good roads, schools and churches. Write for our San Joaquin Valley illustrated folders free. C. L. Soagaves, Industrial Commissioner, AT&SP Bldg., 1933 Ry. Exch., Chicago.

**SELL your property quickly for cash,** no matter where located. Don't pay big commissions. Particulars free. Real Estate Salesmen Co., Desk B, Lincoln, Nebr.

**11 1/2 ACRE Farm,** \$175.00 per acre; will take Automobile. J. Coder, Ames, Iowa.

**FOR Trade or Sale—Chicago income property,** any size deal, for what have you. L. M. Smith & Bro., 3048 Drexel Blvd., Chicago.

**FOR Sale—Ideal home on Mobile Bay,** 29 Acres, \$5,000. J. Matson, Point Clear, Ala.

**25-ACRE Grapefruit Grove—Present crop should pay one-quarter of price asked for property,** \$20,000. E. H. Mote, Leesburg, Florida.

**THIS Little Farm in Virginia is an ideal poultry and fruit proposition;** located in fine community at railroad station and general store in beautiful Shenandoah Valley; 2 miles from good town; modern five-room bungalow, nicely furnished; price \$1,250, easy terms. Send for magazine and list of farms from \$500 up. F. H. Lattaume, Agrl. Agt. N&W Railway, 250 N. & W. Building, Roanoke, Va.

**15 STATES, \$10 an acre up;** stock, tools, and crops often included to settle quickly. Write for Big Illustrated Catalogue. Strout Farm Agency, Dept. 3043, New York.

**BEAUTIFUL Seashore Homesites only \$20.** Special site lots at Alamo Beach, Texas, famous Bayside resort. First 100 lots \$20. Terms \$1 cash, \$1 monthly. Lots 50x140 feet. Splendid investment. Write for free literature and views. Alamo Beach Company, 422 First National Bank, Houston, Texas.

**FOR Sale—Well located Wisconsin out-over land or nice Iowa farm.** Good terms, low price. Write owner, Dr. A. A. Lynn, Waterloo, Iowa.

**SEND name, receive free offers from land owners everywhere.** Mohler, Box 453, Chicago.

**OWN your own Orange or Grapefruit grove in beautiful Fruitland Park.** Let me tell you how melons, peaches, hay, your first crops, should pay for your land and grove. J. G. Lloyd, Desk 93, Fruitland Park, Florida.

#### DOGS, BIRDS, POULTRY, PETS

**SQUABS are raised in one month,** they sell for fancy prices. Write at once for big free book telling how to make money breeding squabs. Plymouth Rock Squab Co., 634 Howard St., Melrose Highlands, Massachusetts.

**RAISE skunks in city or country.** Odorless method. Illustrated circular P free. Skunk Development Bureau, Chicago.

**BIG Money in Pigeons and Squabs.** Free book tells you all about it. Write today. Start profitable business of your own. Demand unlimited. Investment is small. Write today for Free Book. Indiana Squab Co., Dept. 1197, Terre Haute, Ind.

**FOR Sale—Scottish terrier pups from registered stock.** Price \$10-\$15. Ernest Jooz, Tenney, Minn.

**HOUNDS for any game, guaranteed.** Three States Kennels, Somerset, Ky.

**MAKE Big Money Raising Belgian Hares.** Our co-operative plan sent free. Write Mark Twain Stock Assn., 307, Hannibal, Mo.

**IRISH Setter puppies, fifteen dollars up,** according to age. Bred from pedigreed, registered stock. Walter McRoberts, Peoria, Ill.

**FOR Sale—At wartime prices,** Choice unrelated real Northern Canada Silver Black Foxes in pairs. Reid Bros., Bothwell, Ontario, Canada.

**2,000 FERRETS.** Prices and book free. N. A. Knapp, Rochester, Ohio.

**REGISTERED Collie, Female;** bred, \$15; Male Puppies, \$10. Carl Paulson, Arapahoe, Colorado.

**RAISE Guinea Pigs, more profitable than poultry.** Big demand. Thousands needed. Experience unnecessary. Send for our money-making proposition and big free illustrated book, explaining all. Laboratory Supply Co., Dept. K, 2841 Ridge Ave., Phila., Pa.

**EARN \$20 weekly raising Belgian Hares.** Particulars 10c. Anderson's Rabbitry, 2421 Ogden, Denver, Colorado.

**RAISE Belgian Hares for us, Flemish Giants and New Zealand.** Profits large. We supply stock and pay \$3.00 each. Also Cavies, Squab Breeders and fur-bearing animals. Instruction book and contract for dime. None free. Outdoor Enterprise Co., Box 13, Main St., Holmes Park, Mo.

**TRAINED beagles, rabbit hounds, fox-hounds, coon, skunk dogs, ferrets,** catalogue 10c. Brown's Kennels, York, Pa.

**RAISE Guinea Pigs for us.** We buy all you raise. Pay better than poultry. Contract, particulars, booklet how to raise free. Cavies Distributing Co., 3102-A Grand Ave., Kansas City, Mo.

#### PERSONAL

**PROTHER—Discovered pleasant root,** chewed like gum, quickly overcomes tobacco habit. Gladly send particulars. Franklin Stokes, Mohawk, Florida.

**Do you want to enjoy good health?** If so, write at once to Edgar D. Brinkerhoff, Fall River, Mass.

**WHY be only half alive? Get well.** Enjoy life. Let Prof. Ogden tell you how you can become a new being through "Energized Blood." Write for free book today. Ogden College, 414 Bell Block, Cincinnati, O.

**FREE—Stop using tobacco.** We will give free information how to conquer habit easily and permanently. Results Guaranteed. Anti-Tobacco League, Box 370, Omaha, Nebr.

#### MISCELLANEOUS

**WISE Miners, buy centrifugal gold savers.** Works five yards gravel per day. Price \$15.00. E. W. Meyer, Niles, California.

**IF You want to buy home with 3% money—Address, United Sister and Brotherhood of the World, Home producing, Saving Organization, 125 W. 12th, Pueblo, Colo.**

**ADDING Machines \$2.50—\$3.50—\$5.** Bassett, 5921-W Indiana Ave., Chicago.

**LUMINOUS Paint, shines in the dark.** Our Luminous Paint, coated on any article, makes them visible at night. Watches, clocks, electric switch plates, crucifixes, match boxes, etc., can be coated with splendid results. (Everlasting.) Only 25c bottle. Luminous Paint Co., Douglas Park Station, B-21, Chicago, Ill.

**PICK up some easy money gathering butterflies, insects.** I buy 750 kinds. Some \$1-\$7. Intensely interesting. 2c stamp brings prospectus. Get posted. Sinclair, Box 244, D-5, Los Angeles, Cal.

**GRANDFATHER'S Clocks.** Build your own Grandfather's Clock with our free blue prints. Works. Dial, etc., \$5 and up. Others with chimes at all prices. Write for free offer. Clock Co., 1671 Ruffner St., Philadelphia, Pa.

**RUBBER stamps, stencils, seals.** Catalogue 15c. Walter Karstaedt, Dayton, Ohio.

**MAKE your own Printing Cuts cheaply.** "Art of Cutmaking" tells how. 25c. "Bestorall," Box 543-PC, Chicago.

**HEATING System which saves you hundreds of dollars.** Adapted to any furnace for heating Libraries, Schools, Churches, Hotels or wherever heat or steam is required. Easily installed. Patented. Burner and Steam-generator \$50. We employ no salesmen. Root Crude Oil System, 2025 C Street, Eureka, Calif.

**CUTS anybody can make.** Simple, cheap process \$1. Specimens, particulars for stamp. M. Day, Windfall, Ind.



# Get This Car

**And the Agency for Your Territory**

114-inch  
Wheel  
Base  
  
35 H. P.  
32x3 1-2  
Tires  
  
Electric  
Lights and  
Starter  
  
Complete  
Equipment

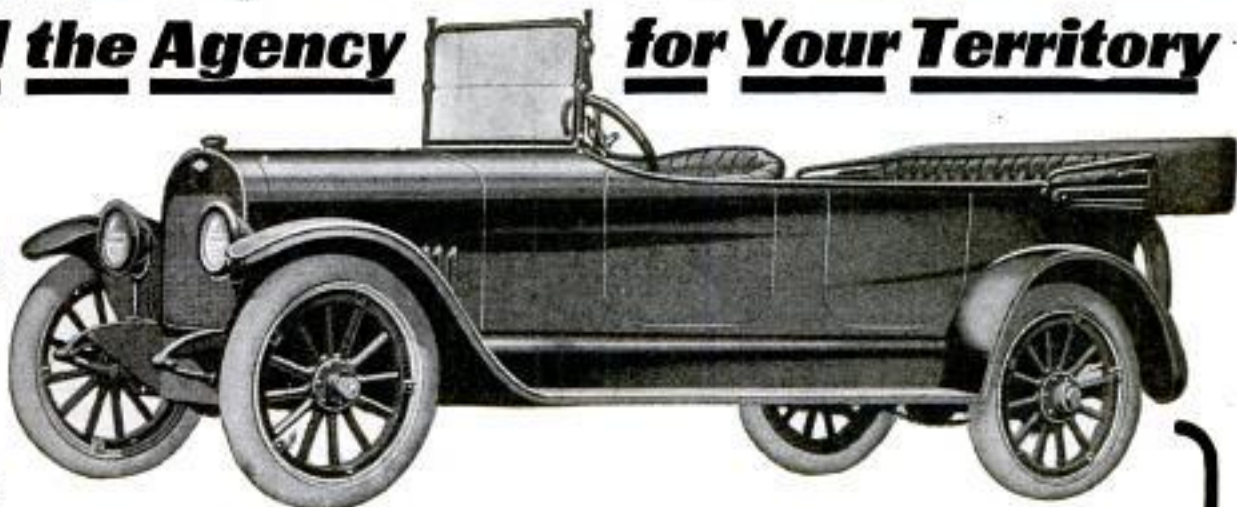

## Write NOW for Full Specifications of BIRCH SUPER-FOUR

Find out how you can get one of these superb cars for yourself and save money selling them to others. Hundreds of cars will be sold this year in every county in the United States. Millions of dollars will be paid to automobile agents. We pay big commissions for selling Birch Cars. Don't miss this opportunity. **Send the coupon now for full information.**

### Here Are a Few of Our Agents—Ask Them

- |                     |                    |
|---------------------|--------------------|
| John Slingerland    | Danforth, Ill.     |
| W. C. Yount         | Pine Bluff, Ark.   |
| Edwin Gaertner      | Dundee, Mich.      |
| Lafe Burleson       | Prescott, Ariz.    |
| Red Bland           | Statesboro, Ga.    |
| H. M. Masley        | Mangum, Okla.      |
| W. R. Harmon        | Kinsley, Kans.     |
| Mitchell & Mitchell | Hillsboro, Texas   |
| Ernest Birch        | St. Anthony, Idaho |
| H. B. Shaly         | Leesville, S. C.   |
| Warren A. Jones     | Winchester, Ill.   |
| C. W. Warnock       | Tarrytown, Ga.     |
| C. L. Sandefur      | Henderson, Ky.     |
| M. E. Biggs         | Omaha, Neb.        |
| S. C. Pierce        | Philadelphia, Pa.  |
| J. D. Farmer        | Anthony, Iowa      |

#### What New Mexico Agent Says:

"I received my car all O. K. It's the finest looking car in the country and suits me better than any car I ever saw. Lots of men have looked at the car and they said it had the finest motor they ever saw on a car. Some have asked me if the car didn't cost \$1,000 or \$1,200.  
R. R. REAGAN, Boaz, N. M."

We can name only a few here but will send names of many others when you write us. We want you to see one of our cars and ride in it if possible. When you do this we know you will be enthusiastic about the Birch and about selling the Birch cars in your locality.

Drive a new 1918 Model Birch Super-Four. Pay for it out of your commissions on sales and make good money selling Birch Cars to your friends and neighbors. Probably you know right now from six to ten people who will buy automobiles in the near future. Make some of these sales yourself. **Get our proposition quick.**

### Birch Agents Are Making Money

One of our Texas Agents sold two carloads of Birch Cars within 60 days after he received his first demonstrating car. There is no reason why you cannot do as well. Every sale means a big commission for you and the Birch is such a wonderful car for the money that it practically sells itself.

Whether you own a car or not, get our great offer. **Mail the coupon in the lower right hand corner right now for big free booklet and full information.**

## Be the Birch Agent in Your Locality

Cash in on the demand for a strictly high-grade, light-weight, fully equipped motor car, that exists right now in your vicinity. You have the customers. We have the cars. Let's get together. **Hurry in the coupon!**

**Previous Experience Not Necessary** We want men of character and ability and high standing. Previous experience not necessary. We require all our agents to take a brief but thorough course of training in Automobile Driving, Repairing and Selling which will fit them to represent us in a manner creditable to us and profitable to them. We have trained hundreds of others for success in this way, and we believe this is one of the reasons for the splendid success which Birch Agents are enjoying. But of course the BIG REASON is the cars themselves and the remarkable records they are making in the hands of satisfied owners all over the United States. Eighty per cent of all Birch cars are in use by farmers and in small towns, and get the hardest kind of service. Mud, sand, rocks, hills and rough going have no terrors for these sturdy cars. Don't delay. **Send the coupon today—RIGHT NOW!**

**Free Book!** **Send for FREE BOOK and Full Information**

Mail the coupon at once. We have agents in every state in the Union now, but we want an agent in every county. You will be astonished at the liberality of our offer. Let us put all the facts before you at once. It costs you nothing to investigate, so tear off coupon right now. **Sign it and mail it today. Ralph Birchard, Pres.**

**BIRCH MOTOR CARS** 81 East Madison Street Dept. 1197—CHICAGO, ILL.

Member Chicago Association of Commerce

**FREE Coupon**

Ralph Birchard  
Pres.  
Birch Motor Cars  
81 East Madison Street  
Dept. 1197 Chicago, Ill.

Please send me your big free booklet and full particulars as to how I can get a Birch Super-Four and the agency.

Name.....

St. No. or R. F. D.....

P. O.....State.....

Please Write Plainly







## A High School Course In Two Years

**Y**OU men and women who never went to high school will welcome this opportunity to get—in your spare time—the valuable training you missed. A high school course insures greater success in business—is vitally necessary if you want to go to college. And you can now get a thorough high school course in your own home—and complete it in two years!

This simple home-study course covers the same subjects as the leading preparatory schools and high schools, including the subjects required for entrance into all colleges and universities. By this new and simplified method of home instruction you will be able to gain a thorough education that will be of inestimable value—even if you don't intend to go to college. It gives you the foundation that is necessary for later success—and it is within the reach of all.

### Use Only Your Idle Hours

The course is so arranged and so written that you may read at home during your idle hours. It was prepared by leading professors and instructors who have made a life work of correspondence instruction, and every line is written so that you can understand it easily and gain from it the maximum amount of good. You will marvel at its completeness. When once you start the lessons, you will be fascinated.

### Meets College Requirements

With this new course you can prepare yourself for either a literary or an engineering education. All the required subjects are covered in detail—and you are given just the kind of training that colleges and universities demand. At the present time, we are preparing hundreds of men and women for college—but even if you are not going to college, you should investigate this opportunity to get the fundamental education that you feel the need of every day. Here is an opportunity to get it in your own home—at a small expense and in a short time.

## Send the Coupon

**American School of Correspondence**

Dept. P. 1197  
Chicago, U.S.A.

Gentlemen: Please send me your new Bulletin and tell me how I can get a high school course in two years.

Name.....

Address.....

### For New Bulletin

Send the coupon or a letter or post card now for our new bulletin. Read of the opportunity that you have to get a general education. Read what it means to you and then decide. Getting the new bulletin will put you under no obligation—and you will find a new inspiration when you read it. Send the coupon NOW!

**American School of Correspondence**

Dept. P. 1197  
Chicago, U.S.A.

# This X Will Prove Your Ambition

**T**HIS little "X" has marked the way to success for thousands of ambitious men. It marked the day when they stopped *dreaming* and began *acting*. Merely dreaming about the job ahead won't help you get it. But marking "X" in the coupon proves your ambition—and shows that you are ready to put your dreams into action to earn success.

The job you dream about can be yours. Not through favor or pull or some lucky chance—but through training. Thousands are proving it every day.

And it is easy for you to get that training. It isn't necessary to make a drudge of yourself. The first step is to mark your "X" before the job you want, and we will show you the way to success.

## Make Your Mark Now

Mark an "X" before the job you want, and mail the coupon to us now. We'll show you your way to success—more simple and easy than you have dreamed. You'll be under no obligation and for the sake of your ambition you should act today. Make your mark now. Send the coupon.

**American School of Correspondence, Chicago, U.S.A.**

Dept. G1197

American School of Correspondence, Dept. G1197, Chicago, U.S.A.

Gentlemen: Please send me booklet and tell me how I can fit myself for the position marked X.

- |                                |                               |
|--------------------------------|-------------------------------|
| .....Electrical Engineer       | .....Business Law             |
| .....Elec. Light & Power Supt. | .....Business Manager         |
| .....Hydro-electric Engineer   | .....Auditor                  |
| .....Telephone Engineer        | .....Accountant               |
| .....Architect                 | .....Cert'd Public Acc'ts     |
| .....Architectural Draftsman   | .....Stenographer             |
| .....Building Contractor       | .....Bookkeeper               |
| .....Building Superintendent   | .....Fire Ins. Inspector      |
| .....Structural Engineer       | .....Fire Ins. Adjuster       |
| .....Structural Draftsman      | .....Fire Ins. Expert         |
| .....Mechanical Engineer       | .....Sanitary Engineer        |
| .....Mechanical Draftsman      | .....Master Plumber           |
| .....Civil Engineer            | .....Plumbing & Heating Est.  |
| .....Steam Engineer            | .....Heating & Vent. Engineer |
| .....Shop Foreman              | .....Reclamation Engineer     |
| .....Shop Superintendent       | .....Automobile Engineer      |
| .....Sheet Metal Draftsman     | .....Automobile Repairer      |
| .....Lawyer                    | .....High School Course       |

We also prepare for civil service examinations in all engineering subjects

Name.....

Address.....





## A New Profession for Ambitious Men

### The Interstate Commerce Expert Now In Demand

Manufacturers, railroads, jobbers—all our great business organizations—need, **must have** men who know how to handle the intricate problems of transportation. The employment of an expert means the saving of thousands of dollars, the facilitation of freight movements, the equitable adjustment of claims, and often the salvation of profits. The man who can handle the interstate commerce of a business therefore commands an expert's salary. He has practically no competition because, where there is one capable man, there are scores of organizations which need this service.

Over 500,000 concerns are directly affected by the laws and decisions governing the shipment of merchandise. More and more these organizations are realizing their necessity for the highly trained man.

#### La Salle Students and Graduates

can now be found employed in the executive departments of practically all the large railroads, business houses and commercial organizations in the United States. Many prominent business concerns can be named in each of which 100 to 500 or more LaSalle students or graduates from our several specialized departments are employed in responsible positions. For instance—

Pennsylvania R. R. . . . .	213
American Telegraph & Telephone Company . . . . .	209
U. S. Steel Corporation . . . . .	250
Baltimore & Ohio R. R. . . . .	164
Armour & Company . . . . .	102
Chicago & N. W. R. R. . . . .	292
Ford Motor Company . . . . .	123
Swift & Company . . . . .	187
Standard Oil Company . . . . .	149

Among the numerous firms and corporations employing 50 to 100 or more LaSalle students or graduates are the following:

Western Electric Company  
International Harvester Co.  
E. F. Goodrich Company  
Wells Fargo Express Company  
Goodyear Tire and Rubber Co.  
and every important railroad company in the United States.

More than 125,000 men in active business life including a large number of corporation officials have enrolled and are receiving the benefits of LaSalle training and service. Over 20,000 new students now enroll annually. The LaSalle organization consists of 800 people, including a staff of 300 business experts, professional men, text writers, special lecture writers, instructors and assistants. LaSalle students and graduates occupying responsible positions can be found throughout the entire English speaking world.

#### Free Consulting Service

As a LaSalle student, you will also be entitled to the free use of our Consulting Service which gives you the privilege of calling on our staff of experts in any department at any time when you need special help or counsel. LaSalle Extension University is a clearing house of business information and through its many highly specialized departments is organized and equipped to render a practical and distinctive service which cannot be supplied by any other institution of similar character.

Railroads also need more men with broad knowledge of transportation problems. The Interstate Commerce Commission needs them. Cities and Chambers of Commerce need them. One city alone in the Middle West pays its traffic expert a salary of \$10,000.00. States are employing men skilled in this field to act in the interests of their shippers. The demand is constantly growing. This is one uncrowded profession.

If you are dissatisfied with your present position or if you now know something about traffic but want to add to your knowledge, send for particulars about the Interstate Commerce, Railway Traffic Course and Consulting Service, given by LaSalle Extension University.

#### Study By Mail

No matter how small your salary may be, you can have this LaSalle Course in Interstate Commerce—you can be trained by these experts in traffic without feeling the cost. The tuition

is so low and the monthly payments are so small that they will place no appreciable tax upon your income. Write for information and get our free books now. The coupon will bring them.

Every point will be made clear to you about Freight Rates, Classifications, Tariffs, Bills of Lading, Routing, Claims, Demurrage, Express, Ocean Trade, R. R. Organization, Regulation and Management, Laws of Carriers, and Interstate Commerce Rulings, R. R. Accounting, Statistics, etc. Everything the interstate expert needs to know is given in minute detail. You will be under direct supervision of the ablest traffic men who will answer your questions, give you suggestions and show you how to get the utmost out of your efforts.

#### Small Tuition—Easy Terms

You can have all this instruction in your own home. You can study in your spare time. Hold your present position while acquiring knowledge that will lead to a larger income.

Make yourself master of this new, paying profession, which gives the opportunity for rapid advancement to a position of importance and prestige in any branch of business today.

#### Mail This Coupon

Let us send you our free book on Interstate Commerce, also our book "Proof" which shows how men have succeeded through this training. We will also send all particulars about the

Course and the Consulting Service, the cost, the terms, etc. This is your opportunity to enter a profession which is becoming more and more important. Act now. Sign and mail the coupon.

### LASALLE EXTENSION UNIVERSITY

"The World's Greatest Extension University" Chicago, Illinois

Dept. 1064-C  
Please send me your books and full information on your Course and Consulting Service in Interstate Commerce and Railway Traffic. Also a copy of your valuable book for the ambitious man, "Ten Years' Promotion in One." This without obligation on my part.

Name.....

Address.....

Present Position.....



Please Mention Popular Mechanics



# MEN WANTED



H. J. RAHE  
President

**\$90 to \$300 a Month**

in the

## Auto and Tractor Business

Thousands of opportunities are waiting for men with proper training and machine shop experience in this—the greatest industry in all the world. I am continually receiving calls for trained men—far more than I can fill. I have trained thousands of men who came to me without a bit of previous experience. My graduates are found in all branches of the automobile and tractor business.

## Rahe Method Insures Success

For 11 years men have been coming from every part of the United States and foreign countries to get my Original Practical Method of Automobile and Tractor Training. My big school uses four huge buildings—all filled with the latest and best equipment. I have a corps of master mechanics to guide you right through the course in easy stages. Everything here to help you learn quickly. Two big garages and repair shops offer you opportunity to get practical experience training at first hand. No books used. No tools to buy.

## \$50 TRACTOR COURSE FREE

If you act at once I will give you a free scholarship for complete course in tractor, gas, stationary engineering, etc. Thousands of Tractor Operators, Repair Men, Demonstrators and Salesmen needed right now. Don't work for small wages. Come to this big successful school and prepare for a successful future.

**Write at Once** Use the coupon or a postal and send today for 80-page catalog. Tells all. Make the start now.

H. J. RAHE, President

**Rahe's Automobile and Tractor School**  
630 E. 11th St., Kansas City, Mo.

## FREE BOOK COUPON!

- H. J. RAHE, President
- Rahe's Auto and Tractor School
- 630 East 11th St., Kansas City, Mo.
- Send me your New 80-Page Catalog postpaid, also reserve a Free Scholarship for the Tractor Engineering Course.
- NAME.....
- ADDRESS.....

Please Mention Popular Mechanics

## SHORTHAND IN 30 DAYS

We absolutely guarantee to teach shorthand complete in only thirty days. You can learn in spare time in your own home, no matter where you live. No need to spend months as with old systems. Boyd's Syllabic System is easy to learn—easy to write—easy to read. Simple. Practical. Speedy. Sure. No ruled lines—no positions—no shading as in other systems. No long lists of word signs to confuse. Only nine characters to learn and you have the entire English language at your absolute command. The best system for stenographers, private secretaries, newspaper reporters and railroad men. Lawyers, ministers, teachers, physicians, literary folk and business men and women may now learn shorthand for their own use. Does not take continual daily practice as with other systems. Our graduates hold high grade positions everywhere. Send today for booklets, testimonials, etc.

**Chicago Correspondence Schools**  
969 Unity Bldg., CHICAGO, ILL.

## STUDY LAW 30 Days FREE

Let us prove to your entire satisfaction, at our expense, that the Hamilton College of Law is the only recognized resident law school in U. S., conferring Degree of Bachelor of Laws—LL. B.—by correspondence. Only law school in U. S. conducting standard resident school and giving same instruction, by mail. Over 500 class-room lectures. Faculty of over 30 prominent lawyers. Guarantee to prepare graduates to pass bar examination. Only law school giving Complete Course in Oratory and Public Speaking. School highly endorsed and recommended by Gov. Officials, Business Men, Noted Lawyers and Students. Send today for Large Handsomely Illustrated Prospectus and Special 30-Day Free Trial.

HAMILTON COLLEGE OF LAW, 1255 Advertising Bldg., Chicago, Ill.

Learn to **PAINT SIGNS and SHOW CARDS**

I teach you personally, by mail, in a short time. Oldest and largest School. Big field, work interesting. You can **EARN \$18 TO \$45 A WEEK**

Pittman, Minn., writes: "Did job after first lesson, got \$10, profit \$7.00." Cross-Corp., St. C. says: "Earned \$200.00 while taking course." Get literature, samples, guarantee—all FREE.

**DETROIT SCHOOL OF LETTERING**  
Established 1899. 210 D. S. of L. Bldg. DETROIT, MICHIGAN

## MUSIC TAUGHT FREE

**IN YOUR OWN HOME**

You can read Music like this quickly

**Piano, Organ, Violin, Mandolin, Guitar, Banjo, etc.**  
Beginners or advanced players. One lesson weekly. Illustrations make everything plain. Only expense about 2c per day to cover cost of postage and music used. Write for FREE booklet which explains everything in full.

**AMERICAN SCHOOL OF MUSIC, 51 Lakeside Building, CHICAGO**

## LEARN WATCHMAKING AND ENGRAVING

Earn while learning. Most practical watch school. Individual instructions. Graduates in great demand. Book free.

**Chicago School of Watchmaking, 63 E. Van Buren St., Chicago**



## WANTED—Railway Mail Clerks

Commence \$75 Month  
Increase to \$150 " **Franklin Institute**  
Dept. 696, Rochester, N. Y.

Common Education Sufficient

Sure Pay. Life Job. Full Un-necessary.

Send me, without charge, (1) sample Railway Mail Clerk Examination questions; (2) schedule showing places of examinations; (3) list of other government jobs now easily obtainable and (4) free book describing them.

NAME.....

ADDRESS.....



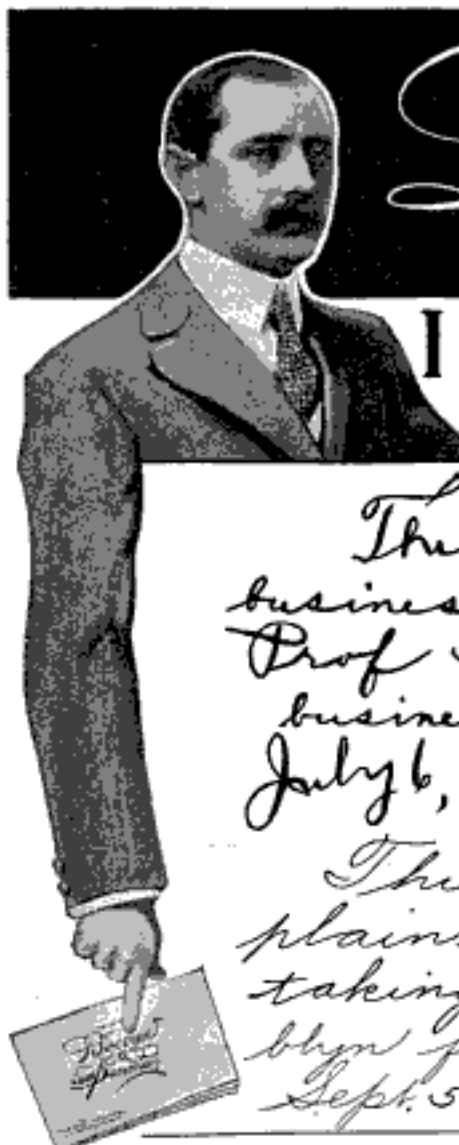

*TO*  
**Learn to Write.**

**I CAN TEACH YOU AT HOME**  
**During Spare time**

*This is a specimen of my business writing before taking Prof Tamblin's course in business writing.*  
July 6, *Clarence P. Weber.*

*This is a specimen of my plain business writing after taking lessons from F. W. Tamblin for 2 months.*  
Sept. 5 *Clarence P. Weber.*

**FREE BOOK**

My 32-Page book "How to Become a Good Penman" is FREE to anyone who wants to write better. Contains copies and information that will help you, and beautiful specimens that will make your eyes twinkle with delight.

**WRITE FOR IT**—use the coupon below—or a postal will do—but

**Send at Once!**

*If you enclose a stamp, I will write your name on a card with white ink, making one of the prettiest specimens of penmanship you ever saw*

**F. W. TAMBLYN**

418 Ridge Bldg., KANSAS CITY, MO., U.S.A.

**"A Wonderful Bargain"** "It is now about two months since I began your course, and while I am not quite half through with Business Writing, I am delighted with my improvement, which is quite marked as you will see by comparing my present writing with the specimen written when I began. My parents objected to my taking it up, but now see I'm getting a wonderful bargain."

—CLARENCE P. WEBER, Middletown, Del.

### Good Writing Is the Very Foundation of Business Success

I can make a good penman of you at your own home, in your spare time, no matter where you live or how poorly you now write. Ever fail to secure a good position because of poor penmanship? Ever know of better positions you could have stepped into if you only wrote a good hand? If not, you're an exception. The advantage of good penmanship is seen all around us.

I have been teaching penmanship by mail over 20 years. I know that any ambitious person can master penmanship just as quickly and thoroughly by my system at home as if in a schoolroom under the personal instruction of the teacher.

**BEGIN NOW** to learn good handwriting and be ready for the next better position that comes your way. Learn right at home—in your own room, outside of working hours. Your spare time is all I ask.

I teach *Spelling* and *Letter Writing* also.

Mr. Weber's wonderful improvement shown in the specimens above was made in 2 months. Hundreds and hundreds of others in all parts of the country are doing the same.

**YOU CAN DO AS WELL**

#### This Brings FREE BOOK

F. W. TAMBLYN, 418 Ridge Bldg., KANSAS CITY, MO.

I am interested in improving my penmanship. Send me your Free Book, "How to Become a Good Penman," postpaid.

Name .....

Address .....



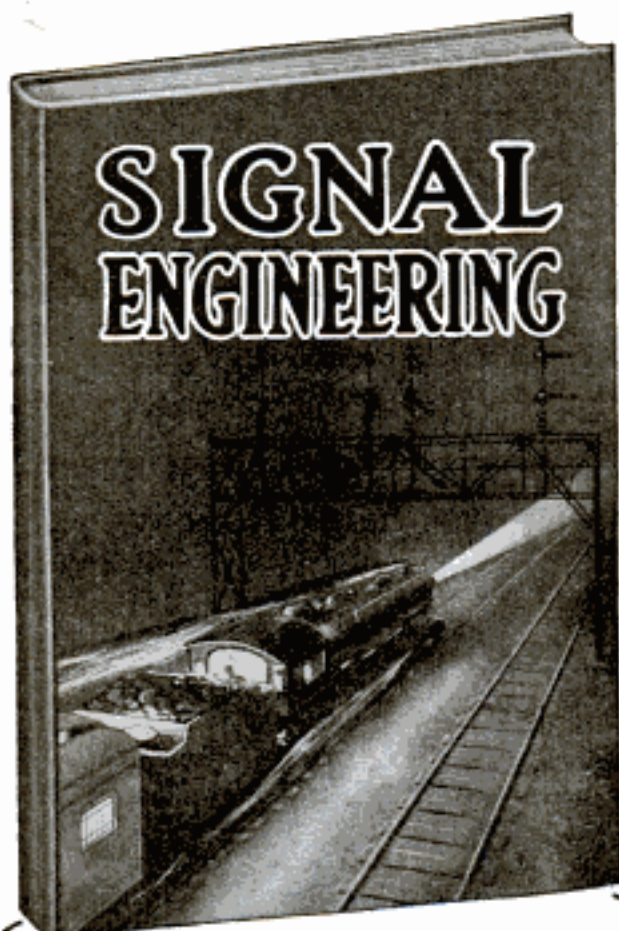

# Free Book On Signal Engineering

**T**HERE are thousands of miles of railroad that must be equipped with block signal systems. To superintend these installations and to maintain the systems now in use thousands of men are necessary. Golden opportunities are offered. Every ambitious man in America should write for the free book on Signal Engineering. It will be sent to you prepaid—without obligation.

## Men Are Needed to Accept High Salaried Positions

When you stop to consider that, at the present time, less than one-fourth of the passenger lines in this country are equipped with automatic block signal systems—and when you read that the day is fast coming when the law will compel railroads to install them, you will realize what remarkable opportunities are offered to ambitious men in the profession of Signal Engineering. The work is big—broad—high salaries are paid. \$250.00 a month is an ordinary salary for a Signal Engineer.

### Department of Signaling

Dept. 1197, 1810 Wilson Ave.,  
Riverswood Station Chicago

GENTLEMEN:—Please send me absolutely free and prepaid your big new book on Signal Engineering. Also full particulars about your great special free outfit offer. It is distinctly understood that I assume no obligations of any kind.

### Send the Coupon

Put your name and address in the coupon, or a letter or post card. Now and get the free book about Signal Engineering. Too, we will tell you how you can get the training that you need in order to become a Signal Engineer. You will be under no obligation by writing for this free book. Do it Now.

### Department of Signaling

Dept. 1197  
1810 Wilson Ave.,  
Riverswood Sta.  
Chicago

Name.....

Address.....

Age..... Occupation.....



## Learn a Paying Profession

that assures you a good income and position for life. For twenty-four years we have successfully taught

## PHOTOGRAPHY

Photo-Engraving and Three-Color Work

Our graduates earn \$20 to \$30 a week. We assist them to secure these positions. Learn how you can become successful. Terms easy—living inexpensive. Write for catalogue—NOW!

ILLINOIS COLLEGE OF PHOTOGRAPHY, Box F, 999 Wabash Av., Effingham, Ill.

## EARN TELEGRAPH

Morse and Wireless—R. R. Accounting (Station Agency) also taught. Tremendous Demand—much greater than supply—Permanent Positions Secured. Big Salaries—recently raised. Ideal Working Conditions—short hours, vacations with pay sick and death benefits, etc.—preparing. Great Opportunities for Advancement. Women Operators also greatly desired by Railways and Western Union. Tuition reasonable. Cheap living expenses—can be earned. Oldest and largest school—two large school buildings, investment exceeds \$25,000.00—established 43 years. Endorsed by railway, Western Union and Marconi-Telegraph officials. Large illustrated catalogue free. Correspondence courses also. Write today. Enroll immediately.

Dodge's Telegraph, Ry. & Wireless Institute  
8th Street, Valparaiso, Ind.

## The University of Chicago

### HOME STUDY

in addition to resident work, offers also instruction by correspondence.

For detailed information address

26th Year U. of C. (Div. V) Chicago, Ill.



## A GOOD POSITION

with UNCLE SAM is most desirable. Life positions, pleasant surroundings, good pay, steady work, short hours, promotions on merit. Both sexes. No political pull. Thousands of appointments yearly. Most thorough preparation \$5. Returned if not appointed. Full information and questions used by the Civil Service Commission free.

AMERICAN CIVIL SERVICE SCHOOL WASHINGTON, D. C.



## IF YOU STAMMER

attend no stammering school till you get my large FIVE book and special rate. Largest and best school in the world curing by natural method. Write today.

Lee Wells Millard, Pres., North-Western School, Inc.,  
2317 Grand Avenue Milwaukee, Wis.

## COPY THIS SKETCH

and let's see what you can do with it. Cartoonists and illustrators earn from \$20.00 to \$125.00 or more per week. My practical system of personal individual lessons by mail will develop your talent. Fifteen years' successful work for newspapers and magazines qualifies me to teach you. Send sketch of Uncle Sam with 5c in stamps for test lesson plus; also collection of drawings showing possibilities for YOU. State your age.



The Landon School of Illustrating and Cartooning  
1489 SCHOFIELD BUILDING, CLEVELAND, O.

## LEARN WATCH REPAIRING



You can learn by our modern and original system of instruction every part of the Watch Repairing Trade at home as good or better than at a shop. You can earn money while learning and secure a well paying position or start in business after completing our course of instruction. Good watch repairers are always in demand and earn from \$20 to \$35 per week. For particulars apply to the Wisconsin School of Watchmaking, 516th Bldg., Milwaukee, Wis.





## "I Got the Job!"

"I'm to be Manager of my Department starting Monday. The boss said he had been watching all the men. When he found I had been studying at home with the International Correspondence Schools he knew I had the right stuff in me—that I was bound to make good. Now we can move over to that house on Oakland Avenue and you can have a maid and take things easy. I tell you, Nell, taking that course with the I. C. S. was the best thing I ever did."

Spare-time study with the I. C. S. is winning promotions for thousands of men and bringing happiness to thousands of homes all over the world. In offices, shops, stores, mines, mills and on railroads, I. C. S. trained men are stepping up to big jobs, over the heads of older men, past those whose only qualification is long service.

There is a job ahead of *you* that some man is going to be picked for. The boss can't take chances. When he selects the one to hold it he is going to choose a trained man with sound, practical knowledge of the work. Get busy right now and put yourself in line for that promotion. You can do it in spare time in your own home through the International Correspondence Schools, just as nearly two million men have done in the last twenty-five years, just as more than 100,000 men are doing today.

The first step these men took was to mark and mail this coupon. Make *your* start the same way—and make it right now.

### TEAR OUT HERE INTERNATIONAL CORRESPONDENCE SCHOOLS BOX 5608, SCRANTON, PA.

Explain, without obligating me, how I can qualify for the position, or in the subject, before which I mark X.

- |   |  |
|---|--|
| <input type="checkbox"/> ELECTRICAL ENGINEER        | <input type="checkbox"/> SALESMANSHIP            |
| <input type="checkbox"/> Electric Lighting          | <input type="checkbox"/> ADVERTISING             |
| <input type="checkbox"/> Electric Railways          | <input type="checkbox"/> Window Trimmer          |
| <input type="checkbox"/> Electric Wiring            | <input type="checkbox"/> Show Card Writer        |
| <input type="checkbox"/> Telegraph Engineer         | <input type="checkbox"/> Sign Painter            |
| <input type="checkbox"/> Telephone Work             | <input type="checkbox"/> Railroad Trainman       |
| <input type="checkbox"/> MECHANICAL ENGINEER        | <input type="checkbox"/> ILLUSTRATING            |
| <input type="checkbox"/> Mechanical Draftsman       | <input type="checkbox"/> Cartooning              |
| <input type="checkbox"/> Machine Shop Practice      | <input type="checkbox"/> BOOKKEEPER              |
| <input type="checkbox"/> Gas Engine Operating       | <input type="checkbox"/> Stenographer and Typist |
| <input type="checkbox"/> CIVIL ENGINEER             | <input type="checkbox"/> Cert. Public Accountant |
| <input type="checkbox"/> Surveying and Mapping      | <input type="checkbox"/> TRAFFIC MANAGER         |
| <input type="checkbox"/> MINE FOREMAN OR ENGINEER   | <input type="checkbox"/> Railway Accountant      |
| <input type="checkbox"/> Metallurgist or Prospector | <input type="checkbox"/> Commercial Law          |
| <input type="checkbox"/> STATIONARY ENGINEER        | <input type="checkbox"/> GOOD ENGLISH            |
| <input type="checkbox"/> Marine Engineer            | <input type="checkbox"/> Teacher                 |
| <input type="checkbox"/> ARCHITECT                  | <input type="checkbox"/> Common School Subjects  |
| <input type="checkbox"/> Contractor and Builder     | <input type="checkbox"/> Mathematics             |
| <input type="checkbox"/> Architectural Draftsman    | <input type="checkbox"/> CIVIL SERVICE           |
| <input type="checkbox"/> Concrete Builder           | <input type="checkbox"/> Railway Mail Clerk      |
| <input type="checkbox"/> Structural Engineer        | <input type="checkbox"/> AUTOMOBILE OPERATING    |
| <input type="checkbox"/> PLUMBING AND HEATING       | <input type="checkbox"/> Auto Repairing          |
| <input type="checkbox"/> Sheet Metal Worker         | <input type="checkbox"/> Navigation              |
| <input type="checkbox"/> Textile Overseer or Supt.  | <input type="checkbox"/> AGRICULTURE             |
| <input type="checkbox"/> CHEMIST                    | <input type="checkbox"/> Poultry Raising         |

Name \_\_\_\_\_

Present Occupation \_\_\_\_\_

Street and No. \_\_\_\_\_

City \_\_\_\_\_ State \_\_\_\_\_





## Music Lessons

**Book Sent FREE** Wonderful home-study music lessons under great American and European teachers given by the University Extension Method. The lessons are a marvel of simplicity and completeness, endorsed by Paderewski and other great authorities. You, too, can now quickly and easily satisfy your musical ambitions.

### Any Instrument or Voice

Write, telling us the course you are interested in, age, how long you have taken lessons if at all, etc., and we will send you our Free Book containing text and illustrations covering Lessons in PIANO (students' or teachers' courses) by the great Wm. H. Sherwood, HARMONY by Dr. Protheroe and Rosenbecker, VOICE COURSE (with aid of Phonograph) by Crampton, PUBLIC SCHOOL MUSIC by Frances E. Clark, VIOLIN, CORNET, MANDOLIN, GUITAR, BANJO, REED ORGAN, CHORAL CONDUCTING, by equally eminent teachers.

**Send NOW** for Free Book and learn how easily you can become a fine singer, or a skillful player. See how quickly you can become successful. Our Free Book tells you how. Write for it today. A few Special Introductory Scholarships now being awarded by our faculty. Full particulars sent with Free Book. Investigate without cost or obligation. Write today.

### University Extension Conservatory

Proprietor Siegel-Myers School of Music

3171 Siegel-Myers Building Chicago, Ill.

Mr. A. R. Patterson, whose advertisement appears below, was for eight years a Civil Service Secretary-Examiner, and is well qualified to help YOU secure a Government Position.

# CIVIL SERVICE NEEDS MEN

Send for Free Book

Show Your Patriotism

By Working for Uncle Sam.

Men in Civil Service do as great a service as those in the field of battle. Positions pay \$75 to \$150 a month. Short hours. Easy work. No strikes, no hard times, no layoffs. No petty bosses. No politics—no pull. Ordinary education sufficient. 15 and 30 day vacations each year with full pay. Sick leave with full pay. Positions for life.

**RAILWAY MAIL CLERK, POSTAL CLERK, REVENUE OFFICER, CUSTOMS SERVICE**

and many other divisions of Government Service offer splendid opportunities for big pay and rapid advancement. If you are an American Citizen, 18 or over, send in your name for all facts about Government Positions and how to get one.

### NEW BOOK FREE!

Mr. Patterson was U. S. Civil Service Secretary-Examiner for 8 years, and has students and graduates in practically every State in the Union in all branches of Government Service. Not one cent. If you do not secure a position. Mail postal NOW for Free Book and special 30-Day Offer! Address

**PATTERSON CIVIL SERVICE SCHOOL**  
810 News Bldg., Rochester, N. Y.

## Wonderful Camera Bargains

High grade Cameras shipped for examination and approval. You examine the Camera at your own home and pay only if you choose to keep it. Satisfaction guaranteed.

### Wholesale Prices

We ship direct from factory to consumer, eliminating all middlemen's profits. The Camera must serve as its own salesman. Our prices are so low and our terms so easy that no one may be deprived of the pleasure of owning a splendid camera.

### Write for Free Catalog

We will mail our latest catalog sheets free to all who ask for them. Write at once. A postal card will do. These catalog sheets show the latest sizes and low prices on the most beautiful line of cameras ever offered Popular Mechanics readers.

H. E. Sever & Co., Dept. 2-P, 140 So. Dearborn St., Chicago



## War Conditions Demand ELECTRICAL

men with training. Prepare for service in military or industrial life. Of 193 students in class of 1917, about one-third are already in the Engineer Corps and two-thirds are speeding production in electrical industries. Having trained over 2000 young men in the past 24 years in the fundamentals of Applied Electricity, **The Bliss Electrical School**, with its well-equipped shops and laboratories, is peculiarly qualified to give a condensed course in Electrical

### ENGINEERING

including Mathematics, Steam and Gas Engines, Mechanical Drawing, Shop Work and Theoretical and Practical Electricity, in all branches. Students actually construct dynamos, install wiring and test efficiency of electrical machinery. Course, with diploma, complete



### IN ONE YEAR

For practical young men with limited time. 25th year opens Sept. 26th. Catalogue on request. 104 Takoma Ave., Washington, D. C.



## Do You Like to Draw? Cartoonists Are Well Paid

We will not give you any grand prize if you answer this ad. Nor will we claim to make you rich in a week. But if you are anxious to develop your talent with a successful cartoonist, so you can make money, send a copy of this picture, with 9c in stamps for portfolio of cartoons and sample lesson plate, and let us explain.

The W. L. Evans School of Cartooning  
821 Leader Bldg., Cleveland, O.

## LEARN WATCH REPAIRING

Be a watchmaker—you can learn this profitable trade by correspondence in a few weeks in your own home by the DeSelms Chart System. After you complete the course you will know a watch from A to Z. You will know just what the matter is and how to repair one. When you graduate you will be a practical watchmaker and repairer and competent to fill any position. Positions for our graduates.

Ask for our Free Book. It explains our system and terms.

**THE DeSELMS WATCH SCHOOL**  
23 Perry Street ATTICA, INDIANA



## LAW High-Grade Instruction by CORRESPONDENCE

Prepares You for the Bar—Est. 1892

Four Courses: College, Post-Graduate, Business Law and Bar Ex. Review. Classes begin each month. Approved by Bench and Bar. University Methods, Unabridged Text-Books, Cases. Course in Oratory, Public Speaking and Moot Court FREE with regular course. Graduates now practicing in every State. Write today for Catalog and Rules for Admission to the Bar. CHICAGO CORRESPONDENCE SCHOOL OF LAW, 520 Repple Block, CHICAGO



## Come to Akron, Ohio The Tire Center and



**LEARN THE TIRE REPAIR BUSINESS**

Big money made in this field. Tires need constant repairing. Profits large, work comes easily. Locations everywhere. **EARN \$100 to \$500 MONTHLY** There is no limit to what you can make. Start business with small capital. We teach you everything about auto tires. School open all year. Start any day. Write for school literature, etc., Now. ALL FREE. Akron Tire Repair School, 73 Tire Bldg., 46-48 N. Main St., Akron, O.



# Free Test Lesson in Draftsmanship

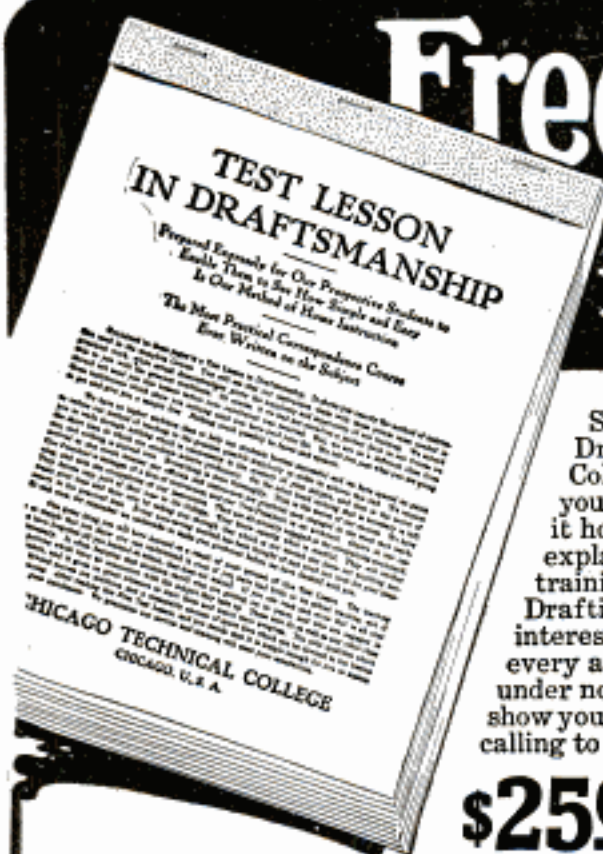

Special offer now. Pay nothing for this Test Lesson in Drafting prepared by the experts of the Chicago Technical College. Learn from a study of this lesson how well equipped you are to take up drafting as a profession. Also see from it how clearly the Chicago "Tech" Course in Draftsmanship explains every point—and how it will give you a practical training in Architectural, Electrical, Structural Steel, Machine Drafting or any other branch of Drafting in which you may be interested. No charge whatever for this lesson. We invite every ambitious man to send for it. To ask for it places you under no obligation. Get it while the offer holds good and let it show you whether or not you are a man who can study this technical calling to advantage. Just sign and mail coupon. Send no money.

## \$25<sup>00</sup> to \$100<sup>00</sup> a Week

Positions are always open to competent draftsmen and the war conditions are sure to create an extra demand. These positions pay good salaries and the well trained man always has the best opportunity for advancement. Our course gives this training in the shortest time consistent with thoroughness. Its practical value is proved by the success of our graduates. If you are in a position where the future looks doubtful, if you want to be a technical expert, if you want to be master of a calling which will make you independent, at least get the Free Lesson and the information we send upon request.

## Come to the College or Study at Home

You need not leave your present occupation to get this expert training in Draftsmanship. We will teach you by mail and you can study at home in your spare time. The work is the same as given in our Day and Evening Classes at the College here in Chicago. Your instruction will be given directly by men who are engaged in the very work they teach. They will teach you how to do just what is being done in the drafting rooms of big organizations where Chicago "Tech" graduates are always in demand at good salaries.

## Easy Payments

Pay for the course as you go along. The fee is so small the terms so easy that no matter how moderate your income may be, you can afford to get this training in Draftsmanship which will prepare you for an important paying position. Catalog and all particulars sent free with the Test Lesson.

## See For Yourself

This Free Lesson is an absolute test, pure and simple. Send for it today. In the privacy of your home study it, then you will know for yourself whether you are proper material for a successful Draftsman. Other institutions will ask for your money first. You find out later at your own expense, whether you can adapt yourself to the work and succeed in the profession.

We do not charge you one cent for the Test Lesson, either now or later. It is absolutely FREE. Nor do we obligate you in any way whatever by writing for the Free Test Lesson, so send coupon or write postal request today. If you do nothing else but secure the Free Test Lesson you will gain such valuable knowledge as will be beneficial to you through life, for the Free Lesson gives the very fundamentals of draftsmanship which are helpful to every man. Mail the coupon.

**CHICAGO TECHNICAL COLLEGE**  
1030 Chicago "Tech" Building Chicago, Ill.

## FREE

### Instruments

Every student of the Chicago "Tech" Course in Draftsmanship receives this set of instruments, or a cash credit in case he already has a set. We start our students at once in practical work with necessary equipment.



## Builders' Course

Men in the Building Trades whether working now as mechanics or contractors should get information about our Courses in Plan Reading and Estimating. We teach men how to make money through knowing more about their business. We want to tell carpenters, bricklayers, stone masons, and other men engaged in building work about these courses. Write for free Lesson in Plan Reading, Builders' Catalog and other instructive information.

**Chicago Technical College,**  
1030 Chicago "Tech" Building, Chicago

Without obligation to me, please send me your FREE Test Lesson in Draftsmanship and other interesting literature covering the subject indicated below.

Mark X opposite work in which you are specially interested.

- |   |   |
|---|---|
| <input type="checkbox"/> Architectural Drafting | <input type="checkbox"/> Builders' Course |
| <input type="checkbox"/> Machine Drafting       | <input type="checkbox"/> Plan Reading     |
| <input type="checkbox"/> Electrical Drafting    | <input type="checkbox"/> Estimating       |
| <input type="checkbox"/> Structural Drafting    | <input type="checkbox"/> Surveying        |
| <input type="checkbox"/> Sheet Metal Drafting   | <input type="checkbox"/> Map Drafting     |

Name.....

Address.....

City..... State.....

College or Home Study? State which.....

Please Mention Popular Mechanics



# Auto Books



## 50c a Week

Only 50c a week buys this brand-new automobile library. It is called **Automobile Engineering**, and in it you will find everything about modern automobiles. Almost two entire volumes are devoted to the new systems of ignition, starting and lighting, welding, vulcanizing, and public garage equipment and operation are thoroughly covered. Five thick volumes, 5 1/2 x 8 inches, flexibly bound in genuine morocco leather, gold stamped, 2,400 pages; 2,000 illustrations, tables and diagrams. Written in simple, easily-understood English, and carefully cross-indexed for quick reference.

## Send No Money

Don't send a penny. Just put your name and address in the coupon and we'll send all five volumes to you. Pay only net transportation charges when they arrive. Read them—study them—examine them carefully before you decide to buy. If you don't like them after 7 days—write us and we'll take them back. If you keep them, send only \$2.00 within 7 days, and then \$2.00 a month—50c a week—until the introductory price of \$17.90 has been paid. The regular price of this set will be \$25.00.

## Consulting Service FREE

In addition to the books you get free of all charge a \$12.00 Consulting Membership. If any question puzzles you—write us. Our corps of auto experts will solve any auto problem. Ask all the questions you want for a whole year. This service is absolutely free.

### Partial List of Subjects

Motors, Welding, Motor Construction and Repair, Carburetors, Valves, Cooling, Lubrication, Fly-Wheels, Clutch, Transmission, Final Drive, Steering, Tires, Vulcanizing, Ignition, Starting and Lighting Systems, Wiring Diagrams, Shop Kinks, Commercial Garage Equipment, Electrical Storage Batteries, Motorcycles, Commercial Trucks, Glossary.

American Technical Society,  
Dept. A1197, Chicago, U.S.A.

Please send me a set of Automobile Engineering for 7 days' free examination. If I decide to buy, will send \$2 in 7 days and balance \$2 a month until \$17.90 has been paid, when books and Consulting Membership will be mine. Otherwise will notify you and hold books subject to your order. Title not to pass until fully paid.

C

NAME .....

ADDRESS .....

REFERENCE .....

# MAIL

## This Coupon

See these books before you decide to buy. Remember—don't send us a penny. Just fill in and mail the coupon. This offer is open to any person living within the boundaries of the U. S. and Canada.

**AMERICAN  
TECHNICAL  
SOCIETY**  
Dept. A1197  
CHICAGO, U.S.A.

# Alcohol as Fuel

For Automobiles,  
Motor Boats,  
Heating,  
Cooking, Lighting  
No Smoke! No Carbon!  
Low Fire Risk!



Wright's book gives full directions for making and de-naturing. Send For It!

Fully Illustrated. 283 Pages. Cloth. By Mail \$1.15

**SPON & CHAMBERLAIN**  
120 P. M. Liberty Street NEW YORK

# ELECTRICITY TAUGHT

Under Practical Working Conditions

3 1/2-day regular instruction in complete equipped laboratories and class rooms, 3 1/2-day employment in electrical concerns who are glad to employ our students. No matter what your education, we prepare you for responsible high-salaried positions.

1-year course in Practical Electricity  
2-year course in Commercial Engineering  
3-year course in Electrical Engineering

Write for free illustrated booklet. Mention age, education and course interested in. Fall term now opening. Enter any time.

School of Engineering of Milwaukee 243 Stroh Building  
MILWAUKEE, WIS.



# SHORTHAND IN 30 DAYS

Shorthand learned at your home in 30 Days

Prepare for a Government Position. Salary \$900 to \$1200 a year. Boyd Syllabic System. Easy to learn and write. No shading—no ruled lines. 100 to 150 words a minute guaranteed. Writers hold World's Record. Best for Court Reporting.

Write Today for FREE Catalog and Special Offer  
Chicago Home Study Schools, 504 Reaper Block, Chicago, Ill.

# CIVIL SERVICE

positions are in all parts of the country. Good pay, steady work, life positions, congenial surroundings, promotions on merit, short hours, annual vacation and sick leave with pay. Many thousands appointed yearly. Both sexes. No political pull. Nearly 300,000 classified positions. Common school education sufficient. Full information and questions used by the Civil Service Commission free.

COLUMBIAN CORRESP. COLLEGE, WASHINGTON, D.C.



If you are earning less than  
**\$50.00 PER WEEK**

and like to draw—you should study

## COMMERCIAL ART

Leading Art Managers—the men who know

—recommend us and employ our students. We

will guarantee to make you successful—Learn at home in your spare time—

or in our resident school—Day or evening. Write for FREE illustrated catalogue.

Commercial Art School, 720, 116 So. Michigan Ave., Chicago, Ill.



LEARNED BY  
ALMOST  
ANYONE

# VENTRILOQUISM

AT HOME

SMALL COST

Send today 2c stamp for particulars and proof.  
O. A. SMITH, Room D 155, 823 Bigelow St., PEORIA, ILL.

# Learn to Concentrate

Prof. Theron Q. Dumont's famous 20 Lesson Course in Concentration, now sent in handy book form, for 5 days' FREE examination. Gives every principle and method. Also practice exercises. Tells you just how to concentrate. Get it now—while offer lasts. Send no money. Read it 5 days. Then, if satisfied, send only \$2. Otherwise return to us. Write for it today on this FREE offer.  
ADVANCED THOUGHT PUB. CO., Dept. 1039, 168 N. Michigan Ave., Chicago



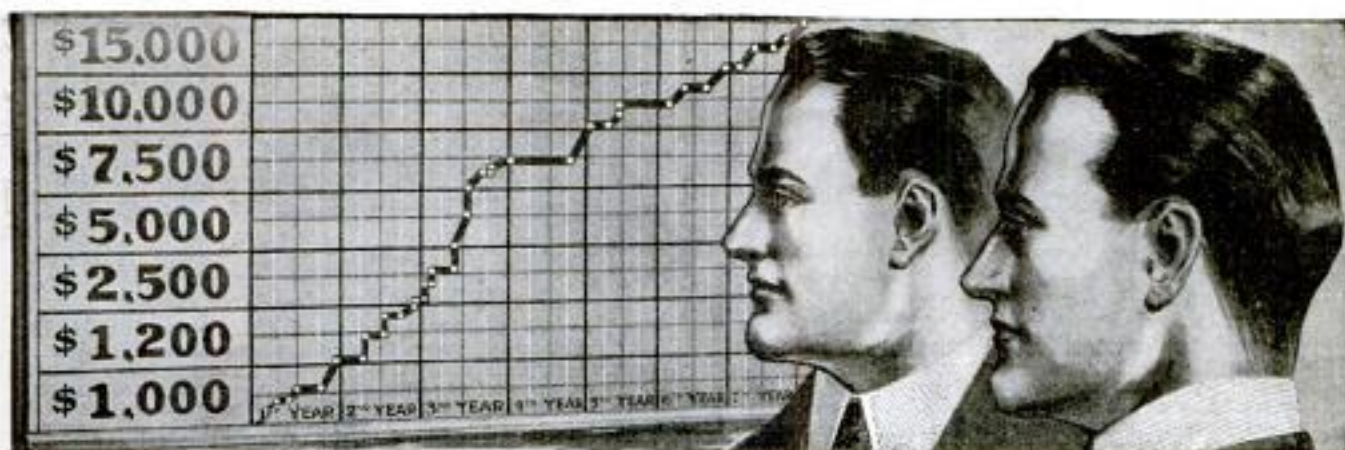

## How Men Raise Their Incomes Through Higher Accounting

The above chart tells the story. An ambitious man on a small salary capitalizes his brains by getting knowledge that is in large demand. He learns Higher Accounting. He acquires the ability to analyze businesses and to tell officers and directors how to eliminate waste and install economies. This is the kind of knowledge that large commercial organizations are willing to pay for—and the call for it is constant and growing every year.

This is a day of commercial efficiency and every progressive house in America feels the need of the highly trained man who can apply scientific, analytical methods and work out economies in its production, accounting and selling problems.

Here is the opportunity to realize your ambition to attain more prestige and a higher income. Increase the worth of the service you can give and you will find plenty who will pay the value of it. The more you know the less will be your competition.

The hard struggle is for small positions. Offers come to the trained man. You can be the man with the training that the corporation, the bank, and large business organizations of every kind are looking for. Write today for information about the Higher Accounting training course and Consulting Service offered by the LaSalle Extension University.

### LaSalle Students and Graduates

can now be found employed in the executive departments of practically all the large railroads, business houses and commercial organizations in the United States. Many prominent business concerns can be named in each of which 100 to 200 or more LaSalle students or graduates from our several specialized departments are employed in responsible positions. For instance—

Pennsylvania R. R. . . . .	918
American Telegraph & Telephone Company . . . . .	259
U. S. Steel Corporation . . . . .	250
Baltimore & Ohio R. R. . . . .	554
Armour & Company . . . . .	152
Chicago & N. W. R. R. . . . .	292
Ford Motor Company . . . . .	122
Swift & Company . . . . .	187
Standard Oil Company . . . . .	149

Among the numerous firms and corporations employing 50 to 100 or more LaSalle students or graduates are the following:

Western Electric Company
International Harvester Co.
B. F. Goodrich Company
Wells Fargo Express Company
Goodyear Tire and Rubber Co.

and every important railroad company in the United States. More than 125,000 men in active business life including a large number of corporation officials have enrolled and are receiving the benefits of LaSalle training and service. Over 20,000 new students now enroll annually. The LaSalle organization consists of 800 people, including a staff of 300 business experts, professional men, text writers, special lecture writers, instructors and assistants. LaSalle students and graduates occupying responsible positions can be found throughout the entire English speaking world.

### Free Consulting Service

As a LaSalle student, you will also be entitled to the free use of our Consulting Service which gives you the privilege of calling on our staff of experts in any department at any time when you need special help or counsel. LaSalle Extension University is a clearing house of business information and through its many highly specialized departments is organized and equipped to render a practical and distinctive service which cannot be supplied by any other institution of similar character.

## Learn Higher Accounting By Mail

You can have the instruction of our expert accountants, by mail.

While you hold your present position you can prepare yourself for one that will pay a larger salary. Every phase of the Science of Accounting and Auditing, Business Organization and Business Management will be made clear to you. You will have, at all times, the personal direction of our staff of experts who will guide you step by step to your ultimate goal. No special education is necessary to acquire this knowledge—only intelligence and the purpose to succeed. That is the experience of thousands of successful men who have taken this LaSalle training by mail.

The LaSalle Course in Higher Accounting helped C. B. Kinkaid of West Virginia to double his salary in a few months.

*Our institution places its courses within the grasp of the man of moderate or even small income on the basis of convenient monthly payments.*

J. V. Hawkinson, Idaho, had his income doubled in a year. J. L. Reeves, Ohio, was promoted to a managership as a result of this training. J. H. Worl, Illinois, quickly received two salary increases after he had begun this study. Hundreds of other LaSalle students send similar reports of rapid advances directly traceable to the training gained at LaSalle Extension University.

Our graduates are given special preparation for the C. P. A. examinations. Certified Public Accountants receive large fees for expert work in auditing. Many Public Accountants earn from \$3,000 to \$10,000 a year. Some executive corporation accountants earn even more than that. They are men who are considered absolutely indispensable.

Our graduates are given special preparation for the C. P. A. examinations. Certified Public Accountants receive large fees for expert work in auditing. Many Public Accountants earn from \$3,000 to \$10,000 a year. Some executive corporation accountants earn even more than that. They are men who are considered absolutely indispensable.

## Send The Coupon

It will bring you our book on Accountancy Facts and full information about this course and our Consulting Service in Higher Accounting. Also our book "Ten Years' Promotion In One".

Promotion In One", and we will give you information about the tuition and the easy terms. All this without cost or obligation to you. Make this the decisive hour. Mail the coupon.

### LASALLE EXTENSION UNIVERSITY

"The World's Greatest Extension University"

Dept. 1064-H

Chicago, Illinois

Without cost or obligation on my part, please send me your Accountancy Catalog describing your Home Study Training and your Consulting Service in Higher Accounting. Also a copy of your valuable book for the ambitious man, "Ten Years' Promotion In One."

Name.....

Address.....

Present Position.....



Please Mention Popular Mechanics





## "You Get the Job"

"Superintendent Harrison tells me that you've been studying Traffic Management in spare time with the International Correspondence Schools—in fact, he showed me some of your work. Well, if there's one thing we need around here it's a Traffic Department; we've lost enough money through our ignorance of freight classifications, rates, and the routing of shipments.

"I'm mighty glad when I find one of our men taking enough interest in the Company's business to study ahead of his job. You can move into the private office as Traffic Manager—we'll give you \$50 a month increase in salary to start with and you can make your own future."

Promotions, honors, big pay, go to men who have trained themselves to earn them. The coupon below is your chance. It has helped hundreds of thousands of others to success; it can help you. Mail it today and find out.

TEAR OUT HERE

INTERNATIONAL CORRESPONDENCE SCHOOLS, Box 5612, Scranton, Pa.

Explain fully about your Course in the subject marked X:

- |   |  |                                       |
|---|--|---------------------------------------|
| <input type="checkbox"/> TRAFFIC MANAGEMENT     | <input type="checkbox"/> ADVERTISING       | <input type="checkbox"/> SELLING      |
| <input type="checkbox"/> Business Law           | <input type="checkbox"/> Bookkeeping       | <input type="checkbox"/> Stenography  |
| <input type="checkbox"/> Architecture           | <input type="checkbox"/> Civil Service     | <input type="checkbox"/> CHEMISTRY    |
| <input type="checkbox"/> Architectural Drafting | <input type="checkbox"/> Ry. Mail Service  | <input type="checkbox"/> Illustrating |
| <input type="checkbox"/> Electrical Engineering | <input type="checkbox"/> Steam Engineering | <input type="checkbox"/> Farming      |
| <input type="checkbox"/> Mechanical Engineering | <input type="checkbox"/> Civil Engineering | <input type="checkbox"/> Poultry      |
| <input type="checkbox"/> Mechanical Drafting    | <input type="checkbox"/> AUTOMOBILES       | <input type="checkbox"/> Languages    |

Name \_\_\_\_\_

Address \_\_\_\_\_

## Stronger, Clearer Voice for You!



Weakness, huskiness and harshness banished. Your voice given a wonderful strength, a wider range, an amazing clearness. This done by the Feuchtinger Method, endorsed by leading European musicians, actors and speakers. Use it in your own home. Simple, silent exercises taken a few minutes daily impart vigor to the vocal organs and give a surpassing quality to the tones. Send for facts and proofs.

### Do You Stammer?

If you have any voice impediment this method will help you. You need not stammer or lisp—if you will follow our instructions.

## WRITE

Send the coupon and get our free book and literature. We will tell you just what this method is, how it is used and what it will do for you. No matter how hopeless your case may seem the Feuchtinger method will improve your voice 100 per cent. No obligation on you if you ask for this information. We gladly send it free, postage prepaid. Just mail the coupon.

**Perfect Voice Institute**  
1810 Wilson Av.  
Studio 1197  
CHICAGO

Name \_\_\_\_\_

Address \_\_\_\_\_

Perfect Voice Institute  
Studio 1197 - 1810  
Wilson Ave., Chicago

Send me the book and facts about the Feuchtinger Method. Have put X opposite subject that interests me most.

- |                                     |                                   |
|-------------------------------------|-----------------------------------|
| <input type="checkbox"/> Singing    | <input type="checkbox"/> Speaking |
| <input type="checkbox"/> Stammering | <input type="checkbox"/> Lipping  |



## Typewrite the New Way

Double Your Speed—Your Salary

80 to 100 words a minute guaranteed. Salaries increased to \$25, \$30, \$35, and even \$40 weekly. Totally new system. It's all in the fingers—gymnastically trained away from machine. Brings amazing speed, perfect accuracy. Easy for anyone. Increases speed first day. Learn in spare time—no interference with regular work.

**WRITE TODAY** Let us send you full particulars and letters from hundreds whose salaries have been doubled and trebled since taking up this remarkable new method. A postal will bring it, but write today—NOW, The Tulloss School, 130 College Hill, Springfield, Ohio

## Learn Electricity IN 4 MONTHS



At America's greatest practical institution. Finest equipment. No books. No classes. All individual instruction. No special education necessary. Day and evening school. Open all year. Entering anytime. Earn while you learn. Also courses in Drafting, Plumbing, Bricklaying, and Motion Picture Operating. Send for free book now. Be sure to state which course interests you. Coyne Trade and Engineering Schools Dept. 97, 39-51 East Illinois St., CHICAGO, ILL.

## Are You Earning Less Than \$3000 Yearly?

If you are,—you're on the wrong job. You're in a rut. Why waste a lifetime working for animal wages,—when it's so easy to get into a Man's Job and earn a Man's Salary?

### Be a Traffic Manager

Get into a new—clean—fascinating—high salaried—dignified profession that assures you a place on Easy Street. Traffic Managers needed everywhere. Field can't be crowded for years to come. A POSTAL BRINGS FULL INFORMATION.

INTERSTATE TRAFFIC SCHOOL, 30 TRAFFIC BLDG. FT. WAYNE, IND.

## WORD POWER

Be a forceful, convincing speaker—overcome timidity and "stage fright." Put power in your words. Dominate all who hear you with the force of your personality. Our new scientific Effective Speaking Course will train you quickly at home—by mail, to speak effectively in public or in private—talk before your club or lodge—make after-dinner speeches—sell more goods—write better letters—enlarge your vocabulary—develop your self-confidence.

**Special Offer—Write Today** Send your name and address for particulars and Special Limited Offer—no obligations. Write now. North American Institute 1194 Manhattan Building Chicago, Ill.

## BE A BANKER

Prepare by mail for this high profession, in which there are great opportunities. Six months' term. Diploma awarded. Send for free book, "How to Become a Banker." EDGAR G. ALDRON, Pres. AMERICAN SCHOOL OF BANKING 419 East State Street, COLUMBUS, OHIO

## DRAWING

Learn by Mail in YOUR OWN HOME Newspaper, Magazine and Commercial Illustrating, Cartooning, Water Color and Oil Painting. Learn drawing or painting for profit and pleasure. We can develop your talent. This school has taught thousands. Free Scholarship Award—special limited offer. Your name and address brings you full explanation and our handsome illustrated Art Annual by return mail. Don't delay, write to-day. Fine Arts Institute, Studio 217, Omaha, Neb.





# The MILLION DOLLAR AUTOMOBILE and TRACTOR SCHOOL

## Sweeney's Talks to Men No. 1

Mechanically inclined men, your chance has come. Get ready to grasp it. Your country needs mechanics, needs you, I mean you, the man who reads this page. Learn a trade that fits your natural inclinations and ambitions—help your country and yourself, and be a success.

### Trained Automobile, Truck, Tractor and Aeroplane Mechanics Must Be Had

both in military and civil life. Our Government is building 100,000 aeroplanes and will need 300,000 mechanics to repair them. Thousands of truck and ambulance drivers will be needed with our army in Europe. Increased business at home, more automobiles and trucks, who's going to run and repair them? YOU, your one great chance is here. Opportunity doesn't keep knocking at your door always, but is knocking NOW. Picture your future, making big money in a work you like. Earn from \$80 to \$200 a month.

### Learn the Automobile and Tractor Business

The business which was started for you, made to order for men who love machinery. You can succeed. It's your chance. The Sweeney System of

teaching this business was originated by me. Mine is the one school which gives you the actual experience and keeps giving it to you. When I say actual experience, I mean it. You get it in my school working on hundreds of machines and cars. You get it every day in my garage, one of the biggest in the West, one run exclusively by students. You get it on my tractor field, and you keep getting it until you say "enough."

Your success is my success. I built this wonderful, world-wide known school on the success of my graduates. My system did it. It made my graduates successful. The results speak for themselves. My school is one of the largest in the world teaching mechanics. I have students from all over the world, Italy, South America, Philippines, Hawaii, South Africa, Australia, Japan, Russia, and Servia. They come to me because of my reputation and success. I teach the automobile and tractor business by teaching you how to teach yourself, doing the actual work, keeping you at it until you know it. That is the reason I have this wonderful school of practical experience.

**Sweeney and Success** stand for the same thing in the automobile and tractor business. I don't need to tell you what equipment I have. I have absolutely every piece of equipment necessary to teach the automobile, tractor and truck business, and special work on aeroplane motors, nothing overlooked. This is the greatest trade school in the world, both in size and equipment.

### SPECIAL FEATURES NO OTHER SCHOOL HAS

Everything for the pleasure and comfort of my students while studying with me in this wonderful building. Indoor Swimming Pool, Shower Baths, Library, Recreation Room, Our Moving Picture Theatre seating 1,000, one of the biggest restaurants in the world, seating 425 at once; rooms for 800 students; every convenience of a big hotel at less price than at a boarding house. Look at the picture of my building. Use your judgment.

**WRITE ME TODAY FOR MY FREE CATALOG** It tells how the Sweeney School has grown, how it teaches the automobile and tractor business, shows a way for you to succeed. Write for my catalog.

E. J. SWEENEY, President

## Sweeney Automobile and Tractor School

1168 E. 15th Street, Kansas City, Mo.

P. S. If you are looking for a soft snap and are afraid to get dirty, don't come here. This school is for men that have backbone and know how to use it. Write now if you are not a quitter.—E. J. S.

**TELL IT TO SWEENEY—CUT THIS COUPON**  
Sweeney Automobile and Tractor School  
1168 E. 15th Street, Kansas City, Mo.  
Send me Free Illustrated Catalogue of your School and how you teach the Automobile and Tractor Business.

Name .....

Address .....



# The War, Electricity —and YOU

Three minutes spent in reading  
this article will be well repaid



President Wilson said:

"The Nation needs each man in the endeavor that will best serve the common good. The Nation is being served only when the sharpshooter marches, and the machinist remains at his levers."

**Serving the Nation Best** This is your opportunity to serve your country

in the manner for which you are best fitted; to take part in the great electrical work now going on. But the Nation needs no dabblers, no half prepared amateurs, who are mere wishers instead of workers. It needs only those who are prepared, who have learned electricity by doing the very work they are later called on to do. That is the kind of training you get in the New York Electrical School. The School that Trains while it Teaches. This is the method which enables you to cut out long years of apprenticeship and start as an expert in electricity.

**Electrical Work in the Army, the Navy and the Industries** All branches of the Government Service offer unlimited opportunities to men adequately trained in electricity. Telegraphy, Telephony, Wiring, Wireless, Power Plant Work—these are only a few of the electrical activities in the U. S. Army and Navy. And in every industry—Government and otherwise, thousands of men are needed for electrical work of all descriptions.

**The Best Way To Train** There is no time to lose, if you would take advantage of this splendid chance to aid your country in the manner for which you are fitted. And in choosing the place to train remember that four thousand five hundred men, young and old, got their real start by learning electricity at the New York Electrical School.

**You Start Higher Up** When you graduate from the New York Electrical School you are ready to step right into a position of responsibility. You are an expert, not a dabbler, in electricity. Yet the course is so simple that anyone with a common school education can take it. We have no requirements for entrance.

We have both day and night sessions, but most of our men take the day sessions because it naturally enables them to complete the course quicker.

**New York the Center** We are located in the heart of New York City. New York is the heart of everything electrical—there are big plants near by, electrical expositions, libraries and facilities for good, quick work in an atmosphere of industry. A large number of our students come from other cities, from all over the United States.

**And Now** If you have an ambition to make a name for yourself in the electrical field and serve your country well, you will want to join the New York Electrical School with our October sessions. Then you should hurry to send for our 64-page book which tells you all about the school, with pictures of our equipment and students at work, and a full description of the course. You need not hesitate to send for this book. It is FREE to everyone interested in electricity. It will not obligate you to send for it. Send the coupon or write us a letter. But write us now while you are thinking about the subject of electricity. Address—NEW YORK ELECTRICAL SCHOOL, 44 West 17th Street, NEW YORK, N. Y.

MAIL THIS COUPON TODAY FOR FREE BOOK

NEW YORK ELECTRICAL SCHOOL, 44 W. 17th St., New York  
Please send FREE and without obligation to me your 64-page book.

NAME.....

ADDRESS.....

Please Mention Popular Mechanics

## This Fob FREE

Are you interested in the mechanical side of an automobile, its proper operation and economical maintenance?

Owners—Garagemen—Chauffeurs

The *American Chauffeur* is a live monthly magazine featuring articles in common sense language, by "men who know," on instructive topics, which will be interesting and of great value to every auto owner, chauffeur and garageman.

### FREE OFFER

To introduce the *American Chauffeur*, we are offering this plated lacquered watch fob, with seal grain leather strap, as illustrated, ABSOLUTELY FREE, with a 3 months subscription to the *American Chauffeur* at the regular price of 25c.

Your money refunded if either the magazine or fob does not come up to your expectation.

THE AMERICAN CHAUFFEUR  
99 Butler Bldg., CINCINNATI, OHIO

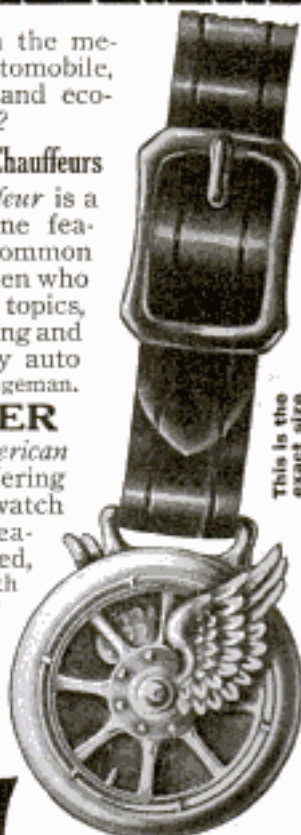

This is the exact size

## Increase Your Income

Learn Show Card Writing and Lettering



A complete course (32 lesson plates) size 11x15, mailed for \$1.00. Guaranteed to suit you or money refunded if returned at once.

Send for descriptive circular.

ALPHA COLOR COMPANY, Inc.  
31 E. 125th Street, New York



### Draw Pictures that MOVE

The demand for animated cartoonists far exceeds supply. Get into this new, uncrowded profession now and

**EARN \$25 TO \$200 A WEEK**

Anyone with ordinary ability can quickly learn at home, in spare time. Write today for free book.

HARRY PALMER STUDIOS  
29 VANDERBILT AVE., NEW YORK CITY.

## Check the Job You Want!

.... Railway Mail Clerk	\$900 to \$1800	.... Customs Positions	\$ 600 to \$1500
.... Postoffice Clerk	\$800 to \$1200	.... Internal Revenue	\$ 700 to \$1800
.... Postoffice Carrier	\$800 to \$1200	.... Stenographer	\$1000 to \$1500
.... Rural Mail Carrier	\$600 to \$1200	.... Clerk at Washington	\$ 840 to \$1500

Name.....

Address.....

Sign your name and address and send us this coupon immediately. We will immediately send you (1) a full description of the position checked (2) a list of many U. S. Gov't Jobs now easily obtainable and directions telling how to get free coaching for the position checked. Thousands War Jobs open.

Franklin Institute, Dept. G97, Rochester, N. Y.



# Stop Forgetting!

## Perfect Your Memory and You Can Command What Salary You Will

Your salary—what it is today—what it will be tomorrow—depends very much on your memory. Tricky memories—wandering minds—unable to grasp detail—have thwarted thousands in their battle for success—have held them down to bare living wages—working long hours with slight prospect of advancement—subordinates for life.

### The Ability to Concentrate, to Think and Express Yourself Clearly Means Everything to Your Success

America's men of power—in business, social or public life—are uniformly men of **trained memories**. Train your memory properly and you will find yourself able to concentrate absolutely on matters at hand—to think and speak connectedly—to develop self control, to overcome self consciousness—to make your **PERSONALITY DOMINATE**. Think what this means—a better position—bigger pay—social and business success—the **EFFICIENT LIFE**.

### Give Me 10 Minutes a Day and I Will Give You a "Steel Trap" Memory

That is all I ask—just ten minutes a day for a few weeks and I will train your memory just as I have trained the memories of 50,000 others. I will make your mind an infallible classified index from which you can instantly select facts, figures, faces, arguments. No matter what your age—your education—your vocation—your place of residence—I can make you "forget proof"—can train your memory for **SUCCESS**.

### Special Offer! "How to Speak in Public"—FREE!

For a limited period I am offering "How to Speak in Public," a de luxe edition, handsomely bound book—regularly priced at \$2.00—FREE to every student enrolling in my course. Full particulars of this unusual offer— together with a copy of my famous Memory Test and my remarkable book "How to Remember" will be sent FREE— simply for the mailing of the coupon or a postal. This is YOUR opportunity—mail it NOW.

The Key to Success

Stop Forgetting

Prof. Henry Dickson, Prin. Dickson School of Memory  
1705 Hearst Bldg., Chicago, Ill.

Please send me free of charge and without obligation your booklet, "How to Remember"; also your remarkable copyrighted "Memory Test." Give me facts on your special offer of a free copy of "How to Speak in Public."

Name .....

Street and No. ....

City ..... State .....



Prof. Henry Dickson

America's foremost Authority on Memory Training, Public Speaking, Self Expression, Lectures and Principal of the Dickson Memory School, Hearst Building, Chicago.

#### The Executive



Mr. William H. Weeks, District Attorney of Putnam County, N. Y., writes:

"After a thorough trial of your method of mental and memory training, I find it to be not only first class—simply wonderful. I can truthfully say that I would not be again without the benefits I have received from your study for \$10,000."

#### The Salesman



O. G. Wehmeler, of the American Miner's Accident Association, Indianapolis, Ind., writes:

"I can honestly and truthfully say I am a new person. I have more friends than I really expected I could have. Everyone who has known me says that a wonderful change has come over me in the last six months. It is all due to the Dickson School of Memory."

#### The Public Speaker



Carl F. Schader, one of California's biggest men, writes:

"I have been improved physically and mentally beyond my own expectations by the continued study of your course. Every business man, especially those called upon to talk at Chambers of Commerce, realty boards, advertising clubs and other meetings should take your course. I unhesitatingly recommend it to my many friends."

#### In Social Life



Roland Miller, of New York City, writes:

"What I have gotten from your method has advanced me both socially and financially and I feel it my duty to tell you of these excellent results."







**Earn \$125 to \$250 a Month**

in the Steam Engineering field. Prepare in your spare time for a Stationary or Marine Engineer's License, or position as Locomotive Engineer. These great books, written by 27 experts, contain all the information necessary for you to take up this fascinating, high-salaried work. We send them free!

**Steam Engineering**

7 volumes; 3300 pages, 7x10 inches; 2500 illustrations, full page plates, diagrams, etc.; hundreds of valuable tables and formulas. Handsomely bound in half red morocco, gold stamped. Covers the construction and operation of stationary, locomotive and marine engines and boilers; the use of gas and gasoline engines for power and locomotion; the transformation of steam and gas power into electricity, and the application of steam and gas power to refrigeration, compressed air, etc.

**Sent FREE—Just Mail the Coupon**

The entire seven volumes will be sent, express prepaid, to any resident of the U. S. or Canada, on receipt of the coupon below. Look these books over for a whole week free. Then decide whether or not you want them. If you do, send us \$2.00 within seven days and \$2.00 a month until the special price of \$19.50 has been paid. Otherwise we'll take them back at our expense. In addition to this liberal discount from the regular price of \$33.00, we include with each set a \$12.00 Consulting Membership. This entitles you to the advice of a staff of experts for a whole year free.

**American Technical Society, Dept. 31197 Chicago, U.S.A.**

Please send Cyclopedia of Steam Engineering for 7 days' free examination. I will send \$2.00 within 7 days and \$2.00 a month until I have paid \$19.50; otherwise I will notify you and hold the books subject to your order. Title not to pass until fully paid.

NAME.....  
 ADDRESS.....  
 REFERENCE.....

**Ridpath's History of the World At a Bargain**



We will name our special low price and easy terms only in direct letters to those mailing us the Coupon below. Tear off Coupon, write name and address plainly, and mail now before you forget it. The 32 Free Sample Pages will give you some idea of the splendid illustrations and wonderfully beautiful style in which the work is written. Thousands have already availed themselves of our offer and every purchaser is more than satisfied. **Mail Coupon Now.**

**FREE COUPON**

**WESTERN NEWSPAPER ASSOCIATION** (10-17)  
 140 So. Dearborn St., Chicago, Ill.

Please mail your 32-page free sample booklet of Ridpath's History of the World, containing photographs of Napoleon, Socrates, Caesar and other great characters in history, and write me full particulars of your special offer to Popular Mechanics readers.

NAME.....  
 ADDRESS.....

**WOULD THE LAW LET YOU MARRY?**

Some States have been wise enough to insist upon a medical examination of the two contracting parties to a marriage before a license is issued. Through the adoption of a law whereby the physically unfit were barred from marriage in every State in the Union, there would indeed be a relatively small percentage of the population that would measure up to the standard.



**WOULD YOU BE ONE OF THOSE** doomed to go through life alone, without the joys that go hand in hand with a loving wife and healthy children? Our first duty is to posterity. We are not put here by an all-wise Providence merely to live out our lives, and then go out like a snuffed candle. We are entrusted with the sacred duty of perpetuating the race.

**LIKE BEGETS LIKE:** A man who is torn and racked by physical ailments and excesses of all kinds will some day see these traits in his children. On the other hand the strong, virile man, who jealously safeguards his body and his health, will some day revel in the sight of offspring that are a picture of joyous, bubbling health.

**YOU OWE IT MOST TO THAT GIRL**

The sweetest, purest, dearest girl in the whole world whom you would call wife. Is your body clean? Do you realize the terrible consequences of the follies that are wrecking your body? Remember then that **STRONGFORTISM** will restore to you perfect health.

I have prepared a little book, "Intelligence in Physical and Health Culture," which should be read by everyone sufficiently interested in themselves to wish for the best in life. It points the way to better health, a cleaner, happier life, and a splendid physique. Three 2-cent stamps will pay for mailing the book. Send for it NOW.

**LIONEL STRONGFORT, Master of Physical Culture**  
 280 Park Building, Newark, N. J.

**NATIONAL TRADE DENTAL SCHOOL**

506 S. Wabash Ave., CHICAGO, ILL.  
**LEARN MECHANICAL DENTISTRY—DEMAND UNLIMITED**  
 Earn \$1200 to \$4000 yearly in mechanical dentistry. A big and growing demand everywhere for mechanical dentists—like a gold mine, unexplored. Attend this school any time of the day or evening; be taught individually and learn by actual practice, without book study. Our system, the most complete in the world, is used exclusively in this school. We are constantly called upon to fill high-salaried positions. Why not qualify for one? Be fair to yourself; find out more about exceptional opportunity we offer. Visit the school or write for booklet.

**7 DAYS** In your own home, during the evenings of just one week, you can learn the famous

**PARAGON SHORTHAND**

Then Practice Brings the Speed

Used in Government service; also in Court Reporting. Adopted by cities for High Schools. Wonderfully easy to read. Speed capacity practically unlimited. Positive proof before you enroll. Send for it TODAY.

PARAGON INSTITUTE, 621 COLISEUM PLACE, NEW ORLEANS, LA.

**Be a Finger Print Expert**

**FINGER PRINTS**

Police departments, factories and industries everywhere are adopting this system of identification. Experts needed at once. You can train yourself in spare time at home. Write for details.

**Free Book—Write** Valuable and interesting book on finger prints sent absolutely free and prepaid. Also details of special limited offer. Write at once, while this offer lasts.

**EVANS UNIVERSITY, FINGER PRINT DEPT.**  
 Desk 9197, 1810 Wilson Avenue, CHICAGO

**LEARN TELEGRAPHY**

Young men and women attend on credit. A practical school with railroad wires. Owned and operated by the A. T. & S. F. N. **EARN FROM \$55 to \$165 PER MONTH.** Write for catalog.

**SANTA FE TELEGRAPH SCHOOL**  
 515 Kansas Ave. TOPEKA, KANSAS

**LEARN WATCHMAKING**

and become independent. Good-paying positions secured. Easy to learn. Send for FREE CATALOG.

**STUDY MEDICINE, SURGERY, BACTERIOLOGY, PUBLIC HEALTH, PHARMACY**

Standard Day and Night courses. Splendid faculty. Unexcelled facilities. **Work-your-way-through plan.** Write for catalog.

**Chicago Hospital College of Medicine, 221 C. 3632 Rhodes Ave., Chicago**

**AT HOME**

**Learn TO SING** Send 2-cent Stamp for Helpful Booklet, "The Voice Made Beautiful."

**HARVEY SUTHERLAND, 1832P 49th St., BROOKLYN, N. Y.**





## Business Is Calling Law Trained Men Prepare for YOUR Opportunity—NOW

A former President of the National City Bank, New York, recently said: "In only a few years every man connected in any official capacity with any banking or business institution will be required to have a legal training." And the President of the New York Life Insurance Co. says: "A man is not equipped for the management of large business interests until he has taken a law course." How evident this appears when you consider that every commercial transaction from the writing of a business letter to closing a million dollar contract involves legal points which some man must know.

Every leading business and banking house today realizes its need of the law trained man. The call is going forth. More and more when executives are chosen, preference is being given to the man who knows law. There is confidence in his judgment and in his decisions. He steps quickly into a position which even years of plodding work without knowledge of law would not qualify him to hold.

And now—opportunity through law training—which means a greater opportunity to rise—is open to any man who will take the course of mail study offered by LaSalle Extension University

### La Salle Students and Graduates

can now be found employed in the executive departments of practically all the large railroads, business houses and commercial organizations in the United States. Many prominent business concerns can be named in each of which 100 to 500 or more LaSalle students or graduates from our several specialized departments are employed in responsible positions. For instance—

Pennsylvania R. R.	913
American Telegraph & Telephone Company	259
U. S. Steel Corporation	259
Baltimore & Ohio R. R.	584
Armour & Company	162
Chicago & N. W. R. R.	382
Ford Motor Company	122
Swift & Company	127
Standard Oil Company	140

Among the numerous firms and corporations employing 50 to 100 or more LaSalle students or graduates are the following:

Western Electric Company
International Harvester Co.
E. F. Goodrich Company
Wells Fargo Express Company
Goodyear Tire and Rubber Co.

and every important railroad company in the United States.

More than 125,000 men in active business life including a large number of corporation officials have enrolled and are receiving the benefits of LaSalle training and service. Over 20,000 new students now enroll annually. The LaSalle organization consists of 800 people, including a staff of 300 business experts, professional men, text writers, special lecture writers, instructors and assistants. LaSalle students and graduates occupying responsible positions can be found throughout the entire English speaking world.

### Free Consulting Service

As a LaSalle student, you will also be entitled to the free use of our Consulting Service which gives you the privilege of calling on our staff of experts in any department at any time when you need special help or counsel. LaSalle Extension University is a clearing house of business information and through its many highly specialized departments is organized and equipped to render a practical and distinctive service which cannot be supplied by any other institution of similar character.

## A University Training in Law by Mail

You are offered here a course in law prepared by men of nationwide reputation as legal authorities. Every principle of law is given in clear, concise form without confusing verbiage—and you are shown how to put these principles into every day practice. You get the same character of instruction which you would receive if you could attend a resident university with all these eminent men on the faculty. But by studying at home you can hold your present position and obtain a thorough law training at a mere fraction of the cost. You have text books, lectures, practice courts, quizzes and examinations; and you are constantly under the direction of the ablest professors who see that you are thoroughly instructed on every point throughout the entire course.

You graduate with the degree of L.L.B.—and then you are ready to qualify as a

practicing attorney or as a man fitted for a responsible position. You will be a better thinker—you will be a man of broader culture, for law training is recognized as one of the greatest developers of mentality.

You can accomplish all this in your spare time, and you can pay for your training in law in small monthly sums.

Our graduates are recognized as among the best trained men in the profession. They pass bar examinations with unusually high standing. Why should not you also be a law trained man? Why not get this university training by mail?

The opportunities are open for you as they have been for others who have studied the LaSalle University Law Course by mail and reached success through this training. At least write for the information we will send. Then make your decision. Mail the coupon today.

### LASALLE EXTENSION UNIVERSITY

"The World's Greatest Extension University"

Dept. 1064-F

Chicago, Illinois

Please send your two books "Evidence" and "Ten Year's Promotion in One," also information on your university training in Law and your Consulting Service free to LaSalle students. This without obligation to me.

Name.....

Address.....

Present Position.....



Please Mention Popular Mechanics



# LEARN AUTOS

WHERE AUTOS ARE MADE



Enlarged  
Facilities

Freely Endorsed by  
Automobile Manufacturers



Detroit is the training camp for men who make good in the automobile and allied lines. Never has the call for men skilled as mechanics, testers, inspectors, repair-men, bearing scrapers, welders, chauffeurs and salesmen been as great as it is today—and the demand is growing.

## The Y.M.C.A. Auto School

is organized to train men. A Course in this School will quickly fit the beginner to do well-paid work, and get in line for advancement in the rapidly growing automobile industry. Tuition fees go to procure the highest class of instructors and best of equipment.

### Growth Brings Added Facilities

The Y.M.C.A. Auto School is now in its New Building. Among the manufacturers who have contributed liberally toward our equipment are: Studebaker, Buick, Hupp, Chalmers, Ford, Packard, Hudson, Gray & Davis, Delco, Cutler-Hammer, Zenith, and many others. Can you ask stronger proof of the school's standing than the fact that men who know give freely of their time and money to co-operate with us.

**Tuition** includes membership in the "Y" and free service of Employment Bureau for one year. Our big Club House, adjoining our New Building, is at your disposal. Reading rooms, lounging rooms, gymnasium, swimming pool, billiard and pool tables, bowling alleys, with five floors of dormitories and restaurant at low rates. You are assured of not only thorough and competent instruction, but good companionship and clean living conditions with the comforts of home and club life combined. **Don't Visit Detroit Without Seeing Us.** You want to consider everything carefully before you enroll for any course of instruction. Come and look us over, whatever purpose brings you to Detroit. Get all the particulars of this school, get the records of our instructors, hear what auto factories and automobile men have to say about us, see for yourself our comfortable quarters and big equipment. We will be glad to see you and show you around whether you enroll or not. Day and night classes. Start at any time.

Write today for full particulars. Address

**EDUCATIONAL  
DIRECTOR**

Box 305, Y.M.C.A., DETROIT, MICH.



NEW HOME OF Y.M.C.A. AUTO SCHOOL

Please Mention Popular Mechanics

Copyrighted material





## Get Into the Fight With Bob and Allan!

Drop down beside them and let the enemy have all that's coming to him. Hear that shrapnel whizzing! Smell the powder and smoke! That's exactly the feeling you'll have when you read *Red Legs*, the new story that has just started in *The American Boy*. It's written so that you'll just imagine yourself right in the trenches.

You'll regard Bob Hurd and Allan Cutler—two American Boys who were caught in the great German rush across Belgium and helped stop the enemy—as comrades. You'll live right with a gun and get into thrilling adventure after adventure.

The *American Boy* is chock full of just such thrilling tales. It also tells all about baseball, football, basketball—all sports. Tells you how to make money. Contains articles on Electricity, Mechanics, Aviation, Camping Stories—stories of boys who get on by using their heads. There are jokes, comic pictures, etc. You'll find it so interesting you'll never let up on it until you read every line.

The *American Boy* costs only 15 cents a copy. You can buy it at almost any news-stand. Show this to mother and father and tell them you would like to have this month's *American Boy*. If you have 15 cents, buy it yourself. We will send you the *American Boy* for a whole year for \$1.50. Whatever you do, get this month's copy and start reading *Red Legs*—it's a PEACH. Get it right now. When writing for year's subscription, address.

**THE SPRAGUE PUBLISHING CO.**  
No. 133 American Bldg. Detroit, Mich.  
\$1.50 a year. 15c a copy on news-stands.

# THE AMERICAN BOY

"the biggest, brightest, best magazine  
for boys in all the world."

Please Mention *Popular Mechanics*

Earn  
\$1500  
to  
\$5000  
Yearly



Learn  
at  
Home

## Civil Engineering 9 Big Volumes FREE Shipped to You

3900 Pages (7x10 in.) 3000 Plates, Maps,  
Diagrams, Etc. Half Red Morocco Binding

Quick action secures this great *Cyclopedia of Civil Engineering* at a record-breaking low price, on little, easy payments. Covers the whole broad field of Civil Engineering. Contains hundreds of valuable tables and formulas. Durably bound in handsome half red morocco, gold stamped. An indispensable reference work for the trained Engineer. Helps ambitious young men qualify for this big-pay profession.

**50¢ A Week** Entire Set on 7 days' Free Examination, express prepaid. If you keep it, send only \$2 within 7 days and then \$2 a month (50c a week) until the \$29.80 has been paid. This is \$12.50 less than the regular price of \$45.

## Free Consulting Service

### Tells About

Plane Surveying  
Plotting and Topography  
Highway Construction  
Railroad Engineering  
Earth-work  
Steel Construction  
Estimating for Steel Bldgs.  
Statics  
Roof Trusses  
Civil Specifications and Contracts  
Bridge Engineering  
Strength of Materials  
Masonry and Reinforced Concrete  
Water Supply  
Sewers and Drains  
Hydraulics  
Water Power Development  
River Improvement  
Harbor Improvement  
Cost Analysis  
Engineering  
Dams and Weirs  
Irrigation  
Engineering

We give a Consulting Membership in the American Technical Society (regular price \$12) FREE with each set. This entitles you to the free advice of a corps of Civil Engineers for a whole year. Thousands of Civil Engineers called to War Service. Big jobs everywhere must be filled. This is your great chance.

### American Technical Society

Dept. C-1197, Chicago, U. S. A.

Please send me the nine volume set of *Cyclopedia of Civil Engineering* for seven days' free examination. If I decide to buy, I will send \$2.00 within seven days and the balance of \$2.00 a month until \$29.80 has been paid. Then you send me a receipt showing that the set of books and the \$12.00 consulting membership are mine and fully paid for. If I think that I can get along without the books after the seven days' trial I will return them at your expense.

NAME.....

ADDRESS.....

REFERENCE.....





**33,000 sq.ft. of Additional Floor Space**

# Come to Detroit

## The Automobile Center and

# LEARN THE AUTOMOBILE BUSINESS

**DETROIT** trained men get preference and get jobs quickly. No other city can give what Detroit offers. Think what it means to learn in the Michigan State Auto School. Factories endorse our school, glad to employ our graduates or offer them territory in which to sell cars and start garages. Unlimited opportunities. 71% of Automobiles are made in Detroit. You're right in the Heart of the Auto Industry. Men are needed everywhere as testers, repairmen, chauffeurs, garage men, and salesmen. Hundreds of our graduates start in business for themselves.

## Earn \$75 to \$300 a Month

We teach you to handle any auto proposition. You graduate in from ten to twelve weeks. Our equipment is new, up-to-the-minute, and complete. No old, obsolete motors, chassis or electrical equipment used. Students actually build cars from start to finish, getting factory training in assembling, block-testing, road-testing, everything. Special complete course in Oxy-Acetylene brazing, welding and cutting, separate from regular course. Learn to time motors, rebore cylinders, adjust carburetors, magnetos, valves and bearings quickly and accurately. Six-cylinder Lozier, Chalmers "6," Detroit "6," Overland, and 8-cylinder King

are used for road instruction. We have the following completely equipped chassis:

<ul style="list-style-type: none"> <li>Chalmers "6-30" 1917 chassis</li> <li>Detroit "6-45" 1917 chassis</li> <li>Buick Light "6" 1917 chassis</li> <li>Willys-Knight 1917 chassis</li> <li>Studebaker "6" 1917 chassis</li> <li>Hudson Super-Six 1917 chassis</li> <li>Cole "8" 1917 chassis</li> <li>King "8" 1917 Chassis</li> </ul>	<ul style="list-style-type: none"> <li>Metz "4" 1917 Chassis</li> <li>Detroit Electric 1917 chassis</li> <li>G. M. C. 2 Ton Truck</li> <li>Saxon "6" 1917 chassis</li> <li>Maxwell 1917 chassis</li> <li>Oldsmobile "8" 1917 chassis</li> <li>Winton "6" chassis</li> <li>Packard Twin "6" 1917 chassis</li> <li>Chalmers "4" 1913 Chassis</li> </ul>
---	---

All completely equipped for students to work on. We have more than 20 motors in our block test department—2 cyl., 4 cyl., 6 cyl., 8 cyl., and 12 cyl. Our electrical department is complete, having every standard starting, lighting, and ignition system, including Delco System as used in Buick, Hudson, and Packard Twin "6."

## Detroit Is the Place to Learn—Start Any Time

There are 44 auto factories in Detroit and vicinity and 140 accessories and parts factories. Our students have the privilege of going through any or all of them. We operate Starting, Lighting, Ignition Service Station. This has added thousands of dollars' worth of equipment and makes our electrical department unequalled. Students get actual experience in handling all kinds of electrical auto equipment and taking care of trouble. We have just installed a Sprague Electric Dynamometer for block-testing purposes for students' use. Ours is the only Auto

school having this equipment. Auto factories need Dynamometer men constantly. Factories and garages are paying big salaries to men who know how to handle electrical equipment quickly and properly. Detroit is the automobile center. You get practical instruction. School open all the year. Enter classes any time, any day. Three classes daily: morning, afternoon, evening. All instructors are members of the Society of Automobile Engineers (S.A.E.) There is a great demand for Michigan State Auto School students. Auto factories write and phone for men constantly.

## Follow the Crowd to the Michigan State Auto School. Come to Detroit

### MONEY-BACK GUARANTEE

We guarantee to qualify you in a short time for a position as chauffeur, repair man, tester, demonstrator, auto electrician, garage man, or automobile dealer, paying from \$10 to \$300 monthly or refund your money. We have constantly more requests for Detroit trained men at GOOD salaries than we can supply.



THIS IS ONE OF THE FEBRUARY 1917 CLASSES



DETROIT THE HEART OF THE AUTO INDUSTRY

### Additional Building and Equipment

Thousands of dollars' worth of new equipment, plenty of room for students to work, at 687-89-91 Woodward Ave., in addition to our building at 11-19 Selden Ave. Our school has grown by leaps and bounds, students come from all over the world. We are constantly adding new equipment. Our electrical department is thorough and complete.

### Factory Co-Operation

We have completed arrangements with the Auto factories to put them in touch with men who intend going into business for themselves. Men who know the auto business from A to Z are in biggest demand. Remember, the price of course is based on giving full value. Graduates in the complete auto course are competent to handle farm tractors.

### Auto Factories Endorse Our School

The Leading Automobile factories in Detroit, as well as in other cities, endorse our school. They have been watching our school and graduates for years and are satisfied. They are putting their latest model, complete chassis in our school for students to work on. They are employing our graduates in their factories and service stations and assisting them in opening garages and salesrooms. They allow our students to go through their factories. They need trained, competent men and are asking for more of our graduates constantly. The Michigan State Auto School in Detroit, the heart of the Auto Industry, is endorsed by the Leading Auto Factories, is receiving their hearty co-operation. What better endorsement could you ask?

### The Leading Automobile Factories in Detroit

They have been watching our school and graduates for years and are satisfied. They are putting their latest model, complete chassis in our school for students to work on. They are employing our graduates in their factories and service stations and assisting them in opening garages and salesrooms. They allow our students to go through their factories. They need trained, competent men and are asking for more of our graduates constantly. The Michigan State Auto School in Detroit, the heart of the Auto Industry, is endorsed by the Leading Auto Factories, is receiving their hearty co-operation. What better endorsement could you ask?

## Act Quickly—NOW!

Fill in the coupon; get full particulars, "Auto School News" and New 128-Page Illustrated Catalog. All absolutely free. Or better still, jump on the train, as hundreds have done, and come to the "Heart of the Automobile Industry," and learn right. We have no branches. Write or come direct to this school.

## Michigan State Auto School

The Old Reliable School

A. G. ZELLER, Pres.

310 Auto Building  
687-89-91 Woodward Ave.      DETROIT, MICHIGAN, U. S. A.

### SEND THIS COUPON TODAY

**MICHIGAN STATE AUTO SCHOOL**  
310 Auto Bldg., 687-89-91 Woodward Ave.  
DETROIT, MICHIGAN, U. S. A.

Gentlemen: Send me absolutely FREE "Auto School News" and New Catalog, or better still, you can expect me about.....

Name.....

Street.....

Town..... State.....



Our Country needs competent trained  
Auto Mechanics in the  
Quartermaster's  
Dept. and Signal  
Corps

The United States needs thousands of truck, transport, aeroplane and motorcycle drivers. Trained competent men are needed, men who can take care of the machines, men who know how to keep them in service. Any piece of motor driven machinery the government owns or will own must be in service. Preference will be given to trained men. No matter what service the Army is doing it must be fed. If it is on the firing line it will need thousands of rounds of ammunition. The importance of trained men is very evident. Food and ammunition must be delivered regularly. Then too, the army must often be transported.

## Quartermaster Department and Signal Corps Needs Trained Men

The Michigan State Auto School trains men thoroughly.

Every student learns pleasure cars, trucks, motorcycles and gasoline motors of every kind from A to Z. Graduates of the Michigan State Auto School are in big demand by the leading Automobile plants in Detroit. These factories know from actual experience that our men are thoroughly, completely and practically trained. No matter what happens to a truck or pleasure car, a Michigan State Auto School graduate is competent to repair it. Cars in the care of a graduate give highest efficiency.

This is the kind of men Our Government wants and is daily enlisting. Trained men who will be efficient themselves and keep every bit of motor driven equipment in the most serviceable condition.

This branch of the Army Service pays good salaries. There are wonderful opportunities for clean, clear headed, trained men to advance in the service and certainly now is the time to train.



Aerial View of Motor Truck Group at Ft. Sam Houston, Texas. Major F. H. Pope, Cavalry, Commanding

This view gives an idea of the large number of transport trucks that will be used in our Army. Thousands of trained men are needed and will be needed to care for these machines and keep them operating up to their highest efficiency. Trained men will be given preference and men who graduate from the Michigan State Auto School are now and have been holding big, responsible jobs in Detroit and over the country and will be able to serve their country in the most efficient way.

## Thousands of Trained Motor Mechanics Needed in Army

Thousands of Motor Mechanics are needed in the army in the Quartermaster's Dept. and the Signal Corps. Nearly every man must be trained. Hundreds of thousands of men will be taken from every branch of the automobile business. Factories, garages and service stations will be depleted. There will be a crying need for trained men, both in the Army and out of it.

It is essential that an army be made up of the ablest fellows. It is absolutely necessary for men not of conscription age to fill the places left by men going to the front. Never were there such opportunities for men to get ahead in the Auto business. And never were trained men in such demand both in and out of the Army.

## Thousands of Trained Motor Mechanics Needed at Home

With the army taking a million and a half men, there will be an enormous drain on the Automobile business. Trained men will be needed to fill the vacated jobs. Men older and younger than 21 to 31 years will step into the work. Trained Auto Mechanics will get the big paying jobs. Factories, service stations, garages, will be paying even higher salaries than ever. Thousands of new cars

are going into service daily. The United States and her Allies are ordering trucks and Autos by the thousands. Can you imagine a better chance to get into a money-making business? The Auto business has been good for years. It is getting better constantly. But right now is the opportunity of a lifetime — Get busy — write for catalog — train now to help Uncle Sam or yourself.

No matter whether you join the colors or stay at home,  
you can do your bit best as a trained Auto Mechanic.



A Packard Truck  
Used By The  
U.S. Government



## Going up?

AGE 30-\$1800

AGE 40-\$3500

AGE 50-\$5000

AGE 20-\$600

AGE 30-\$700

AGE 40-\$600

AGE 50-\$500

## -or down?

**H**ERE is your future charted, for you, based on the actual average earnings of trained and untrained men.

Which way will you go—up, through training, to a position that means good money, or down, through lack of training, into the ranks of the poorly paid?

It rests with you. And now is the time to decide. Not next year, not next month, but now. You can get the training that will command a trained man's salary. The International Correspondence Schools have helped hundreds of thousands to qualify for advancement. Let them show you how you can prepare yourself, in your own home, for the position you want in the work you like best.

Just mark and mail this coupon. It will be the first step upward. Mark and mail today.

I. C. S., Box 5614, Scranton, Pa.

### TEAR OUT HERE

## INTERNATIONAL CORRESPONDENCE SCHOOLS

BOX 5614, SCRANTON, PA.

Explain, without obligating me, how I can qualify for the position, or in the subject, before which I mark X.

- |   |  |
|---|--|
| <input type="checkbox"/> ELECTRICAL ENGINEER        | <input type="checkbox"/> SALESMANSHIP            |
| <input type="checkbox"/> Electric Lighting          | <input type="checkbox"/> ADVERTISING             |
| <input type="checkbox"/> Electric Railways          | <input type="checkbox"/> Window Trimmer          |
| <input type="checkbox"/> Electric Wiring            | <input type="checkbox"/> Show Card Writer        |
| <input type="checkbox"/> Telegraph Engineer         | <input type="checkbox"/> Sign Painter            |
| <input type="checkbox"/> Telephone Work             | <input type="checkbox"/> Railroad Tinsmith       |
| <input type="checkbox"/> MECHANICAL ENGINEER        | <input type="checkbox"/> ILLUSTRATING            |
| <input type="checkbox"/> Mechanical Draftsman       | <input type="checkbox"/> Cartooning              |
| <input type="checkbox"/> Machine Shop Practice      | <input type="checkbox"/> BOOKKEEPER              |
| <input type="checkbox"/> Gas Engine Operating       | <input type="checkbox"/> Stenographer and Typist |
| <input type="checkbox"/> CIVIL ENGINEER             | <input type="checkbox"/> Cert. Public Accountant |
| <input type="checkbox"/> Surveying and Mapping      | <input type="checkbox"/> TRAFFIC MANAGER         |
| <input type="checkbox"/> MINE FOREMAN OR ENGINEER   | <input type="checkbox"/> Railway Accountant      |
| <input type="checkbox"/> Metallurgist or Prospector | <input type="checkbox"/> Commercial Law          |
| <input type="checkbox"/> STATIONARY ENGINEER        | <input type="checkbox"/> GOOD ENGLISH            |
| <input type="checkbox"/> Marine Engineer            | <input type="checkbox"/> Teacher                 |
| <input type="checkbox"/> ARCHITECT                  | <input type="checkbox"/> Common School Subjects  |
| <input type="checkbox"/> Contractor and Builder     | <input type="checkbox"/> Mathematics             |
| <input type="checkbox"/> Architectural Draftsman    | <input type="checkbox"/> CIVIL SERVICE           |
| <input type="checkbox"/> Concrete Builder           | <input type="checkbox"/> Railway Mail Clerk      |
| <input type="checkbox"/> Structural Engineer        | <input type="checkbox"/> AUTOMOBILE OPERATING    |
| <input type="checkbox"/> PLUMBING AND HEATING       | <input type="checkbox"/> Auto Repairing          |
| <input type="checkbox"/> Sheet Metal Worker         | <input type="checkbox"/> Navigation              |
| <input type="checkbox"/> Textile Overseer or Supt.  | <input type="checkbox"/> AGRICULTURE             |
| <input type="checkbox"/> CHEMIST                    | <input type="checkbox"/> Poultry Raising         |
- Spanish  
 German  
 French  
 Italian

Name \_\_\_\_\_  
Present Occupation \_\_\_\_\_  
Street and No. \_\_\_\_\_  
City \_\_\_\_\_ State \_\_\_\_\_

Please Mention Popular Mechanics

## Hello, Brother!

If you like Hunting, Fishing, Trapping, and stories and pictures of outdoor life and adventure, the actual experiences of red-blooded sportsmen, don't miss this month's issue of the NATIONAL SPORTSMAN MAGAZINE. It's crammed from cover to cover with the sort of stuff you will sit up all night to read, besides a lot of valuable information about guns, rifles, revolvers, fishing tackle, camping and trapping outfits and the best places to go for good sport.

### Special Offer

Send us 25c in stamps or coin and we will mail you, postage prepaid, a copy of this month's NATIONAL SPORTSMAN MAGAZINE together with one of our handsome Ormulo Gold Watch Fobs. When you wear this fob you will get the glad hand of good fellowship from brother sportsmen wherever you go. Send your order right now—today.

**NATIONAL SPORTSMAN MAGAZINE**  
251 Columbus Avenue BOSTON, MASS.

## Short Story Writers Wanted!

There is a tremendous demand for short stories, photo plays, magazine and newspaper articles, 24,368 publications buy short stories, \$3,000.00 a year is a small income for a writer. You can be successful. Jack London said so. He and other great writers have endorsed our course. Learn at home during your spare time. Write Today for FREE BOOK Our free book, "How to Write," tells you about it. Also gives details of the special introductory offer that is being made for a limited time. Don't lose this opportunity. Write today. Hoosier Institute Short Story Dept., Dept. 1197, Fort Wayne, Ind.

## Big Money for You

### There's Money in the Automobile Business

and all it takes to get it is experience. We give you the experience. Eight weeks in our school is worth more than two years of figuring it out for yourself. The cost is light, the reward great—there's a job waiting for you as soon as you're through. Don't delay—Act Now.

**INDIANAPOLIS MOTOR SCHOOL**  
110 Southeastern Ave., INDIANAPOLIS, IND.

## FREE FOR 5 DAYS

Olson Swett Marden's newest and greatest success-building book "Everybody Ahead." Thousands of readers say this inspiring book is helping them to become more proficient and successful. Rent to you on 5 days approval. Send no money. If you don't want to keep the book, return it, otherwise remit \$3.95.

**Frank E. Morrison, Publisher, Dept. 22, 1133 Broadway, New York, N. Y.**

## Advertising Manager—\$5000 a Year

YOU CAN BE ONE

If our Vocational Director will accept you, then you can succeed in advertising. Ten practical business men will teach you. Write for booklet, "Poverty to \$10,000 a Year" and "Free Personal Analysis blank."

**BRYANT & STRATTON COLLEGE, 1023 Bryant & Stratton Bldg., CHICAGO, ILL.**

## Learn Electricity! 20 Lessons Free!

Let me give you 20 regular lessons in Electricity FREE. Write postal for my great book and successful offer. Rent about my new method of teaching you by mail in your own home. Earn \$2400 to \$4000 a year! SEND POSTAL TODAY. Let me show you what I have done for thousands of others. My guarantee gives you entire Course Free unless satisfied with my 20 Lessons. Write for Book and Offer Now. Address: Albert Wood Wicks, S.S., E.E., President Wicks Electrical Institute, Dept. 489, 61 W. Randolph Street, Chicago





# Amazing Opportunities in the AIRPLANE INDUSTRY

Never before have ambitious men had such a glorious chance as is offered today in this wonderful new industry. The war news only proves that the Airplane has come to stay — that thousands and hundreds of thousands of airplanes will be demanded for commercial uses when peace returns.

Meanwhile an army of *trained men* must be found to man the new aeroplane factories that are being built everywhere this fall and winter. This makes the big chance for you — a chance of a lifetime. Enroll NOW for our complete Course of training in Practical Aeronautics and the Science of Aviation and prepare yourself in a few short months to double or treble your present salary.

## We Teach You By Mail in Your Spare Time at Home

Our new, scientific Course is personally conducted by Bud Morriss, the famous aviator, and has the endorsement of airplane manufacturers, aeronautical experts, aviators and leading aero clubs. Every Lesson, Lecture, Blue Print and Bulletin is self-explanatory. You can't fail to learn. No book study. No schooling required. Lessons are written in non-technical, easy-to-understand language. You'll not have the slightest difficulty in mastering them. The Course is absolutely authoritative and right down to the minute in every respect. Covers the entire field of Practical Aeronautics and Science of Aviation in a thorough, practical manner. Under Bud Morriss' direction, you get just the kind of practical training you must have in order to succeed in this wonderful industry.

## Special Offer NOW

Send This Coupon Today

It is our duty to help in every possible way to supply the urgent need for graduates of this great school. We have facilities for teaching a few more students and to secure them quickly we are making a remarkable Special Offer which will be withdrawn without notice. Write today — or send the coupon — for full particulars. Don't risk delay. Do it now.

### Prepare for one of these positions

Aeronautical Instructor	\$60 to \$150 per week
Aeronautical Engineer	\$100 to \$250 per week
Aeronautical Contractor	Enormous Profits
Aeroplane Repairman	\$60 to \$75 per week
Aeroplane Mechanic	\$40 to \$60 per week
Aeroplane Inspector	\$75 per week and up
Aeroplane Salesman	\$50.00 per year and up
Aeroplane Assembler	\$40 to \$65 per week
Aeroplane Builder	\$75 to \$200 per week



AIRPLANE BUILDER



AIRPLANE MECHANIC



AIRPLANE ENGINEER



INSPECTOR

**American School of Aviation**  
431 S. Dearborn Street, Dept. 119A, Chicago, Ill.

Mr. Bud Morriss  
Chief Instructor  
American School  
of Aviation  
431 S. Dearborn St., Dept. 119A  
Chicago, Ill.

Without any obligations  
on my part, you may send me  
full particulars of your course  
in Practical Aeronautics and  
your Special LIMITED Offer.

Name.....

Address.....



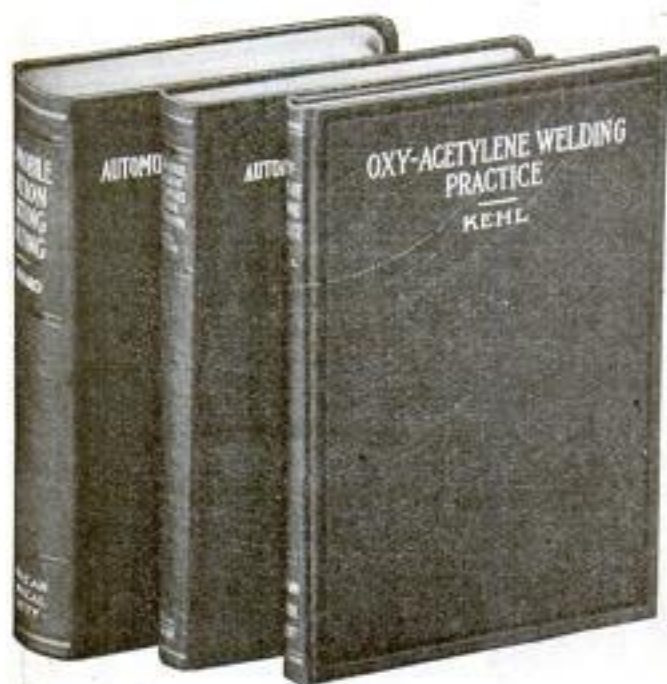

## Everything About Auto Repairing

can be found in these three brand-new handbooks. Each and every detail is explained in non-technical language, and hundreds of illustrations and diagrams make difficult points as simple as A-B-C. No man interested in automobiles should be without these books. If a car owner, they will save you many times their cost in repair charges. If a chauffeur or repairman, they will fit you for a better job and bigger pay.

**Automobile Ignition, Starting and Lighting** describes all important ignition, starting and lighting systems. No matter what electrical equipment a car may have, this handy volume will help you locate troubles and show you how to overcome them. 750 pages (5½ by 8¾ inches); 480 wiring diagrams and illustrations. Flexibly bound in leather, gold stamped. **Price, \$2.50**

**Automobile Troubles and Repairs** covers engine, carburetor, clutch, transmission, axle, brake, frame, spring, running gear and wheel troubles and repairs; also contains a valuable article on vulcanizing. 254 pages (5½ by 8¾ inches); 217 illustrations, diagrams, etc. Flexibly bound in leather, gold stamped. **Price, \$1.50**

**Oxy-Acetylene Welding Practice** gives full instructions for handling practically every kind of welding job. Especially valuable to the automobile repairman, as the examples have been taken entirely from the automobile industry. 110 pages (5¾ by 8½ inches); 117 illustrations, tables, formulas, etc. Bound in cloth, gold stamped. **Price, \$1.00**

While any one of these books may be purchased separately, the price of the entire three volumes is only \$5.00. It will pay you to purchase the complete set, for sooner or later you will have need of each book.

## Your Dealer Has Them

Hundreds of progressive bookdealers stock these handbooks. If your dealer can't supply you, send us the price of the books you want and we'll send them to you postpaid. Examine them carefully—use them at your work for five days. Then if they fail to suit your needs, return them and get your money back. We refer you, for our responsibility, to the Union Bank of Chicago.

**American Technical Society, Chicago, U. S. A.**

**American Technical Society:** P. M. 10-17

Enclosed is \$..... Please send me the titles checked below, with the understanding that if they fail to suit my needs I may return them within five days and get my money back.

- ..... **Automobile Ignition, Starting and Lighting**  
 ..... **Automobile Troubles and Repairs**  
 ..... **Oxy-Acetylene Welding Practice**

Name.....

Address.....

# Take a Pencil and make an "X"

A LITTLE X, like the one shown here, has marked the starting point for a good many big successes. It's an easy thing to make. Your pencil will make it in a jiffy BUT it may mark the turning point in your life.

These days the thing that puts a man above his fellows is TRAINING.

And this little "X" when marked on the coupon below will bring you a handsome free book that will tell just exactly how YOU can get the training that has put THOUSANDS of men into high positions. It won't be necessary for you to leave your home to get this training. For twenty years the American School has been giving ambitious men practical training that started them on the road to success.

## Send the Coupon

Take a pencil now and mark an X before the position for which you want to qualify yourself. Let us tell you how we have given other men the training that enabled them to hold these positions. Let us tell you how you can get THIS VERY TRAINING right in your own home during your idle hours. You will be under no obligations by sending the coupon.

Find out for yourself what the American School will do for you. Make your mark in the coupon now for the sake of your ambition and the man you want to be. Opportunity is calling. Your ambition is saying, send the coupon. Do it now.

**American School**  
 of Correspondence, Chicago, U.S.A.  
 Dept. G-1197 Chicago, U. S. A.

Mark  
an X  
and  
Mail  
Today

**American School of Correspondence, Dept. G-1197 Chicago, U.S.A.**

Gentlemen: Without obligation please send me booklet and tell me how I can qualify for position marked X.

- |                                 |                               |
|---------------------------------|-------------------------------|
| ..... Electrical Engineer       | ..... Business Law            |
| ..... Elec. Light & Power Supt. | ..... Business Manager        |
| ..... Hydroelectric Engineer    | ..... Auditor                 |
| ..... Telephone Engineer        | ..... Accountant              |
| ..... Architect                 | ..... Cert'f'd Public Acc'tnt |
| ..... Architectural Draftsman   | ..... Stenographer            |
| ..... Building Contractor       | ..... Bookkeeper              |
| ..... Building Superintendent   | ..... Fire Ins. Inspector     |
| ..... Structural Engineer       | ..... Fire Ins. Adjuster      |
| ..... Structural Draftsman      | ..... Fire Ins. Expert        |
| ..... Mechanical Engineer       | ..... Sanitary Engineer       |
| ..... Mechanical Draftsman      | ..... Master Plumber          |
| ..... Civil Engineer            | ..... Heat and Vent. Eng.     |
| ..... Steam Engineer            | ..... Plumb. and Heat. Est.   |
| ..... Shop Foreman              | ..... Reclamation Engineer    |
| ..... Shop Superintendent       | ..... Automobile Engineer     |
| ..... Sheet Metal Draftsman     | ..... Automobile Repairer     |
| ..... Lawyer                    | ..... High School Course      |

We also prepare for civil service examinations in all engineering subjects.

Name.....

Address.....



# TRAINED ARTISTS — HIGHLY PAID —

The never-satisfied cry of the modern business world is "more trained commercial artists." Today commercial illustrators with thoroughly developed ability—both men and women—

**Earn \$25, \$50, \$75 a Week and Upward**

Are YOU awake to the splendid opportunities in this great modern field of enterprise? The business and publishing worlds pay big prices for forceful designs and appealing illustrations—and artists who can produce them earn extraordinary incomes. The Federal Course is a Proven Result-Getter. If you like to draw, develop your talent into a high-salaried ability. The work is fascinating, easy to learn and to apply. Results obtained by Federal Students are strongest evidence of the value of "Federal" Training.

## The Federal Advisory Council

Nationally known American illustrators and designers have thoroughly endorsed "Federal" Training. On our Advisory Council are **Charles E. Chambers** (who illustrates Get-Rich-Quick Wallingford stories), **Franklin Booth** (Painter with the Pen), **Harold Gross** of the Gorham Company, **Coles Phillips** (famous for his magazine covers and advertisements), and **Edwin V. Brewer** of "Cream of Wheat" fame. The Course includes exclusive, original lessons especially prepared by these men.

## Send Now for "Your Future"

You owe it to YOUR future to read this book. In these swiftly-moving times when speed and efficiency are imperative, "Federal" Training offers you a short, proven road to a substantial income.

This book shows you how to start—how to win success by using spare time now frittered away. It has 56 pages, beautifully printed in colors, showing remarkable work by Federal Students. Prepare yourself to win the splendid success possible for you. Send the coupon right now, while you're thinking about it.



**Federal School of Commercial Designing**  
623 Warner Building Minneapolis, Minn.

*Firms desiring the services of thoroughly trained commercial artists should write us, stating their requirements.*

GENTLEMEN: Please send me "Your Future," without any obligation to me.

NAME.....

(Write your address plainly in margin)

623



## Answers to 10,000 Questions on Architecture, Carpentry, Building



### Order Books Before Advance in Price!

### Send TODAY—SAVE \$5.00

The present low price on this great work will be withdrawn when the few remaining sets are sold. Buy now! before the advance. The price of the next edition will be at least \$5 more.

## A VAST FUND of BUILDING FACTS

10 Volumes—4760 Pages  
4,000 Plates, and Working Diagrams, etc.

The one great, practical, complete, authoritative work on Architecture, Carpentry, and Building. Prepared by 26 well-known architects, building contractors, and civil, sanitary, and electrical engineers.

**Books Tell All About:** Mechanical, Freehand, Perspective and Architectural Drawing, Lettering, Pen and Ink Rendering, The Orders, Superintendence, Strength of Materials, Masonry, Reinforced Concrete, Carpentry, Steel Square, Stair-Building, Hardware, Steel Construction, Roof Trusses, Practical Problems, Estimating, Contracts, Specifications, Building Law, Sanitation, Sheet Metal Work, Electric Wiring and Lighting.

**50c a Week** Only 50c a week—\$2.00 a month—for these great books at the present low price of \$24.80. If you live within the United States or Canada, send the coupon today.

### Books Sent 7 Days FREE!

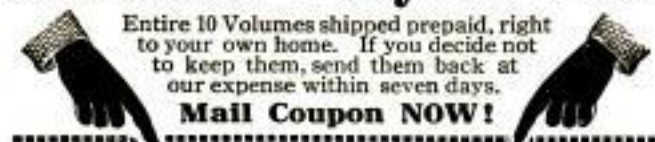

**American Technical Society**  
Dept. R1197, CHICAGO, U. S. A.

Please send Cyclopedia of Architecture, Carpentry and Building for seven days' examination. I will send \$2.00 within seven days and \$2.00 a month until I have paid \$24.80, or notify you to send for the books at your expense. Title not to pass until fully paid.

Name.....

Address.....

Reference.....

Please Mention Popular Mechanics



# FREE!

**A FLYING** model aeroplane and all materials to build your own scale model furnished free, with our great Home Course in the Principles of Aviation. Write at once before this offer is withdrawn. Tremendous demand for airplane designers, builders, engineers, assemblers, salesmen, repairmen, mechanics, contractors, inspectors, instructors. Get ready now!

### Learn Science of Aviation At Home!

We offer you a small course of 68 lessons—under direction of aeronautical experts—men like Walter L. Brock, the famous aviator who won the great London to Paris race. While you cannot learn to fly by mail, this great home course gives you all the basic training needed for any of the positions mentioned above. And there is big money for you in aviation! Don't miss this opportunity.

**Write at Once!** Send for special offer—including free aeroplane model and materials—and greatly reduced price for Course. Write before this offer is withdrawn. Don't delay. Do it right away—NOW.

National Aero Institute, Dept. 1197 Morton Bldg., Chicago, Ill.

## Study LAW

Like Lincoln at Home in Spare Time

Be a leader! The biggest men in business are law-trained men. Law will help you. Our Home Study Course is thorough, intensely practical. Write for 80-page book "How to Acquire a Legal Training"—it's FREE.

American School of Correspondence, Dept. L1197 Chicago, Ill.

## Train for Big Pay As An Expert ACCOUNTANT!

WAR conditions have created thousands of new jobs for skilled accountants. Big salaries are paid. Our Home Study Course gives thorough training in 18 months. Equips you for C. P. A. examinations. This is your big chance! Tells all about this great new big-pay profession. Write at once.

**Book Free** American School of Correspondence Dept. A1197 Chicago, Illinois



## The Western Front at a Glance

Just off the press, this new war map is designed to satisfy those who desire a complete, large-scale map of the Western Front; scale 10 miles to one inch; size 28x36 inches. Shows forests, fortifications, altitudes, aircraft depots, wireless stations, etc. It contains upwards of 5,000 place names which can be readily located by means of the complete index which accompanies the map.

Paper, \$1 (money refunded if dissatisfied); Cloth, \$2 postpaid

POPULAR MECHANICS BOOK DEPT.  
6 N. Michigan Ave., CHICAGO



# JUMP INTO THE KING ROW

VACANT

TRAFFIC  
MANAGER

\$10,000 A Year



VACANT

TRAFFIC  
MANAGER

\$10,000 A Year

Lack  
of  
Training

Daniel Willard  
Pres. B. & O. R. R.  
Traffic Head  
Appointed by  
President Wilson

Lack  
of  
Training



## IT'S YOUR MOVE

Will you wait to be "jumped" or will you win a king-row position? Have you real ambition, or is it merely palpitation of the wishbone? Stop dreaming and start doing if you want to land in high-salaried ranks.

### Thousands of Traffic Men Needed

The shortage in traffic men today is alarming. Ask the railroads; ask the manufacturers and shippers. They are looking eagerly for trained traffic men who can prevent mistakes in rates, routings, demurrage and handling charges, incorrect classifications, etc. The war is creating vacancies daily. Thousands of such positions are awaiting you—but you must be qualified. Shippers are crying for help—willing to pay big salaries. Splendid opportunities for young and middle-aged men.

### Name Your Own Salary

Your salary will depend largely upon how much you can save your employer. Gramm Motor Truck Traffic Manager saved \$3000 on single shipment of trucks to Russia—using a C. F. A. 116 Series rate—what do you suppose he is worth to his house? National Tube Company Traffic Manager found lowest legal rate on 1500 cars iron pipe—total saving on shipment \$36,000—no quibble over his salary. Traffic salaries commonly range from \$2,500 to \$10,000, but experienced, King-Row traffic managers receive \$25,000 to \$40,000 and even more in some instances.

### Shipments Tied Up

Railway freight sheds, warehouses, and steamship wharves are packed and gorged with vast quantities of goods—food, munitions, machinery, etc. Government is hampered because of traffic delays. Factories short of supplies—cities lack fuel for power—perishable freight destroyed daily. Situation is staggering.

**American Commerce Association**  
Dept. 11, American Commerce Bldg., Chicago, Ill.

### Trained Men Only

You must have special training to become Traffic Manager. **We Will Train You.** Our course requires not only complete knowledge, but application of that knowledge to actual traffic problems and situations. We give you individual coaching and train you by our "Experience" method. You will be put in touch with more than 300 big traffic managers, belonging to this association. These men are connected with big railroads—steamship, manufacturing and shipping concerns of the U. S. You will in a short time acquire the same valuable knowledge, gained by these experts only after a life-time of hard work and tedious study. With your membership you will get FREE our Fifteen-Volume Traffic Management Digest, prepared by these experts at a cost of nearly \$75,000, and which took more than five years to prepare.

### Join This Association; Training Easy to Acquire

Traffic is the only uncrowded profession. Law, medicine and engineering, require years of college work, and uncertainty of success after graduation. Our work is easy to learn—it is easy to become an efficient traffic man. **YOU CAN QUALIFY DURING YOUR SPARE TIME EVENINGS.** After taking our training you will know how to get **Quick Action**, and how to save **freight money.** Prompt decisions must be made by traffic men. Decide today. Send the Coupon now for complete particulars by **RETURN MAIL.**

### COUPON

**AMERICAN COMMERCE ASSOCIATION**

Dept. 11, American Commerce Bldg., Chicago, Ill.

Send me FREE and without obligation complete information concerning the Association and how I can train as a traffic man.

Name.....

Occupation.....

Address.....

City..... State.....





*On the inviting autumn roads to woods and river*

# BLUE STREAKS

TRADE MARK REG. U. S. PAT. OFF.

## They Can Reclaim Your Bicycle

On the inviting autumn roads to woods and river, you'll very likely find more bicycles equipped with Blue Streak Tires than you saw last spring.

If you are one of those who trudge around on holidays and after school instead of riding where you please, you probably know the reason.

The wheels that had poor tires went back to garret and shed during the summer because tire trouble took all the sport out of riding.

In this best bicycle season of the year their owners are reclaiming them with Blue Streak Tires.

If you have an unused bicycle, take off its most troublesome tire and compare it with one of these Goodyears.

You'll find the Goodyear *lighter* and therefore use will prove it vastly stronger.

The toughest tire rubber is live and very light.

That's the kind of rubber out of which we make your Blue Streak.

We could make the tire much heavier by using only a *small* amount of light real rubber mixed with heavy chemicals.

But such a tire wouldn't last as Blue Streaks last.

And they won't make pedal-

ing as easy as Blue Streaks make it for you.

In every way they help you get all the trouble-free sport and easy speed out of your bicycle.

If you go to several dealers before you buy, you'll find that the price everywhere is \$3.25 for this non-skid tire with the good looking blue streaks.

And you'll generally notice that they are the only tires for which the demand is so great that they are sold by more than one dealer in your locality.

The Goodyear Tire & Rubber Co.  
Akron, Ohio

*Boys everywhere are wearing Goodyear Bicycle Caps. Ask your dealer. They're especially popular with Bicycle Clubs—name of club printed on the cap.*

# GOODYEAR

AKRON

Please Mention Popular Mechanics



# AUTO EXPERTS WANTED

The U. S. Government needs auto experts. We are thoroughly prepared to train you at once to fill one of these well-paid positions. We have just completed our new \$40,000 building, fully equipped with shower baths, reading and writing rooms, motion picture machines and all the best and most modern appliances to help make you an automobile expert.

Our course is increased *many times* in value, and we must train men to meet the vast demand for our graduates. Our Graduates are regularly earning from \$100 to \$300 and more per month as Race Drivers, Expert Engineers, Final Testers, Shop Foremen, Tractor Experts, Chauffeurs, Salesmen, Garage Owners and Managers,

House-Lighting Experts; and hundreds are in Government employ as Aviators, Truck Drivers and Dispatch Bearers—all because of the *practical* training we give.

Opportunities for *practically* trained men men now, are simply wonderful. We have constant calls for more men than we can furnish. *We need you.*

## Cleveland Auto School

Established 1903  
Individual Instruction

Up-to-date Equipment  
14 Years of Success

### 4,000 GRADUATES MAKING GOOD OUR EQUIPMENT CLEVELAND LEADS

includes all types of motors, including Knight type, and 4, 6, 8 and 12 cylinder; a dozen cars at the disposal of students; latest starting and lighting equipment; Akron-Williams tire repair outfits, oxy-acetylene welding and cutting outfits; all the latest electrical testing outfits; and everything necessary to give you a thorough and practical training.

in the manufacture of parts, accessories and high grade cars, and is gaining faster than any other city in new factories. Up-to-date training in 4 to 8 weeks; board and room only \$6 per week near school; we help you get located in congenial surroundings and feel at home. We absolutely guarantee to qualify you for a good paying position in the Auto business on completion of our course.

**Get Ready Now** to jump into the field of unlimited opportunities that are constantly opening.

## Cleveland Automobile School

CLYDE H. PRATT, President, Dept. 10, 1814 E. 24th St., CLEVELAND, OHIO

Auto Dealer or Salesman



Tire Repair Shop



Garage Owner or Manager



**Your Own Business**

Call  
or write  
us  
**TODAY**

We Teach



Race Driver

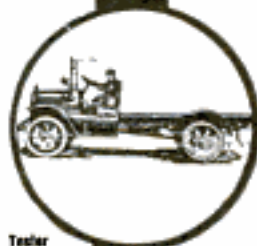

Teacher



Master of 12-cyl. Motor



Private Chauffeur



# A Big Job For a Little



## Take Ten Lessons— then decide

**T**AKE your pencil now—and make an X in the coupon before the position in life that you want to fill. You will be under no obligation. This little X is an easy thing to make but it will bring to you a vital, inspiring message that will tell just exactly how you can qualify yourself, right in your own home, to fill the position that you are dreaming about.

We'll tell you, too, how you can start this training and get ten complete lessons. And, then, if you don't think the course is going to put you into the position you want, we'll refund every cent you have paid.

Nowadays, the thing that puts a man in a high position is training! There isn't one man in a thousand who can get this training without help.

This advertisement brings to you the chance to get the help that has put thousands on the road to success. And you can prove it to yourself. You can take ten lessons and, if you are not satisfied, we'll refund your money.

## Send the Coupon

Make an "X" in this coupon now before the position you want to fill. Find out for yourself what the American School has to offer to you. Find out how the hard places have been made easy and how thousands and thousands of men all over the world are now making their marks in the business world—because they have training. You will be under no obligation by sending the coupon. Send it now.

**American School**  
of Correspondence, Chicago, U.S.A.  
Dept. G 1197

American School of Correspondence, Dept. G 1197 Chicago, U. S. A.

Gentlemen: Please send me booklet and tell me how I can fit myself for the position marked X.

- |                                 |                                |
|---------------------------------|--------------------------------|
| ..... Electrical Engineer       | ..... Business Law             |
| ..... Elec. Light & Power Supt. | ..... Business Manager         |
| ..... Hydroelectric Engineer    | ..... Auditor                  |
| ..... Telephone Engineer        | ..... Accountant               |
| ..... Architect                 | ..... Cert'f'd Public Acc't    |
| ..... Architectural Draftsman   | ..... Stenographer             |
| ..... Building Contractor       | ..... Bookkeeper               |
| ..... Building Superintendent   | ..... Fire Ins. Inspector      |
| ..... Structural Engineer       | ..... Fire Ins. Adjuster       |
| ..... Structural Draftsman      | ..... Fire Ins. Expert         |
| ..... Mechanical Engineer       | ..... Sanitary Engineer        |
| ..... Mechanical Draftsman      | ..... Master Plumber           |
| ..... Civil Engineer            | ..... Plumbing & Heating Est.  |
| ..... Steam Engineer            | ..... Heating & Vent. Engineer |
| ..... Shop Foreman              | ..... Reclamation Engineer     |
| ..... Shop Superintendent       | ..... Automobile Engineer      |
| ..... Sheet Metal Draftsman     | ..... Automobile Repairer      |
| ..... Lawyer                    | ..... High School Course       |

We also prepare for civil service examinations in all engineering subjects

Name.....

Address.....

# Prest-O-Lite

for  
Motorcycles

## Brilliant, Reliable Light at Low Cost

For brilliant, steady, reliable light for your motorcycle you can't beat Prest-O-Lite. It's the only practical light for motorcycles, and is used by the majority or riders in every kind of service, the country over.

Prest-O-Lite gives the rider a clear vision of the road ahead—penetrates dust, fog and smoke. It makes night riding safe and enjoyable.

It is perfectly simple to operate—what little attention it needs the rider can easily give.

The first cost of Prest-O-Lite is small—its upkeep expense is trifling.

## Get Prest-O-Lite on Your Motorcycle

Prest-O-Lite can be quickly and easily attached to any make of motorcycle. Your dealer probably can supply you with this popular equipment combination—"Prest-O-Lite, a good lamp and mechanical horn." This equipment will give you the greatest value and best service for the least money. See your dealer today.

Write us for interesting literature on Prest-O-Lite for motorcycle lighting. Sent you on request.

## The Prest-O-Lite Co., Inc.

U. S. Main Office & Factory, 265 Speedway, Indianapolis  
Canadian General Office, Dept. N-8, Toronto, Ont.

Prest-O-Lite Exchange Agencies Everywhere

The World's Largest  
Makers of  
Dissolved Acetylene

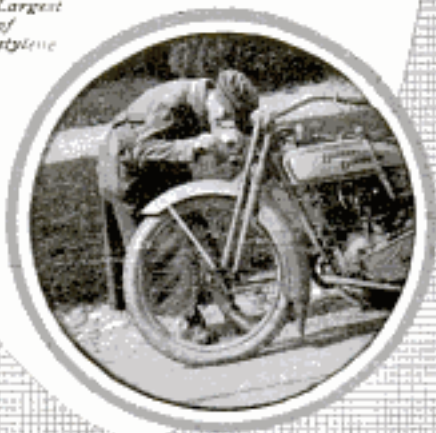

Please Mention Popular Mechanics

Copyrighted material



Never Mind How **STRONG**  
You are—  
**What d'ye Know?**



Today it's a battle of wits—and *brains* win. Muscle and brawn don't count so much as they used to.

The great question now is "What do you Know?" It draws the line between failure and success.

What do *you* know? Have you special ability in any one line? Could *you* "make good" in a big job right now?

For 25 years the International Correspondence Schools have been helping men to get ready for better work and bigger salaries. They can do the same for **YOU**. No matter where you live, what hours you work, or how little your education—the I. C. S. can train you for a more important and better-paying position.

Mark and mail the attached coupon—it won't obligate you in the least—it won't cost you anything to find out how you can get this salary-raising ability right in your own home, during your spare time.

**MARK THE COUPON NOW**

TEAR OUT HERE

**INTERNATIONAL CORRESPONDENCE SCHOOLS**

Box 5613, SCRANTON, PA.

Explain, without obligating me, how I can qualify for the position, or in the subject, before which I mark X.

- |   |  |
|---|--|
| <input type="checkbox"/> ELECTRICAL ENGINEER        | <input type="checkbox"/> SALESMANSHIP              |
| <input type="checkbox"/> Electric Lighting          | <input type="checkbox"/> ADVERTISING MAN           |
| <input type="checkbox"/> Electric Car Running       | <input type="checkbox"/> Window Trimmer            |
| <input type="checkbox"/> Electric Wiring            | <input type="checkbox"/> Show Card Writer          |
| <input type="checkbox"/> Telegraph Expert           | <input type="checkbox"/> Outdoor Sign Painter      |
| <input type="checkbox"/> Practical Telephony        | <input type="checkbox"/> RAILROADER                |
| <input type="checkbox"/> MECHANICAL ENGINEER        | <input type="checkbox"/> ILLUSTRATOR               |
| <input type="checkbox"/> Mechanical Draftsman       | <input type="checkbox"/> DESIGNER                  |
| <input type="checkbox"/> Machine Shop Practice      | <input type="checkbox"/> BOOKKEEPER                |
| <input type="checkbox"/> Gas Engineer               | <input type="checkbox"/> Stenographer and Typist   |
| <input type="checkbox"/> CIVIL ENGINEER             | <input type="checkbox"/> Cert. Public Accountant   |
| <input type="checkbox"/> Surveying and Mapping      | <input type="checkbox"/> Railway Accountant        |
| <input type="checkbox"/> MINE FOREMAN OR ENGINEER   | <input type="checkbox"/> Commercial Law            |
| <input type="checkbox"/> Metallurgist or Prospector | <input type="checkbox"/> GOOD ENGLISH              |
| <input type="checkbox"/> STATIONARY ENGINEER        | <input type="checkbox"/> Teacher                   |
| <input type="checkbox"/> Marine Engineer            | <input type="checkbox"/> Common School Subjects    |
| <input type="checkbox"/> ARCHITECT                  | <input type="checkbox"/> CIVIL SERVICE             |
| <input type="checkbox"/> Contractor and Builder     | <input type="checkbox"/> Railway Mail Clerk        |
| <input type="checkbox"/> Architectural Draftsman    | <input type="checkbox"/> AGRICULTURE               |
| <input type="checkbox"/> Concrete Builder           | <input type="checkbox"/> Textile Overseer or Supt. |
| <input type="checkbox"/> Structural Engineer        | <input type="checkbox"/> Navigator                 |
| <input type="checkbox"/> PLUMBING AND HEATING       | <input type="checkbox"/> Poultry Raising           |
| <input type="checkbox"/> Sheet Metal Worker         | <input type="checkbox"/> AUTOMOBILES               |
| <input type="checkbox"/> CHEMICAL ENGINEER          | <input type="checkbox"/> Auto Repairing            |
|   | <input type="checkbox"/> Spanish                   |
|   | <input type="checkbox"/> German                    |
|   | <input type="checkbox"/> French                    |
|   | <input type="checkbox"/> Italian                   |

Name \_\_\_\_\_

Occupation & Employer \_\_\_\_\_

Street and No. \_\_\_\_\_

City \_\_\_\_\_ State \_\_\_\_\_

If name of Course you want is not in this list, write it below.

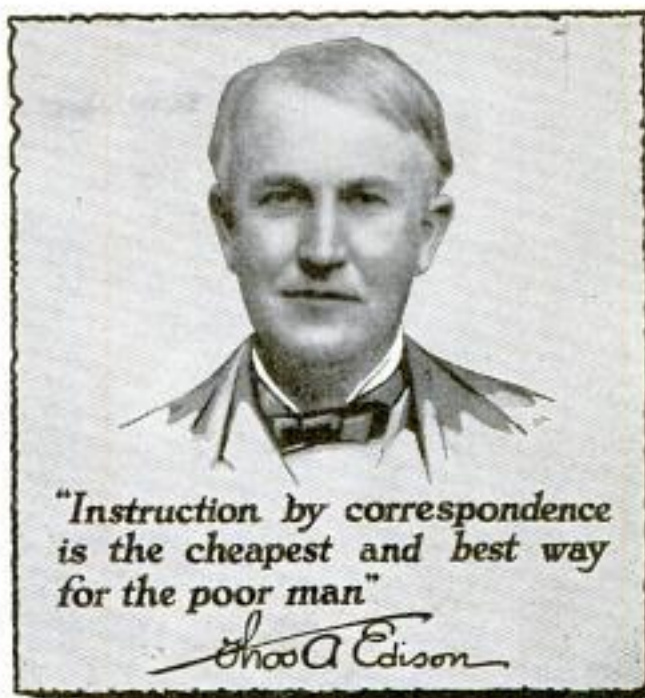

"Instruction by correspondence is the cheapest and best way for the poor man"

Thomas Edison

**Edison is Right!!!**

You admit the International Correspondence Schools are a good thing. You'd take a course right now "if"—"except"—

"If" what? If you weren't so "overworked," with such "long hours," or had more strength and energy?

Wasn't it Edison who stayed up half the night educating himself in spite of every handicap you could ever have?

All big men who have made their mark in the world had the *ambition*—the *determination*—to improve their spare time, to train themselves for big work. You, too, can possess power, money and happiness if you'll only make the effort. The reward is great—it's worth it.

Here's all we ask: Merely mail this coupon. Put it up to us without paying or promising. Let us send you the details of others' success through the I. C. S., and then decide. Mark and mail this coupon now.

I. C. S., Box 5609, Scranton, Pa.

TEAR OUT HERE

**INTERNATIONAL CORRESPONDENCE SCHOOLS**

BOX 5609, SCRANTON, PA.

Explain, without obligating me, how I can qualify for the position, or in the subject, before which I mark X.

- |   |  |
|---|--|
| <input type="checkbox"/> ELECTRICAL ENGINEER        | <input type="checkbox"/> SALESMANSHIP            |
| <input type="checkbox"/> Electric Lighting          | <input type="checkbox"/> ADVERTISING             |
| <input type="checkbox"/> Electric Railways          | <input type="checkbox"/> Window Trimmer          |
| <input type="checkbox"/> Electric Wiring            | <input type="checkbox"/> Show Card Writer        |
| <input type="checkbox"/> Telegraph Engineer         | <input type="checkbox"/> Sign Painter            |
| <input type="checkbox"/> Telephone Work             | <input type="checkbox"/> Railroad Trainman       |
| <input type="checkbox"/> MECHANICAL ENGINEER        | <input type="checkbox"/> ILLUSTRATING            |
| <input type="checkbox"/> Mechanical Draftsman       | <input type="checkbox"/> Cartooning              |
| <input type="checkbox"/> Machine Shop Practice      | <input type="checkbox"/> BOOKKEEPER              |
| <input type="checkbox"/> Gas Engine Operating       | <input type="checkbox"/> Stenographer and Typist |
| <input type="checkbox"/> CIVIL ENGINEER             | <input type="checkbox"/> Cert. Public Accountant |
| <input type="checkbox"/> Surveying and Mapping      | <input type="checkbox"/> TRAFFIC MANAGER         |
| <input type="checkbox"/> MINE FOREMAN OR ENGINEER   | <input type="checkbox"/> Railway Accountant      |
| <input type="checkbox"/> Metallurgist or Prospector | <input type="checkbox"/> Commercial Law          |
| <input type="checkbox"/> STATIONARY ENGINEER        | <input type="checkbox"/> GOOD ENGLISH            |
| <input type="checkbox"/> Marine Engineer            | <input type="checkbox"/> Teacher                 |
| <input type="checkbox"/> ARCHITECT                  | <input type="checkbox"/> Common School Subjects  |
| <input type="checkbox"/> Contractor and Builder     | <input type="checkbox"/> Mathematics             |
| <input type="checkbox"/> Architectural Draftsman    | <input type="checkbox"/> CIVIL SERVICE           |
| <input type="checkbox"/> Concrete Builder           | <input type="checkbox"/> Railway Mail Clerk      |
| <input type="checkbox"/> Structural Engineer        | <input type="checkbox"/> AUTOMOBILE OPERATING    |
| <input type="checkbox"/> PLUMBING AND HEATING       | <input type="checkbox"/> Auto Repairing          |
| <input type="checkbox"/> Sheet Metal Worker         | <input type="checkbox"/> Navigation              |
| <input type="checkbox"/> Textile Overseer or Supt.  | <input type="checkbox"/> AGRICULTURE             |
| <input type="checkbox"/> CHEMIST                    | <input type="checkbox"/> Poultry Raising         |
|   | <input type="checkbox"/> Spanish                 |
|   | <input type="checkbox"/> German                  |
|   | <input type="checkbox"/> French                  |
|   | <input type="checkbox"/> Italian                 |

Name \_\_\_\_\_

Present Occupation \_\_\_\_\_

Street and No. \_\_\_\_\_

City \_\_\_\_\_ State \_\_\_\_\_

Please Mention Popular Mechanics





*To you whose spirit yearns for nature and the great outdoors, the profession of Tree Surgery offers a rare opportunity for a fascinating, vitalizing and uplifting work with unusual advancement in keeping with the best that is in you.*

## An offer to train and employ 250 Young Men

BY A GREAT NATIONAL ORGANIZATION

**H**OW would you like to have a position, as a trained expert, with the largest and most successful organization of its kind in the world—a position that offers you an unusual opportunity to make good in a big way? Where your advancement is limited only by yourself?

That is just the kind of position the Davey Tree Expert Company offers to 250 ambitious young men—to YOU, if you can qualify.

The Davey Tree Expert Company—with branch offices in New York, Chicago, and Philadelphia, and with permanent representatives in all principal cities east of the Mississippi—practices the profession of Tree Surgery on a large national scale.

Owners of this country's most beautiful estates—such men as Rockefeller, Vanderbilt, Astor, Armour, etc.—come to Davey experts for the scientific treatment of their trees.

The demand for Davey service is growing so rapidly that we find it necessary to train for

our organization 250 additional young men.

We cannot secure trained experts from outside sources. The science of Tree Surgery was originated and developed entirely by the Davey company, hence we can add expert Tree Surgeons to our organization only by training them ourselves.

Therefore, we have arranged to train 250 young men this fall and winter—either at their homes in their spare time, or under personal instructors at our Kent headquarters—so that they will be ready to take up their new positions with us next season.

### THE OPPORTUNITY OF A LIFETIME

Considered from every standpoint, the profession of the Davey Tree Surgeon is ideal.

His day is a day of fresh air and properly balanced outdoor exercise—a combination that means health and an inspiring relief from the monotony and grind and dust of ordinary work.



His work is not only pleasant, but is fascinating in the extreme, developing in a man mechanical skill and scientific accuracy.

He practices his profession on beautiful country estates and around the finest homes, and conducts his business with men and women of wealth and refinement.

His profession commands the respect of everybody. It is a highly useful and impressive work. The field is inexhaustible, and the demand for real experts who are honest and efficient is increasingly greater than the supply.

He enjoys a rare opportunity to travel and see the best parts of the country with car fare paid. He works with the finest type of clean, American manhood; not molly-coddles, but fine, manly fellows.

He is well paid—responsible men in the Davey organization earning from \$1,000 to \$10,000 a year. And best of all, there is no limit to his chance for advancement. There is abundant room at the top in the Davey organization and everything possible is done to help him get there quickly—merit, and merit only, is recognized.

The Davey organization is built and intensively maintained to give quality-first work always and honest service.

#### THE OPINION OF A BUSINESS MAN

The following letter was written by Mr. John R. Hegeman, Presi-



*W. H. Wilhoir—At age 20 a clerk in clothing store at meager salary. Joined Davey Organization. Secured complete training. Took advantage of wonderful opportunity which he found and in 4 years became one of the highest salaried men in the field here.*



*D. Q. Greve—A school teacher who found in the profession of Tree Surgery his great opportunity. He had the ability and the zeal. The Davey Organization developed it. He now makes five times as much as formerly. Moreover, he loves his work.*



*Perry E. Hudson—Here is a typical record of success resulting from natural ability and a wonderful opportunity to develop it. He was a farmer boy with a modest education and very small pay. It now earns 20 times what he was making on the farm.*

dent of the Metropolitan Life Insurance Co., New York, after his trees had been treated by Davey Tree Surgeons:

"You seem to have an unusual body of men in your service—in love with trees—fond of their work—very intelligent and industrious—doing their work with rare skill and neatness—and altogether worthy of commendation."

#### THE OPINION OF A MAN OF SCIENCE

A letter from Dr. H. D. House, New York State Botanist and formerly professor at Biltmore Forestry School, after he had seen the Davey organization in convention at Kent:

"After an inspection of the work accomplished by your men and a study of their methods, I am convinced that their work measures up to the highest degree of efficiency which training and experience can produce."

#### QUALIFICATIONS

If your age is between 18 and 32, if you are healthy, and if you can furnish satisfactory references as to character, you are qualified for training and employment by the Davey company. Unmarried men preferred.

#### A LIFETIME PROFESSION

We are not seeking men to fill temporary gaps in the Davey organization. We are offering an opportunity to 250 young men to join forces with us permanently if they so desire—in a healthful, fascinating, profitable profession worthy of any man's lifetime work. If you are interested, write quickly please.

#### WE WILL TRAIN YOU AT THE DAVEY INSTITUTE LABORATORIES

For those who can conveniently leave home for winter resident instruction, we conduct at Kent our own training school. This includes practical field work in addition to several months of intensive class-roll training and laboratory work. The instruction is in charge of experienced Davey Tree Surgeons and special scientists gifted in the art of teaching. On completion of this course you will be ready to take a permanent guaranteed position with the Davey organization. For full information about this offer mail the "Resident Training" coupon below.

#### OR WE WILL TRAIN YOU AT YOUR HOME

For those who are unable to come to Kent for the resident instruction and laboratory work, we have arranged a special course of preliminary home study, followed by thorough, practical training. Each lesson has been so carefully planned for the requirements of home study that you can readily complete the entire course during the winter months. Your home study will not make you a finished expert, let us say frankly, but it will give you such a thorough grasp of the fundamentals of Davey Tree Surgery that your progress will be rapid and certain. In the Spring, after your winter study is finished, we will call you in for practical training and a guaranteed position with the Davey organization. For full information about this offer mail the "Home Study" coupon below.

## The Davey Tree Expert Company

2710 Elm Street, Kent, Ohio

Branch Offices, with telephone connection: 225 Fifth Ave., New York; 2017 Land Title Bldg., Philadelphia; 430 McCormick Bldg., Chicago. Permanent representatives located at Boston, Newport, Lenox, Hartford, Stamford, Albany, Poughkeepsie, White Plains.

Jarvis, L. I.; Newark, N. J.; Philadelphia, Harrisburg, Baltimore, Washington, Buffalo, Pittsburgh, Cleveland, Detroit, Cincinnati, Louisville, Calcutta, Milwaukee, Minneapolis, St. Louis, Kansas City. Canadian address: 22 Victoria Square, Montreal.

#### MAIL TRAINING COUPON

The Davey Tree Expert Co., 2710 Elm St., Kent, Ohio

I am interested in your offer to train and employ men as Davey Tree Surgeons. Please send me full information about your plan of home training. It is understood that this request obligates me in no way.

Name.....  
Street and No.....  
City..... State.....



#### RESIDENCE TRAINING COUPON

The Davey Tree Expert Co., 2710 Elm St., Kent, Ohio

I am interested in your offer to train and employ men as Davey Tree Surgeons. Please send me full information about your plan of resident training. It is understood that this request obligates me in no way.

Name.....  
Street and No.....  
City..... State.....

Please Mention Popular Mechanics





Infinite  
Variety in  
Tone or  
Color May  
Be Had

With the  
Use of  
Stains on  
Southern  
Pine

## Economy in Interior Trim

It is no longer necessary to expend large sums for rare and costly woods for the interior finish of your home.

Modern improvements in materials and methods now make it possible for you to obtain any desired effect of tone or color in interior trim with the use of the least expensive woods. This substantial saving does not necessitate any sacrifice of beauty or utility when the wood used is

## Southern Pine

Curtis Millwork Co. Design



"The Wood of Service"

Southern Pine not only is exceptionally workable and durable, but it has a wonderfully varied and pleasing grain; and it takes and holds stains perfectly, making possible a wide range of color and tone effects in floors, standing trim and all interior woodwork. Furthermore, it costs less than any other high-class building wood, and it may be had anywhere east of the Rocky Mountains.

It will pay you to send for the new booklets, "The Interior of Your Home" and "Beauty Plus Service In Floors." They are Free. Please address Department F-52.

**Southern Pine**  
**Association**  
New Orleans, La.

Please Mention Popular Mechanics

Copyrighted material



4934

# Popular Mechanics Magazine

REGISTERED IN U. S. PATENT OFFICE

WRITTEN SO YOU CAN UNDERSTAND IT

Vol. 28

OCTOBER, 1917

• No. 4

## Human Sled Carries Wounded Man to Safety

**F**OR years the fine qualities of manhood and the striking efficiency characterizing the personnel of the Northwest Mounted Police have clothed that remarkable body with a most enviable reputation. Gradually the deep-chested guardians of our timber lands, the forest rangers, are earning a somewhat similar standing. The reason for this is well illustrated by an incident that occurred a few weeks ago on the upper slope of snow-covered Mount Hood. A guide had taken a party of men and women to the summit of the mountain. On the way down one member of the group, a woman,

suddenly slipped. As she did so, the heel of one of her shoes struck the handle



While Holding the Wounded Guide in His Arms, the Lookout of Mount Hood was Dragged Down the Snow-Covered Slope for Two Miles. In This Heroic Way the Helpless Fellow was Assisted to a Point Where a Stretcher could be Procured. He was Then Carried to an Automobile Station



1 - Inv: E. Hart, n. l. Oren.  
Quinn's Enclavation Co.  
417 - 8th Ave. New York City.  
482

2 - ...  
Canadian Government  
Rt. to the Monitor Yds  
Moncton, N. B. Canada

# POPULAR MECHANICS

of an ax carried by the guide. The sharp instrument was hurled in such a way that it struck the man in the abdomen, wounding him dangerously.

Far above, at the summit of the mountain, the Forest Service has a lookout. Watching the descending party through binoculars, he witnessed the accident. No one can tell how many minutes and seconds this fire hunter of Mount Hood spent in reaching the injured man who lay on the snow a mile below. He slid, coasted on his back, and virtually volplaned down the precipitous incline.

In a few moments he was at the guide's side administering first aid. That done, he lay flat on his back, pulled the injured man on top of him, and instructed the bewildered onlookers to tie a rope to his feet. Claspings the fellow in his arms, he gave the word to move ahead. The body of the nervy lookout was a human sled. He was dragged down the mountain for two miles to a point where a stretcher was available. From there the guide was carried to an automobile station.

The lookout of Mount Hood is Elijah Coalman, American.

## NEW AUTOMATIC LIGHT BUOY MAKES OWN ELECTRICITY

4264

Because an automatic light buoy designed by an inventor of marine apparatus produces its own electric current



Showing the General Appearance of the Buoy and the Character and Arrangement of Its Interior Mechanism

and demands only casual attention, the cost of maintaining it amounts to practically nothing. Its mechanism is not complicated. A vertical shaft mounted on ball bearings is actuated by a

weighted horizontal arm that swings back and forth when the buoy is rocked by the waves. The motion is transmitted through gears to a high-tension magneto. Each time the weight swings either to the left or the right, the generator makes a few quick turns and develops a strong spark that passes through a gas-filled glass tube and produces a bright flash of light. Obviously the strength and frequency of the flashes increase as the sea grows rougher. The prismatic outer cylinder of the lamp is red, blue, or any desired color. There is no filament in the gas-filled tube.

Dec. 18 - 33 ✓

## NEW DEVICE FOR PHONING FROM MOVING TRAINS

4947

Telephone connection between a moving train and a dispatcher's office was established recently by employing apparatus with which transmission is made through the wheel and axle, without the assistance of any contributing medium. The demonstration of the equipment took place on a double-track line where the rails were properly bonded for the block-signal system, but it is claimed that the apparatus would work equally well on any track where the rails were similarly bonded without regard to the presence or absence of a block-signal installation. According to reports of the experiments, the communication established was satisfactory in every way.



El Paso County Jail - El Paso Texas

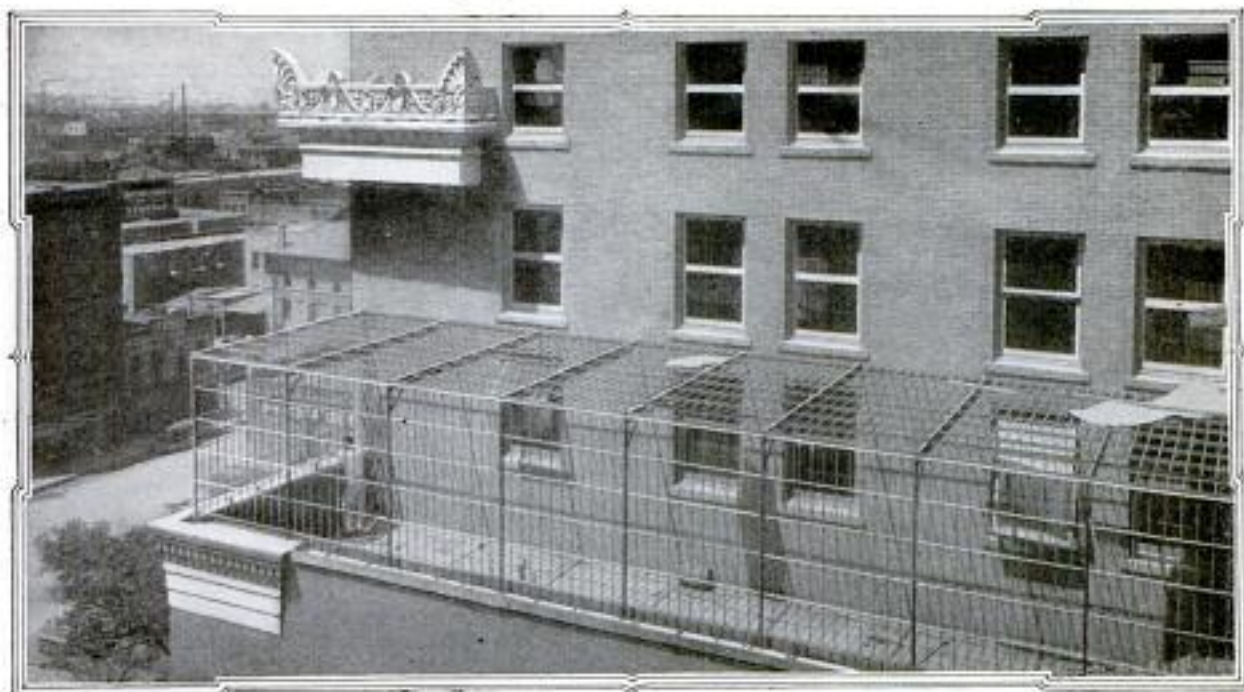

One of the Steel "Sun Parlors" in Which Inmates of El Paso's New County Jail are Given a Chance to Exercise during Certain Hours Each Day When the Weather Permits

4899

## MODEL JAIL IS PROVIDED IN COUNTY BUILDING

TO El Paso County in Texas belongs the distinction of supporting one of the finest courthouses and most modernly planned and equipped jails in the Southwest. Both of these institutions are under the same roof and have only recently been completed and placed in use. The first floor of the building is occupied by various county offices, while

on the second and third floors are the judicial chambers of the several courts. The top four floors are devoted to the jail. The latter might well serve as a model for most communities. It is light and airy, and so thoroughly outfitted with sanitary and other facilities that it reflects credit upon the ingenuity of those who designed it.

When a pris-



Exterior View of Splendid County Building Recently Erected at El Paso, Texas: The Upper Floors of the Structure are Devoted to One of the Best-Equipped Jails in the Southwest



oner enters the place he is taken to a cell room in the basement where he is given a bath and clothed in a clean uniform. His own garments are thor-

stallation of as many more should they eventually be needed.

Outdoor cells, or caged porches, where gymnasium apparatus is installed, are among the unusual features of the institution. These spaces are large and airy and provide excellent opportunity for prisoners to exercise and enjoy the sun's rays. Inmates in good standing are allowed the privileges of these "roof gardens," as they are locally termed, for an hour each day. This enables them to keep in good physical and mental trim, although they are confined. Proper recreation has the additional advantage of improving the morale of prisoners.

Since the point has been strongly stressed by two correspondents, it seems entirely in place to mention that the prison "sun parlors" overlook the Rio

Grande and afford an excellent view of the Mexican hills, and particularly of

oughly fumigated and stored in a steel locker where they are kept until he is released. The man is next subjected to a physical examination to preclude the chance of his spreading a contagious disease. Finally he is taken to the jail above in a two-compartment elevator, built so that it is impossible for the operator to be reached or the control of the car affected.

The cells are arranged in segregated groups and may be locked or unlocked simultaneously from the corridors. The interior of each is finished in white enamel, equipped with porcelain toilet facilities, and supplied with hot and cold water. A shower bath is installed in each compartment to serve the occupants of the 10 cells inclosed. A chapel and small library are also maintained. At the present time there are about 300 cells, but space is available for the in-



Interior of Barred Recreation Balcony: Equipped with Gymnasium Apparatus. It Gives Prisoners a Chance to Keep in Good Physical Condition While Incarcerated



Looking through the Doorway into One of the Mobile Padded Cells with Which the Jail is Supplied



the town of Juarez, twice captured by rebels during the insurrections of the last few years. One writer ventures: "In the event of another attack upon the place, they [the prisoners] will have grand-stand seats from which to witness the battle—and they won't have to pay for them." The latter phrase seems to be the important feature, for law-abiding citizens, it appears, have viewed the previous battles only after paying liberally for standing room on the roofs of El Paso's business buildings.

The equipment provided for imposing death penalties is somewhat unusual. The execution is accomplished without requiring the services of a hangman. A condemned man is bound in a chair so that he cannot free himself and a noose is placed around his neck. He is then left to his fate. The jailer locks the door of the chamber and from the outside sets a time clock which, through electric connections, releases the trap and ends the prisoner's life without the affair being witnessed.

El Paso County has a rather mixed population. For that reason the women's section of the jail is arranged so that white, Mexican, and negro girls and women may be segregated.

Mobile padded cells are used for violent and dangerously insane inmates. The heavy upholstery and soft-rubber matting in these cells may be removed, when desired, leaving a light portable cage. These are mounted on wheels and can be readily pushed from one place to another. There are various situations that arise in handling unbalanced persons that make cells of this type exceedingly serviceable. When such a prisoner is to be given an examination, medical or other treatment, or taken for an airing, one or two attendants can push the cell to different parts of the jail, or to the "roof garden," without difficulty or danger.

The new county building is attractive architecturally and structurally. It is built of steel and concrete and faced with light-colored brick, this construction eliminating firescapes.

## PASTEBOARD SOLDIER BUILT TO AID CAMOUFLAGE

Papier-mâché soldiers may yet be used against the Germans. Camouflage, the art of fooling the enemy by disguis-



Two Sammys, One of Flesh and Blood, the Other of Papier-Mâché Made to Fool the Enemy

ing and concealing the implements of warfare, has brought about the development of a dummy soldier that defies binoculars. As is well known to those who are in touch with the trend of things at the front, field guns are made to look like broken tree trunks, and broken tree trunks are made to look like fields guns, all for the purpose of hampering the enemy's observers and misdirecting its gunners. In making stumps and old carts pass as artillery pieces it is necessary to provide inanimate gunners for the sake of appearances, hence this pasteboard soldier, the recent invention of an American student officer. As must be obvious, there are innumerable ways in which the dummy might be used to advantage.

## RING WATCH IS NEWEST STYLE OF TIMEPIECE

The popularity of the easily accessible wrist watch was doubtless what inspired the production by Parisian jewelry designers of a ring watch. It consists of a tiny timepiece mounted on a finger ring and, if desired, embellished with precious stones. At a distance the little dial might be easily mistaken for a large stone setting.



Jerome M. Weston

July 1917

Copyrighted material



Encl: H. W. Hollenzer  
Reedville, Ill. Can

486

Encl: Jas. J. Russell  
1654 Monroe St. Bldg.

### GOOD MAKESHIFT REPAIR OF 4953 CRIPPLED TRACTOR

When an agricultural implement breaks down in the midst of a busy



With the Fore Truck of a Wagon in Place, It Was an Easy Matter to Steer the Broken Tractor and Keep It at Work

season, a farmer usually finds some way of making a temporary repair that will permit its use until a new part can be obtained. For instance, the front hub of a three-wheeled tractor operated by a Canadian farmer broke at a time when the machine was badly needed. Instead of allowing it to remain idle for several weeks, he removed the crippled wheel and brought the fore truck of a wagon into use. A heavy plank was chained to the front end of the tractor's frame. A hole in the opposite end of the timber, which was rested on the wagon axle, accommodated a king-pin. By hitching a team of horses to the outfit and providing a driver, the tractor was then steered without any difficulty.

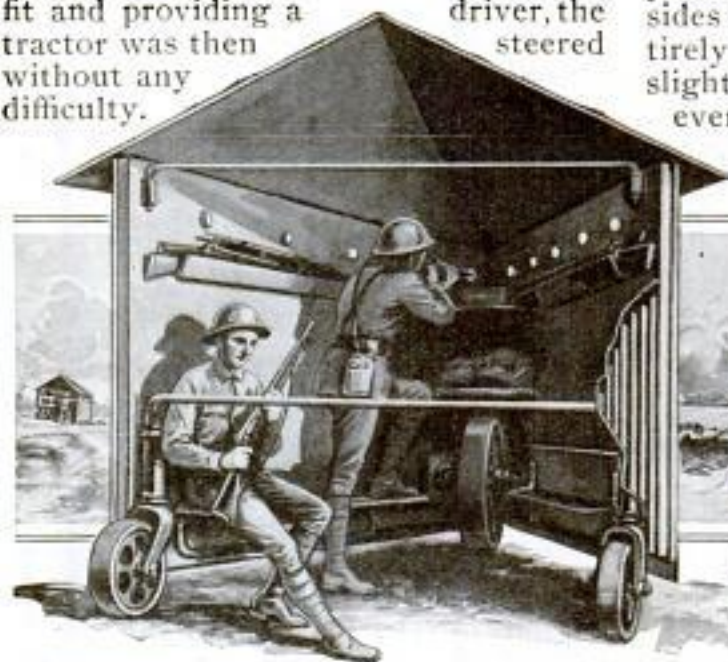

Showing the Interior Arrangement of the Fighting Shield and the Character of the Deflector Inserted between the Double Walls Forming the Sides

### STEEL SHIELD TO PROTECT 819 ADVANCING SOLDIERS

No single instrument of destruction is playing a more vital rôle in the present war than the machine gun.

To deprive Germany of this weapon by offsetting its effect is the purpose of an inventor who has developed a bullet-proof fighting shield that is perhaps worthy of study. The device is a wedge-shaped steel shelter mounted on

one front and two rear wheels and intended to accommodate 10 infantrymen. The walls forming its two sides are 10 ft. long, 6 ft. high, 7 ft. apart at the extreme rear, and supplied with loopholes. They are surmounted by a detachable roof inclined to deflect shrapnel. The shield is designed to be folded flat and carried through the communication trenches to the firing line, where it could be assembled quickly under cover of darkness, ready to protect Sammies, Tommies, and Poilus during an early morning advance across "No Man's Land." A lever permits the vertical adjustment of the sides so that they can be dropped entirely down to the ground, or raised slightly to facilitate movement over uneven places. One of the contrivances would weigh about 1,750 pounds.



Above, the Artist Pictures a Squadron of the Wedge-Shaped Machines Going into Action, Protecting Infantrymen on Their Way across "No Man's Land"

The construction of the walls is interesting. The exterior surface consists of a sheet of





Diving into the Flaming Pool, a Neryy Swimmer Went to the Rescue of Three Helpless Children. He Swam Submerged to the Boat and by Splashing Vigorously Forced the Burning Gasoline into the Current

$\frac{1}{8}$ -in. steel, while the inner one is of half that thickness. The space between the two amounts to about an inch and a half and accommodates a crimped lining of  $\frac{1}{16}$ -in. material. The outer plate could be pierced by a bullet that struck it squarely, but the contention is that the saw-toothed inside lining would stop it, or at least prevent it from penetrating the third thickness. Projectiles fired from points within a certain angle on either side of the wedge, of course, would be deflected by the outer sheet. If equipped with a large number of these devices, soldiers would have a fair chance in the face of machine guns, the inventor claims, for they would be able to reach the enemy's trenches before exposing themselves to fire.

### LEAPS INTO BLAZING POOL AND RESCUES CHILDREN

Three small children in an open launch encircled by blazing gasoline were saved from injury and possible death recently when a neryy young swimmer spectacularly went to their rescue. The owner had landed and left

the craft unattended while he visited a near-by garage. When he was absent the children entered the boat. Subsequently several gallons of fuel exploded from some unknown cause, spread out on the water, and surrounded the launch, the flames imprisoning the children. Attracted by their screams, a quick-witted fellow ran to the water's edge. He remembered once having seen a circus performer plunge into a tank of water which was covered with a burning film of gasoline. He repeated the feat, diving deeply and swimming submerged to one side of the motorboat. As he came up he made a quick twist with his head and shoulders, splashing the water and breaking an opening in the burning film. By continued efforts he forced the flaming gasoline out into the stream, thus removing the danger and saving the children.

CA new material used for sound-proofing the walls of a music-school building consists of seaweed chemically treated, fireproofed, and made into pads.



## 4945 LOADED TRANSPORT RAMMED IN AMERICAN PORT

While lying at anchor in a certain domestic port a few weeks ago, the army transport "Saratoga," with a



COPYRIGHT, INTERNATIONAL FILM SERVICE  
A Diver Descending to Determine the Extent of the "Saratoga's" Injuries: The Picture Shows the Hole Torn in the Port Side of the Transport by the Steamship "Panama"

regiment of Sammies aboard, was rammed by the government's liner "Panama," inbound from Colon with passengers. Although a large rent was torn in the port side of the former Ward Line steamer, no one was injured and the troops were quickly transferred to other vessels. The hole extended from below the water line to the rail, and before the "Saratoga" could reach a shipyard, it began to list and was beached. The only explanation of the accident is that there was a misunderstanding of signals in the engine room of the "Panama." The vessel was wending its way among a number of ships when the pilot saw that he could not clear the transport. He ordered full steam astern, but his signals were not obeyed and the crash resulted. The incident

took place early in the afternoon on a perfectly clear day. The incoming liner was not injured, and proceeded to its pier.

## 4956 STRENGTH OF DOUBLE-LOCK AND SHUTTLE STITCHES

Accurate tests of the comparative strength of seams sewed with the double-lock stitch and the shuttle stitch, sometimes called the lock stitch, have recently been made by the Bureau of Standards at Washington. These two stitches are the ones most commonly used on sewing machines today. The shuttle stitch is produced by the use of a shuttle which supplies the under thread and involves the inconvenience of removing the bobbin from the shuttle from time to time to be refilled. The double-lock stitch is produced without a shuttle, all threads being fed directly from the original spools. In testing a variety of fabrics, sewed with threads of various sizes, it was found that seams made with the double-lock stitch were stronger than those made with the shuttle stitch and were less weakened by thread breaks. Other important factors relating to the merits of the two types of sewing machines, such as speed and cost of operation, were not considered in these tests.

## 4993 DISCOVERY OF NEW POWER A BIG WAR SECRET?

Power transmission by a method which will revolutionize all existing systems has been discovered and is now largely used by the British war office and admiralty, according to a statement made by an engineer in a recent public address in India. Indian Engineering, in referring to this remarkable utterance, quotes the speaker as saying that "the whole output [of the new system of power transmission] is taken up for war purposes. After the war this system will be available; it will revolutionize all forms of power transmission and will be highly beneficial to rubber estates, tin mines, and to all power users."

3- Speech by

J. S. Washburn  
at Central

Copyrighted material



# A HOSPITAL FOR DAMAGED GEAR

BY LEWIS R FREEMAN

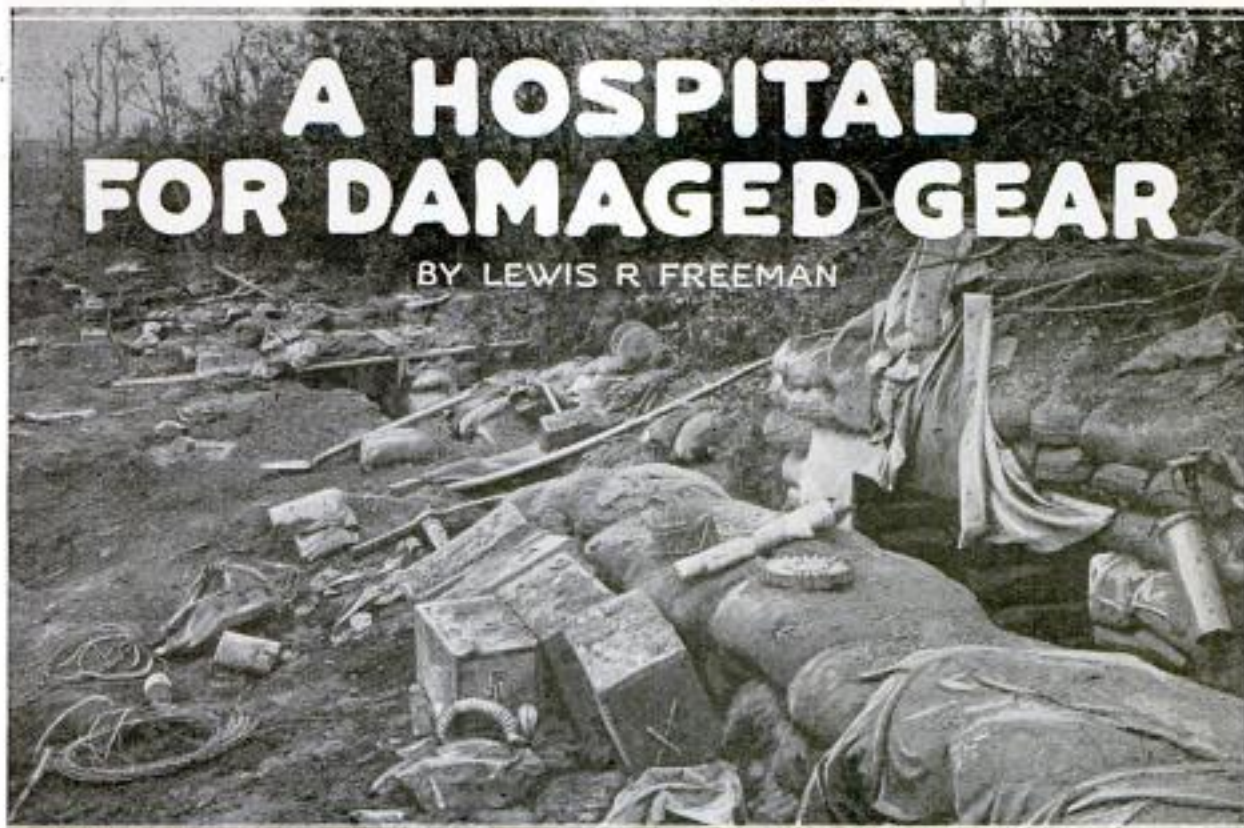

COPYRIGHTED BY THE CANADIAN GOVERNMENT

Picks, Shovels, Broken Machine Guns, Gas Masks, Ammunition Cases, Wire, Canvas, and Other Discarded Articles Are Visible in This Picture of a Trench Left by an Advancing Regiment of Canadians

3017

**O**VER the hospital for wounded soldiers floats the Red Cross flag, and over the camp for the treatment of wounded horses is the flag of the Blue Cross; the "hospital" for damaged gear bears no distinctive sign, but if one were to be chosen for it, perhaps nothing could be more fitting than the "Khaki Cross."

In wars of the past, and even down to the second year of the pres-

ent war, battle-damaged and war-worn gear of all kinds—boots, caps, uniforms, saddles, harness, rifles, guns, etc.—went at once to the junk piles and bonfires, to be written off a nation's books as a part of the cost of the war. Even the canny and meticulously economical Japanese had no comprehensive system for salvaging damaged material, and I clearly recall seeing thousands of yens' worth of only slightly worn or torn accouterment being burned or



One of the British Salvaging Squads Bringing in Rifles and Other Equipment from "No Man's Land;" Repairs are Made at the Base "Hospital" for Damaged Gear, an Important and Highly Interesting Institution





This Official Panorama was Taken Following a Concerted British Advance on the Western Front. It Shows Place. As Pieces of Abandoned Equipment are Found, They are Placed in Way the British are Conserving Their

buried with the dead in lime-covered pits at Port Arthur. Even in the present struggle, the waste of material on both sides in the chaotic opening months was incalculable, and in this, as with munitions and so many other things, it is probable that the Germans were the first in the field to minimize that loss. And the parallel may be carried still farther, for just as the

slower but surer-moving British have finally overtaken and passed the Teuton in munitionment, so, also, have they developed a system for renewing or re-utilizing their damaged uniforms, boots, and other gear, as well as guns, rifles, and other arms, including, in some instances, material captured from the enemy, which is, at least, the equal of anything the vaunted efficiency and

organizing talent of the Germans have put into execution. Perhaps nothing that one can see in all England—not even excepting one of the great new munition works—is more clearly and illuminatively indicative of the reserve of adaptability that has lurked—more or less unsuspected even by himself—behind the Briton's hitherto impenetrable mask of conservatism than the great "hospital" for damaged war gear "somewhere" back of the front in France.

The manner in which my attention was first



Cobblers Working in the Open Air Repairing Worn Shoes That in the Past would have been Discarded: Such Work is Now Chiefly Done at the Main Repair Depot





Troops in a Captured Village Clearing Away the Débris That Remained after the Terrific Bombardment of the Piles and Eventually Shipped to the "Hospital" for Renovation. In This Materials and Saving Millions of Dollars

called to the thoroughness with which the British are utilizing the "by-products of battle" was somewhat amusing—grimly amusing, of course, like all the funny things that befall in the shadow of Armageddon. In the course of a recent visit to the British front we—three journalists and the officers escorting us—spread our picnic lunch one day in a little garden on the back slope

of a certain hill famed for the desperate fighting which took place there when the French regained it from the Germans, and for the fact that it is one of the most advantageously located observation points on either side of the western battle line. As the point was well within range of the intermittently thundering German guns, and as its usefulness as a lookout drew an ad-

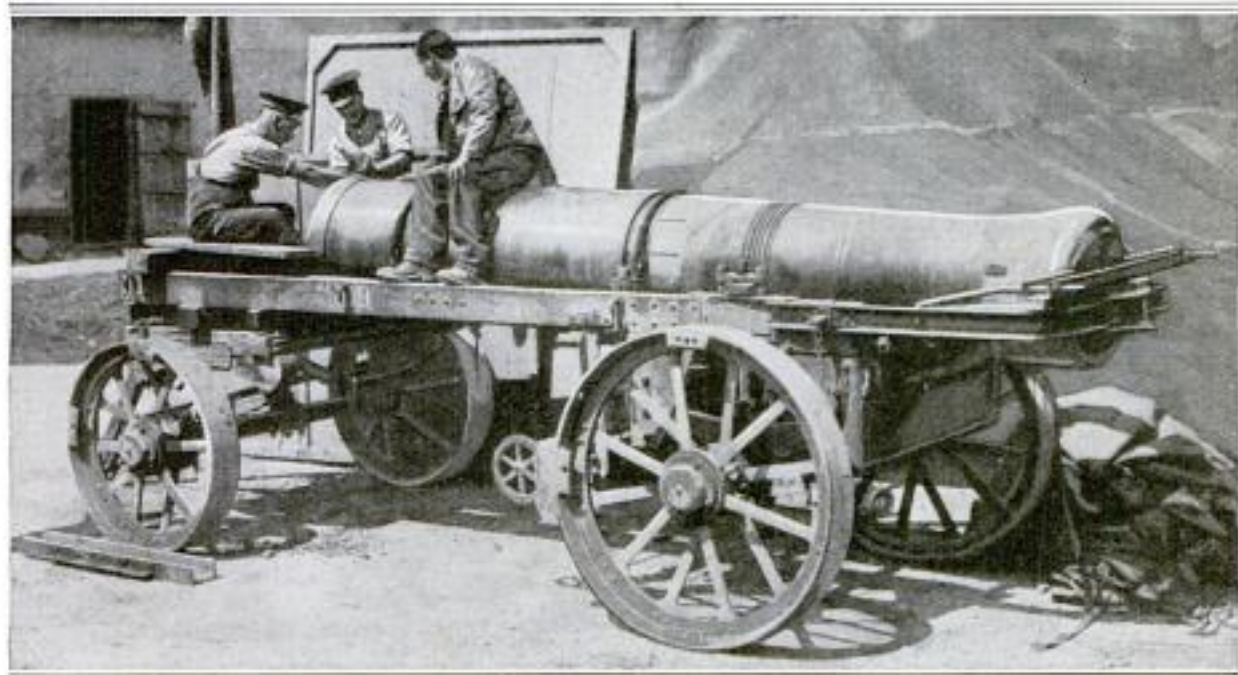

Traveling Cannon Menders at Work: Equipped with a Well-Outfitted Mobile Workshop, These Expert Repairmen Rejuvenate Disabled Artillery Pieces near the Front. This Shows Them at Work on a Big Gun



monitory "Jack Johnson" every now and then, we, acting on orders, had brought the little knapsacks containing

petite, but if you must know, the flap of that mask you just had on was made from the tail of a Tommy's shirt picked up on the battle field. Possibly he thought he could chase Boches faster if he threw it away; possibly it was cut off him when a comrade applied 'first aid'; possibly—

"That will do," I cut in, hastily rolling up the mask and returning it to its case. "Here's hoping no asphyxiating shells sail over today to force us to the dread alternative."

Captain R. smiled. "It really isn't as bad as it sounds," he said. "Of course, everything that is picked up is thoroughly disinfected, and the old 'grayback' flannel in that gas mask is as free from germs as



Salvaging of War's Scrap Heap is Not Confined to the Western Front: Here Tommies are Sorting Turkish Rifles and Other Articles, Collected in Mesopotamia, Preparatory to Sending Them to the Repair Base

gas masks (they are one's inseparable companions all along the active part of the front), from the motor and laid them close at hand in case a questing shell chance along during lunch.

Unrolling my mask to read the directions for its use and to try it on, I noticed that the gray fabric had a strangely familiar look, and that one corner of the "skirt" of the queer contrivance was pieced out from a rounded seam.

"What's this stuff they use in the gas masks?" I asked of Captain R., who reclined at my elbow. "I'm sure I've seen something like it before."

"'Grayback,'" was the laconic reply. "I should hate to say anything to spoil your ap-

septic gauze. So is everything else we send out of the 'repair shop' down at X—. You shall see this afternoon how we gather the 'damaged goods' from the battle field, and tomorrow you

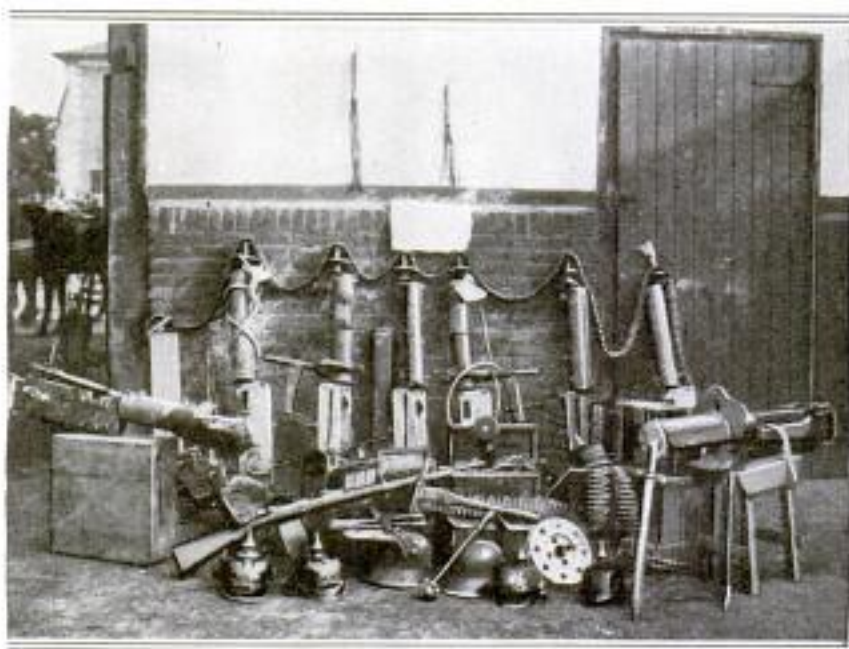

Machine Guns, Rifles, and Helmets Captured by the British During an Advance in the West: They are Shipped to the Salvaging Station Where Something of Use is Made of Them





One Often Wonders What Disposition is Made of the Enormous Piles of Empty Artillery Shells That Accumulate. They are Carefully Collected and Re-Used. Piles Like This Form in a Few Hours

may see at X—how we make them whole again. Nothing is thrown away nowadays. You couldn't have a better illustration than that gas mask of the system on which we work. Those pieces of flannel were doubtless no longer of use for shirting; saturated with chemicals, they are in every respect as good as new fabric for the skirts of masks or 'smoke helmets.'

Among many absorbingly interesting things about the desperately fought-for conquered areas of the Somme, nothing impressed me more—in contrast with other battle fields I have known—than the way it had been "cleaned up," this applying no less to the "consolidated" trenches—in which Tommies were already snugly "keeping house"—than to those more open areas between the trenches where one usually forages for souvenirs. Of "dud" or unexploded shells and hand grenades, there were a number, but as to these, we were given unequivocal orders to give a wide berth; of innocuous fragments, even of rags, there was a singular dearth.

"It is because we have 'combed' the battle field for anything and everything that can be turned to some use again," explained R. "And there is little, in-

deed, even from the things the Boches left behind them, that cannot be made to serve in some way. Presently we shall go back and see the 'combinging.'

The advanced "combing station" chanced to be located right between what had been the original British and German trenches before the offensive of July 1, and but a few hundred paces from the crumbling ruins of obliterated Fricourt. It was nothing more or less than a couple of acres of level ground covered with orderly piles of disorderly fragments of every conceivable thing from pocketknives to field guns that figured in the life and activities of the British and German armies, gas helmets, flash lamps, oxygen apparatus for reviving those poisoned with gas, mess kits, rifles, hand grenades, boots, puttees, caps, belts, tunics, trousers, a thousand things, the mere cataloging of which filled pages of closely typed paper.

German and British articles were kept apart, and also the damaged and undamaged things, the latter to be re-distributed at the front, the former to go back to the "base hospital" far in the rear. The "combers" were Tommies with bags and push carts, and



their duty was to go methodically over the conquered territory, as fast as it was cleared of the enemy, and bring in everything possible of renewing or working over into something else.

Such of this flotsam and jetsam of the battle field as is finally adjudged worth "doing over" is carted to one of the inconspicuous but ubiquitous spurs of light railway that are pushed up steadily behind every advance, and go by that to a "standard gauge" and thence to the waiting "wards" of the great "hospital" nearly a hundred miles away. This remarkable repair shop I was taken to visit the following day. Its "strategic" situation from an industrial standpoint is ideal, for not only is it in one of the best-served of French towns, but it has a railway and motor roads running directly into its busy yards.

This great plant at present employs something over 3,000 hands, about two-thirds of whom are French girls, and most of the remainder men of the British Army Service Corps. The girls are of the average factory type, quick with their hands and minds, but with no especial training. Their immediate "foremen" are English girls and women of a volunteer organization that has done important work in diverse fields of war endeavor. The men include many highly skilled workers, especially in the machine shops, for some of the repair work on such things as rifles and artillery demands quite as great a degree of technical training as does the making of such arms in the first place.

Of the work on arms, munitions, and kindred things, one is, of course, shown no more and told no more than if he were visiting an arsenal anywhere else. I was especially interested in learning to what extent material captured from the enemy is utilized, but this, naturally, is a question that would necessarily have to be answered with some reticence. Undoubtedly practically all of the captured material is used again in some form or other, but I gathered that no attempt is made to restore such things as German machine guns and

artillery, even when ample munitions have been seized with them.

The work on boots, uniforms, and ordinary accouterment is as open to the inspection of the visitor as that in any factory. The work is as completely systematized as in any of the great manufacturing plants of the United States, and every stage of renewal is in the hands of a person who devotes himself to nothing else. The rapidity of the work is bewildering, especially to one not familiar with the manner in which enthusiastic and unselfish women workers have sped up the works in French and British munition factories since the outbreak of the war. Some of the transitions, both in their speed and completeness, are sheer wizardry, and the best way to get an idea of what is happening is to follow a "patient"—let us say a pair of boots—once water and blood-soaked, and later baked in the sun until they are nothing but shapeless masses of dried mud and leather, from the time of their "admission," through a few of their "treatments," to the moment they are "discharged" as fit for service again.

A preliminary steam bath accomplishes the double purpose of disinfecting and cleansing the boots (or uniform, shirt, puttees, or any other article of wear) sufficiently for an inspector to determine what repairs are required. Let us say that they need new soles, heels, and hobnails, and that the upper of one of them has been torn by barbed wire. The boots are passed along to men who, with a few deft nips with pincers, remove the worn portions of the soles and heels, before handing them on to a girl who rips off the piece of torn upper. A second or two later, a new piece of upper is being stitched into place on a machine which, like most of the others in this department, bears an American trade-mark. Half a minute later this boot has followed its mate into the hands of the solers where, after a brief interval of fitting, trimming, and preliminary nailing, another machine finishes that portion of the job. Even less time is consumed in heeling, and then both boots pass to a machine



Movers: H. L. Brown

Low for ...

which begins pointing an accusing steel finger at its soles, with each gesture planting a rough-headed hobnail in place. Less than a minute is taken in completing the nailing job, and then, with scarcely five minutes elapsed since the beginning of the work, the repairs proper—work that would have taken an ordinary cobbler a couple of hours—are finished. A dip into a huge bath of warm cod-liver oil, a swift, deft kneading in the strong fingers of a singing French maid, a brief interval of rubbing, drying, and polishing, and those shapeless masses of caked mud and leather which we saw a few minutes ago are ready for their "discharge," a soft, durable pair of army boots that the experienced Tommy will pick every time in preference to those fresh from the factory. The work on uniforms, kit, gear, etc., is just as speedy, differing from that on boots only in the nature of the processes.

After what had occurred the day before at lunch, I was, not unnaturally,

interested in the making of gas masks. In the long half-open shed where this work was going on I was shown stacks of chemical-saturated fragments of cloth which, on closer inspection, turned out to be pieces cut from shirts, tunics, blankets, and other things doubtless too much damaged themselves to warrant restoring as such. The masks were turned out with incredible rapidity. Pieces were cut to pattern from the chemically impregnated fabrics, stitched together, fitted with goggles and mouthpiece and laid out ready for wear almost as fast as one could follow them as they passed from hand to hand down the long benches. The girls sang as they worked, and at the completion of the last operation—the fitting of the exhaling valve—I noticed that most of them gave the rubber tube a vigorous smack with their lips, a salute to the Tommy who was expected to use it in the trenches. Rather a pretty way of cementing the entente, I thought.

**TRUCK AND TRAILER CARRY TWENTY-ONE-TON LOAD**

4873

An extraordinary feat in big-load hauling was accomplished recently when a five-ton truck and a two-wheel trailer carried an oil agitator weighing 21 tons a distance of half a mile. A big hoisting derrick was secured to load the big cylinder, but it proved so heavy that finally three such derricks were re-

quired to get it in place. The carriers successfully moved their big load at about two miles an hour.

A 500-ton locomotive jib crane capable of lowering, raising, or swinging a 56-ton load at its maximum working radius of 87 ft., has been built for installation on the Panama Canal at Balboa. It is said to be the largest machine of its kind in the world.

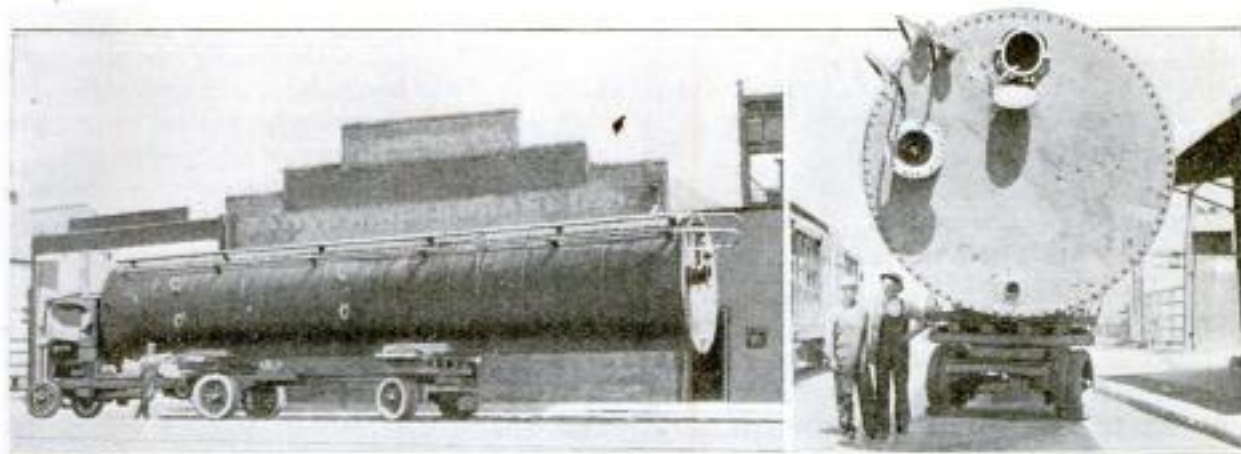

Five-Ton Truck and Two-Wheel Trailer Carrying a Huge Oil Agitator Weighing 21 Tons: The Load was Transported Half a Mile without Mishap



## HANDLESS MAN DRIVES CAR WITH MAGNETIC CONTROL

4852 A handless man has recently driven an automobile across the continent. The feat was made possible by reason



Motorist with Artificial Hands Who Drove His Car across the Continent: A Feature Which Made the Automobile Easy to Operate Was the Magnetic Gear Shift

of the fact that his arm stumps were provided with apparatus to take the place of hands, and that the car which he drove was equipped with a magnetic gear shift. The long drive, which was undertaken to demonstrate the ease with which the car, so equipped, could be handled, was marked by no mishaps.

## HINGED TOOTH SAFEGUARDS AGAINST DISEASE

6136 A hinged false tooth has been invented by a dentist to take the place of ordinary bridge work in special cases. The tooth is divided into two parts, the base half being permanently



The Hinged Tooth, Which is Shown Both Open and Closed, Permits the Treatment of the Gums and of Adjoining Surfaces in a Way Which Ordinary Bridge Work Does Not

anchored in position close to the gum. To turn back the grinding or cutting part of the tooth, the wearer presses firmly against it with his finger, disengaging the two sections which inter-

lock quite securely. In this way the sides of the adjoining teeth and the gum are exposed for treatment.

## BUYING FOOD AND CLOTHES FOR NAVY A HUGE TASK

5000 Some idea of how large a problem it is to feed and clothe the fighting forces of the United States in these war times can be gained from figures relating to the needs of our navy which now enrolls approximately 200,000 men. This branch of the service does not propose to lose its reputation of being "the best fed and the best clad navy in the world." For example, each month 5,500,000 lb. of meat must be provided for our sea forces, 4,854,000 lb. of flour, 8,700,000 lb. of vegetables, 620,000 lb. of butter, 1,678,000 lb. of sugar, 100,000 lb. of white navy beans, 624,000 lb. of evaporated milk, and so on. These supplies are purchased in various parts of the country where market conditions are favorable and then are assembled at the ports where they are needed to provision the ships and provide for the men training ashore.

Items relating to clothing for the navy are on an equally large scale, the totals being such that it is difficult for the average person to comprehend them. More than 100,000 men have enlisted in the navy and the naval reserves since war was declared, and to outfit them has required 200,000 over-shirts, 200,000 pairs of blue trousers, 100,000 blue caps, 200,000 pairs of shoes, etc. The navy manufactures most of its uniforms in its own factories. The one at Charleston is being enlarged so that it will soon be able to turn out 200,000 suits of white clothing per month and the factory at the New York Navy Yard will soon be able to produce 70,000 blue uniforms per month.

Plans are being worked out in California whereby at the end of the honey-gathering season bees will be transported to a new region where flowers are blooming to see if they will continue their work and thereby increase the output.



**SPEED SCOUT SHOWS WAR'S EFFECT ON AIR CRAFT**

Those who are interested in the war's influence upon aeronautics will find the accompanying photographs of a swift Nieuport scout machine worthy of study. They explain graphically the present trend in French designing and afford two exceptional views of a type of craft that is taking a vital part in the aerial activities along the western front. The most obvious change to be noticed in the structure of the Nieuport is, of course, its evolution from a monoplane to a biplane. This took place early in the conflict and has been generally known for two years at least. Technical interest will be found in the arrangement of the bracing wires and possibly also in the manner in which the struts are installed. Very

little can be said regarding performance, for such details are not given general circulation. It is known, however, that the French are using speed scouts that are able to travel 175 miles or more an hour and climb at almost unbelievable rates. Incidentally it is rather interesting to note that the lines of the Nieuport bear quite a close resemblance to those of the Thomas-Morse aeroplane, an American-built craft. There is

a marked difference between the two, however, in the struts and bracing wires.

CA noninflammable, nonbreakable substitute for celluloid and glass is now being introduced in England for use in windshields, as an aeroplane-wing covering, for map covers, etc. Its weight is about one-sixth that of glass.

*Harley H. ...  
Patent R. D. ... E.*

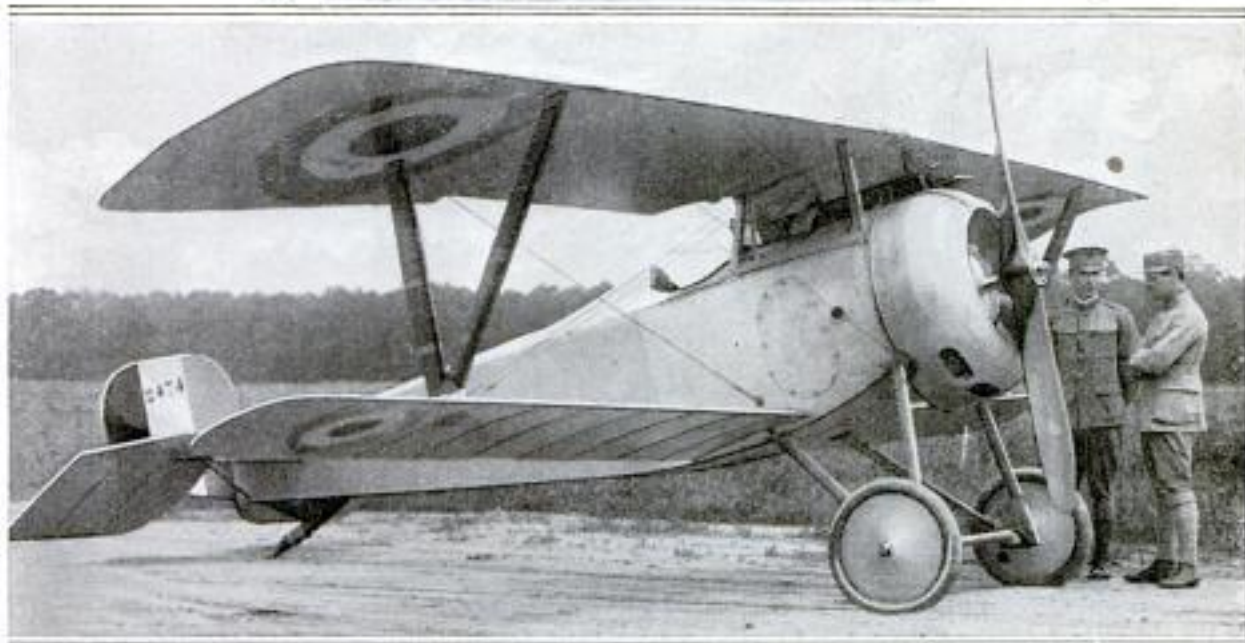

COPYRIGHT, INTERNATIONAL FILM SERVICE  
**Close Views of a Nieuport Speed Scout during Its Inspection by an American Army Officer: At the Top is Shown the Nine-Cylinder Rotary Motor That Drives the Craft, While Below an Excellent Idea is Given of the Arrangement of the Struts and Bracing Wires**



4927

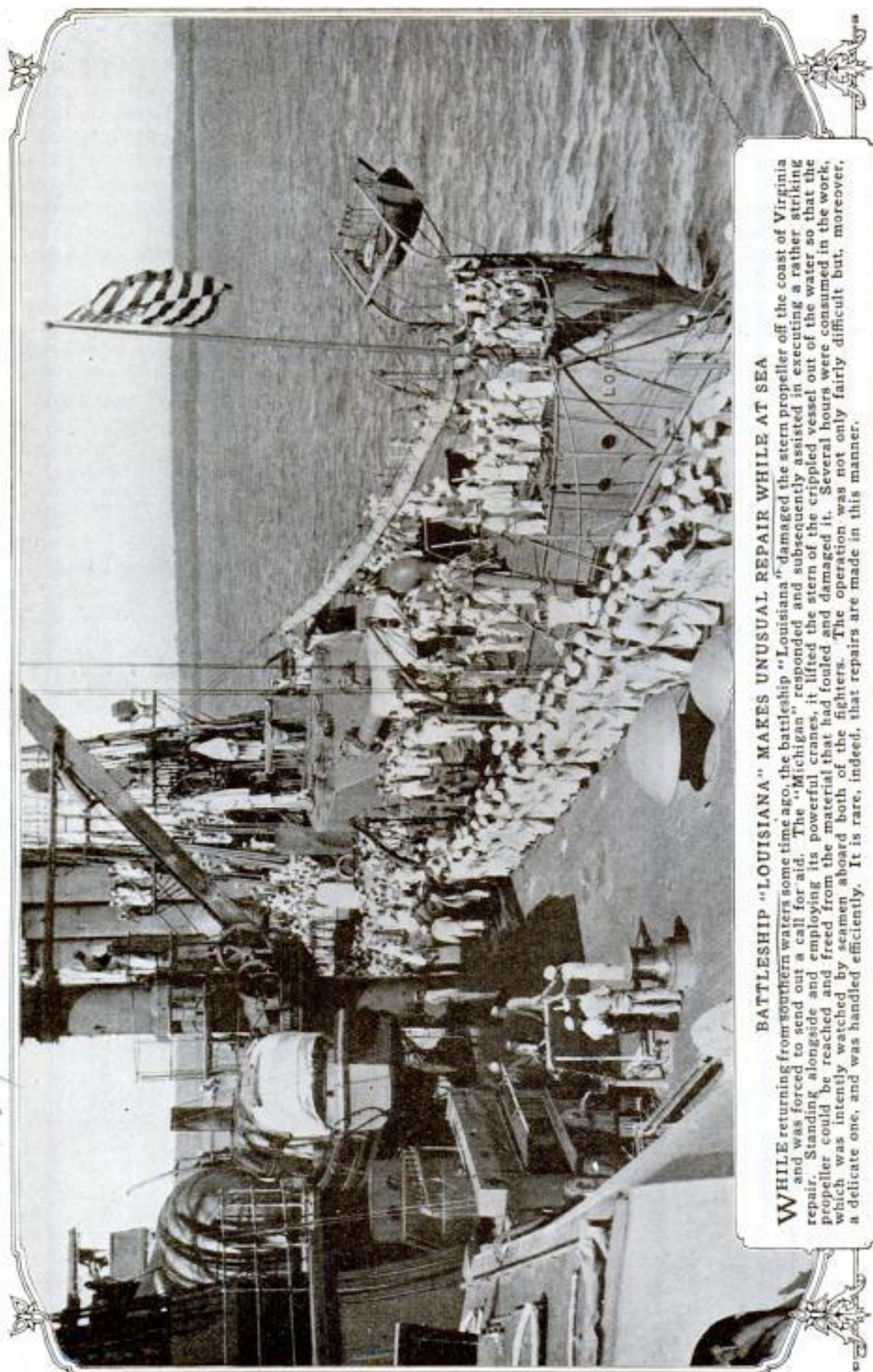

**BATTLESHIP "LOUISIANA" MAKES UNUSUAL REPAIR WHILE AT SEA**

WHILE returning from southern waters some time ago, the battleship "Louisiana" damaged the stern propeller off the coast of Virginia and was forced to send out a call for aid. The "Michigan" responded and subsequently assisted in executing a rather striking repair. Standing alongside and employing its powerful cranes, it lifted the stern of the crippled vessel out of the water so that the propeller could be reached and freed from the material that had fouled and damaged it. Several hours were consumed in the work, which was intently watched by seamen aboard both of the fighters. The operation was not only fairly difficult but, moreover, a delicate one, and was handled efficiently. It is rare, indeed, that repairs are made in this manner.

COPYRIGHT, ENRIQUE MULLER



## WASHINGTON POLITICIANS STIRRED BY WAR STATUE

Comment was aroused in Washington some weeks ago when a clay model of a symbolic group intended to commemorate America's entrance into the world struggle was displayed on the floor of the House of Representatives. The work was executed by a former student of the late Augustus Saint-Gaudens and some congressmen expressed great surprise that the group did not create a more warlike impression, deploring the absence of uniformed soldiers, fiery steeds, and the usual military trappings, while others realized that the sculptress in working out her theme, "In the Cause of Humanity, Civilization, and Liberty," looked beyond the mere paraphernalia of war to symbolize the ideals that inspire our participation in the struggle for world democracy. In doing this she has shown an athletic young warrior with drawn sword stepping forward against the waves of tyranny, which lash the rock of Liberty on which he stands. Columbia, just behind him, points the way, while Civilization protects a young child, Humanity, who clings to her skirts.

## HOW ENGLISHMEN'S MINDS ACT DURING AIR RAIDS

The Germans who have been repeatedly ordering air raids on the city of London in the belief that such "frightfulness," would tend to break down the courage and fighting spirit of the

English, will find anything but satisfaction in an extended report on how the people of London have acted during the raids. This report, which appears in *The Lancet*, shows that, with very few exceptions, the inmates of 12 or more institutions for the sick displayed remarkable courage and self-possession when the enemy fliers appeared. Here and there are such comments as "Two girls cried," or "One patient hid under the bed," but for the most part it is a record of remarkable poise and calm, which indicates pretty clearly the splendid manner in which the English public is facing every phase of the war.

It is pointed out that the Zeppelin attacks have afforded an excellent chance to study the psychology of English crowds. The first instinct of the person who hears air raiders overhead is self-preservation. But in a great many instances, perhaps in the majority, curiosity overcomes fear. This accounts for the fact that people have been prone to swarm into the streets to watch the enemy above them when there has been grave danger of

being killed. It is noted, too, that the spectators often take strange satisfaction in the excitement caused by a raid, apparently forgetful of the anguish and destruction which it may be causing. But the one thing which the Germans hope for most—a weakening of Englishmen's fighting spirit—certainly is not brought about by the depredations. Instead, each raid increases the determination to "see it through."



Because of the Absence of Horses and Khaki Uniforms, Many Washington Politicians Thought This Symbolical Group a Queer Statue for Commemoration of America's Participation in the World War



Inv. C. J. V. Morrell  
56 Lexington St

500 Col. en. Ill. POPULAR MECHANICS

## UNUSUAL WORK IS EXECUTED WITH FLEXIBLE CAMERA

Results beyond the ordinary are claimed to be attained with a camera of great flexibility that has lately been



Although This Photograph of a Tall Hotel Building has Lost Much in Reduction and Reproduction, Its Sharpness Gives One an Impression of the Class of Work Accomplished by the New Camera

developed. Possibly the most surprising thing about it is its purported ability to photograph very tall objects, such as skyscrapers, at close range without producing objectionable distortions. Because of this feature, the

instrument permits an operator to obtain perfectly focused, sharp pictures under conditions that would ordinarily render satisfactory work extremely difficult.

Without discussing the optical principles involved, a fair conception of the nature of the apparatus and its powers is offered by its structural characteristics. Both the lens and plate supports are independently adjustable to any desired vertical or horizontal angle. The bellows interposed between these members are supplied with spring supports, so that regardless of the relative positions assumed by the lens and plate, an unobstructed path is provided for the light. Unlike cameras that are supplied with rising and falling fronts, the lens of this one is always kept in line with the center of the plate when an exposure is made. For most work the latter is also held in an upright position, but may be turned sharply to one side or another.

The adjustments are supposed not only to allow the proper perspective to be obtained without distortion, but to bring all parts of a plate into focus. It is in this way that the image of a building some 400 ft. high, photographed at a distance of about 200 ft., is made almost as sharp at the apex as at the base.

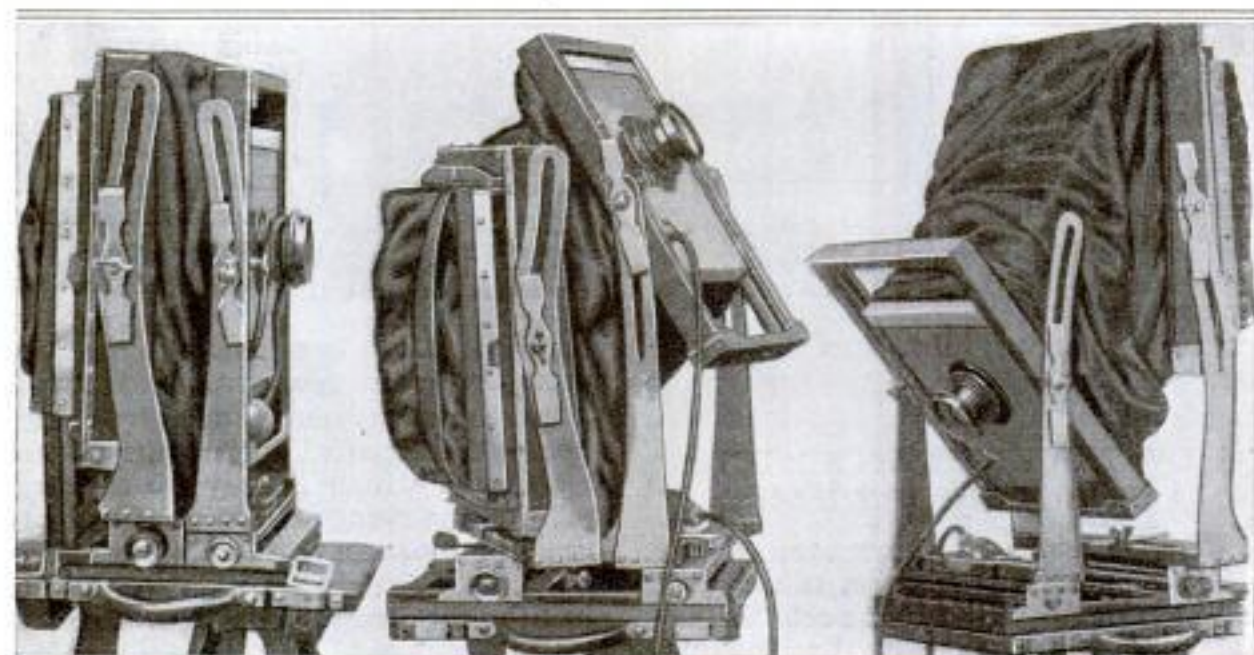

Above, the Camera is Focused in Three Different Ways to Show Its Extreme Flexibility. In the Middle Picture It will be Observed That the Plate is Turned at an Angle and the Lens Elevated and Inclined



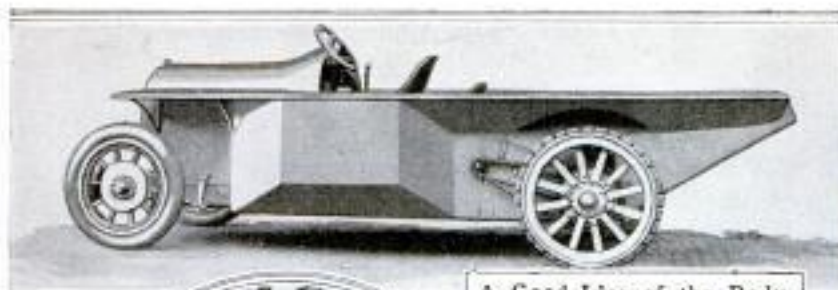

A Good Idea of the Body Lines of the Amphibious Army Truck is Afforded by the Illustration Above. The Machine Is Capable of 10 Miles an Hour in the Water



Bow View of the Land-and-Water Machine Showing the Tractor Propeller Mounted Immediately below the Crankshaft: The Front Axle Is Also Worthy of Notice



Loaded with a Dozen Men, the Machine is Seen Leaving the Land, the Propeller Churning the Water Vigorously and Beginning to Take Hold



The Front of the Engine Compartment is Sealed by a Steel Bulkhead so That Water can Not Enter through the Radiator. As may be Seen Above, the Car Serves Efficiently as a Motorboat When a Deep, Bridgeless Stream has to be Negotiated

Regardless of the character of work imposed upon the camera, it is never necessary to tilt the tripod. When, however, objects at the street surface, for instance, are to be photographed from high elevations, the plate support is inclined. The use of the instrument is not limited to photography of tall structures and similar work; it is equally serviceable for interior views, especially when space is cramped and handicaps are to be overcome.

## NEW MILITARY MOTOR TRUCK IS AT HOME IN WATER

Amphibious automobiles are not altogether unfamiliar contrivances, but land-and-water motor trucks designed primarily for military purposes are far from usual. Such a machine has been developed, and there is reason to believe that it will in time see the

battle fields of France. It has behaved well in recent tests and inspired considerable confidence in the minds of those who have seen it perform. While carrying a dozen passengers, the car has been driven into rivers and lakes and cruised the same as a motorboat. Its body, of course, is water-tight and of rather distinctive lines. At the front end a two-blade tractor propeller is mounted below the crankshaft. This pulls the machine through the water at a speed of about 10 miles an hour. To prevent leakage, the construction of the hood is obviously different from those of ordinary cars. A steel bulkhead seals the front of the engine compartment so that water cannot enter it by passing through the radiator. Broad horizontal planes extend along each side of the car. They prevent water from splashing into the tonneau or cockpit, and also act as mudguards. For scouting parties and



2 - The Argonauts &  
 Snowy Peak Ry. Co  
 1641 Market St.  
 Denver, Colo.

others operating in advance of an army, it is thought that the car should prove immensely useful, especially in view of the fact that the enemy in retiring, never leaves bridges standing.

### PLACE FOR TOOLS PROVIDED IN MOTOR-CAR TIRE RACK

Storage space for inner tubes, tire tools, and similar accessories, is pro-



Showing Interior of Upper Compartment Provided in Tire Rack for Storage of Tools

vided in compartments occupying the space inside of a drum that is part of a tire holder lately introduced for motor cars. The device may be attached to one of the running boards of a machine,

or at the rear. When used with a car that has a tool box installed elsewhere than beneath one of the seats, so that access may be gained conveniently, the storage compartments in the tire rack may be used for other purposes. They offer adequate room for the food supplies carried when one is touring, or for light motor wraps and raincoats.

### GASOLINE RAILROAD CARS USED ON MOUNTAIN LINE

Gasoline railway motor cars are being used to negotiate the heavy grades encountered in a Colorado scenic line between Silver Plume and the summit of Mount McClellan, the altitude of which is approximately the same as that of Pike's Peak. Each of the cars is driven by a six-cylinder, 150-hp. engine and carries 40 passengers in addition to a small trailer. They climb grades that vary from two to ten, and average six and a half per cent, traveling the route at speeds ranging from two to 20 miles an hour. The particular section of the road on which they are operated consists of 16 miles of track. Trains from Denver were formerly pulled from Silver Plume to the mountain top by a couple of special steam locomotives. It is these that the new motor cars replace. The narrow-gauge track rises several thousand feet by a zigzag series of steps, or switchbacks. At one point six tracks are visible, one above the other, extending up the side of the mountain.



The Gasoline Railroad Motor Cars and Trailer at the Summit of Mount McClellan



Henry James Mgr: Rockefeller Institute  
66th St & Avenue A, New York City.



View of the Model Base Hospital Established on the Grounds of the Rockefeller Institute at New York: Here, under Near-War Conditions, American Surgeons will be Taught the Carrel-Dakin Treatment of Wounds

## 4978 MODEL ARMY BASE HOSPITAL IS BUILT AT NEW YORK

AMERICAN surgeons are to be taught the Carrel-Dakin method of treating wounds at a demonstration war hospital established on the grounds of the Rockefeller Institute in New York. Within the last few weeks a complete model base hospital, consisting of 15 buildings, of portable house-unit construction, has been erected, the purpose being to present to members of the medical and architectural professions a material example of the base hospital as it exists at its best on the western battle front. Those who receive instruction in the chemical sterilization of wounds will thus be trained under conditions as nearly analogous to those actually

to be found in the war zone as can be provided. Furthermore, the plan makes possible the thorough testing of the unit portable hospital so that its merits and defects may be determined at home:

The structures are connected by covered passageways but except for this, each is entirely separate from the others. They are grouped in such a manner as to eliminate, so far as possible, all unnecessary

work in handling patients. The administration building consists of a waiting room for visitors and offices for various functionaries. Adjoining it is the laboratory in which a demonstration and lecture room is provided. The receiving and discharging pavilion



Hinged Panels are Provided to Permit Speedy Evacuation of the Ward Buildings in Case of Fire. This Shows One of Them being Lowered



offers facilities for bathing patients as they arrive and dressing them in fresh hospital garments. Their own clothing is dispatched to the laundry and later

maids, compose the rest of the buildings.

The structures have a number of interesting features. On each side of a ward, for instance, two panels are hinged at the bottom so that they may be swung out to permit quick evacuation of the building in the event of fire. Double walls and roofs are used. Also, the windows are designed to prevent drafts and avoid interference with the spacing of the beds.

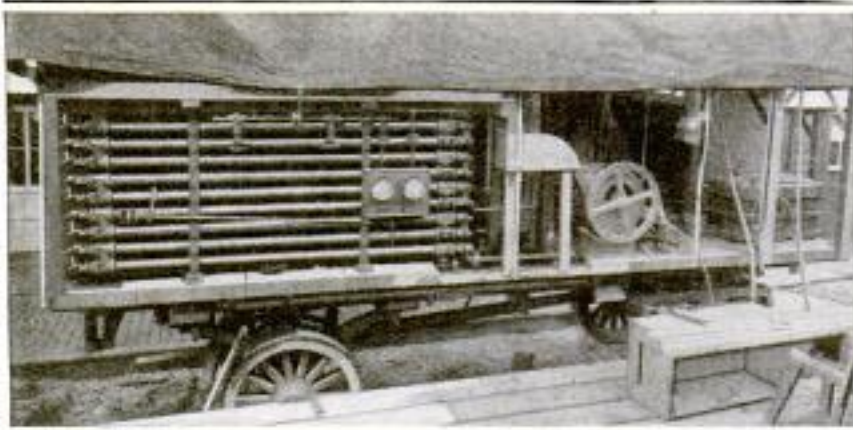

The Mobile Ice-Making Machine Is One of the Valuable Pieces of Equipment Employed at Modern Base Hospitals

returned and stored until again needed. Immediately back of this structure is the operating pavilion, which is divided into various rooms. Two ward buildings each contain 24 beds and have a "quiet" room suitable for the accommodation of one patient. An isolation pavilion where contagious diseases developing after patients have been accepted, may be treated, is fitted with four beds. A recreation hall, mess hall, kitchen, laundry, supply house, and quarters for orderlies, nurses, and

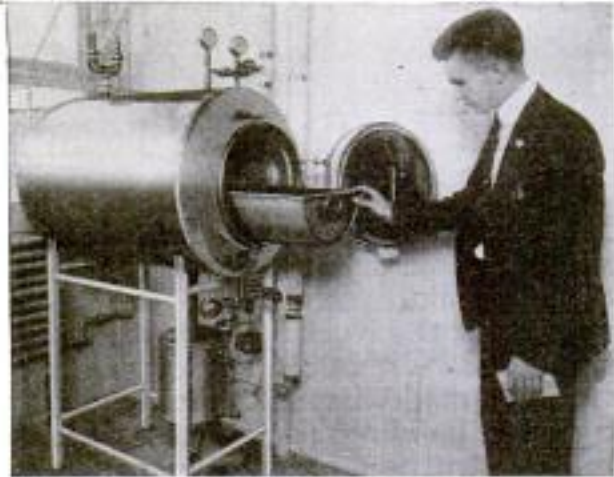

The Demonstration Hospital at New York is Fully Outfitted with Modern Appliances.

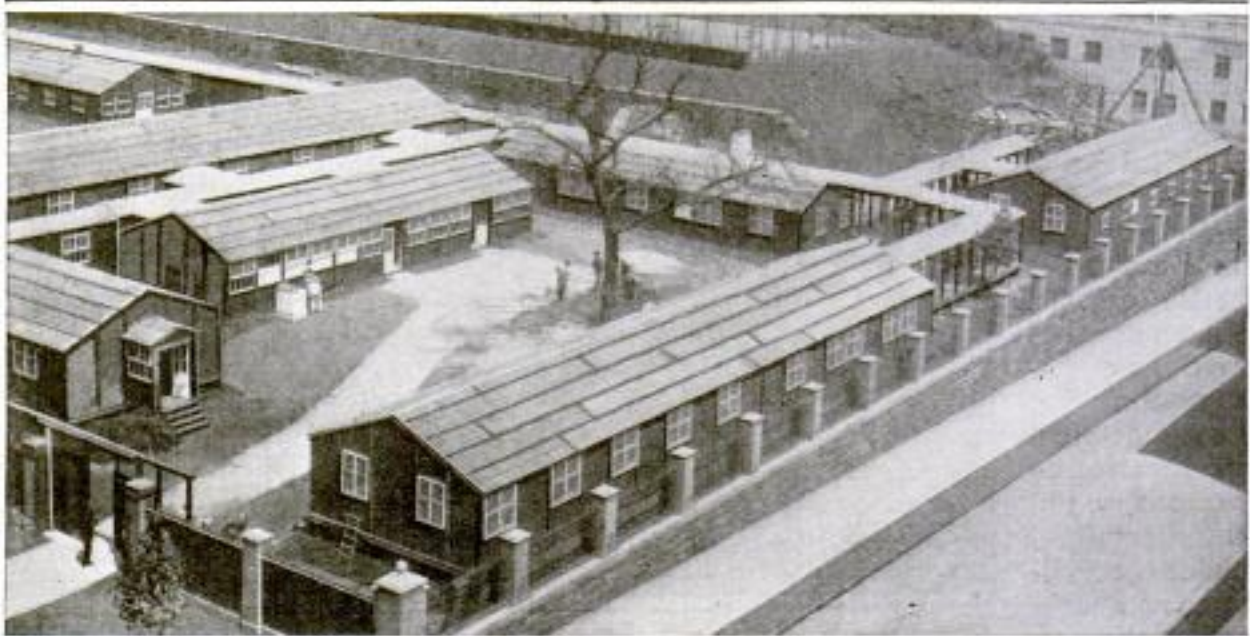

Close View of Some of the Hospital Buildings, Which Are of Portable House-Unit Construction: It will be Observed That the Various Structures are Connected by Covered Passageways



2 - R. H. Supner,  
 Window Ventilator & Supply Co.  
 P. O. Box 671, Dallas, Texas



Los Angeles' Great Aqueduct was Broken, as Shown Above, When an Earthquake Caused a Hillside to Slip and a Large Section of the Concrete Flume to Settle Six Feet

The lower sashes are fixed, while the upper ones are hinged at the bottom so as to swing inward.

It will be understood that the buildings are constructed of portable units. These are 5 ft. in length, either 8 or 10 ft. in height, and in standard widths of 16, 22, and 28 ft. They are small enough to be readily handled and transported, and large enough for ample window space or double doors.

**EARTHQUAKE AND LANDSLIDE  
 BREAK AQUEDUCT**

4948

Quite a peculiar as well as a serious break occurred in the long aqueduct that supplies Los Angeles with water from the Owens River region. One hundred and sixty feet of concrete flume along the face of the Alhambra Hills was completely shattered. At first it was thought to be the work of alien enemies, but in reality it was due to a far different cause. An earthquake occurred in the Owens Valley district and in turn caused a landslide which wrecked the conduit. For many years there has been a small spring on the side of the hill some distance above the point where the aqueduct was broken. The whole slope, therefore, has been water-soaked. On the other hand, when a railway was projected along the base of the hill, a high embankment was established. In building it, earth was

excavated at the bottom of the slope, thus weakening the support of the saturated mass above. The subterranean tremors readily caused a slide, and the waterway suffered. Temporary repairs were made quickly by bridging the gap with steel pipe. The permanent reconstruction of the section, however, will require considerable labor. It is understood that the hillside will be subdrained and that, at the base, provision will be made for supporting the earth against slipping. It is believed that in this way recurrence of the accident can be prevented.

**DRAFT SHIELD FOR WINDOW  
 MAY BE ADJUSTED**

4849

For office and residence windows, an adjustable draft deflector has been introduced. Except that it is so arranged that it may be set at different angles so as to conform to prevailing air currents, it is not unlike a similar device that has been in use for some time. The shield is adjusted by means of thumbscrews that slide in curved slots provided in the metal brackets that hold the glass in place.





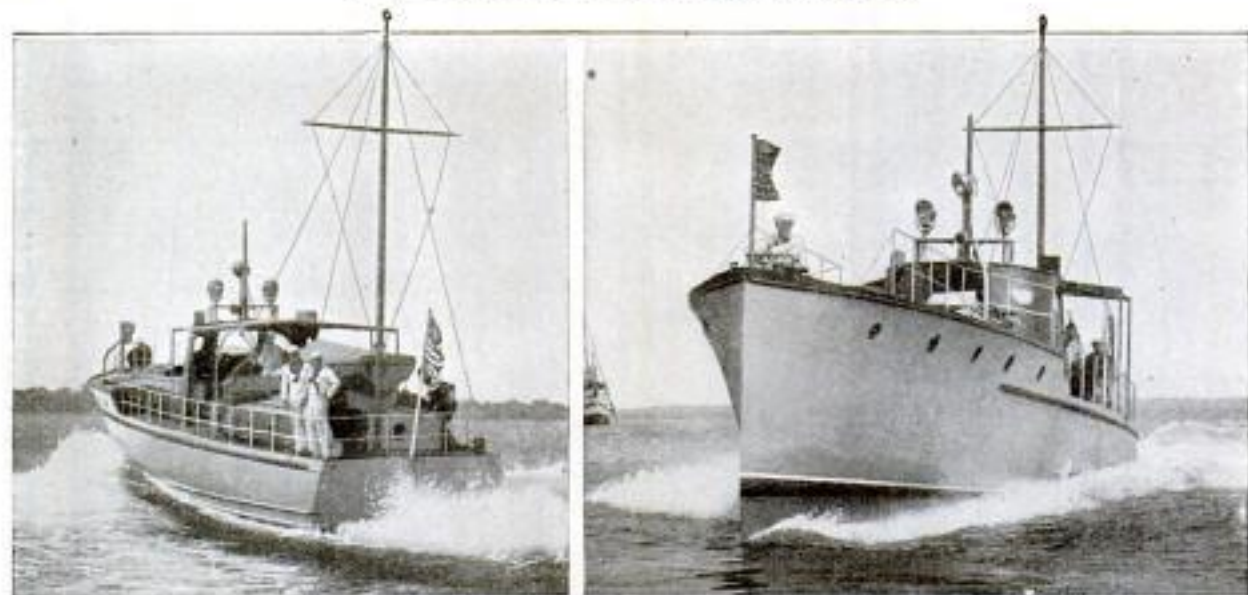

COPYRIGHT, BROWN & DAWSON

Dual-Service Boat, 66 Feet Long, Which the Government Recommends Yachtsmen to Copy in Building New Craft, so That in Case of Emergency Such Boats can be Requisitioned for Naval-Patrol Work

### FAST BOAT FOR BOTH WAR AND PEACE SERVICE

4864 The government has given yachtsmen an opportunity to render patriotic service by suggesting that new boats which they may order be constructed, where practical, according to specifications which the naval authorities have approved, so that in case of

emergency the craft can be taken from peaceful cruising and utilized in off-shore service in submarine warfare. A boat which meets these dual-service requirements has been constructed and put on exhibition. It is 66 ft. long, has a 13-ft. beam, and draws 4 ft. of water. It is equipped with three 200-hp., eight-cylinder engines which give it a speed of 28 miles per hour.

### BUSH TWO CENTURIES OLD BOUGHT FOR GARDEN

4856 It would seem that age—certainly the appearance of age—in a formal garden, can be bought just like garden fur-

niture, fountains, etc. At least such has been the achievement of a wealthy owner of an estate who desired to give an appearance of great age to his newly laid-out grounds. One of the ways in which he obtained the desired effect was by purchasing a boxwood bush which is over 200 years old. For the privilege of acquiring this magnificent, hardy specimen which was planted a quarter of a century before Washington was born, the sum of \$1,100 was paid. It stands 12 ft. high and measures from 19 to 21 ft. through its diameter.



Giant Boxwood Bush Over 200 Years Old, Which was Recently Set Out in a Garden to Help Give It an Appearance of Age

Purchased by:  
Richard H. Spence, N.Y. Cotton Exchange Serial



Municipal Market  
Salt Lake City, Utah.

## CITY PRESERVING PLANT CONSERVES FOOD

4933

By O. J. GRIMES

WITH a view to preventing food waste at the municipal market, the women of Salt Lake City, with the assistance of the city commission, have established a preserving plant in connection with the market, designed to care for all left-over fruits and vegetables suitable for preservation. So far as it is known, this is the only institution of the kind in the United States.

All fresh fruits and vegetables unsold at the closing hour of the market each day are bought by the plant at prevailing market prices and preserved either in jars or by drying. The preserved products are



Above Are Women Volunteers Preparing Their City's Surplus of Peas for Canning. At the Left Are the Finished Products Ready to be Sold Almost at Cost



offered for sale to the general public at prices slightly in excess of the actual cost of the raw materials and the jars.

To further encourage food conservation, patrons of the market may purchase the fruits and vegetables they desire preserved and deliver them to the plant where they will be preserved at a nominal cost.

The capacity of the plant is approximately 150 jars of preserved products a day. Comparatively little has been done toward drying fruits and vegetables as yet, because the demand has been greater than the supply of products in jars. At the end of the first two weeks of operation, after many orders had been filled, there were 1,000 jars of fruits and vegetables on hand,



Preserving Beets in Salt Lake City's Municipal Canning Plant in Which the Workers Are Women Who Donate a Certain Amount of Their Time Each Week



1- Invt:

Forest Lee, Hagner  
Buchanan, Iowa

508

B. J. Melligan  
Riverside, Calif

# POPULAR MECHANICS

while the orders called for more than 1,500.

But the work does not stop with the actual preservation of the foodstuffs. Realizing that many women are not familiar with the processes of preserving foodstuffs, demonstrations are conducted daily by experts employed for that purpose by the city government. By this means it is expected that the movement for the conservation of foodstuffs will be carried into the homes. In addition to the demonstrations at the plant, there are demonstrations by volunteer workers at community centers throughout the city.

All work done by the women is without charge. The only paid workers are two experts employed by the city gov-

ernment. The idea of the municipal preserving plant originated with the women's committee on food conservation and this committee has arranged for a certain number of volunteer workers each day. In some instances a particular organization conducts the preserving operations, under the direction of the experts, on a certain day each week.

Besides furnishing the experts, the city provided the building and the equipment for the preserving plant and 10,000 glass jars. By making the charge for the preserved products slightly in excess of the cost of the raw materials and the jars, the women expect to reimburse the city by the close of the season.

## NEW AUTOMATIC BRAKE FOR RIDING PLOW

4805

An automatic brake has been invented which attaches to a riding plow

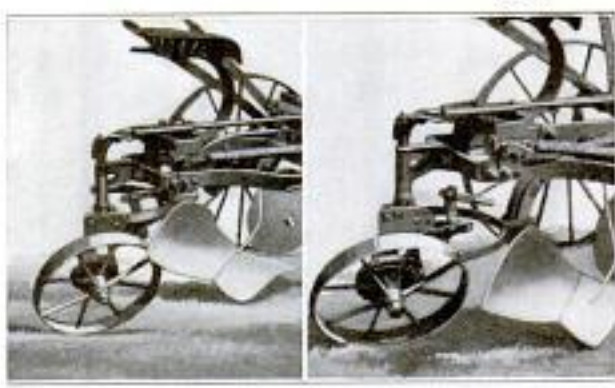

Two Views of an Automatic Brake on a Riding Plow: The One on the Left Shows the Plowshare Raised and the Brake Set; the Other Shows the Plow Lowered and the Brake Released

and serves to prevent the implement from running forward into the horses when the plowshare is lifted from the ground or when the plow is being drawn from field to field. A drum is fastened to the rear caster wheel and about it is placed a friction-brake band which is operated by a short lever. Attached to the plow beam, just above the blade, is a semicircular bar which extends backward either side of the caster wheel. Whenever the plowshare is raised this beam strikes the brake lever, causing the brake to operate.

## SPECIAL AXLE INCREASES SIDECAR CAPACITY

4780

By devising an adjustable axle for a sidecar, a motorcycle dealer has increased the carrying capacity of a machine materially. Besides accommodating a passenger in addition to the rider, the cycle is able to transport a crated machine at the same time. The latter is supported on a small platform arranged for the purpose and occupies the space provided between the sidecar and the outer wheel. Adjustment of the axle requires only a moment's time and is accomplished by loosening and tightening four bolts. When a



The Adjustable Axle Provides Space between the Sidecar and the Outer Wheel for a Small Platform on Which to Carry a Crated Motorcycle

new motorcycle requires immediate delivery this scheme proves valuable.



Denver Opportunity School  
See Card



Receiving Instruction in a School Which Has No Entrance Requirements Save an Earnest Purpose to Become Efficient in Some Task or Trade: The Teaching is Done by Men and Women Who have been Successful in Their Respective Lines

*Trade*  
**OPPORTUNITY SCHOOL, DENVER EDUCATIONAL  
FEATURE**

4480  
"MINUTE MAN" service is the keynote of the Opportunity Public School, conducted by the Denver school system for the benefit of those who never had a fair chance in life. There have been vocational schools, manual-training schools, trade schools, but the Opportunity School differs from all these. A man or woman, boy or girl, can secure, day by day, instruction there that will enable the student to hold down a new job. Or, one who has never been a student at the school may call upon it for instant help and receive it as readily as one of the regularly enrolled pupils. All instruction is given by men and women who are successful in the shops and stores of the city. Foremen and forewomen give several hours a day or night to guide the raw youth or the middle-aged misfit in a practical manner. Men and women over 60 years old are among the pupils. Twenty nationalities are represented among the foreign students.

The Opportunity School teaches automobile mechanics, Red Cross work, cooking, dietetics, bed-making and other

domestic-science arts, salesmanship, hairdressing, manicuring, mechanical drafting, millinery, dental assistance, bookkeeping, stenography, and other practical, everyday work. Nearly every week some new class is started, and the number of pupils has increased steadily until now there are nearly two thousand enrolled. Most of these have jobs, and this fact makes the employment bureau of the school the most efficient in the city. The workers hear of vacancies before anyone else and are able to give information of openings before the employers themselves have time to advertise for help. Since the United States entered the great war the Opportunity School has developed several groups that constitute preparedness classes. There are both men's and women's automobile classes, where cars are taken down or assembled. The women don overalls and attack the cars with the same spirit displayed by the men.

The dietary course for nurses includes courses for feeding wounded men, as well as study of the proper diets for various contagious and non-





Learning to Buy and Sell: There Is a Decided Economic Gain to Denver in Having a Department in the School Where Young People can Fit Themselves for Positions in the City's Stores. This School Store was Furnished by the Manufacturers' Association



A Lesson in Manicuring in Which Modesty of Dress and Manner is Emphasized as Well as the Proper Care of the Hands: A Course of This Sort Helps Materially to Raise the Standards of the Trade



Teaching Girls to Be Competent Hairdressers: Heretofore Those Wishing to Enter This Line of Work Had No Place under Public Auspices Where They could Make a Beginning, and Their Instruction was Apt to be Obtained in a Very Unsystematic and Unsatisfactory Manner





A Women's Class in Automobile Mechanics: The War-Time Shortage of Male Workers in Mechanical Trades has Created Opportunities to Which the School has Responded by Teaching Women How to Assemble the Parts of a Motor Car

Learning to Become Dentists' Assistants: Alert Young Women being Taught the Names and Uses of Dentists' Instruments, How to Prepare Fillings, to Sterilize, and to Care for the Patients



Men Who are Proving Their Determination to Progress by Learning Trades after Work Hours: The School's Enrollment Includes Many Who are Rapidly Becoming Machinists, Chauffeurs, and Ambulance Drivers. Some will Seek Positions in the New National Army



*Used in Salt Lake City*      *to know by:*  
*A. L. Rappaport*  
*Natic, Oregon*

contagious diseases. The Red Cross section is under a trained nurse, and here even such a simple thing as bed-making is taught. A first-aid course is included. The domestic-science classes are now reaching into food values and substitutes for the more common articles of diet. Practical workers in electricity are trained in a course laid out by the local electric-light company, and would be a valuable aid in trench warfare and wire-entanglement work.

Probably the most unusual class in public-school work is that in which hair-dressing and manicuring are taught. The girls are instructed that the first

and most important thing to learn is self-respect for themselves and their trade. Vulgar talk, loud dressing, and the use of cosmetics are forbidden. The instructor, the head of the largest Denver beauty parlor, tells her pupils that the big parlors want wholesome girls.

Perhaps the most remarkable thing about this unusual public school is the fact that its head and inspiring genius is a woman. Miss Emily Griffith, the principal, was a poor farm girl, who began to teach when 14 years old. Her sympathy and quick perception have contributed as much as any other factor in making the school a success.

**OFFICER DIRECTS TRAFFIC FROM RAISED PLATFORM**

*4759* A small platform, 2½ ft. above the ground, has been erected by the side of a corner telephone post at an important street intersection in a large city, for use by the traffic officer.



It is surrounded by an iron railing, and a circular awning shelters the occupant from the sun's rays. From this elevated position a policeman may obtain a clear view of the streets in

both directions, and so can tell when to operate the levers which control the green and red semaphore signals in the center of the street.

**BIG CATCHES OF CRAWFISH MADE WITH MOUSETRAPS**

*5005* Mousetraps are being employed with great success in catching crawfish, which are sold by the owner of the traps at an excellent profit. The man engaged in this unusual sort of trapping finds that the creatures which swarm

the quiet places in a near-by stream are not at all particular about the bait offered them, so that catching them is quite an easy matter. The trapper places a large number of the little spring mechanisms in well-selected places in the river and is kept busy a good part of the day removing his catches and attaching new bait.

**FIREPROOF PHONOGRAPHS FOR ARMY AND NAVY**

*4894* A limited number of phonographs which will withstand the roughest usage have been manufactured for the army and navy, and already certain military units have been provided with them. The machine furnished is 23



in. high, 19 in. wide, and 23 in. deep, and weighs 100 lb. The excessive weight is due to the outer case which is water and fire-proof and is reinforced so that it may be thrown into an army wagon or ship's hold without being injured. The instrument is designed especially for outdoor use and can be heard distinctly at 200 yards.

COPYRIGHT, UNDERWOOD & UNDERWOOD

*3 - Chas. H. Edwards*  
*Edwards Patent*  
*East Orange N. J.*  
 Copyrighted material



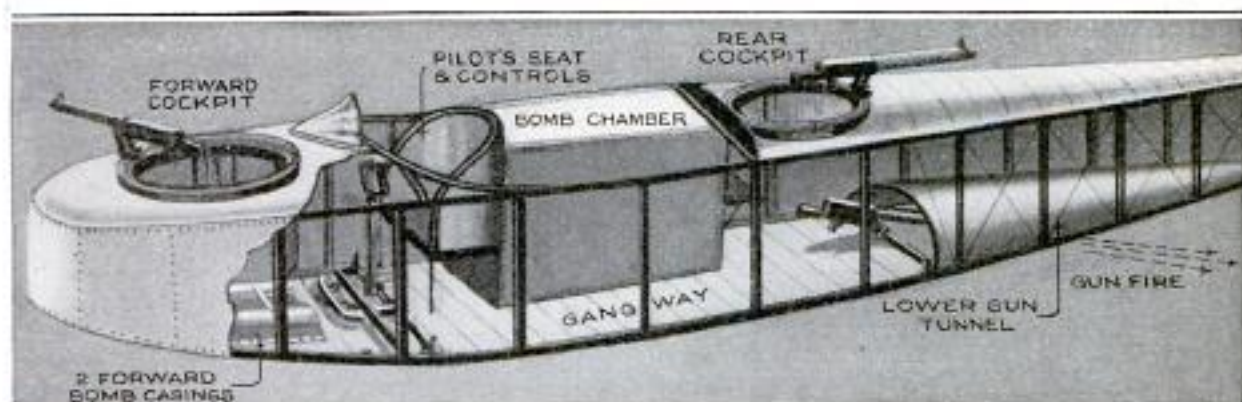

FROM THE SPHERE, LONDON, COPYRIGHT BY THE NEW YORK HERALD COMPANY

Showing the Interior Arrangement of the Fuselage of One of Germany's Big Gotha Battleplanes: The Plan Is an Entirely New and a Very Advantageous One

### BIG GERMAN BATTLEPLANE 5044 SPLENDIDLY DESIGNED

Considerable attention is being paid to Germany's newest aeroplane, the dual-motored Gotha, which was well represented in the great aerial raid upon London in July. The machine is known as a bombing battleplane and has a wing spread of 78 ft., which, for comparison, is more than three times as great as that of the famous Nieuport speed scout used by the French and British. Aside from its size, which enables it to carry a pilot, two gunners, and more than 800 lb. of bombs, its outstanding features are found in the arrangement of the fuselage. The driver's seat is on the right side of the body, and immediately back of it is the bomb chamber. Extending along the side of these and separating them from the opposite wall of the fuselage is a gangway that connects the forward cockpit, or gun position, with the rear one. Behind the latter cockpit the bottom of the fuselage is arched to form a tunnel that gives the gunner an unobstructed view of the front part of a pursuing craft in the same horizontal plane. This removes the last remaining "blind spot" from the military aeroplane and gives the Gotha an advantage over adversaries. Two rifles are mounted in the rear cockpit. One commands the gun tunnel, while the other is carried in the usual position. The gangway makes it possible for a wounded gunner to be replaced by his associate, and

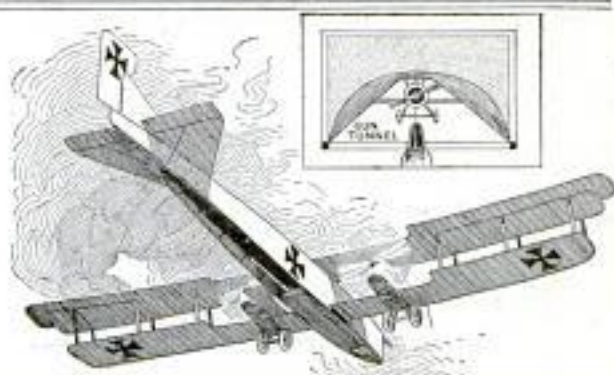

Inset, Looking through the Gun Tunnel at a Pursuing Plane; the Other Drawing Shows a Gotha Machine and Its Arched Fuselage

also enables both marksmen to man the stern guns in the event of a hot pursuit. The Gotha carries fourteen 60-lb. bombs, 12 of which are held in horizontal racks provided in the compartment behind the pilot's seat. The other two are contained in casings installed in the floor of the forward cockpit. Two Mercedes motors that develop a total of 520 hp., drive pusher propellers, and are mounted on opposite sides of the body.

### MONUMENT COMMEMORATES FORTITUDE OF PIONEERS

495  
Bronze casts are now being made for a splendid monument which will be unveiled next June at Donner Lake, three miles west of Truckee, Calif., on the spot where a group of pioneers, known as the Donner party, was caught by mountain snowstorms in 1846 and compelled to halt for the winter. During the months of cold and privation that preceded the coming of spring, 32 of the party perished. Of those who survived, six are still living. The statue, which commemorates the

*Cast by the Donner Lake  
near Truckee, Calif.*  
Copyrighted material



*Swimmer's  
Henry Eliason*

tragic episode and the heroism of those who shared in it, will stand 16 ft. high on a base 22 ft. high and will cost



Model of Statue to be Erected near Truckee, California, on the Spot Where the Donner Party of Pioneers was Forced to Make Camp for the Winter in 1846. Thirty-Two of the Party Perished from Privation

\$30,000. It represents a pioneer and his wife with a babe in her arms, peer-

ing with great anxiety into the distance. A second child kneels wearily at his father's feet. Base inscriptions will give a brief history of the Donner party.

### MAN SWIMS MANY MILES

#### 5009 TIED TO A CHAIR

Not long ago the attention of spectators on the shore at Bay Ridge, Long Island, was attracted to a man clad in a bathing suit who had been securely shackled with ropes to a chair. Presently he was lifted by his companions and hurled into the water, still tied to the chair. Thus began a spectacular swim from Bay Ridge to the Battery, some five miles distant. In spite of the unusual handicap the swimmer, who was an expert, made steady progress. Much of the time only two chair legs and a rubber bathing cap remained above the water to indicate that the struggle was continuing. Three hours and 20 minutes after he had been hurled into the bay the swimmer reached the Battery and was showered with congratulations by friends who had gathered to witness the remarkable feat.



At the Right: The Start of a Spectacular Swim: Expert Swimmer Bound to a Chair being Hurled into Upper New York Bay. Above: The Shackled Swimmer, Not Drowning but Fighting Hard, Progressing on His Long Course with Only His Cap Visible at the Instant the Picture was Taken



COPYRIGHT, UNDERWOOD & UNDERWOOD





Inflating the Gas Bag at a Filling Station: London Motor Busses Operating between the City and Its Suburbs are Said to Use Illuminating Gas Instead of Gasoline for Fuel

### ILLUMINATING GAS IS FUEL FOR LONDON BUSESSES

4836 According to reports that have lately reached America, the shortage of gasoline and methyl alcohol in Europe and the vital necessity of conserving the available supply for military purposes have brought about the use of illuminating gas as a fuel for motor busses operating between London and some of its suburbs. Bags that resemble small captive balloons are anchored to the tops of the big cars and inflated by pumps at filling stations that have been established along the routes of travel. Certain of these are understood to be merely lamp-posts conveniently situated at the curbs. The plan obviously has necessitated certain mechanical changes in the engines which, at least, involve the carburetors, besides the feeding and compression systems. The amount of power obtained from the lighting gas depends upon a number of things, and a reliable estimate could not be made without more detailed information than is at hand. It is also not altogether clear

why unwieldy bags are being used instead of compact steel cylinders which could carry gas under high pressure. Although, at first thought, it seems that there might be danger of accidental ignition, this is undoubtedly avoided by providing fireproof covers for the bags.

### BROKEN STEEPLE POINT SHOWN IN MID-AIR

4940 A very unusual photograph, showing a wholly detached section of a 205-ft. church spire as it was falling to earth, was obtained recently while the wreckers were demolishing an old church in Columbus, Ohio. When work had begun on razing the edifice it was found that the framework of the upper part of the steeple was composed of 8-in. hewn oak timbers which converged at a point 30 ft. from the top. It was decided to cut off the spire at this point, and after it had been steadied by block and tackle the timbers were sawed through. The upper end was then pulled over with guy ropes hitched to a heavy truck in the

St. Paul's Evangelical  
Lutheran Church  
Columbus, Ohio.  
Copyrighted material



street below. In the fall the big fragment turned a complete somersault



Unusual Photograph Taken at the Instant the Point of This 205-Foot Church Spire was Toppling to the Ground

and landed in the auditorium of the church, which had already been made roofless.

### MOTOR CAR'S LOAD CARRIED BY HORIZONTAL SPRINGS

474 Among the new suspension systems that have been devised for motor cars, there is one which employs the cantilever principle in combination with horizontal coil springs. The purpose is to absorb road shocks by indirect means so that no vertical movement

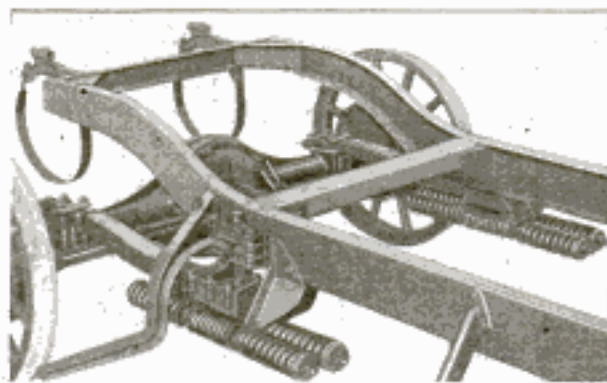

Indirect Suspension is Said to Oblviate the Rebound and Side Sway Produced by Ordinary Springs When Compressed by Road Bumps

will be transmitted to the frame or body of a machine. It is claimed that this is accomplished and that no rebound, recoil, or side sway is caused when the wheels strike ordinary obstructions. Laminated levers are clamped solidly to the axles and connected with the frame through large bearings. This permits free movement at the axle end without vertical shocks being imparted to the chassis. Oscillation of the levers operates coil springs held over horizontal rods carried by brackets suspended from the frame and box clamps of the bearings. Sufficient initial compression is applied to keep the springs under slight tension all of the time.

### 4999 ABYSSINIAN POTASH MINE BEING DEVELOPED

It now seems probable that a rich deposit of potash, said to resemble that at Stassfurt, Germany, which was discovered a few years ago on the boundary between Abyssinia and Eritrea in eastern Africa, will soon be made more accessible to the world. This valuable property is located about 46 miles from the Red Sea, and while a company has been working it more or less extensively since the outbreak of the war in 1914, it has been handicapped by having to send the potash to the coast by camels and thence by boat to near-by seaports where it is transferred to larger vessels.

Owing to the value of potash for munitions, a contract was let some months ago for the construction of a railway from the coast to the mine to facilitate transportation. The grading of this line has been completed and rolling stock has been ordered, but the track has not been laid, according to recent reports. Difficulties have arisen in recent weeks in the matter of steamer transportation and the operation of the mine, but in spite of these delays, it is believed that large shipments from this deposit will soon be made to various countries. There is some thought of establishing direct steamship communication with the United States.



## GAY AUTUMN TOGS FOR OUTDOOR ACTIVITIES



This Smart Street Suit of White Jersey Trimmed with Navy Blue Is the Very Essence of Mode Achieved by Simple Lines and Restraint of Ornamentation.

Good Golf Is Impossible if One is Distracted by Ill-Fitting Garments. This Costume Is Graceful and Light, Yet Warm Enough for Crisp Fall Mornings



*Hand  
v  
Taylor*



For Target Shooting the Skirt and Blouse Presented Above Are Particularly Suitable. One of the Three Pockets Is Removable; the Other Two Are Patch. The Costume was Designed and is Worn by One of the Country's Expert Woman Rifle Shots

The Gardening Frock of This Little Swing Girl Suggests Musical Comedy, a Spot Light, and a Sentimental Song. As a Morning Dress, However, in Pink Chambray Trimmed with Flowered Cretonne It Has a Delectable Freshness Wholly Girlish. The Bonnet to Match, Completes the Picture



Common-Sense Designing Is the Outstanding Feature of the Khaki Walking Garb Illustrated Above. It is Not Intended for the Girl of Mincing Steps, but for the Young Woman of Red Blood and Energy Who Really Knows How to Walk. Rain and Dust, Obviously, can Not Injure the Suit



### PLACE ARMY-DRAFT BOWL NEAR LIBERTY BELL

507 ✓ The army-draft bowl used recently in Washington, together with sample capsules and numbers, and the spoon

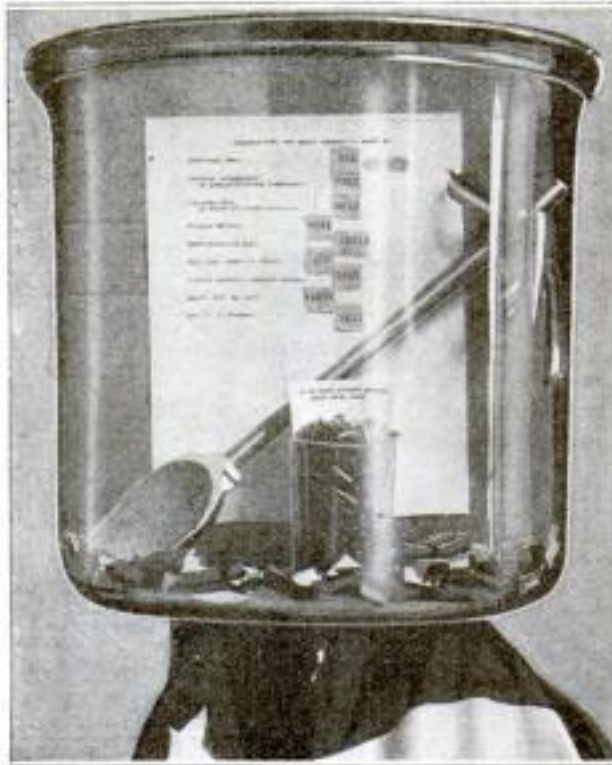

Draft Bowl, Capsules and Numbers, and the Spoon Used in Stirring Them, Which are to be Placed near the Liberty Bell, in Independence Hall

used to stir them, will be placed near the Liberty Bell in Independence Hall, Philadelphia, as a new memorial of America's love of liberty. The bowl contains a tumbler filled with capsules as they appeared before being opened, while about the tumbler are several numbers and opened containers. On a placard is a list of the officials who began the lottery and the numbers they drew.

### CLAIMS TO KNOW SECRET OF HARDENING COPPER

4998 Not content with the claims of other researchers in the deeply interesting subject of how to harden copper, nor discouraged by the many failures of others, an inventor of advanced years maintains that he has rediscovered this lost art and offers as one proof a bal-

ance spring in his watch, which he says is of copper hardened by his process. While the merits of this product cannot be vouched for, it is said that a number of concerns are using the alloy. "Hardened copper is not pure copper," the inventor is quoted as saying, "as it is impossible to temper copper as one tempers steel. My copper alloy, which is physically identical with the best brass of the ancients, will take a keen edge and will hold it under some conditions where steel cannot. Analytical chemistry will not disclose the nature of the constituents that give my hardened copper its peculiar properties. The alloy can be remelted any number of times without parting with any of its distinctive characteristics. In other words, once hardened, copper is always so."

### FIR LOG MAKES RUSTIC TIMEPIECE

501 ✓ A short, partly hollow log, cut from a fir tree 226 years old, has been made into a clock and serves as a novel adornment for the exhibition rooms of a manufacturers' association. One end of the log is used as the dial of the timepiece, the figures being painted on it. The hands are connected with the works by a rod which penetrates the center of the face. The clock has rendered excellent service for a number of years.



Log Cut from a 226-Year-Old Fir Tree Which has been Transformed into a Very Serviceable Timepiece

In:  
Samuel J. ...  
N.Y.C.

Wm. G. ...  
Hall, ...  
Copyrighted material



## ARMY'S SHOE-REPAIR SHOP IN TRUCK AND TRAILER

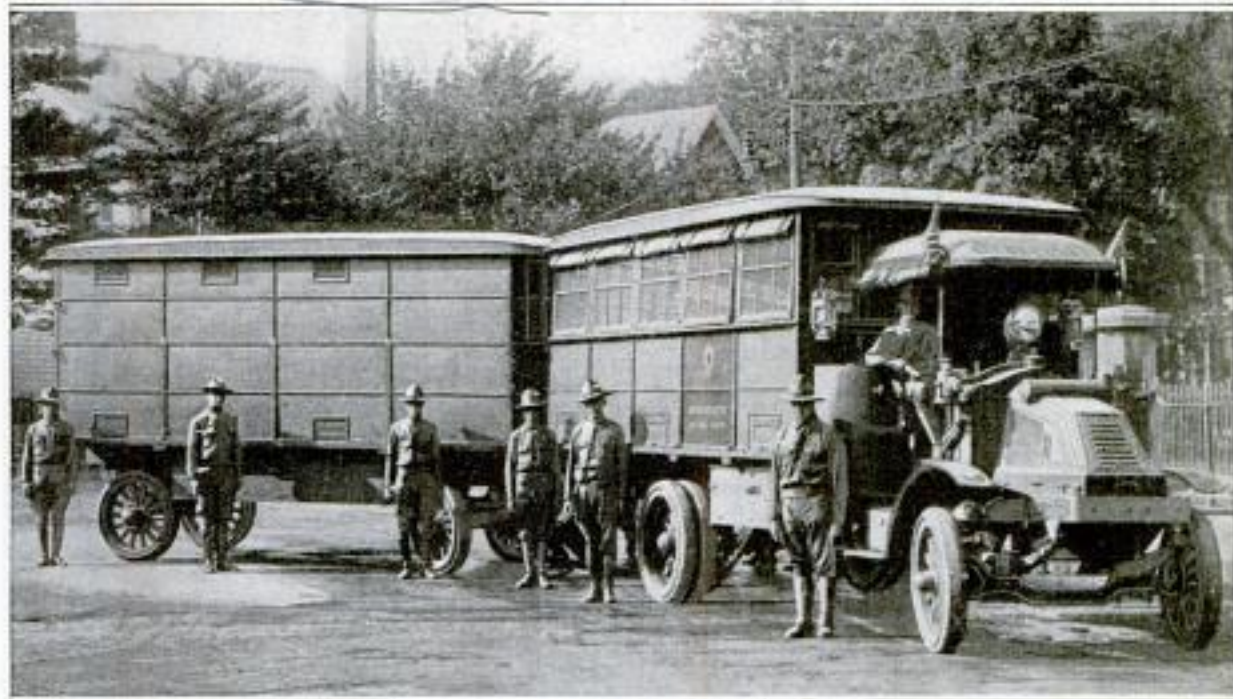

Truck Equipped with Machinery for Repairing Army Shoes and a Trailer Containing Supplies and Bunks for the Crew which is



Interior of the Portable Shoe Shop Showing a Soldier Shoemaker at Work: The Equipment Resembles That Found in the Most Modern Repair Establishments, Every Facility being Provided for Rapid, Efficient Work by the Half-Dozen Skilled Soldiers in Charge

Composed of Six Skilled Workers and the Driver: The Machinery Includes a Lock-Stitch Sewer, a Nailer, and Apparatus for Finishing

5000 A unit which will play an important part in keeping one section of our new army in fighting trim is a shoe-repair department compactly housed in an auto truck and trailer. The former is equipped with machinery, rack, and benches for mending footwear quickly and on a large scale. The equipment includes a lock-stitch machine, a nailer, and apparatus for buffing, scouring, finishing, and patching. The truck is provided with numerous windows which give the workers within plenty of light. In the trailer are leather stores, food supplies, bunks for the crew of six and the driver, and extra machinery. The great advantage of

such an outfit is that it can be ready at almost a moment's notice to move with the army and doubtless shoe repairing could be continued while on the road, if necessary.

### "CAMPAIGN CLOCKS" SPEED UP ARMS PRODUCTION

5015 "Campaign clocks" which have been used with such success in raising funds for various causes are proving equally effective in stimulating the production of firearms in a large Federal armory.

Three huge dials have been erected at points on the factory grounds where the employes can see them. Each bears numbers ranging from 25,000 to

*Plan for...  
Col. ...  
Federal ...*



200,000 and each day a green hand is set to indicate the number of pieces

*Mr. W. Douglas,  
104 N. 2nd St.*  
*Manuel Polak, Minn.*  
**4918** **FOUR-FOOTED FARM TRACTOR**  
**STEPS RIGHT ALONG**

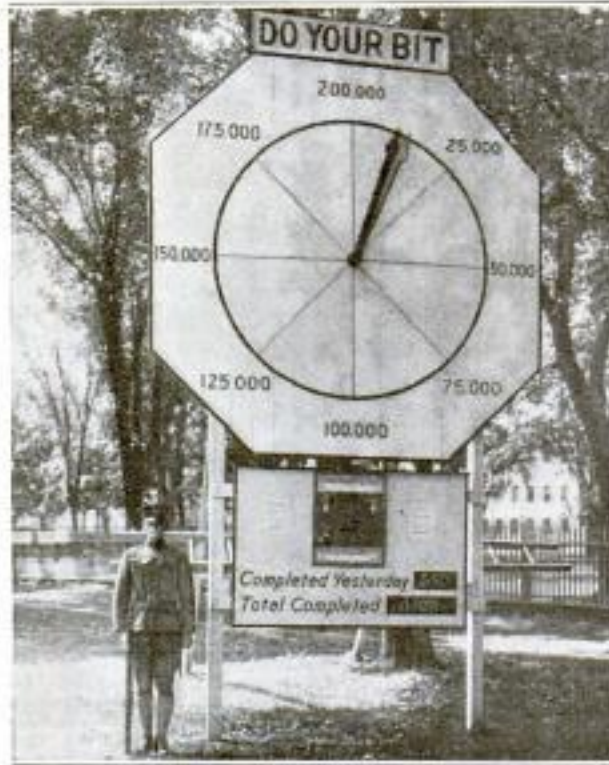

One of Three "Speed-Up" Clocks Erected on the Grounds of a Federal Armory: The Hands are Set Daily to Show the Actual and the Desired Production

produced, while a red hand shows the number which the management planned to turn out. A bulletin below the dial states the daily production and grand total in figures. The clocks have aided materially in speeding up an already busy army of workers.

CA new star was discovered recently in the constellation of Cepheus, near the constellations of Draco and Cassiopeia, by an astronomer at Mt. Wilson observatory.



Not a Comic Cartoon, but a Drawing Showing a Four-Legged Farm Tractor Hitched to a Hayrack, is Presented Above. The Machine, Seriously Designed for Real Work, Is Literally a Motor-Driven Steel Horse

In plowing and cultivating, a well-trained, intelligent team of horses means much to a farmer. Therefore it is not surprising that many agriculturists are slow in accepting the tractor, with its clumsy wheels and grinding motor, for such work. For these reluctant ruralists, however, a new kind of machine has been invented. It is wheelless and comes as near being a four-legged steel horse as anything ever conceived outside the realm of cartoondom. The ingeniousness of the contrivance makes it humorous. It has feet and legs as well as hips, knees, and ankles, and is designed to amble along as steadily as any sorrel team that ever pulled a disk. The chief difference in the arrangement of the pedal extremities of the machine and those of a flesh-and-blood draft animal, is that there are no forward and hind legs. Instead, there are outside and inside ones, as the two pairs are mounted on opposite sides, rather than ends, of a rectangular frame.

The feet of the steel beast are ski-shaped members and attached to the forelegs by universal joints. The steering is accomplished with levers which cause the limbs on one side to take long steps and those on the other to take





Portable Altar for Use in the Army, Made of Oak, Carved and Stained Silver-Gray: The Cross, Vases, Candlesticks, and Book Rest Are of Wood Also

short ones, when a corner, for instance, is negotiated. Reversing is accomplished by shifting the kneecaps from the front to the hind sides of the legs, and speed is regulated by shortening or lengthening the steps, as the case may be. The power is supplied by a gasoline motor installed at the front of the frame. It is pointed out that the "horse" is particularly adapted for cultivating corn, for its height is such that it can straddle a row of six-foot corn without touching the stalks. Only a small fraction of the power consumed by an ordinary wheel tractor is required to propel the walking machine, according to the inventor, and the fuel consumption should therefore be low.

#### HANDSOME PORTABLE ALTAR FOR COAST ARTILLERY

In order that a certain coast-artillery chaplain may be able to conduct religious services in the field according to the ritual of his denomination, he has been presented with a handsome portable altar. Set up, its dimensions are 57 by 33 by 19 in., a size which permits it to be carried with other field



Altar Packed in Its Canvas Case: At Right Is a Field Trunk Having Special Compartments to Hold Altar Furnishings and the Chaplain's Vestments

packages. It is provided with a canvas cover and weighs 95 lb. The material used is oak, stained silver-gray, and carved with ecclesiastical symbols and two crossed cannons, the symbol of the coast artillery. Furnishings, consisting of a cross, a pair of candlesticks, a book rest, and two vases, are made of wood. The vases are metal-lined and are designed to be filled with any available wild flowers. The furnishings, also the communion vessels and the chaplain's vestments, may all be packed in a regulation field-trunk locker provided with special compartments.

#### NEW CYCLOMETER MEASURES FREIGHT CAR'S TRIPS

The question of just how far a freight car travels in a stated period is of such importance to a railroad that a cyclometer has been devised which registers a car's mileage much as an automobile's mileage is recorded. This meter is attached to the framing of the car truck and is provided with a friction wheel which engages the car wheel, so that the exact distance traversed is indicated. The data supplied in this way does away with guesswork entirely.



5013

Designed by: Major Arthur  
P. S. Hyde, Wash. Coast  
Artillery Corps, Seattle, Wash.



Dr: A. DeLamore  
839 H Washington St  
522

# POPULAR MECHANICS

## POWER-DRIVEN TURNTABLE CONTROLLED FROM CAR

4971

Convenient for the motorist is a turntable control system, lately devised, that enables a driver to reverse the position of a car without leaving



The Push Button Hangs within Easy Reach, Enabling the Driver to Start and Stop the Turntable without Leaving the Car

his seat. A push button connected to a heavily insulated cable is held over the middle part of the revolving concrete platform by an arm extending from a pole installed at one side. This starts and stops an electric motor in a pit beneath the turntable. The latter is placed in the driveway immediately in front of the garage entrance or inside the building, as best suits local conditions. In a garage floor it eliminates all backing.

## POPULAR READING COURSE FOR PATRIOTIC MEN

Thirty articles of about 1,000 words each have been prepared by the War Department as a preliminary course of instruction for men who have been selected for service in the national army. While they are designed primarily to prepare the selected soldiers for intensive training, it is expected that they will prove equally interesting to thousands of other readers. With this in view the department has asked all daily papers to publish one article each week day for a period of five weeks following their release. This means will be relied upon for the present in making the articles available for the public. However, at a later date, the government may reprint the material in pamphlet form. The

language of the series will be simple and nontechnical, and the authors have not presupposed any military knowledge on the part of the readers. Among the subjects which will be treated are: "Making Good as a Soldier," "Cleanliness in Camp," "Your Health," "Marching and Care of Feet," "Fighting Arms of the Service," "Army Insignia," "The Army System of Training," "Army Courtesy," and "The Soldier in Battle."



Making Up for the Car Shortage: Train Composed of 50 Logging Cars Util-



### SKINS OF FIVE-YEAR-OLD

4997 SEALS TO BE TESTED

During the coming season the secretary of commerce will permit the killing of a limited number of male five-year-old seals on the Pribilof Islands, Alaska, for the purpose of experimenting with their skins. A few pelts of this character have been dressed and machined and, according to experts, are fully equal to the average skins of younger seals that heretofore have made up the quota for the natives' use. The probable high price for seal pelts and the relatively large number of five-year-old animals on the islands have been considerations which led the secretary to sanction the experiment. In many cases these skins are about twice as large as those of the three-year-old animals.

### CARRY BIG LUMBER LOADS

4970 ON LOGGING CARS

In the serious shortage of railway cars which has existed during recent months the lumber companies, along with other concerns, have utilized every available resource to obtain transportation facilities. A large lumber company in Louisiana found a way out of the difficult situation by taking 50 of its logging cars from its logging roads and making them up into one long lumber train. By this unusual arrangement it was able to transport 1,500,000 ft. of lumber in a single trainload. The effort was so successful that the train has made a number of trips to the North.

### TRAVELING SIGN AN INDEX

4989 TO RED CROSS "DRIVE"

The fact that the streets intersecting Fifth Avenue, New York City, bear numerical names gave an opportunity recently for the use of a novel sign in connection with the Red Cross \$100,000,000 campaign. A barrel, suitably painted and mounted on a low truck served as a base for a circular sign which read: "The Number of This Street Is the Number of the Millions Given to the Red Cross to Date. Help Me Along to 100th



The Position of This Sign in Fifth Avenue Marked the Progress of a Red Cross Campaign: The Number of the Intersecting Street Told the Number of Millions Pledged

Street." The sign was placed in the center of Fifth Avenue and gradually was moved northward and stopped at streets whose numbers corresponded to the number of millions subscribed.



ized by a Louisiana Lumber Company to Carry Lumber to Northern Points

Property of  
Great Southern Lumber Co. Bogalusa La  
Copyrighted material



No. 1. Electric Utility Co. 163 Park Ave. N.Y.C.

**COMPACT ELECTRIC RANGE  
SERVES MANY PURPOSES**

4939

A new combination electric kitchen range is especially suited for use in a



New Combination Electric Range: As Shown in the Center It Is Ready for Broiling. The Oven Stands at the Right

small apartment, kitchenette, or buffet because of its compactness and many uses. It consists of a broiler and a removable oven. The heating grid is permanently placed in the upper section of the broiler, the heat being thrown downward by a removable baffle plate. For boiling, the baffle plate is placed in the slide under the heating unit, while another plate is placed on top which is provided with a lid that can be kept in place or removed as the occasion demands. For baking and roasting, the oven is substituted for the top plate and lid. A three-heat switch controls the current. The oven retains heat well, being double-walled and well insulated.

**MOBILE BAKERY EQUIPMENT DESIGNED FOR ARMY USE**

5046

For the army commissary department there is now a new portable bakery unit. It is one of the latest pieces of

turning out 6,000 loaves of bread an hour. The machinery is carried on a large motor truck so that the outfit has the same mobility as the portable ice-making plants and kitchens commonly in use in the field. The five attendants employed in its operation are able to do as much work as can ordinarily be accomplished by a hundred men. In view of its efficiency, the high cost of the equipment is really justifiable.



General Appearance of the Bread-Making Apparatus, Which Is as Portable as the Ordinary Field-Kitchen Outfit

army equipment, and incidentally one of the most interesting, that has been devised for the benefit of S a m m y. Thousands of loaves of bread have to be produced daily at field ovens to feed the forces at the front. The new apparatus accomplishes most of the work except the actual baking, and in practical demonstrations has proved itself capable of



One of the Machines at Work: With Five Men Attending to Its Operation, It Produces 6,000 Loaves of Bread an Hour

Demarest J. M. ...  
no ...



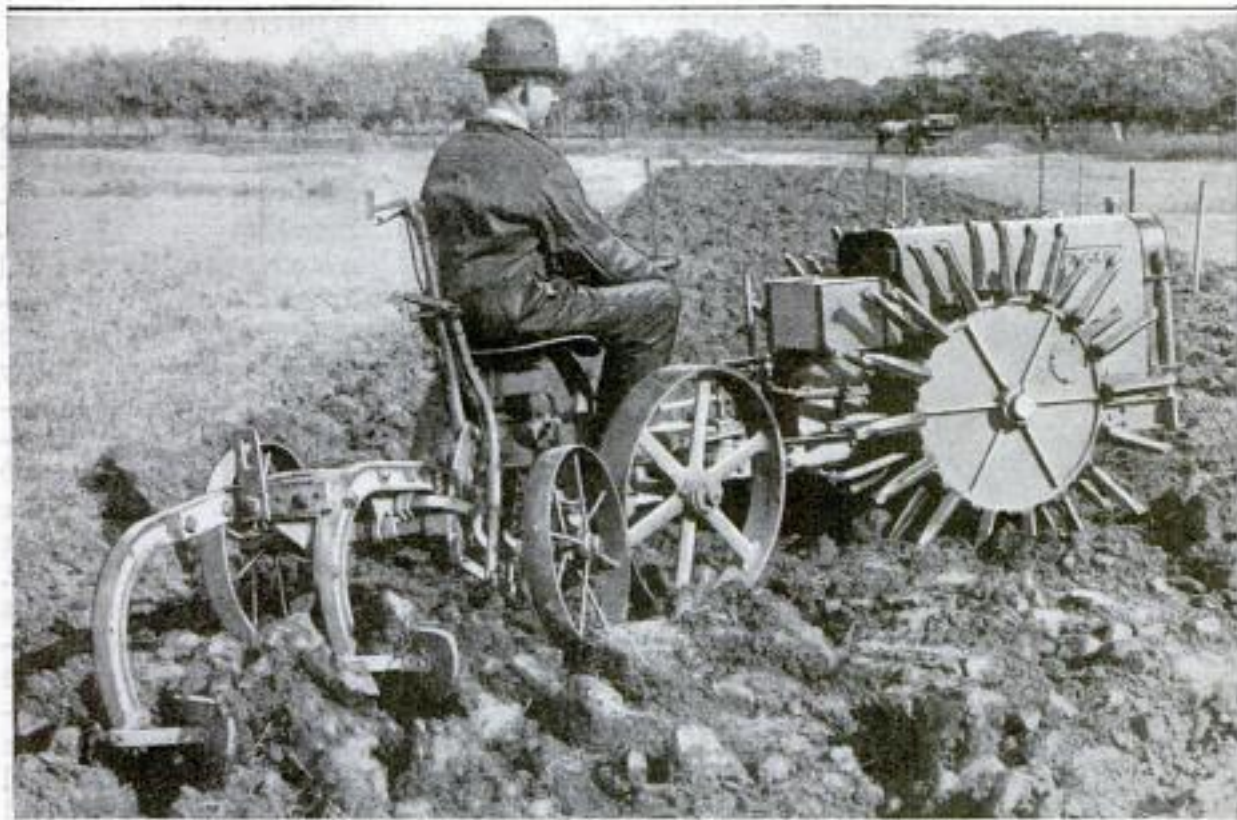

New Type of Farm Tractor Which is Suited to a Variety of Uses Because of Its Small Size, Good Speed, and Low Fuel Consumption: The Wheels with the Radiating Legs Are the Drivers

5008 **SMALL FARM TRACTOR  
TRAVELS ON LEGS**

A small, easily managed farm tractor is now on the market which has as a conspicuous feature two drive wheels that are provided with numerous pairs of radiating legs. These penetrate the dirt as the machine travels over plowed or other soft soil, giving it the desired tractive force. The engine, fuel tank, etc., are situated between the two drivers, while the operator's seat is mounted above two ordinary wheels at the rear. The machine is only 4 ft. high and 3½ ft. wide, and permits a center hitch for a plow or cultivator, so that it is well suited for use between rows of fruit trees with low-hanging branches. It can turn a plow within a radius of 6½ ft., the fuel consumption is 1½ to 1¾ gal. per acre, and the speed is two and one-half miles per hour.

☞The capacity of Great Britain for producing munitions has so increased that munition making in Canada has been stopped by government order.

5011 **POSTER MAKES PATRIOTIC  
APPEAL TO MINERS**

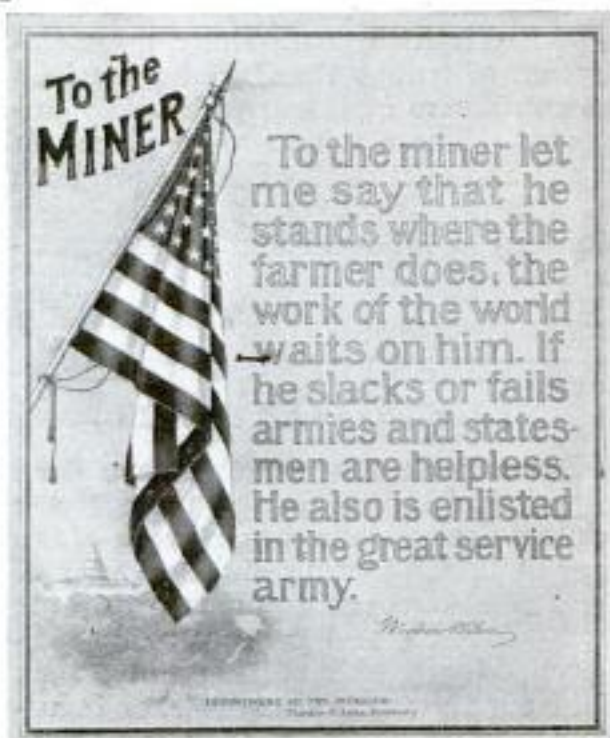

A Poster Which is Painted in Colors and is being Distributed by the Department of the Interior to Mining Districts throughout the Country: It Reproduces a Patriotic Appeal by President Wilson

Dept. of Interior  
Copyrighted material



**4818** **BOOTLEGGERS' TRUNKS SOLD  
TO AID RED CROSS**

Of the many means employed in the recent Red Cross campaigns to raise



Raising Funds by Selling Bootleggers' Equipment: Auctioning Off Trunks Seized as Containers of Illegally Imported Liquor

funds, few equal in novelty the sale held by the police officials of Portland, Ore., who had in their possession a large collection of trunks that had been seized as containers of liquor unlawfully imported. These trunks were placed in a pile and auctioned off in the presence of a large crowd, the proceeds being donated to the local Red Cross organization.

**5003** **WHY SCANDINAVIANS NEED  
COAL DESPITE FORESTS**

Many people have wondered why Scandinavian countries which possess such large forested regions as compared with their total areas should be so seriously affected by the coal shortage caused by the submarine campaign. In these countries coal is selling at 20 times its normal price and yet the demand is greater than the supply. However, a few facts regarding the fuel situation of Norway alone show that the Scandinavian forests would be inadequate as a fuel source, even if the wood could be seasoned and transported. The total output of the Norwegian forests is equivalent to

about 3,450,000 cords, and two-thirds of this is for home consumption. On the other hand, Norway's imports of coal, coke, mineral oils, etc., are equivalent to 3,500,000 tons of coal, or some 4,500,000 cords of wood. It is apparent therefore that if all the normal forest output were devoted to fuel purposes and if no coal were available, the forests would have to be seriously depleted.

**IMMENSE FOREIGN TRADE  
DURING WAR YEARS**

Remarkable new records have been established by the foreign trade of the United States since the outbreak of the war in 1914. During the fiscal year of 1917 the imports amounted to over \$2,600,000,000, and exports to \$6,294,000,000 for merchandizing only, thus showing an excess of exports, or favorable balance of trade, of over \$3,600,000,000 with a total foreign trade of nearly \$9,000,000,000. The exports of the past fiscal year show an increase of

\$1,961,000,000 over the year before and an increase of \$3,929,000,000 over 1914, which was the last normal year before the war. The gain in the balance of trade for 1917 over 1916 amounted to nearly \$1,500,000,000. The gain over 1914 was \$3,164,000,000. These comparisons with the pre-war period indicate what a tremendous shifting of trade has resulted from that great conflict. It is of interest to note that in June of this year the total imports were \$307,000,000 of which 71 per cent was entered free of duty in accordance with present tariff regulations.



Keystone Studios

Miles & Pictorial  
Shulkin

# "AWFUL LION" SAFELY CAGED WHILE "HORRIFYING" ACTORS

4 145



At the Crucial Moment, the Lion Invariably Crawled Out of the "Log" and Spoiled the Picture



The Camera Men were Stationed in This Wire Cage Where They could Work Unmolested



Pulling a Lion by the Tail Is Not so Difficult as It Is Unpleasant. This Shows How It is Done

Interesting as well as amusing is an example of triple-exposure work in the movies that has been called to notice by the production of a film comedy in which a capable-looking lion assumes an important part. In the course of the business a jungle maid and a comedian crawl into opposite ends of a "hollow log," in the middle of which is the lion. That, with exciting embellishments, is the screen version of what occurred. But that is not all that happened.

The lion was driven into the log and compelled to crouch in a certain, carefully marked, space. Only a narrow strip in the middle of the film was exposed when the animal was photographed. An exact record of the number of separate pictures taken was kept. On a certain count he was made to snarl viciously and show his teeth. That constituted the first step. The lion was returned to his cage and the jungle maid put through her rôle, the film being rolled back to the starting point, and all of it—except that part extending from one edge of the exposed

center section to the outer margin—shielded from light. On that strip the girl's action was recorded. After a prescribed number of pictures were made, to show her end of the scene, she entered the log and started to crawl toward the center. At the proper instant—this being determined by count—she became "terrified" by the sight and snarl of the lion and was momentarily unable to retreat. Then at a signal from the director, she appealed to the comedian, supposed to be in the opposite end of the log, to pull the beast out by its tail. Subsequently, the film was again run back and the third exposure—this showing the comedian's action on the opposite edge of the film—made.

What is pronounced a new world's record for uninterruptedly looping the loop in an aeroplane with a passenger was established recently by Edward Stinson when, accompanied by a woman passenger, he executed 34 consecutive loops without a break.

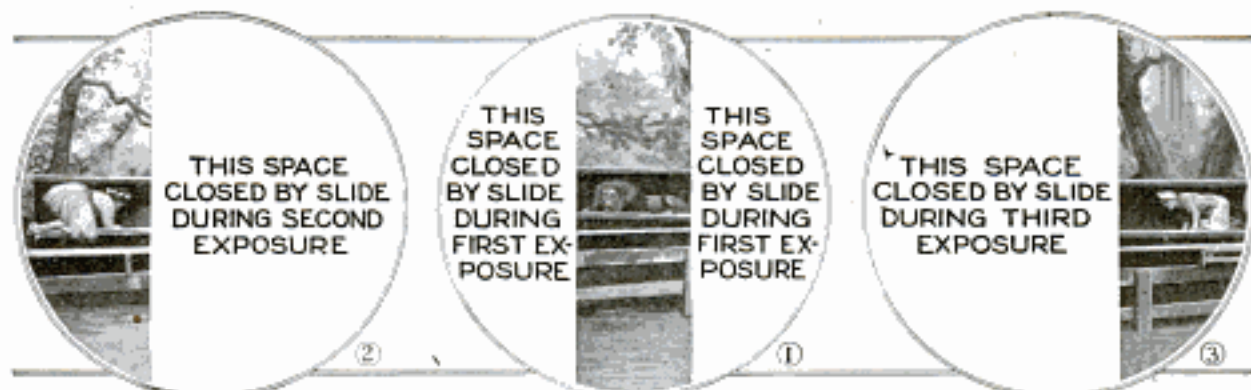

Above is Explained How the Triple Exposure was Made. Several Failures Resulted Before the Scene was Successfully Filmed, for the Lion Was Not Always Prompt in Obeying the Director



## INTERESTING SIDE LIGHTS ON WORLD-WIDE WAR

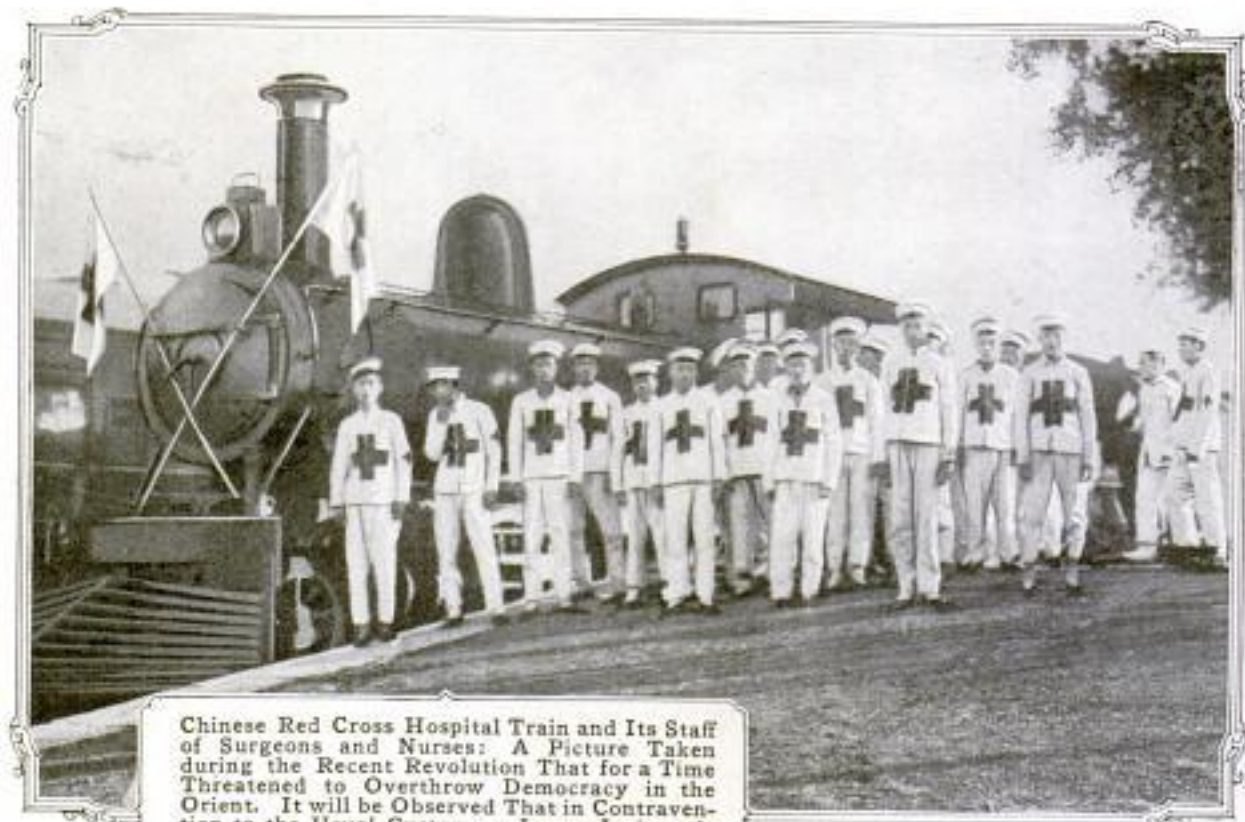

Chinese Red Cross Hospital Train and Its Staff of Surgeons and Nurses: A Picture Taken during the Recent Revolution That for a Time Threatened to Overthrow Democracy in the Orient. It will be Observed That in Contravention to the Usual Custom, a Large Insigne is Sewed across the Front of the Jackets Worn by the Men. This is to Give the Workers Greater Protection Than They Otherwise Might Have



Here Are Some of Russia's Women Patriots, Members of the "Legion of Death." Many of These Amazons Are College Girls and Are Members of Some of the Country's Prominent Families. Their Heroism has Demonstrated Their Right to Carry the Standard of Liberty and Democracy Wherever Gallant Fighting is to be Done. During Recent Engagements with the Boche They Proved to Be a Surprisingly Formidable Foe. Hundreds of Stanch-Hearted Girls Are Now in the Service



## AT THE FRONT IN FRANCE WITH THE POILUS



Railway Construction in the War Zone has been Reduced to a Fine Art, as is Indicated by the Photograph Presented at the Top of the Page. It will be Observed That Rail Locks are Employed Instead of Spikes, and That Track is Laid Almost as Rapidly as the Ties can be Distributed and Alined. The Supply Train Follows the Workmen as the Rails are Projected. The Picture was Taken in the Aisne District



FRENCH OFFICIAL WAR PHOTO

Resembling, Perhaps, the Famous Night Riders of the Ku-Klux Klan, the French Gunners Shown Herewith are Wearing Respirators and Hooded Coats That are Apparently Employed for Additional Protection against Noxious Gases. The Rifle is One of the Famous "75s"



In the Wheat Fields of the Somme Sector, French Artillerymen Pay Their Respects to the Boche at Long Range. The Gun is One of the Long 6.5-Inch Pieces and is Mounted on an Armored Railway Car. Many of These Mobile Units are in Operation, and for Certain Kinds of Work have Proved Themselves to be Extremely Effective

FRENCH OFFICIAL WAR PHOTO



## SOME WAR-TIME DEVICES OF ODD CHARACTER



Contrary to First Impression, the Headgear of the Sammy Pictured Above Is Not That of a Chinese Woman of Rank. It Is a New Type of Helmet and Face Shield That is being Subjected to Tests by the War Department. The Rest of the Outfit Is Semiflexible Armor Made of Thin Steel Plates



Motor Ambulances Are Useless in the Desert, so the Camel Is the Official Stretcher Bearer. This Shows One of the Beasts Equipped with a Double Stretcher Fitted with Frames That Prevent Wounded Men from Falling from Their Elevated Berths



The Sign Marks the Position of an Unexploded Projectile Fired on the Macedonian Front and Warns Tommy Not to Disturb It. Such Shells are Eventually Collected by Salvaging Crews

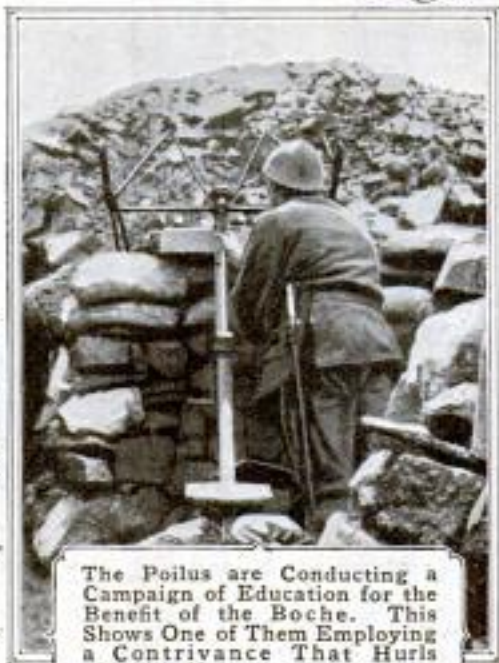

The Poilus are Conducting a Campaign of Education for the Benefit of the Boche. This Shows One of Them Employing a Contrivance That Hurls French Newspapers into the German Trenches



War Is Doubtless the Greatest Stimulus for Invention, Since "Necessity" Continually Presents Itself. The Photograph Reproduced Herewith Shows a Pack Donkey Carrying a Reel of Wire for French Soldiers Who are Laying Communication Lines on the Front in Macedonia. In Passing, It Is Interesting to Note That the French, Who are Using Many American Mules, are Reputed to have Made a Great Improvement in the Beasts. By Performing a Simple Surgical Operation, It is Said They have Eliminated the "Hee-Haw"



## USED BY SAMMIES AND BROTHERS-IN-ARMS



Tomato Cans with Perforated Bottoms Make Excellent Outdoor Shower Baths When Suspended in Midair and Fed by a Pipe as is Shown Above. The Picture Gives a Rather Intimate Glimpse of Some of the Enlisted Personnel of the New York National Guard at a Training Camp. After Vigorous Work in the Full Glare of the Blazing Sun, the Comfort of a Cool Shower, Even from Improvised Apparatus Like This, Requires No Imagination



This Is One of the Most Modern Portable Kitchen Units That has been Constructed for Army Purposes. It was Presented to the Engineering Corps of the New York National Guard by a Good Fellow and is Now in Regular Use. In Addition to a Range and Steam-Cooking Equipment, It Possesses a Fair-Sized Oven, a Storage Compartment in Which Supplies are Carried, and a Refrigerator for Perishable Foods. The Outfit Cost Approximately \$7,000



## IN FRANCE WITH MAJOR GENERAL PERSHING

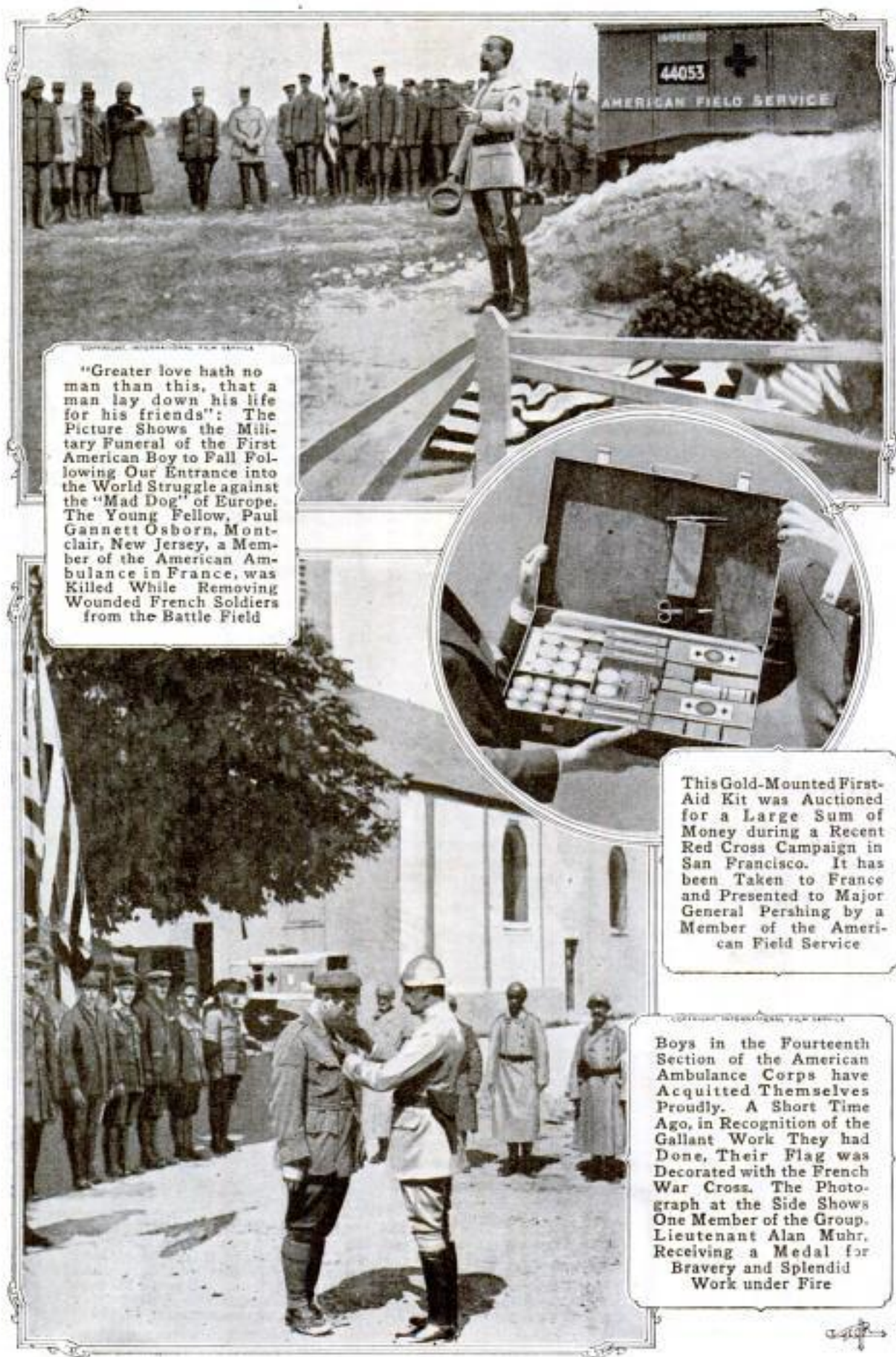

"Greater love hath no man than this, that a man lay down his life for his friends": The Picture Shows the Military Funeral of the First American Boy to Fall Following Our Entrance into the World Struggle against the "Mad Dog" of Europe. The Young Fellow, Paul Gannett Osborn, Montclair, New Jersey, a Member of the American Ambulance in France, was Killed While Removing Wounded French Soldiers from the Battle Field

This Gold-Mounted First-Aid Kit was Auctioned for a Large Sum of Money during a Recent Red Cross Campaign in San Francisco. It has been Taken to France and Presented to Major General Pershing by a Member of the American Field Service

Boys in the Fourteenth Section of the American Ambulance Corps have Acquitted Themselves Proudly. A Short Time Ago, in Recognition of the Gallant Work They had Done, Their Flag was Decorated with the French War Cross. The Photograph at the Side Shows One Member of the Group, Lieutenant Alan Muhr, Receiving a Medal for Bravery and Splendid Work under Fire



## AND MEMBERS OF THE AMERICAN AMBULANCE

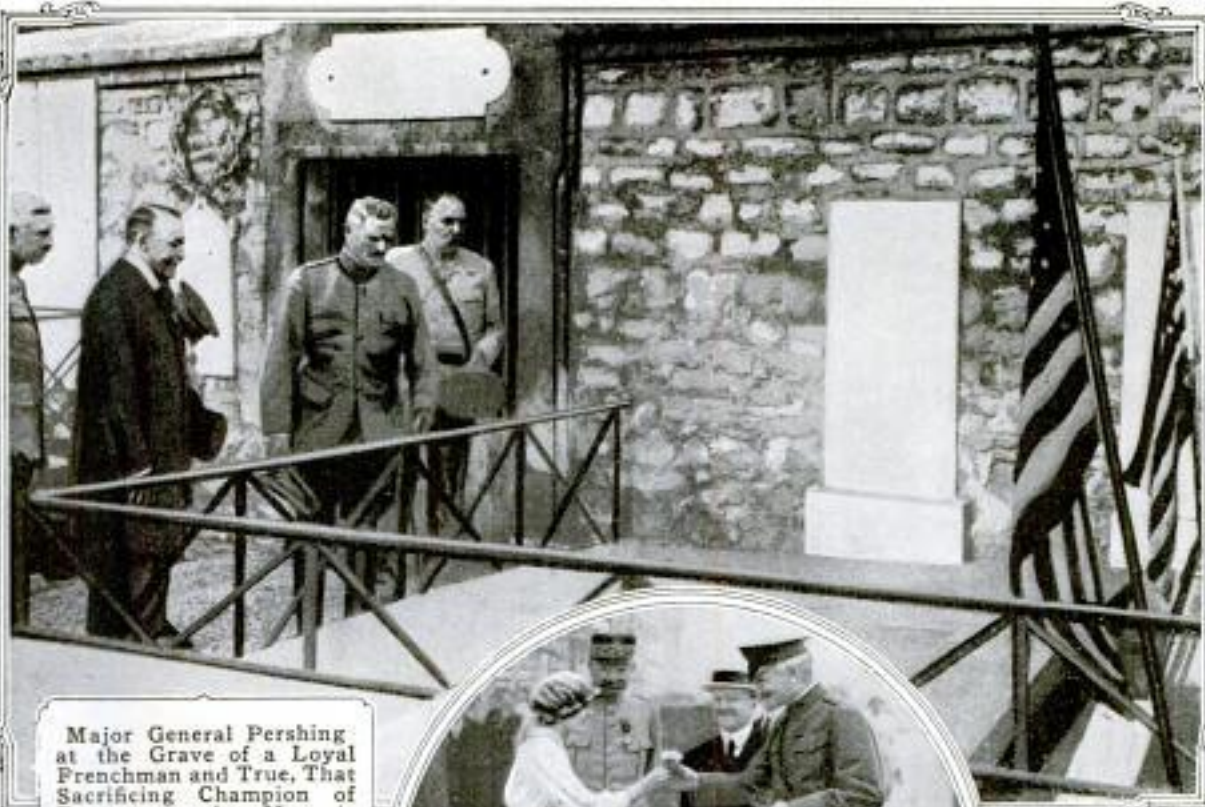

Major General Pershing at the Grave of a Loyal Frenchman and True, That Sacrificing Champion of Democracy, the Marquis de Lafayette, a Patriot Whose Memory is Cherished and Revered by All Americans: The Spirit That Animated Lafayette in Revolutionary Days Now Stirs the Blood of the Commander of Our Expeditionary Forces in France



There Is a World of Sentiment in a Fresh White Rose. One is Presented to the "Big Chief" of the Sammies by a Wisp of a French Maid, a Hard Little Worker, These War Days, in a Large Munition Plant

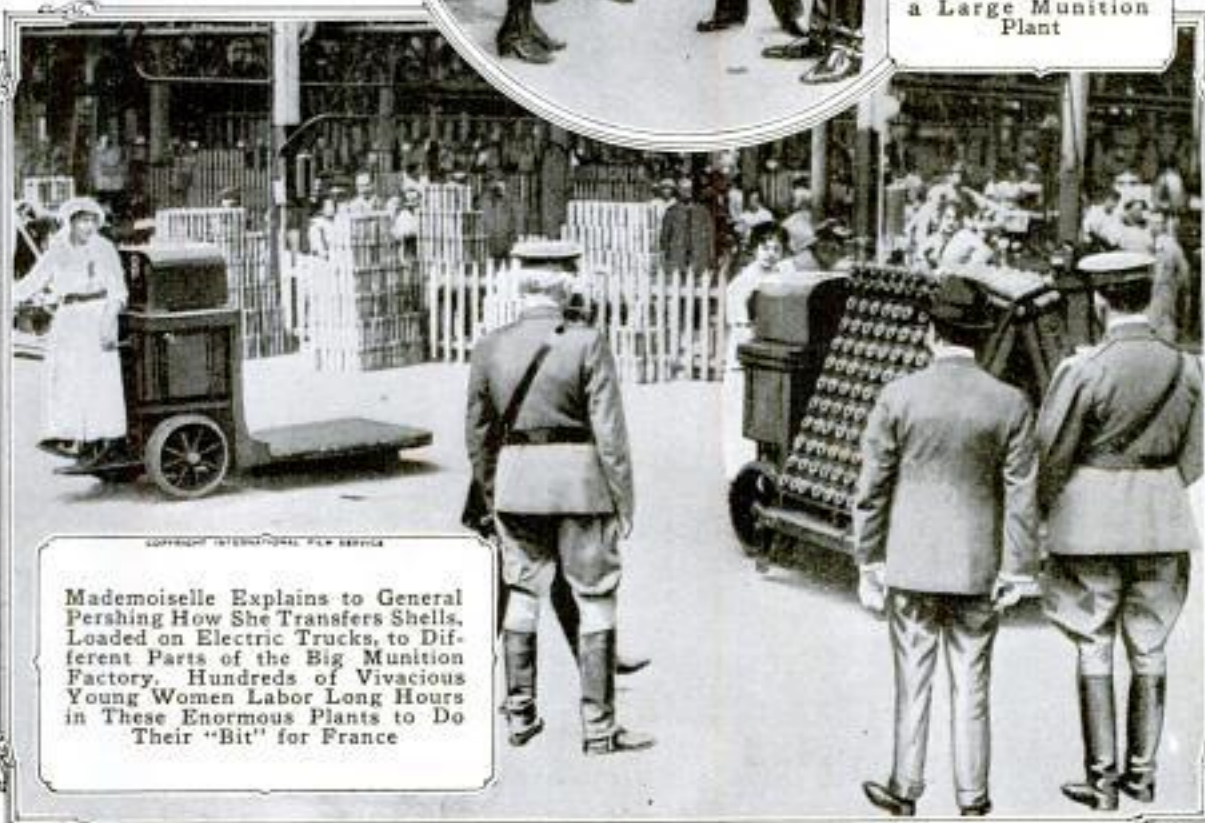

Mademoiselle Explains to General Pershing How She Transfers Shells, Loaded on Electric Trucks, to Different Parts of the Big Munition Factory. Hundreds of Vivacious Young Women Labor Long Hours in These Enormous Plants to Do Their "Bit" for France



## BRITISHERS AFTER BATTLE AND AS OUR GUESTS



Reproduced Above Is a Photograph That Is Interesting Not for Its Artistic or News Value, but Because It Gives a Clear Portrayal of the Varied Impulses That Seize Soldiers Immediately Following a Desperate Battle. These Men have Just Passed through the Dread "Valley" and Left Many of Their Comrades on the Field. It will be Observed That Some of Them have Dropped to the Ground Exhausted, That Others are Bathing Themselves as Best They Can, and That Still Others are Trying to Cleanse Their Garments of Blood and Trench Filth



The "Kilties" have been Here to Assist in the British-Canadian Recruiting Campaign. When They Marched in Michigan Avenue at Chicago, the Police Were Unable to Hold Back the Crowds of Men and Women Who Surged Out on the Pavement to Cheer Them. At New York and Boston They were Given Rousing Welcomes That They Well Deserved for They Are Heroes of Vimy Ridge. The Picture Presented Herewith was Taken When Mayor Mitchel was Serenaded by Highland Pipers Who Gathered in Front of Gotham's City Hall



## LEGIONS OF RUSSIA AND FRANCE IN REVIEW



M. Kerensky (Standing in the Motor Car), Virtually the Dictator of Russia, Heralded as the George Washington of the Hour, Reviewing the Troops at the Front and Rousing Them to a Patriotic Pitch That Caused Them to Reface the Boche and Make the Remarkable Drive That Recently Stirred the Whole World and Kindled New Hope for the Nation's Future



The Forty-Second Division of the French Army Passing in Review Back of the Firing Zone in the Region of the Aisne Early in July: The Occasion Was One of Great Ceremony and Pomp in Which the Whole of the Army Participated

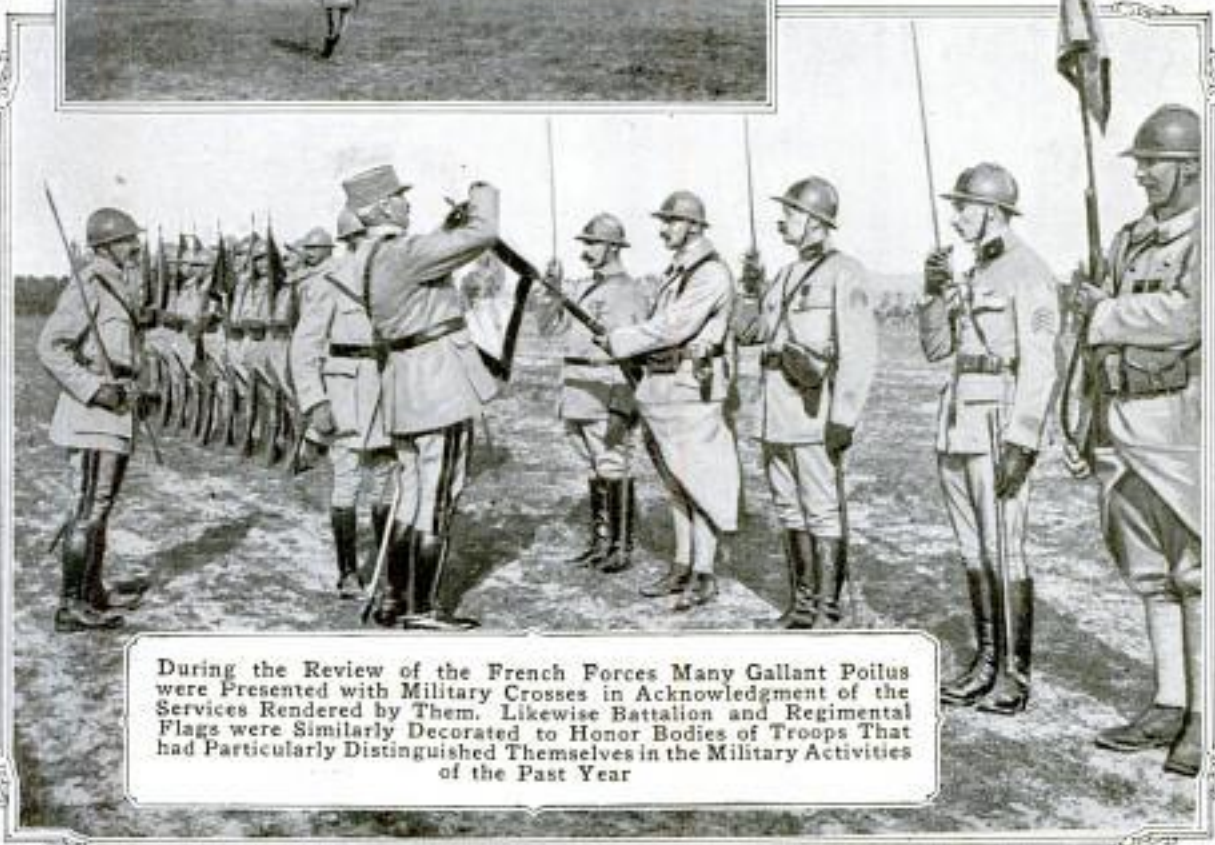

During the Review of the French Forces Many Gallant Poilus were Presented with Military Crosses in Acknowledgment of the Services Rendered by Them. Likewise Battalion and Regimental Flags were Similarly Decorated to Honor Bodies of Troops That had Particularly Distinguished Themselves in the Military Activities of the Past Year



## CONTRASTING VIEWS OF GERMAN EFFICIENCY

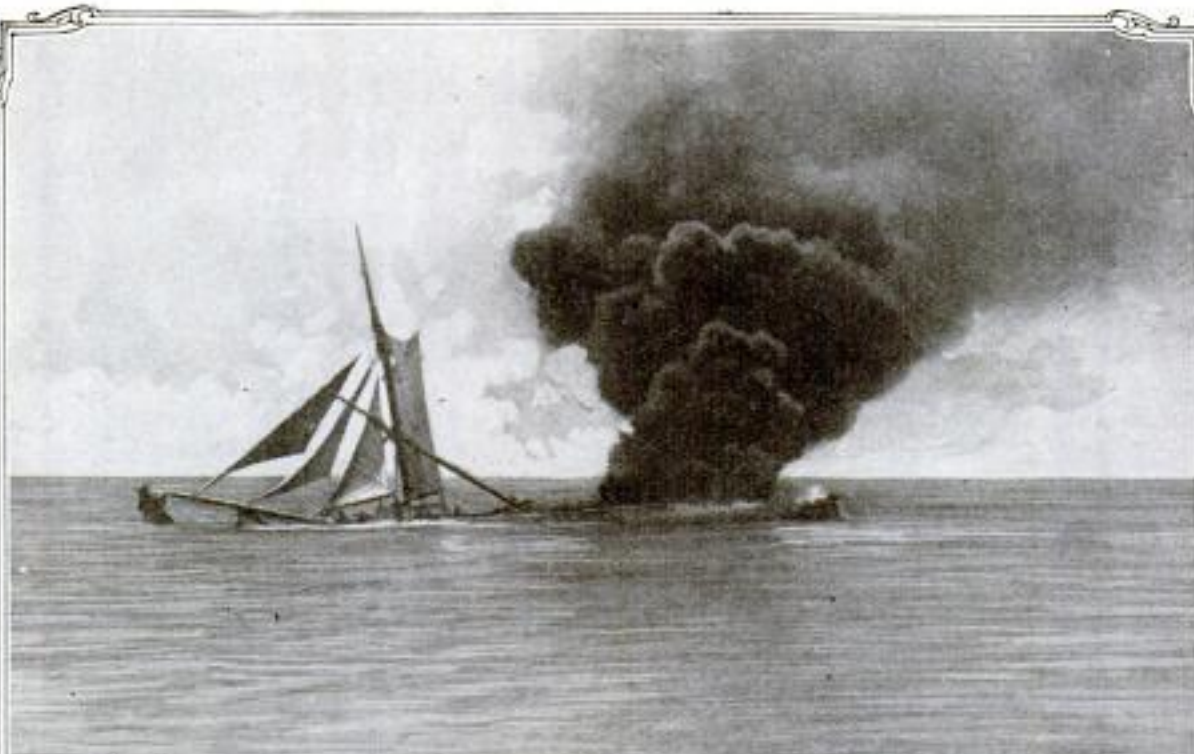

It can Hardly be Assumed That the Commander of the German Submarine That Sank This Sailing Vessel would Waste Time to Say to the Victims, "The patrol will pick you up." Singularly, However, the Torpedoing of the Little Ship was Looked upon as an Important Victory for Prussianism by the Editors of the Berliner Illustrierte Zeitung, Who Used This Picture as Evidence of the Success of the Kaiser's Unrestricted U-Boat Campaign against the Merchant Ships of the Whole World, Including Those of the Neutral Nations That have been Feeding Germany



German Prisoners of War Engaged in the Reconstruction of Buildings Previously Damaged and Destroyed by Them and Their Comrades during the Bombardment of a French Town; It Is Pitiful That the Major Injuries Worked by the Kaiser's Forces Are Irreparable. The Wrongs Committed can Never be Righted, but, in a Measure, They may Eventually be Compensated by Crushing Military Despotism so That Future Generations may be Safe from Its Yoke. This, at Least, Is the Avowed Purpose of the Civilized Nations Involved in the Conflict



## SWIFT GERMAN PLANES SWARM OVER LONDON



One of the Small Victims of Germany's Mid-summer Aerial Attack upon London: It was Officially Reported That 40 Persons were Killed and 194 Injured. Of the Latter Number, 52 Were Children. Such Pictures Form an Index of Prussianism and Give Warning of the Dangers of Premature Peace



The Flying Huns Approach London in Orderly Formation at a Height of 7,000 Feet. This is One of the Most Remarkable Aerial Photographs Ever Made. It Shows More Than 30 Bombing and Battle Planes, Most of Them Dual-Motored Gothas, on a Diabolical Mission



Women Ambulance Drivers Racing to Their Posts in Response to a General Alarm Sounded amid the Thundering of Prussian Bombs: The Aeroplanes Appeared over the Metropolitan Area Shortly after 10 O'Clock on Saturday Morning, July 7. About 100 Bombs, Each Weighing 60 Pounds, were Dropped. Distress Calls were Answered by Nerve Women, Such as These, and Red Cross Nurses. Two Outstanding Effects of the Raid were Loud Demands for Reprisals and More Adequate Aerial Defenses. Since, Additional Assaults have been Made



## WAR'S EFFECT UPON WOMEN AND CHILDREN



Germany's Treatment of French and Belgian Women in Occupied Territory has Astounded the Whole Civilized World. While the Picture Above does Not Deal with Any of the Abhorrent Phases of Teutonic Mastery, It Nevertheless Shows the Boorishness of Prussianism Which Puts into Practice Some of Nietzsche's Warped Philosophy. The Picture, Found in the Possession of a Captured German Officer, Shows Women of a French Town—Not Peasants Who are Used to Hard Labor—being Herded into the Fields by One of the Kaiser's Puppets

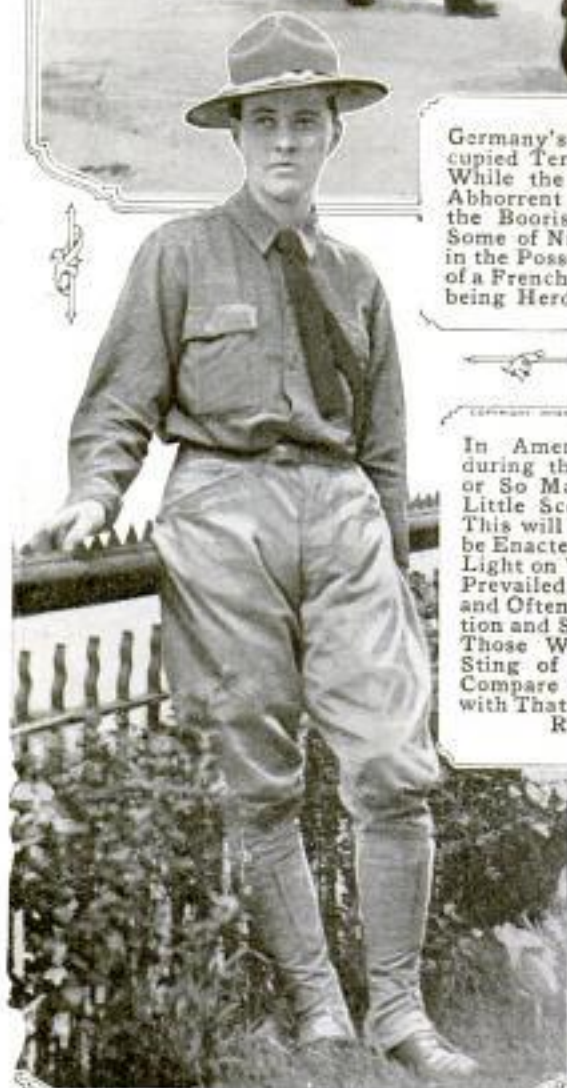

In American Homes during the Next Year or So Many Touching Little Scenes Such as This will Undoubtedly be Enacted. It is a Side Light on War That has Prevailed for Centuries and Often Brings Privation and Suffering. But Those Who Feel the Sting of War Should Compare This Picture with That Above; Then Reflect



Inspired by the Same Motives That Caused the Famous Madame Jean Velasquez to Begin Her Romantic Career as a Soldier a Half Century Ago, This Arizona Bride Tried to Accompany her Husband to the Trenches of France. She Crossed the Atlantic with the Sammler, but was Discovered and Sent Home



## HERE AND IN COUNTRIES OF OUR ALLIES



Fleeing German "Kultur" in Macedonia: The Photograph, Taken after the Teutons had Executed One of Their Aerial Bomb-Dropping Escapades, Shows Women and Children Deserting Their Burning Village and Seeking Safety in the Open. Regardless of Where He is Operating, Whether in the Air, on Land, or under the Sea, the German Has No Respect for Defenseless Noncombatants. Even though They Be Women and Children of an Ancient Province



Young Russia Is Not Unmindful of the Significance of the Great Social Upheaval That has Converted Its Dark Empire into the World's Youngest Republic. Children have Taken a Conspicuous Part in Many of the Recent Public Demonstrations. Not Long Ago Hundreds of Them Paraded the Streets of Petrograd Carrying Banners Bearing the Legend: "Long Live Education for the People." With Freedom and Schooling, These Youngsters will Exert a Profound Influence upon Russia's Future



## AMERICA FORGETS THE "YARROWDALE" CASE



INTERNATIONAL TOUR SERVICE

Interned Sailors of the "Kronprinz Wilhelm" Lined Up to be Counted before Beginning Work. The Men are Employed in Erecting Quarters near Fort McPherson, Georgia, Which will Shelter 2,500 Germans



This Hotel at Hot Springs, North Carolina, was Leased by the Government Early Last June and has Since been Occupied by Interned Officers of German Merchantmen and Commerce Raiders. As the Photograph Indicates, the Men Have Far from Unpleasant Surroundings



Wash Day at the Hot Springs Camp: German Officers Laundering Their Linens. Practically All of the Labor Required in Maintaining the Place is Supplied by the Men, Who Receive \$20 a Month for Their Services, Providing They Care to Work

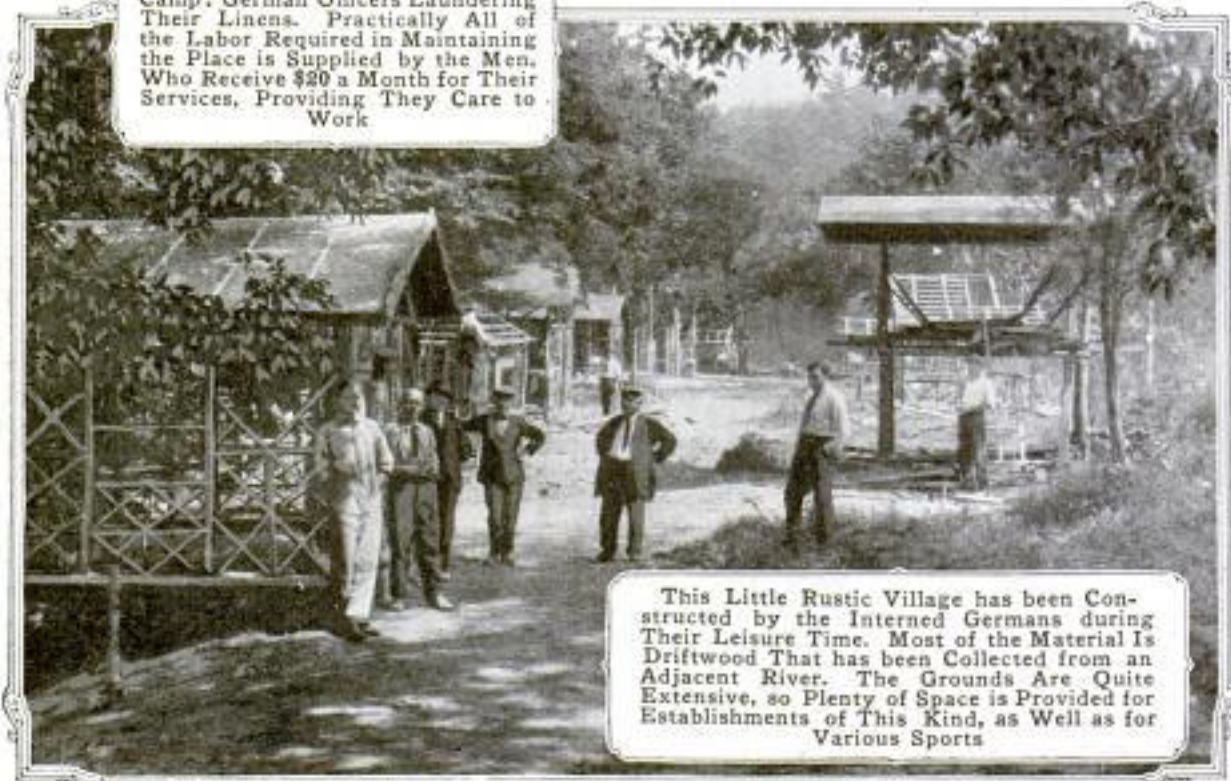

This Little Rustic Village has been Constructed by the Interned Germans during Their Leisure Time. Most of the Material Is Driftwood That has been Collected from an Adjacent River. The Grounds Are Quite Extensive, so Plenty of Space is Provided for Establishments of This Kind, as Well as for Various Sports



## IN CARING FOR INTERNED GERMAN SEAMEN



The Frame Houses Visible within the Stockade Above Sheltered the Officers of the "Cormoran" during Their Stay on the Island. After Several Weeks They were Brought to the United States and are Now Held at One of the Concentration Camps. The Elevated Platforms Shown in the Picture were Used by Sentries



Group of German Prisoners of War being Questioned by an Officer: These Young Fellows, Most of Them Mere Boys, Belong to the Class of 1918 and were Captured by the French during an Advance in the Oise District

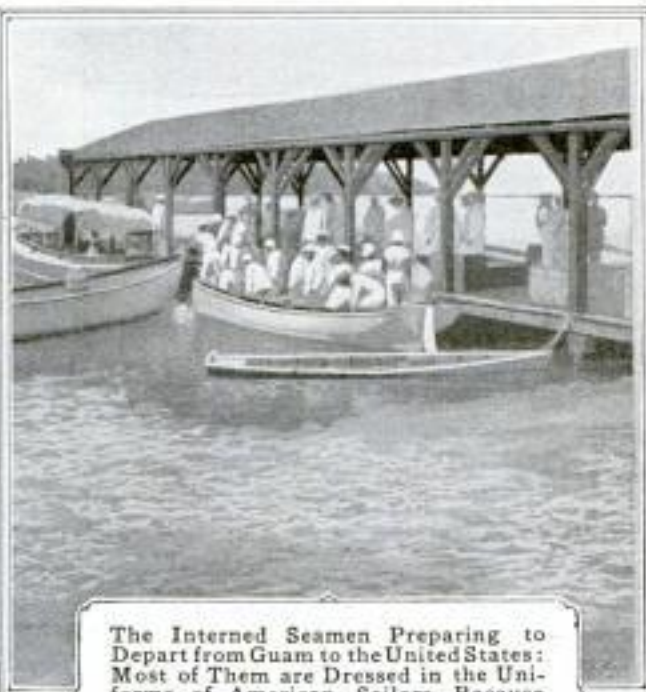

The Interned Seamen Preparing to Depart from Guam to the United States: Most of Them are Dressed in the Uniforms of American Sailors Because They Left Their Own Clothing Behind When They Took to the Water from Their Sinking Ship



The Tent Camp and Stockade for Enlisted Personnel of the German Ship "Cormoran," Which was Interned at Guam Previous to Our War Proclamation: Upon America's Entrance into the World Struggle, the Vessel was Destroyed in the Harbor by Its Crew. The Men were Forced to Leap Overboard and Swim Until Picked Up. The Camp Pictured Herewith was Then Prepared for Them



## GERMAN PLACARDS EVIDENCE OF NOYON'S OPPRESSION

Since the Germanic hordes smashed their way through Belgium into north-

dragged into slavery, children outraged, food commandeered, property seized or ruthlessly destroyed, and countless other diabolical crimes perpetrated in the name of "military necessity." When the French town of Noyon was evacuated by Von Hindenburg's forces last spring, thousands of official notices were left behind. These placards furnish documentary evidence of how the people in that particular community were oppressed by the iron rule of the mailed fist. Many of the posted announcements bear rules that any army under similar circumstances would have perfect right to impose. Others, however, show the bigotry and boorishness of German character and the tyrannical injustice of German military rule. Staggering fines, long terms of imprisonment, and capital punishment were imposed for trifling offenses. During the winter months the inhabitants were compelled to remain indoors after five o'clock in the evening. Permits had to be obtained and fees of 25 and 50 cents paid before one could make a trip by carriage or train. To damage telegraph or electric-light lines in any way was to incur death.

One poster has an amusing turn to it, for it gives a glimpse of the Prussian love of "lording it." The announcement calls attention to the fact that all masculine inhabitants 12 or more years of age are required to doff their hats upon meeting a German officer or functionary with the rank of officer. It further states that many young men have neglected to observe the rule, or have obeyed it in a derisive way. In consequence, warning is given that strict conformance to the order is demanded.

## CLAIMS FISH HARVESTER TO HAVE BIG CAPACITY

By constructing and operating an enormous harvester in accordance with plans developed by him, an inventor contends that the fish industry could be put on a more profitable basis than it now enjoys. He even goes so far as to estimate that the machine would capture and deliver to the deck of its

### Ordre public.

Selon l'ordre supérieur du commandement (suprême de l'armée, les noms des personnages qui répondront sur leur vie de la sûreté des chemins de fer sur le territoire de Noyon sont publiés comme suit:

- M. Félix, Maire
- „ Jouve, Adjoint au Maire
- „ Cozette, Docteur Vétérinaire
- „ Brière, Banquier
- „ Nancel, Négociant.

Noyon, le 8 octobre 1915.

Le commandant de la place.

The Above Notice Informs the Inhabitants in French That the Mayor, His Assistant, a Doctor, a Banker, and a Merchant are Regarded as Hostages and are Held Responsible for the Safety of the Railways in the Vicinity of Noyon. In Other Words, These Men would be Punished with Death should a Bridge be Dynamited, or Other Injury Committed

ern France, the world has learned something of what military rule by an autocratic government means in occupied territory. Men and women have been

**Toutes les lampes à pétrole avec mèche et cylindre seront réquisitionnées. Il faut les déposer sous 3 jours à la Commandanture, où un bon sera délivré.**

Les lampes trouvées après ce temps seront réquisitionnées sans bon et les propriétaires punis d'amende jusqu'à 100 M. ou de prison jusqu'à 2 semaines.

Noyon, le 18 janvier 1917.

Le commandant de place.

This Placard Announces That All Inhabitants Who Possess Kerosene Lamps with Wicks and Cylinders must Deliver Them to the Commander of Noyon within Three Days. Otherwise They will be Subject to a Fine of 100 Marks or Two Weeks' Imprisonment

4901  
Inventor: M. J. ...

... ..



1 - Asbury Park  
" Boardwalk - N. J.

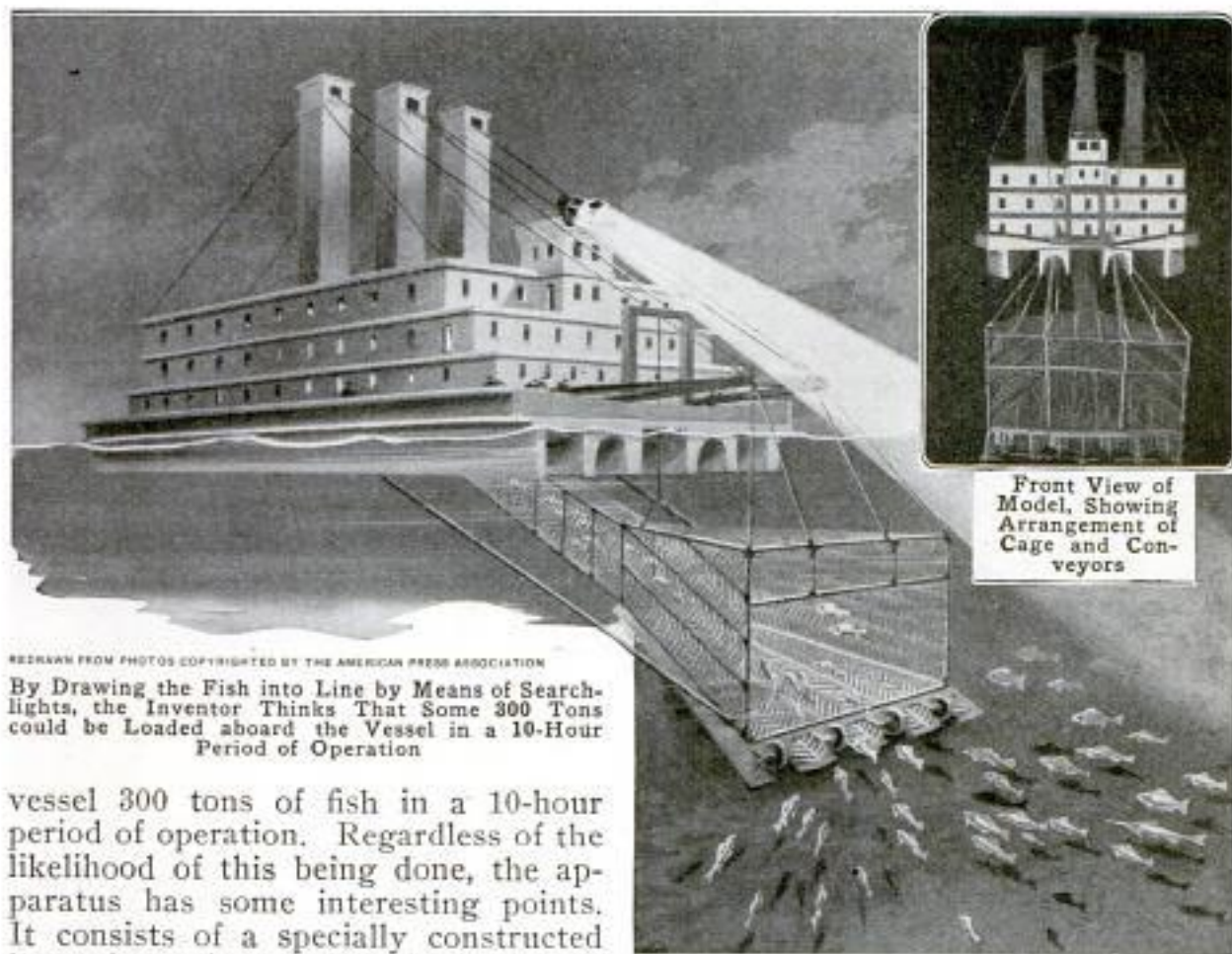

REERMAN FROM PHOTOS COPYRIGHTED BY THE AMERICAN PRESS ASSOCIATION  
By Drawing the Fish into Line by Means of Searchlights, the Inventor Thinks That Some 300 Tons could be Loaded aboard the Vessel in a 10-Hour Period of Operation

vessel 300 tons of fish in a 10-hour period of operation. Regardless of the likelihood of this being done, the apparatus has some interesting points. It consists of a specially constructed boat of odd lines, equipped at its prow with a large adjustable steel trap which ensnares the fish and leads them to a conveyor. The harvester would be used at night and its work aided by searchlights. The projectors would illuminate a triangular area extending far in advance of the craft, which is designed to travel at a speed of about

10 miles an hour. The fish, the inventor points out, attracted by the light, would congregate in large numbers in the direct path of the boat. Lack of illumination immediately in front of the trap would momentarily confuse them and cause them to be guided by the walls to the rapidly moving conveyor.

### PLANKS OF CONCRETE USED 4926 IN SEASHORE WALK

When a board walk at an ocean port was repaired recently, some 20 feet of it was laid with concrete "planks," as an experiment. They are reinforced with steel rods and are about the same size as ordinary planks. It has been found that they withstand wear well, but are disliked because pedestrians feel that they are tiring to walk on.

¶The Y. W. C. A. will spend \$100,000 in building shelters near camps where soldiers can meet women relatives and friends.



Board Walk at an Ocean Resort Which has been Repaired in Part with Planks of Concrete: These have been Found Very Durable but Less Pleasing to Walk On Than Wood



## SHIP LIVE "MOCK" TURTLES WITHOUT CRATE

Unusual simplicity characterizes the express companies' requirements for shipping large live turtles, much used

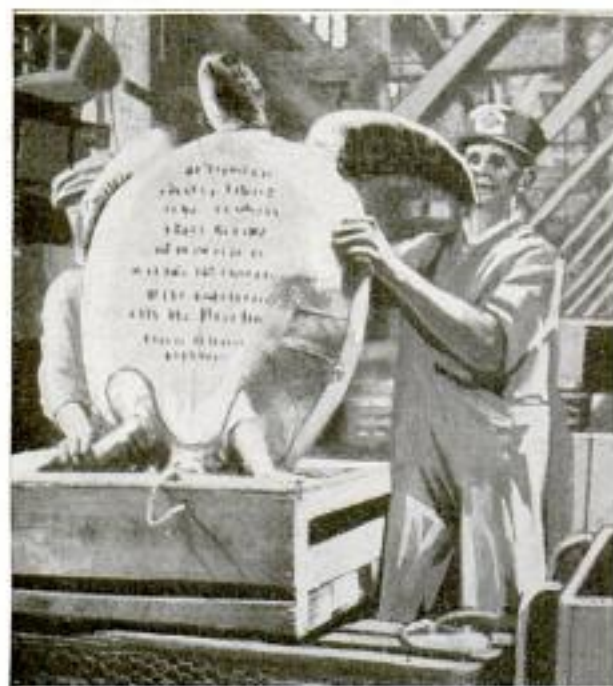

A Live Turtle Which Needs No Crate for Shipment by Express: Full Directions, Including the Words "Perishable! Rush!" are Stenciled on the Under Shell

in soups and in some localities known as "mock" turtles. While almost every sort of living creature must be put in a crate for transportation, turtles are sent just as they are. Often they are in a weakened condition, but as a precaution they are turned on their backs when not being watched. No tags are necessary as all the shipping directions can be stenciled on the spacious backs or under shells of the creatures.

## SCIENTISTS SEEK TO CLEAR MYSTERY OF KING'S DEATH

To modern science has fallen the problem of solving the two-century-old mystery shrouding the death of Charles XII of Sweden. The remarkable career of the ruler, who was known both as the "young lion of the north" and as the "madman of the north," fills one of the most romantic pages of European history. But the story of the climax of

his life has always been blurred. He met his death in December, 1718, during the war with Norway. A ball pierced his skull in the midst of the fighting before the fortress of Fredriksten. Whether the missile was hurled from a Norwegian gun, or fired by an assassin within his own lines, has never been determined to the complete satisfaction of many historians. So his slaying for generations has been acclaimed the work of a "dubious hand." According to one accepted version, however, the Swedish approaches had reached a point less than 300 yards from the fortification when Charles looked over the parapet of the first-line trench and was struck by a bullet.

A movement lately launched by a Swedish patriotic society is expected eventually to throw valuable light on the subject. The organization, with the sanction of the royal family, has put the question to a jury of experts for decision. The body of the king has been exhumed and examined by eminent surgeons and scientists who, with the aid of X-ray and other apparatus, have made a technical investigation upon which the ultimate findings will be based. The research is being conducted with great thoroughness and no known source of information left disregarded. Engineers have located supposedly the exact position where the Swedish lines were drawn at the time the king's last battle was raging, and have made careful measurements of the distance between the points where the enemy batteries were situated and the place where the king fell. Eventually an official statement of the investigating body's conclusions will be issued, but until that time nothing will be published regarding the opinions formulated.

It was late in July that the body was disinterred and laid in state in the famous mausoleum of Gustavus Adolphus at Stockholm. There it was viewed by Swedish nobility, army and navy authorities, and state officials. It is interesting that after 199 years, the body should be found in an almost perfect state of preservation.



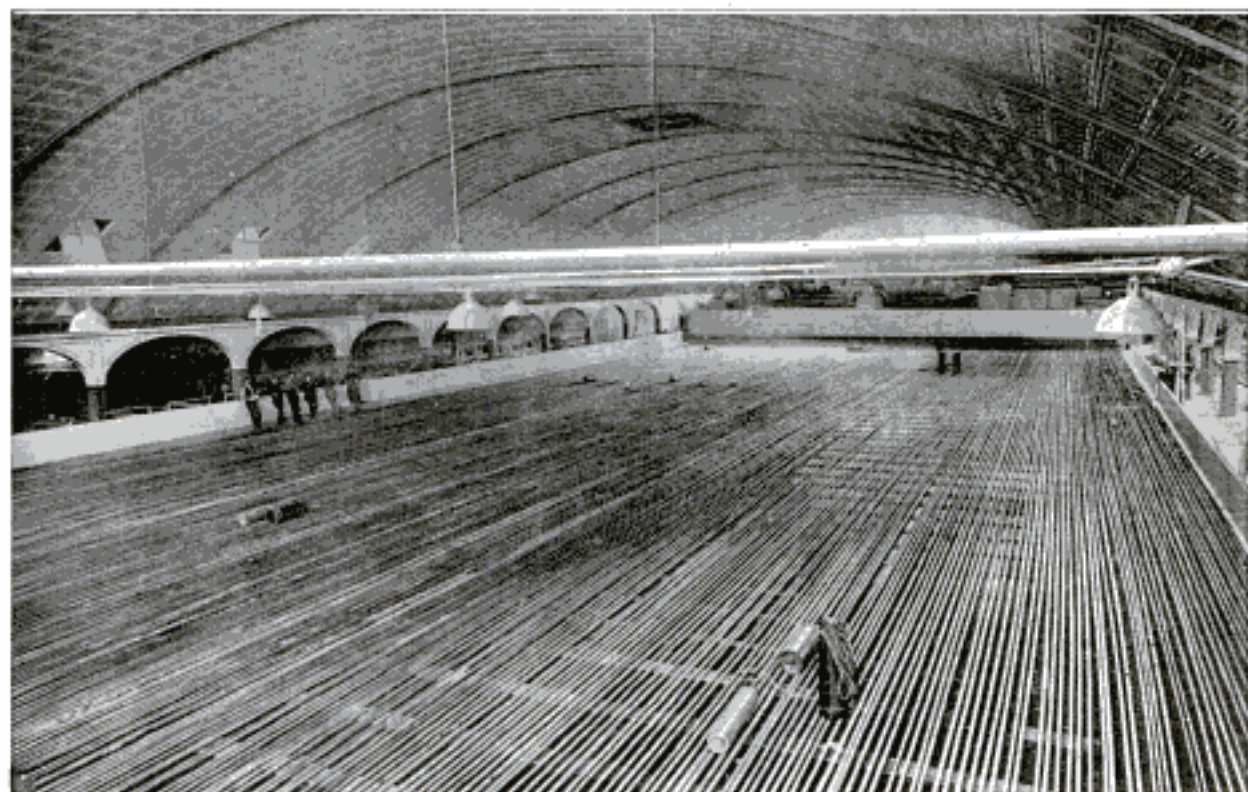

Ice Rink, Measuring 90 by 210 Feet, Showing the Floor Covered with 10 Miles of Refrigerating Pipe Which was Welded in Over 2,000 Places by the Oxyacetylene Process

### OVER TWO THOUSAND WELDS IN SKATING-RINK PIPE

To make every joint in 10 miles of pipe leak-proof and trouble-proof after it was buried in ice, was the problem that was successfully solved by the builders of an ice-skating rink in San Francisco. In many such rinks where ammonia systems are used, screwed fittings have caused trouble, and so it was decided to weld the joints by the oxyacetylene process. The floor which was covered with this pipe measured 90 by 210 ft., and the welded joints numbered over 2,000. After several months of use no leaks have developed in the 10 miles of tubing. It is asserted that the cost per joint was approximately the same as the cost of ordinary screw fittings.

### CONVENIENT DOORS FOR A DOUBLE GARAGE

An automobile owner of Port Townsend, Wash., has recently built a double garage after his own plans, with a set of doors of interesting design, which are not only convenient and

easily operated, but also neat and pleasing in appearance. The doors, which are being patented, are in three sections, those at the sides being hung like ordinary doors, while the central section, equal in width to the two others combined, swings on pivots secured in sockets placed at the top and bottom of the building. When open or closed, the swinging door is firmly held by sliding bolts that fit into sockets in the floor. The automobiles can readily pass on either side. When closed, the doors are secured from within by wooden bars.

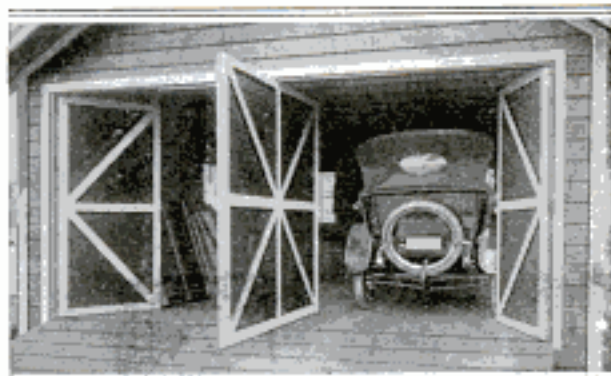

Handy Set of Doors for a Double Garage, Designed by the Owner and Built by His Son and a Boy Friend

*Fred J. Darling  
Port Townsend, Wash.*



### BAMBOO USED IN BUILDING RAILWAY BRIDGES

3476  
In Japanese railway-construction work bamboo is used for many pur-

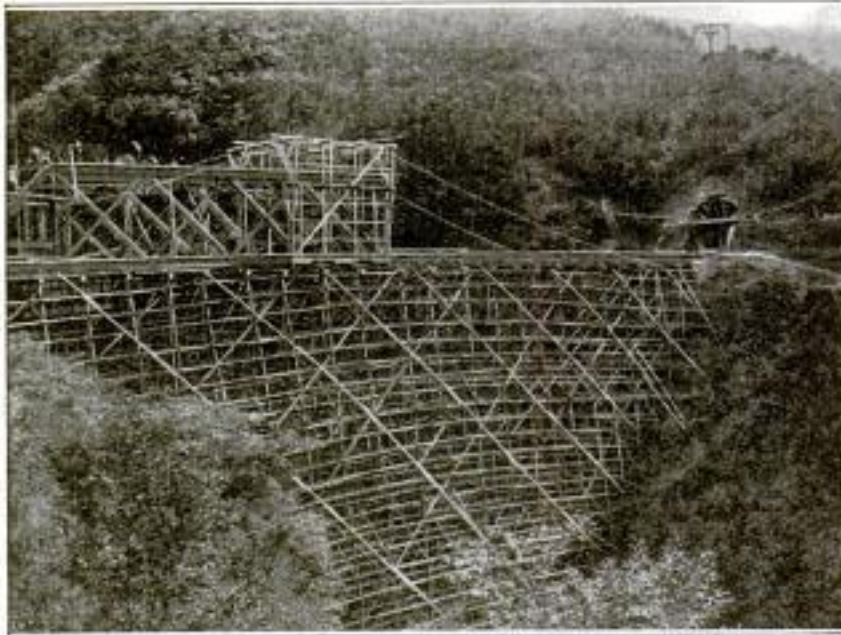

COPYRIGHT BY E. W. NEWMAN AND BROWN & SAVON

Japanese Railway Bridge being Built on a Falsework of Bamboo: The Useful "Grass" is Also Used for Scaffolding to Raise the Heavy Steel Beams to Place

poses. It even serves for the false or temporary work required in bridge building, as illustrated in the case of a railway bridge in course of construction across a ravine in a wooded region in

Japan. The heavy steel-work of the bridge was placed in its permanent position by means of a temporary supporting structure of bamboo, built up with infinite labor from the bottom of the ravine to the level of the roadbed on either side. The laying of the steel floor beams was then a comparatively easy matter. As bamboo is classed by botanists as a grass, its use in bridge construction seems odd, but it combines strength with lightness and is rendered capable of supporting heavy strains.

### MINERS USE HEAVY LEVER IN DUMPING ORE CARS

4767  
Although it is, perhaps, crude in construction, an arrangement employed at a certain small mine for discharging ore cars at the dump, is nevertheless efficient. It is merely an application of the time-honored principle of the lever. A timber framework spans the end of the track that extends to the



Tipping an Ore Car and Discharging Its Contents on the Dump, with the Aid of a Powerful Lever

dump. To the crossbar of this, a heavy pole, carrying at its outer extremity a stanch chain, is pivoted. A hook connected to the chain fits into a steel eye provided on the rear of the car. The operation is obvious.

### LIGHT PLANT MODERNIZES SAILING VESSEL

Plying the Pacific is a handsome, four-masted sailing vessel—engaged for the most part in carrying precious war-time cargoes of oil and gasoline—that has taken on a new lease of life. Up to a short time ago this boat, known as the "John Ena," was forced to pay burdensome insurance rates when laden with combustible material, for it was lighted with oil lamps. As every marine-insurance man knows, such a vessel may suffer disaster because of overturned lamps when there is no danger from storm. But this big hazard was removed by providing a simple electric-light plant, which also





The "John Ena" Which Plies the Pacific with Oil and Gasoline Cargoes: By Supplanting the Craft's Oil Lamps with a Simple Electric-Light Plant, Insurance Charges were Reduced Enough the First Voyage to Pay for the New Outfit

furnishes power for the sewing machine used in mending the sails. The reduction in insurance charges for the first voyage after installing the new lighting system far exceeded the entire cost of the plant. What has been done on this attractive-looking sailing ship only serves to indicate how large numbers of craft can be modernized to supply the present extraordinary demands for ocean-going vessels.

The outfit on the "John Ena"

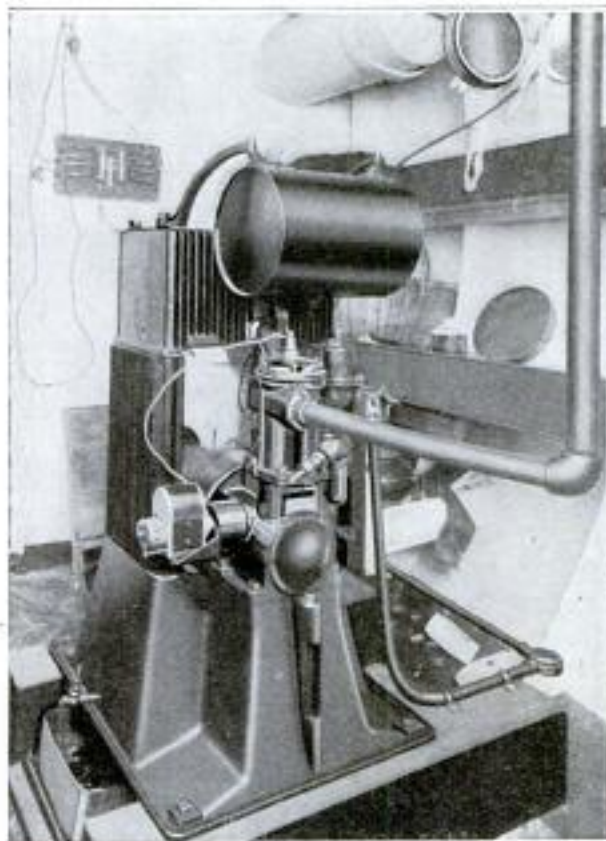

The Ship's Smooth-Running Light and Power Plant: Its Rated Capacity Is 500 Watts at 110 Volts. No Storage Batteries are Used

uses no storage batteries and has no complicated switchboard. It consists of a single unit, standing 45 in. high and occupying 24 by 25 in. of floor space. An especially designed engine of the sleeve-valve type drives the generator, which is also made after a special pattern. The rated capacity of the engine is 500 watts at 110 volts, direct current, but it can take a generous overload. A muffler, and other features, make its operation noiseless.



Rev: John J. Odenwald.  
1204 H. St. N. W. Washington D.C.

## THE ELECTRIC INITIATION OF JAMES JOSEPHUS

The Royal Order of Electric Sparkers Tries Out Some of the Recent Apparatus Devised for the Entertainment of Lodge Candidates

By SEARLE HENDEE

4862

**I**T turned out to be a prickly evening for James Josephus, the uninsulated candidate who aspired to membership in the "Royal Order of Electric Sparkers." James,

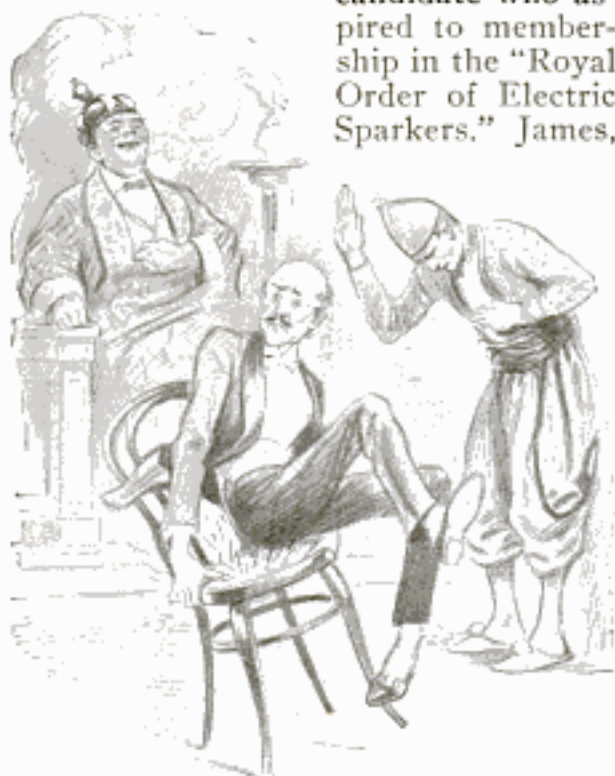

*"No sooner had he touched the chair than he sprang wildly, and most ungracefully, into the air, emitting an irrepressible whoop."*

a graduate of the "Pole Climbers' Long-Distance School," was a rank amateur, but nevertheless eligible for admission to that semiprofessional and highly unbenevolent organization.

The neophyte looked upon the occasion with the utmost solemnity. To the efficient team of "royal brothers" to whom the rough work of his initiation had been entrusted, however, there was nothing particularly sublime or august about the approaching ceremony. On the contrary, the night was dedicated to Puck.

James Josephus was ushered into a large room where many of the exalted members of the R. O. of E. S. were assembled. He was greeted jovially and offered a chair right beside the Grand Motorgul and past masters of the illustrious order. It was not an armchair such as some of the others

lounge in, but a light, well-built chair with a cane seat, or what looked like one. As he seated himself he was conscious that all eyes were upon him and in another second he realized why, for no sooner had he touched the chair than he sprang wildly, and most ungracefully, into the air, emitting an irrepressible whoop.

"Entirely automatic," explained one of the royal brothers. "An exceedingly ingenious contrivance for public and private entertainments. The amount of current is not so great as to injure one, but sufficient to animate the most sluggish. You will be interested, no doubt, in its construction. Look it over. The wiring is cleverly concealed, you see, so that no one would suspect it to be an electric chair."

"Yes, deucedly clever," responded the candidate, "and a capable demonstrator of electrodynamic induction. Please, may I have a drink? The evening is becoming warm."

"Assuredly," replied a robed frater. "In honor of the occasion we have prepared some sparkling nectar which I am positive you will enjoy." He led the willing victim to a round table where a number of thirsty "electric



*"His arms cramped and he strove vainly to drop the tingling ladle and glass. . . . Another of our unusual accessories," explained a royal brother.*



sparkers" had already grouped themselves about a large punch bowl.

"Ah, this, indeed, is a pleasure," exclaimed the aspirant, smiling with satisfaction.

"You will be delighted with it, I am sure," agreed his escort. "Just help yourself; we are very informal here."

James Josephus lifted the silver ladle and began to pour the deep-red liquid into a glass. But before he could smack his lips in anticipation of the refreshing draft, something happened. His whole body quivered, his face contorted, and he hopped on tiptoe at a rate that was astonishing. His arms cramped and he strove vainly to drop the tingling ladle and glass. Suddenly the overpowering sensation ceased, but the paroxysms of laughter that convulsed the spectators made his blood burn with chagrin.

"Another of our unusual accessories," explained a much-pleased royal brother. "It insures sobriety on all occasions. The bowl, you will observe, is of imitation cut glass and measures 7 by 16 inches. It comes well packed to guard against breakage. The interesting thing is that the special spark coil consumes only about one and a fourth amperes. It is very efficient."

"Yes, very efficient," agreed James Josephus. "The spark is very energetic — very — and excellently suited for high-frequency apparatus. It operates on dry cells, I suppose."

"You don't feel weak, do you?" questioned one of the brothers.

"No, indeed," James Josephus assured him.

"To prove it I'll wager I can lift that 200-lb. weight, yonder, higher than any of you can." It was agreed upon, and all present gathered around

the heavy-looking metal object, on top of which were two grips for the hands. One of the members tugged unavail-



"Oh, the juice!" shrieked the amateur strong man. "O ho! the juice!" shouted the entertainment committee. The weight dropped to the floor with a thud.

ingly and swore he could not budge it.

"Weakling," scoffed our hero. "I'll give you a demonstration of muscle," and he gripped the weight with both hands and began to lift.

"Oh, the juice!" shrieked the amateur strong man.

"O ho! The juice!" shouted the entertainment committee.

The weight dropped to the floor with a heavy

thud. The novice rubbed his arms and gazed around in disgust. "What's the big idea?" he stammered. "Trying to make a fool of me?"

"You're sure the weight lifter 'round here," confided a solicitous member of the Electric Sparkers.

"None of us ever tackles that thing, even if it does weigh only 40 pounds.

But you are handy with the weights, all right. You sure got that one up."



"James Josephus put to shame old Saint Vitus himself and far surpassed the leaping skill of the agile Russian-ballet artists."



"Now, my fellow," said a voice, "we have laughed enough at your expense.

You have proved yourself worthy of entering the presence of the great Dynamo-

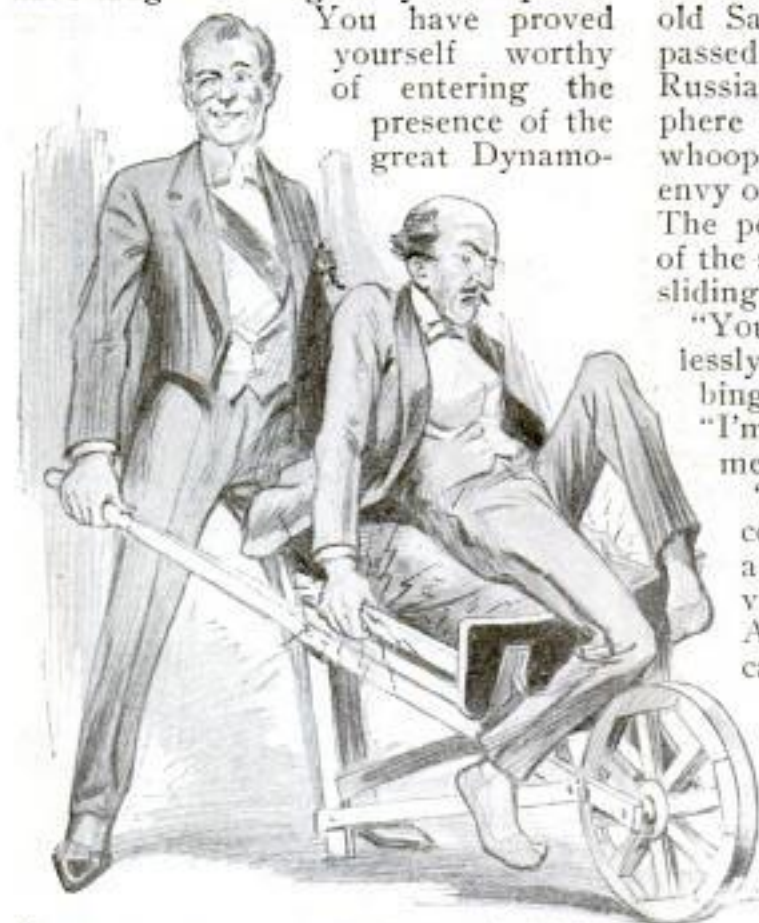

"So they put Jimmy in the wheelbarrow and rolled him into an adjacent room where the great high priest was seated on his throne before the magic carpet."

torine—the exalted high priest of our high-voltage inner circuit—and to kneel before him on the magic carpet. To do so, however, you must remove your shoes and incase your feet in these royal sabots, made of wood taken from the first telegraph pole." And so it was that the expectant one slipped into Dutch shoes that would have doubled the speed of Mercury, had he worn them.

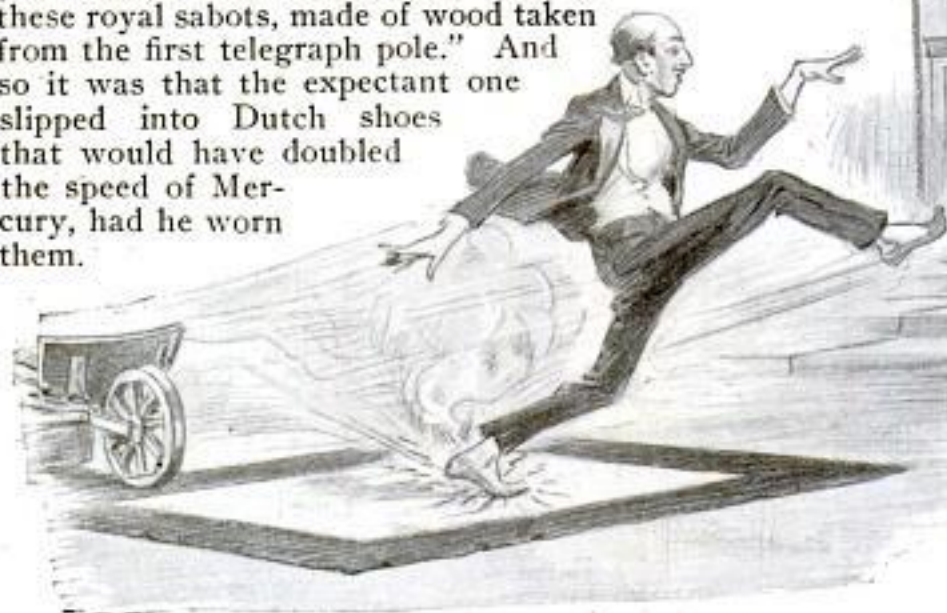

"'Burning sands of Sahara!' he yelled. 'This sacred thing is full of electric tacks.'"

Then followed the most classic of dances. James Josephus put to shame old Saint Vitus himself and far surpassed the leaping skill of the agile Russian-ballet artists. The atmosphere was filled with blood-curdling whoops that would have excited the envy of the most scalp-craving redskin. The performance continued until one of the shoes became loosened and went sliding across the floor.

"You are a heartless crew," breathlessly complained the candidate, rubbing the soles of his smarting feet. "I'm on to you, now. You won't get me to walk another step."

"We won't ask you to," was the comforting reply. "You have had a strenuous time. But you must visit the exalted Dynamotorine. And to do that you cannot wear calfskin shoes. He won't have it.

And besides, leather must never touch the sacred rug. Here, climb into this wheelbarrow and we'll ride you in, just for fun. Such an unconventional sight will please the old fellow immensely, I am sure."

So they put Jimmy in the wheelbarrow and rolled him

into an adjacent room where the great high priest was seated on his throne before the magic





carpet. He clung tenaciously to the vehicle, determined to be prepared for eventualities. Then, suddenly, as they stopped before the sacred rug and the Dynamotorine slowly lifted his eyes ten billion demons assaulted the neophyte with as many needles. Balancing on his hands, he threw his legs into the air. The current shot on and off intermittently, and James became a human jumping-jack with no place to jump. When his limbs were in the air and free from the agonizing prickling, his hands shook with the piercing pain of the electric current. Then it ceased, and he arose quickly and jumped on the magic rug.

"Burning sands of Sahara!" he yelled as he danced energetically. "This sacred thing is full of electric tacks."

"Full of heating elements and amperes," corrected a "practical worker."

The last ordeal continued only a second, however, for James Josephus bounded off the electric rug in two marvelous leaps.

"Too bad, too bad!" consoled the

great Dynamotorine, leaving his throne and approaching the proselyte. "They forgot to insulate the wheelbarrow and you should not have stepped on the mystic rug without protecting your feet with the royal sabots."

"Quite right, quite right," ejaculated the injured party. "If the current has been turned off, I wouldn't mind having some of that royal punch, I'm awfully warm."

"Surely," replied the high priest, "but first please climb the rope at the left and bring down my imperial fez which has been hung high out of the reach of moths."

"I'm climbing no electric rope or live lightning rod tonight," avowed James Josephus. "I'm next to your spark coils and induction phenomena. I'm initiated!"

"Enter the fold!" shouted the others. "You have proved a good conductor. Now we will initiate you into the mysteries of the Royal Order of Electric Sparkers. Keen pleasure and a wonderful static display await you."

## 4896 DEALER'S COAL BINS BUILT LIKE SILOS

Four big cylinders of concrete are the bins of an unusual type which a progressive coal dealer has provided to hold his supply of fuel. Each of these silolike reservoirs is 18 ft. in diameter and 50 ft. high, and has a capacity of 1,400 tons. They are filled by an electrically driven conveyor which discharges the fuel into the top. Extending over the four bins, is a single wooden roof which houses the hoisting machinery. False bottoms, 6 ft. above the ground, permit wagons to be driven directly beneath the reservoirs so that they can be loaded by gravity.

Everything about these big bins speaks unusual neatness and thrift.

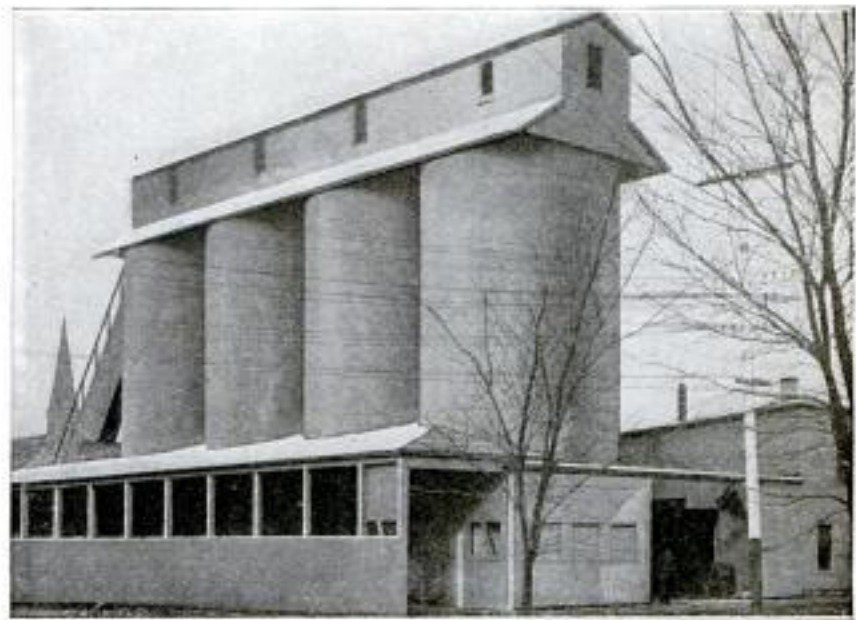

Coal Bins of an Unusual Type: These Cylinders Are 18 Feet in Diameter, 50 Feet High, and Each Has a Capacity of 1,400 Tons of Fuel

Barker Lumber & Fuel Co. Watertown, Mass.  
Copyrighted material



**STEREOSCOPIC CAMERA MADE FOR BINOCULAR MICROSCOPE**

4954

For making stereoscopic photographs with a binocular microscope, a special camera has been devised that serves a wide range of uses in research and industrial laboratories. One of its particular advantages is that it produces photomicrographs that embody the same valuable characteristics as the magnified images obtained visually, and thus

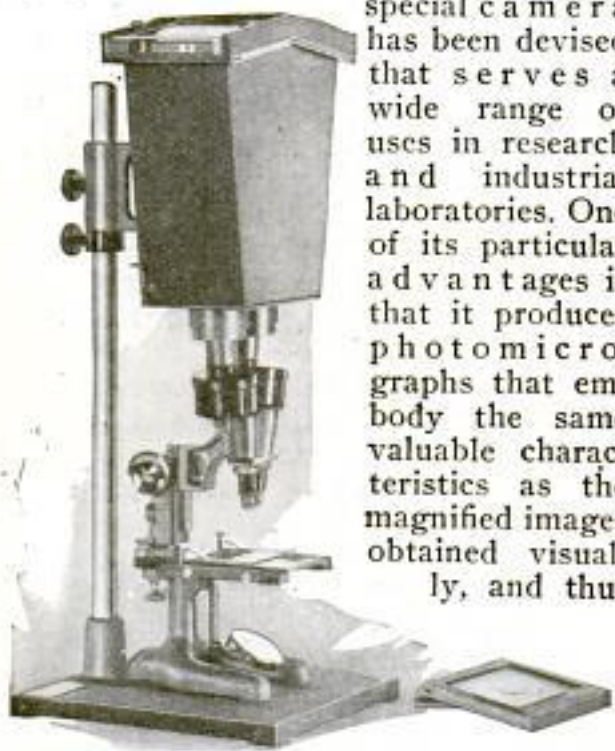

The New Camera Enables a Scientist to Make Permanent Records that Have Perspective, Depth, and Proper Form

permits permanent records of the most favorable nature to be made. The camera is double—its two halves sep-

arated by a partition—and arranged so that the ground glasses are in normal relation to the axes of their respective optical systems. It has a 10-in. projection distance, a length that gives magnifications identical with those obtained in visual work with the microscope. To provide a light-proof connection between the two instruments and at the same time afford freedom of movement for focusing, metal adapters are used which slip over the eyepieces of the microscope and fit into the corresponding tubes attached to the front board of the camera.

**BOTH CHANCE AND SKILL ENTER INTO NEW GAME**

4957

Among the new indoor games that have been devised for home and club is one which embodies, in a modified way, some of the elements of roulette and chess. It is a light diversion, requiring enough thought to keep interest alive and involving sufficient chance to make the complexion of a contest change constantly, so that speculation is always rife. Action is introduced at the beginning and prevails to the end, for the path to victory is the path of greatest danger. A feature which popularizes the pastime is that it may be

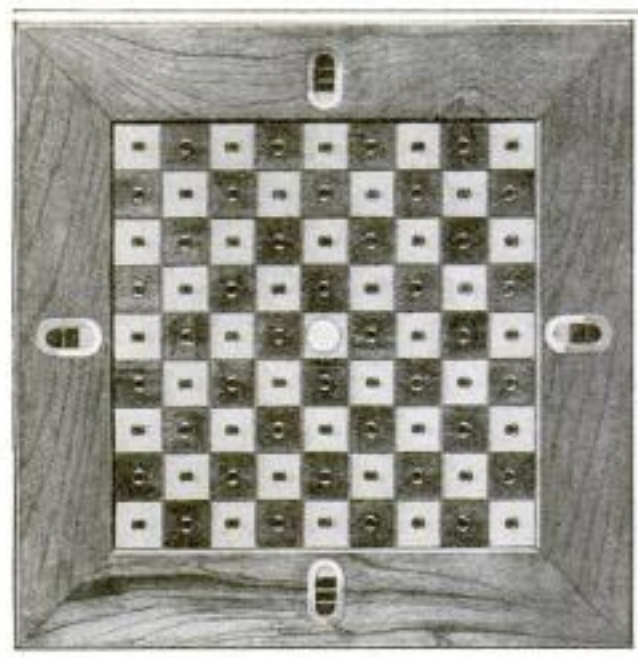

COPYRIGHT BY BROWN & DAWSON

Showing the Character of the Board Used for the New Game, and the Way It is Set

2- Inv: George Henry Parker  
Hampden, Mass.



1- Mfg: Goodell-Frost Co

Greenwood, Mass.

enjoyed by two, three, or four persons, each of whom is given 14 men, five kings, and one crown, the latter being the most important piece. A color wheel, incorporated in a checkerlike board on which the game is fought, is spun before each play. It indicates the move to be made, what color of square one may move from, how many spaces may be passed, and what color of square one may move a man over and on. There are, however, from two to eight ways in which a move may be made. It is the method of execution that tests the player's cleverness.

NEW UNIVERSAL CALIPER

463 FOR SMALL WORK

A caliper of a new type which can be used for making any inside, outside, or depth measurement up to 4 1/2 in., consists of a slotted bar through which two movable jaws project transversely. One side of the tool is graduated in sixteenths of an inch and the



A Caliper for Making Any Inside, Outside, or Depth Measurement up to Four and One-Half Inches or 11 3/4 Centimeters

other in millimeters. A thumbscrew locks the movable parts as desired.

MOTORING TAUGHT IN CAR WITH DUAL CONTROL

4902

Two sets of controlling devices constitute a feature of a new car which has been built for use in teaching persons how to drive automobiles. With a car of this sort the principles of motoring may be learned quickly and without danger of mishap. There are two sets of clutch and brake pedals, two accelerators, and two steering wheels. The latter are connected by an endless chain which passes around a cogwheel located beneath each steering wheel, so that the two move in unison. The single-gear shift is centrally located and can be operated by either person in the front seat. It is

thought that there will be a considerable demand for cars of this type

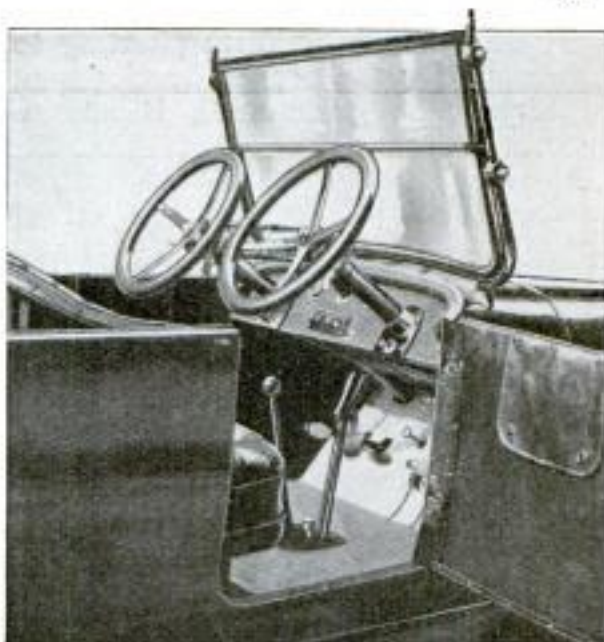

Car in Which Instruction is Given in Motor Driving: Danger of Accident is Practically Eliminated by the Use of Two Sets of Controlling Devices

when additional drivers are needed to take the place of those entering war service.

NEW GREASE CUP HAS NOVEL AND CONVENIENT POINTS

469

Two distinctive features are incorporated in a grease cup lately designed. A four-sided post is anchored in the base of the device, while fixed at the top in the middle of the cap there is a spring seat, or socket, to receive it. The arrangement overcomes the difficulty often encountered in screwing a cup together, for the post centers the two members instantly. The springs press against the sides of the upright bar and prevent the cap from becoming loose and falling off.



3- Mfg: Norton Mfg Co. Chicago Copyrighted material



State Agricultural Experiment Station, Madison, Wis.

**DEVICE USED IN PLANTING GRAIN BRED FOR SEED**

4554

The absolutely uniform planting so necessary for the proper development of high-grade grain seed, is accom-

plished at the State Agricultural Experiment Station of Wisconsin with the aid of a novel planter. This machine runs on a track and is operated by two men, one of whom deposits the seeds in 14 uniformly spaced planting spouts that lead down into the soil. The second man operates a "covering" lever which in turn actuates rods which thrust the grains into the ground to the proper depth. A second lever is used to propel the planter forward the proper distance—in the case of barley, 4 in. at a time. Beginning with a thousand, or more, selected kernels, beds are planted in this manner for several consecutive seasons, the seed each time being selected from a few of the finest plants of the previous year.

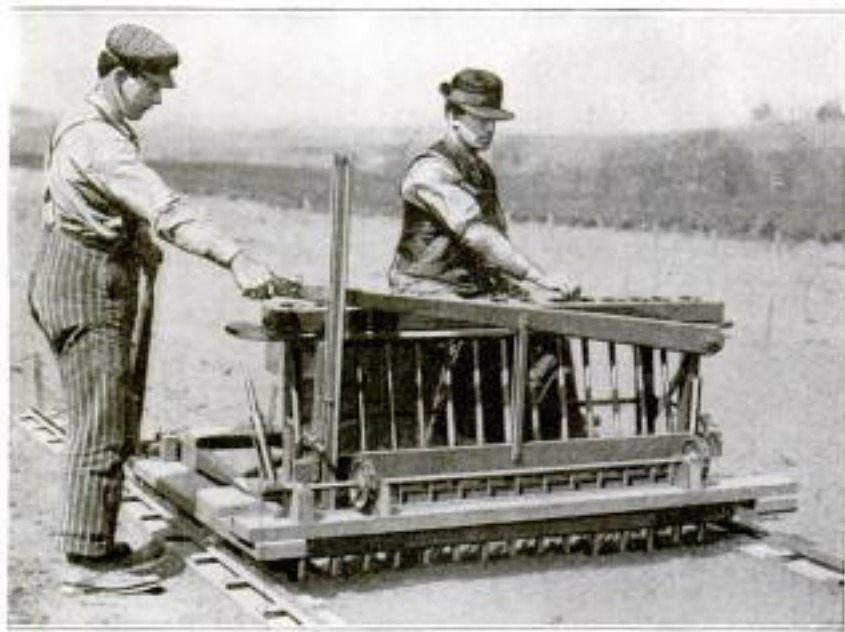

Machine Used in Planting Selected Grain for Seed Purposes: The Seated Operator Deposits the Seed in the Vertical Spouts, and the Other Operates a Lever Which Thrusts the Kernels into the Ground to a Uniform Depth

**SIMPLE UNLOADING TACKLE FOR AUTO DEALERS**

4468

The feature of the tackle illustrated herewith, which is used by automobile

dealers in unloading automobiles from gondola cars, is its simplicity. A single heavy scantling and some rope constitute practically all the material used. The rope is looped about the beam at either end and then tied to the front and back wheels. Additional rope is looped about the center and around the ends of the beam so that a crane can easily pick up the tackle and the load to which it may be attached. To prevent marring, the rope is padded at points where it comes in contact with the car. Proper adjustment keeps the car from tilting.

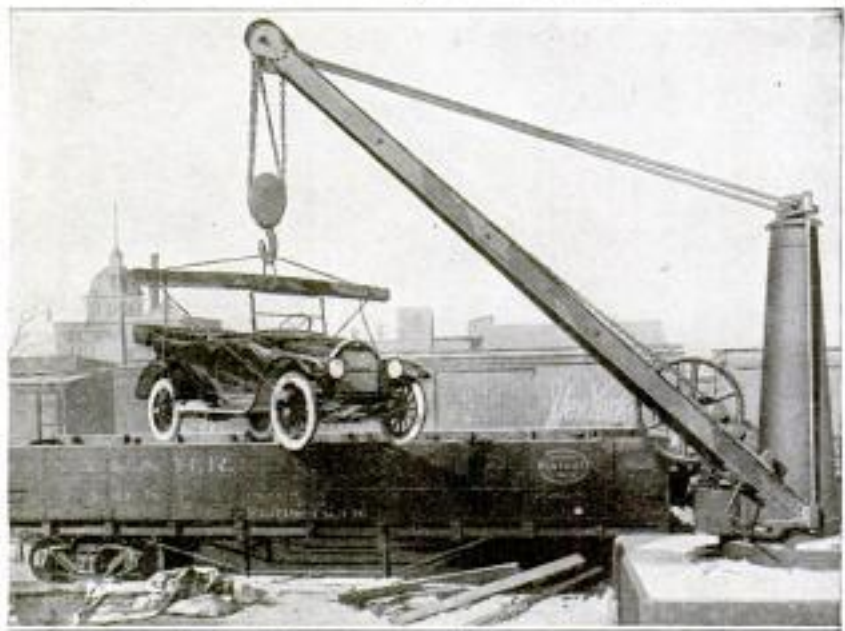

Simple Tackle for Lifting Automobiles from Gondola Cars: At the Points Where the Rope Touches the Car, Padding is Employed to Prevent Marring

Mfg: H. H. H. - C. H. H. Co.  
Sole Agent: C. H. H.



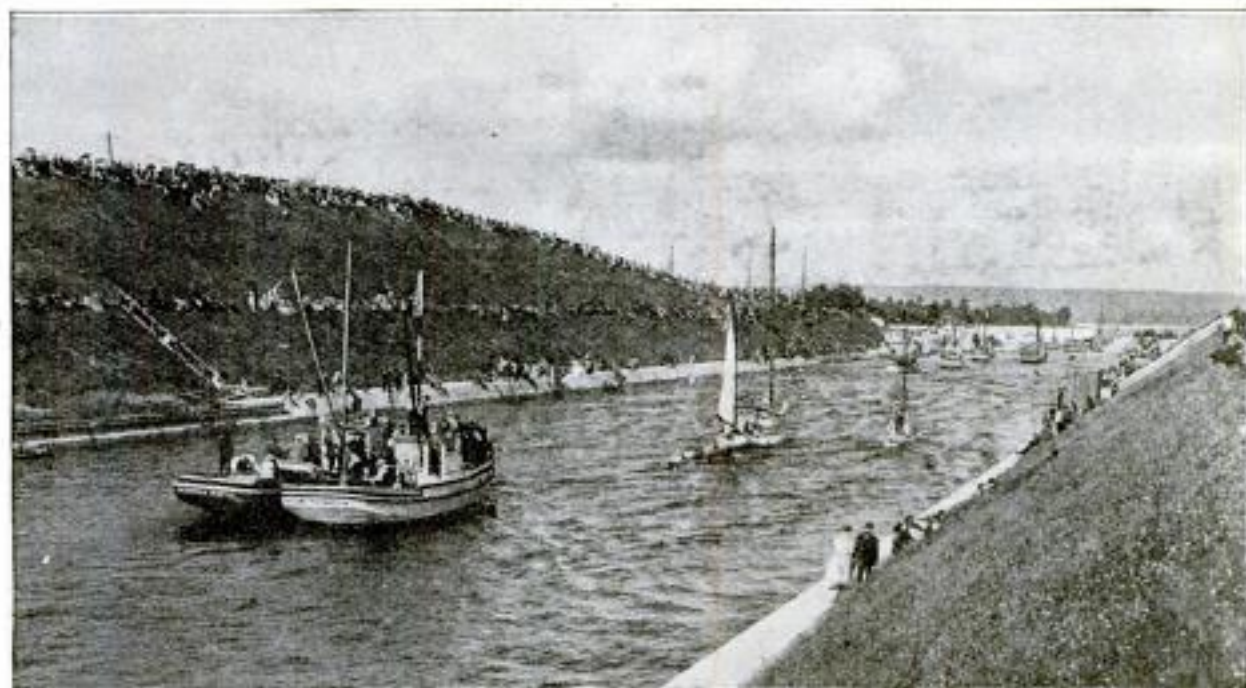

Scene at Formal Opening of the Canal Which Gives Seattle a Great Fresh-Water Harbor: The Waterway Is Five Miles Long, Cost \$5,000,000, and Connects Two Lakes with Puget Sound, Thereby Giving a Vast Additional Area Direct Access to the Sea

### SEATTLE'S SHIP CANAL

#### 4866 FORMALLY OPENED

The fondest dream of the city of Seattle, Wash., was realized, after many years of waiting, when the \$5,000,000 Lake Washington Canal, which cuts through the north end of that city, was formally opened a few weeks ago. The waterway is five miles long and, by connecting two lakes with Puget Sound, opens up a vast industrial area which is destined to make Seattle one of the greatest ports on the Pacific coast. In celebration of the opening, a marine pageant was held in which thousands of craft participated. The building of the locks in this canal, and other features of it, have been described in Popular Mechanics Magazine.

### CIRCULAR-LETTER PRINTER MAKES OWN STATIONERY

4938 For turning out form letters in large quantities, a machine has been developed that not only does the work usually accomplished by devices of the kind, but does a number of other things at the same time. It prints letterheads in color, stamps signatures in another shade of ink, automatically

changes the name, address, and salutation of each copy, gives the body of the letter a typewritten appearance, and lastly, cuts the paper into 11-in. lengths. Thus it makes the stationery in the same operation that the letter is printed. Paper is fed to the machine from a roll, 8½ in. wide. If the stock is embossed or lithographed an automatic sheet feed is used. Post-cards are printed and addressed, wrappers directed, and, with an attachment, "sticker" addresses produced.

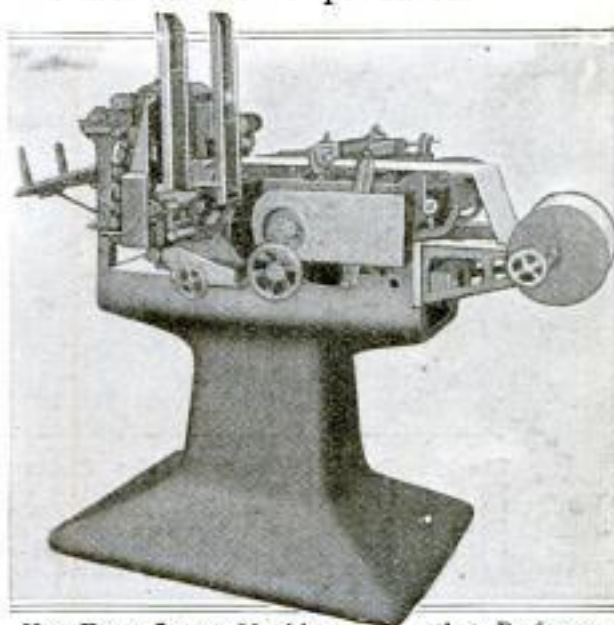

New Form-Letter Machine that Performs a Wide Range of Operations.

Inv: E. E. Strawn, Dean of the  
College of Commerce, High School, Des Moines, Iowa.  
Copyrighted Material



Submarine Warfare  
Protection

4900

# WEAVING MIGHTY NETS TO FOIL THE U-BOATS



Preparing for the U-Boats: A Dock, "Somewhere on the Atlantic Coast," Laden with Material to be Used in Constructing Nets That will Protect Certain Harbors from Enemy Submarines. The Mushroomlike Objects in the Foreground Each Weigh Many Hundred Pounds and are to be Attached to the Lower Edges of Nets Placed in Deep Water

Naval Reserves Making Nets: Probably Nothing Short of the Extraordinary Necessities of War would Call for Nets of Such Powerful Cables and with 10-Foot Meshes, as are Shown Here. Naval Authorities Believe That These Hidden Barriers, together with Other Proper Safeguards, will be Able to Keep Back the Most Venturesome U-Boat



The Weaving of a Mighty Fabric: Civilians are Not Permitted to Enter This Area, but the Censor has Allowed This Photograph to be Taken, Which Shows Some of the 200 Naval Reserves Who are Engaged in Fastening together the Cables That Compose the Nets. It is Doubtless a "Gate" in a Barrier Similar to This Which, According to News Dispatches, is Occasionally Opened and Closed at the Mouth of New York Harbor. "Skeins" of Cable Yet to be Woven are Shown in the Foreground



## AND KEEP OUR HARBORS SAFE FROM ATTACK

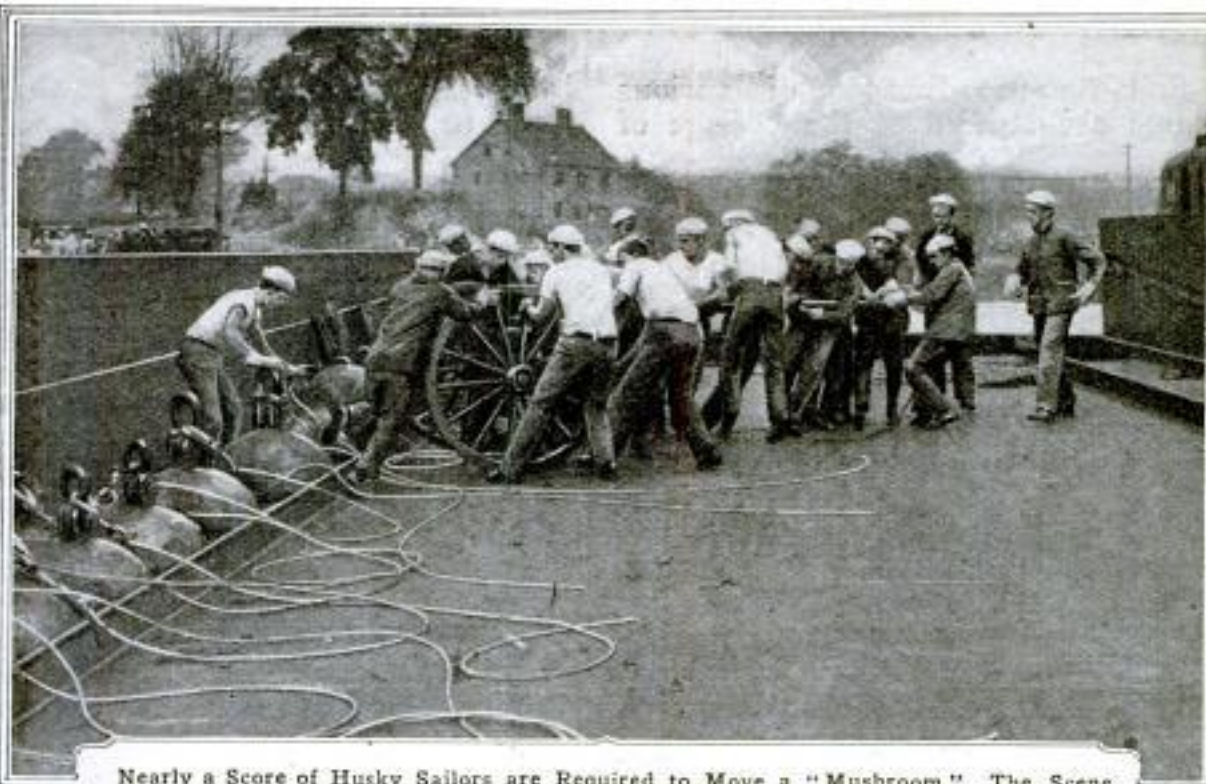

Nearly a Score of Husky Sailors are Required to Move a "Mushroom." The Scene Vividly Shows How Heavy These Weights Are. The Nets must be Built and Weighted to Withstand Not Only Possible Attack but Also to Remain in Place in Spite of the Terrific Strain that Storms and the Tide may Produce. The Long "Tails" Attached to the Tops of the Big Hemispheres are Used to Tie Them in Place on the Under Edges of the Nets. Creosoted Barrels are Attached to the Upper Edges to Serve as Floats

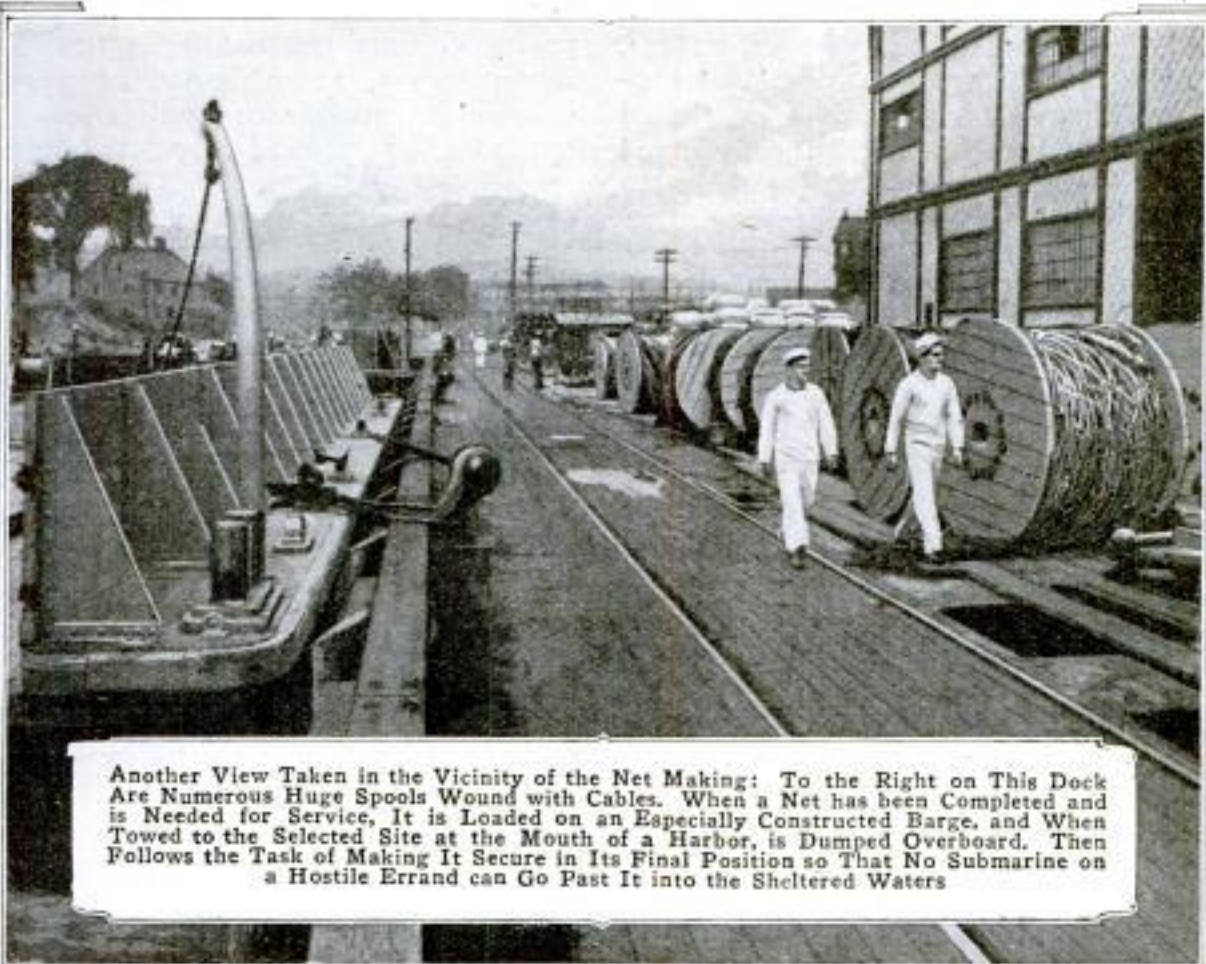

Another View Taken in the Vicinity of the Net Making: To the Right on This Dock Are Numerous Huge Spools Wound with Cables. When a Net has been Completed and is Needed for Service, it is Loaded on an Especially Constructed Barge, and When Towed to the Selected Site at the Mouth of a Harbor, is Dumped Overboard. Then Follows the Task of Making it Secure in its Final Position so That No Submarine on a Hostile Errand can Go Past It into the Sheltered Waters

JAMES EASTMAN INTERNATIONAL FILM SERVICE



**NEW REGULATOR FOR SOIL-TEMPERATURE TEST**

4286 Soil-fungus diseases of various iron. This is divided into 12 equal plants are studied at the College of compartments, or small tanks, each

having suspended in it four 10-qt. "batteries," or metal jars, filled with soil in which the plants to be tested are set. Water connections are provided at one end of the tank, steam and electric connections at the other end. Continuous-flow outlet and bottom drain pipes are also installed. In experimenting, cold water is turned into the tank until it is filled, when the temperature is raised gradually by means of steam tubing and electric-light bulbs

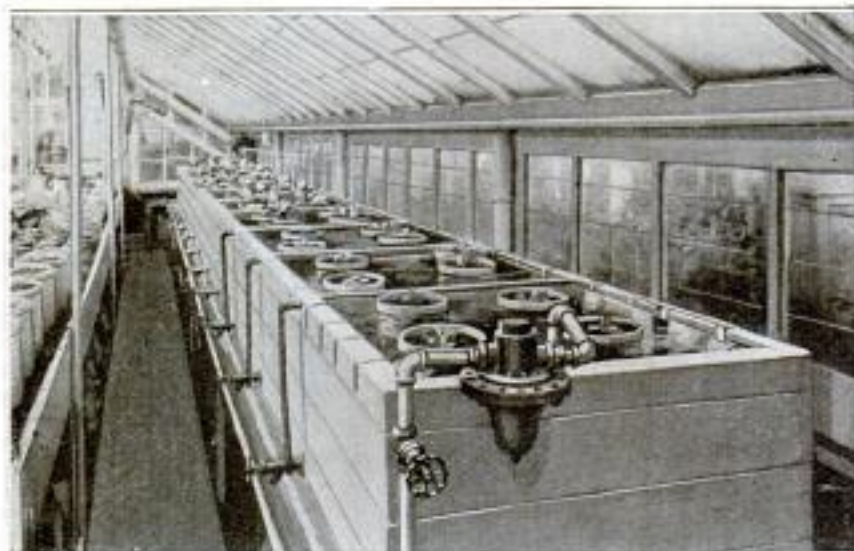

Special Apparatus for Testing Plant Diseases in Soil at Constant Temperatures in Use at the Wisconsin College of Agriculture: The Jars Seen in the Tank Compartments Contain Soil and Plants under Observation

Agriculture, University of Wisconsin, by means of a new apparatus devised by specialists of the faculty. To hold soil at constant degrees of temperature, a tank regulator, 30 ft. long, was constructed of heavy planks insulated with felt and lined with galvanized

suspended in the water, until it varies from about 45° F. at one end to about 90° at the other. These temperatures are maintained constantly, and regular inspections give reliable data of fungus-disease growths in the soil jars. The apparatus has proved very satisfactory.

4637 **FIRE-PUMP UNIT CARRIED ON LIGHT TRAILER**

One of the latest fire-fighting appliances is a motor-driven pump mounted on a light four-wheel trailer. Its moderate cost and apparent efficiency quite probably adapt the unit to the needs of many small communities that maintain limited equipment. It is provided with a four-cylinder, 30-hp. motor, and at a pump pressure of 135 lb. delivers 410 gal. of water a minute. Because it is a trailer, the cost of taking it to a fire is practically nothing.

One man is able to operate it without assistance.

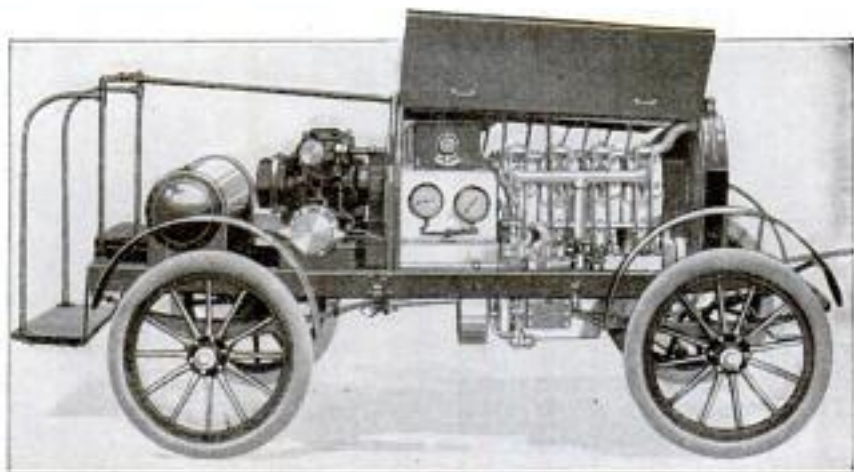

Novel Trailer "Fire Engine" of Low Cost That may be Operated at Moderate Expense by Small Municipalities and Suburban Communities



Copy furnished by

J. G. ...  
POPULAR MECHANICS

Indyenne, Wyo.



Picnic Luncheon Tables on Site of a Big Tree That Flourished Many Centuries Ago: Its Descendants of the Third and Fourth Generations Surround the Spot

### BIG-TREE CHILDREN OF THE FOREST

4175

The California redwoods, the big trees of the coast range, are gregarious, reproducing and thriving in families, often located in strictly limited areas or patches. These patches are seldom decimated by fire, because of the asbestoslike nature of the thick bark.

However, after the trees attain an age of two or three thousand years or so, a sort of senility seems to result from the accumulation of diseases, insects, accidents, and storms, and the parent stem perishes. Also, before their protection in national-monument reservations, woodmen destroyed the big trees for timber.

Promptly upon the death or removal of the tree, numerous sprouts burst forth from the roots close around the base of the stump; and unlike its distant hardwood relative of the eastern states, which starts a score of sprouts and molts all but one or two, all the redwood sprouts grow in complete harmony, like an ideal family of children. Symmetrically disposed around the parent position, these offspring command attention for their beauty.

There are traces of many large cir-

cular clusters of trees whose original ring was so large as to indicate the present generation to be great-great-grandchildren, if not the children in the sixth generation from the central stem, whose era probably dates back nearly to the glacial period of ten thousand years ago.

The picnic ground seen in the accompanying view is formed by a circle of great-grandchildren of a missing tree, apparently not a single first child or grandchild remaining. These great-grandchildren trees are approximately 100 years old.

### COUNTING THE BALLS IN FILLING SHRAPNEL

4675

How many balls in a shrapnel, and who counts them? The number of balls varies with the size of the shrapnel, and, anyway, the vital consideration is not one of number of balls, but entirely a matter of correct weight. The size of the bullets varies slightly and there is also slight unavoidable variation in the weight of casings, and other parts.

An eastern company, which makes 3-in. Russian shrapnel, has devised a very simple but perfectly satisfactory

Vermont Armory  
Copyrighted material



machine for counting balls and filling the shrapnel.

The balls come from a large tank, not shown in the picture, which is



COURTESY OF MACHINERY

Filling Shrapnel in a Modern Munitions Plant: An Ingenious Arrangement Releases the Correct Number of Balls at Each Operation

located near the ceiling, and slide down the inclined pipes to the smaller storage tanks forming parts of the counting machines. Two distinct counting processes are then undertaken. In the first process, 90 balls are dropped into the casing. They are automatically counted in this way: From the base of the small storage tank, shown in the illustration directly in front of the operator, runs an inclined raceway. This raceway is divided into ten little channels and a gateway is built across it at a distance from the base of the storage tank equal to the diameter of nine balls. The operator opens the gate at the base of the little reservoir and enough balls run out to fill each of the ten channels with nine balls; that is, 90 balls run out. Then the operator closes that gate and opens another, and these 90 balls drop into the shrapnel case. While they are dropping, the case is being mechanically joggled continually. The partly filled shrapnel is next taken to a hydraulic press, where it is subjected to a three-ton pressure.

At the second counting machine, by an exactly similar process to that used in the first part of the operation, 150

balls are added. A charge of smoke-making powder is then added and the whole shrapnel weighed. A certain exact weight has to be attained and it is often necessary to add a few more balls in order to get this desired result. With the weight correct, the filled case is again subjected to a three-ton hydraulic pressure.

### CAMP-FIRE PERMITS ISSUED IN FOREST RESERVATION

In an endeavor to obtain coöperation and thus minimize the danger of costly conflagrations, a ruling has been made that requires campers and hunters to procure permits before building fires for any purpose in the Angeles National Forest, Calif. The system has been in force since last spring, and seems to be working satisfactorily. Permits are issued by all forest officers free of charge. They remain in effect only between dates indicated in writing, and specify a list of conditions which must be observed. For instance, only small fires are allowed, and these must be built in the open, at least 20 ft. from standing brush, and not against a tree or log. Leaves and trash must be removed from around the place where the fire is to be kindled. A fire must never be unattended, even for a short time. Before it is left, it should be extinguished with water and covered with fresh dirt. The back of the permit lists general precautions that should be observed when one is in the forest, and also gives instructions for notifying rangers of a fire, should one be discovered that is too big to extinguish without additional assistance. All the rules are so fair that any good sportsman will observe them voluntarily.

By a recent decree of King George of England, the descendants of Queen Victoria who are subjects of Great Britain have been ordered to discontinue the use of all titles, degrees, etc., of German origin, and hereafter the English royal house will be known as the house of Windsor.



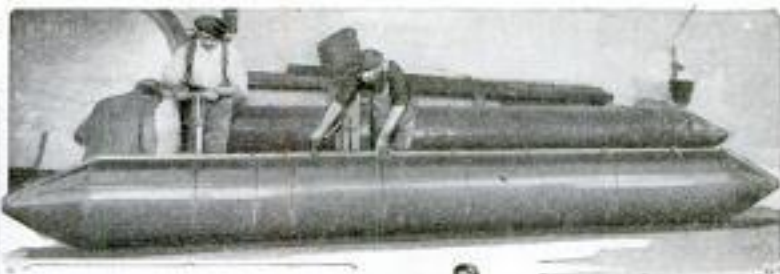

Testing a Pair of Pontoons before Installing Them

Left: Constructing a Section of the Double Platform for Large Raft

Right: Two of the Completed Life Rafts Ready for Service



**LIFE RAFTS PLACED ABOARD TRANSATLANTIC SHIPS**

For the safety of those aboard, life rafts are being carried, in addition to the usual small boats, by some of the American vessels that are running the gauntlet of Germany's submarines. The devices are of different designs and sizes, but one fairly common type is built with two stanch wooden platforms, 13½ ft. long and 9 ft. wide, placed one above the other, and separated by air-filled pontoons that extend along the sides. Such a raft is capable of supporting 20 or more persons and weathering a heavy sea. The cylinders are made in sections so that if one of them becomes punctured, or springs a leak, only part of its buoyancy is lost. Although it is possible for such a raft to be capsized, there is little danger of it.

more, for certain light cars. To install the device, the intake manifold is tapped above the carburetor. A copper tube extends from it to the top of the radiator, while, to permit regulation, a flexible cable, reaching to a convenient point on the steering column, is supplied. After the motor has been warmed up, the valve is opened slightly. Suction causes moisture or steam to be drawn in from the upper part of the radiator. Because of its simplicity, there is little danger of the device failing to operate so long as the connections are tight. It is claimed

**MOTOR APPLIANCE DESIGNED AS FUEL ECONOMIZER**

For water-cooled pleasure cars and trucks, a valve has been devised which permits moist air or vapor to be introduced into the engine cylinders. The effect of this is to reduce fuel consumption, prevent carbon deposit, and cool the motor. According to reported, but unofficial tests, the saving of gasoline amounts to 25 per cent, or

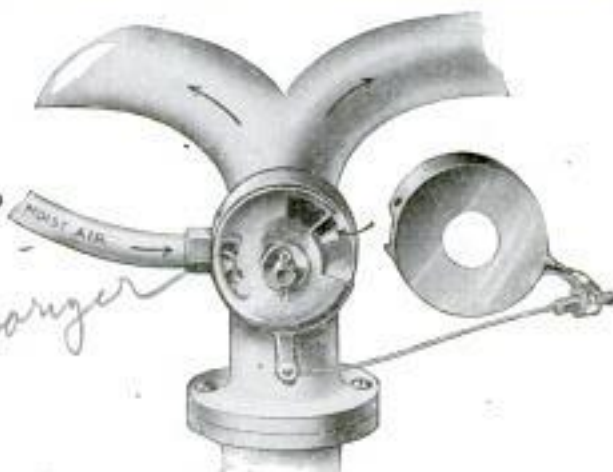

Showing Installation of Fuel-Saver, Which is Said to Cool an Engine and Eliminate Carbon

that, besides increasing mileage, the device reduces the carbon nuisance and cools an engine without chilling it.

49

839

*Quite Accurate*

*Vaporizer*

*Mfg. by: 'Tulcha' Products Co.  
 1313 - 3rd Ave., N.Y.C.*

*Price \$5.00*  
 Copyrighted material



1- Healy J. Hittler Construction Co.  
 Mark 1-111 new St. San Francisco, Calif.

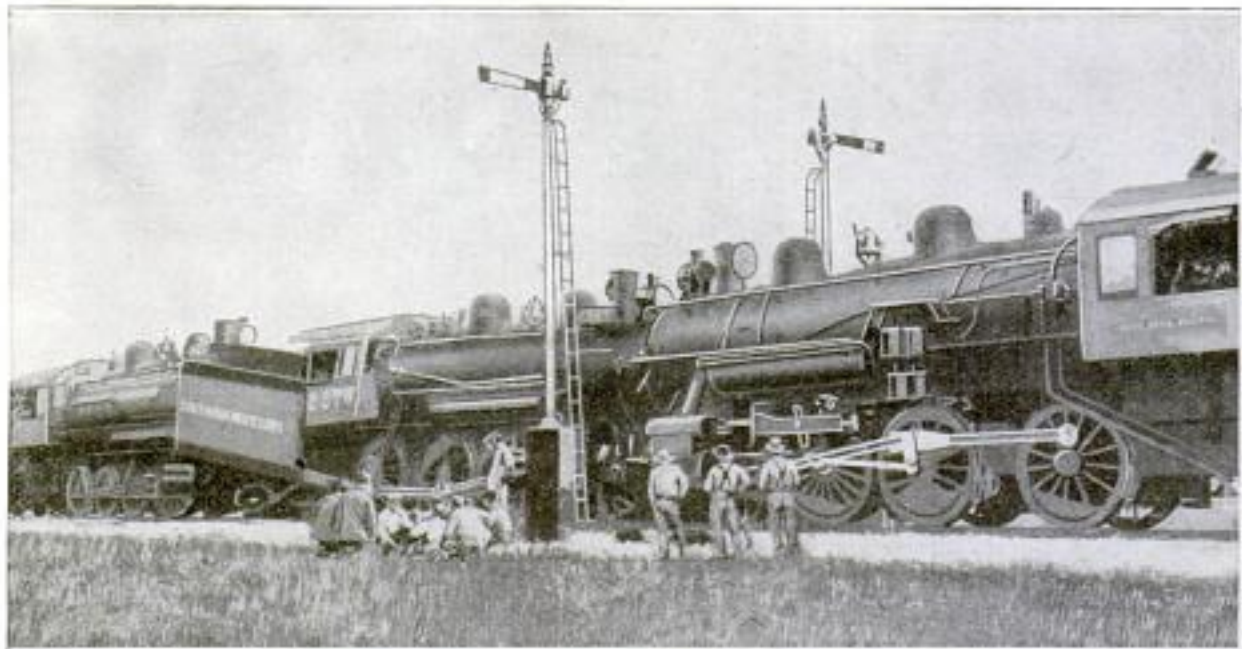

Collision Which Was Remarkable in That It Occurred Just at the End of a Signal Block: One Train Entered One Block Only Five Seconds Later Than the Other Entered the Adjoining Block. Both Trains were Drawn by Two Engines

**DRIVERS OF RECORD HEIGHT SINK LONG PILES**

33.15

Two of the tallest pile drivers ever employed have been used in connection with the foundation work for a new general office building that is being erected in San Francisco by one of the railway companies. The site of the structure is on filled ground, a fact that made it necessary to sink 2,285 piles, varying in length from 115 to 125 ft. Each of the drivers measures 133 ft. from its sill to the under side of its headblock.



**HEAD-ON TRAIN COLLISION AT END OF SIGNAL BLOCK**

48.15

A recent head-on collision of two freight trains has few parallels in railway history in that it occurred at the point where two block signals were located to mark the division between two blocks on a track which was used

*Railroad*

for trains traveling in opposite directions. The two trains met almost exactly at this deadline, because one entered one block only five seconds after the other had entered the adjoining block. Other factors contributing to the accident were the facts that the dispatchers' orders were defective and that a heavy fog obscured the right of way. Each train was drawn by two big locomotives. Two men were slightly injured in the crash.

**NEW AUTO LOCK HAS ALARM AS AN ADDED FEATURE**

A thick triangular block, to which a strong U-shaped metal member is attached, constitutes a new type of automobile lock. To protect a car the U-shaped part is clasped about the tire and rim of a front wheel, and then the two parts are snapped together like a padlock. A key unlocks it, but if it is tampered with, a gong begins to ring.



*San Francisco, Pacific Lines*

*Cairwald Mfg. Co*



THE wonders of modern artillery are by no means limited to the big siege guns, heavy fieldpieces, and other mighty weapons. These represent but one phase of artillery development and one which, deadly and destructive as these guns have proved to be, can be comprehended, in part at least, by the layman, even though "service in France" may be necessary to bring a full realization of the devastation wrought by these big fellows. The imagination can more readily conceive guns of large caliber throwing tons of shrapnel or high explosive shells than it can grasp the picture of the deadly, belt-fed, automatic machine guns—the Maxims, the Vickers, the Benet-Mercies, and the Colts—which are capable of discharging hundreds of small-caliber cartridges per minute, or one cartridge at a time, if desired, or of concentrating a rapid succession of any number of shots at any instant. Yet the story of the progress of the great war has been sharply punctuated by the achievements of these fire-spitting little arms, with which charges are prefaced and assaults broken down. Wonderful little mechanisms they are, indeed, but in reality, not very complicated, at least so far as their principle of operation is concerned.

The one most difficult task in connection with automatic guns is to keep the fiery little weapons cool, for the rapid fire these guns are capable of sustaining naturally results in rapid and serious overheating. For carrying off some of the heat, most machine guns are therefore surrounded by jackets in which water is caused to circulate. This necessitates a supply of water,

suitable connections, etc., and reduces the mobility of the gun. There is one exception to this arrangement, however, among the successful guns, and that is the Colt. The Colt differs from other belt-fed automatic guns—that is, guns in which the cartridges are carried and fed to the guns on long belts—in that it is air instead of water-cooled, and therefore of somewhat simpler construction. This air cooling is decidedly an advantage.

Briefly, the operation of the Colt automatic gun, which is typical of belt-fed machine guns in general, is as follows: Near the muzzle of the gun there is a small hole, known as the "vent," extending through the under side of the barrel to the bore. Right under the vent is a "cylinder," through which a larger hole extends to the vent in the barrel. Prior to the discharge of a cartridge—in fact, at all times except when the gun is being cocked—a piston fits into this cylinder, much as a cork fits into the muzzle of a popgun. On the discharge of the cartridge, part of the expanding gases propelling the projectile from the barrel escape through the vent after the projectile has passed that point, and

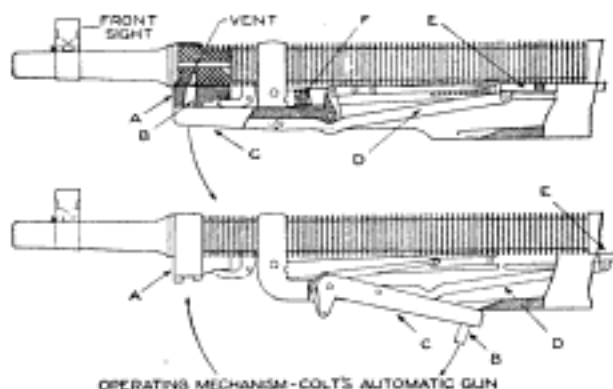

OPERATING MECHANISM—COLT'S AUTOMATIC GUN  
In the Upper Drawing the Gas Lever is Shown in the Closed Position, While in the Other Diagram It is Thrown to the Rear and the Retracting Springs Compressed. A, Gas Cylinder; B, Piston; C, Gas Lever; D, Gas-Lever Connection; E, Slide; F, Retracting Springs

blows the piston from the cylinder exactly as the cork is driven from the muzzle of the popgun. The piston is carried at one end of a lever, pivoted at its other end to the sides of the gun body, so that when the piston is blown from the cylinder, this gas lever swings through an arc of a circle, much as does the lever of an ordinary magazine rifle. In swinging through this arc, the gas lever compresses a spring—really a pair of springs, called "retracting springs"—by which it is returned to its



original position when the force by which the piston is driven from the cylinder is expended. Connected to the gas lever is a link which drives a guide under the barrel proper, toward the breech of the gun. This simple operation actuates the balance of the operating mechanism.

The backward travel of the guide causes an extractor to grasp the head of a cartridge in the feeding belt, withdraw it, and place it on the cartridge carrier. At the same time the ejector withdraws the exploded cartridge from the breech and casts it aside. Further backward travel of the guide causes the cartridge carrier to be tilted and the cartridge to be presented to the breech. Then the hammer of the gun is forced back, compressing the mainspring behind it, thus cocking the gun.

On the forward travel of the guide, that is, once the retracting springs have been compressed sufficiently to overcome the force which drove the piston from the cylinder, the gas lever starts back to its closed position, the cartridge is forced into the breech of the gun, the breech closed and locked,

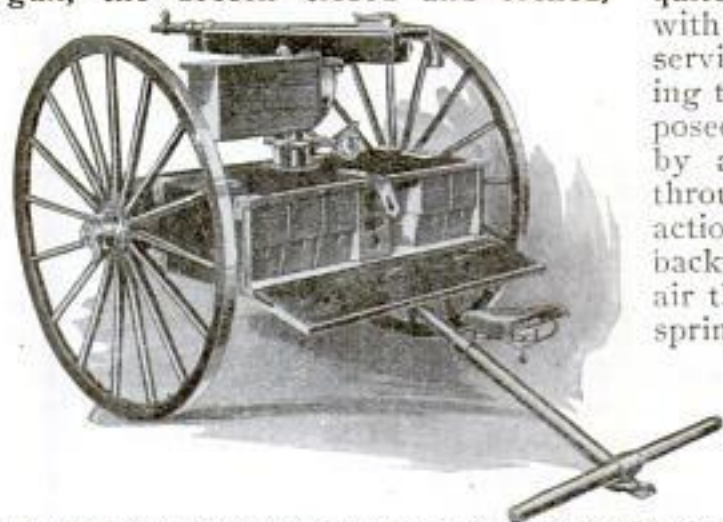

Here the Gun is Mounted on a Light Landing Carriage. The Ammunition Chest, Which is Shown Open, Contains Feed Boxes That Have a Capacity of 2,000 Rounds. The Seat is Attached to the Carriage Tongue

while the feeding wheel is indexed, so as to place the next cartridge in posi-

tion for the extractors on the next backward travel of the guide. The gun is then loaded and ready for firing, for the hammer which was forced back at the end of the backward travel of the guide is latched in a cocked position by the trigger and the sear. This sear automatically releases the hammer, in automatic operation, just as would a pull on the trigger, but only after the new cartridge has been placed in the breech and the

breech locked. The gun thus operates automatically as long as any cartridges remain in the feeding belt. When a steady stream of shots is discharged from the gun, which is accomplished by holding the trigger back without releasing it, the hammer is held by the sear in this cocked position only momentarily. Pulling the trigger of the gun operates the sear and releases the hammer, which is then driven forward forcibly by the mainspring behind it, the hammer striking the firing pin which explodes the cartridge.

The gun barrel, as will be noted, is quite heavy and its surface is indented with deep serrations, which are of great service in keeping the gun cool, giving to the barrel a large amount of exposed surface. This cooling is assisted by a jet of air automatically forced through the barrel by the reciprocating action of the hammer. On moving backward, the hammer compresses the air that has been trapped in the mainspring pocket, and this is forced through a small tube leading to the chamber of the gun, so that, on the ejection of each spent cartridge and before the insertion of a fresh one, a jet of air blows the barrel clean and free of unburnt bits of powder or of hot gases.

These automatic guns are usually mounted on tripods, in such a way that



Showing Empty Cartridge Belt being Fed Out of Colt Automatic Gun Mounted on a Standard Tripod: The Operator's Seat, Similar to That of a Bicycle, is Fastened to the Rear Leg, Which Also Carries the Tool Kit



they can be pointed in almost any direction. Or they may be mounted on light two-wheeled carriages, on automobiles, or on parapet mountings for fortifications, and in various other ways.

To place the gun in operation, a feed box in which the long belt containing the cartridges are looped in layers is attached to the breech casing of the gun, and the end of the belt is entered between the feed guides. To cock the gun and start things going, the gas lever has first to be pulled, by hand, down and back, just as is the lever of a magazine rifle. Pulling the trigger then explodes the first cartridge, and as long as the trigger is held back the operation of the gun is entirely automatic. The Colt automatic gun can fire slightly over 400 shots per minute.

Any machine gun which is called upon to fire some thousands of cartridges continuously will naturally become pretty hot. In the Colt-gun construction this handicap is overcome by ability to disconnect the heated barrel and replace it with a fresh, cool barrel. This change can be accomplished in a few seconds.

Only one man is required to operate the gun, although two others usually accompany him, one to handle the feed boxes and a third in case of accident

to either of the other two. The regular standard two-wheeled light carriage is furnished with an ammunition chest holding several cartridge belts, the individual belts containing 250 cartridges. Each belt is carried in a separate feed box, the belt laid in horizontal layers so that it can be withdrawn by the feeding mechanism of the gun.

Four feed boxes are included in the equipment accompanying the standard tripod mount, which requires two or three men for its transportation, one man to carry the gun, weighing about 35 pounds, and the mount, weighing 28 pounds, while the others divide between them the tripod proper with its tool bag and the thousand cartridges in

four belts, totaling about 125 pounds. Or the complete equipment, consisting of the gun, tripod, tool bag, and four belts of cartridges, in feed boxes, weighing in all, about 180 pounds, can readily be carried by a horse.

The empty belts, conditions permitting, can be gathered up as they drop from the gun, replaced in the feed boxes and subsequently

reloaded, either by hand or by an ingenious little belt-loading machine which is operated at a fair rate of speed by a hand crank.

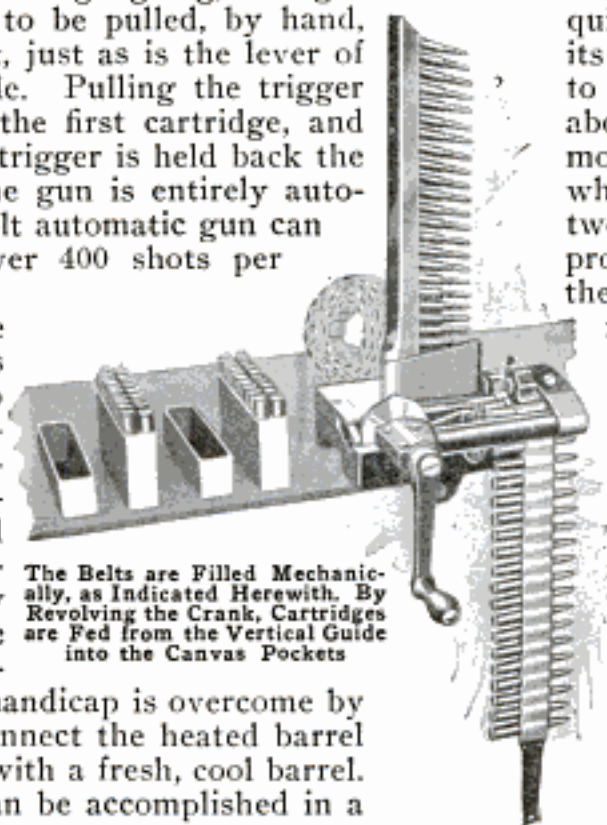

The Belts are Filled Mechanically, as Indicated Herewith. By Revolving the Crank, Cartridges are Fed from the Vertical Guide into the Canvas Pockets

### 387 | MAKING FOG TO ORDER TO HUMIDIFY AIR

Fogs are in such great demand in certain industries that they must be made to order at great expense. Cotton, wool, silk, and cordage mills, warehouses, paper mills, leather and felt factories, printing plants, and scores of other industrial works require a uniformly humid atmosphere which is not naturally obtainable. One of the most common means of attaining this end is

by producing fog at numerous points throughout a plant and mixing it with the surrounding air.

Humidification often eliminates a multitude of difficulties. Consider cotton making, for instance. Cotton, as it is gathered from the fields, contains considerable moisture. In order to make the cotton fibers cling together, and remain strong and elastic, it is



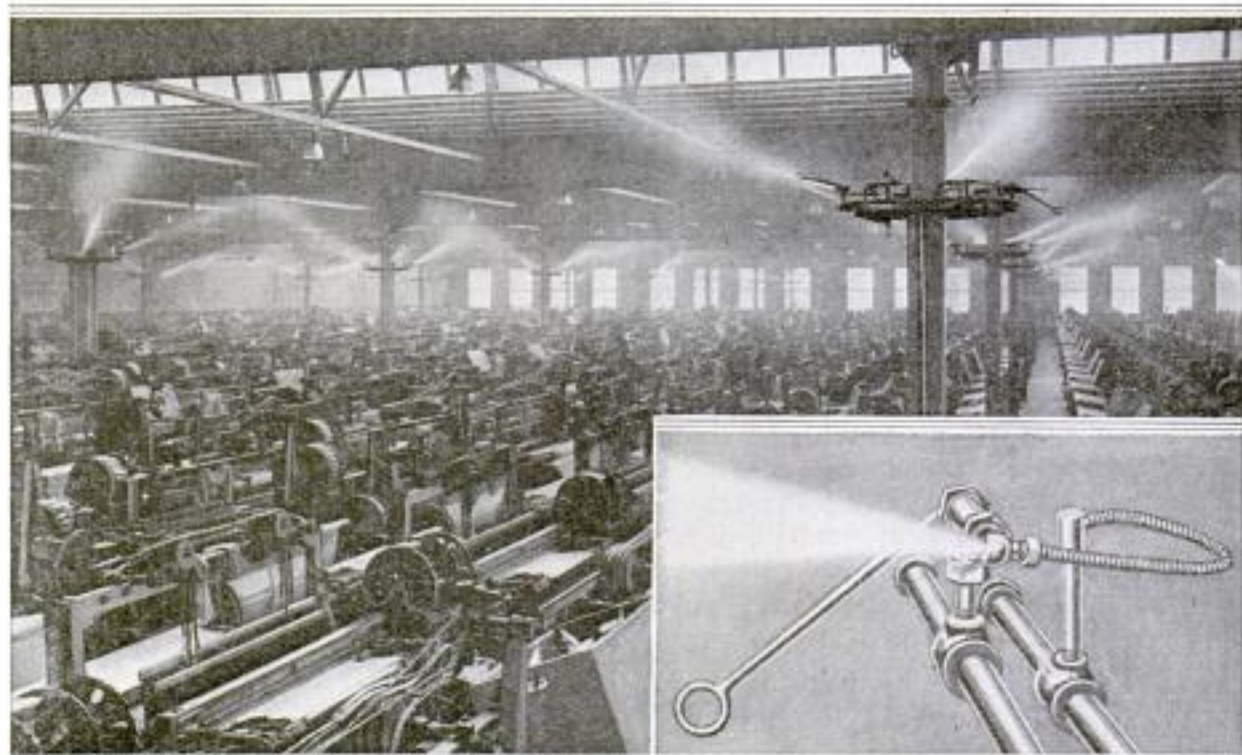

Humidifying the Air in a Textile Factory to Secure the Best Working Conditions for the Raw Material and Fabrics Made: The Insert Shows Details of Spraying Apparatus Seen on Each of the Pillars in the Larger Picture

essential that the natural moisture should be retained. Hence it is necessary to spin, weave, or knit in air sufficiently humid to prevent drying of the fibers. Cotton worked too dry throws off minute fibers in large quantities in the form of dust or lint. This lint quickly accumulates and not only is a considerable loss in itself, but also necessitates constant cleaning of mill and machinery. Furthermore, such dust is highly injurious to the workers and increases the fire hazard.

The fact that the climate of Great Britain is exceptionally moist undoubtedly had much to do with its remarkably early development of textile manufacture. In this country, for similar reasons, textile mills were formerly located almost exclusively on the Atlantic seaboard. Nowadays, climatic conditions make little difference in the choice of a factory site, for rainy-day atmosphere can be obtained the year round, if desired, by artificial humidification. Even in England over half of the cotton mills are today humidified by artificial means.

In the early days of textile manufacturing, floors were sprinkled and

troughs of water were kept near the machines—a crude method. Later, steam was employed. This accomplished the desired result, but overheated the air and made working conditions intolerable. Nowadays one of the commonest ways of humidifying in mills is accomplished with the aid of compressed air. In the atomizing apparatus used for this purpose, water flows by gravity through a pipe having a nozzle near its end, but it is not under sufficient pressure to rise to the nozzle of its own accord. Compressed air is conducted through another pipe. By turning a lever compressed air enters the nozzle, and in escaping, forms a partial vacuum which draws the water into the nozzle. Here it mixes with the escaping air and is blown out with considerable force in the form of an exceedingly fine spray—in other words, a dense fog—which quickly mixes with the surrounding air. The compressed air alone controls the operation and water cannot overflow and damage stock in process of manufacture.

Sometimes hundreds of these atomizing nozzles are located in a single room of an industrial plant.



## SPECIAL BODY WILL ANSWER INQUIRIES ABOUT "SAMMIES"

4929 Announcement has been made of the creation of a special division in the army charged with the duty of gathering information regarding the welfare of American soldiers in France for the benefit of families and friends. The branch is known as the Statistical Division and will embrace a personnel of about 1,200 officers, men, and field clerks. Members of the organization will be stationed with the general, divisional, and regimental headquarters as well as with each organization unit at the front. The service will also reach field and base hospitals, ports of embarkation, and training camps in the United States. Because of the small size of our regular army in the past, it has never been necessary to maintain a special body of this character. With a million or more men in the field, however, conditions will be changed. The Navy Department, on the other hand, has arranged to expedite the transmission of so-called "life and death" messages passing between officers and enlisted men and their families. It has been announced that such telegrams should be dispatched to the Bureau of Navigation at Washington so that they may be immediately forwarded by wire or cable to the proper naval station or ship. Communications should be addressed according to the following form: John Jones, U. S. S. Kansas, c.o. Bureau of Navigation, Navy Department, Washington.

Parcel post

## CLERKS HANDLE HOLIDAY MAIL IN EXTRA CAGE

3646 Last year congestion of the holiday mails was entirely avoided in the post office at Cañon City, Colo., by partitioning off a suitable space at the rear of the post-office lobby with heavy wire netting and using this reserved area for handling the Christmas packages. The "cage" was provided with a counter, scales, etc., and clerks were stationed at either side of the window to receive, weigh, and stamp the pack-

ages. Because of this well-planned arrangement, the office was able to handle 16,500 parcel-post articles and



Special Cage Erected in Canon City, Colorado, Post Office in Which Holiday Packages Were Handled, Thereby Preventing Any Congestion in the Part of the Office Where the Regular Mail was Managed

1,624 insured parcels during the week before Christmas—all without interference with the routine postal service.

## IRRIGATION SPILL PIPE OF ORNAMENTAL TYPE

4779 In marked contrast to the ordinary spill pipe to be found in irrigated regions, is a very ornamental one inclosed in a paneled concrete column, as shown herewith. The wealthy ranch owner applied artistic taste in the construction of his house and out-buildings and considered it only appropriate that this pipe should be in harmony with its surroundings.



By an interesting street-numbering system adopted at Pernambuco, Brazil, a building's number indicates its distance in meters from a central dividing line. A house bearing "235," for instance, would be about 235 meters from the starting point.

An Invaluable  
Harvard L. S. Copyrighted material  
Culver City, Calif.



## SALMON-DRESSING MACHINE WORKS AT HIGH SPEED

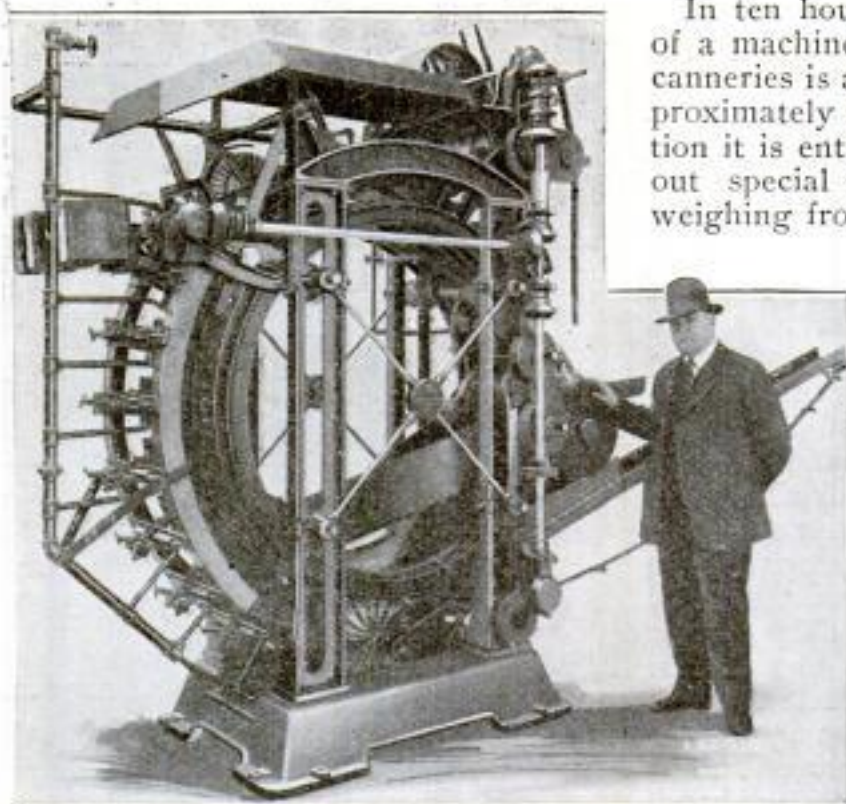

In ten hours' time the latest model of a machine intended for use in fish canneries is able to clean and dress approximately 36,000 salmon. In operation it is entirely automatic, and without special adjustment handles fish weighing from two to 20 lb. Because of its speed, it is able to do the work of about 60 expert laborers, and thus is an important economic factor in a cannery. As salmon are carried upward and around a large wheel, they come in contact with knives and revolving devices that remove the heads, tails, fins, and entrails. The offal drops to conveyors which carry it to near by fertilizing plants, while the fish proceed to scrubbing troughs.

Doing the Work of About 60 Experts, This Machine Dresses and Cleans One Salmon Every Second

## 4483. ARTESIAN WELL BURSTS FROM ITS CASING

An artesian well that has been a source of trouble to the village of Sheldon, N. D., ever since it was drilled

ft. deep and incased by a 4-in. iron pipe, the original pressure of water at the bottom being 80 lb. to the square inch.



Crater and Deep Lake Formed by the Bursting of an Artesian Well That Threatened to Undermine the Business Part of a North Dakota Village

15 years ago, burst out of its casing recently and threatened great damage to the community. The well was 780

ft. deep and incased by a 4-in. iron pipe, the original pressure of water at the bottom being 80 lb. to the square inch. An overflow outside the casing soon after the well was connected with the waterworks system, flooded several square miles of surrounding farm territory, and the village was still fighting damage suits brought by farmers when the latest outbreak of water occurred. This time the well pipe sank out of sight and a cavity, 80 ft. in diameter, opened up, the water being in violent motion for two days. Soundings showed the crater to be 70 ft. deep at the point where the well



House at  
1821 W. Adams 1927  
Los Angeles, Cal.

pipe disappeared, and its size slowly increased as the edges fell into the newly formed lake. The village officials planned to fill it in and cut off the threatening flow of water by dumping in gravel, to be furnished by the local railroad. It was estimated that at least 130 carloads of gravel and sand would be required to stop the dangerous flow.

4713 **BUILT-IN FLOWER BOXES FOR APARTMENT HOUSE**

A very artistic and convenient feature which has been incorporated in a new apartment house consists of concrete flower boxes which have been built into the walls of the dwelling as an integral part of it. A spray pipe, connected with the water system, extends along the inner edge of the boxes so that the plants can be sprayed

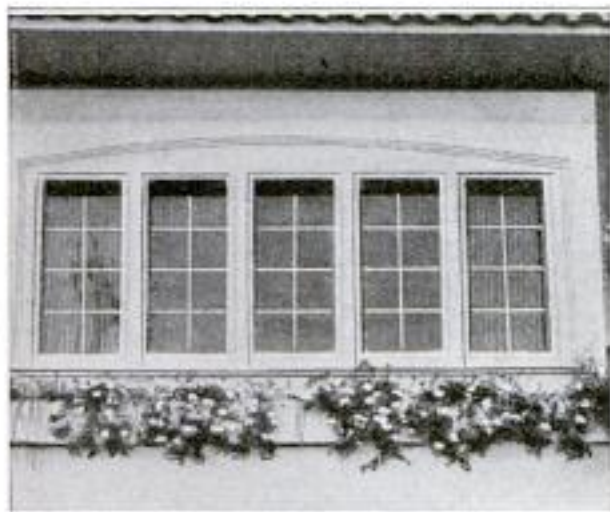

View of End of Apartment House, Showing Flower Boxes Built into the Wall at the Second-Story Level: They are Provided with Permanently Connected Spray Pipes and Drains

merely by turning on the water. Drains are provided which connect with the descending gutter pipes.

4748 **WHEN A WHEELBARROW ISN'T A WHEELBARROW AT ALL**

To many persons, perhaps, the convenience of a mobile washtub is not entirely apparent. To "Mexican John," who lacks one of a more approved type, however, it gives complete satisfaction. At first thought, the story of a "greaser" washing his shirt in an iron



Possibly an Unusual Glimpse of an Alien Guest: A Mexican Who Washes His Clothes in a Wheelbarrow

wheelbarrow seems inane, but "Mexican John" gets his shirt clean. That makes it a story!

4813 **AUTO FOR ALASKAN TRAILS HAS RUNNERS IN FRONT**

The field of the light, well-built American automobile extends even to the snow-clad regions of Alaska. One car owner in the northland has made his machine serviceable on good winter trails by equipping the front wheels with runners and the rear wheels with heavy chains. A special body, which also incloses the engine, is used in place of the regular equipment. This arrangement imparts added warmth to the interior of the car.

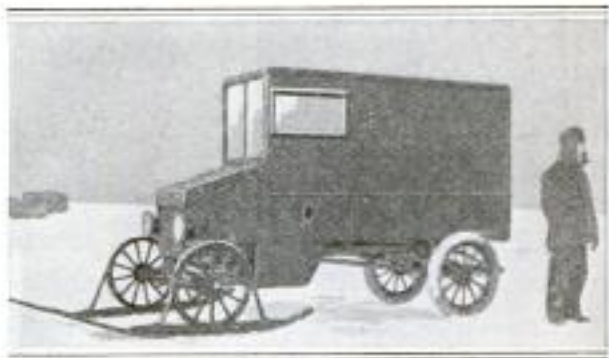

Automobile Which Gives Good Service in the Snowy Trails of Alaska: The Rear Wheels Have Heavy Chains

No. Inf.



NEW AND SERVICEABLE OUTFITS AND DEVICES

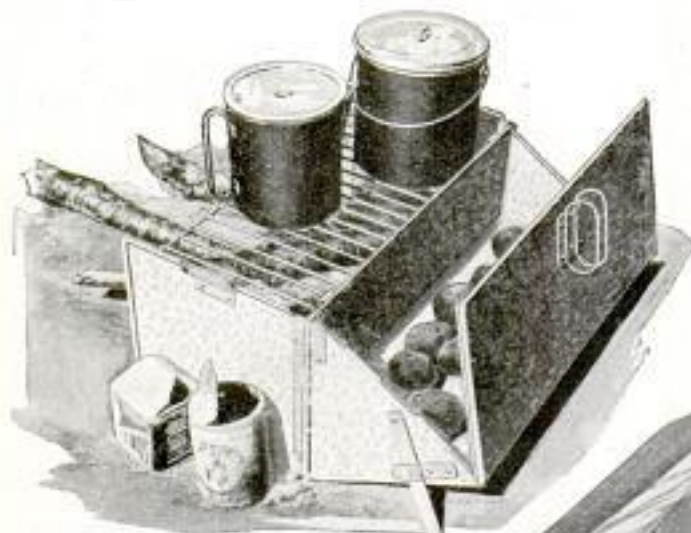

Collapsible Stove and Oven of Galvanized Iron: Wood of Any Length can be Burned by Inserting Sticks Endwise. Folded, It Makes a Flat Thin Package with Smoked Surfaces Within



Broiler and Frying Pan Combined: Grease Runs from Corrugations into the Outer Ring Where It is Not Apt to Burn



Well-Planned Outfit, Including Seven-by-Seven-Foot Tent, Two Double Beds, Two Camp Chairs, and Table: Latter Is of Sheet Metal. Folded, It Measures 11 by 18 by 48 Inches and Serves as a Case for the Whole Equipment, as Shown at the Left



By Using Mother's Fruit-Jar Holders the Jars Become Handy Picnic Pails



Folding Picnic Table and Seats for Six, Made of Angle Steel and Heavy Khaki: Outfit is Quickly Set Up, as Shown Below, and When Knocked Down Makes a Roll Only 34 Inches Long

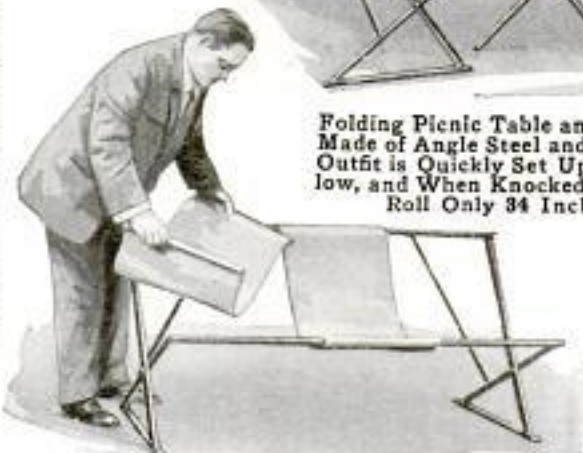

*Campfire Comfort on Camping Co.  
430 - ...*



*1915*  
**THAT ADD TO THE PLEASURE OF OUTDOOR LIVING**  
*Camping Outfits*



Leather Refreshment Case with Two Heat-Retaining Bottles and Lunch Box

The Frame of This Outer's Tent Consists of Three Pairs of Stakes Which also Support a Cot: Outfit can be Rolled into a Package Four Feet Long, as Shown at Left



A Collapsible Grate for an Open Fire: It Is Strong, Quickly Set Up, and can be Packed into a Small Space



Handy Canteen Holder That can be Clamped to Any Auto Running Board without Marring Same



Head Protector of Wire Gauze with Isinglass Window and "Blowhole" That is Handy for the Smoker



Very Serviceable Table of Wood and Steel for Auto Parties: Collapsed It Measures Four and One-Half by 36 Inches; Weight, 15 Pounds



A Type of Chamois Jacket Made for Men and Women: Light, Soft, Very Warm, and Water-proof; Fine for Outings

*Mfg. Southerland Co.  
 Knoxville, Tenn.*

*1915*



### WORLD'S TALLEST CHIMNEY COMPLETED IN JAPAN

4828

In many cities in various lands are chimneys which have been proclaimed as "the tallest in the world," but the structure which, without doubt, truly possesses this title has recently been completed in Sagonoseki, Japan. It is of reinforced concrete and stands 570 ft. high, on a hill 430 ft. higher than the copper smelter with which it is connected, so that it discharges its poisonous fumes 1,000 ft. above the plant. The chimney is 42 ft. in diameter at the

2,700 cu. yd. of concrete. The first 150 ft. of the chimney has a concrete lining separated from the outer wall by a 5-in. air space. Four hundred tons of steel were used in the whole construction. Only by comparing the photograph of the completed structure with that showing the base alone, which contains an arch 31 ft. high, can one get an adequate idea of the dimensions of this great chimney. A long zigzag flue leads from the smelter up the hill, to the base of the structure.

The reason for making this passageway so irregular was to thoroughly baffle the gases as they passed on their way to the great upright vent.

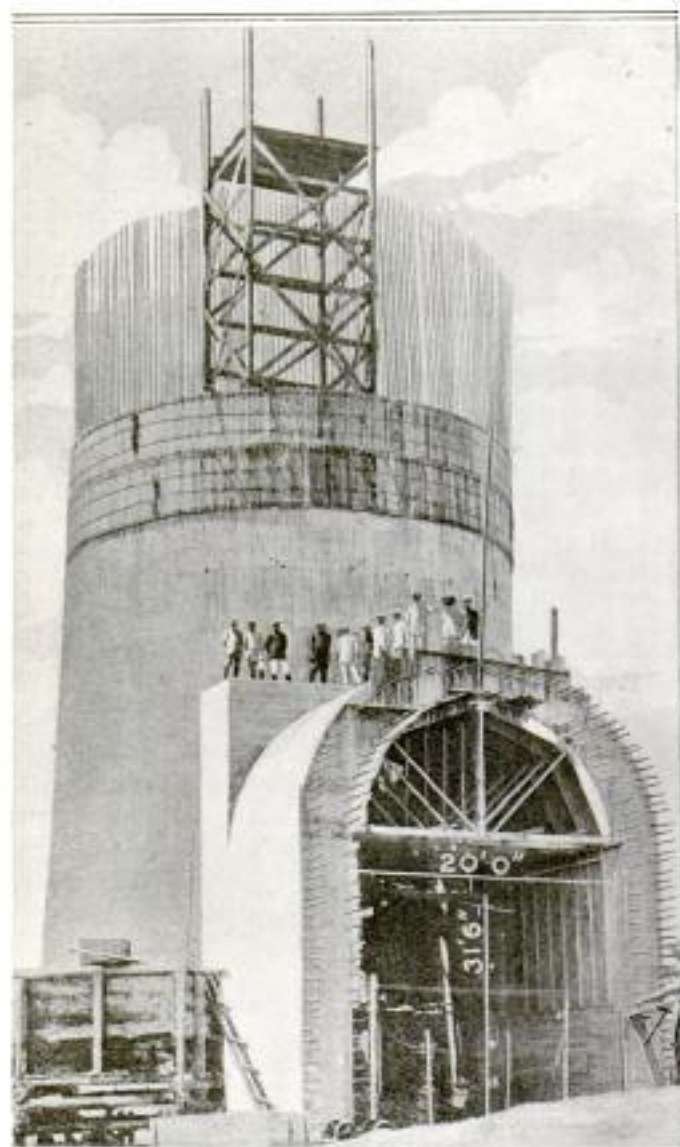

The Base of the World's Greatest Chimney. Showing the 31-Foot Arch to Which a Zigzag Flue was Later Built from the Smelter



If the Woolworth Building Stood on the Ground beside the Smelter This Chimney Serves, the Stack would Tower above the Building About as Shown

base and its inside diameter at the top is  $26\frac{1}{4}$  ft. The foundation is 95 ft. in diameter and contains



**CABLEWAY AT BOTTOM OF  
WORLD'S GREATEST GORGE**

The cableway across the Colorado River in the Grand Cañon possesses an interest which perhaps no similar carrier in the world has because of its magnificent surroundings and the extraordinary difficulties encountered in installing it. This aerial way is located a little upstream from the Grand Cañon railway station, which is on the south rim, and is 500 ft. long, the river at this point being 400 ft. wide. The big steel cable was purchased at Salt Lake City and hauled by wagon 225 miles from the end of a railway in Utah to the head of Bright Angel Cañon on the north rim of the great gorge. Here it was divided into seven pairs of coils which were strapped to seven pack horses. The perilous trip down a rough deer trail to the river, though covering only 12

miles, consumed three days. One animal was lost on the way. On reaching the bottom a riverman crossed the turbulent stream trailing behind him a rope with which the cable was later drawn across. Anchored in the steep

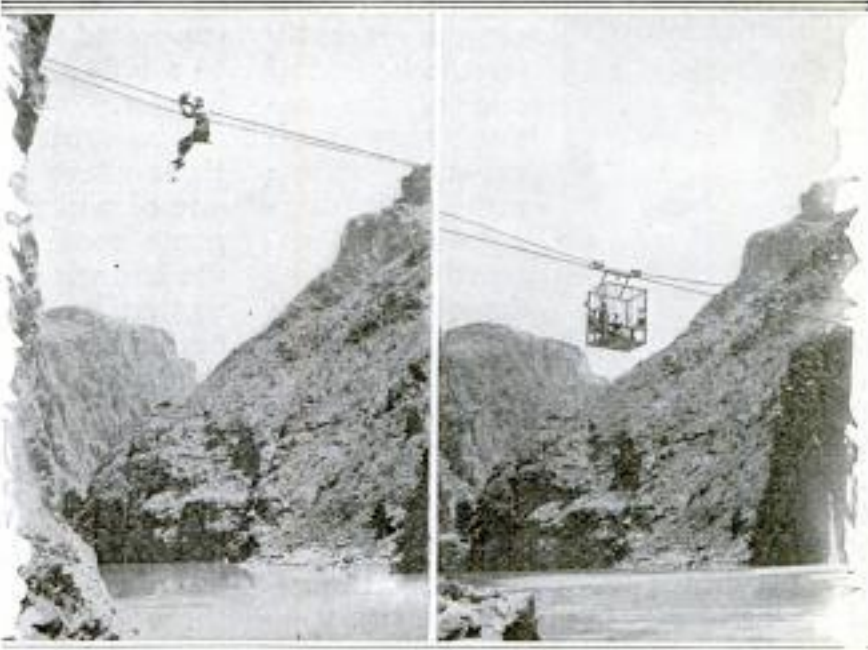

PHOTOS BY D. D. RUST  
Left: Crossing Hand over Hand with a Trapeze. When the Cage is Not Available One must Cross This Way or "Go Around," Which Means About a Week's Journey. Right: The Cage Propelled by Means of a Hand Windlass and a Light Cable; It Rides About 60 Feet above Mean Water Level

walls, the steel line supports a cage that is drawn back and forth by a smaller cable and a hand windlass. A toll is charged for use of the cage.

**LAUNDRY APPARATUS DRIES  
AND IRONS HOSIERY**

A labor-saving device, especially suited for laundries that do family washing, is a hosiery ironer consisting of a long, low table, from which hollow stocking-shaped forms of various sizes project diagonally. Over these forms, which are heated by steam supplied from a pipe extending under the table, the damp, freshly washed hose are stretched to dry and to be ironed at one operation. By means of an adjustable heel, each form can be made to fit stockings of

several sizes. A clamp is provided which clasps the top of the stocking and holds it close to the form, supplying the required tension during the drying, process.

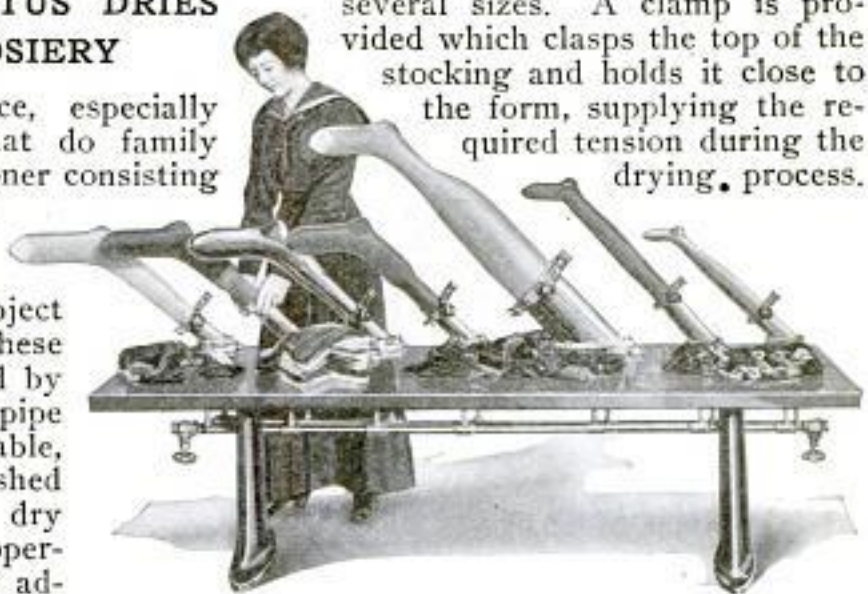

Hose Stretched over These Steam-Heated Forms are Dried and Ironed at One Operation. By Means of an Adjustable Heel, Each Form can be Made to Fit Stockings of Various Sizes

*Huebner Mfg Co. 309 Mfgs. Home  
Milwaukee, Wis.*



### AUTOGRAPHED BASEBALL BRINGS BIG PRICE

4932  
A baseball bearing the signature of President Wilson was the novel memento put up at auction at a ball game



which was played recently for the benefit of one of the nation's new regiments. The president's signature was secured by one of the congressmen

on behalf of constituents who sought to obtain something out of the ordinary for the occasion. The ball was widely advertised and, on being offered to the highest bidder at the opening of the game, was sold for \$151. It cost \$1.25. The proceeds from the sale of tickets and the ball will be used to purchase delicacies for the regiment.

### NEW VARIATION OF TENNIS PLAYED WITHOUT A NET

692  
A modification of lawn tennis, known as "netless" tennis, is attracting the attention of many lovers of mild outdoor sport because it requires less strenuous effort than regular tennis, and yet affords great opportunity for a display of skill. The game is played on a court about half the size of an ordinary tennis court, at one end of which

stands a smooth brick wall, extending the full width of the area. The end of the court next to this wall is 3 in. higher than the opposite end. In the center, at the top, the wall has a rounded projection encircling a 10-in. hole, or trap, behind which is a netting connected with a chute that leads down to a hole near the bottom of the brick barrier.

The court is divided lengthwise into three alleys of equal width, the center one of which is called "neutral." The game consists in each player driving the ball with his racket against the wall so that it will rebound into the neutral, or his opponent's, alley. If it strikes the wall below what is called the "fault line," which extends across the barrier 27 in. above the ground, it is considered "out." A ball cannot be played on the second bounce. All points count one except when a ball is driven into the trap and is returned through the hole below, in which case it counts five. The score for a game is 15. Only one service ball is allowed, and when a person is serving he stands facing the left, with his feet parallel to the wall, but after the serve the plays are made in natural positions. The server, or "hand in" as he is called, starts in the right court and alternates after each hand as long as he continues to win. As soon as the server loses a point, the service goes to the opponent, who begins in whichever court he then happens to occupy.

The cost of constructing

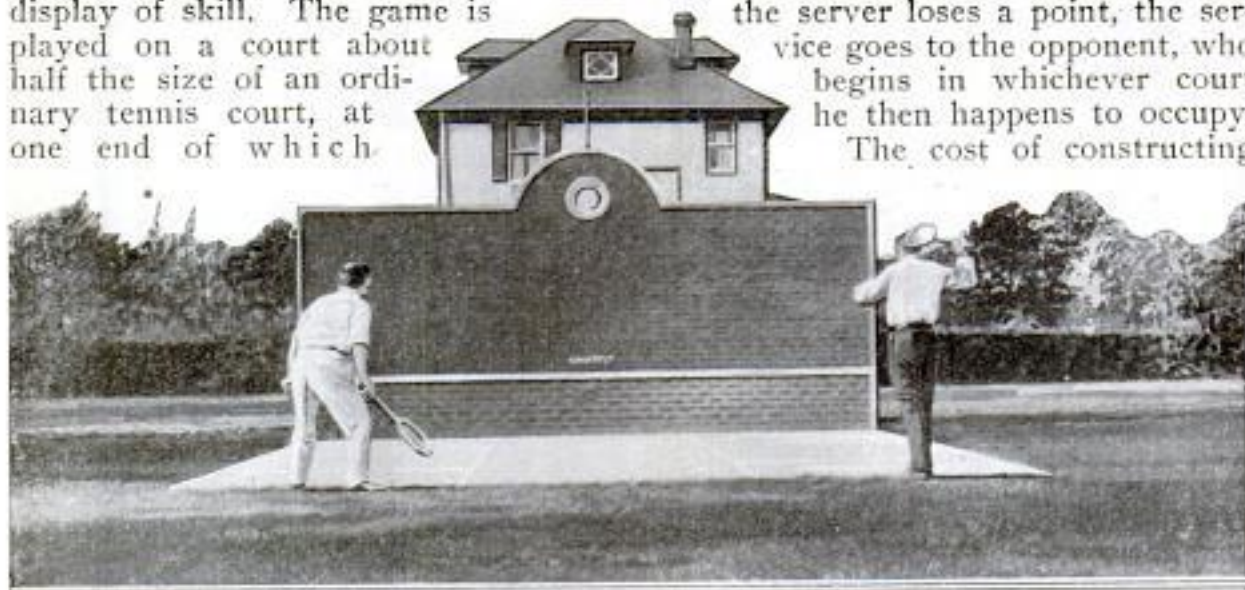

Playing Tennis without a Net: A Variation of a Popular Game in Which the Players Stand at One End of a Short Court and Seek to Serve, or Return, the Ball so That It will Rebound into the "Neutral" Alley or That of the Opponent

For further info see p. 100

L. R. W. Williams, 170 Roseville Ave., New York, N. Y.

Copyrighted material



Blaine Clark Co.  
Sporting Goods  
Los Angeles

one of these courts depends largely on the taste of the owner. When once built there is practically no upkeep expense. Netting extensions should be placed about the wall to catch wild balls. The floor of the court may be of well-rolled clay or of cement.

**MOONSHADE CAMP ACCESSORY FOR OPEN-AIR OUTERS**

4973

To prevent the moon's mellow rays from disturbing the slumber of mountain campers who taboo tents during pleasant weather, a special shield has been devised. It consists of a rectangular piece of canvas attached to the top of two sticks that are pointed at their lower ends so that they may be driven into the ground readily. By placing the shield at the proper angle and near the head of a cot, one may effectually screen himself from the direct glare of a full moon. The device has been introduced in a district where the absence of dew, and the general



The Shield Screens the Open-Air Sleeper from the Direct Glare of a Full Moon

prevalence of fair weather, make open-air camping the rule rather than the exception among sportsmen and outers.

**NOVEL MOTOR UTILIZES WASTE WATER POWER**

4764

With a view to utilizing the wasted water power of a stream without building a dam, an interesting experiment has been conducted with an unusual type of water motor which, it is claimed, has operated satisfactorily. The mechanism consists of two floats, 40 in. long, beneath which are two spiral screws, 10 in. in diameter and 32 in. long. An-

chored in a stream flowing 27/10 miles per hour, it is asserted that the motor

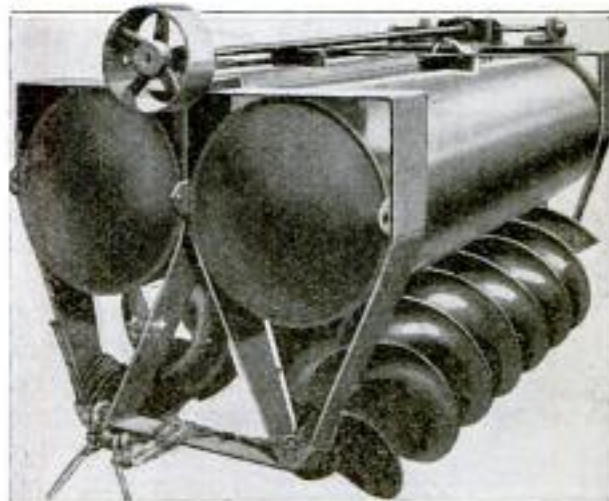

By Means of the Two Spiral Members, Which Are 10 Inches in Diameter, This Water Motor was Able to Develop More Than One-Fourth of One Horsepower in a Stream Having a Moderate Current

developed a little more than 1/4 hp. The possibilities of motors of this sort for practical service are yet to be determined, but the inventor estimates that two motors, 40 ft. long, could produce over 100 horsepower.

**BACK YARDS TRANSFORMED INTO AUTO STALLS**

4555

Because a western city has been unable to provide adequate parking space for the increasing number of automobiles, residents are fencing off their back yards into auto stalls and are renting them at stated rates. One yard contains four such divisions, each surrounded with a strong wire fence and provided with a gate that locks with a padlock.



Back Yard, a Portion of Which has been Fenced off into Automobile Stalls: Each Division Has a Separate Gate and is Locked with a Padlock

W. J. ...  
Mechanical ...



Inu: M.H. Cottrell  
32-*Brook St.*

*Central Park  
Lombard Ave. Calif*

**HEIGHT-MEASURING DEVICE  
IS CONCESSION MACHINE**

485

Apparently on the assumption that a person's height is a matter of almost as much interest to him as his weight, an inventor has recently patented a measuring machine that is intended to take a place beside the gum dispensers, and numerous other vending devices, so familiar in public places. By dropping a coin in a slot and pulling down a flexible contrivance until it comes in contact with the top of the head, one's height, in terms of feet and inches, is registered on a dial on the front of the



apparatus. In general design it has much the appearance of the familiar coin-collecting weighing machine.

force thrusts this greasy mass against the sides of the container and the oil gradually works its way through the holes, while the metal remains within. The oil so conserved is used again and again representing an important saving to the company.

**CONCRETE CONE OBVIATES  
RESETTING OF STAFF**

By constructing a large cone of concrete about the base of a 120-ft. flag-staff, a resourceful city engineer obviated the necessity of resetting the staff, which had become so loose that it threatened to fall. The cost of reënforcing the base was about half the estimated cost of resetting. Several braces were firmly spiked to the pole near its base, and then



earth was excavated around it to a depth of 10 ft. At the bottom of this hole, 12-ft. piles were driven, 6 ft. apart. A cone of concrete which projected several inches above ground level, was then poured over the top of the piles and earth filled in about it. The new base made the staff absolutely secure.

**SEPARATORS SAVE OIL  
IN BIG AUTO PLANT**

485

In a large automobile manufacturing plant which uses 1,300 gal. of cutting oil per day for drills and other cutting tools, 12 oil separators are employed which effect a saving of 500 gal. daily. Each machine is provided with an outer cylindrical case, within which is a smaller perforated cylinder which revolves swiftly. Into



this whirling container workmen shovel metal chips and oil collected from various machines. Centrifugal

**QUEER PHOTO SHOWS PUFFS  
PRECEDING BIG BLAST**

485

A strange-looking photograph, which at first glance might be mistaken for a picture of trees of some strange species, was taken recently just as a big blasting charge was set off in a lime quarry. Eight tons of powder were placed in fifty-four 8-in. holes that penetrated the earth to a depth of 50 ft. The picture is very unusual in that it shows smoke shooting from

*Explosives & Cement Co.  
Copyrighted material*

*Opera Co.  
Har & Wilcox*



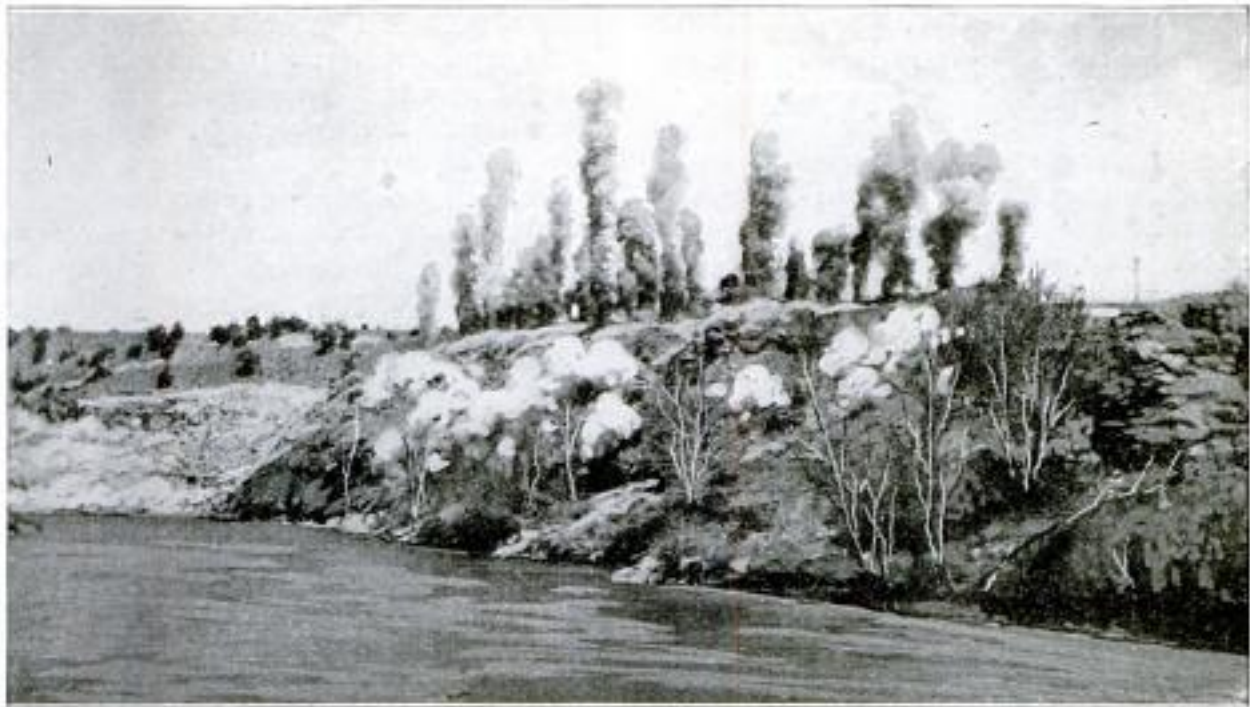

The Beginning of a Tremendous Blast: This View was Snapped Just After Eight Tons of Blasting Powder was Set off. The Vertical Puffs of Smoke Preceded the Upheaval by Only an Instant

the holes in tall, straight puffs immediately before any earth was dislodged. Evidence of the upheaval that was to

follow is found also in the little clouds of smoke issuing from the sides of the embankment.

### LITTLE ENGINE FOR HOME HAS ORIGINAL DESIGN

Both in appearance and in other features a little portable engine for home and farm use, now on the market, is unusual. As a safety precaution, all its moving parts are inclosed, except the pulley, on which a belt can be placed to run practically any machine that can be operated by a hand crank. The flywheel is in reality a large fan which forces a blast of air down around the cylinder to keep it cool. The latter is inverted in order to insure a favorable starting condition even in the coldest weather and to prevent flooding. The connecting rod is easily adjustable and is provided with ball bearings. The engine has no oil cups, lubrication being obtained by mixing

oil with the gasoline. One feature which makes it easy for inexperienced persons to operate this engine is a combination foot starter and countershaft. A speed of from 500 to 1,400 revolutions

per minute can be obtained and is controlled by turning a thumbscrew above the main bearing.

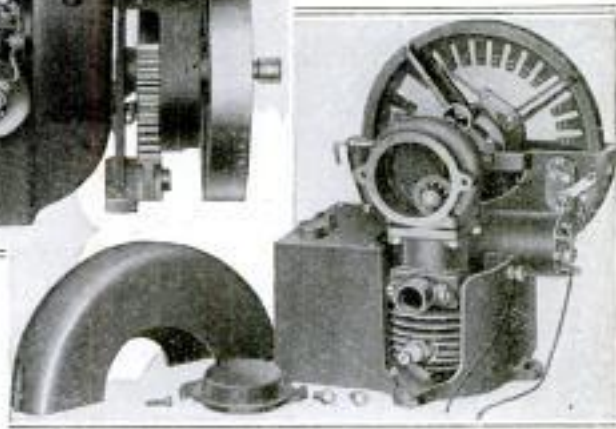
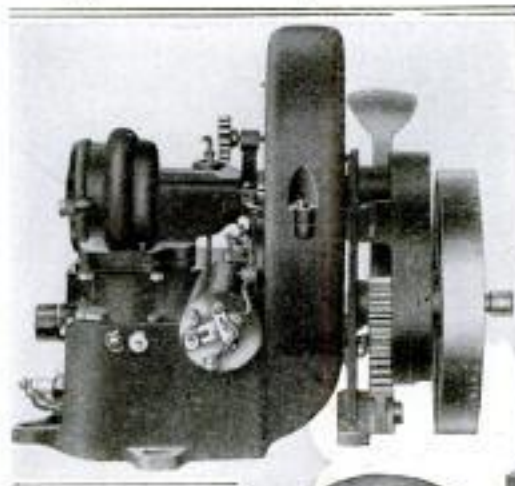

View of Portable Engine for Home Use Easily Operated by an Inexperienced Person. Lower View: Engine with Crank-Case and Flywheel Covers Removed, Showing Fan Flywheel and Cylinder

*Elgin Case Mfg Co*  
*Elgin, Ill.*



## REVOLVING BRUSH CLEANS 4924 THREADS IN SHELLS

At a certain plant now engaged in the manufacture of war munitions, an efficient scheme has been devised for cleaning the threads in the nose of a shell. A wire brush attached to the tool end of a portable electric drill is employed. The shells lie horizontally



COURTESY OF MACHINERY  
Cleaning the Threads of Shells with the Aid of the  
Motor-Driven Wire Brush

in racks so that the brush may be readily introduced into the orifice. In this way only a moment is consumed in freeing the threads of small chips and dust particles.

## 4811 WAR DEPARTMENT'S VIEWS REGARDING USE OF FLAG

Many inquiries have been received by the War Department concerning the proper methods of displaying and hanging the national emblem. In response, the adjutant general has issued a statement in which several suggestions are made to civilians. In doing

this, attention has been called to the fact that there is no federal law regulating such matters and that the War Department exercises no authority outside of the army.

Each day of the year, regardless of weather conditions, it is the custom in the army to hoist the flag briskly at sunrise and to lower it slowly and ceremoniously at sunset. On Memorial Day it is displayed at half-mast from sunrise until noon, and at full-mast from noon until sunset. In general, the flag should be suspended from a staff in the formal way, and not displayed otherwise. For decorative purposes bunting, not the flag, should be employed. If, however, the emblem is to be used in that way, it should always be hung flat with the union toward the north or east, regardless of whether the display is made inside or outside of a building. A flag should rarely be placed in a horizontal position or laid flat, and under no circumstance should it be hung where it would easily become soiled or injured. It should never be draped over chairs or benches that are to be used for seating purposes, and in no case should anything be placed upon or above it. The War Department sees no objection in flying the flag at nighttime on civilian property. When several banners are unfurled on the same pole, or otherwise displayed, the Stars and Stripes should be run up first and given the position of honor above all others.

When a flag becomes old or worn it should not be used. If it is no longer fit for display, it should be privately destroyed. This should be done by burning it in a manner free from all suggestion of irreverence or disrespect.

Several states and, undoubtedly, many municipalities have enacted laws bearing upon the question of how the flag should be used and treated. In the main, however, it is only necessary that civilians show due respect. If strict military ethics are observed, the flag will not be draped for decorative purposes. But if it should be used in such a manner, care must be taken that it is not cut or otherwise mutilated.





Deaf School Children at Play: The Manner of These Well-Trained Little Folks on the School Ground Is Quite Like That of Normal Boys and Girls

## 4541 TEACHING THE DEAF TO HEAR WITH THEIR EYES

*Rec. in L. S. C. C.*

BY ROBERT H. MOULTON

AMONG the twelve hundred pupils of the Parker School, one of Chicago's largest public schools, there are more than a hundred children, ranging in age from five to fifteen years, who have never heard the sound of a human voice. Yet to distinguish these children from their more fortunate fellows because of any imperfection in their speech or their inability to understand the speech of others, would be a difficult task. Although born deaf, they have been taught to speak almost as well as hearing children, while their skill in reading the lips of a speaker is little short of miraculous.

If you should go to the Parker School any fine morning you would probably see on the broad lawn in front of the school various groups of children at play under the watchful eyes of their teachers. But it is not likely that your attention

would be attracted to any particular group because of anything unusual in the children's manner of addressing their teacher or one another; all are romping, laughing, and shouting merrily. Yet the chances are that some of these children are among the hundred who have never known the blessed privilege of hearing.

Entering the school, you might go from room to room, and not discover for quite a while anything peculiar in the manner of instructing certain of the classes. But in some of them you will find the same little tots, who cannot hear, that you passed on the lawn. If their eyes happen to be turned away from the visitor upon his entrance, their attention is not attracted,



Learning to Make Sounds Properly: In the Instruction of Deaf Children Much Depends on Properly Illustrating How to Place the Tongue with Relation to the Teeth

since their organs of sight have to perform the duty of the useless ears. Should they see the newcomer, however, they will smile a welcome,



then direct their gaze once more to the lips of their teacher. It is this concentration of gaze which first betrays their physical handicap. All the knowledge they receive must come through the sense of sight, and so their eyes

children. If they were allowed to depend on gestures or written forms to any extent they would not so readily acquire the fixed habits of watching the lips and of concentrating attention that are necessary to catch the meaning of the spoken form.

Only the simplest words are given to the child to reproduce at first. These are really not words at all, but mere sounds. When individual sounds have been mastered, they are combined to form words. For example, suppose the child has learned to make the sounds of the vowel "a" (ah) and the consonant "m." The teacher now

places the child's hand upon her throat, and the child, all eagerness, prepares to imitate her. First she begins with the sound of "a" and, while still uttering it, gently closes her lips. This action causes the sound of "m" to follow "a," and the result is the word "arm." When the little scholar is made to understand to what the word applies he is usually so delighted that

he needs no urging to repeat it over and over until he has it just right.

Sometimes the positions may be excellent, but the sounding weak. The teacher will then direct the child to use his voice. The meaning of this direction and the way of obeying it are taught in the very beginning of the work by holding the child's hand upon the teacher's throat and chest while making utterance of a sound. His



Learning to Say "Dog": Note How Intently the Pupils are Watching the Teacher

are ever on the alert to catch the smallest movement of their teacher's lips. When they speak a little later in answer to some question, the voices of the very young children may sound a little peculiar to one who is not accustomed to talking with the orally taught deaf, but this peculiarity vanishes as their education advances.

The teacher always talks busily and naturally to the children, just as if they could hear, no form of communication other than spoken language being employed. This is necessary in order to so develop the mentality of the children that they shall think and express themselves in spoken language as naturally and unconsciously as hearing



Teaching and Illustrating the Word "Smell": Objects are Used Very Effectively in Conveying Many Different Ideas, Especially to Younger Pupils





Combining Instruction with Play: Because of the Children's Infirmity Those Who are Instructing Them Necessarily Come into Intimate and Personal Contact with Each One. It will be Noted That the Pupils' Faces are Turned toward the Teacher so That He or She can Watch the Movement of Her Lips



A Daily Lesson in "Feeling" the Sound of a Piano: Vibrations Felt in a Musical Instrument Help to Teach the Unfortunate Children Some of the Principles They must Learn



The Hands are Much Used in Teaching Proper Speech to the Deaf: Here the Child is Learning to Make the Sound of "e" in the Word "Me"



Few Persons Realize the Difficulties Involved in Teaching Children Who have Always been Deaf to Make Certain Sounds. Much Depends on Showing the Pupil How to Place the Lips, Tongue, and Teeth. In the Picture Above, the Teacher has Found That the Boy on Coming to the Word "Plants" Has Difficulty with the "ts," and is Endeavoring to Show Him How the Proper Sound is Made



hand is then applied to his own throat and chest until he has produced similar vibrations. All the while, of course, he is watching his teacher's lips, and the direction is repeated until he has learned its meaning.

The power to distinguish differences of vibration by touch is a very important thing, for it is the child's chief guide in modifying his own voice later—in raising it if it is too deep, or lowering it if it is too shrill. Exercises bearing upon this are conducted with musical instruments such as the guitar and piano, and then applied to the vibrations as felt in the chest, head, and throat. The teacher first strikes a low note, and the child, watching, feels the vibration. Then she strikes a high note and calls his attention to the difference. Next, she places his hand upon her throat while she sings low and high notes alternately, and in time he acquires the ability to recognize the difference in tone by touch.

The making of aspirate sounds, requiring the forcible exhalation of breath, such as "p," is explained by using a feather or lighted candle. The expulsion of breath blows the feather away or causes the flame of the candle to flicker.

Speech-reading, which is the ability to understand spoken language by watching the speech movements on the speaker's face, goes side by side with the teaching of speech. From the first hour the child is taught to watch his teacher's lips and to attach a meaning to all their movements, and he learns to interpret spoken language with his

eyes as the hearing child does with his ears without knowing the how or why of it. The older pupils at the Parker School are all extremely proficient in reading speech. They easily receive communications from their teachers across a large room, and some of them can take words quite as readily from the profile as from the face when turned directly toward them. One girl showed her ability in this direction by reading the lips of a speaker from the shadow cast on a wall.

The teaching of speech to deaf children puts them on a more equal footing with hearing children both in their social and business life. Very few hearing people will take the trouble to learn the sign language, or finger spelling, just for the purpose of conversing with one or two persons, and a system of written communication is always slow and laborious. For this reason the deaf child who cannot speak is always at a great disadvantage when attempting to mingle with his more fortunate brothers. But with speech at his command he finds open to him a thousand avenues of happiness and usefulness of which he formerly knew nothing. To one who watches, the work of transformation that takes place in a little deaf child after a few months of teaching by the oral method is simply amazing. The change from nervous and moody discontent, such as characterizes many of them in the beginning, into a state of radiant happiness and peace of mind, is like beholding the evolution of winter into spring.



Lazy-Tong Type of Holder for a Running Board: It is Light and Durable and can be Folded Back against the Rear Fender When Not in Use

#### FOLDING HOLDER ATTACHES

TO SIDE OF AUTO *across*

The running board of an automobile can be safely loaded from end to end by equipping it with a holder of lazy-tong type, which can be stretched from the front to the rear fender. Advantages of such a carrier are that it is light and durable and when not in use may be folded back against the rear fender to which it is attached.

*Hirchner Supply Co. 130 N. Main St.  
Los Angeles*



Mfr: The B-H. Re. Co. N.Y. C.  
253

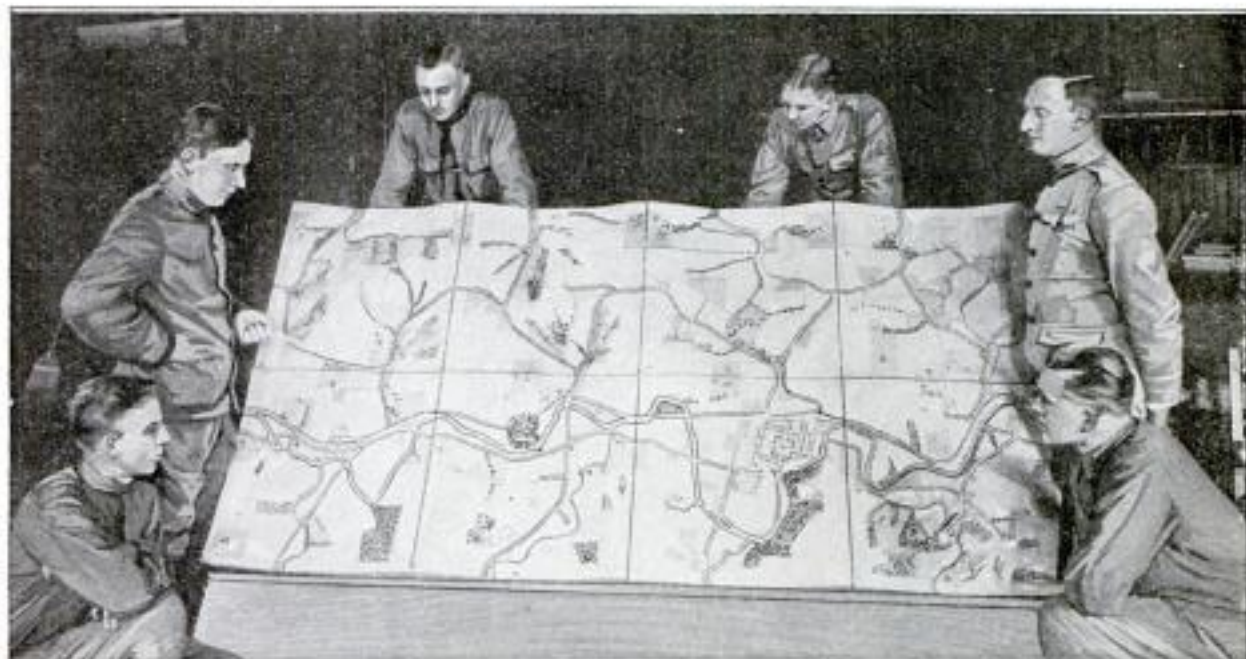

Solving War Problems: Soldiers Studying an Ingeniously Designed Relief Map Composed of Eight Sections Which can be Interchanged to Make More Than 2,000 Different Combinations

### MILITARY RELIEF MAP HAS INTERCHANGEABLE PARTS

4906

A single relief map which is composed of interchangeable sections, so designed that they can be put together in more than 2,000 different combinations, is now being employed in schools and by many military groups in the study of tactics, map reading, intrenching, and topographic sketching. Each section varies from  $\frac{3}{4}$  to  $2\frac{5}{8}$  in. in thickness and is 2 ft. square. The eight sections represent eight square miles and are finished in five colors, indicating a variety of natural conditions. Practically any type of terrain the instructor may desire can be obtained

with these parts. The sections are interchangeable because certain of them have similar profiles, thus permitting them to be fitted together in the great variety of ways stated. The map comes packed in a cabinet measuring 25 by 25 by 28 inches.

### PHOTOS SHOW HARDSHIPS OF MINING

4511

The two flash-light photographs taken in mines, which are shown herewith, while possessing little that appears at first glance to be unusual, are nevertheless of interest in that they indicate certain difficulties under which mining is sometimes conducted. To

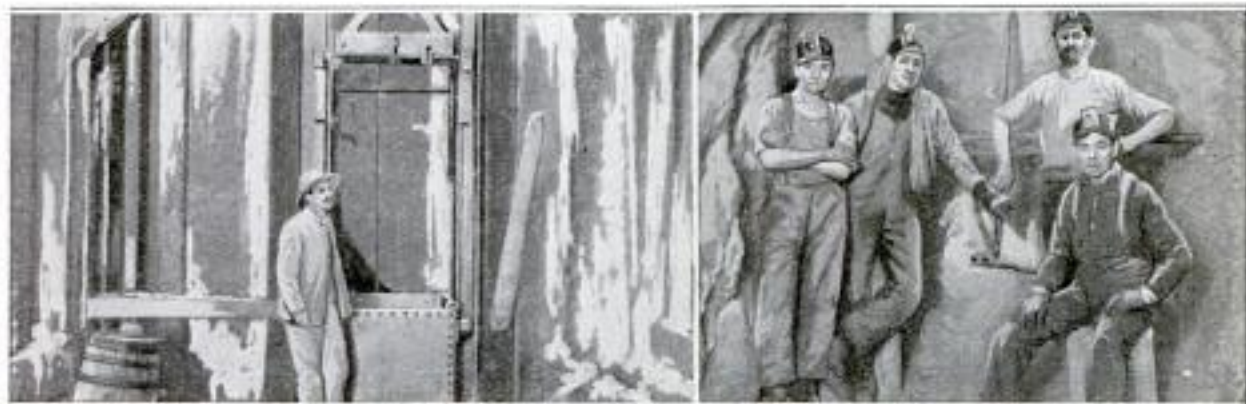

Left: At the Right Side of This View, Taken in a Mining Shaft, Is a Mass of Ice Incasing a Ladder, an Eight-Inch Water Pipe, a Six-Inch Compressed-Air Pipe, and Four Electric Wire Conduits. Right: The Mouth of This Shaft Is Only 16 Feet above Sea Level, and the Men Are 3,000 Feet below the Mouth



the right of the lone miner shown in one picture is a large formation of ice produced by the downward draft of air in the shaft. Included among the objects incased in this ice are a ladder, an 8-in. water pipe, a 6-in. compressed-air pipe, and four electric-wire conduits. The other view was taken on the 3,000-ft. level of a coal mine, and as the altitude at the mouth of this shaft is only 16 ft., these men are working nearly three-fifths of a mile below sea level.

### SMALL SAILBOATS FORM ARMS OF A WINDMILL

An odd form of windmill is used for the double purpose of operating a pump and attracting attention to a solar heater in which the pump circulates



Sailboat Windmill Which Drives the Pump of the Solar Water Heater Seen below It

water. The mill is formed of four small sailboats of different colors, mounted on arms which turn on a central shaft and so operate the pump when the wind blows.

### ARTISTS TAKE VITAL PART IN WAR'S ACTIVITIES

European painters and sculptors are playing a most fascinating rôle in the world conflict. Through their efforts the art of "camouflage," as the French call it, has been developed to such a remarkable degree that it now takes a highly important part in military operations. The word is derived from the verb "camoufler," and, as an idiom, means to make up, disguise, or render unrecognizable. Many of France's younger artists belong to the "Bataillon de le Camoufle," and are literally the scene painters who fashion the sham stage settings and properties for the theater of war. To them falls the task of making ammunition depots look like hillocks or even open fields; of giving a howitzer or mortar the appearance of a tree or stump; of concealing from the view of enemy airmen an important road over which troops and munitions are to be moved; of making broken trees and dilapidated carts look like big guns so that the enemy artillery will waste its effort; and of executing hundreds of other deceptions of similar character. Motor trucks are painted with splotches of blues and purples, chromes and greens, to render them inconspicuous.

The work of these fellows is not without its dangers. Often it is necessary for them to ascend in aeroplanes and study from aloft the effect of their efforts. At other times they have to advance ahead of the first line under cover of darkness and take measurements that will enable them to make a copy of some tree trunk or crumbled wall in "No Man's Land," armor it and have it quickly substituted before dawn to serve as a bullet-proof shelter for observers. All of the nations at war are practicing camouflage, but so far the French seem to have the lead. It is interesting, in view of the part we are now assuming in the hostilities, that an academy of camouflage was conducted during the summer months at a military preparatory camp established by an eastern university.



POWERFUL ELECTRIC ENGINE IS BUILT IN EAST

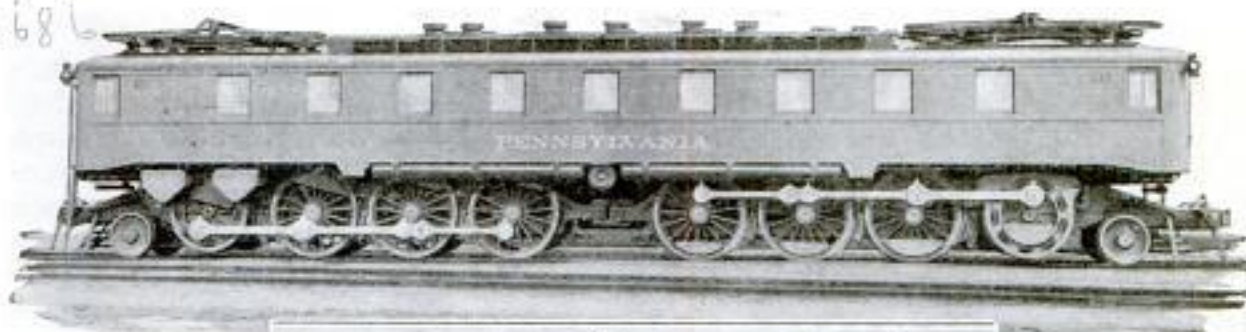

In size and power an electric "Mother Hubbard" that has been constructed by the Pennsylvania Railroad Company commands attention. It is said to be the largest locomotive of its type so far constructed in

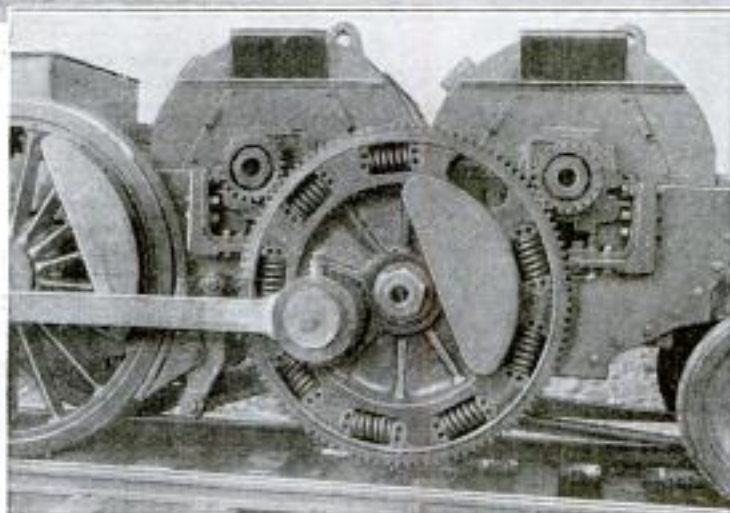

Big Electric Locomotive Constructed in Anticipation of the Electrification of a Railway Line in the Allegheny Mountains and a Close View of One of the Trucks, Showing the Character of the Spring-Gear Wheels through Which Dual Motors Transmit Their Power to the Drivers

America, but irrespective of the correctness of the claim, the engine has an over-all length of 76½ ft. and, at a speed of 20.6 miles an hour exerts a tractive effort of 87,200 lb. It weighs 240 tons and is mounted on two trucks, each of which has dual motors connected to a jackshaft that operates the drivers through a pair of spring-gear wheels. The latter are joined to the

driving wheels by side rods, while the remainder of the driving and running gears are similar to those used for steam locomotives. The engine uses an 11,000 - volt, single - phase current which is taken from an overhead trolley. Each

of the four motors develops 1,200 hp. Electric machinery is attached to a platform floor, or upper deck, which extends over the central part of the cab for a distance of about 37 ft. The roof above this section is removable, and turtle decks at either end of the locomotive have large hatches, to permit the removal and replacement of the electric apparatus.

UNIVERSITY CULTIVATES DRUG HERBS

By R. P. CRAWFORD

THE College of Pharmacy of the University of Nebraska now secures its supply of crude drugs from its own garden. While the project was started in a very small way a few years ago, it has now been extended until 110 different drug-producing plants are grown. The actual conditions under which such plants can be successfully propagated are being stud-

ied, since with the imports of crude drugs cut off, a great deal of importance attaches to the discovery of means by which the industry can be successfully carried on in this country. What is believed to be the first course of its kind to be offered in a university has been established this year, consisting in the study of the raising, curing, and preserving of crude drugs.



While there are commercial drug gardens in which some varieties of plants are raised, there are few gar-

the amount of actual drug to each pound of the crude product. This factor may lie in the quality of seed, the time of harvesting, the kind of soil, method of curing, and perhaps four or five other factors. The stupendous character of the study of scores of plants, especially in their relation to a temperate climate, may easily be perceived. There are certain plants such as belladonna and stramonium which, for instance, require lime in the soil, since they produce medicinal alka-



The Drug Garden has been Planned so Skillfully That a Casual Observer would Doubtless Imagine It a Part of the Landscaping of the University Campus

dens, indeed, in which practically every plant producing a well-known drug is represented. As many as 13 varieties of a single plant, digitalis, have been grown, and when it is recalled that there are 110 different kinds of plants in the garden, the magnitude of the undertaking is apparent. Practically every corner of the country was combed in the search for seeds and plants from which certain drug plantations could be started. Even an obscure little nursery in India was sought out in the effort to get hold of some tropical products. The fact that the drug-plant industry is in its infancy in this country made the securing of certain seeds and plants extremely difficult.

The University of Nebraska is endeavoring to develop plants that are efficient and adapted to a temperate climate. While in the past, drugs have often been secured from the leaves of plants which grow wild, the large drug houses are now demanding a high quality of product. The average person would think that all plants of a certain variety would be the same as regards drug content. The University of Nebraska, however, is seeking to increase



One Hundred and Ten Different Drug Herbs are Grown by the College of Pharmacy at the University of Nebraska. Above. Some of the Plants are being Dried

loids. Among the plants which it has been determined may be raised with good hope of success by the ordinary gardener in the Middle West are the mints, peppermint and spearmint, digitalis, henbane, purgative rhubarb, hydrastis, lavender, and Indian hemp. It should be noted that some plants are quite poisonous and the amateur engaging in the drug-plant business should take care that domestic animals do not accidentally feed on the leaves.

Aside from being a novel project of its kind, the Nebraska garden has been made still more out of the ordinary by its arrangement as a part of the university campus design. There was no space available for a garden of merely a utilitarian sort and it was concluded to make it decorative as well. One of the rectangles on the campus was set



aside for the project and here the drug plants have been grouped in a symmetrical design. The trees and shrubs have been placed on one side, while the smaller plants are set in little plots, each surrounded by grass. In the center is a pool, around which the water plants are arranged. The whole is enclosed by a privet hedge. So skillfully was the work done that the casual observer would take the garden to be only a decorative feature of the grounds.

### CONCRETE-MIXING OUTFIT HAS TRAVELING TOWER

A concrete-mixing outfit for railroad-construction work, in which a number of money-saving features have been embodied, has as its principal unit a flat car on which is mounted an ordinary mixer. The car is strongly trussed and when the nature of the work requires it, an 8 by 8-ft. tower is mounted on one end for use in pouring the concrete. In such a case the mixer engine is used to hoist the material to the top of the tower. Since the latter requires no guys to steady it, it can be moved back and forth as desired, thus making possible a great saving of time and labor. When only a single track is available for the construction crew, a train of gondola cars loaded with cement and gravel is attached to the mixer, and the workmen wheel the material along planks, laid on top of the train, to the hopper. When two tracks are available, a self-propelling crane may be used to transfer material to the mixer's hopper from cars drawn alongside.



### FLEXIBLE GEAR EQUALIZES POWER OF CYCLE ENGINE

To equalize the varying power of twin-cylinder motorcycle engines and thus relieve the machine and rider from vibrations, a spring sprocket has been developed. It is said to eliminate the jars due to power transmission without lessening the efficiency of the motor. Six heavy coil springs, incorporated in the gear, receive excess power and deliver it to the rear wheel between strokes when the pull of the engine is at its lowest ebb. At a cost of considerable energy, vibration has formerly been combated by allowing slipping in belts, clutches, and compensating sprockets. With the new appliance, the surplus power is conserved and utilized instead of being lost.

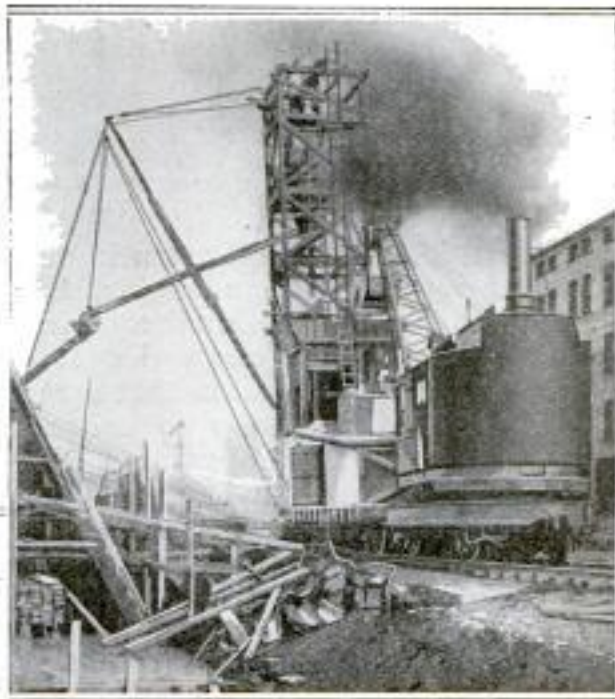

Above is a view of a portable concrete-mixing outfit, including a tower, mounted on a car. At the near end of the material-and-construction train in the left-hand picture, the mixer car is shown with tower removed.



### TRUCK APPLIANCE OPERATES WATER-MAIN VALVES

To facilitate the work of opening and closing the valves of water mains, a device, mounted on one of the run-

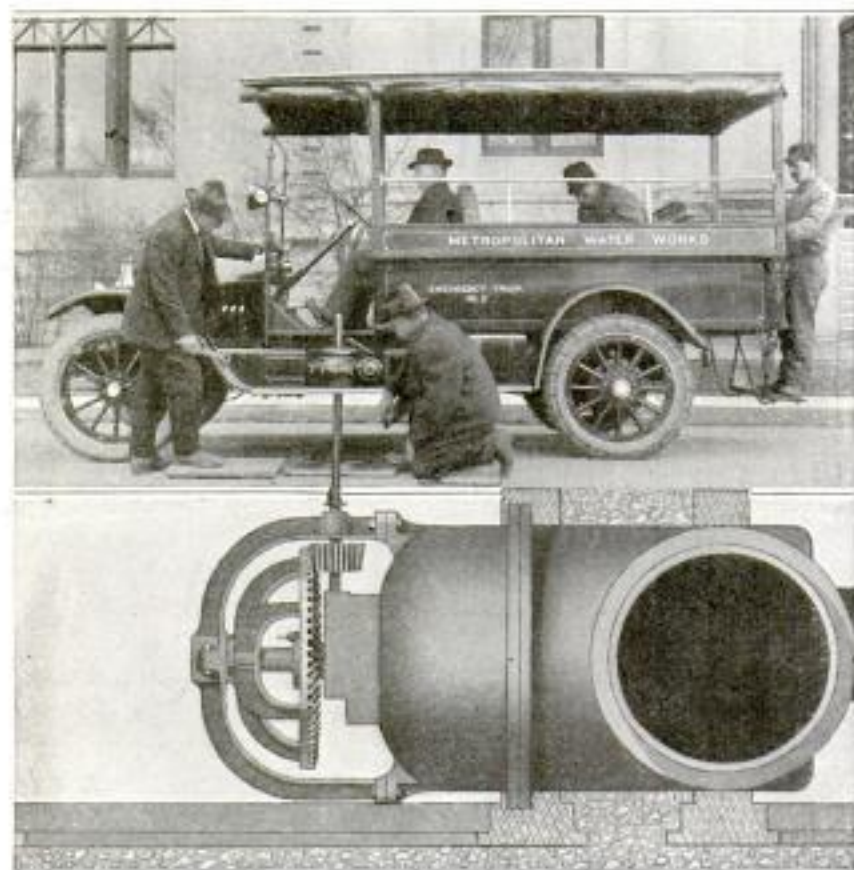

Showing the Device in Operation Opening a Water-Main Valve. It Saves Much of the Time and All the Labor Required by the Manual Method

ning boards of a motor truck and operated by the latter's engine, has been developed. In use, a car equipped with the appliance is stopped over a manhole in such a position that a rod may be placed vertically to connect the valve stem with the apparatus. The driver shifts the gears to low speed and allows the engine to run until a safety mark, indicating that the valve has been opened or closed, as the case may be, appears on the valve stem.

☞The War Department has ordered a map prepared showing the electric railway lines of the country, the idea being, where possible, to relieve steam roads of excessive strain at points connecting with military camps, etc. Trolley lines can render a big service in this way.

### SMALL MEN GIVEN CHANCE BY NEW ARMY RULING

American boys of small stature and good physical condition have been given an opportunity to do their "bit" in France. Orders recently issued by the War Department to army recruiting stations change the minimum height and weight ruling from 5 ft. 4 in. and 120 lb., to 5 ft. 1 in. and 110 lb. It is understood that the revision was made upon the recommendation of Surgeon-General Gorgas who contended that many capable fighters were being needlessly kept out of military service. The new order recalls an incident that occurred some time ago when a nationally known bantam-weight pugilist endeavored to enlist. Although in perfect physical shape and respected by men twice his size, he was refused admission to the army because of his height—or rather, the lack of it.

### TYPEWRITER ERASER HOLDER NEW OFFICE ACCESSORY

Convenient for stenographers and others is an eraser holder which may be attached to the frame of a typewriter at one side of the keyboard where it is within easy reach. The appliance is a small metal pocket that will hold an eraser of almost any of the standard sizes used in offices. Its use obviates a source of much confusion.





## TRAIN EQUIPPED AS A PORTABLE LUMBER CAMP

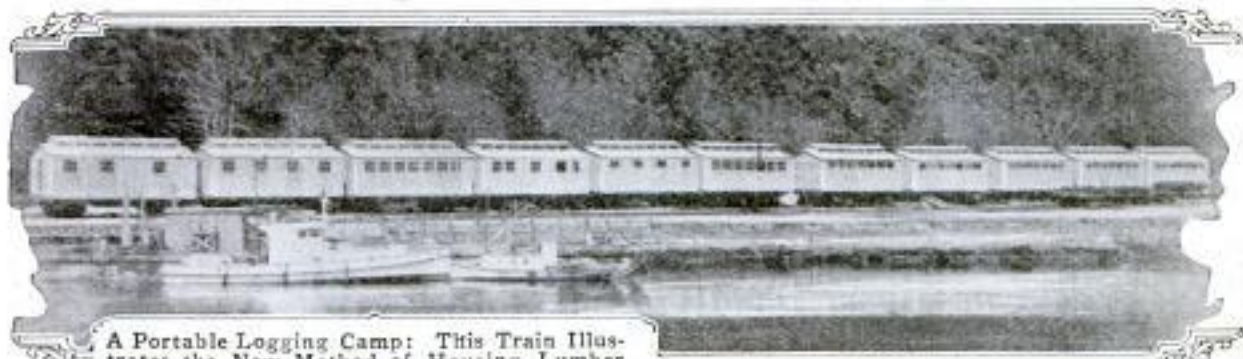

A Portable Logging Camp: This Train Illustrates the New Method of Housing Lumber Crews and the Like. It can be Placed on a Sidetrack within Easy Access of the Timber to be Cut and can be Moved Any Distance Desired on Very Short Notice and with Little Inconvenience to the Men. Old Flat Cars are Often Used in Making These Outfits



Above: Workmen's Sleeping Car with a Capacity for 28 Persons. The Bunks are Arranged in Two Tiers Like Regular Berths and Each is Provided with a Separate Window. A Diner is Shown at the Left

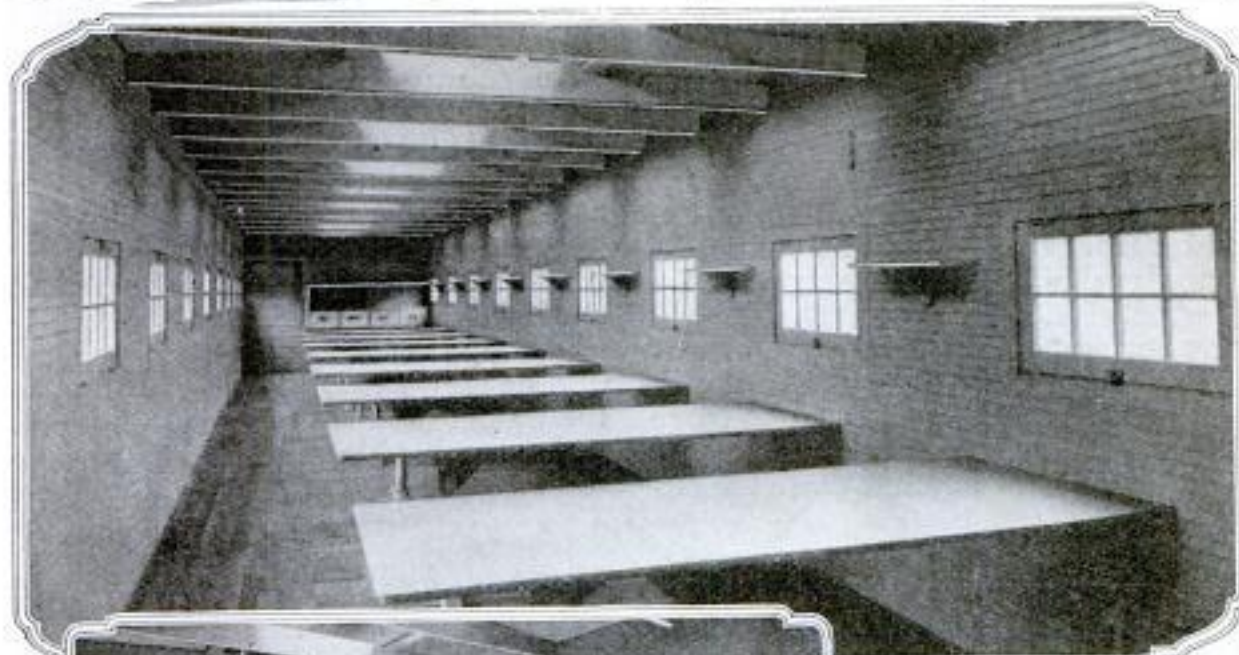

The Picture Above Is of the Interior of a Dining Car Which Seats 72 Men. Stools are Provided Instead of Benches. Overhead Ventilators Let in Additional Light and Air



Left: A Combination Kitchen and Dining-Car Designed Especially for Use by Crews of 20 to 40 Men. View Shows Typical Kitchen Equipment and Gives a Glimpse of Dining-Room



### FOOLPROOF RHEOSTAT FOR GARAGES

A new universal rheostat, designed for use in garages where batteries of various sizes are charged, is provided

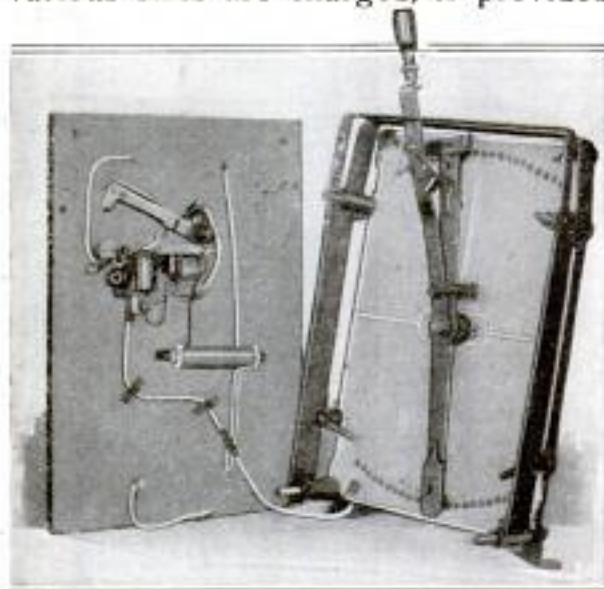

Foolproof Type of Universal Rheostat Taken Apart to Show the Lever Which Interlocks with Circuit Breaker so That When the Latter Is Open the Lever must First be Set at the Minimum Charging Rate to Close the Circuit

with an interlocking underload-and-overload-release circuit breaker, which has a foolproof feature. The underload circuit breaker prevents the battery from discharging back into the line. The other one protects the rheostat, battery, and entire circuit against excessive current. When the circuit breaker is open it is necessary to move the rheostat lever to the position of the minimum charging rate to close the cir-

cuit. This prevents its operation by thoughtlessly putting the lever into a position that would cause practically a dead short circuit on the line. Instead he starts at the minimum position and moves the lever up to the point where the breaker will just stay in.

### COTTONWOOD POSTS BESIDE DITCH BECOME TREES

In an unusual way nature helped the city of Redlands, Calif., to construct drainage-ditch banks which proved strong enough to restrain the floods that for several seasons had devastated fields adjoining the artificial channel. It was after various futile attempts to strengthen the banks of the ditch, built to carry off water in the rainy season, that the city engineer proposed erecting a barbed-wire fence back of which brush would be piled. Railroad ties were first used as posts in constructing this fence, but later cottonwood posts were substituted, thereby saving the city about 10 cents per post. These were obtained from the material trimmed from the city's cottonwoods at the time the fence was being made. The new barrier proved effective and during the second season, as some had anticipated, the cottonwood posts began to sprout and now they are thriving trees which not only strengthen the walls of the drainage ditch but also add a touch of beauty to an otherwise barren landscape.



Left: Drainage Ditch in the Dry Season, Showing a Section in Which Railroad Ties were Used in Making a Protective Fence. Right: Portion of the Ditch Lined with Cottonwoods That Grew from Posts



## PROTESTING AGAINST TYRANNY IN AMERICA

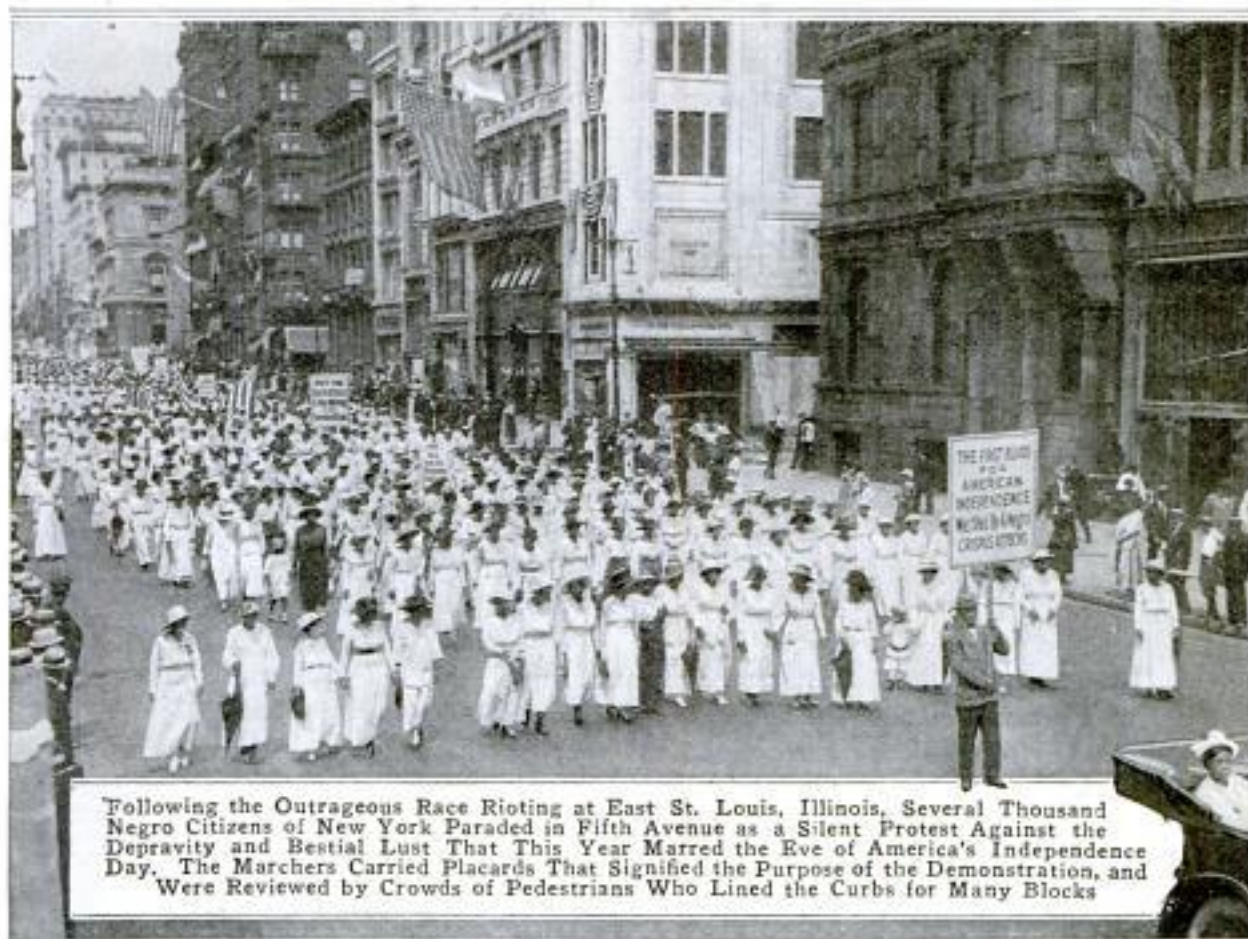

Following the Outrageous Race Rioting at East St. Louis, Illinois, Several Thousand Negro Citizens of New York Paraded in Fifth Avenue as a Silent Protest Against the Depravity and Bestial Lust That This Year Marred the Eve of America's Independence Day. The Marchers Carried Placards That Signified the Purpose of the Demonstration, and Were Reviewed by Crowds of Pedestrians Who Lined the Curbs for Many Blocks

COPYRIGHT UNDERWOOD & UNDERWOOD

### CITRUS TREES FUMIGATED UNDER CANVAS SHELTERS

In the beautiful citrus groves of southern California it is a common experience during summer and fall, particularly at night, to see long rows of orange or lemon trees shrouded in canvas. These coverings, which at first present an almost weird appearance, are employed in fumigating the trees to kill a destructive scale. The canvas pieces are put in place with poles, or with the aid of special apparatus mounted on a wagon. Hydrocyanic acid gas, commonly known as prussic acid

gas, is used for fumigating, the necessary ingredients being placed in a vessel that is set inside the shelter and allowed to give off fumes. While this is an expensive expedient, it is a thoroughly effective one.



View in an Orchard, Showing Long Row of Trees Shrouded in Canvas beneath Which Prussic-Acid Gas is Generated to Kill a Destructive Scale: It is Estimated That California Citrus Growers Spend \$1,000,000 Annually in Fumigation of This Sort



### WATER-HEATER EXPLOSION DUE TO CARELESSNESS

The disastrous explosion illustrated herewith, which almost completely



Bungalow Wrecked by Explosion of Water Heater, Caused by Failure to Shut off the Gas

wrecked a comfortable bungalow, was caused by failure to turn off a gas heater at a time when various circum-

stances made possible the accumulation of an excessive amount of steam in the hot-water tank. The accident serves to emphasize the necessity of great care in shutting off a gas heater at the proper time, especially if it is not provided with an automatic cut-off of any kind. In this instance, the pressure regulator on the water-supply pipe had become choked and shut off the flow of water into the heater. The occupant of the bungalow opened a faucet situated in the back yard, while the hot-water faucet at the kitchen sink was open. This resulted in siphoning part of the water from the heater tank. The gas heater was left burning, and in time, enough steam was generated to cause an explosion.

### WORM-GEAR TRACTION LIFT OPERATES AT LOW COST

Among the advantages claimed for a worm-gear traction elevator now on the market are simplicity of operation, low starting current, reduced wear on controller switches, and uniform operation under all load conditions while going either up or down. Four wires are all that are required to give full control to the car. A variable speed motor is used. It is claimed that a fully loaded elevator will start with one-half the full-load current and that the current will never exceed the full-load running current by more than 10 per cent—a factor which means a great saving in cost of operation. Acceleration to full

speed is obtained in about eight feet of travel. The elevator has but two speeds that are controlled by the switch in the car, but there are intermediate steps controlled by magnet switches on the panel board. A special method of roping is used,

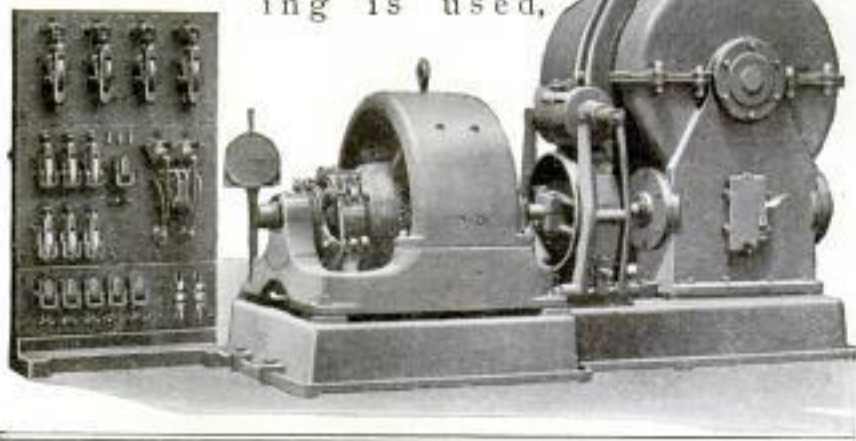

Worm-Gear Traction Elevator Engine Which Requires Low Starting Current and Is Easy to Operate: Panel Board, Which Is of Comparatively Simple Construction, is Shown at the Left of the Engine

whereby the life of the cables is greatly increased.



*Un*  
**RAILWAY IS FINALLY BUILT  
 TO RUSSIAN ARCTIC PORT**

According to recent advices the Russians, after several disheartening and costly failures, have finally succeeded in establishing a three-track railway between Petrograd and Kola Bay, the ice-free arctic port that gives ready access to the Atlantic. About two years ago it was announced that the line was practically ready for operation. Because of incompetent supervision, however, much of the track had to be reconstructed several times. The ties had been laid on the frozen tundra which with the coming of spring turned into a vast morass. One construction train, it is understood, got through to Kola Bay. But before it started back, warm weather caused miles upon miles of the track to sink into endless fields of mud and water.

The first and easiest part of the road was constructed by Russian labor. But when the men were needed at the front, they were relieved by Austrian prisoners who were as ignorant of railway engineering as were the guards placed over them. With the aid of torches they worked in the arctic night, braving hunger, disease, and terrific cold, but accomplishing what was worse than useless. After their first failure they were given better supervision and managed to build what passed for a rock-ballasted roadbed. It was poorly laid and failed to hold up when the spring thaw came. Chinese coolies were then imported and the work done properly. The railroad extends through Petrozavodsk, on Lake Onega, to Ekaterina, on the Murman coast and is known, at least popularly, as the Murman railway. Because of the warm winter climate enjoyed by Kola Bay and parts of the adjacent seas, on account of the Gulf Stream that crosses the Atlantic and flows easterly along the coast of the Arctic Ocean, the port is open to navigation the year around. The military value of the new line is considered to be of much importance to Russia at this time.

*G. Y. et al.*  
**WOODEN PLAYERS ARE USED  
 IN BALL-PITCHING GAME**

Life-sized, uniformed manikins serve as batter and catcher in a novel baseball concession intended for summer

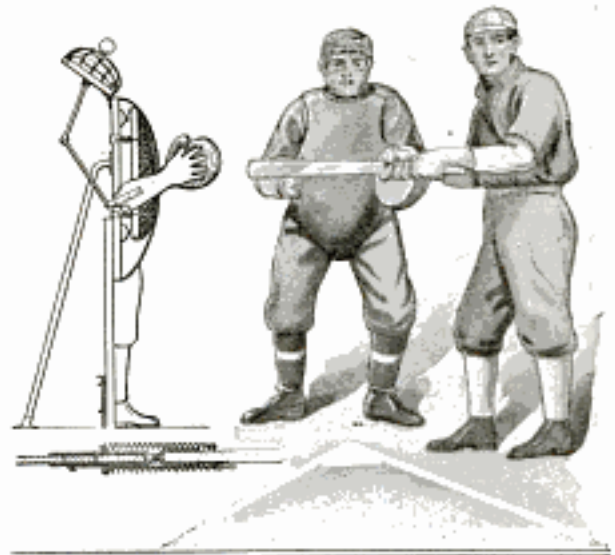

Wooden Manikins Clothed in Uniforms Act as Batter and Catcher for Carnival Patrons of Baseball Concession Game

parks and itinerant amusement companies. The game is played in the usual way for the customary prizes, the patron paying a certain fee for the privilege of throwing three or more balls. The middle part of the chest protector worn by the catcher covers a padded board. When this is struck by a pitched ball, a bell is sounded. The catcher's head is hinged so that it is thrown back when hit. This action operates levers which force the manikin's arms forward as if an attempt were made to catch the ball. When the bat held by the other figure is struck, it swings forward. A player who is able to strike the bat, or ring the bell three times in succession, wins a prize.

CA pleasing illustration of the fellowship which men in our new army are experiencing is found in the common ties that are already binding together the soldiers known as the "258's." In many places special social events have been held in honor of these men whose number stands first in the drafted list.



# SOME NOVEL AND LITTLE-KNOWN ACCESSORIES



Clamp Fitted with Vacuum Cups Which Cling to the Surface of the Glass Churn and Hold It in Place on Top of Table



Spoon Holder That may Readily be Attached to Any Ordinary Cooking Vessel: It Saves Much Inconvenience



Just as Convenient as It Is Novel: A Baby Basket That may be Carried on the Arm



A Brush, Suitable for Hats and Similar Articles, That Is a Bit Out of the Ordinary. Price \$2.50



Practical Dish Washers for Family Use Require Only a Few Quarts of Boiling Water. Here Is One Which is Equipped with a Special Heater. Price about \$20



Fuel-Saving Aluminum Cooking Receptacle That is Divided into Four Compartments and Provided with a Base That Prevents Scorching. Price \$6



For Card Players Who are Apt to Forget the Trump Suit, Next Dealer, and Amount Bid. This Indicator is Supplied in Nickel, Brass, or Gun Metal for \$1.50



Electric Iron with Special Thumb Rest Provided at Front End of Handle to Aid Operation and Lessen Wrist Strain. Price \$4.50



Garment Hanger Decorated with Hand-Painted Portrait of the Idol of One's Affections. Price \$1.25



The Advantage of the Sectional Mattress Is That It may be Handled More Easily than Those of Ordinary Pattern. Slight Effort is Required in Rolling It



DATA OCTOBER NOVELTIES

- MOTH REPELLENT: SANITARY REPELLANT CO., Sheboygan Wis.
- FLOWER BASKET: DENNISON MFG. CO., 80 E. Randolph, Chicago
- HOUSEMAID'S BASKET: LEWIS & CONGER, 45th St. & 6th Ave., N. Y. C.
- ARMY COMYKIT: NATHAN NOVELTY CO., 84 Reade St., N. Y. C.
- TOASTER: (MESCO): MANHATTAN ELECTRIC SUPPLY CO., 114 S. 5th. Ave., Chicago
- ELEPHANT STUFF: MARSHALL FIELD & CO
- VEGETABLE RACK: LEWIS & CONGER (ABOVE) *size 4 ft, In #1900*
- FOLDING OIL STOVE: SILVER'S, 304 Hewes St., Brooklyn, N. Y.
- GLASS KNIFE: E. S. PEASE CO., 698 Main St., Buffalo, N. Y.
- CHURN HOLDER: DAISY CHURN MFG. CO., St. Louis, Mo.
- SPOON HOLDER: INVT: FRANCIS EUGENE KERSHNER, Henry, W. Va.
- BABY BASKET: ORIOLE GO-BASKET CO.....
- BRUSH: DANIEL LOW & CO., SALEM, MASS.
- DISH WASHER: HERSHEY & SEXTON CO., Philadelphia
- SCIENTIFIC COOKER: (POTTER FAULTLESS) - *Nat. Museum Hooker  
Elmira, N.Y.*
- ELECTRIC IRON: HOT POINT, CHICAGO *Electric Heating Co. - Ogden*
- INDICATOR: GAME INDICATOR MFG. CO., 1700 Greenleaf Ave., Chicago
- COAT HANGER: DANIEL LOW & CO., (ABOVE)
- MATRRESS: EZYROLL MATTRESS CO., CLARKSVILLE, TEXAS



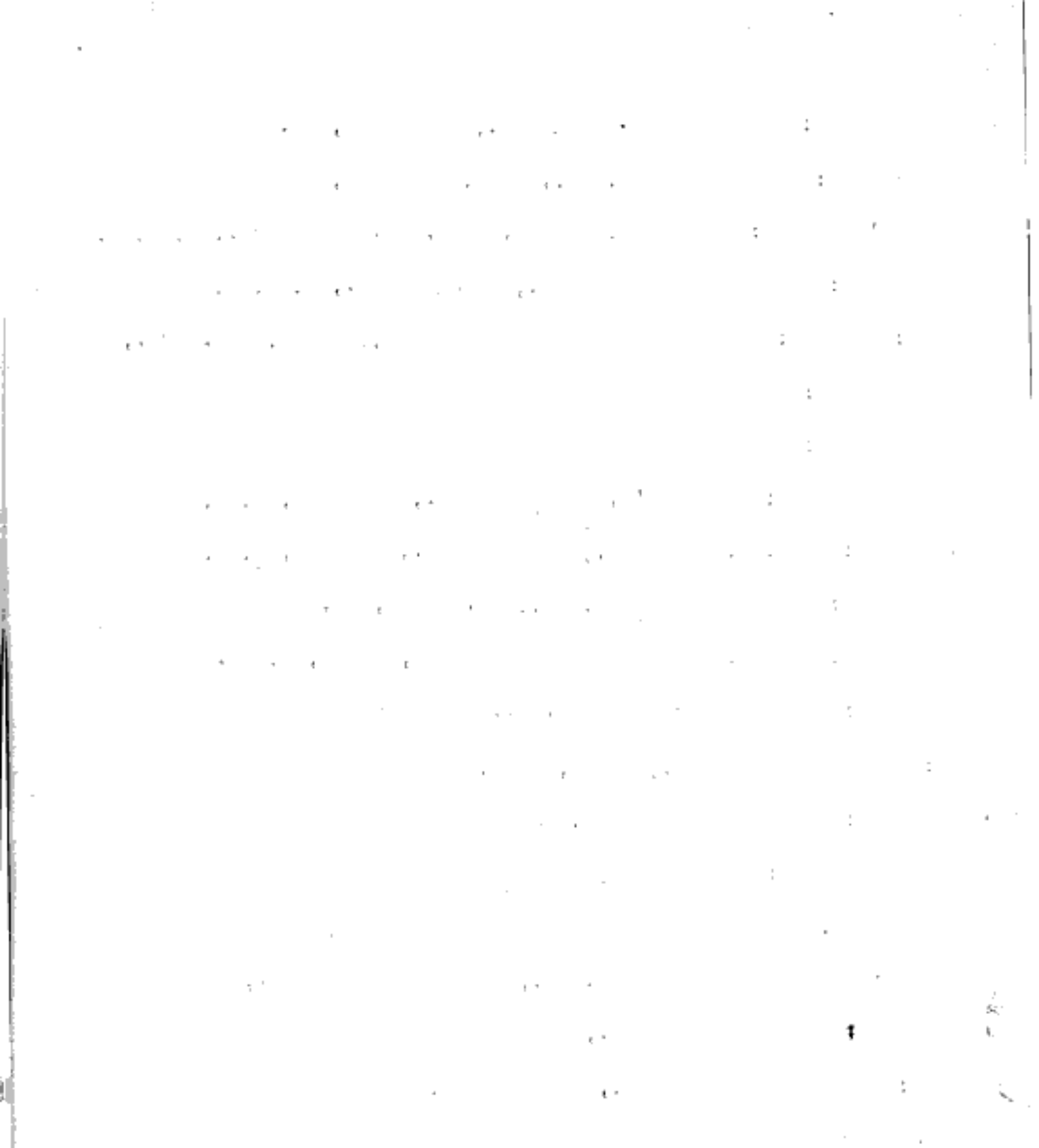



# INTENDED FOR THE HOME AND ITS MEMBERS

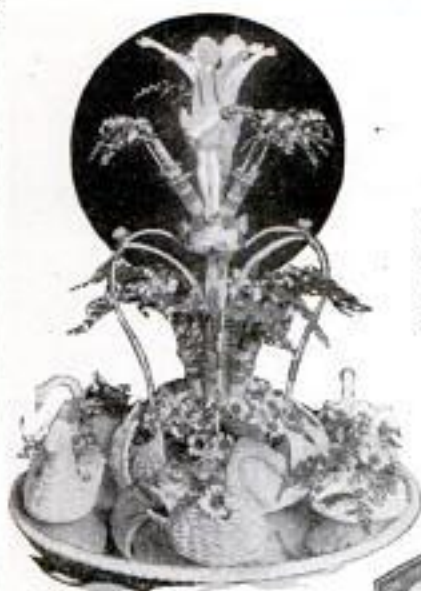

This Ornate Flower Basket is Made of Rope and Intended to Represent an Opening Lily. There Are Numerous Places Where It may be Used



For the Wardrobe or Chest, an Odorizer That Repels Moths and Protects Clothing from Injury during the Months It is Stored. Price 50 Cents

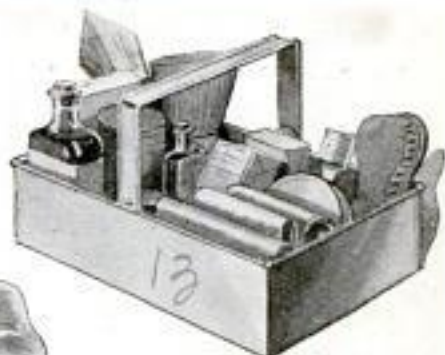

Convenient and Timesaving Is This Metal Basket Which is Divided into Compartments for Dusting, Cleaning, and Polishing Accessories. Price \$3.50



Splendid Utility Kit for Soldier or Sailor. It is Made of Water-Proof Fabric and Contains a Well-Selected Assortment of Standard Toilet Accessories and Personal Articles, Including a Safety Razor. Price \$5

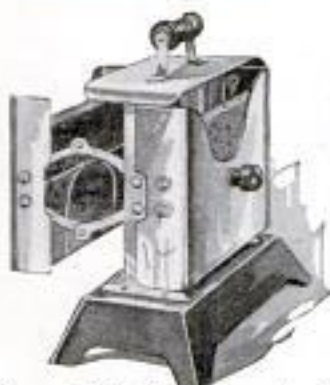

Dry or Moist Toast may be Prepared Quickly with This Appliance. It Has Adjustable Arms That Hold the Bread at the Desired Distance from Heating Element. Price \$4.50



This Conveniently Arranged Galvanized-Wire Rack, Fitted with Inclined Shelves, is Intended as a Vegetable Bin. It Permits Free Circulation of Air and Thereby Prevents Premature Decay of Produce



Two Unusual Specimens of Leathercraft: An Umbrella Stand and a Fire Screen. One Made of the Leg and the Other of the Ear of an Elephant. The Prices Are \$250 and \$50 Respectively

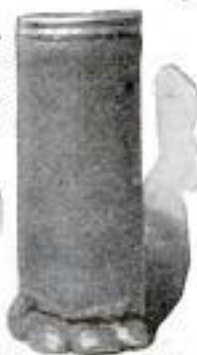

Folding Oil Stove That is Readily Portable and Therefore Well Suited for Campers, Motor Tourists, and Others



For Cutting Grapefruit, Oranges, and Lemons, a Keen-Edged Knife Made of Special Quality Glass: It Has the Advantages of Remaining Sharp, Never Corroding, and of Being Easy to Wash. Price 35 Cents

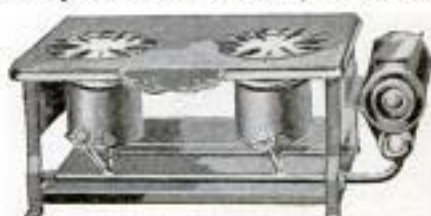



### TROUBLE-SAVING GASOLINE GAUGE FOR MOTOR CAR

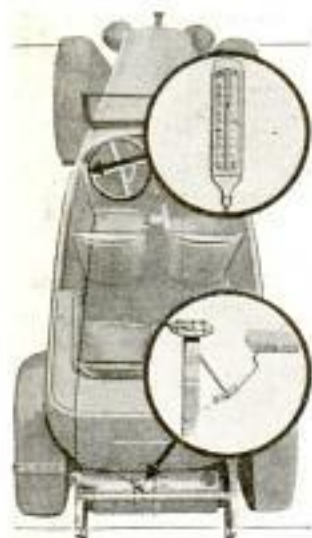

For the benefit of motorists, a gasoline gauge with an indicator that may be installed on the cowl, or in some other position where it would be readily visible, has been introduced. The accessory is easily installed and is of obvious convenience, especially to the tourist. An elongated dial somewhat similar to that of an ordinary mercury thermometer is used for a scale.

### NEW PARLOR GAME TEACHES ELEMENTS OF MUSIC

A recently patented parlor game that bears some resemblance to parchesi is designed to teach the players the names and values of musical notes. The board on which it is played is marked with a large staff and each move of the men on this board is determined by spinning an arrow on a dial whose circumference is marked

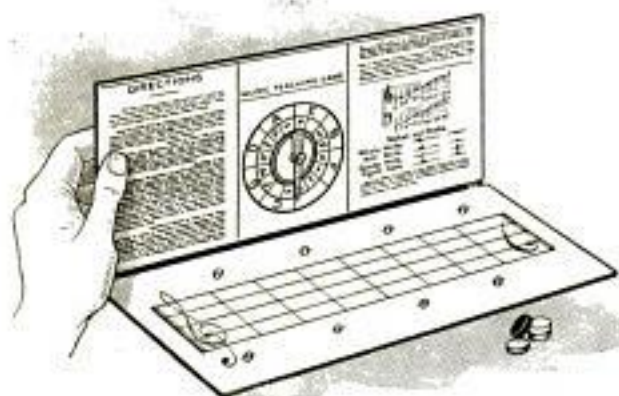

Parlor Game Which Teaches the Names and Values of Notes: The Progress of Each Player's Men across the Board is Determined by Spinning the Arrow

by the seven letters of the scale. The letter to which the arrow points when it comes to rest indicates the next posi-

tion to which a man must be moved. The path the men follow runs alternately up and down through successive measures. Rests and notes of various values are also marked on the dial. By taking these into account at each move the game can be made more difficult.

### SALT DEVICE TO PREVENT DRAIN-PIPE FREEZING

In a recently patented device to prevent the freezing of outside drain pipes, a small hopper filled with rock salt is placed mid-



way of the length of the pipe. The drain water from the eaves trough thus passes in a thin stream over the chunks of salt, so that it becomes a salty solution for its passage downward from the hopper, preventing the usual freezing of the pipe from the bottom up. A few cents' worth of rock salt will last all winter. The plan depends for its success on the fact that the freezing begins at the bottom of a pipe.

### FIRE ENGINE PUMPS WATER TO NEW HEIGHT

In a series of remarkable tests conducted on the Woolworth building in New York City a few weeks ago, the tremendous pumping power of an advanced type of fire engine was demonstrated, when water was forced from the street level to a nozzle located 730 ft. above ground. In one instance 50 ft. of 2½-in. rubber hose was connected with the standpipe at the lofty elevation named, and a nozzle pressure of 67 lb. was attained with an engine pressure of 400 lb. As this skyscraper is the tallest in the world and the water was pumped well up toward



its top, the achievement doubtless establishes a new record for fire engines. It was asserted by firemen participating in the exhibition that the water could have been forced to an even greater height with the same equipment. When the Woolworth building was erected the architects believed that they had outstripped all fire pumps, but these tests show how successfully the designers of fire-engine pumps have kept pace with modern needs.

### SAFETY SPRING SEAT MADE FOR FARM IMPLEMENTS

For cultivators and certain other farm implements, a shock-absorbing seat has been devised to protect a driver from severe jolting and to eliminate the danger of his being thrown

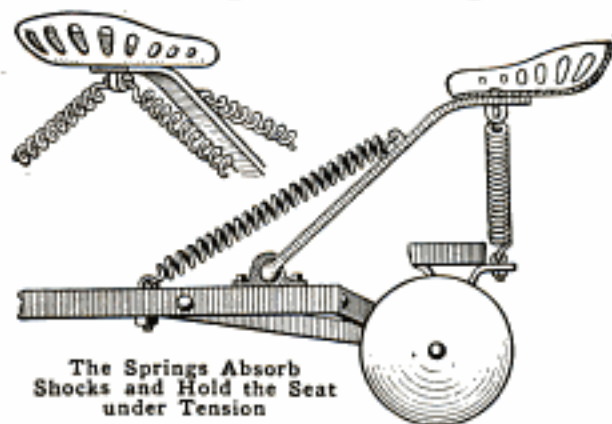

The Springs Absorb Shocks and Hold the Seat under Tension

from a machine. The seat post is pivoted to the tongue and held in position by three coil springs. One of these is stretched between the tongue and the upper part of the seat post, while the other two extend diagonally to either side, connecting the seat and the frame. This arrangement prevents undue movement in any direction and supports the seat without its having a rigid connection.

### LEG GUARDS IMPROVE INVALID'S CHAIR

A feature of an invalid's chair which adds much to the comfort of the occupant in case he has suffered the fracture of a leg, consists of metal leg guards that can be attached to either

side of the adjustable leg rest. They prevent the limb from sliding off and, if desired, cloth loops can be stretched

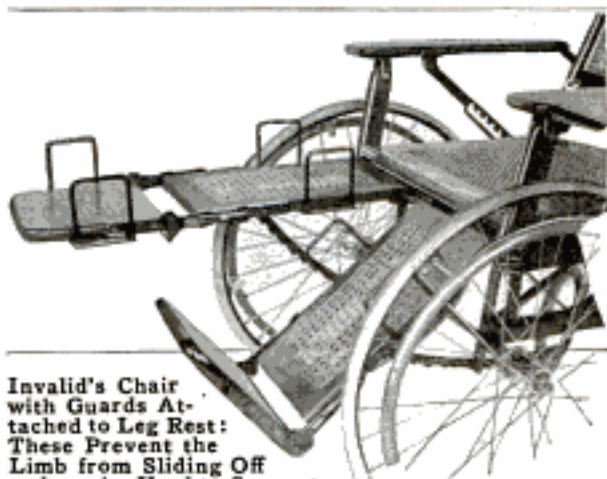

Invalid's Chair with Guards Attached to Leg Rest: These Prevent the Limb from Sliding Off and can be Used to Support Bands of Cloth on Which the Leg can Lie More Comfortably

across from one guard to another, forming a support in which the injured member can rest.

### BUGLE USED TO TRANSMIT MILITARY SIGNALS

To surmount the difficulty encountered in signaling by wigwagging with flags and lamps when the atmosphere is foggy, a system has been proposed which would enable a bugle to be used effectively. Messages would be transmitted in code by "dots" and "dashes," and the calls projected for considerable distances by utilizing a portable sound-board designed to be strapped to the back of the bugler. The latter contrivance, which is shaped like a large shell and made of light wood, extends from a man's waist to a point about a foot above his head. It projects the bugle's notes so that they can be heard distinctly enough for signaling purposes at distances of two or three miles, depending, of course, upon the topography of the district.

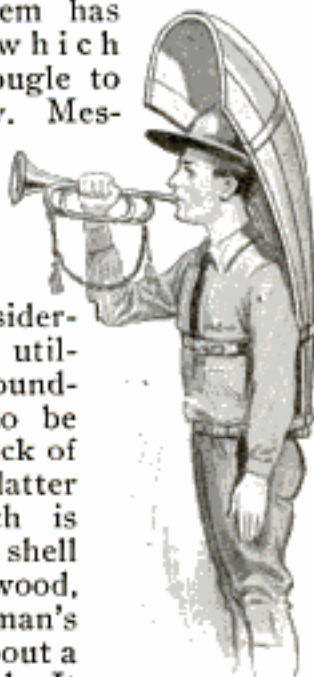

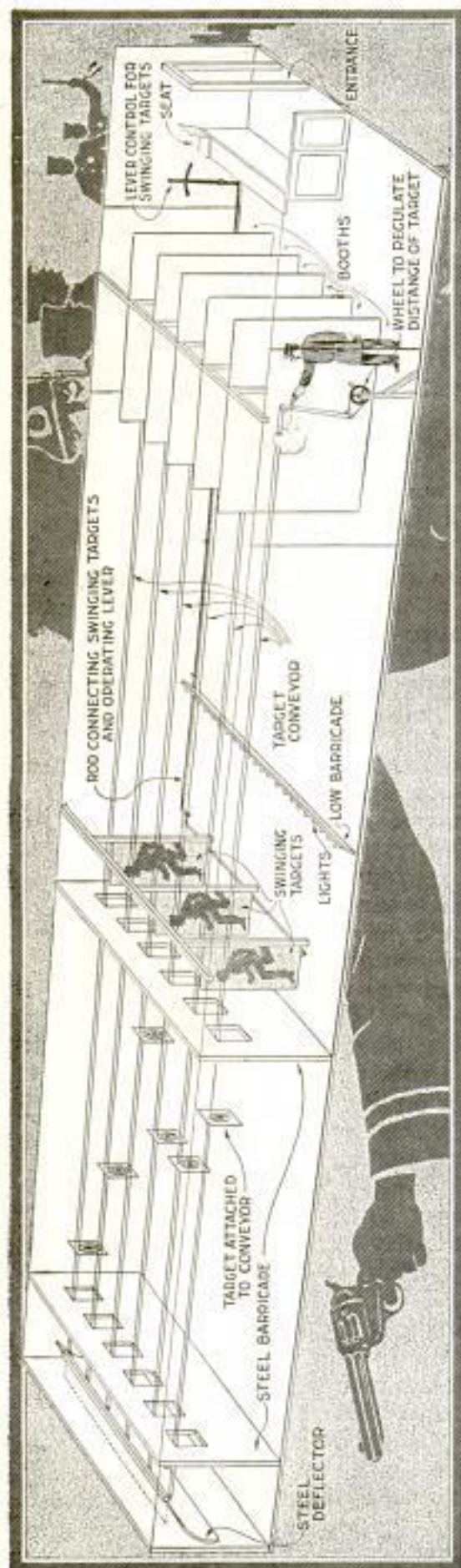

*Revolver*

Pistol Range of Improved Design at Police Headquarters, Wilmington, Delaware: The Sketch Shows the Human-Figure Targets Swung out of the Way While the Marksman Fires at an Individual Target through the First Steel Barricade

### IMPROVED RANGE TO MAKE POLICE MARKSMEN

An improved form of indoor range for revolver practice has been installed at police headquarters in Wilmington, Del., to increase the efficiency of the officers as marksmen when called on to use their guns. The new range is 60 ft. long from the firing stand to the rear wall of  $\frac{1}{2}$ -in. steel plate, and 17 ft. 9 in. wide, accommodating six officers at a time, the firing booths being separated by steel barricades. Midway of the range are three swinging targets representing human figures running. These are operated by a lever at the front end of the range and can be swung endwise out of the way, or removed, at will. Each booth has an operating wheel for regulating the distance of the ordinary individual paper targets, which are attached to a conveyor by which they can be recovered for examination. Two steel barricades are set across the range, with rectangular apertures through which the marksman fires to hit his individual target.

### FAILURES IN JELLY MAKING ARE EASILY PREVENTED

In making jellies, guesswork leads to many unnecessary failures and much waste. The Bureau of Chemistry points out how these may be prevented, and sugar—now an expensive article—conserved. To determine accurately the amount of sugar to be used, one should put a spoonful of juice in a glass and add an equal amount of 95-per-cent grain alcohol, mixing the two by gentle shaking. Then slowly pour the contents from the glass, noticing at the same time how the pectin—the substance that makes fruit juices jellyfy—is precipitated. If it is bound in one lump, a cup of sugar is needed for each cup of juice. If, however, there are several lumps, only three-fourths as much sugar as juice is wanted. When no lump appears and the pectin is merely precipitated, a half cup, or less, of sugar to a cup of juice should be



the proportion. If the test fails to cause precipitation, it indicates that the juice is unsuitable for jelly, and must be combined with some other juice that is rich in pectin, such as apple juice.

### FRICITION GEAR PRESSURE SECURED BY MAGNETS

In a new form of friction gear, used with disk drive, the pressure necessary for friction is supplied by a system of magnets, placed symmetrically about the points of contact. The usual practice is to apply pressure behind the disk and along the center line of the shaft holding it. This involves a twisting force to be overcome in the bearing, along with the pressure applied. The magnets used in the new gear insure the pressure coming at each point of contact, at right angles to it, and eliminate pressure from the bearings and also the undesirable twisting force. A self-adjusting feature maintains a constant air gap between the magnets and the disk. Three friction wheels are used, interlocked by a system of differential gearing, in order to transmit more power for a given diameter of wheel. With four disks and the three

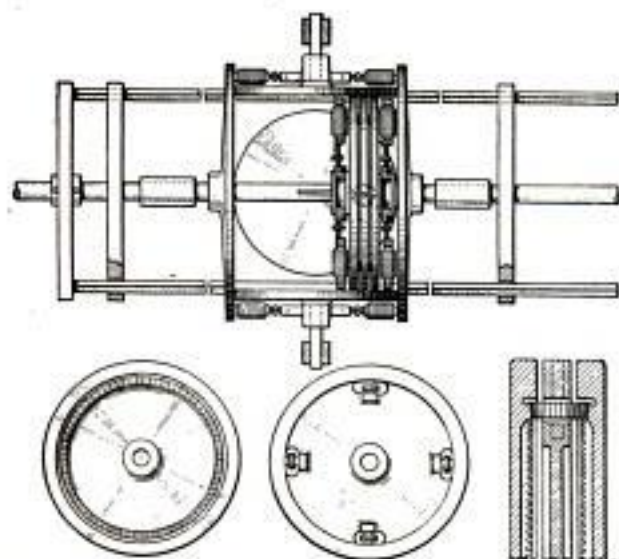

New Method of Applying Pressure in Friction Gear, by Means of Magnets: The Lower Sketches Show the Friction Wheels

friction wheels there are 12 points of contact with pressure constantly maintained by the magnets.

### GAS FURNACE CONTROLLED BY ELECTRIC SWITCH

Convenient electrical control is one of the features of a gas heater designed

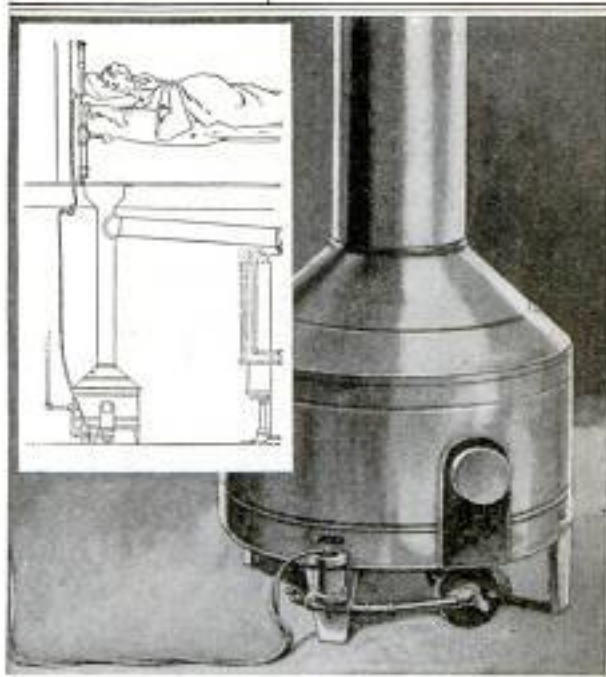

Gas Heater for Warming One or Two Rooms, Which may be Installed in the Basement: It is Controlled by Electric Switches Situated in the Rooms That It Heats

to warm one or two rooms, or to supplement a furnace of insufficient capacity. The apparatus is inclosed in a galvanized-iron cylinder, 2 ft. in diameter and 2 ft. high, and can be installed in the basement, or suspended from the ceiling of a downstairs closet to heat an upstairs room. The air warmed by it is discharged into the rooms through ordinary hot-air shafts. The gas supply is controlled by an electromagnetic valve which, in turn, is operated by a switch, conveniently located. By turning on the switch the valve is opened, whereupon the gas is lighted by a pilot light that burns constantly. Fumes from the heater are kept separate from the warmed air.

⌈The public library in Chicago has offered quantities of old periodicals to volunteers who will agree to cut them up and make scrap books suitable for convalescent soldiers, including those that are too weak to handle heavy books.





The Toyland Co. Inc.  
631 Broadway, Denver, Colo.

**SOME OF TOYLAND'S NEWEST AND BEST PRODUCTS**



The Animals Marching across the Top and Bottom of These Two Pages are All Made of Very Durable Composition Board, except the Funny Bulldog, Which Is of Wood. Skilled Artists Designed and Colored Each One



This Doll Almost Talks. Just Pull One of Her Earrings and She will Wriggle Her Tongue as if She were Saying Something



Put One of the Shells in This Cannon and Then Strike the Upright Air Cylinder, and the Piece will Shoot Like a Real Coast-Defense Gun, Which It Resembles



Something New and Fascinating in Building Blocks: Bar Magnets Set in the Wood Hold the Blocks Together

A Child's Car That Affords Lots of Fun and Healthful Exercise: It is Driven by Working the Handle Back and Forth. A Warning Horn, Electric Headlight, and Tail Light are All Provided



Hot Air Runs This Toy Power Plant. Place It on a Register and It will Drive a Belt for Various Little Machines



Charming, Durable Toy Figures and Furniture Which can be Used in Telling the Often-Repeated Nursery Tales: This Set Illustrates "Goldilocks and the Three Bears"





THAT WILL DELIGHT CHILDREN OF VARIOUS AGES



*E. J. Kern...*  
 A Fine Oak Teeter Board, Stained Green, Which is Mounted on a Pivot so That It Serves as a Merry-Go-Round Too



Perhaps Because Each Represents a Character in "Alice in Wonderland," Knocks cannot Keep the Balls in This Croquet Set from Smiling, Though the Stakes Look Quite Stern

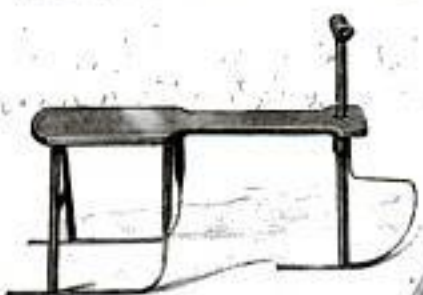

A Sled That Baby can Steer: It is Just the Right Size and There is Little to Get Out of Order



This Coaster Has a Fine New Feature. The Seat and Post can be Held Down Out of the Way with One Foot, While Getting Up Speed. When Ready to Coast, Move the Foot, and Up Springs the Seat into Place, as Shown



The Sand House on the Right Measures Four by Four Feet, and Because It Has a Canopy It Keeps the Sun off the Little Folks Playing in the Sand, and Sometimes the Rain, Also

Here They have Taken Peter Rabbit, Whom Nearly Every Child Knows, and Made Him into a Little Bean Bag, Brightly Colored and Waterproofed



*Quality Plastic Mfg. Co.  
 Name to be in...*



### PRODUCE UPRIGHT BATHTUBS FOR JAPS IN AMERICA

American bathtubs have never met Japanese approval, and as a result a



Nipponese tub is now being made for the convenience of the mikado's subjects who are residents of this country. It is provided in different sizes, one of which is 25 $\frac{3}{4}$  in. high, 35 $\frac{1}{2}$  in. long, and 28 $\frac{1}{2}$  in. wide. The receptacle is virtually a large porcelain-finished bowl.

### NEW SYSTEM OF SUSPENDING CARS DISSIPATES SHOCKS

Entirely obviating, according to the claims of the inventor, the need of shock absorbers, a new sort of spring



has been developed which is suited alike for pleasure cars and trucks. It replaces the ordinary type of spring and is purported to carry a vehicle over rough roads smoothly and without the usual vibrations and rebounds. In one form it consists of a wedge, supported on the axle, that works between two spring-controlled rollers mounted in a frame attached to the body. In another instance the sides of the wedge are toothed bars against which cogs, instead of rollers, operate. The principle of the device is the same in each case. Coil springs, held horizontally, are employed. Their recoil, after sudden compression, is exerted against the wedge instead of upwardly against the body. This causes the latter to return gradually and without jolting to its normal riding position.

### "MOTHER MAPS" GREAT HELP IN ESTIMATING BIDS

Attention has been called by the government to the availability of topographical maps produced by the Geological Survey, and their value to construction contractors, engineers, official boards, and county or state authorities. Mention is made that in some counties where extensive road improvement has been planned, maps showing the locations of material supplies and railway connections have been prepared to accompany specifications and calls for bids. The Department of the Interior points out that when things of this kind are to be undertaken, it should first be learned whether or not the Geological Survey has prepared topographical maps of the regions concerned. These are known as "mother maps," or engineering base maps, and contain far more vital information than any chart that could be specially prepared for the purpose except at prohibitive cost. Pertinent data could be platted on the topographical maps, and the contractor enabled to locate his sources of materials, ascertain the best routes and means of transportation, and thereby have increased confidence in the accuracy of his estimates.

### IMPROVED LOCK SNAP FOR HARNESES



An improved type of lock snap for harness, etc., that is non-fouling and can be easily operated by one hand, has just been put on the market. The mouth of the hook is closed by means of a notched member that is locked in position by a thumb spring projecting from the side of the shank. By pressing this spring the notched member is released so that a ring can be readily inserted into or removed from the hook.





## Cable Trolley Rides over Guy Wires in Its Path

By J. S. ZERBE

**T**HERE are many places where it is impossible to run cables for the transmission of carriers for ore or other products around mountain sides, or across gorges, without using guy wires laterally from one or both sides of the cable. The suspension of the buckets, below such a winding and stayed cable, is accomplished by a contrivance in which the trolley wheel, which supports the carrier on the cable, is rigged with two spider wheels and a special carrier frame, as detailed. The pivot pin of the trolley wheel extends out, to receive, at each end, a spider, the arms of which project beyond the periphery of the trolley wheel, as shown in the side view. The ends of these arms, or spokes, are each provided, on their outer sides, with an

antifriction wheel. The carrier frame is grooved to ride on these wheels. This frame is built up of two sidepieces, generally triangular. The upper rim of these plates is curved and grooved to ride on the antifriction wheels. These pieces are joined together below the spider by bolts, as shown in the end view. The load is carried on the load bar of this frame. The spiders turn independently of the trolley wheel.

When the trolley wheel moves in either direction, the spider wheels do not turn until one of the arms strikes a cross wire. The cross wire then passes up between the arm which strikes it and the next arm ahead. The action is a stepping over the guy, or cross wire. The carrier passes beneath

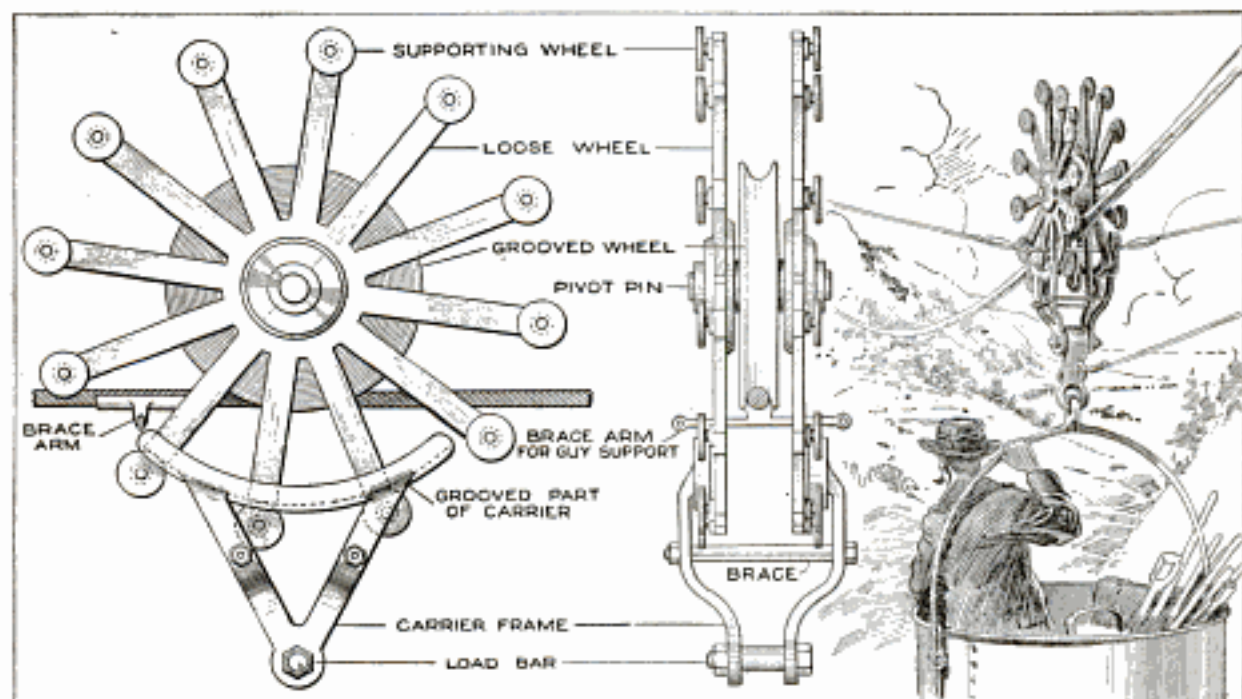

When a Guy Wire is Encountered, the Trolley Wheel Rides on the Cable, Passing over the Wire, and the Load is Carried under the Wire, by Means of the Spider-Wheel Device, Which Supports the Load Carrier



the cross wire, riding along on the anti-friction wheels, as the spiders revolve. The spiders again remain stationary until the next cross wire is reached. The propulsive force can be applied to the pivot pin of the trolley wheel, or to the carrier; in either case the spider will ride over, and the carrier beneath, the guy wires. This arrangement can also be used for a large variety of suspension cable lines for amusement de-

vices, as the lines can be run in many directions in a comparatively small area, and can be laterally supported so as to prevent a swinging motion. Two of these wheels can be used to support motive power, the trolleys being connected by a frame. The carriers are thus self-contained, and useful for transporting products by cable where the usual motive cables are not practical, or economical.

### Hinged Insulator Brackets Prevent Breakage of Wires by Swaying

Municipalities with electrolier street lighting often find trouble in keeping



the overhead wires from rubbing on trees. The swaying of the trees wears the insulation from the feeder wire, and on wet days produces a partial ground and leakage of current. Steel

pins driven into the trees, or wooden brackets spiked on, with the feeder securely tied to the glass, or porcelain, insulator, are unsatisfactory, in many cases causing an almost perfect ground. A simple remedy was devised by attaching a wooden wire bracket to a large hinge, spiked to the tree trunk. The swaying in the direction of the line is provided for in the hinge and the cross swaying in the slack in the feeder wire.—J. F. Bront, Denver, Colo.

### Air Pumped through Water Jacket Cools Gasoline Motor

A four-cycle, water-cooled gasoline engine was installed in a small shop and used only intermittently for small jobs. When the weather became cold, the danger from frost and the job of filling and emptying the tank and jacket caused the operator to devise an air-cooling system for it. Into a collar of suitable size he put a projecting

pin, in such a manner that when the collar was put on the end of the crank shaft, the pin served as a crank pin. From this improvised crank pin he operated bellows attached to the floor below. By means of hose, he connected the nozzle of the bellows with the lower water connection of the water jacket. This caused air to circulate through the jacket while the engine was in motion. Frost did not injure it, and it required practically no attention. The method is, of course, hardly feasible on an engine running for long periods.—J. E. McCormack, Haliburton, Ont., Canada.

### Weight of Goggles Relieved by Rubber Band

In steel foundries, or shops, where the eyes of the workmen are endangered by flying particles of steel or sand, many of the men do not keep their goggles on as much as they should, because the goggles are heavy, and un-



less a man is used to wearing glasses continually, the weight on the bridge of the nose is annoying. A light rubber band looped over the

bridge of the goggles and slipped into a small hook of a hook and eye, sewed on the edge of the cap or hat band, as shown, relieves the pressure. The adjustment desired can be obtained by moving the cap.—J. A. Fitzpatrick, Altoona, Pa.



### Roughening Slippery Iron-Floor Plates

When iron-floor plates become worn smooth, they are dangerous under foot, especially when wet. A method of roughening them slightly is as follows: Mix a small quantity of powdered sal ammoniac thoroughly with fine sand. Sprinkle the mixture over the iron floor, covering it with a thin layer. Dampen the surface with a sprinkling can and permit the material to remain over night, or preferably over a holiday. Sweep up the sand, and it will be found that a rough coating has been formed, which will last several weeks. The process may be repeated until the desired roughness is obtained.

### Raised Letters and Designs Painted with Roller

A quick and effective way of painting raised letters, with flat faces like type, or other designs, is to roll over them with a small roller such as printers use in inking type when they pull a proof. The paint is carried on a board, and the roller is covered with paint by running it across the board. In some cities the names of streets, on lamp-posts at the corners, are written in flat-faced white letters, raised, on a background of green, and this method was used with success to paint the letters after the post had been painted green.—Alfred J. Miller, Albuquerque, New Mexico.



Much Time was Saved in Painting Street Signs by This Method

### Pedal Controls for Washbasin Faucets

A physician has an ingenious device in his operating room by which he can turn on the water in the lavatory with-

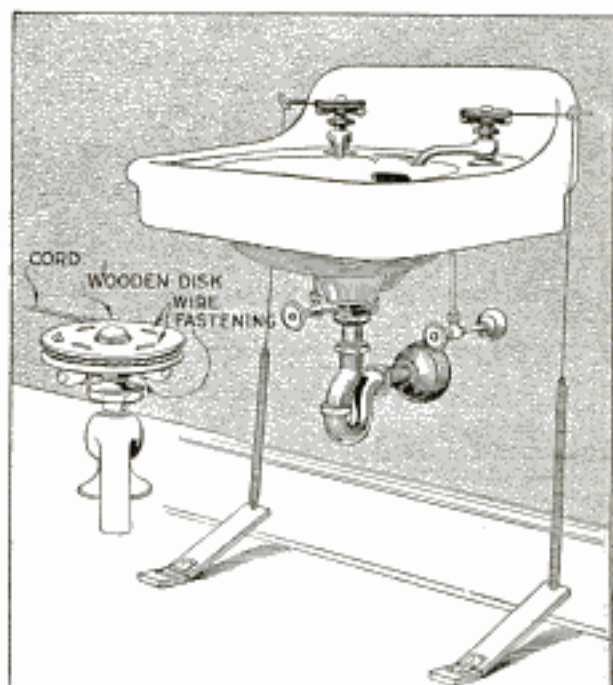

With This Arrangement the Faucets can be Turned On with the Foot, the Hands Not Soiling the Handles

out gripping the handles of the faucets at the washbowl. This is a sanitary feature of importance in his surgical work. The arrangement consists of two pedals fastened to the floor beneath the washstand, and rigged as shown. They are hinged to the floor, and the free ends are held slightly elevated by cords. These cords run through screw eyes in the wall, and are connected to pulleys set on the faucets, as detailed. By treading on either pedal, the corresponding faucet is turned on; when the pressure is released, the spring in the faucets shuts off the water.—John D. Gilbert, Eugene, Ore.

### Gate Adjustable to Heavy Snowfall

In regions where the snowfall is heavy, especially on the farm or in suburban places, considerable labor is involved in shoveling away the snow so that gates can be opened at their



usual level. By arranging the gates so that they can be raised above the level of the snow as it accumulates, much of this labor becomes unnecessary. In the arrangement shown, a heavy iron



Instead of Shoveling a Path for the Gate at Its Usual Level, It is Raised and Supported on Pins Set in the Long Pipe

pipe, 3 ft. higher than the usual height of the gate, was set in a concrete base and supported by bolts through the fence posts, at the hinged end of the gate. The gate was arranged to slide vertically on this pipe, which supported it from large eyes, or loops around the pipe. Holes bored through the pipe at intervals were fitted with adjusting pins, one for each hinge support of the gate. The gate was quickly raised to the proper level, and the pins set into place.—Ethel S. Platt, Traverse City, Michigan.

### Guide for Cutting Triangular Strips on Circular Saw

In reinforced-concrete construction the inner corners of the beam and column forms are filled with triangular

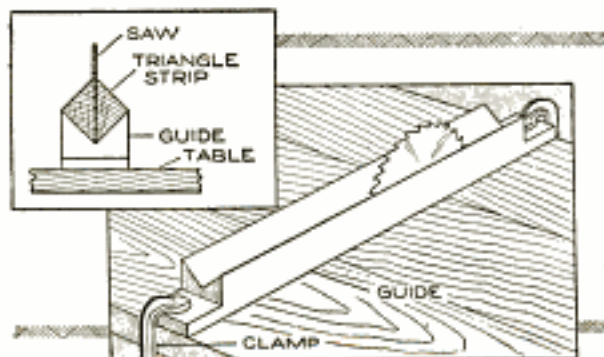

The Guide is Clamped on the Saw Table and the Squared Stock Ripped Diagonally

wood strips, known as fillets. The contractor's circular saw usually is not equipped with a tilting table, and some sort of a jig is required for ripping the fillet strips from the square stock. The sketch shows such an arrangement. A trough-shaped guide, with a slot to accommodate the saw, is clamped to the saw table, and the square stock is pushed along this guide.—J. J. O'Brien, Buffalo, N. Y.

### A Homemade Low-Pressure Angle Valve

A low and medium-pressure valve, that is valuable as an emergency device, and which also gives good service as a fitting for the home workshop, was made of materials easily obtained. This valve possesses points of superiority over some commercial valves, for when the valve is open, the water, etc., passing through the pipes, has an



unobstructed flow, and because of its simple construction will appeal to the home mechanic. It is made of a tee in which is fitted at one end a pipe, beveled to form a seat for the valve. In the other end of the tee is a common plug, drilled and tapped centrally for a  $\frac{3}{4}$ -in. bolt used as a valve stem. The handwheel is a makeshift, and a plain metal or fiber disk, beveled to fit the valve seat, is fastened to it with a screw. The valve was designed especially for a low-priced tree-spraying and painting machine.—J. B. Murphy, Plainfield, N. J.

### Scraping Dirt from Piston-Ring Grooves

I put in many piston rings in automobile-repair work, and as it is quite a job to scrape carbon from ring grooves, I use a section of a broken piston ring as a scraper. It is fitted in a file handle, and scrapes both the sides and bottoms of the grooves.—Irl R. Hicks, Centralia, Mo.



## A Sanitary Drinking Fountain of Concrete

By GEORGE E. TONNEY

**B**UBBLING drinking fountains are being installed on the sidewalks by many cities throughout the country, but because of the expense fewer than needed are often provided. By making forms for a substantial, artistic fountain of standard design in concrete, like that shown in the illustration, these public conveniences can be built at small cost. The mold, as detailed, is adaptable to a large variety of designs. It is built up of wood, joined together at the four corners in a miter joint, and the sections are held together, while the form is in use, by a top and a bottom plate, and wires twisted around the shaft portion of the mold. The concrete is poured in through an opening in the upper frame, or plate. For quantity production, several duplicate forms may be made. The water-feed pipe is incased in a 1½-in. drain pipe, cast into the mold when the concrete is poured in.

The construction of the fountain, detailed briefly, is as follows: Lay out a full-size sketch of the fountain, as shown in the sectional view of the working drawings. This can be done handily on a wide board, or on a long strip of wrapping paper. Indicate both the front and top views, and then lay out the parts of the wooden form, as detailed in the top view and the vertical section of the mold ready for the concrete. The wood used is 7/8 in. thick. Care must be taken in laying out this drawing carefully, especially as to the joining of the pieces, which are arranged to be nailed handily. In shaping the pieces make all the light

strips at the same time, cutting a board long enough for all the shorter sections

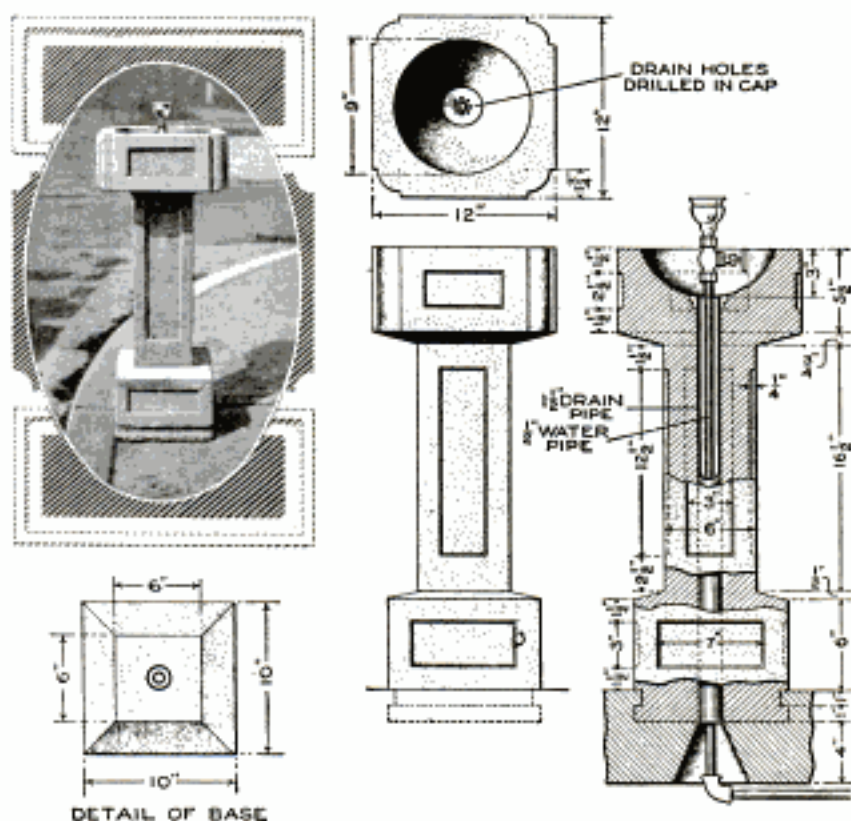

This Substantial and Artistic Sidewalk Bubbling Drinking Fountain was Made in a Simple Wooden Form, Which can be Adapted to a Large Variety of Designs

of each variety. Fit the pieces to the full-size drawing, and cut them, for the corner joints, in a miter box. Smooth the inner surfaces of the pieces carefully before nailing them together.

When the outer 7/8-in. boards are shaped and fitted for the four sides, nail them together, driving the nails part way in, and fit the sides together. Then make the top and bottom frames to hold the sides in place. If the joints fit snugly, drive the nails in and set their heads slightly below the surface.

Before putting the panel blocks into place, smooth off the inner surface of the mold and sandpaper away all the sharp corners. Then make the panels, which are 1/4 in. thick. Nail them into place, centering them carefully on the sides of the sections. The panels should be beveled slightly, so as to withdraw readily from the concrete. Fill all of the nail holes smoothly with plaster of Paris. Make a wooden block



for the basin at the top of the fountain, and arrange it to be set on top of the pipe, which is adjusted carefully in the center of the mold and held in place by nails driven into blocks set in the ends. A tin pan may also be used to form the

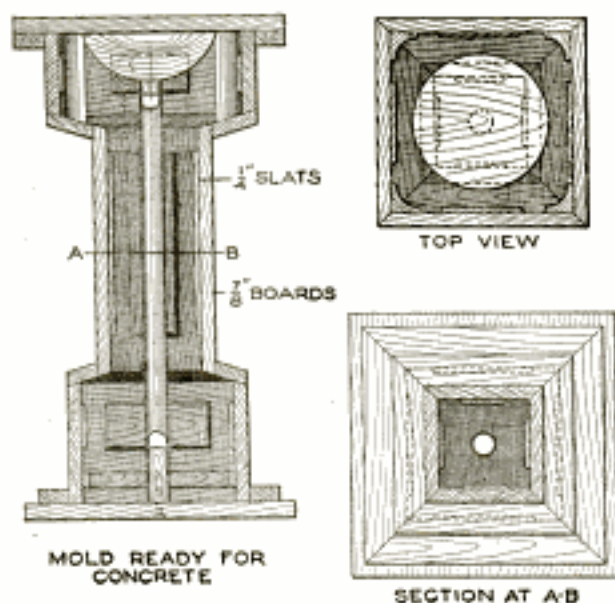

In Making the Forms, a Full-Sized Diagram is Laid Out and the Pieces of Wood Fitted Accurately to the Drawing

basin. Apply two coats of shellac, sanding them lightly when dry, on all surfaces of the mold which come into contact with the concrete. If the mold is to be used repeatedly, it will pay to use extra-good wood, preferably pine, and to soak the wood in oil.

If the form is properly made, little difficulty should be experienced in setting it up and pouring the concrete. Apply a uniform coat of linseed oil to the inside of the form. Bind the center portion of the form tightly with heavy wire, and set the top and bottom frames securely into place, tacking them with light wire nails. Mix a 1:3 mixture—one part Portland cement to three parts coarse clean sand—making it quite wet. Pour in the mixture, and jar the mold slightly to insure that the concrete runs into all the corners. Permit the fountain to dry at least 48 hours, in a cool, dry place. Remove the form carefully, tapping it slightly to prevent any of the corners from breaking. Repair any breakage or holes by filling the spots with the mixture. Wet the fountain for several

days, while it is permitted to dry thoroughly. If desired, the surfaces may be tooled smooth by applying a paste of cement.

Provision is made in the mold for locking the fountain securely into the concrete sidewalk, as shown in the sectional view. The fountain is set in a recess in the sidewalk, 2 in. deep, and concrete surfaced around it to the lower edge of the paneled base.

### An Improved Mixing Box for Mortar or Grouting

In repairing a roadway, the varying levels and the crown from the curb to the center made it awkward to use a box of the ordinary construction, mounted on wheels, for mixing the grouting and moving it from place to place. When the box was nearly full, the varying level of the material caused splashing and spilling. A special mixing box was therefore constructed, the principle of which can be adapted to mixing boxes for various uses. The mixing trough was constructed so that the mixture flowed to one corner, which was the deepest. The top of the box was so arranged, by varying the height at the four corners, that it was level

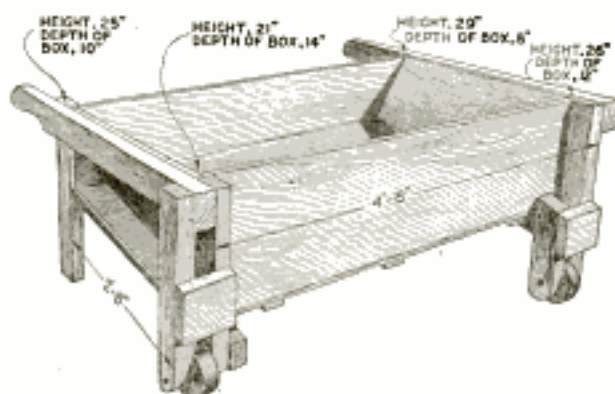

The Varying Height of the Supports for This Mixing Box Made Possible the Transporting of a Large Load without Spilling

in spite of the curve of the roadway when the box was transported, the back end being raised.—J. E. Cahill, Jr., New York, N. Y.

ⒸDo not force a tap that binds, but remove it and determine what is the cause, or a broken tap may result.



### Cutting Grooves in the Edges of Thin Disks

Having to make slots,  $\frac{1}{32}$  in. wide by  $\frac{1}{32}$  in. deep, in the edges of a number of 5-in. disks of aluminum,  $\frac{5}{64}$  in. thick, to carry fine steel wire, we used the following method: First, in the tool post was fitted a piece of boxwood with a slot,  $\frac{5}{64}$  in. wide and  $\frac{1}{4}$  in. long. Over this was placed the special cutter which had a point,  $\frac{1}{32}$  in. wide and  $\frac{1}{32}$  in. long, projecting beyond a shoulder, which acted as a gauge for depth. The slot in the boxwood guide was just a snug fit for the thickness of the disks. As the holes in the disks and their hubs were but  $\frac{5}{32}$  in., and there must be no vibration, such a method became necessary. When all was ready, a very slight turn of the end screw on the lathe moved the carriage slightly toward the chuck. This

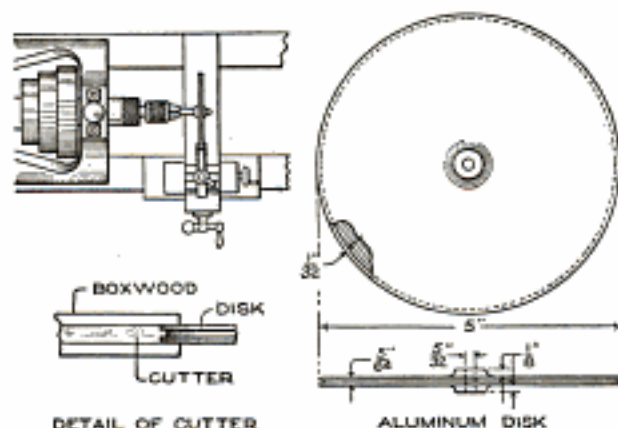

DETAIL OF CUTTER  
ALUMINUM DISK  
These Aluminum Disks were Grooved on Their Circumference by Rigging a Special Tool, as Shown

kept the disk absolutely true. We drove the disks 3,000 revolutions per minute, and as the cutter fed slowly forward, a hairlike thread of aluminum came almost unbroken up to the full depth. Under a magnifier, the slot showed a polished surface.—L. M. Drake, Daytona, Fla.

### Roller-Skate Truck Saves Carrying Doors and Sash

In a sash-and-door factory, much time and labor was saved in moving doors, and similar products, by the use of a small truck made of a roller skate. The four wheels, with the two axles,

from an old roller skate were removed, and the distance between them lengthened by a strip of strap steel, about 4

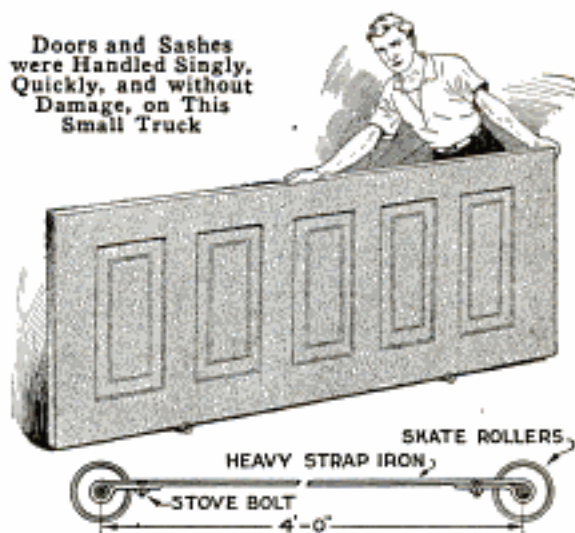

ft. long. This was bolted to the center of the two axles, as shown. The doors were quickly shifted singly, in spaces where a large truck could not be used.—Dale R. Van Horn, Milton, Wis.

### Stock Racks for Rods and Pipes Quickly Devised

On a large machine job, where a great quantity of steel rods had to be handled quickly, it was found that the necessary racks were not available in the shop. As the work was only temporary, it was not desirable to make additional racks, and a makeshift was devised. Steel kegs, or drums, used in the shop were set up in pairs, and lengths of iron pipe, or rod, set in them to form a rack, as shown in the sketch.



This Method of Storing Pipes or Rods Temporarily can be Adapted Widely, Using Wooden Kegs or Boxes if Necessary

The arrangement proved very efficient, it being easy to transport the pipes and kegs from place to place, as needed.—Charles Doescher, Waterbury, Conn.



### Leather Wrench for Tightening Screw Clamps

Many workmen, especially those who make use of the common wood clamps

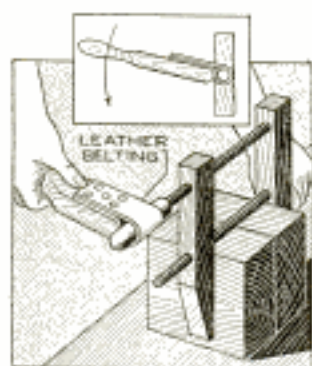

only occasionally, blister their hands in attempting to tighten up the screws on hand clamps of the cabinetmaker's type. In order to avoid this, a handy tool can be used, that is made of a strip of leather belting fastened to a handle with screws, as shown. The leather loop acts as a wrench, and the clamp screws can be tightened as securely as desired by the use of this tool.—Henry Wedde, Chicago, Ill.

### Band-Sawing Cabriole or Curved Furniture Legs

Among the many pieces of work brought into a job shop, or undertaken by the ambitious home cabinetmaker,

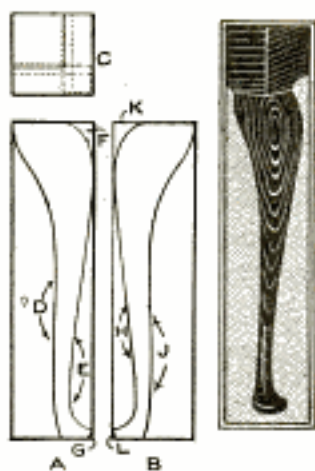

one which is perplexing to the workman who undertakes it for the first time, is the band-sawing of a Dutch or cabriole leg. A pattern for the work is desirable. The outline is marked upon two adjoining sides of the stick from which the leg is to be sawed, as indicated at A and B, C being a top view. The cuts D, E, F, G, should be sawed first. Cut each piece whole, and lay it back in the place from which it came, to provide a true surface upon which the stick may rest while the other sides are being sawed. Each piece may be held in place by hand, by fastening with small brads so

the saw will clear them, or by gluing them lightly. The latter is the best method if time permits. Next saw through H, J, K, and L.

After band-sawing the leg, it will be square in section, and often a leg of this sort is finished this way. If finished round, as in the sketch, careful work is necessary to make the sweeping curves without destroying the proportions and outlines of the leg.—Charles A. King, East Kingston, N. H.

### Changing Grinder to Left-Hand Drive

A hand grinder which I used in my home shop was arranged so that the grinding was done with the left hand, while turning a crank with the right hand, in using the tool rest. I drilled a hole and tapped it, as indicated at C,



so that the tool rest may be used either at A or at B. The grinding may thus be done with either hand, as is convenient.—Hugo Kretschmar, West Nyack, N. Y.

### An Improved Charcoal Soldering Furnace

This soldering furnace, which I made and have used for some time, is quite an improvement over the old kind.

To make it, obtain a can, A, 6 or 8 in. in diameter and 18 in. tall, with a lid, B. Rivet on a piece of 2-in. sheet-iron pipe, C, having a damper, D, as shown. Next rivet on two pieces of pipe, 2 in. in diameter and 3 in. long, E and F. Fit a piece of sheet iron, G, inside of the pot, provid-

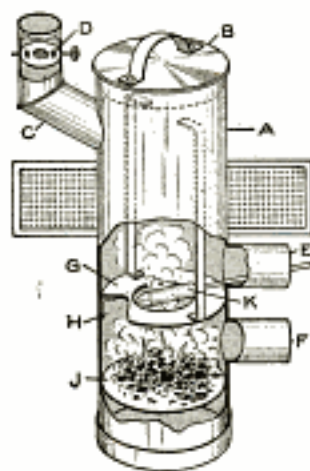



ing lugs, H, for riveting it to the can at three places. Cut a 4-in. opening in this, and rivet it just below pipe E. Put a charcoal fire in the bottom J, and it is ready for use. The soldering iron K is inserted through the pipe E. As considerable air goes in at E, the handle of the iron will not heat easily or burn. The draft for the fire goes in at pipe F. The copper itself will heat more quickly, owing to the intensity of the heat through the hole H.—R. S. Matzen, Fort Collins, Colo.

### One-Man Method of Adjusting Auto Foot Brakes

Many automobile owners neglect the close adjustment of foot brakes, causing needless expense and possible danger. The principal reason for such neglect is that it usually takes two men to adjust the

brakes successfully. One presses the pedal, while the other tests the wheels to insure even braking power. One man

may easily and successfully adjust the brakes with the use of a jack, as shown in the illustration. The jack A, with a block, B, to protect the seat, is placed between the seat and the brake pedal C. The jack is applied to the desired pressure on the brake pedal, and the proper adjustments made.—Koerner Rombauer, Prescott, Ariz.

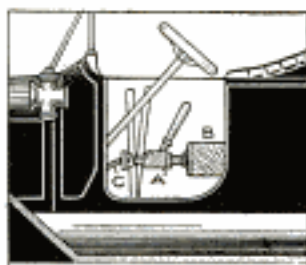

### Repair for Air-Pump Stuffing Box

When the fine threads of the brass stuffing box on an air pump became so worn that they no longer held, the following method of repairing it was used: The stuffing-box cap was removed and its threads filed down until they cleared the inner threads. Two hose connections were procured, and one soldered into place, as shown in the sketch. The other was screwed

into place with a metal washer between it and the stuffing-box cap, so as to distribute the pressure evenly on the cap

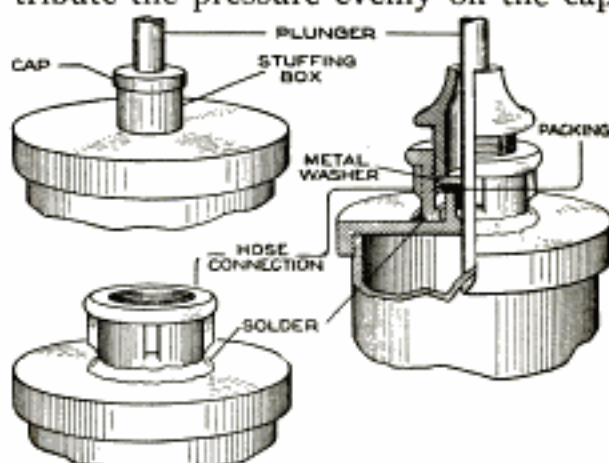

Hose Connections were Used to Repair the Stuffing Box, Making It Quite Serviceable

head. The repair proved even stronger than the original arrangement.—James M. Kane, Doylestown, Pa.

### Handcart for Railway Tracks

For use in repair work on tracks and other railway equipment the handcart shown in the illustration was found convenient. It is strongly built of oak and mounted on an axle fitted to a set of flange wheels. The frame is supported on the axle by means of two bearings of strap iron, formed as

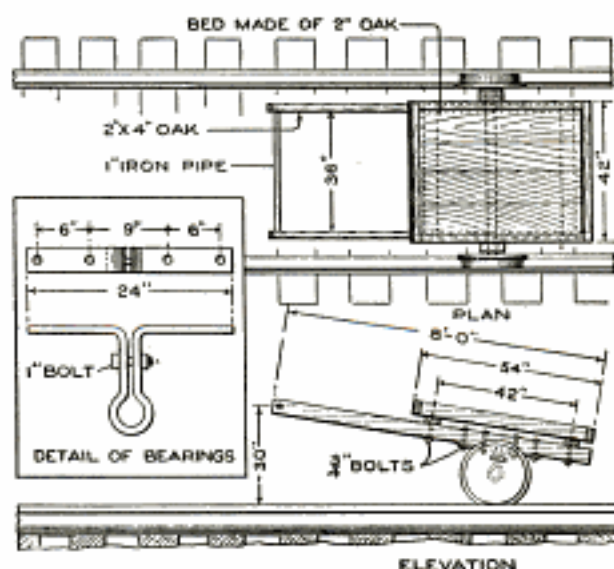

Heavy Loads are Carried on This Cart for Railway Repair Work

shown in the detail, and bolted to the frame.—Roy H. Poston, Flat River, Missouri.



### Stopping a Hole in a Hollow-Metal Float

A simple and effective method of repairing a leak in a float is as follows:

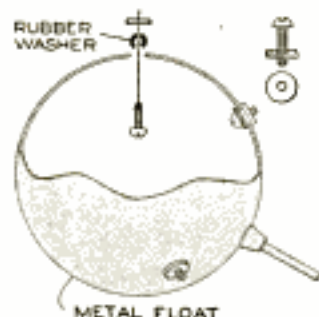

Ream out the hole in the float to the size of the head of the  $\frac{3}{16}$  by  $\frac{1}{2}$ -in. stove bolt used. Tie a piece of string to the bolt, as shown; push the bolt into the ball, and place the washer over the string. Double the washer and force it through the hole in the float. Pull up the bolt through the hole in the washer, and screw on the nut. The bolt will not turn, and considerable pressure can be put on the nut without pulling the washer through the hole.—James E. Noble, Portsmouth, Ont., Can.

### Fire or Warning Whistle Operated by Electric Release Weight

A reliable electric trip for a fire whistle, suitable for small towns or villages, was constructed as shown in the diagram. The weight fastened to the whistle cord is hung on a lever, D. This lever is held in place by a hook, C. Both the lever and the hook pivot on bolts. A magnet coil, A, is placed directly

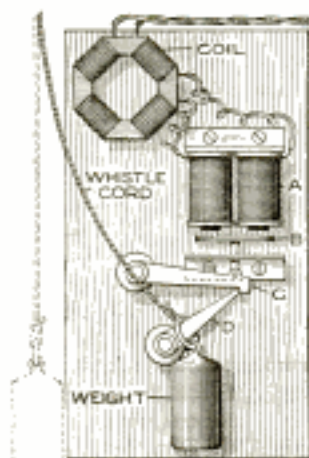

above the hook, and its armature, B, is attached to it by a short connecting rod. When the current is turned on, the magnetic action in the coil lifts the hook, allowing the lower lever to drop. The whistle weight then slides off the lever, opening the steam valve, and blowing the whistle. The controlling switch may be located at the local tele-

phone exchange or city hall. When an alarm of fire is telephoned in, the telephone operator turns on the switch and immediately the whistle sounds the alarm. When the weight is replaced, the device is in readiness for the next alarm. The device may be arranged on the ordinary 110-volt circuit with suitable fixtures. Various kinds of warning whistles may be similarly controlled.—P. E. Bertram, Crystal Lake, Illinois.

### Drill-Press Table Supports Tool Tray

Many times when using a drill press, the job takes nearly all of the table, and there is no room for calipers, gauges,

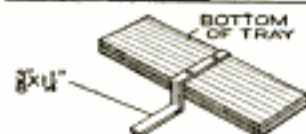

etc., without danger of losing them. I have found a little table, made as shown in the sketch, very useful. A bar of iron or steel, to fit the slot, is bent with an offset so that the top of the tray set on it will be below the top of the drill-press table. A wood tray is fastened to it by two round-head bolts. The tray can be used on the table where most convenient, and laid aside quickly when not needed.—Alfred E. Carter, Providence, R. I.

### A Starting Handle for Small Gas Engine

A neighbor who had a 4-hp. pumping engine, was often away when water was needed, and, as his wife could not turn the flywheel over to start the engine, he rigged up a device for starting the engine and the pump without any undue effort. A hardwood lever, A, of a length twice the diameter of the flywheel, was fitted as shown. The lever is wider at the bottom, and through the center is sawed a slot as detailed. The pivot plate B was made by a blacksmith. It just clears the



rim of the flywheel. A coil spring is fitted between the pivot bolt and the bottom of the slot, at C.

To install the device, turn the engine until the compression point is reached, and one spoke of the wheel is slightly raised above the horizontal. Then fasten a pin, E, to the spoke, about 2 in. in from the rim, and a bolt, D, to the lever to engage the pin at this point. The operation is simple. Turn the wheel to compression, engage the bolt D over E, on the under side of the spoke, and pull sharply forward by the handle. As the rim rises in its revolution, the bolt follows it by means of the slot and spring regulation in the lower end of the lever. The bolt D is forced out from its place at the pin E by the action of a second coil spring at the bottom of the lever, eliminating any danger if the grip on the lever is re-

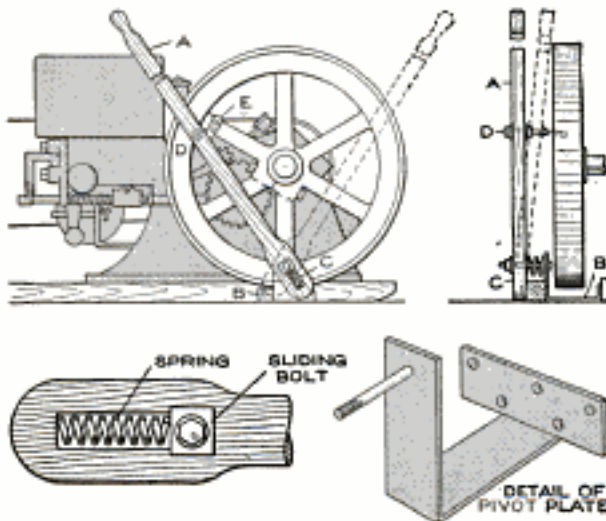

DETAIL OF HANDLE END  
An Engine, Too Heavy to be Started Handily Except by a Strong Person, was Rigged with a Starting Lever That a Woman can Use

leased too soon. When not in use the lever is laid on the floor beside the motor.—L. B. Robbins, Harwich, Massachusetts.

### Large Wheel Refaced on Lathe Rigged as Grinder

Machinists in small communities, where there is not sufficient work to install machinery for many kinds of jobs, often have their ingenuity tested. The photograph shows how a job, which many machinists, without spe-

cial equipment, would have given up as impossible, was done. The wheel on the framework is one of two used for a band saw to run on. The ma-

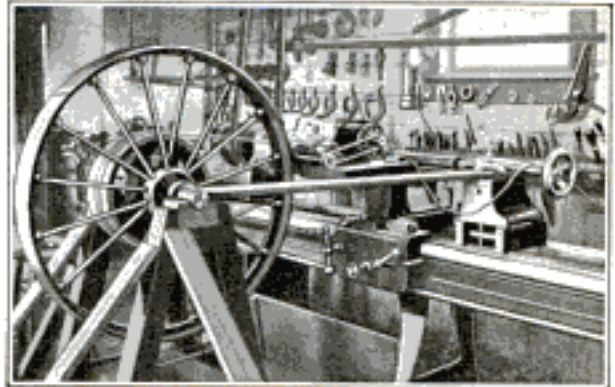

By This Simple Yet Ingenious Arrangement a Special Machine Job was Accomplished in Spite of Very Limited Equipment

chine had been left out in the weather until the surface was rough and uneven. It was necessary to dress the face, and the shop had no equipment for handling work of that size. The job was accomplished by fitting a shaft into the wheel, fitting a drive pulley onto the same shaft, and squaring the arrangement up in front of the lathe. A belt was run from the revolving shaft of the lathe to the drive pulley, thus putting the large wheel in motion. An emery wheel, operated by an individual motor, was then fastened on the lathe, on an adjustable shelf, and put in contact with the moving wheel. By this method a perfect face was put on the two wheels.—Elbert Bede, Cottage Grove, Ore.

### Safety Gas Cock with Ball Valve

A simple appliance can be made from any ordinary gas cock insuring a more nearly safe connection with a rubber hose, when the latter is accidentally pulled from a gas heater, or stove, unnoticed. A coil spring and a small rubber ball, with retaining collar, are fitted, as shown. When the hose is removed from this gas cock

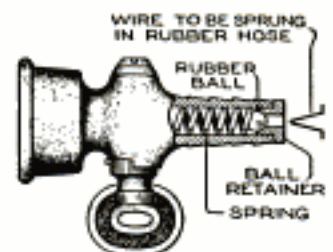

hose is removed from this gas cock



the rubber ball springs in place, stopping the flow of gas. The wire set in the end of the hose pushes the ball from the opening when the hose is attached.—A. H. Hale, Brooklyn, N. Y.

### Hood Confines Forge Fire for Intermittent Use

Having trouble with the fire going out in a portable forge, as soon as I left the blower, I overcame the trouble by fitting a 100-lb. sheet-steel, white-lead drum over the fire. A 2-in. hole was cut in one side close to the bottom. To hold the fire for some time, I heap the coals in the middle of the forge, place the drum over it, and press the rim firmly into the ashes around the fire. The fire inside is protected from drafts, and will keep for a long time.—Dennis L. Wilson, Orr's Island, Me.



overcame the trouble by fitting a 100-lb. sheet-steel, white-lead drum over the fire. A 2-in. hole was cut in one side close to the bottom. To hold the fire for some time, I heap the coals in the middle of the forge, place the drum over it, and press the rim firmly into the ashes around the fire. The fire inside is protected from drafts, and will keep for a long time.—Dennis L. Wilson, Orr's Island, Me.

### Foot-Rest Locker Built into Auto Tonneau

A locker set crosswise in the tonneau floor of an automobile, just behind the front seats, and fitted with hinged covers, inclined at the correct angle to make them serve as comfortable foot rests, is a practical feature that the autoist, himself, may install. The covers and the top of the locker are bound in brass and carpeted with the same material used on the floor of the tonneau. Each lid is fitted with a lock, and the compartment is subdivided as desired. It extends to a depth of 3 or 4 in. below the floor level. Robes

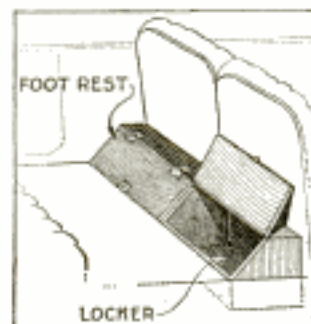

can be locked up to prevent theft when the car is left unguarded, and one of the chambers can be used for carrying the pump, jack, and other frequently used tools, which, if stored under the back seat, cause considerable inconvenience to the passengers. Where the drive shaft interferes, a space can be left for it.—Winsor R. Davis, New York, N. Y.

### Attaching a Hose Coupling with a Vulcanized Joint

A good method of fastening a metal splicer in rubber hose is one by which the coupling is, in effect, vulcanized into the end of the hose. Support the end of the hose securely, as shown, clamping a block of wood over it with nails. The hose can also be held in a vise. Hold the coupling with a pair of pliers, and heat it in a flame to a dull red. Then the hot coupling is thrust into the end of the hose, where it will stick, and immediately the hose end, with the coupling, is soused in cold water. The rubber has, after a fashion, been vulcanized to the metal. Then, after the usual wire, or spring, clamps have been applied, on the outside of the hose around the coupling, the metal will, under ordinary conditions, give no further trouble from coming out.—R. A. Talbot, Omaha, Neb.



### Refacing Jaws of Wooden Clamps

When the jaws of wooden clamps become "chewed up" from heavy use, new life can be given to the clamp by cutting away the inner faces of the jaws along the whole length, deep enough to remove the marred parts. Another way is to cut out about 1/4 in. in the front end of each jaw, and fasten in pieces of fiber, or wood.



# Combination Turning, Sawing, and Grinding Machine

By HENRY L. COOLIDGE

SIX different kinds of machine work can be done on a combination job-shop machine, which I rigged up from an old high-wheeler bicycle: a circular-saw table rips lumber up to  $1\frac{1}{4}$  in. thick and crosscuts stock nearly as thick; a molding-cutting attachment on the saw spindle cuts various kinds of wood moldings; the emery wheel does general grinding, and the lathe, and scroll saw perform the usual work done on these machines, within the range of these features. The photograph shows the machine in operation, and the sketch shows the arrangement of several of the working parts. While the machine cannot readily be duplicated, it offers suggestions for the building of other novel combination machines of pick-up materials. The lathe and emery wheel are shown in the foreground of the photograph; the scroll-saw table is tilted upward, back of the emery wheel, and the circular-saw table is shown in the background. The large wheel of the bicycle was mounted in

the frame, and supported on the floor by hangers at the pedal shaft and pipe connections at the rear brace, as shown in the sketch. The lower part of the wheel runs in a pit in the floor. The power is transmitted from the pedal shaft to a countershaft, by means of a round rope belt, running in the tire groove of the large wheel, over an idler, and engaging a 9-in. grooved

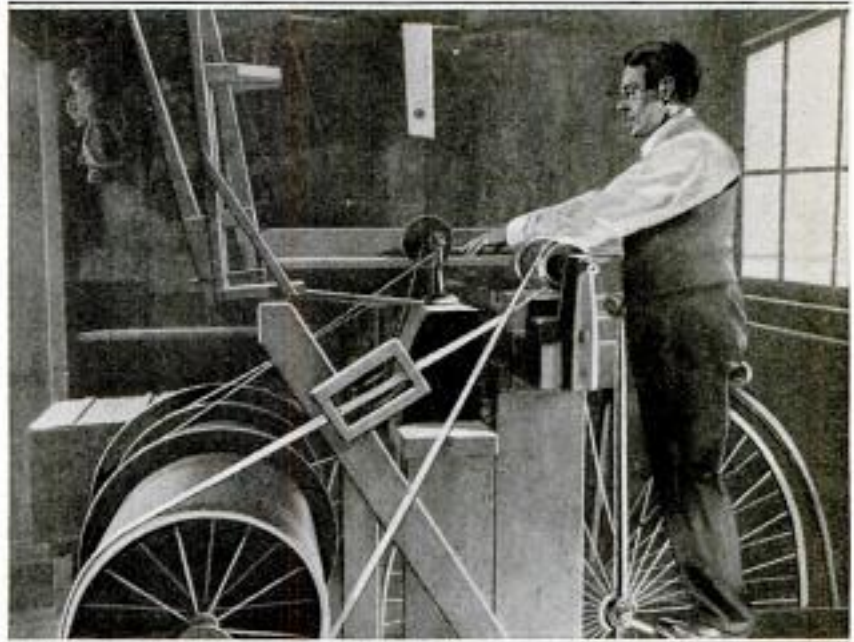

An Old-Fashioned High-Wheeler Bicycle was Rigged Up to Provide the Driving Gear for This Combination Machine; the Operator is Ripping Stock on the Circular-Saw Attachment

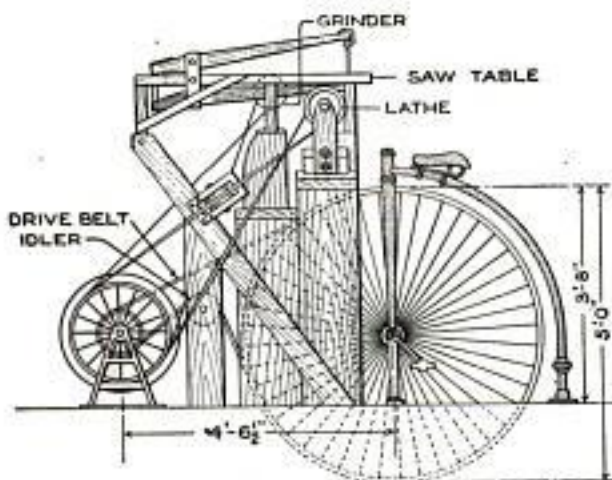

Side Elevation of the Machine, Showing Several of the Working Features, and the Driving Mechanism

pulley, set on the middle of the countershaft. Two of the small rear wheels used on this type of bicycle are mounted on the ends of the countershaft, and drums built over them, to carry the necessary belts for the lathe, emery wheel, and other tools.

The lathe bed is mounted on a wooden platform, and carries the wooden headstock, in which the bearings and spindle are mounted, as indicated. These were made from the bearings and shaft of the bicycle. The tailstock of the lathe is not shown, as it is moved back on the bed, behind the circular-saw table, when the latter is in use. The emery wheel is mounted on an iron stand, which is hinged to fold back toward the countershaft, when the scroll saw is in use.



The scroll saw is mounted in the usual type of wooden arms, and the saw table for it, together with these arms, folds upward, as shown in the photograph. When in use, the front end rests on the lathe bed, and power is transmitted to the arms from the lathe spindle, a lever giving a stroke of 2 in. The circular-saw table is shown at the farther end of the lathe bed, and is folded upward, similar to the scroll-saw table, when not in use. The free end of the table rests on the lathe bed, and is supported firmly. The rip and crosscut saws, and the molding cutters, are mounted on the circular-saw spindle, which is driven directly from the farther end of the countershaft by a pulley and belt.

#### Motor Commutator Turned Up True in Position

The commutator of a motor became badly worn, requiring truing up. In making the repair, the brush yoke was removed, slipped over the bearing, and laid down, as shown. A piece of timber, fitted with another piece which

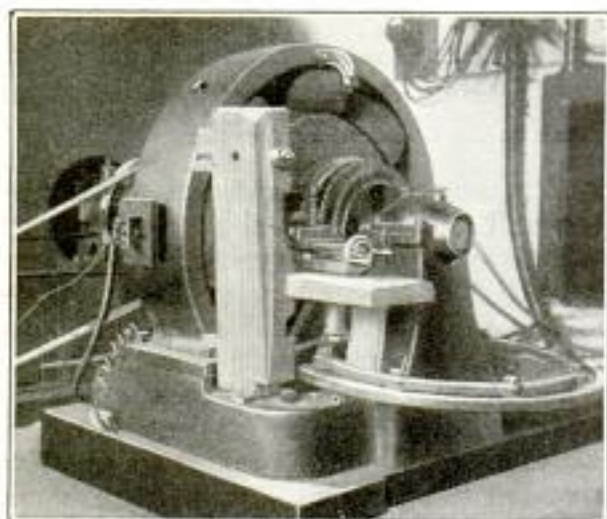

The Commutator was Turned True Quickly with This Arrangement, and the Motor was Out of Commission Only a Short Time, Because It Was Not Necessary to Take Down the Machine

acted as a knee, on which was fastened a tool rest, was bolted to the motor. The tool rest and slide fixture used were taken from a small speed lathe. This provided a movement for the feed of the tool and the depth of

cut. The rigging was fastened firmly, to prevent vibration and consequent roughening of the surface cut. The armature was driven by another motor connected to it by a belt. One side of the commutator may be harder than the other, and so care must be taken when moving the tool across the soft parts to prevent it from digging in.—Harvey Mead, Scranton, Pa.

#### Rubber Goods Kept Pliable by Oil

Soft-rubber apparatus deteriorates comparatively rapidly, and a method of preserving it sometimes used by surgeons is to inclose the rubber articles in a tight receptacle, in the bottom of which a small quantity of kerosene oil is permitted to evaporate. A large tin box, or can, with a close-fitting lid makes a good container. Perforated trays are fitted into it to hold the rubber goods. The bottom tray should be several inches above the oil, about two teaspoonfuls of oil being required. The oil must not come in contact with the rubber, which must, of course, be given a thorough washing before use, if sanitation is a requirement.

#### Automatic Feed-Water Pan for Furnaces

Most hot-air furnaces are equipped with a water pan placed usually at the front, or side, in the narrow space between the outside casing and the fire chamber. Such a pan is commonly filled only when the overbaked smell from the dry pan gives tardy notice of the need of attention. The following description of a thoroughly satisfactory, automatically filled pan devised for a hot-air furnace is suggestive as to further means of accomplishing the same purpose.

The pan A, which need not be large, was placed where a sufficient volume of water could be evaporated, on top of the fire box. The heat might melt soldered joints, so a seamless drum, a container of white lead, was used. A hole



was punched through the side, near the bottom and fitted with a horizontal length of  $\frac{1}{2}$ -in. pipe, B, long enough to extend through the sheet-iron casing of the furnace, a distance of about 2 ft., to a wooden post, as shown. On this post, a shelf was placed to hold a paint can, D, to which the other end of the 1-in. pipe was attached, also near the bottom. Within this can, a float, F, was devised, in the form of an inverted cup, open at the bottom, and guided by a central tube, G, fitted over a vertical wire, H, soldered to the bottom of the can. To the top of the float was attached a needle stem, I, about 2 in. long, serving as a valve stem for the control of the water supply.

A water connection was made by a short length of garden hose, L, as shown. The valve J consisted of a thin sheet of copper soldered over the

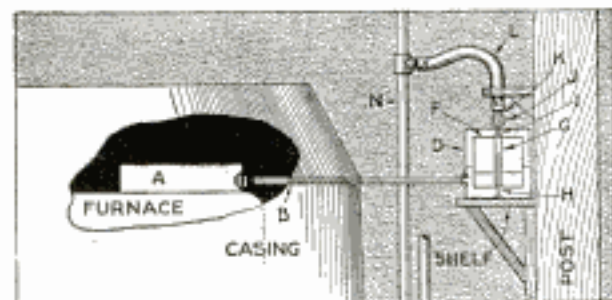

This Arrangement Automatically Keeps the Humidifying Water Tank of the Furnace Filled to the Proper Level, and Insures Healthful Moisture in the Rooms Heated

end of a hose coupling, connected to a nipple, K. A small hole was made in the copper disk, and the needle point entering this hole made a self-guiding valve. The evaporation of the water in the hot-air chamber of the furnace lowers the water level, causing the float to descend and let in water from the hose until the float is raised again, and the water shut off. The regulation of the water supply thus becomes automatic.—B. H. G., Chicago, Ill.

CA careful operator will not carry developer over to the fixing bath on his hands, or bring them into contact with the developer, until after washing them thoroughly, if any of the fixing bath has come into contact with them.

### Back Rest for Supporting Wood in Lathe

In turning a long piece upon an ordinary wood-turning lathe, one or more back rests, or supports, may be necessary to control the vibration.

The device shown in the sketch was found efficient, and can be made easily. The piece B passes between the shears A of the lathe, and is held in place by a wedge, C, space being left to allow the wedge to pull. The top end of the piece B is mortised and pinned into the base, and the standard E, mortised and pinned. The front end of the arm F is V-shaped. The other end of the arm is slotted to permit lateral adjustment. The screw G, and the hole in the upright E, are threaded, and arranged to hold the arm in place. In use, the V of the arm should be kept waxed with paraffin, so that the spindle will turn easily without scratching, and the rest should be centered over the stock carefully.

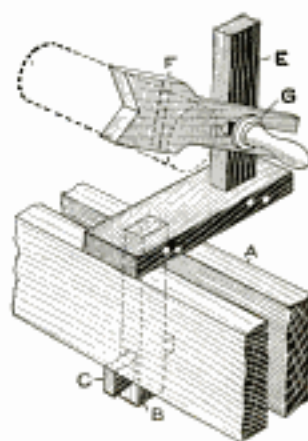

### Renewing Wooden Posts with Concrete

Wooden posts, supporting fences, signs, or buildings generally, decay at the ground line.

It is not always possible to renew them without disturbing the structure they support, and besides, if the timber is sound except at the one point, there is a needless waste of lumber if they are discarded. To renew the life of such a post it is only necessary to remove the dirt for 6 in.

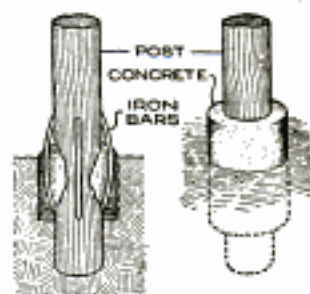



around the post. Next a wooden or sheet-metal form is made, and concrete poured in the form around the post, reinforced with iron bars, to a level with the top of the form. After the concrete has set, the post is stronger and less likely to decay farther than before the treatment.—K. M. Coggeshall, Webster Groves, Mo.

### Safety Circular-Saw Guard Prevents Back Thrust

The old saying "never monkey with a buzz saw" is as sound as ever, and the careful mechanic will provide his circular saw with a guard which can be homemade, as shown. Make two steel plates, as detailed, and grind or file teeth into them on the curved edge. Drill the plates for screws and fasten them to a wooden core,



permitting the toothed edge to project slightly. Various ways of clamping the guard on the saw-table fence can be devised. The dangerous back thrust of stock being cut is overcome by this guard.—L. J. Young, Cape Porpoise, Maine.

### Revolution Counter Rigged to Determine Lineal Travel on Machinery

It is often desirable to know the speed a belt is traveling, or the rate of surface travel of a piece of metal being cut in a machine tool. These speeds can be easily calculated if the diameter of the surfaces and the revolutions per minute are known, but often it is inconvenient to measure one or both of them. Most machine shops and engine rooms possess a revolution counter of the type shown. A wheel,

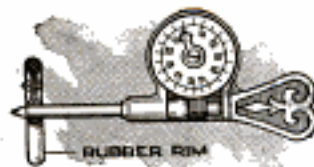

exactly  $1\frac{5}{16}$  in. in outside diameter, with a rubber rim, was made as shown, to slip onto the counter in place of the pointer. This diameter is calculated so closely that it gives very accurate results. The revolutions per minute, as indicated by the counter, are timed by a watch. To obtain the distance travel of the surface in feet per minute, divide the revolutions per minute of the counter wheel by 2, which gives the number of feet per minute of surface travel, the circumference of the counter wheel being very close to 6 inches.—R. L. Hervey, Washington, D. C.

exactly  $1\frac{5}{16}$  in. in outside diameter, with a rubber rim, was made as shown, to slip onto the counter in place of the pointer. This diameter is calculated so closely that it gives very accurate results. The revolutions per minute, as indicated by the counter, are timed by a watch. To obtain the distance travel of the surface in feet per minute, divide the revolutions per minute of the counter wheel by 2, which gives the number of feet per minute of surface travel, the circumference of the counter wheel being very close to 6 inches.—R. L. Hervey, Washington, D. C.

### Tool for Applying Hose Clamps Handily in Vise

The operation of putting a clamp on a rubber hose at a connection is sometimes difficult, especially if it is an extra-tight fit and the bolt accompanying the clamp is a trifle short. In a shop where the application of clamps on hose, for the purpose of splicing, is part of the daily routine, a tool was made which simplifies the operation.

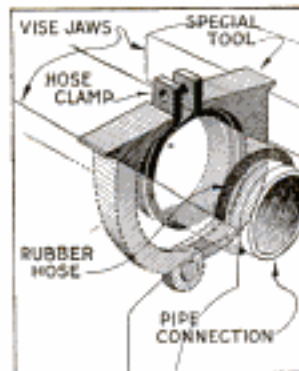

The device, as shown in the illustration, is U-shaped, hinged at the bottom, and large enough to accommodate hose from 1 to 4 in. in diameter. It may be forged with but little trouble. In applying a clamp to the hose, the tool is applied so that its jaws grip the ends of the clamps, and the whole is placed in a vise. By gradually closing the vise jaws, the ends of the clamp are brought together, and a connection made easily and quickly.—L. Schoolcraft, Chicago, Ill.

☞ In stenciling around the corner of the wall, use two stencils, one for straight work and the other to bend around the corner, as the bending injures the stencil.



### Clothes Drier Attached to Kitchen Boiler

Men in the household usually object to the stringing of wash lines across the kitchen, and the home mechanic who is willing to do a little work to do away with this nuisance, can provide for a considerable quantity of clothes to be dried by arranging a drier around the kitchen boiler. The heat from the boiler reduces considerably the time necessary to dry the clothes. The device should be set near the top of the tank, as shown. It consists of a band-iron ring, which is split at one side and drawn tightly around the boiler by means of a bolt. Small angles, bent from similar band iron, hold the wooden strips on which the clothes are hung. A novel feature of these supports is the spring-clip device, shown in detail, which supports the strips when used. When not in use, the strips can be folded down, out of the way, against the side of the tank. The spring clips are bolted beside the left

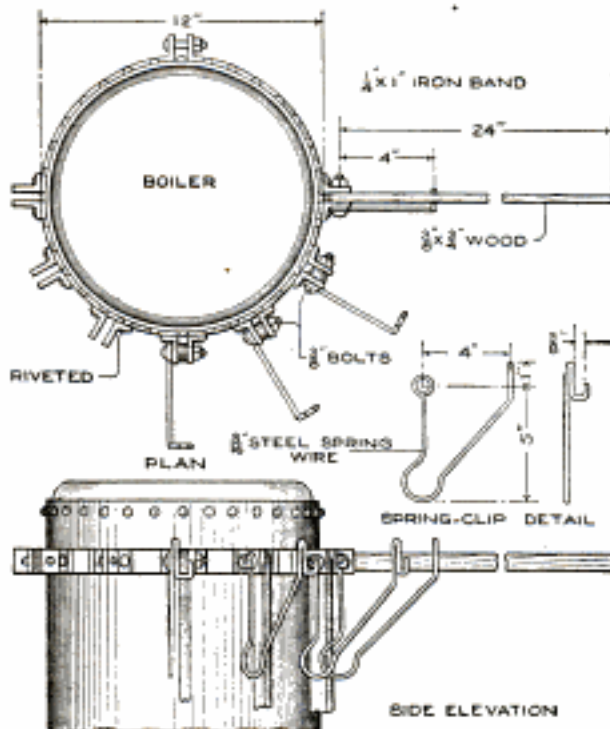

Quick Drying of Clothes in the Kitchen is Provided For by This Practical Arrangement, Which Permits the Wooden Strips to be Folded Down When Not in Use

angle of each pair of angles, which support the wooden strips bolted between them.—P. P. Avery, Garfield, N. J.

### Folding Table, Robe Rack, and Extra Compartment in Automobile

An ingenious method of construction and manner of stowing a folding table, and other details of luncheon equip-

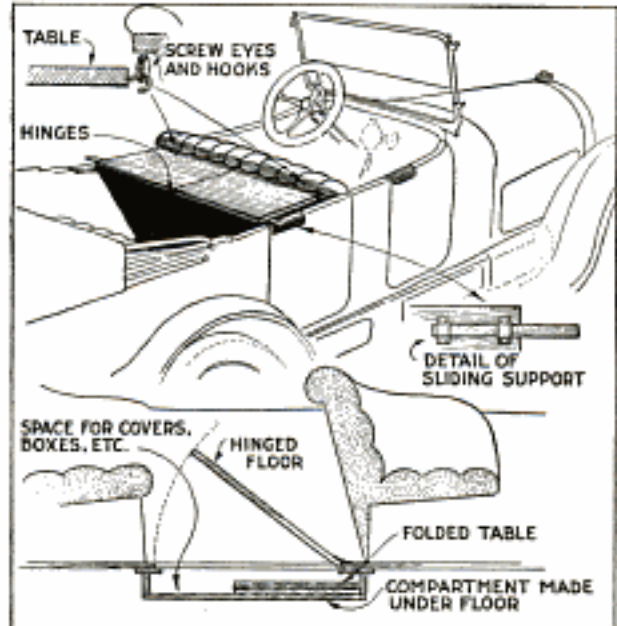

The Table Is a Handy Feature, and When Folded is Stowed Away with Other Articles in the Floor Compartment

ment, is used by the owner of a light five-passenger car. The table consists of two nearly square boards, secured together by two strap hinges on the under side. Two metal slides and two screw hooks are provided for setting it up in the rear of the car, as shown. At the rear of the upper edge of the front seat, two screw eyes are secured. A leather strap through them serves as a robe rack. The hooks on the edge of the table are placed through these screw eyes, and the slides are extended, resting on the doors. The slides are wooden strips set in sheet-metal straps, fastened to the under side of the table.

Under the rear floor of the car is a shallow container, and the floor boards have been cut out and fastened together to form a cover. The compartment accommodates the table when folded, and also other materials. The preference for eating in the car arose because of insects and other annoyances, when the luncheon is spread upon the ground.—G. A. Luers, Washington, D. C.



### A Farm Feed and Water Heater of Concrete

An ingenious farmer made a handy cooker for cooking feed for stock and poultry. The forms for pouring the concrete were set up with rough boards. The food is cooked in an old iron kettle, under which is



This Concrete Outdoor Farm Cooking Stove can be Made Handily with Simple Forms

provided a place for a fire connecting with the chimney. The water is supplied by the pipe shown at the left. The device is thoroughly practical, and one that any farmer can build in spare time at small cost, as a permanent farm improvement.

### Adaptable Tool for Machining Circular Curves on Lathe

Considerable lathe work involving circular corners and grooves was done

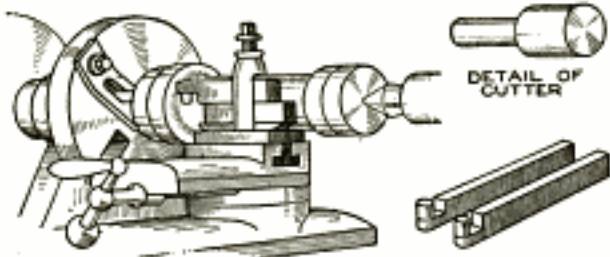

Smooth, Circular Curves were Cut in Turned Work on the Lathe by Means of Adaptable Cutters Made in Several Standard Sizes

in a machine shop, and this made it worth while to design and make a set of radius cutters of standard sizes, by which the curves could be cut quickly and uniformly. The cutters were turned up in various sizes, ranging upward from  $\frac{3}{32}$  in., made of tool steel, as shown in the detailed sketch. They were set in shanks of steel to fit the tool post. In use, the cutters were set in the tool post upside down, as shown; the drive belt was reversed, and plenty of oil was applied to the cutter. An accurate, smooth job resulted when the feed was carefully regulated.—Ben Frantzreb, Indianapolis, Ind.

### Fitting Gasoline-Motor Piston Rings Accurately

One of the most common causes of a lack in power of an engine is poor compression, the result of poorly fitting valves or leaky piston rings. First, there is much difference between fitting in and putting in piston rings. A method of fitting the rings, that has been found highly satisfactory, is here described.

The ring, as it comes from the factory, should be a trifle oversize. First fit the ring to the cylinder, and then to the piston. A wooden piston is made, slightly smaller than the cylinder. To the end of this wooden plug, the piston ring is fastened by a strip of wood held in place by a screw. The ring should be held loosely. The inside of the cylinder is next coated with Prussian blue, then the wooden piston and ring are inserted, and moved back and forth a few times. Upon removing the ring, the high spots on the ring are bright, while the low spots are colored. The high spots on the ring should be filed down carefully, or polished off with emery cloth. After a few trials, the ring can usually be made to fit the cylinder all the way around. Attention must be given to the joint in the ring. A very small clearance,  $\frac{1}{64}$  in. often being sufficient, should be left at the joint to allow for expansion from the heat.

The ring is then ready to be fitted to



the piston. The ring should be turned around in the groove, and if it binds, it should be smoothed off. To smooth off the sides of the ring it should be rubbed across emery cloth laid flat on a board, shifting it during the process. It frequently happens that an engine does not have as good compression after new rings have been put in without proper care. Proper fitting of the rings will make a surprising difference in the efficiency and power of a motor.—B. F. Bell, Waverly, Neb.

### Emery-Wheel Dresser Made of Old Emery Wheel

For dressing down emery wheels, a small worn-out emery wheel is useful, when properly mounted. Set the small wheel on a large bolt, provided with two handles, as shown. Place two large washers between the wheel proper and the handles, which are held by nuts, with washers, at the ends to give slight play. In use, the small wheel is held against the wheel to be dressed, at an angle, and the handles are forced together to slow up the dressing wheel, and produce a grinding effect.—Thomas W. Benson, Hastings-upon-Hudson, N. Y.

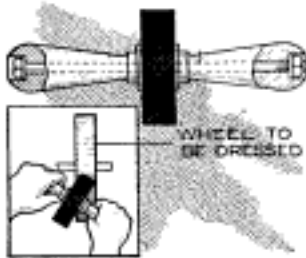

### Pulley Lever That does Not Damage Rims

In the maintenance of machinery and mechanical power-transmission equipment, it is frequently necessary to turn a pulley, which is mounted on a shaft or machine, through a revolution or fraction thereof, to reset it. When a lever is required, monkey wrenches are often used, with a piece of pipe slipped over the handle. This method sometimes breaks pieces from the rims of the pulleys. A pulley-starting lever, which will not break the rims, can be

made as detailed in Fig. 1. With this lever the stress on the pulley rim is distributed over a wide area. For best

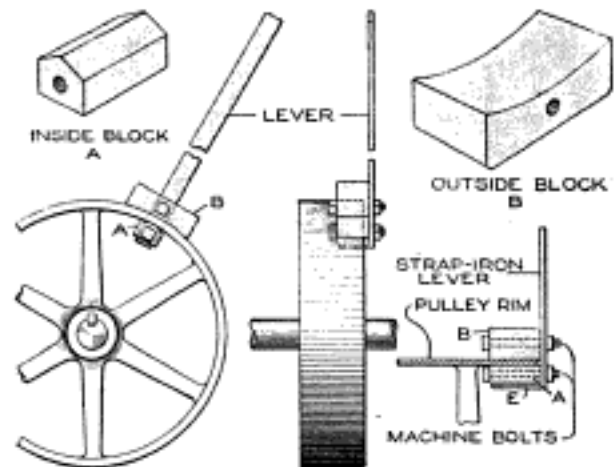

By the Use of This Lever Arrangement the Rims are Not Nicked in Resetting Pulleys

results, a different-size outside block, B, should be made for pulleys varying considerably in diameter. The blocks A and B may be made of cast or wrought iron, or even of hard wood. The lever is of strap iron, and the blocks are held to it with machine bolts.—R. C. Farrell, Chicago, Ill.

### Device for Centering Work on Boring Mills

The centering of round work on a vertical boring mill is easily accomplished with the use of the roller centering device shown in the sketch. The casting is placed on the table, not bolted down, and the table run slowly, and, as the wheel on the centering device is loose, the casting is centered by moving the head horizontally until the wheel runs against the casting all the way around. Centering work on a boring mill is usually done with the aid of the cutting tool, which often results in damage to the work, but with the use of the roller there is no liability of damage from this source.—J. R. Minter, Washington, Ind.

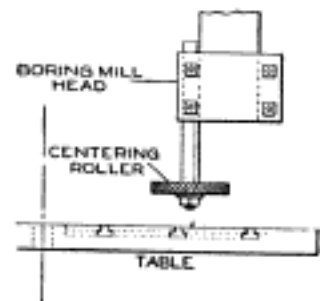



### Ventilating Door on Roof Opened from Ground

A novel door made for the roof of a silo, in place of the usual type of ventilating door, and which can be opened from the ground by means of a rope threaded through pulleys, has numerous other applications. The door is hinged in the usual manner, and a wooden bracket built on its inner side, as shown. The rope is tied at the upper corner of the bracket, when the door is opened and resting on its stop on the roof. By drawing on the rope, the door is raised sufficiently so that its weight acts as a counterbalance, closing it. To open the door, the rope is also pulled, until the door is carried past the point of balance, when it again carries itself to the open position by its own weight. If the door is a heavy one, counterweights and bumping pads should be arranged for it.—L. A. Knutsen, Everett, Wash.

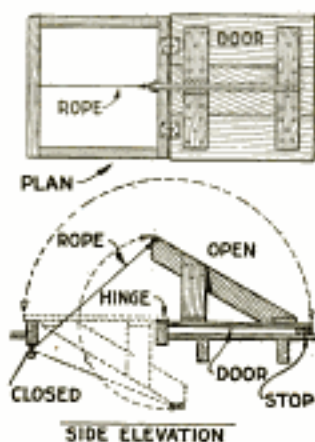

The rope is tied at the upper corner of the bracket, when the door is opened and resting on its stop on the roof. By drawing on the rope, the door is raised sufficiently so that its weight acts as a counterbalance, closing it. To open the door, the rope is also pulled, until the door is carried past the point of balance, when it again carries itself to the open position by its own weight. If the door is a heavy one, counterweights and bumping pads should be arranged for it.—L. A. Knutsen, Everett, Wash.

### Simple Method of Making Core Prints without Lathe

It is customary with patternmakers to turn core prints integral with the patterns themselves. At times, however, the separate print is preferred. Also, some patternmakers have no power tools besides a saw and a sand wheel. Then prints can be easily and as quickly made as in a lathe by rough-sawing the block, as shown, and sanding it down to the scribed circle. A scribed circle on the pattern locates the print.—Donald A. Hampson, Middletown, New York.

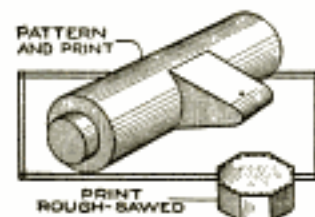

### Pile of Rods Protected by Painted Stripe

A practical method of detecting if pieces have been taken from a pile of pipe, tubing, or bar stock, as often is the case especially where the material is stored in vacant lots or in shop yards, is to paint a bright-colored stripe over the pile. If pieces are taken from the pile, there will be a break in the colored stripe. This aids in placing the responsibility quickly, and cuts down the unauthorized use or theft of stock.—C. C. Spreen, Flint, Mich.

### Block for Starting Flow of Ink in Ruling Pen

The ink in a ruling pen often refuses to flow, and in order to avoid the common practice of touching the point on the finger, I made a block that does the work nicely.



To make it, drill a  $\frac{1}{2}$ -in. hole in the end of a  $1\frac{3}{4}$  by  $1\frac{1}{2}$ -in. block of wood, as shown. Cut a curved slot from the top into the hole, rounding off the corners smoothly. Glue pieces of cardboard over the ends and provide a base. When the pen is contrary, push the point through the slot, and the ink is released. The block can easily be cut to fit pens of various sizes.—Walter Whitley, Lawrence, Mass.

### Cleaning Glass Chemical Containers

Graduates, reagent bottles, and similar vessels used for chemicals, should be cleaned thoroughly before refilling them, especially if a new liquid is used. A good cleansing agent is vinegar into which a quantity of coal dust has been poured. Fill the vessel about one-third full and shake it vigorously until the interior is polished clean. Wash the vessel in clear water, preferably distilled.





## A Tree Hut and Rustic Shelter of Poles and Brushwood

By EDWARD A. KRUEGER

**I**RRESISTIBLE is the lure of autumn's days to the woodsman, young or old, calling him forth over a carpet of fallen leaves, to roam or hunt, with a companion or two, in the quiet of the woods. As if in anticipation of winter's rigors, it is the season for the building of a rustic hut, a shelter from the elements. For the younger woodsmen, at least, this becomes a romantic retreat, a storied scout's camp of older days, or a secret rendezvous of warring Indians, perhaps. A novel woods shelter of unusual construction, that boys can build with only a few tools, is a tree hut of timber poles and brushwood. It may be supported by a single large tree, or by two or more trees. In the latter case, the framework may be built around the trees, or between them, depending on their relative position. The octagonal tree house, shown in the

sketch, is strongly framed. The joints are bolted, or spiked, together, and the weight is carried by the main-floor beams, firmly braced against the tree trunk. Round poles and brush sticks, as they are gathered or cut in the

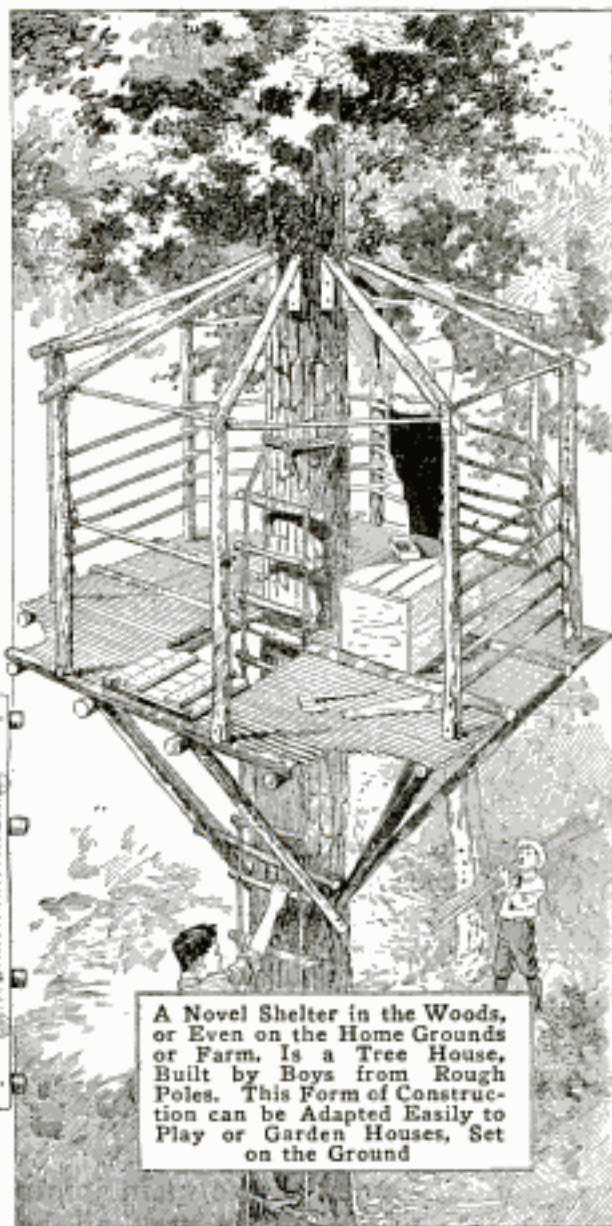
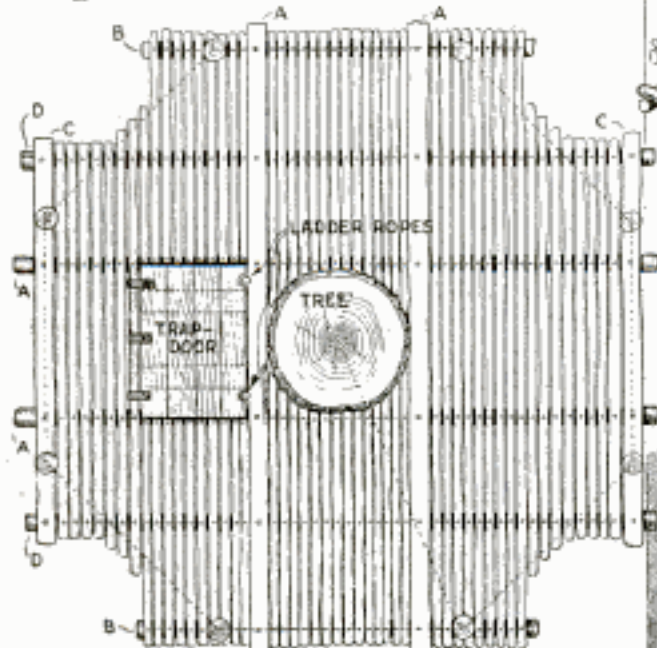

A Novel Shelter in the Woods, or Even on the Home Grounds or Farm, Is a Tree House, Built by Boys from Rough Poles. This Form of Construction can be Adapted Easily to Play or Garden Houses, Set on the Ground



woods, are used throughout. The construction can, of course, be carried out with standard mill stock, 2 by 4-in. stuff being used for the heavier timbers; 2 by 2-in., for the rafters, and 1-in. strips and boards, for the floor and the smaller braces.

The same general method of framing, omitting unnecessary features, can be adapted to an octagonal hut built around the base of a tree. On clear ground, where no central support is available, the roof rafters can be braced around a short section of timber, about 6 in. in diameter. The ground framing may consist only of sills, extending around the octagonal outline, with or without a floor. Built on the ground, a structure of this type can serve as a rustic garden shelter, as a children's playhouse, or even for the more common purpose of a storage shed.

The dimensions of the framing may vary, within safe limits, and the sizes suggested are suitable for a tree about 2 ft. in diameter. The octagon, on which the framing for the floor is laid out, as shown in the plan, has a 4-ft. radius. This is a safe maximum for the type of construction shown, for if the main timbers are made longer, it is difficult to support them properly from a single tree trunk. To make the main framework for the floor, cut four poles, A, 3 in. in diameter and 8 ft. long, as scaled from the plan. To obtain dimensions from the plan readily, make a strip of paper, 1 in. wide and as long as the heavy floor supports. Divide this length into eight parts, each of which will represent 1 ft. on the construction. If the tree is of uniform diameter, near the ground and at the point where the floor frame is supported, the frame may be bolted together firmly on the ground, and hoisted into place. Otherwise, it should be fitted together on the ground, and not bolted finally until in place. The timbers are supported by four blocks, nailed to the trunk at the point where the frame is to be set. It is further held in place by spikes.

If bolts are used at the main joints of the frame, the pieces may all be

cut and fitted on the ground, and then raised and put into place finally, one at a time. Cut two pieces, B, 2½ in. in diameter and 5 ft. long; two pieces, C, 2½ in. by 5½ ft. long; and two pieces, D, 2½ in. by 8 ft. long. The pieces D are bolted under the pieces C, and two of the pieces A are set slightly nearer the other pieces A, than the pieces B. When the main frame is in place, brace it from the trunk, the notches for the ends of the braces being cut into two of the pieces A, 8 in. from their ends, on the ground. The corresponding ends of the braces are sharpened to a wedge to fit them, and spiked into place. The braces that are notched into two of the pieces A are parallel, as shown, their lower ends being spiked to the sides of the trunk. The two braces on each of the other two braced sides are not parallel. They are notched into the pieces B, and spiked, at the notches and at the junction with the trunk, just above the parallel braces.

The climbing ladder, of rope and short sections of 1½-in. poles, can be made on the ground and hoisted into place. It is spread from the trunk at the top and at intervals by short sticks, spiked to the trunk. The ladder is arranged so that it can be drawn up into the house, if desired. The floor of the platform is made of poles, 1½ to 2 in. in diameter, arranged across the timbers, as shown, and nailed in place. It is important that the poles for the floor be extended well beyond the beams, as indicated, so that no long, free ends of the poles project. The trapdoor is made of 1-in. lumber, braced with two cleats. It is hinged on strips of leather, and arranged so that its ends rest on the adjoining beams A. It is shown closed, in the plan, and open, in the sketch.

The sides and roof of the house are supported by 2½-in. poles, for studing, and 2-in. poles, for the rafters. They are cut on the ground, and the joints at the eaves halved, and bolted, or spiked, as shown. The upper ends of the rafters are set on wooden strips, nailed to the trunk at a uniform height,



and spiked in place. The studding and rafters are braced with smaller poles, extending around the octagon at the top, and around the inside, as a guard against the occupants of the house falling out.

The tree hut can be covered in various ways. To carry out the rustic effect completely, the roof and sides may

be thatched with twigs and brush. If the house is used only during fairly moderate weather, a latticework of small poles is satisfactory, and a canvas roof may be used. The sides may also be covered with canvas, and the entire structure may be boarded over, leaving, in each case, sufficient openings for light.

### Bell Alarm Warns of Garden Intruders

Being troubled with garden thieves, I rigged the device shown in the sketch to prevent further depredations. Small copper wire was placed on stakes around the garden, and the two terminals led into the house, and connected to the small electromagnet. The bell connections being made, the apparatus works as follows: When the circuit around the garden is closed, the magnet holds the contact points apart, and the bell does not ring. Breaking the wire, or pulling it apart between any two of the small stakes, opens the magnet circuit and allows the contact points to come together, thereby clos-

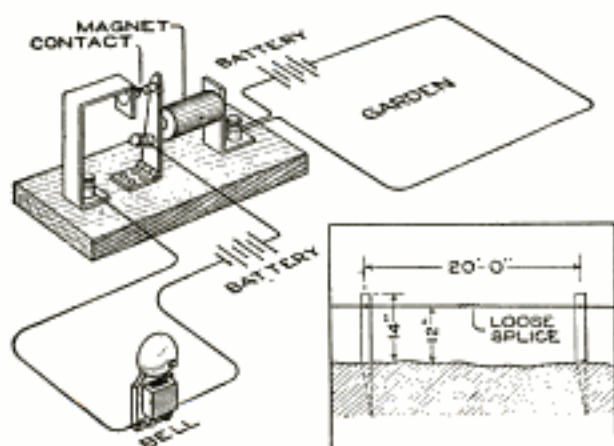

When Intruders in the Garden Break the Wire Circuit at Any of the Loose Joints, a Warning Bell Rings in the House

ing the bell circuit and causing the bell to ring, warning those in the house of the presence of intruders.—H. R. Post, Los Angeles, Calif.

☞ In laying a large rug, sweep from the center toward the edges of it, removing the air and leaving the rug smooth.

### Folding Camp Stove with Large Hinges as Legs

Makeshift camp stoves are nearly as numerous as campers, but here is a homemade arrangement that will give

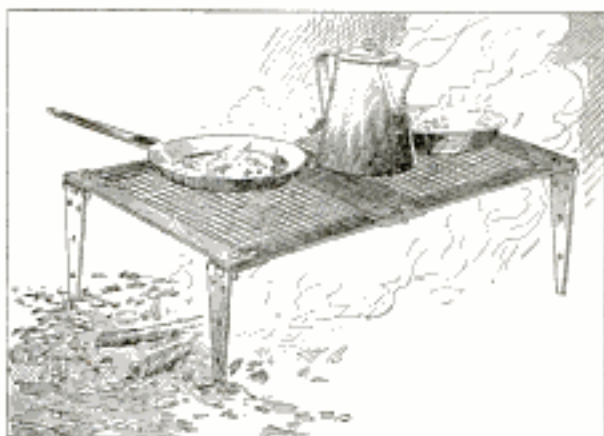

This Practical Camp Stove Folds Up Compactly and is Made of Materials Easily Obtained

good service, folds compactly, and is made of materials that nearly every camper can get. Narrow 10-in. strap hinges are used for the legs. The frame is made of  $\frac{1}{4}$  by 1-in. iron strips, bolted together with  $\frac{3}{16}$ -in. bolts. Wire mesh is fastened over the frame, which is hinged at the center, the hinges being set so that they will not collapse under the weight of the cooking utensils. Small chains may be fitted to the legs to steady them, but pressing the ends of the hinges into the ground is usually sufficient.—P. P. Avery, Garfield, N. J.

### Tablecloths Kept on Rollers in Drawer

A neat and economical, as well as a space-saving, method of keeping tablecloths is to roll them on curtain rollers set in a drawer. Creasing or folding of the cloths is largely eliminated, which



adds to their appearance when in use, as well as saving wear. An ordinary deep drawer is used. Several shade rollers, the size and strength deter-

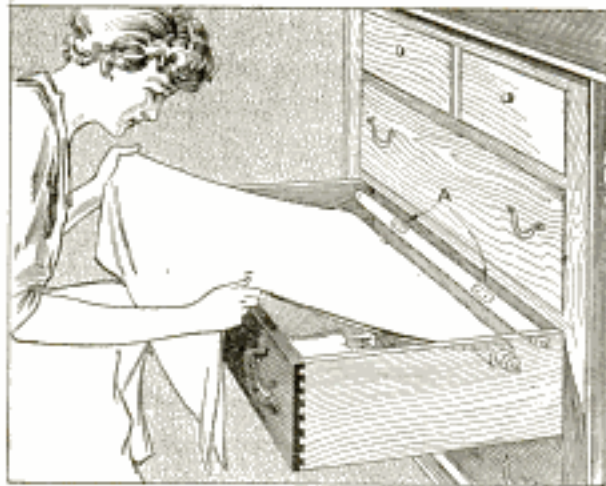

The Tablecloths are Rolled Up in the Drawer on Shade Rollers, Avoiding Much Folding and Wear

mined by the number of cloths to be rolled upon them, are set into it. If placed in position at an angle of about  $45^\circ$ , as indicated, three or four rollers can be placed in one drawer, allowing, also, room in the front part of drawer for napkins and other table linen. The cover is folded once, and one end placed under spring clips, A, and wound up, as in operating a shade roller.—A. A. Mack, Chicago, Ill.

### Gas Heater Made of Stovepipe

Finding the bathroom uncomfortable in chilly weather, I made a heater out of an old section of stovepipe and a small gas plate, which proved effective. A galvanized-iron plate was fitted to the top of the pipe with four small strips of band iron, arranged to catch on the top edge, as shown. Holes were punched

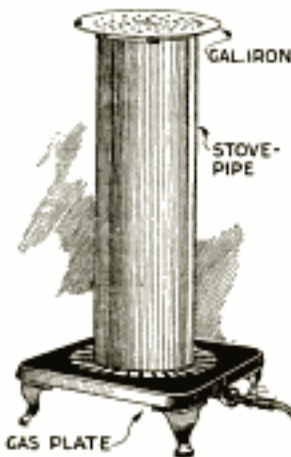

through the iron, and additional draft was afforded by the space under the cover. The lower end of the pipe was

slit 2 in. from the end, and the resulting strips bent outward at a right angle, to form a wider base for the pipe. Some of the strips were fastened to the webbed top of the gas plate, to prevent the stovepipe from tipping over easily. Proper ventilation should, of course, be maintained to insure against the danger of exhausting the oxygen in the room.—Charles Rorer, Bridgeport, Conn.

### Substantial Typewriter Cover Made of Wood and Cardboard

A typewriter cover that will keep out the dust better than the average rubber, or oilcloth, cover can easily be made out of a few thin boards and a large sheet of heavy cardboard. The shape and size of the cover will, of course, depend upon the kind of machine to be housed, and the illustration

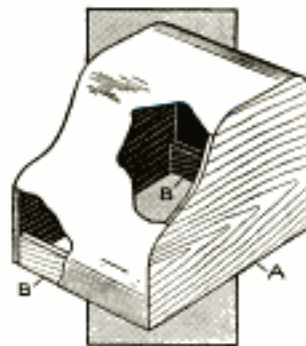

shows the common form. The sides A of the cover are made of two  $\frac{3}{8}$ -in. boards. The front and back pieces B are made of similar strips, 3 in. wide. The latter pieces are nailed

between the sidepieces, as shown. The cardboard is cut to the proper width and length to fully cover the front, top, and back of the framework. Dampen the cardboard with a wet sponge, so that it will conform to the curves of the wooden sides. Using small flat-headed tacks, fasten it along the edges. When the top is tacked, and all rough edges trimmed off, heavy paper, or strong cloth, should be glued over the cover to make a smooth job, and cover the tack heads, after which a coat of paint or varnish may be applied to make the cover match the desk.—Frank L. Matter, Portland, Ore.

Ⓒ A small metal, or wooden, ball fixed to the end tines of a rake will prevent it from injuring a lawn.



# Hitting the Bull's-Eye

## With the Pistol

by Stillman Taylor



**S**PORTSMEN should become familiar with the revolver and pistol, as well as with the rifle and shotgun, notwithstanding the same expertness is more difficult of accomplishment in the case of the one-hand weapon. There is no secret or mystery about skill with such an arm; and any person with average vision and strength will be able to shoot well after systematic practice.

The selection of the weapon is important. The novice should begin his practice with a .22-caliber arm, because of the small expense, and the slight



Fig. 1—A Good Type of Single-Shot .22-Caliber Pistol for the Beginner in Small-Arms Shooting

recoil, as well. The beginner is inclined to close the eyes and flinch at the moment of pulling the trigger. This is fatal to good shooting, and is encouraged by the loud report and heavy recoil of the large-caliber arms. Better progress can therefore be made with a light-caliber weapon. The .22-caliber is useful also for indoor shooting, and such practice may be had if proper provision is made. In buying an arm, a single-shot pistol with an 8-in. barrel is a good choice. A good type of single-shot pistol, adapted for .22 short and

.22 long, rifle cartridges, is shown in Fig. 1.

If the sportsman prefers to begin with a "six-shooter," a good choice is a .22 revolver with 6-in. barrel, with square target-grip stock and fitted with adjustable open target sights, as shown in Fig. 2. A revolver of the heavy-frame type, with swing-out cylinder, is a common choice of discriminating expert revolver marksmen. In selecting



Fig. 2—A .22-Caliber Target-Grip Stock Revolver, Fitted with Adjustable Target Sights

a suitable heavier weapon, after considerable skill has been acquired, the calibers mostly used are the .32, .38, .44, and .45, the .38, as shown in Fig. 3, being the general choice for target or snap-shooting.

The balance of the revolver should be well considered. The grip and balance should be such that the barrel will fall in line with the mark without making it necessary for the shooter to crook his wrist. The barrel should fall in line with the eye as easily as the index finger is pointed at an object.

In the choice of sights, the shooter has a wide range of selection, each



Fig. 3—A Heavy Frame, .38-Caliber "Six Shooter," a Favorite with the Expert Revolver Marksman

choice having its skillful advocates. For a front sight, the several forms of bead sights are preferred by many good



marksmen. Bead sights may be fitted to any standard make of revolver or pistol, and may be obtained in many sizes. The rear sight is best provided with screw adjustment for windage, and the notch should be in the form of a shallow "U," or semicircle. A good



Fig. 4—Revolver Sights: Adjustable Rear Sight; Adjustable Rear and Front Bead Sights, in Alignment, and a Bead Front Sight

form of sight is the combination shown in Fig. 4.

In order to become a practical shot, it is necessary that the shooter grip the weapon correctly, and also acquire the knack of holding the sight on the mark. If the revolver is fitted with a well-designed stock, the shooter's hand will so conform to the contour of the butt that the weapon is held firmly without tenseness of the muscles, and with the middle finger resting upon the frame just back of the trigger, as shown in Fig. 5. This position is a great aid to good shooting.

The first, and most important, step in good revolver marksmanship is to learn how to hold the sight and press the trigger. For quickly training arm, hand, and eye to act in unison, there is

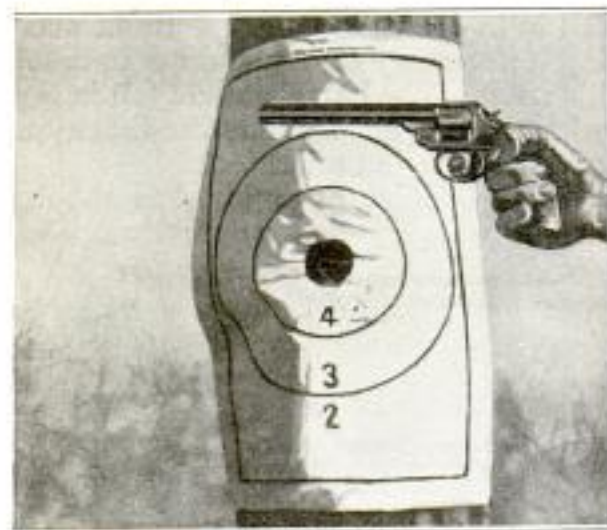

Fig. 5—The Revolver is Held Firmly, without Tenseness, the Middle Finger Resting Just Back of the Trigger Frame

no better method than the silent aiming drill. This preliminary practice may be done in a room, by pinning to the wall a target, or square of white paper, in the center of which a black, circular  $\frac{3}{4}$ -in. disk is pasted. Pin the target with the bull's-eye on a level with the eyes, and take a position about 15 ft. distant, with empty weapon in hand. Extend the arm naturally, and, as soon as the sights are in line with the mark, squeeze the trigger by closing the whole hand upon the grip. The aim should be held on the bull's-eye after the hammer has fallen, to enable one to note whether the muzzle is thrown up, or to the right or left of the mark, upon the impact of the hammer. In conducting this drill, the novice should assume an easy standing position, with the left, or free, hand hanging straight down and close to the side. The correct position is shown in Figs. 6 and 7. However, when the hand is inclined to be unsteady, the left hand may rest upon the hip, or grip the thigh. The trigger is squeezed, or pressed, straight back, not pulled by the finger alone. The novice will find it an aid to bring up the revolver with a light grip, and gradually close the hand as the sights are brought into line, when the hammer will fall without jerking the muzzle from the mark.

Another important point that must be observed is to keep the rear sight level, and not canted to one side. This is a common error with beginners, and is the chief reason for shooting off to one side. To prevent injury to the mainspring, it is a good plan to fill the chambers of the cylinders with empty shells, and let the soft copper heads absorb the jar of the falling hammer.

In practicing the aiming drill, as well as when shooting at the mark, the revolver should be cocked with the thumb. After a week or two of practice at the dummy target, the shooter may begin by shooting at a 4-in. bull's-eye, at 20 ft., and as soon as almost every shot can be placed in the 4-in. bull's-eye, he may rightly consider himself a fair revolver shot.

Having become skillful in punching





Figs. 6 and 7—The Novice Should Assume an Easy Standing Position, the Left Hand Close to the Side, and Practice the Silent Aiming Drill

holes in the large target, the shooter is now prepared to practice his gun play at a smaller fixed target, and for this purpose the regulation targets should be used. Each target is a record, on which should be noted the score and such other details as distance, date, and sequence of shots. These targets should be preserved, so that the marksman may correct his mistakes.

The standard American target has been adopted by the majority of revolver clubs, and shooting should be confined to this system of scoring, because it enables the marksman to compare his own shooting with the scores made by others. The standard target, in its original dimensions, is used for rifle, revolver, and pistol practice, and is made up for the several regulation ranges. For 100-yd. rifle and 50-yd. revolver practice the bull's-eye is 8 in. in diameter. The regulation indoor revolver range is 20 yd., and for this distance the bull's-eye is reduced to  $2\frac{3}{4}$  in. in diameter. For 10-yd. ranges, the bull's-eye is 1 in. in diameter. In counting a score made on this target, the bullet touching a line of any circle is counted as the next higher ring, and the marksman is always given the benefit of any doubtful shots. The same targets may

be used over and over again by pasting over the holes. A more economical way is to make the targets by copying the sample targets, and drawing the concentric rings with a pair of compasses. The black bull's-eye may be made with pigment, or a circular disk of black paper may be pasted on.

Now that the shooter is to try his skill at a fine mark, the details of sighting the arm must be considered. In adjusting the sights of a revolver for all ordinary shooting, it is more satisfactory to aline the sights for the distance usually shot over. Target sights are, of course, adjustable for different ranges. The rear sight should be so placed that the revolver will land its shots on a vertical line through the center of the bull's-eye. This lateral sighting is done by moving the rear sight in the same direction it is desired to place the bullet. The elevation is secured by raising the rear sight or shortening the front sight, the former being the handiest.

To make it convenient to refer to the shots on the target, the black center, or bull's-eye, has been likened to the face of a clock: The top of the bull's-eye is called twelve o'clock; the bottom, six o'clock; the left side, nine o'clock; the



right side, three o'clock, etc. Now, in taking aim at the target, the sight should be taken just below the bottom edge of the bull's-eye at six o'clock, and a point of white should show between the sight and the bull's-eye. In altering the sights, adjust them so that when the aim is taken at six o'clock the bullet will go in the center of the bull's-eye.

In practicing difficult stationary shots, the marksman must first become

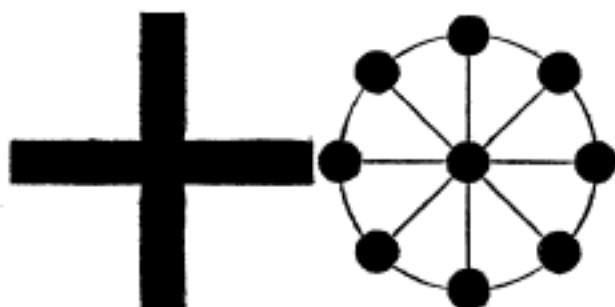

Fig. 8—The Cross Target Is Useful in Training the Shooter to Hold on Center; the Clockface Target Demands Careful Holding, and Affords Variety

proficient in holding at both vertical and horizontal lines, and for speedily acquiring skill in this branch of revolver work, the following homemade targets are useful: The cross target, shown in Fig. 8, is particularly useful in acquiring the knack of holding on center. The horizontal holding must be correct in order to place the bullet in the narrow vertical strip, while the elevation must be exactly right to shoot within the width of the horizontal arm. The clockface target, Fig. 8, is an agreeable change from the other forms, and demands good holding to place the shots in the circular centers. For a beginning, the shooter should not make the mistake of shooting at too small a mark, and the cross and clockface targets should be drawn on a fairly large scale, 1-in. strips or spots being satisfactory.

To become a good all-around shot, practice should not be confined to fine target shooting, but a balance struck by using the revolver in snap-shooting at moving objects. At first, the best practice is that obtained by suspending a common rubber ball to a length of string, and endeavoring to hit the

sphere as it swings back and forth like a pendulum. To be seen clearly, the ball should be painted black and suspended in front of a square of white paper tacked to the backstop. In snap-shooting, the aim is never taken directly at the object, but allowance is made for the rate of movement. There are three important factors to keep in mind: the distance from shooter to mark, the rate or speed of movement, and the angle which is shot over. In short, the shooter must calculate to aim, not where the object is, but where it will be when the bullet reaches it. Hence the actual aim is taken at an imaginary spot just inside the arc made by the swinging ball, and while the ball is farthest to the right or left. The shot must be made quickly, or it will be too late.

If the target is thrown up, the lead must be above, and under, when shooting at a descending object. If the target is moving to the left and descending, hold ahead and under the mark, etc. The tendency is to shoot over rather than under a mark. After the marksman becomes expert in hitting the swinging ball, he may try his hand at objects thrown in the air. The usual precautions of wiping and oiling firearms lightly are necessary to keep revolvers and pistols clean and in the best shape.

#### Reinforcing Loose Fishpole Tips

Sometimes the tip on a fishing rod slips off, due to the cracking of the cement. If a thin strip of metal is soldered on the outside of the ferrule, it can be easily fastened to the rod by winding silk thread around the strip and the rod, just below the ferrule, as indicated. This also strengthens the tip of the rod where it often breaks off. The strip can also be made longer to strengthen a longer portion of the rod.—E. W. Werner, Ann Arbor, Mich.

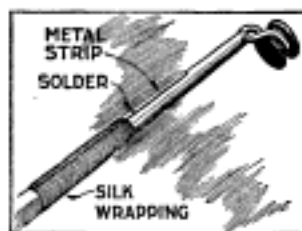



### Electric Temperature Regulator for Brooder

A large brooder for young turkeys gave much trouble, overheating or getting too cold, so I made a device, which indicates when the heat increases or decreases greatly by ringing a doorbell in my room. I put together a piece of steel from an old hack-saw blade and a piece of sheet brass the same width, but  $\frac{1}{2}$  in. shorter, and bent the extra  $\frac{1}{2}$  in. of the steel over the brass on the ends, and soldered them together. Next I made three stanchions, and sawed a slot in one, into which the long piece of brass was fitted, with a small screw. The parts were assembled on a board, as shown. When the heat increases, the brass strip expands rapidly, and bends, making a connection on one of

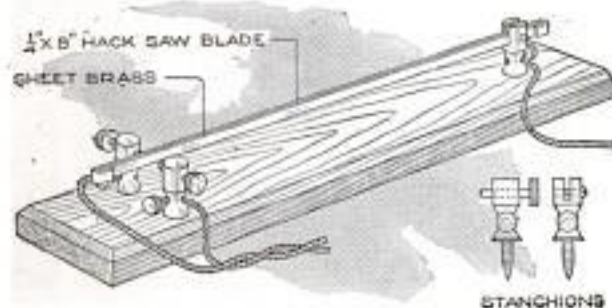

When the Incubator Becomes Too Hot or Too Cold, the Strip is Bent Toward One of the Binding Posts, and the Bell is Rung at a Distance

the stanchions, and ringing the bell in my room. When the heat decreases, the brass contracts rapidly, and bends the strip the other way, making a connection on the other stanchion. The difference in the expansion and contraction of the two pieces of metal is, of course, responsible for the bending. It can be adjusted to ring at various points,  $80^{\circ}$  and  $76^{\circ}$  being satisfactory.—Waller L. Kaufmann, Santa Ana, California.

### Water Fed to Grapes from Bottles Keeps Them Fresh

A simple and inexpensive method by which grapes can be kept fresh for several months after picking, is as follows: Select bunches of grapes that have stems 2 or 3 in. long. Obtain medium-

sized glass bottles, one for each bunch of grapes, and fit each bottle with a

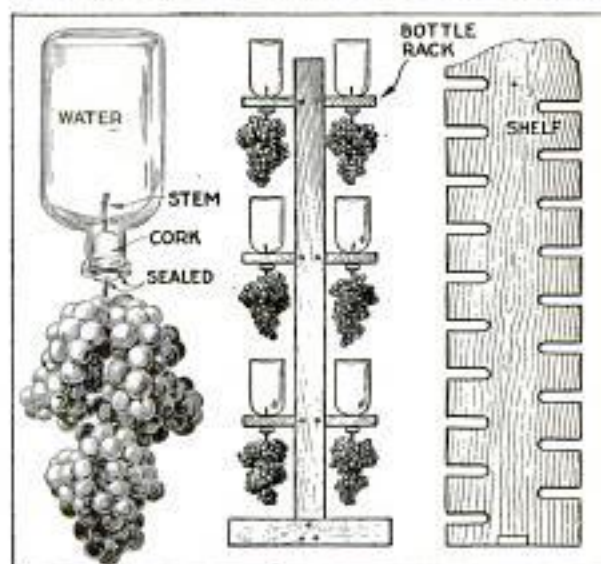

The Stems are Inserted in the Bottles, Which are Filled with Water and Supported from the Rack

cork stopper. Through each stopper bore a hole to admit the stem of a bunch of grapes, as shown. Fill the bottles with water, and invert them. Place them in a cool, dark place, preferably on a rack, as indicated. If the stem does not fit into the hole tightly, pour melted paraffin around the hole. A little chloride of lime in the storeroom will absorb excess moisture from the atmosphere.—E. P. Sullivan, Arlington, Mass.

### Coin Mailer Folded from Sheet of Paper

A convenient method of mailing a coin—large or small—so that it will not slide about, is shown in the sketch. A sheet of ordinary letter paper is used, making it unnecessary to cut cardboard, or other material, as is usual in such devices. The coin is folded into the sheet, the various stages in the process being indicated in the sketch.—James M. Kane, Doylestown, Pa.





### A Revolving Trump Indicator for Card Games

In many card games it is desirable to have an indicator on the table showing the trump, and the device shown in the illustration serves this purpose. It was made of wood and cardboard, and the card symbols were cut from an old pack of cards and mounted on the revolving cardboard disk.

The base is a block of wood,  $\frac{7}{8}$  by  $2\frac{3}{4}$  by 3 in. in size. Cardboard triangles are pasted on it at the four corners. In the center, the dial is mounted, which is  $1\frac{1}{2}$  in. in radius. The symbols are pasted on the dial, and a cover of heavy cardboard is fastened over the dial with screws. A hole through the cardboard exposes the trump indication.—A. G. Lange, Chicago, Ill.

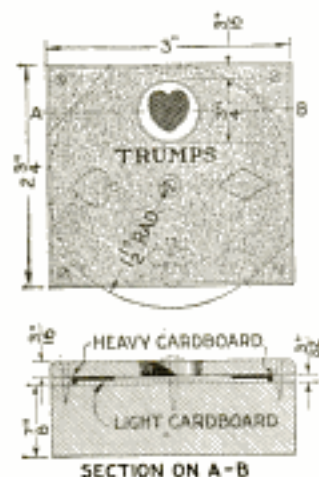

### Match Safe Cut in Frame of Lantern

A lantern without a match is an unpleasant but quite common experience, and the arrangement shown in the sketch provides for the keeping of matches in a safe cut into the frame of the lantern, without materially weakening it. Two horizontal cuts are

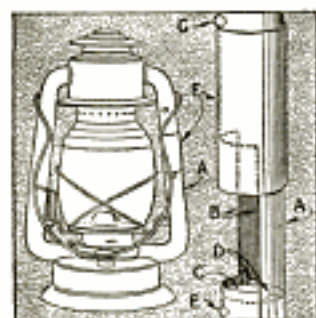

made into the frame of the lantern, halfway through, and the cut portion is bent in against the opposite side, at A. The fold B should be at the seam, if the frame has one. A disk, C, is soldered into place with drops of solder, D. A sleeve, F, is fitted closely over the frame and its movement is

limited by the stops E and G. The sleeve can be made to slide up or down, depending on the structure of the frame, down being preferable, only the upper third of the match-safe opening being exposed. This is sufficient for filling the match safe or removing matches, and prevents the scattering of matches.—L. D. Obitts, Wellington, Ohio.

### A Fisherman's Homemade Fly Book

While trout fishing, I experienced trouble in removing flies from my book,

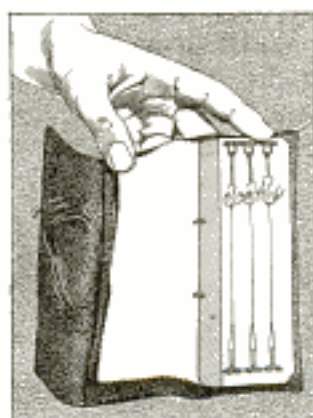

two or three usually getting tangled when pulled out. Finally I made one out of an old leather cover. In place of the celluloid leaf, I used cardboard, gluing linen on the binding edge and giving the whole two coats of spar

varnish. Next, I sewed ordinary hooks and eyes to both sides of the cardboard, the eyes at the top, and the hooks at the bottom. I then attached small rubber bands to the eyes, thus keeping the gut taut. One fly can be removed without disturbing the others.—E. E. Buchanan, Jr., Elmira, N. Y.

### Safe Method of Holding Tacks

A person trying to hold an ordinary tack in the fingers to drive it with a hammer will usually miss the head of the tack and damage his finger, and perhaps his temper. An easier method is to push the tack into the end of a strip of paper, which can be used as a holder without danger to the fingers. If a number of tacks are to be driven, they can be set in the strip one after another, a slight pull on the paper, just before the tack is driven home, releasing the strip.—Merrill B. Folsom, Tonka Bay, Minn.



### A Mirror Frame and Hall Rack

A useful piece of home furniture that can be made by the amateur craftsman is a hall rack provided with a mirror. One of simple design is shown in the illustration, and the parts should be worked out to the dimensions given in order to preserve the pleasing proportions. Hard wood, preferably oak or chestnut, is suitable, and the pieces should be cut so that the best grain of the wood comes to the front. A plain or a beveled mirror may be used, and the more skillful worker may even make the hooks from copper, riveting the screw plates to the bent pieces. Various finishes can be applied, a dark stain and several coats of wax being good.

Begin the construction by cutting the pieces to shape, and planing them down to the dimensions indicated. Lay out the joints carefully, as shown in the details. Note that the four spindles are not shouldered but set into mortises their full width and thickness. The shaped portion at the top can best be made after the end joints are fitted. Careful work is required in making the joints at the four corners

of the mirror, as shown in the detail. They must be made right and left, and the rabbets for the glass are cut with a chisel or a rabbet plane.

When all the parts are fitted, clean

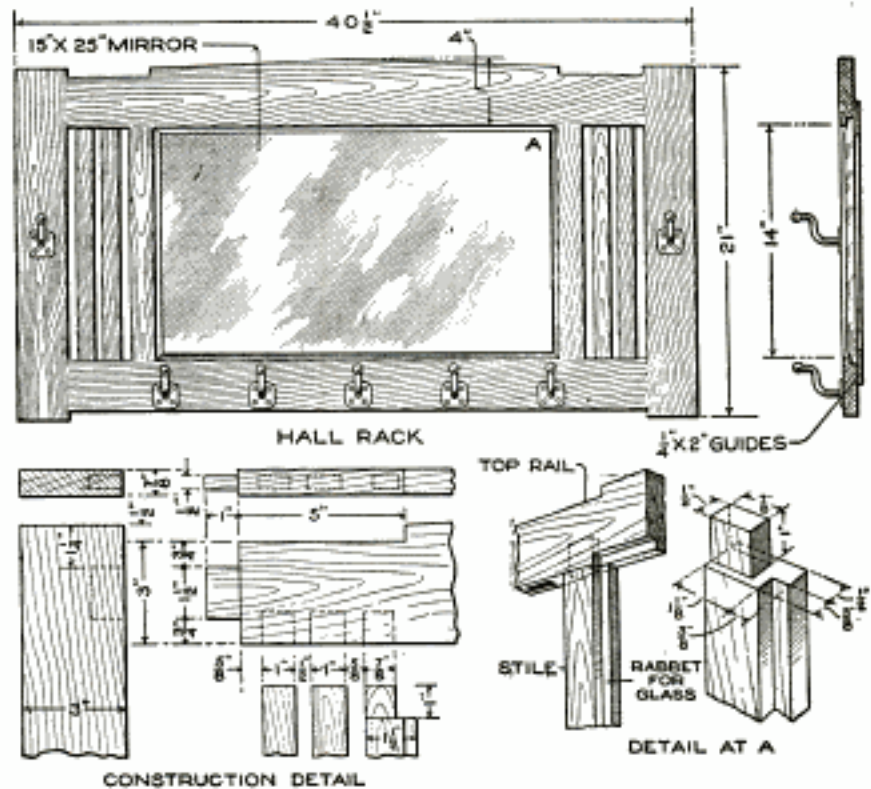

This Attractive Hall Rack and Mirror Frame can be Made to Match the Furniture in the Home by Reasonably Careful Workmanship

the surfaces with a sharp plane, and glue the joints, clamping them for about 12 hours at least. Remove the excess glue, scrape and sandpaper the surfaces, and place the mirror temporarily, fastening it with the  $\frac{1}{4}$  by 2-in. guides. Remove these pieces and the mirror, and apply the finish. Then set the mirror into place finally, and attach the hooks.—G. W. Bretz, Berwick, Pa.

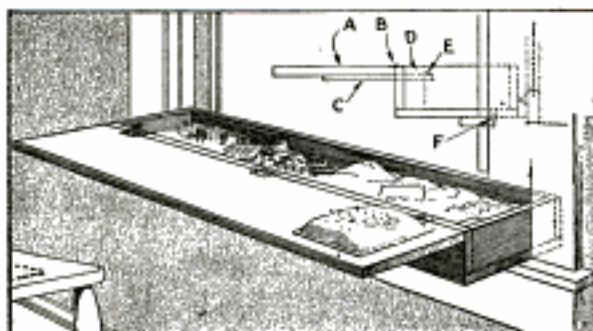

A Sewing Box Built into the Window Frame Provides for the Sewing Materials, at the Place Where They are Generally Used

### Sewing Box Fitted on Window Stool

As the most convenient place for hand sewing, and similar work, is near a window, a sewing box built on the window stool, as shown in the sketch, affords a handy storage place for the sewing material, as well as a worktable. The box is fitted closely between the sides of the frame. It is set back from the sash enough to permit cleaning and handy raising of the sash. The cover



A of the box swings forward on hinges, B, and rests on two  $\frac{1}{2}$ -in. dowel rods, C, which slide into the blocks D, set in the box at the ends, as detailed, with small round-head screws, E, as stops. The bottom of the box is fastened with screws, F. A pincushion on the lid, and, perhaps, pockets for sewing materials are convenient.

### Sawhorse Weighted by Sawyer Standing on Footstep

By placing a small step on a sawhorse, the weight of the sawyer holds it steady, and eliminates the sudden pinching of the saw, due to slight shifting of the horse. The legs of the horse should be made about 8 in. longer than usual, and the step set so as to bring the weight well forward of the extreme point of contact of the legs with the ground.—F. R. Vance, Chicago, Ill.



### Silencing the Clapper on a Bell

While on a prospecting expedition, I wished to silence the bells on my pack animals without removing the bells from their necks. To do this I cut a piece of heavy leather from an old shoe and fitted it inside of the bell just above the clapper. I then cut a hole in the center, smaller than the clapper, and four slits from it. The leather is quickly pushed over the clapper, silencing it, and can be quickly removed.—E. B. Warren, Garnet, Montana.



### Pressing Cloth with Moist-Paper Protection

A practical kink in pressing cloth, which was discovered by the need of a substitute for the usual cloth, is to use paper as a protection. The paper should be clean and strong. Moisten it and place it over the goods to be pressed. Proceed in the usual manner in ironing, and it will be found that the iron moves easily over the paper and that no lint is left on the goods. Dry paper, placed over the usual dampened cloth, also makes the iron work more smoothly, and prevents the pressing cloth from wrinkling.—Mary F. Scott, Albany, N. Y.

### An Outdoor "Kennel" for Cats

Auricular evidence proves that even pet cats do considerable prowling at night. However, the pets would be quieter, and more contented, if provided with a suitable place to catch those much-needed "forty winks" in the wee hours of the morning.



The photographs show the construction of a retreat for "kitty," made by converting a soap box into a cat's palace. Hinges of leather permit the box to be opened for cleaning, or airing, or on warm nights. A catch prevents the door from opening, should the inmates kick in their sleep. A curtain of sack-ing over the entrance gives protection on exceptionally cold nights. This curtain must not entirely close the lower part of the entrance. If the cat is conservative, her feline majesty can be fed in the new domicile until it becomes an old story.





## Homemade Apparatus for Drying Fruits and Vegetables

**E**CONOMY in fruits and vegetables can be effected by drying them in the sun. In its simplest form such drying consists in spreading the freshly prepared slices or pieces on clean muslin, held down with stones. Bright, hot sunny days are chosen for this work, and a close watch is kept to see that no rain or dew wets the product. A mosquito bar is thrown over the produce, and once or twice a day the slices are stirred and the thin ones, which dry first, are taken out. Fruits and vegetables, when dried in the sun, generally are spread on large trays of uniform size, as shown in Fig. 1, the design for these and other apparatus described being taken from data prepared by the Department of Agriculture. They can be stacked and protected from rain by means of a suitable cover. A cheap tray can be made of strips of lumber,

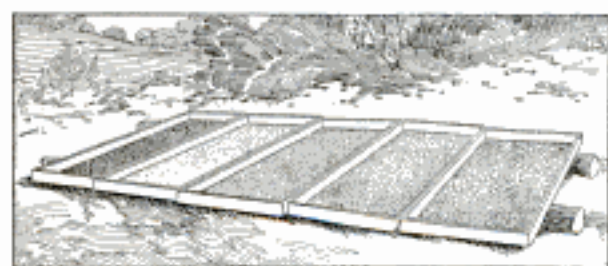

Fig. 1—The Fruit is Spread on the Trays. Protected by Mosquito Netting, and Permitted to Dry in the Sun

$\frac{3}{4}$  in. thick and 2 in. wide, which form the sides and ends, and lath, spaced  $\frac{1}{8}$  in. apart, to form the bottom. Screen,  $\frac{1}{8}$  or  $\frac{1}{4}$ -in. mesh, can also be used.

A drier for use over the kitchen stove can be made of galvanized-wire netting and strips of wood, about  $\frac{1}{2}$  in. thick and 2 in. wide, as shown in Fig. 2. This drier can be suspended over the kitchen range, or over an oil, gasoline, or gas stove, and utilizes the hot air which rises while cooking is being done. It can be raised out of the way or swung to one side by a crane made of lath, when the stove is required for cooking.

Another cookstove drier, that can be used on a wood or coal range or a kerosene stove, is shown in Fig. 3. Its dimensions are: base, 24 by 16 in.; height, 36 in. The base, 6 in. high, is made of galvanized sheet iron. It has

two small openings for ventilation in each of the four sides. The boxlike



Fig. 2—This Multiple-Deck Tray Arrangement Utilizes the Waste Heat from the Stove, and can be Swung Aside When in the Way for Cooking

frame is made of 1 or  $1\frac{1}{2}$ -in. strips of wood. The trays in the drier rest on cleats, placed at intervals of 3 in. The

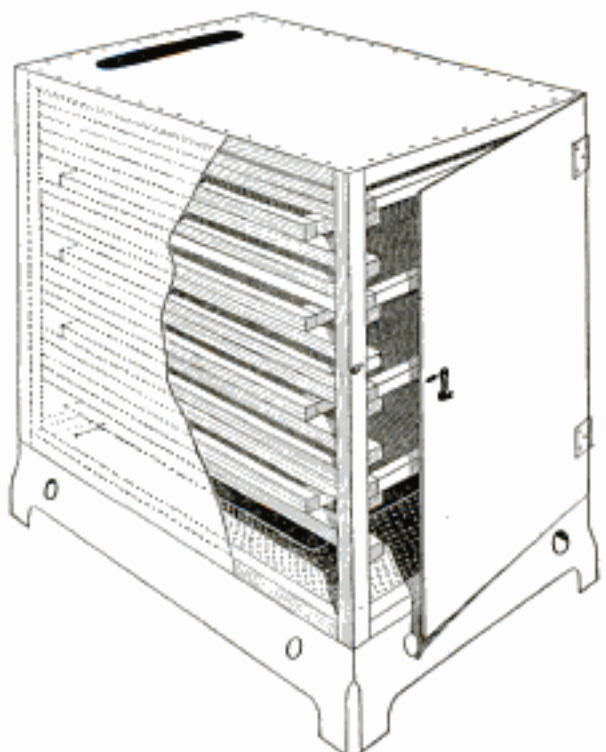

Fig. 3—Eight Trays are Housed in This Substantial Drier of Sheet Metal, Which is Set Directly on the Stove

frame is covered with tin, or galvanized sheet iron. The bottom of the drier is



made of perforated galvanized sheet iron. Two inches above the bottom is placed a solid sheet of galvanized iron which is 3 in. less in length and width than the bottom. This sheet rests on two wires fastened to the sides of the drier, which prevents the direct heat from coming in contact with the product. The drier holds eight trays. The frame of the tray is made of 1-in. strips

on which is tacked galvanized screen wire, which forms the bottom. The tray is 21 by 15 in. long. The trays alternate, one being flush with the front, and the next 3 in. back. This permits the current of heated air to pass around and over the trays. A ventilator opening, about 2 in. wide and 6 in. long, is left in the top of the drier, through which the moist air may pass.

### Foot-Power Emery Grinder Quickly Made

Desiring quickly a simple and inexpensive emery wheel for the finishing of plates and grinding of tools in

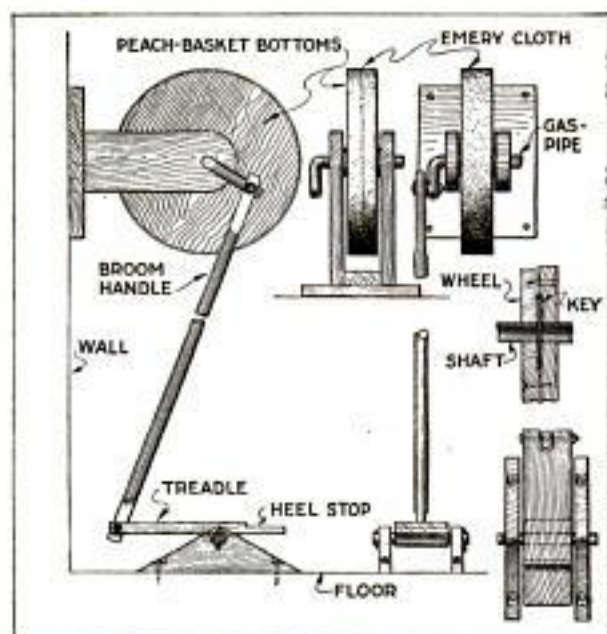

This Emery Grinder Proved so Handy in a Diesinker's Shop That One was Made for Home Use

a diesinker's shop, one as shown was made from materials at hand. The gas pipe was bent and drilled, a nail inserted, and the disks placed upon the ends of the pipe and screwed together. A coat of glue fastens the emery cloth to the wheel. A nail through one end of the broom handle was riveted into the bent end of the wheel pivot. The treadle is fastened similarly. The treadle brackets support a short section of pipe, fastened to the treadle. The supporting bracket is fastened to the wall by screws, or expansion bolts.—Frank A. Gould, Washington, D. C.

### Machine for Drawing Ellipses

When properly set and operated, the machine shown in the sketch will draw ellipses of dimensions up to the limit determined by the size of the machine, which can be made to suit individual needs. The construction is simple, and the main constructive features are as follows: The arm A is mounted in a grooved block, B, which is rigidly attached to the arm C by means of the circular shaft D. The arm C is mounted in the grooved block E, attached firmly to the shaft F, with the handle G mounted on its upper end. The shaft D passes through an opening in the horizontal piece H, and this piece is mounted on two supports, one of which is shown at I, so that it can move endwise only. The shaft F passes through an opening in the block J, which is mounted on two stiff dowel rods, K and L, so that it can move along these rods only. It must be observed that the block J moves in a path at right angles

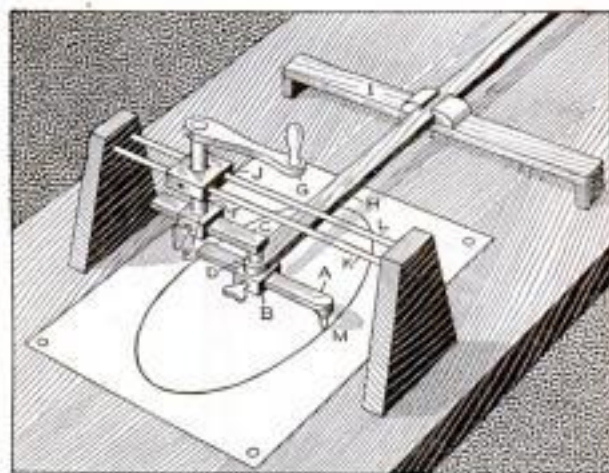

The Machine is Set According to the Desired Major and Minor Axes of the Ellipse, and the Figure Drawn Precisely



to the path in which the piece H moves. If the center of the shaft D were placed directly beneath the center of the shaft F, and the handle rotated, the tracing point M would mark out a circle, having a radius equal to the distance between the end of the tracing point and the center of the shaft D. If the center of the shaft D be moved to one side of the center of the shaft F, as shown in the figure, the path of the tracing point will not be a circle, but an ellipse, as indicated. The dimensions of this ellipse will depend upon the adjustment of the two arms A and C. The distance across the ellipse will be equal to twice the distance from the center of the shaft D to the center of the tracing point, and the distance from end to end will be equal to twice the distance from the center of the shaft F to the center of the tracing point.—M. P. Norton, Chicago, Ill.

#### Electric Bulb Used as Spot Light

A convenient and inexpensive spot light to be used in a dark room for developing pictures, or in the sick room, can be provided by slipping over an electric globe, the strawboard container that the globe is incased in when purchased. A suitable hole is cut into the cardboard, as shown. By turning the strawboard container around the globe, the spotlight may be placed in any desired direction.—Roy H. Poston, Flat River, Missouri.

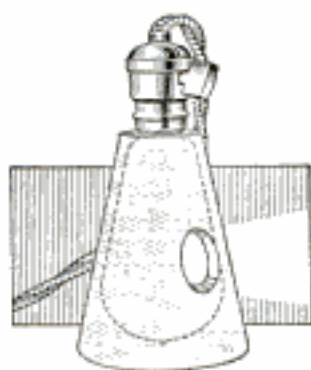

#### Holder for Kitchen-Sink Accessories

Considerable time is saved daily in our kitchen, and disagreeable work made less so, by the use of a small tray for holding the various cleaning agents used at the sink. Soaps, pow-

ders, brushes, scraper, etc., are here assembled, drained, and kept off the sink board. The tray is made as fol-

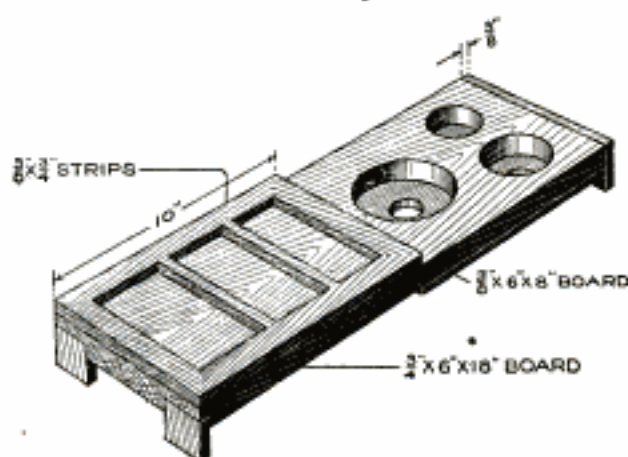

The Cleaning Materials and Tools at the Sink are Cared for Properly by the Use of This Holder

lows: Cut a  $\frac{3}{4}$ -in. board 10 by 18 in. long; with  $\frac{3}{8}$  by  $\frac{3}{4}$ -in. strips, make a shallow frame, as shown, at one end of the board, for soap bars. In the other end of the board, bore holes to accommodate cans of cleaning material, and other articles needed. Cover the under side of this end with a thin board, and through it, in each hole, bore a  $\frac{3}{4}$ -in. hole for drainage, and similarly, in each compartment in the soap frame. Nail four small legs to the corners. Putty the nail holes, and apply two coats of linseed oil to the device.—Henry Simon, Laguna Beach, Calif.

#### Cloth Polishing Brushes Made from Bristle Brushes

Being in need of a furniture polisher, I made one that worked very well in the following manner: I removed the handle from a worn-out stove brush, and then cut a strip of heavy Brussels carpet, twice as long as the brush. The bristles were bent over, and the strip of carpet was drawn over the brush part, as shown, and fastened with screws.—Dale R. Van Horn, Milton, Wisconsin.





### A Time Switch Fitted to a Dollar Watch

One who has not made the experiment is likely to doubt the statement that a 16-cp. carbon-filament lamp can be lighted through a single copper wire,

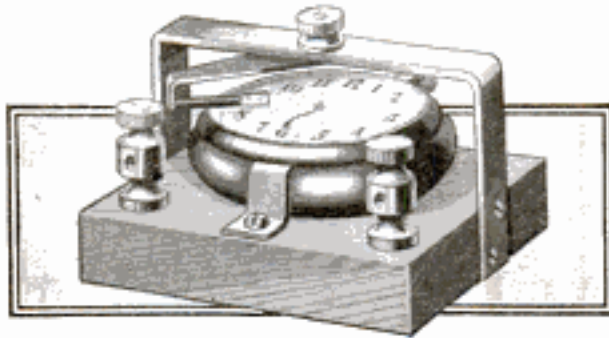

This Dollar-Watch Time Switch Arouses the Sleeper and Turns on Current for Heating His Shaving Water

.005 in. in diameter, without overheating it. An ordinary dry cell will burn up a short length of such a wire, but the half ampere under 110 volts requires little metal to accommodate it. It was this fact that led to experimenting with the ordinary dollar watch to actuate a time switch. Such a switch has been used to turn on the light at arising time during the winter season, and also to turn on the current in a shaving-water heater.

The device is arranged as follows: First procure the watch and build the mechanism to suit it. A hardwood block is used as a base, and three metal brackets hold the watch to the base, as shown. Screw these down so that the stem winder will project beyond the edge of the base to allow ample room for the fingers when winding. A strip

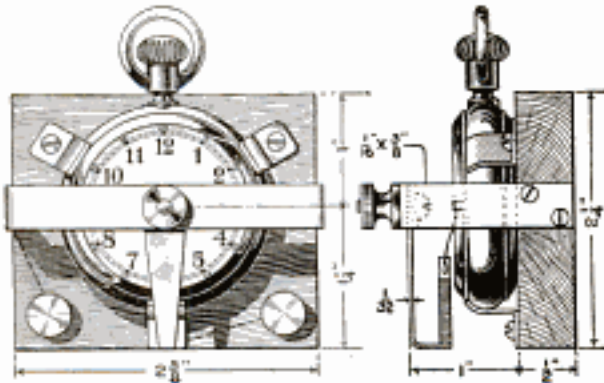

The Watch is Clamped on the Base and Electrical Connections Made as Indicated

of sheet brass forms the bridge across the top. Drill this for screws at each end, as indicated in the diagram, and at the exact center, for the brass bolt of an old dry cell. The regulating arm is then shaped, drilled at the large end, and bent down at the other. This piece holds the spring that intercepts and makes contact with the hour hand of the watch. While a very small strip of extremely thin metal will answer, a more even and delicate pressure may be had by winding fine brass spring wire into a close coil, about  $\frac{3}{32}$  in. in diameter, and use this coil as a flat spring. Solder one end to the regulating arm, and a small piece of brass to the other end. A closer timing may be had by tipping it with platinum. Two binding posts are set on the base, one connected with the bridge, and the other to one of the base brackets. Remove the glass, and bend the minute hand well up out of the way, or remove it, and raise the tip of the hour hand slightly. Attach the bridge, and see that the regulating arm swings freely in a complete circle, at any point of which it may be clamped.

The action is apparent: The  $\frac{1}{2}$ -ampere alternating current flows through the watch, without harming it, along the hour hand to the regulating arm, thence along the bridge to the other binding post.—John D. Adams, Phoenix, Ariz.

### Enameling Spokes and Worn Rims of Motorcycle

Scatched rims, and rusty spokes and hubs, detract from the appearance of a motorcycle. Old rims and rusty spokes may be made more attractive by enameling them black or white, preferably the latter. The enamel should be removed from the rims with a knife and sandpaper, and all oil and grease removed from the spokes and hubs with gasoline. The rim, spokes, and hubs are then given a coat of primer. The second coat should be a glossy enamel, and, if properly done, the wheels will resemble the wire wheels on some automobiles. Wheels



thus treated are practically rustproof, and whenever it becomes necessary to clean them, a sponge and water, with a little "elbow grease," will do the work effectively.—Francis W. Nunenmacher, Berkeley, Calif.

### Uniform Photo-Bath Temperature Prevents Blisters

A common difficulty encountered by the amateur photographer is the blistering of plates or prints. This is usually ascribed to hot weather. The real cause is the difference in temperature between the atmosphere and the developing baths. In summer atmosphere the wash water and toning bath are of uniform but high temperature. The fresh hypo bath becomes cold because of the fall in temperature when hypo is dissolved in water. When the prints are plunged into the cold bath, after being in the warmer one, blisters frequently result. In winter, similar difficulties may be met with if one of the baths is much colder than the other. The remedy lies in testing the temperatures and making them uniform.

### Handy Removable Pencil Clip Attached to Blank Book

It is necessary in our office to make switching orders in triplicate for each

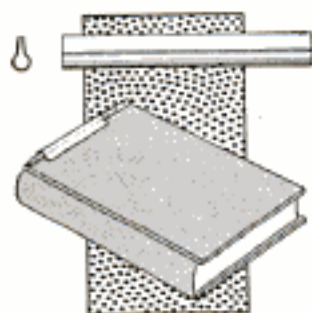

car that goes from the plant. To fumble in the pocket, or look for a copying pencil, is annoying, so a holder for the copying pencil was made, keeping it with the book in

which the manifold copying is to be done. A piece of light tin, with an opening just large enough to receive the pencil, is slipped on the upper edge of the book, and after making the copies, the pencil is shoved into the holder. When a book is emptied, the holder is transferred to the new book.—A. C. Gandy, West Lafayette, Ind.

### Target Arrangement for Rifle-Sighting Practice

Excellent sighting practice with a rifle may be had by securing the rifle firmly in a vise, or rack, and sighting

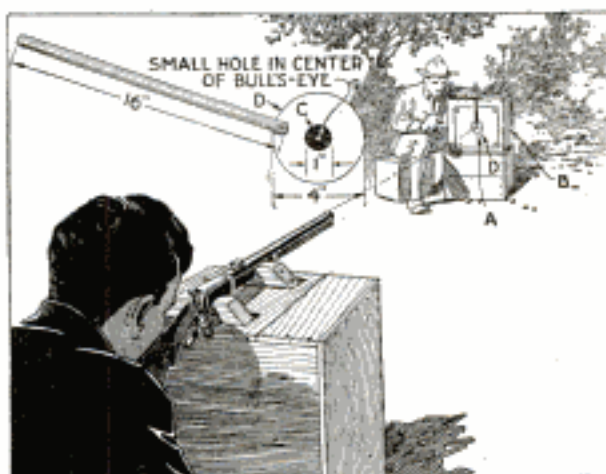

The Novice Sights the Rifle and the Marker Indicates on the Target the Accuracy of the Aim

it repeatedly at an object placed 20 or 25 ft. away. A similar system is used in the army to accustom men to sighting properly. The sketch shows the rifle secured in notches cut in blocks set on a box, and trained on the target. This is shown in the detail, where A is a square of white paper, secured to a box, B, by thumb tacks. The bull's-eye C is a black circle, 1 in. in diameter, with a small hole in the center. D is a round piece of cardboard, 4 in. in diameter, attached to a wooden handle, 16 in. long.

In sighting practice, a person holds the bull's-eye on the target and moves it at the directions of the rifleman until it is in the position at which the rifleman would pull the trigger. The rifleman then orders "mark," and the marker makes a dot on the target by putting the point of a pencil through the hole in the center of the bull's-eye. Three "shots" are allowed each time, and, with fair marksmanship, they should hit within  $\frac{1}{2}$  in. of each other. Neither the rifle nor the target are moved during the shots, the bull's-eye only being moved to line up with the rifleman's sight.—George M. Petersen, Watertown, N. Y.



## CHARMING BUNGALOW FOR SMALL FAMILY

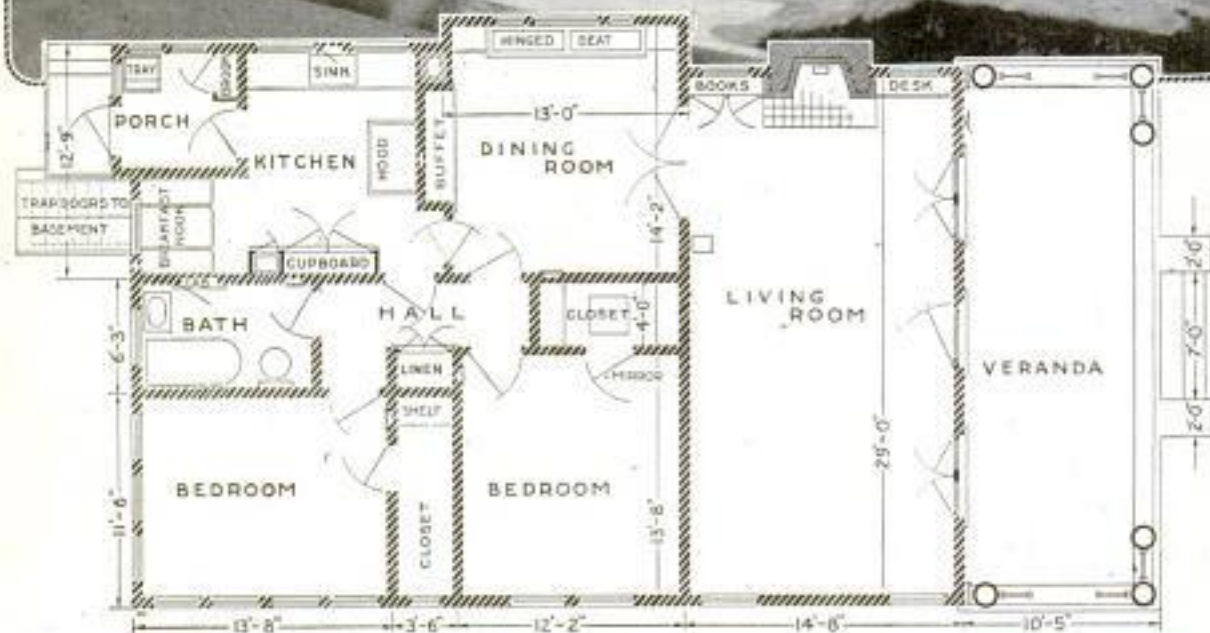

**F**OR the small family of modest requirements, the picturesque little bungalow illustrated herewith may spell "home." The interior arrangement has the virtue of being as convenient as the outside architecture is attractive. A glance at the floor plan will stress this point. The rooms are all of comfortable size, while the living room is really an exceptional one for a small dwelling. Furthermore, it will be observed that in spite of the overhanging roof and broad veranda, sunlight is not excluded, for French windows glaze a large part of the front wall. The architecture is a modification of the Colonial style that during the past two or three years has become increasingly popular in southern California. Except for the green-shingled roof and the brickwork, the exterior is entirely white. White-enameled pine is used throughout for the inside finish and all the floors are of quarter-sawn oak except those in the kitchen and toilet. The big fireplace has a French-gray mantel of Colonial design, which adds much to the coziness of the living room. A hot-air furnace is installed in the basement. The bungalow has been erected for \$3,850. This price includes the heating plant.

**I**N accordance with the editorial policy of this magazine never to accept compensation in any form for what appears in our reading pages, and also to avoid all appearance of doing so, we are obliged to omit the name of the maker or the seller of any article described. This information, however, is kept on file and will be furnished free, by addressing Bureau of Information, Popular Mechanics Magazine, Chicago. [Editor.]



# This Modern Seven Room ALADDIN HOME

Shipped Anywhere

**\$1088**

Here is a splendidly designed, modern and conveniently arranged home. You can build it this fall easily before snow flies—move in within thirty days after arrival of the material. It's built for the coldest climate and the strongest winds. Has three bedrooms, living room, dining room, kitchen, bath and closets. All material readi-cut by the original Aladdin system, saving 18% of the lumber and nearly half of the labor. The Aladdin catalog No. 180 gives FULL information.



# This Shingled Bungalow (3 bedrooms) \$758



This is the Stanhope, a charming shingled bungalow, rooms all on one floor—convenient and comfortable and with three bedrooms. It's one of the most popular homes ever designed and the price is remarkably low. Built of Aladdin's famous knotless material, all shingles, outside finish, interior woodwork, flooring, doors, and porch work furnished in beautiful clear lumber, free from all knots or defects of every kind. The Aladdin catalog No. 180, shows a large colored photograph of it, floor plans and full description.

# This is the STRATHMORE—8 rooms with 4 bedrooms \$1381



The Strathmore has many interesting features. A front entrance porch, a side pergola porch, with French doors leading to living room, open stairway to second floor, large living room, dining room, kitchen and pantry and four bedrooms and bath. Examine the arrangement of rooms on first and second floors as shown in pictures at right. The catalog No. 180 contains much more interesting information about the Strathmore.



# Get the beautiful ALADDIN Catalog:: 100 Designs

A beautiful bound book of 120 pages profusely illustrated with four-color photographs will be sent you upon your mailing the coupon below. This Aladdin Book of Homes No. 180 is invaluable if you expect to build. It gives full information on the subject of building, on the subject of the original Aladdin Read-Cut System of Construction, and pictures over one hundred modern homes priced from \$100 up to several thousand dollars. Send for it today.

The ALADDIN CO.  
1466 Aladdin Ave., Bay City, Mich.  
Without cost to me, send me at once your Book of Aladdin Homes No. 180.

I expect to build.....  
Name.....  
Box or Street.....  
Town.....State.....

**THE ALADDIN COMPANY·BAY CITY, MICH.**

Please Mention Popular Mechanics



# HOW I EARNED \$200,000 IN THREE YEARS

*The amazing and inspiring story of a young man who jumped from failure to fortune; did not speculate; says no man need beg for success. —As Told by Himself.*

SOME people say it *takes* money to *make* money—others complain that they never made money because they never had any luck. When one is up against the stern reality of making both ends meet, it is natural to feel that if they only had a little money, or a little luck, they wouldn't have to worry about their bread and butter, and rent, and clothes.

Three short years ago I, too, felt that way. I was \$5,000 "in the hole"—and earning \$30 a week. Figure out how long it would take me to pay what I owed! I had a wife and two children to support, and I used to worry myself sick about their future. What would become of her? What would become of them? Would we always have to skimp and scrape? Would we ever be able to pay what I owed?—to say nothing of saving something for the "rainy day."

Today—it seems like a dream—all my troubles are over. I am worth \$175,000—enough to keep me and my family in comfort for the rest of our lives. I own two automobiles. My children go to private schools. I have just purchased, for cash, a \$25,000 home. I go hunting, fishing, motoring, traveling, whenever I care to.

Let me say in all sincerity that I believe what I have done, you—*anyone*—can do. I am only an average man—not "brilliant"—have never gone to college—my education is limited. I know at least a hundred men who know more than I, who are better educated and better informed,—yet not one of them has made as much money as I have and their earnings probably average less than \$50 weekly, while my income is over \$1,000 weekly. I mention this to show that earning capacity is not governed by the extent of a man's education—to encourage those who have not had the advantage of a comprehensive education.

What, then, is the secret of my success? Let me tell you how it came about.

One day, about three years ago, something happened that woke me up to what was wrong with me. It was necessary for me to make a decision on a matter which was of no great consequence. I knew in my heart what was the right thing to do, but something held me back. I said one thing, then another; I decided one way, then another. I couldn't for the life of me make the decision I knew was right.

I lay awake most of that night thinking about the matter—not because it was of any great importance in itself, but because I was beginning to discover *what was wrong with me!* Along towards dawn I resolved to experiment. I decided to cultivate my will power, believing that if I did this I would not hesitate about making decisions—that when I had an idea I would have sufficient confidence in myself to "put it over"—that I would not be afraid of myself or of things or of others. I felt that if I could smash my ideas across I would soon make my presence felt. I knew that heretofore I had always begged for success—had always stood, hat in hand, depending on others to give me the things I desired. In short, I was controlled by the will of others. Henceforth, I determined to have a strong will of my own—to demand and command what I wanted.

With this new purpose in mind I applied myself to finding out something more about will power. I was sure that other men must have studied the subject, and the results of their experience would doubtless be of great value to me in understanding the workings of my own will. So, with a directness of purpose that I had scarcely known before, I began my search.

The results at first were discouraging. While a good deal had been written about



the memory and other faculties of the brain, I could find nothing that offered any help to me in acquiring the new power that I had hoped might be possible.

But a little later in my investigation I encountered the works of Prof. Frank Channing Haddock. To my amazement and delight I discovered that this eminent scientist, whose name ranks with James, Bergson, and Royce, had just completed the most thorough and constructive study of will power ever made. I was astonished to read his statement, "The will is just as susceptible of development as the muscles of the body!" My question was answered! Eagerly I read further—how Dr. Haddock had devoted twenty years to this study—how he had so completely mastered it that he was actually able to set down the very exercises by which anyone could develop the will, making it a bigger, stronger force each day, simply through an easy, progressive course of Training.

It is almost needless to say that I at once began to practice the exercises formulated by Dr. Haddock. And I need not recount the extraordinary results that I obtained almost from the first day. I have already indicated the success that my developed power of will has made for me.

But it may be thought that my case is exceptional. Let me again assure you that I am but an average man, with no super-developed powers, save that of my own will. And to further prove my contention let me say that since Prof. Haddock's lessons, rules, and exercises have been published in book form, I have come across hundreds of other cases where strengthened will power has brought success and fortune to people who were failures, has enabled thousands to overcome drink and other vices almost overnight—has helped overcome sickness and nervousness, has transformed unhappy, envious, discontented people into dominating personalities filled with the joy of living.

I have been authorized by the publishers to say that any reader who cares to examine this startling book may do so without sending any money in advance. In other words, if after a week's reading you do not feel that "Power of Will" is worth \$3, the sum asked, return it and you will owe nothing. When you receive your copy for examination I suggest that you first read the articles on: the law of great thinking; how to develop analytical power; how to guard against errors in thought; how to drive from the mind unwelcome thoughts; how to develop fearlessness; how to use the mind in sickness; how to acquire a dominating personality.

Some few doubters will scoff at the idea of will power being the fountainhead of wealth, position, and everything we are striving for, and some may say that no mere book can teach the development of the will. But the great mass of intelligent men and women will at least investigate for themselves by sending for the book at the publisher's risk. I am sure that any book that has done for me—and for thousands of others—what "Power of Will" has done, is well worth investigating. It is interesting to note that among the 200,000 owners who have read, used, and praised "Power of Will" are such prominent men as Judge Ben B. Lindsey; Supreme Court Justice Parker; Wu Ting Fang, ex-U. S. Chinese Ambassador; Lieut.-Gov. McKelvie, of Nebraska; Assistant Postmaster-General Britt; General Manager Christeson, of Wells-Fargo Express Co.; E. St. Elmo Lewis; Governor Arthur Capper, of Kansas, and thousands of others.

As a first step in will training, I would suggest immediate action in this matter before you. It is not even necessary to write a letter. Use the blank form below, if you prefer, addressing it to the Pelton Publishing Company, 13-S Wilcox Block, Meriden, Conn., and the book will come by return mail. This one act may mean the turning point of your life, as it has meant to me and to so many others.

---

### PELTON PUBLISHING COMPANY

13-S Wilcox Block, Meriden, Conn.

I will examine a copy of "Power of Will" at your risk. I agree to remit \$3 or remail the book in 5 days.

Name .....

Address .....

Please Mention Popular Mechanics





# Champion Toledo

**Dependable  
Spark Plugs**

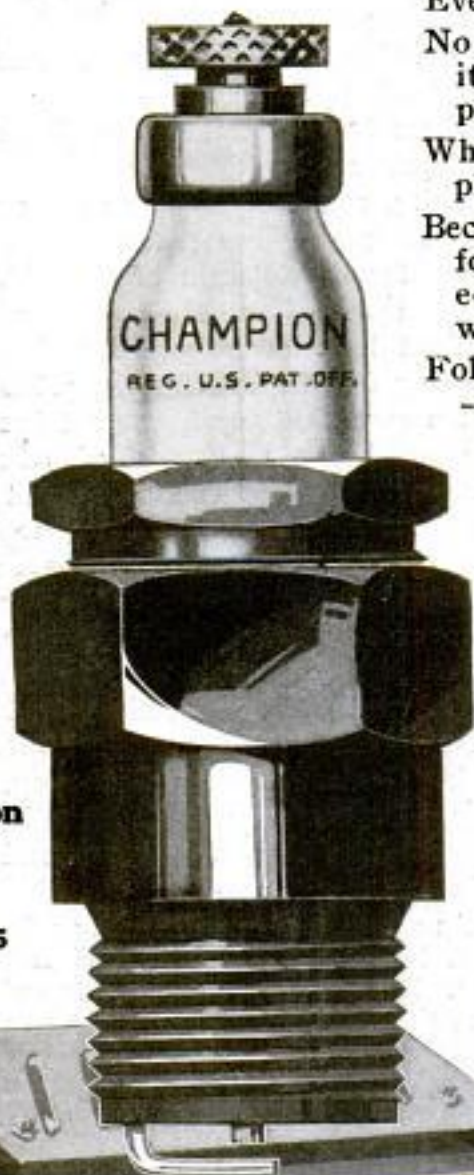

**Champion  
Heavy  
Stone**

**Price, \$1.25**

## The Guarantee Under the Hood!

The engine is the most important part of your car. Everything else depends upon its efficiency.

No matter who built it, nor how many cylinders it has, it is just as efficient as its spark plugs permit it to be.

Why risk inferior plugs in *your* car? Get the plugs you *know* are dependable.

Because Champion Spark Plugs *are* dependable four out of every five cars leave their factories equipped with them—come to you, when new, with this guarantee under their hoods.

Follow the experience of these expert engineers—use Champions.

Avoid substitutes by looking for the name *Champion on the porcelain.*

There is a Champion Spark Plug especially designed for *every* type of engine and sold everywhere.

**Champion Spark Plug Co.**  
421 Upton Ave. Toledo, Ohio

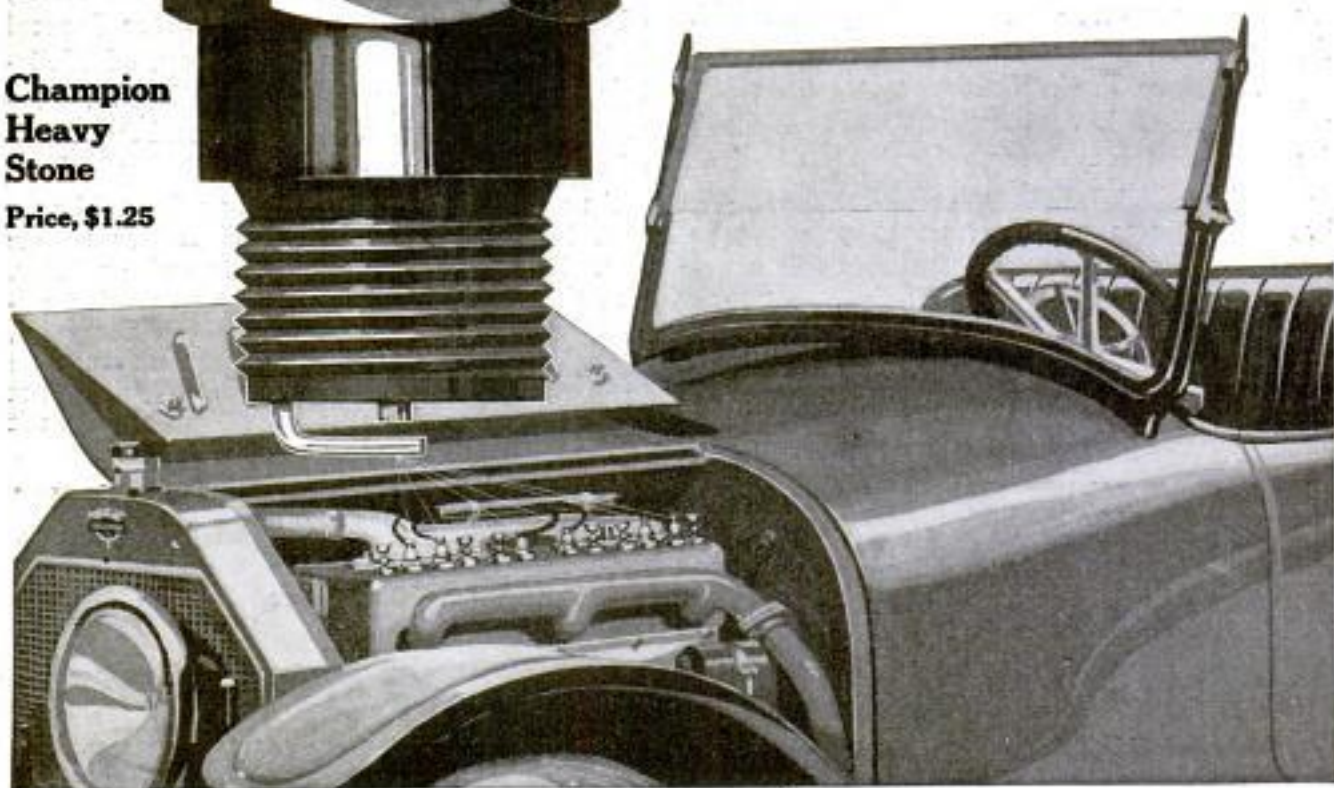



1847

1917

# CHASE Plush Motor Car Robes

Made by Sanford Mills

Of wonderful fast colors,  
they will outwear—many  
times over—other woven  
fabric robes. Say "Chase"  
to your merchant.

**L·C·CHASE & CO.**

NEW YORK BOSTON CHICAGO  
Leaders in Manufacturing Since 1847



Please Mention Popular Mechanics



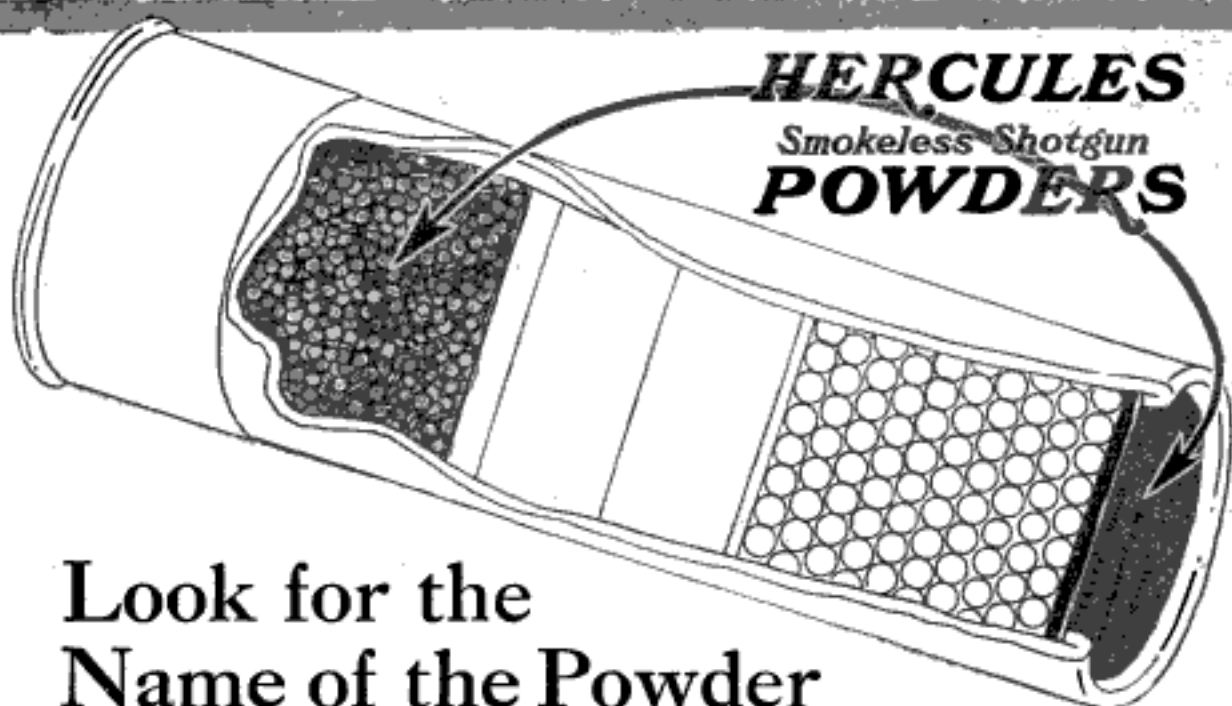

## Look for the Name of the Powder

**A**NY sportsman who gives the matter a moment's thought will agree that the powder contained in the shotgun shells he uses is a factor of prime importance to him when shooting either in the field or at the traps.

This being so it is a matter of ordinary prudence when buying loaded shotgun shells to specify that they be loaded with a powder with which you are familiar—a powder upon which you can depend under all circumstances.

You get such a powder when you specify either Infallible or "E. C."—the two Hercules Smokeless Shotgun Powders.

Undoubtedly the name of your favorite make of shell is given in the list at the right. You can obtain either of these Hercules Powders in *that shell by asking your dealer for it.*

On the top wad of every shell, and on the cover of the box in which the shells are sold, is printed the name of the powder with which the shell is loaded. Look for this name when buying. See that it is either Infallible or "E. C."

These powders are of high quality and uniform quality. They give light recoil, even patterns, and high velocity. Write for a free booklet which describes them fully.

Infallible and "E. C." can be obtained in all of the following makes of shotgun shells.

**PETERS**  
**REMINGTON**  
**SELBY**  
**U. S.**  
**WESTERN**  
**WINCHESTER**

### **HERCULES POWDER CO.**

1025 Market Street  
Wilmington Delaware







**"Oh, J-I-M-M-Y, come on over,  
we're goin' shootin'!"**

Your boy's summer vacation is pretty nearly over now. Don't let him miss a single day of real sport.

Remember the fun you used to get out of your Winchester on those early fall days, just before school opened.

It's the boy's turn now. Give him a Winchester and let him have the same fun you had at his age. He's old enough now to have a Winchester of his own, to know the joy of trigger-magic.

#### What a gun will do for your boy

The sport of shooting is the greatest developer of mental resources—mental quickness, fair play, steady nerves, control, and the ability to mix in manly competition with companions.

A boy's natural interest in a gun is going to make him get his hands on one sooner or later, so the sooner you teach him the correct use of a gun, the better. Remember that it is just as important for every boy to know how to handle a gun safely as it is that he should know how to swim.

#### Let your boy earn a Winchester Medal

To encourage marksmanship and the correct handling of a rifle among boys and girls of America we are awarding Gold Plated and Silver Plated Medals for skill with the Winchester .22 caliber rifle.

These Medals are awarded by the Winchester Junior Rifle Corps, an honorary club with membership among the boys and girls all over the United States. There are no dues and no military obligations involved.

Get your boy a Winchester rifle. Let him have the benefits that a gun will bring to him. Get him in on this Winchester competition which will teach him the correct use of a gun from the start.

#### What the name "Winchester" means

The name "Winchester" stands for the best traditions in gun making. For over half a century Winchester has been the standard of pioneers and sportsmen. The Winchester Company today is an organization of expert gun makers with fifty years of gun-making reputation behind it.

Every gun or rifle that bears the name "Winchester" is fired many times for accuracy and smooth action, and with excess loads for strength.

No Winchester barrel varies one one-thousandth of an inch in thickness or diameter. The Bennett Process, used exclusively by Winchester, gives the Winchester barrel a distinctive blue finish that, with proper care, will last a lifetime.

The same care that is taken with Winchester guns is taken with Winchester ammunition. The two are made for each other.

#### Let the boy have it now

Don't delay any longer giving your boy the benefits of a Winchester. There is a place near you, either in the open or at a club, where he can go shooting. If you do not know where to shoot, write us and we will tell you where and how you can, or we will help you organize a club.

Ask your dealer for our catalog and booklet, on the proper use of a gun. If your dealer cannot supply you, write direct to us.

WINCHESTER REPEATING ARMS CO.  
Dept. 143 New Haven, Conn.



## Boys and Girls

### Winchester Medals for Skill with the Rifle

**The Gold Plated "Sharpshooter" Medal** goes to any boy or girl under 16 who makes the first grade score with a Winchester .22 rifle and Winchester ammunition.

**The Silver Plated "Marksman" Medal** goes to the boy or girl who makes the second grade score.

Go to your dealer today; he will give you a sample target and booklet explaining the full conditions of the contest. This booklet also tells you how to get the best results from your Winchester. The dealer will also supply you with plenty of targets.

If your dealer cannot supply you, write to the Winchester Repeating Arms Co., Dept. 143, New Haven, Conn.



*Model 06. Take-down repeating .22 caliber rifle. 20-inch round barrel. Shoots three sizes of ammunition. The most popular .22 caliber repeater ever placed on the market.*

*Take-down .22 caliber single shot rifle. A low priced, light weight gun in two sizes.*

# WINCHESTER

World Standard Guns and Ammunition



# KEEN KUTTER

## PLANES won't chatter

even in the toughest wood because underneath the cutter there's an exclusive KEEN KUTTER feature.

This consists of a novel construction of the frog seat that gives greater solidity right where it is needed—right where exhaustive study and many tests showed that extra rigidity was the one practical way to eliminate chattering, at the same time permitting the use of a thin bit.

Handle grips are designed to give plenty of finger room and to prevent tiring of the hand and wrist in long continued use.

Obtainable with corrugated or smooth bottom.

You can do a real man's work every day and enjoy a real workman's satisfaction with a KEEN KUTTER Plane.

**SIMMONS HARDWARE CO.**

*Manufacturers and Distributors*

St. Louis   New York   Philadelphia  
Toledo   Minneapolis  
Wichita   Sioux City

Plane  
No. K5

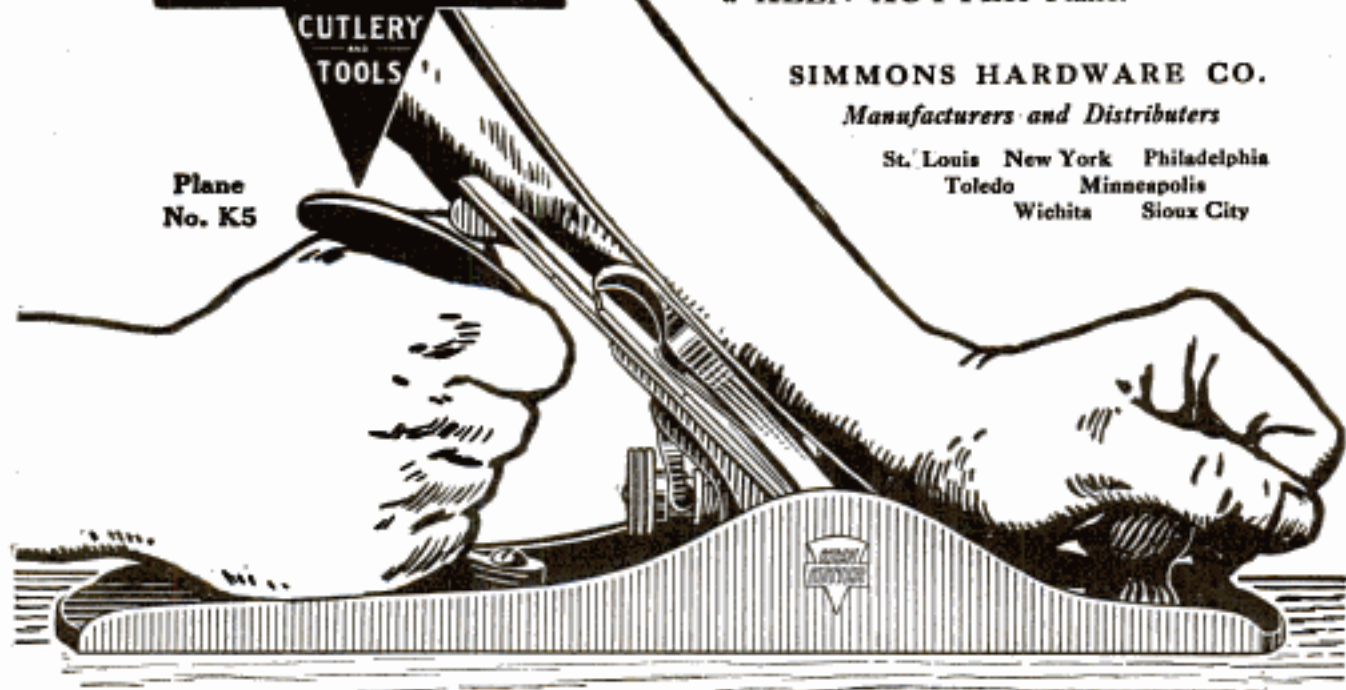

**"The recollection of QUALITY remains long after the PRICE is forgotten"**

TRADE MARK REGISTERED

— E.C. SIMMONS

*Please Mention Popular Mechanics*

Copyrighted material





SPANNING a decade the "*St. Paul Road*" has wrested from tomorrow the comforts and conveniences of electric travel and made them the heritage of today.

Giant electric locomotives, the mightiest in the world, impelled by the forces of the mountains themselves, haul the heavy steel trains of this railway across the Great Continental Divide—440 miles through the Belt, Rocky and Bitter Root Mountains—with ease.

No smoke—no jars—no cinders—just smooth, even, almost silent travel through the glories of the mountains.

So successful has been the operation of these electrified mountain divisions that work is well under way for the electrification of 211 additional miles through the snow-capped Cascades in Washington.

The future has indeed been made to serve the present.

When you journey to Spokane, Seattle, Tacoma, Portland and other Pacific Northwest cities travel the electric way—the

CHICAGO  
**Milwaukee & St. Paul**  
 RAILWAY

Send for electrification and western travel literature — address

F. A. MILLER, *Passenger Traffic Manager*, CHICAGO

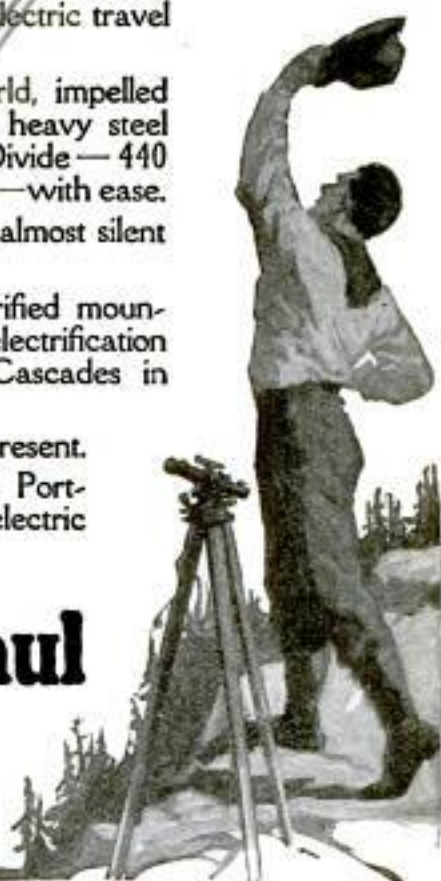

Please Mention Popular Mechanics





House on Fresh Pond Parkway, Cambridge, Mass. Charles R. Greco, Architect, Boston, Mass.

**A**LL woods have certain uses for which they are especially adapted by reason of the peculiar qualities and characteristics which nature has given them; and on their proper selection for these uses, hinges the whole problem of economy in wood construction.

Three centuries of experience in this country have demonstrated that no other wood lasts as long or gives such satisfactory service as

## WHITE PINE

for outside finish lumber—siding and corner boards; window sash, frames and casings; outside doors, door frames and casings; outside blinds; all exposed porch and balcony lumber; cornice boards, brackets, ornaments and mouldings; and other outside requirements, *not* including shingles.

If your lumber dealer is unable to supply White Pine, we should appreciate the opportunity of being helpful to you in securing it.

Address **WHITE PINE BUREAU,**  
2026 MERCHANTS BANK BUILDING, ST. PAUL, MINN.

Representing

The Northern Pine Manufacturers' Association of Minnesota, Wisconsin and Michigan, and The Associated White Pine Manufacturers of Idaho



"White Pine in Home-Building" is beautifully illustrated and full of valuable information and suggestions on home-building. Send today for this booklet—free to all prospective home-builders.

"The Helen Speer Book of Children's White Pine Toys and Furniture"—a fascinating children's plan book, from which a child may build its own toys and toy furniture. Prepared by Helen Speer, the toy expert. If there are children in your home, sent free on request.



# Startling **NEW** 1918 Book for You

Startling Low Prices on **NEW**, Highest-Grade Cameras, Lenses, Kodaks, Supplies

**You Get  
New, Just-From-Factory  
Cameras 'Way Less Than  
Manufacturers' Prices!**

This new 1918 book tells you how *and why* we can save money for you on any kind, size, style or make of camera, lens or supplies. A big, handsomely illustrated 96-page book that knocks the props from under high prices. The facts are startling. The offers genuine. Every one of them backed by a positive money-back guarantee. Every one of them offered to you on

**10 DAYS' FREE TRIAL  
Money-Back Guarantee**

And back of that guarantee is our record of over 32 years of honest, above-board dealing. Any bank—any mercantile rating agency will assure you that we are reliable. Over 18,000 camera users, all over the world, know *by experience* that we can—and we *do*—save big money for all our customers. The remarkable bargain in lower left hand corner of this ad is only one of hundreds of equally



**One of Hundreds**



**EASTMAN \$3<sup>75</sup>**

No. 2 Cartridge Promo  
Genuine Eastman, direct from factory, compact, folding and takes 2 1/4 x 3 1/4 pictures. Genuine, selected Meniscus Achromatic Lens. Simple, sure operation. Regular price, \$5.00.

low-priced offerings that pack *every page* of our wonderful 1918 catalog.

## INVESTIGATE!

**Send the Coupon at Once!  
The Free Book Gives All Facts!**

Ask for catalog Learn for yourself how easily—*surely* you can save a big slice off the regular prices of everything—anything in cameras, lenses and camera supplies. Don't pass this by. *It means money to you.*

**DAVID STERN COMPANY**

"In Business Since 1885—Everything in Cameras"

1010 Davsco Bldg.  
1027 Madison St.

Chicago,  
Illinois

David Stern Company, 1010 Davsco Bldg., Chicago, Ill.  
Gentlemen—Send me your catalog and prove to me that I can save money on any motion picture outfit, camera, Kodak, lens, etc., or photographic accessories.

Name.....  
Address.....  
City.....  
State.....

Please Mention Popular Mechanics





**2 Distinct Sparks**

**Adds Energy Reduces Carbon Always Sure to Fire**

The spark plug you've waited for. Excels anything else on the market. Adds "pep" to your motor. Laughs at soot and oil. Gives double intensity and perfect combustion. Economizes fuel. Always sure to fire. Absolutely guaranteed.

**TWIN FIRE**

spark plugs fire two independent sparks at the same instant. No other spark plug does this. Hence point clogs, the other still fires, and the hot explosions clean the foul one. Install a set and forget 'em. If your dealer can't supply you, write us.

**Dealers:** There's a big demand for Twin Fire Plugs. Write for our attractive proposition.

**TWIN FIRE SPARK PLUG CO., 660 Woodward Ave., Detroit, Mich.**

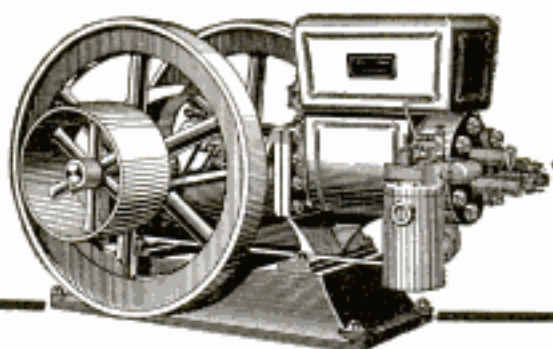

## OTTAWA ENGINES

### Kerosene Oil, Gasoline and Gas

Let me send you an engine to earn its own cost while you use it—for my Kerosene engine gives more power from a gallon of 6-cent kerosene than you can get from a gallon of 20- or 25-cent gasoline in a gasoline engine—Easy to start; easy to operate; no cranking; no batteries. All sizes—2 H. P. to 22 H. P.—Stationary, Portable, and Sawing Outfits. **10-Year Guarantee on Every Engine. Write for Latest Prices.**

### Direct From My Big Factory

Ever since I started my factory, years ago, I have been selling engines direct from the factory to the man in the shop or on the farm. Now, as before, any honest man can have my engine on **90 Days' Trial** Every engine I send out must make good all I guarantee. No need to pay double my price for any good engine, or take an out-of-date engine for any kind of a price. Let me show you how to figure what an engine is worth and

#### How to Know Better Engines

My newest book helps you choose a safe and value-received engine—How to make simple tests—and all about valve in head motor. Send me your address today. Just a postal card will bring this newest and latest book.

**GEO. E. LONG, OTTAWA MFG. CO., 535 King Street, OTTAWA, KANS.**

**GET FACTORY PRICES ON GALVANIZED ROOFING**



## EDWARDS "REO" Metal Shingles

Absolutely rust-proof—edges as well as sides. Not the space of a pin point exposed to weather. Also fire and lightning proof. Reduce insurance. Outlast building. Need no repairs—end all roofing expense. Easy to lay—one man can do the work—hammer and nails only tools needed. Lay over old shingles if desired. Patent interlocking device makes water tight seams—all nail heads covered—no rust or leaks possible.

### Exclusive "Tightcote" Process

Put all Edwards Galvanized Roofing in a class by itself. Bend, twist, strike it with a hammer as much as you like—you can't loosen or scale off the galvanizing—due to our "TIGHTCOTE" process which (scientifically) makes zinc covering a part of the metal sheet. No other galvanized roofing can withstand this test.

### FREE Roofing Book

Don't buy roofing until you get our big free book, describing Edwards famous "Tightcote"



**THE EDWARDS MFG. CO., CINCINNATI, O.**  
1000-1050 Pike St.



Roofings, Sidings, and Ceilings, and our lowest freight paid prices. We sell you direct and save you in-between dealers' profits. Write for Roofing Book No. 1050.

**Garage \$69.50 and Up**  
Lowest prices on Ready-Made Fire-Proof Steel Garages. Set up any place. Send postal for Garage Book showing styles.

**FREE Samples & Roofing Book**

## How Do You Clean Your Gas Range?



Have you tried the new way, the clean way, the 3-in-One way? If not, you don't know how easy a gas range is to keep clean and bright and working right. You simply rub

**3-in-One**

on the black iron. That's all. It shines up immediately and is also protected from rust caused by steam, gases or moisture.

In addition 3-in-One keeps the nickel parts bright and free from tarnish and oils all action parts of burners. All stores sell 3-in-One. In Handy Oil cans, 25c. In bottles, 15c, 25c, 50c.

**Free**—Generous sample of 3-in-One and Dictionary of Uses. Write for them.

**Three-in-One Oil Co., 165 NW Broadway, N. Y.**

Please Mention Popular Mechanics



# You Get **This** \$9<sup>00</sup> ACORN UNI-LITE As A Present

## Just Mail the Coupon Today!

That gives you a chance to join my Army of Money-Winners, too! Yes—and you get the Uni-Lite without paying a penny for it. And you may join my big band of men who are “coining money” without interfering with their present work—without doing much of anything except calling on their fellow townspeople and talking neighbor-like to them.

Let me tell you all about it. Just send me your name and address on the coupon (or post card) so I can tell you how you get your Acorn Uni-Lite free.

### The NEW Light That Makes Electricity Look Dim

The New 1918 Acorn Uni-Lite. Thousands exported. Used by U. S.

forces. Gives brilliant, steady radiance equal to the combined light of 20 ordinary lanterns or lamps. Burns 15 hours on one filling! Costs only ¼ of a penny per hour. Burns common kerosene or gasoline. Storm-proof, bug-proof. Use as a lamp—or carry as a lantern. Handsome in finish—neat in design—durable in construction. A

wonderful light in and around homes—farms—garages—barns—shops—in camps—driving on dark roads—boating—for night watchmen—hunters, railroad men, etc. And my New 1918 Offer tells you how you can get one free.

### All You've Got to Do is Answer This Ad Today!

Anyone can “win out”—make big money by my NEW 1918 Plan! It's simple and straightforward. I'll tell you all about it, just as soon as you send me your name and address. Don't put this off. Do it now. It won't take a minute.

300  
Candle Power

Weights only  
4¼ lbs.



Acorn Brass Mfg. Co. 120 Factory Bldg., CHICAGO, ILL.

*Clyde E. Padden*  
SALES MANAGER

**Clyde E. Padden, Sales Manager, ACORN BRASS MFG. CO.**  
120 Factory Bldg., CHICAGO, ILL.

I want to get me a \$9.00 Acorn Uni-Lite FREE as a present—and also join your Army of Money-Winners.

Name .....

R. R. or Street No. ....

City .....

State .....





Right now, when defence is the issue of the hour, is the time for every man to settle the question of *complete* defence of his home. It's a man's *duty* to defend his loved ones from the aggression of prowling burglars.



A friendly Iver Johnson Revolver should be in every home just for the peace of mind and mental comfort it gives. It is the safest small arm that you can own. You can drop it, throw it against a wall, or "Hammer the Hammer"—the cartridge will *not* explode. Only one thing under the sun can make it go off—a pull on the trigger.

Hammer model with Regular Grip, \$8.00. Hammerless model with Regular Grip, \$8.75. "Perfect" Rubber or "Western" Walnut Grip, extra.



**Iver Johnson's Arms & Cycle Works**  
307 River Street, Fitchburg, Mass.

89 Chambers Street, New York  
717 Market Street, San Francisco

**Three Books FREE**

Indicate which books you want: A—"Fire-arms," B—"Bicycles," C—"Motorcycles."



Iver Johnson "Western" Walnut Grip Revolver with 5-inch barrel shown here is a real man's gun. It has perfect balance and is a dead shot. Accidental discharge impossible. \$10.00.

## Russel Internal Gear Drive Axle



The most serviceable and economical motor truck axle made. Write for convincing reasons why your truck should be equipped with the Russel Axle.

RUSSEL MOTOR AXLE COMPANY, Central Ave., North Detroit



## The "BEST" LIGHT

Positively the cheapest and strongest light on earth. Used in every country on the globe. Makes and burns its own gas. Casts no shadows. Clean and odorless. Absolutely safe. Over 200 styles, 100 to 2000 Candle Power. Fully Guaranteed. Write for catalog. AGENTS WANTED EVERYWHERE.

THE BEST LIGHT CO., 324 E. 5th St., CANTON, O.

## SPECIALY PRICED TO INTRODUCE OUR XMAS GIFT CATALOG

FORTUNATE purchase before leather advanced in price enables us to offer 28,000 of our PRACTICAL BILFOLD at what the leather alone is worth today. THIS INVALUABLE combination currency-card case, a *distinctive Young Gift*, in genuine Sealgrain Leather, yours at this low price of 50c (\$5.40 Dog.) prepaid while they last. This model design with photo frame, transparent identification card, 1918 calendar and loose leaf MEMO PAD.

SIZE closed 3x3 1/4; open 8x3 1/4 inches. Packed in handsome gift box, with engraved card. SAME in fine Morocco Leather, only \$1.00 (310 Dog.) prepaid. Order scores of each at once. Only SHIPPED DAY RECEIVED. Illustrated catalog FREE. SEND DRAFT, MONEY ORDER or STAMPS TODAY. Money cheerfully refunded.

A. LANDA & SONS CO., Mfrs.

Dept. A-2

CHICAGO



## 50c

Postpaid

Name Engraved FREE in

23-kt. Gold

For Ladies and Gentlemen



# LOOK AT THESE PRICES

**\$100.00  
Values at  
Less Than  
ONE-  
THIRD**

**All Makes  
Typewriters  
Guaranteed**

**Sold For  
Low Cash  
Installments  
or  
Rented by  
Month**

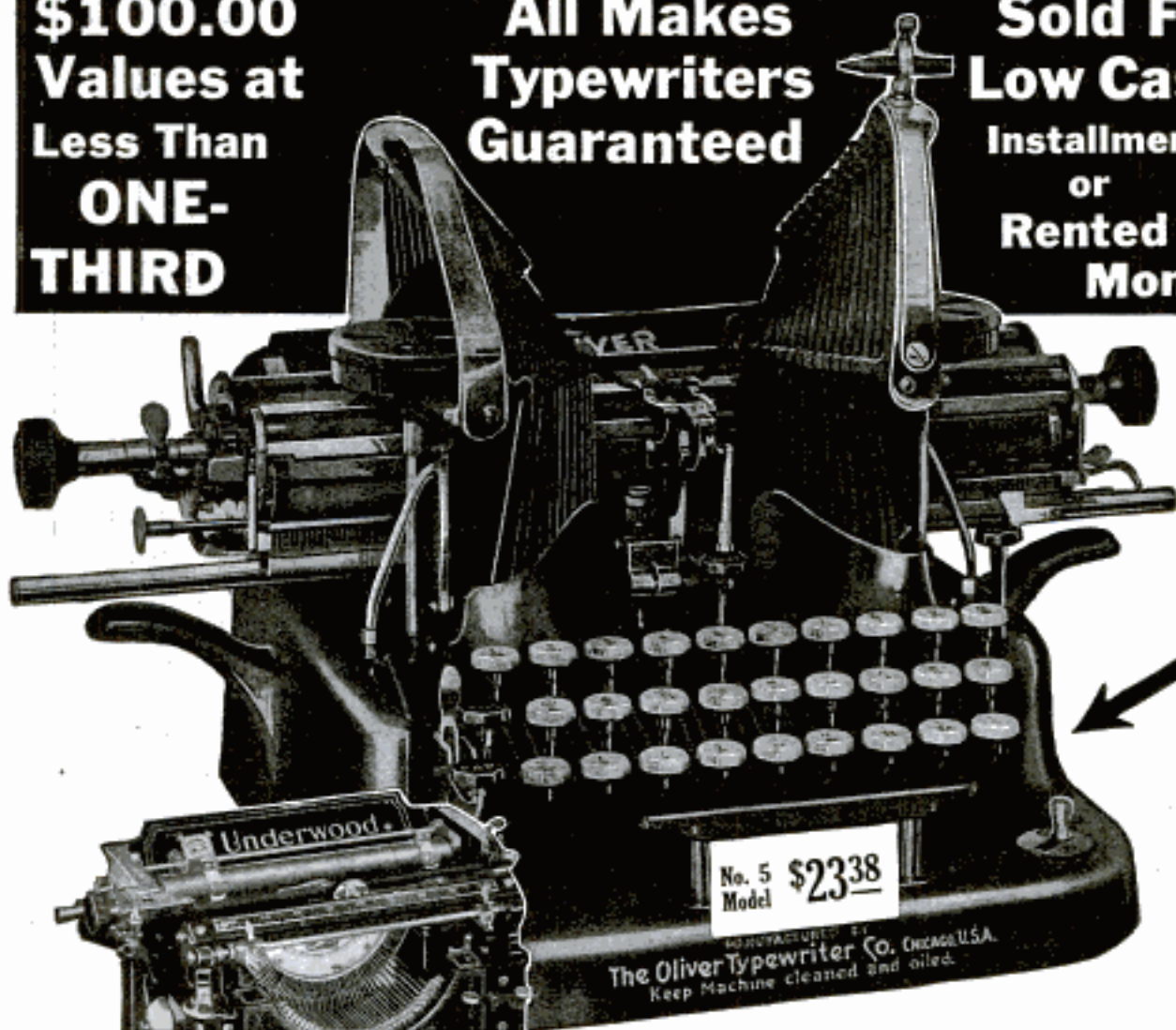

**WHY** pay a high price for a typewriter? A dollar saved is a dollar earned—and we can supply you with any standard make of machine on the market for **LESS** than *one-third* the manufacturer's price. Isn't this saving worth investigating?

## 10-DAY TRIAL

We not only give you an iron-clad guarantee with your machine but also give you the privilege of using the machine for **TEN DAYS**. If, after a thorough trial you are not satisfied, return the machine to us and we will cheerfully refund your money. We have to satisfy you.

## Rebuilt by the Famous "YOUNG PROCESS"

The reason why we can give you a strong guarantee—why we can send our machines out on a Ten-Day Trial is due to the fact that they are rebuilt by the famous "YOUNG PROCESS." This means that every machine is thoroughly rebuilt—new parts replacing those worn or weak. Any machine we sell looks like and is as good as new.

## Send for Free Catalog and "The Truth About Typewriters"

Before you invest a cent in a typewriter be sure and send for our big free catalog and also "The Truth About Typewriters." You should learn all about the Young Process Rebuilt Typewriters. There is more to know than you may think. Our prices will surprise you. Our guarantee and Trial offer absolutely protect you. **MAIL COUPON NOW.**

**YOUNG TYPEWRITER CO. Inc.** Dept. 320, 62 W. Madison St.  
CHICAGO, ILLINOIS

Please send me Free Catalog and "The Truth About Typewriters" without obligation  
P.M.

Name \_\_\_\_\_

Address \_\_\_\_\_

Town \_\_\_\_\_ State \_\_\_\_\_



# You Can Build This Dandy Crane With MECCANO

## Toy Engineering for Boys

Works just like a regular crane, because it's built from true engineering parts. But this is only one of hundreds of models pictured in the Meccano Manual contained with sets from No. 1 upward. No need to study. Manual enables you to begin building immediately. But, be sure you get Meccano! With Meccano—

Any Boy Can Build looms, clocks, wagons, cannon, machine guns, "tanks" and thousands of other enchanting things. Why! It's almost magic. If you want your models to run like real machinery you can get the powerful Meccano Electric Motor for \$4 (reversing type) or \$2 (non-reversing). Or you can get the Meccano Spring Motor for \$3. Set No. 1X, \$4.50, contains the \$2 electric motor.

### Book of Models Free

Lots of fine prize models. Send your name and three of your friends' names and we will mail it to each, along with a free subscription to the "Meccano Engineer" and prize contest details.

**MECCANO CO., Inc.** Bldg. 10H, Bush Terminal  
BROOKLYN, N. Y.

Each Set  
Complete.

Nothing  
More to  
Buy.

### PRICES OF MECCANO SETS

No. 00 . . . . .	\$1.00
No. 0 . . . . .	1.50
No. 1 . . . . .	3.00
No. 2 . . . . .	6.00
No. 3 . . . . .	9.00

And up to \$40.00

Sent prepaid on receipt of  
price if not at your dealer's.



### B-E-T-T-E-R MUSIC

#### Williams' Sounding Board

Placed under record on  
any disc phonograph.

SEND \$1.50 TO

O. B. WILLIAMS CO., Seattle, Wash.  
U. S. A.  
Manufacturers Sash and Doors.

### The Harley-Davidson "Master 17"



It sets the pace for 1917. Has more power, more speed, greater flexibility, faster getaway. Equipped with hand-operated, auxiliary brake in addition to regular service brake. Finished in beautiful military drab. Write for 1917 catalog.

**HARLEY-DAVIDSON MOTOR COMPANY**  
509-B Street Milwaukee, Wis.  
Producers of High-Grade Motorcycles for More Than Fifteen Years

## DIAMONDS, WATCHES ON CREDIT

YOU SHOULD HAVE THE JAMES BERGMAN 160 PAGE JEWELRY BOOK IN YOUR HOME. 4,000 Photos, Diamonds, Watches, Jewelry, Toilet Articles, etc. Anything selected sent on approval, all charges prepaid. If satisfactory, Pay 20 per cent Down—10 per cent Monthly. Write Today for Big Free Catalog No. 5. It tells all about our confidential relations, binding guarantee and Liberal Exchange. **James Bergman** 37-39 MAIDEN LANE, N. Y. Offer, 10 per cent off for cash. Estd. 1826 NEW YORK CITY



### How to Chart

GET OUR BOOK  
"How to Chart  
Your Business"

learn all about INSTANT USE  
CHART STATIONERY. Send 10  
2c stamps for book and sample.

**Chart Stationery Co., 1021 Monroe Bldg., Chicago, Ill.**

No other method gives so quickly  
the vital facts concerning sales, sell-  
ing costs and percentages of profits  
as circular charts. Di-  
vided into 100 units,  
making their use easy.

## Your Business

### POP-CORN CRISPETTES MAKE BIG MONEY



**\$1,500 Made One Month**

Ferris, Cal., took in \$380 in one day. Almost the enormous profit of 400 per cent. \$1 cash returned you for every 25c spent. Not theory! Not guess work! But actual bonafide proven records of profits. Send for book.

1351 HIGH ST. **W-Z-LONG CO.** SPRINGFIELD, OHIO

Hand  
Forged  
Razor Steel  
Blades, No. 57

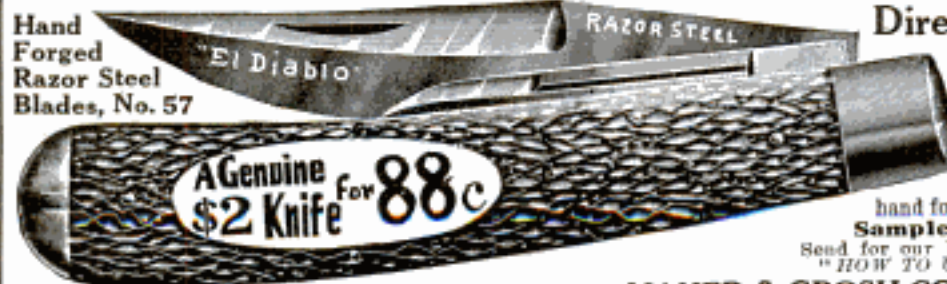

A Genuine  
\$2 Knife for 88c

### Direct at Factory Prices

This \$2 KNIFE 88c Postpaid  
Hand Forged Razor Steel Blades

Handy shaped blade makes this  
knife best for mechanics, sportsmen  
and farmers; light but strong; re-  
sharpened easily. Stag handle, Ger-  
man silver finish; blades file tested,  
hand forged from razor steel and warranted.

Sample 88c. 3 for \$2.12 postpaid.

Send for our 100 page List and  
"HOW TO USE A RAZOR" **FREE**

**MAHER & GROSH CO., 106 A. St., Toledo, Ohio**



## The Inspiration of a Woman's Needs Produced this New Kind of a Sewing Machine



Keep it on the closet shelf.



Carry it upstairs or down.



Put it on any kind of a table.



Connect to any light socket.



Take it with you when you travel.



The ordinary foot-power sewing machine is a clumsy affair. You cannot easily move it around, so you must bring your work to it. It is no ornament and takes up a lot of room. The woman who uses it pays dearly in a tired body and tired nerves.

## Western Electric Portable Sewing Machine

The heavy unnecessary parts of the old-fashioned machine are eliminated. With motor complete is no larger than a typewriter, yet it has all the attachments and will do the work of any sewing machine.

The speed is controlled by a touch of your foot and you can run the machine for five hours on one and a half cents' worth of electricity. With a Western Electric 2-way Plug you can operate both the machine and a lamp from a single socket at the same time.

If your lighting company or electrical dealer cannot show you this new kind of sewing machine, write to the nearest office for Booklet No. 516-AW.

Costs Only **\$35**

(\$37 West of the Rockies)

**WESTERN ELECTRIC COMPANY**  
Inc.

Gentlemen  
Please send me Booklet No. 516-AW, describing your portable electric sewing machine.

**WESTERN ELECTRIC COMPANY, Inc.**

New York Chicago  
Kansas City San Francisco

Houses in all Principal Cities

Name \_\_\_\_\_

Address \_\_\_\_\_



# MAZDA

*"Not the name of a thing,*

*but the mark of a service"*

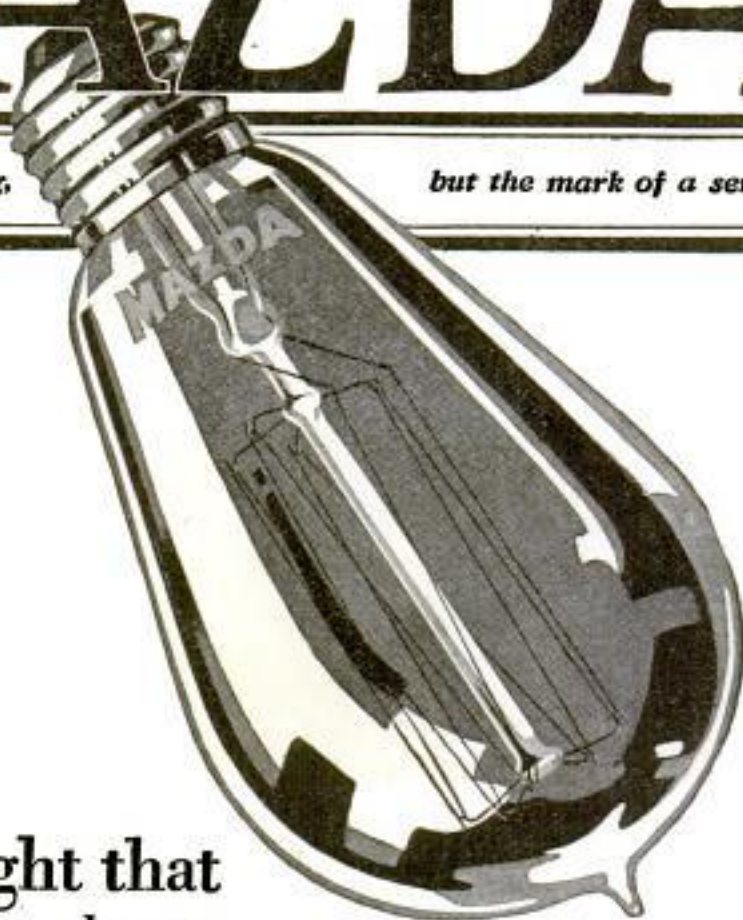

The new light that  
MAZDA Service throws  
on lamp-manufacturers'  
problems is reflected in  
the brighter, whiter light  
that MAZDA Lamps  
give in your home : :

## The Meaning of MAZDA

MAZDA is the trademark of a world-wide service to certain lamp manufacturers. Its purpose is to collect and select scientific and practical information concerning progress and developments in the art of incandescent lamp manufacturing and to distribute this information to the companies entitled to receive this Service.

MAZDA Service is centered in the Research Laboratories of the General Electric Company at Schenectady, New York. The mark MAZDA can appear only on lamps which meet the standards of MAZDA Service. It is thus an assurance of quality. This trademark is the property of the General Electric Company.



RESEARCH LABORATORIES OF GENERAL ELECTRIC COMPANY

4631





## The scars left by hot dishes

and moisture stains that mar the table top are things unknown to thousands of housewives. They use table mats and pads of

# JOHNS-MANVILLE

# Asbestos

Resistant to heat,

water, wear and weather



Practically unknown for ages, this mineral is today, through Johns-Manville, available in every conceivable form. On factory piping it conserves heat — on electric wires in your home it spells safety.

COVERS  
THE CONTINENT

The theatre curtain, the moving-picture booth, the brake lining on your motor car—all depend on J-M Asbestos. The history of Johns-Manville is read in the growth of Asbestos as a world-wide utility.

H. W. JOHNS-MANVILLE COMPANY

New York City

10 Factories—Branches in 55 Large Cities

Asbestos Fabrics, Packings, Roofings, Shingles, Brake Linings, Building Materials, Electrical Devices, Heat Insulations, Refractory Cements, Waterproofing.

The Motor Car



The Farm



The Home



Industry



Power Plants



Transportation



Roofings



When you think of Asbestos you think of  
**Johns-Manville**

Please Mention Popular Mechanics

Copyrighted material



# Gillette U. S. Service Set

## It Fits the Kit or the Pocket

**H**ERE is how the Great War developed the most compact and efficient shaving outfit in the world.

From the start, all the Allied Armies called for Gillette Razors—first by thousands, then by hundreds of thousands. All sorts of sets—leather, metal, Standard Sets and Pocket Editions. The demand finally centered on the Metal case; they stood the racket. Suggestions came from every front.

A year ago our own boys were called to the Mexican Border; among them a young Officer from the Gillette Organization. He came back with an idea—a soldier's idea of what the Gillette means to the

fighting man—the best model to go in the soldier's Kit or the sailor's Ditty-box!

We went to work on a Service Model—sifted all the suggestions, all the ideas, and developed them. When Uncle Sam jumped into the Big War the Gillette was ready to do its bit.

So here is the new U. S. Service Set; a solid metal case, heavy nickel-plated and embossed with the Insignia of the U. S. Army and Navy. Strong, thin, compact; 1 3/4 inches wide, 4 inches long, 3/8 inch thick. It fits the Kit or slips into the breast pocket of the shirt or coat. Contains a nickel-plated Gillette Safety Razor, Blades and Blade Box. Indestructible Trench Mirror inside the lid.

Price, \$5



The U. S. Army Regulations call for a shaving outfit. Every man has to bring his own. Here is his favorite razor and the one that takes up the least room. You ought to see the boys reach for them! Every man in Khaki ought to have one.

If you're a friend of his give it to him, or get it to him. Most gifts he will have to leave behind. This one he will carry with him and use every day. No Straps or Hones. Nothing to carry but the compact little case, and new Blades can be had anywhere in France, England, Russia and Italy.

*The Gillette U. S. Service Set is a leading specialty with Gillette Dealers everywhere*

**Gillette Safety Razor Company**  
Boston, Mass., U. S. A.

**Gillette Safety Razor Company**  
of Canada, Ltd.

73 St. Alexander Street, Montreal

If he has already gone, you can send him a Gillette U. S. Service Set by mail. If your dealer does not have this Set, send us \$5 and your Sammie's address, and we will make free delivery direct to his hands from our Paris Office or to any American Cantonment from our Boston Office.



Please Mention Popular Mechanics



# CORONA

*The Personal Writing Machine*



*Wallace Smith, of the Chicago "American," with Pershing's column in Mexico.*

**W**HERE every extra pound of equipment is a handicap, and where convenience, adaptability, and rugged strength are all essential, there you will find Corona.

Not only have war correspondents, army officers and adventurous travelers learned to appreciate Corona, but a hundred thousand men and women in every walk of life have made it their *personal writing machine*.

With Corona you can handle the intimate details of your work privately and put all your personal correspondence or reports into neat, legible, business-like form, with carbon copies for future reference.

Corona weighs but 6 pounds, and *folds* for travel so compactly that you can take it anywhere. Cost, complete with case, \$50. Write for booklet No. 13 and learn the details of this unique and helpful little machine.

**CORONA TYPEWRITER CO., GROTON, N. Y.**  
 NEW YORK    CHICAGO    SAN FRANCISCO  
 AGENCIES IN ALL PRINCIPAL CITIES



*-fold it up-take it with you-typewrite anywhere*



# Oxy-Acetylene Welding and Cutting

## Combating higher material costs by saving waste

**I**N practically every line of metal manufacture and repair work—oxy-acetylene welding means the conservation of time and material. Its savings are offsetting the increased cost of materials in many great factories.

In thousands of instances, such as the making of aluminum bodies, this process has opened new possibilities in the design and manufacture of higher quality products at lower cost.

In the manufacture of practically every metal product—oxy-acetylene welding makes the finished product stronger and neater—simplifies production—cuts costs—*minimizes material waste*.

From the manufacture of massive machinery to the making of delicate surgical instruments, this process is, in many instances, supplanting the bolt and rivet where two pieces of metal are to be joined.



*Aluminum sheets are welded into the body of this automobile body, enabling the manufacturer to utilize small pieces of valuable material which would otherwise become scrap.*

# Prest-O-Lite

## PROCESS

Provides a simple, inexpensive, portable process of welding for all classes of work. Prest-O-Lite Dissolved Acetylene is furnished in convenient cylinders, making the welding outfit portable for use inside or outside the shop.

The Prest-O-Lite System of exchanging empty cylinders for full ones insures universal, perpetual service. Avoids the initial investment and depreciation incurred in making crude acetylene in carbide generators. Insures better welds, quicker work and lower operating costs.

In thousands of shops and factories, in almost every line of industry, this process is reclaiming valuable materials and parts from the scrap pile.

By avoiding costly tie-ups and delays in production through the breakdown of an important machine, and also by saving the cost of a new part, one Prest-O-Lite welding repair can easily save the entire cost of the outfit.

Our literature describes hundreds of profitable uses for the Prest-O-Lite Process in manufacturing, construction and repair work. Write for it.

### Big Profits in Job Welding

Repair shops and garages are making good profits for themselves and saving time and money for customers by doing job welding. **Your** customers will appreciate this service.

To enterprising mechanics job welding presents a first class business opportunity. Equipment cost is low. Immense and growing demand insures steady profits from the start.

Write us for details TODAY.

The Prest-O-Lite Co., Inc.

U. S. Main Offices and Factory  
516 SPEEDWAY, INDIANAPOLIS  
Canadian General Office  
Dept. U. TORONTO, ONT.

59 Branches and Charging Plants



## World's Largest Makers of Dissolved Acetylene



## The Best Proof of Witte Quality

"I have run gas, gasoline and kerosene engines for several years, but I have never found an engine that equals the WITTE Engine for power, reliability and saving of fuel."  
—W. W. Demorest, Lamar, Ark.

"I find the engine is complete in every way, very still running and powerful. It is very sensitive to the governor and runs with even motion. If I was to buy another engine it would be a WITTE sure."  
—H. I. Sporr, Beadloaf, Vt.

"I know it would be a pleasure for Mr. Lackey to recommend the WITTE Engine, as ours is doing such excellent work and giving such splendid service. He had such a time with engines and spent so much on them before he got a WITTE, that it is truly a pleasure to have one so satisfactory."  
—Mrs. H. R. Lackey, Chautauque, Kans.

"I have never had a bit of trouble with my WITTE Engine. All I have to do to start it is just turn the wheel and she is off."  
—W. M. Land, Lardo, Idaho.

"My 4 H. P. WITTE certainly worked fine, doing the work of a 6 H. P. It has as much power as any 6 horse engine I ever saw."  
—Richard Hoffman, Arlington, Ill.

"If you will allow me to say a few words for your engine: I call it the WITTE Common Sense Engine, for any man with common sense can run one, and it has all the power you claim, and about one-third more."  
—W. L. Hawk, Barton, Ala.



ED. H. WITTE

# I Can Make You The Best PRICE

## On a Kerosene Engine

Sell You a Better Engine—Save You \$15 to \$200

Not an experiment! Hundreds in Use! Better and more powerful than ever! Starts as easily as a gas engine! Will use any fuel that can be used in a Kerosene engine! You get three times as much power for the money at present fuel prices! Your own terms! Cash, Deposit, Payments, or No Money Down! If you are in the market, write me today! I CAN MAKE YOU THE BEST PRICE—Sell You a BETTER Engine—Ship At Once! Any Style—Stationary or Portable.

## WITTE ENGINES

Kerosene and Gasoline—2 to 22 H-P.

are made in the largest exclusive direct selling engine factory in the world. I make nothing but engines. Over 30 years success proves quality—immediate shipment proves superior factory equipment and business methods—just as my engines are superior. You can see the high quality in every line and curve. Look at the long solid base affording absolutely solid footing. See how cleanly-built—no cumbersome overweight of metal—no cylinder hanging out behind—no interior packing—vertical valves and many other special features that make WITTE Engines high-grade, better, and more desirable. 90-Day Trial will fully convince you of superior quality. Write for latest prices and free book, or come to factory and see them—You are welcome. Ed. H. Witte,

FREE



## WITTE ENGINE WORKS

1746 Oakland Ave., Kansas City, Mo.

1746 Empire Bldg.,  
Pittsburgh,  
Pa.

Write for this Beautiful 3 Color Illustrated FREE BOOK Today! Yours for a Post Card—by Return Mail.

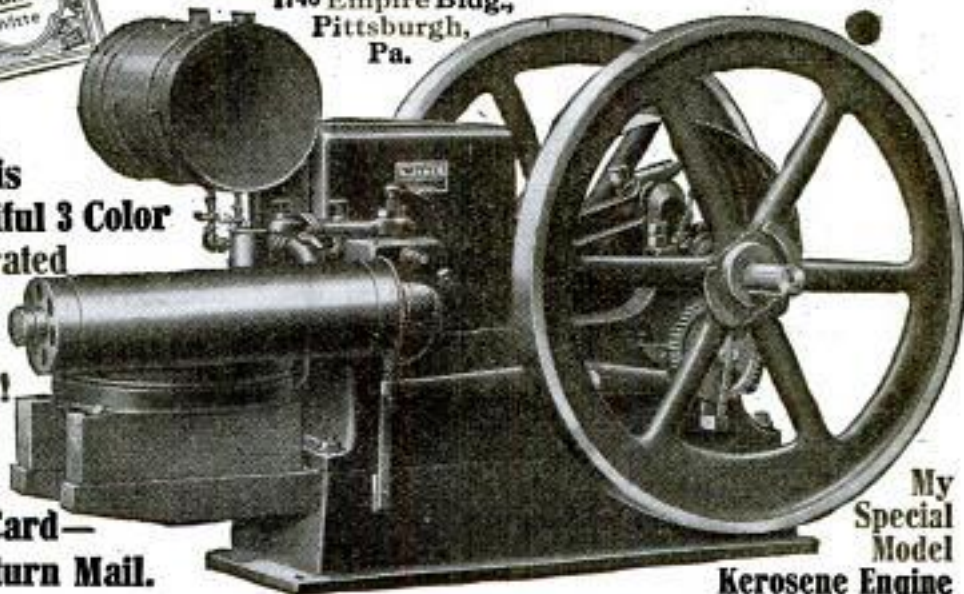

My Special Model Kerosene Engine

**OR MAIL THIS SLIP**

With Name and Address and I will send postage paid "How to Judge Engines" and "How to Make Money."

NAME.....

TOWN..... STATE.....





Many offers like this in our Catalog. Mail the Coupon today.

Rocker 037A is given with a \$10 purchase of Larkin Products. It would cost you \$10 at retail. Try it at our expense.

## Given-To-You WITHOUT EXPENSE

Buy your necessary home supplies from Larkin Co. and the saving you make by dealing from **FACTORY TO FAMILY** is given you in the form of this Rocker or a thousand and one other useful things of your selection.

### NEW CATALOG FREE

Explains our Premium Plan in full; also tells how you can buy foods, soap, etc., without Premiums at low factory-to-family prices. Make your own comparisons. Complete satisfaction guaranteed.

Send Coupon Today to Nearest Address

**Larkin Co.** Buffalo Peoria Chicago

Please send me your new Catalog No. 148.

NAME.....

ADDRESS.....

G. P. 383.....

## Eat Tyler's Macerated Wheat

Whole Wheat, Nuts, Raisins, Etc.  
Greatest of all Health Foods.

**R**IGHTLY used is a sure and quick cure for constipation and indigestion, obviates headaches and makes you weigh just what you should. Lowers blood pressure, lessens hardening of the arteries, puts iron and other mineral salts in the blood, so essential in the maintenance of the chemical equation of the body—key to health and efficiency. A boon to old men, nervous women and sickly, puny babies. Insures thrifty growth and sound teeth in children.

Send ten cents for a big assule can, and Tyler's Raw Food Book and Health Guide, or better still send \$1.00 for a 3-lb. can postpaid everywhere. Absolutely guaranteed or money back. Testimonials without number. Write today for convincing proofs.

BYRON TYLER, (Estab. 1890)  
60 Gibraltar Bldg., Kansas City, Mo., U. S. A.



## Do You Need More Money?

To help your husband—to help your children—to help yourself? We can show you an easy way that is dignified, honorable and profitable

The happy, contented women shown above are all free from worry and with money coming in. Each of them has founded, with our help, a growing and prosperous business and every year sees each of them making more money. And these cases are by no means exceptional, for

**In More Than 13,000 Cases We Have Helped**

ambitious, deserving women. You can do the same as they have done. Sell World's Star Hosiery and Klean-Knit Underwear in your home town. No previous experience is necessary—we show you how to make money in an easy, congenial and profitable way. We sell direct from the mill to the hose through our local representatives, and our lines of hosiery and underwear for men, women and children are famous the world over.

Write today for our free catalog. It tells the whole story.

**WORLD'S STAR KNITTING CO.**  
DEPT. 148 BAY CITY, MICH.

We have been in business here for more than 22 years



## Raise Mushrooms Profits Astonishing

Easy to grow in spare time at home, in cellars, barns, sheds, boxes, etc. I furnish market. Success guaranteed. Free illustrated booklet. Read how a beginner took \$231.50 from cellar bed. Write today.

**HIRAM BARTON**  
Desk 2, 329 W. 48th St., New York



Red or Black "Vulcan" Ink Pencils

The ONLY perfect, non-leakable ink pencils at moderate prices.

Two Sizes—  
4 1/4 and 5 1/2 inches.  
Extra Size—8 inches (black only) \$1.25.  
Your name in gold inlay 35c.  
**FREE**—liberal supply of ink with retail orders. Agents Wanted. Big Profits.

Order today \$1

J. C. ULLRICH & CO., 27 Thames St., New York

## AGENTS

Get Next to This!

A Big Money Maker



The biggest, fastest, snap-

plest sellers in the world.

A big box of the finest Toilet Soaps, and give a pair of Patented Tension Shears free with each sale.

Hundreds of other Big Snaps. Makes selling easy. Beginners cleaning up \$5 to \$6 a day. Start while new. Outfit furnished free. Write today.

A WORLD BEATER

AMERICAN PRODUCTS CO., 2439 3rd St., CINCINNATI, O.



The Prophylactic Tooth Brush

Most of your friends use it and profit by it





## The 21-Jewel Burlington

Adjusted to positions  
isochronism and tem-  
perature. The new-  
est gold strata cases.

**\$2<sup>50</sup>**

a Month

Pays for the master  
watch. Send coupon.

**Send This Coupon**

**BURLINGTON WATCH COMPANY, Dept. 1197**  
19th Street and Marshall Boulevard, Chicago, Ill.  
Please send me your free watch book and full particulars  
about your rock-bottom, direct offer on the Burlington  
Watch, either for cash or \$2.50 a month.

Name.....

Address.....



**KEEP TO THE RIGHT**



# White House Brand Coffee and Teas

**"None Better at Any Price"**

WHITE HOUSE COFFEE is always the same *perfect* blend of the highest grade coffees obtainable

WHITE HOUSE TEAS are the choicest product of the Orient. All varieties. Distributed by over 25,000 dealers in the United States

**KEEP TO THE RIGHT**  
*All-tin packages keep contents in perfect condition*

**DWINELL-WRIGHT COMPANY**  
*Principal Coffee Roasters*      *Boston—Chicago*



**ARE** you reading the double-page Westinghouse more-than-advertisements in The Saturday Evening Post, Literary Digest, Collier's, Leslie's, National Geographic, Popular Mechanics and other publications?

**Lost**—A valuable key. Dropped it in the dark. Burned my fingers several times with lighted matches. Could have found it instantly with an Eveready DAYLO—the light that says, "There it is!"

## Four Weeks' Trial



Choice of 33 Styles  
of the Superb

**Wing**  
Pianos

Yes, we will ship you on four weeks' absolutely free trial direct from our own factory your choice of 33 new styles of the highest-grade Wing Piano or Player Piano.

**No Money Down**

Nothing on arrival; no freight either way; no deposit. Use it and enjoy it four full weeks; then, if you wish, ship it back at our expense. You alone are the judge. You will be amazed at our rock-bottom, direct price on the superb Wing, guaranteed 60 years. Easy monthly payments or cash—but first 4 weeks free trial. Write today.

**Valuable Book—FREE**—*"The Book of Complete Information About Pianos"* sent free and postage paid. Tells how to judge pianos. Beautiful art catalog also sent and particulars of great Free Shipment Offer. Write today—now.

Wing & Son (Est. 1868), Wing Building, 9th Ave. & 13th St., Dept. 1197, New York



Bell Telephone highways make you the near neighbor of your farthest-away fellow-citizen.

**AMERICAN TELEPHONE & TELEGRAPH CO.**  
AND ASSOCIATED COMPANIES

*One Policy      One System      Universal Service*

**FREE**



**BOOK TELLS HOW TO MAKE \$150 TO \$1000 PER MONTH**

Making celebrated **Flavo** Nature-Flavored Flour in rural communities or small towns with **AMERICAN MARVEL Flour Mill**

(Self-Contained)  
You can quickly become a member of Community Marvel Millers. We start you. Help you. 30 days' free trial. Investment and terms easy to handle. Write for fully illustrated book. **ANGLO-AMERICAN MILL CO., Inc.**  
135-141 Trust Bldg.      Owensboro, Ky.

**TRY THIS GUN OIL FREE**

Here's oil that keeps guns and rifles in perfect condition. Dissolves the residue of all black and smokeless powders, including Cordite. Acts instantly—stops corrosive action—positively removes and prevents rust and cuts off dirt and gum. The wonderful properties of

**MARBLE'S NITRO-SOLVENT OIL**

make it an absolute necessity to every gun owner. It's a perfect lubricant and polish as well as a rust preventive. 2-oz. bottle 25c; 6-oz. can 50c. Postage 5c extra. Direct by mail if your dealer hasn't it. Write today for free trial bottle. Mention your dealer's name. Ask for catalog Marble's 60 specialties for sportsmen.

**MARBLE ARMS & MFG. CO.**  
576 Delta Ave., Gladstone, Mich.

E21





# Get the Bicycle Bug!

Free—the beautiful green-gold stick-pin shown here! It costs you nothing. Fill out the coupon below.

These are the days when bicycle riding is a real pleasure, and you'll find that a spin on the road is a double pleasure if your bike is equipped with United States Tires—the *GOOD* tires.

Twelve different types from which to choose the one that fits your needs.

Get the Bicycle Bug! Fill out the coupon **NOW**.

**United States Tire Company**  
1791 Broadway NEW YORK

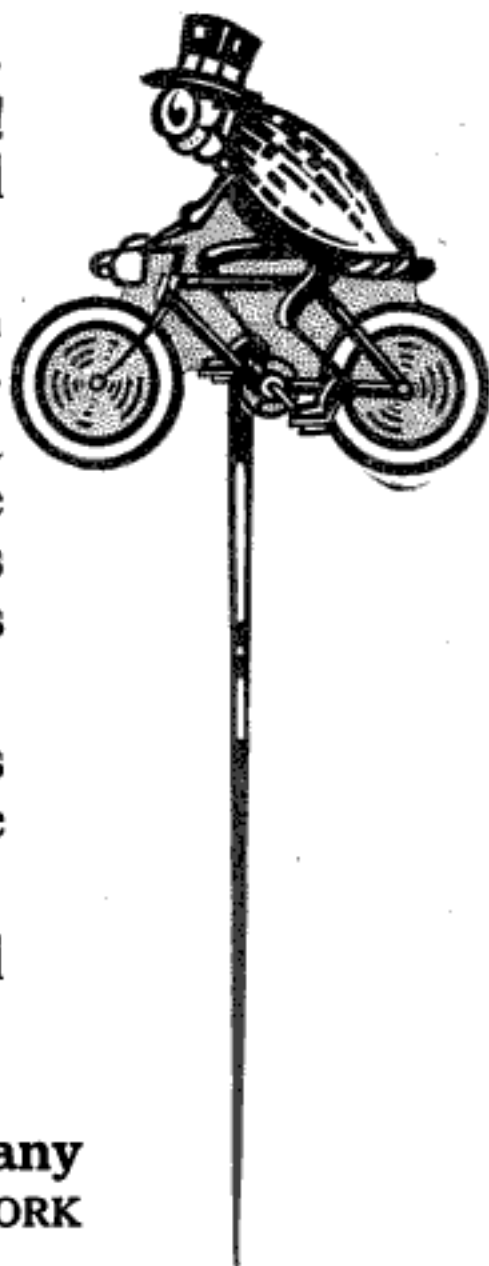

**FILL OUT—TEAR OUT—MAIL TODAY**

*Gentlemen:*

Please tell me how to get one of your beautiful green-gold bicycle bugs free.

*Full Name* .....

*Address* .....

*Name of Nearest Bicycle Dealer* .....

*Address of Nearest Dealer* .....



# \$1 A MONTH AND UP

## WATCHES DIAMONDS AND HOLIDAY GIFTS

Prices Lower Than Cash Houses

**An Old Customer Writes—**  
 "I have been trading with you nearly 15 years and know I can depend on what you say. You have made it possible for me and other wage earners to have the best at the lowest price on easy terms we can afford to pay."

### Sent On Approval!

Let us send you Elgin's Newest Thin Model 17 Jewel Watch. This is the one Watch that has carried modern efficiency to a higher plane than any other Watch of the age. Its accuracy has given a value to seconds they never had before. At our

#### Sensationally Low Price

and Easy Terms, it has planted the flag of quality and economy upon watchdom's topmost pedestal. It is the one Watch that is mechanically correct. It is **Timed, Adjusted and Regulated** for you at the great Elgin Factory. We make it possible for you and every one to own this superb Watch or any Watch you wish if you send your name and address now.



9091 — \$39.50  
**Tiffany Fine White—Genuine Diamond Ring**, remarkable lustre, \$50 value, 14k solid gold mounting. Special price for our Holiday Club only . . . \$39.50



9091X — \$49.50  
**Extra Fine Diamond La Valliere—new model—\$50 value. Special Club Price . . . \$49.50**

### Why Pay Cash?

We trust you and all honest wage earners. You assume no risk whatever. We make quick shipment on **30 days Approval**. Comparison will convince you that we **smash the terms, lower the price and boost the quality.**

**Free Catalog** More than a half million people have said that our Catalog was the real guide for thrifty buyers. To get a copy of this New Book, before this edition is exhausted you should send us your name at once.

**HARRIS-GOAR CO.,** Department 172  
 KANSAS CITY, MO.

## Trap Outfit For 20¢ a Day

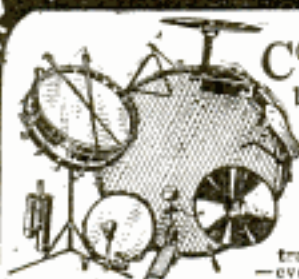

**COMPLETE** trap outfit for 20¢ a day. Hear the boat whistle, the hen cackle, the baby cry and the horse gallop. Realistic theatre music for 20¢ a day. Money back if not satisfied.

### Send for Catalog

Write for information about trap outfits, Catalogs and circulars—everything free. Write today.

**The Rudolph Wurlitzer Company** — Dept. 4557  
 E. 4th Street, Cincinnati, O. — S. Wabash Avenue, Chicago, Ill.

# PATENTS

**IF YOU HAVE AN INVENTION** which you wish to patent you can write fully and freely to Munn & Co. for advice in regard to the best way of obtaining protection. Please send sketches or a model of your invention and a description of the device, explaining its operation.

All communications are strictly confidential. Our vast practice, extending over a period of seventy years, enables us in many cases to advise in regard to patentability without any expense to the client. Our Hand-Book on Patents is sent free on request. This explains our methods, terms, etc., in regard to **Patents, Trade Marks, Foreign Patents, etc.**

All patents secured through us are described without cost to the patentee in the **SCIENTIFIC AMERICAN.**

**MUNN & CO.**  
 SOLICITORS OF PATENTS  
 672 WOOLWORTH BLDG., NEW YORK  
 and 625 F STREET, WASHINGTON, D. C.

Write today for our 168-page **FREE Book** on

## Deafness

and learn how **Perfect Hearing** is now being restored in every condition of deafness or defective hearing. Our "**Little Wireless Phones for the Ears**" require no medicine, but effectively replace what is lacking or defective in the natural ear drums. They are simple devices, which the wearer easily fits into the ears where they are invisible. Soft, safe and comfortable.

**WILSON EAR DRUM CO., Incorporated**  
 951 Inter-Southern Bldg. LOUISVILLE, KY.



We are **Under Govt. Bond**



## PRINT MY OWN

Cards, circulars, menus, book, paper, etc. Press \$5. Larger \$18. Rotary \$60. Save money. Print for others, big profit. All easy, rules sent. Write factory today for illustrated catalog presses, TYPE, cards, samples. **EXCELLENCE THE PRESS CO. D-37. MERIDEN, CONNECTICUT.**

## "I Would Not Part with it for \$10,000"

writes an enthusiastic, grateful customer. "Worth more than a farm," says another. So testify over 100,000 Men and Women who have worn it.

## The Natural Body Brace

Develops erect, graceful figure. Brings comfort, health, strength and pep.

### Makes You Feel Good and Look Good

Replaces and supports misplaced internal organs; reduces enlarged abdomen; straightens shoulders; relieves backache, curvatures, nervousness, ruptures, etc., in both sexes. Fine after operations. Write today for illustrated booklet, measurement blank and our very liberal free trial proposition.

**HOWARD C. RASH, President**  
 Natural Body Brace Co., 223 Rash Building., Salina, Kans.





# I Will Save You More Than 1/2 on a \$100 UNDERWOOD

E. W. S. SHIPMAN, President

**E**VERYONE knows the reputation of the Underwood Typewriter. I will send you on **TEN DAYS' FREE TRIAL** a High Grade No. 4 Visible Writing Underwood, with Back Spacer, Tabulator, Stencil Attachment, Two-color Ribbon, Waterproof Cover and Special Touch Typewriting Instruction Book, that will teach you to operate this simple Underwood in one day. I will give you a **written** guarantee of **FIVE YEARS' SERVICE** from date of sale and I will save you much more than one-half the manufacturer's price.

## 25 Years' Experience—Confidence of 200,000 Customers

I am the largest typewriter re-builder in the world, employing the most expert workmen in the typewriter business. I handle only Underwoods, obtaining all my machines and all new parts direct from the Underwood Company.

## How I Double the Life of An Underwood

Do not confuse me with a second-hand dealer. I put each machine through a process that I have spent 25 years perfecting. Each machine is taken apart and re-built from top to bottom.

The frame is re-enamelled, the bright parts re-nickeled. All parts unfit for further service are discarded and replaced by new parts purchased from the Underwood Company. Every machine is equipped with new type, new platen, new ribbon vibrator, front scale, feed roll, ribbon, space bar, key rings, key glasses, rubber feet, etc. Expert mechanics re-adjust and re-align each machine. It will stand any mechanical typewriter test.

You May  
**RENT** APPLYING RENT ON PURCHASE PRICE  
OR  
**BUY** FOR CASH OR ON EASY PAYMENTS

## My Five Year Guarantee—Ten Days Free Trial

I personally stand back of every machine that goes through my factory with a **WRITTEN FIVE YEAR GUARANTEE OF SERVICE**. I guarantee to send you a genuine Underwood, exactly as illustrated and described herewith. You don't even have to buy the machine at the time you get it. You can try it for ten days **FREE** and then, if you conclude the machine I send you does not look, work and write like new, you may return it and I will refund any deposit or charges paid by you. This guarantee affords you complete protection.

**Rent or Buy** Mail coupon or post card today for special low price and terms. You can **RENT**, applying six months' rental on purchase price, buy on easy terms or secure discount for cash.

## Our Other Plan Brings Underwood FREE

A new plan—our agency plan. You are not asked to do any canvassing or soliciting for orders. You simply co-operate with us, becoming part of our nation-wide organization. You can easily get your Underwood **FREE** in this way. Send name and address on coupon today and learn about Offer No. 52.

E. W. S. SHIPMAN, President

**Typewriter Emporium**  
CHICAGO



Five  
Year  
Guarantee

Ten  
Days'  
Free Trial

**SIGN AND MAIL COUPON TODAY**  
**TYPEWRITER EMPORIUM, 34-36 W. Lake Street, CHICAGO**  
Send me immediately full facts about your Special Offer No. 52.

Name.....  
Street or R. R. No.....  
City.....  
State.....

Please Mention Popular Mechanics



# Don't Go By-



## Don't Keep That Corn

Every drug store that you pass has Blue-jay waiting for you.

Stop and get it, and it means the end of any corn.

Pass it by, and the corn will stay. You know that from experience.

Blue-jay does more than end a corn. It proves that corns are needless.

Apply it, and the corn pain stops. Leave it on two days, and the whole corn disappears. Only extra stubborn corns need a second application.

**BAUER & BLACK**  
Chicago and New York  
Makers of  
Surgical Dressings, etc.

### Blue=jay

**Stops Pain—Ends Corns**  
Instantly Quickly

Prove that once, and corn troubles end forever. You will never again permit them.

To millions of people—users of Blue-jay—corns are a pest of the past.

Do what they did—try it. See what a Blue-jay does. Learn why so many millions are now used each year.

Lay aside the old-time methods. Use this modern way tonight. You will wish that you had started years ago.

25c packages at  
Druggists

Also Blue-jay Bunion  
Plasters

## Don't Wear a Truss

**Brooks' Appliance**, the modern scientific invention, the wonderful new discovery that relieves rupture will be sent on trial. No obnoxious springs or pads.

### Brooks' Rupture Appliance

Has automatic Air Cushions. Binds and draws the broken parts together as you would a broken limb. No salves. No lies. Durable, cheap. Sent on trial to prove it. Protected by U. S. patents. Catalogue and measure blanks mailed free. Send name and address today.

**C. E. BROOKS, 126 State St., Marshall, Mich.**

Please Mention Popular Mechanics

## RECIPE FOR GRAY HAIR

To half pint of water add 1 oz. Bay Rum, a small box of Barbo Compound, and  $\frac{3}{4}$  oz. of glycerine. Any druggist can put this up or you can mix it at home at very little cost. Full directions for making and use come in each box of Barbo Compound. It will gradually darken streaked, faded gray hair, and make it soft and glossy. It will not color the scalp, is not sticky or greasy, and does not rub off. Adv.



## Deafness Is Misery

I know because I was Deaf and had **Head Noises** for over 30 years. My invisible Anti-septic Ear Drums restored my hearing and stopped Head Noises, and will do it for you. They are Tiny Megaphones. Cannot be seen when worn. Easy to put in, easy to take out. Are "Unseen Comforts." Inexpensive. Write for Booklet and my sworn statement of how I recovered my hearing.

**A. O. Leonard, Suite 226, 150 5th Ave., N. Y. City**



# Swear Off Tobacco



Tobacco Tells on Nervous System



Tobacco Ruins Digestion



Tobacco Stunts Boy's Growth



Tobacco Robs Man of Virility



Tobacco Steals from You the Pleasures, Comforts, Luxuries of Life

## Tobacco Habit Banished In 48 to 72 Hours

### Immediate Results

Trying to quit the tobacco habit unaided is a losing fight against heavy odds, and means a serious shock to your nervous system. So don't try it! Make the tobacco habit quit you. It will quit you if you will just take **Tobacco Redeemer** according to directions.

It doesn't make a particle of difference whether you've been a user of tobacco for a single month or 50 years, or how much you use, or in what form you use it. Whether you smoke cigars, cigarettes, pipe, chew plug or fine cut or use snuff—**Tobacco Redeemer** will positively remove all craving for tobacco in any form in from 48 to 72 hours. Your tobacco craving will begin to decrease after the very first dose—there's no long waiting for results.

**Tobacco Redeemer** contains no habit-forming drugs of any kind and is the most marvelously quick, absolutely scientific and thoroughly reliable remedy for the tobacco habit.

### Not a Substitute

**Tobacco Redeemer** is in no sense a substitute for tobacco, but is a radical, efficient treatment. After finishing the treatment you have absolutely no desire to use tobacco again or to continue the use of the remedy. It quiets the nerves, and will make you feel better in every way. If you really want to quit the tobacco habit—get rid of it so completely that when you see others using it, it will not awaken the slightest desire in you—you should at once begin a course of **Tobacco Redeemer** treatment for the habit.

### Results Absolutely Guaranteed

A single trial will convince the most skeptical. Our legal, binding, money-back guarantee goes with each full treatment. If **Tobacco Redeemer** fails to banish the tobacco habit when taken according to the plain and easy directions, your money will be cheerfully refunded upon demand.

### Let Us Send You Convincing Proof

If you're a slave of the tobacco habit and want to find a sure, quick way of quitting "for keeps" you owe it to yourself and to your family to mail the coupon below or send your name and address on a postal and receive our free booklet on the deadly effect of tobacco on the human system, and positive proof that **Tobacco Redeemer** will quickly free you from the habit.

**Newell Pharmacal Company**  
Dept. 300 St. Louis, Mo.



### Free Book Coupon

**NEWELL PHARMACAL CO.,**

Dept. 300

St. Louis, Mo.

Please send, without obligating me in any way, your free booklet regarding the tobacco habit and proof that **Tobacco Redeemer** will positively free me from the tobacco habit.

Name.....

Street and No.....

Town..... State.....

Please Mention Popular Mechanics





## Back from *the Country and Feeling Fine*

Back from your vacation—feeling like a fighting cock. Lots of digging in to do—and in you dig. Hours crowded with work; no time for bodily exercise; hurried meals; nature's signals unheeded.

Then comes constipation.

Ward off constipation—while readjusting yourself to a sedentary occupation—with the Nujol treatment. The Nujol way is the safe, efficient way to regulate the bowels without irritation.

Nujol is harmless as it is not absorbed into the system. It is the satisfactory, sensible method of freeing yourself both from constipation and from the use of harmful, irritating, habit-forming laxative drugs. Nujol is neither fattening nor heating.

Nujol is sold in pint bottles only that are filled and sealed at the Nujol laboratories, never in bulk. At all drug stores. Refuse imitations. There is only *one* Nujol. Send for our Nujol booklet.

# Nujol for constipation

STANDARD OIL COMPANY

(New Jersey)

BAYONNE (Dept. 22) NEW JERSEY



# 5 MONTHS TO PAY 5

Send  
for  
Style Book  
and  
Samples  
of  
Fabrics

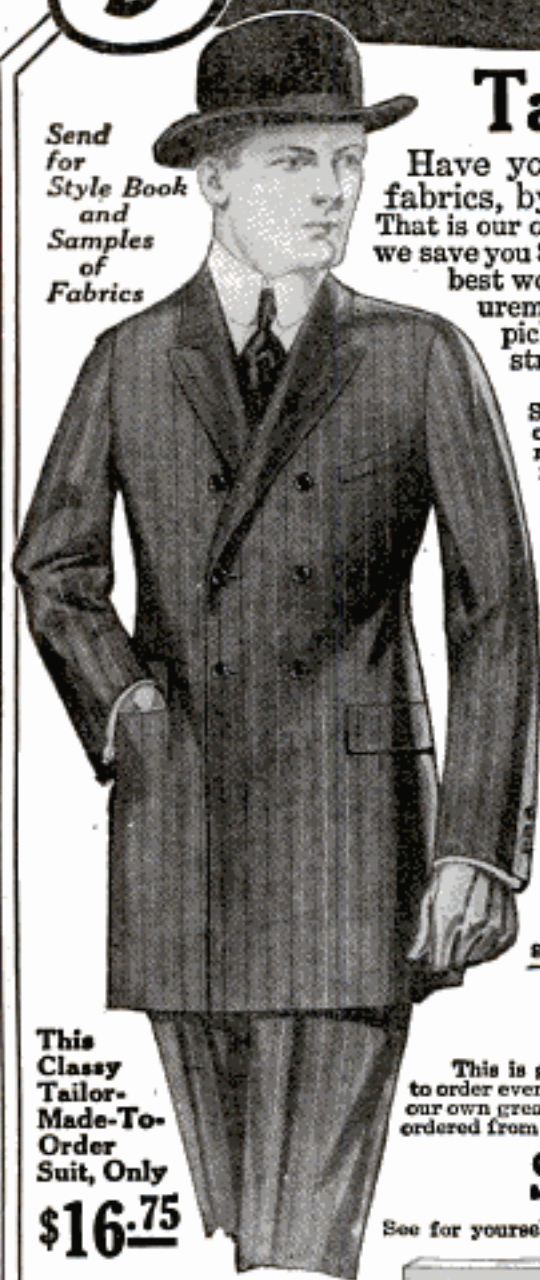

This  
Classy  
Tailor-  
Made-To-  
Order  
Suit, Only  
**\$16.75**

## Free Style Book

We will send you the big Style Book with pictures in actual colors of garments made by us. You see exactly how you will look. Choose direct from the big selection of 70 cloth samples—the very best fabrics selected by our experts. All prices and terms given too. You ought to get this book even if you are not ready to order now. Get posted on the styles and the prices you should pay for highest class made-to-order clothes. The Style Book is free. Send the coupon, and get it now.

**Stanley-Rogers Company**  
1015 Jackson Blvd., Dept. 1036 Chicago, Ills

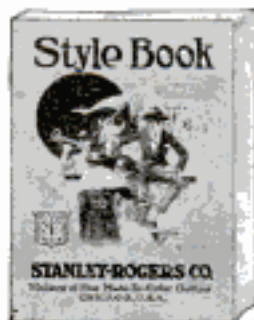

## Tailor-Made-to-Order

Have your clothes made to order from finest, stylish fabrics, by our expert tailors and take 5 months to pay. That is our offer to men who wish to dress in latest style—and then we save you \$15 to \$25. Every garment guaranteed a perfect fit and best workmanship—actually made to order from your measurements. Your choice of handsomest fabrics—the very pick and cream of the weaver's art, in plain colors, checks, stripes, plaids, and all weaves.

Look into this offer—get the facts (all explained in our Style Book). See if this is not the fairest, most liberal proposition you have ever had on tailor-made-to-order clothes. We leave the decision on fit, workmanship and quality all to you. Try on the suit we make for you and if not the best value you have ever received—if not satisfactory in every way, return it at our expense. If it is all that we say and you are fully satisfied, pay balance on our easy terms.

As  
Little \$ **1.00**  
As .Down

You can order by sending as little as a dollar down—and that back if you wish to return the suit. Send now for our big Style Book showing the latest snappiest, fashions for this season—also samples of our fabrics. Learn from this book how we can buy these fabrics in immense quantities at rock-bottom mill prices and share our savings with you. Learn also how we tailor our garments to give them the style to suit your figure and personality—how we interline and hand sew and give you garments that keep their shape. The Style Book tells all about this—and also gives full directions for self measurement. Send for it free.

## \$1,000 Reward

This is given in gold to anyone who can prove that we do not actually make to order every garment ordered from us from the customer's measure. We operate our own great tailoring shops, employing the most skilled tailors and every garment ordered from us is made here under expert supervision.

## Save \$15.00 to \$25.00

See for yourself. Compare our fabrics and prices with any elsewhere and see what our quantity buying and direct selling to customers saves you. By operating on such a large scale we cut down the "overhead" expense and give our customers the benefit in low prices on extra fine quality.

**SEND THIS COUPON NOW**

**Stanley-Rogers Company,**  
1015 Jackson Blvd., Dept. 1036, Chicago, Ill.

Please send me FREE your new Fall Style Book showing latest Metropolitan Styles, also 70 Cloth Samples and full particulars of your \$1.00 down with 5-Months-to-Pay-Offer.

Name .....

Address .....

Town.....State.....

Please Mention Popular Mechanics



# A Good Bookcase for the price of a good book!

Good, sturdy, attractive bookcases sold at moderate prices direct to you from factory



On Approval \$ **1.75** Per Section and Up

## Lundstrom

IT GROWS WITH YOUR LIBRARY

### The UNIVERSAL BOOKCASE

Endorsed by over 100,000 Users

Made for and universally used in the finest homes and offices throughout the country. They are made in sections, combining practical utility, economy and attractive appearance. Style illustrated is beautifully finished in SOLID OAK with non-binding, disappearing glass doors; price: top \$1.25, leg base \$1.50—combination complete \$8.00. Other styles and grades at correspondingly low prices. On orders of \$10.00 and over we pay all freight except to extreme western states, where we pay part freight. Shipped direct from factory ON APPROVAL and at considerable saving TO YOU. Write for new Catalog 21-0.

The C. J. Lundstrom Mfg. Co., Little Falls, N. Y.  
Mrs. Sectional Bookcases and Filing Cabinets  
Branch Office: Flatiron Bldg., New York City

## COIN RINGS, 50 CENTS POST-PAID

Made of new dimes, embossed. Big hit! Agents, big discount. Send 50 cents for sample. Money refunded if not satisfied. WM. COMERFORD, 44 Seneca Street, BUFFALO, NEW YORK

## ASBESTOS

We are miners and shippers of Crude Asbestos in any quantity. We produce all grades at our world-famous Bell Asbestos Mines, in Canada. We also card fibres, spin yarns, weave cloths, and make all sorts of Asbestos products.

For anything you want in Asbestos, turn to

**KEASBEY & MATTISON COMPANY**  
Dept. S-3, AMBLER, PENNA., U.S.A.  
Owners of the world's largest Asbestos Mines

## THE FAMOUS ILLINOIS MILITARY WATCH

The "KITCHENER" the REAL Triumph in Military Watch Manufacturing. Order "MILITARY", save ONE-THIRD of the regular retail price.

### 30 DAYS FREE TRIAL

Every penny of the money you pay us will be returned to you within 30 days, if the watch is unsatisfactory in any particular. Your risk absolutely nothing.

TAKE ADVANTAGE OF THIS STUNNING OFFER  
ORDER YOUR WATCH TODAY

## 11 JEWEL KITCHENER

# \$11.75

FULLY GUARANTEED

The Movement—made in 11 or 12 jewel, Illinois movement, this model, new set, ABSOLUTELY GUARANTEED. Here is a watch that will keep you on time. Available in the highest degree. Do not confuse this splendid watch with the cheap 7 jewel so-called Military watches offered by retail jewelers at prices higher than the "Kitchener" is sold "direct." The Strap—The "Kitchener" strap is high grade, genuine leather, lined with broad white canvas, wears, breaks, handles. Easy and comfortably adjusted to the wrist. The Case—May be furnished in either nickel or gold metal, or both cases. Be sure to note which is preferred. Add 50 cents extra for gold metal case.

#### PRICES

11 Jewel, Gentlemen's Watch, Illinois movement, Kitchener strap, specified dial . . . \$11.75  
11 Jewel, Ladies' Watch, Illinois movement, Kitchener strap, specified dial . . . \$14.00  
11 Jewel, Gentlemen's Watch, Illinois movement, Kitchener strap, NIGHT DIAL . . . \$14.00  
11 Jewel, Gentlemen's Watch, Illinois movement, Kitchener strap, NIGHT DIAL . . . \$14.00

Your name stamped FREE on back of case if desired. Double illustrated circular with letter THE MILITARY WATCH COMPANY, Dept. O-98 Topeka, Kansas

## BIG CHANCE FOR AGENTS



You can earn BIG MONEY

selling the most complete line of guaranteed transparent handle Knives and Razors with Photo, Name and Lodge Emblem—also full line of cutlery. Write today for catalogue and terms. Golden Rule Cutlery Co., 212 N. Sheldon St., Dept. 312, Chicago, Ill.

## \$5 TO \$10 A DAY AGENTS—BIG HIT 5-Piece Aluminum Set

Cheaper than enamel ware. Guaranteed 20 years. Retail value \$5.00. You sell to housewives for only \$1.98. Sure sale wherever shown. Answer quick for your territory. American Aluminum Mfg. Co. Div. I X 5 Lemont, Illinois

## FIBRE LEGS FIBRE ARMS



### 4-LB. FIBRE LEGS—ON EASY TERMS

Orthopedic braces for all deformities. Send for booklet. MINNEAPOLIS ARTIFICIAL LIMB CO., 636 Dean Bldg., MINNEAPOLIS, MINN.

## Relief to Ruptured People

Any appliance is a truss. Ruptured people must wear a support. Our New Sponge Rubber Pad (pat'd) is velvety, soft to the skin, pliable, easiest to adjust, extremely comfortable, adapts itself to ruptured parts with less pressure, is sanitary, long lived. Massages and strengthens muscles, allows blood circulation and produces many cures.

**Scrotal Pad Needs No Leg Strap**  
Our New Akron Sponge Rubber Scrotal Pad (pat'd) holds 8 out of 10 cases of scrotal hernia perfectly without strap between the legs.

**Cures Man of 86**  
The Akron Truss Co., Gentlemen: I am 86 years and 6 months old and have had a rupture for 27 years. I am an active man, tend to a large garden, saw and split the wood and do the household chores. I bought an Akron Truss and wore it one year and am as good as a dollar. Respectfully yours, S. W. Glaze, Illinois.

**Cured Double Hernia**  
The Akron Truss Co., Gentlemen: I have worn one of your trusses for some time. All this time have carried two heavy sarsaparilla cases, notwithstanding this handicap, your truss has cured me of a double hernia. Yours truly, O. E. Jones, Indiana.

**Girl Baby Cured**  
The Akron Truss Co., Gentlemen: The infant's truss was a perfect success. The child wore it about one year, and the rupture healed so that a person cannot see she was ruptured. Yours truly, J. Haynes, Illinois.

**Free Sample Pad** A Sample Akron Sponge Rubber Truss Pad will be sent absolutely FREE upon request, also booklet "Relief to Truss Users." It's full of help. Ask your dealer, or write us. THE AKRON TRUSS CO. 70 TRUSS BLDG. Akron, Ohio



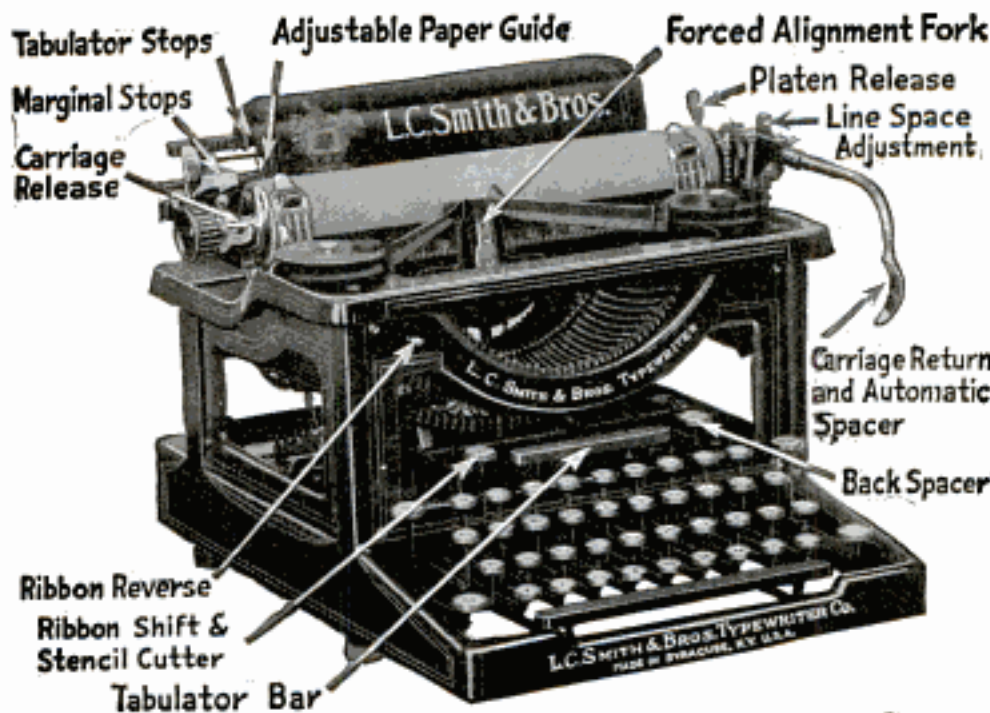

ALL LATEST IMPROVEMENTS

# TYPEWRITER SENSATION

Free TRIAL—Use As You Pay

Send me only \$2.50 a month until the low total price of \$48.80 is paid, and the machine is yours

This is absolutely the most generous typewriter offer ever made. Do not rent a machine when you can pay \$2.50 a month and own one. Think of it—Buying a \$100.00 machine for \$48.80. Cash price, \$45.45. Never before has anything like this been attempted.

## STANDARD L. C. SMITH VISIBLE

Perfect machines, standard size, keyboard of standard universal arrangement—universally used in teaching the touch system. The entire line of writing completely visible at all times, has the inbuilt tabulator with billing devices, the two color ribbon—with automatic reverse and key controlled shift, automatic flexible paper feed—automatic paper fingers, the back spacer—ball bearing carriage action—ball bearing shift action—ball bearing type bars—in fact, every late style feature and modern operating convenience. Comes to you with everything complete, tools, cover, operating book and instructions, ribbon, practice paper—nothing extra to buy. You cannot imagine the perfection of this beautiful reconstructed typewriter until you have seen it. I have sold several thousand of these perfect latest style L. C. Smith machines at this bargain price, and every one of these thousands of satisfied customers had this beautiful, strictly up-to-date machine on five days' free trial before deciding to buy it. I will send it to you F. O. B. Chicago for five days' free trial. It will sell itself, but if you are not satisfied that this is the greatest typewriter you ever saw, you can return it at my expense. You won't want to return it after you try it—you cannot equal this wonderful value anywhere.

### You Take No Risk—Put In Your Order Now

When the typewriter arrives deposit with the express agent \$8.80 and take the machine for five days' trial. If you are convinced that it is the best typewriter you ever saw, keep it and send me \$2.50 a month until my bargain price of \$48.80 is paid. If you don't want it, return it to the express agent, receive your \$8.80 and return the machine to me. I will pay the return express charges. This machine is guaranteed just as if you paid \$100.00 for it. It is standard. Over one hundred thousand people own and use these typewriters and think them the best ever manufactured.

The supply at this price is very limited, the price will probably be raised when my next advertisement appears, so don't delay. Fill in the coupon today—mail to me—the typewriter will be shipped promptly. There is no red tape. I employ no solicitors—no collectors—no chattel mortgage. It is simply understood that I retain title to the machine until the full \$48.80 is paid. You cannot lose. It is the greatest typewriter opportunity you will ever have. Do not send me one cent. Get the coupon in the mails today—sure.

**HARRY A. SMITH, 510-231 N. Fifth Ave., Chicago**

I want, through this advertisement, to establish as friendly business relations with you as I possibly can. I want you to realize also, that it is my earnest effort and intention to give you full honest value for every dollar that you spend with me. This is the only way I can succeed. My advertisement has appeared in this magazine continuously for more than four years.

I am building up my business on the foundation of good value and square dealings. I am saving thousands of satisfied customers thousands of dollars, by supplying, perfect—late style—visible writing—typewriters, at remarkably low prices.

All my transactions are handled throughout by personal correspondence. I assure you every courtesy and consideration, in your dealings with me. Your order will have my prompt, careful, personal attention. I will be glad to do business with you.

*Harry A. Smith*

**H. A. SMITH**  
Room 510-231 N. Fifth Ave.  
CHICAGO, ILL.

Ship me the L. C. Smith F. O. B. Chicago, as described in this advertisement. I will pay you the \$40.00 balance of the SPECIAL \$48.80 purchase price, at the rate of \$2.50 per month. The title to remain in you until fully paid for. It is understood that I have five days in which to examine and try the typewriter. If I choose not to keep it I will carefully re-pack it and return it to the express agent. It is understood that you give the standard guarantee for one year.

Name .....

Address .....

.....Pop. Mech. Oct

Please Mention Popular Mechanics



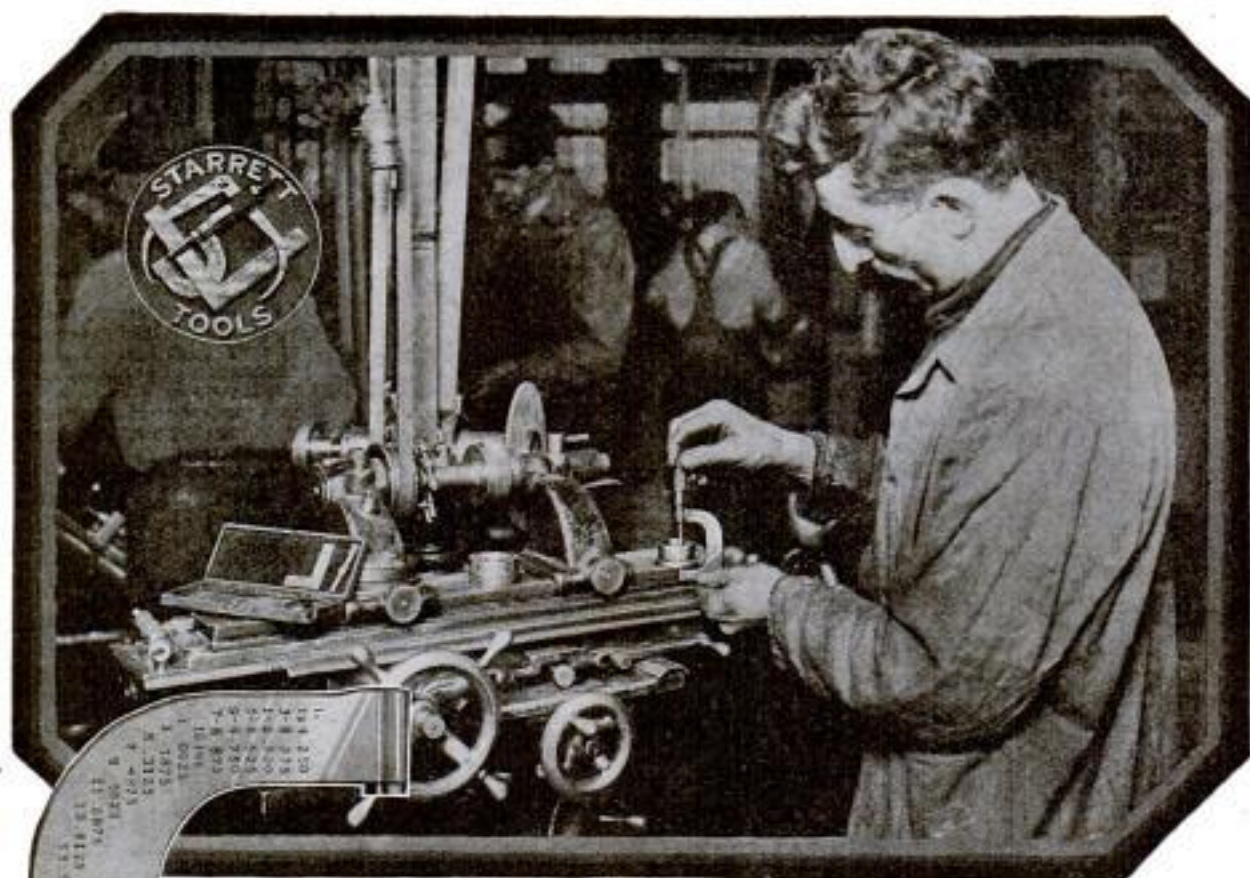

## When You Work To Close Limits

Ask this machinist what tools he uses and he will tell you "Starrett Tools." That is the same as saying "tools of dependable accuracy."

When you do quality work and must measure in thousandths and ten-thousandths, you will want to be just as certain of your tools, as he is of his tools.

## Starrett Tools

TRADE MARK  
REG. U.S. PAT. OFF.

are known for their accuracy, and the 2100 styles and sizes offer you tools for every class of precision work.

In addition to micrometers there are calipers and dividers, rules, squares, tapes, combination squares, vernier calipers, vernier height and depth gages, and many others.

*Write today for Free Catalog  
No. 21AP, describing the full line.*

### The L. S. Starrett Co.

The World's Greatest Tool Makers

ATHOL, MASS.

42-710



# DISSTON

## SAWS AND TOOLS

Disston  
D-3 Saw-Filing Guide

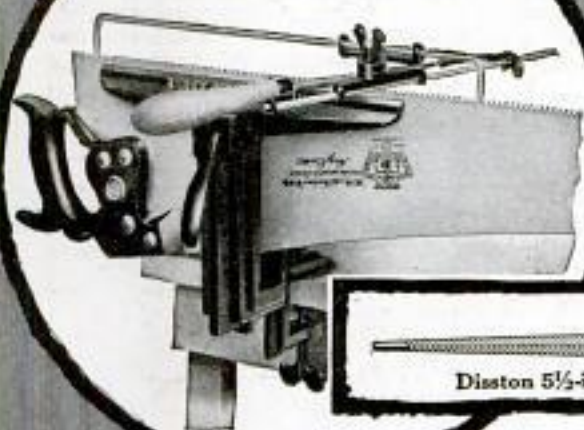

Disston  
Triumph Saw-Set



Disston 5½-inch Slim Taper Saw-File



### Give Your Saws Proper Care

No saw, not even the best, can do the right kind of work unless it is properly filed and set.

The setting of saws by hand requires years of practice. To insure that Disston saws are properly re-set so as to give continued satisfaction to their owners, Henry Disston & Sons make the Triumph Saw-Set. This saw-set has two plungers, one of which holds the saw-set securely in position against the saw, while the other sets the tooth. It is made by the largest manufacturers of saws in the world. With this saw-set results can be secured practically equal to hand setting given Disston saws by Disston experts at the factory.

The D-3 Filing Guide insures uniformity of filing throughout the saw, and makes it possible for the inexperienced saw-filer to sharpen a saw correctly. Use a 5½-inch Disston slim taper file with this filing guide to get the best results.

Send for Free "Hand-Saw Booklet"

HENRY DISSTON & SONS, Incorporated  
PHILADELPHIA, U. S. A.

Canadian Works: Toronto, Canada

DISSTON



Please Mention Popular Mechanics



# Every Builder and Contractor Needs this Level

## 10 Days' Free Trial

We have been makers of transits and levels since 1863 and our instruments are the standard of the world. Prove the superior quality of the Aloe Convertible Level by giving it a 10 days free trial. Use it on your every-day work laying out buildings, leveling up foundations, walls and floors, aligning, shafting walls, piers, etc., for getting angles or levels anywhere.

### Easy Monthly Payments

If you decide to keep it, the instrument will earn its way while you make monthly payments so small that you hardly feel them. Costs no more than to pay all cash. No red tape about it, no embarrassing questions, everything confidential.

### Aloe Convertible Level

is the finest instrument ever offered at anywhere near its price. Permits taking of sights both above and below the horizontal. For taking vertical sights it is provided with a special convertible bracket rigidly and permanently attached to the cross bar. The telescope is fitted with permanent axis which rests in bracket bearings and is held by clamps easily and quickly released.

Aside from being a level, it is a modified transit that permits a much wider range of work than is possible with the ordinary architect's level. With it the man without technical training can obtain the same absolutely accurate results as the expert. Write today for descriptive circular.

**A. S. ALOE CO.,**  
620 OLIVE ST., ST. LOUIS, MO.



A complete line of appliances for the transmission of Power. Anything from a belt to a complete mill or factory outfit. Send for catalogue. Largest Manufacturers of Pulleys in the country.  
**W.A. Jones Foundry & Machine Co.,** 4403 W. 121st Street  
CHICAGO



### A Constant Water Supply for Your Farm Home

Don't depend on a windmill or the back-breaking hand pump to fill your water tank. It's more reliable and economical to install a

### RIFE RAM

and be sure of a constant supply of fresh water, without fuel or attention. The Rife Ram operates by the flow of any stream having a fall of 3 feet or more and a supply of 3 gallons or more per minute. Will maintain air pressure system. Simple to install. Over 11,000 in use. Satisfaction guaranteed.

Write today for catalog and free estimate

**RIFE ENGINE CO.**  
Dept. F, 90 West St. NEW YORK



## "RED DEVIL" CIRCULAR GLASS CUTTER

A useful tool for cutting circles and curves from plain or plate glass. Cuts 2 to 20 in. diameter. Steel cutting wheel, adjustable rod. Style No. 033, sample postpaid for 50c.

Glass Cutter Booklet Free.

**SMITH & HEMENWAY CO., Inc.** 97 Coit Street  
IRVINGTON, N. J.



Cuts Auto Headlights, Etc.



## Portable Cases

For Tool Makers and Machinists

Twelve styles, felt lined drawers, solid brass trimmings, best of material, beautiful finish, low prices, satisfaction guaranteed. Ask for booklet of cases built for service.

**THE PILLIOD LUMBER CO.**  
SWANTON, OHIO

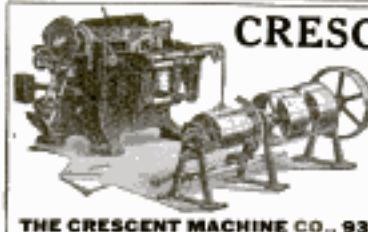

## CRESCENT WOOD WORKING MACHINERY

will largely compensate for shortage in labor at this time, and you owe it to yourself to investigate this splendid line of wood working machinery right away. Ask for free catalog of hand saws, jointers, saw tables, planers, planers and matchers, disk grinders, swing saws, post borers, shapers, variety wood workers, hollow chisel mortiser, universal wood workers.

**THE CRESCENT MACHINE CO.,** 93 Columbia St., Leetonia, O.

Made of Metal

## RICHARDSON'S Pantocrat Six-in-One Frameless Runner SLIDE RULE

The only Slide Rule made that has Inter-Changeable Slides. Thus a Mannheim Slide Rule can be changed into a Polymetric, Binary Polymetric, Logometric (Log Log) or adding and subtracting slide rule by simply changing slides. If you want to know all there is to be known about slide rules, send us \$10.00 and we will send you our six-in-one in most full leather case, consisting of one 10" metal slide rule, five extra slides, and 100 page book—with 135 illustrations showing just how to set these slides, with explanation so you can understand it. These six slide rules would cost you \$30.00 if bought separately and of other makes. But we sell the six, separately at \$2.00, \$3.00, \$4.00, \$4.00, \$4.00, \$5.00, easily \$22.00. Therefore you save \$12.00 by purchasing the six-in-one in leather case at \$10.00 or you can purchase a single rule and slide later. The book is the most complete ever written. These slide rules are not affected by water, soap, acids, guaranteed accurate and to remain so in any climate. No problem but what this six-in-one can solve. Be prepared and order this outfit to start and save expense later. Used extensively by U. S. Government in most every department. Why? Because moisture will not affect them and being made of metal, white face and black line. Accuracy is a permanent factor. Can be carried in pocket. Size in leather case 1 7/8" x 3/16" x 10". Special! All metal EDUCATOR slide rule with reciprocal scale \$1.50 with book.

**GEORGE W. RICHARDSON** Ex-Chief Electrician  
U. S. Navy  
4218 24th Place CHICAGO, U. S. A.



Made in Chicago

Write for Illustrated circular





**SIMPLICITY**  
in construction, yet  
embodying all neces-  
sary features and backed  
up by perfect workman-  
ship, is what we offer in a  
**SEBASTIAN**

13-14- and 15-inch Swing

**The Sebastian Lathe Co.** 107 Culvert Street  
Cincinnati, O., U.S.A.

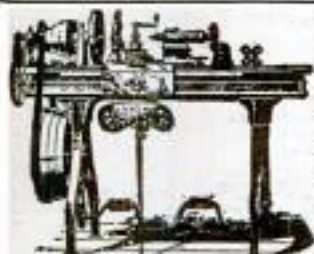

## LATHES

9 to 18-inch Swing

List price \$75 and up according  
to size. When ready to buy send  
for Lathe Catalog and prices.

**W. F. & John Barnes Co.**  
100 Ruby Street, ROCKFORD, ILL.



**South Bend Lathes**  
For the Machine and Repair Shop

**How to Run a Lathe**  
A 50 cent book for 10 cents.  
Postpaid, stamps accepted.

Straight or Gap Beds. Send for free  
catalog giving prices on entire line.  
**SOUTH BEND LATHE WORKS**  
423 Madison St., South Bend, Ind.

Real-estate mortgages are the oldest investments. It  
is on record that money was loaned against such security  
as early as 2,100 years before Christ.



Cash with order buys this small  
**\$3 BENCH LATHE**

Swing 3 in. 8 in. C. to C. Shipping Wt. 10 lbs.  
**PETER AUSTIN, 310 W. First St., MUNCIE, IND.**

## Drilling Wells is a Year Round Business

Drilling Water Wells is a profitable, healthful,  
year-round business. There are wells all  
around you to be drilled. Don't you want  
to get into a money-making business for  
yourself? Write for particulars.

**STAR DRILLING MACHINE CO.**  
664 Washington St. AKRON, OHIO

## TOOL CASES

For Up-to-Date TOOLMAKERS and MACHINISTS

We carry the finest and most complete  
line of mechanics' toolcases and tools  
in the country. We guarantee to please  
you or refund money. Write for free catalogue.

**J. M. WATERSTON**

75 Woodward Ave., DETROIT, MICH.

# LE PAGE'S CHINA CEMENT

STANDS HOT AND COLD WATER 10¢



STANLEY "45" PLANE

## SEVEN TOOLS IN ONE

1—Beading and Centre Beading Plane. 2—Rabbit  
and Filletster Plane. 3—Dado Plane. 4—Plow Plane.  
5—Matching Plane. 6—Sash Plane. 7—Superior  
Slitting Plane.

A very practical and useful tool  
for Carpenters, Joiners, Cabinet  
Makers, Pattern Makers, or any  
artisan interested in wood work-  
ing of any description.

For Sale by All Hardware Dealers.

Send for special 12-page Booklet describing  
in detail this most interesting tool

**STANLEY RULE & LEVEL CO.**  
NEW BRITAIN, CONN. U.S.A.

## Find Out About This 1/2 and 1 H.P. Engine

Here's the biggest value you ever saw in  
a 1/2 or 1 h. p. engine. You can hitch it up  
to your lathe, drill, grindstone, emery wheel,  
food chopper, wash machine, ice cream freezer,  
churn, cream separator or any other light machine,  
and it will run like a clock. The ever-dependable

## Maytag Multi-Motor

is the smallest, lightest and simplest engine made—  
1/2 h. p. 35 lbs., 1 h. p. 65 lbs. Easy to carry. Use  
it anywhere. Equipped for gas or gasoline. Starts in-  
stantly without effort. No cams, gears or valves to  
get out of order. The best low-cost power unit on the  
market. Guaranteed for life. Get our special low  
factory prices and illustrated folder. Send the  
coupon now, while it's handy.

**THE MAYTAG CO.**

Dept. 228  
NEWTON,  
IOWA

**THE  
MAYTAG  
COMPANY**  
Newton, Iowa

Send me illustrated  
Multi-Motor folder  
and give special factory  
price.



Name.....  
Address.....  
Town.....  
State.....





# SIMONDS

## The Handy Saw

is the saw that is sharp, reliable and strong, the kind that doesn't fail when you need it. You can always depend on a

## Simonds Saw

for any kind of cutting

Every saw is of special steel of our own manufacture. Made for service and always ready for service, Simonds Saws are handy in every sense of the word. To pick out the ideal saw for every purpose it is only necessary to look for the Simonds trademark.

Send for our booklet.

**Simonds Manufacturing Co.**

"The Saw Makers"

Established 1832

FITCHBURG, MASS.

5 Factories 11 Branches



"I Tell You Its  
A Great Saw"

Please Mention Popular Mechanics



## UNCLE SAM'S CRACK CORPS

The Signal Corps and Aeronautical Division are made up of the keenest men in the Country's Service. Where feats of the greatest valor are a point of honor—where delay or uncertainty may change the fortunes of a nation—the Crescent Wrench has gained complete preference.

Its scientific construction makes possible quick, accurate work in the "tight" places. Crescent materials insure against failure in the most grueling service.

**Crescent Tool Co.**  
Jamestown, N. Y.



## The Midget Slide Rule

will add, subtract, multiply, divide, solve problems involving even and uneven roots and powers. Also gives the Logarithms of numbers and the Sines, Tangents, Cosines and Cotangents of all angles. Its operation is very simple; quickly solves any mathematical problem. Made of wood and metal. Adapted for shop and office use. Fits the pocket, 3 1/4" in diameter.

Price, with instructions..... 75c

Your money back if you are not satisfied

**GILSON SLIDE RULE CO., NILES, MICH.**



## ToolCases for Toolmakers and Machinists

Keep your tools orderly arranged in a Gerstner Portable Tool Case. There's a space for every tool in one of the felt lined drawers. Every up-to-date mechanic needs one and you'll find our Cases the best built, neatest and most practical on the market. We guarantee to please or refund all money. Write for our free booklet

*Gerstner & Sons*

Mfrs. of Mechanics' High Grade Tool Cases  
808 Columbia St., DAYTON, OHIO

## Bartlett DROP-FORGED Compound Lever Snips \$2.00 to \$4.60

Made for hardest service. Highly tempered crucible steel, drop forged. Cuts keen. Holds the edge. Cuts 18-gauge metal at point easily—cutting power three times that of ordinary straight snip. For sale by dealers or sent postpaid in United States at these prices:

7-inch, stamped	\$1.50
8-inch	2.00
10-inch	3.00
12-inch	4.00
14-inch	4.60



CIRCULAR ON REQUEST

**BARTLETT MFG. CO., 20 E. Lafayette Ave., Detroit, Mich.**

# GOODELL PRATT

1500 GOOD TOOLS





4  
size  
bolt  
or  
motor  
drive

## Combination Threading Machines

# OSTER

**No. 304 A**

Pipe, 1 to 4 inch  
Bolts, 1/2 to 1 1/2 inch

Combine your pipe bolt and nipple threading in one simple, compact machine requiring only a few feet of floor space. Three days' work a month is sufficient to make an Oster pay a big dividend on the investment.

Catalog No. 30 Free—Write for it today.

**THE OSTER MFG. CO.**  
2100 E. 61st St., Cleveland, Ohio

## THE AWL YOU WANT

See That Reel



Is the genuine MYERS \$1.00 "Lock Stitch" Sewing Awl with the exclusive feature. See thread reel in front of handle under the finger tips. Natural tension. Sews heavy or light material, diamond point, full grooved needles used to protect the thread when sewing. C. A. MYERS COMPANY, 6339 University Ave., Chicago, Illinois

## Duplicate Keys

for all Yale and similar Locks made in one minute with Harrison M. I. P. Key Filing Machine. No insets. Thousands in use. \$3.50 net. Special diamond-shaped files for angular cut keys, 40c each. Harrison C. K. Key Clamp duplicates all common keys without a caliper. Price, \$1.10. Parcel post prepaid.

Money returned if not satisfactory.

HARRISON & CO., 81 New St., New York

## Acetylene Blow Torch Prest-O-Torch

Quicker and cheaper than a gasoline blow-torch for brazing and soldering

For factories, repair shops, linemen, dentists, jewelers, the Prest-O-Torch saves time and money. Used with Prest-O-Lite Tanks—ready-made gas. Intense, concentrated flame instantly lighted. No depreciation, safe and convenient.

Style A, price, \$1.25 (Canada, \$1.35) will braze up to 3/4 inch round rod. Style "C" for heavier work, \$2.75 (Canada, \$2.85). Special styles for dentists. Write for literature or send order now. Money refunded if not satisfied.

**The Prest-O-Lite Co., Inc.** 835 Speedway  
Indianapolis, Ind.  
Canadian General Office, Dept. A4, Toronto, Ont.



## In Cramped Places

this little "Yankee" No. 1530 will operate when other drills can't. It is but 10 1/2 in. long, weighs only 1 1/4 lbs., yet has right, left and double ratchet movements.

The shifter between the small gears controls these adjustments:

1. Plain Drill
2. Left-hand Ratchet
3. Right-hand Ratchet
4. Double Ratchet
5. Lock

# YANKEE

# TOOLS

*Make Better Mechanics*

The marvel of this hand drill is the double ratchet movement. In this adjustment any and every motion of the crank, forward or back, and no matter how slight, causes the drill to cut continuously.

## "YANKEE" Ratchet Drill

Hand Drill  
No. 1530—\$3.50

Three-jaw steel chuck for round shank's up to 3/16 in. Hardened steel thrust bearing. Steel spindle. Cut gears. Magazine handle for holding drills.

Your Dealer Can Supply You

Write for free "'Yankee' Tool Book" of metal-drilling, wood-boring and screw-driving tools.

**NORTH BROS. MFG. CO., PHILADELPHIA**

Please Mention Popular Mechanics



**B·S**  
TRADE MARK



## Are You Protected Against Errors?

You know the importance of accuracy. You know that errors are costly. You know that your reputation as a skilled workman depends on the attainment of accuracy and the elimination of costly errors. Is your reputation for accurate workmanship protected? It is if you use

## Brown & Sharpe Tools

This sixty-six year old, world-endorsed line of tools numbers one thousand varieties embracing rules, calipers, micrometers, vernier height and depth gauges, etc., etc.

### Send for Catalog 27 TODAY

which, besides listing the entire line, contains instructive matter of interest to every shop man.

*You'll find it a valuable  
book to keep in your kit.*

**Brown & Sharpe Mfg. Co.**

Providence, R. I., U. S. A.

# SARGENT



## For Every Bench Use There's a Sargent Automatic Set Plane

And every user feels it's a different plane by the way it takes hold of *any* wood.

Here's why: Thin cutter with quicker grinding advantage, Rigidity for sure work, Quick and Easy Adjustment for coarse or fine cuts, Adjustable Knob, and Automatic Set, by which the clamp, when replaced after removal, will always return to its original position until reset.

Ask your dealer to show you the Planes that do work not possible with other planes, or send for catalogue describing these and other Sargent Planes.

**SARGENT & COMPANY**  
49 Water St., New Haven, Conn.

**VALUE OF ADVERTISING**—The value of advertising is again exemplified in a wholly unexpected and remarkable way, says the Christian Science Monitor. A former resident of Missouri, who thought the Southwest would suit him better, was walking beside a railroad track in Arizona when he picked up a lead pencil that was lying between the rails. It bore the advertisement of a Missouri real-estate dealer. The circumstance gave the wanderer such a yearning for home that he immediately returned, and bought a farm from the man who had sent the lead pencil forth on its mission of publicity.

## "Interlox" QUICK AND ACCURATE INSIDE MEASUREMENTS!

MASTER SLIDE RULE  
Exact Inside Measurement to Smallest Fraction of Inch

USE IT for all measuring—inside or out. The only interlocking, sliding Rule. Ideal for Carpenters, Mechanics, Engineers, Electricians, etc. If not at dealer's, send his name and 25c per ft. for rule sent prepaid (any length, from 2 to 8 ft.).

DAHL MFG. CO., 841-43 E. 136th St., NEW YORK CITY  
Dealers and Agents: Write for Liberal Proposition

## How About a UNION Tool Chest

An actual help in your everyday work. A roomy, compact tool chest that will stop the nuisance of lost tools. Has a place for every tool. You know immediately if one is mislaid or borrowed.

**Unconditional Money-Back Guarantee**  
Write for our Catalog and Prices and Special Offer if we have no dealer near you.

**Union Tool Chest Works**  
22 Railroad St. Rochester, N. Y.



Style G—2 sizes. 17 other styles and sizes. Built of selected plain or quartered oak or leatherette covered, some with mahogany fronts. Correctly designed. Perfectly fitted drawers. Many sizes.



# STOP USING A TRUSS

Do Away With Steel And Rubber Bands

## FREE TRIAL



### FREE to 5,000 Truss Sufferers

To the extent of 5,000 sufferers who may apply I will send, ABSOLUTELY FREE, a sufficient quantity of the Plapao to positively convince them that this is the only logical, common-sense way of treating ruptures. Plapao is a highly astringent medication placed within the Plapao-Pad and being absorbed through the skin, creates a wonderful feeling of relief and at the same time tends to strengthen the weakened muscles and thus permanently close the rupture opening. The process of recovery is natural, so you'll have no use for a truss—you can throw it away forever! Old and young have testified under oath that the Plapao-Pads cured their ruptures—many of them long-standing, aggravated cases—without delay from work. Patent allowed in U. S. and foreign countries. Awarded Gold Medal at Rome and Grand Prix at Paris.

**Send No Money**—for a sufficient quantity of the Plapao is sent without charge to enable you to give it a thorough test; you pay nothing for this trial now or ever. Write for it and full information today. Address Plapao Laboratories, Block 1427 St. Louis, Mo.

## MEN

For \$15.00 we hand tailor to your measure and deliver express charges prepaid, a \$25.00 all wool suit or overcoat, absolutely guaranteed to fit and delight you or you don't pay us one cent. Our new Fall-Winter Style book and about 50 samples mailed free on request.

THE RUBY TAILORS, Dept. 41, CHICAGO, ILL.

## A Yearly Income for You

Would you invest a moderate amount in small monthly or semi-annual installments, if you felt assured it would earn for you an income from \$1000.00 to \$5000.00 annually, according to your investment? A Dixie Estate near Tampa, Florida, planted to grapefruit, oranges and avocados, should do this for you. The proof is what you want. We have it and will gladly send it to you free. Write us today for details of this money making opportunity.

The Thomas Nurseries, Inc., Tower Bldg., Chicago

## GROW MUSHROOMS!



Start right, have good paying business month in and month out, right at home. Costs little to start, grow fast. Mushrooms in big demand everywhere. Men, women and children can grow them, in sheds, cellars, boxes, etc., in spare time. Learn expert facts about successful growing, right spawn, etc., from America's great authority. Send for free illus. publication, "TRUTH ABOUT MUSHROOMS," today.

BUREAU OF MUSHROOM INDUSTRY  
Dept. 426 1342 N. Clark St., CHICAGO

## RIDER AGENTS WANTED

Everywhere to ride and exhibit the new Ranger "Motorbike" completely equipped with electric light and horn, carrier, stand, tool tank, coaster-brake, mud guards and anti-skid tires. Choice of 44 other styles, colors and sizes in the famous "Ranger" line of bicycles, all at Factory-to-Rider prices.

DELIVERED FREE on approval and 30 DAYS TRIAL. Send for big free catalog and particulars of our Thirty Days Free Trial offer and marvelous offers and terms.

**TIRES** Lamps, Horns, Wheels, Sundries, and repair parts and supplies for all bicycles—at half usual prices.

SEND NO MONEY but tell us exactly what you need. Do not buy until you get our Factory-Direct-to-Rider prices, terms and the big FREE catalog.

MEAD CYCLE COMPANY  
DEPT. 6108, CHICAGO, U.S.A.



## Why Pay Full Prices for Diamonds

Christmas Offerings Ready

HERE you can get diamonds at 40 to 50 per cent lower than market prices, proved by customers' letters. Diamonds which originally sold at full prices. The exact qualities for which full prices are paid today. Any new mounting you prefer. Kissed in a handsome gift box.

### Diamond Banking

For over sixty years we have been in the business of diamond banking—lending money on high grade diamonds, watches, and other jewelry. When the money we lend is not repaid, we must sell the diamonds.

**Look Here are a few of the bargains in our latest bulletin.**  
The very thing for an engagement ring. A Mus-white, brilliant, perfectly cut, genuine diamond of high degree of perfection. It weighs 8/8—1/2 ct. and is mounted in a new white gold top ring. Just try to match it at 60 per cent more. Shipped for free examination. Guaranteed Cash Loan \$49.80 \$40. Unpaid Loan Bargain Price

Gentlemen; wear a diamond; but don't pay a full price. 1-1/16 kt. in the weight of this beautiful, perfectly cut solitaire. Fine blue-white color. Investment protected by Guaranteed Loan of \$130. Unpaid \$156.00 Loan Bargain Price.

A cluster that really looks like a large fiery solitaire. Brand new mounting of 14-kt. solid gold. See what you can buy at retail for \$50 then send for and compare this. You'll decide on this big bargain at Unpaid \$28.85 Loan Bargain Price.

Many wonderful watch bargains are shown in our bulletin. Here is a 21-jeweled double roller, full size, Vanguard (Waltham) in genuine 30-year gold-filled case. Guaranteed good as new and to pass railroad inspection. Try to match at full 60 per cent more. Unpaid Loan Bar-\$22.35 gain Price.

### Sent on Approval!

We will be glad to send you, prepaid, on approval and without obligations, any of our bargains for FREE EXAMINATION. See them for yourself—and examine them before you decide to buy.

### To Make Quick Sales We Offer Astonishing Bargains!

We save you 40 to 50%. Hundreds of customers' letters testify that they have made this saving. Write for our bulletin today.

### Guaranteed Cash Loans

Diamonds bought here are like insurance policies. You know what you can borrow before you buy—see our Cash Back Guarantees.

### Send the Coupon!

Hundreds of special bargains listed in this new bulletin. Write for it today. Not just one quality of diamonds, but all qualities are shown in this remarkable bulletin. Your name and address on the coupon is enough, but write NOW.

Jos. DeRoy & Sons  
Only Opp. Post Office  
1931 DeRoy Building  
Pittsburgh, Pa.

Reference by permission:  
Pension Depos-  
it Nat. Bank,  
Marine Nat.  
Bank, any  
Pittsburgh  
Daily News-  
paper.

Name.....

Address.....

Jos.  
DeRoy & Sons  
1931 DeRoy Bldg.,  
Pittsburgh, Pa.

Gentlemen:—Please send me, absolutely free and prepaid, your new Bargain Bulletin of diamonds, watches and other jewelry. It is distinctly understood that I assume no obligation of any kind.



## BISSELL'S Vacuum Sweeper

### Prevents Dust Accumulation

The three powerful bellows pumps in BISSELL'S Vacuum Sweeper create such a current of rushing air that the fine dust is prevented from becoming deeply imbedded in your carpets and rugs, when only harsh methods will suffice to remove it. The rear-opening dust-bag and nozzle, coming out *in one piece*, make emptying an easy and cleanly operation. In all, the BISSELL'S is at once a most efficient and easily operated vacuum sweeper.

BISSELL'S Carpet Sweepers have predominated in the world's markets for over 40 years, even in countries where national loyalty is most intense. Only mechanical superiority could command such universal acceptance. Its use in connection with BISSELL'S Vacuum Sweeper, which so ably combines air suction and brush agitation, is a dustless, hygienic method of *keeping the whole house clean*.

Vacuum Sweepers, \$6.00 and \$12.50; "Cyclo" Ball-Bearing Carpet Sweepers, \$3.25 to \$6.25—depending on style and locality. At dealers everywhere. Booklet on request.

**BISSELL CARPET SWEEPER CO.**

Largest and Oldest Sweeper Makers  
GRAND RAPIDS, MICH.  
MADE IN CANADA, TOO

(304)

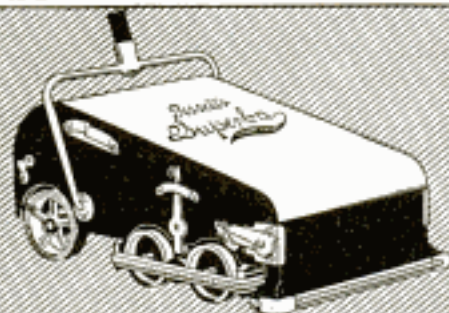

**RECTIFIERS** for garages. All sizes. Charge from alternating current 1 to 8 batteries. \$12.00 upwards.  
**AMERICAN BATTERY CO., 1137 Fulton St., Chicago. (Etab. 1883)**



## Sunshine Lamp 300 Candle Power

# FREE

TO TRY IN YOUR OWN HOME

Wonderful new combined table and hanging lamp. Turns night into day. Gives better light than gas, electricity or eighteen ordinary lamps at one-tenth the cost. Costs only one cent a night. For homes, stores, halls, churches. A child can carry it. Makes its own gas from common gasoline. No wick. No chimney. No dirt. No smoke. No odor. Absolutely safe. Guaranteed 5 years.

### Make \$30 to \$60 Every Week

We loan you sample. No experience necessary. Everyone a possible customer. Exclusive territory free. We want one person in each locality to whom we can refer new customers.

Take advantage of our Free Trial Offer

**SUNSHINE SAFETY LAMP CO., 200 Factory Building, KANSAS CITY, MO.**

## Make Water Pressure Work and Save Your Back

The Divine Red Devil Water Motor built with bucket-wheels like big water wheels—easy to install, has nothing to get out of order and does work at very low cost.

**4 in. Motor Complete, \$3.** Including Emery, Buffing Wheel and Pulley for household use. With pulley for sewing-machine only \$2.50.

**6 in. Motor with Pulley, \$5.** For Mechanics, Tradesmen, Doctors and Dentists and the Home. Will run washing machine easy. Guaranteed to give satisfaction or money back. **Booklet and Prices Sent Free** if you will write today and give us size of faucet, water pipe and water pressure and work to be done. You must furnish information to get booklet.

**DIVINE WATER MOTOR CO.**  
Dept. P., Utica, N. Y.

## 300 Candle Power of Light at a Cost of 1-8c Per Hour

Burns Kerosene or Gasoline

This lamp generates and burns its own gas from ordinary kerosene. "QUICKLIT" gasoline lamps can be lit with an ordinary match like city gas.

Write today for illustrated catalog of our complete line of kerosene and gasoline lamps, lanterns **Agents Wanted** and lighting systems.

**The Nagel-Chase Mfg. Co.**  
176 East Erie St., Chicago

## WHITE FLAME

**BURNERS** make your old kerosene lamps and lanterns give a brilliant white light better than electricity or gas. Doubles your light. Saves oil. **NO MANTLE TO BREAK.** Guaranteed Safe and Reliable. Delights every user. Send now for complete sample postpaid 35 cents, stamps or coin. 3 for \$1. **MONEY BACK IF NOT SATISFACTORY.** Live Representatives Wanted. Exclusive Territory.

**WHITE FLAME LIGHT CO., 68 Clark Bldg., Grand Rapids, Mich.**



Made by Makers of Good Goods Only

## Replace Your Heating Plant with a ROUND OAK Moistair Heating System

Only Heating System that Automatically Ventilates and HUMIDIFIES.—Keeps air moist, free from disease germs. Durable, dependable, easy to operate, a big fuel-saver. Send for FREE Book explaining all.

**The Beckwith Co.** Round Oak Folks—Established 1871  
100 Front St., DOWAGIAC, MICH.



# All Metal-White Enamel

## Get Kalamazoo Quality

SEND for our new catalog and learn how little it costs to own this wonder of a cabinet—white enameled—all metal porcelain enamel sliding top—nickel-trimmed. Glass rolling pin, patented bread board and 8-piece crystal spice set included free.

**Write Today**—Get our "direct-to-you" price—cash or easy payments. We pay freight—quick shipment—30 days' trial. 300,000 customers boosting for Kalamazoo products. Write today.

Ask for Catalog No. 15

Kalamazoo Stove Company  
Manufacturers  
Kalamazoo, Mich.

Stoves, Ranges,  
Gas Ranges,  
Furnaces, White  
Enameled, All-  
Metal Kitchen  
Cabinets, Tables.

A Kalamazoo  
Direct to You



Does The Socket Chafe Your Stump?  
B. M. YOU ARE NOT WEAK!

**BUCHSTEIN'S VULCANIZED FIBER LIMB** which is soothing to your stump, cool, neat, light, walls not much thicker than a silver dollar, strong

Sold on easy payments to good people. D. Buchstein  
Co., 113 6th St. S., Minneapolis, Minn. **Guaranteed 5 Years!**

**The Thor**

Send for the big Thor Book which describes the Thor Electric Washing Machine and shows how a good sized washing can be done at a cost of only 2 cents.

**HURLEY MACHINE CO., Dept. 1197, CHICAGO**

**How to Cut Coal Bills 1/2 to 2/3**

Free Book "From Overfed to UNDERFEED" tells how—guaranteed. Tells how to burn cheaper grades of coal cleanly and effectively. No clinkers. No partly burned coal. Ashes few, clean and white. No sifting. A boy can tend the Williamson UNDERFEED Furnace or Boiler with expert results. Coal fed from below. Hot, clean fire always on top. Write for free book today. NOW.

**THE WILLIAMSON HEATER COMPANY**  
65 Fifth Avenue Cincinnati, Ohio

**SMALL ENGINES**

Perfected Gasoline Engines—1 and 1 1/2 h. p.—for Farm and Shop use. Price \$19.50 and up. Also

**WASHING MACHINES**

We ship on trial. Send for Booklet and Special Offer.

**SIEVERKROPP ENGINE CO.**  
1224 19th St. RACINE, WIS.

**STARTER for FORD CARS**



# Power for YOU!

Power from within! Strength that is **more** than mere muscular strength—the strength of better health, abundant nerve force—the strength of the perfect man. Don't you want it?

Nine people out of every ten are only **half alive!** How about yourself.

## All the Exhilarating Joys of Life Strength Youth

Do you feel just right? If you do not—if you haven't that vigorous "go ahead" feeling all the time—don't fail to send the coupon for full particulars about the White Cross Electric Vibrator. In vibration there exists many of the secrets of life. You now have an opportunity of seeing what vibration will do for you—how every nerve, every fibre in your whole body will fairly tingle. Try this remarkable instrument for yourself—test it. Now is the time for YOU to send for the free book, "Health and Beauty." Thousands have received it. You are invited to write for it, too.



### The White Cross Electric Vibrator

is the result of years of work and experiment. If you have your house wired for electricity, you connect it up as easily as an electric lamp; if not, we can supply you with models operated on their own batteries.

### Special Offer for a Limited Time

For a short time only we are making a remarkable Special Introductory Offer on the White Cross Electric Vibrator, in order to place at least one of these splendid instruments in every city, town, village in the country.

### Free Book Sign the coupon and mail it today.

Get our splendid big FREE book telling you all about the marvels of Vibration. Read what scientists say. Post yourself on what it will do for you. Learn all about the White Cross Electric Vibrator and our limited offer. No obligations at all—send the coupon or a post card or letter today.

Send for This Book

**LINDSTROM, SMITH CO.**  
1100 S. Wabash Avenue  
Dept. 1197, Chicago, Ill.

Without any obligations on my part, please send me, free and prepaid, your free book on Vibration, full particulars of the White Cross Vibrator and your Special Offer.

**Lindstrom, Smith Co.**  
1100 South Wabash Avenue  
Dept. 1197, Chicago, Ill.

We also manufacture White Cross Electric Stoves, Irons, Hair Dryers, Electric Lamps, Electric Fans, Electric Automobile Horns, Electric Carrying Irons, Heating Pads, Small Motors, etc. Dealers write.

Name \_\_\_\_\_  
Address \_\_\_\_\_  
My Electrical Dealer's Name is \_\_\_\_\_

Please Mention Popular Mechanics



# To The Man Who Walks

If you walk to your work or to your play; if you ride on street cars or elevated trains, or if you are considering the purchase of a cheap automobile

## This Message Is For You

The following quotations are from an article by A. Ludlow Clayden which appeared in AUTOMOBILE AND AUTOMOTIVE INDUSTRIES, a publication devoted primarily to the interest of the automobile:

"—for the use of two people in fair weather the motorcycle and sidecar will give the same service as a two seated car at not more than one quarter the cost.

"For those who love speed it can only be surpassed by cars costing well up into the thousands of dollars.

"—a sidecar is vastly more comfortable than the majority of full sized automobiles—more easily housed—less trouble to use for short distances than a car owing to its small

size and consequent ability to work its way thru traffic.

"Its rapid getaway and hill climbing ability; its intense 'life' cause it to appeal to the class of man who likes to use a powerful roadster.

"—motorcycles now being made are comparable in engineering quality and workmanship with cars that sell from \$2000 upward—the touring car which will hold five or more is very apt to force entertainment expense upon the owner."

The foregoing, coming from an automobile paper, should convince the dubious that the motorcycle is the thing to buy if the utmost in COMFORT, ECONOMY, SPEED, LONG LIFE and UTILITY is to be realized.

The performance records of the EXCELSIOR Motorcycle stand out as a final proof that of all good motorcycles the EXCELSIOR is the BEST and, therefore, deserves the first consideration in the mind of the prospective purchaser.

See an Excelsior Dealer to-day or write for our catalog.

**EXCELSIOR MOTOR MFG. & SUPPLY CO.** 3702 Cortland St. CHICAGO, ILLINOIS

## America's Tested Tires

# GOODRICH

## BLACK SAFETY TREADS

THE B.F. GOODRICH COMPANY, Akron, Ohio

## STANWELD Cold Drawn Seamless Steel TUBING

Lightest, smoothest, strongest Steel Tubing made. World's largest manufacturers of bicycles, motorcycles and automobiles use it exclusively. Send for Folder "A."

THE STANDARD WELDING COMPANY  
Main Office and Factory CLEVELAND, OHIO



# Mobiloils

A grade for each type of motor



## Convert Your Bicycle into a Motor-Cycle

Motor fits any wheel. BEST, MOST RELIABLE. Best hill climber. More STEFFEYS in use than all others. Stamp for circulars. STEFFEY MFG. CO., 5007 Brews Street, PHILA., PA.

## THE CORBIN DUPLEX COASTER BRAKE

is the standard brake equipment assuring absolute control. Equip it now. Send for catalog. THE CORBIN SCREW CORP. The American Hardware Corporation, Successor NEW BRITAIN, CONN. BRANCHES: New York, Chicago, Philadelphia

# An Easy Way to Make Money

Don't be content to plod along on a small salary. Be independent. Go in the tire repairing business and make \$60 or more a week. One man made \$45 the first day he received his outfit. Others are making \$25 a day and hundreds of wide-awake men are making \$200 to \$500 a month.

No experience needed. We teach you how. Very little capital required. But slight risk, as every car owner in your town is a possible customer. Jobs are plentiful because tires blow out and puncture every day.

## SHALER Tire Repair Outfit, \$65

will do as much and as perfect work as the big \$250 to \$500 vulcanizing outfits. A boy can vulcanize perfectly with this simple machine. It's the only vulcanizer that has Automatic Heat Control. It must vulcanize just right. It can't undercure or overcure a tire. Requires no watching or regulating. You can learn to do expert tire vulcanizing in half an hour with the Shaler.

WRITE FOR FREE BOOK "HOW TO OPEN A TIRE REPAIR SHOP" and complete Catalog, which gives full information. WRITE QUICK BEFORE SOME HUSTLER GETS AHEAD OF YOU.

C. A. SHALER CO., 2009 Fourth Street, WAUPUN, WIS.





# The Cleveland Lightweight



$\frac{1}{2}$  the Weight  
 $\frac{1}{2}$  the Cost

One enthusiastic owner after riding 32,000 miles has figured that his *entire upkeep cost* has been 3-5 of a cent per mile, and his machine, he says, is good for another 32,000 miles.

Do not judge the Cleveland Lightweight by any motorcycle you ever saw or rode—it is *entirely new and different.*

Write us for the facts.



\$170 f.o.b. Cleveland

to the gallon Cleveland Motorcycle Mfg. Company, Cleveland, O.

## MIAMI-MADE BICYCLES

Stand at the top of the bicycle world.  
RACYCLE, HUDSON, MIAMI, FLYING MERKEL  
Write for our catalog.  
THE MIAMI CYCLE & MFG. CO., MIDDLETOWN, OHIO

## More Miles From Gasoline—Guaranteed!

The Wilmo Manifold gives your car a flying start at the first few turns of the motor—increases gasoline mileage from 42 to 54 per cent by actual official A. A. tests—keeps the engine free from carbon—makes a smoother running motor at all speeds. Quickly and easily applied with a monkey-wrench. No holes to bore. Absolutely guaranteed. Made for various cars. Price \$7.50 up. Ask your dealer or garage man, or write.

THE WHITTIER CO., 2007 Michigan Ave., Dept. 8010, CHICAGO



## \$40 Motorcycle

We have the largest line of new and used motorcycles in the country at the lowest prices. Every machine guaranteed. Send for catalog. We are the largest and only exclusive motorcycle supply house in the world. Repairs a Specialty. Send us your machine to be overhauled. Motors and castings for airplanes and railway velocipedes. WE EXCHANGE MOTORCYCLES.

HARRY R. GEER CO., 888 McLaran Ave., St. Louis, Mo.



## 35 MILES PER HOUR

IS RECORD OF THIS CAR

Built by a boy from Junior parts furnished by us. Parts very cheap. Send 25 cents

for blue prints and price list of parts, showing how to build this speedy little car.

Any boy can build this car

SYEPHER MANUFACTURING CO., 146 Warren St., Toledo, O.

Please Mention Popular Mechanics



## Compare It With a Diamond

*If You Can Tell the Difference  
—Send it Back at Our Expense*

THESE new, man-made gems will be a revelation to you. After centuries of research, science has at last produced a gem of dazzling brilliance that so closely resembles the diamond that you'll not be able to distinguish it. You may see it for yourself—without charge. We will send you any of the Lachnite Gems that you may select for a ten days' free trial. We want you to put it to every diamond test. Make it cut glass—stand the diamond file, fire, acid—use every diamond test that you ever heard about. Then, if you can distinguish it from a diamond, send it back at our expense. Write for our new, free jewelry book.

## Pay As You Wish

If you wish to keep the remarkable new gem, you may pay the rock-bottom price at the rate of only a few cents a day. Terms as low as 3½ cents a day without interest. No notes, mortgages or red tape. You pay only the direct, rock-bottom price—a mere fraction of what a diamond costs.

## Set in Solid Gold

Lachnite Gems are never set in anything but solid gold. In our new jewelry book you will see scores of beautiful rings, La Vallieres, necklaces, stick pins, cuff links, etc., etc. from which you have to choose.

## Send Coupon For New Jewelry Book

Put your name and address in the coupon or on a letter or post card now and get our new jewelry book absolutely free. You will be under no obligations to buy anything—or to pay for anything. The jewelry book is free. Send your name and address now.

Harold  
Lachman Co.  
12 N. Michigan Ave.  
Dept. 1197  
Chicago, Illinois

Harold  
Lachman Co.  
12 N. Michigan Av.  
Dept. 1197, Chicago

Gentlemen: Please send me absolutely free and prepaid your new jewelry book and full particulars of your free trial, easy payment plan. I assume no obligations of any kind.

Name.....

Address.....



**\$2500. to \$7500.  
ANNUAL PROFITS**

## ANDERSON STEAM VULCANIZER

Men wanted everywhere to get into vulcanizing business using the greatest vulcanizing machine on the market. Big demand—large profits. 25,000,000 tires sold in 1917—millions to be repaired. An easily handled side line—garages, auto and tire agencies, repair shops, harness shops can "clean up" by installing an Anderson Vulcanizer.

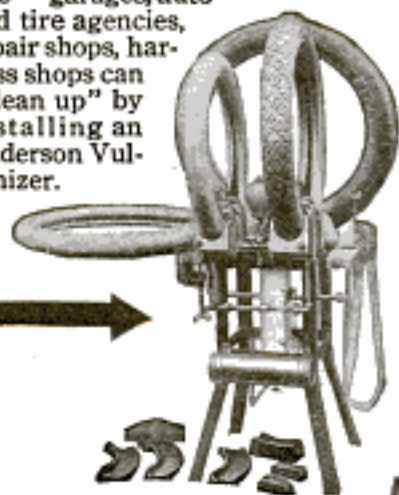

Act now!  
"Cash in"  
on this  
new  
game

The  
Anderson  
Vulcanizer

### Uses Unlimited Pressure

Air bags, as used on many machines, and costing \$2 to \$5, take only 90 lbs. pressure, are unsatisfactory, and *do not really vulcanize*. We use NO air bag pressure. Our flexible conformation device takes TONS of pressure—it assures true vulcanization inside and out, at one operation. Anderson process forces rubber and cement at curing heat into the fabric—cooked in—making a perfect union. Work will not lump, blister or pull loose. Rim cuts repaired perfectly.

### Repairs Tires and Tubes

—Anderson outfit repairs everything from 1½" bicycle tires to 37" x 5½" auto tires. Machine shipped complete ready for use. PAYS OUT IN WEEK. \$160 its daily capacity. Keep molds reasonably busy; you'll clean up enough first week over all expenses to pay for machine and leave a handsome profit beside.

State Organizers and District Sales Managers wanted—actually the "best seller" on the market.

**Anderson Steam Vulcanizer Co.**  
2 Industrial Building Indianapolis, Indiana

Please Mention Popular Mechanics



A rusty or sticky cylinder responds quickly to

## HOMOL

Get this sportsmen's oil—excellent for guns, reels, traps and tools, and for every use around the house.

If your dealer cannot supply you with Homol, we will—just send us his name and 25 cents for a 5-ounce can—quick.

**WILLIAM PETERMAN**

Incorporated  
200 Fifth Avenue  
NEW YORK CITY



**TOWN GETS GAS FROM BACK-YARD WELLS**—Residents of Houma, La., are providing their own natural gas for cooking and lighting. Wells of less than 100-ft. depth supply the gas, and more than 52 of them

1917  
**Indian Motorcycles** With New Power-plus Motor and Cradle Springframe. Write for catalog.  
HENDEE MFG. CO., 710 State Street, SPRINGFIELD, MASS.

Attractive **Columbia Bicycles**  
Catalog Free  
WESTFIELD MFG. CO. Department 15 WESTFIELD, MASS.

## MAKE YOUR BIKE A MOTORCYCLE

at a small cost, by using our attachable outfit. Fits any Bicycle. Easily attached. No special tools required.

### "Used His Four Years"

Harry A. Hyatt, of Boreas River, New York, writes: "About four years ago I received my motor attachment, and wish to say that I am satisfied with it in every way, for it has certainly given me good service. Anyone wanting a motorcycle or attachment, I would recommend them to the Shaw Manufacturing Co."

**FREE BOOK** Write today for bargain list and free booklet, fully describing the SHAW Bicycle Motor Attachment. Motorcycles all makes, new and second-hand, \$35.00 up.

**SHAW MANUFACTURING CO.**  
Dept. 6 GALESBURG, KANSAS



Copyrighted material





Try the most luxurious and efficient garter selling for less than fifty cents  
**The New Double Grip**

**Satin Pad** **Boston Garter** **Cable Web**

Pads are light and cool — no heavy thicknesses — only thin facings and clean white linings, which prevent discoloration.

Ask for Number 835—35c.  
"Double Grips" 35c. and 50c.  
"Single Grips" 25c. and 50c.

GEORGE FROST CO., MAKERS, BOSTON



had been drilled in back yards not long ago. Discovery of gas some 20 miles away led the enterprising householders to search for it in their own lots.

**BEES PAY BIG PROFITS**  
Raise your own honey. We start you right. Send today for Bee Supply Catalog. Sent FREE.  
**DADANT & SONS** Box 50 HAMILTON, ILL.

**TYPEWRITERS** **FACTORY REBUILT**

Save You  
From \$25 to \$75

Up-to-date Machines of Standard Makes thoroughly rebuilt, trade-marked and guaranteed the same as new. Efficient service through Branch Stores in leading cities. Send for latest booklet.

American Writing Machine Co., Inc., 339 Broadway, N. Y.



**RABBITS**

Tells all you want to know about Rabbits. Our book: "The Rabbit; How to Select, Breed, and Manage the Rabbit and Belgian Hare for Pleasure or Profit," by breeders of long experience with rabbits. Sixth edition, nicely illustrated, enlarged and much improved. Price 25 cents with sample copy of the *American Poultry Advocate* containing Belgian Hare Department.

POULTRY ADVOCATE, Dept. 257, Syracuse, N. Y.

**Over 100,000 in Use**  
Mostly sold through recommendation. For PERSONAL DESK or GENERAL OFFICE. It checks mental calculations. Buy through your Stationer. Write for 10-day trial offer.

**E. GANCHER, A. A. M. CO.**  
148 Duane Street, NEW YORK

**AGENTS WANTED**

**Golden Gem**  
PORTABLE \$5  
Adding Machine

Multiplics - Subtracts

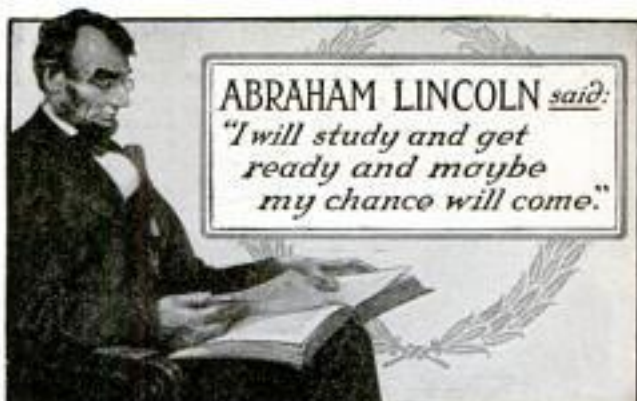

ABRAHAM LINCOLN said:  
"I will study and get ready and maybe my chance will come."

## YOUR Chance Will Come

Born in a log cabin, Abraham Lincoln had little chance to acquire an education. But he was determined to succeed. "Some day," he said, "my chance *will* come." So he studied and got ready. And his chance *DID* come.

Your chance will come. Some day you'll be considered for promotion or for a good job in some other line of work. If you are ready, you'll go up.

And you *CAN* get ready. No matter if your schooling was limited—if you do have to work long hours. If you really want a better job, the International Correspondence Schools can train you for it at home during your spare time.

Every month more than 400 I. C. S. Students voluntarily report promotions or salary increases due to I. C. S. help. What the I. C. S. have done for these men they can do for YOU. Mark and mail the coupon NOW.

INTERNATIONAL CORRESPONDENCE SCHOOLS, Box 5611, Scranton, Pa.

INTERNATIONAL CORRESPONDENCE SCHOOLS  
BOX 5611, SCRANTON, PA.

Explain, without obligating me, how I can qualify for the position, or in the subject, before which I mark X.

- |  |  |
|--|--|
| <input type="checkbox"/> ADVERTISING MAN             | <input type="checkbox"/> ELECTRICAL ENGINEER                             |
| <input type="checkbox"/> Salesmanship                | <input type="checkbox"/> Electric Lighting                               |
| <input type="checkbox"/> Commercial Law              | <input type="checkbox"/> Electric Car Running                            |
| <input type="checkbox"/> BUSINESS (Complete)         | <input type="checkbox"/> Electric Wiring                                 |
| <input type="checkbox"/> Certified Public Accountant | <input type="checkbox"/> Telegraph Expert                                |
| <input type="checkbox"/> Higher Accounting           | <input type="checkbox"/> Practical Telephony                             |
| <input type="checkbox"/> Bookkeeper                  | <input type="checkbox"/> Railroader                                      |
| <input type="checkbox"/> Stenographer and Typist     | <input type="checkbox"/> Pipe Foreman or Engineer                        |
| <input type="checkbox"/> Railway Accountant          | <input type="checkbox"/> Metallurgist or Prospector                      |
| <input type="checkbox"/> WINDOW TRIMMER              | <input type="checkbox"/> ARCHITECT                                       |
| <input type="checkbox"/> Show Card Writer            | <input type="checkbox"/> Contractor and Builder                          |
| <input type="checkbox"/> Outdoor Sign Painter        | <input type="checkbox"/> Architectural Draftsman                         |
| <input type="checkbox"/> Common School Subjects      | <input type="checkbox"/> Concrete Builder                                |
| <input type="checkbox"/> Good English                | <input type="checkbox"/> Structural Engineer                             |
| <input type="checkbox"/> Teacher                     | <input type="checkbox"/> Plumbing and Heating                            |
| <input type="checkbox"/> Civil Service               | <input type="checkbox"/> Sheet Metal Worker                              |
| <input type="checkbox"/> Railway Mail Clerk          | <input type="checkbox"/> CHEMICAL ENGINEER                               |
| <input type="checkbox"/> CIVIL ENGINEER              | <input type="checkbox"/> Illustrator                                     |
| <input type="checkbox"/> Surveying and Mapping       | <input type="checkbox"/> Designer  |
| <input type="checkbox"/> MECHANICAL ENGINEER         | <input type="checkbox"/> Textile Overseer or Supt.                       |
| <input type="checkbox"/> Mechanical Draftsman        | <input type="checkbox"/> AGRICULTURE <input type="checkbox"/> Spanish    |
| <input type="checkbox"/> Machine Shop Practice       | <input type="checkbox"/> Navigator <input type="checkbox"/> German       |
| <input type="checkbox"/> Stationary Engineer         | <input type="checkbox"/> Poultry Raising <input type="checkbox"/> French |
| <input type="checkbox"/> Gas Engineer                | <input type="checkbox"/> AUTOMOBILES <input type="checkbox"/> Italian    |

Name \_\_\_\_\_

Present Occupation \_\_\_\_\_

Street and No. \_\_\_\_\_

City \_\_\_\_\_ State \_\_\_\_\_

If name of Course you want is not in this list, write it below.

Please Mention Popular Mechanics



**The Santa Fe SHATTERS WATCH PRICES**

SEE THIS WATCH FIRST



*Don't Send a Penny Examine Watch Free*

**The ILLINOIS Famous \$2.50 Santa Fe Special 21 JEWEL RAILROAD WATCH A MONTH**

— the one standard railroad watch "That's Guaranteed for Life," thin model, all sizes, adjusted to positions, adjusted to isochronism, adjusted to temperature, adjusted to the second.

**Write for FREE Watch Book Today —**

shows newest watch case designs in 4 colors. Read the so-called Secrets of watch-making. Read how you can save from One-Third to One-Half of your money—Buy Direct, cut out the wholesale jeweler's profit.

**EASY PAYMENTS TO SUIT YOU — WRITE TODAY**

Our "Direct-to-You," easy payment plan is explained fully in the Santa Fe Special catalog. Payments are so small you will not miss the money, only \$2.50 a month and you wear the watch right from the start. Sent on Approval Without One Cent Down.

**NEW CASE DESIGNS**

The new watch book shows all the very latest designs of the world's most talented engravers, each case illustrated in beautiful color combinations, showing three color inlay monograms, engraved monograms, fraternity emblems, French art and special designs.

A postal brings the new watch book. Address Dept. 0-6  
**SANTA FE WATCH CO.**  
Topeka, Kan.



**Vitalic Bicycle Tires Deluxe**  
\$8 a pair, Brigadier \$6 a pair—made for endurance  
Continental Rubber Works, 1964 Liberty St., Erie, Pa.

## DODGE BROTHERS MOTOR CAR

## Pulls you out of trouble

Carry this little Pull-U-Out in your tool box and you will be independent of road conditions. With it a boy can, unaided, pull a 5000 lb. car out of ditch or mud. Pays for itself on its first job. Besides pulling autos out of trouble it will do all kinds of lifting and pulling in the factory, garage, on the farm or construction job, etc.

Consists of a winding drum, lever crank, 40 feet of steel cable, two 7 ft. chains and 3 stakes. Weighs only 28 lbs. and goes in space 4x8x14 inches.

A pressure of only 30 lbs. on the handle will lift a ton



Cheaper and better than a chain block. Does jobs no other machine can do.

**WRITE FOR BOOKLET—VERY INTERESTING**  
Tells how and why this marvelous little Pull-U-Out works.

**Pull-U-Out Sales Co., 1435 Syndicate Trust Bldg., St. Louis, Mo.**

## Lift Corns out with Fingers



A few drops of Freezone applied directly upon a tender, aching corn stops the soreness at once and soon the entire corn or callus loosens and can be lifted off with the fingers without even a twinge of pain.

## Freezone

Removes hard corns, soft corns, also corns between the toes and hardened calluses. Does not irritate or inflame the surrounding skin or tissue. You feel no pain when applying it or afterward.

Women! Keep a small bottle of Freezone on your dresser and never let a corn ache twice.

*Small bottles can be had at any drug store in the U.S. or Canada*

THE EDWARD WESLEY CO. CINCINNATI, OHIO

## MAKE \$3,000<sup>00</sup> THIS YEAR

You can do it in a Tire Repairing Business of your own. The one field where there is more work than men to handle it. Easy to learn—Small investment and big profits for you.

### AKRON-WILLIAMS TIRE REPAIR EQUIPMENT

Used and endorsed by 90 per cent of the big tire factories and most successful tire repair shops.

Don't delay. Send for details of our plan to help you start on big-paying basis from the very first day.

**The Williams Foundry & Machine Co.**  
50 Cherry Street AKRON, OHIO





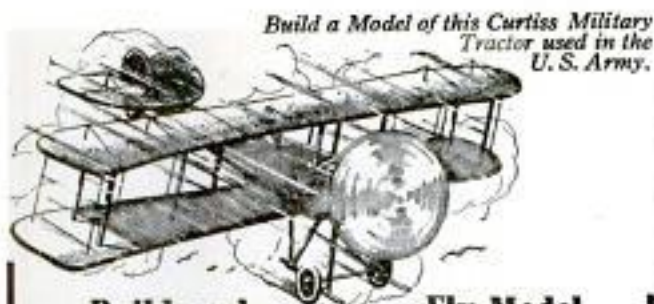

Build a Model of this Curtiss Military Tractor used in the U. S. Army.

## Build and Fly Model War Aeroplanes

that are perfect copies of real, war-famous airships; that rise from the ground by their own power and fly 50 to 100 feet in the air. It's easy! We furnish IDEAL Accurate Scale Drawings and Building and Flying Instructions which show how to construct a 3-foot Model Aeroplane that will fly.

Send Today for These Drawings and Instructions

Curtiss Military Tractor	<b>25c</b>	Wright Biplane
Bleriot Monoplane		Curtiss Hydroplane
Newport Monoplane	<b>EACH</b>	Curtiss Flying Boat
Tube Monoplane	<b>8 for \$1.75</b>	Cecil Peell Racer

IDEAL Aeroplane Construction Outfits, containing all parts and materials needed to build these Aeroplanes, are sold by leading Toy, Sporting Goods and Department Stores. Ask your dealer for IDEAL Aeroplane Construction Outfits. They make building easy!

## Send 5c for This Aeroplane Catalogue

Tells about Model Aeroplanes and how they are built. About Racing Aeroplanes and Flying Toys. Lists all kinds of parts and supplies to build them with. 48 pages for five cents. Send for it today.

IDEAL AEROPLANE & SUPPLY CO.  
82-88 West Broadway New York



Thomas A. Edison

## Mr. Edison's Wonderful New Phonograph

The world's greatest inventor has made the music of the phonograph life-like, at last. Success—after years of labor on his favorite invention! Read our offer on his wonderful new phonograph.



Only **\$1.00** and after trial

An astounding offer—the New Edison, Mr. Edison's great new phonograph with the new Diamond Stylus reproducer and your choice of all the brand new Diamond Amberol Records will be sent to you on free trial without a penny down. The finest, the best that money can buy at very, very much less than the price at which imitations of the genuine Edison are offered—a rock-bottom offer direct from us.

## Entertain Your Friends

Hear all the latest up-to-date song hits of the big cities. Laugh at the side-splitting minstrel shows. Entertain your family and your friends with everything from Grand Opera to Comic Vaudeville—then if you choose, send the outfit back to us at our expense.

## Rock-Bottom Direct Offer

If you wish to keep Mr. Edison's superb new instrument, send us only \$1.00 after the free trial. Pay the balance on the easiest kind of monthly payments.

Think of it—a \$1.00 payment, and a few dollars a month to get this outfit of Mr. Edison's new phonograph with the Diamond Stylus reproducer, the life-like music—the same Diamond Amberol Records—all the musical results of the highest priced outfit—yes, the greatest value for \$1.00 down, balance on easiest monthly terms. Convince your self—a free trial first! No money down, no C. O. D., not one cent to pay us unless you choose to keep the instrument.

## Our New Edison Catalog Sent Free

Your name and address on a postal or a letter (or just the coupon) is enough. No obligations in asking for the catalog. Get this offer—while this offer lasts. Fill out coupon today.

F. K. BABSON  
Edison Phonograph Distributors  
1197 Edison Block  
Chicago, Ill.

Canadian Office:  
855 Portage Ave.  
Winnipeg,  
Manitoba.

Name.....  
Address.....

Gentlemen: Please send me your New Edison Catalog and full particulars of your free trial offer on the new model Edison Phonograph.

To  
F. K. Babson  
Edison  
Phonograph Distributors  
1197 Edison Bk.  
Chicago, Ill.

## Motor Perfection

is what you get in Watkins Class "B" all iron motors. Especially fine for canoes and light boats. Constant and efficient.

3 H. P. single cylinder	45 lbs.
6 H. P. double cylinder	85 lbs.
12 H. P. four cylinder	155 lbs.

Are light, at the same time strong, accomplished by using semi-steel castings, high carbon steel shaft, bronze bearings, high class workmanship.

THE WATKINS MOTOR CO.  
Cincinnati, Ohio  
837-839 W. 6th Street\*

## Mullins Steel Boats Can't Sink

When you think of buying a boat, whether it be a 16-foot Runabout, a big 26-foot Auto Boat, or something in between—remember that Mullins Steel Boats are guaranteed for life. They cannot sink, leak, water-log, dry out or open at the

seams—never require caulking. Designed by America's foremost naval architects—built in the largest boat factory in the world. More than 65,000 in use. Big catalog of steel or wooden motor boats, row-boats or canoes, on request.

THE W. H. MULLINS CO., 52 Franklin Street, SALEM, OHIO

## Universal MARINE MOTOR

9-12 H. P. 4 Cycle 4-Cylinder. Speed range 300 to 1800 R. P. M. Adapted to boats from 14 to 30 feet. Write to

UNIVERSAL MOTOR CO.  
OSHKOSH, WIS. Dept. P

For Bulletin No. 25 giving full description

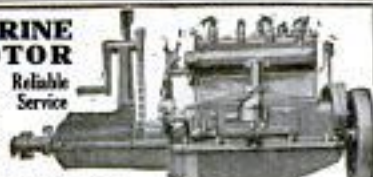

## EVINRUDE

Detachable rowboat and canoe motors. Magneto—Built-In Fly-Wheel Type. Silencer and Automatic Reverse. CATALOG FREE USED BY 25,000'S. OVER 80,000 SOLD

EVINRUDE MOTOR COMPANY  
563 Evinrude Block Milwaukee, Wis.







## SAVE MONEY

AND

Grind Your Own Tools  
Sharpen Your Own Cutlery  
Polish Your Own Silver

ATTACH TO ANY  
SOCKET

Cut down the useless expense of sending your tools, etc., away to be sharpened or polished when you can save many a dollar and lots of time by doing it yourself with a

## Racine Universal Motor

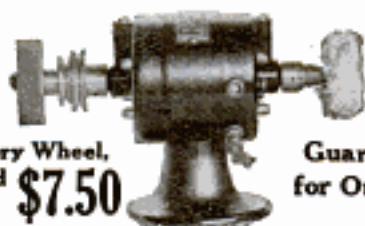

With Emery Wheel,  
Buffer and  
Cord **\$7.50**

Guaranteed  
for One Year

### PAYS FOR ITSELF

Can be attached to any light socket, no fuss—no bolts—no expense. Always handy—never gets out of order. Indispensable for countless small duties—you must be satisfied, or we return your money. Only \$7.50 with all attachments.

Ask your dealer today, or write direct for descriptive circular—It's Free.

**RACINE UNIVERSAL MOTOR CO.**  
53 W. Jackson Blvd., Chicago, Ill.



DEALERS—SEND  
FOR SALES PLAN

## COMPLETE Model Outfit and Instruction Book \$1

Make 3 times as many real working models. Use construction material many times. Buy more at only 50c per 100 ft. Make bridges, wind mills, engines, hoists, battleships. Follow the book or invent your own. Enter our prize contest (see the book).

## FLEXO-BUILD

Strong, thick patented strips in many beautiful colors. Can be bent 2 ways, cut in any number of equal lengths. Practical, inexpensive, serviceable. Buy more as you learn to build. Models taken down or set up without tools. Makes permanent, useful things: baskets, lamp shades, playhouses, etc., or mechanical models and toys that can be taken down.

### Send for Free Book

If you want to see what Flexo-Build makes, get our free book. Or send \$1.00 for outfit. Other outfits at similar low prices. Money back if not delighted with Flexo-Build outfits.

**GAYLORD BROS.**  
510 Clinton St., SYRACUSE, N. Y.

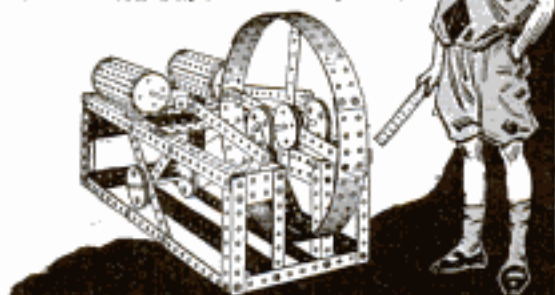

## FURNACE TROUBLE BANISHED LESS FUEL—MORE HEAT

### PILLEY'S CLINKER TONGS

Remove clinkers from furnace while fire is afloat. PILLEY'S CLINKER TONGS are flexible and retain a firm and steady grip on the clinker. Handle guards protect your hands from the heat.



### PILLEY'S CLINKER TONGS

Will save their cost regularly. Less coal required when clinkers are removed. They are made of steel and iron and will last a life-time. SEND \$1.50. We prepay expressage RIGHT TO YOUR HOME. AGENTS WANTED.

**PILLEY MFG. CO.** 611 3rd. St. St. Louis, Mo.

## IF IT ISN'T AN EASTMAN IT ISN'T A KODAK



Thordarson Improved

## TOY Transformer

An ideal Christmas gift for a live boy. Runs a dozen toys at once. Connects direct to light circuit, doing away with heavy, expensive batteries. Large capacity—11 different voltages; absolutely safe. Economical. Lasts forever. **PRICE, \$3.00.**

Write Today for Description

**THORDARSON ELECTRIC MFG. CO.**  
501 S. Jefferson Street CHICAGO



## Touch a Button—Away She Darts!

— out of the yards, down the main line at full speed. Starts and stops at a touch of your hand— from any place in the room. Say, but it's just to have a real Lionel Train!

Unbreakable steel locomotives, passenger and freight cars of all kinds; bright enamel colors that last. Operate economically on battery or house current. Just the Christmas present for a live boy or girl. \$5 and up.

J. Lionel Cowen, Pres. **THE LIONEL MFG. CO.**, 48G, E. 21st St., New York City

### Christmas Catalog

**FREE** Contains the whole Lionel line. Over a hundred pictures. Select your present now— and order from your dealer; if not at your dealer's, order from me. I'll ship prepaid on receipt of price.

# LIONEL ELECTRIC TOY TRAINS

& Multivolt Transformers



# DIAMONDS WATCHES ON CREDIT

## Our Great Special! LOFTIS PERFECTION DIAMOND RING

The most popular Solitaire. Each diamond is specially selected by our diamond experts, and is skillfully mounted in our famous Loftis "Perfection" 14 karat solid gold 6-prong ring, possessing every line of delicate grace and beauty.



Cased in Hardsome Ring Box

**\$5** Down, and \$1.50 a Month,  
buys a \$25 Ring.

**\$15** Down, and \$7.50 a Month,  
buys a \$75 Ring.

**\$10** Down, and \$5 a Month,  
buys a \$50 Ring.

**\$20** Down, and \$10 a Month,  
buys a \$100 Ring.

### For Gifts

All through the year there are gift occasions—such as weddings, anniversaries, birthdays, parting gifts, and the Great Gift Season now approaching. There is no need for you to make trifling presents in order to pay all cash. You can open a charge account with us and make handsome, "worth-while" gifts with very little ready money.

### SEND FOR FREE CATALOG

There are over 2000 illustrations of Diamonds, Watches, Jewelry, etc. Whatever you select will be sent, all shipping charges prepaid.

You see and examine the article right in your own hands.

If satisfied, pay one-fifth of purchase price and keep it; balance divided into eight equal amounts, payable monthly.

Our Catalog shows all the new watches—15, 17, 19, 21, 23 Jewels, adjusted. Guaranteed by the factory and further guaranteed by us. Watches that pass railroad inspection as low as \$2.50 a month.

Every article in our Catalog is specially selected and priced direct to you with no middle-man's profits to pay.

**LOFTIS** The National Credit Jewelers  
Dept. E894 108 N. State St., Chicago, Ill.  
BROS & CO. 1932  
STORES IN LEADING CITIES

### WRITE FOR FREE BOAT BOOK



Build your own boat—From \$3 up for full-sized patterns—\$33 buys complete frame, 12-pk. 23-ft. Motor Boat. Write today.  
BROOKS MFG. CO., 821 9 Rust Av., Saginaw, Mich.

### GET THIS CATALOG

FULL OF VALUABLE INFORMATION TO EVERY BOAT OWNER ON

RACING PROPELLER WHEELS,  
REVERSE GEARS AND  
MARINE ACCESSORIES

LARGE CATALOG FREE. SEND TODAY

MICHIGAN WHEEL CO.  
1139 MONROE AVE., GRAND RAPIDS, MICH.



### Get this LA Engine Book



—it gives valuable information about motor boat engines. It also describes the full line of L-A motors and tells of the 30 days' free trial plan. Write for your copy today.

LOCKWOOD-ASH MOTOR CO.  
1430 Horton Ave. Jackson, Mich. (27)

### 30 Days Free Trial

and freight prepaid on a new 1918 "RANGER" bicycle. Write at once for our big catalog and special offers. Take your choice from 44 styles, colors and sizes in the famous "RANGER" line.

Marvelous improvements. Extraordinary values in our 1918 price offers. You cannot afford to buy without getting our latest propositions and Factory-to-Rider prices.

Boys, be a "Rider Agent" and make big money taking orders for bicycles and supplies. Get our liberal terms on a sample to introduce the new "RANGER."

TIRES equipment, sundries and everything in the bicycle line, at half usual prices. Write today. A post card will do.

**MEAD CYCLE COMPANY**  
Dept. 6108, Chicago

Ranger  
Electric  
Lighted  
Motorbike

# Yes Sir - I Can SAVE YOU Money on that ENGINE



I will put you on the "inside" in the engine question. I'll make it possible for you to buy your engine at wholesale—yes, and even less because I sell direct-to-you from my immense engine factory and save you 25% to 30% on just the engine you want. I guarantee satisfaction or money back. I have been building gasoline engines for fourteen years and my engines have

Because of rapidly rising costs my low prices cannot last. Act now!

## Proved Quality in 11,000 Users Hands

Everywhere, in all parts of the country, on all kinds of work you'll find Galloway Engines on the job delivering 100% service. I make all kinds—from the small 1 3/4 horse-power—to the big, powerful horse drawn—16 horse-power. For every kind of a power work there is a Galloway Engine just built to do it.

### Mail Coupon for Book and Low Price

and full information. It explains my special engine features and improvements; Valves in the head, like high class automobile motors—Economy carburetor—cuts down fuel bills—makes easy starting in all weathers—frost-proof cylinder and water pot; my blue hot spark magnets and new make and break igniter which never misses fire. Write today. Mail Coupon below for low prices.

WM. GALLOWAY CO., Box 965, Waterloo, Iowa

1 3/4  
H.P.  
to  
16  
H.P.

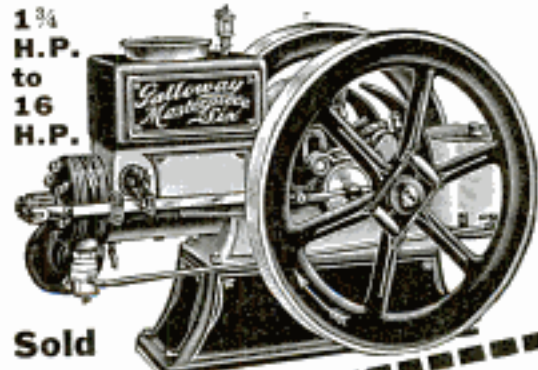

Sold  
on  
90 Days  
Trial  
Test

### MAIL ME THIS!

WM. GALLOWAY CO.  
Box 965, Waterloo, Iowa

I am interested in Gas Engines—send me your Book and low prices.

Please Mention Popular Mechanics



Take Pictures with—

The **EXPO WATCH CAMERA**

A camera that closely resembles a watch in size and appearance—takes pictures  $\frac{1}{2} \times \frac{3}{4}$  inches as shown on margin. Easy to operate. It's a camera for both amateur and professional.

**Surprise Your Friends**

Take their picture in the act of doing some funny stunt. Next time you see them produce the print. You will have a lot of fun over their bewilderment and catching people in queer and awkward positions. Carry the EXPO about in your pocket—easily concealed in the palm of the hand—picture can be taken unobserved. Produces clear, sharp negatives, indoors or outdoors equal to any camera on the market.

**One Cent a Picture**

The EXPO loads in daylight with a 25 exposure film costing 25c. A whole day's outing picture taking can be had for the small sum of 1c a picture. Films are also made in 10 exposures for 15c. Photos may be enlarged to any size. We have Automatic Enlargers specially made for the purpose, that may be had any time.

**Quick as a Flash**

The EXPO takes pictures through the stem, where the rapid fire lens is located. Equipped with a time and instantaneous shutter. Weights but three ounces and is highly nickel-plated. Endorsed and in constant use by the police, newspaper reporters, detectives and general public. Important evidence can be secured with a camera of this kind. Sold under a positive guarantee. Delivered to any address in the world.

**\$2.50**

For EXPO WATCH CAMERA, postage 10c extra. Films, 25 Exposures, 25c—10 Exposures 15c. Leather Pocket Carrying Case 35c. Adjustable View Finder for Watch Camera 50c. **JOHNSON SMITH & CO., Dept. 51, 54 West Lake St., CHICAGO**

Johnson  
Smith & Co.

Dept. 51  
54 W. Lake St.  
CHICAGO, ILL.

Please send me one EXPO  
WATCH CAMERA for which  
I enclose \$2.50 and 10c to  
cover postage.

Name \_\_\_\_\_

Street Address \_\_\_\_\_

City \_\_\_\_\_



Be Sure It's **"POROSKNIT"**  
**GENUINE SUMMER UNDERWEAR**  
Cool, elastic, comfortable—**GUARANTEED**  
Chalmers Knitting Co., 78 Washington St., Amsterdam, N. Y.

## DIAMONDS- AND WATCHES ON CREDIT

**GREAT DIAMOND SALE**

The most astounding sale of perfect cut diamonds ever offered.

**TERMS LOW AS \$1.50 PER MONTH**

It is your opportunity to get that long wanted diamond at a bargain.

This is an Extraordinary Saving.

**SPECIAL \$39.50**

**GENUINE DIAMOND RING**

A wonderful value, \$4.50 per month.

**SENSATIONAL ELGIN WATCH SALE.**

**\$12.50 Famous Genuine Elgin**

**Watch 17 Ruby Jewels**

Guaranteed Factory Tested and Adjusted

Easy Payments \$2.00 Per Month

**30 DAYS' FREE TRIAL**

Any watch you want on easy payments. Be

sure to send for our 112 page catalogue. Over

2000 suggestions. Watches, Jewelry, Diamonds.

This book describes our big bargains in all lines.

All sold on Easy Payments and Free Trial.

Send for it this minute. A postal will bring it.

**ALFRED WARE COMPANY. Dept. 781 St. Louis, Mo.**

# Big Free Catalog

## THIS BUNGALOW \$900 CAN BE BUILT FOR

This and many others in my new book, Building Plans for Modern Homes, will save you hundreds of dollars. One of the most complete and comprehensive books of plans ever published by any architect. Fifth edition just off the press. Two hundred and fifty floor plans and photographs of bungalows, etc., costing from \$200 up 1 gives sizes and cost to build. Sent postpaid for \$1.00



**FREDERICK H. GOWING  
ARCHITECT**

18 Tremont St., BOSTON, MASS.

## "BOW LEGS and KNOCK- KNEES" UNSIGHTLY

SEND FOR BOOKLET SHOWING PHOTOS OF MEN WITH AND WITHOUT THE PERFECT LEG FORMS  
**PERFECT SALES CO., 140 N. May-  
field Ave., Dept. 5 Chicago, Ill.**

## Comfort Indoor Closet

Odorless, Sanitary, Germ-proof. Can be placed anywhere in home. A guarantee of healthy, sanitary conditions. 30 days' Free Trial.

**SWAT FLY BREEDING CLOSET**

Have city conveniences. Germ-life killed instantly by chemicals. Employed once a month. Needs no other attention. Boards of Health endorse. Write for literature.

Agents wanted—exclusive territory  
**COMFORT CHEMICAL CLOSET CO. 330 Factory Bldg.  
TOLEDO, OHIO**



Used by All Leading Makers  
As Regular Equipment

# Firestone

Motorcycle  
**TIRES**

Please Mention Popular Mechanics



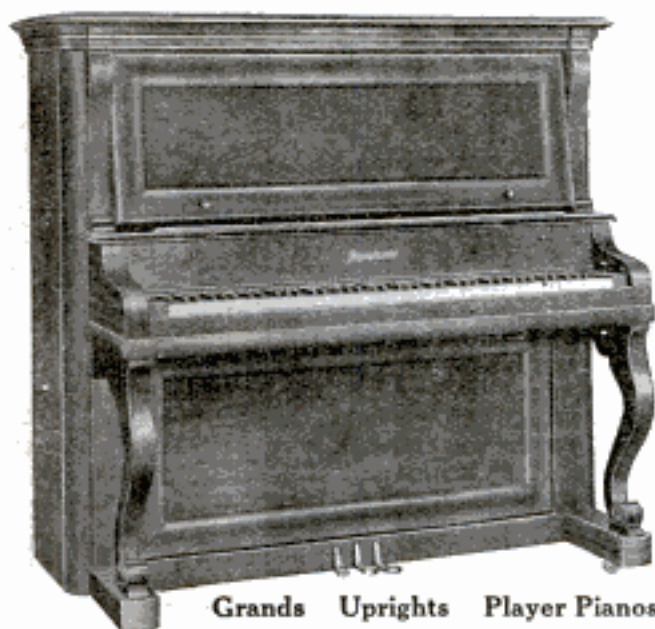

Grands Uprights Player Pianos

## \$5 Brings This Superb Symphonic Piano

Try it a month in your home. Invite other good musicians of your acquaintance to pass judgment on this instrument. Then if you do not agree that it is by far the best Piano value ever brought to your attention, the trial will be at our expense. Our Factory-to-Family plan saves you much money. It brings you a high quality piano on easy payments which may cover four years.

### Ask Today For Your Piano Book

It shows Symphonic Pianos, Symphonic Player Pianos, and GRAND Pianos in actual colors. Tells about our convenient offers. Before you buy any instrument, get this FREE book. Write today and please state instrument interested in.

Larkin Co. Desk PM-1017 BUFFALO, N. Y.

## Bausch and Lomb BALOPTICON

THE PERFECT STEREOPTICON

Bausch & Lomb Optical Co., 576 St. Paul St., Rochester, N. Y.

## FREE STEEL SHOE BOOK SAVES \$20



Tells all about my Celebrated Steel Shoes. One of the greatest inventions in footwear the world has ever known. Over a million people now wearing them. Wear as long as three to six pairs of leather shoes. Easiest, most comfortable shoes you ever had on your feet. No cold, wet feet. Therefore Pains, Rheumatism, Grip, Lumbago, Lamé Back, and other ailments prevented. 1/2" soles, bananas or tender, lined feet. Write today for my free book.

Investigate this wonderful proposition.

Address: RUTHSTEIN, Steel Shoe Man, Dept. 32, RACINE, WIS.



## I will send my 25c Book STRONG ARMS and MILITARY SHOULDERS

for 10c in stamps or coin

Illustrated with 20 full-page half-tone cuts, showing exercises that will quickly develop, beautify and gain great strength in your shoulders, arms, and hands, without any apparatus.

PROF. ANTHONY BARKER  
Studio 640, 127 West 42nd Street, New York

## KEITH'S \$1 Offer

1st—A 100-page number of Keith's Magazine, a special number devoted to Bungalows. 2nd—A big book containing up-to-date designs for 100 ARTISTIC HOMES. 3rd—A four months' subscription to the well known and leading authority for home builders, Keith's Magazine. \$2.50 a year, 25 cents a copy. Newsstands.

ALL THE ABOVE, SPECIAL \$1.00

KEITH'S, 750 Met. Bank Bldg., MINNEAPOLIS, MINN.



## Here's Health

—vim, vigor, vitality! The keen, vivid relish of youth for work and pleasure! Snap, ginger, punch in every thought and action! The joy of glorious health, strength, power, life—yours through vibration.

Wake up that sluggish circulation! Send the rich, red blood leaping along through every vein and artery! Tune up those jangled nerves! Stir up those sluggish organs! Flood your whole body with health! Don't be satisfied with mere existence! **Begin to live!**

## Arnold Vibrator

Try this wonderful machine yourself. Test it on your own body. Notice the difference after the very first treatment. See how pleasant and easy it is to use—how marvelous the results. And don't forget that these results are permanent because vibration gets right at the cause of things—goes to the very root of the trouble. Aches and pains vanish like magic. You don't need to take anybody's word for these things—you can find out for yourself.

## 10 Days' Trial Free

Get the facts about our generous free trial offer. Learn how you may get these things yourself at our risk, and if you are familiar with the prices asked for ordinary vibrators you will be amazed to find how much less it costs to own the genuine guaranteed Arnold Vibrator. When there is so much at stake why risk buying an imitation unknown machine? Insist on the Arnold. Ask for it by name.



## 80-Page Book Free

Your name and address on the coupon or a postal or letter brings you valuable 80-page book on Vibration free and full particulars of our special offer.

ARNOLD ELECTRIC CO., 1485 W. 12th St., Racine, Wis.

## Mail Coupon For FREE Book

ARNOLD ELECTRIC CO., 1485 W. 12th St., Racine, Wis.

Please send me your big illustrated Book and 10 days' TRIAL REDUCED PRICE OFFER, all free.

Name .....

Street .....

City.....State.....

Please Mention Popular Mechanics



# Belber

## TRAVELING GOODS

### Man's Suit Case

No. 682 Black  
No. 686 Brown

A sturdy, well made suit case in small cross-grain effect. Has sewed-on, heavy corners, sewed-on loops, heavy strap all around, reinforced by two strong belts and side lisp lock. Durable lining and equipped with BELBER FITALL to hold your own toilet articles.

24 inch size, \$10.00  
26 inch size, 12.00



**B**UILT to stand the hardships of the road yet natty in design and luxurious in appearance. Rugged, sturdy, handsome bags and suit cases made by master bag makers and constructed of Du Pont Fabrikoid, Craftsman Quality—the very best Fabrikoid made. Each bag or suit case doubly guaranteed by these quality trade marks.



Sixteen styles for men and women

**\$7.50 to \$12.00**

At the better shops and department stores

Write for illustrated booklet

**The Belber Trunk and Bag Co.**  
Turner & Mascher Streets, Philadelphia, Pa.

### Super-Sensitive Microphone Only \$7.50

This instrument is offered at an extremely low price. It is excellent for building your own amplifier. Can also be used in many experiments where a sensitive microphone is required.

### Detectograph, \$15

This detecting instrument of marvelous sensitivity can be used for detecting secret conversations. Outfit consists of Sensitive Transmitter, 25-ft. Black Cord, Receiver, Headband, Case and Battery.

Send for One Today and Convince Yourself.

Detectograph, \$15

### THE \$15 MICROPHO DEAF-PHONE

is a super-sensitive instrument which has been developed to meet the demands for a practical and efficient hearing device at an extremely low price. It is equal to any \$35 instrument made and superior to most of them. The outfit consists of One Super-Sensitive Transmitter with cord connector; One Super-Sensitive Ear Piece with small black cord; One Black Single Headband; Black Case and Two Batteries. Ships today in its basket.

### MICROPHO-DETECTOR COMPANY

Gaston Boissonnault, President

25 DEY STREET

NEW YORK

Makers of Super-Sensitive Microphone Apparatus

### WANTED EXCEPTIONAL MEN



Attaches  
to the  
Door

rights and a discount that will make you more money than any other business proposition ever offered. The Season is HERE and you must act QUICK. Send for particulars; also mention what territory you would prefer.

Crown Fuel Saver Co., 323 W. Lake St., Chicago

### Sell Crown Fuel Savers!

Guaranteed to save 20% in fuel or No Pay. Every Coal Buyer owning a Heating plant is a prospective customer. If you are a capable man you can build a mighty big business in your locality.

### We Do Not Sell Territory!

But if you are a live wire, able to place a small order to start, ordering larger quantity later, we will give exclusive selling

### Be a Taxidermy Artist



### Marvelous Book Sent FREE

You can now learn Taxidermy, the wonderful art of mounting birds, animals, fanning skins, etc. Learn at home, by mail. The free book tells how. Mount your own trophies. Decorate homes and den. Hunters, trappers, nature lovers, you need taxidermy. Interesting, fascinating, big profits. Join our school, 25,000 students. Success guaranteed. Get our free book without delay. Send right now—today.

N. W. School of Taxidermy, 1197 Elwood Bldg., Omaha, Neb.

## WATCHES — WATCHES — WATCHES

The lowest price and best terms for standard makes, including the famous 19-jewel Illinois Rockland. SEND FOR ACTUAL PHOTOGRAPH—SHOWS CASE AND MOVEMENT.

**LENOX JEWELRY Co.** 373 Washington St., BOSTON, MASS.

Our prices on easy payment plan are lower than others charge for cash.





## Bring a Great Stove Factory Direct to Your Door

**THAT'S** practically what you do in getting this new big Kalamazoo catalog. You get a picture exhibit of the highest quality stoves, ranges, furnaces and kitchen cabinets ever made—all quoted at money-saving "direct-to-you" wholesale prices.

**Write Today** and learn why Kalamazoo customers in nearly every county in the United States saved money and are boosting for Kalamazoo quality. Learn how you can heat your home at lowest cost this winter. See how easily you can own and enjoy the comforts of a Kalamazoo Pipeless Furnace—heat your entire home through one register. Easy to install. Burns any fuel. Cash or easy payments; 30 days' trial. Quick shipment; no waiting. **We pay the freight** and guarantee safe delivery. Write today. Ask for Catalog No. 473.

**Kalamazoo Stove Co., Mfrs.,**  
Kalamazoo, Michigan

We manufacture Stoves, Ranges, Gas Ranges, Furnaces, Kitchen Cabinets and Tables.



**"A Kalamazoo Direct to You"**  
Trade Mark Registered



### Make Yourself as Healthy and Attractive As You'd Like to Be

Enjoy vigorous, glorious health. Wonderful new invention—most scientific, successful, natural way of acquiring beauty and health. Users astonished at results.

## The Violetta

most advanced design of Violet Ray Instruments. Fairly saturates system with beauty and health-giving life. Enriches blood with ozone. Massages tissues with action of Violet Ray. Strengthens entire body. Brings glow of natural feeling, inevitable beauty and health. A delight to use. No shocks. Remarkably speedy benefits.

No other method of Beauty or Health Culture compares with it. Wonderfully effective in treatment of skin affections and scalp diseases. The most successful means of relieving ailments of any nature. Send now for free booklet that shows how to make yourself as attractive as you'd like to be.

**BLEADON-DUNN CO.**  
Dept. C, 11 So. Desplaines St., Chicago, Ill.



## What a wonderful Christmas Present this would be!

Here are five combinations of the finest rods and reels ever produced by one of the world's most successful fishing tackle manufacturers. Bristol No. 11 all purpose Rod, \$4.50 to \$6.50 and Meek Blue Grass Reel No. 5 at \$15.00; "Bristol" No. 33 Bait Casting Rod, \$12.00 and Meek Blue Grass Reel No. 25, \$10.00; "Bristol" DeLuxe Bait Casting Rod, \$25.00 and No. 3 Meek Tournament Reel, \$33.00; "Bristol" No. 8 Fly Rod, \$4.50 to \$6.50 and No. 33 Meek Blue Grass Reel, \$7.50 and "Bristol" DeLuxe Fly Rod, \$25.00 and Meek Reel No. 32, full jeweled, \$32.00.

Both Catalogs Free giving full information and descriptions  
**The Horton Mfg. Co.** 196 Horton Street  
BRISTOL, CONN.

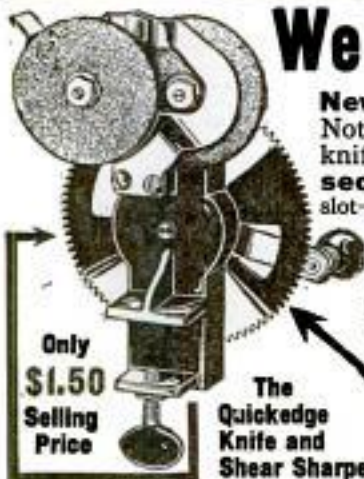

Only  
**\$1.50**  
Selling  
Price

The  
**Quickedge**  
Knife and  
Shear Sharpener

## We Want Agents at \$30 to \$75 a Week

**New Invention**—Just out. Needed in every home every day. Patented. Nothing else like it. Low priced—**Sells on sight.** Sharpens any kitchen knife, paring knife, carving knife, bread knife, or shears and scissors in **ten seconds.** Mechanical masterpiece. A child can use it. Just put knife in slot—turn crank—sharpens both sides at once automatically. **We want representatives at once**—men and women hustlers. Get this position where **profits start first day.**

**No Experience Necessary — 200% Profit**

Make as much money next week as these men are making now. J. C. Lewis, of Kansas, says: "I have sold one hundred sharpeners in four days." Hobart Kerr, of Md., writes: "The women can hardly wait till they get them." Herbert Cain, of Ky., sold nine after supper. At the end of the first day, J. W. Gordon, of Pa., writes: "I sold two dozen and I sold to every one I saw." Wm. G. Hall, of N. J., says: "I think it is great. I sold six in about one-half hour. The machine is a mighty fine proposition. I am a mechanic and I know what I am talking about." You can make this money. **WRITE TODAY. TERRITORY FREE. GET BUSY AT ONCE.**

**QUICKEDGE SHARPENER CO.,** 690 Sharpener Bldg., 215 N. Desplaines St. **CHICAGO, ILL.**





**KEEP YOUR CAR YOUNG  
PAINT IT YOURSELF WITH**

**Effecto  
AUTO  
FINISHES**

A coat or two of Effecto will do the trick, without the loss of your car for more than one or two days. Not a wax or polish, but a durable, quick-drying, high-luster auto enamel, made in seven beautiful colors. Sold by paint, hardware and auto accessory dealers. Send for Color Card. Pratt & Lambert-Inc., 153 Tonawanda Street, Buffalo, N. Y. In Canada, 99 Courtwright Street, Bridgeburg, Ontario.

**MADE BY THE MAKERS OF  
PRATT & LAMBERT VARNISHES**

WEAR

Trade Mark  
Registered

**B.V.D.** U. S. Patent Office  
and Foreign Countries

UNDERWEAR



**10 Cents a Day Pays for This Symphonola**

Plays all records, Victor, Columbia, Edison, Pathe, Little Wonder, Emerson. You may make a year to pay, after 30 days' trial. Compare its tone for clearness, sweetness, volume with much more costly instruments. Make the test in your home. Return after trial at our expense if it fails to make good. Send a postal today for the

**Beautifully Illustrated Symphonola Book FREE**

It shows this and other Symphonola Styles, all sold on easy payments the Larkin Factory-to-Family Way.

**Larkin Co.** Dept. SPM-1017 Buffalo, N. Y.

GREEN AUTOMATIC  
MACHINE



**Let This Machine Grind Out Money for You**

**THE GREEN AUTOMATIC MACHINE \$10 A DAY AND UP**

Sharpens, Honors and Strops all kinds of safety razor blades in one operation, from four to six blades in one minute. For both quality and quantity this machine is in a class by itself. There is nothing like it on the market. Let us send you our free booklet explaining everything, including the "AMERICAN" Key Cutter—cuts square, angular or round slots.

**AMERICAN SHARPENING MACHINE CO. (Inc.), 184 W. Washington St., Dept. 10, CHICAGO**



"AMERICAN"  
Key Cutter

**DIAMONDS  
WATCHES & JEWELRY**

**Unusual Values**  
in perfect cut, blue white diamonds exceptionally brilliant and sparkling. Charge accounts opened with any honest person, on easy terms.  
**20% down—10% a month**  
No interest charged or security required. You take no risk. If not an unusual value return the goods at our expense, money refunded.  
Guarantee certificate with every diamond attesting its value and providing for exchange at full purchase price. Send for Catalog No. 3. It's free.  
Note new address, No. 1 Maiden Lane.  
**J. M. LYON & CO.**  
Established 1843  
1 Maiden Lane, New York, U.S.A.  
Northeast cor. Broadway

**Rider Agents Wanted**



in each town to ride and show a new 1918 model "RANGER" bicycle. Write for our liberal terms.

**DELIVERED FREE** on approval and **30 days' trial**. Send for big free catalog and particulars of most marvelous offer ever made on a bicycle. You will be astonished at our low prices and remarkable terms.

**FACTORY CLEARING SALE**—a limited number of old models of various makes, \$9 to \$15. A few good second-hand wheels \$5 to \$8. Write if you want a bargain.

Tires, lamps, wheels, sundries and repair parts for all makes of bicycles, at half usual prices. Write us before buying.

**MEAD CYCLE CO., DEPT. G108, CHICAGO**

**LEARN MILITARY FRENCH  
ON YOUR OWN PHONOGRAPH**



with disc records from the Cortina French-English Military Manual by J. A. Fiorard of the French Army. Foreword by Major-General Leonard Wood. SEND FOR FREE CIRCULAR.  
**CORTINA ACADEMY OF LANGUAGES**  
Suite 2280, 12 East 46th St., New York

**Spanish-French-English-Italian-German**

**NOW TIME TO START**

To Take Care of Food Shortage This Winter

An uncrowded occupation. Exceptional opportunities for live men and women. Raised at home. Only small space needed. Small expenditure will start you in a practical money-making enterprise. Big Profits. Booklet telling all free. Write.  
**Nat'l Spawm Co., Dept. 12, Boston, Mass.**



**MONEY  
IN  
MUSHROOMS**



## Save Laundry Bills



### Challenge Cleanable Collars

Insurance against soot, crocking, and rain or perspiration wilting. The appearance, fit and flexibility of your "linen" collar—with not starch but water-proof stiffening. Ever white. Dull linen finish.

30c each. Order a half dozen from your dealer or send direct. State your style and (half) size. Booklet on request.

E. I. Du Pont de Nemours & Co.  
The Arlington Works  
725 Broadway New York 

### Unframed Pictures

Easily and quickly displayed on walls without marring the paper or plaster by using

#### MOORE PUSH-PINS

Glass Heads, Steel Points

Moore Push-less Hangers, the Hanger with a Twist, for framed pictures, mirrors, etc.

At Stationery, Hardware, Drug and Photo Supply stores. In Canada 13c. Sample and Booklet Free. Write Dept. 36.

MOORE PUSH-PIN CO., Philadelphia, Pa.

### THE "ELECTRO" TELEGRAPH

is not a toy, but a practical, honestly built telegraph outfit, which not only sounds but works like the big commercial instruments. By studying the code for 30 days you can become a first-class telegraph operator. Such operators are in big demand now. Outfit consists of TWO complete telegraph instruments, each measuring 3 1/2 x 2 1/2 x 2 1/2. All metal parts are lightly nickel plated, including key lever, note hard rubber knob. Telegraph Code Chart, telegraph blanks and connecting wire come with set, but no batteries. Outfit works on two dry cells (one cell for each instrument). The "Electro" is the ONLY outfit that works both ways; each station can call; no switches, no extras. Nothing to get out of order. Guaranteed to please you or money back. Price complete as illustrated.

**\$1.25**

AT ALL GOOD DEALERS AND DEPARTMENT STORES

If your dealer cannot supply you send us \$1.25 for outfit and add mailing charges for two pounds, otherwise we ship express collect. Goods shown here are only a fraction of our wonderful assortment illustrated and described in our great 228-p age *Electrical Encyclopedia*, contains more information than most electrical works. Also contains twenty coupons for free Wireless Course.

Electro Importing Co., 245 Fulton Street, New York City

#### TELEGRAPH CODES



**\$1.25**



*Encyclopedia*  
Sent FREE on receipt of 6c in cover postage  
Send for your copy today

Please Mention Popular Mechanics



**ONE MILE IN 38 1/10 SECONDS**  
MADE BY STROMBERG EQUIPPED CHALMERS STOCK CHASSIS  
**WITH FAN REMOVED**

That record was hung up by Joe Dawson, May 4th at Jacksonville, Fla. Chances are you'll never want to split seconds with so swift a pace. That doesn't matter—doesn't enter into the consideration. All you care about is this—the

### New Stromberg Carburetor

—a stock carburetor at that—*must* have given perfect performance—*must* have delivered the proper gas mixture at the proper time—or that speed could never have been attained.

That's the "meat of the matter"—*proper performance*—greatest power—swiftest speed. If Joe Dawson got it from a *Stromberg* equipped stock car—with *fan removed*—it's certain you'll get the same high standard of efficiency and linked with it greatest economy. Let us convince you of that with a 10-day trial on your car.

Send now for full particulars, giving name, year and model of your machine

**Stromberg Motor Devices Co.**  
Dept. 1014. 64 E. 25th St., CHICAGO

**New STROMBERG Does it!**  
CARBURETOR



# WANTED IDEAS



Inquiries from Manufacturers and Other Buyers of Patents  
Who Are Looking for Good Ideas

## Protected by Owen Patents

Are constantly being received. Hundreds of ideas are wanted—a market exists for them to-day. YOURS may be one of them. Send for my free books and see for yourself—read the requests for inventions protected by me. Many are simple. You can help supply this demand.

As soon as my clients' rights are protected I aid in every practicable way, without charge, to sell. Their applications are advertised free—their patents are called to the attention of the proper prospective buyers—every necessary thing is done. Get my booklets and see.

### THESE ARE FREE

You will incur no obligation by writing me. A simple request will bring them to you—the finest, most reliable and instructive patent books published. A postal will do.

**"Successful Patents"**—a 72 page guide book, tells how to proceed; describes my advantageous business methods; gives references, testimonials, etc.

**"Stepping Stones"**—gives hundreds of hints of inventions wanted; articles from interviews of noted authorities; tells the truth about prizes for inventions.

**"Patent Promotion"**—tells you how to sell; why some inventors fail; discusses the value of your idea; how I aid my clients; manufacturing aids furnished you; recent successful patents, etc.

**"Patent Buyers"**—Publishes letters, and abstracts of letters, from over 400 of the many manufacturers, and other patent buyers, who wish to buy, or obtain on royalty, Owen Patents on innumerable inventions of interest to them.

You will also be sent from time to time, as new inventions are wanted, full information concerning them. Only in this way can you keep up to date.

**WRITE FOR THESE TO-DAY**—Advice costs nothing. All communications confidential. Your work will receive my personal supervision—but my fees are no higher than others.

### Results Speak Loudest—But Here Are Some References

Columbia National Bank,  
Washington, D.C.  
National Locktite Co.,  
Washington, D.C.  
The Carnahan Press,  
Washington, D.C.  
Lightning Gun & Cycle Works,  
Oklahoma City, Okla.

Antholene Mfg. Co., Hutchinson, Kan.  
National Rack Co.,  
61 Hanover St., Boston, Mass.  
The C. J. Loftus Co.,  
13 Spring Common, Youngstown, Ohio.  
Whitehead Hosiery Mills,  
Burlington, N. C.  
Dickinson Mfg. Co., Des Moines, Iowa.

A LARGE NUMBER OF OTHERS IN MY BOOKLETS.

**RICHARD B. OWEN** 9-303 OWEN BLDG.  
WASHINGTON, D. C.  
NEW YORK OFFICE: 22nd Floor Woolworth Building

Inventors submitting their inventions to me are protected in a tangible manner until their applications are filed.

### Nuts for You to Crack

Invent something for which a demand exists—for which there is a waiting market. Here are abstracts from a few recent requests—hundreds are published in full in my literature. Can you invent any of these? Watch this list each month.

A rich Eastern company desires to purchase patents upon improved "rifles, guns, cannons and machine guns of any kind." The European War has created an insatiable demand for anything in this line.

A very well known company manufacturing sheet metal products desires to purchase patents upon "revolving or stationary ventilators, such as used by schools and mills, or some window ventilators made of sheet metal." They are also interested "in steel window sash or upon skylight frames made of wrought sheet steel."

An Eastern financier wants to obtain a patent upon a dry cell (electric battery). Past experience has shown that there is a great demand for anything of this kind.

A very successful promoter desires to take up the promotion of patents covering improvements "on auto trucks and farm machinery." He is also interested "in improved railroad cars, both freight and passenger."

### SPECIAL FREE REPORT

Send sketch or model of your invention for free report on patentability, practicability, etc.



# Wanted—Ideas

Inventors! Send for these Remarkable FREE BOOKS, Today

## "Inventions Needed"

This book lays before you a description of the active and profitable field of invention. It tells you the inventions the world needs today, the devices manufacturers are seeking for their business, the ideas for which the public will pay big money.

## "How to Get Your Patent"

This book is a guide to the inventor. If you have invented something and desire to learn what it will cost you to get your patent and what you must do to find your market, read this book.

## "Special Bulletin of Patent Buyers"

This bulletin contains letters from men who are seeking to purchase patents. We act as intermediary without one cent of charge, between the man who invents and the man who invests.

Send Model or Sketch and description of your invention for Free Opinion as to patentability

*Rejected and Difficult Cases are Our Specialty*

**RANDOLPH & CO.**

600 F St., N.W., Washington, D.C.

**RANDOLPH & CO.**

600 F St., N. W., Washington, D. C.

Gentlemen: Please send me without obligation on my part, the books indicated on margin of this coupon. (Write on margin of coupon, names of books desired.)

NAME.....

STREET.....

CITY.....STATE.....

## Protective Patents

Procured Promptly. No fee refund, no guarantee certificate, no so-called prize or free search schemes used in our business. Inventors 104 page Blue Book sent on request.

Robb & Robb, 211-215A Southern Bldg., Washington, D. C.

Send for FREE BOOK { WHAT TO INVENT  
WHAT NOT TO INVENT  
HOW TO SELL YOUR PATENT

Nearest Patents and report in each case to be filed—no charge  
H. L. WOODWARD, 9th and G Sts., WASHINGTON, D. C.



MECHANICAL SUPPLIES AND MATERIAL of all kinds.

EXPERIMENTAL AND LIGHT MACHINE WORK to order.

132 MILK STREET. BOSTON

Models and Gears

Experimenters—Inventors

Developing inventions and making working models our specialty. Well equipped shop and staff of experts at your service. Carry complete stock of gears. Shipments same day order received. ESTABLISHED 1882.

UNION MODEL WORKS, 121 S. Clark St., CHICAGO



AGENTS \$60 WEEKLY

Robinson Folding Bath Tub. Big seller. Costs little, no plumbing, little water. Weight 15 pounds, folds into small roll. Full length baths, far better than tin tubs. Guaranteed 10 years. \$10 a day easily made. Write for free tub offer.

ROBINSON CABINET MFG. CO. 4740 factories Bldg., Toledo, Ohio



\$500 REWARD

We will pay \$500.00 reward to anyone who can permanently dim the brilliancy of the RAJAH Im. diamond without destroying the stone.

RAJAH Im. Diamonds

They stand all diamond tests—fire, acid, file, and glass cutting. Their brilliancy is eternal. Guaranteed for a lifetime. Set in solid gold, and sent to you on 30 Days' Free Trial. If you can tell it from a real diamond, we'll return it. Send today for our beautiful, FREE illustrated jewelry catalog in colors. Write now. KRAUTH & REED, 159 N. State St., Dept. P-2 CHICAGO, ILL.

A YEAR TO PAY

## HIGH-VALUE PATENTS

the ONLY kind Wanted and BOUGHT by Manufacturers. Send 5c. postage for new book of Extraordinary Interest to Inventors

R. S. & A. B. LACEY, 51 Barrister Building, Washington, D. C.

## PATENTS

C. L. PARKER

Formerly Member Examining Corps, U. S. Patent Office

PATENT LAWYER

MCGILL BLDG.

WASHINGTON, D. C.

Patents, Trade Marks, Copyrights, Patent Litigation

Handbook for Inventors, "Protecting, Exploiting and Selling Inventions," sent free upon request.

## PATENTS SECURED OR ALL FEES RETURNED!

THAT PAY ACTUAL FREE SEARCH of Patent-Office Record as to Patentability of your invention

With each favorable report we issue a Contract to Return All Fees!

Send data at once by registered mail and we will promptly advise how OUR CLIENTS PROCEED TO MAKE FORTUNES. Over \$627,212.00 made by clients.

Patents Sold FREE: Read "Patent Sales Department" of our 190-page Guide Book, FREE!

Don't miss this book. Mail postal today.

E. E. VROOMAN & CO., 871 F Street, WASHINGTON, D. C.



# PATENTS TRADE-MARKS AND COPYRIGHTS

LARGEST PATENT FIRM  
IN THE WORLD

## SPECIAL OFFER Free Opinion as to Patentability

Before sending your invention to any attorney or manufacturer or disclosing your invention, write for our free blank form **PROOF OF CONCEPTION** in order to protect your invention and secure your rights. This should be signed and witnessed and returned to us, together with a model or sketch and description of your invention, and we will give a **FREE OPINION** as to the patentability of the invention. If we report the invention patentable we will furnish a Certificate of Patentability.

**VICTOR J. EVANS**

**This Certificate of Patentability, together with our blank form Proof of Conception will protect the inventor and serve as proof of the invention until the case can be filed in the U. S. Patent Office.**

**Obtaining Assistance for Inventors**—Our certificate is of great assistance to inventors who require financial aid to obtain patents.

## OUR FIVE BOOKS MAILED FREE

(See Coupon Below)

to any address. Send for these books—the finest publications ever issued for free distribution.

### How to Obtain a Patent

Our illustrated eighty-page Guide Book is a book of reference for inventors and contains 100 mechanical movements, illustrated and described. Tells how to invent for profit.

### What to Invent

Contains a valuable list of inventions wanted and suggestions concerning profitable fields of inventions; also information regarding prizes offered for inventions amounting to

**One Million Dollars**

### Millions in Trade-Marks

Shows the value of Trade-Marks and information regarding unfair competition.

**We Advertise Our Clients' Inventions Free** in a list of Sunday newspapers, in manufacturers' journals and in World's Progress. Sample Copy Free. We save you time and money in securing patents. After the patent is granted we assist you to sell your patent.

### List of Patent Buyers

Contains requests from manufacturers, mail order houses and promoters for patents secured by us and suggestions as to **New Ideas** they wish to purchase. We place our clients in touch with capital free of charge. We have recently received over 300 requests from manufacturers.

### Foreign Patents

We have direct agencies in all the principal foreign countries and secure foreign patents in the shortest possible time and at the lowest cost. Write for our illustrated Guide Book on Foreign Patents, sent free to any address.

## WANTED NEW IDEAS

Prepare Now to meet the Demands of Industry in All Fields for New Ideas and New Inventions. We are constantly receiving requests from manufacturers who consult us when purchasing patents for inventions in all lines. We invite manufacturers and promoters to address our Sales Department regarding the purchase or leasing of a number of meritorious patents secured by us.

VICTOR BUILDING



**FREE COUPON!**

**VICTOR J. EVANS & CO.**

New York Offices: 1007 Woolworth Bldg. Pittsburgh Offices: 514 Empire Bldg. Philadelphia Offices: 1429 Chestnut St.  
Main Offices: 765 Ninth St., N. W., WASHINGTON, D. C.

Name..... Address.....

Please Mention Popular Mechanics

Copyrighted material



# PATENTS SECURED OR FEE RETURNED

Latest and Most Complete Patent Book Ever Published for Free Distribution  
**WRITE FOR IT**

Compare My **SERVICE** and **TERMS** with Those of Any First Class Attorney

Send Sketch, Photograph, or Model of your invention for an **ACTUAL SEARCH** of the Records of the Patent Office and report as to patentability — **FREE**. I give every detail of every case my closest personal attention and do not entrust your interests to assistants. Impartial advice on your ideas. I help you sell your patent. Terms moderate. My 90-page book (1917 edition) tells what inventors should know before they apply for a patent.

**GEORGE P. KIMMEL**, Patent Lawyer, 200 Barrister Bldg. Washington, D. C.

COMPETENT PATENT SERVICE  
BY FORMER EXAMINING OFFICIALS  
OF THE U. S. PATENT OFFICE

**WHITAKER & PLANT**  
LAWYERS AND ENGINEERS

10 WHITAKER BLDG. WASHINGTON, D. C.  
INQUIRIES INVITED



**Patent Secured or Fee Returned**

Hundreds of inventions sold yearly. We help market yours without cost. Our new book is **FREE**. Send model or sketch for free opinion.

**A. M. BUCK & CO.**  
204 2nd Nat'l Bank Bldg., Washington, D. C.

## PATENTS

THAT PROTECT AND PAY  
**Books and Advice Free**

Send sketch or model for search. Highest References. Best Results. Promptness Assured.

**WATSON E. COLEMAN**, Patent Lawyer  
624 F Street, N. W. Washington, D. C.

## Patents on Easy Payments

Send sketch for free opinion as to patentability. Write today for our new book on what to invent and how to protect your invention under our **NEW EASY PAYMENT PLAN**.

**C. C. HINES & CO.**  
591a W. L. & T. Bldg., WASHINGTON, D. C.

THE DAWN PATENTS OF INVENTION  
AND  
- PATENT - POSSIBILITIES -

THE WAR opens a virgin field to inventors. Submarine Destroyers, Torpedo Carriers, Airships, etc. are needed. Hide your country from the enemy.  
AFTER THE WAR Tanks, Agricultural Machines, Railway Appliances, etc. will be needed. Profits can be made supplying these demands. Prepare now for the future. Get the right start by reading the free book, "Patents and Patent Possibilities." It tells how to obtain a patent and where to sell it. Write for it today.  
H. S. HILL, 802 M. Larkin Building, Washington, D. C.

## U.S. PATENTS

**FREE** →  
BOOK-BULLETINS & ADVICE

REGISTERED ATTORNEYS

**LANCASTER & ALLWINE**  
D.C.

204 OURAY BLDG. WASHINGTON, D. C.

**Don't Lose Your Rights**

We publish forms called "**Evidence of Conception**" by which you can establish your rights before sending the invention to anyone. It is your best protection. We issue up-to-date bulletins of improvements wanted; aid inventors to promote their rights; render reliable opinions free of charge and secure valuable patents and trade marks on reasonable terms. Personal services assured by our **Service Guarantee Contract**. References: 2nd National Bank, Washington; John P. Roth Packing Co., Cincinnati.

**SIMPLY MAIL COUPON**

LANCASTER & ALLWINE, 204 Ouray Bldg., Washington, D. C.  
Send me free book "Inventions—Patenting and Promoting," Bulletins of Improvements Wanted and blank form, "Evidence of Conception."

Name .....

Address .....



## PATENTS

Send Sketch or Model of Your Invention for  
**Free Opinion as to Patentability**

Our Certificate of Patentability is Evidence of Conception of your invention and may prove valuable to you. Our Credit System enables you to file your application for Patent and proceed without delay. Every case receives personal attention of one or both members of the firm.

Patents we secure advertised at our expense in Popular Mechanics Magazine.  
Write today for Free copy of 104-page book, "How to Obtain a Patent and What to Invent!"  
**Talbert & Parker**, Patent Lawyers  
4683 Talbert Bldg. WASHINGTON, D. C.



Please Mention Popular Mechanics

Copyrighted material



## GOOD NEWS FOR INVENTORS

### Big Factories Throughout the Country Crying for New Ideas to Manufacture

Never in the history of the United States has the opportunity for the inventive mind to cash in been so great. If you have an ingenious idea in the back of your head—some little household device that may make housework easier—some improvement in office equipment, that will add to the day's efficiency, some industrial or mechanical device or improvement that will facilitate manufacturing in many fields—now is the time to bring it forth, get it on paper, patent it, and cash in on it.

"There are a number of clear-cut reasons why this is the golden age of opportunity for the inventor," said a member of the firm of Chandlee & Chandlee, Patent Attorneys at Washington, D. C., in a recent interview. "One of the foremost reasons is the fact that the market, in a number of industries, is now on the wane—notably in the carriage and harness industries and to a large extent in the bottling industry. Here these manufacturers are, with a big investment tied up in plants and machinery, while the market for their goods is fading away. They are literally crying for new things to produce, in order to maintain their factories, keep their machines busy and keep their big selling forces on the job.

"Many of these factories have switched clear away from the lines which they formerly produced, finding some unique simple or useful invention, either purchasing it outright or producing it on a royalty basis. And in a number of instances, are making more money than ever before, on top of paying a handsome income to the inventor.

### Conservation and Efficiency Means Still More Opportunities

"The recent and present agitation in the conservation of coal, shows the opportunities that lie in one direction. One crying need right now is for the invention of a dustless ash sifter. The need is just as great for inventions along the line of food conservation. And the progress of the war has shown the dire need of greater efficiency in every manufacturing industry, in every business office, in every household—on the road, on the railroad, on the farms, in the mines, on the sea.

"If ever there was a time when the opportunity for turning an idea into real money had everything in its favor, that time is right now."

### Do Not Be Afraid of Competition

Hundreds and thousands of men and women when they get an idea think to themselves "why this is so simple that everybody must already have thought of it," or "thousands of other people must be thinking of this at this very moment—what chance have I?" and they never send their ideas in to find out whether or not they can be patented. Yet if they had, they might be living in independent luxury today.

"Never before, in the 22 years we have been in business," said Mr. Chandlee, "have we had so many manufacturers calling upon us insistently for things to produce in their factories, nor have we ever before known desirable inventions to be so scarce. We have hundreds of letters from manufacturers and moneyed men asking for new inventions while the U. S. Government wants everything that can be of service in winning the war.

"The field is open and fertile to those with inventive minds, and the demand for ideas far outstrips the supply.

"The two books we publish 'What to Invent' and 'How to Obtain a Patent,' sent free to anyone—save the inventor many wasted hours working along lines for which there may be no market."

These books are of practical aid to every inventor. They show him along what lines to work and how to protect his ideas. If you will write to Chandlee & Chandlee, 537 7th Street, Washington, D. C., they will be glad to send you these books, and if you will send a sketch and description of your invention, they will tell you whether or not it is proper subject matter for patent protection. If you apply for a patent through them, they will advertise it for sale free of charge and will send you the names and addresses of persons who have written to them to buy patents. If your invention is a war device, they will submit it to the proper Government department without charge.

## DIAMONDS —ON— CREDIT

330  
\$75

383  
\$50

362  
\$75

403 \$50

529  
\$50

**Eight Months  
to Pay  
Beautiful Diamond  
Sent on Approval—No  
Money Down**

No obligation; pay as you can. Order any diamond from our catalogue; when received, if not absolutely satisfactory, return it. Otherwise keep it and pay 20% of the price, and only 10% per month thereafter. Ten per cent discount for all cash. A binding guarantee as to quality with each diamond. Any diamond purchased from us can be exchanged at a yearly increased value of 7½% on a larger purchase.

**SEND FOR FREE CATALOGUE  
DELUXE 6D.** Contains over one thousand photographs of rings, pins, diamonds, and other precious stones.

**L. W. SWEET & CO., Inc.**  
2 and 4 Maiden Lane, New York City

415  
\$25

425  
\$75

420  
\$50

428  
\$100

**R. MORGAN ELLIOTT & Co.**  
PATENT ATTORNEYS  
MECHANICAL, ELECTRICAL & CHEMICAL EXPERTS  
713-721 WOODWARD BUILDING  
WASHINGTON, D. C.

## NO MORE BALD HEADS



**W**HEN our VACUUM CAP is used a few minutes daily. We accept no pay until you have tried the Cap 60 days and are satisfied. The Vacuum Cap is an appliance that draws the blood to the Hair Roots and starts a new healthy crop of hair. It stops Dandruff, stops the hair from falling out.

Bought by Doctors and men who know that it is the only reasonable HAIR GROWER known to science. No Drugs Used. Write for application blank, testimonials, and booklet on "HAIR," sent sealed in plain envelope, FREE.

**THE MODERN VACUUM CAP CO.**  
U. 559 BARCLAY, DENVER, COLO.



# 5¢ A DAY BUYS A GIBSON



Terms as low as \$1.00 down—\$1.50 per month. Mandolin or Guitar sent on approval. Liberal allowance on old instruments in exchange for the "Gibson." The wonderful new "Gibson" violin construction has set the whole Mandolin and Guitar world talking. Get our new **Free Book**—112 pages—111 illustrations, a valuable fund of information for player and teacher. Also **Free** treatise on "How to Practice."

## Exclusive Features that Make Every Gibson Matchless:

Stradivarius arching—scientific graduation from thickness at center to thinness at rim, securing strength—sensitiveness—free vibration of entire sounding board. **Tilted neck, high bridge with extension string-holder**, securing increased string pressure that vibrates a larger sounding board, producing a richness of tone never before realized. **Reinforced, non-warpable neck—elevated guard plate or finger rest—easy action—adjustable string-bearing at bridge** overcoming sharpening of heavier strings in upper positions.

## MAKE \$1800 TO \$5000 A YEAR Teaching and Selling the "Gibson"

Become a teacher. Splendid opportunities for either sex in every locality for private and class instruction and the sale of "Gibsons." "Gibson" instruments have "made" many a teacher, professionally and financially. A. C. Brockmeyer, St. Louis, Mo., teacher and Director, writes: "Will do \$10,000.00 business in 1917; did \$7,000.00 in 1916." C. A. Templeton, Teacher, Sioux City, Ia., writes: "\$4,500.00 gross business for the year." Wm. Place, Jr., America's Greatest Mandolin Virtuoso, Star Soloist for Victor Talking Machine Co., UNQUALIFIEDLY ENDORSES THE GIBSON. We have a permanent teaching and business opportunity now open for either sex. Other positions pending. Write promptly.

### Do Business on Our Capital

Become our agent. We help sell. Agent's territory protected. Stock furnished. We pay the advertising. You make the profit. You pay for goods when sold; return goods not sold. Try our "Still Hunt." FREE to those interested, our new \$1.00 book, "The Organization, Direction and Maintenance of the Mandolin Orchestra," by America's most successful director, Wm. Place, Jr. Write now for Catalog, Treatise, "How You Can Qualify to Teach and Sell," all free. Don't Wait. ACT NOW—Fill in the coupon.

Gibson Mandolin-Guitar Co., 170 Parsons St., Kalamazoo, Mich., U.S.A.



"Everyone A 'Gibson'ite" The Aeolian; The Hazard Mandolin Quartet



"Everyone A 'Gibson'ite" Thompson's Mandolin Orchestra

Gibson Mandolin-Guitar Co., 170 Parsons St., Kalamazoo, Mich.

Gentlemen: Without obligation send me free book, pamphlets, Catalog, free treatise, also information about the Wm. Place, Jr., book and instrument checked below.

- If teacher check here
- |                                      |                                      |
|--------------------------------------|--------------------------------------|
| <input type="checkbox"/> Mandolin    | <input type="checkbox"/> Mando-bass  |
| <input type="checkbox"/> Mandola     | <input type="checkbox"/> Guitar      |
| <input type="checkbox"/> Mando-cello | <input type="checkbox"/> Harp-guitar |

Name.....  
Address.....  
Be sure you have checked instrument.

A rabbit-canning factory has been started in Argentina in the hope of ridding some portions of the country of a pest in a profitable way.

## Ten-Pinnet

### The New Bowling Sensation!



Great Special Offer.  
Write Quick.

GET into business of your own with this great new automatic bowling game. Has taken the country by storm. Great chance! Big money, quick profits! Cash rolls in every day. No operating expense. Find out quick about this great opportunity. Send for our big FREE book.

**\$25.00 to \$75.00 a Week**

That's what you can earn with Ten-Pinnet. Get the big money. You can! Free Book Write today for free book and special offer. Learn how to start with little money—pay for alleys out of profits.

TEN-PINNET CO., Dept. 1197, Indianapolis, Ind.

## DUCK'S BIG 300-Page No. 11 CATALOG

Mailed on receipt of 8 cents in stamps or coin, which may be deducted on first dollar purchase. Great cost of catalog and low prices prohibit distribution otherwise. Catalog contains 160 pages of wireless apparatus and 140 pages of electrical supplies. No bigger or better values are obtainable elsewhere. THE WILLIAM B. DUCK CO., 223-227 Superior Street, TOLEDO, OHIO

### SEND for CATALOG P28

It will be pocket size, 8x4 1/2 and will contain 248 pages with over 1,100 illustrations, describing in plain, clear language all about Bells, Push Buttons, Batteries, Telephone and Telegraph Material, Electric Toys, Burglar and Fire Alarm Contrivances, Electric Call Bells, Electric Alarm Clocks, Medical Batteries, Motor Boat Horns, Electrically Heated Apparatus, Battery Connectors, Switches, Battery Gauges, Wireless Telegraph Instruments, Ignition Supplies, etc.



Send for a copy now.

Manhattan Electrical Supply Company, Inc.

New York, 17 Park Place St. Louis, 1106 Pine St. Chicago, 114 So. 5th Ave. San Francisco, 604 Mission St.



## OSTER BULL-DOG DIE-STOCKS

TO speed your work and lighten your labor, use Bull-Dog Die-Stocks, the tools with the 5 big Oster features.

- (1) Self-Locking, adjustable dies.
- (2) Self-Centering guides.
- (3) Dies open up at end of cut and tool lifts off pipe without "unwinding."
- (4) Three-lever control, doing away with loose parts, bushings and lock-nuts.
- (5) No small, breakable parts.

The Oster Mfg. Co., 2100 East 61st St., Cleveland, Ohio



Please send free Catalog of 20 tools, plain or ratchet.

Name.....  
Address.....  
City.....  
State.....  
Occupation..... (2100)





## Here's Fun, and Lots of It!

You'll like Billiards and Pool better and better as your game improves. Practice makes perfect and everybody, man or boy, wants to play a good game. You'll soon learn to make the draw, follow and cushion shots, the banks, combinations and kisses, if you play at home on your own

# BURROWES

## Billiard and Pool Table

Many famous experts use Burrowes Tables for home practice. They are correct in every detail. The new 1918 models are just ready. They certainly are dandies! The most delicate shots can be made with the utmost accuracy. Burrowes Regis High-Speed Rubber Cushions are unquestionably the finest rubber cushions made.

### \$1 DOWN

Prices of Burrowes Tables range from \$15 up, on terms of \$1 or more down and a small amount monthly. Cues, balls, etc., free. Sizes range up to 4½x9 ft. (standard), with smaller sizes for smaller rooms.

### No Special Room Needed

You can put up or take down your Burrowes Table in a moment, on your dining or library table or on its own legs or folding stand.

### FREE TRIAL — NO RED TAPE

On receipt of first installment we will ship Table. Play on it one week. If unsatisfactory return it, and on its receipt we will refund your deposit. This insures you a free trial. Write for illustrated catalog, giving prices, convenient terms of payment and full information.

### THE E. T. BURROWES CO.

160 Spring Street, Portland, Me.

Burrowes Tables are now on sale in many cities and towns. You can inspect them before ordering if you wish.

## Do YOUR OWN Plumbing or Heating Our New EASY WAY Buy From Us Direct—Save ½



### Send for Our Big Valuable "Handy-Man" Book

Shows over 10,000 different fixtures and supplies in plumbing and heating goods at Wholesale, with our new easy adjustable installing features.

OUR HANDY-MAN BOOK shows and tells you how to properly install our new cut-to-fit STEAM, HOT WATER, or HOT AIR HEATING PLANTS, or plumbing outfits, and how to make any plumbing or heating repairs. Any handy man with a few ordinary tools, and the help of our free planning service, can properly do the work himself.

### "Our New Hardin Easy Way"

To avoid sending this large 236 page, well bound, valuable book broadcast, we ask a temporary deposit of 25c, which will be refunded on first order. Or if you are not satisfied, return book, and we will refund your money at once.

Every home owner, contractor, farmer, institution, etc. needs this BIG HANDY-MAN BOOK. WRITE TODAY.

**HARDIN LAVIN CO.**

40 Years at

4510-50 Cottage Grove Avenue  
Dept. 9 CHICAGO, ILL.



### Battery Charging Pays Big Profits

H-B 600 watt charger guarantees quick charging and large profits. Users are clearing \$30 to \$60 every month. Battery charging pays 10c to \$1.00 per battery, with current cost of 15c to 10c for each battery charged. \$15 Cash Payment Pays This Money-Maker in Your Garage. Balance in 8 monthly payments of \$20. Easily paid from earnings. Money-back guarantee. Mail this ad with name for full particulars. **HOBERT BROS. CO., Box 510, Troy, Ohio**

## FOLDING TRUCK BODY



Open, it's a strong, serviceable, practical, economical, light truck. Closed, it's an attractive roadster. No tools needed to change. Nicely finished in black enamel. Lettering does not show when folded. Easily attached. Low in price. For Ford or Chevrolet. Write for free circular giving full description. Also shows other style bodies. **BUTLER MANUFACTURING CO.**  
804 Butler Bldg., Kansas City, Mo.  
899 Sixth Ave. S. E., Minneapolis, Minn.

60 SECONDS MAKES THIS CHANGE—



TO GET YOU  
STARTED  
AS OUR

AGENT

WE OFFER  
YOUR CHOICE  
OF ANY OF  
OUR HIGH GRADE

Made-to-Measure Pants

delivered at your home by parcel post for your approval on receipt of only \$1 deposit. Satisfaction Guaranteed or Money Refunded.

Complete AGENTS Outfit FREE

Your name on a postal card brings 60 real cloth samples and everything needed to start earning big money free. **Spencer Mead Co., Dept. 1728, Chicago**

SEND ONLY

\$100

AN  
EXTRA  
PRESENT  
WITH EVERY  
ORDER

Please Mention Popular Mechanics





# DEAF?

## Make This Test In Your Own Home

The Acousticon will surely make you hear because it has succeeded with over 800,000 delighted patrons of ours who were so troubled.

You do not know this, however, and we are confident enough to want everyone to know before he spends a cent.

Everyone knows that deafness is progressive—and unless the ears are stirred to activity they grow steadily worse; thousands write us the Acousticon enables them to hear perfectly and has permanently improved their hearing.

Therefore we ask that you write us, saying: "I am hard of hearing and will try the Acousticon"—That's all. We will send you, delivery charges paid, the

### Acousticon For Ten Days' FREE TRIAL No Deposit—No Expense

All we ask is that you give it a fair trial in your own home and among familiar surroundings. Then there can be no doubt of whether it improves your hearing.

If it does not do so, we want it back without a cent of expense to you for the trial, because we know it is good business policy to have none but satisfied and enthusiastic customers—That's the only kind we now have. Write for your FREE TRIAL today.

GENERAL ACOUSTIC CO., 1307 Candler Building, N. Y. Canadian Address, 621 New Birks Bldg., Montreal

## TRAPS AND GUNS at Wholesale Prices

Just to get in touch with you when you have furs to sell. Write for catalog of Trappers' Supplies and Price List of Raw Furs. You will save money here.

E. W. BIGGS & CO., 187 Biggs Bldg., Kansas City, Mo.

## 50c Trial Order for 10c

**Best Kodak** Any size roll developed 10c; six prints free with first roll. Or send six negatives, any size, and 10c for 6 prints. Beautiful 8x10 mounted enlargements 35c.

ROANOKE PHOTO FINISHING COMPANY, Formerly Roanoke Cycle Co. 208 Bell Ave., ROANOKE, VA.

## \$40 PER WEEK EASY!

Men and women wanted to take orders for Fast-Selling GOODYEAR GUARANTEED RAINCOATS. Classy coats as low as \$2.75. No delivering. No collecting. You get your profits in advance. Easy to sell.

**FREE** Free full outfit and sample coat free. Make \$40 and more per week. No capital required. Write for agency

GOODYEAR MFG. CO. DEPT. 23 KANSAS CITY, MO.



## GRAFLEX—KODAKS

Cameras, Lenses and supplies of every description. We can save you 25 to 60 per cent on slightly used outfits. Write at once for our free

**Bargain Book and Catalog**

listing hundreds of slightly used and new cameras and supplies at money-saving prices. All goods sold on ten days' free trial. Money refunded in full if unsatisfactory. You take no chances by dealing with us. We have been established in the photographic business over 16 years.

CENTRAL CAMERA CO. 124 S. Wabash Ave., Dept. 1301, Chicago, Ill.

## Driver Agents Wanted

Five-Pass., 34.7 H. P. Drive and demonstrate the Bush Car. Pay for it out of your commissions on sales, our agents are making money.

32 x 3 1/2 Tires. Bush Cars guaranteed or money back. Write at once for my 48-page catalog and all particulars, 1918 models now ready. Address J. H. Bush, Pres. Dept. 1017

BUSH MOTOR COMPANY, Bush Temple, Chicago, Ill.

115-inch Wheelbase Delco Ignition—Elect. Stg. & Ltg. BUSH MOTOR COMPANY, Bush Temple, Chicago, Ill.

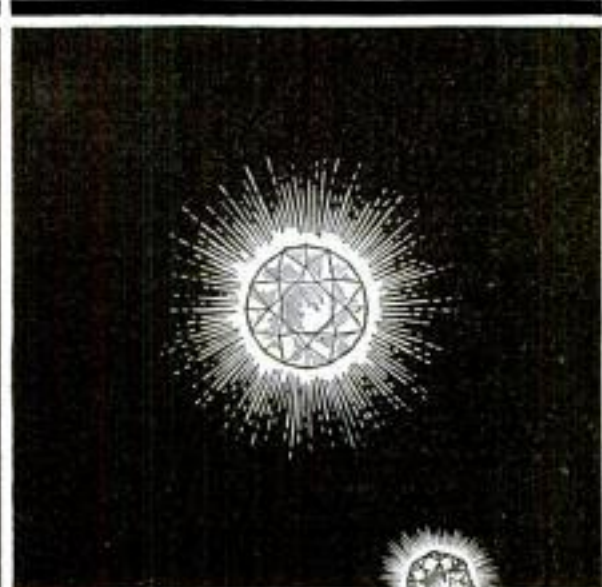

## You Can Now Buy Direct

Buy any diamond you choose—direct from us—at our rock-bottom price. No jobber or retailer to pay. And every diamond absolutely guaranteed. Write at once for our net price list and Diamond Book showing exquisite collection of blue-white

## Diamonds

Rings in all styles—settings Tiffany, Belcher, etc., La Vallieres, brooches and other diamond jewelry. Every diamond a superb gem. Selected by a famous expert. Perfectly cut to give maximum brilliancy. Richly mounted in solid gold and platinum settings.

### Free Examination

Not a cent down—you see the diamond before you accept it. We want you to compare these diamonds with others at twice their price.

# \$2.50 Monthly

Only \$2.50 a month will make you the wearer of a beautiful diamond ring. Other terms, \$3.50, \$4.50 and up—and middlemen's profits are cut out.

## Write

For Net Price List and Diamond Book

Shows the different gems, styles of mountings and gives out best net prices with terms of payment. Do it now—today.

BURLINGTON WATCH CO. Dept. 1197 Chicago, Ill.

Burlington Watch Co. Dept. 1197 Chicago, Ill.

Without obligations send me your net price offer on diamonds; also send Diamond Book.

Name.....

Address.....

Please Mention Popular Mechanics

Copyrighted material





### JAPANESE ROSE BUSHES

#### The Wonder of the World

Japanese Rose Bushes bloom all the year round. Just think of it. Six weeks after planting the seed, the plants will be in full bloom. It may not seem possible, but we positively guarantee it to be so. They will bloom every ten weeks, Summer or Winter, and when three years old the bush will be a mass of roses, bearing from five hundred to a thousand roses on each bush. The flowers are in three shades—white, pink, and crimson. The plants will do well both in and out doors. We guarantee at least three bushes to grow from each packet of seed. Price, 10c packet, 3 pkts. for 25c postpaid.

10 Cts.

### Shoo Fly Plant



A very remarkable Botanical curiosity you should have. Though quite odorless, it will not remain in a room where it is grown. Bears very pretty blossoms; blooms summer and winter. Grows rapidly from seed.

SEEDS 15c packet, 3 for 40c, postpaid.

### Weather Plant



NATURE'S WEATHER PROPHECY By mysterious changes that take place, this remarkable plant accurately forecasts the weather many hours in advance. Will grow anywhere all the year around. An interesting house plant. Bears large, fragrant, pink, butterfly shaped flowers.

SEEDS 15c packet, 3 for 40c, postpaid.



### LUMINOUS PAINT

#### Make Your Watches, Clocks, Etc., Visible by Night

The very latest discovery in the scientific world. Hitherto, practically unobtainable except at an exorbitant price, we have at last succeeded in producing this remarkable LUMINOUS PAINT, which, applied to the surface of any article, emits rays of white light, rendering it perfectly visible in the dark. THE DARKER THE NIGHT, THE MORE BRILLIANT IT SHINES. Quite simple to use. Anyone—you can do it. A little applied to the dial of your watch or clock will enable you to tell the time by night. You can coat the push buttons or switch plates of your electric lights, match boxes, and innumerable other articles; make your own Luminous Crucifixes, Luminous Candles, etc. Bottle containing sufficient to coat several small articles. Price 25c. Larger sizes 50c and \$1 postpaid. Johnson Smith & Co., Dept. 90, 54 W. Lake St., Chicago

### NEW BOOK ON

## ROPE SPLICING

Useful Knots, Hitches, Splices, etc.

How Different Knots Are Made and What They Are Used For INDISPENSABLE TO EVERY MECHANIC AND RIGGER

PRICE 20c



A most practical handbook giving complete and simple direction for making all the most useful knots, hitches, rigging, splices, etc. Over 100 illustrations. All about wire rope attachments, lashing, blocks, tackles, etc. 37 Heraldic Knots illustrated. Of great value to mechanics, riggers, campers, boatmen. Price 20 cents postpaid.



### INVISIBLE INK

The most confidential messages can be written with this ink, for the writing MAKES NO MARK. Cannot be seen unless you know the secret. Invaluable for many reasons. Keep your postals and other private communications away from prying eyes. Great fun for playing practical jokes. Only 15c Bottle



### VANISHING INK

Writing written with this remarkable ink vanishes entirely in a few weeks (sooner if desired) leaving the paper QUITE BLANK. 15c p.p.d.



LUMINOUS INK writing can be READ ONLY IN A DARK ROOM; writing shines like fire. Quite invisible at daytime. Very remarkable. 15c

### Sneezing Powder

Greatest joke out. A small amount blown into the air and the unsuspecting victims begin sneezing without knowing the reason why. Price 12c, 3 for 30c. p. pd.

Stage Money With a bunch of these bills it is easy to appear prosperous. By flashing a roll at the proper time, the effect will be found to be all that can be desired. 15 Bills 10c, 50 Bills 25c



### AMERICAN FLAG GUM STICKERS

These Flags are about same size as a postage stamp. Gummed on the reverse side ready for use. Use them on your envelopes, stationery, etc., and let every one know you are an American. Put up in sheets, each containing 100 flags. Tear them apart like stamps. PRICE 10c per sheet, 3 sheets for 25c. J. S. & Co.



### All the Latest Surprising and Joke Novelties

- Pharo's Bonanza Eggs, box . . . 10c
- Minkuro, (sugar) "fido" . . . 10c
- Geopina's Snake (very lifelike) . . . 10c
- Paloo Mustache (for your friends) . . . 5c
- Ford Auto Puzzle (Latest) . . . 15c
- Magic Flute (anyone can play it) . . . 15c
- Hubber Razor (very formidable) . . . 25c
- Hubber Dagger (sensational) . . . 25c
- Window Smashers (great joke) . . . 25c
- Pocket Detective (see behind you) . . . 15c
- Great Mind Reading Mystery Cds. . . 10c
- Thurston's Mysterious Trick Cds. . . 10c
- Fighting Roosters, pair . . . 15c
- Cover the Book Trick, a scene, nov. . . 10c
- 8 Ray Novelty . . . 10c
- Trick Pencil . . . 10c
- Hubber Tacks (a good joke) . . . 10c

- Memorized Penny (defies the law of gravitation) . . . 20c
- Mysterious Tumbler and Vanishing Coin Trick . . . 25c
- Enchanted Bottle (won't lay down) . . . 5c
- Magic Plate Lifter . . . 25c
- Imitation Gold Teeth . . . 3 for 10c
- Great Burger Puzzle . . . 10c
- Wire Puzzle; 10c, 25 different, \$1.00
- Electric Trick; Push Button . . . 10c
- Jackless Pen (writes with water) . . . 10c
- Imitation Red Bugs . . . 10c
- Squirt Ring . . . 25c
- Trick Bill Book . . . 10c
- Glass Revolver . . . 25c
- Glass Watch . . . 25c
- Multiplying Billiard Ball Trick . . . 25c

Johnson Smith & Co., Dept. 90, 54 W. Lake St., Chicago

## Automatic Repeating Rifle

Fires 20 Shots in One Loading



This is a regular size automatic revolver. Shoots B. B. shots obtainable anywhere, same as other rifles and guns. Repeats 20 times with one loading. Very handsomely finished.

Only 25c Postpd

No caps or load necessary, as it works with a spring and shoots with rapidity and accuracy. Simply load with 20 B. B. shot, then press the trigger. Nothing to explode—absolutely harmless and safe. Remember, it is not a mere toy, but the same size and shape as a REGULAR AUTOMATIC. Sent complete with a round of shot for ONLY 25c postpaid. Johnson Smith & Co.

## GREATEST TOY SENSATION OF THE DAY! FIGHTING DREADNAUGHT

SENSATIONALLY REALISTIC!!!

Here is a model of Uncle Sam's fighting monsters. Eight big guns, each of which flashes, at correct intervals, from twelve to twenty times. Extra ammunition always obtainable. Absolutely harmless. Can be operated indoors or out. Now, boys! Here's your chance to see a battleship in action, and the best of it is you can OWN the ship and command the firing yourself! By having two or more Battleships, you can arrange EXCITING NAVAL BATTLES in your own home. Price of Warship and Ammunition, 15c, three for 40c, or a fleet of 12 ships for \$1.50 postpaid. Extra Ammunition, 5 cents per pkg.



## SONOPHONE CORNET

You can play it if you can talk. No knowledge of music needed

The simplest and most successful musical instrument ever brought out. Any man, woman or child that is able to talk or hum a tune can play it right from the very start without any previous practice whatsoever. Simply place the mouth-piece of the Cornet to your lips, hum through it any tune that you are familiar with, leaving out the words, and you'll have success straight off, and you will be everjoyed with the marvelous results. By a wonderful acoustic effect it is quite easy to very closely reproduce on the Sonophone the tone of a trumpet or flugel-horn, and with some practice you can imitate a saxhorn or tenor trombone in a surprisingly brilliant manner. Harmonizes well with piano or any other musical instrument. Failure is absolutely impossible. Well made of brass, highly polished, 7/8 inch long, 3 1/2-inch bell. The outfit includes 1 Sonophone Cornet, 1 Extra package Diaphragms, and one book of nearly 100 New and Old Time Favorite Songs, words and music. Price only 50c. The complete outfit mailed postpaid anywhere.



PIANO PLAYING MADE EASY

## New Vamping Card

### NO TEACHER NEEDED—SURPRISINGLY SIMPLE SYSTEM

Persons having neglected their Musical Education need not despair, for with the aid of our new VAMPING CARD (glazing the card upright over the piano keys), you can at once Vamp away to thousands of Songs, Ballads, Waltzes, Rag Time, etc., etc., equal to a Professional Musician. No knowledge of music is required. After using it a few times, you will be able to dispense with the aid of the Vamping Card entirely. The price of this very clever invention is only 15 cts. postpaid.

## DAISY AUTOMATIC LIQUID PISTOL



The Daisy Improved Automatic Liquid Pistol is the very latest design in Water Guns, and would readily be taken for one of the real Automatic Pistols. It is made from steel, with blued finish. Very simple to load and discharge. No rubber bulb to get out of order. Great sport for boys and girls, as it throws a fine stream of water a distance of 25 feet. When diluted ammonia is used, it makes a very effective weapon against vicious men and animals. Measures 6 inches in length, and weighs 6 ounces. Price 25 cents, postpaid.

Johnson Smith & Co. Dept. 90, 54 W. Lake St., Chicago Only Concern of Its Kind in America





**NEW-SKIN**  
An Antiseptic.  
For cuts and scrapes.

Invaluable in camp  
and in service.

A medium sized bottle of New-skin will  
be sent post paid by us to any ad-  
dress on receipt of 25 cents in stamps.

NEWSKIN CO., NEW YORK

# \$100 for this Fountain Pen

A pen offer made to introduce our De Luxe Jewelry and Diamond book. Pen is full size, 6 1/2 in. long, lever self-filler, guaranteed non-leakable. Barrel and cap are pure Para Rubber. **Your Name Inlaid in Gold Free.** Pen is 14K solid gold Iridium tipped. We guarantee free repairs for 2 years. Order direct from this ad, including our special factory price of \$1.00.

## FREE EXAMINATION Money-Back Guarantee!

Basch takes all the risk in sending diamonds for free examination. You pay nothing until you have examined and proved to yourself that the diamond you ordered is a real Bargain. Our Money-Back Guarantee protects you from any possible loss.

Refer to any bank, Express Co. Magazine or Mercantile Agency.



## \$97<sup>50</sup> Per Carat For Diamonds

BASCH has not raised prices 35 to 50% on genuine diamonds. We are still low on all grades. Right now you may still have diamonds for \$97.50 per carat, 1/2 carat stones for \$9. 1/4 carat stones for \$20, 1/2 carats for \$48.75, 3/4 carats for \$72.00. Also other grades at higher prices.

**Write for Catalog** for the Basch De Luxe Diamond Book—FREE—a big beautiful catalog of Diamonds, Jewelry, Watches, etc. The best diamond guide ever issued. You cannot afford to purchase a diamond until you have read it. Send for it TODAY. Mail either the coupon or a postal or letter.

## L. BASCH & CO.

Dept. N3320 State & Quincy Sts., CHICAGO

### FREE DIAMOND BOOK COUPON

Please mail me FREE, without obligating me, the Basch De Luxe Diamond book.

Name.....

Address.....

L. BASCH & CO.

Dept. N3320 State & Quincy Sts., CHICAGO, U.S.A.

**Engine User-Agents Wanted**

Men wanted in every county to USA, demonstrate and sell "BIG BEN"—wonderful new gasoline engine for every work. Big demand. Liberal profits. Free data and introductory offer. C. Baumgardner & Sons, Department 511, Hamilton, Ohio.

**IVES TOYS**  
Make Happy Boys

The finest line of electrical and mechanical trains you ever saw. Just like real trains. Switches and signals and stations, too. Also IVES STRUKT-IRON to build bridges, derricks and buildings. FREE FOLDER on toy railroading. Write for it.

THE IVES MFG. CORP'N, 202 Holland Ave., Bridgeport, Conn.

**INDOOR CLOSET**  
More Comfortable, Healthful and Convenient than the Out-Door Closet

Eliminates the out-door closet and open vault. They are breeding places for germs. Have a warm, sanitary, odorless toilet right in your house. No going out in cold weather. A boon to invalids. Endorsed by State Boards of Health.

W. M. Davis writes: "Your indoor closet is giving absolute satisfaction. It is certainly the thing for a home without sewerage."

**Absolutely Odorless Put It Anywhere in the House**

The germs are killed by a chemical process in water in the container, which you empty once a month. **Absolutely no odor.** No more trouble to empty than dishwater. Closet absolutely guaranteed. Write for full description and price.

**Agents Wanted—Big Profits** Wonderful opportunities in every best season just at hand. Every home is a good prospect. Sell right out of every ten you call on. Ernest Ridwell writes, "Have ten orders." G. A. Dierman says: "Ship at once twenty closets and fifteen washstands. Sold them all in one community." Sell itself. Everybody hates the out-door closet. Everybody wants a Ro-San Indoor Closet. Write quick for territory and full particulars. We are prepared to ship promptly any quantity of closets—no waiting.

ROWE SANITARY MFG. CO., 12610 Sixth St., Detroit, Mich.  
Ask about the Ro-San Washstand—Hot and Cold Rinsing Water Without Plumbing





## What Packard thinks of DIXON'S ELDORADO

*"the master drawing pencil"*

"The samples of Eldorado created a satisfactory impression."

"We are now using this pencil in our drafting rooms."

"We have received no complaints regarding them."

"They run uniform as to grade and color."

"They are free from hard spots."

When the Packard Motor Company, whose drafting work is intricate and exacting, says such things about a pencil, isn't it proof of unusual quality?

But don't take Packard's word for it. Send 16c in stamps for full-length samples worth double the money, and try out "the master drawing pencil" for yourself.

**JOSEPH DIXON CRUCIBLE COMPANY**  
Dept. 10-J, Jersey City, N. J.

**DIXON'S BEST WHITE No 352**

*writes white on blueprints*

Please Mention Popular Mechanics

## "LITTLE GUARD" THE NEW TORREY

for a real shave and no cuts.

Here's a man's kind of safety razor — with a perfect shaving edge.

**\$2**

It is a beautiful, keen blade,  $\frac{3}{8}$  regular size, made safe with a reversible guard.

It shaves quick, clean and close, but never roughs the skin.

Guaranteed — if it isn't satisfactory, return it for a new one. If your dealer hasn't Torrey razors, write us; we'll tell you where to buy them. Free — "How to Shave."

Use the new Torrey honing strap.

**THE J. R. TORREY RAZOR COMPANY**  
Dept. P, Worcester, Mass.

## WEBER Throttle-Governed VALVE-IN-HEAD KEROSENE ENGINES

WILL SAVE YOU HALF IN FUEL COST. All 1937 Weber Engines are equipped with that great engine improvement, the "Weberator." Makes Kerosene as convenient to use as Gasoline. Saves 1/2 the cost. Write today for full details and 60 day trial offer. Sold direct to user at factory prices.

**WEBER ENGINE CO.**  
Dept. 1777 KANSAS CITY, MO.

## "Best" Hand Lantern



A powerful portable lamp, giving a 300 candle power pure white light. Just what the farmer, dairyman, stockman, etc., needs. Safe — Reliable — Economical — Absolutely Rain, Storm and Bug proof. Burns either gasoline or kerosene. Light in weight. Agents wanted. Big Profits. Write for Catalog.

The Best Light Co., 324 E. 5th St., Canton, O.

## GET THIS SUIT

made to your own measure. It won't cost you one single cent. We will give it to you so you can show it to your friends and take a few orders. It will be a big advertisement for us. You can easily make from

**\$35 to \$50 EXTRA**  
Every Week

and besides that be the best dressed man in your town. It's an opportunity you cannot afford to overlook. Even if you only want to order a suit for yourself, don't fail to

**Write for OUR BIG OFFER**

Don't delay a minute. Drop us a line or send us your name on a post-card, and we will send you, absolutely free, our wonderful style book, containing 64 beautiful samples to choose from. **WRITE NOW.**

The Progress Tailoring Co., Dept. 876, Chicago







# ANY WATCH YOU WANT

On  
Credit



1918-MODELS  
HOWARD  
HAMPDEN  
SOUTH-BEND  
ELGIN  
WALTHAM  
HAMILTON  
ILLINOIS

## WRITE FOR GREAT NEW OFFERS

From Square Deal Miller you can get the watch you want at manufacturer's cash prices—but on the easiest terms. In the new Miller-Hoefer catalog, the latest models of America's best known time-pieces are listed, also **Genuine Diamonds**, and a vast assortment of **Jewelry**—all on **Credit**, all on **Free Approval**, all on **30 Days' Trial**, and all **Guaranteed**. This new book is yours for the asking. The coupon, or your name and address on a post card brings it **Free**.

### Factory Prices and Easy Terms

Your Money Back If You Can Buy Cheaper for Cash

#### Send No Money

You need not send one penny with any order for a Watch, a Diamond, or any Jewelry, unless you prefer. I will send you anything you select for **Free Examination**—even pay the express charges. Only after you find the goods are as represented, need you pay the first payment of my **Easy Credit Terms**.

#### 30 Days' FREE Trial

After a test in your own possession of any Watch, Diamonds, or Jewelry, should you want to return the goods, you can do so, and your money will be refunded. That is the way the Miller-Hoefer Company has taken the risk out of mail order buying—how it assures every customer of a Square Deal, but this is not all—

### The Miller-Hoefer Credit Plan

No Reference Demanded — An Open Account

A New Kind of Credit—liberal—dignified—open and above board. You can have an **Open Account**—the same kind of credit you get from your grocer. **No Interest—No Notes—No Bank Guarantee—No Red Tape—No Collectors—just plain honesty between one man and another.**

**Send Coupon Today** I want you to have my new Free

Book if you are interested in Watches, Diamonds, or Jewelry. It's **Free and Postpaid**. Remember—there is no obligation—just the opportunity if you wish, to take advantage of the most liberal, squarest, Watch, Diamond, and Jewelry offer ever made.

**SQUARE DEAL MILLER, Pres.**  
**MILLER-HOEFER CO.**

33 State St., Dept. 930, DETROIT, MICH.

**VALUABLE CATALOG FREE**  
Square Deal Miller, Pres. Miller-Hoefer Co.  
33 State St., Dept. 930, Detroit, Mich.  
Dear Sir:—Please send me your FREE  
Watch, Diamond, and Jewelry Cata-  
log as advertised.  
NAME.....  
ADDRESS.....

**Buy A  
Diamond  
On Credit  
Better Than  
a Bank**

The Miller-Hoefer Company sells only the highest grade, finest quality, perfect diamonds. It is the only kind to buy, the best investment possible. Catalog shows hundreds for your selection. Choose any one for **Free Examination**.





# "DON'T SHAVE YOURSELF"

Until you have tried a "BALIHONE," writes an enthusiastic user.

He continues: "Two years ago, after years of torture from imperfectly sharpened razors, a friend brought me a "BALIHONE," and asked me to try it. I knew no more about sharpening razors than a farmer would about cutting out a suit of clothes. My attempts at sharpening were successful from the first and shaving has been a pleasure ever since. I have not been shaved by a barber during this period; I have saved at least \$15.00 in money on the situation; I can have a perfectly satisfactory shave when I want it and no man living has or can have a sharper razor than I. I have used but one razor since getting the BALIHONE.—This is the true testimony of one and we can furnish others of a like character. Prove it yourself.

**Hone and Stop It Yourself!** Regular or safety. New idea. New principle in the Balihone. Makes your old razor as good as new. Makes your safety blade better than new. Produces a marvelous edge every time. You can't fall with it. Send for one today and make your shaving a joy. The Balihone is a hone and a stop all in one. It will make your poor razor shave beautifully. Size of Balihone set  $\frac{1}{4}$  in., weight 3 oz.

**Very Popular with Army and Navy Men**

PRICE, \$1.00 — With Holder for Safety Blades, \$1.25. AGENTS WANTED  
BALIHONE COMPANY, 1403 Conway Building, CHICAGO, ILL.



USING ORDINARY RAZOR  
USING SAFETY RAZOR

BUY DIRECT FROM THE DIAMOND CUTTERS



70

Per Carat  
ALL SIZES  
10 to 14  
Carats

Save 40 Per Cent

We are the only diamond cutters in the United States selling to the public direct. The prices at which we sell all grades of diamonds—from \$39 to \$275 a carat—are a revelation to everybody. These prices include any style 14K. solid gold mountings, free. We ship selections at our risk and expense to any Bank or Express for free examination.

**Money Back in Full**

Our Protective Money-Back Guarantee Bond given with every diamond, refunding full purchase price any time within one year.

Write for 244-page Free Catalog

This book will open your eyes to the marvelous values which we, as diamond cutters, are able to offer. It is the greatest authority on diamonds ever published. Write for free copy today.

**J. PRESS & SONS**  
IMPORTERS AND CUTTERS OF DIAMONDS  
WHOLESALE JEWELERS  
5014 CHESTNUT ST.  
PHILADELPHIA, PA.

125

Per Carat  
ALL SIZES  
10 to 14  
Carats

- 1-8 Carat Rings \$6.25
- 3-16 Carat Rings \$10.00
- 1-4 Carat Rings \$16.25
- 3-8 Carat Rings \$26.00
- 1-2 Carat Rings \$35.00
- 5-8 Carat Rings \$42.75
- 3-4 Carat Rings \$42.50
- 7-8 Carat Rings \$61.25
- 1 Carat Rings \$70.00

- 1-8 Carat Rings \$9.75
- 3-16 Carat Rings \$14.00
- 1-4 Carat Rings \$21.88
- 1-3 Carat Rings \$21.50
- 3-8 Carat Rings \$28.50
- 1-2 Carat Rings \$28.75
- 5-8 Carat Rings \$35.00
- 3-4 Carat Rings \$43.75
- 1 Carat Rings \$125

Has The Motor Boat Bug Got You?



Health and happiness are assured with one of the new popular priced Gray motors in your boat. Select your boat from our 1917 Boat Builders Catalog showing products of 200 leading boat builders. Select your engine from our new complete Engine Catalog. Both books FREE. Send today.  
**GRAY MOTOR COMPANY**  
1046 Oakland Ave., DETROIT, MICH.



3 YEARS TO PAY

**Meister Piano** 30 days' free trial in your own home  
**\$1 A WEEK or Price \$210.00**  
**\$5 A MONTH**

No cash payment down. No interest—no extras. Piano stool and scarf free.  
**ROTHSCHILD & COMPANY**  
Dept. H16 CHICAGO, ILL.



Be Your Own Boss

Work for yourself. Learn how to make big profits with a Kingery Peanut Roaster and Corn Popper. 50 styles. Easy terms.

Write for Catalogue P. M. telling what others have done.  
**Kingery Mfg. Co.** 302 E. Pearl St. CINCINNATI, O.



RAISE BELGIAN HARES For U.S.

HUGE PROFITS easily and pleasantly made. We furnish stock and pay you \$6.00 a pair and express charges for all you raise. Contract and book "Fortunes in Hares," 10c. Nothing free.  
**NATIONAL FOOD & FUR ASSOCIATION**  
Dept. 70. 557 12th St., MILWAUKEE, WIS.

The Electrical Experimenter



BOYS!

Here is THE electrical magazine for you. For the Dabbler and the "How-to-make-it" fiend. Chuck full of experiments and the latest electrical doings. Non-technical—in plain English. One of the foremost authorities on WIRELESS in the U. S.

200 Illustrations, 96 big pages, over 100 articles.

One Copy Will Convince You.  
At All News Stands, 15c.

\$1.50 a year (Foreign \$2.00). Send 25c for 3 numbers.

The Electrical Experimenter  
234 Fulton St., NEW YORK

A Birthday Present

If you are racking your brains to think of a suitable birthday present—stop. Go to any dealer and ask to see Ingersoll watches. There are eleven kinds from a \$1 to \$3.

\$4.50 Offer

Only \$4.50 down brings you the brand new Rex (with 10 years' guarantee) built because world's greatest merchandise house wanted a better machine than any on market. Sent on trial. Typewriter price smashed! Write today for our big free book and our startling offer. Our big illustrated book is an education in typewriters. Write for it now!  
**Rex Typewriter Co., Dept. 1197 LeMoyné Bldg., Chicago**



Please Mention Popular Mechanics



# A Lightning Edge on Safety Blades



A keener edge than you ever felt. An edge that will flash through the stiffest, wiriest hair. Only a few strokes works marvels on any safety blade. You can't fail to get a lightning edge. You can't misuse a Stag Sharpener. A child can sharpen blades on a Stag as well as an expert. Makes old blades better than new. Makes new blades better.

Complete, including unbreakable Trench Mirror, \$1 postpaid to you on this special offer.

**Stag Sharpener**

with barber's hone and strop and Trench Mirror complete, on our money back guarantee

**\$1**

## Protect Yourself

A dull razor is dangerous to health and life itself. The Stag Sharpener is a health protection as well as a positive luxury in shaving. The truest, simplest, quickest, easiest safety blade sharpener on earth.

## Sharpen Any Blade

Positively gives new blades a better shaving edge. Puts the oldest, dullest blades in lightning edge condition. You can never know the delights of shaving with a positively perfect razor edge, until you sharpen your own blades with the Stag Sharpener. The quickest, truest, surest, safest, easiest. The wheels of the sharpener guide the angle. Nothing to adjust. Nothing to get out of order. Practically lasts a lifetime. Our new patented feature makes the Stag more desirable than ever. Stag Sharpeners are used around the world. Complete outfit includes heavily nicked sharpener, barber's hone, strop and Trench Mirror in neat box, suitable for traveler's kit. Complete, postpaid to you only \$1. Send now.



## Trench Mirror Free

With every Stag Sharpener we will send you a Trench Mirror positively free. Can't break. The Stag Sharpener is the ideal outfit for every soldier and sailor. We have therefore decided to give a Trench Mirror free for a limited time with every Stag Sharpener. If you want the Trench Mirror alone enclose only 35c. It will be sent to you postpaid for only 35c. Send only \$1 for the Stag Sharpener outfit complete with Trench Mirror or for the Trench Mirror only 35c.

## Sent on FREE TRIAL

Try a Stag Sharpener at our risk and at our expense. Use it ten days free. Use it at our risk and at our expense. Then if you are not delighted, send it back and get your money back in full. We gladly assume the risk and welcome your order on this liberal, free trial, money back guarantee. **Send only \$1 today.**

**Hone and Strop Free** With every Stag Sharpener we send a barber's hone and strop

## Dealers

Write to us for special terms to dealers. The Stag is the quickest and best seller on earth. Get the benefit of this advertising and our Dealer Service.

free. It is a part of the Stag outfit. The new patented, simplified improvements in the perfected Stag Sharpener and a new broad-width barber's hone and strop in attractive kit-box, all complete only \$1. Two minutes after you open the box, you can enjoy the first soft, smooth, silent shave with a lightning Stag edge. You will wonder how you ever got along without a Stag. It is the most suitable and welcome Christmas gift for any man. Send only \$1 today.

## Special \$1 Coupon

Hone, Strop and Trench Mirror Free

**THE STAG COMPANY**

329 Plymouth Ct., Dept. 5242, Chicago

GENTLEMEN: Wishing to take advantage of your 10 days' free trial and money-back guarantee, you may send a Stag Sharpener, hone, strop and Trench Mirror complete. I am sending herewith \$1.

## Send Today

Enclose only \$1, money order, draft, dollar bill, or check. Send today and make a comfortable shave for yourself. You need a Stag Sharpener. Clip coupon, put in \$1 and get it by return mail.

**The Stag Company**  
329 Plymouth Ct., Dept. 5242, Chicago

Name .....

Address .....

For Trench Mirror alone send only 35c



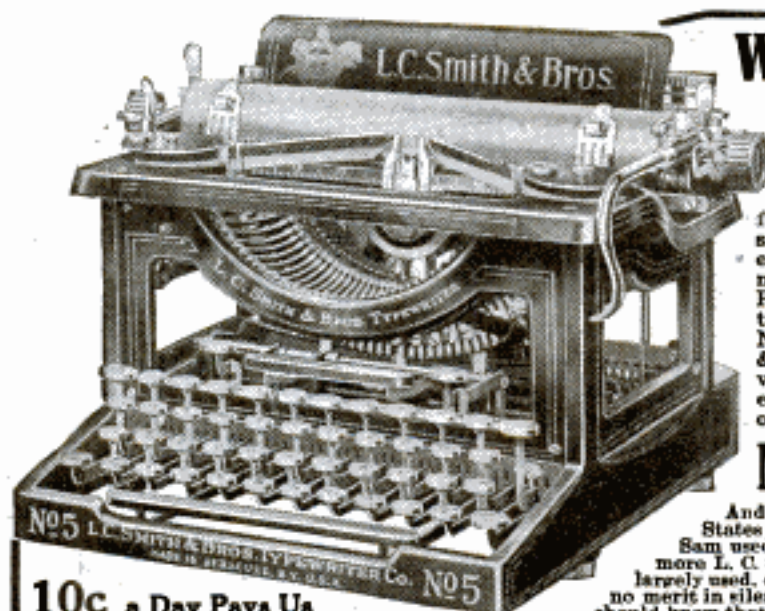

### 10c a Day Pays Us

A dime a day gives you the use of this fully guaranteed Model 5 Visible L. C. Smith while you complete payment. It is worth more than that small sum a day to have such a Typewriter on which you can place absolute dependence. Anyone needing a typewriter can get it on these terms.

**Guaranteed 5 Years—Sent on 30 Days' Trial** We use 600 Model 5's, having used them daily for years. We know how they stand up under the wear and tear of steady work. Hence this long five years' guaranty. Prove the merits of this Typewriter by the 30 days' writing test in your office or home. What better way could you ask to prove its quality? See how it responds to every demand you'll make upon it! Clip and sign the Coupon now. By return mail we will send the offer.

**Larkin Co. Desk IPM-1017, Buffalo, N.Y.**

Send all the details of your offer on the factory-rebuilt Model 5 L. C. Smith, with complete descriptive Typewriter Catalog.

Name .....

Address .....

## What Other Typewriter Approaches This Record?

Where will you find another typewriter so universally adopted by great business institutions as this one? Space permits mention of only those using from 100 to 2000 Model 5 L. C. Smith Typewriters, the same make and model as here pictured. The publishers of the Ladies' Home Journal and Saturday Evening Post, Acme White Lead & Color Co., Du Pont Powder Co., Firestone Tire & Rubber Co., International Harvester Co., Kellogg Toasted Corn Flake Co., National Biscuit Co., National Surety Co., Park, Davis & Co., Sears Roebuck Co., Sherwin Williams Co., Solvay Process, A. G. Crosby Co., Westinghouse Interests, six Great Railway Systems, Larkin Co. What other typewriter can muster an honor roll such as the

## Model 5 L. C. Smith Typewriters

And we haven't mentioned the biggest user of all, the United States Government. Up to the time war was declared, Uncle Sam used 5000 Model 5's. Since then he has bought thousands more L. C. Smith Typewriters. If other typewriters were being so largely used, don't you think their makers would tell you so? There is no merit in silence on a subject so important to them and to you. You should know that in possessing this genuine factory-rebuilt Model 5 which we offer, that according to the judgment of these great business firms and the United States Government, you can get no better. Their large usage puts a stamp of approval on this Typewriter which you cannot afford to ignore.

## Why Not Have the Best?—Don't Be Content with Less

In view of the Model 5's most modern improvements, some of which are not obtainable on any other typewriter, you'll be most agreeably surprised when you learn of our price and terms of sale. It is only by their distribution direct the money-saving Larkin Factory-to-Family way that we can make such an offer. It is unnecessary for you to be content with a less perfect typewriter. Big business has proven the great worth of this Typewriter. Why should you be content with one inferior to this Model 5? Ask for our offer, which makes known the most convenient conditions. **GET IT NOW.**

**Send the Coupon Now for Catalog and Offer**

## WONDER Pipe Bender

Saves the cost and waste of elbow-joints

Bends 2-in. pipe cold to 90 degrees in one minute.

No heating, treating, filling, cracking or crimping. Bends horizontally.

Handles any length pipe.

THREE SIZES: 1/2 in. to 1 in., 1 1/2 in. to 2 in., 2 1/2 in. to 3 in.

No job too large, no shop too small for the WONDER'S profitable use.

Write for Price List & Catalog

**AMERICAN PIPE BENDING MACHINE CO.**

49 Pearl Street Boston, Mass.

Some samples of the WONDER'S work



Used by Leading Firms in many lines

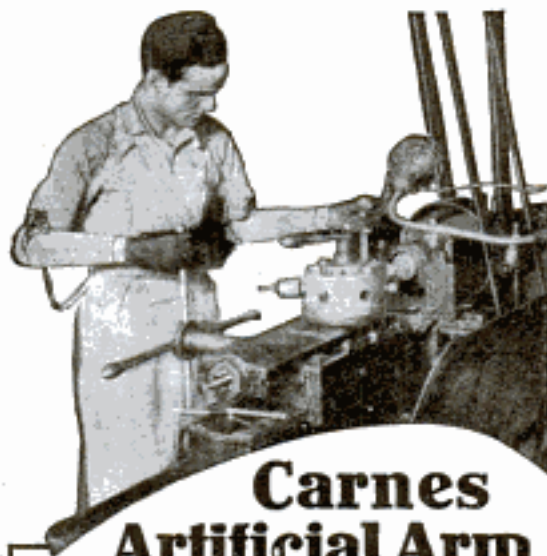

## Carnes Artificial Arm

has put Louis Rondeau back on the payroll as a wage-earner. He now is employed in a big Kansas City factory operating a machine. Both of his arms have been amputated and he wears two Carnes Artificial Arms. His salary and efficiency have not been lessened.

Endorsed by surgeons everywhere, the Carnes Arm has been declared to be the best substitute ever invented for a natural arm. Is the only arm with full finger motion, hand turning and bending wrist and bending elbow.

**Awarded Gold Medal at San Francisco, San Diego and London.**

Write in today for big illustrated Catalog B.25 containing pictures and testimonials from wearers of Carnes Arms.

**CARNES ARTIFICIAL LIMB CO.**

31 Carnes Bldg.,  
904 East 12th St. Kansas City, Mo.



## Adjusted

Skilful adjustment of this beautiful time piece insures its time keeping qualities. Probably you know already of the fame which has come to the Illinois watches because of their "to the second" constancy. No matter how hot or cold or what position you hold the watch in it will still keep time to the second.

Factory fixed  
selling price  
**\$25.00**



## 17-Jewel

Extra thin model, 12 size, only 2 1/4 inches across with 17 jewels (rubies and sapphires) beautiful silver dial with handsome figures. It has solid gold center wheel and double roller pinion. Fitted in gold filled case. Warranted for 25 years. No jeweler can sell you this watch for less than \$25.00. Our price \$23.50.

Our easy pay-  
ment plan price  
**\$23.50**

# Send Only **\$2<sup>00</sup>**

## And We'll Send You This 17-Jewel Illinois

**H**ERE'S a genuine Illinois Watch on a "take it quick" offer. 17 Jewels and only \$2.00 down. The identical watch which is being sold by local jewelers everywhere—for \$25.00—but our price is \$23.50. A substantial saving—a low payment—then easy terms. Mail coupon and get watch today.

## Wear It for Ten Days at Our Expense!

That's the best way to find out what a watch will do. Check it up with Uncle Sam's time or the "depot clock". Send the coupon below with the first small payment of \$2.00 and we will send you this watch at once. If you are not satisfied return at our expense any time within 10 days.

## Order This Watch Today

We assume all the risk—so why not order this watch today? As we told you this is a "take it quick" offer. We can't tell you how long this price will be maintained. We can tell you our supply is not so big as we would like and almost any day we may be compelled to ask more. Our advice is—don't delay, when you can get this genuine Illinois at this reduced price and on such terms. Clip the coupon and send it today with only \$2.00. The balance in monthly payments of \$3. But get the coupon in the mail today—that's the thing.

**Harold Lachman Company**  
12 No. Michigan Ave. Dept. 9197 Chicago

**Harold Lachman  
Company**  
12 No. Michigan Ave.  
Dept. 9197 Chicago, Ill.

Gentlemen:—Please send me the 17-Jewel Illinois watch illustrated above, on 10 days' free trial. I enclose \$2.00 as first payment and agree to pay balance in monthly payments of \$3.00 each until \$23.50 has been paid. If I am not satisfied with the watch I have the privilege of returning it within 10 days, and you will refund my \$2.00 at once.

Name .....

Address .....



6249 **Kwik-Lite** the **QUALITY Flashlight**—Designed with Skill—Built by Experts 8261

Telescopic Construction strengthens the case and permits easy inspection and renewal of battery. Distinguishes KWIK-LITE and protects against substitution. Self-Locking Switch allows steady or intermittent light and prevents accidental contact. Improved Reflector has precise angle that gives brighter light without requiring more current.

**KWIK-LITE Seamless Batteries** (drawn from sheet zinc) are guaranteed for 25% longer life. Renew any flashlight with a Seamless Battery. Costs no more. Sold by leading Hardware, Drug, Electrical and Sporting Goods Stores. No. 42000 has handsome nickel finish, \$2. No. 8261 Black Metal Just over \$1.38. There are 66 other styles. Booklet 34 describes the complete line.

The **Usona Manufacturing Co.**  
New York-Toledo-San Francisco

**THIS IS TEMCO**

The speedy, dependable and durable portable electric drill—taking the place of hand work in thousands of machine shops, garages, factories, ship yards, public buildings, etc. A wonderful tool enjoying a wonderful and fast increasing popularity.

**EXECUTIVES AND SUPERINTENDENTS**—investigate this money and time saving tool.

**MECHANICS**—ask the boss to get a TEMCO. Show them you are alive to good things.

Five sizes—9 to 19 pounds. Capacities to  $\frac{1}{2}$ " drilling in steel.

Also Temco Drills, Grinders, Buffers, etc., of larger capacity.

At leading Dealers and Jobbers Everywhere. Write for our catalog.

**The Temco Electric Motor Company**  
143 Sugar Street LEIPSI, OHIO

Makers also of TEMCO-Air Shock Absorbers and TEMCO Shock Absorbers. Master Vibrators and Lock Switches for Fords.

Drills by electricity anywhere—direct or alternating current

**TEMCO**  
THE TOOL OF MANY USES

**LARGE WAR MAP** in Colors 26 x 30 in.  
Complete and authentic. Smallest details of Western battle front. Every hamlet indexed, easy to locate. Battle lines of past and present. Inset of Eastern fronts. Postpaid, 50c.  
**TRIAD PUB. CO., 405 Edison Bldg., Minneapolis, Minn.**

We Send Prepaid,  
No Money Down,  
10 Nights' Free Trial

See it, try it, test it in any way you want in your own home, alongside any other light. Then if you feel like parting with it send it back at our expense. The trial costs you nothing. We take all the risk.

**U. S. GOVERNMENT** report shows mantle oil light more than 3 times as efficient as ordinary lamp. The Daylite is whiter and brighter than gas or electric, at  $\frac{1}{4}$  the cost. Pays for itself in a few months in oil saved. No smoke, no dirt, no odor. Uses common wick and is lighted same as ordinary lamp. Simple and safe, cannot explode. Only oil light guaranteed for 5 years. Only mantle light with telescoping tube; full details in complete illustrated catalog—It's FREE.

**AGENTS WANTED.** No money—no experience—needed. Five out of six buy the Daylite the minute they see it. Wanted in every home. No talking necessary. Sells itself. No capital required. We supply stock, all necessary equipment, and protected territory. Men with rigs or autos are making \$6 to \$15 every day, month after month.

**WRITE NOW FOR LAMP—FREE** for ten nights' trial. Tell us if you have a rig or auto, whether you can work spare time or steady, your age, occupation, what territory you want and when you can start.

**DAYLITE COMPANY, 303 DAYLITE BUILDING, CHICAGO, ILLINOIS**

**TREAT YOURSELF WITH HEALTH GIVING VIOLET RAY**

**Health Strength Beauty**

Electricity from your light socket transformed into the greatest healthgiving agency known to Science—**Violet Ray**—powerfully effective, yet soothing and gentle in action; 110 volts without the slightest shock; pleasant and perfectly safe.

**RenuLife Violet Ray High Frequency Generator**

Treats the lowest priced, most effective instrument of the kind in the world. Used and endorsed by physicians and beauty specialists. You can receive the benefits in the privacy of your own home, heretofore only procurable through costly treatments. Write for particulars.

**RenuLife Electric Co.**  
591 Marquette Bldg. DETROIT, MICH.

**Wanted** Men and women representatives to demonstrate to doctors and individuals. Earn \$50 a week up. We give full instructions. Get our proposition.

**RENULIFE VIOLET RAY GENERATOR**

**GEARS ALL KINDS SMALL**

The most accurate made and prices reasonable. We carry a complete line of gears in stock for immediate shipment. Can also quote on special gears of all kinds. Send us your inquiries. WRITE FOR CATALOGUE.

**CHICAGO STOCK GEAR WORKS**  
16 S. Fifth Av. CHICAGO

**ERECTOR THE TOY LIKE STRUCTURAL STEEL**

**BOYS:** Write for facts about Gilbert Toys and get Toy Tips, the boys' magazine, FREE.

**THE A. C. GILBERT COMPANY, 104 Fox St., New Haven, Conn.**

**BURNS KEROSENE**





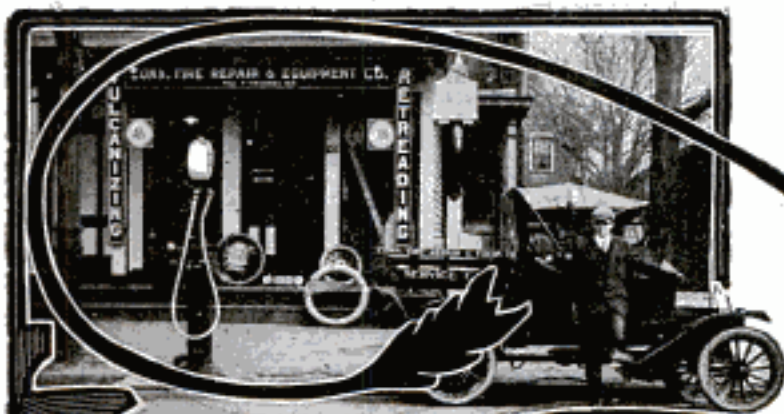

**The Haywood Tire  
Repair Shop of  
Paul R. Fredricks  
Wallingford, Conn.**

**Now doing an average  
business of  
\$450 a week.**

## YOU TOO CAN MAKE BIG MONEY

We need immediately, more men like Paul R. Fredricks to manage Haywood Tire Repair stations. "Just a year in the business and now doing \$400 to \$450 a week at a good round profit" tells the story of this ambitious young man's rapid rise to fortune. Scores of men like Fredricks have found their independence in the Tire Repair business, have opened Haywood shops and are making big money. The coupon below or a post card with your name and address will tell you how to start. Send today.

### **Tire Repairing Revolutionized!! Motorists To Save Millions in Tire Expense**

The Haywood method of tire repairing is different—*Scientific*. It strikes a new chord in tire economy. It is efficient—saves tires—increases mileage—lasts. It has required years of experience to develop it. Practical tests have proven it. Its superiority is acknowledged—accepted by those who know, as a *Triumph*.

### **30 Million Tires to Repair**

The demand for tire repairing is now so great that more Haywood stations must be established at once throughout the country. We want capable, energetic, ambitious men in charge of each—men who are dependable—competent. *You can have this opportunity—share in the Haywood success—become a link in a mammoth chain of a country-wide, thoroughly efficient Tire Repair Service.*

### **Make \$3,000 a Year or Better! You Own Your Own Business! Keep Your Own Profits!**

Haywood equipment is sold outright. We teach you Haywood Scientific Tire Repairing in our Laboratory especially equipped for this purpose. Here you learn all about tires—the inner mechanism of construction—how to repair *scientifically* every tire injury. This training is thorough—practical and equips you to give Haywood Service of the standard we advertise nationally and are so careful to maintain—the Service that saves motorists millions of dollars in tire up-keep.

### **A Wonderful Opportunity**

The coupon—your name and address, brings full particulars. How to start. How to tie up with the Haywood Service. We'll give inside facts and figures about costs and profits. Explain in detail our Co-operative Business Building Plans. Write today without fail. Learn how you can start at once.

**Haywood Tire & Equipment Co.**  
609 N. Capitol Ave. Indianapolis, Ind.

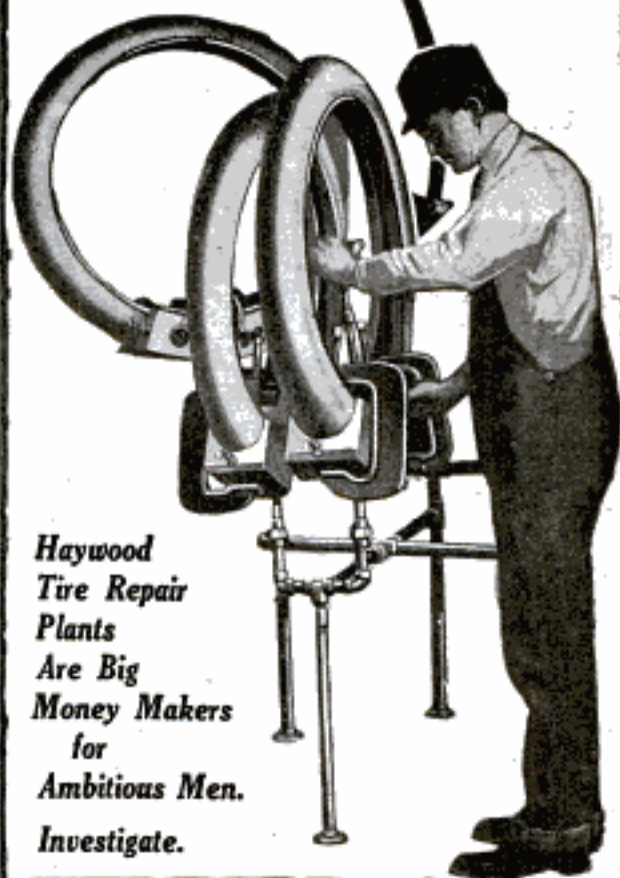

**Haywood  
Tire Repair  
Plants  
Are Big  
Money Makers  
for  
Ambitious Men.  
Investigate.**

**Mail this Today**

**HAYWOOD TIRE & EQUIPMENT CO.**  
609 N. Capitol Avenue, Indianapolis, Ind.

Gentlemen:—

Please send full particulars of your Scientific Tire Repair Service and details of your Co-operative Business Building Plans.

Name .....

Address .....

Please Mention Popular Mechanics



# E. Z. GARTER



## Made on the RIGHT Principle WIDE WEBBING

No restriction or marking of the leg. The wear is evenly distributed over a wide area, hence the muscles and veins are not confined and "you don't know you've got 'em on."

Every wearer is an enthusiast. You will be surprised and delighted with the E. Z.

Ask your dealer to-day. 25c for lisle, 50c for silk. Also the E. Z. 2-GRIP, 40c and 60c. If dealer hasn't them, send us his name and price. THE THOS. P. TAYLOR CO., Dept. P, Bridgeport, Conn.

**Dealers:** Ask your jobber, or order sample dozens from us without obligation.

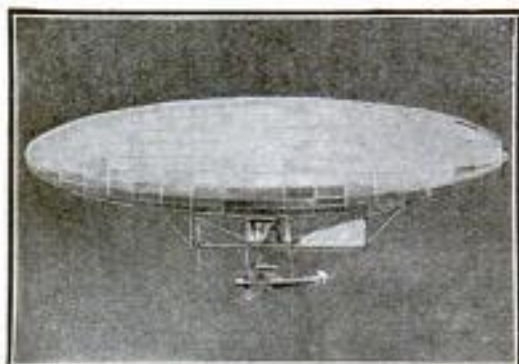

## A REAL ZEPPELIN MILITARY DIRIGIBLE AIRSHIP!

Actually the BIGGEST SENSATION in the Aeronautical Field in Years. A Five Foot Complete Model of the German Dirigible. Equipped with Large Parachute, Dropping Apparatus and complete Inflating Arrangement. Will Positively Fly ONE MILE and release Parachute at height of ONE THOUSAND FEET.

Airship is easily retrieved and may be flown numbers of times with a complete exhibition at every flight. May be flown free, or, on a will day, attached to a light cord.

### IT WILL AMAZE YOU!

Every outfit Complete and Warranted to give more Genuine Satisfaction than any Article heretofore offered in the Aerial Field. Absolutely new design involved. Shipped anywhere for \$1.00. UNITED STATES WAR RITE, Cloth Planes Complete. Large reel of Strong Twine, Silk Parachute and Releasing Device, postpaid for \$1.80. This kite is of the Ripstone Type and will carry aloft a small Camera, Parachute and Bombs at the same flight, and drop them safely and with remarkable precision. An exact model of the Man-Carrying Kites in use at the front today.

Both Flyers Prepaid \$2.25

The Scientific Novelty Co., Dept. 71, Binghamton, N. Y.

**A Real Zeppelin  
AIRSHIP  
\$1.00 Prepaid**

Please Mention Popular Mechanics

# FEDERAL BICYCLE TIRES



## Take Pride in Owning Federal Bicycle Tires

Boys learn the value of good bicycle tires on their long jaunts into the country.

The fall months are the most glorious of all for such trips.

Be sure you have Federal Tires. You can get speed and they are sturdy and strong.

THE FEDERAL RUBBER COMPANY  
OF MILWAUKEE  
Factories: Cudahy, Wisconsin

Manufacturers of Automobile Tires, Tubes and Spacers, Motorcycle Tires and Tubes, Roller Tires, Golf Balls, Tennis Balls, and Rubber Goods.



## After an Auto Owner Uses an Explosion Whistle

and learns its many good features he generally writes us a testimonial expressing his gratification with the Buell. Its certain operation and ability to withstand excessive vibration has led to its use by sixteen truck manufacturers. The O. K. of their engineers is our strongest commendation.

If you are interested in the real security that a positive efficient warning bestows write us for descriptive circular.

THE BUELL CO. 1610 Michigan Ave.  
CHICAGO

A Baseball Jersey



## Be the First in Your Club

School, City or Town, to wear this pure, all wool sweater, double collar and cuffs. Your choice in colors. This Jersey was selected by 10,000 of my customers for last season. Your club will recommend it. Send for my big illustrated catalogue. Write me and learn my offer for your club's order. Popular Prices. Best Grade Sporting Goods—Baseball, Basketball, Tennis, Golf, Football, etc.

WRITE ME NOW.

JACK SHANNON CO., Dept. 46, 54 E. Monroe St., Chicago



## MAKE \$60 A WEEK

We want Special Agents to travel by automobile selling our new gas-generating Coal-oil lamp.

Absolutely safe. Big money saver.

### 300 Candle Power

It's simply wonderful the way this new lamp is selling. Every home a possible sale. Big Money easy. Lowest priced high grade lamp on the market.

## This Auto GIVEN



Write for plan how we furnish representatives with an automobile. This is no contest where only one person wins. Anyone can earn this auto.

THOMAS MFG. CO., 1248 East St., DAYTON, OHIO

Copyrighted material



# \$1 Is All You Send

Any article shown here, sent direct to your home, for only \$1.00 now. Use it for 30 days, then if, for any reason whatever, you want to return it to us, we will pay the freight both ways and refund your money. If you decide to keep it, pay the balance on our easy terms. Order more than one article if you wish, direct from this ad or from our catalog.

That is the offer from the House of Hartman which gives you an opportunity to share in the benefits of our great buying power and of our charge account system which means getting the utmost in value and the easiest terms. That "the customer is always right" is the foundation of the policy on which we have built success from a little store to a \$12,000,000 concern with hundreds of thousands of customers. Send to us for anything you want. Order direct from this advertisement, or get our 454 page book, make your selection from it, and your charge account will be opened. Send coupon.

## \$1 Brings You This Royal Chair



**Golden, Fumed Oak or Mahogany finish.** Frame 28 in. high; 30 in. wide; 27 1/2 in. deep (outside measurements). Seat 20 1/2 x 20 1/2 in. inside. Back 21 1/2 x 27 in. inside. Length reclining 44 in.; with foot rest extended, 66 in. Upholstered in durable imitation Spanish brown leather; 8 springs in back, 4 springs in seat. Press button on right arm and back automatically adjusts itself.

State whether Golden or Fumed Oak or Mahogany finish is desired.

Foot rest is out of sight when not in use and in foot rest is hidden basket for newspapers, magazines, etc.

Made in Golden or Fumed Oak or Mahogany finish. Oak chair has genuine quarter-sawed oak arms, front posts and front rail.

Shipped direct from our Chicago Warehouse.

Order by No. 84MA5. Price \$15.65. Send \$1.00 now. Balance in monthly payments of \$1.75 each.

## \$1 Brings This Bed Outfit



**Complete Outfit—** Full size bed, spring, mattress, two pillows. Bed has heavy 11-16 in. continuous posts. Seven 3/4 in. upright grouped fillers. Head end is 54 in. and foot end 34 in. from floor. Choice of White or Gold Bronze (Vernis Martin) finish. Spring has fabric top fitted on heavy angle iron frame and is supported at ends by resilient steel helical coil springs. Mattress good grade sanitary cotton top well filled with wood fibre. Covered with neat striped ticking. Weight, burlaped, about 60 lbs. Pillows filled with specially blended selected feathers and measure full 18x25 inches. Covered with durable stripe ticking. Shipped from our Chicago Warehouse.

Order by No. 153MA10. Price for complete outfit \$14.79. Send only \$1.00 now. Balance in monthly payments of \$1.50 each.

## \$1 Brings This 4-Piece Mission Library Suite



Seasoned solid oak, rich, fumed finish; correct Mission design. Chair and rocker have quarter-sawed oak arm rests and top panels, also neat carving. Seat upholstered over steel spring slats, well filled with wood fibre and covered with soft cotton jute. Upholstering is in imitation Spanish brown leather. Table is 24x34 inches and ornamented with carving. Tabourette has octagon top about 11 1/2 in. across and is 17 in. high. Shipped direct from our factory in Western New York State. Substantially crated.

Order by No. 110MA4. Price for the complete set \$9.89. Send only \$1.00 now. Balance in monthly payments of \$1.00 each.

Quarter-Sawed Oak Arm Rests and Top Panels

# FREE

## 454 Page Bargain Catalog

This book shows amazing values in Furniture, Stoves, Silverware, Jewelry, Lamps, Baby Carriages, Phonographs, Kitchen Cabinets, Ice Boxes, Dishes, Curtains, Sewing Machines, Carpets, Rugs, Aluminum Ware, Vacuum Cleaners, Paints, Roofing, Gasoline Engines, Cream Separators and hundreds of other articles. Mark coupon to order direct or send post card or coupon for the catalog. We will mail it free upon request.



**Hartman Furniture and Carpet Co.**  
3945 Wentworth Ave., Dept. 1028 Chicago, Ill.

## Hartman Furniture and Carpet Co.

3945 Wentworth Avenue, Dept. 1028 Chicago  
Send me the merchandise marked X, it is understood that I am to have the use of it for 30 days and if, for any reason, I do not wish to keep it I may return it at the end of that time and you will pay the freight both ways and refund my payment. If I keep it, I am to pay balance on your easy terms.

Royal Chair No. 84MA5  4-Piece Library Suite No. 110MA4  Bed Outfit No. 153MA10

Name.....  
Address.....  
City..... State.....  
If Catalog only is wanted, write name and address or send post card.

Please Mention Popular Mechanics



# New KEROSENE LIGHT BEATS ELECTRIC OR GASOLINE

10 Days FREE—Send No Money

Men With  
Rigs or Autos  
Make

**\$100 to \$300  
Per Month**

Our trial delivery plan makes it easy. No previous experience necessary. Practically every farm home and small town home will buy after trying. One farmer who had never sold anything in his life before writes: "I sold 51 the first seven days." Christensen, Wis., says: "Have never seen an article that sells so easily." Nearing, Iowa, says: "92 per cent of homes visited bought." Phillips, Ohio, says: "Every customer becomes a friend and booster." Kemering, Minn., says: "No flowery talk necessary. Sells itself." Thousands who are coming money endorse the Aladdin just as strongly.

## No Money Required.

We furnish stock to get started. Sample sent prepaid for 10 days' free trial and given absolutely without cost when you become a distributor. Ask for our distributor's plan. State occupation, age whether you have rig or auto; whether you can work spare time or steady; when can start; over ship's most convenient for you to work in.

BURNS  
9-4%  
AIR



TWICE THE LIGHT  
ON HALF THE OIL

We don't ask you to pay us a cent until you have used this wonderful modern white light in your own home ten days, then you may return it at our expense if not perfectly satisfied. We want to prove to you that it makes an ordinary oil lamp look like a candle; beats electric, gasoline or acetylene. Passed by Insurance Underwriters. Children handle easily. Tests by U. S. Government and 35 leading Universities show that the new ALADDIN

## Burns 50 Hours on One Gallon

common kerosene (coal oil), no odor, smoke or noise, simple, clean, won't explode. Over three million people already enjoying this powerful, white, steady light, nearest to sunlight. Won Gold Medal at Panama Exposition. Greatest invention of the age. Guaranteed.

**\$1000 Reward** will be given to the person who shows Aladdin in every way (details of offer given in our circular). We want one user in each locality to whom we can refer customers. To that person we have a special introductory offer to make, under which one lamp is given free. Write quick

**Yours FREE** (see our 10-Day Free Trial Offer and learn **Yours FREE** how to get one free, all charges prepaid).

**MANTLE LAMP CO., 312 Aladdin Building, CHICAGO, ILL.**  
Largest Kerosene (Coal Oil) Mantle Lamp House in the World

**Get One FREE**

## Health, Strength, Vitality

Use



To improve physical strength, restore health and aid all vital functions. Vi-Ray-O is not a vibrator, but a scientific instrument used by thousands of physicians daily. It benefits by electricity. No shocks, no pain, no disagreeable sensations of any kind. Feeds your nerves with vitalizing energy, relieves aches and pains, develops muscles, aids beauty and purifies the blood. Effective treatment for skin and scalp diseases, headaches and chronic ailments.

**Use It for 30 Days—Free** Our Big Free illustrated book tells of the wonderful benefits that can be obtained by use of the Vi-Ray-O treatments. Try it in your own home 30 days free. Write today. **Dealers Wanted** Western Coil & Electrical Co., Box 29, Racine, Wis.

## TYPEWRITERS



We have hundreds of practically new typewriters in this special sale. All in A-1 condition. In this lot are Underwoods, L. C. Smiths, Monarchs, Remingtons, Olivets, Foxes and many other well-known makes, positively as good as new. To be sold at 30% discount this month only. Write to our typewriter catalog and we will tell you how you can save money on your typewriter.

Write Today

**American Typewriter Exchange**  
12-14 W. Washington St. CHICAGO

**THERE IS BIG MONEY IN  
CARD PRINTING**  
of all kinds if done with an  
**Automatic Press**

Send for our Free Booklet No. 6

**S. B. FEUERSTEIN & CO.**

Manufacturers  
542 Jackson Bldg., Chicago

**Prints  
While  
You Wait**  
100 Cards a  
Minute  
Any Size



**\$5 TO \$10 A DAY** easily earned taking orders for our high grade Soaps and Toilet Preparations. Our goods well known — nationally advertised. Ladies and men make 100% profit. No experience necessary. Write for sample case offer. **CROFTS & REED CO., Dept. C-167, Chicago, Ill.**

**FREE Trial**  
**PIEDMONT RED CEDAR CHESTS**



New Catalog  
Reduced Prices

Your choice of 90 styles of the famous Piedmont genuine Southern Red Cedar Chests. 15 days' free trial. We pay the freight. A Piedmont protects furs, woolens and linens from moths, mice, dust and damp. Distinctively beautiful. Wonderfully useful and economical. Finest Xmas or wedding gift. Write today for big new 64-page catalog with reduced prices. Postpaid free. **Piedmont Red Cedar Chest Co., Dept. M, Statesville, N. C.**

## STRUCTO

Boys' Engineering. Write for booklet. **Structo Manufacturing Company, Dept. 119, Freeport, Ill.**

## AGENTS—NEW INVENTION

Ventilated chemical indoor closet, for country, village and suburban homes; no plumbing, no waterworks, no cesspool; absolutely odorless; 30 days' free trial guarantee; every village and farm home a customer; an order at every house; one agent made \$112 commission in 8 hours. Agent's outfit free. Exclusive territory contract. Write today for full particulars of this biggest winner ever offered to salesmen. Address **SHAFFER MFG. CO., 484 Colton Bldg., Toledo, O.**



## The Perfect Garage Door Hanger

Quickly Installed—Easily Operated

Garage doors are a mean proposition if they don't work right—cause all sorts of trouble and often damage car going in or out.

## The Topping garage Set does end your troubles

Moderate in cost—easy to install—no small parts to get out of order—built to stand wear and tear—yet a child can operate.

The result of years of concentrated effort to solve Garage Door Hanger trouble.

Ask your hardware dealer—or write us direct for unusually low price. Do this today—you'll be amazed at Topping performance.

Dealers—No Hanger so satisfactory as the Topping. There's a big demand and a big profit in it. Architects—The one important detail in your plans that satisfy if you specify "Topping Hanger." Write for terms.

**Safety Door Hanger Co., 110 Topping Bldg., Ashland, Ohio**





**FREE**  
For 10 Days Wear

## Compare It With a Diamond

### Solid Gold Mountings

**Flat Belcher Ring**  
No. 1. Solid gold mounting. Eight claw design with flat wide band. Almost a carat, guaranteed genuine Tifnite Gem. Price \$12.50; only \$3.50 upon arrival, balance \$9 per month. Can be returned at our expense within 10 days.

**Ladies' Ring**  
No. 2. Solid gold mounting. Has a guaranteed genuine Tifnite Gem almost a carat in size. Price \$12.50; only \$3.50 upon arrival, balance \$9 per month. Can be returned at our expense within 10 days.

**Tooth Belcher Ring**  
No. 3. Solid gold, six-prong tooth mounting. Guaranteed genuine Tifnite Gem almost a carat in size. Price \$12.50; only \$3.50 upon arrival, balance \$9 per month. Can be returned at our expense within 10 days.

To quickly introduce into every locality our beautiful TIFNITE GEMS, we will absolutely and positively send them out FREE and on trial for 10 days' wear. In appearance and by every test, these wonderful gems are so much like a diamond that even an expert can hardly tell the difference. But only 10,000 will be shipped on this plan. To take advantage of it, you must act quickly.

Send the coupon NOW! Send no money. Tell us which ring you prefer. We'll send it at once. After you see the beautiful, dazzling gem and the handsome solid gold mounting—after you have carefully made an examination and decided that you have a wonderful bargain and want to keep it, you can pay for it in such small easy payments that you'll hardly miss the money. If you can tell a TIFNITE GEM from a genuine diamond, or if, for any reason at all, you do not wish to keep it, return it at our expense.

## Remarkable New Discovery

The closest thing to a diamond ever discovered. In appearance a TIFNITE and a diamond are as alike as two peas. TIFNITE GEMS have the wonderful pure white color of diamonds of the first water, the dazzling fire, brilliancy, cut and polish. Stand every diamond test—fire, acid and diamond file. Mountings are exclusively fashioned in latest designs—and guaranteed solid gold.

**How to Order Rings** To get the right size ring, cut a strip of heavy paper so that the ends exactly meet when drawn tightly around the second joint of finger on which you want to wear the ring. Be careful that the measuring paper fits snugly without overlapping, and measure at the second joint. Send the strip of paper to us with order coupon.

## Send No Money

Just send coupon. Send no reference, no money, no obligation to you in any way! You run no risk. The coupon brings you any of the exquisitely beautiful rings shown and described here for 10 days' wear free. Be sure to enclose strip of paper showing exact finger measurement as explained.

## Mail This Coupon

Send now and get a TIFNITE GEM on this liberal offer. Wear it for 10 days on trial. Every one set in latest style solid gold mountings. Decide then whether you want to keep it or not. Send for yours now—today—sure. Send no money.

### The Tifnite Gem Company

Rand McNally Bldg., Dept. 254 Chicago, Ill.

## Mail This Coupon

THE TIFNITE GEM CO.  
Rand McNally Bldg., Dept. 254 Chicago, Ill.

Send me Ring No. .... on 10 days' approval. (In ordering ring, be sure to enclose size as described above.) If satisfactory, I agree to pay \$3.50 upon arrival and balance at rate of \$9.00 per month. If not satisfactory, I will return same within ten days at your expense.

Name.....

Address.....

Please Mention Popular Mechanics



**BERNARD-HEWITT & CO.,**  
Desk F2A, 424-434 So. Green St.,  
CHICAGO, ILL.

Please send me your new Fall and Winter style book with 70 samples free — also full details of your special lining offer.

Name .....

Address .....



**MAIL COUPON**

For Fall and Winter  
**STYLE BOOK**

**70 SAMPLES  
FREE**

## High Grade Blue Serge Suit Made to Measure only **\$15**

GUARANTEED ALL WOOL

**A** SPECIAL proposition to introduce the wonderful values offered by our system of tailoring. We have no agents — no dealers — no traveling salesmen — our values make their own customers — and once a Bernard-Hewitt customer always a Bernard-Hewitt customer. That's why, to secure your first order, we are willing to make to your individual measure, a handsome, all pure wool worsted blue serge suit (usual \$25 value) for only \$15 and line it with a

**WE PAY  
SHIPPING  
CHARGES**

**\$4 SATIN  
LINING FREE**

Remember, this suit is strictly hand tailored to your individual measure from the very finest all wool blue, light blue, black or gray serge, in the latest approved Chicago style, and by the very best tailors in this whole city.

But perhaps you don't care for a serge suit. Well, our big book which we will send you free contains generous samples of the latest fabrics; plain and fancy mixtures, the up-to-the-minute offering of leading woolen mills.

The \$4.00 Satin Lining free offer goes, no matter what fabric you select — and we pay all shipping charges. We take all the risk — you none — for this is

**OUR GUARANTEE** Complete Satisfaction  
or Refund of Money

You must be pleased in every particular — in fit — in style — in workmanship and in materials, or we don't want your money. Could anything be fairer? Write today — wear real tailor-made clothes — dress better and save money.

**Take Your Own \$10  
Measure — Save \$10**

**Write for Your Copy of Our Big Book Today**

Our big new Fall and Winter book is ready for you — contains 70 samples latest woolens — also lowest prices on men's hats, shoes and furnishings. It is your guide to correct and economical clothes buying. Mail coupon above or send post card for your copy. Please mention POPULAR MECHANICS so that we can identify this special offer.

**BERNARD-HEWITT & COMPANY**

424-434 So. Green St.

Desk F2A

CHICAGO, ILLINOIS



# New Oliver Typewriters At Half Price

## Latest Model

Number  
Nine

Was \$100  
Now \$49

**FREE TRIAL—  
No Money Down  
Over a Year to Pay**



## Save \$51

**By This New Plan—Be Your Own Salesman  
A \$2,000,000 Guarantee That This \$49 Typewriter Was \$100**

Since March 1st The Oliver Typewriter Company has had no expensive sales force of 15,000 salesmen and agents, no high office rents in 50 cities, no idle stocks, no costly subsidies, no excessive distribution costs.

By selling direct from the factory to you, we save \$51 in sales costs.

This now goes to you. The \$49 Oliver is the identical machine that was formerly \$100. Not one change has been made in design or materials. Each machine is absolutely brand new. This we guarantee.

### The \$100 Model

The Oliver Nine is the finest, the costliest, the most successful model we ever built. If any typewriter is worth \$100, it is this handsome machine, the greatest Oliver triumph.

Over 600,000 have been sold. This is the same commercial machine used by the U. S. Steel Corporation, the Standard Oil Company, the National City Bank of New York, Montgomery Ward & Co., the National Biscuit Company, the Pennsylvania Railroad, and a host of others. Any operator can use the Oliver.

### Free Trial; No Money Down

Here is our plan: We ship an Oliver Nine to you for five days' free trial. No money down—no C. O. D. Use it in your office or at home. Try it without anyone to influence you.

If you want to keep it, send us \$3 per month. If you want to send it back, we even refund the transportation charges you paid.

That is the entire plan. You are the sole judge. At no time during the trial are you under the slightest obligation to buy. Superiority and economy alone must convince you.

Canadian Price, \$62.65

### Amazing Facts

We have just published a startling book, entitled "The High Cost of Typewriters—The Reason and the Remedy," which reveals the inside history of the typewriter world—old customs of selling—secrets never before divulged—all about price inflation—subsidies, etc. All the follies of \$100 pricing are exposed. Readers are astounded.

Mail the coupon now. You will be surprised.

This book tells everything. With it we send our catalog, free trial order blanks, etc. After reading it, you may order a free-trial Oliver.

One copy of this expose will be sent to each person who mails the coupon below.

The Oliver Typewriter Co.  
1097 Oliver Typewriter Bldg., Chicago

**FREE  
BOOK**

THE OLIVER TYPEWRITER CO.  
1097 Oliver Typewriter Bldg.  
Chicago, Ill.

Ship me a new Oliver Nine for five days' free inspection. If I keep it, I will pay \$49 at the rate of \$3 per month. The title to remain in you until fully paid for.

My shipping point is.....

This does not place me under any obligation to buy. If I choose to return the Oliver, I will ship it back at your expense at the end of five days.

Do not send a machine until I order it. Mail me your book—"The High Cost of Typewriters—The Reason and the Remedy," your de luxe catalogs and further information.

Name.....

Street Address.....

City.....State.....





Ignatius Barnard, Pres't.

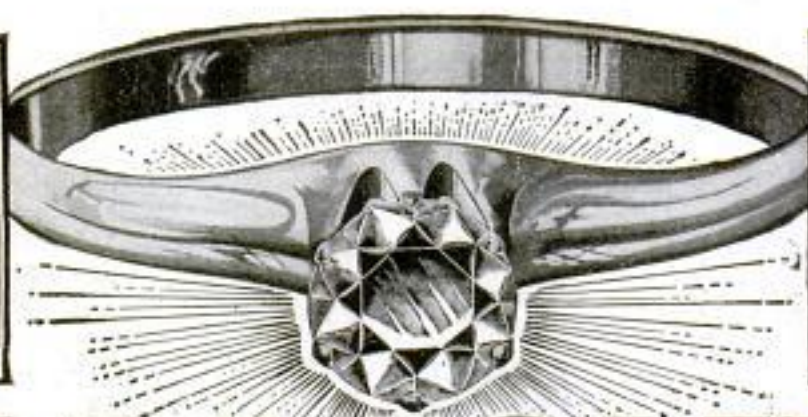

**\$88**  
PER  
CARAT

# DIAMONDS

**Direct From Barnard, The Importer  
At World's Lowest Prices**

Here are the secrets of my money-saving prices on diamonds: With my world-wide business of tremendous volume, I can buy direct from the cutters of Europe, then resell direct to you at the smallest margin of profit. I have eliminated all middlemen—all waste—in the selling of diamonds and guarantee that you cannot match my prices anywhere, wholesale or retail. If you don't see a saving of 35% in the diamond I send you for free examination, send it back!

Small Sizes <b>\$50</b> Per Carat	Extra Blue White <b>\$133</b> Per Carat	Wesselton Blue White <b>\$177</b> Per Carat	Jagers Steel Blue <b>\$233</b> Per Carat	Jagers Blue Perfect <b>\$288</b> Per Carat
--	--	--	---	---

## Send No Money!

Merely send for my beautiful Diamond Book—select the diamond and mounting of your choice, and I'll ship it for your inspection—at my expense and without obligating you to buy. As we get all our business in this way our success proves our prices lowest by comparison.

### BANKABLE MONEY BACK GUARANTEE

The only bankable Money Back Guarantee in the diamond business. You can take it to any bank and cash in your diamond investment if you want to. The only guarantee

without red-tape, delays or evasions. It is also a legal certificate of carat weight, quality and value of the diamond. Allows you to exchange it at full value at any time.

### FREE 1918 De Luxe Book of DIAMONDS

Profusely illustrated in colors. Shows thousands of the greatest bargains in diamonds. Tells you all about diamond qualities, colors, imperfections. Shows every fashionable and popular style of mounting in 14K solid gold and platinum at actual factory cost. Also all sizes of diamonds in 7 different qualities at import prices. Free for the asking.



1918  
De Luxe  
BOOK OF  
DIAMONDS



#### 14K Engagement Solitaire

Prices Complete

1/2 Carat \$ 8.00 to \$ 19.75  
3/4 Carat \$17.25 to \$ 43.75  
1 Carat \$31.00 to \$ 77.50  
1 1/4 Carat \$42.75 to \$121.50  
1 1/2 Carat \$57.13 to \$208.00  
1 Carat \$90.88 to \$290.88  
Large sizes to 10 carats.



#### 14K Men's "Ideal" Ring

Prices Complete

3/4 Carat \$ 20.00 to \$ 46.50  
1 Carat \$ 44.75 to \$123.50  
1 1/4 Carat \$ 68.75 to \$209.50  
1 Kt. \$ 92.50 to \$292.50  
1 1/2 Kt. \$142.50 to \$409.50



### SPECIAL!

A \$75.00 solitaire ring (style shown by picture above) reduced to \$45.38 by direct importing, elimination of middleman's profits and cash methods. Wesselton Blue White perfect cut, of richest brilliancy, guaranteed weight 1/2 less 5-64 carat. Engagement quality 14K solid gold mounting. Special price... **\$45.38**

Platinum Tips \$2.38 Extra.

## BARNARD & CO.

N. W. Cor. State and Monroe Sts. Chicago, U.S.A.  
Dept. 3288-C

**FREE BOOK COUPON**  
BARNARD & CO., Dept. 3288-C  
N. W. Cor. State and Monroe Sts. Chicago  
Without expense to you or the slightest obligation  
please mail 1918 De Luxe Book of Diamonds to  
Name.....  
Address.....





## Sons and Fathers Meet at Billiards —MAN TO MAN!

Play Carom and Pocket Billiards *in your home* and rear red-blooded boys. Unite *all* members of your family in this life-long comradeship. Homes need the protection of these fascinating pastimes shared in common—you owe your boys and girls your own society.

Parents who secured home tables for their young folks write us that they themselves can hardly wait each day for the "Billiard Hour."

# BRUNSWICK HOME BILLIARD TABLES

Not toys—but scientific Carom and Pocket Billiard Tables with fast Monarch cushions, accurate angles and ever-level playing beds.

Handsome designs in oak and mahogany. Regular or folding styles in sizes to fit all homes.

### EASY TERMS—BALLS, ETC., FREE

Brunswick prices range from \$35 upward, according to size and design. Popular Purchase Plan lets you play while you pay—on low monthly payments.

Expert Book of 33 Carom and Pocket Games and High Class Outfit of Balls, Cues etc., given with every Brunswick.

### SEND FOR BILLIARD BOOK FREE

Learn how billiards exhilarates mind and body, aids digestion and—how it keeps boys off the street. See the tables in attractive color reproductions and get our low price and home trial offer. All contained in our color-book, "Billiards—The Home Magnet." Send your address today without fail for free copy.

**THE BRUNSWICK-BALKE-COLLENDER CO.**  
Dept. 55L, 623-633 S. Wabash Ave., Chicago



"Baby Grand"  
DEALERS: Write for agency proposition without delay.

### THE BRUNSWICK-BALKE-COLLENDER CO.

Dept. 55L, 623-633 S. Wabash Ave., Chicago

You may send me free copy of your color book—"BILLIARDS—The Home Magnet," and tell about your home trial offer.

Name .....

Address .....





## Two Ways to Iron! Which is Yours?

**The inefficient, expensive way** — by hand — 11 o'clock in the morning — only a few pieces ironed — kitchen hot — housewife tired and discouraged — hours of hard work ahead.

**The efficient, cheaper way** with the Simplex — 9 o'clock — the ironing finished — work beautifully done — kitchen cool — housewife fresh and smiling — the rest of the day free for other duties, recreation or pleasure. *No woman should do by hand what a machine can do better for her.*

# SIMPLEX IRONER

*Does the Work of an Expert Hand Laundress in One-Fourth The Time*

Conserve your time and strength by ironing "the Simplex way." Do your entire ironing in one hour. Eliminate lifting and pushing of irons and long tiresome standing. Cut down your gas and electricity bills by using the Simplex — total expense of an ironing only 2 to 4c.

Have the luxury of an abundance of fresh, well-ironed linen! The even heat and uniform pressure of the Simplex produces a more beautiful finish than possible with a hand iron. The Simplex irons everything except shirtwaists and skirts.

Electric Drive Simplex Ironer for homes supplied with electric current. Power ironer for the farm or for the washing machine user. Hand Power Simplex for the home without gas or electricity.

Can be had on Easy Payments and on Trial. Various Prices. Eight sizes. The Simplex is durably made to last a lifetime. Write for our Free Illustrated Book "Clean Linen in Abundance."

*Laundresses and maids are enthusiastic over the Simplex*

**AMERICAN IRONING MACHINE CO., 505, 168 N. Michigan Avenue, CHICAGO**

*We also make Ironing Machines and Equipment for the Small or Hand Laundry, Hotel, Institution, etc. Write for catalog.*

A 387



**M**OTHER NATURE knows more about putting mellowness in tobacco than mortal man ever will know.

There are quicker, cheaper ways to cure tobacco than Nature's slow patient way. But you never tasted VELVET'S smoothness and mellowness in any of those so called "improvements" on Nature.

VELVET takes two years natural ageing in wooden hogsheads to come to its full perfection—and we are more than repaid for this extra expense by the goodwill of pipe smokers who think there is nothing like VELVET.

*Buy a tin of  
VELVET today.*

**T**HE greatest works of man generally ain't works of man at all—they're just works of Nature that man helped out. Nature sure deserves a heap of credit for makin' VELVET.

*Velvet Joe.*



M-LEONE  
BRACKER



# Williams' Shaving Cream

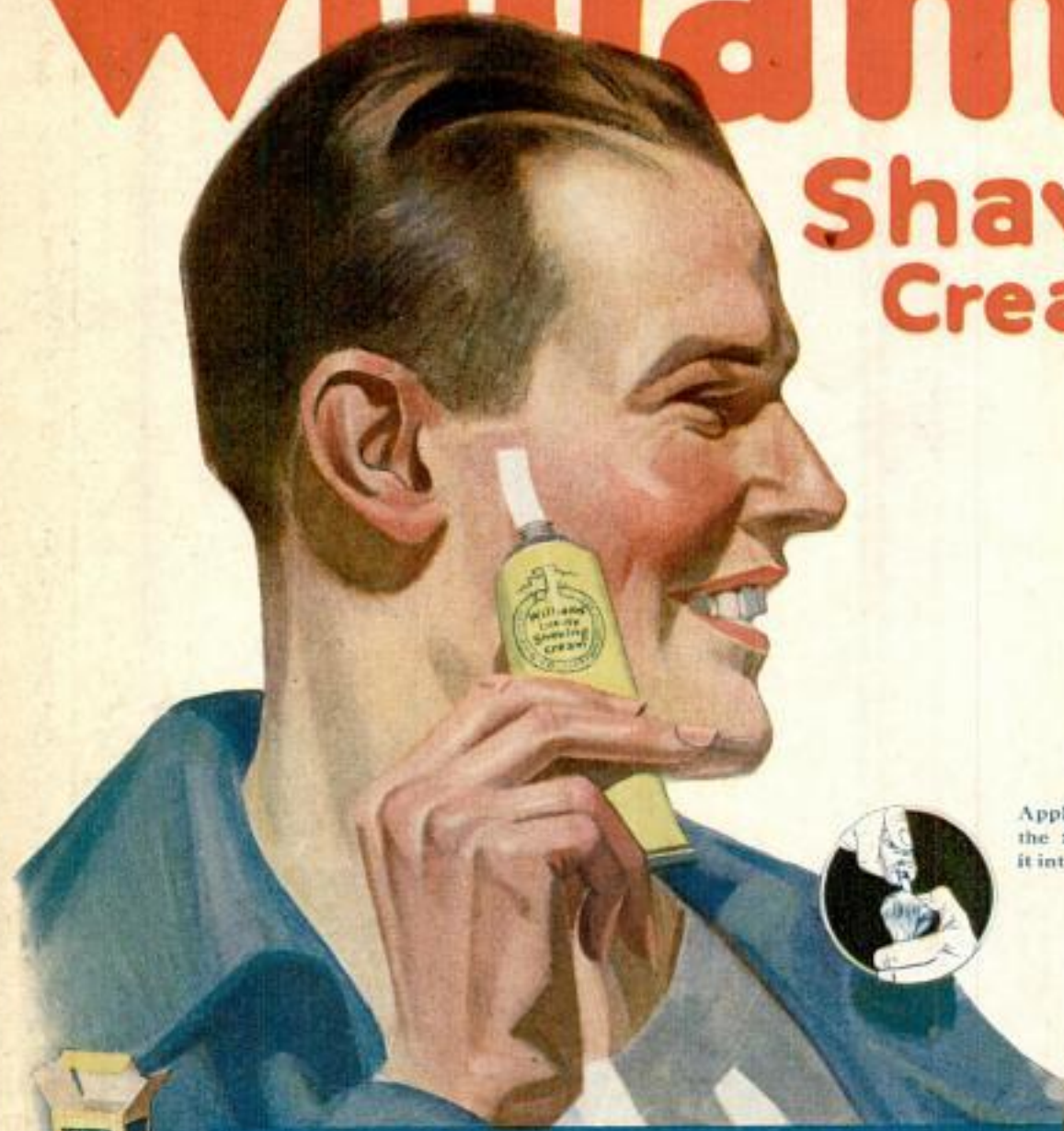

Apply it directly to the face or squeeze it into the wet brush.

**F**OR the sake of your face—be careful. Getting the wrong shaving soap is serious. Calling it a cream isn't enough. It may be cream but it must be shaving soap. We have taken the famous Williams' lather and put it into a tube. You release a little every morning and get a shave that is a joy in the getting and a comfort all day. When the beard sees it coming it just gives up and quits. But the skin rejoices and never knows a razor has been along. That's shaving cream for you! Ask for it by its first name—"Williams'."

Send 12c in stamps for trial sizes of the Stick, Powder, Cream, Liquid and then decide which you prefer. Or send 4c in stamps for any one.

**The J. B. WILLIAMS COMPANY**  
Dept. A, Glastonbury, Conn.

*Add the finishing touch to your shave with Williams' luxurious Tale Powder*



WILLIAMS