

September
15 Cents

NOTICE TO READER: When you finish reading this magazine place a 1-cent stamp on this notice, hand same to any postal employe and it will be placed in the hands of our soldiers or sailors at the front. NO WRAPPING—NO ADDRESS. A. S. Burleson, Postmaster General.

POPULAR MECHANICS MAGAZINE

WRITTEN SO YOU CAN UNDERSTAND IT

REG. U. S. PAT. OFF.

*Drafting
in 1863*

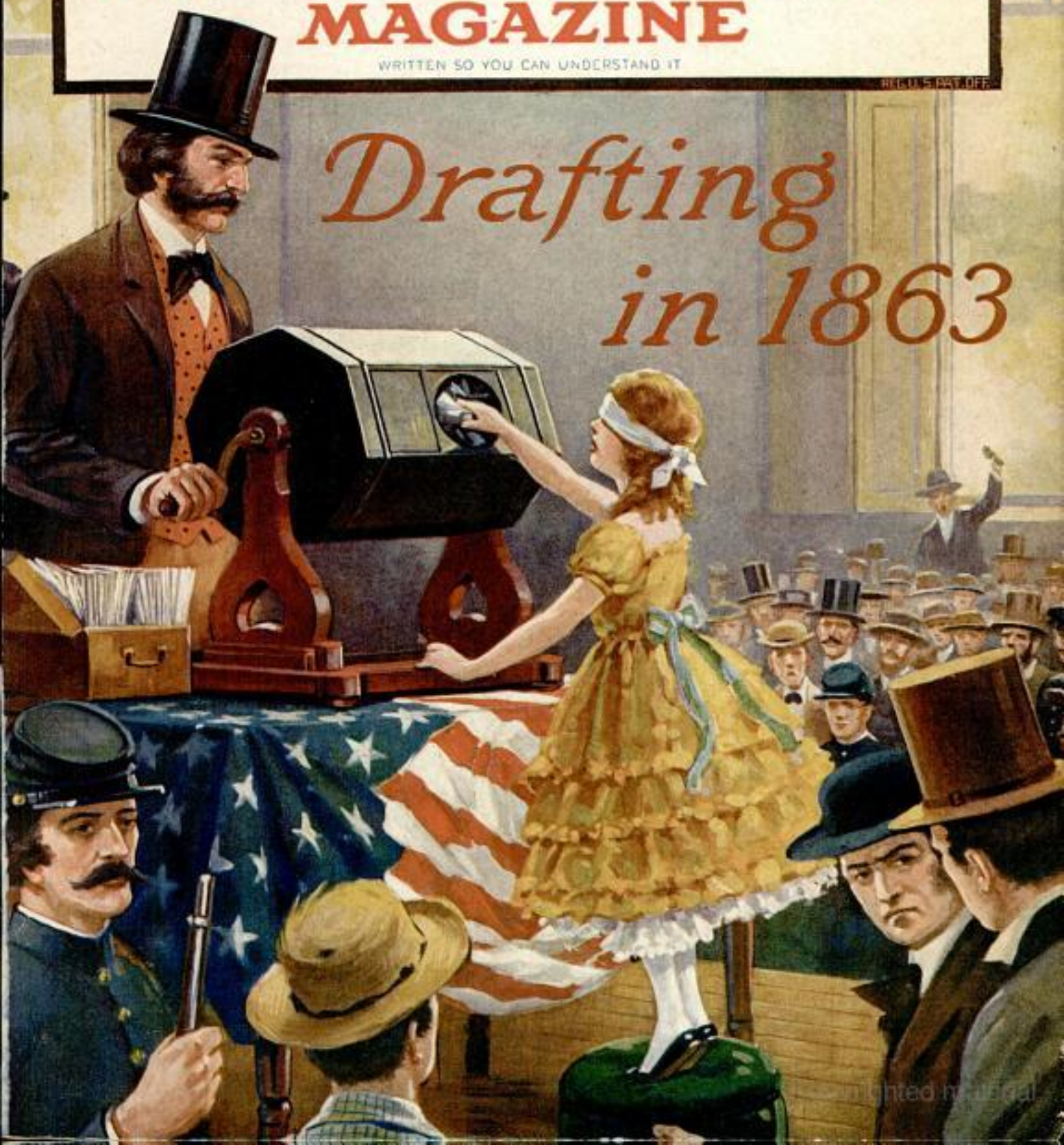

HARRIS HOMES



When You Build The Harris Way—you build to stay, and secure the *utmost possible* in Quality, Economy and Service. Why? Simply because you profit directly—*immediately*—by our 24 years experience. You get the benefit of our practical knowledge as the *originators* of the "Direct to You" Home Building Industry. We were the *first* to sell Lumber and Material direct to Home Builders at one small profit. We were the *first* to reduce vitally important industry to a *perfect system* and extend the benefits uniformly to the people of the nation. *The splendid Harris Home below has 6 rooms, bath, pantry, large living room, etc. The size is 30x26 ft. A thoroughly modern American Home in every respect.*

"The Harris Way" has exclusive merits—special advantages for the shrewd and careful Home Builder, possessed by no other plan or method. It is the best, safest and most sensible way to build your ideal home *right* without sacrifice of quality, *or the waste of a single penny!* Thousands have built "THE HARRIS WAY" with profit and satisfaction.

Advance in Prices Our prices are so low that it will be impossible to maintain same for any length of time. They are bound to advance. If you are needing a house, either for investment purposes or for a home, write now. Do not delay another moment if you wish to make a saving.

The Material used in building all Harris Homes is prepared by us complete for your use in a way that is instantly and easily understood. It is sensibly cut-to-fit with *absolute accuracy and positive elimination of all waste.* You pay for nothing you do not get—you pay our bed rock low, one-small profit bargain price *only* for what is needed to do the work *right* "THE HARRIS WAY."

\$10,000,000

Capital Stock and Surplus—stands back of our guarantee to every Harris Home Buyer—you cannot lose.

Free Book of Plans Be sure to mail free coupon for the latest edition of the famous \$10,000 HARRIS HOME PLAN BOOK now ready. A golden guide to Quality, Service and Economy in Building. Explains fully and freely, everything about building economy. Contains 100 modern Harris Home Designs, with descriptions, material, specifications, prices, etc., and explains how we save you \$50.00 to \$250.00 on plans and material. Think twice before you pass this opportunity.

\$1042 Buys The Material To Build This Beautiful Home No. 161
—Best Quality Material Throughout—Best Construction — Sensibly Cut-To-Fit.

CUT OUT AND MAIL

Harris Bros. Co., Dept. FL7
Chicago

Please send me free—without the slightest obligation—the following books checked,

- Book of Plans
- Plumbing and Heating
- Paints
- Presto-Up Ready Made Sectional Houses & Garages

Name.....

Address.....



HARRIS BROTHERS CO. CHICAGO Dept. FL7, 35th and Iron Sts.



Victrola—the highest attainment in the arts of sound

The mission of the Victrola is purely one of transmission. The recorder and reproducer should tell the simple truth, no more, no less.

The Victrola is not an instrument in which the interpretation and expression depend on the player like the organ, piano, etc. No instrument can be made to *improve* on Melba, Caruso and the other great artists. The true function of the Victrola is to reproduce faithfully the work of these artists.

The only modifications permissible are those obtained by *changing the needles from loud tone to soft tone* and by adjusting the *sound doors* to suit the size of the room or the mood of the listener.

There are Victor dealers everywhere, and they will gladly play your favorite music for you and demonstrate the various styles of the Victor and Victrola—\$10 to \$400.

Victor Talking Machine Co., Camden, N. J., U. S. A.

Bellier Gramophone Co., Montreal, Canadian Distributors

Victor Supremacy

"Victrola" is the Registered Trade-mark of the Victor Talking Machine Company designating the products of this Company only. **Warning:** The use of the word **Victrola** upon or in the promotion or sale of any other Talking Machine or Phonograph products is misleading and illegal.

To insure Victor quality, always look for the famous trademark, "His Master's Voice." It is on all genuine products of the Victor Talking Machine Company.

New Victor Records demonstrated at all dealers on the 1st of each month



Important Notice. Victor Records and Victor Machines are scientifically coordinated and synchronized by our special processes of manufacture, and their use, one with the other, is absolutely essential to a perfect Victor reproduction.

This One



TSLK-OXU-LBQP

Please Mention Popular Mechanics

Copyrighted material

"Buy by the Cypress Arrow"
ACCEPT NO "CYPRESS" UNLESS IT BEARS THIS MARK:—

**"TIDE-WATER" CYPRESS
MANUFACTURED BY
ASSOCIATION MILLS
IS IDENTIFIED BY
THIS TRADE-MARK**



TRADE MARK REG. U.S. PAT. OFFICE

Only mills which are qualified by the superior physical character of their product AND the ethical character of their business practice can belong to the Southern Cypress Mfrs. Assn.—and *only member-mills* can ever apply this legally registered trade-mark to ANY Cypress.

WHAT YOU WANT IS
"Tide-water" Cypress
YOU CAN TELL IT BY THE ARROW

(shown above) Indelibly
Stamped in the end of EVERY
BOARD or on every bundle.

The one way for you to be sure that the Cypress you get was grown in a region near enough to the coast to possess the MAXIMUM of *decay-resisting quality* is to refuse all but genuine "TIDE-WATER" CYPRESS—and the **only way** to *know* that you're getting *Tide-water* Cypress is to *insist* (and *keep on insisting*) upon SEEING WITH YOUR OWN EYES the REGISTERED TRADE-MARK of the Southern Cypress Mfrs. Assn., *stamped ineradicably* in *one or both ends* of EVERY CYPRESS BOARD OR TIMBER, and on EVERY BUNDLE of "small sticks," such as flooring, siding, moulding and shingles. This is the mark to BUY BY—now that every piece of the TRUE "Wood Eternal" made by a member of the established and ever-watchful Association is at once *identified by its maker* and "O.K.'d" by the Association mark.

Let our ALL-ROUND HELPS DEPARTMENT help YOU MORE.

Our entire resources are at your service with Reliable Counsel.

SOUTHERN CYPRESS MANUFACTURERS' ASSOCIATION
1219 HIBERNIA BANK BLDG., NEW ORLEANS, LA., or 1219 HEARD NAT'L BANK BLDG., JACKSONVILLE, FLA.

INSIST ON TRADE-MARKED CYPRESS AT YOUR LOCAL LUMBER DEALER'S.

IF HE HASN'T IT, LET US KNOW.

TELL HIM TO REMEMBER "BUY BY THE CYPRESS ARROW"
"Signed Lumber is Safe Lumber."

Please Mention Popular Mechanics

Popular Mechanics Magazine

6 N. Michigan Avenue, Chicago, U. S. A.

EDITED BY H. H. WINDSOR

England: The International News Co.
5 Beams Bldg., Chancery Lane, London, E. C.

Australia:
The Australasian News Co.

ISSUED MONTHLY

SUBSCRIPTION:

SINGLE COPY, 15 CENTS

In United States, and its possessions, Cuba and Mexico, per year, postpaid \$1.50
To Canada 1.75
To all other countries in the Postal Union 2.50

All subscriptions are discontinued at expiration. Please examine the date printed on your wrapper.

Entered as Second Class Matter Sept. 15, 1903, at the Post Office at Chicago, Illinois, under Act of March 3rd, 1879.

Entered as Second Class Matter at the Post Office Department, Canada.

Published monthly by POPULAR MECHANICS CO.

Copyright, 1917, by H. H. WINDSOR.

Copyright, in France.

Contents for September, 1917

Accident—"L" Cars Plunge to Street without Fatal Results	341
Accident—Many Killed When Vessel is Hit by Falling Tank	333
Accident—Terrible Niagara Wreck under Investigation	324
Accident—Truck and Driver Fall through High Bridge	417
Advertising, Commercial and Patriotic, Effective Ideas in	410
Aerics, Searchers for, Have Perilous Task	408
Aeroplane Models, Incorporate New Features in Late	340
Air Gas System for Use in Home or Factory	394
Airman's Sense of Balance, Testing	301
Auto Lifter, One Man, for Garages	352
Automobile Body, Folding, Makes Two Cars of One	334
Automobile Carries Odd Trophy of Desert Encounter	412
Automobile Radiator, Frog on, Admits Moist Air	430
Automobile Signal, Arrow Painted on Glass Serves as	306
Automobiles, Electric Warning Signal Designed for	412
Banner, Star Spangled, Made of Brick	434
Barbers' Towels, Steamer and Sterilizer for	339
Barge, Stranded, Journeys Half a Mile Overland	393
Bluejacket Factory of the Great Lakes, The, by Jack Lait	327
Boat, Telescoping Steel, Stanch and Portable	383
Bobbed and Auto, Novel Combination of	413
Boiler Furnace Device Aids Combustion	309
Bottle, Nonrefillable, of New Design	387
Buffer, Yielding, Guards against Bridge Mishaps	382
Building Where Town Entertains Its Guests	480
Cable, Splicing Clip for, Is Self-Tightening	434
Cactus Tree, Climbing of Not Painless Diversion	305
Camera, Folding, Two Focusing Scales Used on	322
Camera, Submarine, Control Electrically	360
Can Filling Machine, Capacity of Is Great	420
Car, Gasoline Passenger, on an Electric Road	394
Car Shortage, Wasted space One Reason for Great	434
Carbon Monoxide Poisons Many in Modern Plants	433
Cars, Diners Afforded Privacy in Newly Planned	325
Casket, Swiss, Too Large for American Hearse	394
Casters can be Adjusted to an Uneven Floor	420
Castle, Wooden Model of, Built by Young Woman	335
Children, School, at New Tasks and at Play	440

Cigars, Special Way of Packing Matches with	400
Coal Chute, Metal Window, Protection to Building	409
Comment and Review, by H. H. Windsor	349
Coolies, Hardy, Supply Whole City with Water	425
Corkscrew, Folding, Used in Sealing Bottle	432
Corn Planter Attachment for Motor Cultivator	430
Cot for Campers, Strong, Folds Up Compactly	345
Cottage, Pleasing Summer, is Built over Water	389
Curb, Notched, Excludes Autos but Not Cycles	432
Dam, Illuminate, to Protect It from Enemy	427
Developing Product, New, Takes Place of Metal	398
Dogs, Sheep Killing, Cause Enormous Waste	394
Donkey, Seven Passenger, Makes Overland Trip	421
Door Controller, Electric, for Passenger Lifts	435
Drafting America's Youth, by Searle Hendee	353
Dreadnaught "Oklahoma," Glimpses of "Jackies" at Work Aboard	372
Elephant, Sick, Inhales Vinegar Fumes	418
Elevator Mileage Basis for Power Charge	422
Film, Use of Dial Adds Extra Exposure to	365
Fire Extinguisher Posts Marked with Red Spots	442
Fire Extinguishers, Each Year Pupils Empty	423
Fires in Forests, Many Caused by Lightning	417
Firemen, Cuban, Mobile Lighting Equipment Aids	393
Flag, Service, is Designed as Family Honor Emblem	324
Fly Killing Made Sport by New Indoor Gun	305
Flying Boat, Light Weight, Built for Pleasure Use	387
Foresters are Recruited for Special Regiment	409
Game, Falls while Riding Swiftly on Motorcycle	385
Gas in Place of Steam, Use in Steam Engine	415
Gas, War, Sabadilla Seeds Used in Making	395
Gauge, Air, Dual Purposes Served by Motorist's	331
Glazier's Tools, Five Combined in One	414
Golf Links, Bricks, Stovepipes, Rugs Help Make	410
Goose, "Flying," Yoke Keeps in Poultry Yard	363
Governor, Turbine, Quick Response Feature of	402
Grade Crossing, Safe, for Whole County	385
Guano Gatherers Live in Island Cave	395
Guard for Big Buzz Saw Protection to Workers	429
Gymnasium Building of Elliptical Form	413
Hair Cut, Novel, Leaves Red Cross on Top	396
Hall, Municipal, Erected over Unightly Creek	425
Hand Rest, Helpful, Made for Bookkeepers	352
Hands, What a Man can Do without	343
Harvester Outfit Built as Motor Attachment	332
Highway, Markers Placed at State Lines along	415
Hospital for Military Use, School Builds	419
Iron, Destruction of, a Problem in Tropics	322
Irrigation Ditch Used as Bicycle Path	420

[Continued on Page 6]

Popular Mechanics offers no premiums; does not join in "clubbing offers," and employs no solicitors to secure subscriptions. It is for sale by nearly every newsdealer in the United States and Canada.

[Contents—Continued]

Knitting Machine, Power, Full Automatic.....	386
Lifboat, New, Nonsinkable and Self-Righting..	387
Lighting System, Niagara Falls, Made Perma- nent.....	412
Lion Chase, Staging for the Movies.....	431
Lion Cub and Puppy Live Happily in Same Cage	424
Locomotive, Big, Provided with Ten Driving Wheels.....	400
Lumber, Machine Imprints Brand on Ends of..	415
Maps, Relief, Big Aid to Lumber Firms.....	427
Medicine Stand Prevents Errors in Taking Doses	438
Micro-Megaphones Protect Quaker City.....	342
Mixer, New Malted Milk, Has Porcelain Support	398
Monument, Concrete, Raise for Former Fighters	338
Motor Aprons, Smart, Worn by Women Drivers.	433
Motorboat, Trim, Sets Record during Maiden Trials.....	324
Motorcycle, Attachment Makes Four Passenger Car.....	399
Navy's Identification Tags, Finger Prints on... 414	
Novelties for the Home and Its Members.....	426
Ore Separator for Use in Desert Gold Mining... 383	
Ore Transfer Car, New, Operates Quickly.....	392
Paper Hoist Saves Time in Printing Plant.....	395
Pavilion, Frozen North, Hotel's Summer Feature	364
Phonograph Outfit for the Army.....	398
Phonograph Records Peal of Liberty Bell.....	415
Photographs, Repeating Attachment for.....	426
Photography, Flash, Synchronizing Apparatus for.....	398
Pine Bending Machine Eliminates Joints.....	392
Pine Cleaner, Japanese, Has Portable Outfit...	423
Piston Ring, New, Has No Outside Joints.....	433
Potatoes, Outfit Sprays Many Acres of in Day.	331
Projectile, New, Releases Smoke and Liquid Fire	334
Pulp Mill, Government, Proposed in Alaska... 394	
Pump, Tire Filling, Driven by Rear Wheel of Car.....	340
Rail Forming Press, Big, Has High Efficiency..	423
Railroad—Trans-Andean Line to Tap Peruvian Resources.....	408
Reading Rack of Glass for Bed Patients.....	433
Riots, Race, in East St. Louis.....	346
Road Built across Marsh by Dredging Canal... 422	
Roads, Poor, Make Cartage Costs Enormous... 348	
Rope Nets for Protection of Structural Workers	384
Rose Festival, Features of Portland's Recent...	390
School, Large One Story, Has Special Ad- vantages.....	348
Schooner, Big Five Mast, Launches Itself.....	397
Semaphores Used to Stop Auto Stage.....	352
Sewage Treating Plan, Foreign, Adopted Here... 386	
Sheave, Self-Lubricating, Saves Workmen's Time	439
Shells, Vast Quantity of Used by Artillery... 345	
Ship "Idaho"—Massive Steel Fighter Takes Maiden Plunge.....	323
Shipping Boxes of Standard Sizes, Advocate... 420	
Ships' Speed, Depth of Water Affects.....	426
Shrapnel, Making, for Pershing's Gunners.....	350
Siren, Motor Driven, of New Type.....	358
Spark Plug, Self-Cleaning, Escapes Carbon Nu- isance.....	420
Sprinkler, Big Traveling, for Extensive Grounds.	341
Stove of New Design, Has Large Heating Area.	389
Stove, Shielded, in Door of Camping Car.....	417
Subdivision, Odd Plot of Shown on Street Signs	426
Submarine Chasers, Contracts Let for Fleet of.. 422	
Submarines, Bomb Laden Net to Foil.....	321
Sugar Cane Harvester, New, Does Work of Many Men.....	360
Summer Home, Group of Tiny Bungalows Is Family's.....	362
Tappan, Homemade Metal, of Convenient Type	336
Telescope, Massive Reflector for Transported to Summit of Mt. Wilson.....	358
Tennis Racquet, Moisture Proof Covering for.. 438	
Theaters, One Stage and Orchestra Serve Two.. 418	
Tire, Tread of, Reinforced by Intermeshed Wires	438
Tool, Adjustable Rim, for Tire Removal.....	442
Typewriter Ribbon, Re-Inker Lengthens Life of.	432
Ukulele-Banjo New Craze with Street Song Lov- ers.....	414
Unicycle, Old, Ridden in Recent Parade.....	424
University Commencement Held at Army Post.. 335	
Valve Grinder, Convenient, for Automobile En- gine.....	439
Valve Keeps Reserve in Motorcycle Fuel Tank.	438
Vegetable Drier to Save Garden Surplus.....	358
Vise, New Bench, Capable of Many Adjustments	422
War, European: Automobile Has One Door for Both Seats... 405	
Boys Who Flaunt Our Emblem before Boches	367
Concrete Chuting System, Time and Trouble Saving.....	407
Concrete Field Fortifications Used by Germans	381
Draining Southern Swamps for Farming Pur- poses.....	404
England Salutes Pershing on Way to Front... 371	
Films, Zoological, Produce for Universities... 405	
France Hails Pershing.....	370
"French Traps" of the Germans, by Lewis R. Freeman.....	401
Motorcycle and Sidecar Carry Family of Four	407
On Snow Covered Alpine Battle Grounds.....	378
Paper Cup, Double Walled, Keeps Hot Drinks Warm.....	405
Phases, Striking, Pictorial Reports of War's... 375	
Red Cross, Our, can Learn Much from British	406
"Sammy" Reaches Lafayette's Martyred Land	366
Stirring Aspects of War on Western Front... 376	
Tanks, Spirited Charge on French.....	374
Vaudeville beneath the Trenches in France... 368	
War-Plant Workers, Many Poisoned by Gases.. 336	
War Steps, Riots, and Rebellion Stir China... 363	
Water Sports.....	337
Water Tanks, Make Square to Match Outbuild- ings.....	396
Wheels, Car, Loading and Unloading by Man Power, by J. E. Murphy.....	428

SHOP NOTES

Ball Bearings, Babbitting Mountings for.....	459
Baseball Backstop, A Portable.....	443
Bench, Iron Lawn, Replacing Broken Foot on... 452	
Blowtorch, Gas Mantle Fixture Used as.....	451
Blueprint Reproduction, Typewriting on Tracing Paper for.....	444
Bottles, Washing, Chuck on Emery Grinder Used for.....	453
Cabinet, Folding, for Drafting Equipment.....	451
Carboys, Tipping Cradle for.....	455
Cement, Tough, for Pipe Joints.....	445
Crane, Traveling, for the Farm.....	445
Cuspidors, Shop, Sanitary Shields for.....	451
Cylinder Pins, Enlarging, Aids in Cooling En- gine.....	444
Drafting Table, Extension to, for Long Radii... 458	
Elevator, Freight, Gong Warning System for... 445	
Floor Openings, Cutting with Hand Circular Saw	445
Footbridge, Novel, of Woven Wire.....	450
Forge, Blast for, from Stream of Water.....	452
Furnace, Hot Air, Hot Water Supply and Ra- diator Heat from.....	456
Gas Engine Transported by Rolling on Flywheels	462
Headlights, White Opal Glass Useful for.....	456
Lightning Protection, Equipping Buildings with	447
Mirror, Safety, Attached to Automobile Mud- guard.....	456
Motion-Picture Lanterns, Emergency Fuse Switch for.....	450
Paint, Old, Torch for Burning Off.....	455
Pipe Connection, Roofing Paper as Emergency... 445	
Pipe Cutter Marks Round Stock for Sawing... 456	
Piston Rings, Tool for Fitting.....	451
Ripsaw Cuts Large Nail without Injury.....	456
Rivet, Setting Handily in Awkward Place... 452	
Safety Pins Replace Small Cotter Pins to Ad- vantage.....	456
Screw Threads, Rigging for Grinding.....	450
Soldering Wrought Iron Rings by Dipping Saves Time.....	453
Spark Plug Cleaned with Bag of Shot.....	450
Spring, Compression Coil, with Double-Action Case.....	453
Stakes, Wedge Shaped Marking, Prove Superior	452
Steel Columns, Old, Reinforcing by Concrete Casing.....	456
Stencil, Wire Gauze.....	455
Stereotyping without Special Apparatus... 450	
Stream, Measuring Velocity of.....	462

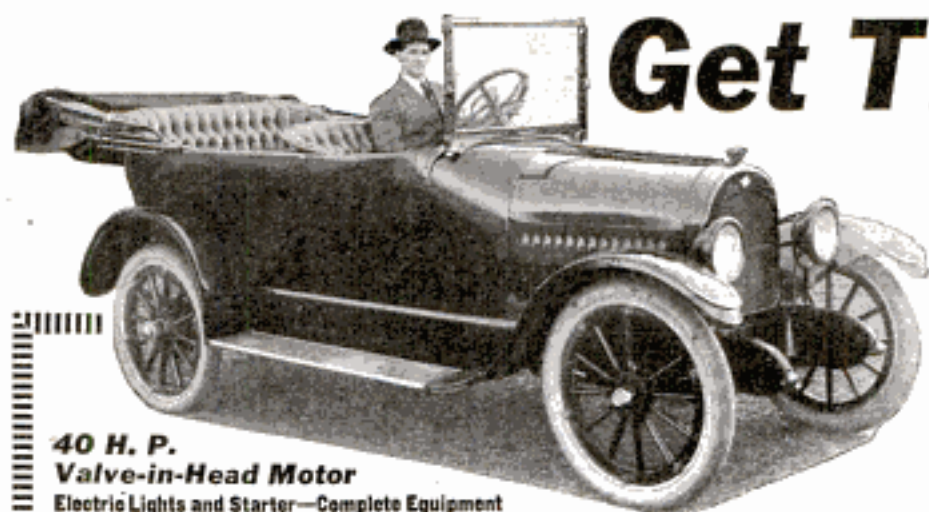

Get This Car

and

The Agency

for Your Territory

40 H. P.
Valve-in-Head Motor
 Electric Lights and Starter—Complete Equipment

Write now for full specifications of BIRCH LIGHT-SIX

Find out how you can get one of these superb cars for yourself and make money selling them to others. A big opportunity is open to ambitious men who are willing to train themselves and then get out and hustle. Hundreds of cars will be sold this year in every county in the United States. Millions of dollars will be paid to automobile agents. We pay big commissions for selling Birch Cars. *Send the coupon now for full information.*

Here Are a Few of Our Agents—

John Slingerland . . . Danforth, Ill.
 W. C. Yount . . . Pine Bluff, Ark.
 Louis H. Totterdale . . . Warren, Ohio
 Edwin Gaertner . . . Dundee, Mich.
 Lafe Burlison . . . Prescott, Ariz.
 Nell Bland . . . Statesboro, Ga.
 J. C. Linn . . . Electra, Texas
 H. M. Maloy . . . Mangum, Okla.
 W. E. Davis . . . Ashton, Kan.
 Mitchell & Mitchell, Hillsboro, Texas
 Ernest Birch . . . St. Anthony, Idaho
 R. B. Shealy . . . Leesville, S. C.
 R. G. Moore . . . Mt. Vernon, Oregon
 Warren A. Jones . . . Winchester, Ill.
 Ben Doyle . . . Carlisle, Ky.

Ask Them



What New Mexico Agent Says:

"I received my car all O. K. It's the finest looking car in the county and suits me better than any car I ever saw. Lots of men have looked at the car and they said it had the finest motor they ever saw on a car. Some have asked me if the car didn't cost \$1,000 or \$1,200.
 R. R. REAGAN, Boaz, N. M."

Birch Agents Are Making Money

One of our Texas Agents sold two carloads of Birch cars within 60 days after he received his first demonstrating car. His territory is no better than others. There is no reason why you cannot do as well. Every sale means a good big commission for you and the Birch is such a wonderful car for the money that it practically sells itself to men who know automobile values.

Whether you own a car or not, get the full details of our great offer. We have a proposition worthy of the careful consideration of every man who wants to make more money. Let us hear from you as soon as possible. *Mail the coupon in the lower right hand corner right now for big free booklet and full information.*

Be The BIRCH AGENT in Your Locality

Cash in on the demand for a strictly high-grade, light-weight, fully-equipped motor car, that exists right now in your vicinity. You have the customers. We have the cars. Let's get together. *Hurry in the coupon so we can send you all the facts about this great opportunity.*

PREVIOUS EXPERIENCE NOT NECESSARY

We want men of character and ability and high standing in their communities to represent us. Previous experience in the automobile business is unnecessary. We require all our agents to take a brief but thorough course of training in Automobile Driving, Repairing, and Selling which will fit them to represent us in a manner creditable to us and profitable to them. We have trained hundreds of others for success in this way, and we believe this is one of the reasons for the splendid success which Birch Agents are enjoying. But of course the BIG REASON is the cars themselves and the remarkable records they are making in the hands of satisfied owners all over the United States. Eighty per cent of all Birch cars are in use by farmers and in small towns, and get the hardest kind of service. Mud, sand, rocks, hills and rough going have no terrors for these sturdy cars.

Send COUPON for Big FREE BOOK and Full Information

Get all the details at once. We have agents in every state in the Union now, but we want an agent in every county. You will be astonished at the liberality of our offer. Let us put all the facts before you at once. It costs you nothing to investigate, so tear off the coupon right now. Sign it and mail it to us today. RALPH BIRCHARD, Pres.

BIRCH MOTOR CARS Dept. 919, 81 E. Madison St.
 CHICAGO, ILLINOIS

MEMBER CHICAGO ASSOCIATION OF COMMERCE

Sign and
 Mail This
 Coupon

FREE COUPON NOW!

Name.....

Street No. or R. F. D.....

P. O. State.....

Please Write Plainly

FREE
 COUPON

Ralph Birchard, Pres.
 Birch Motor Cars
 81 E. Madison St., Chicago
 Dept. 919

Please send me your big free booklet and full particulars as to how I can get a Birch Light-Six and the agency.

Learn the Automobile Business



More help needed and big pay

No other business offers such opportunities. It's easy to learn. An Auto Repairman is not a machinist—his work consists of adjustments and refitting worn parts; "knowing the principle," that's the thing.

IF we prove to you that we've started others you must admit we can do the same for you.

DYKE'S NEW IDEA OF TEACHING BY MAIL WITH WORKING MODELS

On these models you get actual practice, see the actual operation and learn more than you could from the auto itself—it's easy and quick. You don't have to study hard with this system—we teach through the eye—a new idea. Mr. Dyke is the originator of the system of teaching by mail with models—therefore beware of imitators. Some of the divisions of the U. S. Army: TRUCK, AVIATION, MOTORCYCLE, are using Mr. Dyke's instruction books.

FREE Mr. Dyke's 32-Page Booklet WRITE FOR IT—NOW!

It is interesting and instructive in itself. Learn how you can get all this training for only \$18. Fill out below or write a postal—but do it now.

Dyke's Correspondence School of Motoring
Box 198, Granite Bldg., St. Louis, Mo.

Send me your free 32-page booklet about your New Idea Working Model Course and testimonials and proofs. It is understood I am under no obligations in sending for this.



Name

Town

Street.....State.....

This school is a department of the firm A. L. Dyke, Publisher and Importer. Dyke's system is endorsed by leading motor authorities of the world.

SPECIAL INSTRUCTION on Six, Eight, Twelve Cylinder Engines. Electric Starting and Generating Systems.

Ridpath's History of the World At a Bargain



Nine Big Vols.

4000 Pages
2000 Pictures

We will name our special low price and easy terms only in direct letters to those mailing us the Coupon below. Tear off Coupon, write name and address plainly, and mail now before you forget it. The 32 Free Sample Pages will give you some idea of the splendid illustrations and wonderfully beautiful style in which the work is written. Thousands have already availed themselves of our offer and every purchaser is more than satisfied. **Mail Coupon Now.**

FREE COUPON

WESTERN NEWSPAPER ASSOCIATION 9-17
140 So. Dearborn St., Chicago, Ill.

Please mail your 32-page free sample booklet of Ridpath's History of the World, containing photogravures of Napoleon, Socrates, Caesar and other great characters in history, and write me full particulars of your special offer to Popular Mechanics readers.

NAME.....

ADDRESS.....

Please Mention Popular Mechanics

(Contents—Continued from Page 6)

Survey Level, Builder's, with Sights from Old Rifle	454
Swine Cafeteria in a Barrel	454
Switchboards, Pockets on, for Memos of Special Calls	453
Tread, Hinged, Covers Puddle at Worn Door Step	460
Truck, Barrel, Made of Pine and Fittings	459
Truck for Canoe or Small Boat	445
Vacuum Cleaner, Wire Protective Screen Increases Usefulness of	459
Wardrobe, Canvas Covered, Protects Workmen's Clothes	444
Washers, Cutting Thin Metal, by Hand	462
Water Tank, Small, Repairing a Hole in	452
Window Display, Mystery Sailing Ship as	451
Wire Mesh, Device for Unrolling and Measuring Handily	460
Wireless Transmitter, Heavy Current	457
Wrench with Drift-Pin Handle, Handy	469

AMATEUR MECHANICS

Alligator, Mechanical Toy, of Wood	478
Arrow, Whirling Fan	471
Atomizer for Spraying Paint on Small Objects	476
Automobile Tops, Cleaning Celluloid Panels in	471
Battery Buzzer Converted into Telegraph Sounder	465
Bird Feeding Tray, Winter, on Inclined Wire	469
Box Cover, Hinged, Made without Hinges	465
Cameras, Small, Shutter Release Attachment for	471
Card Table, Folding, Handy for Invalid in Bed	468
Chicken or Rabbit Feed, Oats Sprouter for	470
Coal Hopper, Gravity Feed, on Truck	464
Door Release, Mirror and Buzzer System for	476
Door Spring, Angle Bracket Gives Leverage on	478
Dressing Table Made from Old Washstand	474
Egg Candler for Daylight Use	472
Eggs, Incubator, Carpeted Tray Turns without Handling	479
Electric Toaster with Coils on Mica Strips	469
Elk Horns as Electric Light Fixture for Den	476
Embossing, Making Rubber Stamp Impression Appear Like	477
Feeding Pans, Nested, for Dogs and Other Animals	470
Fishing Tackle Outfit in Shotgun Shell	460
Flash Light, Automatic, Snaps Chicken Coop Marauder	466
Flowers, Potted, Turntable Stand for	468
Horseshoes, Old, Practical Uses for	473
Hose, Steam, Proves Economical for Garden Use	479
Hunter's Turkey Call	478
Index for Magazine on Bookshelf	468
Keys Held in Rack by Sliding Tags	475
Knot, Lock, Useful in Tying Parcels	475
Lawn Seats Built on Tree Stumps	465
Lettering Pen, Split Bamboo	466
Marshmallow Toaster, Individual	473
Morris Chair with Newspaper Rack and Smoker's Trays	467
Photographic Screen, Grinding Glass for	474
Photographs in Falling Snow, Taking	464
Rectifier, Alternating Current	476
Reflector and Mirror, Combination Indirect Light	478
Roller Shade, Wedge Kink for Holding	471
Screws Soldered on Rods Provide Threaded Connections	474
Searchlight, Pivoted, Made of an Old Milk Strainer	463
Snow Glasses, Mountain, Made of Old Bottle and a Shoe	475
Spring, Tension, on Bicycle Mudguard Used as Brake	475
Submarine Droplight, Electric	473
Thermometer Support in Home Candy Kettle	471
Trimming Board with Foot Control and Counterweight	468
Typewriter Stand, Homemade Swinging	472
Vibrator, Double Contact	464
Water Spigot, Old Gas Bracket Used as	477



Marvelous FREE Book Sent

You can now learn Taxidermy, the wonderful art of mounting birds, animals, tanning skins, etc. Learn at home, by mail. The free book tells how. Mount your own trophies. Decorate home and den. Hunters, trappers, nature lovers, you need taxidermy. Interesting, fascinating, big profits. Join our school, 55,000 students. Success guaranteed. Get our free book without delay. Send right now—today.

N. W. School of Taxidermy, 1126 Elwood Bldg., Omaha, Neb.

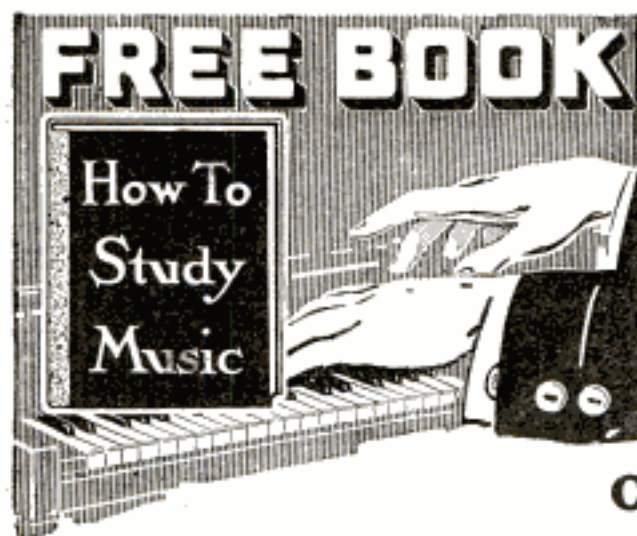

FREE BOOK This Great Book

is

Winning Hundreds to

Modern Methods of Learning Piano

Be sure to write for this 64-page book *today*. It explains the pleasures and social advantages of musical skill. It tells how you can increase your earning power by professional playing or by giving musical instruction to others. It explains the sensible, the scientific, the *economical* way of learning to play piano or organ. It is **FREE**

Short Lesson with Expert Better than a Dozen Other Lessons

This is the age of **EFFICIENCY**—in music just as much as in any other Art or Science. Now, more than ever before, your teacher must be an **EXPERT**, or you will waste months and years of time practicing in out-of-date ways. Your teacher must possess more than mere playing ability—**much** more. He must know **MUSICAL SCIENCE** as well—and such knowledge is very rare even in the largest cities. The old-fashioned system of studying with a "private teacher" is rapidly being abandoned. And anybody can see why. If you want the **entire** attention of your teacher, but can afford only a dollar or two for each lesson, you can get only **third-rate-instruction**. Whereas, if you join a **class** at a Conservatory, you can secure the services of a **real expert** at **even less cost**—and you learn **correctly** and thus **more rapidly**.

Learn Right at Home—By Scientific, Guaranteed Method

Dr. Quinn's famous Written Method brings right to your home, **wherever you live**, all the great advantages of Conservatory study. You obtain a complete Course of Music Lessons which has been prepared according to the **latest developments** of scientific teaching and has been successfully used by **thousands** of men and women. **Satisfaction is Guaranteed.**

Easy to Understand—Music Furnished Free

The Course is fully illustrated with photographs showing every position and movement of the fingers, hands and arms. You can refer to these photographs at any time, day or night. You are **certain** of practicing correctly. Verbal instructions, given by a "private teacher," are unsatisfactory, because, even if correct, it is impossible to remember them **in full** when you practice. Dr. Quinn instructs and guides you at every step. You cannot go wrong, and no matter how far you continue your music you will never have anything to unlearn. All necessary music is included **FREE**. A diploma of internationally-recognized value is granted. Progress as rapidly or as slowly as you wish.

For Beginners or Experienced Players

The Course is entirely different from any other that you have ever seen or heard of. In thoroughness and in the subjects covered it corresponds to the usual three-year term of study. Yet it can easily be mastered in seventy-five weeks and some students finish it in less than a year. These prompt results are because the Course is systematic, and is carefully planned in advance; **not** because anything is omitted. Not a minute of your time nor an ounce of your effort is wasted. Nothing is forgotten or needlessly covered twice, because errors such as this would have been discovered and corrected long ago. Men and women who have failed by all other methods have quickly and easily attained success when using Dr. Quinn's method. It brings the same surprising results to either beginners or experienced players.

Endorsed by Distinguished Musicians

Among our graduates are thousands of accomplished amateur players, as well as prominent professional players, successful teachers and leading composers. We have enrolled more students so far in 1917 than in 1916 and 1915 combined. This is due to the remarkable results we have produced. The Course is endorsed by many distinguished musicians, educators and men of affairs who would not recommend any Course but the **best**.

Investigate Without Cost—Special Offer

Write today, using postcard, letter, or Free Book Coupon, for our new 64-page book, "How to Study Music." It is the most complete explanation of modern teaching methods ever published by a Conservatory. It tells how much the lessons cost, gives the records and opinions of our students and much other valuable information. Our Tuition Fee is greatly reduced just now on account of our Twenty-Fifth Anniversary Offer. Investigate without cost or obligation **NOW**.

Marcus Lucius Quinn Conservatory of Music
Studio KW, Social Union Building, BOSTON, MASS.

FREE Book Coupon

QUINN CONSERVATORY
Studio KW, Social Union Bldg., Boston, Mass.

You may send me without obligation or expense your 64-page Free Book, "How to Study Music," which describes Dr. Quinn's WRITTEN METHOD of teaching piano or organ at home in 142 lessons. Also tell me how much the lessons cost at the reduced Tuition Fee allowed this month as a Twenty-Fifth Anniversary offer.

NAME

ADDRESS

HAWKINS ELECTRICAL GUIDES

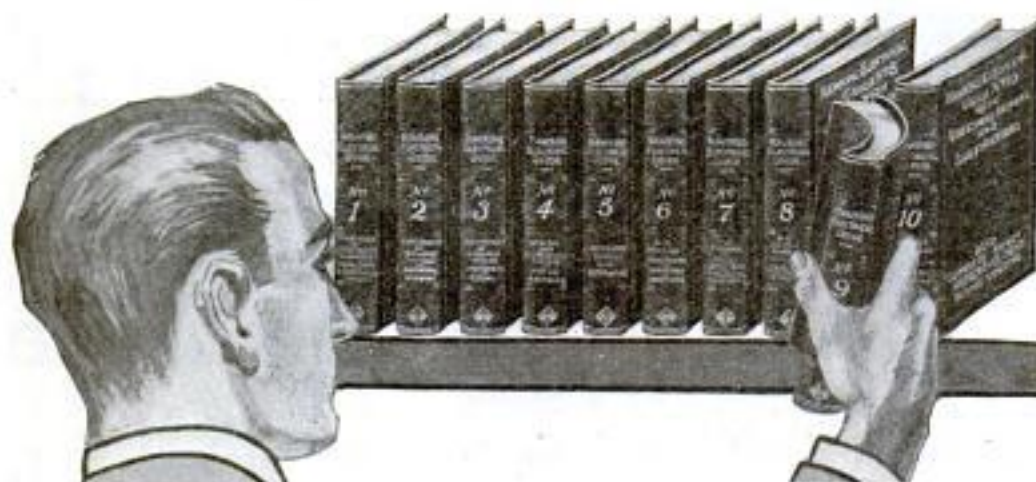

10 Volumes
3500 Pages
4700 Pictures

Pocket Size
Flexible Black
Covers

\$1 Per Volume
\$1 Per Month

An advertisement written entirely by men who have pushed ahead to greater success in Electricity through owning and using the Guides.

Helped Him Make Good

"It is only right for me to recommend highly the Hawkins Guides, for they have been of the greatest assistance to me in placing me in my present position as Superintendent of Construction Department of one of Ohio's largest Electrical Companies. I would like to see every man have a set of Hawkins Guides." Geo. Knecht, Columbus, Ohio.

A Man Who Arrived

"I am a machinist — I never professed to be an electrical machinist. But I received an unsolicited offer of a position in the Steel Works here (by the largest stockholder). And I want to say that I got my 'Juice' from Hawkins Guides. They are the only books for a man who wants to learn without having to wade first thru a lot of technical phrases he doesn't understand."

W. R. Hammer, Connellsville, Pa.

Up the Ladder

"While in Cuba, I applied for the position of Chief Electrician for the Government. I secured it, and though only a machinist I pulled through with the wonderful help of the Guides. With a repair shop, full supplies and three men, I had 100 telephones to care for, part of the system being under water. I also had the lighting system for shops and residences and wiring for power. Before that time I had never taken a transmitter or receiver apart. Owing to the climate, I later left there and have secured a fine position in the Westinghouse Electric Co."

William Cardell, Newark, N. J.

In the Naval Service

"I wish to state to you that I have resigned the position of Chief Electrician of Sears-Roebuck plant here in Dallas, and joined the U. S. Navy as an Electrician. Made a good grade which was largely aided by the Guides of Hawkins. I can highly recommend them."

Frank E. Lane, Dallas, Tex.

Saved Him Money

"Hawkins Guides saved me just \$3.50 the first time I looked through No. 10 Book. I had a spark coil played out, and that book showed me how to rewind it; and I made it as good as new. Hawkins Guides are the best ever."

H. F. Ramey, Piedmont, Mo.

Superintendent

"I am now superintendent of the Dunnville Hydro-Electric Systems, and Hawkins Guides were a great help to me in holding down a responsible position."

W. E. Swartz, Dunnville, Ontario.

Even in College

"I am attending Cornell University, but I use the Hawkins Guides every day for general information which I cannot get in recitation work or in laboratory experiments. I'll always speak a good word for the ever-ready Guides."

J. Winfield Kurtz, Joanna, Berke Co., Pa.

Wireless Operators

"I have worked wireless for ten years — but I wish I had these books years ago, as they have saved me a great deal of trouble."

H. Marshall,
Steamer M & B No. 2, Walkersville, Ont.

HAWKINS ELECTRICAL GUIDES

Help

"My work lately has comprised the supervision of four trucks and other cars; also the wiring and electrification of sundry buildings on our place—the C. W. Munson Farm Assn., Roslyn, L. I., including the Packing House, Hot Houses, etc. There's never a point comes up that Hawkins Guides do not help me to solve."

Jacob Weiss, Port Washington, L. I.

The Trouble With Them

"The only trouble I find with the Hawkins Guides is that everybody is always borrowing them. My set was even borrowed by a high school instructor for reference work in a physics class. I find them highly instructive."

Carl Hasenwinkle, Hettinger, N. D.

First Aid

"Number 10 Guide arrived all O. K. and completes the set, which I am very proud of. I don't think it would be possible to find a better set for either the beginner or the professional electrician."

Elmer A. Stevens,

U. S. S. Nebraska, Postmaster, N. Y.

In the Naval Electrical Dept.

"The Hawkins Guides are great help to me in the Naval Electrical Department, which they cover very thoroughly."

C. J. Cornell,

U. S. Receiving Ship, Brooklyn, N. Y.

Handy to Carry

"The great beauty of them is that you can carry them in your pocket. That suits me, for I

never want to be without them." F. S. Collins,
Richardson Engineering Co., Hartford, Conn.

Look Through This List of Subjects:

No. 1 Contains 348 pages, 388 illustrations. Electrical signs and symbols—static and current electricity—primary cells—conductors and insulators—resistance and conductivity—magnetism—induction coils—dynamo principles—classes of dynamos—armatures—windings—commutation—brushes, etc.

No. 2 Contains 348 pages, 394 illustrations. Motor principles—armature reaction—motor starting—calculations—brake horsepower—selection and installation of dynamos and motors—galvanometers—standard cells—current measurement—resistance measurement—voltmeters—wattmeters—watt hour meters—operation of dynamos—operation of motors, etc.

No. 3 Contains 300 pages, 423 illustrations. Distribution systems—wires and wire calculations—inside, outside and underground wiring—sign flashers—lightning protection—rectifiers—storage battery systems, etc.

No. 4 Contains 270 pages, 379 illustrations. Alternating current principles—alternating current diagrams—the power factor—alternator principles—alternator construction—windings, etc.

No. 5 Contains 320 pages, 614 illustrations. A. C. Motors—synchronous and induction motor principles—A. C. commutator motors—induction motors—transformers—losses, construction, connections, tests—converters—rectifiers, etc.

No. 6 Contains 298 pages, 472 illustrations. Alternating current systems—switching devices—circuit breakers—relays—lightning protector apparatus—regulating devices—synchronous condensers—indicating devices—meters—power factor indicators—wave form measurement—switch boards, etc.

No. 7 Contains 316 pages, 379 illustrations. Alternating current, wiring power stations—turbines: management, selection, location, erection, testing, running, care and repair—telephones, etc.

No. 8 Contains 332 pages, 436 illustrations. Telegraph—simultaneous telegraphy and telephony—wireless—electric bells—electric lighting—photometry, etc.

No. 9 Contains 322 pages, 627 illustrations. Electric railways—electric locomotives—car lighting—trolley car operation—miscellaneous applications—motion pictures—gas engine ignition—automobile self-starters and lighting systems, electric vehicles, etc.

No. 10 Contains 513 pages, 599 illustrations. Elevators—cranes—pumps—air compressors—electric heating—electric welding—soldering and brazing—industrial electrolysis—electro-plating—electro-therapeutics—X-rays, etc.

Also a complete 125-page ready reference index of the complete library. This index has been planned to render easily accessible all the vast information contained in the 10 electrical guides. There are over 13,500 cross references. You find what you want to know instantly.

SEND NO MONEY

The entire set of 10 Volumes

SHIPPED TO YOU FREE

Send no money. Examine the books first. Use them for seven days in connection with your work, and decide for yourself that they are the most complete, the most helpful and the clearest written electrical books ever published.

This unusual offer is a sign of our confidence in the Guides.

EASY PAYMENTS

Accept the offer now—mail the coupon today. If you decide to keep the books you can make settlement at only \$1 per month until paid for.

THEO. AUDEL & CO.
72 Fifth Ave., New York, N.Y.

THEO.
AUDEL & CO.
72 Fifth Avenue
New York, N.Y.

Please submit me for examination Hawkins Electrical Guides (price \$1 each). Ship at once, prepaid, the 10 numbers. If satisfactory I agree to send you \$1 within seven days and to further mail you \$1 each month until paid.

Signature.....

Occupation.....

Business Address.....

Residence.....

Since we have not yet had the pleasure of business relations with you, we shall appreciate your giving us name of reference on line below.

Reference..... P.M. Sept. '17

Thousands of Engineers Wanted

These New Books for **STEAM ENGINEERS** With Standard Examination QUESTIONS and ANSWERS

Will Fit You for a Good Position

All New Editions—Just Published



Complete Examination Questions and Answers for Marine and Stationary Engineers

By Calvin F. Swingle, M. E. Giving the latest and most approved answers to all leading questions asked applicants for licenses for both Marine and Stationary Engineers. 400 pages. Fully illustrated. Pocket size. Leather, gold stamping, red edges. Price, postpaid **\$1.50**

Steam Boilers, Their Construction, Care and Operation WITH QUESTIONS AND ANSWERS

By Calvin F. Swingle, M. E. A complete instruction book on all types of steam boilers. Special sections on Superheated Steam and Oil Fuel for Steam Boilers. 303 pages. Fully illustrated. Pocket size. Leather, gold stamping, red edges. Price, postpaid **\$1.50**

Swingle's Handbook for Steam Engineers and Electricians

By Calvin F. Swingle, M. E. A practical non-technical treatise on the care and management of Steam Engines, boilers and electric machinery, also gas and oil engines, steam turbines, air compressors and elevators. With questions and answers. 1500 pages, 700 illustrations, bound in leather, gold stamping and gold edges, boxed. Price, postpaid **\$3.00**

Swingle's Catechism of Steam, Gas and Electrical Engineering

By Calvin F. Swingle, M. E. A new instruction book covering all important points on the care and operation of steam boilers, engines, turbines, elevators and electrical machinery, including transformers, converters, and switch boards. Indexed. 180 pages. Illustrated. Pocket size. Leather, gold stamping, red edges. Price, postpaid **\$1.50**

FOR SALE AT ALL BOOKSTORES

Send for our large, free catalogue of books for electricians, shop men, railroad men, automobilists, carpenters, builders, sign and scene painters, card writers, etc.

Frederick J. Drake & Co., 1008 Michigan Ave., Chicago



Stronger, Clearer Voice for You!



Weakness, huskiness and harshness banished. Your voice given a wonderful strength, a wider range, an amazing clearness. This done by the Feuchtinger Method, endorsed by leading European musicians, actors and speakers. Use it in your own home. Simple, silent exercises taken a few minutes daily impart vigor to the vocal organs and give a surpassing quality to the tones. Send for the facts and proofs.

Do You Stammer?

If you have any voice impediment this method will help you. You need not stammer or lip—if you will follow our instructions.

WRITE

Send the coupon and get our free book and literature. We will tell you just what this method is, how it is used and what it will do for you. No matter how hopeless your case may seem the Feuchtinger method will improve your voice 800 per cent. No obligation on you if you ask for this information. We gladly send it free, postage prepaid. Just mail the coupon.

Perfect Voice Institute
2810 Wilson Av.
Studio 1196
CHICAGO

Name

Address

Perfect Voice Institute
Studio 1196 - 1810
Wilson Ave., Chicago

Send me the book and facts about the Feuchtinger Method. Have put X opposite subject that interests me most.

Singing Speaking
 Stammering Liping

Make Alcohol

It Is the Coming Fuel

Get Wright's Book. It gives full directions for making and De-Naturing.

Fully Illustrated. 283 Pages. Cloth. By Mail \$1.15

SPON & CHAMBERLAIN
120 P. M. Liberty Street NEW YORK



Wonderful Camera Bargains

High grade Cameras shipped for one full week's examination and approval. You use the Camera and test it out for one full week and pay only if you choose to keep it. Satisfaction guaranteed.

Wholesale Prices

We ship direct from factory to consumer, eliminating all middlemen's profits. The Camera must serve as its own salesman. Our prices are so low and our terms of payment so easy that no one may be deprived of the pleasure of owning a splendid camera.

Write for Free Catalog

We will mail our latest catalog sheets free to all who ask for them. Write at once. A postal card will do. These catalog sheets show the latest sizes and low prices on the most beautiful line of cameras ever offered. (Dept. P)

H. E. Sever & Co., 140 So. Dearborn St., Chicago



Please Mention Popular Mechanics

Co-Operative Electrical Education

Learn by the thorough approved practical methods which our 13 years of specializing enable us to give you. No entrance examination or high school diploma required. Courses complete and condensed. Unnecessary theory eliminated. **Earn while you learn.** We furnish you with a position in an electrical or manufacturing concern for half a day at good wages. The remaining half day you get regular instruction in our extensive modern laboratories, testing and classrooms. Select one of the courses: One-year Practical Electricity. Two-year Commercial Engineering. Three-year Electrical Engineering.

Write for free illustrated book, mentioning age, education and course interested in.
New Term Opens September 10, 1917.

School of Engineering of Milwaukee, 337 Stroß Bldg., Milwaukee, Wis.

SPEAK A FOREIGN LANGUAGE !!!

The War has created unlimited opportunities for those who know Spanish, French, German or Italian. Better your position or increase your business. You can learn quickly and easily, at home, during spare moments, by the



LANGUAGE-PHONE METHOD And Rosenthal's Practical Linguistry

(Highest Award Panama-Pacific Exposition, 1915)
You listen to the living voice of a native professor pronounce the foreign language, over and over, until you know it. Our records on all talking machines. Write for Booklet, particulars of Free Trial.

The Language-Phone Method, 991 Putnam Bldg., 2 W. 45th St., N.Y.

COPY THIS SKETCH

and let's see what you can do with it. Cartoonists and illustrators earn from \$20.00 to \$125.00 or more per week. My practical system of personal individual lessons by mail will develop your talent. Fifteen years' successful work for newspapers and magazines qualifies me to teach you. Send sketch of Uncle Sam with 6c in stamps for test lesson plate; also collection of drawings showing possibilities for YOU. State your age.



The Landon School of Illustrating and Cartooning
1438 SCHOFIELD BUILDING, CLEVELAND, O.

EARN TELEGRAPH

Morse and Wireless—R. R. Accounting (Station Agency) taught. Splendid opportunities. Positions secured. Marconi Co. contracts to employ graduates. We own and exclusively occupy two large modern buildings equipped with R.R. and Western Union wires and complete 2 K. W. Marconi Wireless Station. Largest school—established 43 years. Investment \$25.00. Endorsed by Railroad, Marconi and Western Union Officials. Expert practical teachers. Low living expenses: easily earned if desired. Tuition low. Easy payments. Correspondence courses also. Catalogs Free.

Dodge's Telegraph, Ry. & Wireless Institute
8th Street, Valparaiso, Ind.

IF YOU STAMMER

attend no stammering school till you get my large FREE book and special rate. Largest and best school in the world curing by natural method. Write today.

Lee Wells Millard, Pres., North-Western School, Inc.
2317 Grand Avenue Milwaukee, Wis.

"Get a Better Job"

To the men with training, bigger salaries are paid now than ever before. The nation—and all its industries demands that men be trained. And you can get just the training you need right in your own home. We are training thousands of men, for high positions in all lines of business. Here you will find your opportunity. Write today—and let us tell you how others have "made good" through American School training.

Write Today for the Free Book We'll send you our new book "How To Get a Better Job" free and prepaid. It tells you how to link up natural ability with experience in order to make the most money. You will be under no obligations. Also we'll send you our new catalog that tells how to develop your natural ability with training. Free to any address. Write today.

AMERICAN SCHOOL OF CORRESPONDENCE, Dept. G8196 Chicago, Ill.

A Short Cut to BIGGER PAY Make \$25--\$50 Per Week



MACHINE SHOP Practice Complete Small Monthly Payments Only \$2 per mo. \$16 complete

The machine shops are looking everywhere for trained men. The demand is urgent, therefore wages are higher than ever before and opportunities for advancement were never better. As you know, capable machinists are earning from \$25 to \$50 per week and the machine shop specialist practically commands his own price.

How to Qualify for High Pay

COVERS

Practical Mathematics, by Palmer. Drawing and Design by Marshall. Composition Heat Treatment of Steel, by Lake. American Machinist Gear Book, by Logue. Accurate Tool Work, by Goodrich and Stanley. American Machinist.

There's no secret to machine shop success. All that is necessary is to put in an hour or less per day with the Machine Shop Library, which is written by 8 experts and over 200 practical contributors. Everything you need to know about machine shop practice is contained in these nine handsomely bound volumes, containing over 3000 pages and 3000 illustrations. You have, for instant use,

more knowledge and time-saving suggestions than one man can possibly gain in a life-time of practice.

10 Days' Free Examination

Let us send the Machine Shop Library to your home address, charges paid, for ten days' free examination. No one can judge the worth of the Machine Shop Library until he sees it. If you feel that you cannot do without the Library after 10 days, simply send \$2.00 and the balance at the rate of \$2.00 monthly until \$16.00 has been paid. May we receive the coupon at once?

FREE EXAMINATION COUPON

McGraw-Hill Book Co., Inc., 239 W. 39th St., New York

Gentlemen:—I am interested in your Machine Shop Library. You may send me the nine volumes, charges paid, for my inspection. If satisfactory I will send \$2 in ten days and \$2 per month until I have paid the price of the books, \$16. If the books are not what I want, I will write you for shipping instructions.

SIGNATURE.....

HOME ADDRESS.....

CITY AND STATE.....

NAME OF EMPLOYER.....

HIS ADDRESS.....

YOUR POSITION..... P.M. Sep. '17



"I propose
to fight it out
on this line if it
takes all summer"

—Gen. U.S. Grant

Resolve to Win!

Determination made Grant one of the greatest generals in history. The world knows his story. It knows, too, the stories of thousands of other determined men, who succeeded because they had a purpose and stuck to it.

Do you want to succeed? Do you want that better job? Do you want that increase in pay?

If you *do* want to get out of the rut—if you *are* determined to make something of yourself, send the International Correspondence Schools the attached coupon. Tell them what kind of position you want and they will show you how you can fit yourself to get it.

More than 100,000 determined men and women are getting ready for better positions right now through I. C. S. training. They are securing this training in their own homes, at small cost and without losing an hour from their everyday work.

**Determine to mark and
mail the coupon to-day**

INTERNATIONAL CORRESPONDENCE SCHOOLS BOX 5604, SCRANTON, PA.

Explain, without obligating me, how I can qualify for the position, or in the subject, before which I mark X.

- | | |
|---|--|
| <input type="checkbox"/> ELECTRICAL ENGINEER | <input type="checkbox"/> SALESMANSHIP |
| <input type="checkbox"/> Electric Lighting | <input type="checkbox"/> ADVERTISING |
| <input type="checkbox"/> Electric Railways | <input type="checkbox"/> Window Trimmer |
| <input type="checkbox"/> Electric Wiring | <input type="checkbox"/> Show Card Writer |
| <input type="checkbox"/> Telegraph Engineer | <input type="checkbox"/> Sign Painter |
| <input type="checkbox"/> Telephone Work | <input type="checkbox"/> Railroad Trainman |
| <input type="checkbox"/> MECHANICAL ENGINEER | <input type="checkbox"/> ILLUSTRATING |
| <input type="checkbox"/> Mechanical Draftsman | <input type="checkbox"/> Cartooning |
| <input type="checkbox"/> Machine Shop Practice | <input type="checkbox"/> BOOKKEEPER |
| <input type="checkbox"/> Gas Engine Operating | <input type="checkbox"/> Stenographer and Typist |
| <input type="checkbox"/> CIVIL ENGINEER | <input type="checkbox"/> Cert. Public Accountant |
| <input type="checkbox"/> Surveying and Mapping | <input type="checkbox"/> TRAFFIC MANAGER |
| <input type="checkbox"/> MINE FOREMAN OR ENGINEER | <input type="checkbox"/> Railway Accountant |
| <input type="checkbox"/> Metallurgist or Prospector | <input type="checkbox"/> Commercial Law |
| <input type="checkbox"/> STATIONARY ENGINEER | <input type="checkbox"/> GOOD ENGLISH |
| <input type="checkbox"/> Marine Engineer | <input type="checkbox"/> Teacher |
| <input type="checkbox"/> ARCHITECT | <input type="checkbox"/> Common School Subjects |
| <input type="checkbox"/> Contractor and Builder | <input type="checkbox"/> Mathematics |
| <input type="checkbox"/> Architectural Draftsman | <input type="checkbox"/> CIVIL SERVICE |
| <input type="checkbox"/> Concrete Builder | <input type="checkbox"/> Railway Mail Clerk |
| <input type="checkbox"/> Structural Engineer | <input type="checkbox"/> AUTOMOBILE OPERATING |
| <input type="checkbox"/> PLEUMBING AND HEATING | <input type="checkbox"/> Auto Repairing |
| <input type="checkbox"/> Sheet Metal Worker | <input type="checkbox"/> Navigation |
| <input type="checkbox"/> Textile Overseer or Supt. | <input type="checkbox"/> AGRICULTURE |
| <input type="checkbox"/> CHEMIST | <input type="checkbox"/> Poultry Raising |
- Spanish
 German
 Italian

Name _____
Present Occupation _____
Street and No. _____
City _____ State _____

Please Mention Popular Mechanics

16 Easy Lessons

that teach you everything about automobiles. The book that tells it ALL.

The Automobile Instructor

By Clyde H. Pratt, B. Sc., M. E., Member Nat'l Society of Auto Engineers, 304 pages, 210 illustrations, cloth bound. Shipping wt., 22 lbs.

New 1917 edition just out. The standard work for home-study, class-room and reference, for amateur and expert. A complete course for all who desire to master this profitable profession.

LEARN AT HOME HOW TO DRIVE AND REPAIR ALL CARS

Invaluable pointers for every car owner, driver, garage man and repair man. Adopted by **Cleveland** and other Auto Schools and by **Boards of Education** as their standard text-book. The author will answer your auto inquiries FREE. This book is guaranteed to be just what you want or your money back. (Auto schools, write for quantity prices.)

Price, postpaid - - - - - \$1.50

Shrewsbury Publishing Co. 5525 South Boulevard CHICAGO, U. S. A.

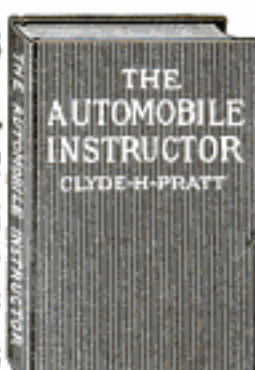

Motor Craft Encyclopedia illustrated. Tells how to build and operate Motor Boats. Best book on boats. Price, \$1.00.

LEARN WATCH REPAIRING



You can learn by our modern and original system of instruction every part of the Watch Repairing Trade at home as good or better than at a shop. You can earn money while learning and secure a well paying position or start in business after completing our course of instruction. Good watch repairers are always in demand and earn from \$20 to \$35 per week. For particulars apply to the Wisconsin School of Watchmaking, Stroh Bldg., Milwaukee, Wis.

CIVIL SERVICE

positions are in all parts of the country. Good pay, steady work, life positions, congenial surroundings, promotions on merit, short hours, annual vacation and sick leave with pay. Many thousands appointed yearly. Both sexes. No political pull. Nearly 300,000 classified positions. Common school education sufficient. Full information and questions used by the Civil Service Commission free.

COLUMBIAN CORRESP. COLLEGE, WASHINGTON, D. C.

MUSIC TAUGHT FREE



You can read Music like this quickly

IN YOUR
OWN
HOME

Piano, Organ, Violin, Mandolin, Guitar, Banjo, etc. Beginners or advanced players. One lesson weekly. Illustrations make everything plain. Only expense about 2c per day to cover cost of postage and music used. Write for FREE booklet which explains everything in full.

AMERICAN SCHOOL OF MUSIC, 51 Lakeside Building, CHICAGO



Do You Like to Draw? Cartoonists Are Well Paid

We will not give you any grand prize if you answer this ad. Nor will we claim to make you rich in a week. But if you are anxious to develop your talent with a successful cartoonist, so you can make money, send a copy of this picture, with 5c in stamps for portfolio of cartoons and sample lesson plate, and let us explain.

The W. L. Evans School of Cartooning
821 Leader Bldg., Cleveland, O.

7 DAYS

PARAGON SHORTHAND

Then Practice Brings the Speed

PARAGON INSTITUTE, 520

In your own home, during the evenings of just one week, you can learn the famous

Used in Government service; also in Court Reporting. Adopted by cities for High Schools. Wonderfully easy to read. Speed capacity practically unlimited. Positive proof before you enroll. Send for it TODAY. COLISEUM PLACE, NEW ORLEANS, LA.



VENTRILOQUISM

Send today 2c stamp for particulars and proof. O. A. SMITH, Room D 154, 823 Bigelow St., PEORIA, ILL.

LEARNED BY
ALMOST
ANYONE
AT HOME
SMALL COST

Aviation

PRACTICAL AERONAUTICS BY MAIL

EARN \$50 to \$500 a Week!



BUD MORRISS, Chief Instructor American School of Aviation

HERE is the one inexhaustible gold mine of opportunity and here is the man

who will lead you to it. It is the most extraordinary condition ever presented, owing to the sudden world-wide demand for aeroplanes. High class positions by the thousand calling for trained men—fame and fortune actually thrust at them. Salaries of from \$50 to \$500 a week are awaiting men who can fill these positions. And now, for the first time in history, a practical, home-study course in practical aeronautics is open to every man at a trifling expense. No matter what your occupation, you can prepare for a better position with big pay. Now is your opportunity.

Enter a practically untrodden field—a new profession. Seize the opportunity that has burst upon the country with tremendous force. Hustle ahead with the rapid development of the aeroplane industry which is outrivaling that of automobile and motion picture, as the quick and sure road to financial independence.

Prepare NOW
for these positions

Aeronautical Engineer
Aeronautical Instructor
Aeronautical Contractor
Aeroplane Repairman
Aeroplane Mechanic
Aeroplane Inspector
Aeroplane Salesman
Aeroplane Assembler
Aeroplane Builder

Conducted by Famous Aviators and Aeroplane Builders

The Course has been prepared by men of international reputation. Mr. Bud Morriss, the well-known aviator, is Chief Instructor and personally guides the progress of each student. He is assisted by a distinguished staff of Aviators, Aeroplane manufacturers and Aeronautical Engineers. Every Lesson, Lecture, Blue Print and Bulletin is self-explanatory, in plain terms for quick understanding. The Course is absolutely up-to-the-minute with every known fact concerning Aeronautics. You get practical, working knowledge of the very highest merit. Now is the time and this is your opportunity to step right into fame and fortune. You are needed. Where there's a will here's the way.

What Our Students Say:

Mr. Stanfield Fries

Fort Bliss, Tex.

My estimation of the new course is excellent: it could positively not be any better.

Mr. Z. Purdy

Shreveport, La.

It is hard to believe that lessons on such a subject could be gotten up in such an interesting manner.

Mr. Lloyd Royer

Haigler, Neb.

I can hardly thank you enough for the way you have personally taken up my enrollment.

Mr. Mayne Eble

Manistee, Mich.

I believe I learn more from my lessons than an aviator who takes his first lesson with an airman in a aeroplane.

Write Now for Our Great Offer

Send the coupon for full particulars of our remarkable special offer open to you now. Find out all about the marvelous opportunities that are opening in the Aviation game. This offer is the greatest stepping stone to bigger opportunities ever known. Write today for complete literature, all free and prepaid. You are not obligated in any way. Do not waste time in thinking about it. Act! Send the coupon or a letter or a post card will do. Write at once.

American School
of Aviation
431 So. Dearborn St.
Dept. 2629
Chicago, Ill.

Gentlemen: Please send me free and without obligation, full particulars of your Course in Practical Aeronautics and your Special Offer to those who write at once.

American School of Aviation
431 So. Dearborn Street, Dept. 2629, CHICAGO, ILL.

Name.....

Address.....

Please Mention Popular Mechanics

AMERICAN SCHOOL OF CORRESPONDENCE
CHARTERED AS AN EDUCATIONAL INSTITUTION
 CHICAGO, U.S.A.

Refund Guarantee

This Certifies That *James R. Webster*
 in consideration of his making the enclosed Application for Enrollment immediately, is guaranteed the return of the ENTIRE AMOUNT paid on his Course, if within one week after the completion of his term examination, he will notify the School that he does not wish to continue his Course.

Signed and Dated
 Feb. 21-1917 *A. S. Mullen*

Find Out What Training Means to You

WE hear a great deal nowadays about training—and how it has put men into high positions.

But do you realize what training will do for you? Here is an offer through which you can find out. The American School will start training you for the very position that you are dreaming about and you can see just exactly how this training helps you in your daily work.

Take Ten Lessons —Then Decide

You can take ten lessons in any course offered by the American School with the distinct understanding that if, after you have completed the ten lessons, you are not convinced that this training is going to put you in a high position, every cent that you have paid will be refunded.

Send the Coupon Today

Make your mark in this coupon before the position in life that you are dreaming about and let us tell you how easy you can get the training that will fit you for that job, right in your own home.

You will be under no obligations. Send the coupon now.

American School
 of Correspondence, Chicago, U.S.A.

Dept. G9196

American School of Correspondence,
 Dept. G9196 Chicago, U. S. A.

Gentlemen: Please send me booklet and tell me how I can fit myself for the position marked X.

- | | |
|--------------------------------|-----------------------------|
| Electrical Engineer | Business Law |
| Elec. Light & Power Supt. | Business Manager |
| Hydroelectric Engineer | Auditor |
| Telephone Engineer | Accountant |
| Architect | Certified Public Acc't |
| Architectural Draftsman | Stenographer |
| Building Contractor | Bookkeeper |
| Building Superintendent | Fire Ins. Inspector |
| Structural Engineer | Fire Ins. Adjustor |
| Structural Draftsman | Fire Ins. Expert |
| Mechanical Engineer | Sanitary Engineer |
| Mechanical Draftsman | Master Plumber |
| Civil Engineer | Plumb'g & Heat'g Est. |
| Steam Engineer | Heat'g & Vent. Engin'r |
| Shop Foreman | Reclamation Engineer |
| Shop Superintendent | Automobile Engineer |
| Sheet Metal Draftsman | Automobile Repairer |
| Lawyer | High School Course |

We also prepare for civil service examinations in all engineering subjects.

Name.....

Address.....

SHORTHAND IN 30 DAYS

We absolutely guarantee to teach shorthand complete in only thirty days. You can learn in spare time in your own home, no matter where you live. No need to spend months as with old systems. Boyd's Syllabic System is easy to learn—easy to write—easy to read. Simple. Practical. Speedy. Sure. No ruled lines—no positions—no shading as in other systems. No long lists of word signs to confuse. Only nine characters to learn and you have the entire English language at your absolute command. The best system for stenographers, private secretaries, newspaper reporters and railroad men. Lawyers, ministers, teachers, physicians, literary folk and business men and women may now learn shorthand for their own use. Does not take continual daily practice as with other systems. Our graduates hold high grade positions everywhere. Send today for booklets, testimonials, etc.

Chicago Correspondence Schools
 969 Unity Bldg., CHICAGO, ILL.



Draw Pictures that MOVE

The demand for animated cartoonists far exceeds supply. Get into this new, uncrowded profession now and

EARN \$25 TO \$200 A WEEK

Anyone with ordinary ability can quickly learn at home, in spare time. Write today for free book.

HARRY PALMER STUDIOS

25 VANDERBILT AVE., NEW YORK CITY.

A GOOD POSITION

with **UNCLE SAM** is most desirable. Life positions, pleasant surroundings, good pay, steady work, short hours, promotions on merit.

Both sexes. No political pull. Thousands of appointments yearly.

Most thorough preparation \$5. Returned if not appointed. Full

information and questions used by the Civil Service Commission free.

AMERICAN CIVIL SERVICE SCHOOL WASHINGTON, D. C.



MEN WANTED

Prepare as **Firemen, Brakemen, Electric Motormen, and colored Train Porters.** First Class Standard Roads. Hundreds put to work—\$65 to \$150 a month without any experience. **\$500 more wanted. Uniforms and passes arranged for when necessary.** Enclose stamp for Application Blank. Name position you want.

I. RAILWAY C. I., Dept. 35, Indianapolis, Ind.

LAW High-Grade Instruction by CORRESPONDENCE

Prepares You for
 the Bar—Est. 1892

Four Courses: College, Post-Graduate, Business Law and Bar Ex. Review. Classes begin each month. Approved by Bench and Bar. University Methods, Unabridged Text-Books, Cases. Course in Oratory, Public Speaking and Moot Court FREE with regular course. Graduates now practicing in every State. Write today for Catalog and Rules for Admission to the Bar. CHICAGO CORRESPONDENCE SCHOOL OF LAW, 120 Roper Bldg., CHICAGO



STAMMERERS

Our course of private lessons will correct your impediments.
BOSTON STAMMERERS' INSTITUTE
 Founded 1867. Samuel D. Robbins, Principal.
 246 Huntington Ave. BOSTON, MASS.



SEND 2 CENTS

in United States stamps to pay postage and we will send you FREE a **SAMPLE COLLAR** of our New Style "Copley." State size wanted.
REVERSIBLE COLLAR CO., Dept. U, BOSTON, MASS.

Please Mention Popular Mechanics

Stop Forgetting!



Prof. Henry Dickson

America's foremost Authority on Memory Training, Public Speaking, Self Expression, Lecturer and Principal of the Dickson Memory School, Hearst Building, Chicago.

The Executive



Mr. William H. Weeks, District Attorney of Putnam County, N. Y., writes:

"After a thorough trial of your method of mental and memory training, I find it to be not only first class—simply wonderful. I can truthfully say that I would not be again without the benefits I have received from your study for \$10,000."

The Salesman



O. G. Wehmer, of the American Miner's Accident Association, Indianapolis, Ind., writes:

"I can honestly and truthfully say I am a new person. I have more friends than I really expected I could have. Everyone who has known me says that a wonderful change has come over me in the last six months. It is all due to the Dickson School of Memory."

Perfect Your Memory and You Can Command What Salary You Will

Your salary—what it is today—what it will be tomorrow—depends very much on your memory. Tricky memories—wandering minds—unable to grasp detail—have thwarted thousands in their battle for success—have held them down to bare living wages—working long hours with slight prospect of advancement—subordinates for life.

The Ability to Concentrate, to Think and Express Yourself Clearly Means Everything to Your Success

America's men of power—in business, social or public life—are uniformly men of trained memories. Train your memory properly and you will find yourself able to concentrate absolutely on matters at hand—to think and speak connectedly—to develop self control, to overcome self consciousness—to make your PERSONALITY DOMINATE. Think what this means—a better position—bigger pay—social and business success—the EFFICIENT LIFE.

Give Me 10 Minutes a Day and I Will Give You a "Steel Trap" Memory

That is all I ask—just ten minutes a day for a few weeks and I will train your memory just as I have trained the memories of 50,000 others. I will make your mind an infallible classified index from which you can instantly select facts, figures, faces, arguments. No matter what your age—your education—your vocation—your place of residence—I can make you "forget proof"—can train your memory for SUCCESS.

Special Offer! "How to Speak in Public"—FREE!

For a limited period I am offering "How to Speak in Public," a de luxe edition, handsomely bound book—regularly priced at \$2.00—FREE to every student enrolling in my course. Full particulars of this unusual offer—together with a copy of my famous Memory Test and my remarkable book "How to Remember" will be sent FREE—simply for the mailing of the coupon or a postal. This is YOUR opportunity—mail it NOW.

The Key to Success

Stop forgetting

Prof. Henry Dickson, Prin. Dickson School of Memory 1705 Hearst Bldg., Chicago, Ill.

Please send me free of charge and without obligation your booklet, "How to Remember"; also your remarkable copyrighted "Memory Test." Give me facts on your special offer of a free copy of "How to Speak in Public."

Name

Street and No.

City State

The Public Speaker



Carl F. Schader, one of California's biggest men, writes:

"I have been improved physically and mentally beyond my own expectations by the continued study of your course. Every business man, especially those called upon to talk at Chambers of Commerce, reality boards, advertising clubs and other meetings should take your course. I unhesitatingly recommend it to my many friends."

In Social Life



Roland Miller, of New York City, writes:

"What I have gotten from your method has advanced me both socially and financially and I feel it my duty to tell you of these excellent results."



Be A Certificated ELECTRICIAN

Your Future
is in Electricity—Obey
that "Hunch."

Get a Move on Yourself
—Here's Your Chance—

*If You Act Quick I Will
Give You Special Per-
sonal Training at Home.*

Only a Limited Number
of Students Can Secure
My Special Instruction
—ACT NOW.



CHIEF ENGINEER
Your Instructor

Qualify at Home
—With My Help

STUDY BY MAIL

My New Course and a
Common School Edu-
cation All You Need.

*Fit Yourself in Spare
Time to Earn \$45.00
to \$175.00 a week.*

SPECIAL

Earn While You Learn
Right After You Are Enrolled
I Will Give You a Short Course
in Quick Money-Making Elec-
trical Branch—FREE.

MY OFFER TO YOU:

If you act quick I will accept you among a few more students to complete Home Study class now forming. Grasp this wonderful opportunity. Fit yourself by a few months' fascinating Home Training to be a **REGULAR CERTIFICATED ELECTRICIAN**.

I have a splendidly attractive proposition for you. I **GUARANTEE** you satisfaction in the study of this great profession. Decide to enter it while you can do so on terms especially advantageous to you. Plan a glorious future. Secure for yourself the assured independence, the handsome income, the agreeable working conditions, the easy professional hours and the unlimited opportunities of trained and experienced Electrician.

CHIEF
ENGINEER
429 Cass St.
Chicago, Illinois

Without obligation
on my part kindly
send at once, fully pre-
paid, particulars of your
complete Practical Home
Study Course in Electricity.

FREE ELECTRICAL OUTFIT

For the next 30 days I am giving each student an Outfit of Electrical Test-
ing Instruments, Tools, Electrical materials and Motor absolutely Free.

My instruction is by practical methods and this outfit is used in work-
ing out the lessons. Practical training with the theory makes perfect.

I am Chief Engineer of the Chicago Engineering Works, and I can
give you the training that will land the big jobs and hold them.

I haven't the space here to tell you all the advantages, benefits
and privileges **GUARANTEED** to my students. If you are

ambitious to make a big success in the greatest profession on earth—if
you are ready to start right in and study Electricity the "easy" way—
at home—mail me the FREE "OUTFIT" coupon without delay. I

will send you full particulars of my personal instruction plan, my
splendid laboratory and educational facilities, my wonderfully
complete and fascinating course of bed-rock lessons, and my
thoroughly practical method of making Electricity easy to
understand and master. Write me NOW.

NAME.....

ADDRESS.....

TOWN..... STATE.....

CHIEF ENGINEER
Chicago Engineering Works
429 Cass Street, CHICAGO, ILL.

CLASSIFIED ADVERTISEMENTS

WORLD'S BEST WANT AD MEDIUM

We have records to prove that a classified ad in these columns will find a buyer for almost anything which can be sold. Doubtless you have some article of value to some one else which you no longer need. Why not turn it into money?

Advertisements in this section, 18 cents per word, each insertion, minimum 10 words, payable in advance. To insure ads being inserted under proper classified head in the October issue, copy must reach this office not later than August 30th.

Popular Mechanics Magazine, Chicago, Ill.

Gentlemen: I received wonderful results from my classified ad in your magazine. The ad was inserted only once and I received 42 letters in reply. I was greatly surprised to get an answer from a gentleman in British Honduras, S. A. Also 2 letters from Honolulu, Hawaii. I can say that I am very well satisfied with the results.

Very truly yours,

JOHN DIETRICH,
Cadott, Wis.

AUTOMOBILES

LEGAL Points for Automobile Owners gives Briefly your liability under various circumstances, as when your car is being driven by your friend or a member of your family, by an unlicensed chauffeur, by your chauffeur, with and without your consent; when you lend your auto; defense for speeding, etc. Contains 28 chapters, 55 pages. Cloth bound. Price, 59 cents postpaid. J. S. Ogilvie Publishing Co., 377 Rose St., New York.

OFFICIAL Auto Wiring Guide—Just Out. The most valuable book ever offered to the automobile world. Contains 480 pages; 448 of which are guaranteed accurate blueprint diagrams showing complete wiring circuits of all makes of gas and gas-electric cars, dating back as far as 1912. Miscellaneous wiring diagrams covering all starting and lighting systems are shown as well as diagrams for re-wiring cars, both grounded and multiple systems. Price \$7.50 prepaid. Send for 8-page descriptive circular. Popular Mechanics Book Dept., 6 N. Michigan Ave., Chicago.

INVENT Something; your ideas may bring wealth; free book tells what to invent and how to obtain a patent, through our credit system. Talbert & Parker, 4657 Talbert Bldg., Washington, D. C.

THE Modern Gasoline Automobile—Most complete and up to the minute automobile book published. Recognized as the standard book on construction, operation, maintenance and repair, showing every recent improvement. Over 700 pages, 500 illustrations. Cloth. Price, \$2.50 postpaid. Send for complete description of this and other reliable automobile books. Popular Mechanics Book Dept., 6 N. Michigan Ave., Chicago.

STORAGE Batteries Simplified—A complete new treatise on action—maintenance—repair—use. Describes fully the Exide, Edison, Gould, Willard, U. S. L. and other forms. Only complete and up-to-date book on subject. 320 pages, fully illustrated. \$1.50 postpaid. Complete description sent upon request. Popular Mechanics Book Dept., 6 N. Michigan Ave., Chicago.

GET into the Automobile business, as salesman, chauffeur, garage manager, mechanic. Automobile instruction in four weeks' residence course. Send for booklet P. M., West Side Y. M. C. A. Auto School, 318 West 57th St., New York.

CYLINDERS reground, new pistons and rings fitted. Restores lost power. Write for prices, giving make and model. The Everts Machine Co., Hartford, Conn.

PATENTS for Automobile Improvements are in great demand. We have special Automobile Department in charge of experts who are in touch with demands of trade. Write for "What To Invent and List of Patent Buyers," sent free. Victor J. Evans & Co., 158 Ninth, Washington, D. C.

AUTOMOBILE SUPPLIES

AUTOMOBILE Parts for most all makes of cars: Buicks 10, 17, 19, 27, 29, 35 and 39. Maxwells, E. M. F. Flanders, Paige 25 and 30, Overlands 37, 38, 42 and 53. Cadillacs '09 to 1912. Parry, Regals '09 to 1913. Oakland, Jeffery, Mitchells '07 to 1913. Empire, Elmore, Chalmers '09 to 1914. Auburn, Jackson 23, Interstate, Hudson 20 and 33, Hupp 20, Ohio, Staver, Marion, Cole, Melroe, Stearns-Knight, Rambler, Howard, Thomas, Imperial and many others. Pistons, connecting rods, cam-shafts, crank-shafts, cylinders, axles, bearings and gears for most any make of car. Write us for a Stock List. Satisfaction guaranteed. Auto Parts Company, 4116-18 Olive Street, St. Louis, Missouri.

INSYDE Tyres, inner armor for Automobile tires, double mileage and prevent punctures and blowouts. Quickly applied. Cost little. Demand tremendous. Profits unlimited. Details free. American Automobile Accessories Co., Dept. P2, Cincinnati, O.

GET into biggest money-making end automobile business—replacing necessary equipment. Live, ambitious men wanted as special factory representatives, exclusive territory, taking orders for logs, top coverings, seat covers, "Stik-Tite" Windows. No experience necessary. No capital required. No competition. Copyrighted system protects you. Free catalog, samples, full details. Cincinnati Auto Specialty Company, Dept. MA-97, Cincinnati, Ohio.

BIG Profits HB Battery Charging. City current to operate. Hobarts, Troy, Ohio. Easy Payment.

BESCO Gas Tonic—One ounce to 5 Gallons of Gasoline. Wonderful discovery. Big Market. Retail \$2.00 quart. Sample 25c. Formula \$1.00. Beardley Specialty Laboratories, Rock Island, Illinois.

VULCANIZE auto tires. Make big money. Learn with our book \$1.00. Vanderpools, Springfield, Ohio.

THOUSANDS of Automobileists endorse "Air-Cure" self-vulcanizing Tire Patch. Send 25c for regular 50c cutoff. Wild Mfg. Co., 1307 Nicollet Ave., Minneapolis, Minn.

DOUBLE Service Tires. Guaranteed to give good service. Size, 30 x 3, \$3.50; 30 x 3 1/2, \$4.00; 34 x 4, \$4.80; 34 x 4, \$9.00; 36 x 4, \$9.00; 36 x 4 1/2, \$11.00; 36 x 5, \$12.10; 37 x 5, \$12.10. Non-skid \$1.00 extra. 10% required on all C. O. D. orders. State if Q. D. straight side or clincher type. 5% discount if cash accompanies order. Also special discount to dealers. I. Jaffes, 1319-5th Ave., New York. Branch—241 West 54th St., New York.

MAGNETOS—Bosch, all sizes and types, \$10.00 up. Remy and Spitzdorf \$3.50. Coils—Steering Wheels—Auto accessories all kinds. Write for list. Johnston, West End, Pittsburgh, Pa.

TIRES—Double Tread Guaranteed for good service. Absolutely Puncture-Proof. Big—Strong—Extra heavy, 30x3 tire, \$5.00; 30x3 1/2, \$6.00; 33x4, \$8.00; 34x4, \$9.25; 36x4 1/2, \$12.00; 37x5, \$13.00. Big saving on other sizes and tubes also. Trade in your old tires. Discount to dealers. 10% deposit required on C. O. D. orders. Send for list now! State size and brand of tire. Max Liben & Co., 295B West 48th Street, New York.

AUTO Motors—4-cylinder, water-cooled, \$35.00 up. Buick 10-24-39 and 17. Mitchell-Everett 29—Hup 29—Flanders 20—Continental and Buda motors all sizes. Johnston, West End, Pittsburgh, Pa.

EXPLOSION Whistle—Fits priming cup. First whistle adopted as standard equipment on any automobile. Buell Co., 1610 Michigan Ave., Chicago.

MAKE \$15 daily profit selling our auto washer and other brush specialties; every car owner buys on sight. This is the best season for big sales. Every sale 100% profit. Puritan Co., Dept. M, 1966 Broadway, N. Y.

UNUSUAL Bargains in Automobile Repair Parts. Axles, Bearings, Carburetors, Complete Engines, Cylinders, Differentials, Magnets, Pistons, Radiators, Springs, Valves, Wheels and other parts for Buick, Cadillac, Chalmers, Interstate, Maxwell, Mitchell, Moco, Overland, Packard, Peerless, Regal, Studebaker, Thomas and other cars, at a discount of 50% to 75% off manufacturer's list price. Maxwell Bros., 3931 Olive St., St. Louis, Mo.

AUTO Top Roof Covers Save you two-thirds price of new top; tailored to fit any car; easy to apply; \$6 to \$15, parcel post paid; seat covers \$5 and up; catalog and samples free. S. & H. Top Co., 439 Hunt St., Cincinnati, O.

GEARS for all purposes; transmission gears, bevel-drive gears, sprockets, axles. Special machine work. Must have old parts or drawing. Turley Gear Plant, 1505 N. 10th St., St. Louis, Mo.

VULCANIZE your own tires; save money; full particulars free. Superior Vulcanizer Co., 16B Fulton Ave., Rochester, N. Y.

SPARK Plug Trouble?—Pronto Spark-Gaps Shoot any spark plug any condition. Pronto Spark-Gap Plugs, new combination; last forever. Wonderful demonstrators. Splendid proposition. Pronto Manufacturing Co., Omaha, Nebraska.

MOTORISTS Save Money Using "Gidz." After testing, one firm purchased 14,400 cans. There's a reason. It satisfies. "Gidz" is not a self-ounce proposition. It repeats. Representatives and dealers wanted. Fine protective contract. Write to-day. "Gidz" Mfr., Galesburg, Illinois.

POWER increased; carbon eliminated; results guaranteed. Write for folder. Automobile Accessories Co., (G.) Baltimore, Md.

AUTOMOBILE Repairing Made Easy—The most needed and useful book on automobiles ever written. Only book of its kind—just out. Covers every phase of automobile repairing practice. 1,056 pages (5 1/2 x 8 in.), 1,000 engravings. Cloth. Price \$3.00 postpaid. Send for complete description of this and other reliable automobile books. Popular Mechanics Book Dept., 6 N. Michigan Ave., Chicago.

WELDING—Automobile Welding with the Oxy-Acetylene Flame—Just Out—167 pages, fully illustrated. Price, \$1.00 postpaid. Explains the actual welding of all automobile parts in a manner understandable by everyone. Popular Mechanics Book Dept., 6 N. Michigan Ave., Chicago.

SAVE 50% to 70% on your next tire purchase. Our tires are practically blow-out and puncture-proof. Guaranteed for 2,500 miles. Send for illustrated catalog No. 4 and Price List. Tuxedo Auto Tire Exchange, 305 W. 54th St., New York City.

JUST Out—Modern Starting, Lighting and Ignition Systems—A new book on automobile electricity without an equal. Nearly 400 Pages. 250 Engravings. Cloth. Price \$1.50 postpaid. Complete description sent on request. Popular Mechanics Book Dept., 6 N. Michigan Ave., Chicago.

TO FORD OWNERS

THE Furlarm—Horn button on gasoline control lever right under your finger. Safety and convenience, \$1.00. Circular free. Detroit Novelty Mfg. Co., 590 Marquette Bldg., Detroit, Mich.

GET 100 per cent. more light with Sunlight System. Good light at low speed, throws most of light into one headlight. Wire and Connection for \$1.00. Can be attached in five minutes. No holes to drill or tools required. Guaranteed satisfactory. Many garages charge \$5 for similar light wiring. Box 3, 6900 Lakewood Ave., Chicago, Ill.

THE Fordlumer dims or brightens the headlights; most practical, convenient, easiest installed. Fully guaranteed \$1.50. Illustrated circular free. Detroit Novelty Mfg. Co., 590 Marquette Bldg., Detroit, Mich.

WHY Break Your Arm Starting Your Ford? Send us one dollar and we will mail you postpaid one of Miller's Kant-Kicks. Can put it on your car in five minutes. No mechanic needed. Keeps your car from kicking and locks your Ford so the other fellow can't use it. Buy direct and save your money. Miller & Jayne Mfg. Company, Monmouth, Illinois.

FORD Electric Lighting systems. \$37.50 complete. Goodlite Company, Indianapolis, Ind.

SLEEP in your Ford in McMullin Auto Bed, \$8.50. Other small cars \$10. Free booklet on auto camping. Auto Bed Company, Box O, Bellingham, Wash.

FORD Top Roof Cover \$6 and up. Easy to apply. You save two-thirds price of new top. Seat covers \$5 and up. Samples and catalog free. S. & H. Top Co., 429 Hunt St., Cincinnati, O.

FORD ACCESSORIES

WANTED: An agent in every town to sell our Clamp-On Shock Absorbers to Ford owners. Makes every road a boulevard for the Ford. Sell themselves wherever shown. Big profits for Agents. Write at once for particulars. Milwaukee Shock Absorber Co., Milwaukee, Wis.

LOW Speed Write-Lite. Easily attached, 50c prepaid. Hoco Engineering Co., Anderson, Indiana.

NEW 300-page book on the Ford car for every Ford owner, dealer and repairman. Deals fully with construction, operation and repair. 100 engravings. Best and most complete Ford book published. Price, \$1.00 postpaid. Also Ford Engine Chart, 25x38 in. Location of engine troubles made easy. Price, 25 cents postpaid. Popular Mechanics Book Dept., 6 N. Michigan Ave., Chicago.

DUBOLITE and Dimmer, doubles both lights on Ford car also dimmer that complies with any state law. Price \$4.00. Dealers wanted. Handy Dimmer Co., 15-17 Library St., Grand Rapids, Mich.

IMPROVE your Ford 1,000%—attach an Irreversible Worm Steering Gear, style used on all high-priced cars. Holds your Ford straight ahead and steady—prevents turning turtle, leaving the road or turning past center. Absorbs vibration and strain. Easily put on. Thousands in use. \$12. Satisfaction or money back. Attach one now. Sell them in your locality. Good proposition. Wire or write E. H. Sprague Mfg. Co., Dept. 5, Omaha, Neb.

MOTORCYCLES, BICYCLES & SUPPLIES

MOTORCYCLES \$50.00 and up. We are cleaning up all 1916 stock and offer you a real bargain in every machine listed. The first check or money-order gets each machine, no reserving. 23 single cylinder 1916 Flying Merkle Machines, complete, each \$120.00, 6 twin cylinder 1916 Flying Merkle Machines complete, each, \$165.00. Two-speed for either item, \$20.00 extra. All the above have regular catalog specifications with Firestone or Federal Tires, 50 Model 15, 1916 design, Miami Power Bicycles, catalog specifications, all guaranteed, each \$99.00. 5 twin chain Merkle, second hand with Splendor Mag. and Fed. Tires, worked over models, better than new, each \$110.00. 1 twin belt Merkle, second hand, with same specifications as above, in A-1 condition, \$85.00. 1 1913 Harley twin, chain drive, single speed, not run over 100 miles, a good buy at \$99.00. 1 Special Overhead Valve, Twin Chain Drive Merkle, motor built for racing. Has gone 80 miles per hr., \$135.00. Remember every machine is in first-class condition and the first money order received for each machine takes it. Specify a substitute in ordering. The Miami Cycle & Mfg. Co., 1520-1536 Grand Ave., Middletown, Ohio.

GET a 1916 Henderson fully equipped, like new, \$159; 1916 Powerplus Indiana, \$169; fine Nine-Horsepower new DeLuxe motor complete, \$75. Over one hundred machines at \$29 up. Send for list. Tires and accessories sacrificed. W. E. Wandersee Company, 1561 Woodward Ave., Detroit, Mich.

USED Motorcycle Bargains—Harley, Single \$50, Excelsior Twin \$70, Thor Twin \$80, Harley Twin \$125, Indian 2 Speed \$130, Excelsior, big valve, etc. \$220. Many more at exceptionally low prices. C. H. Lang, 1704 Michigan, Chicago, Ill.

INVESTIGATE, save 50% on your motorcycle; all makes, singles, twins, \$30 up. All guaranteed. Big bargain list, free. Write today. Western Supplies Company, 198 Hayutin Bldg., Denver, Colo. Oldest and Best Motorcycle House.

SPECIAL Sale. 500 Unguaranteed Inner Tubes, All Sizes, \$1.50 Each. Cash must accompany order. Leo McDaniel, 613 Ohio Street, Cairo, Illinois.

LARGE stock of rebuilt motorcycles, new parts for all makes 25% discount; second-hand parts, good as new, 50% discount. Motorcycle Parts Mfg. Co., Chicago.

DON'T buy a Bicycle Motor Attachment until you get our catalogue and prices. Shaw Mfg. Co., Dept. 27, Galesburg, Kans.

FOR Sale—Harley-Davidson. Good condition. \$85.00. Write Oliver Felberg, Wolf Point, Montana.

BICYCLES \$7.50; Tandems \$15. Repairing. McDougald, 309 North 5th Ave., Chicago.

MOTORCYCLES, Side Cars and Cycle-cars. Their Construction, Management and Repair—The only complete work published on this subject. The dealer, mechanic and rider will find this an excellent treatise. 550 pages, cloth, 350 illus. Price, \$1.50 postpaid. Complete description sent upon request. Popular Mechanics Book Dept., 6 N. Michigan Ave., Chicago.

I SAVE you half on parts and accessories for all makes. Jones "The Parisman," Box 591, Brockton, Mass.

JUST the Motorcycle you want at right price is here. Send for price list. Seiber & Hofheins, Buffalo, N. Y.

WILL trade brand new Sonora cabinet phonograph and twelve records. Cost complete, \$400, for Henderson 4-cylinder motorcycle. L. A. Lenz, Box 496, La Grange, Ill.

1917 EAGLE Motorcycles now ready. Get Circular M9, and agency proposition. Eagle Motorcycle Company, Brockton, Mass.

INDIAN three-speed, equipped and new tires, \$150. Liberty Bonds or cash. R. Hart, R. S. Sterling, Ill.

5 REBUILT Indian Twin Motorcycles, chrome frames, look new. Your choice \$100 each. 100 Used Motorcycles, all makes. Send for our free catalog. Myerow Bros., 149 Berkeley St., Boston, Mass.

USED Motorcycles at bargain prices. All makes 15% discount for 30 days. We ship subject to examination. Ask for list 303A. Clymers Motorcycle Garage, Greeley, Colo.

EASY terms on new and rebuilt motorcycles, side cars, tandems, and lighting outfit. Motorcycle Investment Co., 809 Centre St., Brockton, Mass.

BIG bargains in good motorcycles we have taken in exchange on new ones. Send for special bargain list. Shaw Mfg. Co., Galesburg, Kansas.

GET your Motorcycle or Bicycle at your price. Motorcycles \$25.00 up. Bicycles \$5.00 up (Guaranteed). Parts for all motorcycles and bicycles carried in stock; repairing. Send for big Bargain Bulletin. American Motorcycle Co., Chicago.

35 NEW and used Indian motorcycles at a sacrifice, to close estate. Write for list. Albert Hanson, 212 Shukert Bldg., Kansas City, Missouri.

MOTORCYCLES from \$25 up—New and second hand—easy terms—large list to choose from—all makes. Send 4 cents stamps for Bulletin "K." Peerless Motorcycle Co., Boston, Mass.

BIG bargains in second-hand motorcycles, \$25 up. Indians, Harleys, Thors, Excelsiors and Mercks. Write for description. Howard A. French & Co., Baltimore, Md.

WANTED: We pay cash for used motorcycles or take them in on exchange for new machines. Write with complete description. State condition of tires, frame, motor, make and model. Shaw Manufacturing Co., Dept. 157, Galesburg, Kans.

WELDING

EARN big money by repairing scored automobile cylinders with our low fusing alloy process; no boring or new piston necessary. Outfit includes necessary apparatus for applying and finishing, also a quantity of material. Price \$25. New Process Welding Co., not Inc. Lock Box No. 709, Chicago, Ill.

DON'T scrap aluminum parts—trial bar 50c. So-Luminum, new great welding compound for aluminum. Perfect substitute for acetylene welding. ¼ time and cost. Use gasoline or blow torch. Booklet 1 and directions, \$3.00 per pound. So-Luminum Mfg. Co., 1790 Broadway, New York.

HERE'S your best opportunity to learn to solder aluminum to any metal with ordinary solder, brass steel and cast iron. Write for booklet. Modern School of Soldering, 471 Fabre, Montreal, Canada.

BERMO Welding Plants, oxy-acetylene, 12 years' successful record. Guaranteed. Write for Catalog and Easy Terms. \$25 to \$250. Bermo Supply Co., Omaha, Neb.

SIMPLE Soldering, both hard and soft—82-page book telling how to join metals. Do your own repairing. 52 illustrations. 25c postpaid. Popular Mechanics Book Dept., 6 N. Michigan Ave., Chicago.

OXY-ACETYLENE Welding and Cutting. Electric and Thermit Welding. Brand new book of practical instruction in this process. The workman will find all necessary information for handling any kind of welding. 215 pages, fully illus. Cloth, \$1.00; Leather, \$1.50 postpaid. Popular Mechanics Book Dept., 6 N. Michigan Ave., Chicago.

AERONAUTICS

AVIATION. Send for free and prepaid literature on Aviation. Courses in Practical Aeronautics and Flying. Learn how you may prepare yourself for this fascinating and big paying profession at home. Special Limited Offer to all who write immediately. American School of Aviation, Dept. 7919, 431 South Dearborn St., Chicago.

AEROPLANE mechanics wanted; thousands needed right now. Will give thorough, practical training course on modern machines for \$110. No book study, actual work only. U. S. Aero, 38 Park Row, N. Y. C.

INVENT Something. Your ideas may bring wealth. Free book tells what to invent and how to obtain a patent through our credit system. Talbert & Parker, 4659 Talbert Bldg., Washington, D. C.

THE American School of Aviation offers new and complete courses in Aviation. Exceptional opportunities open for men who write today for our Special Reduced Price Offer. American School of Aviation, Dept. 7929, 431 South Dearborn St., Chicago.

MEN or Women Learn Aviation. Government or exhibition. Pilot license guaranteed. Actual flights. Ground training device saves time—money—lives. Ideal training camp. A. C. Beech, Chief Instructor, Write Moler Aviation Instructors, Inc., 143 S. Fifth Ave., Chicago.

FOR Sale—Curtiss aeroplane. Three propellers. J. E. Odeh, Waterloo, Iowa.

FOR Sale—Nearly completed Blériot Monoplane and motor. George Gaylor, Clearfield, Pa.

MODEL Aeroplanes, material and supplies. Compressed Air Motors. Practical course in Aeroplanes construction. Send 5c for catalogue. Wading River Mfg. Co., 559 Macon St., Brooklyn.

PATENTS Wanted in Aeronautics—U. S. Government spending millions in this class for Army and Navy. Our Aeronautic Department will give full information on this subject upon inquiry. Write for "What to Invent," sent free. Victor J. Evans & Co., 169 Ninth, Washington, D. C.

AVIATION Dictionary \$1, cloth \$1.50. Languages Publishing Company, New York.

GET our latest Aeroplane Book containing full information about "Ideal" Model Aeroplanes, parts, plans, etc. 5c postpaid. Ideal Aeroplane Co., 82½ West Broadway, N. Y.

TANDEM Monoplane Glider, full size, how to make—Our book "Amateur Mechanics No. 6" contains a complete detailed description of how to make one and also over a hundred other interesting articles. Price, 25c postpaid. Popular Mechanics Book Dept., 6 N. Michigan Ave., Chicago.

BUILDING and Flying an Aeroplane—160-page handbook covering the building of small models and full-sized gliders and machines. In both biplane and monoplane models the well-known Curtiss and Blériot types are followed. Fully illustrated with detail drawings. Price, \$1 postpaid. Popular Mechanics Book Dept., 6 N. Michigan Ave., Chicago.

HEATH Aerial Products and Supplies. Why are they the best and cheapest? It's the old story—quantity production. Aeronautical supply catalogue, 6 red stamps; propeller catalogue, 3 red stamps. Heath Aeroplane Co., formerly Heath Aerial Vehicle Co., Chicago.

AVIATION Motors, all makes, up to 150 H.P., \$250 up. Complete aeroplanes, all types, \$500 up. State your needs. Aero Exchange, 38 Park Row, N. Y. C.

BOOKS AND PERIODICALS

GREATEST patriotic hit, "Go, My Son, God Bless You!" 15c. Orchestration 20c. Lovely Valse Ballad, "My Love is for Thee," 15c. Sovereign Pub. Co., 160 Sycamore, Buffalo, N. Y.

"**SENAM**," spirit voice of the mysterious Hindoo mystic, 25c. Sovereign Pub. Co., 160 Sycamore, Buffalo, N. Y.

WORLD-ROMIC, Languages Masterkey, 56c. Languages Publishing Company, New York.

U. S. ARMY Infantry Drill Regulations, 58 cents. Field Service Regulations, 80 cents. Cavalry Drill Manual, 80 cents. Small Arms Firing Manual, 80 cents, cloth, postpaid. Also send for complete list of over fifty standard military and naval books. Popular Mechanics Book Dept., 6 N. Michigan Ave., Chicago.

ENGINEERS' questions and answers for license by Hobson, for twenty-five cents, postpaid. Send stamps. Reilly's Book Store, Philadelphia, Pa.

BINDER for Popular Mechanics magazines. Best adjustable magazine binder on the market made especially to hold any number from one to six copies of this magazine with name "Popular Mechanics" in gold letters on front cover. No laces or cutting or perforating of pages necessary. Simple, unique adjustment; handsome, durable and neat. We buy in quantities and can offer our readers this regular \$1.50 binder for \$1.25, all shipping charges prepaid. Address Popular Mechanics Book Dept., 6 N. Michigan Avenue, Chicago.

NEW 1917 Catalog of Latest and Best Books on Mechanical, Electrical and Industrial Subjects, comprising 128 pages and adequately describing more than 400 works. Sent free upon request by Popular Mechanics Book Dept., 6 N. Michigan Ave., Chicago.

FIND Out for Yourself what to invent and how to procure and sell a patent for the same. My book, "Inventor's Universal Educator," covers the matter from A to Z. 140 pages, elegantly bound. Also contains 600 mechanical movements and 50 perpetual motions. Price \$1.00, postage free. F. G. Dieterich, 651 Ouray Bldg., Washington, D. C.

USED Books, Bargains, Catalog. Higney's, A-2441 Post, San Francisco. (Books Bought.)

EDUCATIONAL AND INSTRUCTION

WANTED, draftsmen, everywhere. Practical home drafting course. Circulars telling how others have succeeded, free. J. Edward Goss, 860 President Ave., Fall River, Mass.

"FACE-READING on Sight"—A new book telling how to: See others as they are in fact; Obtain better salary; Choose profitable occupation; Discriminate between efficient and non-efficient employees. Illustrated. By mail \$1. Mollen-Photo-Works, 601 Times Bldg., Chicago.

LEARN Armature Rewinding, Automobile Electric Starting, Motors and Generators. Easy to learn at home by our plain, simple course. We furnish working model armature, etc. Good armature winders earn big pay. Free literature. S-A Electric Works, 1906 Emmet St., Omaha, Nebraska.

SHORTHAND—Gregg, the only system based on longhand writing. Speedy and dependable. Has endorsement of 70% of the educational institutions. Writers rank first everywhere. Learned at home. Write for catalogue, Fairfield School of Shorthand, 186 Davis Bldg., Fairton, New Jersey.

SHORTHAND—McEwan's Easy method. Teacher's course. 1110 Advertising Bldg., Chicago.

LEARN Cartooning, Commercial Art, Lettering, Signs and Showcards. Original examples. D. Freeburn System, Hicksville, O.

MARR'S "De Bookkeeping and Stenography Boiled Down," 50c; practical home study. B285, Nashville, Tenn.

SIGN Painting and Show Card Writing learned by reading the Sign Painter's magazine. Special, 3 months 25c. National Review, 535 Belmont, Chicago.

ARTISTS in big demand. \$50 paid for one drawing. Learn quickly at home, in spare time. Commercial Art, Cartooning, Illustrating, Designing. Outfit Free to new students. Handsome book free explains. Write now. Washington School of Art, 1109 H. St., N. W. Washington, D. C.

FREE Tuition by Mail; Normal Grammar School, High School, Bookkeeping, Shorthand, Typewriting, Civil Service, Agricultural, Drawing, Domestic Science, Engineering, Automobile, Salesmanship, Law and Real Estate Courses thoroughly taught by mail. Membership Fee, \$10.00; tuition free. For "Free Tuition Plan," address, Carnegie College, Rogers, Ohio.

SPANISH Alphagam, Pronunciation Masterkey, 37c. Languages Publishing Company, New York.

GOOD Opportunities for Veterinarians. Send for Catalog. Grand Rapids Veterinary College, Grand Rapids, Michigan. Dept. Z.

WAR Atlas—Large 29-page (11x15 in.) Atlas of the War in Europe, containing large colored scale maps of the Battleground, showing Europe, Austria, Serbia, Germany, England, Belgium, France, Russia, Italy, Greece, the World, etc. Special data showing comparison of armies and navies involved, pictures of rulers, etc. Price 30 cents postpaid, Popular Mechanics Book Dept., 6 N. Michigan Ave., Chicago.

IDEAL Atlas—Just Published—Contains large scale maps, yet is a book of handy size. Has special maps of all war zones in addition to all regular maps found in a good atlas. Is self-revising, that is, contains a certificate entitling the purchaser to a supplement of new maps after the war is over. Genuine flexible leather binding. 512 pages, 256 pages of maps, 256 pages of text. Price \$2.50, Cloth binding \$1.65 postpaid, Popular Mechanics Book Dept., 6 N. Michigan Ave., Chicago.

WANTED—New Ideas. Write for list of Patent Buyers and Inventions Wanted. \$1,000,000 in prizes offered for inventions. Our Four Books sent free upon request. Victor J. Evans & Co., 167 Ninth, Washington, D. C.

FINGER Print Instructor—A text book for the guidance of finger print experts and an instructor for persons interested in the study of finger prints. Book based on the Henry System and prepared by an expert. Cloth, 155 pages, illustrated. Price, \$2.00 postpaid. Popular Mechanics Book Dept., 6 N. Michigan Ave., Chicago.

MOULD making for ornamental casting, particulars, 200 illustrations, free. Mahler, Woodhaven, N. Y.

ARTIFICIAL Marble, sanitary flooring, complete instructions, \$1. Ornamental casting, concrete, plaster, papiermache, decorations, garden furniture, statuary, rubber moulds, electrometallurgy. Particulars, 200 illustrations free. Mahler, D-721 Woodland Ave., Woodhaven, L. I., New York.

ROPP'S Calculator and Short-Cut Arithmetic—Shows the answer as quickly as a watch shows the time to all problems likely to occur in office, store, shop, bank, farm or factory. Over two million sold. Price, vest pocket size, 50 cents; leather, pocket size, \$1.00; large, desk size, \$1.25 postpaid. Complete description sent upon request. Popular Mechanics Book Dept., 6 N. Michigan Ave., Chicago.

LEARN Drafting—One of the most practical subjects, and indispensable in many occupations. Individual study at home without an instructor may be successfully carried on with the aid of our book, "A Practical Course in Mechanical Drawing," 160 pages, 137 drawings. Cloth. Price 50 cents postpaid. Popular Mechanics Book Dept., 6 N. Michigan Ave., Chicago.

TRADE SCHOOLS

ELECTRICITY, Plumbing, Bricklaying, Mechanical, Architectural and other Drafting Courses. Motion Picture Operating taught by practical work. Largest, best equipped practical trade school in America. Short time to learn. Small cost, easy payments. Write for big illustrated book; it's free. Coyne National Trade Schools, Dept. 1896, Chicago, Ill.

HILE'S Watchmaking and Engraving School, the largest and best equipped school in the West. 717 Market Street, San Francisco, Cal.

PRACTICAL Training in Paperhanging, Graining, Sign Painting, Showcard Writing. Chicago Painting School, 131 North Fifth Avenue, Chicago.

OPTICAL SUPPLIES

BROKEN Lenses duplicated no matter how fitted them. Frames repaired. New ones reasonable. E. G. Pfeiffer, 509 No. Robey St., Chicago.

TELEGRAPHY

TELEGRAPHIC—both Morse and Wireless, also Station Agency, taught quickly. Tremendous demand—much greater than supply—permanent positions secured. Big salaries—recently raised. Ideal working conditions—short hours, vacations with pay, sick and death benefits, etc., prevailing. Great opportunities for advancement. Women operators also greatly desired by Railways and Western Union. Tuition reasonable. Cheap living expenses—can be earned. Oldest and largest school—established 43 years. Endorsed by railway, Western Union, and Marconi Telegraph officials. Large illustrated catalogues free. Correspondence courses also. Write today. Enroll immediately. Dodge's Institute, 15th St., Valparaiso, Indiana.

THE Telegraph Instructor—Sixth and Revised Edition, just from the press—containing 348 pages of valuable information pertaining to railway and commercial telegraphy. Many illustrations showing how to erect a line, the different telegraph instruments, switch-boards and their different connections; numerous colored illustrations of train movements and semaphore signals as used by all railroads. Complete in every detail and written in language easily understood. Used by many telegraph schools as a text book. No student of telegraphy or telegraph operator can afford to be without this book. Price \$1.25 postage prepaid. Money returned if it doesn't please. Popular Mechanics Book Dept., 6 N. Michigan Ave., Chicago.

TELEGRAPHY—Morse and Wireless—taught at home in half usual time and at trifling cost. Omnigraph Automatic Transmitter will send, on Souder or Buzzer, unlimited messages, any speed, just as expert operator would. Adopted by U. S. Govt. and used by leading Universities, Colleges, Technical and Telegraph Schools throughout U. S. Catalog free. Omnigraph Mfg. Co., 41-G Cortlandt St., New York.

PICTURES, POSTCARDS, PENNANTS

WANTED to buy old-fashioned picture albums. P. O. Box 531, Manchester, N. H.

10 NICE Postcards, Club Membership, and Catalogue 10c. Stewart Co., Providence, R. I.

WOULD you like to exchange postcards, letters, photos, stamps, coins (state which) with some of our 17,500 members in many countries? Membership 15c. Hakeyon, Box 133-P, Erie, Pa.

BARGAIN—16 assorted post cards only 10c. This ad with order brings a gift. Florence Ackerman, Plainville, Kans.

PRETTY view cards from everywhere. Membership and 6 pretty cards, 10c. Riverside Club, Knoxville, Md.

CROSS-SECTIONAL view of ocean liner "Britannic," showing interior arrangement of ship in colors, size, 14x29 inches, on heavy plate paper for framing or hanging. Very interesting. Reproduced from front cover design of July, 1914, Popular Mechanics. Will be sent postpaid to any address in the world on receipt of 4 cents in stamps to cover packing and mailing. Popular Mechanics Magazine, 6 N. Michigan Ave., Chicago.

CAMERAS AND PHOTO SUPPLIES

YOU will save more than you think on our Autumn sale of slightly used and new Kodaks, Graflex, Ansco, Bexco and Premo Cameras, also Lenses and supplies of every description. Take advantage and write at once for our latest free Bargain Book and Catalogue listing hundreds of real bargains. You will surely find a suitable outfit for your special requirements. Money back if unsatisfactory after ten days free trial. \$50.00 Igenito Enlarging Lantern, \$27.50; \$29.00 3A Autographic Kodak, \$11.50; \$67.00—5x7 Goetz Dinger F; 6.8 Lens in Optimo Shutter, \$43.50; \$9.50—2 1/2x3 1/4 Ansco Vest Pocket Camera, \$6.25. First-class developing, printing and enlarging at moderate prices. Our prompt and fair dealing will please you. Central Camera Company, Department E-4, 124 So. Wabash Avenue, Chicago, Illinois.

BEAUTIFUL transparent Photos easily reproduced on Watch Dials, Cases, etc. Formula and working instruction 25c. "Restoval," Box 543-M, Chicago.

FILMS Developed, any size 3c. Any size prints 3c. 8x10 enlargements 25c. Work returned same day received. Address Camera Shop, Box 69, Ann Arbor, Michigan.

SAVE Camera Money. Deal with Specialists. Everything in Photography. You save nearly half. Everything guaranteed and sold on our Liberal 10 Days' Free Trial Plan. Note these sample Bargains: No. 2 Premio Cart. Roll Film, New, \$4.50. \$22.50 No. 3 Ansoo Roll Film, R. R. lens, New, \$12.75. \$91.00 1-A Graflex with Velostigmat f:4.5 lens, used, \$55.00. Write your camera problems to "America's Camera Headquarters." See our display ad on Page 158. Send today for our famous Book of Bass Bargains. Bass Camera Co., Dept. 56, 109 N. Dearborn St., Chicago.

NEW Cameras—right from the factory— Eastman Kodaks—Graflex—save from 20% to 50% on all standard makes. No. 2 V-P Ansoo, F:7.5 Anastigmat lens, extra Speed Bionic shutter, \$15.00. 2 1/4x3 1/4 Eastman Folding Cartridge Promo. Meniscus Achromatic lens, \$4.00. Vest Pocket Autographic Kodak, \$5.00. 5x7 New Improved Seneca View, \$15.75. Every article guaranteed and backed by 10 days' Free Trial. Save money. Write for catalog now. See our display advertisement on Page 166. David Stern Co. "Everything in Cameras." In Business since 1885. 918 Davaco Bldg., 1047 Madison St., Chicago.

FREE. Send negative for sample print. Film developed 5c per roll, print 2 1/4x3 1/4 3c each, 3 1/4x4 1/4 4c each. 8x10 enlargement 25c each, from your own negative. Send for price list. M. A. Leves, 611 9th St., Washington, D. C.

FILMS developed free. Prints, Post cards, 2 1/2c. 8x10 Enlargements, 25c. Guaranteed. Email Sprauer, Hamilton, Ohio.

"ECONOMIZE." Attach a film Economizer to your camera; use all of film for exposure and get seven pictures on six-exposure film. Pays for self many times over. Price One Dollar. State name of camera, film used and size. Satisfaction guaranteed. Voigt Mfg. Co., Sheboygan, Wis.

FILMS Developed 10c roll. Six prints free. Ask for descriptive booklet. Roanoke Photo Finishing Company, 209 Bell Avenue, Roanoke, Virginia.

FILMS Developed Free. High Class work. Perfect Prints. No charge for developing. Prints 3c to 7c. We do the best work in the Photo City. Send us your films and rent with order and get returns same day. Bryans' Drug House, Rochester, N. Y.

PHOTOGRAPHS and Films enlarged on Sateen Pillow Tops or Bromide paper. Amateur work, specialty. United Print Co., Chicago, Ill.

KODAK Pictures Wanted. I can get good prices for your prints. Any size. Send samples or write at once. Henry Shaw, 44 Boylston St., Boston, Mass., Dept. 11.

FILMS developed free. Prints (trial order) 3c. Low prices. Prompt service. Quality work guaranteed. Bennett Studio Co., Cincinnati, Ohio.

INVENTIONS Wanted in Motion Pictures and Photography. Special department for these classes of invention. Advice. What to Invent and List of Patent Buyers Sent Free. Victor J. Evans & Co., 159 Ninth, Washington, D. C.

EQUIP your camera or Kodak with a Wollensak lens and shutter and obtain the best possible results. Beautiful descriptive catalogue "B" sent on request gratis. Wollensak Optical Co., Rochester, N. Y.

FILMS developed, 10c; prints, 3c to 5c. A reputable incorporated company conducting largest existing plant. Price list and special offer. Enlargements our specialty. Chicago Photo Finishing Co., 54 W. Lake St., Dept. A, Chicago.

FILMS Developed, 10c. all sizes. Prints 2 1/4x3 1/4, 3c; 3 1/4x4 1/4, 4c. We give you Profit Sharing Coupons. 24-hour service, all work guaranteed. Send negatives for samples. Girard's Com'l Photo Shop, Holyoke, Mass.

BIG Money Saved on Photographic Lenses and Apparatus—goods exchanged; repairing done. Ralph J. Golsen, 5123 Kenmore Ave., Chicago, Department F.

MOTION PICTURES

FOR Sale—Moving Picture Outfit \$75. Also four reel feature picture \$32. Sacrifice. Movie Show Co., P. O. B. No. 611, Silesia, Mont.

SPECIAL Arc Generator Produces current for half. Your engine operates. Easy Payments. Hobarts, Troy, Ohio.

MOTION Picture Machine and ten reels films, \$75.00. Stereopticon, brand new, cost \$25, special at \$18.00. Leland, Montpelier, Vermont.

MOVING Picture Films for sale \$2.50 a reel—big list. Lyric Film & Supply Co., Terre Haute, Ind.

"MOVIES"—Instructions making inexpensive, complete, projector without machine shop, 50c. Guaranteed performs equal to professional machine. Winchester, 9703 Clifton, Cleveland, O.

MOVING Picture films \$3 reel up, No. 6 Power machine, at \$100 (cost \$250). Leland, Montpelier, Vermont.

MOTION Picture Film developed and printed. Film Titles; Cartoon-films; Expert Camera man furnished. Scenarios produced. Camera Bargains. Standard Motion Picture Co., Suite 1620, Mallers Building, Chicago.

MOTION Picture Operation, Stage Electricity and Illusions—The only practical handbook and guide published for motion picture operators, theater electricians and managers. A thoroughly practical and useful book, covering the subject comprehensively. Pocket size, leather, 293 pages, fully illustrated. Price \$2.00 postpaid. Popular Mechanics Book Dept., 6 N. Michigan Ave., Chicago.

WRITE for Free Copy "Hints on Writing and Selling Photographs, Short Stories, Poems." Atlas Publishing Co., 271, Cincinnati.

MAKE Big Money in moving-picture business. We start you and furnish guaranteed outfit on easy payment plan. Easy to accomplish. Catalog free. Monarch Film Service, 228 Union Ave., Dept. P, Memphis, Tenn.

MAKE a complete Motion Picture Camera and Projector from instructions given in our book Amateur Mechanics No. 4. Full details given. Not hard to construct. Worlds of enjoyment taking and exhibiting subjects dear to the heart. Price of book only 25c, postpaid. Popular Mechanics Book Dept., 6 N. Michigan Ave., Chicago.

MAKE money writing Photo-plays; details free to beginners. No correspondence course. Producers League, 239 Wainwright, St. Louis.

BIG Profit Nightly—Moving Picture Business—small capital starts you, easily accomplished. Teach you—furnish everything. Ralph J. Golsen, 5123 Kenmore Ave., Chicago, Dept. M.

BUSINESS OPPORTUNITIES

LUMINOUS Paint—10 formulas, different colors, 25c. "Recharging Dry Batteries" — "Reilvering Mirrors" — "Gas Tonic" — "Puncture Plugger." Carton Remover. 20c each. Complete collection 50c. "Bestoval." Box 543-M, Chicago.

INVENT Something. Your ideas may bring wealth. Free book tells what to invent and how to obtain a patent through our credit system. Talbert & Parker, 4071 Ta'bert Bldg., Washington, D. C.

"EVERYBODY Eats." Run a Portable Trunk Lunch Outfit at Fall Fairs. Large profits. Easy work. Write for particulars. Williams Amusement Device Co., Denver, Colo.

PLASTOGRAPHY: Make beautiful imitation marble Medallions yourself. Instructions \$2.00. Mould or model of President Wilson or Lincoln sent free with your order. P. B. Spahr, York, Penna.

BUILD a profitable business of your own. Let us start you in the collection business. No capital needed; big field. We teach secrets of collecting money; refer business to you. Write today for Free Pointers and new plan. American Collection Service, 101 State Street, Detroit, Mich.

ADVERTISERS, Mail Dealers. Our New Rate Book lists 2,000 Principal Publications, rates, circulation. Includes 39 Mail-Order Plans. Free. Dearborn Advertising Agency, 210 Franklin Bldg., Chicago.

WANTED—In every town and city—men anxious to get into paying automobile accessories business. Protected territory; close co-operation; new plan; great demand; quick sales; large profits. Small capital. Write now for territory. Orlo Manufacturing Company, Dept. A, Louisville, Ky.

SELF Shining shoe polish. Easily and cheaply made. Brand new. Instructions for making 10 cents. Chemist, 1640 Oak St., Mt. Oliver P. O., Pa.

500 FORMULAS including Reilvering Mirrors—Renewing Dry Batteries—Luminous Paint, 25c. "The Ideal." Box 543-J, Chicago.

INCREASE your income easily. Make and sell something that sells rapidly. 5 Guaranteed manufacturing formulas 25c. Fort Clark Company, Box 563, Peoria, Illinois.

BESCOLITE cannot freeze. Substitute for Alcohol in Auto Radiators. Write now for territory and particulars. Sample 25c. Bearisley Specialty Laboratories, Rock Island, Ill.

PRACTICAL—Manufacturing Formulas—All kinds. Claus, 1864 Harmon Street, Brooklyn.

MAKE money in the Candy business. Get into this big-paying, fascinating business—Retail—Wholesale, start at home. It's clean, easy, big profits. Complete equipment absolutely free. Write for book—tells how to start. Otter-Swain Corporation, Suite 118, 4759 Broadway, Chicago.

START a Vacuum Clothes and Carpet Cleaning business, \$125.00 for machinery required. Write today. General Compressed Air & Vacuum Machinery Co., St. Louis.

THE Leonard Manufacturing Company will furnish complete typewritten instructions (no printed trash) for the manufacture of Toilet articles, Perfumes, Extracts, Disinfectants, Shoe Polish, Inks, Chewing Gum, etc. Guaranteed working instructions. Send for particulars and list of formulas. Twenty years' practical experience. Also we put up preparations with your name, in small or large quantities. Manufacturers of "Leonard's Washing Compound." Sample free. Leonard Manufacturing Co., Memphis, Tenn.

EXPERT wants work for 9-inch lath. George Gulick, 1281 Mechanic St., Camden, N. J.

SILVERING Mirrors! My exclusive French Tartaric method opens enormously profitable business. Booklet Free. H. Barstow, 514 25th Street, Oakland, Calif.

PROFITABLE formulas, trade secrets and money-making plans. Particulars free. Write now. Three "B" Supply Co., Perth Amboy N. J.

EXPERT Chemical Service. Commercial Analysis, Instructions, Formulas, Processes and Trade Secrets. Manufacturing problems solved. Satisfaction guaranteed. Write for Lists and Valuable Information. W. I. Cummings, Ph. D., 127 Standart St., Syracuse, N. Y.

MONTHLY income paid those writing lists of names for us at home, spare time; no supplies to purchase, no investment, expense or other work required; postal brings particulars. National Exchange, Box 1491, New York.

HAVE a Business of your own, manufacture name plates, numbers, etc. Big illustrated book sent free. E. E. Palmer, Wooster, O.

ADVERTISE everywhere; 25 words in 100 syndicate monthlies, \$1; 100 country weeklies, \$2.50; 40 big Sunday papers, \$10; year advertising matter written free by experts. P. Cope Agency, St. Louis.

I MADE Good income last year as Business Broker. You can too, with small capital. Particulars free. Miss Jack Kytman, Chemical, St. Louis, Mo.

PATENTABLE Ideas Wanted—Send for 4 free books. R. B. Owen, 30 Owen Bldg., Washington, D. C.

MANUFACTURERS, Promoters and Patent Buyers are invited to write us stating the line of invention in which they are interested, as we can supply their wants in any class of patents. Victor J. Evans & Co., 163 Ninth St., Washington, D. C.

BIG money in promoting inventions. Write Adam Fisher Mfg. Co., 2061D Railway Exchange, St. Louis, Mo.

ENTER a new business. Earn \$3,000 to \$6,000 yearly in professional fees making and fitting a foot specialty, openings everywhere, with all the trade you can attend to; easily learned by anyone at home in a few weeks, at small expense; no further capital required, no goods to buy, job hunting, soliciting or agency. Address Stephenson Laboratory, 11 Back Bay, Boston, Mass.

WE start you in business furnishing everything; men and women make handsome income weekly operating our "New System Specialty Candy Factories" home or small room anywhere; no canvassing. Opportunity lifetime; booklet free. W. Ragsdale Co., East Orange, N. J.

INVENTORS: We develop and perfect inventions, make models, dies, tools. Metal stamping and special manufacturing. Garding Bros., Lion Bldg., Cincinnati, O.

LEARN the real estate business; our enlarged instruction book teaches listing, appraising, management, salesmanship, insurance, brokerage, advertising, renting, agency, estates, titles, rights, forms, etc.; revised edition; 240 indexed subjects; excels \$2; correspondence course; backers cover, \$1; silk cloth, \$1.25, postpaid. Realty Book Co., Dept. No. 29, Cleveland, Ohio.

BUSINESS FOR SALE

FOR Sale—Machine and Auto repair shop. Price reasonable. Address Jas. N. Thomas, Burlington, Wis.

MUST Sell our Vulcanizing shop on account of my health. Flaudreau Tire Shop, Flaudreau, S. Dak.

TO MANUFACTURERS

MANUFACTURERS—We want several articles to sell direct or through our agents in homes, offices. Give price, details. Will consider correspondence course, plans, or mail order business with success possibility. Mchler, Box 453, Chicago.

MAIL-ORDER SUPPLIES

PRACTICAL—Manufacturing Formulas—All kinds. Class, 1894 Harmon Street, Brooklyn.

ARTICLES of genuine utility mean success for the Mail Dealer. Choice of hundreds. Write Merchandising Service Company, 339 Broadway, New York.

INCREASE your sales. Place your proposition before the readers of "Cartoons Magazine," 20,000 copies guaranteed every month. Classified rate 5c per word. Mail in a trial ad today. Cartoons Classified Dept., 78 E. Madison St., Chicago.

FOR ADVERTISERS

ADVERTISE your goods in Russia. Anton Lelap, San Francisco, Cal.

20-WORD Advertisement in 100 magazines \$1.00. American System Hollywood, California.

ADVERTISE—25 words in 50 weeklies, \$1.50; 100 syndicate monthlies \$1; 10 big dailies, \$2.50. P. Cope Agency, St. Louis.

ADVERTISERS—Here's your opportunity. Your proposition placed before the readers of "Cartoons Magazine" for only 5c per word. Circulation 20,000 copies guaranteed. Send a trial ad for our next issue. Cartoons Classified Dept., 6 N. Michigan Ave., Chicago, Ill.

BUSINESS SERVICE

INCORPORATE. Our lawyers do the work, saving you time, annoyance and money in incorporating under the most liberal laws of Arizona. Laws and forms free. Southwestern Securities & Investment Co., Box D488, Phoenix, Ariz.

AGENTS WANTED

DISCOVERED! Extraordinary New Proposition. Supreme Opportunity. \$200 per week Easy, demonstrating marvelous Adding Machine. Retail \$7.50. Work equals \$300 machine. Subtracts, Multiplies, Divides, automatically. Whirlwind in speed. Guaranteed Five Years. Used by U. S. Government. Sells everywhere. Amazing profits. Write quick for exclusive territory. Calculator Corp., Dept. PM, Grand Rapids, Mich.

TWO best articles in America. Legass sells every automobile owner. 300% profit; exclusive territory; money-back guarantee. Samples 50 cents, particulars free. Write Horn, 3721 Pasco, Kansas City, Mo.

MAKE and sell your own goods. Machinery unnecessary. Expert Chemists' advice. Special attention to beginners. Formula Catalog for Stamp. Blake Mystic Company, Washington, D. C.

NACMA repeat-order household products are big money-makers. Catchy selling plan gets and holds the business. Free selling helps and samples. Exclusive territory. The Nacma Co., Dept. A-7, 20 W. Lake, Chicago.

\$15.00 MADE first day by 13-year-old boy with shomescope. Woman made \$6.00 first hour. Particulars Free. Shomescope Mfg. Co., 4923 Montgall, Kansas City, Mo.

AGENTS—"Shavers" Shaves without razor. Harmless. Whirlwind seller. Michael Riensl, Cutler St., Newark, N. J.

NEW invention, fast seller to all classes. Popular price, many buy dozens, no competition. Big profit. Dandy mail-order proposition. The Clark Co., Clark Building, Jacksonville, Fla.

ANTI-CHAFE in trouser pockets prevents chafing. Price 25c. Agents wanted. Valentine, 208 W. 23d, New York.

WANTED. General Agent to represent us in your locality. Exclusive territory. Big inducements. Chicago Agency Co., 840 Altgeld St., Chicago.

MEN and women with spare time—whether employed or not employed—can make a lot of extra money with our All Profit offer. No goods to buy or sell. No deliveries. No collections. National, Dept. A-15, 18 W. Lake St., Chicago.

AGENTS: Biggest money-maker ever put on the market. "Eggette," the original egg substitute. Takes place of eggs in baking and cooking at less than ten cents per dozen. Sells rapidly to homes, stores, bakers, etc. A Guaranteed pure food product. Good opportunity to build permanent business with big income. No competition. Regular size package 10c equal to 12 eggs. Attractive money-making proposition free. Write quick. Bestever Products Co., B-6 Douglas Park Station, Chicago, Ill.

TAILORING Agents Wanted—Big complete sample outfit and case, nearly 200 large cloth samples, 3 piece lists and everything needed for canvassing, or use in store, free to live agents. \$25.00 to \$50.00 a week; may make more. Write us today for free elegant outfit to begin, cloth samples, wholesale prices, special offer on a suit for yourself and full information—see our wonderful values, beautiful fabrics and styles. Established 28 years. Every garment made to measure—everything guaranteed and express prepaid. Just send a postal. American Woolen Mills Co., Dept. 914, Chicago.

DECALCOMANIA Transfer Initials and Monograms: You apply them on automobiles while they wait; cost 2c each; profit \$1.38 on \$1.50 job; free particulars. Auto Monogram Supply Co., Dept. 1, Niagara Bldg., Newark, N. J.

LARGE manufacturer wants Agents to sell guaranteed custom-made rain coats. We deliver to customer. Enormous profits. Defy competition. 1917 outfit free. Acrovo, P. 121, Canal St., N. Y.

GET into biggest money-making end automobile business—replacing necessary equipment. Live, ambitious men wanted as special factory representatives, exclusive territory, taking orders for tops, top coverings, seat covers, "Stik-Tite" windows. No experience necessary. No capital required. No competition. Copyrighted system protects you. Free catalog, samples, full details. Cincinnati Auto Specialty Company, Dept. MC-97, Cincinnati, Ohio.

WANTED—New Ideas. Write for list of Patent Buyers and Inventions Wanted. \$1,000,000 in prizes offered for inventions. Our Four Books sent free upon request. Victor J. Evans & Co., 163 Ninth, Washington, D. C.

WHO wants to make more money selling brushes that every household needs? Special method of getting entrance to demonstrate. Fuller Sanitary Brushes are nationally advertised—largest output—best terms and prices—western distributing stations. Your territory is valuable. Write. Fuller Brush Company, Hartford, Conn.; Rock Island, Ill.

AGENTS—Ho-Ro-Co Skin Soap and Toilet Goods plan beats everything for agents' profits. "Ho-Ro-Co," 112 Locust St., St. Louis, Mo.

AGENTS: \$30 to \$100 a week. Free samples. Gold sign letters for Stores and Office Windows. Anyone can do it. Liberal offer to general agents. Metallic Letter Co., 407 N. Clark, Chicago.

CALIFORNIA Flower Bead Necklaces beat anything for quick sales and profits. Absolutely new. Write for agent's proposition. Mission, 2819 P.M. West Pic, Los Angeles, Calif.

AGENTS. Make Big Money; fast office seller; particulars and samples free. One Dip Pen Co., Dept. 2, Baltimore, Md.

PHOTO Pillow Tops, Portraits, Frames, Sheet Pictures, Photo Plates, Pennants. Rejects credited. Prompt shipments; samples and catalogues free to agents; 30 days' credit. Jas. C. Bailey Co., Desk 8-4, Chicago.

233% PROFIT selling Jubilee Spark Intensifiers to automobile owners, garages. Sure cure for Spark Plug troubles. Sells like wildfire. Brand new. Exclusive territory. Write today. Jubilee Mfg. Co., Dept. M-10, Omaha, Nebraska.

AGENTS—\$5 daily selling our Handy Tool, 12 articles in one. Lightning seller. Sample free. Thomas Mfg. Company, 762 North St., Dayton, Ohio.

HOSIERY and Underwear Manufacturer offers permanent position supplying regular customers at mill prices. \$50.00 to \$100.00 monthly. All or spare time. Credit. D. Parker Mills, 2733 No. 12th St., Phila., Pa.

AGENTS Wanted—To advertise our goods by distributing free samples to consumer. 30 cents an hour. Write for full particulars. Thomas Mfg. Co., 562 North St., Dayton, O.

POSTCARDS 90c per 1,000 up. Comics, views, etc. Samples, price list 10c. Gross Onard Co., 2147 Arthur Ave., N. Y.

INVENT Something. Your ideas may bring wealth. Free book tells what to invent and how to obtain a patent through our credit system. Talbert & Parker, 4663 Talbert Bldg., Washington, D. C.

OPPORTUNITY to establish yourself in business. Auto accessory, big demand, easy seller, large profit, exclusive territory. Write today. The Liberty Bell Company, Cleveland, Ohio.

LEAHEY'S Heatless Trousers Press. Lightning seller. Agents wanted. Particulars free. Sample \$1. Write quick. Siewers & Frank Sales Co., Box 12, Chicago Heights, Ill.

HEL-MIT the Kaiser Pin—Latest war novelty—Biggest Hit Out; oxidized silver; thousands are being sold; simple matter handing them out and taking money; sample with agents' terms, 10 cents. O. Finch, 1002 S. Ionia Ave., Grand Rapids, Mich.

AGENTS, dealers, manufacture what you sell; manufacturing list 10c. Manufacturers Syndicate Co., 2123 Madison Ave., New York.

STOP! Here they are, newest inventions, just marketing. Home and auto necessities, quick sellers, big profits, exclusive territory, act quick. Reliable Specialty Co., Keosauqua, Iowa.

AGENTS—Sell rich-looking imported 36x68 rugs, \$1 each. Carter, Tenn., sold 115 in 4 days. Profit, \$37. You can do same. Write for sample offer selling plan; exclusive territory. Sample rug by parcel post prepaid, 95c. E. H. Condon, Importer, Stonington, Maine.

FEATHER Flowers, the all-purpose Home flower. Business clean, attractive, profitable. Sample fifteen cents. De Witt Sisters, Route Ten, Battle Creek, Mich.

DISTRICT and local agents with Ford cars wanted to demonstrate to Ford owners wonderful Simplex Ford Starter and Simplex Windshield Ventilating Bracket. Both are big selling accessories for good live men. Write today for proposition and exclusive agency. Simplex Mfg. Company, Dept. 443, Anderson, Indiana.

AGENTS Wanted for best-selling household specialties on earth; goods sell themselves; write at once. The Addison Co., 315 Washington Ave., Scranton, Pa.

THE Favorite Cream Whipper beats egg, churns butter and does the mixing for the kitchen. Fits any screw-top fruit jar found in every home. Strong talking points for Salesmen. Send 50c for sample and Agents' terms. The Favorite Products Co., Tinianon City, Ohio.

AGENTS—Salesmen—Managers. Brand new invention just out. Eisen Attachment tilts Ford Steering Wheels and also locks car. Greatest selling Ford article on market—needed on every machine. Fully guaranteed. Low in price—sells like lightning. Listen: Birley, Ill., made \$394 in five weeks. Allen, Md., cleared \$13.86 first day. Not sold in stores. No experience necessary, we show you how. Sales guaranteed. You cannot lose. Write quick for special offer. Address Eisen Instrument Company, 1209 Valentine Bldg., Toledo, Ohio.

BEST raincoat proposition ever offered. Easy sales. Big Commissions. Agents making \$50 to \$100 per week. Sample coat and outfit free. Write quick. Tiffany Raincoat Co., 1047 E. Beelden Ave., Chicago.

AGENTS—Send for sample "Fretnot"—the wash day wonder. Be convinced you can do a whirlwind business. You can clear at least \$20 to \$100 weekly, according to spare or whole time. You don't have to talk; if she doesn't buy at sight, leave sample; she will be looking for you long before you are able to make the rounds again. Samples furnished free. Premiums for your customers. Exclusive territory guaranteed to agents who can produce. Credit given. Don't call. P. M. Motter & Sons, 3213 Warren Ave., Chicago.

EASY, pleasant work for Mechanic, Shop Men, Clerks, during spare hours, will add many dollars to their salaries. Also want persons who can give full time. Big wages assured. Novelty Cutlery Co., 67 Bar St., Canton, Ohio.

EXCLUSIVE county rights. Sell Tankik; modern auto fast. Profitable. Tankik Chemical Co., Cleveland, Ohio.

MERCHANTS Buy at Sight. New changeable letter sign for window advertising. Large metal sign with 270 letters. Sells \$1.50, 300% profit. Greatest seller ever invented. Write for proposition. Changeable Sign Co., E. 162, Cleveland.

GAS Fire in any cook stove from common coal oil. Agents coin money. Wonder Burner Company, Columbus, Ohio.

HERE is the one live agent's seller. Every one needs it. 100% profit. Particulars free. Thomas Supply Co., Aurora, Col.

AGENTS—We want 150 hard workers to take orders for Buckeye Raincoats. You can easily make \$75.00 a week. Wonderful raincoat for \$3.95. We deliver and collect. Sample and outfit free to you. The biggest Fall season just starting. Join our big money makers at once. Hurry! Buckeye Manufacturing Co., C-1 Union Square, New York City.

STEADY money for male and female agents everywhere taking orders for our patented umbrella with eyes. Something new. Not sold in stores. Demonstration makes sale. Send for full particulars and territory wanted. P. W. Wilson Co., Inc., 138 West 96th St., New York City.

AGENTS—Something new: patented sanitary kitchen article; whirlwind seller; big profits; write quick. Valley Supply Co., Latrobe St., Grafton, W. Va.

HOUSEWIVES are looking for something to kill the unpleasant odor caused by cooking Cabbage, Kraut, Onions, Fish, etc. "Nodur" does it perfectly. Agents cash in on this. Particulars free. Nebraska Specialty Co., Benson, Neb.

TOBACCO habit completely overcome with \$1.00 full treatment. Agents can make big money with this on a fifty-fifty basis. Particulars free. Nebraska Specialty Co., Benson, Nebraska.

SELL Guaranteed Made to Measure Raincoats. Agents price \$8.50 delivered. Agents making big money. Outfit free. Standard Raincoat Co., 395 Broadway, New York.

PRACTICAL—Manufacturing Formulas—All kinds. Class, 1864 Harmon Street, Brooklyn.

GASOLINE Saver for Fords: New Principle: Saves 30% Gasoline; Gives 30% more power. No moving parts; Put on with wrench in ten minutes. Price \$1.50. Guaranteed. 100% proposition to agents. The Little Cyclone Accessories Co., Dayton, Ohio.

AGENTS. New \$2.50 Automatic Adder. Sell every business man. Big profits. No competition. Does work of high priced machines. Bassett, 5921-R Indiana Ave., Chicago.

GOOD income refinishing chandeliers, brass beds, automobiles by new method, producing amazing results; no capital or experience necessary; particulars free. Gunmetal Co., Ave. H, Decatur, Ill.

\$61.50 WEEKLY. Introducing and selling a new gas light burner for kerosene lamps. Beautiful light. No chimney. No mantle. Samples free. Luther Manufacturing Co., Dept. 316, Cincinnati, Ohio.

AGENTS financially responsible who understand heating plants to sell Blasko Fuel-Saving Devices on monthly payment plan. Every heating plant a prospect. Guaranteed to save 20%. Evaporation tests at two universities averaged 25% saving. Wolf Fuel Saver Company, 14 East Jackson, Chicago.

AGENTS make 500 per cent profit selling our Auto Monograms and Initials, Window Sign Letters, Changeable Signs, and Show Cards, 1,000 Varieties. Enormous Demand. Sullivan Co., 1123 Van Buren St., Chicago, Ill.

RUSH postal for Free Sample "Spik & Span." Wonderful new washing tablet. Washes clothes spotless, without rubbing. Tremendous seller. 200% profit. Free Samples to boost sales. Newberry Co., 212 Peoria, Chicago, Ill.

AGENTS—Big Seller. Every man needs one. The Curtis Co., Remont, Ills.

SEND me 25c and I will send you a beautiful Silkoline Pillow Top. If satisfactory, send me 8c each for as many as you desire. Retail at 50c. J. Walborn, Webster City, Iowa.

LUMINOUS Crucifixes, Headless Trouser Presses, Ford Auto Starters. Get our prices first. Old Paducah, Paducah, Ky.

AGENTS or Salesmen Everywhere for new line sales-slip pads; every merchant possible customer; exclusive sale and territory. Embrey Sales Book Co., Hartford Bldg., Chicago, Ill.

PHOTO Pillow Tops, Photographs and Films enlarged. United Print Co., Inc., Chicago, Ill.

AGENTS Wanted—"Air-Cure" self-vulcanizing Tire Patch. Wild Mfg. Co., 1367 Nicollet Ave., Minneapolis, Minn.

PORTRAIT Agents: Write for prices. Bromides, Portraits, Frames. Prompt shipments. Cicero Studio, 4828 Van Buren St., Chicago.

WILL \$60 weekly income satisfy you? Best proposition with surest results ever offered solicitors. Outfit free. No selling, delivering, or showing samples. Address Room 343 Wells Building, Quincy, Illinois.

AGENTS: Wonderful sample, 100% proposition absolutely guaranteed. Famous Products Co., 203 Citizens Bank Building, Decatur, Illinois.

LUMINOUS Paint! Shines in the dark. Big seller to hotels, garages, etc. Any article can be coated with splendid results, watches, clocks, electric switch plates, crucifixes, match boxes, etc. (Everlasting.) Only 25c a bottle. Luminous Paint Co., B-19, Douglas Park Station, Chicago, Ill.

EXQUISITE Colored Photographs in first development from ordinary negatives. New, inexpensive, practical. Quick sales, big profits selling instruction book or the developer to Kodakists, Photographers, Kodak Finishers. Photography knowledge unnecessary. Big demand, no competition. Just showing samples gets the money. Easy terms. Perfecto Printing Co., Drawer 968, Oklahoma City, Okla.

AGENTS: By my plan you get the latest offers of 10 leading dealers every month free. Send stamp for particulars. Henry Shaw, 44 Boylston St., Boston, Mass., Dept. 31.

TRANSFER initials at 100% saving. Monogram automobiles, trunks, etc., sell stores, appoint subagents. Samples and particulars free. Globe Decalcomanie Co., Dept. 7, Jersey City, N. J.

AGENTS: You can make big money taking orders for our fine made-to-measure clothes, so write quick for 69 beautiful cloth samples, 32 smart styles in rich colors, wholesale and retail price lists, lowest prices and best offer to agents. \$5.00 to \$10.00 a day easy. Big outfit, over 250 samples free to live wires. No experience needed—no capital. We furnish everything free—pay postage or express charges—back you, boost you, show you how and clearly explain everything. Costs nothing to try. Let us make you a stylish suit to measure to prove our fine quality and style. Send postal or letter today. Paragon Tailoring Co., Dept. 914, Chicago.

AGENTS make 500% profit handling Auto Monograms, Patriotic Pictures, Flag Novelties, Window Letters and Changeable Signs. Catalog free. Hinton Co., 6142 46th Court, Chicago, Ill.

AGENTS make \$100.00 monthly selling our 500 Handy Household Articles; Catalogue free. Scheff Company, Desplaines, Ills.

AGENTS—Steady Income. Large manufacturer of Handkerchiefs and Dress Goods, etc., wishes representative in each locality. Factory to consumer. Big profits, honest goods. Whole or spare time. Credit given. Send for particulars. Freeport Mfg. Co., 59 Main St., Brooklyn, N. Y.

WANTED—Agents to sell the Handy Auto Painting Outfit. Contains everything needed. Big profits. Saratoga Paint Works, 334 N. Calvert St., Baltimore, Md.

GRAB Territory on our new specialties. Full line samples and terms \$2.00. Money back if wanted. Adam Fisher Mfg. Co., 2061-G, St. Louis, Mo.

ANY Man or Woman can make \$35 or more weekly selling Puritan Brushes to every household. Big profits, easy work. Exclusive territory. Special method for making sales easy. Puritan Co., Dept. M, 1966 Broadway, New York.

MAKE \$150 a month easy money. Agents and garagemen are clearing as high as \$150 a month selling automobile body polish made from my exclusive formula. Going like wild fire wherever introduced. The formula is yours for only \$5. There is no limit to the profits you can make. For full particulars, address B. Sonntag, Waco, Texas.

WONDER Pudding Powder makes the most delicious Chocolate, Raspberry, or Lemon pudding you ever tasted. 5 to 7 large dishes in a jiffy for 10c. Sell it to stores, restaurants, hotels, families. Appoint agents. Big profits, wonderful seller. Package and particulars 10c postpaid. Morrissey Company, 4414 Madison, Chicago, Ill.

AGENTS Wanted—We want 1,000 more men and women agents at once. You can easily earn \$5 to \$10 a day taking orders for our fast selling, attractive line of Soaps, Perfumes, Face Creams and Toilet preparations. Sample case free to workers. Every call a sale. We are an old established firm. Our goods well advertised and well known. You make 100% profit. Get busy—write now for our liberal proposition to agents. Crofts & Reed Co., Dept. C, 90, Chicago, Ill.

AGENTS—To sell automobile owners an absolute necessity. Also a repeater. Sells for \$1.00. Sample 25c. Particulars Free. R. O. Carpenter, LaFayette, Ind.

SELL Motor-Vim, the carbon chaser. Write today. Marvella Co., Monticello, Iowa.

WANTED Reliable People—Place Eggs in stores and appoint agents. Takes place of eggs in baking and cooking at 9c doz. Large package and particulars 10c postpaid. Morrissey Company, 4403-5 Madison, Chicago.

AUTOMOBILE three flag holder, 25c. Agents wanted. Garfield Supply, 5839 Wissahickon Ave., Philadelphia.

SELL every business man in your locality this telephone device. Only instrument not an attachment and approved by telephone companies. Sensational seller at a big profit. Free hands—clears wire and makes all conversation easily understood. Write about your territory. Wedophone Inc., 378 Lafayette St., New York City.

PLT's GREATTEST Sensation. 11-piece toilet goods combination selling like blazes at \$1.00 with \$1.00 Carving Set Free. Everybody buys. Engle's profit first week \$51.00. Great crew proposition. Pierce Co., Dept. P, 806 Lake St., Chicago.

SELL Fritz's Wizard Fly and insect destroyer; 100% profit. Particulars and sample 25c. Fritz Chemical Co., Chicago, Ill.

AGENTS, 500% Profit. Sign-Letters for office and store fronts. Samples and particulars free. Inter-States Letter, 2424 N. Halsted St., Chicago.

AGENTS—with selling experience—to sell direct to consumer made-to-measure suits and overcoats, \$13.50 and \$17.50. If you want an independent business with Big Money, answer at once before territory is taken. Outfits furnished. Midland Tailors, Dept. 6, 19 So. Fifth Ave., Chicago.

QUICK—Snap this winner; brand new; big profits; sells on sight; unlimited field; free particulars. Sunnyside Co., 614 Sunnyside, Danville, Va.

\$1,000 PER Man per county. Strange invention startles world—agents amazed. Ten inexperienced men divide \$40,000. Korstad, a farmer, did \$2,200 in 14 days. Schleicher, a minister, \$195 in first 12 hours. \$1,200 cold cash made, paid, banked by Stoneman in 30 days; \$15,000 to date. A hot or cold running water bath equipment for any home at only \$6.50. Self-heating. No plumbing or waterworks required. Investigate. Exclusive sale. Credit given. Send no money. Write letter or postal today. Allen Mfg. Co., 311 Allen Bldg., Toledo, Ohio.

AGENTS. We have a good proposition for you. Write for particulars and samples. Chicago Agency Co., 838 Altgeld St., Chicago.

PORTRAIT Agents, new and old, write us. We know what you want and need. Established 17 years. Pioneer, 1252 W. 63rd St., Chicago.

AGENTS Wanted: Sell Polishing Cloths, Rust Remover, Food Flavors, etc. 130 household necessities, guaranteed line, big profits, quick repeater, permanent business. Stuart & Co., 16 Main St., Newark, N. Y.

AGENTS sell Reliable Custom-Made Raincoats and Gabardines. Big commission. Complete sample line free. Temple Raincoat Company, Templeton, Mass.

PORTRAIT Agents: Our goods will make you big profits. Delivery guaranteed. Rejects credited. Prompt shipments. Send for latest catalogue and prices. Adam J. Kroll & Co., 692 Blue Island Ave., Chicago, Ill.

HUNDREDS of Agents are now making goods to sell from Miller's Guaranteed Manufacturers' Formulas. Wizard Washing Tablets—no wax, potash, lye. Costs 5c pound. Brings 60c. Eggolene, only pure food substitute for eggs at 9c a dozen. Non-Alcoholic Tube Flavors. Ice Saving Cloths, many new sellers including latest Automobile Specialties. Carbo-Cide, the only recognized Gasoline Intensifier-Decarboxylizer—80% profit. Enormous sales. Fibro-Vac Guaranteed Puncture Plugger. Exclusive territory. Particulars for stamp. Miller, Manufacturers' Chemist, Tampa, Florida.

AGENTS—Stamping names on Pocket Key Protectors; sample Check with your name and address, 12c. Stamping Outfits, Emblem Checks, Check Fobs, Name Plates, Hart Mfg. Co., Desk 2, 303 Degraw St., Brooklyn, N. Y.

SIGN Letter Agents and Painters: 500% Profit Gold and Silver Sign Letters for Stores and Office Windows. Anyone can put on. Big demand. Free samples. Metallic Letter Co., 401 N. Clark St., Chicago.

HUGE profits selling Nibco Sanitary Brushes, Auto Washers, Brown Beauty Adjustable Floor Mops, Dustless Dusters, and other specialties. Big line. Fast sellers. Write today. Silver-Chamberlin Company, Department M, Clayton, New Jersey.

FREE sample with particulars. No splashing water strainers. Easy seller. Returns big. Experience unnecessary. Union Filters Co., New York.

MAN Wanted in each country community and every small town, to wear beautiful new tailored-to-order suit of clothes and be Agent in spare time among friends, relatives and neighbors. Confidential wholesale prices given, good profit on each order. No experience required, we teach you all you need to know. Write at once and get gorgeous, illustrated book of cloth samples free, and full instructions. Banner Tailoring Co., Dept. 665, Chicago.

STATE Representatives and Agents—We want men of known ability for best line of Cutlery offered for salesmen. Extremely liberal margins. Dept. P, Aerial Cutlery Manufacturing Company, Marinette, Wisconsin.

LARGE Manufacturer wants representatives to sell shirts, underwear, hosiery, dresses, waists, skirts, direct to homes. Write for free samples. Madison Mills, 503 Broadway, New York City.

NINETY Per Cent of Your Calls Turned into Sales! Wonderful Enthusiasm Follows Every Demonstration! Write at Once for Full Particulars of Our Line of Eradium (Luminous) Articles. Startling! Mysterious! Everlasting! Novel! They Shine in the Dark. Crucifixes, House Numbers, Bulbs, Match Boxes, Pictures, Switch Plates, Sole Manufacturers, The Pioneer Corporation, 1259 W. 63rd, Chicago.

YOU can be your own boss with our Key Check outfit. Good for \$5 a day stamping names on pocket key checks, fobs, etc. Sample check with your name and address, 15 cents. Pease Die Works, Dept. M, Winchester, N. H.

NEW Patriotic War Atlas Free with my 1917 "Business Guide." Sells everywhere. Beginners clear \$7 daily. 50% commission. Outfit free. Prof. Nichols, Box P. M. 3, Naperville, Ill.

AGENTS, \$50 a week. Will show you how. Genuine Gold Leaf Window Letters. Chicago Agency Co., 842 Alford St., Chicago.

INSIDE Tyres, inner armor for Automobile tires, double mileage and prevent punctures and blowouts. Quickly applied. Cost little. Demand tremendous. Profits unlimited. Details free. American Automobile Accessories Co., Dept. P, Cincinnati, O.

GET Davis' Latest Proposition. \$15.00 daily a clock. No matter how many times you have answered my ads in last 20 years, write again. E. M. Davis, Dept. 506, 903 Lake, Chicago.

AGENTS—Our gold window letter proposition beats 'em all. Stahlrite Co., Dept. P, 1115 Second Ave., N. Y. Established 1905.

AGENTS: Big Hit: Our 5-Piece Aluminum Set is all the rage. Cheaper than Enamel Ware. Sells like wildfire. Guaranteed 20 years. Retail value \$5.00. You sell to housewives for only \$1.98. Biggest seller of the age. 9 sure sales out of every 10 shown. Others cleaning up \$10.00 to \$20.00 a day. Answer this quick to secure your territory. Div. GG5, American Aluminum Mfg. Co., Lemont, Ill.

\$50 WEEKLY and up selling Mexican Diamonds. Exactly resemble genuine; Same Rainbow Fire; Stand tests; sell at 80%; Repeat orders. Write quick for Sample Case offer free. Mexican Diamond Importing Co., S. W. Los Cruces, New Mexico.

"GOLDLINE" Sign Letters—1,000% profit. Particulars free. Johnston Co., Quincy, Ill.

AGENTS show our made to order guaranteed \$15.00 suits, real \$25.00 values. No experience necessary. Wonderful selling plan. You furnish prospects, we make sale. Chicago Woolen Mills, Dept. A, Chicago.

SALESMEN WANTED

WANTED—Salesmen for local territory to sell United States Keroseene Carburetor, every auto needs one, saves two-thirds cost of running a car. Big money for real workers. United States Carburetor Company, Omaha, Nebraska.

SALESMEN wanted to sell the Liberty Flag Holder with ally flags. A timely device that is selling rapidly. Here is an unusual opportunity for buskers. Will net you from \$5,000 to \$8,000 a year. Liberal commissions with weekly settlements. No busy samples. State experience and territory wanted. Write today. Liberty Flag Division, Dept. P. M., Stanley Manufacturing Company, Dayton, Ohio.

SALESMEN Wanted! New food product. Big profits. Wonderful repeater. Territories going fast. Write quick. Bestever Products Co., B-7 Douglas Park Sta., Chicago, Ill.

SALESMEN—Sell the Mysterious Advertising Clock. Holds people spellbound. Wonderful attraction. \$10.00 for every sale you make. Sales Manager, 201 Granite Bldg., St. Louis, Mo.

SALESMEN Wanted—\$25 to \$40 weekly; if you have clothing or tailoring experience, if you have taken orders for made-to-measure suits or raincoats, if you can do big things in a big way, we are ready to show you a big, permanent, profitable proposition. P. M., Nelson Tailoring Co., 241 W. Van Buren, Chicago.

TRAVELING Salesmen Wanted—Experience unnecessary. Earn while you learn. Hundreds of good positions open. Write today for large list of openings and testimonials from hundreds of members we have placed in positions paying \$100 to \$500 a month. Address nearest office, Dept. 125M, National Salesmen Training Association, Chicago, New York, San Francisco.

BIG opportunity for traveling salesmen for side line to establish agencies for a fuel-saving device. University tests show 25% saving. Commission basis. Wolff Fuel Saver Co., Lytton Bldg., Chicago.

SALESMEN—Sell our non-alcoholic beverages to retailers. Big demand; large commissions and drawing account. Herthal Mfg. Co., St. Louis, Mo.

SIDE Line Men. Do you want a real one that one order a day will pay you \$9.00. No samples to carry. Something new. Write today. Canfield Mfg. Co., 298 Sigel St., Chicago, Ill.

SALESMEN calling on Manufacturing and Factory Trade to sell High-Grade Legitimate product as a side-line. No samples to carry. Liberal commission proposition. Write North American Lined Products Co., Cleveland, Ohio.

SALESMEN—Acquainted with grocery trade. Large demand; liberal commission; pocket sample. Wirth Salesbook Co., Dept. P, Chicago.

WANTED—Representatives everywhere. Exclusive territory. Gold sign letters for stores and office windows. Any one can put on. Write today for free sample. Metallic Letter Co., 403 N. Clark St., Chicago.

EARN \$5,000 to \$20,000 yearly. New business necessity. Retail \$5 to \$200. 100-200% profit. Purchaser satisfied or money refunded. No competition. Exclusive territory. Free samples. Sayers, 408 Wainwright, St. Louis.

SALESMEN—Get our plan for Monogramming Automobiles and motorcycles by transfer methods. Very large profits. Motorists' Accessories Co., Mansfield, O.

HELP WANTED

MEN and Young Men to prepare for positions as Draftsmen with the Government and private firms; salaries excellent; unusual demand. Personal attention guaranteed. Get particulars promptly. Columbia School of Drafting, McLachlen Building, Washington, D. C.

GET Government War Jobs. \$100 month. List free. Franklin Institute, Dept. F-21, Rochester, N. Y.

CIVIL Service Examinations open the way to good Government positions. I can coach you by mail at small cost. Full particulars free to any American citizen of eighteen or over. Write today for Booklet CD-29. Earl Hopkins, Washington, D. C.

CASH paid for butterflies, insects. Some \$1 to \$7 each. Easy work. Even two boys earned good money with mother's help and my pictures, descriptions, price list, and simple instructions on painless killing, etc. Send 2c stamp at once for prospectus. Sinclair, Box 214, D 6, Los Angeles, Cal.

GOVERNMENT Positions are easy to get. My free booklet BY-29 tells how. Write today—now. Earl Hopkins, Washington, D. C.

WANTED—Immediately—Men—women Government War Jobs, \$100 month. List free. Franklin Institute, Dept. F-21, Rochester, N. Y.

GOVERNMENT pays \$900 to \$1,800 yearly. Prepare for coming "exams" under former Civil Service Examiner, New Book Free. Write Patterson Civil Service School, Box 2920, Rochester, N. Y.

HUNDREDS Government War positions open. Men—women wanted, \$100 month. Write immediately for list. Franklin Institute, Dept. F-21, Rochester, N. Y.

WORK for Uncle Sam. He is the best employer. Big pay, sure work, easy hours, long vacations, rapid advance. Thousands of jobs open this year. I will help you get one. Write for my big free book, BY-29, today. Earl Hopkins, Washington, D. C.

FIREMEN, Brakemen, Baggage-men, 8 hours, \$140. Colored Porters wanted everywhere. Experience unnecessary. 810 Ry. Bureau, East St. Louis, Ill.

DO you want a sure job with big pay, easy hours and rapid advance? Write for my big free book, DW-29, which tells you how you can get a good Government position. Earl Hopkins, Washington, D. C.

RAILWAY Mail Clerks Wanted, Age 18 to 25, \$75 month. Full particulars free. Franklin Institute, Dept. F-21, Rochester, N. Y.

CIVIL service examinations lead to good government positions. Railway mail pays up to \$1,200; postoffice clerk, carrier, \$1,200; customs, \$2,500; internal revenue, \$2,190; bookkeeper, \$2,500; stenographer, \$1,800; clerk, \$1,800; technical, \$4,000; carrier, \$1,200; women, \$1,800; guard, \$10 up. I can coach you by mail at small cost and give bond guaranteeing success or money refunded. Particulars free to American citizens over seventeen. Ask for booklet QE-29, naming position wanted. Earl Hopkins, Washington, D. C.

GOOD income refinishing chandeliers, brass beds, automobiles by new method, producing amazing results; no capital or experience necessary; particulars free. Gunmetal Co., Ave. G, Decatur, Ill.

THE way to get a gov't job is through the Washington Civil Service School. We prepare you and you get a position or we guarantee to refund your money. Write to Earl Hopkins, President, Washington, D. C., for Book PK-29, telling about 292,926 Gov't Positions with lifetime employment, short hours, sure pay, regular vacations.

A POSITION is open for you in the Government service after we have helped you qualify. My money back offer guarantees it. Write quick for big free book, DA-29. Earl Hopkins, Washington, D. C.

BE a Mirror Expert. Good income; spare time home at first; no capital; we train, start you making and silvering mirrors; French method. Free prospectus. W. P. Derr, Pres. 579 Decatur, Brooklyn, N. Y.

WANTED—Men and women to qualify for Government positions. Several thousand appointments to be made next few months. Full information about openings, how to prepare, etc., free. Write immediately for booklet CG-29. Earl Hopkins, Washington, D. C.

INVENT Something. Your ideas may bring wealth. Free book tells what to invent and how to obtain a patent through our credit system. Talbert & Parker, 4162 Talbert Bldg., Washington, D. C.

UNCLE SAM has thousands of jobs open this year. I will help you get one. Write for my big free book DX-29. Earl Hopkins, Washington, D. C.

FIREMEN, Brakemen, beginners \$100-\$150 monthly; Vancouver railroads, experience unnecessary, positions guaranteed. Railway Association, Dept. 254, Brooklyn, N. Y.

GET a sure job with big pay, steady work, short hours, regular vacations, rapid advance. Thousands of positions open with Uncle Sam. I will prepare you in a few weeks at small cost. Write immediately for big free book DU-29, with special offer. Earl Hopkins, Washington, D. C.

EARN Big Money during spare time, calling on doctors, coal dealers, general stores. Nothing to sell. Everything furnished. No money needed. National Credit Reporter, Delphos, Ohio.

U. S. GOVERNMENT Wants Help. Men—women, 18 or over, \$100 month. War necessitates hundreds appointments. Write immediately for list positions. Franklin Institute, Dept. F21, Rochester, N. Y.

PIES Illustrated Book tells of about 300,000 protected positions in U. S. service. Thousands of vacancies every year. There is a big chance here for you, sure and generous pay, lifetime employment. Just ask for booklet CS-29. No obligation. Earl Hopkins, Washington, D. C.

Do you want a position for life, with big pay, short hours and sure advancement? Then work for Uncle Sam. My free illustrated book DK-29 tells how to get an appointment. Earl Hopkins, Washington, D. C.

FOREMEN, Shopmen, and Officers Wanted to work spare time as special representative of large well-known mail-order house, selling Watches, Diamonds and Jewelry on Credit. Liberal commissions and exclusive sales rights granted. No investment or deposit required for outfit or samples. Write at once for details. Address S. D. Miller, Dept. 14, Agency Division, Miller Bldg., Detroit, Mich.

RAILWAY Mail clerks wanted, \$75.00 month. Examinations soon. Also Salesmen wanted. Civil Service and Salesmanship Courses by mail. For "Free Tuition Plan," address Carnegie College, Rogers, Ohio.

GOVERNMENT Examinations. Most thorough preparation, \$5; returned if not appointed; particulars free. American Civil Service School, Washington, D. C.

MAKE money writing Photo-plays; details free to beginners. No correspondence course. Producers' League, 330 Wainwright, St. Louis.

WANTED—An Ideal Who can think of some simple thing to patent? Protect your ideas; they may bring you wealth. Write for "Needed Inventions" and "How to Get Your Patent and Your Money." Randolph & Co., Patent Attorneys, 629 F. St., Washington, D. C.

WANTED

COUPONS, Highest prices paid for all kinds. Chas. S. Edelman, 1311 East 84th St., Cleveland, Ohio.

MAIL-ORDER Proposals of merit wanted. E. Gibson, Havana, Ills.

FOR SALE

POWERFUL Marine day and night glasses with case, 25-mile adjustment, \$9.50. Satisfaction or money returned. Wells Curiosity Shop, 29 South Second Street, Philadelphia, Penna.

75 TAKES Long's pop-corn crispette outfit. Excellent condition. Cost \$225.00. Robert Thompson, Britt, Iowa.

"RADIO" Luminous Paint. Highest Power, quart lot. Only American Manufacturer. American Luminous Products Co., Huntington Park, California.

FIRST-CLASS Arnold vibrator. Good as new. Guaranteed. Price reasonable. Thos. C. Christianson, Waukegan, Wis.

REBUILT Multigraphs, Dictaphones, Addressographs, Mimeographs. Guaranteed year. Price, Inc., Monon Bldg., Chicago.

UNIVERSAL Knitting Machines. Many styles, hand or power. For Catalogue, address Daniel Booker, Peabody, Mass.

SALE OR EXCHANGE

WANT to Swap? Send 10 cents for "The Market for Exchange" to Pierre Noltey, 141 Milk Street, Boston, Mass. It gives a long list of those who have things to trade or sell. Send list of things you have to trade or sell.

GUNS, SPORTING GOODS, ETC.

BARGAINS. Will trade, buy or sell Guns, Rifles, Revolvers. Send Stamp for Bargain List. Oldest, most reliable Dealer in Country. Wm. B. Burkhard, 143 East Fourth Street, St. Paul, Minnesota.

BUY, sell, exchange old-time and modern Fire-arms. Antiques wanted. Stephen Van Rensselaer, 865 Madison Avenue, New York.

FLOUR & FEED MILLING MACHINERY

SPECIAL bargains in second hand Attrition mills, burr mills, crushers, corn shellers, bran dusters, dust collectors, purifiers, reels, double, single, 2 and 3-pair high roller mills, sieve bolters, receiving separators, scourers, etc. Write for description and prices. Sprout, Waldron & Co., P. O. Box 429, Muncy, Pa.

MACHINERY, TOOLS AND SUPPLIES

"RED Devil" Glass Cutter, improved type; cuts more glass; sample 10c. Glaziers' booklet free. Smith & Hemenway Co., 97B Coit St., Irvington, N. J.

OUR Lathe Miller saves its cost in one year. Ricknell Mfg. & Supply Co., Janesville, Wis.

FOR Sale: 2 No. 5 A Potter & Johnson semi-automatic. All condition. 1 Dry Tumbling Barrel. 1 Pangborn Sand Machine. Address H. H. Franklin Manufacturing Company, Syracuse, N. Y.

FOR Sale: Air Tank, 24 in. diameter, 5 ft. high, guaranteed for 110 lbs. working pressure. Price \$53.00. B. F. Biggs Pump Co., Lafayette, Ind.

FOR Sale, Two Stiles & Parker No. 2 old-style presses, one old-style wooden cone pulley power feed milling machine, no countershaft; also one clock wheel gear cutter. The C. J. Root Company, Bristol, Conn.

SEND for circular. 15" Quick Change Gear, Screw Cutting Lathe, Compound Rest, Power Cross Feed, Complete, \$200.00. W. F. Trotter, 818 Union Trust Bldg., Cincinnati, Ohio.

PULLEYS, Gears, Sprockets, Shafting, Hangers. See page 146. W. A. Jones Foundry & Machine Co., Chicago.

TOOLS—for shop, factory, garage and home—many high-class tools attractively priced in our "Odds and Ends" pamphlet—which is mailed free on request by Montgomery & Co., Inc., 195 Fulton St., New York City.

WIRE—all sizes— $\frac{1}{8}$ to No. 16. Coppered, tinned, galvanized and plain steel wire for sale. Cooley Mfg. Co., 553 W. Monroe St., Chicago, Ill.

ENGINES, MOTORS AND DYNAMOS

ALTERNATING and direct current rebuilt guaranteed motor bargains. General Electric, Wagner, Westinghouse, Emerson, Peerless, Crocker-Wheeler. Sizes from 1/2 H.P. upwards. Moneyworth or Moneyback. Send for new illustrated wholesale catalog supplies and motors. Hyre Electric Co., 613 GM South Dearborn St., Chicago.

SEVEN $\frac{1}{2}$ -hp. 220-Volt, 2,200 Rpm., Western Electric DC, also eleven $\frac{1}{2}$ to 1/2-hp.—110 and 220-Volt; good used motors \$6 each. Electric Supply Machinery, 527 Van Buren, Chicago.

SMALL Motors and Generators—Quantity $\frac{1}{4}$ H. P. A. C. Motors—110 volts—slightly used, \$14.00. Small generators—charging—lighting—moving picture Arc machines, \$10 each and up. A. C. Motors 1 and 3 phase up to 5 H. P. for immediate delivery. Write for Bankruptcy Stock sheet. Johnston, West End, Pittsburgh, Pa.

65 EVINRUDE rowboat motor, complete, \$27.50. Wesco, 1448 Larimer, Denver, Colo.

GENERATORS, Ball-bearing, 32 volt, 11 to 35 amperes, complete with base and pulley. Prompt shipments. Goodlie Company, Indianapolis, Ind.

FOR Sale: D. C. Motors, 1 1/2 H. P., 2 H. P., 3 H. P., 7 1/2 H. P., 15 H. P. Generators 30 KW, 20 KW guaranteed. Naboth Vineyards, Brocton, N. Y.

ENGINE User Agents Wanted to use, demonstrate and sell "Big Ben," wonderful new 2 1/2 H. P. gasoline engine. Free introductory offer and free details. C. Henningshofen & Sons, Dept. P, Hamilton, Ohio.

REBUILT Engines—We have rebuilt "Buffalo" Engines, guaranteed, at greatly reduced prices. Write for bargain list. Buffalo Gasoline Motor Co., 1293-1295 Niagara Street, Buffalo, N. Y.

FOOS Gas Engine, Two hundred horsepower. Good condition. Mildred Seaton, Corpus Christi, Texas.

FOR MECHANICS

PATENTS Wanted. Write for list of Patent Buyers who wish to purchase patents and what to invent with list of inventions Wanted. \$1,000,000 in prizes offered for inventions. Send sketch for free opinion as to patentability. Write for our four Guide books sent free upon request. Patents advertised Free. We assist inventors to sell their inventions. Victor J. Evans & Co., 184 Ninth, Washington, D. C.

TOOL Cases. For Carpenters and Machinists. Write for catalog. Keystone Case Co., 4920 Lake St., Chicago.

BLACKSMITHS

BLACKSMITHS, Listen! Prepare for big wages in Navy and Arsenal with Toy's Modern Methods doing hard jobs easy. Forging and making solid welds, hardening and tempering to a standard, with colored tempering charts. All for one dollar. Samples free. W. M. Toy, Sidney, Ohio.

ELECTRICAL

ILLUSTRATED catalog, wholesale prices, just issued. Electrical motors and supplies including sockets, switches, loom-wire, knobs, cleats, rosaries, cut-outs. Hyre Electric Co., 613 RF South Dearborn St., Chicago.

PRACTICAL Electric—Universal handy book on every-day electrical matters, alarms, batteries, bells, carbons, connections, coils, dynamos, wires, lamps, motors, telephones, etc. 125 pages, 126 illustrations. 25c postpaid. Popular Mechanics Book Dept., 6 N. Michigan Ave., Chicago.

DRY Batteries and Their Construction for All Purposes. A practical handbook of 60 pages with 30 illustrations dealing with batteries for automobiles, gas engines, medical and coil work, electric bells, alarms, telephones, experiments, etc. Price, 25 cents postpaid. Popular Mechanics Book Dept., 6 N. Michigan Ave., Chicago.

STAMP COLLECTING

61 All Different Foreign Stamps, including Honduras, Mexico, China, Peru, Australia, Egypt, Japan, Chile, Russia, Argentina, Brazil, Cuba, India, Portugal, etc. Only 7 cents. Royal Stamp Company, 43 N. 51st Street, Philadelphia, Penna.

EGYPTIAN Soudan, Camel Post, 7 different varieties of these large, beautiful, two-colored stamps for 18c. 11 varieties 50c; 14 varieties \$1.25. The Edgewood Stamp Co., Milford, Conn., Dept. H.

24 VARIETIES Cuban stamps, 10 cents. List of 6,000 low-priced stamps free. Chambers Stamp Co., 111 P. Nassau St., New York City.

STAMPS, 75, all different, free. Postage, 2c. Mention paper. Quaker Stamp Co., Toledo, Ohio.

FREE—60 different stamps, including Newfoundland, China, Japan, Mexico, etc., to applicants for our high-grade approvals. Send 2c stamp for return postage. The Edgewood Stamp Company, Dept. H, Milford, Conn.

STAMPS—12 different from warring nations, 10c; 10 different foreign coins, 15c; 20 Belgian stamps, 10c. Lists free. Toledo Stamp Co., Toledo, Ohio.

PRECANCELLED wanted for cash, 100 different 2c. Weatherly, Medina, Ohio.

STAMPS—7 different China and 300 mixed stamps only 10c. J. Henry Orr, 717 West Main St., Muncie, Ind.

ASSORTMENT Siamese stamps; satisfaction guaranteed. One Dollar, check or draft. McQuerry, Bangkok, Siam.

300 DIFFERENT stamps 27c. Lutheran Club, Box 178, Terre Haute, Ind.

20 UNUSED stamps free. All different. Postage, 2c. Flisk Stamps, Toledo, Ohio.

STAMPS, 58, all different: Malay (Jiger), Bolivia, China (junk ship), Mexico, etc.; an album and Perforation Gauge, all for 5c. Interesting List Free. Parn Stamp Co., 138 No. Wellington St., Los Angeles, Calif.

STAMP sent on approval at 70% discount. Reference required. Emory Renold, Hanover, Pa.

STAMPS—500 fine foreign incl. Mex. War, Salvador, incl. officials, Guatemala, China, etc., only 10c. Best App. Sheets 60 to 80% dis. We give valuable extra Presents free! Big 120 pg. catal. free. We buy stamps. Husman Stamp Co., St. Louis, Mo.

PACKET of 23 stamps; no two countries alike, 500 hinges. Set of \$1 and \$2 U. S. Rev., all for 5c. Mention paper. Miami Stamp Co., Toledo, Ohio.

THE way to build your Stamp Collection. Send 50 cents for one of my approval Books. Select the stamps you want, to the value of Fifty Cents, and return me the Book. F. J. Pope, Charlotte, Vermont.

105 CHINA, etc., stamp dictionary, list, 2c. Album (500 illustrations) 3c. Bullard, Sta. A., Boston.

PACKET "A" 100 varieties foreign stamps, 20c. F. J. Pope, Charlotte, Vermont.

RARE COINS

WE pay to \$50.00 for certain large cents; \$5.00 for certain eagle cents, etc. High premiums paid for rare coins to 1913. Many in circulation. Watch your change. Send 4c now. Get our Large descriptive Coin and Stamp Circular. Numismatic Bank, Dept. H, Fort Worth, Texas.

FIVE Villa Coins and Bills 35c. Villa Silver Dollar \$1.75. Moore Coin Company, Commerce, Texas.

CALIFORNIA gold, quarter size 27c, 1/2 size 53c, dollar size \$1.10. Large cent before 1821, Columbian nickel coin, and catalogue, 19c. Norman Shultz, King City, Mo.

OLD Coins. Large Spring Coin Catalogue of Coins for Sale, free. Catalogue quoting prices paid for coins, ten cents. William Hesselin, 161 Tremont St., Boston, Mass.

\$4.25 EACH Paid for U. S. Flying Eagle Cents dated 1856. We pay cash premiums on hundreds of Old Coins. Send ten cents at once for New Illustrated Coin Value Book 4x7. It may mean your fortune. Clarke & Co., Coin Dealers, Box 15, Le Roy, N. Y.

ALL for 30c, a 25c California gold token and a 20c nickel coin of Serbia, V. Walter, New Rochelle, New York.

GAMES AND ENTERTAINMENTS

MUSICAL Glasses, Musical Electric Bells, Coins, Flower Pots, Funnels, Xylophones, etc. Catalogue on receipt of stamps. L. Braunstein, 1012 Napier Avenue, Richmond Hill, N. Y.

TRICKS, Puzzles, Jokes, Magical Apparatus, Plays, Stage Supplies, Mind-reading Acts, Sensational Escapes, and Illusions. Free large illustrated 1917 catalog. Oaks Magical Co., Dept. 431, Oshkosh, Wis.

PUN, fun for Everybody. Just out. Shooting Fountain Pen with caps, 25c prepaid. All the latest tricks, puzzles, pocket novelties. Retail and wholesale. Send 2c for illustrated catalogue. Grandfeld, 1238 Theriot Ave., Bronx, New York.

MAGICAL Goods, Card Tricks, Mind-reading Acts, Sensational Escapes and amusements. Catalog free. Heaney Magic Co., Desk 85, Berlin, Wisconsin.

PARLOR Quills \$1.00. Worth more each week for exercise only. Bicknell, Janesville, Wis.

LEARN the great Vault Escape Mystery, full secret, 10c. V. Buffington, Box 298, Johnstown, Pa.

LATEST Coin Vanish, big bunch of greenbacks and catalogue for 10c. A. Applebee, 6 High St., Amesbury, Mass.

MAGIC! 10c will bring Catalog—Card-Trick and Four Secrets. Western Magic Co., Los Angeles, Cal.

MAGIC—Tricks, Books and Supplies. For Amateurs as well as the Great Professionals. Any one can learn through our instructions. Feature Acts in Mind Reading, Spiritualism, Rope Ties, etc. Large illustrated Professional Catalogue, 10c. Chicago Magic Co., Dept. B, 72 West Adams St., Chicago, Illinois.

THEATRICAL GOODS

SCENERY for Sale and Rent, Amelia Grain, 819 Springgarden Street, Philadelphia, Pa.

FOR BOYS

GOT a Kolor Karicature? Send photo of head. State complexion. I'll draw caricature in colors. \$1.10. K. Rickett, Granville, Ohio.

JUST Issued—Amateur Mechanics No. 8. How to make 132 different interesting things such as electric fountains, bird houses, model monoplane, porch swing, kites of various kinds, fishing rods, camp outfits, scarecrow, shocking machine, etc., 128 pages, 234 illus. Price 25 cents, postpaid. Also all preceding numbers in the series at same price. Popular Mechanics Book Dept., 6 N. Michigan Ave., Chicago.

BIG New Book for Boys—The Boy Mechanic, Vol. II—Just out—A sequel to, but containing nothing found in Vol. I. Tells all about 1,000 interesting things to make and do. 480 pages; 995 illus. Cloth. Price, \$2.00, postpaid. Send for descriptive circular. Popular Mechanics Book Dept., 6 N. Michigan Ave., Chicago.

FOR MEN

"BEST-O-BELTS" for men. Comfortable, sensible. Expands to suit your needs. Automatically adjusts itself. Send for yours today. Year's comfort assured. One dollar. State size. Arty Co., 50 E. 9th St., N. Y. City. Agents wanted.

NEW Invention. Useful, handy. Samples 19c. DeLoof, AC-247 Harmon, Detroit.

"PROTECTOCUFFS" Keep Your Cuffs Clean! Excellently made of khaki. Guaranteed years. Thousands sold. Quarter a pair. "Protectocuffs," satine, same price. Order now. Chic Co., 50 E. 9th St., N. Y. City. Agents wanted.

RAZORS AND BLADES SHARPENED

MAKE shaving a pleasure. Mail your razor and 25c, returned in two days. J. Mox, Expert Honer, 235 Amber St., Pittsburgh, Pa.

SAFETY Blades honed and stropped 2 1/2 each. Stevens Cutlery Works, Denver, Colorado.

SAFETY razors sharpened; two cents each. Guaranteed. Blade box free. Electro Strapping Co., 134 Shelby St., Detroit, Mich.

DIAMONDS, WATCHES AND JEWELRY

GUARANTEED gold filled Waldemar chains 48 cents; Vest chains 75 cents. Watches, Jewelry, prices beat an auction. Write: J. O'Neill, Hammond, Oregon.

PIANOS AND MUSICAL INSTRUMENTS

HOLTON Cornet with case for sale. Perfect tone, tune and pitch. Dr. A. O'Neill, Daytona, Fla.

BEEBE Violins, deep, mellow tone, easy payments. Colored photo and particulars. 136 Clinton St., Muskegon, Mich.

PHONOGRAPHS AND RECORDS

BUILD Your Own Phonograph. Any type. Big saving. Patents expired. Profits making and selling them. We furnish parts you can't make. Full instructions, dimension drawings, illustrations, parts—price-list only 25c. Circular Free. Associated Phonograph Co., Dept. P, Cincinnati, O.

MUSIC

CLARINET playing successfully taught through books, personal letters and phonograph records played by G. Langenus, solo Clarinet New York Symphony Orchestra. Send for Circular D, Langenus Clarinet School, 510 West 140th Street, New York City.

"SWEET Luana" and "Honolulu Pakika," popular Hawaiian songs, 25 cents brings both. Money refunded if dissatisfied. Request catalog, Quincke Company, Majestic Theater Bldg., Los Angeles, Cal.

FORMULAS AND TRADE SECRETS

75 MANUFACTURING Secrets 10c, 1,000 Formulas 25c. Luminous Paint; Gas Tonic; Mechanics Soap; Renewing Dry Batteries—Resilvering Mirrors, 25c each. Entire collection 50c. Satisfaction guaranteed. "The Ideal," Box 543-J, Chicago.

COMPLETE Formulas for making Auto Body polish, Gaseous and Metal polish for Autos. Excello, 1640 Oak. M. Oliver P. O. Penna.

PRACTICAL—Manufacturing Formulas—All kinds. Claus, 1864 Harmon Street, Brooklyn.

10,000 SELECTED scientific, chemical, technological and practical recipes and processes, including hundreds of so-called trade secrets for every business, alphabetically arranged in one large volume of 800 pages. Price \$3 prepaid. Large descriptive circular sent upon request. Popular Mechanics Book Dept., 6 N. Michigan Ave., Chicago.

DUPLICATORS AND DEVICES

"MODERN" Duplicator—a Business Getter. \$1 up, 50 to 75 copies from pen, pencil, typewriter; no glue or gelatine. 35,000 firms use it 30 days' trial. You need one. Booklet Free. J. E. Durkin & Reeves Company, Pittsburgh, Pa.

\$300 MULTIGRAPH like new for \$100. Guaranteed. Russell Baum, Philadelphia Bourse, Philadelphia.

TYPEWRITERS AND SUPPLIES

STARTLING Values in Typewriters. \$10 to \$15 up. Factory rebuilt. All makes. Shipped on trial. Write for our special offer No. 128-1. Whitehead Typewriter Co., 186 N. La Salle St., Chicago.

NEW, Rebuilt and Slightly Used Typewriters, \$8 up. Portable Machines, \$10 up. Write for our catalog 50-M. Beran Typewriter Co., 58 W. Washington St., Chicago.

SEND for list No. 4 of Typewriter Bargains, new and rebuilt; cash, time or rent. 10 days' Free trial. American Typewriter Exchange, 14 N. Dearborn St., Chicago.

GUARANTEED Typewriter Ribbons, any color, for any machine, 3 for \$1.00. Non-smut carbon paper, standard or feather-weight, any color, \$1.00 box. Acme Co., 760 Monon Bldg., Chicago.

WE have a number of second-hand machines traded in on the new model Victor No. 3. All overhauled and in perfect condition. Like new. Write for list and particulars. Victor Typewriter Sales & Supply Co., 60 W. Washington, Chicago.

LARGEST Stock of Typewriters in America. Underwoods, one-fourth to one-half manufacturer's prices; rented anywhere, applying rent on purchase price. Free trial. Installment payments if desired. Write for catalogue 70, Typewriter Emporium, estab. 1892, 34-36 W. Lake St., Chicago, Illinois.

PRINTING, ENGRAVING AND MULTIGRAPHING

QUALITY Printing Prepaid. 500 other envelopes, notecards, cards, statements, \$1.35; 1,000, \$2.25; 500 lines-finished letterheads or envelopes, \$2.25; 1,000, \$3.50. Prepaid. Typewriter letters. Stamp brings samples. Model Company, Manchester, Iowa.

PERFECTION Letter Company, Muncie, Indiana. Multigraphs 500 purple letters with black letter heads, \$2.15. Samples for stamp.

NAME Hand Lettered and 500 bond letterheads, \$3.50 postpaid. Ralph Haight, 2322 Mission St., San Francisco, Calif.

3,000 GUMMED Labels for \$1.00—size 1"x2". Circular free. Catalogue 2c Stamp. The Helms Company, Hoboken, New Jersey.

BILLHEAD Special, 7x8 1/2, 250 \$1.00; 4 1/2x8 1/2, 350 \$1.00; 3 1/2x5 1/2, 500 \$1.00. Walker's Printery, Binghamton, N. Y.

ACME Combination: 250 Letter Heads, 250 Envelopes, 250 Cards, 250 Billheads, 250 Statements, \$3.75. Acme Co., 760 Monon Bldg., Chicago.

INCREASE your business. Suggestions free. Edward Harrison Printing, Baltimore, Maryland.

PREPAID: Name and address 50 elegant cards, 15c. Commercial printers, samples free. Majestic Printing Co., 3644 Loeward Ave., Los Angeles, Cal.

PRE-USED Printing presses, Type, Supplies, cheap. List for stamp. Popular Bargains, Richland, Pa.

MULTIGRAPHED Letters, \$2.00, 1,000 Typewriter Ribbon with each Job. Red stamp for Samples. Overnight Printshop, 750 Monon Bldg., Chicago.

AT Last! Beautiful Lithography for small users. 1,000 Letterheads, 1,000 Billheads and 1,000 Statements, \$9.99. Engraving Free. Kardee Lithographing Co., 764 Teutonia, Milwaukee.

PRINTING Outfits—Presses, type, supplies, type novelties. Send stamp for catalogue. Model Press, York, Penna.

BUSINESS Men—My invention may mean \$100 to you. Samples, 19c. DeLoof, AE-247, Harmon, Detroit.

GOOD Printing at low prices. 1,000 good letterheads, envelopes, cards, billheads, labels, circulars, \$2.50. Samples free. Catalogues, booklets and circulars our specialty. Ernest L. Fautus Co., 523 S. Dearborn St., Chicago.

100 PANELED Visiting Cards, leatherette case, 45c. Wolf Cards, Philadelphia.

GOOD Printing cheap. Estimates. Gummed labels. P-P Printers, Kalida, Ohio.

GUMMED Flag Labels, 1,000, 50c; 100 assorted samples, 10c. Stephens, Box 168, Peckskill, N. Y.

WE print anything. Cuts made from photograph. Samples. Commercial Press, Batavia, Ohio.

PATENT ATTORNEYS

PATENT Your Ideas—\$9,000 offered for certain inventions. Books, "How to Obtain Patent," and "What to Invent," sent free. Send rough sketch for free report as to patentability. Manufacturers constantly writing us for patents we have obtained. We advertise your patent for sale at our expense. Established 20 years. Address Chandler & Chandler, patent attorneys, 1099 F St., Washington, D. C.

PATENTS Wanted. Write for list of Patent Buyers who wish to purchase patents and What to Invent, with list of inventions wanted, \$1,000,000 in prizes offered for inventions. Send sketch for free opinion as to patentability. Write for our four Guide books sent free upon request. Patents advertised free. We assist inventors to sell their inventions. Victor J. Evans & Co., 165 Ninth Washington, D. C.

"PATENTS and Patent Possibilities" is a 72-page treatise which tells all about patents, what to invent and where to sell it. It gives honest advice to inventors and tells about the successes of some of my clients, also explaining what are frequent causes of failure. Manufacturers are constantly writing for protective patents upon all kinds of sound inventions. Can you help supply their wants? The book is free. Write for it today. H. S. Hill, 905 McLauchlin Building, Washington, D. C.

R. MORGAN Elliott & Co., Patent Attorneys. Mechanical, Electrical & Chemical Experts. 713-721 Woodward Building, Washington, D. C.

FITZGERALD & CO., Patent Lawyers. 803 F St., Washington, D. C. Estab. 1880—"The Old Reliable Firm." Our Specification Department in charge of former member examining corps U. S. Patent office.

PATENTS Bring Riches; Protect Your Invention. Attorney's fee payable when patent allowed. Plain advice and "Patent Facts" free. Trademarks registered. Jaynes & Jaynes, 653 Kellogg, Washington, D. C.

PATENTS secured. Write for our booklet; it tells how to protect your ideas and how to proceed with your invention to make money. Featherstonhaugh & Co., 400 Victor Building, Washington, D. C. 35 years' practice in U. S. and Canada.

DON'T Lose Your Rights to Patent protection. Before proceeding further send for our blank form "Evidence of Conception," to be signed and witnessed. Book, suggestions and advice free. Lancaster & Allwine, 221 Ouray Building, Washington, D. C.

PATENTS worth while. No Free booklets, no premiums, no trading stamps—nothing but good service. Samuel Herrick, Master of Patent Laws, Washington, D. C.

HIGH-VALUE Patents. See R. S. & A. B. Lacey's advertisement on page 148.

PATENT What You Invent. It may be valuable. Write me. No attorney's fee until patent is allowed. Estab. 1882. "Inventor's Guide" Free. Franklin H. Hough, 522 Loan & Trust Bldg., Washington, D. C.

KEEP UP with Progress. Promote your patent. Send \$1.00 for year's subscription to best Inventor's Magazine, "Invention and Manufacturing," United States Patent Corporation, Washington, D. C.

PATENTS Secured or All Fees Returned. See E. E. Vrooman & Company's advertisement, page 149.

PATENTS—Send sketch for free search and report. Books on patents and book of reference letters sent free. John S. Duffie & Co., 610 F St., Washington, D. C.

INVENTORS: Write our Patent Dept. Adam Fisher Mfg. Co., 2061 C Railway Exchange, St. Louis, Mo.

PATENTS obtained through D. Swift being promptly sold to manufacturers. Write today for free books of "Inventions Needed" and surpassing references. D. Swift, 317 Seventh St., Washington, D. C.

INVENT Something. Your ideas may bring wealth. Free book tells what to invent and how to obtain a patent through our credit system. Talbert & Parker, 4622 Talbert Bldg., Washington, D. C.

PATENTS on easy payments. Send model or sketch for Free Search and Certified Registration of Your Invention for Your Protection. Free Book Tells What to Invent and How to Obtain a Patent on Easy Payments. C. C. Hines, 591A Loan & Trust Bldg., Washington, D. C.

PATENTS without advance attorney's fees. Send sketch for free report. Books free. Frank Fuller, Washington, D. C.

PATENT secured or fee returned. Hundreds of inventions sold yearly. We will help you sell yours. Send model or sketch. Books and advice free. Sues & Co., Est. 30 years, 539 7th St., Washington, D. C.

THE Patentome is free. An education in obtaining patents. Established 1865. Anderson & Sons, Attorneys, 707 7th St., Washington, D. C.

PROTECTIVE patents procured promptly. 104-page blue book on patents sent on request. Trade-marks registered. Robb & Robb, 211-215 Southern Bldg., Washington, D. C.

PATENTS Secured or Fee Returned. Actual search free. Send sketch or model. 1917 Edition, 90-page patent book free. My patent sales service gets full value for my clients. It should never require more than two days to report upon the patentability of your invention; nor longer than ten days to prepare your application for filing. Longer delay amounts to gross neglect and the jeopardizing of your rights. For prompt personal service write. George P. Kimmel, 212 Barrister Building, Washington, D. C.

PATENTS—Herbert Jenner, patent attorney and mechanical expert. 606 F St., Washington, D. C. I report free of charge if a patent can be had and its exact cost. Send for circular.

PATENTS that protect and pay. Advice and books free. Rates reasonable—highest references; best results. Watson E. Coleman, Patent Lawyer, 624 F St., N. W., Washington, D. C.

H. I. WOODWARD—Safe methods. Paying patents. Write today. 902 G St., Washington, D. C.

PATENTABLE Ideas Wanted—Send for 4 free books. R. B. Owen, 30 Owen Bldg., Washington, D. C.

FOR INVENTORS

INVENTORY Shop Service. We do high-grade experimental and model work. Expert assistance in perfecting automobile and other inventions. Light manufacturing. Write or visit us. Elk Manufacturing Co., 1925 Broadway, N. Y.

INVENTIONS—Patenting and Promoting. A book containing practical advice and directions for inventors and manufacturers. Book, suggestions and advice free. Lancaster & Allwine, 221 Ouray Building, Washington, D. C.

ADVERTISE! 25 words 3 months in 120 monthlies, \$1.50; 220 magazines, \$2.75. Southwestern, 1413-1 Berendo, Los Angeles.

No Attorney fees until patent allowed. Send sketch for free report. Books free. Frank Fuller, Washington, D. C.

PATENTS secured or all fees returned. See E. E. Vrooman & Company's advertisement, page 149.

HIGH-VALUE Patents. See R. S. & A. B. Lacey's advertisement on page 148.

INVENTORS—Do you contemplate prosecuting your own applications? If so, read "Patents and the Preparation and Prosecution of Applications by Applicants Themselves." A paper read before the Examining Corps of the United States Patent Office. Price \$1.00. Address George R. Ide, 644 D Street, N. E., Washington, D. C.

INVENTORS—We specialize in manufacturing new patented articles—make models—dies—and do experimental work. Leo J. Gerding Mfg. Co., Dept. D, Opera Place, Cincinnati, O.

INSURE Success. Skilled designing, automatic and special machines. Practical working drawings. Tipnam, Box 4708, Philadelphia, Pa.

INVENTOR will buy inventions. Give particulars. 621 Caswell Block, Milwaukee.

FOR Inventors—Better be sure than sorry. Before patenting, advertising, or selling your invention, get bulletin by experienced inventor that saves dollars. Circular two-cent stamp. Address, Adviser, P. O. Box 1708, Spokane, Wash.

INVENT Something. Your ideas may bring wealth. Free book tells what to invent and how to obtain a patent through our credit system. Talbert & Parker, 4289 Talbert Bldg., Washington, D. C.

WANTED—An Idea! Who can think of some simple thing to patent? Protect your ideas; they may bring you wealth. Write for "Needed Inventions" and "How to Get Your Patent and Your Money." Randolph & Co., Patent Attorneys, Dept. 144, Washington, D. C.

INVENTORS: Invent for profit. Write for list of needed inventions. Sanders, 7 Webster Bldg., Chicago.

INVENTIONS commercialized on cash and royalty basis. Patents secured. Models, experimental work and contract manufacturing. Inventors should write at once. Adam Fisher Mfg. Co., 2061A Railway Exchange, St. Louis, Mo.

PATENTS, Trade-Marks and Copyrights. Our handbook on patents will be sent free on request. All patents secured through us are described without cost to the patentee in the Scientific American. Munn & Co., Patent Attorneys, 623 Woolworth Bldg., N. Y. Washington, D. C., office, 625 F. St.

PATENTS on easy payments. Send model or sketch for Free Search and Certified Registration of Your Invention for Your Protection. Free Book Tells What to Invent and How to Obtain a Patent on Easy Payments. C. C. Hines, 591A Loan & Trust Bldg., Washington, D. C.

HAVE You An Idea? If so, you should protect it by a patent. Send us a model or sketch for free opinion as to patentability. Write for our Four Books sent free to any address. Victor J. Evans & Co., 157 Ninth St., Washington, D. C.

PATENTABLE Ideas Wanted—Send for 4 free books. R. B. Owen, 30 Owen Bldg., Washington, D. C.

PATENTS FOR SALE

PATENTED improved "Article-Carrier." Cash or royalty basis. Reasonable terms. U. S. Patent No. 1,177,692. Canadian Patent No. 175,789. For full particulars address Joseph Fallis, Gunn, Wyoming.

We have some money-making inventions for placing on royalty; outright sale or trade. Write Adam Fisher Mfg. Co., 2061B Railway Exchange, St. Louis, Mo.

INVENTOR has ninety inventions. Will give interest in each to the person who backs me financially. Particulars free. Elmer Paul, Box 497, Greensburg, Pa.

U. S. PATENT on gate latch for sale outright or lease on royalty basis. Write today. Raymond J. Barton, Mt. Sterling, Iowa.

THERMOSTATIC Heat or Fire Alarm. Simple in construction. Absolutely reliable for fire protection in homes, on boats or any purpose desired. G. S. Simpson, 601 St. Paul St., Baltimore, Md.

PATENT for Sale—Padlock Without Key: will sell for \$12,000. Write to Ivan P. Yuginovic, 406 121st St., Whiting, Ind.

BASEBALL Mask. Absolutely protects player from injury. Very practical. Write Jos. Lajack, R. R. No. 1, Erie, Colo.

COLLAPSIBLE Barrel. Patent pending. Outright. John Arnett, Swift Current, Sask., Canada.

OUTRIGHT or royalty. Automobile hand warmer, also rim closer. Patents pending. Chas. C. Walker, Box 672, Salt Lake City.

PATENTED Automatic life preserver. Body and pocket size. Body also forms pillow when folded. Drowning impossible. Fred Schlachter, 35 Liberty St., Oshkosh, Wis.

PATENTS for sale. Canadian and American. State rights or outright. "Coal saving damper." Latest and best ever invented. Immense possibilities. C. H. Stainton, 268 Havelock St., Toronto, Canada.

PATENT on game board for sale. Address E. Leonard, Thompson, Pa.

FOR Sale—Patent No. 1,224,915. Patented May 8, 1917. Aeroplane Stabilizer. \$350 will buy it before September 25, 1917. It will take more after that date. Patent, Box 897, Sapulpa, Oklahoma.

FOR Sale—Patent Woven-Wire Clamp for stretching wire fence. All farmers need one. S. R. Miller, Alderson, W. Va.

AUTOMATIC Lamp Lock. any one can attach to an incandescent bulb. Cannot be removed unauthorized. Popular Mechanics, page 692, April issue, has full description. Use lock indefinitely. Sample 25 cts. Agencies and state rights open. Automatic Lamp Lock Co., 325 Davis Street, San Francisco, Calif.

PATENT No. 30,924. Automatic Picture Machine, for Advertising. See Illustration in this month's Scientific American Magazine. Halbert M. Wood, Greenfield, Indiana.

FOR Sale: Patent on railway Rail Joint; Good special in War time; issued on January 2, 1917. For terms, etc., address Joran Drohac, 393 Ridge Road, Lackawanna, N. Y.

MANUFACTURERS: Pocket comb holding tooth-brush in back. Novel and simple. Protected in U. S. and Canada. Box 13, Utica, Mich.

PATENT for Sale. Absolutely non-refillable bottle and cheapest manufactured. James M. Miller, 456 East Vancouver, Canada.

MANUFACTURERS. Attention: The largest small invention, pronounced the most perfect in its art, is for sale. Will sell outright, but prefer a royalty. J. P. Spies, Belleville, Ill.

INVESTORS, Attention! Meritorious invention. A needed household necessity. Louis Bruner, Algiers, La.

FOR Sale or Royalty—Box and barrel warehouse truck patent. A. Wollbrandt, 3530 Brookdale Ave., Oakland, Calif.

PATENT on prickly-pear ax and fork for sale. Can be used over a wide area. Used like a spade. R. Brown, 523 Sherman St., San Antonio, Texas.

PATENTS for Sale or Lease. Cash or royalty. Our number 10,486 Dredge Sleeve or Coupling; 10,416 Improved Rake; 10,632 Mechanism for Cleaning Shell Fillers; 10,324 Combination Wall Bearing and Anchorage System. Write for copy of patent prices and terms. Other patents for sale. Talbert & Parker, 4687 Talbert Bldg., Washington, D. C.

PATENT Pending. Combination Rake and Fork, for sale, \$3,000. Tony Pugliese, Los Banos, Cal.

DEVICE for separating, washing and grading sand and gravel. Best and cheapest on the market. Particulars free. H. C. Thompson, Steilacoom, Wash.

PATENT Ash Sifter—Removes and sifts at same time; past experimental stage; proven seller; cash or manufacture on royalty basis. Mr. Chamberlin, R. 85, 154 W. Randolph St., Chicago.

PATENT Buyers are invited to address our sales department for information on any class of Patents they wish to purchase or lease on a royalty. We have secured a number of valuable patents in all lines of invention. Mail Order, Department Store and Household Novelties a specialty. Victor J. Evans & Co., 160 Ninth St., Washington, D. C.

MODELS AND MODEL SUPPLIES

IF you have something to be made write us. Experience is the keynote of success. We make Models, Dies, Tools, Castings, General Manufacturing. Send rough sketch. The United Machinery Company, Station "B," Cincinnati, Ohio.

PRODUCERS of Results: Inventions developed. Models, Experimental work, anything special in metal to order, novelties, spinning, forging, castings in any material, electrical devices, patterns of all kinds, plating, general manufacturing, designing, special tools, punches and dies, stampings. Send drawing or sample. Expert information free. The John's Machine & Stamping Works Company, Dept. C, Cleveland, Ohio.

MODELS, Punches and Dies, Patents Perfected. The Sachs-Lawler Co., Inc., Established 1881, 1543 Larimer St., Denver, Colo.

WANTED—New Ideas. Write for list of Patent Buyers and Inventions Wanted. \$1,000,000 in prizes offered for inventions. Our Four Books sent free upon request. Victor J. Evans & Co., 165 Ninth, Washington, D. C.

WE make working models for inventors; also dies and stamping of specialties, and carry a complete stock of brass gears and model supplies. Send for catalogue. The Pierce Model Works, 3405 Pierce Ave., Chicago, Ill.

PERFECT models sell inventions. We make them. Write Adam Fisher Mfg. Co., 2961E Railway Exchange, St. Louis, Mo.

GINSENG

GOLDEN Seal. "The Golden Opportunity" Booklet, 10c. Ginseng and Golden Seal roots for sale. W. N. Long, Florence, Ky.

GINSENG planting instructions free. Seeds \$1.00 thousand. Specialty Farm, Rockford, Minn.

300 MOST valuable Roots, Herbs, etc., used in medicine; how to gather, where to sell, war prices. Book postpaid only 25c. Medical Plant Co., West Milan, N. H.

MANUFACTURING

SPECIAL machines, tools, dies and models of all kinds made to order. L. Darby, 180 Mulberry St., Newark, N. J.

PRactical—Manufacturing Formulas—All kinds. Claus, 1864 Harmon Street, Brooklyn.

WIRE Goods, all kinds, made to order. Cooley Mfg. Co., 553 W. Monroe St., Chicago.

INVENTIONS manufactured under contract. Write Adam Fisher Mfg. Co., 2961E Railway Exchange, St. Louis, Mo.

DIES and Punch Press Products, machine work, wood and metal patterns. Articles manufactured. Baer Pattern and Manufacturing Co., Toledo, Ohio.

REAL ESTATE AND FARM LANDS

SOUTHERN farmers are prosperous and contented. Favored by nature with mild climate, long growing season and abundant rainfall, fruit, poultry, stock, trucking and general farming succeeds amazingly here. Little Farms in Shenandoah Valley colony of Little Planters, \$250 and up, complete, on easy payments. Good near-by markets, excellent transportation, low freights. Full information on request. F. H. LaBaume, Agr. Agt., N. & W. Ry., 250 N. & W. Bldg., Roanoke, Va.

15 STATES, \$10 an acre up; stock, tools, and crops often included to settle quickly. Write for Big Illustrated Catalogue. Strout Farm Agency, Dept. 3043, New York.

BEAUTIFUL Seashore Homesites only \$20. Special sale lots at Alamo Beach, Texas, famous Barshore resort. First 100 lots \$20. Terms \$1 cash, \$1 monthly. Lots 50x149 feet. Splendid investment. Write for free literature and views. Alamo Beach Company, 422 First National Bank, Houston, Texas.

CALIFORNIA little farms near Los Angeles for sale on easy payments. Write E. R. Waite, Shawnee, Oklahoma.

SEND name, receive free offers from land owners everywhere. Mohler, Box 453, Chicago.

ONLY \$7 down, \$7 month—10-acre farm only \$475, north of Grand Rapids, Mich. Splendid sand loam soil; new 3-room house, well, 100 chickens; partly cleared; plenty small fruit; no waste land; only 2 1/2 miles from depot; close to Diamond Lake fine resorts. Only 6 miles from White Cloud, County Seat. Federal Realty Company, 740 Resper Bldg., Chicago.

WRITE for description of two thousand acres good Virginia land. E. M. Terry, Owner, South Boston, Va.

OWN your own Orange or Grapefruit grove in beautiful Fruitland Park. Let me tell you how melons, peaches, hay, your first crops, should pay for your land and grove. J. Q. Lloyd, Desk 93, Fruitland Park, Florida.

SELL your property quickly for cash, no matter where located. Don't pay big commissions. Particulars free. Real Estate Salesman Co., Desk B, Lincoln, Neb.

A SMALL farm in California will make you more money with less work. You will live longer and better. Delightful climate. Rich soil. Hospitable neighbors. Good roads, schools and churches. Write for our San Joaquin Valley Illustrated folders free. C. L. Seagraves, Industrial Commissioner, AT&S Ry., 1933 Ry. Exch., Chicago.

DOGS, BIRDS, POULTRY, PETS

EARN \$20 weekly raising Belgian Hares, Particulars 10c. Anderson's Rabbitry, 2421 Ogden, Denver, Colorado.

AIREDALE Pups—\$6.00 to \$9.00 each. Alex Davidson, Glen Campbell, Pa.

AIREDALES—Best hunters, best retrievers, best watch dogs, ideal automobile dogs. Shipped everywhere. Best strains in America. Mountain bred dogs and puppies; \$25 upwards. The Cliff Kennel, 2099 Vine Street, Denver, Colo.

BLACK Belt Kennels, R. 5, Montgomery, Ala. Collies all ages.

RABBIT hounds, fox,coon, skunk, squirrel dogs, setters, house dogs, list free. Violet Hill Kennels, Hanover, Pa.

RAISE Belgian Hares for us, Flemish Giants and New Zealand. Profits large. We supply stock and pay \$3.00 each. Also Cavies, Squab Brooders and fur-bearing animals. Instruction book and contract for dime. None free. Outdoor Enterprise Co., Box 13, Main St., Holmes Park, Mo.

AIREDALE Terriers, Blue blooded hunters. Young and grown stock. Washoe Kennels, Anaconda, Mont.

BIG Money in Pigeons and Squabs; Free book tells you all about it. Write today. Start profitable business of your own. Demand unlimited. Investment is small. Write today for Free Book. Indiana Squab Co., Dept. 1195, Terre Haute, Ind.

THOROUGHBRED Collie Pups. F. L. Tappan, Route 2, Hopkins, Minn.

FOR Sale—Pedigreed beagle hound puppies. C. E. Bates, Blanchester, Ohio.

AIREDALES—A grand litter of puppies for sale. Oaklawn Kennels, Marshalltown, Iowa.

TRAINED beagles, rabbit hounds, fox-hounds,coon, skunk dogs, ferrets, catalogues 10c. Brown's Kennels, York, Pa.

RAISE Guinea Pigs for us. We buy all you raise. Pay better than poultry. Contract, particulars, booklet how to raise free. Carver Distributing Co., 3162-A Grand Ave., Kansas City, Mo.

RAISE skunks in city or country. Odorless method. Illustrated circular P free. Skunk Development Bureau, Chicago.

SQUABS are raised in one month, they sell for fancy prices. Write at once for big free book telling how to make money breeding squabs. Plymouth Rock Squab Co., 634 Howard St., Melrose Highlands, Massachusetts.

PERSONAL

BROTHER—discovered nature's antidote, pleasant tasting root, chewed like gum, quickly overcomes tobacco habit and indigestion. Gladly send particulars. F. Stokes, Mohawk, Florida.

ST-STU-T-T-TERING and Stammering cured at home. Instructive booklet free. Walter McDonnell, Room 46, 817 Fifteenth St., N. W., Washington, D. C.

DIVORCE and Marriage Laws every State. Send 6c. Box 568, Reno, Nevada.

TOBACCO habit cured by harmless recipe. Sent free. Superba Co., 88, Baltimore, Md.

FREE—Stop using tobacco. We will give free information how to conquer habit easily and permanently. Results Guaranteed. Anti-Tobacco League, Box 370, Omaha, Neb.

ANTIQUES AND RELICS

POMO Indian Star Baskets. Prices free. Gilham, Highland Springs, Cal.

MISCELLANEOUS

COOLING System for hotels, restaurants, confectioners and the home. Anyone can make it. No ice. Low operating cost. Send \$1 for blueprint and instructions. R. L. Wilmoth, Dahlart, Texas.

LOCKSMITHS. How to unlock cylinder and all locks. 100 tricks of the trade \$1.00; money back if dissatisfied. Boutson, 576 42nd St., Oakland, Cal.

PEARLS, baroque, slugs, bought and sold. Designing, mounting, repairing jewelry done. "Pearls and Pearlery"—best book published \$1.00. Laverne Mapes, Indiana Harbor, Ind.

HEATING System which saves you hundreds of dollars. Adapted to any furnace for heating Libraries, Schools, Churches, Hotels or wherever heat or steam is required. Easily installed. Patented. Burner and Steam-generator \$50. We employ no salesmen. Root Crude Oil System, 2025 C Street, Eureka, Calif.

SHINES in the dark. Our Luminous Paint, coated on any article, makes them visible at night. Watches, clocks, electric switch plates, crucifixes, match boxes, etc., can be coated with splendid results. (Everlasting.) Only 25c bottle. Luminous Paint Co., Douglas Park Station, B-20, Chicago, Ill.

CASH paid for butterflies, insects. Some \$1 to \$7 each. Easy work. Even two boys earned good money with mother's help and my pictures, descriptions, price list, and simple instructions on painless killing, etc. Send 2c stamp at once for prospectus. Sinclair, Box 244, D6, Los Angeles, Cal.

GRANDFATHER Clock Works furnished to replace your worn-out ones. Price \$5 up; others with chimes—all prices. Write for our booklet. Clock Co., Nicetown, Pa.

CUTS anybody can make. Simple, cheap process \$1. Specimens, particulars for stamp. M. Day, Windfall, Ind.

MARK-O-ACID. Marks actual signature on tools. Outfit, 25c (coin). Mark-O Co., Box 15, St. Paul, Minn.

Auto Books



Just Out

A great automobile library is just off the press. It is called **Automobile Engineering**, and in it you will find everything about modern automobiles. Hundreds of pages explain all the new systems of ignition, starting and lighting. Welding, vulcanizing, and commercial garage equipment and operation is thoroughly covered. Five thick volumes, 5½x8 inches, flexibly bound in genuine morocco leather, gold stamped. 2,200 pages; 2,000 illustrations, tables and diagrams. Written in simple, easily-understood English, and carefully cross-indexed for quick reference.

Shipped Free

Don't send a penny. Just put your name and address in the coupon and we'll send all five volumes to you, express prepaid. Read them—study them—examine them carefully before you decide to buy. If you don't like them after 7 days—write us and we'll take them back at our expense. If you keep them, send only \$2.00 within 7 days, and then \$2.00 a month—50c a week—until the introductory price of \$16.50 has been paid. The regular price of this set will be \$25.00.

Partial List of Subjects

Motors, Welding, Motor Construction and Repair, Carburetors, Valves, Cooling, Lubrication, Fit-Wheels, Clutch, Transmission, Final Drive, Steering, Tires, Vulcanizing, Ignition, Starting and Lighting Systems, Wiring Diagrams, Shop Kinks, Commercial Garage Equipment, Electrical, Storage Batteries, Motorcycles, Commercial Trucks, Glossary.

Consulting Service FREE

In addition to the books you get free of all charge a \$12.00 Consulting Membership. If any question puzzles you—write us. Our corps of auto experts will solve any auto problem. Ask all the questions you want for a whole year. This service is absolutely free.

American Technical Society
Dept. A1196, Chicago, U.S.A.

Please send me a set of Automobile Engineering for 7 days' free examination. If I decide to buy, will send \$2 in 7 days and balance \$2 a month until \$16.50 has been paid, when books and Consulting Membership will be mine. Otherwise will notify you and hold books subject to your order. This not to pass until fully paid.

NAME.....

ADDRESS.....

REFERENCE.....

MAIL This Coupon

See these books before you decide to buy. Remember—don't send us a penny. Just fill in and mail the coupon. This offer is open to any person living within the boundaries of the U.S. and Can.

AMERICAN
TECHNICAL
SOCIETY
Dept. A1196
CHICAGO, U. S. A.

Please Mention Popular Mechanics

WIRELESS Taught You at Home TELEGRAPHY IN 8 WEEKS

AN OPPORTUNITY FOR HONOR AND PROFIT

If you wish a desirable means of serving your country, wireless is the answer. If you want to learn a profession that pays big salaries, with splendid opportunity for wide-world travel, quick promotion through positions of excitement and honor, wireless calls to your highest ambition.

Navy, Army and Commercial OPERATORS WANTED

The field of this great opportunity is open to you today—the possibilities are unlimited, and you can now learn at home—in your spare time, under the guidance of experts, at a merely nominal expense—less than one week's salary. The lessons are easy steps into the mysteries of this great modern wonder that today is playing such a powerful part in the struggle of nations. The marvels unfold before you, principle by principle—and in eight short weeks you stand equipped with the fundamental knowledge that places the inspiring opportunities of this profession in your hands.

Instruction by Pioneer U.S. Naval Operator

Personal supervision of the work of every student is given by this expert—also the privilege of free consultation after the course is completed. Full detailed information of this course of instruction in Radio Telegraphy will be mailed you FREE. Also description of equipment which is furnished each student. Write today for this booklet. Investigate this great, new opportunity. Get the proof of what is open to you through wireless.

Send a postal card with your name and address.
Do this immediately.

AMERICAN RADIO INSTITUTE
416 Dickason Building LEIPSI, OHIO

Be a Finger Print Expert

FINGER PRINTS



Police departments, factories and industries everywhere are adopting this system of identification. Experts needed at once. You can train yourself in spare time at home. Write for details.

Free Book—Write Valuable and interesting book on finger prints sent absolutely free and prepaid. Also details of special limited offer. Write at once, while this offer lasts.

EVANS UNIVERSITY, FINGER PRINT DEPT.
Desk 9196, 1810 Wilson Avenue, CHICAGO

Stop Eating Poison! Wrong food combinations are poisonous and destroy health—right combinations build health. Eugene Christian's 24 lessons in Correct Eating tell how to eat for health, strength and efficiency. Send for Free Trial No Money in Advance offer. Write today. **Corrective Eating Co., Dept. 50, 443 Fourth St., New York City**

POWER of WILL By FRANK CHANNING HADDOCK contains 28 fascinating lessons on how to strengthen the Will. Write for free trial offer. Pelton Publishing Company, 13 Wilcox Block, Meriden, Conn.



Learn a Paying Profession

that assures you a good income and position for life. For twenty-four years we have successfully taught

PHOTOGRAPHY

Photo-Engraving and Three-Color Work

Our graduates earn \$20 to \$50 a week. We assist them to secure these positions. Learn how you can become successful. Terms easy—living inexpensive. Write for catalogue—NOW!

ILLINOIS COLLEGE OF PHOTOGRAPHY, Box P, 999 Wabash Av., Effingham, Ill.

Free Test Lesson

**Wonderful
Opportunity for Every Ambitious
Man To Decide Whether or Not To—**

Be A Draftsman!



Charles W. Morey
Pres. of the College
and Head of a Large
Chicago Firm of En-
gineers and Contractors

Here is, without doubt, the most wonderful offer ever made by a Correspondence or Home Study Institution of any kind. Just think of it! We positively will send you a **Free Test Lesson in Draftsmanship** without any obligation on your part whatever. Just the coupon brings you **Free Test Lesson**. We don't even ask you to pay postage. We do that.

We send you this **Free Test Lesson** at our expense simply because we want you to see for yourself that the Chicago "Tech" Course in Draftsmanship is the most practical, simplest and easiest to master of any course ever written on the subject. This **Free Test Lesson** also positively proves that our Course will fit you for a Draftsman's position in the shortest possible time. It will prove that our Course will give you the practical knowledge necessary to make you an expert in any branch—Architectural, Structural, Machine Drafting or in the Building Line. It will prove to you that in Draftsmanship lies your future.

Investigate

If you are wide awake to the possibilities of Draftsmanship as a profession—if you are ambitious—you will at once send coupon for this **Free Test Lesson** and investigate the great future for you in this Big Income Paying Profession.

At present, thousands of Draftsmen are needed in all branches. The demand is increasing every day. The wonderful boom in all businesses in this country has created positions for more trained Draftsmen than can be recruited from the ranks for years to come. Our Special Training is the short cut that brings you to the top quickly. If you start NOW—in a comparatively short time you will be qualified to step into these big paying positions and

Free



Complete Drawing Outfit
and Full Instructions
in Mechanical Drawing
Sent FREE
on Enrollment

See for Yourself

This Free Lesson is an absolute test, pure and simple. Send for it today. In the privacy of your home study it, then you will know for yourself whether you are proper material for a successful Draftsman. Other institutions will ask for your money first. You find out later at your own expense, whether you can adapt yourself to the work and succeed in this profession.

We do not charge you one cent for the Test Lesson, either now or later. It is absolutely FREE. Nor do we obligate you in any way whatever by writing for the Free Test Lesson, so send coupon or write postal request today. If you do nothing else but secure the **Free Test Lesson** you will gain such valuable knowledge as will be beneficial to you through life, for the Free Lesson gives the very fundamentals of draftsmanship which are helpful to every man.

Earn \$25 to \$100 a Week and More

You can do it—with our help. We have successfully trained thousands of ambitious men—fitted them to qualify and hold the best positions in the business. Some of these men attended our school in Chicago—others learned at home—in spare time, evenings, through our simplified, new Correspondence Method. What we have done for these men we will do for you. No special advance training is necessary. The only qualifications you need possess are the ability to read and write. It will pay you to investigate. It means a big future—**independence, prosperity, happiness** for you.

CHICAGO TECHNICAL COLLEGE
930 Chicago "Tech" Building Chicago, Ill.

MAIL THIS COUPON

CHICAGO TECHNICAL COLLEGE,
930 Chicago "Tech" Building, Chicago

Without obligation to me, please send me your **FREE Test Lesson** in Draftsmanship and other interesting literature covering the subject indicated below.

Mark X opposite work in which you are specially interested.

Architectural Drafting.	Building Superintendence.
Builder's Course.	Structural Steel Drafting.
Estimating.	Sheet Metal Drafting.
Plan Reading.	Reinforced Concrete.
House Planning.	Machine Drafting.
General Contracting.	Surveying.

Name.....

Address.....

City.....State.....

College or Home Study Course? State which.....



Come to Detroit
The Automobile
Center
and

LEARN THE AUTOMOBILE BUSINESS

DETROIT
trained men get preference and get jobs quickly. No other city can give what Detroit offers. Think what it means to learn in the Michigan State Auto School. Factories endorse our school, glad to employ our graduates or offer them territory in which to sell cars and start garages. Unlimited opportunities.

71% of Automobiles are made in Detroit. You're right in the Heart of the Auto Industry. Men are needed everywhere as testers, repairmen, chauffeurs, garage men, and salesmen. Hundreds of our graduates start in business for themselves.

Earn \$75 to \$300 a Month

33,000 sq. ft. of Additional Floor Space

We teach you to handle any auto proposition. You graduate in from ten to twelve weeks. Our equipment is new, up-to-the-minute, and complete. No old, obsolete motors, chassis or electrical equipment used. Students actually build cars from start to finish, getting factory training in assembling, block-testing, road-testing, everything. Special complete course in Oxy-Acetylene brazing, welding and cutting, separate from regular course. Learn to time motors, rebore cylinders, adjust carburetors, magnetos, valves and bearings quickly and accurately. Six-cylinder Lozier, Chalmers "6," Detroit "6," Overland, and 8-cylinder King

are used for road instruction. We have the following completely equipped chassis:

Chalmers "6-30" 1917 chassis	Metz "4" 1917 Chassis
Detroit "6-45" 1917 chassis	Detroit Electric 1917 chassis
Buick Light "6" 1917 chassis	G. M. C. 2 Ton Truck
Willys-Knight 1917 chassis	Saxon "6" 1917 chassis
Studebaker "6" 1917 chassis	Maxwell 1917 chassis
Hudson Super-Six 1917 chassis	Oldsmobile "8" 1917 chassis
Cole "8" 1917 chassis	Winton "6" chassis
King "8" 1917 Chassis	Packard Twin "6" 1917 chassis
	Chalmers "4" 1913 Chassis

All completely equipped for students to work on. We have more than 20 motors in our block test department—2 cyl., 4 cyl., 6 cyl., 8 cyl., and 12 cyl. Our electrical department is complete, having every standard starting, lighting, and ignition system, including Delco System as used in Buick, Hudson, and Packard Twin "6."

DETROIT IS THE PLACE TO LEARN—START ANY TIME

There are 44 auto factories in Detroit and vicinity and 140 accessories and parts factories. Our students have the privilege of going through any or all of them. We operate Starting, Lighting, Ignition Service Station. This has added thousands of dollars' worth of equipment and makes our electrical department unequalled. Students get actual experience in handling all kinds of electrical auto equipment and taking care of trouble. We have just installed a Sprague Electric Dynamometer for block-testing purposes for students' use. Ours is the only Auto

school having this equipment. Auto factories need Dynamometer men constantly. Factories and garages are paying big salaries to men who know how to handle electrical equipment quickly and properly. Detroit is the automobile center. You get practical instruction. School open all the year. Enter classes any time, any day. Three classes daily: morning, afternoon, evening. All instructors are members of the Society of Automobile Engineers (S.A.E.) There is a great demand for Michigan State Auto School students. Auto factories write and phone for men constantly.

Follow the Crowd to the Michigan State Auto School. Come to Detroit

MONEY-BACK GUARANTEE

We guarantee to qualify you in a short time for a position as chauffeur, repair man, tester, demonstrator, auto electrician, garage man, or automobile dealer, paying from \$75 to \$200 monthly or refund your money. We have constantly more requests for Detroit trained men at GOOD salaries than we can supply.



THIS IS ONE OF THE FEBRUARY 1917 CLASSES



Additional Building and Equipment

Thousands of dollars' worth of new equipment, plenty of room for students to work, at 687-89-91 Woodward Ave., in addition to our building at 11-19 Selden Ave. Our school has grown by leaps and bounds, students come from all over the world. We are constantly adding new equipment. Our electrical department is thorough and complete.

Factory Co-Operation

We have completed arrangements with the Auto factories to put them in touch with men who intend going into business for themselves. Men who know the auto business from A to Z are in biggest demand. Remember, the price of course is based on giving full value. Graduates in the complete auto course are competent to handle farm tractors.

Auto Factories Endorse Our School

The Leading Automobile factories in Detroit, as well as in other cities, endorse our school. They have been watching our school and graduates for years and are satisfied. They are putting their latest model, complete chassis in our school for students to work on. They are employing our graduates in their factories and service stations and assisting them in opening garages and salesrooms. They allow our students to go through their factories. They need trained, competent men and are asking for more of our graduates constantly. The Michigan State Auto School in Detroit, the heart of the Auto Industry, is endorsed by the Leading Auto Factories, is receiving their hearty co-operation. What better endorsement could you ask?

Act Quickly—NOW! Fill in the coupon; get full particulars, "Auto School News" and New 128-Page Illustrated Catalog. All absolutely free. Or better still, jump on the train, as hundreds have done, and come to the "Heart of the Automobile Industry," and learn right. We have no branches. Write or come direct to this school.

Michigan State Auto School

The Old Reliable School
309 Auto Building
687-89-91 Woodward Ave.

A. G. ZELLER, Pres.
DETROIT, MICHIGAN, U. S. A.

SEND THIS COUPON TODAY

MICHIGAN STATE AUTO SCHOOL
309 Auto Bldg., 887-89-91 Woodward Ave.
DETROIT, MICHIGAN, U. S. A.

Gentlemen: Send me absolutely FREE "Auto School News" and New Catalog, or better still, you can expect

me about.....

Name.....

Street.....

City..... State.....

Our Country needs competent trained
Auto Mechanics in the
Quartermaster's
Dept. and Signal
Corps



A Packard Truck
Used By The
U.S. Government

The United States needs thousands of truck, transport, aeroplane and motor-cycle drivers. Trained competent men are needed, men who can take care of the machines, men who know how to keep them in service. Any piece of motor driven machinery the government owns or will own must be in service. Preference will be given to trained men. No matter what service the Army is doing it must be fed. If it is on the firing line it will need thousands of rounds of ammunition. The importance of trained men is very evident. Food and ammunition must be delivered regularly. Then too, the army must often be transported.

Quartermaster Department and Signal Corps Needs Trained Men

The Michigan State Auto School trains men thoroughly.

Every student learns pleasure cars, trucks, motorcycles and gasoline motors of every kind from A to Z. Graduates of the Michigan State Auto School are in big demand by the leading Automobile plants in Detroit. These factories know from actual experience that our men are thoroughly, completely and practically trained. No matter what happens to a truck or pleasure car, a Michigan State Auto School graduate is competent to repair it. Cars in the care of a graduate give highest efficiency.

This is the kind of men Our Government wants and is daily enlisting. Trained men who will be efficient themselves and keep every bit of motor driven equipment in the most serviceable condition.

This branch of the Army Service pays good salaries. There are wonderful opportunities for clean, clear headed, trained men to advance in the service and certainly now is the time to train.



Aerial View of Motor Truck Group at Ft. Sam Houston, Texas. Major F. H. Pope, Cavalry, Commanding

This view gives an idea of the large number of transport trucks that will be used in our Army. Thousands of trained men are needed and will be needed to care for these machines and keep them operating up to their highest efficiency. Trained men will be given preference and men who graduate from the Michigan State Auto School are now and have been holding big, responsible jobs in Detroit and over the country and will be able to serve their country in the most efficient way.

Thousands of Trained Motor Mechanics Needed in Army

Thousands of Motor Mechanics are needed in the army in the Quartermaster's Dept. and the Signal Corps. Nearly every man must be trained. Hundreds of thousands of men will be taken from every branch of the automobile business. Factories, garages and service stations will be depleted. There will be a crying need for trained men, both in the Army and out of it.

It is essential that an army be made up of the ablest fellows. It is absolutely necessary for men not of conscription age to fill the places left by men going to the front. Never were there such opportunities for men to get ahead in the Auto business. And never were trained men in such demand both in and out of the Army.

Thousands of Trained Motor Mechanics Needed at Home

With the army taking a million and a half men, there will be an enormous drain on the Automobile business. Trained men will be needed to fill the vacated jobs. Men older and younger than 21 to 31 years will step into the work. Trained Auto Mechanics will get the big paying jobs. Factories, service stations, garages, will be paying even higher salaries than ever. Thousands of new cars

are going into service daily. The United States and her Allies are ordering trucks and Autos by the thousands. Can you imagine a better chance to get into a money-making business? The Auto business has been good for years. It is getting better constantly. But right now is the opportunity of a lifetime — Get busy — write for catalog — train now to help Uncle Sam or yourself.

No matter whether you join the colors or stay at home,
you can do your bit best as a trained Auto Mechanic.

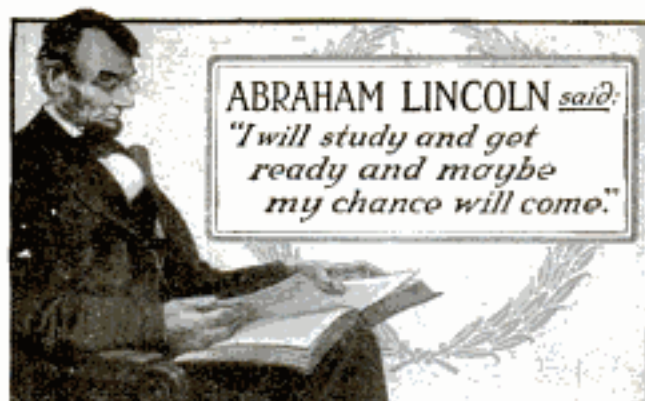

ABRAHAM LINCOLN said:

"I will study and get ready and maybe my chance will come."

YOUR Chance Will Come

Born in a log cabin, Abraham Lincoln had little chance to acquire an education. But he was determined to succeed. "Some day," he said, "my chance will come." So he studied and got ready. And his chance *DID* come.

Your chance will come. Some day you'll be considered for promotion or for a good job in some other line of work. If you are ready, you'll go up.

And you *CAN* get ready. No matter if your schooling was limited—if you do have to work long hours. If you really want a better job, the International Correspondence Schools can train you for it at home during your spare time.

Every month more than 400 I. C. S. Students voluntarily report promotions or salary increases due to I. C. S. help. What the I. C. S. have done for these men they can do for YOU. Mark and mail the coupon NOW.

INTERNATIONAL CORRESPONDENCE SCHOOLS, Box 5607, Scranton, Pa.

TEAR OUT HERE

INTERNATIONAL CORRESPONDENCE SCHOOLS BOX 5607, SCRANTON, PA.

Explain, without obligating me, how I can qualify for the position, or in the subject, before which I mark X.

ADVERTISING MAN
Salesmanship
Commercial Law
BUSINESS (Complete)
Certified Public Accountant
Higher Accounting
Bookkeeper
Stenographer and Typist
Railway Accountant
WINDOW TRIMMER
Show Card Writer
Outdoor Sign Painter
Common School Subjects
Good English
Teacher
Civil Service
Railway Mail Clerk
CIVIL ENGINEER
Surveying and Mapping
MECHANICAL ENGINEER
Mechanical Draftsman
Machine Shop Practice
Stationary Engineer
Gas Engineer

ELECTRICAL ENGINEER
Electric Lighting
Electric Car Running
Electric Wiring
Telegraph Expert
Practical Telegraphy
Railroader
Miss Foreman or Engineer
Metallurgist or Prospector
ARCHITECT
Contractor and Builder
Architectural Draftsman
Concrete Builder
Structural Engineer
Plumbing and Heating
Sheet Metal Worker
CHEMICAL ENGINEER
Illustrator
Designer
Textile Overseer or Supt.
AGRICULTURE
Navigator Spanish
 German
Poultry Raising French
AUTOMOBILES Italian

Name _____
Present Occupation _____
Street and No. _____
City _____ State _____

If name of Course you want is not in this list, write it below.

Please Mention Popular Mechanics

Learn How to WRESTLE



In Your Own Home
By Mail

Yes, learn to become an expert wrestler, right in your own home, by mail, from the greatest wrestlers the world has ever known. Be an athlete, be strong, be healthy. Learn how to throw and handle big men with ease. Learn to defend yourself. All taught in our course of lessons, and illustrated with hundreds of charts and actual photographs by

Farmer Burns and Frank Gotch

Farmer Burns, "the grand old man of the mat," taught Frank Gotch, the present World's Champion, all he knows about wrestling, so Gotch says. He will now teach you Scientific Wrestling—Physical Culture—Jiu-Jitsu—Self Defense. Every man and boy in America, no difference what age, needs this wonderful course of lessons. Write today—your name, age and address on a postcard or letter brings you our free book absolutely free—no obligations of any kind. A splendid book on wrestling and physical culture. Write today stating your age.

Farmer Burns School of Wrestling, 1196 Range Bldg., Omaha

This Wrestling Book FREE



What's Wrong With You? PEP! NERVE! VIGOR!—GONE?

Do you dare to ask yourself why your Health and Strength are falling? Look at yourself in the glass, ask what's wrong? Why are you not able to get the most out of life in the joy of living and earning capacity? Do you realize the danger you are in by neglecting yourself? Is it constipation, nervousness, indigestion, insomnia, weak heart, rheumatism, rupture, physical weakness, poor memory, lung trouble, catarrh, short wind, poor circulation, round shoulders, skin disorders? Are you flat chested or round shouldered? Too thin or too stout? Do you want to increase your height, or muscular development, or just your general health?

ARE YOU AFRAID OF THE TRUTH? Why not come to me as a friend and confidant and tell me what is preventing your getting the most out of life? I will write you a friendly, personal, helpful talk that will lift you out of despair and suffering. I will send it in a plain, sealed envelope. If you are a victim of any habits which are ruining your ambition, endangering your future, even threatening your life, LET ME HELP YOU. DELAY MEANS DANGER. You can't mend the body with OILS, PHYSICS AND PIFFLE! You must know Nature's way. This is the strongest way. I will show you. Send for my wonderful book, "Intelligence in Physical and Health Culture," enclosing 5c. to pay mailing. It will help you to shape your destiny. Be the master, not the slave. Write today.

LIONEL STRONGFORT
PHYSICAL CULTURE EXPERT
220 Park Bldg. NEWARK, N. J.

DRAWING

Learn by Mail in YOUR OWN HOME

Newspaper, Magazine and Commercial Illustrating, Cartooning, Water Color and Oil Painting. Learn drawing or painting for profit and pleasure. We can develop your talent. This school has taught thousands. Free Scholarship Award—special limited offer. Your name and address brings you full explanation and our handsome illustrated Art Annual by return mail. Don't delay, write to-day. Fine Arts Institute, Studio 216, Omaha, Neb.



FREE This Complete Set of Drawing Instruments



\$15.00 Draftsman's Complete Working outfit free to students. They do not cost you a penny on this offer. Write today for particulars. Do it NOW. \$150 to \$300 a Month My graduates are earning from \$150.00 to \$300.00 a month and more. WRITE TODAY. Send for my free book on drafting. No obligations. Write now. Chief Draftsman Dobe, Div. 1195 Engineer's Equipment Co. Chicago

FINLAY Engineering College KANSAS CITY, MISSOURI ONLY SCHOOL OF THE KIND IN THE WEST

Specialties: Electricity, Steam, Gas. Six weeks, three months, year, and two year courses. Auto-Tractor, Armature Winding, Conduit Work, Lathe Work, Oxy-Acetylene Welding, Corliss Valve Setting, Operation of Steam, Gas Electric Machinery. Anything you want, any time you want it, night or day, from a week to two years. Write for Catalog T.

60 BOOKS Bound in Leather \$1.00 AFTER TRIAL

Balance in small payments each month. Not a penny in advance. The masterpieces of Kipling, De Maupassant, Stevenson, G. Bernard Shaw, Victor Hugo and dozens of others. Each book bound in genuine limp leather, pocket size. Write postal now for offer.

LITTLE LEATHER LIBRARY, 150 Newcastle Bldg., 23rd St., New York

Advertising Manager—\$5000 a Year YOU CAN BE ONE

If our Vocational Director will accept you, then you can succeed in advertising. Ten practical business men will teach you. Write for booklet, "Poverty to \$10,000 a Year" and "Free Personal Analysis blank."

BRYANT & STRATTON COLLEGE, 1023 Bryant & Stratton Bldg., CHICAGO, ILL.

Sign The Declaration of your Independence NOW

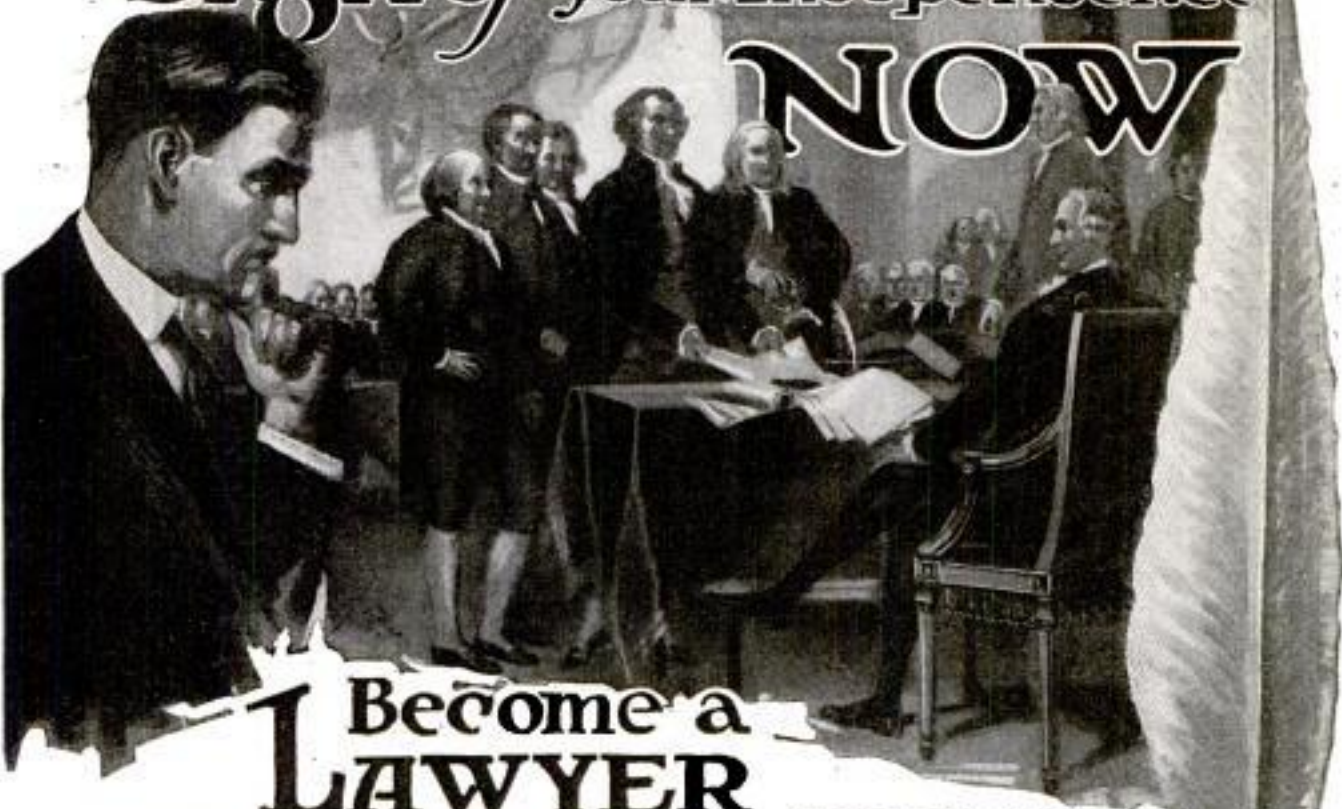

Become a LAWYER

Law will bring You independence—personal, social and financial. Law is the greatest and grandest of all professions. Law is the greatest maker of great men. Law has raised more men to position, wealth, honor and fame than all other professions combined. Everywhere from the country village to the halls of Congress, lawyers are the leaders. The makers of the Great American Republic—our statesmen, presidents, Cabinet officers, congressmen, ambassadors, captains of industry, politicians, officials of states and cities—nearly all—have been men of legal training. The greatest men of today are—lawyers. Many of these men were born in poverty and obscurity and were raised into positions of great power by the law.

The huge growth of the American Government—the vast increase in business—the endless multiplications of firms and corporations have created new opportunities, not only for thousands of lawyers—but for tens of thousands of legally trained men in the professions and in business. Thus NOW is the time for YOU to start reading LAW.

Excellence of La Salle Course Recognized

The Law Course of the La Salle Extension University is nationally recognized as standard for correspondence instruction. Unlike the methods of ordinary correspondence schools—you are not required to learn law slowly and laboriously from dry technical books but you are instructed and "coached" by our professors and instructors just as though you were in class taking a costly course at a resident law school. This La Salle System of "Home University Instruction" has been perfected so that you will require nothing more than clear-thinking brains and the ability to read and write English intelligently. You will meet with no difficulties—nothing beyond your capacity to learn—as our instructors and professors will take you step by step—to the day of your graduation—and with the guarantee that, if you fail to pass the Bar Examination in any state, you will be coached without cost until you do pass.

"We Bring the University to Your Home"

In your home—by our perfected correspondence method, which has won the admiration and approval of the most noted American educators—we give you exactly the same grade of instruction and training that you would receive in class at a resident college of law. From your personal instructor you will receive close detailed supervision, and guidance step by step from one lesson assignment to another—constantly from the day you begin your studies until the day you graduate. You will never be left alone. You will be personally coached, directed, corrected. The daily "Lesson Talks" of your instructor will enable you to grasp and to thoroughly understand the legal principles taught by each lesson. You can write him as often as you wish for special help—and for explanation of points you do not understand clearly. Reply will be immediate. It will be almost like you were with him reading and studying daily.

Determine to become a lawyer—to earn from \$5,000 to \$25,000 or more—a year—you can't go wrong if you follow in the footsteps of the great Americans who have gone before—Sign your declaration of independence NOW.

LA SALLE EXTENSION UNIVERSITY

Dept. 964 F

"The World's Greatest Extension University"

Chicago, Ill.

WE TRAIN YOU AT HOME—BY MAIL

By the system of La Salle "university" law training at home you will be enabled to hold your present position—and earn while you learn. The daily lesson assignments and "lesson talks" will make your progress easy. Success is assured. There are no "extras" to buy—we supply everything—including the La Salle Standard Library of Law entitled: "American Law and Procedure," a wonderful work by some of America's most noted lawyers, jurists, judges and professors of the leading law universities—costing over \$50,000 to produce.

FREE—Complete Course in Public Speaking

No other Course like it. Our training—by mail—will positively teach you the art of persuasive speech. Every Lawyer—every successful man should be a forceful speaker. Our course is highly endorsed as most complete and authoritative—prepared by Frederick B. Robinson, A. B., A. M., Ph. D., Professor Public Speaking at College of City of New York, formerly Editor Public Speaking Review. Send coupon and learn how you can NOW secure this valuable course.

La Salle
Extension
University,
Dept. 964 F
Chicago, Illinois

Send at once
facts about your
free offer of Com-
plete Course in Pub-
lic Speaking; also
free books, "Evidence
and Valuable Law
Guide."

Name.....

St. and No.....

City.....State.....

Please Mention Popular Mechanics

Copyrighted material

LEARN AUTOS

WHERE AUTOS ARE MADE



Enlarged
Facilities

Freely Endorsed by
Automobile Manufacturers

Detroit is the training camp for men who make good in the automobile and allied lines. Never has the call for men skilled as mechanics, testers, inspectors, repair-men, bearing scrapers, welders, chauffeurs and salesmen been as great as it is today — and the demand is growing.

The Y.M.C.A. Auto School

is organized to train men. A Course in this School will quickly fit the beginner to do well-paid work, and get in line for advancement in the rapidly growing automobile industry. Tuition fees go to procure the highest class of instructors and best of equipment.

Growth Brings Added Facilities

The Y.M.C.A. Auto School is now in its New Building. Among the manufacturers who have contributed liberally toward our equipment are: Studebaker, Buick, Hupp, Chalmers, Ford, Packard, Hudson, Gray & Davis, Delco, Cutler-Hammer, Zenith, and many others. Can you ask stronger proof of the school's standing than the fact that men who know give freely of their time and money to co-operate with us.

Tuition includes membership in the "Y" and free service of **Employment Bureau** for one year. Our big Club House, adjoining our New Building, is at your disposal. Reading rooms, lounging rooms, gymnasium, swimming pool, billiard and pool tables, bowling alleys, with five floors of dormitories and restaurant at low rates. You are assured of not only thorough and competent instruction, but good companionship and clean living conditions with the comforts of home and club life combined. **Don't Visit Detroit Without Seeing Us.** You want to consider everything carefully before you enroll for any course of instruction. Come and look us over, whatever purpose brings you to Detroit. Get all the particulars of this school, get the records of our instructors, hear what auto factories and automobile men have to say about us, see for yourself our comfortable quarters and big equipment. We will be glad to see you and show you around whether you enroll or not. Day and night classes. Start at any time.

Write today for full particulars. Address

**EDUCATIONAL
DIRECTOR**

Box 305, Y.M.C.A., DETROIT, MICH.

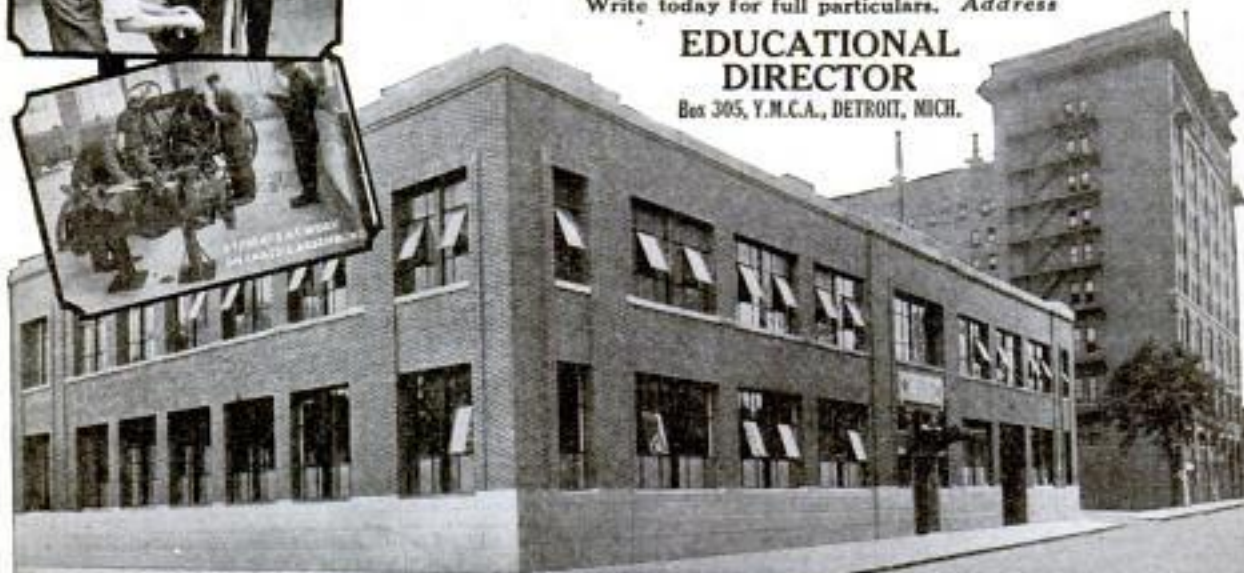

NEW HOME OF Y.M.C.A. AUTO SCHOOL

Pay-Raising Books at Reduced Prices



Here's your chance to get—at a bargain price—a set of books that will fit you for a better job and bigger pay. Yes, and you may pay the bargain price at the rate of only 50c a week. But you must act now! The rising cost of paper and binding materials won't permit us to continue this offer indefinitely.

No matter what your occupation, one of the sets listed below is bound to suit your needs. They are written in simple, non-technical language by recognized authorities, and contain thousands of photographs, full-page plates, diagrams, etc., that make difficult points as simple as A-B-C. Handsomely bound in half or full morocco leather, gold stamped.

Shipped for 7 Days' Free Trial

We'll gladly send any set of books to you for seven days' free examination, shipping charges fully prepaid. Examine them carefully—use them at your work for an entire week. If, at the end of that time, you feel that they aren't worth many times what we ask, send them back to us. If you keep them, pay the specially-reduced price on the easy terms explained below.

An opportunity like this may not come again for years. Take advantage of it today—now! Select the set you need from this list of practical, up-to-date mechanical books and save 20 to 50 per cent.

The American Technical Society's

Practical Mechanical Books

	Vols.	Pages	Size of Page	Illus.	Regular Price	Special Price
Civil Engineering	9	3900	7x10	3000	\$45.00	\$29.80
Architecture, Carpentry and Building	10	4760	7x10	4000	50.00	24.80
Steam Engineering	7	3300	7x10	2500	35.00	19.80
Applied Electricity	7	3000	7x10	2600	35.00	19.80
Fire Prevention and Insurance	4	1500	7x10	600	20.00	15.80
Automobile Engineering	5	2400	5½x8¾	2000	25.00	16.80
Telephony and Telegraphy	4	1728	7x10	2000	20.00	12.80
Modern Shop Practice	6	2300	5½x8¾	2500	30.00	17.80
Heating, Plumbing and Sanitation	4	1600	7x10	1600	20.00	12.80
Drawing	4	1720	7x10	1037	20.00	9.80
Motion Picture Work	2	600	7x10	300	12.00	6.00

Only 50c a Week

Not only can you buy these books at a rock-bottom price, but we offer them to you on the easiest of monthly payments. If, after seven days' examination, you decide to keep the set you have selected, simply send us \$2 and then \$2 a month until the present low price has been paid. Have you ever heard of a more generous offer?

Don't wait. This means money in your pocket if you act now. Remember, you take no chances whatever—it costs nothing to inspect and you are not obliged to keep the books if you do not care to buy. This offer is open to every man living within the boundaries of the U. S. and Canada. Mail the coupon now—before you turn the page!

AMERICAN TECHNICAL SOCIETY
CHICAGO, U. S. A.

SPECIAL DISCOUNT COUPON

AMERICAN TECHNICAL SOCIETY, Chicago, U. S. A.

Please send me set of.....

for 7 DAYS' FREE examination, express prepaid. I will examine the books thoroughly and, if satisfied, will send \$2 within 7 days and \$2 each month until I have paid the special price of..... If I decide not to keep the books, I will notify you at once and hold them subject to your order. Title not to pass to me until the set is fully paid for.

P. Mech. 9-17

NAME.....

ADDRESS.....

REFERENCE.....

Please Mention Popular Mechanics



There Goes a Man of Power

EVERYWHERE the man of power—the healthy, vigorous, manly man—challenges admiration and respect. There is magnetism in his confident, self-reliant poise. The secret of perfect, vital health and power is not in the luck of birth. **You can have it.** Nature is striving all the time to make a manly, masterful man of you. And she needs only a little help to succeed. **And you can give it to her.** Vibration is the secret. It restores power to young men and old—the sparkling, glowing health of buoyant youth. **For vibration is life.**



In this machine there is almost magic power to banish disease and pain, to put sound, firm flesh on shrunken bodies, to remove degenerated fatty deposits, to clear the skin, to **tone up and vitalize** every part and organ of the body. Vibration flushes out the poisonous secretions and helps the blood perform its natural repair work. Every nerve and fibre responds to the wonderful force and your whole body tingles with the exhilaration of your own awakening power.



Send the Coupon For Our New Book

Lindstrom-Smith Co.
1100 S. Wabash Ave.
Dept. 8196, Chicago, Ill.
Please send me, absolutely free and prepaid, your new book, "Health and Beauty," and full particulars about the White Cross Electric Vibrator. I assume no obligations of any kind.

Just put your name and address on the free coupon and mail to us today—we will send you absolutely free and prepaid our big, new book, "Health and Beauty." No obligations. You need the book—it carries a vital message. Write today—now.

Lindstrom-Smith Co.
1100 S. Wabash Ave.
Dept. 8196, CHICAGO, ILL.

We also manufacture
White Cross Electric
Shaves, Irons, Hair
Dressers, Electric
Lampers, Fans,
Automobile Horns,
Curling Irons,
Heating Pads,
Small Motors, etc.
Dealers Write.

Name

Address

My Electrical Dealer's Name is

Please Mention Popular Mechanics

This Fob FREE

Are you interested in the mechanical side of an automobile, its proper operation and economical maintenance?

Owners—Garagemen—Chauffeurs

The *American Chauffeur* is a live monthly magazine featuring articles in common sense language, by "men who know," on instructive topics, which will be interesting and of great value to every auto owner, chauffeur and garageman.

FREE OFFER

To introduce the *American Chauffeur*, we are offering this plated lacquered watch fob, with seal grain leather strap, as illustrated, **ABSOLUTELY FREE**, with a 3 months subscription to the *American Chauffeur* at the regular price of 25c.

Your money refunded if either the magazine or fob does not come up to your expectation.

THE AMERICAN CHAUFFEUR
89 Butler Bldg., CINCINNATI, OHIO

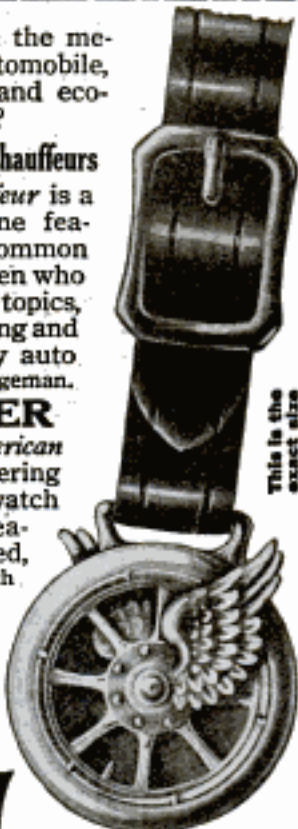

This is the exact size

LEARN WATCHMAKING AND ENGRAVING

Earn while learning. Most practical watch school. Individual instructions. Graduates in great demand. Book free. Chicago School of Watchmaking, 63 E. Van Buren St., Chicago

STUDENTS ART MAGAZINE

Publishes cash art assignments, lessons and articles on Cartooning, Designing, Illustrating, Lettering, and Chalk-Talking. Criticizes amateurs' work. Full of interesting and helpful information for artists and art students. Satisfactory or money refunded. 10 cents a copy, \$1 a year. Send \$1 NOW, stamps or bill.

STUDENTS ART MAGAZINE, Dept. 252, Kalamazoo, Mich.

Learn to Concentrate

Prof. Theron Q. Dumont's famous 20 Lesson Course in Concentration, now sent in handy book form, for 5 days' FREE examination. Gives every principle and method. Also practice exercises. Tells you just how to concentrate. Get it now—while offer lasts. Send no money. Read it 5 days. Then, if satisfied, send only \$2. Otherwise return to us. Write for it today on this FREE offer. **ADVANCED THOUGHT PUB. CO., Dept. 939, 168 N. Michigan Ave., Chicago**



This Man Specialized in Electrical Meter Engineering!

Now he is superintendent of instruments and meters for a large Electric Light and Power Co. and has 25 men under him. The training he got from our easily mastered, home study course enabled him to step into this big job after only a few months study. What he has done YOU CAN DO!

Write Today for Free Literature with this man's own story of his success. Find out about the exceptional opportunities in this interesting, fascinating, profitable profession. Your name and address is enough. The book is free. No obligations. Write today—NOW. You can have a job like this. **Fort Wayne Correspondence School, Dept. 1196, Fort Wayne, Ind.**



"Don't tell me you never had a chance!"

"Four years ago you and I worked at the same bench. We were *both* discontented. Remember the noon we saw the International Correspondence Schools' advertisement? That woke me up. I realized that to get ahead I needed special training, and I decided to let the I. C. S. help me. When I marked the coupon I asked you to sign with me. You said, 'Aw, forget it!'

"I made the most of my opportunity and have been climbing ever since. You had the same chance I had, but you turned it down. No, Jim, you can't expect more money until you've trained yourself to handle bigger work."

There are lots of "Jims" in the world—in stores, factories, offices, everywhere. Are *you* one of them? Wake up! Every time you see an I. C. S. coupon your chance is staring you in the face. Don't turn it down.

Right now over one hundred thousand men are preparing themselves for bigger jobs and better pay through I. C. S. courses.

You can join them and get in line for promotion. Mark and mail this coupon, and find out how.

INTERNATIONAL CORRESPONDENCE SCHOOLS
Box 5601, Scranton, Pa.

Reports on 27,000 typical I. C. S. students show 14,900 now receiving \$1500 a year or more; 2451 receiving \$2500 or more; 413 receiving \$5000 or more; 20 receiving \$10,000 or more; and eight with annual incomes of \$25,000 or more.

WHAT OTHERS HAVE DONE YOU CAN DO

INTERNATIONAL CORRESPONDENCE SCHOOLS

Box 5601, SCRANTON, PA.

Explain, without obligating me, how I can qualify for the position, or in the subject, before which I mark X.

- | | |
|---|--|
| <input type="checkbox"/> ELECTRICAL ENGINEER | <input type="checkbox"/> SALESMANSHIP |
| <input type="checkbox"/> Electric Lighting | <input type="checkbox"/> ADVERTISING MAN |
| <input type="checkbox"/> Electric Car Running | <input type="checkbox"/> Window Trimmer |
| <input type="checkbox"/> Electric Wiring | <input type="checkbox"/> Show Card Writer |
| <input type="checkbox"/> Telegraph Expert | <input type="checkbox"/> RAILROADER |
| <input type="checkbox"/> MECHANICAL ENGINEER | <input type="checkbox"/> ILLUSTRATOR |
| <input type="checkbox"/> Mechanical Draftsman | <input type="checkbox"/> DESIGNER |
| <input type="checkbox"/> Machine Shop Practice | <input type="checkbox"/> BOOKKEEPER |
| <input type="checkbox"/> CIVIL ENGINEER | <input type="checkbox"/> Stenographer and Typist |
| <input type="checkbox"/> Surveying and Mapping | <input type="checkbox"/> Cert. Public Accountant |
| <input type="checkbox"/> HIRE FOREMAN OR ENGINEER | <input type="checkbox"/> Railway Accountant |
| <input type="checkbox"/> Metallurgist or Prospector | <input type="checkbox"/> Commercial Law |
| <input type="checkbox"/> STATIONARY ENGINEER | <input type="checkbox"/> GOOD ENGLISH |
| <input type="checkbox"/> Marine Engineer | <input type="checkbox"/> Teacher |
| <input type="checkbox"/> ARCHITECT | <input type="checkbox"/> Common School Subjects |
| <input type="checkbox"/> Contractor and Builder | <input type="checkbox"/> CIVIL SERVICE |
| <input type="checkbox"/> Architectural Draftsman | <input type="checkbox"/> Railway Mail Clerk |
| <input type="checkbox"/> Concrete Builder | <input type="checkbox"/> AGRICULTURE |
| <input type="checkbox"/> Structural Engineer | <input type="checkbox"/> Textile Overseer or Supt. |
| <input type="checkbox"/> PLUMBING AND HEATING | <input type="checkbox"/> Navigator |
| <input type="checkbox"/> Sheet Metal Worker | <input type="checkbox"/> Poultry Raising |
| <input type="checkbox"/> CHEMICAL ENGINEER | <input type="checkbox"/> AUTOMOBILES |
| | <input type="checkbox"/> Auto Repairing |
| | <input type="checkbox"/> Spanish |
| | <input type="checkbox"/> German |
| | <input type="checkbox"/> French |
| | <input type="checkbox"/> Italian |

Name _____
Occupation & Employer _____
Street and No. _____
City _____ State _____

Please Mention Popular Mechanics

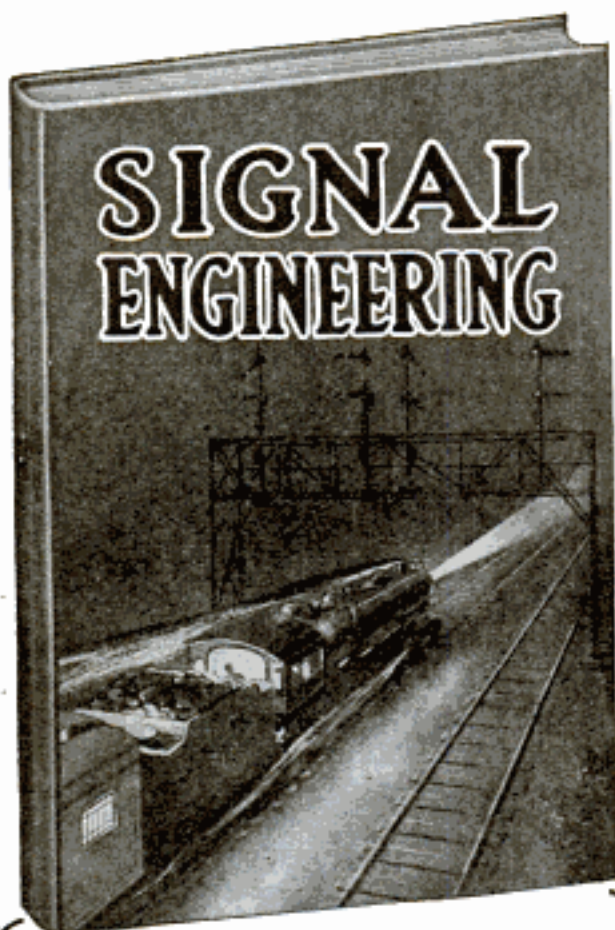

Free Book On Signal Engineering

THERE are thousands of miles of railroad that must be equipped with block signal systems. To superintend these installations and to maintain the systems now in use thousands of men are necessary. Golden opportunities are offered. Every ambitious man in America should write for the free book on Signal Engineering. It will be sent to you prepaid—without obligation.

Men Are Needed to Accept High Salaried Positions

When you stop to consider that, at the present time, less than one-fourth of the passenger lines in this country are equipped with automatic block signal systems—and when you read that the day is fast coming when the law will compel railroads to install them, you will realize what remarkable opportunities are offered to ambitious men in the profession of Signal Engineering. The work is big—broad—high salaries are paid. \$250.00 a month is an ordinary salary for a Signal Engineer.

Department of Signaling

Dept. 1196, 1810 Wilson Ave.
Riverswood Station Chicago

GENTLEMEN:—Please send me absolutely free and prepaid your big new book on Signal Engineering. Also full particulars about your great special free outfit offer. It is distinctly understood that I assume no obligations of any kind.

Name.....

Address.....

Age..... Occupation.....

Send the Coupon

Put your name and address in the coupon, or a letter or post card Now and get the free book about Signal Engineering. Too, we will tell you how you can get the training that you need in order to become a Signal Engineer. You will be under no obligation by writing for this free book. Do it Now.

Department of Signaling

Dept. 1196
1810 Wilson Ave.
Riverswood Sta.
Chicago

Please Mention Popular Mechanics

Mr. A. R. Patterson, whose advertisement appears below, was for eight years a Civil Service Secretary-Examiner, and is well qualified to help YOU secure a Government Position.

CIVIL SERVICE NEEDS MEN

Send for Free Book

By Working for Uncle Sam.

Men in Civil Service do as great a service as those in the field of battle. Positions pay \$35 to \$150 a month. Short hours. Easy work. No strikes, no hard times, no layoffs. No petty bosses. No politics—no pull. Ordinary education sufficient. 15 and 30 day vacations each year with full pay. Sick leave with full pay. Positions for life.

RAILWAY MAIL CLERK, POSTAL CLERK, REVENUE OFFICER, CUSTOMS SERVICE

and many other divisions of Government Service offer splendid opportunities for big pay and rapid advancement. If you are an American Citizen, 18 or over, send in your name for all facts about Government Positions and how to get one.

NEW BOOK FREE!

Mr. Patterson was U. S. Civil Service Secretary-Examiner for 8 years, and has students and graduates in practically every State in the Union in all branches of Government Service. Not one cent, if you do not secure a position. Mail postal NOW for Free Book and special 30-Day Offer! Address

PATTERSON CIVIL SERVICE SCHOOL
89 News Bldg., Rochester, N. Y.

FREE!



A flying model aeroplane and all materials to build your own scale model, Free with our great Home Course in the Principles of Aviation. Write at once—before this offer is withdrawn. Learn the Science of Aviation at Home—under guidance of Experts. Tremendous demand for men who know aviation. Wonderful future. Prepare now. Write us today.

NATIONAL AERO INSTITUTE, Dept. 1196, Morton Bldg., CHICAGO

AT HOME

Learn TO SING

Send 2-cent Stamp for Helpful Booklet, "The Voice Made Beautiful."

HARVEY SUTHERLAND, 1832P 49th St., BROOKLYN, N. Y.

LEARN WATCHMAKING

and become independent. Good-paying positions secured. Easy to learn. Send for FREE CATALOG.

ST. LOUIS WATCHMAKING SCHOOL, Dept. 5, ST. LOUIS, MO.

Capitalize Your Ability With Law Training

No matter what kind of work you may be doing, Law training, plus your natural ability and experience, will enable you to make more money. Many men with remarkable natural ability fail, because they have no knowledge of the legal principles governing their business.

Analysis Free!

Let us tell you how the law will make you more efficient. We have helped thousands—and will give you the same analysis free. We'll tell you whether you are fitted for your present work or for what business or profession you are best fitted. The analysis is free—no obligations. Write today for our Personal Examination blank.

American School of Correspondence
Dept L-1196 Chicago, U. S. A.

LET THE LEADING CARTOONISTS HELP YOU

These Men Will Help You to Success

TODAY the world is looking for men who can sway public opinion. The cartoonists helped sell the Liberty Loan. The cartoonists educated America to patriotic acceptance of the draft.

One Cartoonist Makes \$125,000 a Year

Great cartoonists are well paid. Clare Briggs makes an income estimated to be half as much as that of the President of the United States. Reuben Goldberg is said to receive \$125,000 a year.

Why not make your ideas work for you?

The cartoonist does big things. He does not punch a clock.

IN ONE COURSE:

Cartooning
Chalk-Talking

Animated Motion Picture Art
Window Card Writing

Bart (Charles L. Bartholomew), for 25 years cartoonist of the Minneapolis Journal, has gathered with him on the Advisory Staff of the Federal School of Applied Cartooning the 25 leading cartoonists of today. The cartoonists whose pictures are shown here compose the staff of the Federal School of Applied Cartooning. Together they have instituted a complete service in Cartooning, Chalk-Talking, Animated Motion Picture Art, and Window Card Writing.

In this course these men give you all the fundamentals of these arts. They tell you how they marketed their first work and what is the best way to make your start. Bart's famous course in chalk-talking is included in this instruction. Winsor McCay, the originator of Animated Motion Pictures, here tells the secrets of this coming art for the first time.

Send for "A Road To Bigger Things" Today—"A Road To Bigger Things" contains studio pictures of America's most famous cartoonists, with the story of how they made their way.

Federal School of Applied Cartooning 793 Federal Schools Building MINNEAPOLIS, MINN.

Just cut the coupon here—
with along the dotted line—
sign your name and address



—and mail it now. "A Road
To Bigger Things" will be
sent free by return mail.



CLARE BRIGGS



MCKEE BARCLAY



OSCAR CESARE



JAY N. DARLING



J. H. DONAHAY



RAY EVANS



FONTAINE FOX



WILLIAM IRELAND



W. E. HILL



HERBERT JOHNSON



KIN HUBBARD



D. J. LAVIN



C. L. BARTHOLOMEW



CLIVE WEED



GAAR WILLIAMS

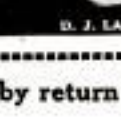

FRANK KING



J. W. MCGUIRE

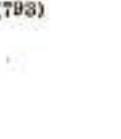

WINSOR MCCAY



J. T. MCCUTCHEON

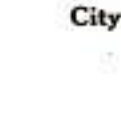

EDW. MARSHALL



CAREY ORR

FRANK WING

S. S. WATTS

CHAS. H. SYKES

SIDNEY SMITH

Please send by return mail my free copy of "A Road To Bigger Things."

Name.....

Street.....

(793)

City and State.....

Take a Pencil and make an "X"

A LITTLE X, like the one shown here, has marked the starting point for a good many big successes. It's an easy thing to make. Your pencil will make it in a jiffy BUT it may mark the turning point in your life.

These days the thing that puts a man above his fellows is TRAINING.

And this little "X" when marked on the coupon below will bring you a handsome free book that will tell just exactly how YOU can get the training that has put THOUSANDS of men into high positions. It won't be necessary for you to leave your home to get this training. For twenty years the American School has been giving ambitious men practical training that started them on the road to success.

Send the Coupon

Take a pencil now and mark an X before the position for which you want to qualify yourself. Let us tell you how we have given other men the training that enabled them to hold these positions. Let us tell you how you can get THIS VERY TRAINING right in your own home during your idle hours. You will be under no obligations by sending the coupon.

Find out for yourself what the American School will do for you. Make your mark in the coupon now for the sake of your ambition and the man you want to be. Opportunity is calling. Your ambition is saying, send the coupon. Do it now.

American School
of Correspondence, Chicago, U.S.A.

Dept G1196 Chicago, U. S. A.

Mark
an X
and
Mail
Today

American School of Correspondence, Dept. G1196 Chicago, U.S.A.
Gentlemen: Without obligation please send me booklet and tell me how I can qualify for position marked X.

- | | |
|--------------------------------|-----------------------------|
|Electrical Engineer |Business Law |
|Elec. Light & Power Supt. |Business Manager |
|Hydroelectric Engineer |Auditor |
|Telephone Engineer |Accountant |
|Architect |Cert'f'd Public Acct't |
|Architectural Draftsman |Stenographer |
|Building Contractor |Bookkeeper |
|Building Superintendent |Fire Ins. Inspector |
|Structural Engineer |Fire Ins. Adjuster |
|Structural Draftsman |Fire Ins. Expert |
|Mechanical Engineer |Sanitary Engineer |
|Mechanical Draftsman |Master Plumber |
|Civil Engineer |Heat and Vent. Eng. |
|Steam Engineer |Plumb. and Heat. Est. |
|Shop Foreman |Reclamation Engineer |
|Shop Superintendent |Automobile Engineer |
|Sheet Metal Draftsman |Automobile Repairer |
|Lawyer |High School Course |

We also prepare for civil service examinations in all engineering subjects.

Name.....

Address.....



Music Lessons

Book FREE Sent Wonderful home-study music lessons under great American and European teachers given by the **University Extension Method**. The lessons are a marvel of simplicity and completeness, endorsed by Paderewski and other great authorities. You, too, can now quickly and easily satisfy your musical ambitions.

Any Instrument or Voice

Write, telling us the course you are interested in, age, how long you have taken lessons if at all, etc., and we will send you our Free Book containing text and illustrations covering Lessons in PIANO (students' or teachers' courses) by the great Wm. H. Sherwood, HARMONY by Dr. Protheroe and Rosenbecker, VOICE COURSE (with aid of Phonograph) by Crampton, PUBLIC SCHOOL MUSIC by Frances E. Clark, VIOLIN, CORNET, MANDOLIN, GUITAR, BANJO, BANJO, REED ORGAN, CHORAL CONDUCTING, by equally eminent teachers.

Send NOW for Free Book and learn how easily you can become a successful, or a skillful player. See how quickly you can become successful. Our Free Book tells you how. Write for it today. A few Special Introductory Scholarships now being awarded by our faculty. Full particulars sent with Free Book. Investigate without cost or obligation. Write today.

University Extension Conservatory

Proprietor Siegel-Myers School of Music

3166 Siegel-Myers Building Chicago, Ill.

LEARN WATCH REPAIRING

Be a watchmaker—you can learn this profitable trade by correspondence in a few weeks in your own home by the DeSelms Chart System. After you complete the course you will know a watch from A to Z. You will know just what the matter is and how to repair one. When you graduate you will be a practical watchmaker and repairer and competent to fill any position. Positions for our graduates.

Ask for our Free Book. It explains our system and terms.

THE DeSELMS WATCH SCHOOL
23 Perry Street ATTICA, INDIANA



Be an Artist

Comics, Cartoons, Commercial, Newspaper and Magazine Illustrating, Pastel and Crayon Portraits. By Mail or Local Classes. **10 FREE LESSONS.** Write now. **ASSOCIATED ART STUDIOS**
30A Flatiron Building, New York

Encyclopaedia Britannica

"HANDY VOLUME" ISSUE
Printed on India Paper



WANTED—Railway Mail Clerks

Commence \$75 Month
Increase to \$150 "

Common Education Sufficient

Sure Pay. Life Job. Pull Un-necessary.

Franklin Institute
Dept. F97, Rochester, N.Y.

Sirs: Send me, without charge, (1) sample Railway Mail Clerk Examination questions; (2) schedule showing places of examinations; (3) list of other government jobs now easily obtainable and (4) free book describing them.

NAME.....

ADDRESS.....

The MILLION DOLLAR AUTOMOBILE and TRACTOR SCHOOL

You Want to Succeed

It is just as easy to be a successful man in a live business as it is in one that holds little opportunity or chance for you. A man that thinks, knows that the automobile and tractor business is the liveliest business in the world. It has grown faster and has made more men big money and opened good positions for them than any other, and the best part of it is that the field is not crowded. In fact there are more chances for the average man today than in any other line of business.

Get in the Game!

There's money, lots of it, to be made, and you might as well make it along with the rest of the live men. Let this successful school, the one that has the reputation of turning out competent mechanics who are making good, give you the training that will start you towards success. It's easy. All it needs is determination and backbone.

I started teaching the automobile business nine years ago, with \$60 and a training in mechanics, the best which was to be had in those days. My success has been that I came out with the idea that no man could learn a mechanical business without actually doing the work. Textbooks and charts and lectures are all right for some lines of education, but not in mechanics. Here you get right down in the work, and you know as well as I do that when you once do a thing, you know it.

My School Today Represents an Investment of \$1,000,000

I have 7 acres floor space and up-to-date equipment in every department of my school. In my Starting and Lighting System room I have every known make of starter. The same way in my battery room. When you get all through my course, then I put you in my garage, where you prove up what you know. It gives you self-confidence, and you can go out and tackle any kind of work, because you know that you can do it, as you have already done it.

Don't Experiment Get in a business with a future, and learn it where success is assured. All it needs is application on your part.

Write Today for My Big, Fully Illustrated Catalog

showing pictures of every department in my school and just how we teach you this business, and then decide your future. This is the day of big opportunities for mechanically inclined men. Write to me today. I will show you a sure road to success.

E. J. SWEENEY, President

SWEENEY AUTOMOBILE AND TRACTOR SCHOOL

The Opportunity School for Mechanically Inclined Men
1167 East 15th St., KANSAS CITY, MISSOURI

Mail This Coupon

Sweeney
Auto and
Tractor School
1167 E. 15th St.
Kansas City, Mo.

Send me Free
Illustrated Catalogue of your
School and how you
teach the Automobile
and Tractor Business.

Name.....

Address.....

War Conditions Demand ELECTRICAL

men with training. Prepare for service in military or industrial life. Of 193 students in class of 1917, about one-third are already in the Engineer Corps and two-thirds are speeding production in electrical industries. Having trained over 2000 young men in the past 24 years in the fundamentals of Applied Electricity, **THE BLISS ELECTRICAL SCHOOL**, with its well-equipped shops and laboratories, is peculiarly well qualified to give a **condensed course in Electrical**

ENGINEERING

including Mathematics, Steam and Gas Engines, Mechanical Drawing, Shop Work, and Theoretical and Practical Electricity, in all branches. Students actually construct dynamos, install wiring and test efficiency of electrical machinery. Course, with diploma, complete

IN ONE YEAR

For practical young men with limited time. 25th year opens Sept. 26th. Catalogue on request. 304 Takoma Ave., Washington, D.C.



COLLEGE OF DENTISTRY University of Illinois

Four year curriculum leading to the degree of Doctor of Dental Surgery. Fifteen units, accredited high school, for admission. Infirmary unexcelled in point of equipment and operating facilities.



Demand for dentists greater than the supply. U. S. Government needs more than 2,000 dentists for military service. Unprecedented opportunities for dental students. Write for catalogue. Box 70.

The Dean, College of Dentistry
University of Illinois
1838 W. Harrison St., Chicago

ARMOUR Institute of Technology CHICAGO, ILL.



Offers complete courses in Mechanical, Electrical, Civil, Chemical, Fire Protection Engineering, Architecture, and Industrial Arts. All courses four years in length, and lead to the degree of Bachelor of Science. Fully Equipped Shops and Laboratories. First Semester begins September 10, 1917. Bulletins sent on request. **Armour Institute, Box 12 - 33rd and Federal Streets, Chicago, Illinois**

Main Building

"I Can Succeed!"



What other men have accomplished through I. C. S. help, I can. If the I. C. S. have raised the salaries of other men, they can raise mine. To me, I. C. S. means 'I CAN SUCCEED.'

Get the "I Can Succeed" spirit, for the International Correspondence Schools can raise your salary—whether you're a dollar-a-day man or a dollar-an-hour man. No matter where you live, what you now do, or how little time or money you may have, the I. C. S. have a plan and a

Course of Training to fit your needs. Hundreds of thousands of ambitious men have been prepared for and have achieved success through I. C. S. help in the past 25 years—over 130,000 are now studying, getting ready for the big job ahead. Join them and make your life something to be proud of—you can do it. Just mark and mail the coupon TODAY and find out how; it won't obligate you in the least.

TEAR OUT HERE

INTERNATIONAL CORRESPONDENCE SCHOOLS, Box 5606, Scranton, Pa.

Explain fully about your Course in the subject marked X:

- | | | |
|---|---|---------------------------------------|
| <input type="checkbox"/> Electrical Engineering | <input type="checkbox"/> ADVERTISING | <input type="checkbox"/> CHEMISTRY |
| <input type="checkbox"/> Mechanical Engineering | <input type="checkbox"/> Salesmanship | <input type="checkbox"/> Illustrating |
| <input type="checkbox"/> Mechanical Drafting | <input type="checkbox"/> Commercial Law | <input type="checkbox"/> Farming |
| <input type="checkbox"/> Civil Engineering | <input type="checkbox"/> Bookkeeping | <input type="checkbox"/> Poultry |
| <input type="checkbox"/> Stationary Engineering | <input type="checkbox"/> Stenography | <input type="checkbox"/> French |
| <input type="checkbox"/> Mining Engineering | <input type="checkbox"/> Civil Service | <input type="checkbox"/> German |
| <input type="checkbox"/> Architecture | <input type="checkbox"/> Ry. Mail Service | <input type="checkbox"/> Italian |
| <input type="checkbox"/> Architectural Drafting | <input type="checkbox"/> AUTOMOBILES | <input type="checkbox"/> SPANISH |

Name _____

Address _____

Please Mention Popular Mechanics

ENGINEERING MECHANICAL ELECTRICAL

One Year Practical Courses. Day and Evening classes. Splendid equipment and instruction. Low tuition. For particulars address

DETROIT TECHNICAL INSTITUTE
Box 308, Y. M. C. A. Building, DETROIT, MICH.

The University of Chicago

HOME STUDY in addition to resident work, offers also instruction by correspondence. For detailed information address

26th Year U. of C. (Div. V) Chicago, Ill.



Learn Watchwork, Jewelrywork and Engraving.

A fine trade commanding a good salary, and your services are always in demand. Address HOROLOGICAL, Dept. F, Bradley Institute, Peoria, Ill., for our latest catalog.

LEWIS INSTITUTE

An Endowed Polytechnic School for Both Sexes

Accredited. College work in Mechanical, Electrical and Civil Engineering, and in Mechanic, Household and Liberal Arts, leading to degree of B. S. High School instruction in Science, Literature and Technology. Well equipped Shops and Laboratories. Day and Evening Sessions. Fall Term opens Sept. 11. Evening Classes Oct. 9, 1917. For Bulletin, address, Dept. 9

LEWIS INSTITUTE Madison and Robey Sts., Chicago



Learn^{TO} *Write*

I CAN TEACH YOU AT HOME
During Spare time

This is a specimen of my business writing before taking Prof Tamblin's course in business writing
July 6, Clarence P. Weber.

This is a specimen of my plain business writing after taking lessons from F. W. Tamblin for 2 months
Sept. 5 Clarence P. Weber.

FREE BOOK

My 32-Page book "How to Become a Good Penman" is FREE to anyone who wants to write better. Contains copies and information that will help you, and beautiful specimens that will make your eyes twinkle with delight.

WRITE FOR IT—use the coupon below—or a postal will do—but

Send at Once!

If you enclose a stamp, I will write your name on a card with white ink, making one of the prettiest specimens of penmanship you ever saw

"A Wonderful Bargain" "It is now about two months since I began your course, and while I am not quite half through with Business Writing, I am delighted with my improvement, which is quite marked as you will see by comparing my present writing with the specimen written when I began. My parents objected to my taking it up, but now see I'm getting a wonderful bargain."

—CLARENCE P. WEBER, Middletown, Del.

Good Writing Is the Very Foundation of Business Success

I can make a good penman of you at your own home, in your spare time, no matter where you live or how poorly you now write. Ever fail to secure a good position because of poor penmanship? Ever know of better positions you could have stepped into if you only wrote a good hand? If not, you're an exception. The advantage of good penmanship is seen all around us.

I have been teaching penmanship by mail over 20 years. I know that any ambitious person can master penmanship just as quickly and thoroughly by my system at home as if in a schoolroom under the personal instruction of the teacher.

BEGIN NOW to learn good handwriting and be ready for the next better position that comes your way. Learn right at home—in your own room, outside of working hours. Your spare time is all I ask.

I teach *Spelling and Letter Writing* also.

Mr. Weber's wonderful improvement shown in the specimens above was made in 2 months. Hundreds and hundreds of others in all parts of the country are doing the same.

YOU CAN DO AS WELL

This Brings FREE BOOK

F. W. TAMBLYN, 418 Ridge Bldg., KANSAS CITY, MO.

I am interested in improving my penmanship. Send me your Free Book, "How to Become a Good Penman," postpaid.

Name.....

Address.....

F. W. TAMBLYN

418 Ridge Bldg., KANSAS CITY, MO., U.S.A.



"You Get The Job"

"We've been watching you, young man. We know you're made of the stuff that wins. The man that cares enough about his future to study an I. C. S. course in his spare time is the kind we want in this firm's responsible positions. You're getting your promotion on what you *know*, and I wish we had more like you."

The boss can't take chances. When he has a responsible job to fill, he picks a man *trained to hold it*. He's watching *you* right now, hoping you'll be ready when your opportunity comes.

The thing for you to do is to start today and train yourself to do some one thing better than others. You can do it in spare time through the International Correspondence Schools. Over 5000 men reported advancement last year as a result of their I. C. S. training.

The first step these men took was to mark and mail this coupon. Make your start the same way—and make it right now.

TEAR OUT HERE

INTERNATIONAL CORRESPONDENCE SCHOOLS Box 5602 SCRANTON, PA.

Explain, without obligating me, how I can qualify for the position, or in the subject, before which I mark X.

- | | |
|---|--|
| <input type="checkbox"/> ELECTRICAL ENGINEER | <input type="checkbox"/> SALESMANSHIP |
| <input type="checkbox"/> Electric Lighting | <input type="checkbox"/> ADVERTISING MAN |
| <input type="checkbox"/> Electric Car Running | <input type="checkbox"/> Window Trimmer |
| <input type="checkbox"/> Electric Wiring | <input type="checkbox"/> Show Card Writer |
| <input type="checkbox"/> Telegraph Expert | <input type="checkbox"/> Outdoor Sign Painter |
| <input type="checkbox"/> Practical Telephony | <input type="checkbox"/> RAILROADER |
| <input type="checkbox"/> MECHANICAL ENGINEER | <input type="checkbox"/> ILLUSTRATOR |
| <input type="checkbox"/> Mechanical Draftsman | <input type="checkbox"/> DESIGNER |
| <input type="checkbox"/> Machine Shop Practice | <input type="checkbox"/> BOOKKEEPER |
| <input type="checkbox"/> Gas Engineer | <input type="checkbox"/> Stenographer and Typist |
| <input type="checkbox"/> CIVIL ENGINEER | <input type="checkbox"/> Cert. Public Accountant |
| <input type="checkbox"/> Surveying and Mapping | <input type="checkbox"/> Railway Accountant |
| <input type="checkbox"/> MINE FOREMAN OR ENGINEER | <input type="checkbox"/> Commercial Law |
| <input type="checkbox"/> Metallurgist or Prospector | <input type="checkbox"/> Traffic Management |
| <input type="checkbox"/> STATIONARY ENGINEER | <input type="checkbox"/> GOOD ENGLISH |
| <input type="checkbox"/> Marine Engineer | <input type="checkbox"/> Teacher |
| <input type="checkbox"/> ARCHITECT | <input type="checkbox"/> Common School Subjects |
| <input type="checkbox"/> Contractor and Builder | <input type="checkbox"/> CIVIL SERVICE |
| <input type="checkbox"/> Architectural Draftsman | <input type="checkbox"/> Railway Mail Clerk |
| <input type="checkbox"/> Concrete Builder | <input type="checkbox"/> Textile Overseer or Supt. |
| <input type="checkbox"/> Structural Engineer | <input type="checkbox"/> Navigator |
| <input type="checkbox"/> PLUMBING AND HEATING | <input type="checkbox"/> AGRICULTURE |
| <input type="checkbox"/> Sheet Metal Worker | <input type="checkbox"/> Penitry Raising |
| <input type="checkbox"/> CHEMICAL ENGINEER | <input type="checkbox"/> AUTOMOBILES |

Name _____

Occupation & Employer _____

Street and No. _____

City _____ State _____

If name of Course you want is not in this list, write it below.

Please Mention Popular Mechanics

ENGINEERING



AND

Mechanical Trade Schools of Highland Park College, Des Moines, Iowa SCHOOL YEAR OPENS SEPT. 11, 1917

Civil, Electrical and Mechanical Engineering—Standard four-year courses completed in three years of forty-eight weeks each, and one-year courses in Civil, Electrical and Mechanical Engineering. Graduates holding some of the best engineering positions in the country.

Machinist and Auto-Machinist Courses—One-year Machinist and Auto-Machinist courses. Elaborately equipped machine shops and skilled mechanics for teachers. Graduates secure positions as journeymen mechanics.

Garage and Traction Courses—Twelve weeks' courses in automobile repairing and Traction engine shop work. Everything taught pertaining to the automobile and Traction engine—gas or steam.

Mechanical Drafting—One-year course, which fits students for any sort of drafting work. One of the largest and best equipped engineering and mechanical Trade schools in the country. Expenses most reasonable. Write for catalog. State course in which you are interested. Address

HIGHLAND PARK COLLEGE, 121 Euclid Ave., Des Moines, Iowa

NATIONAL
TRADE



DENTAL
SCHOOL

506 S. Wabash Ave., CHICAGO, ILL.

LEARN MECHANICAL DENTISTRY—DEMAND UNLIMITED

Earn \$1200 to \$4000 yearly in mechanical dentistry. A big and growing demand everywhere for mechanical dentists—like a gold mine, unexplored. Attend this school any time of the day or evening; be taught individually and learn by actual practice, without book study. Our System, the most complete in the world, is used exclusively in this school. We are constantly called upon to fill high-salaried positions. Why not qualify for one? Be fair to yourself! Find out more about exceptional opportunity we offer. Visit the school or write for booklet B.

Jenner Medical College

Study Medicine at night. Accredited. Unusual demand for doctors to serve the Government. First-class training offered to both young men and women. Opportunity to earn all expenses while in attendance. Splendid laboratory and clinical facilities. High School branches taught to those lacking entrance requirements. Methods approved by quarter of century experience. For full information and catalog address

JOHN D. MACKELLAR, M.D., Box 12, 117 N. Elizabeth St., CHICAGO, ILL.

A High School Course In Two Years

Learn in your own home. Here is a thorough, complete, and simplified high school course that you can finish in two years. Meets all college entrance requirements. Prepared by leading members of the faculties of universities and academies.

Write for booklet. Send your name and address for our booklet and full particulars. No obligations whatever. Write today—now, American School of Correspondence, Dept. P1196, Chicago, U. S. A.



SHORTHAND IN 30 DAYS

THE NEW WAY. Learned at home in 30 DAYS. Boyd Syllabic System, based on Syllables. No shading—no position. Writers hold World's Record. Two of the largest Mail Order Houses have installed the Boyd System. 100 to 150 words a minute guaranteed. Write today for Special Offer, Free Catalog and Sample Lesson.

Chicago Home Study Schools, 504 Reaper Blk., Chicago, Ill.

LEARN THE AUTO BUSINESS

Trained Men in Great Demand

We are just completing an immense new building—owned and used exclusively by us—fully equipped with all the best and most modern appliances for learning the auto business *from the ground up*.

Our course—always recognized as the most thorough and practical—will be increased *many times* in value, and we must train men to meet the vast demand for our graduates.

Our Graduates are regularly earning from \$100 to \$300 and more per month as Race Drivers, Expert Engineers, Final Testers, Shop Foremen, Tractor Experts, Chauffeurs, Sales-

men, Garage Owners and Managers, House-Lighting Experts; and many are in Government employ as Aviators, Truck Drivers and Dispatch Bearers—all because of the *practical* training we give.

Opportunities for *practically* trained men were never better. We have constant calls for more men than we can furnish.

We Teach



Race Driver



Tester



Master of 12-cyl. Motor



Private Chauffeur



Cleveland

Auto School

Established 1903
Individual Instruction

Up-to-date Equipment
14 Years of Success

Over 4,000 Graduates Making Good

OUR EQUIPMENT

includes all types of motors, including Knight type, and 4, 6, 8 and 12 cylinder; a dozen cars at the disposal of students; latest starting and lighting equipment; Akron-Williams tire repair outfits, oxy-acetylene welding and cutting outfits; all the latest electrical testing outfits; and everything necessary to give you a thorough and practical training.

CLEVELAND LEADS

in the manufacture of parts, accessories and high grade cars, and is gaining faster than any other city in new factories. Up-to-date training in 4 to 8 weeks; board and room only \$6 per week near school; we help you get located in congenial surroundings and feel at home. We Absolutely Guarantee to qualify you for a good paying position in the Auto business on completion of our course.

Join Now! Be ready to take advantage of the unlimited opportunities that are now opening faster than ever before.

Cleveland Automobile School

CLYDE H. PRATT, President, Dept. 9, 1814 E. 24th St., CLEVELAND, OHIO



Auto Dealer or Salesman

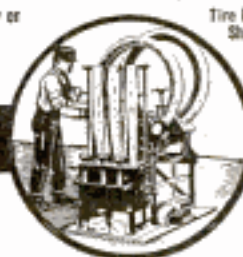

Tire Repair Shop



Garage Owner or Manager

Your Own Business

Call
or write
us
TODAY

Please Mention Popular Mechanics

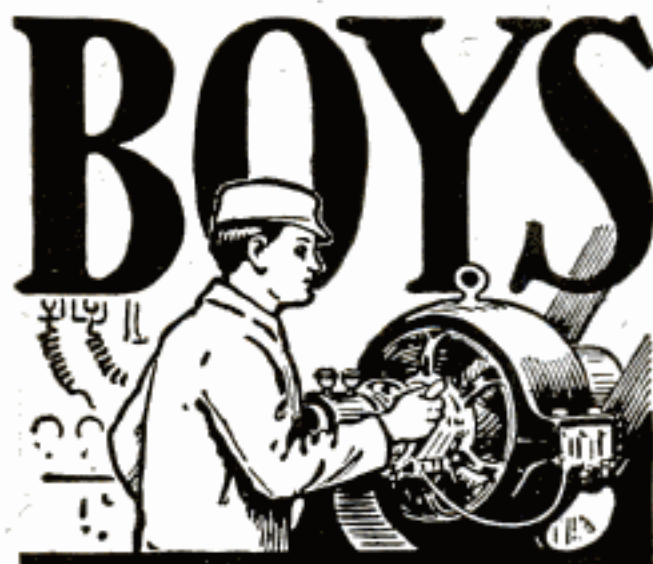

Big Money in Electricity

The Electrical industries offer wonderful opportunities to boys with a liking for Electricity. The salaries paid to trained men are large, promotion comes rapidly and, best of all, the work is fascinating.

The discovery and development of new lines (such as wireless telegraphy and telephony), from time to time, promise attractive and paying fields to those who wish to specialize. The *will to do* and *Special Training* will bring success to you.

The International Correspondence Schools can help you to become an expert in electrical work, no matter what branch you like best. Thousands of young men have already won success through I. C. S. help. You can do as well as anybody, *if you try*. Everything is made so clear that you can learn in your spare time, regardless of where you live or what your work. No books to buy.

There's big money in Electricity. Get after it by marking and mailing the Coupon today. *Finding out costs you nothing.*

INTERNATIONAL CORRESPONDENCE SCHOOLS

Box 5605, SCRANTON, PA.

Explain, without obligating me, how I can train for the position before which I mark X.

- | | |
|--|--|
| <input type="checkbox"/> ELECTRICAL ENGINEER | <input type="checkbox"/> ARCHITECT |
| <input type="checkbox"/> Electrician | <input type="checkbox"/> Architectural Draftsman |
| <input type="checkbox"/> Electric Wiring | <input type="checkbox"/> Mine Foreman or Supt. |
| <input type="checkbox"/> Electric Lighting | <input type="checkbox"/> Business (Complete) |
| <input type="checkbox"/> Electric Car Running | <input type="checkbox"/> Bookkeeper |
| <input type="checkbox"/> Electric Machine Designer | <input type="checkbox"/> Stenographer |
| <input type="checkbox"/> Telegraph Engineer | <input type="checkbox"/> Advertising Man |
| <input type="checkbox"/> MECHANICAL ENGINEER | <input type="checkbox"/> Salesmanship |
| <input type="checkbox"/> Mechanical Draftsman | <input type="checkbox"/> Window Trimmer |
| <input type="checkbox"/> STEAM ENGINEER | <input type="checkbox"/> Civil Service |
| <input type="checkbox"/> GAS ENGINEER | <input type="checkbox"/> AGRICULTURE |
| <input type="checkbox"/> CIVIL ENGINEER | <input type="checkbox"/> Poultry Raising |
| <input type="checkbox"/> Structural Engineer | <input type="checkbox"/> AUTOMOBILES |
| <input type="checkbox"/> CHEMICAL ENGINEER | <input type="checkbox"/> Auto Repairing |

Name _____

Present Occupation and Employer _____

Street and No. _____

City _____ State _____

If name of Course you want is not in this list, write it below.

Please Mention Popular Mechanics

STUDY LAW 30 Days FREE

Let us prove to your entire satisfaction, at our expense, that the Hamilton College of Law is the only recognized resident law school in U. S., Conferring Degree of Bachelor of Laws—LL. B.—by correspondence. Only law school in U. S., conducting standard resident school and giving same instruction, by mail. Over 500 class-room lectures. Faculty of over 30 prominent lawyers. Guarantee to prepare graduates to pass bar examination. Only law school giving Complete Course in Oratory and Public Speaking. School highly endorsed and recommended by Gov. Officials, Business Men, Noted Lawyers and Students. Send today for Large Handsomely Illustrated Prospectus and Special 30-Day Free Trial. HAMILTON COLLEGE OF LAW, 1255 Advertising Bldg., Chicago, Ill.

Learn to PAINT SIGNS and SHOW CARDS

I teach you personally, by mail, in a short time. Oldest and largest School. Big field, work interesting. You can EARN \$18 TO \$45 A WEEK

Frizner, Minn., writes: "Did job after first lesson, got \$10, profit \$7.00." Crowley, N. C., says: "Earned \$30.00 while taking course." Get literature, samples, guarantee—all FREE.

DETROIT SCHOOL OF LETTERING
Established 1899. 2017 D. S. of L. Bldg. DETROIT, MICHIGAN



LEARN TELEGRAPHY

Young men and women attend on credit. A practical school with railroad wires. Owned and operated by the A. T. & S. F. Ry. EARN FROM \$55 to \$165 PER MONTH. Write for catalog.

SANTA FE TELEGRAPH SCHOOL
515 Kansas Ave. TOPEKA, KANSAS



Come to Akron, Ohio
The Tire Center
and
LEARN THE TIRE REPAIR BUSINESS

Big money made in this field. Tires need constant repairing. Profits large, work comes easily. Locations everywhere.

EARN \$100 to \$500 MONTHLY

There is no limit to what you can make. Start business with small capital. We teach you everything about auto tires. School open all year. Start any day. Write for school literature, etc. Now. ALL FREE.

Akron Tire Repair School, 69 Tire Bldg., 48-49 N. Main St., Akron, O.



"I WANT YOU"

-Uncle Sam



Courtesy of Leslie's, Copyrighted

PAY \$75 to \$150 MONTH

U. S. GOVERNMENT WANTS

Railway Mail Clerks—City Mail Carriers—Postoffice Clerks—Clerks at Washington, D. C.

War Necessitates Hundreds of Appointments

Common education sufficient. Send coupon immediately. We coach candidates free.

This coupon, filled out as directed, entitles the sender to (1) free sample examination questions; (2) a free copy of our book, "Government Positions and How to Get Them;" (3) free list of positions now easily obtainable; and (4) to consideration for Free Coaching for the examination here checked.

SEND COUPON BELOW

FRANKLIN INSTITUTE
Dept. F 96, ROCHESTER, N. Y.

COUPON			
.. Railway Mail Clerk	(\$900 to \$1800)	.. Customs Positions	(\$800 to \$1500)
.. Postoffice Clerk	(\$800 to \$1200)	.. Internal Revenue	(\$700 to \$1800)
.. Postoffice Carrier	(\$800 to \$1200)	.. Stenographer	(\$800 to \$1500)
.. Rural Mail Carrier	(\$500 to \$1200)	.. Clerk in the Departments at Washington	(\$800 to \$1500)
.. Bookkeeper	(\$900 to \$1800)		

Name.....

Address..... F 96

Use this before you lose it. Write plainly.

Learn Electricity! Drafting—Plumbing

Earn \$125 to \$300 a Month

That's what many of our graduates earn right from the start. That's what **YOU** can earn if you become a **COYNE** trained man. All of these trades offer exceptional opportunities. Thousands of high-salaried positions are open. We are constantly receiving calls for our graduates. On small capital you can start a business of your own and become entirely independent.

Any man between the ages of 16 and 50 who is ambitious, can learn one of these big paying trades thoroughly in a short time in our \$93,000.00, perfectly equipped shops, at small expense. No previous education or training necessary.



18 YEARS OF SUCCESS

COYNE

TRADE MARK

Trade and Engineering Schools
Largest and Best Equipped in America

U. S. Needs Trained Men

If you want to serve your country best serve it as a **trained man**. Learn one of these big trades **now**, before enlisting and get a higher rating and more money. And, remember, after the war is over the demand for men in these trades will be enormous. Now is the time to act.

FINISH IN 3 MONTHS

Drafting, Estimating and Plan Reading included in **ALL** courses. We charge a small tuition fee which can be made in easy payments if desired. All equipment and material furnished by the school **FREE**. Our institution is open all year round. You can enter any time. Day and Evening classes. Many of our students earn a part or all of their expenses while attending. Our employment bureau is always ready to assist a man to earn expenses, without charge.

Send for FREE Book of Trades



MAIN BUILDING

Fill in this coupon and mail today. Tells all about our courses, terms, etc. Points out wonderful opportunities for ambitious young men. Help us meet the demand for men trained the Coyne way.

ADDRESS

BENNETT WELLINGTON COOKE, Director
**COYNE TRADE AND
ENGINEERING SCHOOLS**
DEPT. 1196
39-51 E. Illinois St., CHICAGO

READ THIS

April 16, 1917.

Mr. B. W. Cooke, Director,
DEAR SIR:—I want to thank you for the interest shown me while at your school. **Sorry** I could not quite finish my course in plumbing as I have enlisted in the Army as a plumber. Am getting along fine and expect to be made Sergeant Plumber in a short time.

Yours sincerely,

J. J. Venzonka, Jefferson Barracks, Mo.

Motion Picture Operating Bricklaying Builders' Course

These new big paying trades are demanding more and more trained men everywhere and our graduates are sought after by theatre managers, contractors, and Engineering firms throughout the country. Free Book of Trades explains all.

SEND THIS COUPON

Bennett Wellington Cooke, Director
Coyne Trade and Engineering Schools
Dept. 1196, 39-51 E. Illinois St., Chicago
Without obligation to me please send at once your wonderful Manual of Trades. I am particularly interested in

- | | |
|---|---|
| <input type="checkbox"/> Electricity | <input type="checkbox"/> Plumbing |
| <input type="checkbox"/> Bricklaying | <input type="checkbox"/> Drafting |
| <input type="checkbox"/> Motion Picture Operating | <input type="checkbox"/> Builders' Course |

(Check course that interests you.)

Name.....

Address.....

Please Mention Popular Mechanics

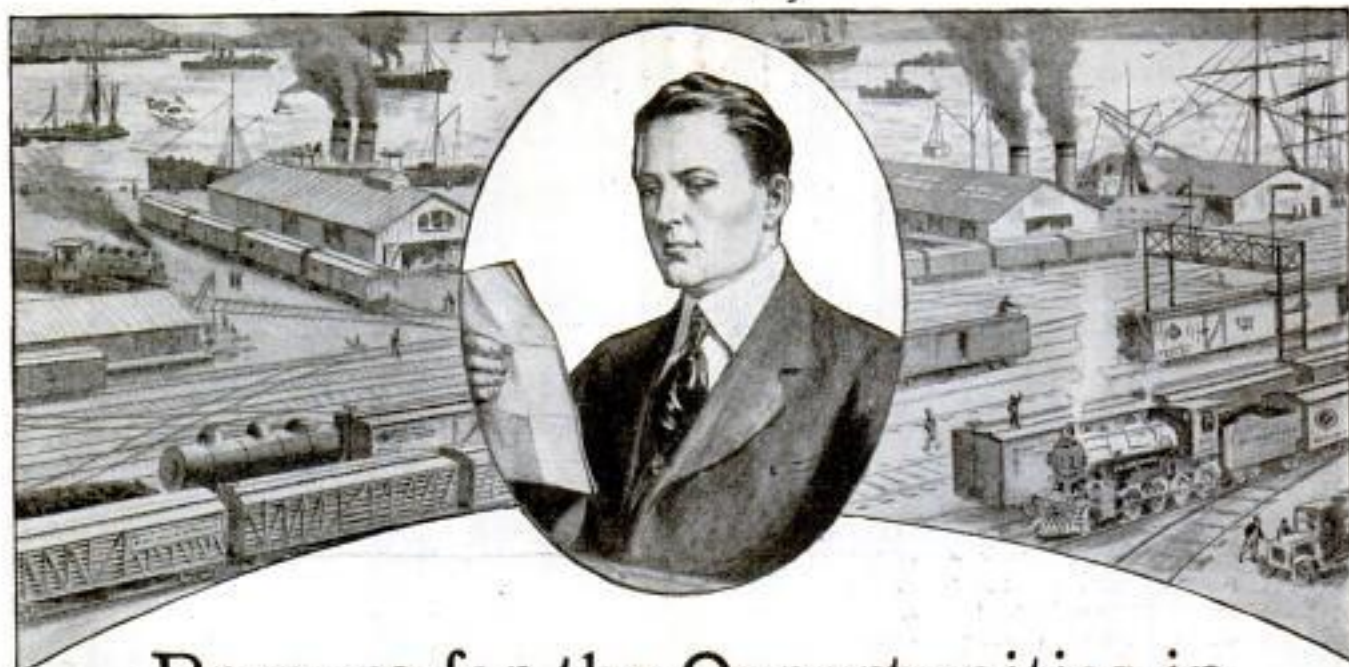

Prepare for the Opportunities in Interstate Commerce

You now have the opportunity to enter a new profession which presents practically unlimited opportunities. Fully half a million business organizations in the United States need men trained in transportation to deal with railroads and express companies and to solve the various complicated problems which arise under interstate commerce laws and rulings. The men really competent to fill the positions are yet so few that the field is wide open to those who will train for this profession now.

The man who is master of Interstate Commerce can save thousands of dollars for his employers. Not only manufacturers and wholesale houses, but railroads, municipalities, chambers of commerce and the Interstate Commerce Commission also are seeking men really qualified to act as traffic experts. The salaries paid are high. The calling itself is a dignified, respected profession.

LaSalle Extension University trains men to hold the most responsible positions as Commerce Counsels, Traffic Managers and Directors of Transportation. Its corps of traffic experts and instructors is composed of men who have learned every condition and problem by actual experience with large railroads and shippers. Each is a specialist in some department of the subject.

These men, assisted by more than a hundred leading railroad and industrial officials, have put their knowledge and experience in transportation into a concrete systemized course of study which will take you step by step through every technicality concerned with Freight Rates, Classifications, Tariffs, Bills of Lading, Routing, Claims, Demurrage, Express Carriers, Ocean Trade, R. R. Organization, Regulation and Management, Laws of Carriers, Interstate Commerce Rulings, R. R. Accounting, Statistics, etc. From the day of your enrollment until you graduate you will be under the direction of skilled traffic men who will guide you in every detail of the work and give you an exhaustive training in every phase of Interstate Commerce.

LaSalle Extension University

"The World's Greatest Extension University"

Capital \$1,000,000. Assets over \$2,000,000. More than 125,000 men of all ranks and positions, from office clerks to corporation officials, have benefited from LaSalle training and service. LaSalle students or graduates now can be found employed in the executive departments of practically all of the big railroads, business houses and commercial organizations in the country, such as Standard Oil Company; General Electric Company; Pennsylvania Railroad; Sears Roebuck & Company; Armour & Company; National Cash Register Company; Burroughs Adding Machine Company; American Telephone and Telegraph Company; Wells Fargo Express Company; etc. More than 70,000 officers and employees of business institutions throughout the United States have been enrolled for LaSalle courses.

Study By Mail

All this instruction is given you in your own home. You can study in your spare time. Hold your present position while acquiring knowledge that will lead to a larger income. Make yourself master of this new profession. At least write and get the particulars in detail. You incur no obligation by doing this.

Small Tuition—Easy Terms

No matter how small your salary may be you can have this LaSalle Course in Interstate Commerce—you can be trained by these experts in traffic without feeling the cost. The tuition is so low and the monthly payments are so small that they will place no appreciable tax upon your income. Send the coupon now—today.

Students Say—

"Raised me from freight checker to General Freight Agent."
 "Was clerk, now Traffic Manager."
 "Promoted from assistant to Traffic Mgr."
 "Appointed Traffic Manager of City of Pawtucket."
 "Fifty per cent increase in salary."

LASALLE EXTENSION UNIVERSITY,

"The World's Greatest Extension University"
 Dept. 964-C Chicago, Illinois

Please send me your book on Interstate Commerce and "Ten Years' Promotion In One" and full information on your course in Interstate Commerce. This without obligation on me.

Name.....

Address.....

Age..... Occupation.....

LaSalle Consulting Service

Mail the coupon and learn how, as a LaSalle student, you will also be entitled to the free use of our General Consulting Service which gives you the privilege of calling on our staff of experts in any department at any time when you need special help or counsel. LaSalle Extension University is a clearing house of business information and through its many highly specialized departments is organized and equipped to render a broad service which is not supplied by any other institution of similar character.



The coupon will also bring our book, "Ten Years' Promotion In One," and full information about our course in Interstate Commerce and our Consulting Service.

LASALLE EXTENSION UNIVERSITY
"The World's Greatest Extension University"
 Dept. 964-C Chicago, Illinois

Please Mention Popular Mechanics



H. J. RAHE
President

This twin-six motor is block mounted.

Then there are the Eight and many other motors for my students' special training and experience.

These motors are in the practice room. All Types of lighting and self-starting devices—full equipment, so that you learn all easily. Tire vulcanizing, Oxy-Acetylene welding—training and experience in all branches of the automobile business. My students do practical work. They handle welding torches under the guidance of master-welders. Don't bother with any training that gives you only a little—come here and I'll hand you a kit of tools—not printed books.



All types of motors—Block-mounted. Easy to get around.



17 Complete Welding Outfits. Big demand for Expert Welders.



Both Types of Tractors, Kerosene and Gasoline. Gang Plows. Big Practical Field.

The Training For YOU!

Come to the School of Complete Equipment

—and let me train you to earn big money in the Automobile and Tractor Business. The supply of men to fill the many open positions and waiting opportunities is far short of the demand. Now is the time to start. I'll help you—I'll train you **right**. My success in training thousands of ambitious men is known throughout the country. I have been right here in Kansas City for a number of years and I rightly claim more successful graduates than any similar institution in the world. I am always ahead with complete equipment—with plenty of floor space and more expert instructors. My graduates earn from

\$75 to \$350 a Month

YOU CAN DO THE SAME if you have ambition and determination to learn. **Rahe's Original Practical Method of Automobile Training and Experience** is everywhere recognized as the most efficient method of training ever devised. Remember—it's not theory—there are **no books or printed lessons**. My training is unique and distinctive—**it's the actual doing**—getting into overalls and starting at the bottom under the guidance of expert instructors.

Only a Few Weeks Required

That's all—just a few weeks and you will have a thorough understanding of the basic principles of this wonderful business. You will then be ready for a position, paying good money right from the start—with a world of opportunity before you. My original practical method is all simple and easy. You get the full instruction in easy stages and you have the wonderful advantages of complete equipment—Automobiles, Tractors, Welding Plants, Big Drill Presses, Power Lathes, Forges, etc. Two big garages and repair shops. Cars of all kinds for my students' practical use. Every type of motor is represented in my equipment—block mounted so they are easy to get around, easy to take apart. It's the Rahe method—

Practical—Efficient—Complete

Tractor Engineering

I want to enroll the full capacity of my school a month earlier this year, and to all students enrolling now I am giving a free scholarship for complete instruction in **Tractor Engineering, Power Farming, Gas and Stationary Engineering**. The development of the farm tractor and its growing popularity is second only to the automobile itself. Come and see my large tractor practice field and complete tractor and farm equipment. With this added knowledge you can reap new profits in an entirely new field. Remember—it's **FREE** when you enroll for my automobile course.

Get My 80-Page Catalog

Use the coupon below or post card, but send now for my new catalog. Filled with Copper Engravings of men at work in the various departments—views of equipment—four big buildings and big tractor farm. Let me start you. **Let me help you to be the success you can be**—if you have backbone and ambition. Send for the book at once and read letters from men like yourself—who came to me without previous experience and are now earning big money.

H. J. RAHE, President,
Rahe's Automobile Training School

(World's Greatest Auto Training School)

611 E. 11th St. Kansas City, Mo.

OPPORTUNITY COUPON

H. J. RAHE, Pres.,
Rahe's Automobile Training School,
611 E. 11th St., Kansas City, Mo.

Send me your new 80-page catalog, fully illustrated, telling of your Practical Training and big money opportunities in the Automobile and Tractor Business.

Name.....

Town.....

Street or R. F. D..... State.....



"Look At Him Today!"

"Six years ago he started in here just as you are doing. Now he's General Manager and makes more in a day than he used to make in a week. The first week he was here he began to train for the job ahead by studying in spare time with the International Correspondence Schools. Inside of six months he got his first promotion. You've got the same chance he had, young man. Follow his example. Take up some I. C. S. course right away. What you are six years from now is entirely up to you."

This is the story of thousands of successful men. They did their work well, and in spare time, with I. C. S. help, trained themselves for advancement. That's the thing for you to do. Whatever your chosen work may be, there is an I. C. S. Course that will prepare you right at home for a better position with bigger pay.

More than 100,000 men are getting ready for promotion right now in the I. C. S. way. Let us tell you what we are doing for them and what we can do for you. The way to find out is easy. Just mark and mail this coupon.

TEAR OUT HERE

INTERNATIONAL CORRESPONDENCE SCHOOLS
BOX 5603, SCRANTON, PA.

Explain, without obligating me, how I can qualify for the position, or in the subject, before which I mark X.

<input type="checkbox"/> ELECTRICAL ENGINEER	<input type="checkbox"/> SALESMANSHIP
<input type="checkbox"/> Electric Lighting	<input type="checkbox"/> ADVERTISING
<input type="checkbox"/> Electric Railways	<input type="checkbox"/> Window Trimmer
<input type="checkbox"/> Electric Wiring	<input type="checkbox"/> Show Card Writer
<input type="checkbox"/> Telegraph Engineer	<input type="checkbox"/> Sign Painter
<input type="checkbox"/> Telephone Work	<input type="checkbox"/> Railroad Trainman
<input type="checkbox"/> MECHANICAL ENGINEER	<input type="checkbox"/> ILLUSTRATING
<input type="checkbox"/> Mechanical Draftsman	<input type="checkbox"/> Cartooning
<input type="checkbox"/> Machine Shop Practice	<input type="checkbox"/> BOOKKEEPER
<input type="checkbox"/> Gas Engine Operating	<input type="checkbox"/> Stenographer and Typist
<input type="checkbox"/> CIVIL ENGINEER	<input type="checkbox"/> Cert. Public Accountant
<input type="checkbox"/> Surveying and Mapping	<input type="checkbox"/> TRAFFIC MANAGER
<input type="checkbox"/> MINE FOREMAN OR ENGINEER	<input type="checkbox"/> Railway Accountant
<input type="checkbox"/> Metallurgist or Prospector	<input type="checkbox"/> Commercial Law
<input type="checkbox"/> STATIONARY ENGINEER	<input type="checkbox"/> GOOD ENGLISH
<input type="checkbox"/> Marine Engineer	<input type="checkbox"/> Teacher
<input type="checkbox"/> ARCHITECT	<input type="checkbox"/> Common School Subjects
<input type="checkbox"/> Contractor and Builder	<input type="checkbox"/> Mathematics
<input type="checkbox"/> Architectural Draftsman	<input type="checkbox"/> CIVIL SERVICE
<input type="checkbox"/> Concrete Builder	<input type="checkbox"/> Railway Mail Clerk
<input type="checkbox"/> Structural Engineer	<input type="checkbox"/> AUTOMOBILE OPERATING
<input type="checkbox"/> PLUMBING AND HEATING	<input type="checkbox"/> Auto Repairing
<input type="checkbox"/> Sheet Metal Worker	<input type="checkbox"/> Navigation
<input type="checkbox"/> Textile Overseer or Supt.	<input type="checkbox"/> AGRICULTURE
<input type="checkbox"/> CHEMIST	<input type="checkbox"/> Poultry Raising

Spanish
 German
 French
 Italian

Name _____
Present Occupation _____
Street and No. _____
City _____ State _____

Please Mention Popular Mechanics

What the WAR means to Electrical MEN

"The Nation needs each man in the endeavor that will best serve the common good. The Nation is being served only when the sharpshooter marches, and the machinist remains at his levers," said President Wilson in his proclamation of May 17th.

Men with electrical training are needed now more than ever before, both at home and at the front. But America needs experts in electricity—not dabblers. You can't learn electricity out of a book.

The Only Way to Learn Electricity

The only way you can become an expert is by doing the very work, under competent instructors, which you will be called upon to do later on. In other words, *learn by doing*. That is the method of the New York Electrical School.

Our concentrated work with actual apparatus under actual conditions will put you ahead of men with from 5 to 20 years' experience in the electrical field. 4,500 of our students have gone forth into electrical success.

Learn by Doing This method makes you an expert, able to command a high salary. All instruction is individual. You go ahead as fast as you can learn. Good students complete the course in seven months. Send today for FREE 64-page book. Tear out this advertisement and mail it with your name and address.

NEW YORK ELECTRICAL SCHOOL
44 W. 17th Street, NEW YORK, N. Y.



Are You Earning Less Than \$3000 Yearly?

If you are,—you're on the wrong job. You're in a rut. Why waste a lifetime working for animal wages,—when it's so easy to get into a Man's Job and earn a Man's Salary?

Be a Traffic Manager

Get into a new—clean—fascinating—high salaried—dignified profession that assures you a place on Easy Street. Traffic Managers needed everywhere. Field can't be crowded for years to come. A POSTAL BRINGS FULL INFORMATION.

INTERSTATE TRAFFIC SCHOOL 29 TRAFFIC BLDG. FT. WAYNE, IND.

Big Money for You



There's Money in the Automobile Business

and all it takes to get it is experience. We give you the experience. Eight weeks in our school is worth more than two years of figuring it out for yourself. The cost is light, the reward great—there's a job waiting for you a soon as you're through. Don't delay—Act Now.

INDIANAPOLIS MOTOR SCHOOL
109 Southeastern Ave., INDIANAPOLIS, IND.

CHIROPODY

The growing profession where demand far exceeds the supply. Dignified, pleasant, remunerative. One year course with degree of Doctor of Surgical Chiropody. Day and evening classes. Meets State board requirements. Write for FREE catalog.

FALL TERM BEGINS SEPTEMBER 3RD
ILLINOIS COLLEGE OF CHIROPODY, 1321 N. Clark St., CHICAGO

STUDY MEDICINE, SURGERY, BACTERIOLOGY, PUBLIC HEALTH, PHARMACY

Standard Day and Night courses. Splendid faculty. Unexcelled facilities. Work-your-way-through plan. Write for catalog. Chicago Hospital College of Medicine, Box C, 3132 Rhodes Ave., Chicago

30 DAY COURSE FREE IN TIRE REPAIRING

Write Today for remarkably low price and particulars about our free course in tire repairing. Let us show you how to make \$3,000 to \$8,000 a year.

RELIABLE TIRE REPAIR SCHOOL 109 Reliable Bldg. DETROIT, MICH.

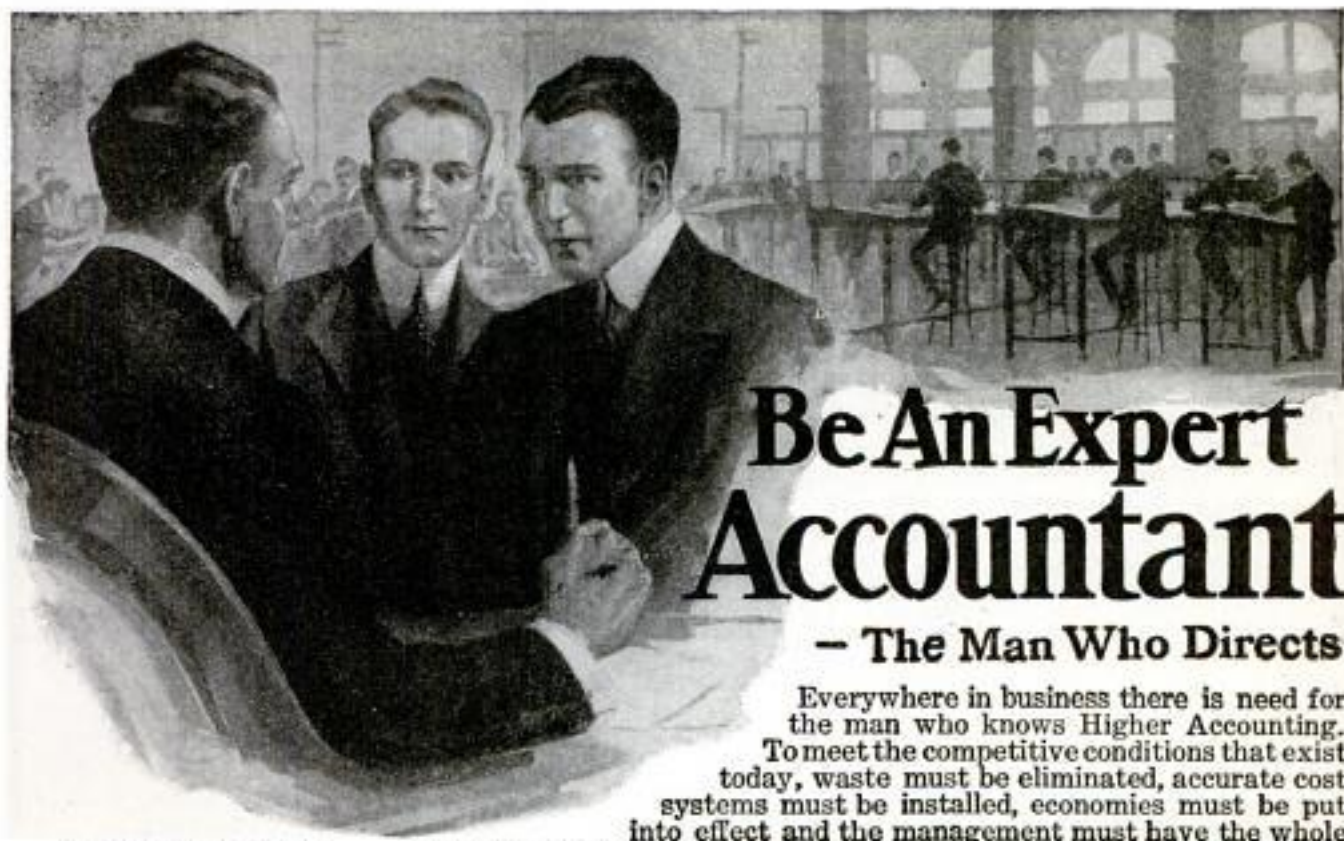

Be An Expert Accountant

— The Man Who Directs

Everywhere in business there is need for the man who knows Higher Accounting. To meet the competitive conditions that exist today, waste must be eliminated, accurate cost systems must be installed, economies must be put into effect and the management must have the whole situation charted and shown in figures whenever wanted. The book-keeper cannot do this. To analyze a business, a man must be to account- ing what the highly trained lawyer is to the legal aspects of commerce.

Over 500,000 American concerns today need the services of Expert Accountants. That shows where opportunity is. Write today for information about the course in Higher Accounting given by the LaSalle Extension University.

La Salle Students and Graduates

can now be found employed in the executive departments of practically all the large railroads, business houses and commercial organizations in the United States. Many prominent business concerns can be named in each of which 100 to 900 or more LaSalle students or graduates from our several specialized departments are employed in responsible positions. For instance—

Pennsylvania R. R. . . . 218
 American Telegraph & Telephone Company . . . 258
 U. S. Steel Corporation . . . 260
 Baltimore & Ohio R. R. . . . 264
 Armour & Company . . . 262
 Chicago & N. W. R. R. . . . 292
 Ford Motor Company . . . 122
 Swift & Company . . . 122
 Standard Oil Company . . . 150

Among the numerous firms and corporations employing 50 to 100 or more LaSalle students or graduates are the following:

Western Electric Company
 International Harvester Co.
 B. F. Goodrich Company
 Wells Fargo Express Company
 Goodyear Tire and Rubber Co.
 and every important railroad company in the United States.

More than 125,000 men in active business life including a large number of corporation officials have enrolled and are receiving the benefits of LaSalle training and service. Over 20,000 new students now enroll annually. The LaSalle organization consists of 800 people, including a staff of 300 business experts, professional men, text writers, special lecture writers, instructors and assistants. LaSalle students and graduates occupying responsible positions can be found throughout the entire English speaking world.

Free Consulting Service

As a LaSalle student, you will also be entitled to the free use of our Consulting Service which gives you the privilege of calling on our staff of experts in any department at any time when you need special help or counsel. LaSalle Extension University is a clearing house of business information and through its many highly specialized departments is organized and equipped to render a practical and distinctive service which cannot be supplied by any other institution of similar character.

Learn Higher Accounting By Mail

Our staff of experts in the Science of Accounting will give you their direct personal instruction by mail, guiding you step by step until you have mastered this paying profession. You will study text books, lectures and accounting methods prepared by authorities—men who are actually employed or retained as expert advisers by leading industries. The underlying principles and the most modern methods of Business Law and Organization, and the Principles of Accounting, Auditing, Commercial Law and Scientific Management all made clear. You will be given special preparation for the C. P. A. examinations and made ready to command a higher salary or to enter business as a Consulting Accountant. You can get all this in your spare time while you hold your present position. How better could you use your hours of leisure?

Easy Terms

No large fees. No large sum to pay down. This instruction is offered on a convenient monthly payment plan. Our courses are for the ambitious man no matter how small his present income. Send the coupon below for full, detailed information.

Mail The Coupon Today

Make the knowledge of these LaSalle experts yours. At least send for information about this course which has helped so many men to rise quickly to positions of greater profit and prestige and which you can easily master by home study.

No matter where you may be or what position you may hold, LaSalle Extension University can put you on the road to greater success. This has been proved by the record of its students and graduates. The information we will send will tell you just what knowledge you require to become proficient in Higher Accounting and how we will teach you in the shortest possible time. It will point out the possibilities that are wide open to the man who has the training demanded by large business organizations. We will also send valuable book "Ten Years' Promotion in One." Mail coupon now.

LASALLE EXTENSION UNIVERSITY

"The World's Greatest Extension University"

Dept. 964-H

Chicago, Illinois

Without cost or obligation on my part, please send me particulars regarding your Home Study Course of Training in Higher Accounting and your Consulting Service. Also a copy of your valuable book for ambitious men, "Ten Years' Promotion in One."

Name.....

Address.....

City.....State.....



Please Mention Popular Mechanics

SALESMANSHIP

\$2500 a year
\$5000 a year
\$7500 a year
\$10000 a year

The Power Behind Big Salaries!

SALESMEN command the largest incomes because they are the direct producers of profits—the very back bone of business. Their services are more valuable than those of the man who makes the goods—the man who thoroughly understands the selling game never lacks a desirable position. Training will enable **you** to become a successful Salesman—will fit you to command a large salary—enjoy independence—good health—travel—achieve **Success**.

Study in Spare Time—Earn While You Learn

☐ Train for a big paying sales position—study our Course in Scientific Salesmanship in spare time. It is the one system of practical training that links ability to opportunity and fits you to earn while you learn.

☐ Employers of Salesmen everywhere are calling on us for trained men. We put you in touch with good positions while you are still a student—and more than helping you secure a good connection—we help you **make good**.

Write for Free Book—"List of Openings".

☐ "A Knight of the Grip" will show you how to become a salesman—how to fit yourself to earn \$2,500 to \$10,000 yearly. Write for this free book today and large "List of Openings".

ADDRESS NEAREST OFFICE NOW — Dept. 12-M

National Salesmen's Training Ass'n — Chicago — San Francisco — New York



**\$800
to
\$1800**

**Hun-
dreds War
Jobs**

YOU, — GET A GOVERNMENT JOB Candidates Coached Free

No "layoffs" without pay, because of strikes, financial failures or the whims of some petty boss. If you want immediate appointment, send **TODAY** for free list of positions now obtainable. Any delay lessens your chance of early appointment.

**War Necessitates Hun-
dreds Appoint-
ments**

Send
Coupon Below
FRANKLIN INSTITUTE
(The pathway to plenty)
Dept. F103, Rochester, N. Y.

This coupon, filled out as directed, entitles the sender to (1) a free copy of our book, "Government Positions and How to Get Them," (2) a full list of positions now obtainable, and (3) consideration for Free Coaching for the position here checked.

COUPON

_____ Railway Mail Clerk	(\$900 to \$1800)	_____ Stenographer	(\$800 to \$1500)
_____ Bookkeeper	(\$900 to \$1800)	_____ Internal Revenue	(\$700 to \$1800)
_____ Postoffice Clerk	(\$800 to \$1200)	_____ Clerk in the Departments at	
_____ Postoffice Carrier	(\$500 to \$1300)	_____ Washington	(\$800 to \$1500)
_____ Rural Mail Carrier	(\$600 to \$1200)	_____ Panama Canal	
_____ Customs Positions	(\$800 to \$1600)	_____ Clerks	(\$1200 to \$1800)

Name.....
Address..... F103
Use this before you lose it. Write plainly

Please Mention Popular Mechanics

Increase Your Income

Learn Show Card Writing and Lettering



A complete course (32 lesson plates) size 11 x 15, mailed for \$1.00. Guaranteed to suit you or money refunded if returned at once. Send for descriptive circular.

ALPHA COLOR COMPANY, Inc., 31 E. 125th St., New York

LEARN TO DRAW for BIG PAY

Be a Cartoonist—Illustrator—Commercial Artist and earn \$25 to \$100 a week. Learn now at home in spare time by our New Instruction Method. Artist's Outfit FREE to new students. Easy terms. Write today for Handsome Book—free.

Washington School of Art, 1099 H St., N. W., Wash., D. C.

The Salaries

of TRAINED TRAFFIC MEN range from \$2,500 to \$10,000 a year. There are thousands of positions open. Train yourself to be a Traffic Manager—in your spare time—at home. Our experience method of training—our traffic library, compiled through the co-operation of more than 300 Traffic Experts of national reputation—the members of our association will make it easy for you to qualify yourself for one of these positions.

Write TODAY for Free Particulars. We will show you how
THE AMERICAN COMMERCE ASSOCIATION
Dept. 142 206 South Wabash Ave. CHICAGO, ILL.

Learn Electricity! 20 Lessons Free!

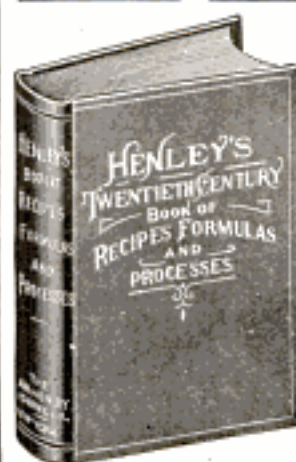

Let me give you 20 regular lessons in Electricity FREE. Write postal for my great book and sensational offer. Read about my new method of teaching you by mail in your own home. Earn \$2400 to \$4000 a year! SEND POSTAL TODAY. Let me show you what I have done for thousands of others. My guarantee gives you entire Course Free unless satisfied. Get my 20 Lessons. Write for Book and Offer NOW. Address: Albert Wood Wicks, S.S., E.E., President Wicks Electrical Institute, Dept. 423, 61 W. Randolph Street, Chicago

10,000 Practical Recipes**HENLEY'S**

Twentieth Century
Book of
**Recipes, Formulas
and Processes**

Edited by
GARDNER D. HISCOX, M. E.

Contains over 10,000 Selected Scientific, Chemical, Technological and Practical Recipes and Processes, including Hundreds of So-Called Trade Secrets for Every Business. This book of 800 pages is the most complete Book of Recipes ever published, giving thousands of recipes for the manufacture of valuable articles for every-day use. Hints, Helps, Practical Ideas and Secret Processes are revealed within its pages. It covers every branch of the useful arts and tells thousands of ways of making money and is just the book everyone should have at his command. A book to which you may turn with confidence that you will find what you are looking for. A mine of information up-to-date in every respect. Contains an immense number of formulas that everyone ought to have that are not found in any other work.

Send for descriptive literature including list of principal contents.

Price, Cloth Binding \$3.00, Half Morocco Binding \$4.00, prepaid to any address.

Popular Mechanics Book Dept.
6 N. Michigan Ave., CHICAGO

BIG MONEY

in the Automobile and Tractor Business

Do you know that there never has been an opportunity like the present for expert automobile and tractor men?

The demand is increasing daily, for the war is stripping the country of skilled mechanics. We teach you everything about repairing and operating every kind of machine, from high-class automobiles to the farm tractor and truck. Nothing is left out or overlooked.

It is just as easy to become a battery, starting and lighting system expert, as it is to be an ordinary mechanic, and the Sweeney School gives the electrical or so-called complicated equipment on cars the attention it deserves.

Qualify Yourself to Make More Money

and make it easy. In this school you actually do the work and learn by experience, and prove that you have learned the business before you leave. It is not theory, it is practice that makes you a valuable man.

Send Today for My Big FREE Catalogue

fully illustrated, that will tell you how to become an expert automobile and tractor mechanic, and command an expert salary. Today is the day to investigate the possibilities in this business. **WRITE NOW!**

E. J. SWEENEY, President

SWEENEY AUTOMOBILE AND TRACTOR SCHOOL
1167 E. 15th Street, Kansas City, Mo.

Members of the Naval Militia, Naval Reserve and Motor-Boat Owners, Yachtsmen, etc., who contemplate entering the service—

The most useful book you can get hold of is

The Elements of Navigation

in a new revised edition by

LIEUT. W. J. HENDERSON
First Naval Battalion of New York

It is the only book published giving the whole science of practical navigation in a nutshell which is non-technical and yet absolutely authoritative. New chapters have been added to cover the motor-boat situation.

It gives a short and complete explanation of the standard methods of finding the position of a ship at sea and the course to be steered. Designed for the instruction of beginners; of especial use to owners of motor-boats and yachts. Recommended by the Navy Department for use by the naval militia.

218 Pages. Illustrated. Cloth Binding. Fits the Pocket.

Price \$1.35 Postpaid

ORDER YOUR COPY TODAY

Popular Mechanics Book Dept.
6 N. Michigan Ave., CHICAGO

JUST OUT

Amateur Mechanics No. 8

An interesting new book for all those who like to make things.

SHOWS HOW TO BUILD

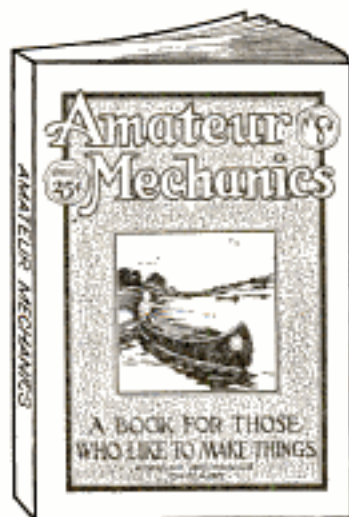

Arc Light
Bird Houses
Bookrack
Camping Outfits
Cement Plant
Dish Washer
Electric Fountain
Fish Lure
Fishing Rods
Grape Arbor
Hammocks
Illuminating Gas Plant
Kites of Various Kinds
Lawn Sprinklers
Monoplane, Model
Motorboat Whistle
Mystery Coin Box
Parlor Table
Porch Swing
Reed Furniture
Scarecrow
Shocking Machine
Swing, Circular
T-Squares
Table Box for Campers
Toy Bank
Tuberculosis Cottage
Wall Shelves
Window Closer
Woven-Top Stool

and scores of other useful articles

128 Pages — 132 Articles — 234 Illustrations

Price 25 Cents, Postpaid

Popular Mechanics Book Dept.
6 North Michigan Ave., CHICAGO



PHOTO BY HALLENBECK

IRVING R. ALLEN

And The Ten Laws of Success

By Henry H. White

I regard Irving R. Allen as the greatest of all personal efficiency experts.

I mean by this that I have never known or heard of any other man with ability equal to his in helping other men get to the top. I have never seen anything in business so remarkable as the work this man does in showing others how to get more out of their brains.

I have watched his career. I have observed the amazing work he has done for giant corporations, who year after year pay him immense fees for his advisory service. I have been told of his results by the heads of these great organizations.

Only a short time ago, the President of a company of vast scope said to me: "Allen has done for us what I never thought any individual could do; and I have said to him again and again, 'If you would just tell others how to do what you are doing—if you would put your methods into print—every man with a spark of ambition, from clerk to president, would eagerly seek your message.'"

The President of a famous university said:

"If Mr. Allen would consent to teach personal efficiency he would startle the educational world with the impetus he would give the student."

As I made further inquiries, I found more and more evidence of the genius of this man who, unknown to the business world a few years ago, now earns a princely income by making the employees of big organizations more efficient.

"Allen developed our business manager from a clerk," I was told in one office.

A sales manager said: "He has shown our salesmen how to double their business."

"I myself have profited immensely from his instruction," are the words of a president.

Then I had an interview with Allen and he told me about the "Ten Laws of Success." That interview, I believe, will be historic, for it was there that the plan was unfolded by which you, reader, and other ambitious men, can have put into your hands the very methods which this master of personal efficiency is using every day. You can now know the principles which have enabled him to rise from obscurity to the pinnacle

Please Mention Popular Mechanics

THE TEN LAWS WHICH MAKE MEN SUCCEED

of success, and to command an income which represents the interest on a million dollars.

"Every man must have an opportunity if he is to succeed," said Allen to me, "and the wonderful truth is that every man can have it. The old idea that opportunity comes but once is exploded. Opportunity is always at your side and can easily be grasped."

"The trouble with most men who fail is simply that they do not know how to seize opportunity even when it bumps right into them."

"And every day I meet men counted as successful—men in executive positions—who are not getting anywhere near what they ought to get out of opportunity."

"They do not know the 'Ten Laws of Success—'"

"The Ten Laws of Success?" I queried.

"Yes—do you realize that every man who has won a commanding position through his own efforts has consciously or unconsciously put into practice certain basic laws or principles?"

"I know a man who twelve years ago lived in a rented room over a grocery store. Today his income is said to be over a million a year. Another was once a newspaper reporter. Now he is the head of a big manufacturing concern and has refused an immense sum for his interests. Still another was an office boy at fifteen. Today at thirty-five he controls a big industry."

"Such successes as these don't come by chance. Luck may give some men a start, but it can't hold them in positions where they have to 'make good.' It is knowledge of the fundamental success laws which puts a man ahead. Any man, big or little, who will apply these laws will develop into a bigger man than he could ever hope to become by haphazard mental methods, by patient plodding, or by blind trust in chance."

"The 'Ten Laws of Success' are as sure and changeless as the law of gravitation. They have existed from the beginning of the human race; they will exist until the last successful man is gone. They explain why men of no more apparent ability than their fellows rise above the multitude. It is the application of these laws which enables the poverty-stricken immigrant to become a merchant prince, the brakeman to develop into a railroad president, the clerk to become a proprietor. It is the knowledge of these laws which enables the executive to get the utmost efficiency out of his organization."

"Yes, opportunity is always at every man's right hand. It is ready to be grasped—and it can be grasped. One need only know these really simple laws to be master of conditions."

I have persuaded Irving R. Allen to do what he has so often been urged to do. He has put into concise, definite, easily understandable form, the full explanation of the "Ten Laws of Success." I think that this is the most remarkable work of the kind that the human brain has yet evolved. A strong statement—yes. But here are the methods for which the keenest business men pay the author thousands of dollars every year to put into practice for them. Here are the laws

of success by which hundreds of men vastly increase their capacity and their earning power.

Never before has this information been published. It is doubtful if many of the world's most successful men could formulate these laws even though they all use them in their daily life. By most men they cannot be put into words. By others they are held as jealously guarded secrets.

But Irving R. Allen is a master analyst of human nature. He knows the motives that cause men to act; he knows what a man must do to develop that which will make him a leader. He can tell how to make opportunity.

This great exposition of the laws which bring success is not the work of a mere theorist. It comes from the brain of a man of big affairs—a man whose own startling success was won by the very laws he explains to you—a man who is showing successful men every day how to be more successful.

"The Ten Laws of Success" places in your hands the very knowledge that every man of power has utilized to carry out his will. And just such an opportunity is offered you now.

This remarkable work under the general title, "The Ten Laws of Success," is divided into subjects, each a masterly exposition of principles. Some of them are: "You and Opportunity," "The First Laws of Success," "The Basics of Human Influence," "Sources of Man Power Analyzed," "Weighing Yourself to Find What's Wanting," "The Ten Interrogation Points of Self," "The Control Chart of Progress," "Putting Will to Work," "The Short Cut to Concentration," "The Multiplied Man," "The Power of Looking Ahead," "The Great Blazer of Ways," "Opportunity to Order," "Revolution versus Evolution."

So sure am I that those who once see what Allen has given them will never part with it that I now make a very extraordinary introductory offer.

I say—send no money. Just tell me that you want to read Irving R. Allen's "Ten Laws of Success," and I will ship the entire 17 short tabloid texts, prepaid. Read them for five days. Then if you find that they will open your eyes to real success, broaden your career, and bring you real opportunity, send only \$5.00 and keep them. Otherwise, return them at my expense.

I make this free examination offer and this special price on the advance edition only. I do not guarantee to hold it open indefinitely. But I know that every set of this work that goes out will create such a sensation and will be so widely discussed that it will bring more valuable publicity than printed advertising.

So I say, get this amazing work at my risk and my expense. Then decide whether you will make it yours or not. All you need to do is to write your name and address on a post card or in a letter—or on the margin of this page, which you can tear out and mail to me. Send no money.

Address Henry H. White, General Manager, Commercial Research Corporation, Dept. 22, Suite 1124, Twentieth Century Bldg., Chicago, Illinois.



Many Woods In One!

THE modern home of beauty and refinement has included in its interior finish a variety of effects in tone and color. These effects can, of course, be produced by the use of a variety of woods—but that involves expense beyond the means of a great majority of us.

It is possible, however, to attain the same result—**easily, economically and permanently**—by the use of **ONE** wood. That wood is

Southern Pine

“The Wood of Many Uses”

Southern Pine not only ranks among the strongest, most durable and most workable of home building material, but because of the readiness with which it takes and holds stains, paints and enamels, it is possible to obtain any desired effect in tone or color. For interior use in the home it is literally “many woods in one.” Furthermore, its wonderfully varied and beautiful grain lends infinite variety to its satiny surface when stained or varnished.

If you have home building or home refinishing in prospect, it will pay you to write us for information that will be valuable to you. Address Department F-51.

**Southern Pine
Association**
New Orleans, La.

Please Mention Popular Mechanics

Send: v Cont. Jos. A. Stearns, Jr.
Morris Bldg. 1411 Chestnut St. Phila, Pa

Popular Mechanics Magazine

REGISTERED IN U. S. PATENT OFFICE

WRITTEN SO YOU CAN UNDERSTAND IT

4796
Vol. 28

SEPTEMBER, 1917

No. 3

Floating Bomb-Laden Net to Foil Submarines

DRIFTING, explosive snare nets, stretched across the entrances to the North Sea or forming protected lanes across the Atlantic have been proposed as a means of defeating the German submarines. This comprehensive scheme has been worked out in considerable detail and calls for careful consideration because all of the materials with which these nets would be made can be had at once in great quantities. The barriers could be constructed in existing plants, and no especially trained men would be required to make them effective. The nets would be made of single-strand telephone

wire, with 15 or 20-ft. meshes, and to them bombs would be attached which would explode on being struck by a submarine. These bombs would be similar to hand grenades but more powerful. The nets would hang to a

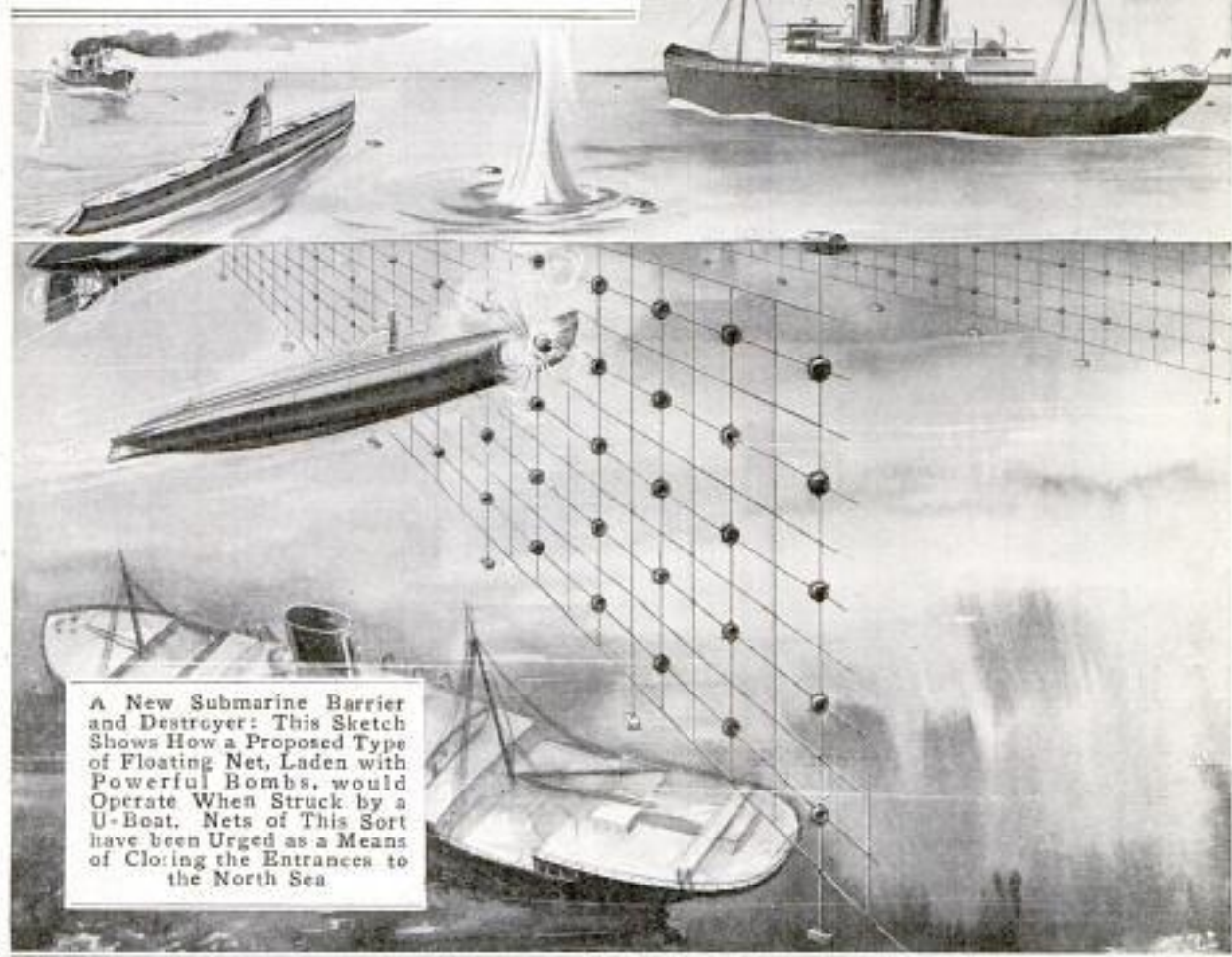

A New Submarine Barrier and Destroyer: This Sketch Shows How a Proposed Type of Floating Net, Laden with Powerful Bombs, would Operate When Struck by a U-Boat. Nets of This Sort have been Urged as a Means of Closing the Entrances to the North Sea

Herbert & Hussey Co. 1818 E. 42nd St. N.Y.C.

depth of about 200 feet, or below the depth to which a submarine can go. Oil barrels would serve as buoys. It is apparent that it would be a sorry day for the U-boat that tried to cut its way through one of these nets with any of the cutting devices which the Germans are reported to have devised and placed on the exterior of their submarines.

With a sufficient number of these nets extending from Scotland to Nor-

way and across the English Channel, if necessary, the inventor believes that these North Sea entrances could be closed to underwater craft. Another use for them would be to form a protected steamship lane by stretching two rows of nets across the Atlantic. In case a submarine rose to the surface, in an effort to destroy or pass over the nets, patrol boats which could be kept on duty could attack the enemy craft.

4807
Attach
measuring

TWO FOCUSING SCALES USED ON FOLDING CAMERA

One of the radical features of a high-grade folding camera that has been introduced especially for the particular amateur, is a new focusing arrangement which permits the necessary adjustments to be made before opening the case. The advantage of this refine-



The Special Focusing Arrangement is Provided in Addition to the Usual Means of Adjustment

ment will be apparent to the person who is practiced in making exposures under trying conditions that call for speed. The exterior scale is provided

on the front side of the case. When the opening button is pressed, the front drops into place, and the lens and shutter holder, attached to the bellows, automatically move out to the proper focal distance and lock.

4798 **DESTRUCTION OF IRON A PROBLEM IN TROPICS**

People living in temperate climates have little conception of the heavy expense and great inconvenience which dwellers in many parts of the tropics are subject to because of the rapid deterioration of iron. The humidity, together with the penetrating salt in the atmosphere, if one is located near the sea, serves rapidly to corrode metal parts or structures which, in other regions, would last a lifetime. For example, in the South Sea Islands corrugated roofing of galvanized iron will be covered with red rust within from five to seven years. Because of this condition pure brass is much in demand, particularly for boat and other marine fixtures. Hooks, pins, and other fittings which are merely coated with brass, or are bronzed, go to pieces within a few months under the action of the elements and so are not worth buying even at low prices. The tendency is for wood also to decay rapidly in a humid tropical climate.

Prof. measured from
structures. Small brass
Devised

4800 (R. H. Wood) launching

MASSIVE STEEL FIGHTER TAKES MAIDEN PLUNGE

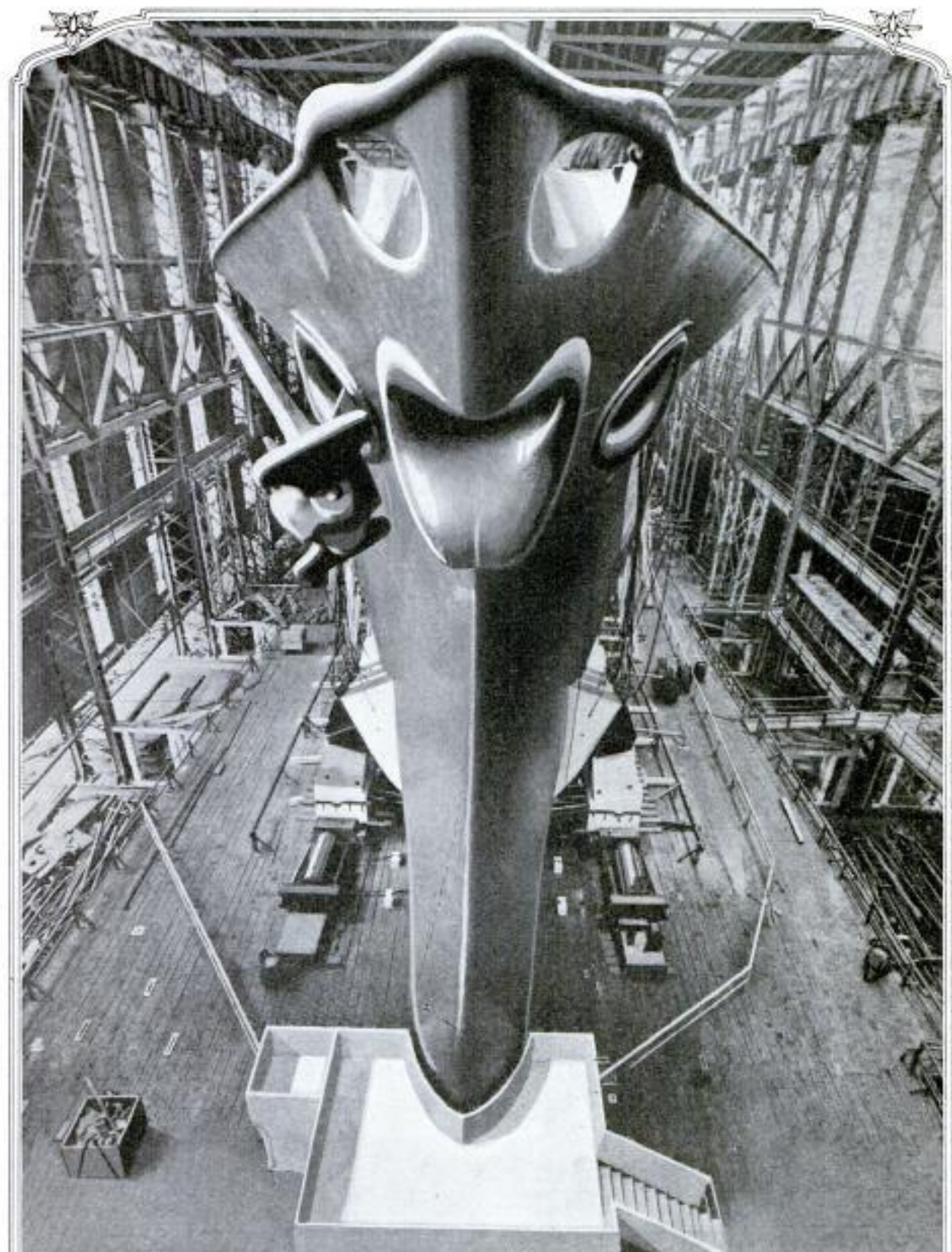

IN the photograph reproduced above, the fantastic face of the dreadnaught "Idaho," recently launched at Camden, New Jersey, stands out with striking unusualness. What appears to be an enormous mouth is the central hawse-pipe opening, and under ordinary conditions would be practically closed by the crown and shank of the anchor in stowage position. The vessel is a sister ship of the "Mississippi" and the "New Mexico." It is 600 feet long, has a displacement of 32,000 tons, mounts turbines that develop 32,000 horsepower, and has a rated speed of about 24 miles an hour. The armament consists of twelve 14-inch rifles arranged in four three-gun turrets, 22 five-inch pieces, and two 21-inch torpedo tubes.

1-D... - Capt. R. L. Furissen - 5th Reg. S...
L... ..

SERVICE FLAG IS DESIGNED AS FAMILY HONOR EMBLEM

Attempt is being made to gain national recognition for a service flag that



Service Flag Adopted Officially by the City of Cleveland and the State of Ohio

has been officially adopted by the city of Cleveland and the state of Ohio. It

is an emblem of honor to be displayed with Old Glory by every family that has one or more members in active war service. The flag is two by three feet in size and consists of one or several blue stars charged on a white field surrounded by a red border, six inches in width. For each enlisted or commissioned member of a family, a five-pointed star, which measures five inches between opposite points, is provided.

47-9

TERRIBLE NIAGARA WRECK UNDER INVESTIGATION

Protracted investigations, instituted by various authorities, have been seeking to ascertain how such a washout as that which caused the terrible wreck on the gorge trolley route at Niagara Falls, could go unnoticed by those who are responsible for the safe operation of this famous scenic railway. As the accompanying illustrations show, the portion of the track which was undermined was several yards in extent and must have been considerable time in forming. Some 50 persons were in the car that plunged down the 20-ft. embankment into the mighty rapids below, and according to revised reports 10 of these were killed, 4 were missing and believed drowned, and 24 were injured.



View Showing Curved Track of the Gorge Route, the Gap Caused by the Washout, and the 20-Foot Embankment over Which the Loaded Trolley Car Plunged into the Rapids Below

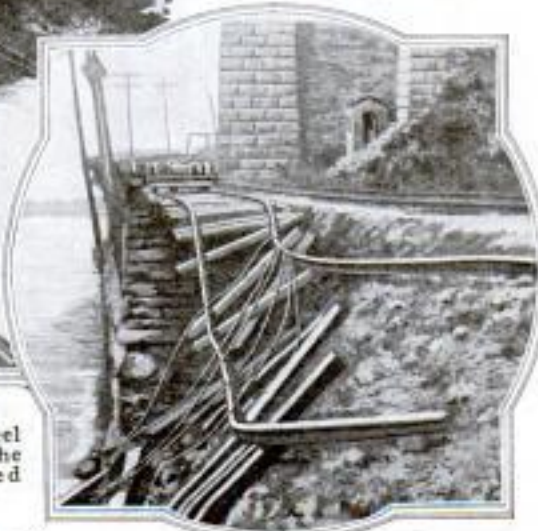

What Fragile Things the Steel Rails Proved to Be When the Embankment was Washed Away is Shown Here

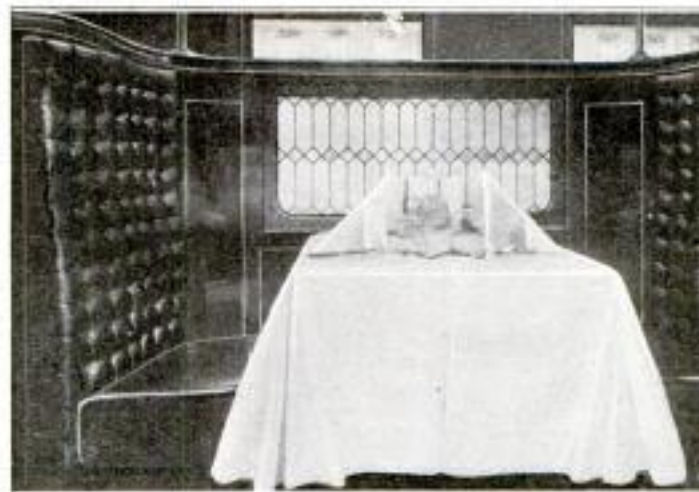

Above is Shown One of the Compartments Divided so as to Provide a Semiprivate Booth for Two Persons. The Picture at the Right Gives a Good Conception of the General Character of the Car

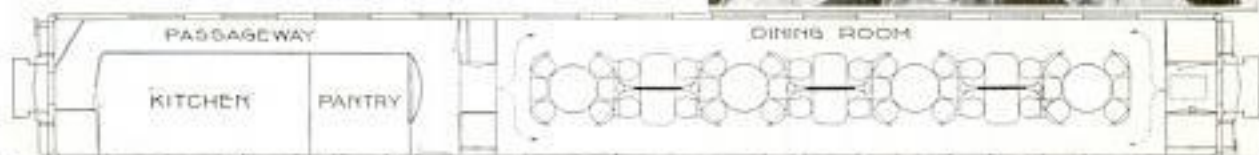

The Drawing Explains in Detail the Whole Arrangement of the New Dining Car, Which is Intended to Afford Patrons Comfort and Convenience While Enjoying Their Meals En Route

DINERS AFFORDED PRIVACY IN NEWLY PLANNED CARS

To promote the comfort and privacy of its patrons, the Erie Railroad has placed in service some dining cars of new character that, from the traveler's standpoint at least, mark a welcome departure from the conventional arrangement. Seven compartments are provided in the middle of the car. Four of these are supplied with large round tables designed to accommodate two couples, or, when necessary, six persons. The alternate booths are convertible. Removable leaded-glass screens divide them so that six tables, each for two diners, are formed. By removing one of the partitions a rectangular table large enough for four persons is made available. An aisle extends along each side of the room, separating the compartments from the walls. This arrangement permits the car windows to be opened during warm weather without causing strong air currents to blow across the tables. The plan is an excellent example of the passengers' comfort and convenience being placed before seating capacity.

JAPANESE PIPE CLEANER HAS PORTABLE OUTFIT

Cleaning tobacco pipes is a trade which affords a livelihood for many an itinerant worker in Japan. The outfit needed to perform this task for Oriental smokers is carried in a covered two-wheel pushcart, and includes a little copper kettle from which a jet of



Japanese Itinerant Worker Cleaning a Smoker's Pipe: His Portable Outfit Includes a Little Copper Boiler from Which a Jet of Steam is Forced into the Pipe After It has been Swabbed Out

steam is forced into the stem of the pipe, after the latter has been swabbed out and dried with a wire and cloth.

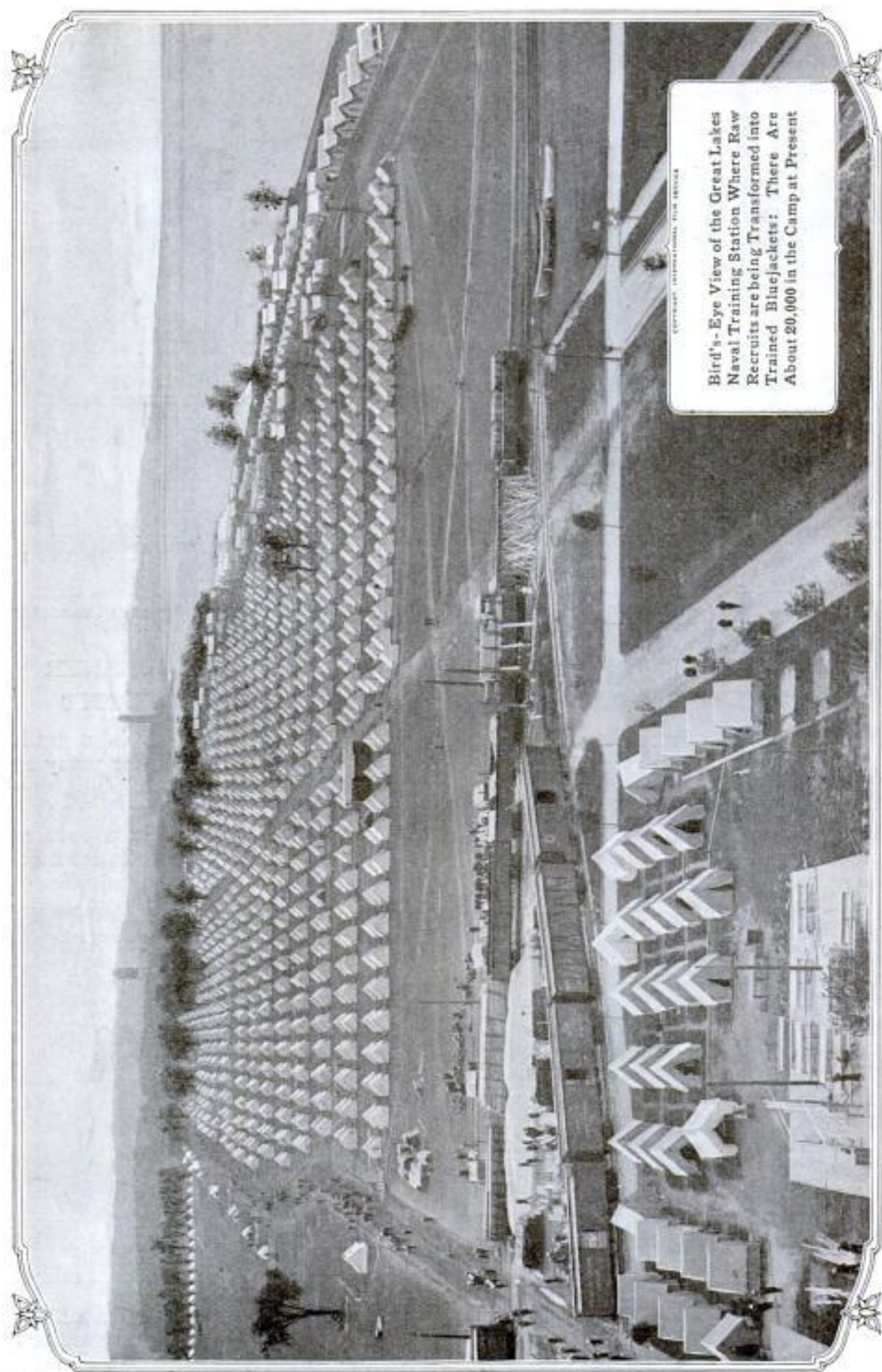

COURTESY, INTERNATIONAL FILM SERVICE

Bird's-Eye View of the Great Lakes Naval Training Station Where Raw Recruits are being Transformed into Trained Bluejackets: There Are About 20,000 in the Camp at Present

THE BLUEJACKET FACTORY OF THE GREAT LAKES

By JACK LAIT

4873
MAKING salt-water sailors out of well-water farmers, fresh-water mechanics, and soda-water clerks is Capt. W. A. Moffett's "bit" at the government's Great Lakes Naval Training Station, a few miles north of Chicago on the shore of Lake Michigan.

Before you will have read this, about 25,000 willing young fellows will have passed through the institution and will be "somewhere on the ocean," or in "an Atlantic port," naval men on active duty.

In May they were scattered through the Middle West—Illinois, Wisconsin, Michigan, Iowa, the Dakotas, Minnesota, Missouri, Arkansas, Louisiana, Tennessee, Kentucky and Indiana—in all callings and all social subdivisions. Not one in twenty of them had ever seen an ocean before he wore his uniform on one, and comparatively few had ever seen a water body of any magnitude at all before they took a peep over the parapet at the training camp and beheld the choppy surface of Lake Michigan.

Moreover, most of these "Jackies" had never been on a boat more formidable than a flat-bottom skiff or, perhaps, a picnic excursion "Jenny,"—and no more had they when their preparation was virtually complete, for, strange to relate, this rapid-fire school for graduating seamen holds classes entirely on dry land. There is a government cutter in the little harbor, and there is a pony train-

ing ship, formerly a unit of the Spanish navy, captured by Schley, which cruises between Great Lakes and Chicago, more for advertising and recruiting display than for practice work.

Steering, rigging, splicing, navigating, naval gunning, torpedo "planting," deck washing (called "walloping"), deep-sea discipline, lifeboat manning, topmast observation, maritime cooking, and marine signaling, all are taught and all must be learned in buildings or on grass plots.

And they must be learned at double-quick speed, for sailors are needed in a hurry. About ten weeks has been the average time consumed in the development of the raw stuff into material ready for embarkation, of which the first three weeks are spent in detention,

physical and social quarantine for sanitary treatment and medical observation.

The life is very much the same as that of men training for the army, except that there is no trench maneuvering.

The boys live in tents. Great Lakes Station was built to take care of 1,800 cadets, as a permanent barracks. Today there are about 20,000 there, most of them living in conical or pyramidal tents on

leased acreage adjoining the main reservation. The existence is not extraordinarily rigorous or trying. The week-end leaves are liberal after the detention period, there is much baseball playing, boxing, wrestling, swim-



John Philip Sousa, the Renowned Bandmaster, Now a Lieutenant, in Conversation with Officers at the Great Lakes Naval Training Station

ming, and leisure. There are thirty baseball teams, playing daily matches on league schedules. Every Thursday afternoon there are boxing contests in which weight-matched youths, selected by elimination battles in their own crews, meet to fight it out for the honor or glory of their respective contingents. I saw a neat little knockout in less than two rounds, to the great glee and prodigal applause of about 5,000 observers, among them many women. The food is beyond faultfinding, plentiful and wholesome. The moral barricades about the camp are impenetrable.

It is almost grotesque to see the squads take their naval training on the grass. A battleship is scattered over about a square mile of neatly mowed prairies, in sections and bits—that is, it is in improvised imitations of portions of a ship, some of them crude in aspect and comical in their application to the parallel paraphernalia of vessels.

Here are stretched two long cables, from which are strung a hundred or more bits of loose rope. The instructor stands between the two cables and demonstrates as the students, one at each rope, rehearse the endless varieties of knots, each denominated in seagoing language, including the "bosun's eye," the "monkey's fist," the "devil's elbow," the "Chinaman's clutch," and some even less delicate in allusion.

When the tyro's fingers are red and swollen and studded with rope slivers, the class moves over to a steering platform where a naval compass has been rigged, as is the rule, in the center of the thing, behind which is the regula-

tion steering wheel, attached with hemp ropes to a drum below, which whips the platform about something as an equal pressure and similar manipulation might swerve a ship, I am assured. Therefrom they proceed to another land apparatus, this one representing bulwarks, davits and a lifeboat. Exercises follow in letting down the boat, and so forth.

So they go through it all, from boarding and filing up and down the companionways to easing into sailors' canvas hammocks and swabbing make-believe quarter-decks.

Target shooting with small arms and long-range ordnance is taught and demonstrated much as it is for army work, except that there is a technical difference in that the practice is more specially applied to navy tactics.

Gymnasium drills are obligatory, tank baths are required, some form of outdoor athletic activity is enforced for each man.

Beyond that and the morning class lectures and light evening studies—two hours of class and an hour of study—there is little to do in the being-made of a U. S. tar.

John Philip Sousa, appointed and commissioned a lieutenant for the purpose, drills and conducts the marine band at Great Lakes. He also helps get the name of the station and its works mentioned in print, which is no mean service, as Captain Moffett believes in floating his recruiting on a sea of ink. Captain Moffett has made a record in the work which established a standard held up to many other naval institutions as a criterion. He is an old salt



CAPTAIN WM. A. MOFFETT
Commandant at the Great Lakes Naval Training Station

at the training business. In times of peace it was his duty to keep alive and stirring the perennial need for filling the ranks of the navy, no weak man's task when there is no sensational patriotism on the breezes.

In those days the training life of a seaman was a dream. He lived in government hotels surrounded by as handsome and commodious a set of grounds as the finest resort on any lake shore could show; he was pampered and entertained; his course was a pleasantly lazy yet amusingly active one; he remained long in his preliminaries—being known then as a "naval reserve"—and fed like a traveling salesman.

But today he is grabbed and whisked through an emergency short-term system, for there is now more than the maintenance of departmental pride and governmental tables for him to support. And Captain Moffett has risen like a combination hero and business man to the swollen demands, so far beyond the normal capacity of his plant, so much more hectic than the normal routine of accustomed operations.

He is probably the busiest man in America.

He arises at 4:30 o'clock every morning and covers every corner of the camp before reveille, looking to physical equipment, conditions of quarters, and the like. By six he is in his office, dictating. Thereafter, all day long, he works four relays of stenographer-typists (enlisted men), so that by about seven he has three of them transcribing while he is dictating to the fourth, and so on in a four-spoke wheel. Depart-

mental red tape makes an enormous amount of letter writing obligatory, besides which he answers personally every inquiry sent him by the relatives of the men; by prospective recruits or those interested in them; by parents or guardians who have lost their boys and think they may have gone into the navy; by newspapers and magazines seeking official information; by business houses that deal with the camp, and by the training inmates.

The last mentioned item touches one of his motive passions. He insists on himself investigating and straightening out every complaint, murmur, criticism, suggestion or difficulty of any of the thousands of his charges. Between nine and noon and between two and 5:30 he is stormed with visitors, paralleling in person the missions of the writers enumerated above. He sees as many of them as he can. Of his noon luncheon he makes a general officers' mess and daily conference board,



MRS. WM. A. MOFFETT
Whose Activities at the Station Keep Her as Busy
as the Captain

taking up over the midday food the myriad issues that must be digested and decided where thousands of volunteers are involved; where a great national duty is to be performed posthaste; where originality and high efficiency are demanded, but where printed and arbitrary regulations must be obeyed.

He has four offices, one back of the other. He stands and fights with the work in hand as long as he can in each successive one, like a soldier defending a line of trenches, and by dinner time has been driven into the last resort, airtight, bombproof, a padded cell with a bolted door in which there is no telephone, no telegraph, and no room for



A Modern "Tank" is Used in the Training at the Great Lakes. If Necessary to Use Seamen as Land Forces at Any Time, They will Be Thoroughly Familiar with the Equipment Used on Terra Firma

any other person. There he toils till late into each night.

Mrs. Moffett, a big, hearty, genial woman, though bearing no official authority, helps him in many substantial capacities. She is mother to the 20,000, and, having so long been the mistress of the naval cantonment, she is an informal authority on naval training law, systems, and customs. Next to seeing the captain himself, one can get sure-fire results by a few minutes with Mrs. Moffett—and an inspiration in practical intensive patriotism, good nature under fire, and optimistic faith in American timber, thrown in.

This may sound as though it were inconsequential detail. But into and through Great Lakes must go about five-eighths of the men—of all the men in all the United States—who respond to the naval call sounded on declaration of the war against Germany.

And the character of the training institution is one of the preponderant and vital things that determine volunteer recruiting. Every sailor is a volunteer. There is no conscription for the navy.

And Great Lakes is an institution of such clean and wholesome and repu-

table standing in the immediate community, where it is best known, that hundreds of mothers chose the navy for their sons in preference to the other fighting branches, in the face of the frenzied appeals for those other branches, because they knew that Great Lakes was a clean and Christian, orderly and sane, businesslike and beautiful, and manifestly meritorious establishment. And Captain Moffett is looked to to preserve its honor, its usefulness, and its character as fully, or more so, as we put faith in the integrity of a bank or business house because of the known qualities of its management.

It is a serious thing for parents to trust their sons' health, morals, influences, and lives to even their own government. We cry aloud for recruits in all our services, and it is a grand, patriotic, general campaign. But to each mother the going of her boy is no atom in a public episode. He is not one of many. He is her boy. And she will scrutinize every element that he is to encounter; she will not be ashamed or too indolent to ask questions—many. One would be amazed, even in the expectancy of this spirit, to hear the

infinitesimal points touched upon in the queries of these guardians and doting ones about what their flesh and blood is to experience in the altruistic and noble function of serving the flag.

Therefore Captain Moffett, who has done all that could be done and more than could be decently asked toward comforting relatives, making recruiting comparatively painless and giving assurances of comfort and heart's ease, has accomplished a fine, monumental work. He has succeeded in dissipating a libelous but stubborn superstition that the navy was a reformatory for wayward boys. He has lent dignity to the navy, helped mightily to fill its ranks without need of involuntary enlistment, and has given to a sailors' camp the atmosphere of a college campus. If this is not heroic, it is at least effective.

Because of the high percentage of cellulose contained in them, a French horticulturist has proposed to use spinach stems in the manufacture of paper.

OUTFIT SPRAYS MANY ACRES OF POTATOES IN DAY

Ten rows of potatoes are sprayed in one operation with an outfit that has been developed for large acreages. The machine is horse-drawn and mounts a

DUAL PURPOSES ARE SERVED BY MOTORIST'S AIR GAUGE

For measuring the compression of engine cylinders, and also for determining the pressure of a tire, a combination gauge has been devised that should be of convenience to the motorist. A spark plug is removed, the gauge screwed in its place, and the motor turned over when a cylinder is to be tested. Fourteen and seven-tenths is added to the dial reading to ascertain the total compression. In this way trouble is quickly located. The method of using the device as a tire gauge is obvious.



100-gal. tank, a small gasoline motor, and at the rear, folding arms that carry 16 nozzles. Its operation, even to the folding of the booms to permit passage through a gateway, is controlled from the driver's seat. The wheels are adjustable to either 60 or 75-in. treads.

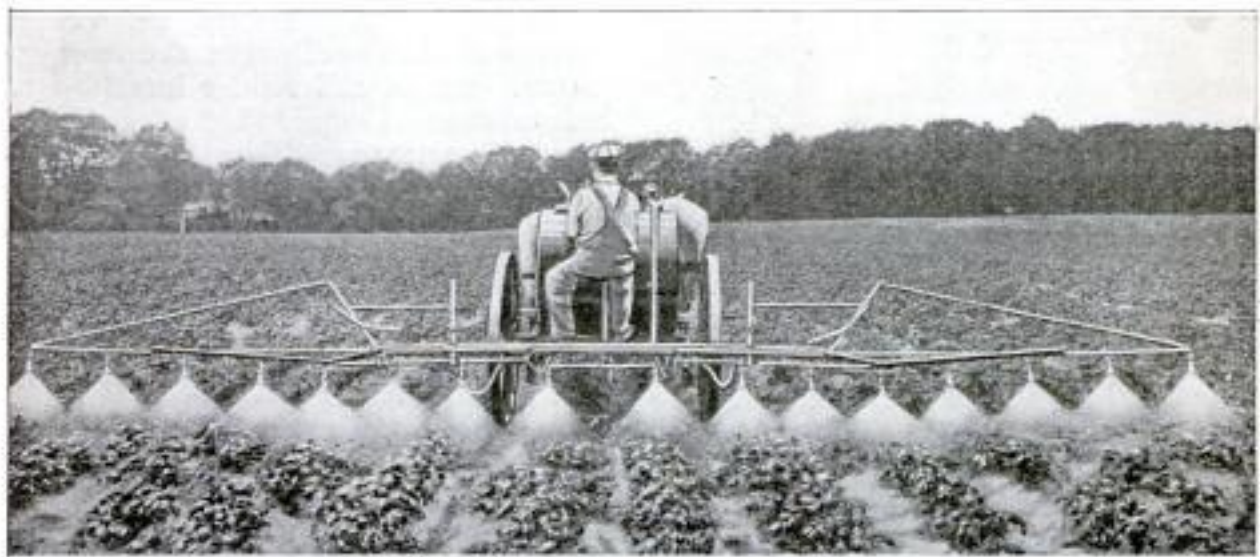

Showing the Sprayer at Work in a Large Potato Field: The Mixture is Pumped to the Nozzles under Pressure by a Gasoline Motor

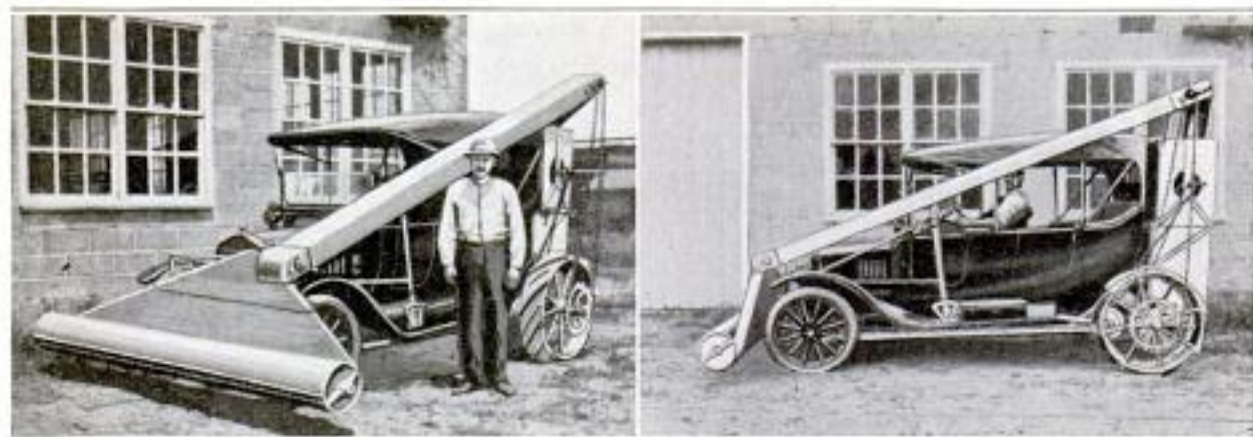

A Front View, Showing the Arrangement of the Cutting Apparatus, is Given at the Left, While at the Right the General Character of the Attachment, When Applied to a Light Car, is Indicated

HELPFUL HAND REST MADE FOR BOOKKEEPERS

One of the new appliances for the business office is intended to overcome the difficulty experienced by bookkeepers, and others, when making entries at the bottom of a ledger which is considerably higher than the surface of the desk on which it is opened. Roughly, the arrangement consists of an adjustable rest that forms an extension to a book and offers a place on which to poise the hand while writing on the lower part of a page. It has a swivel mounting, such as that of a piano stool, and is held by a block terminating in a thin board that fits beneath a record



With the Arm Rest in Place, It Is Easy to Make Entries at the Bottom of a Ledger

book, the block being flush with the margin of a desk.

HARVESTER OUTFIT BUILT AS MOTOR ATTACHMENT

Another invention that contemplates the utilization of the farmer's motor car has made its appearance. This time it is a harvesting and threshing attachment. It can be quickly installed on almost any light automobile, and is claimed to have performed satisfactorily during recent tests in western fields. The cutting apparatus, supported at the front, is adjustable, for instead of operating in the usual manner, it severs the heads of the grain from the straw, which it leaves standing. As this is done, revolving blades throw the material back so that it is caught by the conveyor and carried to the threshing compartment at the rear of the car. The aim of the inventor apparently is to provide a low-priced apparatus that will serve the average farmer's needs and render him largely independent of outside help during the harvesting season. To attach the implement to an automobile it is only necessary to remove the rear wheels, replacing them with the bull wheels.

ⒸThe work of repairing German and Austrian vessels, which have been taken over or purchased since the war began, is progressing rapidly on both the east and west coasts. Some vessels have already been made ready and assigned to the governments of Russia, France, and Italy under special agreements.

4502

MANY KILLED WHEN VESSEL IS HIT BY FALLING TANK

Sixteen lake excursionists were killed and many others injured when the whaleback steamer "Christopher Columbus," a relic of Chicago World's Fair days, met with a strange accident at Milwaukee recently. With its decks comfortably filled with passengers, the vessel, in charge of tugs, was about to pass a bascule bridge spanning the Milwaukee River when something went wrong and the prow of the steamer swung shoreward, crashing against one of the steel supports of a 100-ft. tower upholding a 25,000-gal. tank filled with water. The impact caused the tall, slender structure to rock back and forth briefly. All efforts were made to pull the ship back from its precarious position, but before it had been moved many feet, the tower crumpled and the great tank lunged through the air. With a terrific crash, the vast weight struck the pilot house, tore through the superstructure, and

crushed to death those in its path. The decks and staterooms were flooded. Had the tank fallen immediately, it would have hit the vessel amidships, probably causing greater loss of life, for most of the passengers were congregated there.

While on its remarkable run from the Pacific to the Atlantic, recently, the destroyer "Shaw" established a record by passing through Panama Canal in 5 hr. 45 min. The best previous time was 6 hr. 20 minutes.

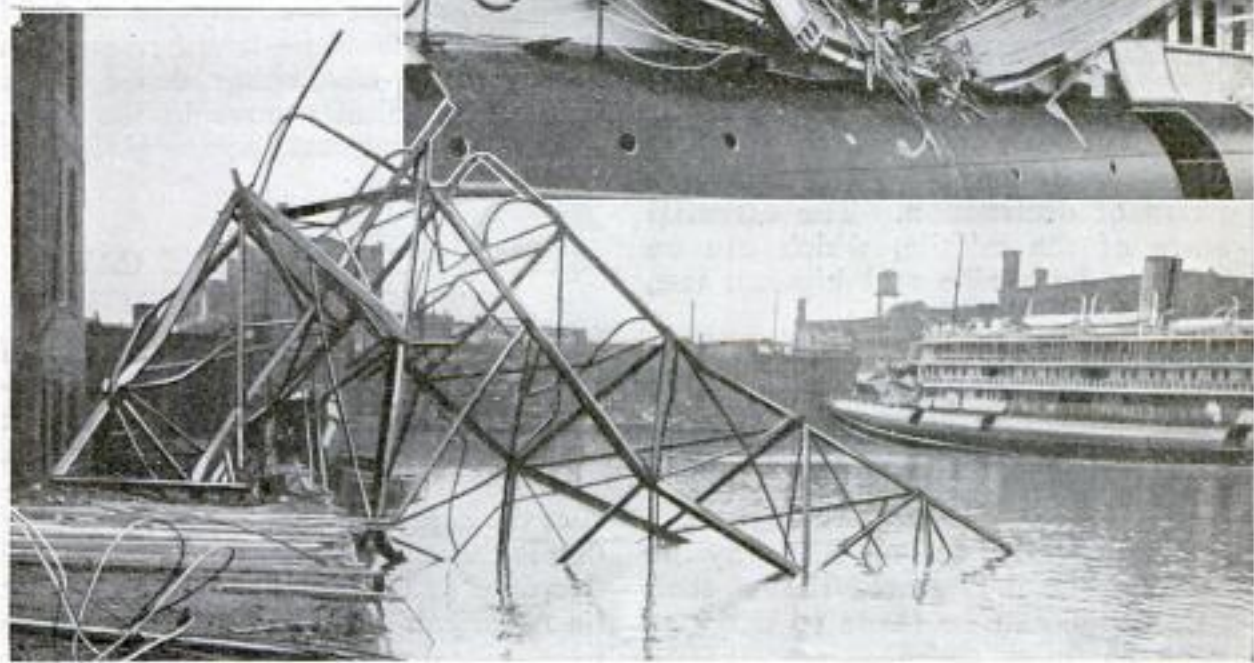

PHOTOS COPYRIGHT, INTERNATIONAL FILM SERVICE

Some of the Damage Done to the Excursion Boat by the Terrific Impact, is Shown in the Picture at the Right. Below, the Twisted Débris of the Overturned Tower is Seen

FOLDING MOTOR-CAR BODY MAKES TWO CARS OF ONE

Those devotees of motoring who desire a roadster one minute and a touring

car the next, but for financial or other reasons content themselves with

one machine, may now satisfy their whims. A convertible body for the automobile has been developed that makes one motor serve as two. By folding the rear section, an action that requires but two minutes, a five or seven-passenger car is changed into an attractive-looking roadster. By reversing this operation, a "single seater" becomes a big, graceful, foreign-appearing touring car, spacious enough for the whole family. The body has only lately been announced. It can be built to fit any chassis from that of a popular-priced light car, to those of expensive models with long wheelbases.

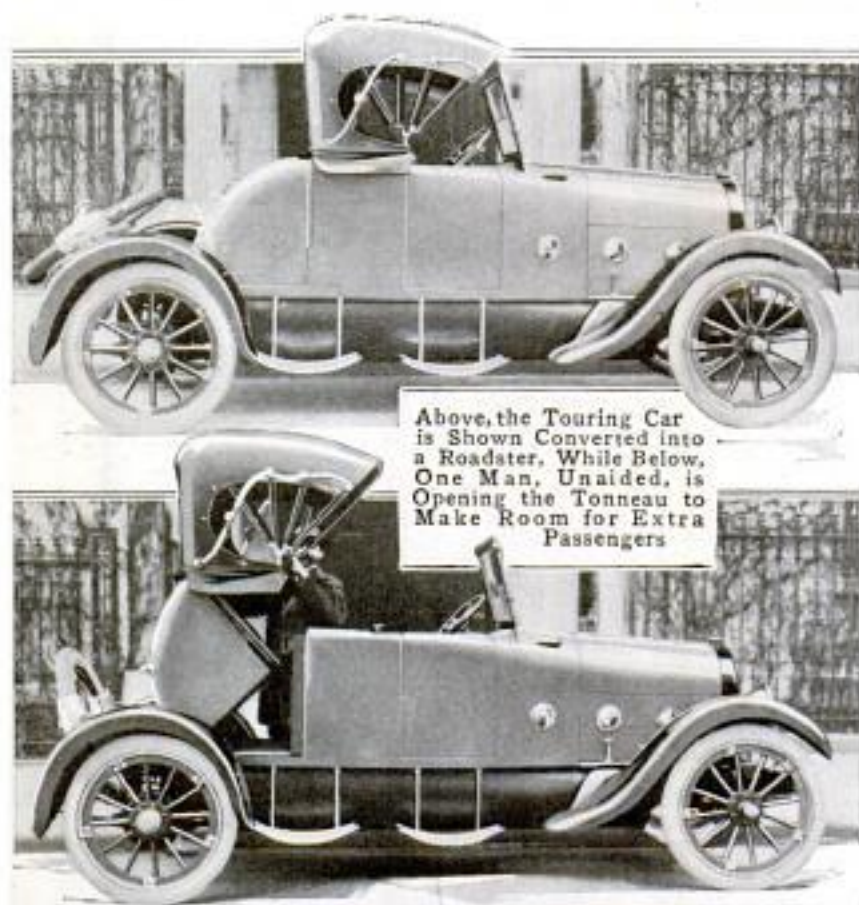

Above, the Touring Car is Shown Converted into a Roadster, While Below, One Man, Unaided, is Opening the Tonneau to Make Room for Extra Passengers

NEW PROJECTILE RELEASES SMOKE AND LIQUID FIRE

A new high-explosive shell is about to be offered to the government, which, it is claimed, possesses extraordinary powers of destruction. The essential nature of the missile, which can be made for both rifle and big-gun use,



Recently Invented High-Explosive Shell: Missiles of This Type, on Exploding, Give Off a Destructive Liquid Fire and an Enveloping Cloud of Smoke

has been revealed to only a few by the inventor, but it is stated that a shell of this type can be made to carry as far as 26 miles and that on striking its objective several scores of units explode. A destructive liquid fire is re-

leased against the enemy by part of the projectile, while another portion gives off an enveloping dense black smoke. A spiral groove in the shell, which is of unusual length, gives it a swirling motion.

SHEEP-KILLING DOGS CAUSE OF ENORMOUS WASTE

At this time, when meat and wool are two of the world's most vital necessities, it is well to turn attention to one of the chief causes of our shortage. The Department of Agriculture sponsors the assertion that the sheep-killing dog is the principal cause of the marked decrease in the number of sheep kept on American farms. Most of us love a good dog, but few persons, once they understood the situation, would willingly give unrestricted freedom to an



This Photograph Shows What Happened in One Night When Two Dogs Attacked a Flock of Sheep. They Killed 50 Animals That Were in the Pink of Condition

animal that in a night's time might slaughter an entire flock of sheep. The government and various organizations are urging that every rural owner of a dog awaken to the situation and take steps to prevent this enormous economic waste.

UNIVERSITY COMMENCEMENT HELD AT ARMY POST

67 38 Sixty-six seniors of the University of Wisconsin participated in unusual graduation exercises late in June when, clad in khaki as members of the reserve officers' training camp at Fort Sheridan, Ill., they were handed their "sheepskins" in the big gymnasium at the army post. Because the men were unable to obtain leaves which would permit them to attend commencement at Madison, the university came to them. The diplomas were distributed by the dean of the men's department, whose address on the occasion was unusual, as befitted the military character of the ceremony. The incident is unique in the history of the institution.

WOODEN MODEL OF CASTLE BUILT BY YOUNG WOMAN

45 1.5 A model of a castle, measuring $4\frac{1}{2}$ by 5 ft., and composed of 2,000 pieces of wood, has recently been constructed by a young woman who spent three months on the task. The walls, towers, battlements, guarded gateway, bartizans, etc., have all been painstakingly reproduced. The finish of the miniature gives it the appearance of stone. It is to be used as a novel electric-light fixture for a large residence.



Model of a Castle Which Measures Four and One-Half by Five Feet, and is Composed of 2,000 Pieces of Wood

RAISE CONCRETE MONUMENT FOR FORMER FIGHTERS

In memory of the soldiers buried in one part of a cemetery at Kinsley, Kans., a monument, paid for by popu-



The Figures and Panels on the Memorial Are Free-Hand Modelings in Concrete

lar subscription, has been erected. One of the interesting things about it is that it is built entirely of reinforced concrete. Bas-relief panels ornament the sides of the square pedestal, which is surmounted by four figures representing the infantry, cavalry, artillery, and navy. A statue of "Winged Victory" crowns the monument. Each of the five figures are free-hand modelings in concrete over iron frames.

MANY WAR-PLANT WORKERS POISONED BY GASES

As a result of an investigation conducted under the direction of the Federal Bureau of Labor Statistics, disclosure has been made that an enormous number of American workers engaged in the production of explo-

sives are succumbing to industrial poisoning. It has been found impossible to obtain accurate figures showing the complete number of cases of sickness and death caused by the work in this country since the opening of the world war. Many cases, it seems, have failed to be recognized, while on the other hand many company and insurance physicians have shown unwillingness to divulge what they know. Solely upon doctors' reports, however, it has been discovered that during a period of about one year, 2,507 known cases of poisoning occurred among workers in 28 plants. Of this number 53 proved fatal. About 55 per cent of the illness and 53 per cent of the deaths, were caused by nitrogen oxides and nitric acid. Most of the victims who suffered from these fumes were employed in making nitrocellulose, picric acid, nitroglycerin, and associated nitrogen products.

HOMEMADE METAL TAPPOON OF CONVENIENT TYPE

A durable and convenient type of tappon illustrated herewith consists of a piece of heavy sheet iron, cut with one straight edge and with the other edge curved to conform to the bed of the irrigation ditch into which it may be inserted to serve as a temporary dam. Handles are provided so that it



At the Right in This Illustration is Shown a Home-made Tappon of Sheet Iron Provided with Handles so That It can be Moved About Easily

can be carried from place to place easily and employed in diverting water into the fields as the occasion may require.

4794

FOR GOOD COLOR: SALT WATER AND SUNSHINE



The Stock Market can "Go Bunch," and So Can Tea Dances and Summer Fiction When the Water Is Warm and There Are "Sea Horses" to be Ridden. "Sea Horses," Incidentally, Are Not Ferocious, but Merely Capricious, and a Bit Balky When the Waves Are Choppy. An Intimate View of One, with a Fair Rider, is Shown at the Left, While Above Many are to be Seen in the Water



A Toboggan for Salt-Water Coasting Gives Some of the Thrills That Make the Snow Slides of the North so Fascinating



Hula Maids, Ukuleles, and Surf Boards Are Three of the Things That have Made Hawaii Famous. This Picture Shows Two of the Latter and Their Mistresses on the Sands at Honolulu



Loaded with Tanned "Huskies" Who Are as Much at Home in the Water as Chorus Girls Are on the Stage, the Life-Savers' Beach Car at a Popular Bathing Resort: The Machine Carries Complete Apparatus for Resuscitating Those Who Have Unfortunate Mishaps in the Water

42
IN THE SURF, WHERE CARES ARE WASHED AWAY



Crowds of Pleasure Seekers Watching Swimming and Diving Contests in a Large Open-Air Tank at a Popular Resort: For Those Who Prefer the Surf, There Is a Beautiful Beach That at Low Tide Accommodates Hundreds of Bathers and "Sand Waders." During the Tourist Season, This Is One of the Gay Spots Where the Spirit of Recreation Runs Riot. The Picture at the Right Shows Bathers Riding a "Torpedo," a Cylindrical Tank That Affords Much Exercise for the Novice and Amusement for the Onlooker



Putting a New Thrill into the Old Swimming Hole: The Catapult, Made by Fastening the Inner Tube of an Automobile Tire to a Horizontal Pole, Throws the Bathers Far Out into the Water. To Stretch the Sling, a Rope and Pulley are Used. The Exhilaration can be Imagined

Light Canvas Coaster, a Frail Little Craft of Odd Design That Permits One to Indulge in All Sorts of Acrobatic Contortions While Enjoying the Swift Ride In from the Breakers: One of the Good Features of the Contrivance Is That, Unlike the Surf Board, Little Skill Is Required in Using It

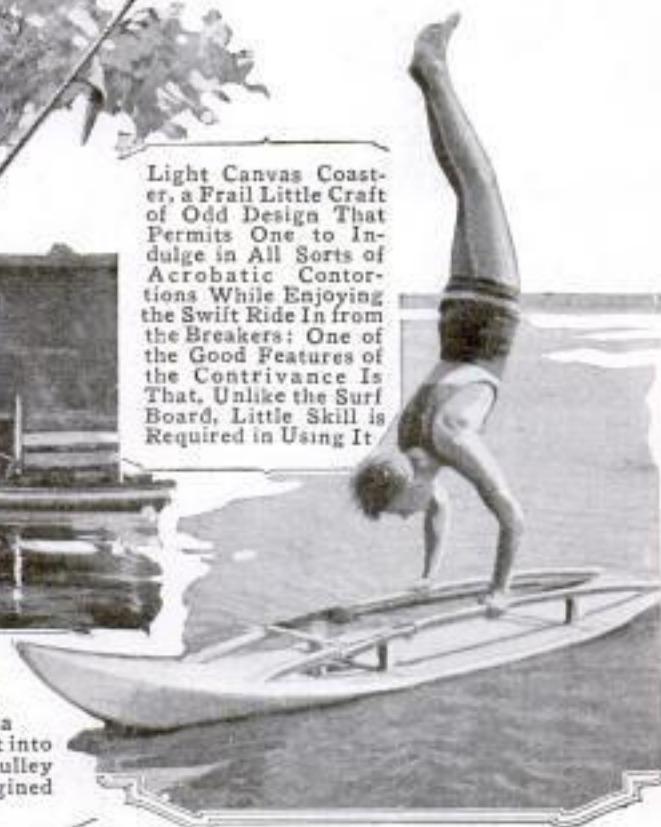

AND YOUTH IS MERELY ONE'S POINT OF VIEW

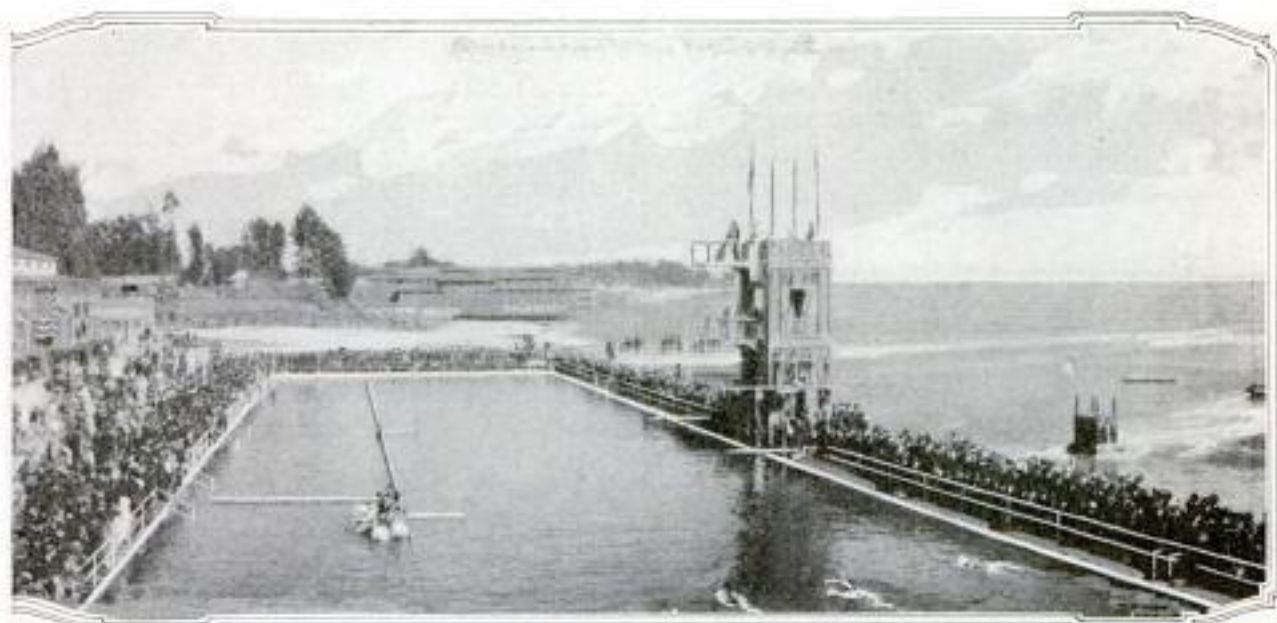

Above, a Group of Water Devotees are Enjoying the Novel Sport Provided by the "Hydro-skis," in Which They are Standing. Although Awkward for the Rank Beginner, One Soon Becomes Adept in Their Use

Glimpse of a Favorite Beach at Night, the Water Illumined by the Glare of a Great Battery of Searchlights Situated at the End of the Pier, Which Extends Out into the Water for a Mile. The Rays of the Projectors Are Visible at Points 40 Miles Inland

In Southern Waters with the "Texas," Showing That the Life of the "Jackie" aboard Our Big Fighting Vessels Is Not All Work and No Play: For the Land-Bred Seamen, However, Who Are Not Amphibious, These Occasional Swimming Meets Afford Slight Opportunity for Instruction. Neck-Deep Water Is as Absent as Sun-Baked Beaches

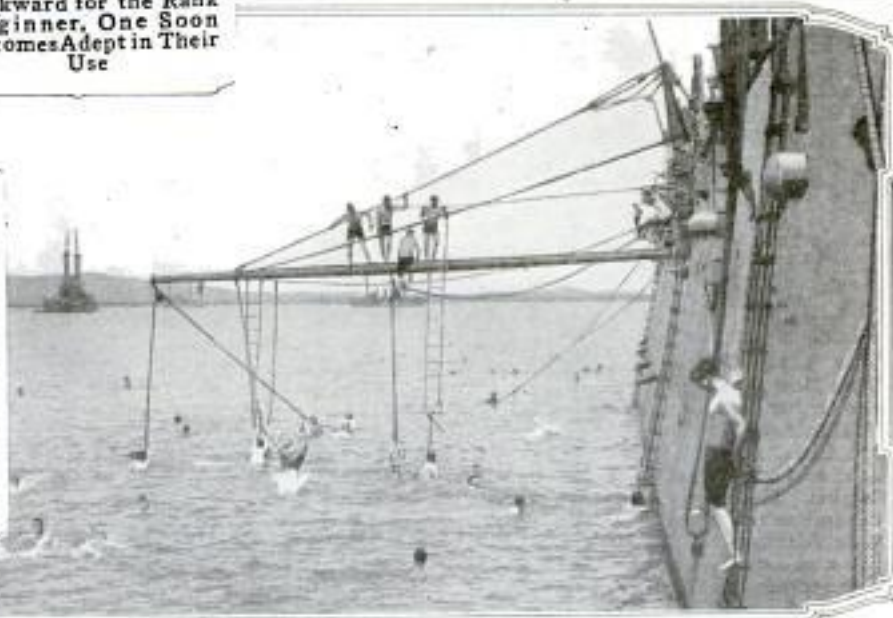

TIRE-FILLING PUMP DRIVEN BY REAR WHEEL OF CAR

Among the motor-car accessories of recent introduction there is a power-



Demonstrating the Method of Attaching the Pump to a Car and Operating It

driven tire pump of simple, yet novel, character. It is a compact contrivance, which is fitted, when in use, to either of two brackets fastened at the rear end of the running boards. When thus mounted, a pulley, which is a part of the instrument, is held in frictional contact with one of the back tires. By jacking up the wheel adjacent to the pump, and starting the engine, air is supplied. In case one of the rear tires is to be inflated, it will be understood that the pump must be attached in front of the opposite one. Tubing of sufficient length to reach either of the front wheels is provided, and connected to it is a pressure gauge. When not in use, the pump is carried in the tool box.

INCORPORATE NEW FEATURES IN LATE AIRPLANE MODELS

Some attractive refinements are embodied in two late models of air craft produced by the Standard Aero Corporation for our army fliers. A three-wheel running gear, for instance, is used on a preliminary training machine, a tractor of sturdy construction built to withstand the hard usage to which instruction planes are subjected. Beginners usually require considerable practice before they master the knack of straightening a craft out, a few feet above the ground, so that it settles onto

the landing gear gracefully. In case this machine encounters the earth at too sharp an angle, the forward wheel tends to throw it back onto those behind. Thus the craft might readily be prevented from digging its nose into the ground. With a full load the range of speed is from 37 to 68 miles an hour.

Ailerons on the upper and lower planes of the military reconnaissance tractor are connected by struts. This unusual practice has been adopted to facilitate control and increase stanchness. The wing spread of both planes is an inch in excess of 40 ft. A 125-hp. motor gives the craft a maximum

speed of 87 miles an hour, and its range of action is about 600 miles.



The Three-Wheel Landing Gear Is a Noticeable Feature of This New Biplane, Which is Now being Supplied to the Govern-

ment for Use as a Preliminary Training Machine at Various Aviation Camps. Right: Military Reconnaissance Tractor with Ailerons on Upper and Lower Planes Connected by Struts to Increase Stanchness and Aid Control

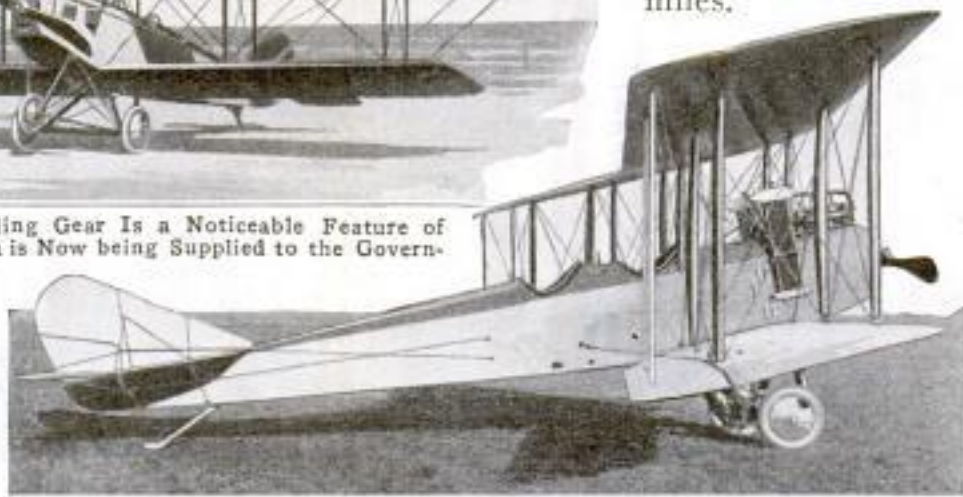



PHOTOS COPYRIGHT, INTERNATIONAL FILM SERVICE

Above and at the Right Are Views of the Wrecked Cars Which were Hurlled from a Brooklyn "L" Structure to the Street as a Result of a Collision



"L" CARS PLUNGE TO STREET WITHOUT FATAL RESULTS

Although several persons were injured, no one was killed when two cars of a Brooklyn elevated train recently left the track and plunged many feet to the pavement. The accident, which was a most remarkable one, occurred when a three-car train crashed into a string of empty carriers that were being switched from the express to the local tracks. The impact of the collision sent the lead car, which carried about 20 persons, crashing to the street. The second car plunged headlong to the sidewalk, and remained in a diagonal position, one end against the walk and the other resting on one edge of the "L" structure. Passengers in this carrier were catapulted to the lower end and half buried beneath loosened seat cushions. To make matters worse, fire broke out.

Our navy's new destroyer "Shaw" made a record run from the Pacific coast, where it was constructed, to an Atlantic port, recently, when it covered a distance of 5,858 miles in 14 days 10 hr. 20 minutes.

BIG TRAVELING SPRINKLER FOR EXTENSIVE GROUNDS

Large lawns, golf and bowling greens, and grass tennis courts are watered thoroughly and without requiring more than casual attention, by



Moving slowly in a circular path, a sprinkler of this type, consisting of three connected units like that shown, can distribute water over an area of more than 1,400 square yards



WHAT A MAN CAN DO WITHOUT HANDS

WHAT would you do if, instead of hands, you had two scarred stubs terminating halfway between the elbows and the place where hands ought to be? What you might do, if you had the courage and persistence, is demonstrated in the case of Joe Glasgow, a teamster and all-round handy man employed by the city of Venice, Calif. When you see this man sauntering into the city yards after lunch, with the air of one well satisfied with life, it is hard to realize his affliction.

Seven years ago, Glasgow, possessed of two good hands, was working as a fireman on a railroad in Michigan. One day there was a collision. The engineer was killed. Glasgow was taken to the hospital, and when he regained consciousness he found that both hands were gone. After leaving the hospital he took up what seemed, for him, the only occupation left, and for two years he stood on the street corners and begged. The occupation paid well but it did not satisfy

him. He wanted the standing among men that he had had before his accident, and he started in learning to work with his stubs.

Now he holds down a job as a teamster, and holds it down so well that a recent attempt to oust him from the city's service, in order to provide a job for a man with two hands and a motor truck, failed. He harnesses and drives his own horse, doing all the loading and unloading without help. When the teaming work is dull he works with



Anyone can Drive a Horse, or at Least Make a Stagger at It, but It Isn't Everyone Who can Harness One. Here Is a Man, a Teamster, Who, in Some Strange Manner, Does Both of These Things without Hands

shovel or saw or at some of the numerous odd jobs to be done about the city

yards. When pay day comes, he writes his name on the back of his check legibly and easily. Once a week he writes "with his own hand" a letter to his mother, whom he supports. He fills and lights his pipe and takes money out of his pocket as readily as do men with two hands. He does these things without hooks or other mechanical aids.

When he came to Venice four years ago it looked as if the city had acquired a new public charge. Glasgow was not long in dispelling this illusion. All he wanted was work, and he started out immediately to find it. A woman telephoned the police station that she wanted a man to mow the lawn and wash windows. They hunted up Glasgow and sent him to the address given. Some time later an indignant woman called up and said she hadn't asked for a cripple—that she wanted an able-bodied man who could work. "Why not give him a chance?" was the suggestion made by the man at the desk. She did, and the way he did the work established him permanently in that neighborhood as a handy man for odd jobs. Later, he went into the express business, buying his horse and wagon with money he had earned. Six months

ago there was an opening for a teamster at the city yards. He went after the job and got it. On several occasions he has had to fight, and on each occasion this was because some misguided person assumed that he would be compelled to submit to an affront because he was a cripple. Glasgow does not admit that he is a cripple, and the only thing he complains of in the matter of fighting is his limited reach. This compels him to take some severe punishment before he can get close enough to his adversary to bring his stubs into effective action.

How does he do these things? It is necessary to see him to understand, and then it seems unbelievable. If he is going to use a tool he "fumbles" it for an instant, gets it in position between his stubs, and uses it so quickly that you scarcely see how it is done. As you watch him you realize that what other men do as a matter of routine is with him a continual triumph. For this reason, perhaps, he is more efficient and thorough than the general run of workmen—more efficient and thorough, it may be, than he would have been if accident had not robbed him of the thing most essential for working.

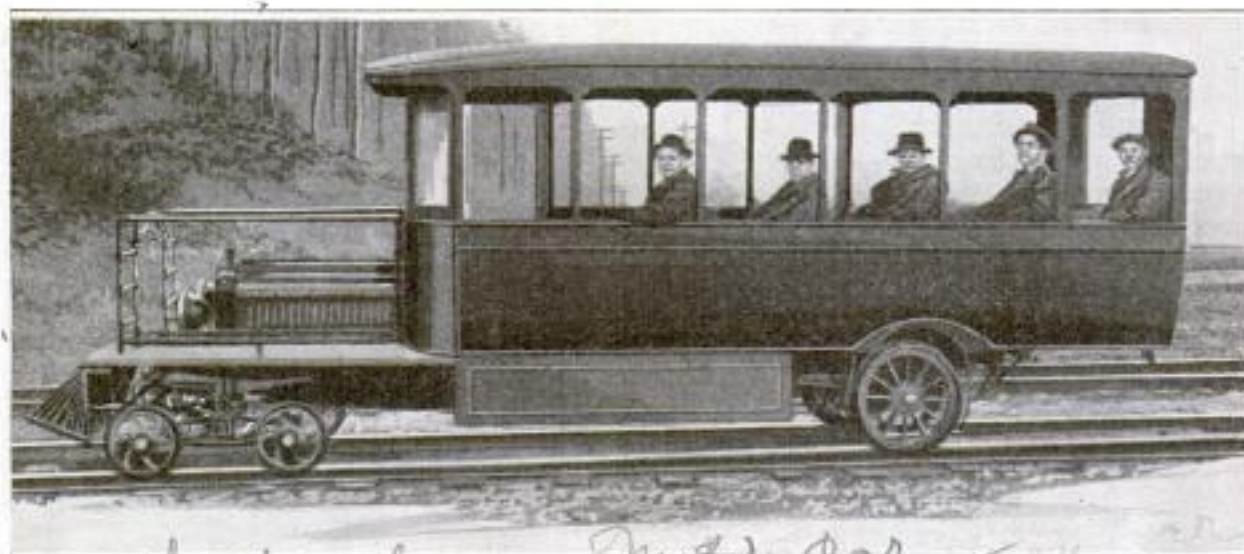

Interurban - Motor Car
GASOLINE PASSENGER CAR ON AN ELECTRIC ROAD

THE roomy gasoline car pictured above makes three return trips daily from Chehalis, Wash., to Onalaska, a lumbering town 18 miles away. It was designed and built for this purpose by a Chehalis concern, and runs over the tracks of a railroad intended for electric service. It is, of course, equipped with flanged wheels, and a special feature is the railed platform built around the automobile engine, above a light four-wheeled truck, with a small cowcatcher of locomotive type in front.

VAST QUANTITY OF SHELLS USED BY ARTILLERY

4531 Although most persons realize that colossal amounts of artillery ammunition are being used daily along the battle fronts of Europe, doubtless few persons have any conception of the actual figures involved. Information of this character has been extracted from General Sixt von Arnim's report of the battle of the Somme in July of last year, according to The Field Artillery Journal. In studying the data, however, it is well to remember that the Germans were on the defensive and lost ground, so that the ammunition expended by them during the period does not even represent the supply needed for a successful defense. The greatest number of projectiles fired in a 24-hour day was 322 rounds for each 3.08-in. field gun, 479 for each 4.20-in. howitzer, 233 for each 6-in. howitzer, 321 for each 4.2-in. gun, and 116 for each 8.4-in. mortar. The daily average for each piece was: 3.08 in., 145 rounds; 4.20 in., 170 rounds; 6 in., 119 rounds; 4.2 in., 118 rounds, and 8.4 in., 51 rounds. Exclusive of heavy pieces, one field gun was placed about every 20 yards along the entire 40 mile front. This would indicate that German 3.08-in. guns fired a total of about 15,732,500 projectiles weighing 121,140.25 tons during the month.

STRONG COT FOR CAMPERS FOLDS UP COMPACTLY

1- A particularly serviceable folding cot is now being used for motorists and campers which can be rolled into a package as long as the opened cot is wide and only a few inches in diameter. The canvas top is supported by four pairs of folding legs which are braced in such a manner that the article does

not tend to collapse when weight is placed upon it. The cot can be set up in a minute's time and knocked down even more quickly. It possesses obvi-



A Strong Comfortable Cot for Campers and Motorists: It is So Constructed That When Occupied, as Shown in the Lower View, It Does Not Tend to Collapse. The Compactness of the Article When Folded is Shown in the Upper View

ous advantages because of its light weight and the small space it occupies when folded.

SABADILLA SEEDS USED IN MAKING WAR GAS *Poison*

A recent report issued by the Smithsonian Institution calls attention to the unusual properties of sabadilla, a Venezuelan plant from the seeds of which were produced some of the asphyxiating and tear-producing gases used by the Germans. It is reported that they bought up all the available supply before the declaration of war. Now, however, the seeds have been declared contraband by Great Britain. A plant of the same genus grows wild in Texas and should the need for sabadilla arise it might be cultivated in the South.

BESTIAL RACE RIOT SHAMES HOME STATE



Fleeing, Not from Blood-Drunk Teutons in Belgium, but from Citizens of East St. Louis in Illinois, the Proud State of the Great Emancipator: The Negroes are Shown Rushing into Missouri, a Former Slave State, to Escape Torture and Murder at the Hands of Their Northern "Defenders"



A Glimpse of the "Black Valley" After the Savage Thirst of White Men and Women had been Satisfied: In This District Negroes were Beaten Insensible, Shot in Cold Blood, Hanged, and Burned. Torches were Applied and More than 300 Homes, Inhabited by the Black Population, Razed



While America, in the Interest of Humanity and Justice, has Cast Its Lot with Gallant France and Her Allies for the Avowed Purpose of Crushing German Autocracy and Brutality, Some 2,000 Soldiers were Forced to Garrison East St. Louis to Quiet the Rioting and Enforce Law and Order. Strife Such as This Interferes with Our Prosecution of the War

HOUSE COPYRIGHT INTERNATIONAL FILM SERVICE

OF LINCOLN ON EVE OF INDEPENDENCE DAY



Flight: A View That Is Remarkable in Its Artistic Qualities and Gripping in Its Portrayal of the Human Element. In the Foreground There Is a Face One should Study. The Girl's Expression Seems Almost Inscrutable. No Two Persons Have Interpreted It Alike



Bird's-Eye View of the Devastated Section of East St. Louis (Which Is Not a Part of St. Louis, Missouri): Several Hundred Thousand Dollars' Worth of Property was Destroyed by the Fire Which Lawless Rioters Kindled. The Outburst Was One of the Most Depraved and Atrocious Massacres That has ever been Enacted in an American City



At the Headquarters of the Red Cross: Refugees Who Escaped the Reign of Terror Seeking Help. During the Disturbances, Negroes were Outraged in Ways Incomprehensible to Those Unfamiliar with Mob Psychology. Even White Women Played Conspicuous Parts in the Loathsome Proceedings

PHOTO-COPYRIGHT INTERNATIONAL FILM SERVICE

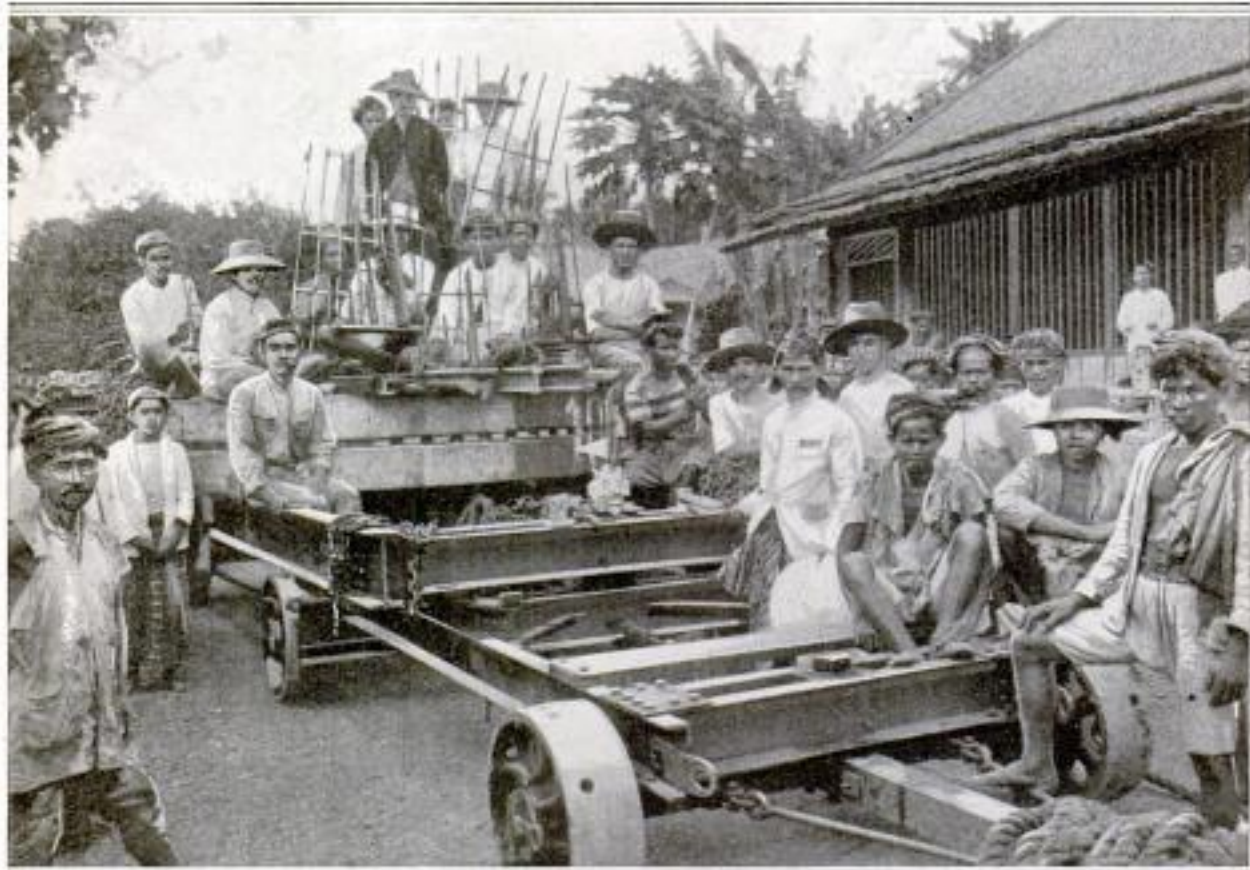

POOR ROADS MAKE CARTAGE COSTS ENORMOUS

AS an indication of the high cost of transportation in some parts of Java, it recently cost a tea merchant \$141 a mile to have a three-ton flywheel hauled from a village to a plantation, 34 miles distant. The absence of railway facilities and the wretched condition of available highways were responsible for the expense incurred, which amounted to \$4,800. The load was carried on two steel trailers specially constructed for the purpose, and was drawn by a pair of heavy motor trucks. Because bridges along the route were not strong enough to support the combined weight of the loaded trailers and the tractors, it was necessary to ford the streams as encountered. Seeing such a caravan for the first time, the natives crowded about it, anxious to have their pictures taken.

LARGE ONE-STORY SCHOOL HAS SPECIAL ADVANTAGES

What is pronounced one of the largest one-story school buildings in



Unusually Large One-Story School at Westfield, Massachusetts, Which Accommodates Nearly 700 Pupils: Considerations of Economy Were Instrumental in Designing This Type of Building. The Rooms are Lighted Chiefly from Above, Like a Studio

New England was completed at Westfield, Mass., some time ago, and covers an area that measures 116 by 182

feet. The school will accommodate nearly 700 pupils and contains an auditorium with seats for 600. A fireproof motion-picture booth is included in the equipment. The only excavation necessary was for the janitor's quarters and for boilers. While the school is not particularly attractive architecturally it has three very practical advantages: It is an economical type of building to erect; it has an especially fine lighting system in that most of the light comes from above as in a studio, and there is very little danger from fire because all the children are on the ground floor.

yet perfected our processes to the high standard of the German dyes, a great deal of progress has been already made, and new and promising results are constantly being announced. During the years 1915, 1916, and to date in 1917, no less than \$189,000,000 has been invested by the companies organized to expand or engage in the making of dyes and chemicals. Results of the most encouraging nature are announced. We already are producing many dyes as good as, or even better than, the imported, and in others of the more difficult processes are making rapid and satisfactory progress. We may fairly claim to have made as much advance in two and one-half years as Germany did in any 10 years; and with the groundwork established here as it is, the next year or two must certainly show even greater advance. The young industrial chemist never before had so promising a future as here and now.



AN unusual advertisement appeared in a Chicago paper recently, desiring the services of five humpbacked men. The explanation of this strange want is even more interesting than the announcement.

*Advertised
for
Cripples*

It seems that a large envelope factory, unable to fill its orders, decided to work nights as well as days. Long experience had demonstrated that in the use of certain machines women were better operators than men by reason of their hands being more delicate and nimble. The owner does not believe in factory work at night for women, and the men proved clumsy and slow. It was then he set about to seek men who were well, but physically incapable of heavy work. He decided that humpbacks had the necessary qualifications of more agile and sensitive touch, and an actual test proved such to be the fact. Hence the advertisement. The suggestion which this incident offers may doubtless be applied in other lines of work.



THE financiers all tell us the saving of money is a habit, natural to a few and something to be acquired by most of us—a most deserving and commendable habit, however, and one which grows with acquaintance. We are inclined in this country to look at things in a large, generous way, and quite apt to despise the day of small things, or the doing of something which seems small in itself. Scarcely a column of any daily paper which does not tell of this or that enterprise the cost of which runs into millions of dollars. The idea of religiously putting away a dollar a week seems small in comparison, so “what’s the use?”

*Training
School
for
Savings*

There are many also whose false pride prevents them from going to the savings bank with a dollar every week, and who intend to wait until they have accumulated five or ten, in order to deposit something worth while. And so the weeks pass, and there seems no convenient time to part with that much, and the man doesn't save.

While its purpose was not to establish a training school for saving, the Liberty Bond bids fair to accomplish that highly desirable

result. In many establishments where employes subscribed for bonds, it was arranged to have the cashier deduct the weekly installment for the bond from the pay envelope, and remit the bank where the subscription is placed. This not only saves the individual time otherwise spent in going to the bank, but materially reduces clerical work, for which no compensation is received in this case. Already most of those who bought the bonds on the weekly-payment plan have them one-fourth paid for. Soon the payments will be completed and the bond delivered. By that time there will doubtless be another issue of government bonds. If not, the saving habit should be continued at a savings bank. A banker studies money; he knows its value, and realizes the possibilities of its possession. Therefore he respects the man, woman, or child who saves his money, and nothing will be farther from his mind than to regard lightly even the smallest amounts that go into a savings fund.

Everyone should strive to have a bank account, especially every man and boy, be it ever so small. One loses nothing in the esteem of his employer and friends by being seen going into or coming out of a bank. Neither does the individual lose any self-respect by being seen at a bank counter, which is more than can be said of some places. There are plenty of good banks; pick out one and stick to it; and when you are tempted to invest in some alluring get-rich-quick scheme, go to your banker and ask his advice. It will not cost you anything to do this, and may save you a loss you cannot afford.

It may safely be assumed that if this course were pursued by all of us, the money sunk in swindles, fake schemes, and impossible enterprises would be reduced to a point where it actually would not pay to make the attempt. Before investing, ask your banker.



IN its Committee of Public Safety, the State of Massachusetts has a most efficient organization for securing those things which help to strengthen the country in these days of war. Among the many practical accomplishments was one recently, in which an unusual supply of a perishable garden vegetable was saved from what promised to be a heavy waste. In one locality the oversupply of spinach was several times the normal demand, and the wholesale price dropped from \$1.25, a profitable price, to 80 cents, a losing price, per barrel, with a prospective loss of several hundred barrels.

*Advertising
Saves
Vegetable
Crop*

To stimulate demand and save waste, it was suggested the growers advertise the big crop and the low price in consequence. The result was an immediate demand which consumed the excess 1,000 barrels, exhausted the supply, and called for more. While the loss or saving of a thousand barrels of spinach in one community is of comparatively little importance, the results obtained are far from insignificant. The same condition exists once or more often every year, in almost every community. If the growers everywhere would avail themselves of the demonstration made in Massachusetts and advertise their overstocks, the aggregate result in the whole country in one year would run into millions.

THE vast quantities of steel used in the manufacture of munitions have made a steadily increasing drain upon even the maximum production of our blast furnaces. Plants which had been closed down

*Sell
Old
Iron*

for years have been rebuilt and are running nights, days, and Sundays. Our machine-building establishments are requiring more than ever before. On every hand the clamor goes up for more steel. This has reduced the supply of raw material to thousands of plants turning out cast iron, and they, too, are feeling the effect of shortage. As an instance of this kind,

some of the largest stove foundries have been obliged to cancel contracts and accept orders subject to their ability to secure the iron to put into the stoves. A single order for 10,000 stoves was thus canceled only a few days ago.

Our habit of throwing away a thing when it is worn out, or partly so, or because we are tired of it, or want a change, has cast into out-of-the-way places, in house and barn and back yard, thousands of tons of old iron. The most of this is suitable for remelting, and today is worth as much per pound as junk as it was ten years ago when new. Here's a chance for the boys to do something; let them search out this discarded material and the result in the aggregate will be thousands of tons. Families who haven't any boys can easily pass the word to the boy next door.

H. H. WINDSOR

July 25th.

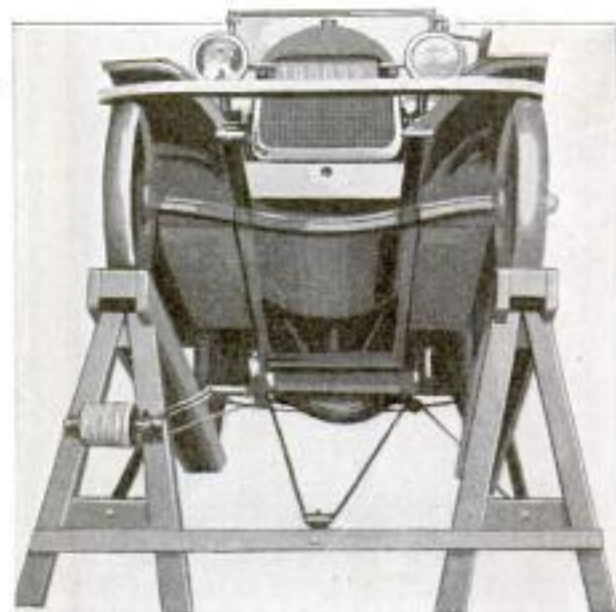

An Incline for Raising One End of an Automobile Which can be Operated by One Man by the Aid of a Winch and Cable; When the Upraised Wheels Reach the Top They are Automatically Locked in Position

ONE-MAN AUTO LIFTER FOR GARAGES

A lifting outfit with which one man can raise up the end of an automobile so that he can work underneath it conveniently, consists of a pair of wooden horses equipped with a winch and a cable. Each horse stands at an incline, having legs at one end only. After the cable has been attached to the running gear, one end of the automobile is drawn up the grooved backs of the horses by operating the winch. The car locks at the top automatically, and the cable can be moved out of the way.

Red, white, and blue globes have been substituted for ordinary transparent ones in many electric signs displayed by advertisers at Los Angeles.

AMERICA CALLS HER YOUTH

How the Great Conscription Lottery was Conducted at the Nation's Capital in Marked Contrast to the Draft of 1863, When Men were Drawn for Service in the Union Armies

By SEARLE HENDEE

TEN thousand five hundred black gelatin capsules, each containing a slip of paper bearing a printed serial number, were held in a large glass bowl and stirred constantly by a blindfolded man, while a second person, whose eyes also were covered, withdrew the tiny cylinders one at a time and handed them in turn to two announcers standing adjacent to him. This, briefly, describes the work of four of the nine principals who took active parts in the draft lottery conducted in the public hearing room of the senate office building at Washington several weeks ago.

Each of the numbers contained in the several thousand capsules represented a group of young Americans who had registered their names at their respective voting places in compliance with the national conscription law. The official drawing, which was carried out in the presence of members of the senate and house military committees, affected approximately 10,000,000 men, of whom 687,000 have since been ordered out by the first call for service.

As one of the announcers received a capsule, he opened it and read aloud the number it contained so that it might be recorded simultaneously by three tally clerks. He then passed the slip to another attendant who checked the accuracy of the original reading. As the verification was made, the ninth participant inscribed the number in its proper order on a large blackboard. When the latter became filled, it was removed from the room and photo-

graphed, another board being substituted and the drawing continuing without interruption.

It was in this manner that the elementary selection of our new army was made. The work was commenced at 9:30 a. m., July 20, and was completed at 2:18 o'clock the following morning. The first number was removed from the glass bowl by Secretary of War Baker.

Striking differences contrast the present draft with that conducted in 1863 to provide much-needed fighters for the Union forces. Although approxi-

mately 3,000,000 men between the ages of 18 and 45 were enrolled, less than 100,000 of them were obtained, through conscription, to assist in ending the Rebellion. The scheme met with serious opposition from the time it was first proposed, and finally ended in the now historical draft riots which in New York were attended with outrages far more depraved and momentous than those recently perpetrated

for other reasons at East St. Louis.

One outstanding phase of the former draft, which distinguishes it markedly from the current selection of soldiers, was an arrangement that permitted conscripts to purchase exemption by payment of a \$300 fee. This obviously put the brunt of the burden on the shoulders of those least able to bear it, and enabled men in comfortable circumstances to escape their obligations.

The actual drawing, instead of being executed at the national capital,



This Old Draft Box Is a Treasured Relic of 1863. It was Used in Massachusetts and is Preserved Today for Its Historical Value. Scores of Similar Contrivances were Employed in Different Parts of the North

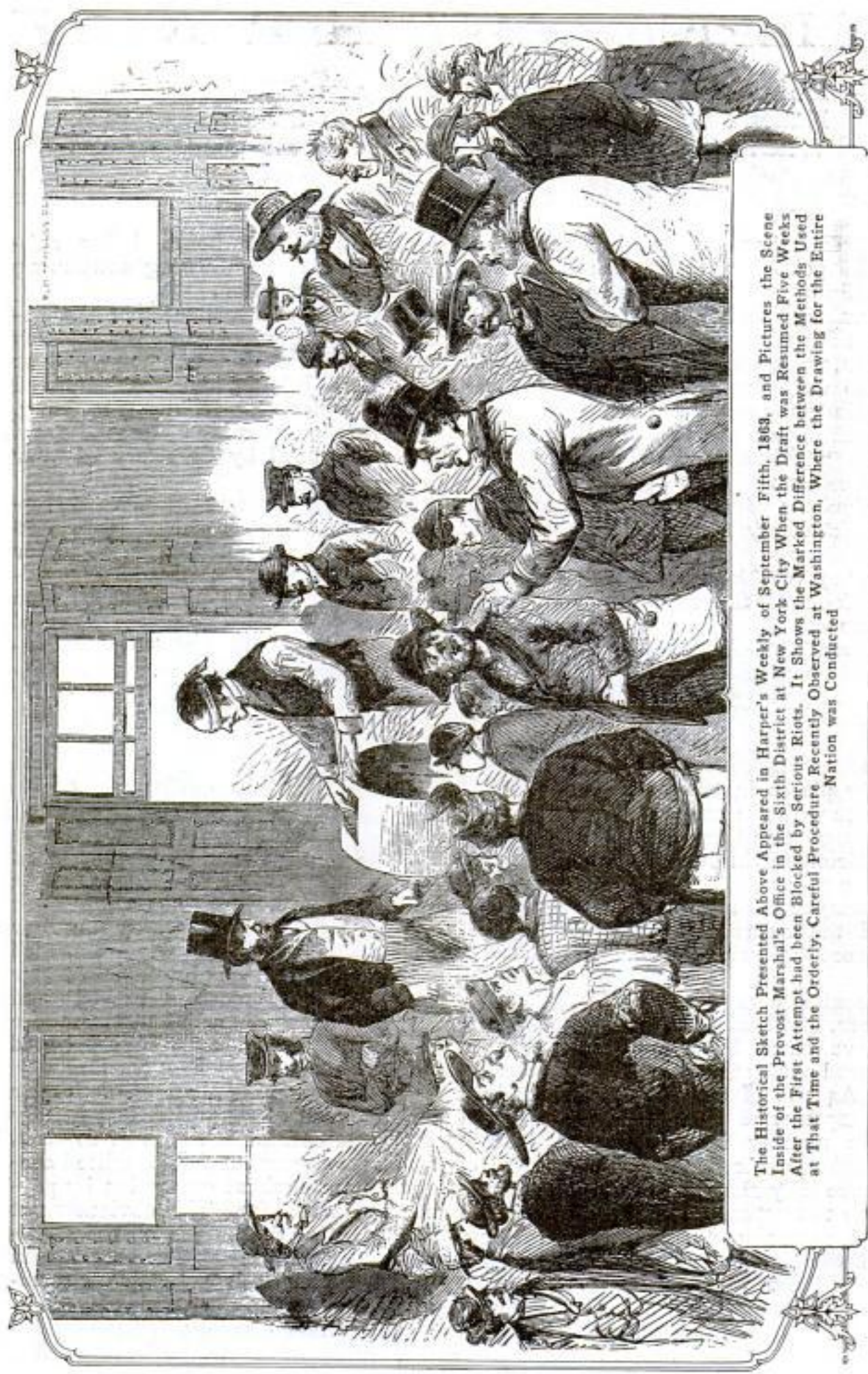

The Historical Sketch Presented Above Appeared in Harper's Weekly of September Fifth, 1863, and Pictures the Scene Inside of the Provost Marshal's Office in the Sixth District at New York City When the Draft was Resumed Five Weeks After the First Attempt had been Blocked by Serious Riots. It Shows the Marked Difference between the Methods Used at That Time and the Orderly, Careful Procedure Recently Observed at Washington, Where the Drafting for the Entire Nation was Conducted

REPRODUCED BY PERMISSION OF HARPER BROS., NEW YORK

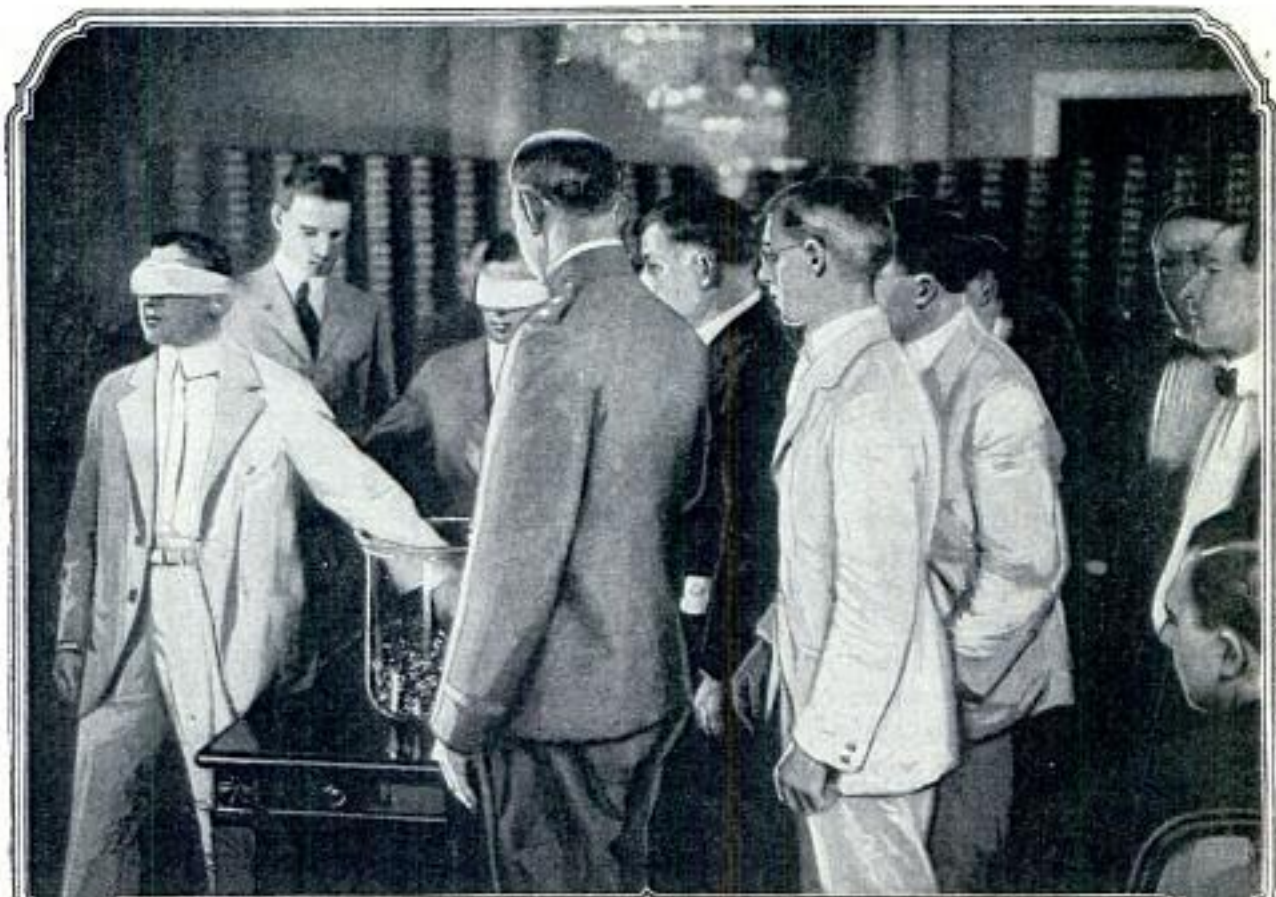

Drawing the Fatal Black Capsules from the Glass Bowl in the Public Hearing Room of the Senate Office Building at Washington before Members of the Congressional Committees on Military Affairs: On This Solemn Occasion, the Futures of Thousands of Youthful Americans, and Doubtlessly the Fortunes of Nations, were Decided. Every Possible Precaution was Taken to Preclude Errors and Insure Absolute Fairness in the Lottery



This Shows One of the Big Blackboards on Which the Serial Numbers were Chalked in Order as They were Drawn, Announced, and Verified. A Similar Count was Also Kept on Paper by Three Tally Clerks. As Rapidly as a Board was Filled, It was Removed from the Chamber and Photographic Record Made of It. Another Board being Substituted in the Meantime, so That the Drawing might Proceed without Interruption

was made a local affair, a school district, a township, or a county, according to the population, making its own selections. In sparsely settled districts where only a few men were liable for service, cards bearing the names were placed in a hat, or some similar receptacle, and drawn by a man, woman, or child appointed for the duty. Ordinarily the person who did the work was blindfolded. The drawings were conducted in halls, or other public places of assembly, before inhabitants of the vicinity who gathered to witness the event. In large centers the slips were usually placed in a "draft box" especially constructed for the purpose. These devices were of different types, but usually consisted of cylindrical or octagonal containers, built either of metal or wood, mounted in frames and provided with cranks so that they could be revolved readily.

As the fateful cards were removed, the names they bore were called out and then recorded. Thus the conscripted men in many instances knew of their selection immediately. They could then obtain substitutes by paying men to take their places, or they could buy their immunity outright. Often they walked about the halls in which the drafting was in progress, holding money aloft and bargaining. As a result many crafty individuals took advantage of the chance for graft. One veteran of the war tells of a comrade who obtained money in that way. The man, dressed in civilian clothes, visited different drafting places at St. Louis, signed as a substitute under fictitious name, received his money, and then disappeared, later putting on his uniform and returning to duty. Innumerable cases of similar fraud were undoubtedly carried out.

VEGETABLE DRIER TO SAVE GARDEN SURPLUS

Government officials and others who have been studying the country's food situation are firmly convinced that if the present season's big surplus in vegetables is to be saved, quantities of these products must be dried. In accord with the government's desire that means be provided for saving as much food as possible, a concern which makes a specialty of food-drying machinery has

planned a drier suitable for large-scale community effort or for private industry, which can be built in part by those operating it and in part purchased from this firm. This vegetable drier measures about 25 feet long and contains six compartments, 3½ ft. square. The latter can be built by any carpenter with the aid of blueprints furnished by the company. Each chamber contains a number of trays, with galvanized-screen bottoms. The equipment for heating and circulating the air is situated at one end. A fan forces air heated by steam radiators among and

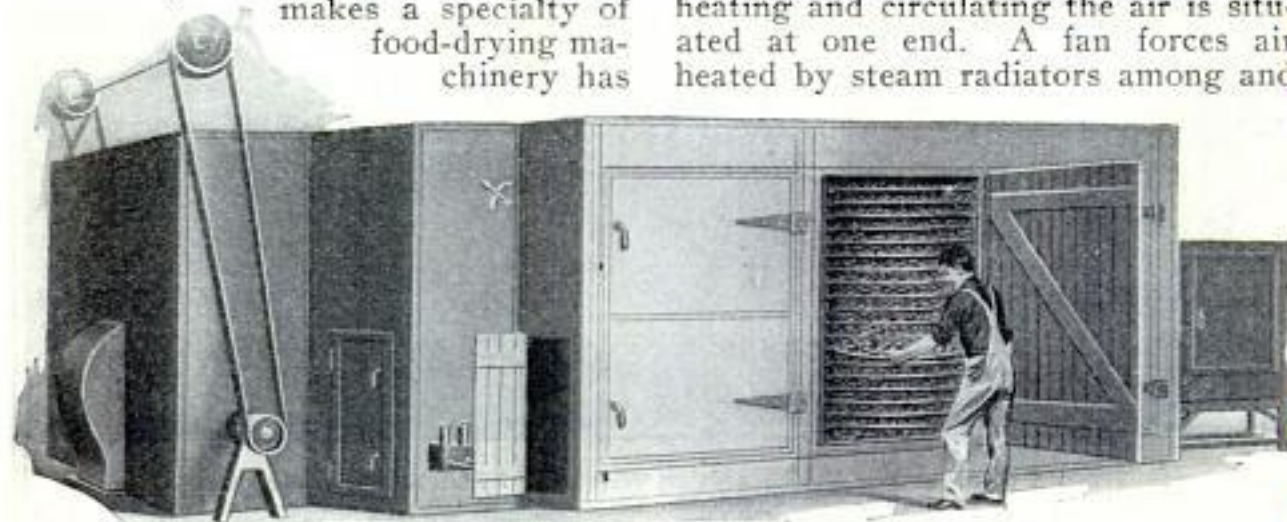

Vegetable Drier so Designed That It can be Constructed in Part by Those Who will Operate It: It Has a Capacity of One and One-Half to Two Tons of Vegetables Every 24 Hours and Is Suitable for Large-Scale Community Effort or for Private Concerns

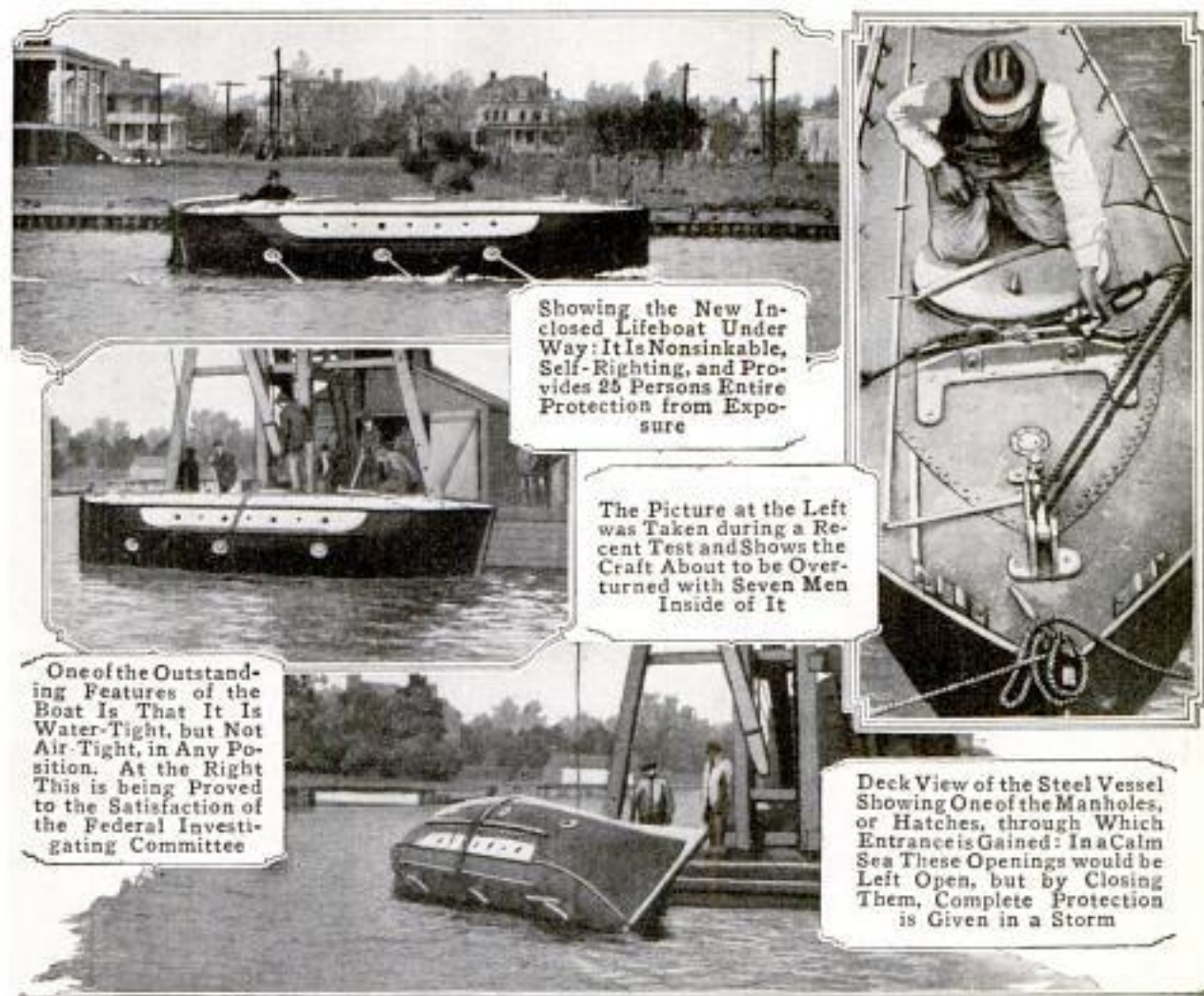

Showing the New In-closed Lifeboat Under Way: It Is Nonsinkable, Self-Righting, and Provides 25 Persons Entire Protection from Exposure

The Picture at the Left was Taken during a Recent Test and Shows the Craft About to be Overturned with Seven Men Inside of It

One of the Outstanding Features of the Boat Is That It Is Water-Tight, but Not Air-Tight, in Any Position. At the Right This is being Proved to the Satisfaction of the Federal Investigating Committee

Deck View of the Steel Vessel Showing One of the Manholes, or Hatches, through Which Entrance is Gained: In a Calm Sea These Openings would be Left Open, but by Closing Them, Complete Protection is Given in a Storm

through the trays, which can be removed as their contents are dried.

To secure the best results, vegetables to be dried should be partly cooked. This is done in a box steam cooker, situated at one end of this outfit and provided with a rack that will hold 10 trays. After remaining in the steam a few minutes the laden trays are transferred to the drying compartments. To operate this drier on the most profitable basis, which means drying one and one-half or two tons of vegetables every 24 hours, a cutter and a peeler, such as are used in canning factories, are required.

NEW LIFEBOAT NONSINKABLE AND SELF-RIGHTING

Recommendation of its formal approval was made a short time ago when a new unsinkable boat was thoroughly tested before the steamboat-inspection service's committee on life-saving ap-

pliances. The craft appears to be of remarkable seaworthiness and has many striking and meritorious features. Its hull is constructed of galvanized steel and is fitted with a 1,000-lb. keel. The boat is 26 ft. long, weighs, complete, 2,600 lb., and is authorized to carry 25 persons. It is equipped with an automatic releasing device, is entirely inclosed, self-righting, and waterproof—and admits air—even when overturned, and is readily handled. It is provided with a mast for sailing and signaling and is rowed with six oars projected through ports in the sides of the hull. In testing the boat before the committee, seven men entered it and closed the manhole plates. When the boat was overturned, it immediately righted itself and was subsequently found to be entirely free from water. The men within the craft suffered no injuries during this rough test and were able to release themselves immediately.

MASSIVE REFLECTOR FOR PREMIER TELESCOPE



Packing the Wonderful Mirror for Its Hazardous Trip: Its Surface was Protected by Thick Layers of Cotton, on Top of Which Heavy Paper was Placed Before a Wooden Covering was Fitted. The Mirror Is 101 Inches in Diameter and was Cast at St. Gobain, France, in 1906.



Making Ready to Hoist the Disk: Lowering a Friction Band into Place about the Circumference of the Mirror. To Protect the Glass, a Layer of Soft Rubber was Placed between It and the Steel Ring.

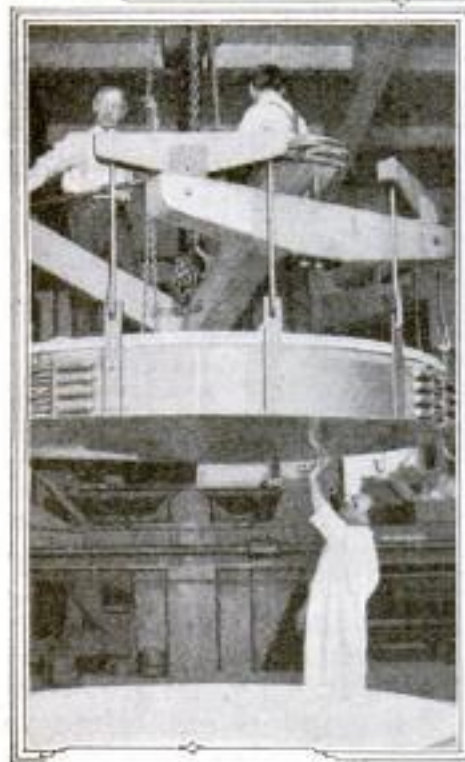

The Layers of Cotton Turned Back to Show a Small Section of the Silvered Surface of the Mirror: It Is the Largest Reflector of Its Kind in the World and will Enable Astronomical Investigations That Are Not Possible with Smaller Instruments.

Gripped by a Friction Band Attached to a Crane, the Heavy Glass Disk was Slowly Lowered onto a Special Cotton Mattress Covering the Lid of the Box in Which the Mirror was Packed for Its Long Mountain Trip.

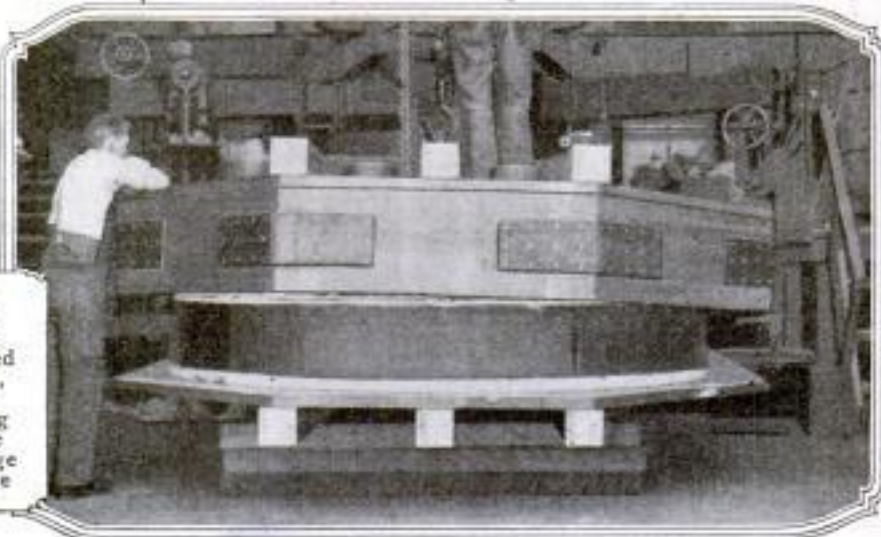

The Picture at the Side Follows in Sequence That Above It, at the Left, and Shows the Box being Slipped in Place over the Reflector, Which is Resting on the Latter's Cover. After being Boxed in This Manner, the Mirror was Placed on Edge in a Spring-Cushioned Cradle.

IS TRANSPORTED TO SUMMIT OF MOUNT WILSON



One of the Most Treacherous Sections of the Long, Winding Road Extending to the Top of the Mountain is Shown Above. After Ascending at a Grade of 22 Per Cent, It Stretches along the "Devil's Backbone," as is to be Seen at the Right. It Was Up This Trail That the Precious Glass Disk was Carried. A Mishap might Easily have Ruined the Costly Work of Years



Showing the Big Mirror Crated and Ready to be Hoisted onto a Motor Truck for the Trip from Pasadena, California, to Mount Wilson Observatory: The Weight of the Reflector, Which Was Four and a Half Tons, was Supported on Springs

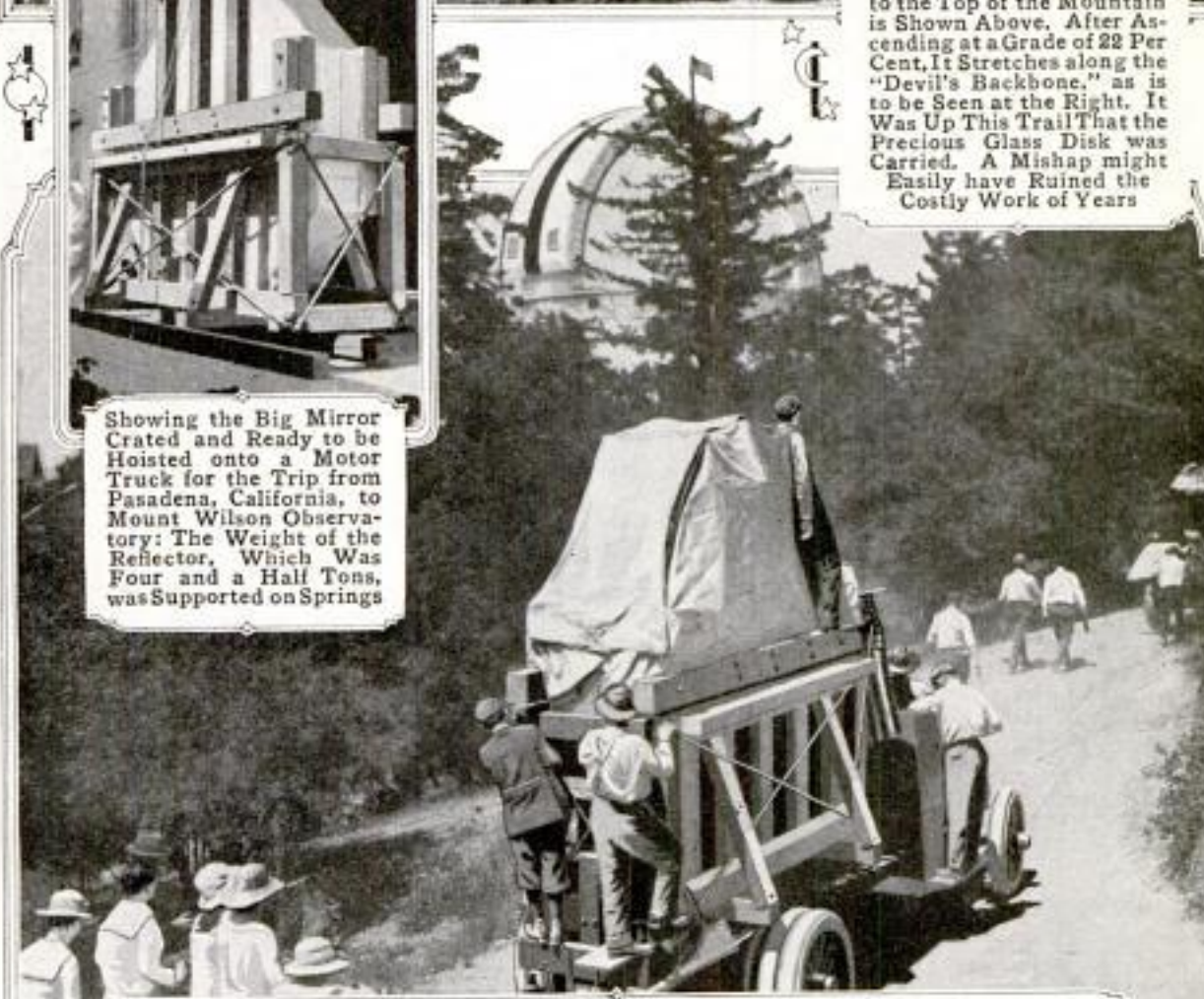

Nearing the Observatory after the Difficult Five-Hour Climb: Because of Anonymous Threats, Precautions were Taken to Prevent the Mirror being Injured by Fanatics. Armed Guards Preceded and Followed the Truck, Keeping a Constant Vigil. A Heavy Bowlder Rolled from Some Point on the Mountain Side, or a Rifle Bullet Shot from Some Place of Concealment, would have Destroyed the Reflector Which, on Account of the War, could Not be Duplicated

CONTROL SUBMARINE CAMERA ELECTRICALLY

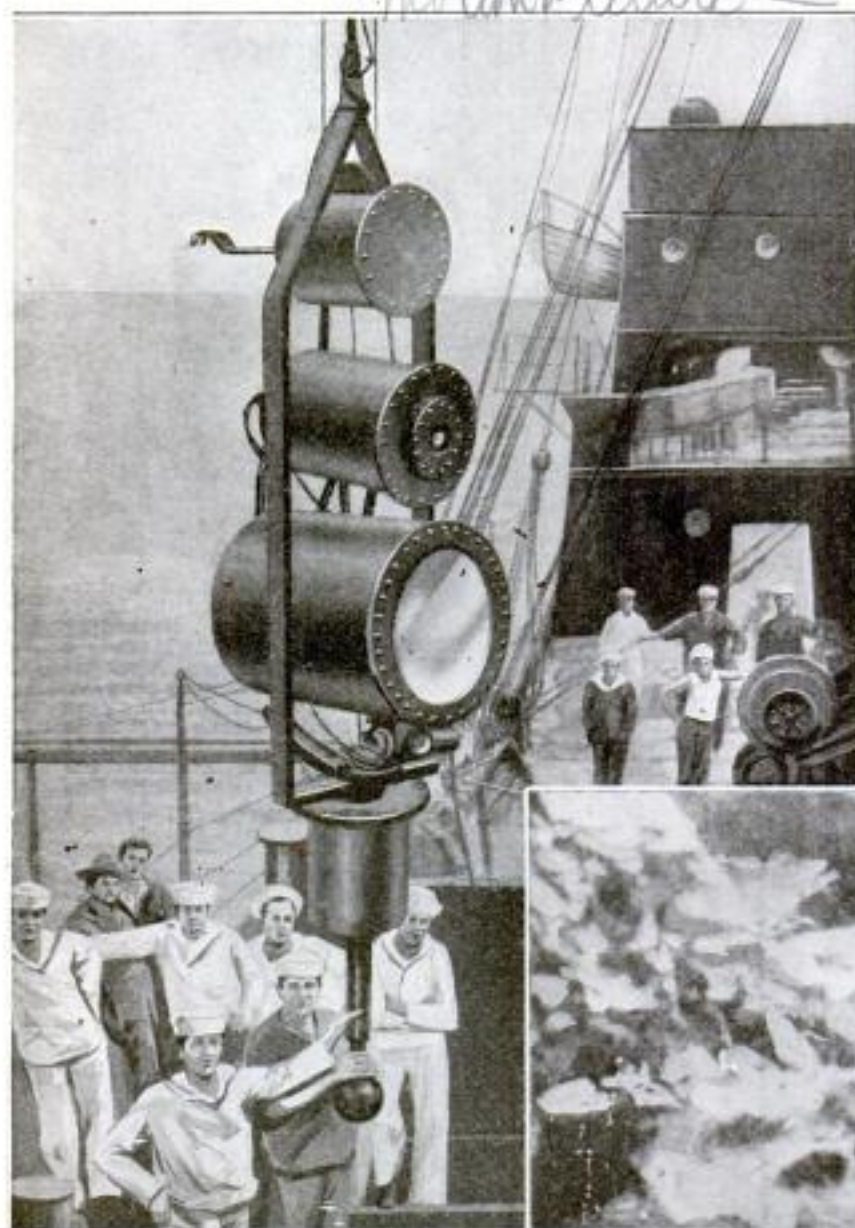

lizer that overcomes the effect of vibrations and holds the instrument steady. Immediately above this member is the light projector, and above it the camera. The cylinder at the top contains a motor that drives a propeller which turns the outfit on its vertical axis. The equipment weighs about 1,500 lb., is built to withstand a pressure of 500 lb. or more to the square inch, and is regulated electrically from the deck of a vessel. By operating switches, the instrument is focused, tilted up or down,



The New Deep-Sea Camera Aboard the U. S. S. "Vestal" during Recent Tests: At the Right is Shown an Enlargement of an Underwater Photograph, Made with the Instrument, Showing the Bottom of the Sea

Highly gratifying results have been attained with an electrically operated moving-picture camera that has been developed for deep-sea photography. Experiments have indicated that the apparatus is suited for practically all kinds of underwater work, and is therefore not merely valuable as an instrument for scientific investigations. It is composed of a series of water-tight cylinders held one above another in a steel framework, at the bottom of which is a shock absorber. The lower cylinder contains a gyroscopic stabi-

turned in different directions, its shutter actuated, and the film exposed.

NEW SUGAR-CANE HARVESTER DOES WORK OF MANY MEN

Tests conducted in Cuba are understood to have demonstrated the merits of a large sugar-cane harvester that has been built to accomplish the work of 60 or 70 men. The machine has an over-all length of about 30 ft., is 13 ft. high, 8 ft. wide, and weighs 11 tons. It is mounted on creepers so that it is



The Heavy Cane Harvester is Carried on Creepers so That Soft Ground Has No Terrors. It Delivers the Stalks Ready for Grinding

able to negotiate soft ground successfully, and is propelled by a gasoline motor that also drives the harvesting mechanism. One of its noticeable advantages is that it severs the cane stalks just above their roots, so that the valuable stumps, usually wasted by hand cutting, are not lost. This operation is performed by two sharp-edged, overlapping disks that are revolved in opposite directions. As the stalks are carried through the machine, they are topped, stripped of leaves, and discharged ready for the grinder.

TESTING AIRMAN'S SENSE OF BALANCE

The triple exposure reproduced in the accompanying illustration shows three postures which applicants for admission to the aviation section of the army must assume while being tested for dizziness, sense of balance, etc. The adjustable chair in which the man is seated, is mounted on a swivel and can be whirled about. One of the tests is to revolve the applicant at high speed, 10 times in each direction, with the eyes closed. On stopping him suddenly, he is asked to open his eyes and look in a certain direction. The first movements of the optics at such a time

reveal to the examiner something of the man's ability to find his balance. On being stopped suddenly after a similar whirling, with the head bent forward and resting on a support, the would-be air man is told to sit up straight or raise his hands straight in front of him. If normal he will throw his weight to the opposite direction from that in which he has been whirling.



Composite Photograph Showing Would-Be Airman in Three Postures Assumed While Taking Tests for Dizziness and Sense of Balance: The Chair is Made so That It can be Whirled About Rapidly



This Group of Cottages Constitutes the Summer Home of a Large Family. Each House Is Complete in Appointments and Equipment

483 ✓ **GROUP OF TINY BUNGALOWS IS FAMILY'S SUMMER HOME**

SIX separate cottages and a garage in the midst of beautiful woods constitute an unusual summer home that has been built for a family of ten persons. The colony idea is no more novel, however, than the manner in which daily life in the camp is conducted. The ages of the eight juvenile members of the family range from 16 to 3½ years. Each of the two oldest daughters has the care of two of the children and one of the bungalows. The boy has his own house and looks after himself, while the

parents live together in their own quarters with the youngest child.

In this way all of the housework is equally proportioned so that the burden of it falls upon no one pair of shoulders, and servants are not required. Each of the cottages is thoroughly equipped with modern facilities, including telephones, electric lights, and toilets, so that it is independent of the others. The members of each little household prepare their own breakfasts and suppers. Dinner is served at noontime,



The Family Which Inhabits the "Colony Home" in Summer Time: The Lucky Boy Keeps Bachelor's Quarters



In Front of Cottage No. 2 Is a Sand Pile Which Is Popular with the Younger Children. As the Cottages are Built in a Grove, the Plot is Nearly Always Shaded



Solid Comfort for Dad in His "Cottage Den," Which Is One of the Six Cottages

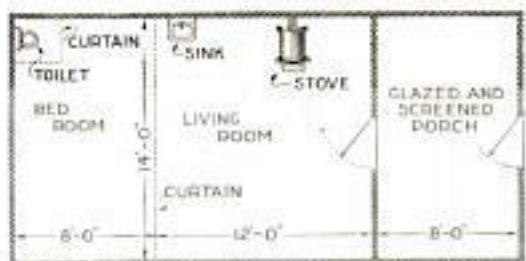

A Rough Floor Plan Showing How All the Cottages are Laid Out: They Are Both Convenient and Inexpensive

A Corner in One of the Bedrooms is Seen at the Left. The Toilet Seat is Screened by a Curtain



The Finest of Modern Plumbing is Used in Each Cottage. The Lavatory Serves as a Sink Also



Flower Beds Surround All the Houses. Pansies are Grown Because They Do Well in Deep Shade

At the Rear, between Two of the Houses, is a Floored Area (Seen at the Right) Where are Placed a Refrigerator, an Electric Washer, and Other Necessary Accessories

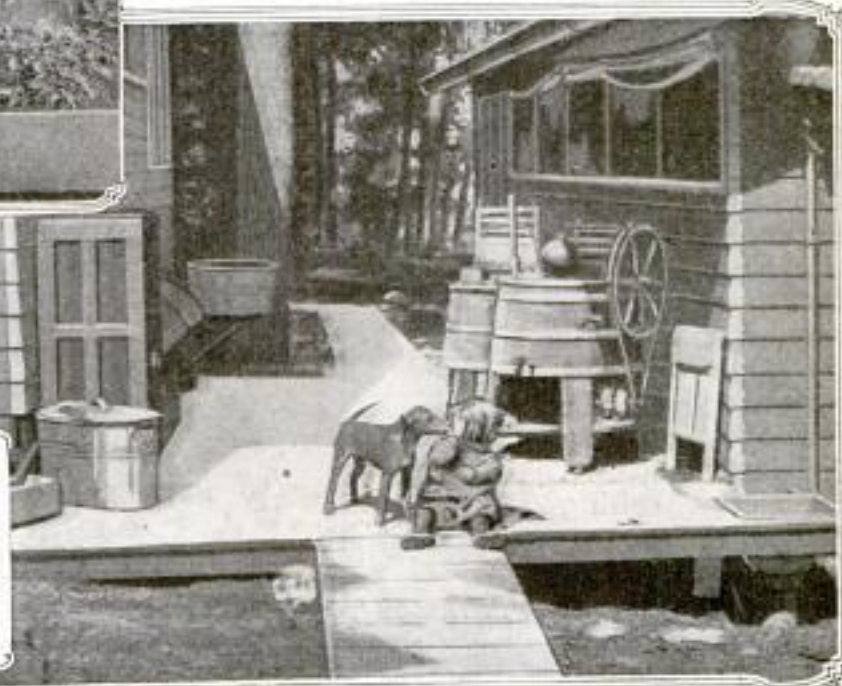

and at this meal the whole family assembles in one of the houses especially equipped as a kitchen and dining room.

Each of the cottages is 14 by 28 ft. in size, with the front section arranged as a screened porch. The exterior walls are covered with stained shingles, and

the roofs have broad overhanging eaves. Pains have been taken to make them all as comfortable and attractive as possible. Including plumbing and wiring, the cost of each of the houses was about three hundred and fifty dollars.

FROZEN-NORTH PAVILION HOTEL'S SUMMER FEATURE

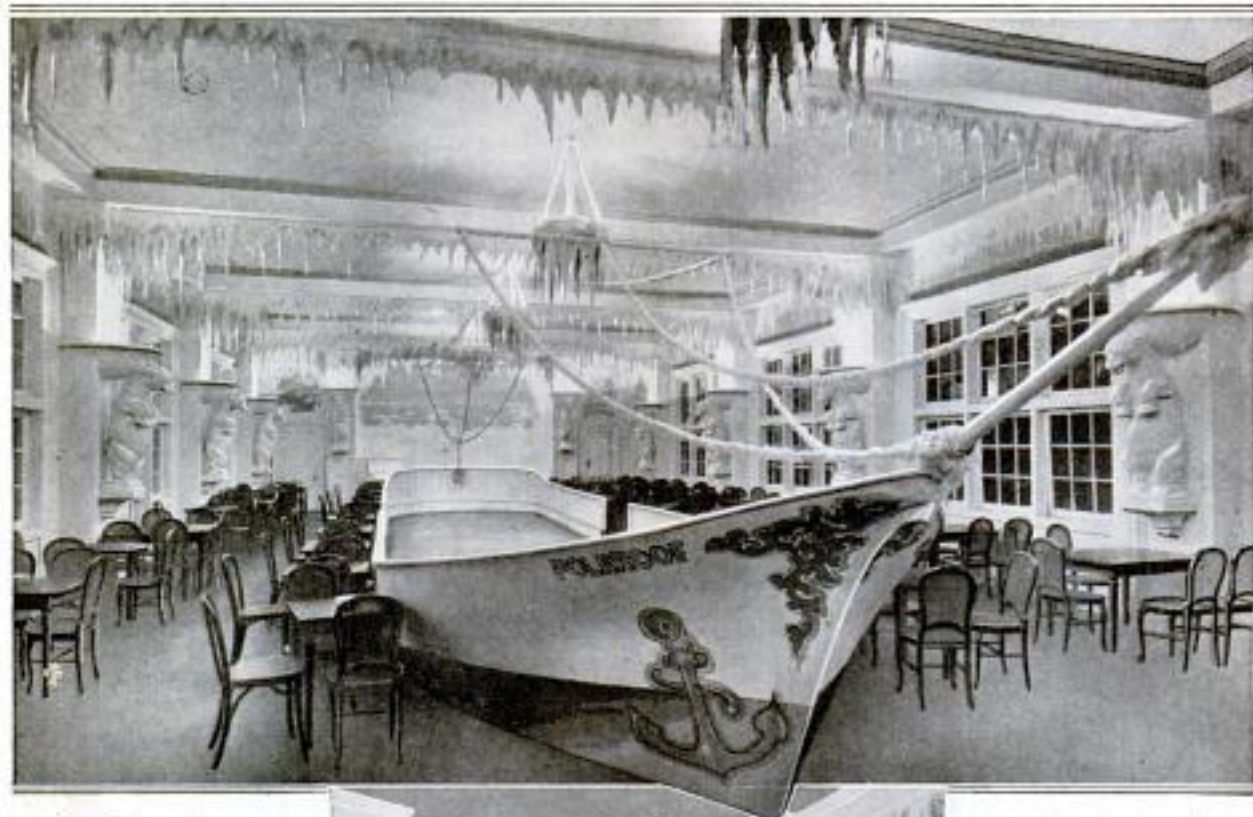

Arctic decorations lend a cool, refreshing appearance to a summer pavilion established on the roof of a midwestern hotel. Scenes of the Far North form a frieze around the walls of one of the rooms, while frosty-looking "icicles" depend from the ceiling beams of the refreshment salon. In the middle of the floor is a boat, the deck of which



If the Power of Suggestion Amounts to Anything, Summer Guests of the Roof Pavilion should Feel Cool. The Picture at the Top Shows the Interior of the Refreshment Salon, and the Other Gives a Glimpse of the Room through Which It is Entered

serves as a dance platform and also as a stage for entertainers. The figures of white bears, spaced at intervals about the walls, support the outer rims of semicircular bowls used for indirect lighting. This arrangement adds considerably to the general effect of the decorating scheme. The tables are placed in rows around the boat, which is rigged with ropes.

USE OF DIAL ADDS EXTRA EXPOSURE TO FILM

By equipping a camera with a new attachment, seven exposures can be made on a standard six-exposure film. The device consists merely of a dial which fits around the winding key. The additional exposure is obtained by eliminating all blank spaces between the exposures. The camera is loaded in the usual manner, but the numbers which can be seen through



the red peephole are disregarded except that at the outset the winding key is turned until "1" appears. Then the dial is moved around until its division marked "1" is directly

beneath one end of the key which has been identified by a scratch or notch. Each succeeding exposure is made by giving the key one full turn and then moving it around to the dial number corresponding to the number of the exposure.

YOKE KEEPS "FLYING" GOOSE IN POULTRY YARD

Yoked geese are novelties—at least to those of us who live in cities. A certain farmer has a white goose that is adept in getting over poultry-yard fences. To prevent this practice, a yoke was placed about its neck.

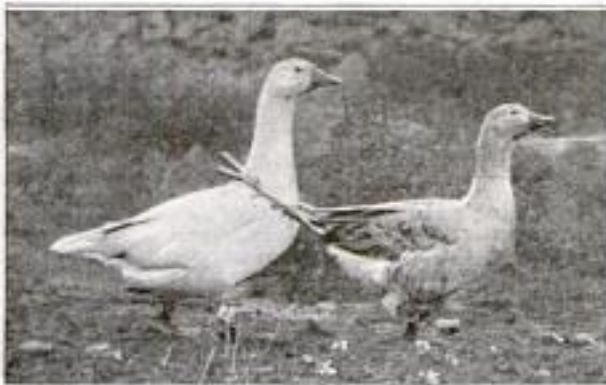

As a Rule a Goose is Easily Kept within an Inclosure, but This One must be Yoked

CLIMBING OF CACTUS TREE NOT PAINLESS DIVERSION

Most persons are more or less familiar with the giant cactuses of Arizona, but it isn't every one who has seen a man climb to the topmost branches of one. Reproduced herewith is a photograph of one of these big trees of the desert, and reposing in it a westerner. Because of its age, this particular cactus is bald in spots. The man did not negotiate it, however, without experiencing some discomfort.



FLY KILLING MADE SPORT BY NEW INDOOR GUN

Through the invention of an odd mechanical gun, fly shooting has been



The Disk-Headed Arrow Kills the Fly but does Not Strike with Enough Force to Break a Window or Mar Furniture

made a possible sport for young America. The weapon hurls a disk-headed arrow with sufficient force to kill a fly at several paces. It will not injure furniture or break window panes, however, and is therefore fairly safe in the hands of the youngster who aspires to be a parlor marksman. Incidentally it offers an easy way of eliminating the flies that often find comparative safety on the ceiling of a room. The disk is perforated to reduce head resistance, and is flexibly attached to the arrow so that it flattens out and delivers a blow even when it strikes at an angle.

"SAMMY" REACHES LAFAYETTE'S MARTYRED LAND



COPYRIGHT, NAGEL & HERBERT

Major General Siebert, Who Has Command in the Field, is Well Liked by the Boys Who Are Now at the Front. This Picture Shows Him Talking with Members of His Staff After the Troops had Disembarked

COPYRIGHT, INTERNATIONAL FILM SERVICE

American Transports, Loaded with Sun-Baked Fighters from the Mexican Expedition, Arriving at a French Port Some Weeks Ago: The Appearance of the "Sammies" Surprised the Populace in France as Much as the News of Their Landing Astonished Millions of Persons in This Country, but It Required Only a Few Minutes to Deck the Streets with the Stars and Stripes and Give the Boys a Hearty Welcome



COPYRIGHT, NAGEL & HERBERT

Pershing's Husky Lads Disembarking in France after Their Long Trip from the Hot Sands of the Southern Frontier: It Was When They Reached Paris That Their Welcome Became the Most Marvelous Demonstration Ever Afforded American Troops Away from Home. At the Time of Writing They are Encamped near the Front

BOYS WHO FLAUNT OUR EMBLEM BEFORE BOCHES



The Stars and Stripes Unfurled at the Front: A Sight That Sends a Thrill of Gladness through the Heart of Every True American. The Picture was Taken in the Wooded Camp of a Company of American Boys on the Aisne. It Shows a Mere Handful of Fighters, but a Group Composed of Nervy Fellows Who Soon will Have Thousands of Equally Nervy Comrades of Their Own Blood Working with Them



The Boys Included in This Photograph Are the Same as Those Shown in the Picture at the Top of the Page. They are Putting on Their Gas Masks Preparatory to Leaving for the Trenches. It Is upon Just Such Scrappers as These That the Attention of the Whole Civilized World is Focused. It Is Up to the American Boy to Turn the Tide of War, and Liberty and Justice Await His Work

VAUDEVILLE BENEATH THE TRENCHES IN FRANCE



MILITARY authorities, during the great war in Europe, have not ignored the psychology of relaxation. Wherever and whenever it has been possible, diversion of some sort has been provided for the men at the front. The picture reproduced above shows the interior of a small subterranean theater established in the vicinity of Verdun. It is one of the places where soldiers who are off duty are given a chance to relax temporarily and forget the hardships and horrors endured on the firing line.

WAR STEPS, RIOTS, AND REBELLION STIR CHINA

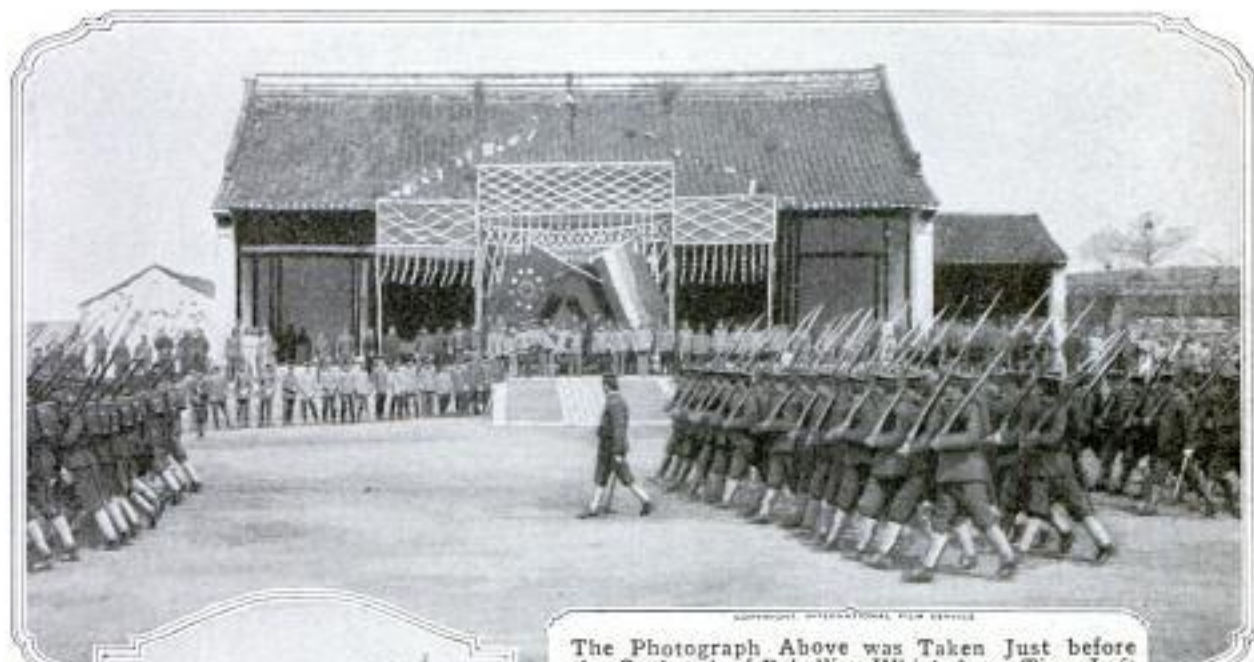

The Photograph Above was Taken Just before the Outbreak of Rebellion Which for a Time Left the Future Government of China Seriously in Doubt. It Shows the Vice President, General Feng Kuo-Chang, Who Is Also the Tuchun of the Province of Kiangsu, Reviewing Troops on a Ceremonial Occasion at Nanking

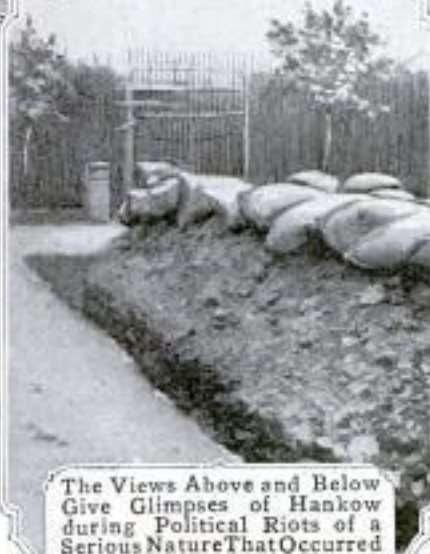

The Views Above and Below Give Glimpses of Hankow during Political Riots of a Serious Nature That Occurred Some Time Ago. The Trench was Established, by German Reservists, in the Street Facing the Japanese Concession



Three Recruits Doing the "Goosestep," a Military Eccentricity Taught Them by Germans against Whose Government the Power of China may be Turned at Any Time: Not Only are All Chinese Soldiers Drilled in This Way of Marching, but Likewise All School Children of Japan



Carrying Away the Dead Following the Disturbance: Fire Destroyed Houses and Business Structures Covering an Area of Some 2,000 Square Yards and Caused the Death of Nearly 1,000 Persons. The Hankow Volunteer Corps, Composed of Foreigners of All Nationalities, was Called Out, and Bluejackets from a United States Gunboat were Landed to Protect the Consulate

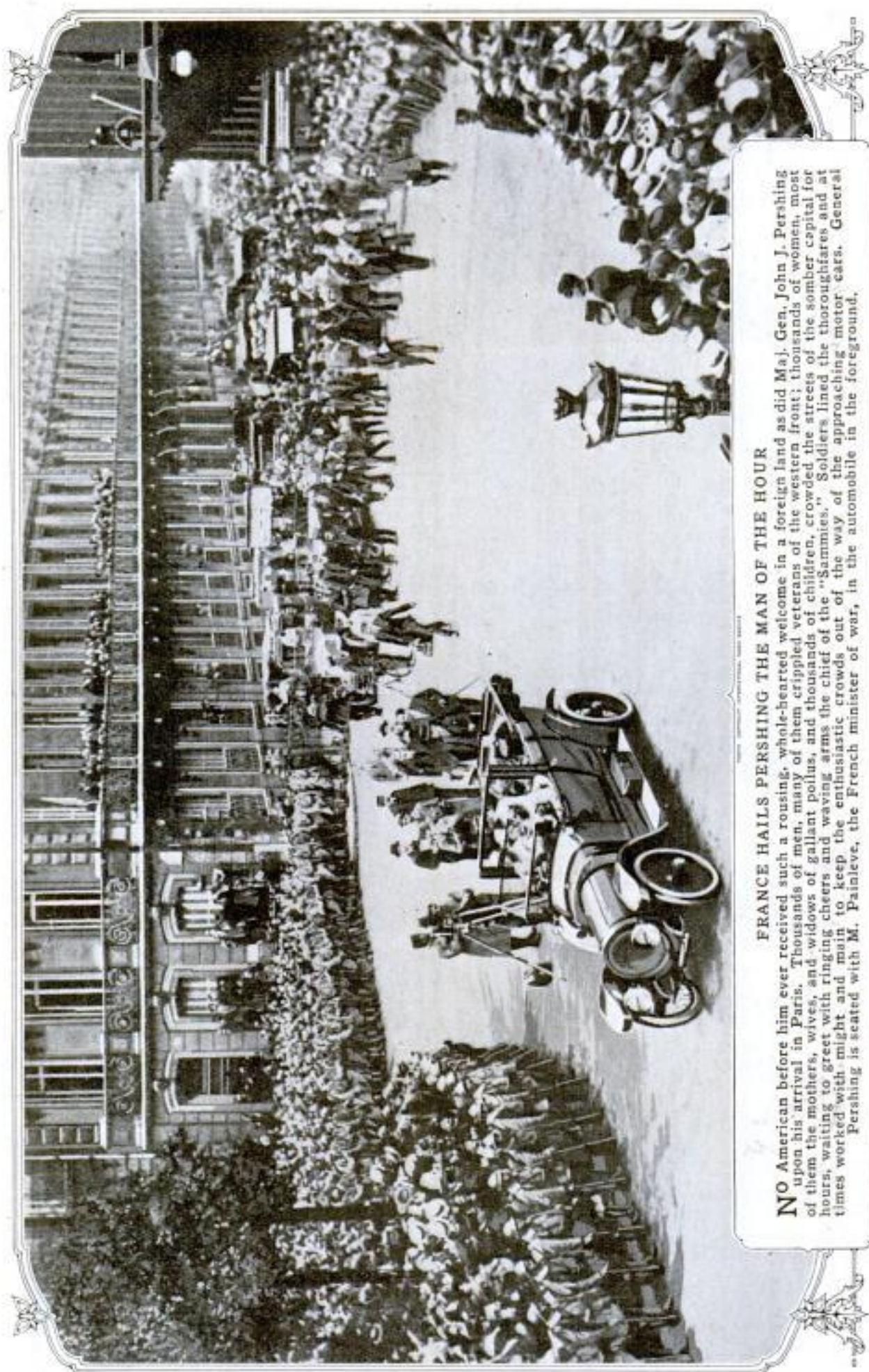

FRANCE HAILS PERSHING THE MAN OF THE HOUR

NO American before him ever received such a rousing, whole-hearted welcome in a foreign land as did Maj. Gen. John J. Pershing upon his arrival in Paris. Thousands of men, many of them crippled veterans of the western front; thousands of women, most of them the mothers, wives, and widows of gallant poilus, and thousands of children, crowded the streets of the somber capital for hours, waiting to greet with ringing cheers and waving arms the chief of the "Sammyes." Soldiers lined the thoroughfares and at times worked with might and main to keep the enthusiastic crowds out of the way of the approaching motor cars. General Pershing is seated with M. Painleve, the French minister of war, in the automobile in the foreground.

ENGLAND SALUTES PERSHING ON WAY TO FRONT



COPYRIGHT BY CENTRAL NEWS PHOTO SERVICE

America's favorite picture of the Commander-in-Chief of its Overseas Force, Major General John J. Pershing, who is expected soon to be elevated to Lieutenant General, and probably later to the rank of General, an office that has not been filled in our Army since the death of General Sheridan: This photograph shows the fighter accompanied by General Pitcairn Campbell, representing the British War Office



COPYRIGHT UNDERWOOD & UNDERWOOD

The Big Chief of the "Sammies" following General Pitcairn Campbell down the gangway of the vessel that carried the American Standard Bearer and his staff across the Atlantic. The three pictures furnish an interesting study of General Pershing's ever-changing facial expression



COPYRIGHT UNDERWOOD & UNDERWOOD

There is little wonder that Major General Pershing is rapidly winning a place in the hearts of our allies, for above all things, he is a soldier and a man. From left to right stand: Pershing, Ambassador Page, Vice Admiral Sims, U. S. N., Lord Derby, British Secretary of War, and Field Marshal Lord French. The picture was taken immediately upon the general's arrival in England

GLIMPSES OF OUR "JACKIES" AT WORK

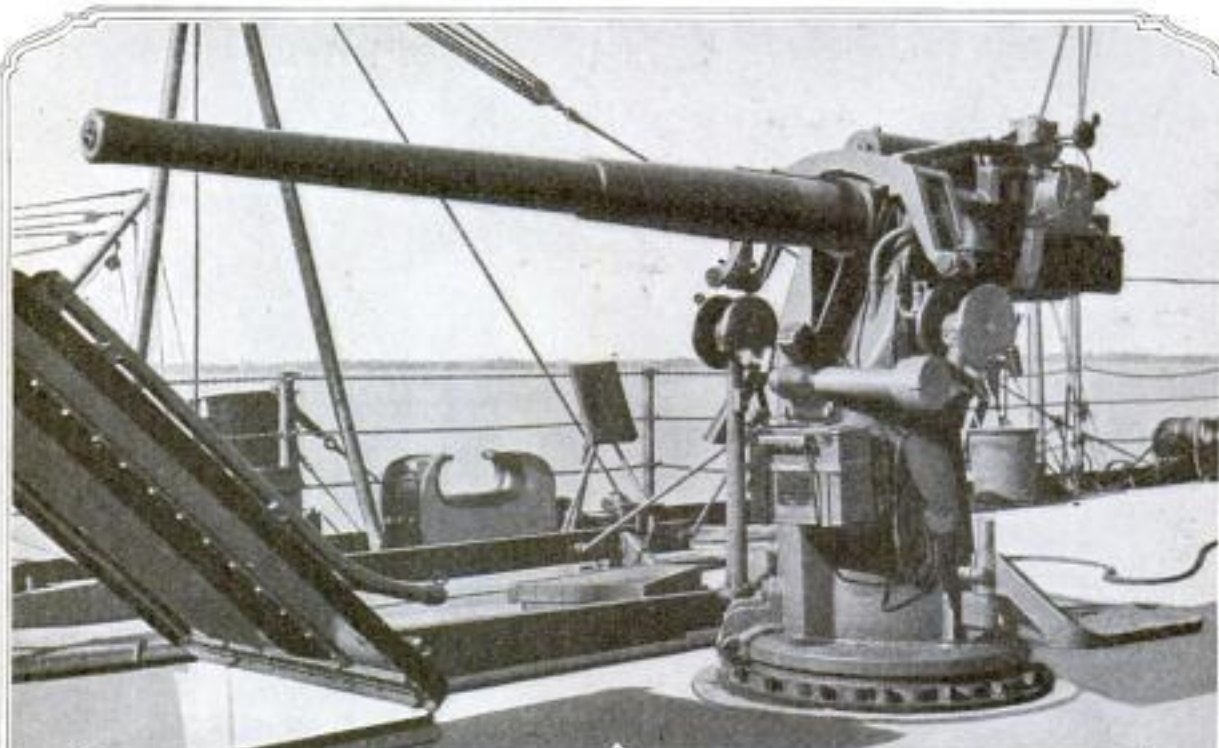

Giving a Close View of One of the Speedy Anti-Aircraft Guns Mounted on the Deck of the War-Gray "Oklahoma," Ready for Business: The Dreadnaught is a Sister Ship of the "Nevada" and is One of the Navy's Most Formidable Steel Fighters. Its Length is 583 Feet and Its Normal Displacement 27,500 Tons. The Vessel's Main Belt of Armor is $17\frac{3}{4}$ Feet Wide and Extends More Than Eight Feet below the Water Line

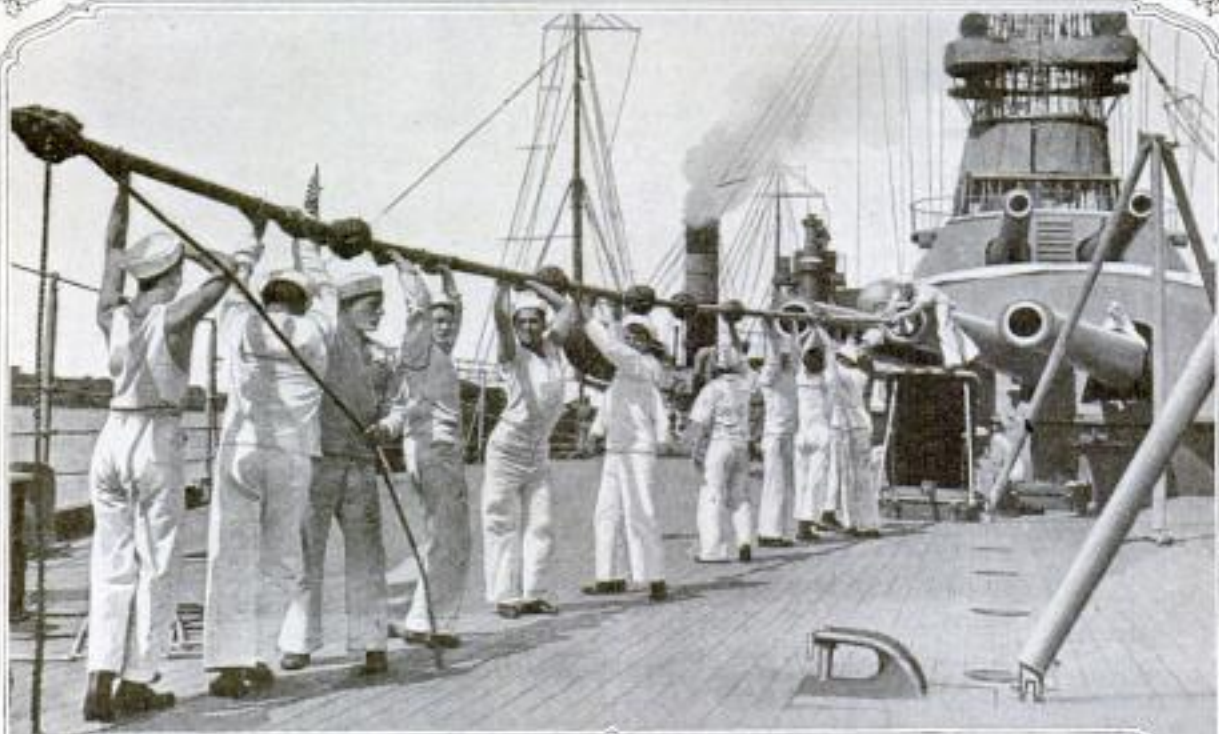

"Jackies" at Work Cleaning the Bores of the 14-Inch Guns Which may Yet Help the Kaiser See Light: Ten of These Big Rifles are Mounted in Four Triple and Double Turrets. The Ship's Other Armament Consists of 21 Five-Inch Guns and Four Submerged 21-Inch Torpedo Tubes. The "Oklahoma" Was the First of Our Fighters to be Constructed in Accordance with the "Everything or Nothing" Idea of Protection

ABOARD THE DREADNAUGHT "OKLAHOMA"



Captive Balloon Hovering above One of the Tall Fighting Masts That Rise from the Deck of the "Oklahoma": These Awkward-Looking Gas Bags are Used for Making Observations at Sea and for That Purpose are as Valuable to the Navy as They are to the Army

Drawing the Captive Balloon Down to the "Oklahoma's" Deck Following an Ascension: The Picture Gives One a Fair Conception of the Relative Size of These Big "Sausages," Which Often Play a Most Important Rôle in Naval Operations. All of the Photographs Presented on These Two Pages have been Passed by the Censor



At the Side, Seamen are Shown Putting Up One of the Big Target Kites for the Aero Gunners. Practice Shooting is Not Usually Indulged in during Time of War and It is Therefore Probable That This Picture was Taken in the Past, or Merely Posed. In Any Event, It Shows the Character of the Targets Used to Represent Air Craft



SPIRITED CHARGE OF FRANCE'S STEEL CAVALRY

THE picture above, taken in the heat of battle, shows a squadron of French "tanks" attacking German positions on the western front. Although the dispatches have carried detailed accounts of the stirring assaults made by these formidable engines, no such graphic illustration of their actual use as this one has previously reached America. In the foreground one of the heavy creeping monsters is crossing a shell-battered trench, while ahead of it a half dozen more may be seen pushing through entanglements and forging ahead into the fray.

COPYRIGHT, CENTRAL NEWS PHOTO SERVICE

PICTORIAL REPORTS OF WAR'S STRIKING PHASES



A Striking Example of Close Cooperation of the Allies: These Sturdy, Sun-Baked Fijians (British Subjects) are Shown being Reviewed at Honolulu by the Commander of the Hawaiian Department. Many Americans Feel Far Removed from the War and Therefore Manifest a "Business as Usual" Attitude. Yet These Barelegged Fellows from the Pacific are Doing Their "Bit." They were Photographed While on Their Long Journey to France Where They are to Serve as Stevedores on Army Transports



To Those Who Object to Service Overseas, but "would Gladly Fight if America were Invaded." This Picture from Gallant France is Respectfully Submitted. It Shows Rows of Naked Trees Lining What Was Once a Beautiful Street of Homes in a Prosperous French Village. This Is What War in One's Native Land Means. The Youth of America Is Fortunate, for He Goes into Battle Knowing That Roofs Shelter the Dear Ones He Leaves Behind

STRIKING ASPECTS OF WAR ON WESTERN FRONT



FROM THE SPHERE, LONDON. COPYRIGHTED IN THE UNITED STATES BY THE NEW YORK HERALD COMPANY

Removing the Crippled and Dying from the Field While an Attack upon the German Positions Is in Progress: The Picture Tells, as Words Cannot, the Story of the Stretcher Bearer, Who of Late Seems to have been Classed with the Shirkers by Many Self-Appointed Critics. When a Fellow is Hit and is Chewing the Dirt and Cursing for Water, the Grandest Emblem on Earth Is the Red Cross on the Sleeve of Some Plucky Boy Who Is Game Enough to Brave a Shrieking Inferno of Shrapnel to Reach Him. The Work of the Field-Ambulance Service, Whether Regimental or Red Cross, is Not Conducted by Cowards



Highlanders in Boston Assisting in Gaining Recruits for the Canadian Forces: The Scotch Veteran Who Is Next to the Mayor of the City Is a Captain and, It will be Observed, is Wearing Knickers in Place of Kilts



These Days There Is Nothing That Pleases a German Quite so Much as the Sight—and Taste—of Regular Food. The Picture Shows a Group of Captives being Questioned by British Officers and Allowed a Few Minutes in Which to Enjoy Refreshments before Submitting to Registration. To the Teutons Who have been Told They would be Horribly Tortured if Captured by the British, the Offer of Something to Eat Comes as a "Grand and Glorious Feeling"

WHERE "SAMMIES" WILL SOON HAVE MUCH TO DO

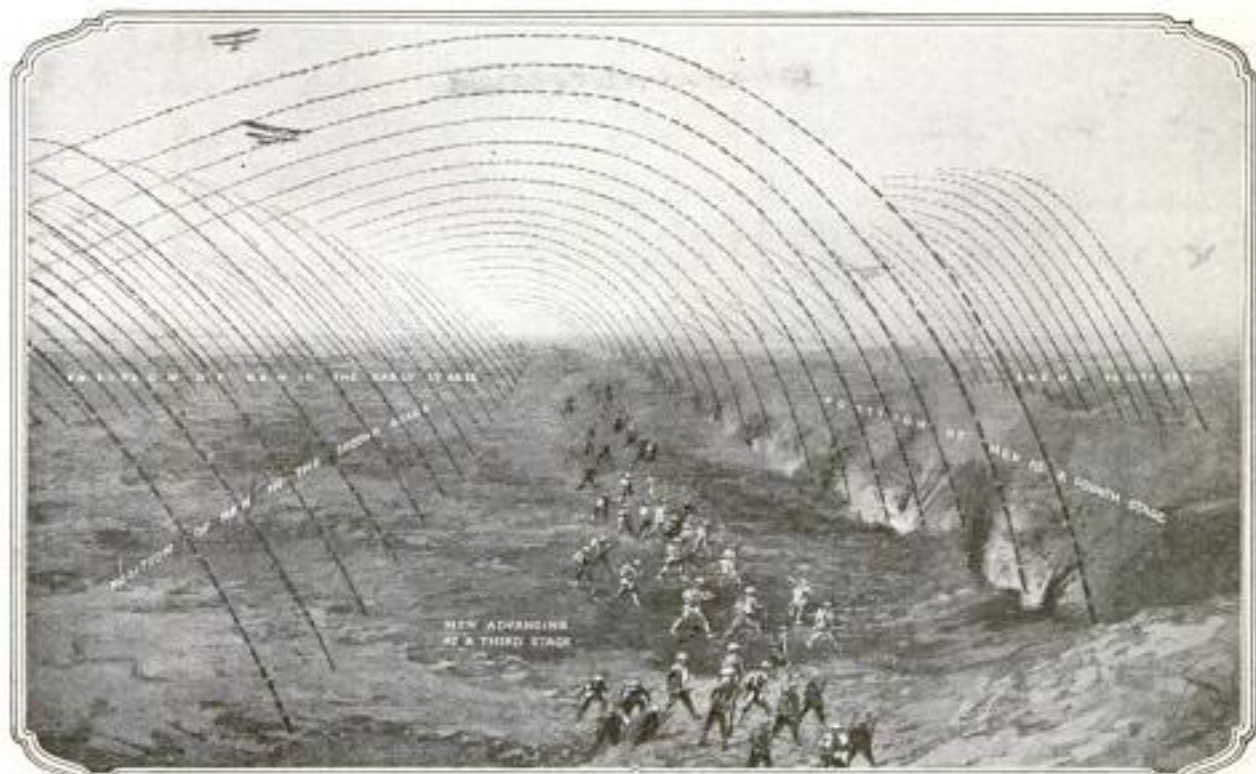

FROM THE SPHERE, LONDON. COPYRIGHTED IN THE UNITED STATES BY THE NEW YORK HERALD COMPANY

British "Tommy" Making an Advance upon German Trenches While Protected by the Artillery's Barrage Fire: The Drawing Shows with Great Clearness the Several Stages of the Advance, and Explains Graphically How the Constant Rain of Shells Precedes the Soldiers Step by Step. All of This is Timed to the Second. All the Gunners must Change Their Ranges Simultaneously and Precisely at the Right Instant, While the Men must Keep Moving Ahead at an Absolutely Accurate Pace. The Remarkableness of the Barrage Fire is Appreciated When It is Remembered That the Gunners Depend Entirely upon Mathematical Calculations

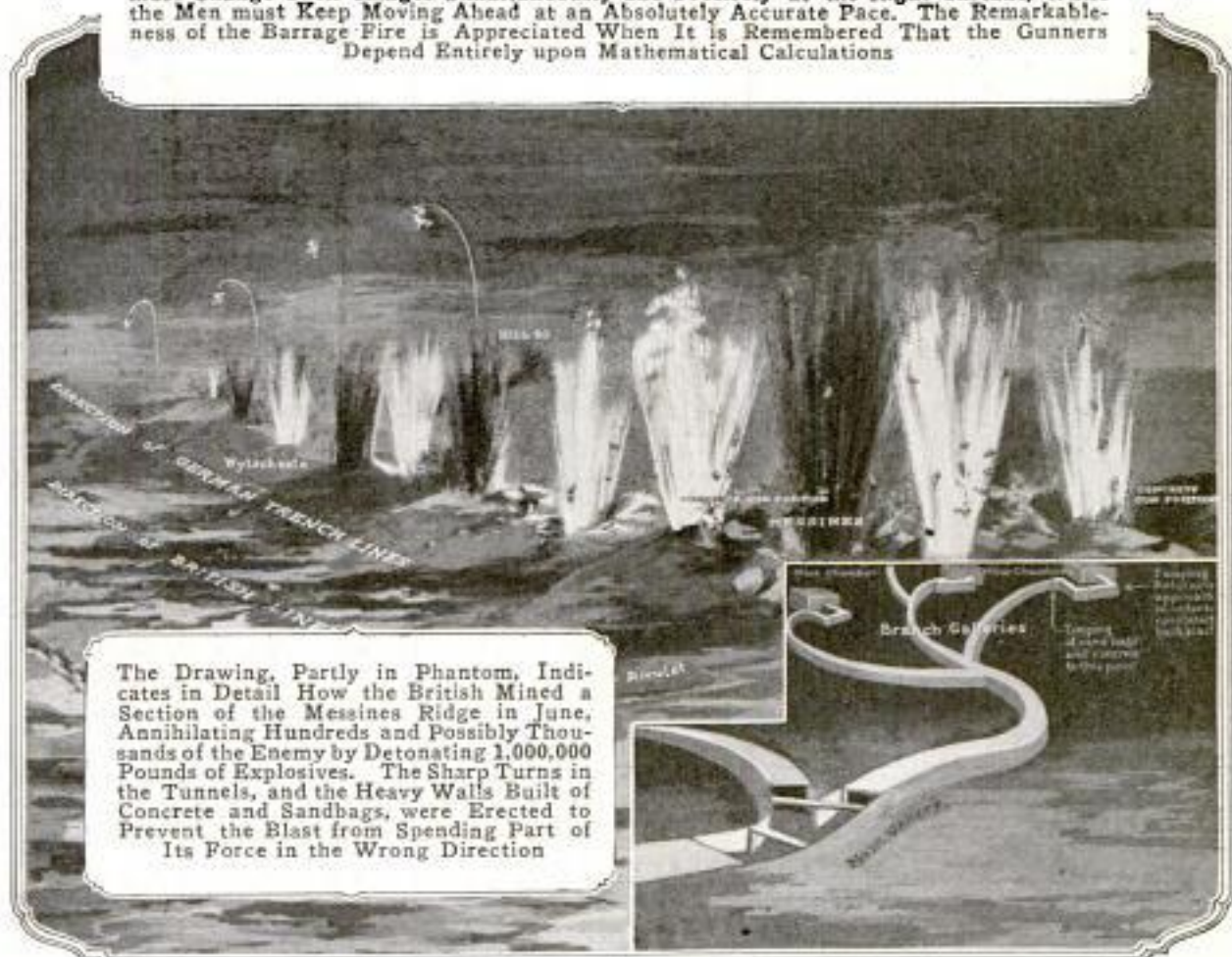

The Drawing, Partly in Phantom, Indicates in Detail How the British Mined a Section of the Messines Ridge in June, Annihilating Hundreds and Possibly Thousands of the Enemy by Detonating 1,000,000 Pounds of Explosives. The Sharp Turns in the Tunnels, and the Heavy Walls Built of Concrete and Sandbags, were Erected to Prevent the Blast from Spending Part of Its Force in the Wrong Direction

FROM THE SPHERE, LONDON. COPYRIGHTED IN THE UNITED STATES BY THE NEW YORK HERALD COMPANY

ON SNOW-COVERED ALPINE BATTLE GROUNDS



Italian Sentries Forging through the Snow to Their Respective Posts in Lonely Mountain Spots: As has Doubtless been Noticed in Previous Photographs Showing Parts of the Alpine Front, the Soldiers are Garbed in White Uniforms. Although from the Standpoint of Warmth These have Disadvantages, They Also Have the Big Merit of Being Inconspicuous



Italian Sentry on Duty in a Tunnel, Supposedly on the Trentino Front: The Operations in the Mountains Are Chiefly of an Engineering Character and Therefore Represent Some of the Most Wonderful Phases of the Present War. The Purpose of the Bore Shown Here is Not Known, but It has Probably been Driven to Facilitate the Transportation of Munitions, or to Make Available as a Gun Position Some Vantage Point That Commands an Enemy Defense



When Operating on the Snow, High in the Alps, the Glare of the Sun Is a Thing with Which to Reckon. The Italians Shown in the Picture Above are Equipped with Colored Goggles That Protect Their Eyes from the Dazzling Light. It will be Observed That the Men's Hands and Faces Are Extremely Dark. That Is Because They are Coated with Black Grease Which Prevents Sunburn

WHERE ITALY UPHOLDS ANCIENT TRADITION



DRAWN FROM MATERIAL SUPPLIED BY F. MATANIA FOR THE SPHERE, LONDON, AND COPYRIGHTED IN THE UNITED STATES BY THE NEW YORK HERALD COMPANY

When Particularly Hazardous Work is to be Done by a Group of Picked Fighters, the Italian Army Equips Its Men with Bullet-Resisting Breastplates and Shoulder Armor, as is Shown in the Above Picture of a Spirited Attack upon an Enemy Position. One Instantly Recalls the Armored Warriors of Ancient Rome, Whose Traditions of Bravery are being Upheld, if Not Overshadowed, by Italy's Nerve Soldiers of Today

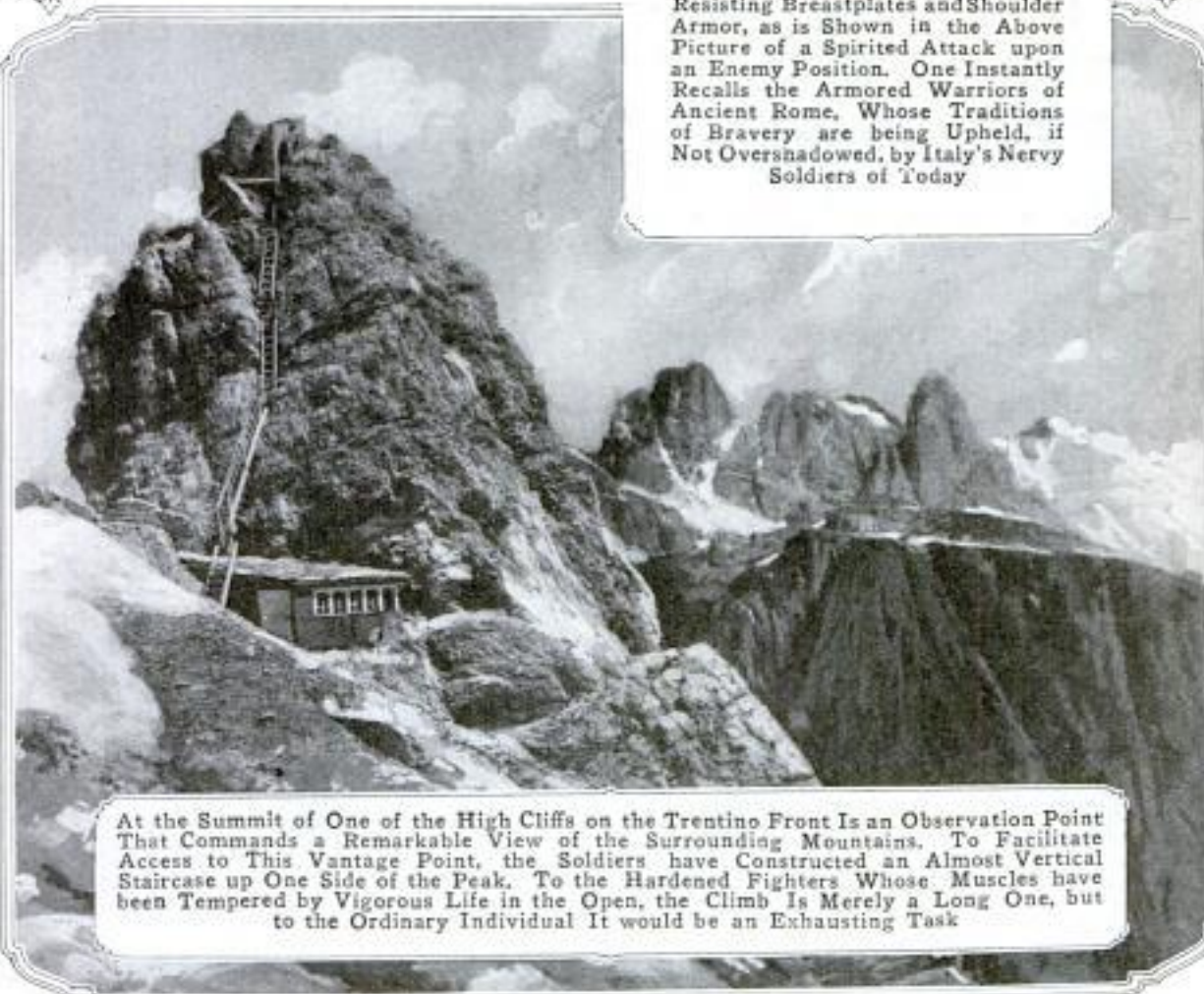

At the Summit of One of the High Cliffs on the Trentino Front is an Observation Point That Commands a Remarkable View of the Surrounding Mountains. To Facilitate Access to This Vantage Point, the Soldiers have Constructed an Almost Vertical Staircase up One Side of the Peak. To the Hardened Fighters Whose Muscles have been Tempered by Vigorous Life in the Open, the Climb is Merely a Long One, but to the Ordinary Individual It would be an Exhausting Task



MAKING SHRAPNEL FOR PERSHING'S GUNNERS IN FRANCE

THIS picture shows the interior of one of our big munition plants, where shrapnel and other forms of ammunition is being manufactured in enormous quantities. The large bins to the right are filled with tens of thousands of balls that are ready to be placed in explosive projectiles. A three-inch shrapnel contains from 240 to 250 of these bullets tightly imbedded in rosin. Shiploads upon shiploads of such missiles are being produced in all possible haste for the use of our gunners now at the front and those who soon will follow. The photograph reproduced herewith has been passed by the military censor and contains no information that will be welcomed by the enemy.

CONCRETE FIELD FORTIFICATIONS USED BY GERMANS



Captured German Machine-Gun Emplacement in Naked Timberland on the Western Front: The Walls are Built of Concrete, Brick, and Flagstones, and on the Fighting Side are Four Feet in Thickness. Entrance to It is Gained through an Underground Doorway. Branches of Trees Cover the Roof to Shield It from the View of Airmen

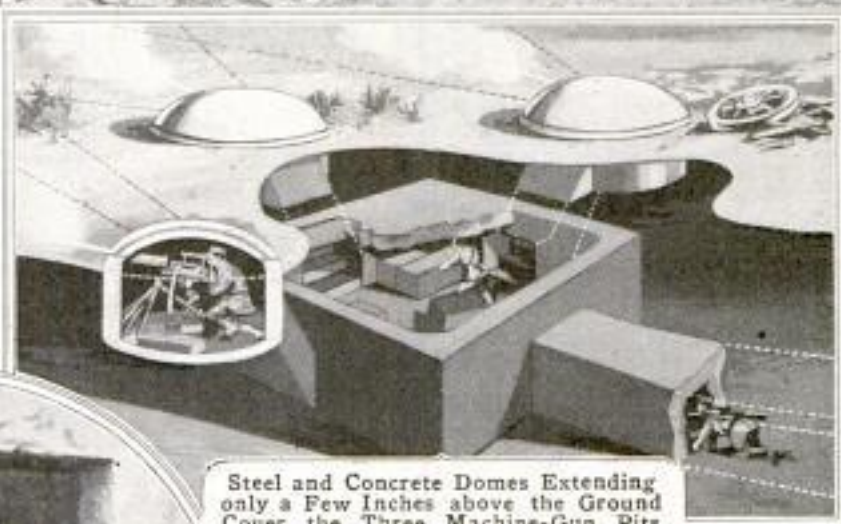

Steel and Concrete Domes Extending only a Few Inches above the Ground Cover the Three Machine-Gun Pits Illustrated Herewith. Shafts Connect Each of the Positions with a Subterranean Ammunition Room, Which is Reached through a Communication Tunnel



The Strength of the Reinforced-Concrete Emplacements is Indicated by the Picture Above, Which Shows a German Gun Silenced by the British. Apparently the Projectile Fell from a High Elevation, Thus Passing the Parapet in Front. The Explosion Wrecked the Cannon, but Did Little Damage to the Surrounding Walls



COURTESY OF L'ILLUSTRATION
Some New Trophies Collected by the French: In the Foreground are Shown Several German Mine Throwers of a Late Pattern Used Effectively on the Western Battle Front. Their Design is Quite Odd and Therefore Interesting. In the Background are Ordinary Field Pieces

SEMAPHORES USED TO STOP AUTO STAGE

Semaphores have been installed at stations along the route of a western



Station on an Auto-Stage Route in the West Showing Semaphore in Front, by Which Drivers are Apprised of the Presence of Waiting Passengers

auto stage as a means of signaling drivers to stop and take on passengers. The pivoted arm, with the word "Stop" painted on it, is drawn into a horizontal position by a wire and often saves a driver much uncertainty as to



The Heavy Buffer is Shown Just Back of the Safety Gates: The Beam with Its Supports Weighs About Two Tons, and It is Stated That It will Stop a 4,000-Pound Car, Running 30 Miles an Hour, without Accident to the Occupants

whether he should halt on his swift journey.

¶The government's foresters are urging more extensive use of fuel wood from the national forests next winter, in order that a possible coal shortage may be experienced without hardship.

YIELDING BUFFER GUARDS AGAINST BRIDGE MISHAPS

A 1,000-lb. movable buffer of fir, which has been erected across the approach to a Chicago bridge of the double-deck bascule type, is a new safety device designed to keep vehicles from plunging over the end of the approach when the bridge is open. The ends of this beam travel in vertical tracks that hang like pendulums from the overhead structure, at either curb. When the bridge is about to open, leaving a well between the approach and the upraised section, the buffer, which is counterweighted, is lowered to the street. Special switches have been provided to permit it to pass the overhead trolley wires. An important problem has been solved by building this safety device so that it will bring vehicles to a halt gradually rather than instantaneously, as would be the case if it were rigidly anchored. In case the beam is struck it rolls backward, on wheels at either end, for about a foot. Then its motion is changed to sliding, tracks 15 ft. long being provided along the curbs. These are curved upward at their ends to stop the progress of the beam.

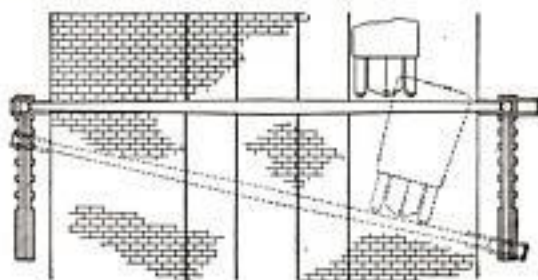
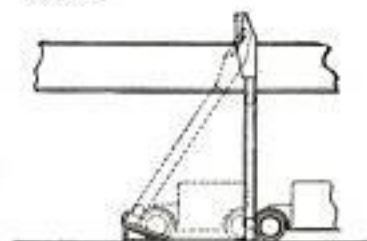

Plan and Side Elevation of Boom, Showing Its Action in Stopping a 4,000-Pound Auto Truck Running at 30 Miles an Hour

ORE SEPARATOR FOR USE IN DESERT GOLD MINING

To meet the difficulty presented by placer mining in a region where water is scarce, an ore separator has been built recently which operates with dry gravel only and is said to separate 90 per cent of the gold from the pay dirt. After the gravel has been screened it is carried from a hopper by an endless conveyor to the uppermost of a series of slotted screens so placed that each discharges into the one beneath it. The screens are provided with several riffles to catch the gold and are made to vibrate through irregular orbits by eccentrics with which they are connected. The lowest screen is provided with a suction draft which aids in the separation. The same is true of the plate into which it

discharges and on which the gold is caught by mercury held in place by riffles. The screens can be easily removed when it is desired to empty the gold from the riffles. This dry washer

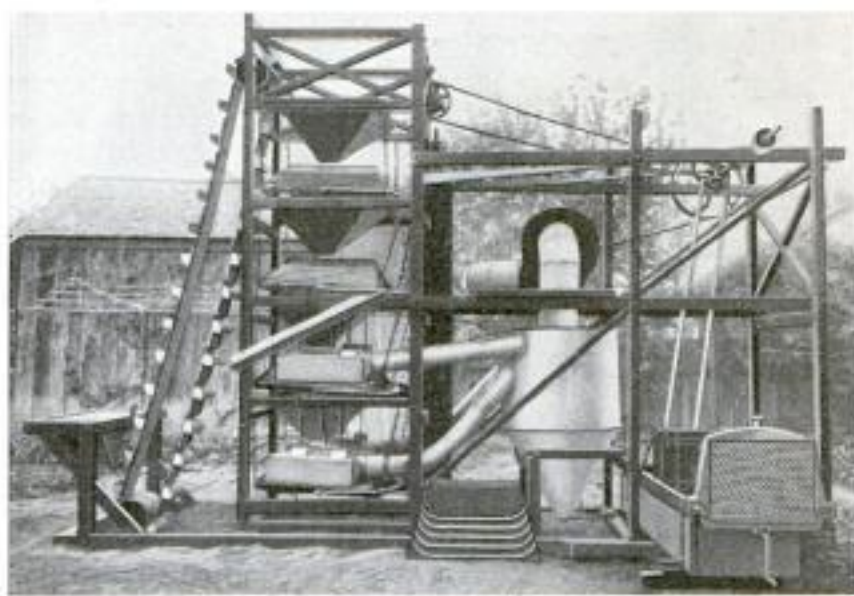

Dry Washer Built to Overcome the Difficulties of Placer Mining in Deserts and Other Regions Where Water is Scarce: The Gold is Separated from the Gravel by Means of Riffles on Slotted Screens, with the Aid of Suction Air Drafts and Mercury

can handle from 50 to 100 cu. yd. of gravel per day and is driven by a 20-hp. engine.

TELESCOPING STEEL BOAT STANCH AND PORTABLE

Sheet metal is the material used in the construction of a nonsinkable, collapsible boat that is intended for military as well as sporting purposes. Its strength and rigidity, as well as compactness when disassembled, adapt it for hard usage and long portages. The craft consists essentially of a series of telescoping sections that form air-tight compartments which, when extended, are held firmly in position by specially designed locking rods. The inner, or large, end of each of the members is sealed by a partition, and leakage prevented by packing rings, for which exterior grooves are provided. The central hull section tapers and has

a keel attached to it, while open-bottomed stabilizing shells are permanently fastened to the sides.

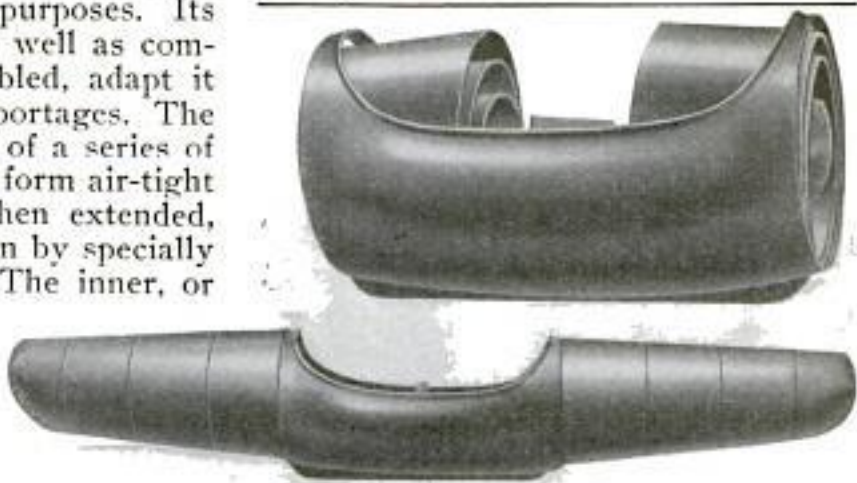

Locked in Place, the Separate Sections Form Air-Tight Compartments. When Telescoped, They Fit Compactly within the Central Hull Member

ROPE NETS FOR PROTECTION OF STRUCTURAL WORKERS

During the past year the lives of several Illinois workmen, employed in the erection of tall structures, were



The Safety Nets Pictured Here Were Supposedly the First To be Used in Structural Work; They were Employed at Chicago and Saved the Lives of Two Painters

saved through the use of rope nets. In some instances precautionary measures of this kind were taken by contractors at the suggestion of state factory inspectors, and, in other cases, at their own initiative. A bill to compel the utilization of nets when men are engaged at dangerous heights, was introduced in the legislature, but aside from the general safety provisions of the structural law, no statute yet in effect requires their use. Thus it is interesting that the results of this casual and essentially voluntary practice have spread to California. The Industrial Accident Commission there has ordered that nets be used on all structural work when it is not practical to provide, in accordance with the law, a plank floor for each story as a building is constructed. The moderate cost of nets and the readiness with which they may be installed, make them especially suitable for safety purposes. They were used successfully in Chicago during the erection of high steel-arch

trusses at the municipal recreation pier, were employed in bridge work on the Mississippi River adjacent to Burlington, and have been tried elsewhere on a number of occasions. Nets with 6-in. mesh, made of $\frac{5}{8}$ -in. Manila rope in 20 by 40-ft. sizes, were utilized at the Chicago pier. It is encouraging, to those who appreciate the need of protecting workmen engaged in dangerous occupations that the use of all except wire rope, for the slings and stirrups of swinging scaffolds, has been prohibited in Illinois. Strict rules governing the construction of such devices are in force.

TRIM CRUISER SETS RECORD DURING MAIDEN TRIALS

During tests conducted over a measured course a few weeks ago, a specially built 40-ft., single-screw express cruiser showed exceptional speed. Powered with an eight-cylinder engine that develops about 325 hp., it attained 35.46 miles an hour with 12 persons aboard. This capacity for covering distance is believed by the builders to be greater by five miles an hour than that of any single-screw craft of similar type ever launched. The boat weighs about five tons, exclusive of equipment, fuel, and passengers, has an 8 $\frac{1}{2}$ -ft. beam, and is of very staunch construction. It offers sleeping accom-



This Little Express Cruiser Cut through the Water at 35 Miles an Hour during Its First Tests

modation for three persons, possesses a 20-ft. deck, and is exceedingly trim.

There were 1,067,332 more registered automobiles in 1916 than in 1915, an increase of 43 per cent. The gross total last year, including commercial cars, was 3,512,996.

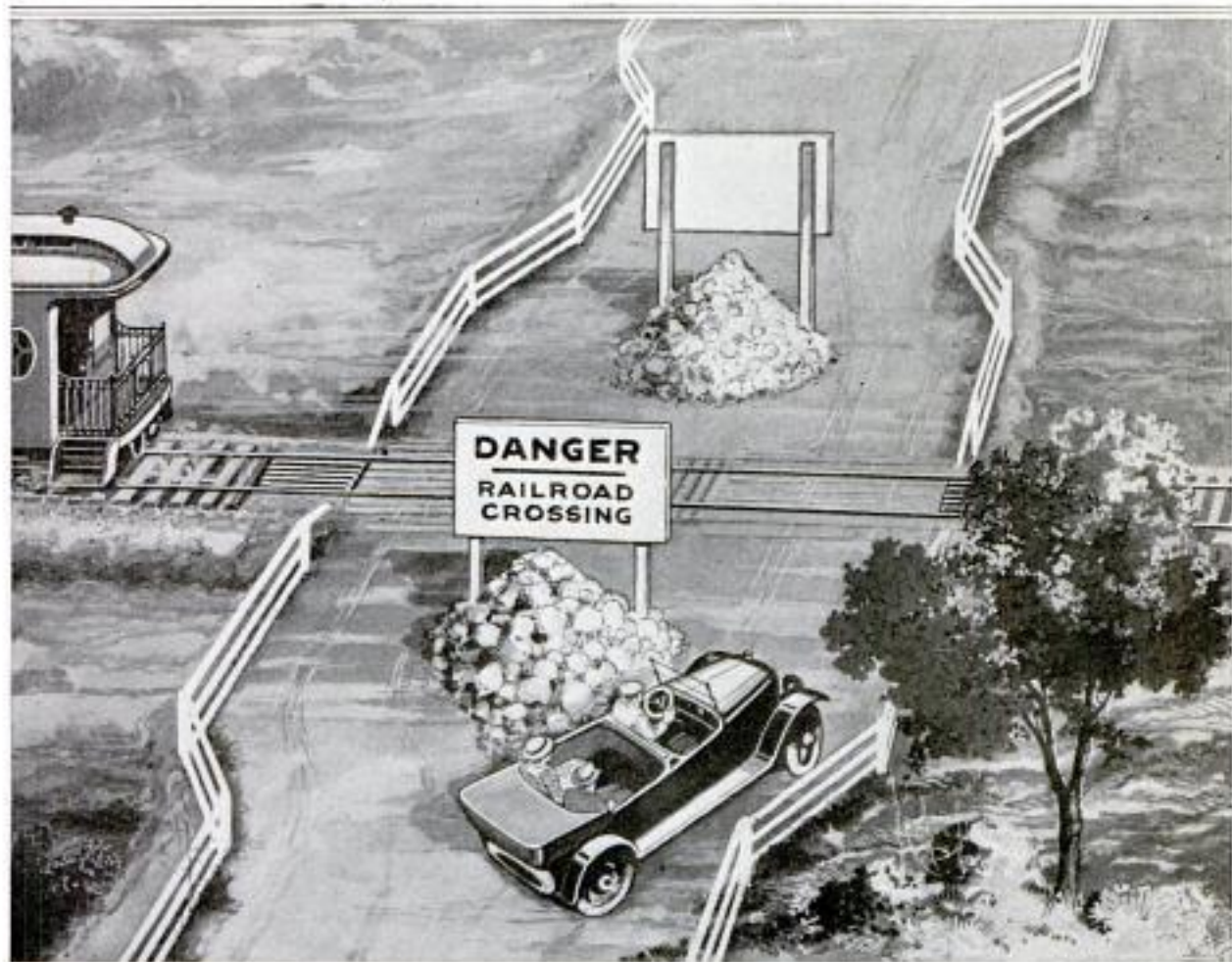

A Grade Crossing That Promotes Safety: Sketch Showing Manner in Which It is Proposed to Alter all the Grade Crossings in a Missouri County so That No Vehicles can Cross Tracks Except at Low Speed

SAFE GRADE CROSSINGS FOR WHOLE COUNTY

Steps have recently been taken to make all the grade crossings in Jackson County, Mo., "fool-proof"—that is, a plan has been adopted which will compel each vehicle to slow down on approaching a railroad track and so materially lessen the probability of accident. The improvement, which will cost about \$300 per crossing, consists in widening the roadway at its intersection with a railway and placing a pile of stones, or fencing off a triangular plot, in the center of each approach, thereby dividing the road into two parts, one for traffic going each way. Signs and white fences built close up to the path of travel call attention to the turns in the road. With this arrangement each vehicle must approach a crossing slowly in order to turn out of the straight course and to

get back into it, after passing over the tracks. In this way drivers are given time to look for approaching trains.

EMERY WHEEL ATTACHED TO SEWING MACHINE

A simple attachment by means of which a sewing machine can be employed to operate an emery wheel or similar device for household use, consists of a shaft extending through two crossed plates that can be clamped to the flywheel of the machine. A sharpening or polishing stone can be firmly mounted on the shaft, which revolves with the flywheel when the treadle is operated.



FULL AUTOMATIC POWER KNITTING MACHINE

An automatic knitting machine of improved type has been introduced in

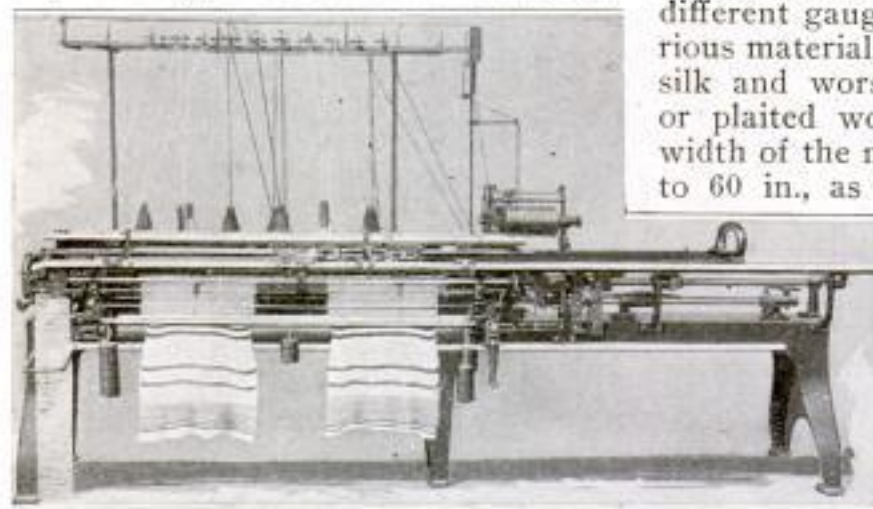

Automatic Knitting Machine for Making Silk or Wool Sweaters and Scarfs: It Uses Little Power and Requires Little Care When in Operation

this country by its Swiss inventors, and is claimed to be as nearly automatic as such a machine can possibly be, in the manufacture of sweaters, scarfs, and similar knit goods. With different gauges it can be used for various materials, including silk, artificial silk and worsted, wool and worsted, or plaited worsted and cotton. The width of the needle bed varies from 10 to 60 in., as required, and its gauge from 3 to 18 needles per inch. One of the special features is an automatic counting device whereby the machine makes different sizes of a garment without resetting. A single operator can take care of four to six machines, minimizing labor costs.

FOREIGN SEWAGE-TREATING PLAN ADOPTED HERE

A new type of sewage-treating plant, which, it is claimed, can be built within city limits without being offensive to those in its vicinity, has been introduced into three American cities from

Europe, namely, Brooklyn, Cleveland, and Long Beach, Calif. It has the special advantage of occupying a small area, and it is asserted that the effluent from the plant can be discharged into local waters without creating a nuisance. The method of treating the sewage is mechanical, a revolving screen being employed to separate the solids and liquid. The separator is a large disklike plate in the center of which rises a cone. Both are of noncorrosive metal and are closely perforated with narrow slits 2 in. long. The screen is tilted at about 15° from horizontal so that one side is submerged in the sewage flow. As it slowly revolves it brings with it the

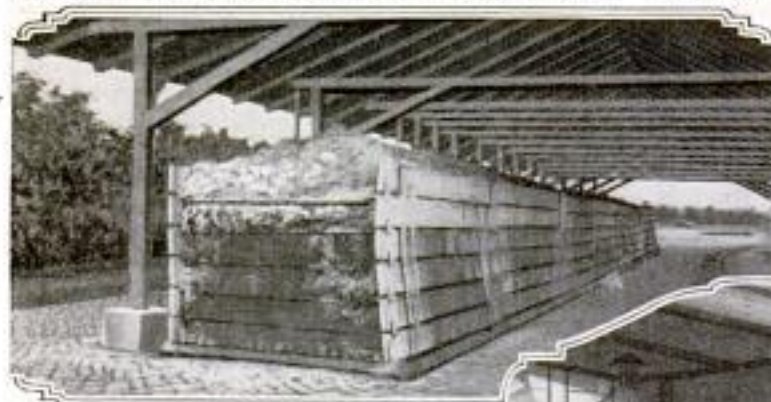

Special Bins Filled with Sewage Screenings Which, in France and Germany, are Sold for Fertilizer

Europe, namely, Brooklyn, Cleveland, and Long Beach, Calif. It has the special advantage of occupying a small area, and it is asserted that the effluent from the plant can be discharged into local waters without creating a nuisance. The method of

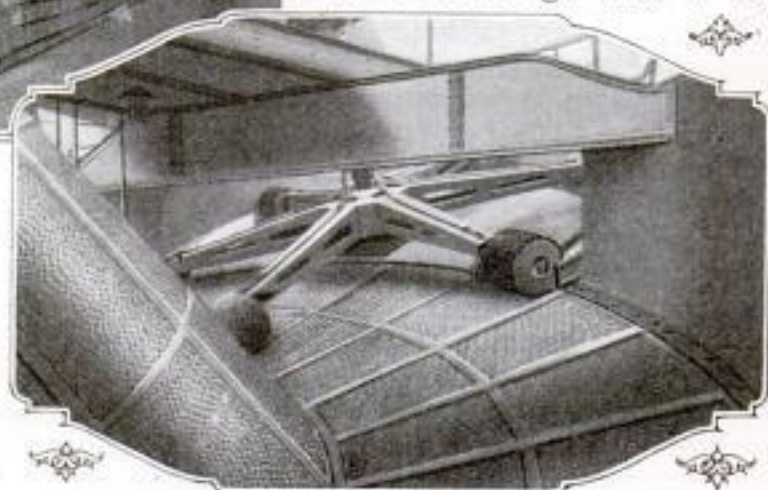

View of the Revolving Screen That Separates the Solid Matter from the Fluid Sewage, and the Rotating Brushes That Discharge It into Troughs

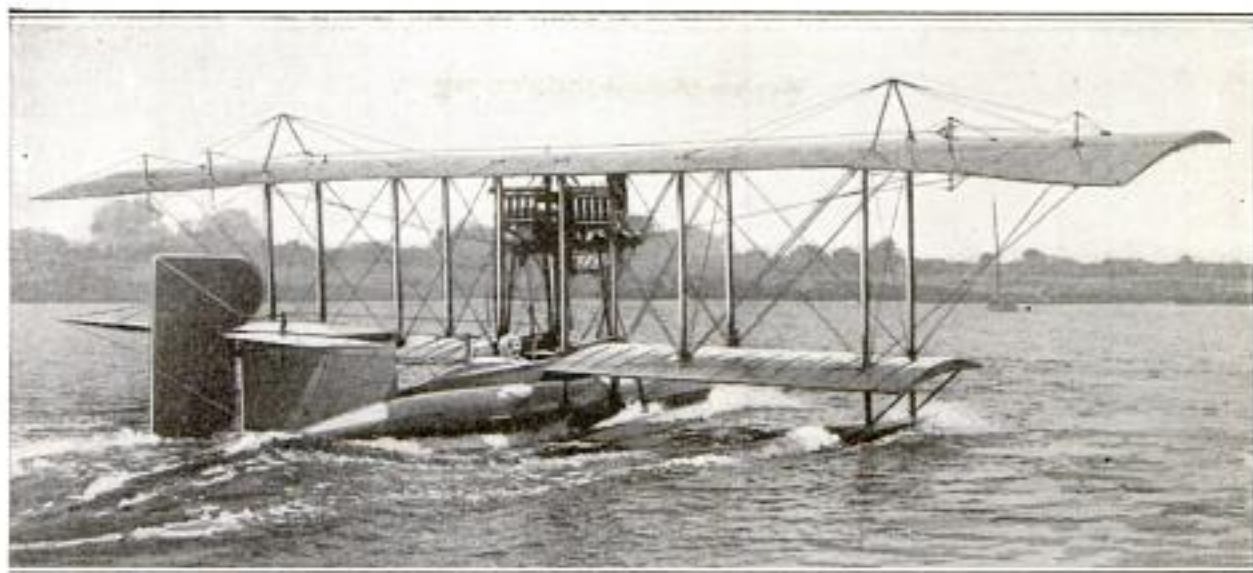

Copyright by FACH PHOTO NEWS CO.

When the Boat Attains Speed, It Planes on Its "Third Wing" with the Hull Raised Out of the Water

solid matter, which is brought under a set of brushes that rotate on an iron spider and also revolve on their axes. These continually brush the sludge off into troughs, and it is eventually burned, reduced or used as fertilizer, according to its chemical content. As it comes from the screen troughs it is bagged and placed in a rotator which expels the water by centrifugal force.

Hydro-air plane

4580 LIGHT-WEIGHT FLYING BOAT BUILT FOR PLEASURE USE

Distinctive features are incorporated in the body design of a sport-type flying boat that has been given extensive tests in eastern waters. The streamline hull is unusually light and is circular in section. Below it is a plane, or third wing, on which the craft skims on the surface of the water. Owing to this form of construction, it is claimed, the head resistance of the vessel amounts to only a little more than that of the ordinary land tractor. The boat is able to plane on the water with its hull entirely clear, while, in alighting, the body is not subjected to the entire shock, for the wing struts are made to bear a proportionate share of it. These points permit the hull to be nearly 300 lb. lighter than that of a standard craft of similar length. It has been found that the boat's design materially facilitates its control and that

it can be handled on the water almost as easily as a motorboat. Such advantages are of importance to the sportsman flier, for they tend to make the craft independent of its hangar and enable it to be anchored wherever the water is sheltered. The machine is known as the Pierce-Breese flying boat and is rated to travel at a speed of from 40 to 50 miles an hour. The upper wing has a span of 48 ft., and the lower member, 31 ft. As a test, the boat was anchored for five months in salt water. During that period the hull did not leak or become logged, nor did any other sign of deterioration appear.

4560 NONREFILLABLE BOTTLE OF NEW DESIGN

A nonrefillable glass bottle of inexpensive design is provided with a neck, shaped like an inverted cone, in which is a glass ball that closes the opening at the lower end of the neck. After filling the bottle and inserting the ball, a flanged glass tube is cemented into the mouth so that the ball valve cannot be dislodged to permit refilling the container.



4691
**MOTOR-DRIVEN SIREN
 OF NEW TYPE**

A recently devised siren for fire-alarm or signal purposes which can be



New Type of Siren Which is Driven by the Motor Shown at the Right: While the Signal is in Operation the Horn, Which Greatly Magnifies the Sound, Swings Around in a Circle

heard great distances is motor-driven and is provided with turbinelike vanes that produce a weird sound as they rapidly revolve. The noise is greatly

magnified by a horn, attached to the top of the apparatus, which projects horizontally and swings slowly around in a circle, while the siren is in operation. By means of a hand-operated slide in connection with the apparatus the sound can be varied at will, or a trained operator can transmit messages with the signal by using a telegraph code.

471
**FELLS GAME WHILE RIDING
 SWIFTLY ON MOTORCYCLE**

The feat of the horseback rider of cowboy days who could kill game or an enemy while riding full tilt, is equaled, if not surpassed, by a naturalist and taxidermist who shoots some of his quarry while riding at high speed on his motorcycle. He has devised a clamp to hold his loaded shotgun above the gasoline tank of his cycle, while a sling attached to the weapon passes over his shoulder. His method is to ride swiftly along the road and, when he sees a desirable bird perched near the highway, he seizes his gun and fires upon it without slackening speed. This, of course, involves skill in riding without touching the handlebars. By this spectacular method the naturalist is able to fell birds which would take flight if approached by stealth.



Skillful Motorcyclist Riding at Full Speed and About to Fire at a Bird Perched by the Roadside: This Bird Is a Stuffed Specimen Which was Killed in the Manner Shown While Sitting on This Very Post

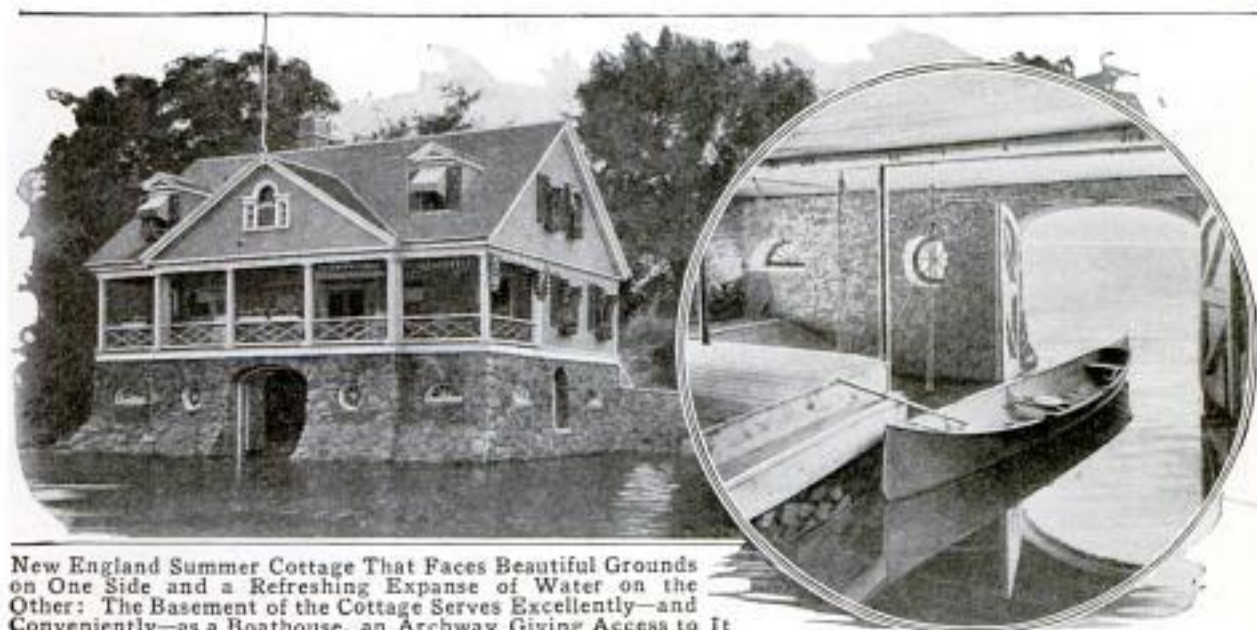

New England Summer Cottage That Faces Beautiful Grounds on One Side and a Refreshing Expanse of Water on the Other: The Basement of the Cottage Serves Excellently—and Conveniently—as a Boathouse, an Archway Giving Access to It

PLEASING SUMMER COTTAGE IS BUILT OVER WATER

Those who love the water and enjoy living near it will appreciate the attractive features of a pleasing New England summer cottage whose basement serves as a boathouse for the owner. On one side the residence faces inviting grounds, and on the other clear, rippling water that to the devotee of aquatic pastimes is equally enticing. The structure is carried on artistic stone walls extending out from the shore of the lake. A large archway with double doors permits boats to enter the basement, where low landings give access to stairs leading to the floor above.

STOVE OF NEW DESIGN HAS LARGE HEATING AREA

A great saving in fuel, it is claimed, can be made by using a new type of stove, whose outward dimensions are not greater than an ordinary heater, but which has four times as much actual radiating area. This stove has an outer and an inner wall, the latter, which surrounds the fire pot, being composed of numerous convolutions arranged radially. Air enters between the two walls through holes in the bottom of the stove and, on being warmed, passes out through the top and sides,

which are perforated. Fuel is supplied through a central opening in the top for which a lid is provided. Extending downward from this opening to well within the reach of the flames, is a drum in which water may be kept. This chamber serves to spread the flames, forcing them against the vertical walls. Air for the draft enters through an adjustable grate in the bot-

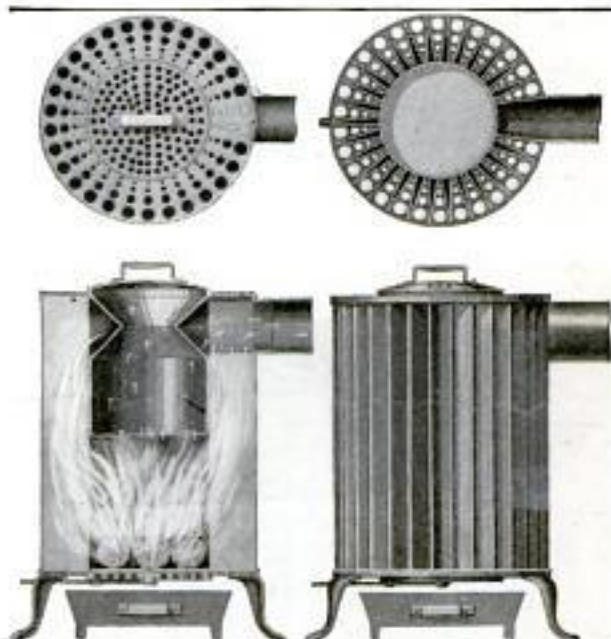

The Convolutions in the Inner Wall of This Stove Give It Four Times as Much Radiating Area as an Ordinary Stove. Air Enters at the Bottom, Rises between the Outer and Inner Walls, and Passes Out through the Top and Sides

tom of the stove and, together with smoke and gases, passes out through a flue situated at one side, near the top.

4750

PATRIOTIC AND OTHER BEAUTIFUL DISPLAYS WERE



The Eleventh Annual Rose Festival Held Recently in Portland, Oregon, was Not Lacking in Patriotic Appeals, Presented in Various Forms. One of the Most Enthusiastically Applauded Sections of the Beautiful Children's Parade Was That Devoted to the Red Cross. The Long Rows of White-Clad Girls, Each Wearing the Red Emblem of Mercy on Her Forehead and Breast, Presented a Spectacle That Was Very Impressive. Back of the Applause Was the Silent Recognition of the Fact That the Red Cross was Soon to Mean More Than Ever Before to America

Very Appropriately, a Replica of the Goddess of Liberty was Made the Central Decorative Feature of the Festival. The Statue, 50 Feet in Height and Weighing Four Tons, was Erected in Festival Center, a Beautifully Gardened Area Composed of Several Blocks. At an Appointed Time the President in Washington Pressed a Button Which Turned on the Many Lights Studding the Statue



Not to be Outdone by the Big Gasoline-Driven Automobiles, This Little Negro Boy Shared Merrily in the Parade, Pumping Along in His Geared Wagon, the Flowers Almost Enveloping Car and Rider



The Automobile Which Received the Prize of \$75 for the Distinctiveness of Its Decoration: The United States Flag was Made of Delphiniums and Red and White Carnations, Set in a Field of Scotch Broom



FEATURES OF PORTLAND'S RECENT ROSE FESTIVAL

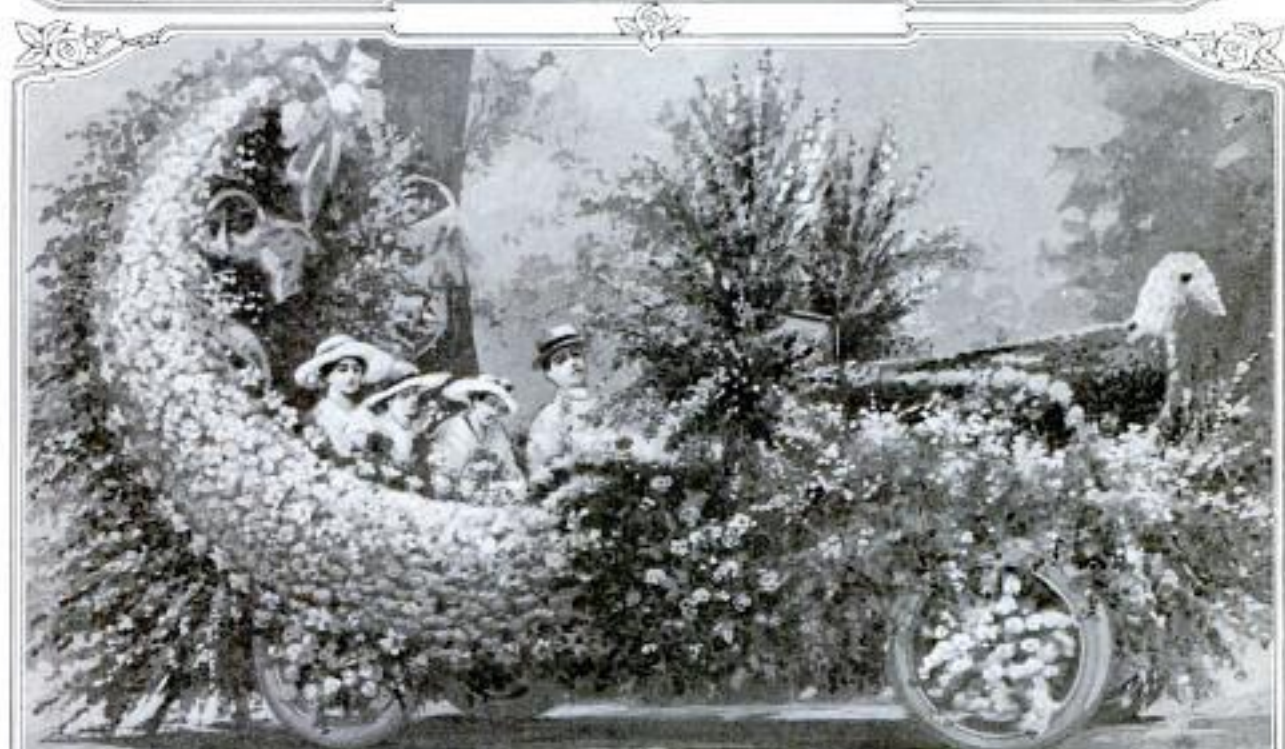

One of the More Pretentious Entries: This Embowered Car Well Illustrates How Gorgeous and Elaborate Are the Floats Prepared for the Annual Festivals. It Represented a Horn of Plenty, the Horn Itself being Made of Carnations, Easter Lilies, and Snowballs. Overflowing from the End of the Horn Were Quantities of Roses Which Completely Covered the Front of the Automobile. Surmounting the Hood Was a Bird Composed of Red and White Carnations.

PIPE-BENDING MACHINE ELIMINATES JOINTS

Pipe bending, which has long been considered a task difficult to perform without cracking or crimping the tubing, can now be accomplished, it is claimed, by unskilled workmen with cold material, by using a new bending machine. This machine is mounted on

a knock-down steel frame and is provided with a set of removable heads of various sizes, each of which resembles a half of a solid pulley, the curved edge having a hollow groove in which the pipe lies when its shape is being altered. The head used corresponds in size to

the pipe to be treated. To operate the machine the pipe is inserted between the head and a set of jaws. By means of a long lever, which projects horizontally, pressure is exerted on the pipe to force it gradually around into the groove of the head, thereby producing a bend of the angle desired. A 2-in. pipe can be bent to a 90° angle in about a minute. The bender effects an important saving of material by doing away with cutting and the use of threaded joints of various types.

Easily Operated Machine for Bending Steel, Brass, or Copper Pipe: A Two-Inch Pipe can be Bent to an Angle of 90 Degrees in About a Minute

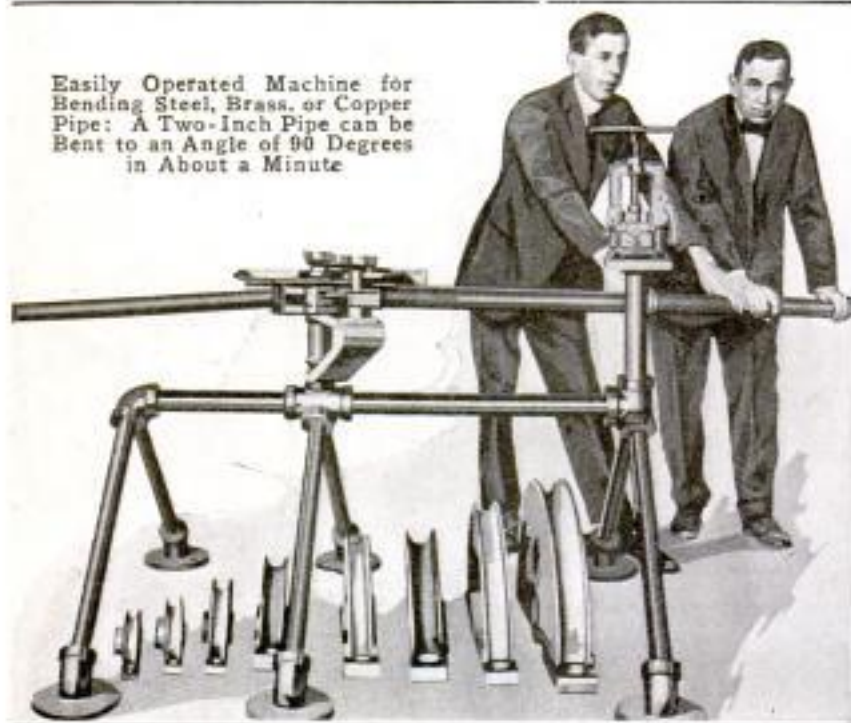

NEW ORE-TRANSFER CAR OPERATES QUICKLY

A feature of a new 50-ton transfer car for ore and limestone, made by a Cleveland builder, is that it can be emp-

tyed in a few seconds by operating one or both pairs of motor-driven hopper gates, with which it is provided. These gates are of the rolling type and when rolled open leave a large, clear passage over the center of the track. They will cut through a pile of material and close up when a bin is not large enough to care for an entire load. The car has two cabs, one at each end, in which center all controlling apparatus. Here also are dials showing the position of the gates. The length of the car is 42 ft. It is driven by four 60-hp. motors, and is of the best type of steel construction throughout.

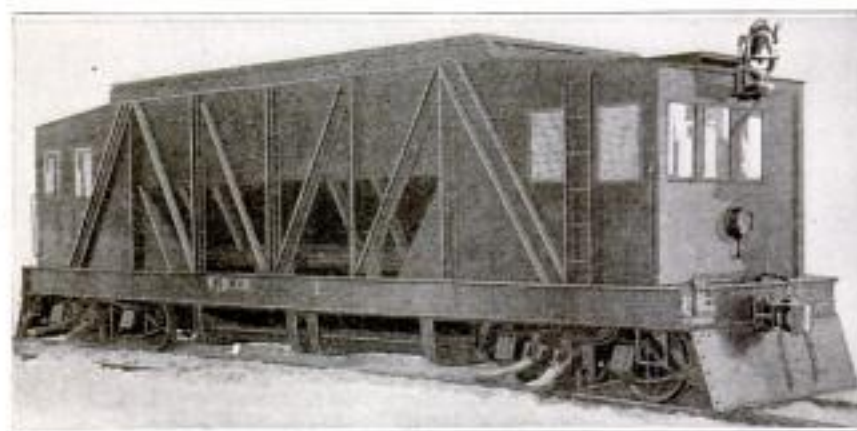

This 50-Ton Transfer Car for Ore or Limestone can be Emptied in a Few Seconds by Operating the Hopper Gates, of the Roller Type, with Which It is Provided

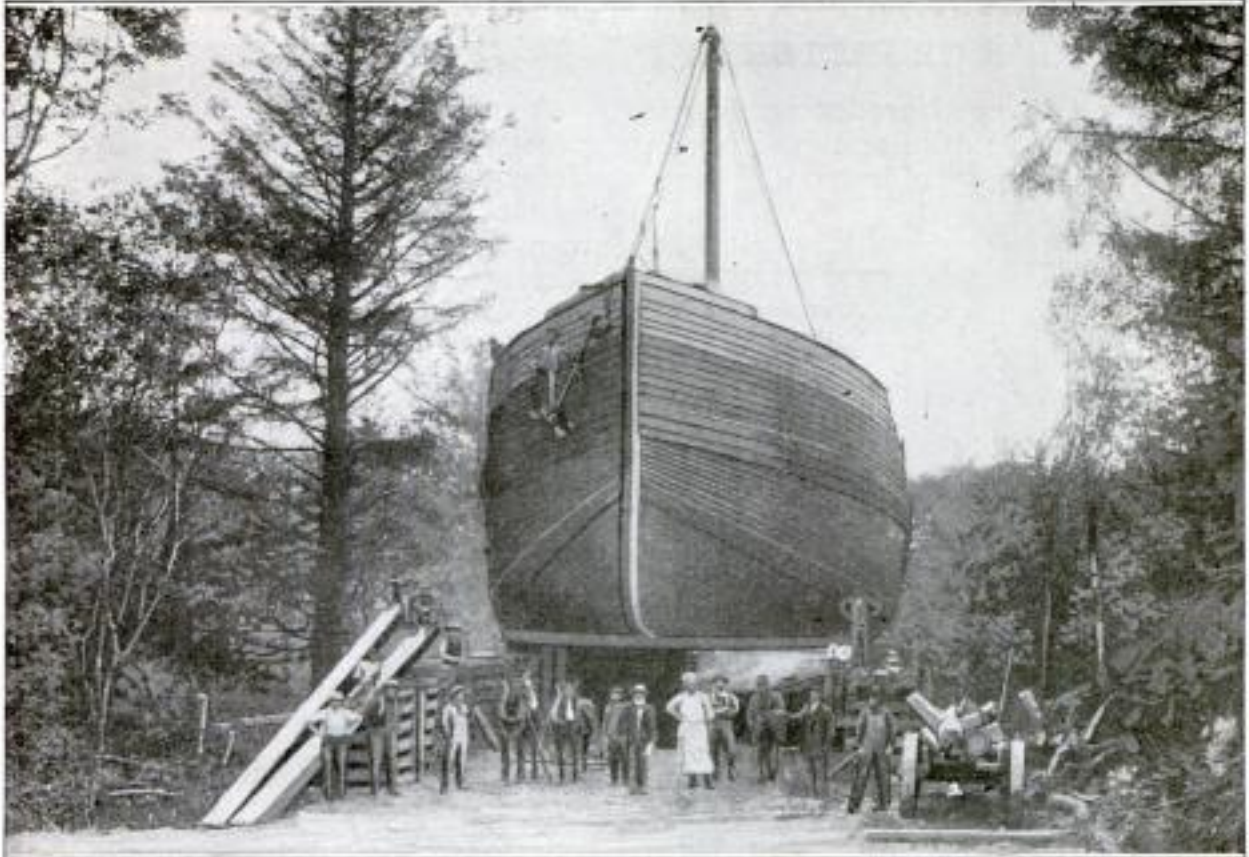

Barge Weighing 1,200 Tons being Drawn from the Place Where It Ran Ashore to a Quiet Bay Over Half a Mile Distant, Where It was Launched with Safety: A Donkey Engine on Board the Boat Aided in Making the Transfer

STRANDED BARGE JOURNEYS HALF A MILE OVERLAND **MOBILE LIGHTING EQUIPAGE AIDS CUBAN FIREMEN**

Following the beaching of a barge weighing 1,200 tons, during a storm on the Pacific coast a few weeks ago, that vessel was given an overland trip of half a mile in preference to putting it back into the water where it had grounded, the fear being that the breakers might dash it to pieces. By making the land journey the boat was brought to quiet water where launching was accomplished with entire safety. The transfer was made by jacking the barge up and moving it on rollers along an especially constructed track. To provide a level path, deep cuts had to be made in places.

Because pork can be used in a great variety of ways, will keep better than most other meats, and can be quickly produced at a relatively low cost, the government is strongly urging farmers to raise more hogs and thereby add to the nation's food supply.

To be of assistance in emergencies at night, a searchlight that projects diffused rays has been installed on a small roadster for the municipal fire department of Havana, Cuba. The light is mounted on top of a two-compartment steel box—intended for batteries and equipment—that is attached at the rear.



Mobile Searchlight Equipment of the Havana, Cuba, Fire Department: The Box below the Light Contains Electric Batteries and Other Equipment

Wood

4403 **AIR-GAS SYSTEM FOR USE
IN HOME OR FACTORY**

A new system of producing air gas, invented in Australia and just finding its way into America, is stated to be so



Apparatus for Producing Air Gas, for Domestic or Industrial Lighting and Heating: The Gas Includes a Small Portion of Gasoline Vapor, Mixed with Air

simple in process and so compact in mechanical proportions that a plant may be installed to furnish light and heat in the average dwelling within a floor space of 5 by 6 ft., at a probable cost of \$125 to \$150 for installation. Essentially, the system consists in producing gas by mixing small quantities of gasoline vapor with large quantities of air. The proportions are 98½ per cent of air to 1½ per cent of vaporized gasoline. This gaseous mixture may be used for domestic or industrial purposes at a small fraction of the cost of methods of lighting and heating now in use, and with perfect safety. The apparatus consists of a patented vaporizer and carburetor, supplying gas direct to the service pipe without the medium of a gasholder. A hot local flame is produced on ignition, with complete combustion and freedom from smoke or smell. Some 300 plants are said to be in successful operation in Australia.

4795 **GOVERNMENT PULP MILL
IN ALASKA PROPOSED**

A pulp mill for the manufacture of news print will be established by the Federal government in Alaska, if the recent petition of the Alaska legislature and the recommendations of the secretary of agriculture are acted on favorably by congress. According to forest-service experts news print made in Alaska could be delivered to New York City via the Panama Canal and sold at not more than \$30 per ton, whereas this product at the present time is selling for \$60 per ton. There are 70,000,000,000 ft. of spruce and hemlock in the national forests, besides timber on other public lands, in the territory. The secretary of agriculture is of the opinion that greater riches will be derived from this source than from all other natural resources in the territory combined.

4587 **SWISS CASKET TOO LARGE
FOR AMERICAN HEARSE**

A massive burial casket was recently shipped to this country all the way from Switzerland, and on arriving here, had to be discarded for a smaller one because its height did not permit it to be loaded into an American hearse. The coffin was made of hand-carved quartered oak, was lined with copper ¾ in. thick, and weighed about 1,200 lb. The retail price paid for it was



Massive Casket of Quartered Oak, Weighing About 1,200 Pounds, Which was Recently Shipped to This Country and Then Discarded Because It could Not be Loaded into an American Hearse

\$2,700. This casket is said to have been similar in design to the one in which the late emperor of Austria was buried.



Wife and Child of Guano Gatherer in Their Cave Home: The Wife is Weaving a Panama Hat



Above Is a General View of the Mouth of the Cave Dwelling, Partly Closed with Thatch, and at the Left Is a View from the Interior of a Cave Estimated to Contain 35,000 Tons of Guano

GUANO GATHERERS LIVE

45 } IN ISLAND CAVE

Numerous caves, one of which serves as a human habitation, and others of which are rich in deposits of bird and bat guano, are to be found on Mona Island, a little body of land lying directly west of Porto Rico and belonging to that territory. The deposits of fertilizer are the accumulation of countless years and are now attracting Americans who are exporting the guano in large quantities. One cave recently opened is estimated to contain 35,000 tons of deposit.

PAPER HOIST SAVES TIME

46 } IN PRINTING PLANT

Most of the labor and time usually consumed in lifting paper stock to the top of a flat press in a printing establishment, are saved through the use of an elevating mechanism that is now being adopted. A steel framework, carrying a motor and hoisting outfit, is attached at the feeding end of a press. The paper is moved beneath it on a small truck. Cables are then at-

tached to the latter and power applied. When the top of the stack reaches the desired height, the hoist stops. As the feeder removes the paper, the remainder is raised automatically so that the stack is maintained at the proper elevation until exhausted.



Showing One of the Paper Elevators, Attached to a Flat Press, in Actual Use

3- R. B. ...
 ... Hard ...

NEW MALTED-MILK MIXER HAS PORCELAIN SUPPORT

An attractive feature possessed by a new malted-milk mixer for soda foun-



tains is a combined base and column which is a single unit of white porcelain that can be easily kept clean. The motor is stationary, being mounted on the top of the column. The mixing spindle can be raised $7\frac{1}{2}$ in. so that even a very tall

container can be placed beneath it. Current is turned on and off by lowering and raising the spindle, which will operate only when at, or near, its lowest position, and so does not splash liquid on being inserted into or withdrawn from a glass.

ARROW PAINTED ON GLOVE SERVES AS AUTO SIGNAL

Merely by painting a double-headed white arrow lengthwise on the back of his left-hand glove a motorist



has provided himself with an effective signal for use while driving. The two arrowheads are at opposite ends of the arrow shaft. When the driver is about to turn to the left he thrusts his gloved hand out from the left side of the car far enough to permit

only that part of the arrow at the outer end of his glove to be visible to those at the rear. When about to turn to the right he thrusts his hand somewhat farther out, with the fist closed. This

leaves visible only the arrowhead pointing to the right. "Stop" is indicated by holding the forearm and hand in a vertical position.

MAKE WATER TANKS SQUARE TO MATCH OUTBUILDINGS

Consistency in architectural design has been carried to such an extent in



the construction of the buildings on a California ranch that the two water reservoirs included among the outbuildings have been made square and in a style that harmonizes in other respects with surrounding structures.

Within each of the two square towers is concealed a cylindrical tank in which the water is kept. The outer structure, in addition to giving the desired appearance, helps to keep the water cool and prevents warping of the reservoirs.

NOVEL HAIR CUT LEAVES RED CROSS ON TOP

During a recent Red Cross campaign a young man having red hair decided



to show his patriotism and advertise the cause, in which he was much interested, by having his head shaved clean except for a large cross-shaped area on the top. As he tipped his hat and bowed, on meeting friends

on the street, he was sure to attract attention.

1055 **BIG FIVE-MAST SCHOONER LAUNCHES ITSELF**

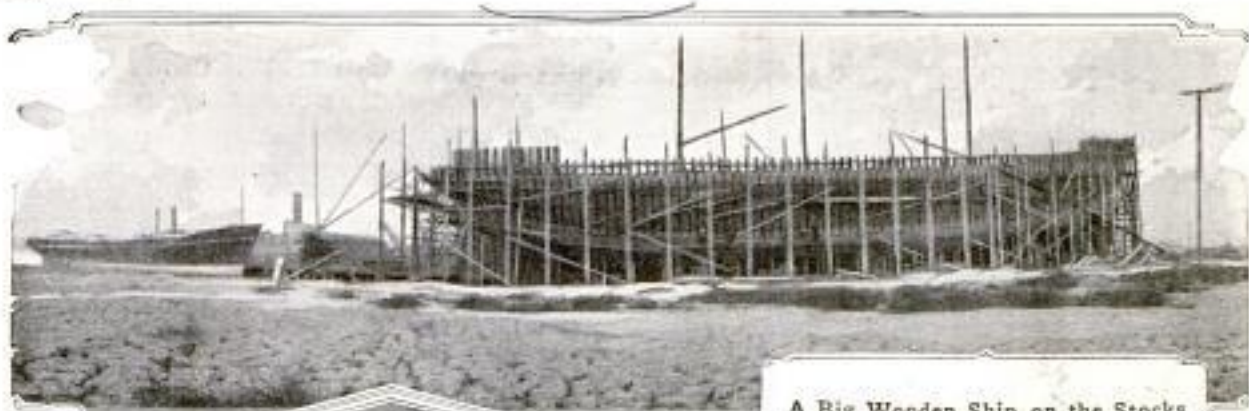

A Big Wooden Ship on the Stocks during Its Construction on the Pacific Coast: When Preparations were being Made to Launch It, the Vessel Broke Loose and Slid into the Water. This Unexpected Procedure Prevented the Christening of the Craft



Using Big Mallets to Start the Four-Foot Pins That Hold the Hull's Timbers Together: Four of Them, Two Wooden and Two Iron, are Used at Each of the Hundreds of Places Where the Planks Cross the Ribs



Driving the Pins into Place with a Compressed-Air Hammer, One of the Important Stages in the Construction of a Wooden Hull: The Vessel Has a Cargo Capacity of 2,000 Tons



The Hull of the Boat is Constructed of Oregon and California Pine. This Picture Shows How the Ribs are Put in Place, One at a Time. The Ship is 271 Feet in Length

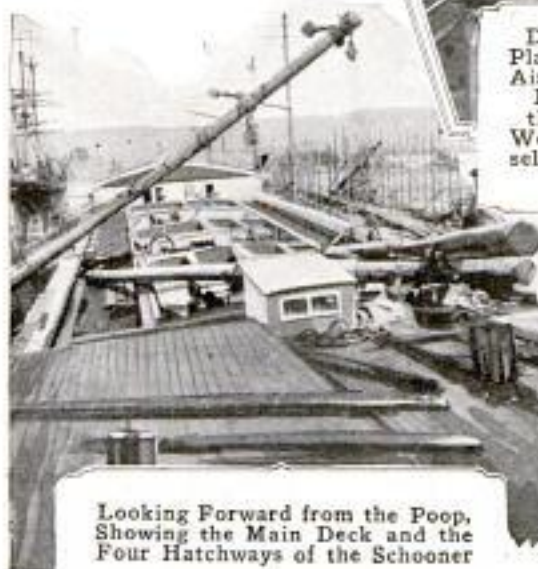

Looking Forward from the Poop, Showing the Main Deck and the Four Hatchways of the Schooner



Chipping Off the Edges of the Heavy Planks: The Men Who Do This Work are Followed by Planers Who Finish the Hull

PHONOGRAPH OUTFIT

FOR THE ARMY

Among the various means of entertainment that are to be provided for the American soldier who enters this war, will be the phonograph. A special outfit has been devised for army purposes, consisting of a hornless instrument, and a waterproof fiber case. The latter is made like a suitcase, and is divided into compartments for the phonograph, 30 or more records, and extra parts, including needles. The weight of the outfit complete is about 36 pounds. In camp, the container, which is very substantial in construction, can be used as a standard for the instrument while it is being played.



NEW DEVELOPING PRODUCT TAKES PLACE OF METOL

A new photographic developer, said to be of reliable quality, has been placed on the market recently as a substitute for metol. The latter is a whitish developing powder which is made in Germany and is not now obtainable on account of the war. The



Birds Photographed by Flash Light, the Camera being Set for One Two-Hundredth of a Second and the Shutter Operated by a New Automatic Synchronizer

new product is suitable for plates, photographic papers, and films, including motion-picture films. It is another example of how American chemists are meeting war emergencies.

SYNCHRONIZING APPARATUS FOR FLASH PHOTOGRAPHY

A recently devised attachment for actuating a camera shutter at the instant a flash-light powder explodes depends for its operation on the burning of a silk thread by the explosive. A plunger which is a part of this synchronizer projects up through the flash-light pan and is connected with the camera shutter by a wire that passes through a flexible tube. A coil spring at the lower end of the plunger tends to thrust the latter upward. However, when a picture is about to be taken the plunger is tied down by a silk thread stretched across its upper end. Any of the usual means for setting off the powder can be employed. When the explosion takes place in the pan the heat burns the restraining thread and allows the plunger to fly upward. This in turn pulls the wire, so that the shutter is operated at the instant the flash is at its maximum.

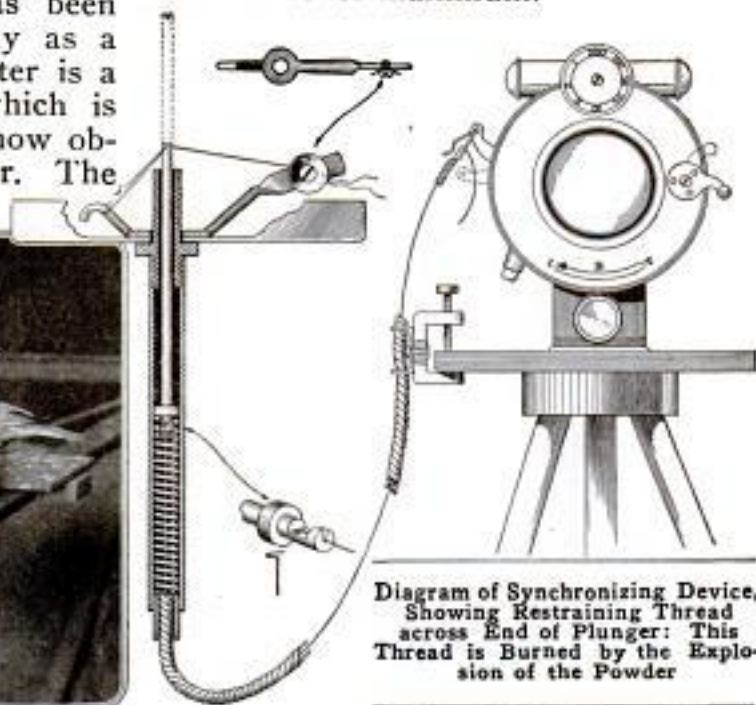

Diagram of Synchronizing Device, Showing Restraining Thread across End of Plunger: This Thread is Burned by the Explosion of the Powder

ATTACHMENT MAKES CYCLE FOUR-PASSENGER CAR

4:00 For military and police purposes a two-wheeled cart attachment for a motorcycle has been developed which is able to transport four men and a store of rifles and ammunition at high speed. It forms a four-wheeled vehicle that is very flexible, easily controlled, and convenient for emergency use. The seats are placed back to back, and beneath each is a storage compartment of proper length to receive firearms. Owing to the low fuel consumption of a motorcycle, the combination provides an economical machine.



Showing a New Cart Attachment for Military or Police Motorcycles That Allows Four Men to be Carried: Under the Seats Is Storage Space for Arms and Ammunition

BOILER-FURNACE DEVICE AIDS COMBUSTION

Many owners of apartment houses, and other large buildings, are installing an appliance in their boiler furnaces which promotes better combustion by furnishing a better air supply to the burning fuel. The appliance can be installed in any low-pressure fire-box boiler, or return tubular boiler, having 1,200 sq. ft. or more of radiation. One feature consists of two perforated plates situated one at each front corner of the fire box, through which the air enters the fuel chamber. The other principal feature is a brick arch, or partition, that divides the upper part of the fire box into a front and back compartment. The former is kept

filled with coal up to the partition. Air entering through the perforated plates is heated and, together with gases given off by the heated coal, passes through openings provided in the partition. These passages force the heated



Diagrammatic View of Fire Box Showing Brick Partition Dividing It into Two Parts: Heated Air and Gases Pass through the Openings Down into the Burning Fuel and So Promote Combustion. The Perforated Plates are Not Shown

air and gas downward onto the burning fuel in the second compartment and thereby greatly facilitate combustion.

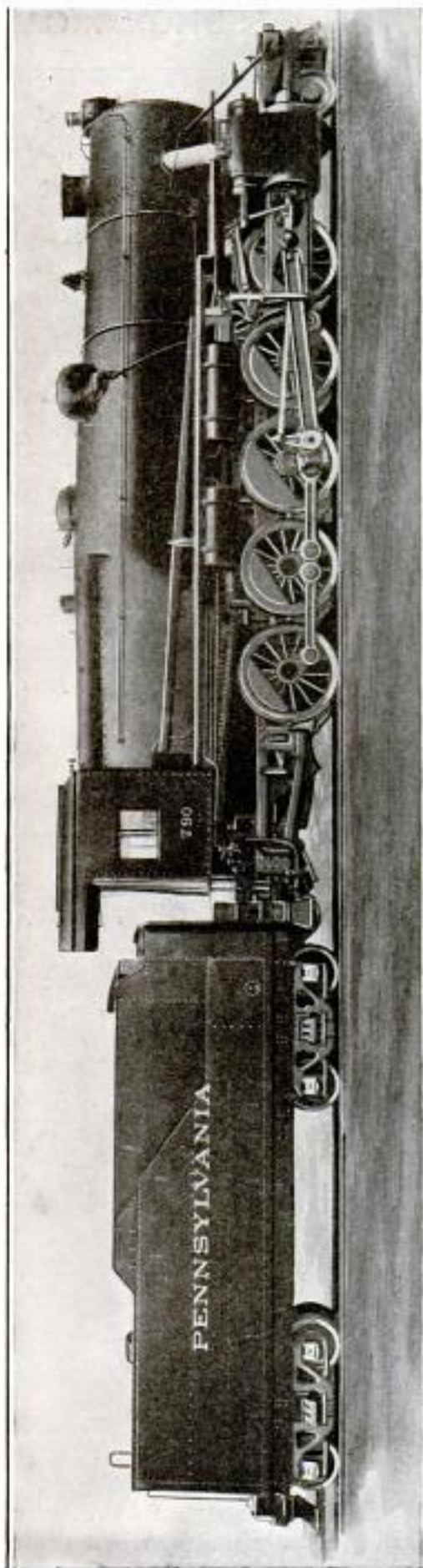

This Powerful Locomotive has been Constructed by the Pennsylvania Railroad for Experimental Purposes. It is Distinguished by Its Five Pairs of Drivers and Marks an Interesting Trend in Current Designing. Because of the Number of Its Driving Wheels, It is Known as the Decapod Type. This Feature Makes It More or Less Uncommon, but Not Unique. Engines of Similar Character are being Used by Certain Other Companies

BIG LOCOMOTIVE PROVIDED WITH TEN DRIVING WHEELS

In recent weeks tests have been conducted with an interesting locomotive that has been developed for experimental purposes by the Pennsylvania Railroad. It is of the "decapod type," having five pairs of driving wheels instead of the more customary set of four pairs. This arrangement gives the engine additional traction and enables greater utilization of its power so that starting and stopping are accomplished more smoothly than otherwise would be the case. The boiler is designed to carry a pressure of 250 lb., which is an increase over the usual capacity of the company's big locomotives. It is equipped with a 48-unit superheater and has 244 two and a quarter inch flues, 228 in. long, between the tube sheets. The area of the fire grate is 70 sq. ft., while the total heating surface of the boiler amounts to 6,494 sq. ft. The wheel-base of the engine and its tender is a half inch more than 73 ft. The driving wheels have a diameter of 62 in. The forward and rear sets are flanged, but the others are not. For the driver brakes two air cylinders, capable of exerting a braking power of 230,000 lb., are used. This is understood to be the largest locomotive that has been designed by the company. Primarily it is intended for freight service.

SPECIAL WAY OF PACKING

MATCHES WITH CIGARS

According to the terms of a recent patent, each cigar can be provided with a match so that a smoker need suffer no inconvenience in obtaining a light. The match is to be incased in a waterproof wrapper and imbedded in the butt of the cigar at the time the latter is made. The end of the wrapper will project from between the tobacco leaves and can be withdrawn easily. It is claimed that the cost of this feature would be small, as the work can be done mechanically.

"TRENCH TRAPS" OF THE GERMANS

By LEWIS R. FREEMAN

3 C. 11
"WHAT do you think made that wound?" asked an officer who was conducting me through one of the advanced hospitals on the Somme, pointing to the badly swollen and lacerated ankle of a soldier that was just being dressed. The puffy and discolored flesh might have come from a severe sprain, but two or three black punctures on either side indicated that the injury was a more aggravated one. "If there was a tropical river about," I replied finally,

"I should hazard a guess that the man had stepped into the mouth of an alligator, or had been nipped by one while swimming. As I have never heard of alligators in the Somme, I fear I shall have to give it up. What *did* do it?"

"Trench trap," was the laconic reply; "or, to be more exact, a wolf trap. Ever since the steady pressure of our advance began to tell—since the Boche began to realize that he would have to continue backing up before our attacks—the Germans have been leaving them behind in the trenches, or laid in inviting little runways through the wire entanglements. Not many of our men were caught after the first day or two—we have only had two or three cases here—but several scores of traps have been discovered, along with a lot

more of diabolically ingenious contrivances designed to hamper our advance or to give us pause in the matter of occupying abandoned dugouts. In fact, the dodging of the trench traps has added quite a new interest and zest to our latest attacks."

Scientific "trench trappery" is indeed a new development of modern warfare, and, like so many other things, it has taken the methodical and thorough

Teuton to bring out its refinements, to make

a fine art of it. Ever since the discovery of gunpowder the practice of mining a position about to be abandoned, the mine to be exploded when the advancing enemy came over it, has been

resorted to, and that, indeed, was just about as far as it had gone—even in the present war—up to the time that it became apparent that the French and British pressure on the Somme was likely to go on indefinitely and increasingly. The

wolf traps were only the first of a series of many devilish little de-

vices left behind by the ousted Germans to deliver a last blow at the victorious "Tommy" or "Poilu," a sort of modernization of the famous Parthian shot.

Obviously, "trench trappery" par excellence is only practicable in the face



"'Trench trap,' was the laconic reply. 'The Germans have been leaving them behind in the trenches, or laid in inviting little runways through the wire entanglements.'"

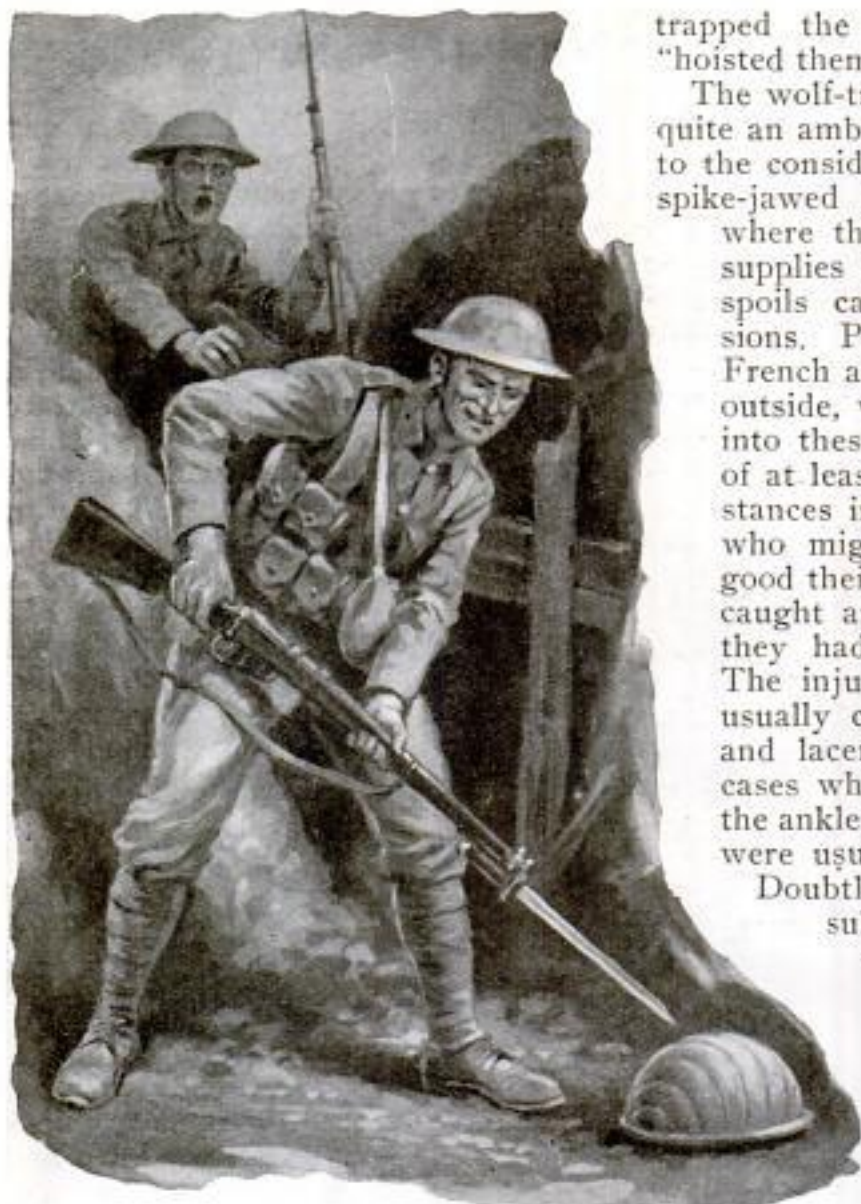

"The usefulness of the tortoise was over as soon as the wary Tommy ceased stroking its back with his bayonet and instead began hailing its appearance with hand grenades hurled from a respectful distance."

of a slowly and steadily advancing movement; just such a one as that on the Somme has become, or as Verdun was in its opening phases. Obviously, too—since the proverb that a once-burned child is twice shy applies with equal force to the French and British soldier—it must show a progressive development to stand any chance of success, must be constantly varied, constantly carried on in a new way. That the general scheme has been a flat failure is principally due to the fact that the Germans have not been able to vary their devices sufficiently to baffle their wary quarry, who, meeting guile with guile, have as often as not

trapped the would-be trappers and "hoisted them with their own petards."

The wolf-trap scheme was evidently quite an ambitious one, for in addition to the considerable number of the big spike-jawed contrivances rounded up where they had been set, reserve supplies of them were among the spoils captured on several occasions. Probably not over a dozen French and British soldiers, at the outside, were stopped by stepping into these traps, while one is told of at least half that number of instances in which fleeing Germans, who might otherwise have made good their escape, were themselves caught and held in the very jaws they had spread for the enemy. The injury from these traps was usually confined to badly bruised and lacerated flesh, but in those cases where the jaws closed upon the ankle several of the small bones were usually broken or displaced.

Doubtless realizing that the results from the wolf traps were not commensurate with the trouble, the use of them has apparently been given up within the last few weeks, and the ingenuity of the Germans concentrated upon subtler but more deadly contrivances, mostly of the mine or grenade order.

An abomination of creased steel, looking more like one of the famous ceremonial *kava* bowls of the Samoans than anything else I have ever seen, has evidently been manufactured in considerable quantities for no other purpose than to furnish unpleasant surprises to precipitate Tommies. The latter have nicknamed it the "tortoise," and until they learned that, like its slow-moving animal prototype, it was unsafe to take liberties with, several of them paid the penalty of their curiosity by being injured when it blew up as a consequence of their friendly prods of investigation. In that its very strangeness of appearance invites attention,



"It is still the custom to give any picture with a suspicious bulge behind it a few shots before seeking closer acquaintance."

the tortoise is like the famous Trojan horse, and the consequences of investigation are, likewise, disastrous. The least touch to the wobbly thing established a contact, doubtless through fulminate of mercury, on the same principle as employed in the floating mine, which detonated 20 or 30 pounds of explosive with a force that shattered the thick steel shell—creased as it was like the casing of a hand grenade—and scattered the fragments over a wide area. The menace of the tortoise was over as soon as Tommy learned to curb his curiosity. On my visit to a collecting depot I was allowed to "play" with one of them, from which the "teeth" had been drawn, and I must confess that the weird roly-poly thing might well exercise considerable fascination upon one encountering it for the first time. One feels that he simply *has* to go up and give it a shove with the toe of his boot, just to watch it wobble, the very action calculated

to make it "put up back" and "fly to pieces."

The usefulness of the tortoise was over just as soon as the wary Tommy ceased stroking its back with his bayonet and instead began hailing its appearance with hand grenades hurled from a respectful distance, and the wily Teuton was forced to rack his brain to devise still deeper "subtlety." Something of the direction his latest effort has taken was revealed by a Tommy who was exhibiting to me some of the treasures he had gathered in cleaning up a recently occupied German dugout. One of these, carefully preserved between the leaves of a magazine, was the photograph of what was evidently a German girl, punctured with not less than a dozen bullet holes.

"Did you take it from a German soldier?" I asked.

"No, sir," was the reply; "only from the wall of a dugout."

"But how did she come to get so

shot to pieces?" I asked; adding banteringly, "I have never heard that the *British* soldier makes war on women."

"But this 'Un lydy was makin' war on us, sir," he answered with a grin; "or leastways one of 'er friends three or four dugouts down the line tried to *strafe* us, and we had orders to *strafe* back."

Then he went on to explain that the Tommies had always vied with each other in collecting photographs from the walls of the captured dugouts as souvenirs, a circumstance which the Germans, who appeared to have got wind of it in some way, endeavored to take advantage of by running a wire from the back of some of these mural decorations to mines concealed beneath the floor. The Tommies had already

learned to avoid stepping on the loose ends of boards, and to refrain from rocking tortoisés and picking up inconsequential odds and ends from the floor; but the "mined" photograph was something new, and before the ruse was discovered several "cleaning-up" parties were made to pay rather heavily for the desire of certain of their members to add another "'Un frawline" to their picture galleries. Photo collecting languished for some little time after the "designing" nature of some of these abandoned Gretchens and Hildas had been disclosed, and it is still the custom to give any picture with a suspicious bulge behind it—if there is room to do it in safety—a few propitiatory shots before seeking closer acquaintance.

David

DRAINING SOUTHERN SWAMPS FOR FARMING PURPOSES

Reclamation work of noteworthy character is transforming large areas of southern Louisiana swamp land into rich tracts for intensive cultivation. Although the method employed is comparatively simple in plan, its execution involves much arduous labor. By digging a navigable canal around

the four sides of a district to be drained, a levee is thrown up which protects the land from tidewater as well as that which is backed up by strong Gulf winds. At some central point along the dike system, piling is driven to support a concrete foundation for a pumping station. Extending from the site and bisecting the tract, which usually embraces from four to six sections of land, a broad reservoir canal



Dredge at Work Deepening One of the Big Irrigating Canals in Southern Louisiana Where the Reclamation of Swamp Lands is being Carried Out: The Building in the Background Is the Pumping Station for the District

is projected. Along it, at intervals of about a half mile, lateral slips, approximately 25 ft. in width, are excavated at right angles. Radiating from these, in turn, narrow sublateral ditches are dug, 200 or 300 ft. apart. Thus the whole area is reached, and during wet seasons, when from 10 to 12 in. of rain may fall in a month, the water is carried into the central reservoir canal from which it is pumped to some outlet. Although such a thing is rarely necessary, because protracted dry periods are extremely exceptional in southern Louisiana, the fields can be subirrigated by siphoning enough water to fill the sublateral, or field, ditches.

The cost of the reclamation averages about \$40 an acre, while the annual maintenance charge ranges from 75 cents to a dollar. The canals serve a twofold purpose, for in addition to draining the land and rendering it fit for cultivation, they provide the transportation arteries used by the agriculturist in reaching his markets. The harvested products are conveyed to distributing points by barges. Climatic conditions permit the land to be utilized almost the year around, from three to four crops being raised annually.

DOUBLE-WALLED PAPER CUP KEEPS HOT DRINKS WARM

An inexpensive paraffined-paper cup has been invented in which coffee, or other liquids, can be kept warm for a long time and so is especially suited for selling hot beverages on trains or excursion boats. It is provided with a tightly fitting cover. Its heat-retaining property is derived from the fact that it is double-walled, with a dead-air space between the two walls which are kept apart by a layer of corrugated paper.



ROADSTER HAS ONE DOOR FOR BOTH SEATS

An important new feature of a moderate-priced roadster is a single door,

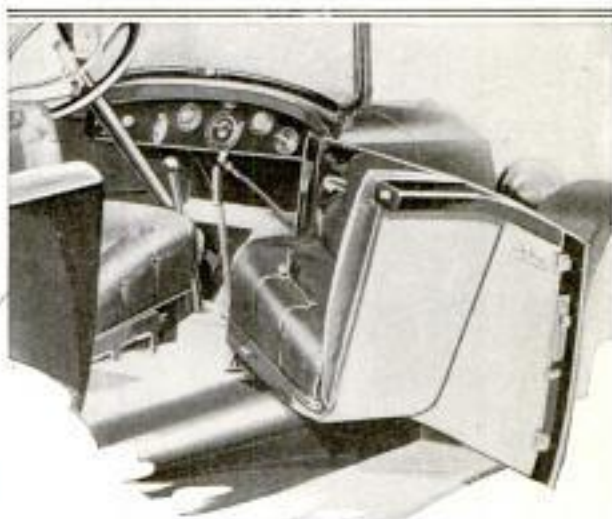

New Type of Roadster Door Which Gives Direct Access to Front and Rear Seats: With the Door Closed the Two Parts of the Front Seat Fit Tightly Together

29 in. wide, which gives direct access to both front and rear seats. This sort of entrance is made possible by attaching a 7-in. section of the front seat to the inner side of the door, the upholstery being so arranged that the two parts of the cushion fit together tightly when the door is closed. When it is open it leaves an entrance to the front seat, 7½ in. wide at its narrowest point. The passage to the rear seat is 10 in. wide. The stationary portion of the front seat is 34 in. wide, and so can hold two comfortably when the door is open. The latch is operated by either of two handles, one of which is accessible from the front and the other from the rear seat. A 17-in. door is provided for the driver.

PRODUCE ZOOLOGICAL FILMS FOR UNIVERSITIES

Natural-color moving pictures of scientific value and much general interest are being made by a young zoölogist who is devoting his attention to the production of films dealing with intimate phases of plant, bird, insect, and microscopic life. Much of his apparatus is of his own development.

In addition to a studio, which consists of a laboratory, dark room, drying



Insects are the Actors in the Outdoor Movie Play being Filmed as Shown Here. The Mirror is Used for Lighting Purposes

room, and workshop, he has a conservatory, the entire roof of which is

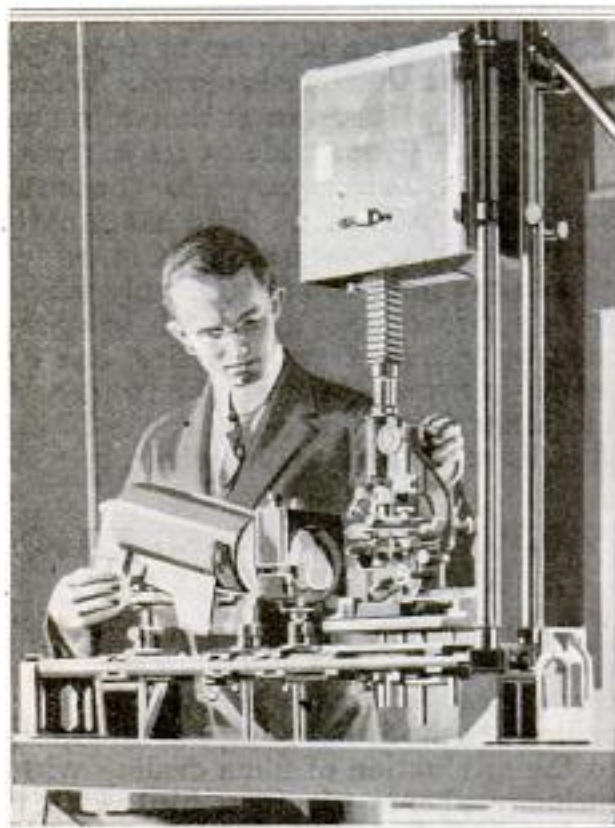

Making Films of Microscopic Life in the Laboratory with Specially Designed Equipment

covered by shutters composed of movable sections so arranged that daylight may be excluded from the glass house. A single control system is employed which, upon being set in action, closes the shutters, turns on high-power lamps, exposes the movie film, extinguishes the lights, and finally opens the daylight shutters. Films made at the plant are chiefly of an educational character and intended for certain universities which use them in connection with class lectures. Nature-study films of purely popular interest are also to be turned out for movie-producing companies.

OUR RED CROSS CAN LEARN 471! MUCH FROM BRITISH

That the American Red Cross can learn as much from the British Red Cross as our army leaders are learning from European fighters, is the opinion of those who have a personal knowledge of the greatly enlarged tasks that now confront our society for the care of the needy and the suffering. England found, for example, that at the outset there was much extravagance and overlapping of effort, partly because of the overenthusiasm of workers. Today, under strict government control, the expenses of the British Red Cross are exactly nine cents in every five dollars.

One of the great services which our society will soon be performing, according to Lord Northcliffe, who is a British Red Cross officer, is the search for the missing and wounded. "In a few months will come across the cables the sad and significant word 'missing,'" he declares in a recent statement. "Anxious parents and relations will instantly start cabling that inquiries be made. The British Red Cross Society has opened a branch whose sole task it is to collect every possible item with regard to missing men. Some of the work is undertaken by priests and clergymen who go around the hospitals and board the hospital ships, asking questions of each of the missing men's comrades. All this information is col-

1 - Insley W. G. ...
Incorporated ...

2 - H. E. Miller
Director of, B. S.

lected and filed systematically. . . .
The society has over and over again
discovered men reported missing."

The eagerness of Americans to
serve in this cause must now be sup-
plemented by an equal measure of
efficiency.

⁴⁶²⁰
**MOTORCYCLE AND SIDECAR
CARRY FAMILY OF FOUR**

A very roomy sidecar of odd design
has been attached to a motorcycle by



Motorcycle and Unusually Roomy Sidecar, with
Which a Husband, Wife, and Two Children
can Enjoy Outing

⁴³⁷⁰
**TIME AND TROUBLE-
SAVING
CONCRETE-CHUTING SYSTEM**

In erecting a warehouse for the
harbor commission at Los Angeles, a
gravity concrete conveyer, arranged to
permit easy and quick shifts, has been
employed. The disadvantages of sup-
porting the spouting system by means
of overhead cables, or by floor tripods,
are overcome by a new plan of suspen-
sion. An open steel boom, hinged to
the face of a hoist tower so that it can
be revolved through an arc of about
180°, holds the first section of the
chute. The trough is of the same length
as the boom, and passes through the
middle part of it. A counterweighted
trussed frame, held by a cable sus-
pended from the outer extremity of the
boom above, carries the second section
of spouting. With this arrangement
pouring can be done rapidly and eco-
nomically over a semicircular area
with a radius of 100 ft. The range
can be extended to about 200 ft., when
necessary, by carrying an additional
100 ft. of chute on floor tripods. In
such cases the height and weight of
the supports are not so great as
to make it difficult to shift
them. The plant is essen-
tially adapted, however,
for work in which the
pouring is to be done
over a limited
area.

its owner so that he can take his wife
and two children with him on outings.
The addition resembles two sidecars
combined, with the two seats facing
each other. The three extra passen-
gers find it very comfortable riding in
this conveyance
and the addi-
tional weight
has not
hampered
the
driver

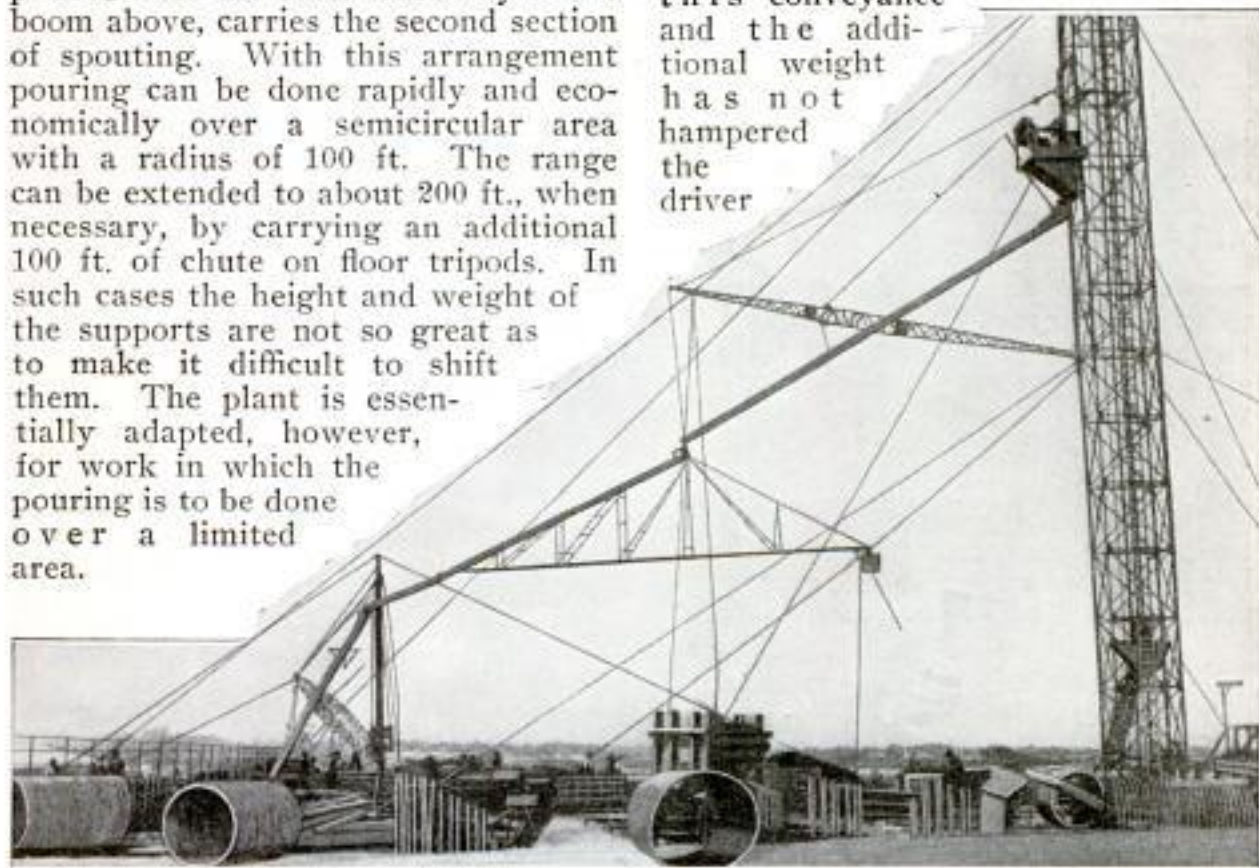

Showing the Easily Shifted Gravity Concrete-Chuting System as Used in Erecting a Warehouse for
the Harbor Commission of Los Angeles



Party, Including Photographers, Scaling Barren and Almost Perpendicular Cliff in Search of Eagles' Nests



Above: Two Eaglets, 60 Days Old, Quite Able to Manifest Their Displeasure toward Intruders



Right: Capturing Mother Bird While Hanging over a Precipice

to advantage. The searcher for the lofty nests also finds that the young, 50 or 60 days old, can become disagreeably aggressive.

FORESTERS ARE RECRUITED FOR SPECIAL REGIMENT

Acting upon a suggestion made by the British war mission during the series of conferences at Washington, the War Department has ordered that a forestry regiment be organized as one unit of the engineer corps that is soon to be sent to France. It will be the duty of this force to convert available timber into suitable material for use in bridge, railroad, and trench construction. Technical experts, in cooperation with French foresters, will superintend all cutting in order to avoid needless waste and to prevent, so far as possible, permanent damage to timber lands. The body will be officered by trained foresters and expert lumbermen, but will be recruited only partly from the government forest service. To accompany the unit to the front a special regimental flag has been designed. It consists of a deep-blue field on which a white pine-tree shield is encircled by 13 stars.

METAL-WINDOW COAL CHUTE PROTECTION TO BUILDING

To prevent the adjacent wall from being needlessly marred and blackened when coal is discharged into the basement of a building, a cast-iron and steel chute window has been introduced. The front of it is fitted with a pane of reinforced glass so that it normally serves as a burglar-proof cellar window. When the device is opened, a metal shield, that protects the wall surface above the aperture, is automatically raised into position. Similarly the top segment of the chute slides forward and covers the glass.

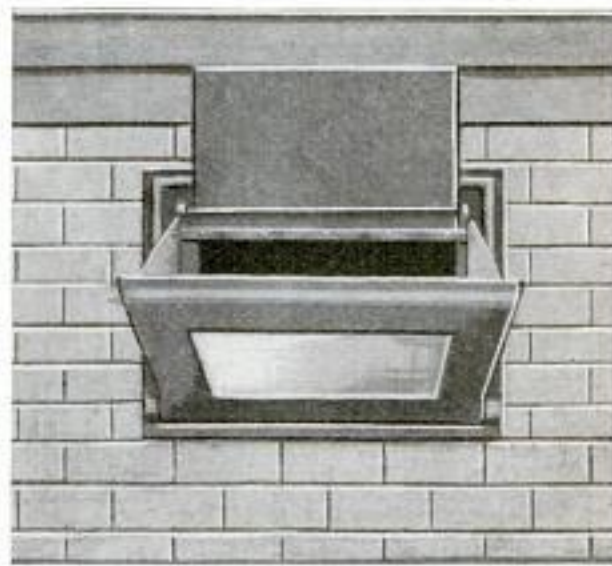

The Feature of This Coal Chute and Burglar-Proof Window Is the Automatically Opening Lid That Protects the Wall above It

4785

EFFECTIVE IDEAS USED IN VARIOUS CITIES



This Model of a Des Moines Home-Building Company's Most Popular Bungalow Adorns the Canopy over the Concern's Office Entrance. Lace Curtains Hang in the Windows, Which are Lighted at Night, and Smoke Issues from the Chimney



New Headgear for a Sandwich Man: Inside This High Hat with Its Transparent Sides is a Woman's Shoe That Effectively Advertises a New York Store

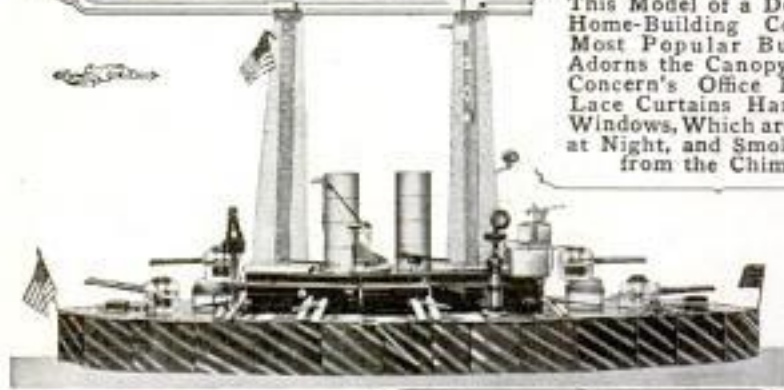

Not a Real Battleship, of Course, but a Clever Combination of Office Supplies in a St. Joseph, Missouri, Window. The Hull is of Metal Book Ends; Guns Are Penholders; Rolls of Adding-Machine Paper Compose the Smokestacks. Wire Forms, Covered with Clips, Make the Masts



This Coat Rack is so Made That When a Garment is Hung on the Hook a Card Bearing an Advertisement is Turned Up in Full View of Passers-By



COPYRIGHTED BY THE DANDYLIN COMPANY

Paper Dolls as Business-Getters: Each Dress Which is Provided with This Paper Doll Accurately Illustrates a Girl's Ready-Made Dress, Which can be Purchased in Various Sizes. The Store Selling the Dresses Carries an Ad on the Back of the Doll

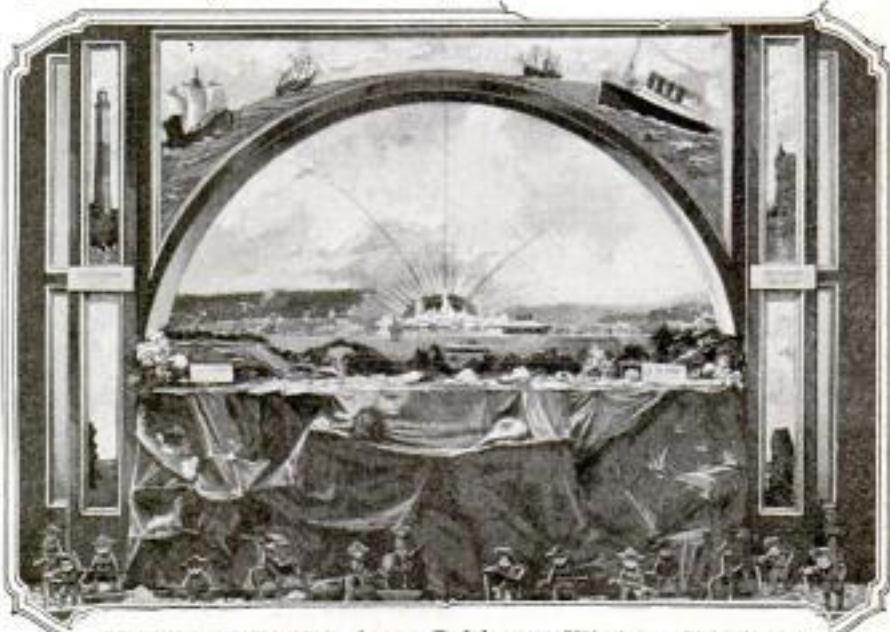

Mechanical Display in a Baltimore Window, Showing a Merchant Submarine's Operations: The Craft Travels between Shores Representing Europe and America, Submerging at Intervals and with Periscope Operating. In the Background is an Iceberg Representing the Northland

IN COMMERCIAL AND PATRIOTIC ADVERTISING

LOOK!
Here's The Man We Need



JOIN NOW
TEXAS NATIONAL GUARD
Room 8
CHAMBER OF COMMERCE
EL PASO, TEXAS
Open 1916
OPEN EVENINGS

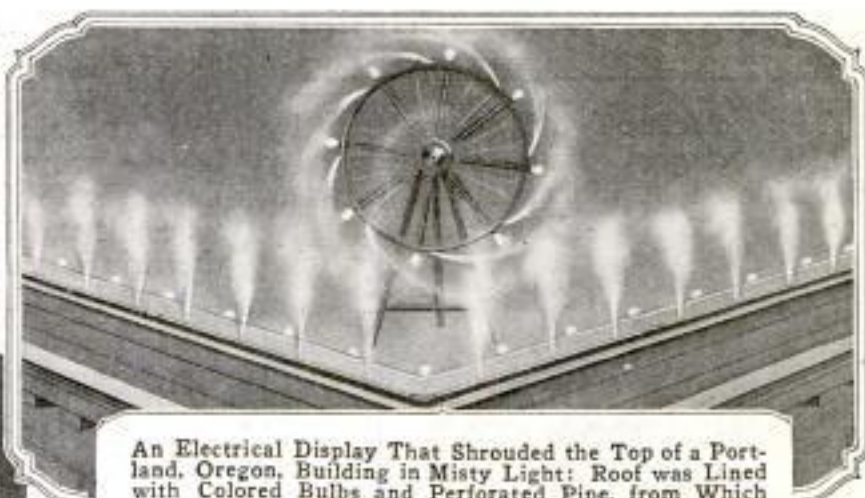

An Electrical Display That Shrouded the Top of a Portland, Oregon, Building in Misty Light: Roof was Lined with Colored Bulbs and Perforated Pipe, from Which Steam Issued. A Wheel Similarly Equipped Revolved Like a Pin Wheel.

A Telling Appeal for Recruits: A Mirror Which Takes the Place of the Face in This El Paso, Texas, Poster, Reflects the Face of Every Passing Reader



Living "Dolls" Attract Much Attention: A New York City Store, Desiring to Advertise Its Stock of Dolls, Dressed Living Models in Costumes That Duplicated the Dolls' Clothes. The Playthings and Their Human Duplicates were Displayed Together



Four Scales Indicate Total Weight of Car: A Des Moines Dealer has Figured Its Cost on a Pound Basis, as Shown in His Clever Placard



Patriotic Billboard Display, Overlooking Grant Park, Chicago, Which is Striking Because of Its Composition, Coloring, and Great Size, the Dimensions Being 50 by 133 Feet: The Figures of the Sailors Are About 30 Feet High. Columbia is Represented as Comforting a Weeping Woman, While a Stricken Child Lies at Her Feet



Bank in Which to Save Dimes for a Camera: Amount Needed for Various Cameras is Indicated on the Side. The Storekeeper Alone Knows the Combination

3-Mfr. Motor Rental Co.
455 S. W. International Bldg

NIAGARA FALLS LIGHTING SYSTEM MADE PERMANENT

The electric-lighting system by which Niagara Falls is beautifully illuminated at night, and which was

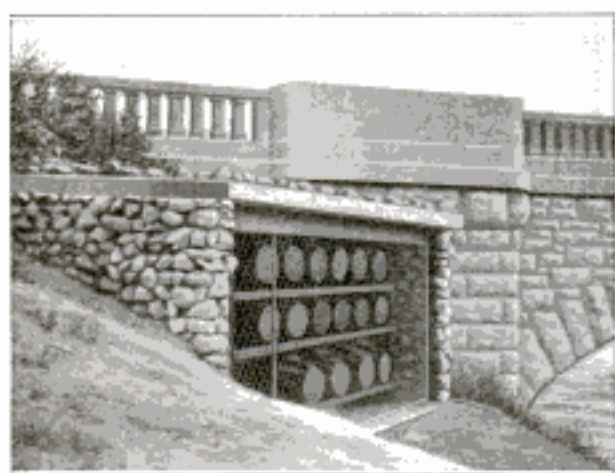

One of the Permanent Shelters Which have been Built to House the Powerful Lights That Illuminate Niagara Falls at Night

described in Popular Mechanics Magazine a year ago, has been made permanent by local municipal authorities. The powerful lamps are now arranged at various advantageous points in cavelike shelters of rough stone and cement, which are partly concealed by shrubbery. Across the front of these housings extends wire netting to keep out intruders.

AUTO CARRIES ODD TROPHY OF DESERT ENCOUNTER

A motorist living in the Southwest carries the skin of a 5 1/2-ft. rattlesnake stretched on one car fender, as a souvenir of an unusual encounter.



While driving slowly along a desert road, the rattlesnake attacked the car and, as the machine was being brought to a stop, the reptile tried to get into

the pan under the engine. Finding this too hot he crawled to the rear, twin-

ing himself about the running gear. With the aid of a long stick the intruder was forced up on top of a battery under the car floor. The floor boards were then removed and the snake was driven out onto the fender where it was killed with a club. Later the skin was stretched on the fender to dry, and has been left there since.

ELECTRIC WARNING SIGNAL DESIGNED FOR MOTOR CARS

For automobiles, an electric warning signal that is virtually automatic in operation has been designed to minimize road accidents. The device, a lamp with a cylindrical reflector, is independent of the conventional tail light, although it is mounted on the same bracket and carries beneath it a license plate. The front is covered with a rectangular piece of glass that bears the word "SLOW" in large red letters, which are not visible except when the incandescent lamp within the housing is ignited. A push button incorporated in the clutch pedal controls the signal circuit. Thus, whenever the foot member is operated, the warning lamp is illuminated and following motorists signaled. Use of the device requires no thought on the motorist's part unless he expects to make a turn without disengaging the clutch. It eliminates, in most cases, the necessity of signaling with the arm, a practice that is often almost useless at night and quite impossible when closed cars are driven. A pilot bulb installed on the cowl always indicates whether or not the signal is responding properly.



Post-office officials ask that wherever there is an option between the use of one or more large-denomination stamps and several small-denomination stamps, on mail, preference should always be given to the former.

Copyrighted material

4659

✓

4659

2

2- O. V. Parkway, Park...

Copyrighted material



Hybrid Conveyance Employed in the Northwest, Consisting of a Long Bobsled Driven by an Automobile Stripped of Its Body and Front Wheels

NOVEL COMBINATION OF BOBSLED AND AUTO

Many persons derived much pleasure and the owner considerable profit from the hybrid conveyance shown in the accompanying photograph, taken in the Northwest. It consists of a low-priced automobile stripped of its chas-

sis and deprived of its front wheels. The forward end rests on the rear end of a long bobsled built for coasting. The rear wheels were provided with chains so that the car and sled made excellent speed in the snow, much to the delight of the closely packed passengers. The sled was guided with a circular steering wheel.

GYMNASIUM BUILDING OF ELLIPTICAL FORM

A gymnasium building recently erected on the campus of the Stevens Institute of Technology, Hoboken, N. J., at a cost of \$125,000, the gift of a resident of New York, is of elliptical shape and be-

lieved to stand alone in this respect. The elliptical ground plan was adopted



A \$125,000 Gymnasium Having an Elliptical Ground Plan

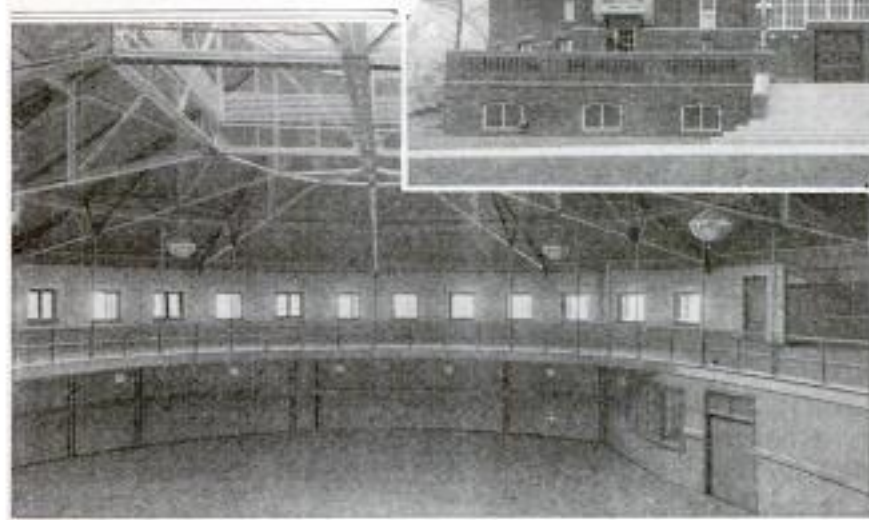

Interior View of Gymnasium Showing Part of Elliptical Running Track, to the Shape of Which the Outside Walls Conform Quite Closely

partly because of the irregular shape of the building lot and also to provide a running track of unusual attractiveness, due to the conformity of the walls with the shape of the track. Some experts

claim that the popularity and use of a track depend upon the psychological effect of its appearance, and this was borne in mind in planning the gymnasium. It is a two-story building of red brick, with limestone and terracotta trim, and a green-shingle tile roof. The first floor contains locker rooms, washrooms, offices, and a large practice room, 110 by 50 ft., 12 ft. high. A swimming pool, 60 ft. long, is provided at the south front of the building. The second floor contains the main gymnasium and oval running track with gallery space.

FIVE GLAZIER'S TOOLS COMBINED IN ONE

In an article possessing four folding parts have been combined several

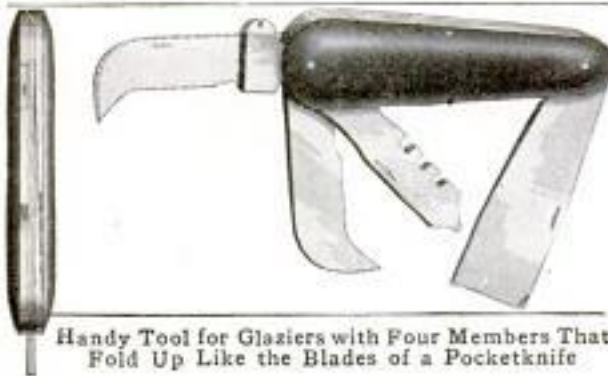

glazier's tools, namely a glass cutter, a putty knife, a putty gouge, a glazier's hammer, and a tack puller. When the members are folded up, the combination tool has the size and appearance of a pocketknife.

FINGER PRINTS ON NAVY'S IDENTIFICATION TAGS

The Navy Department has recently adopted what is believed to be the best system of identification known, being superior to that used in the European armies and navies. Each enlisted officer and man in the navy is to be provided with an oval identification tag of an alloy, known as monel, and measuring $1\frac{1}{4}$ in. wide by $1\frac{1}{2}$ in. long. It is hung about the neck on a wire incased in a cotton sleeve. On one side of the tag will be etched the

finger print of the right index finger and on the other side the owner's initials and surname, the date of his birth and of his enlistment, and the letters "U. S. N." The rank of officers will also be stated. A copy of these data, including the finger print made on paper, will be filed in the navy's identification bureau. The finger print is first made on the tag in ink, and the other data are written on the metal. The tag is then sprinkled with powdered asphaltum which is melted into the ink over an alcohol flame. Next, the tag is placed in a nitric-acid bath which etches the print and data on the metal. Monel is the alloy of which battleship propellers are made. It will resist a high temperature, will not corrode, and is not affected by salt water.

UKULELE-BANJO NEW CRAZE WITH STREET-SONG LOVERS

In one particular district where the ukulele gained remarkable popularity a year or two ago, a new instrument that is an adaptation of the Hawaiian device and the banjo is receiving considerable favor among the devotees of sentimental and ragtime music. Its tone is soft and nonmetallic and has even been compared by enthusiasts with that of the cello. It is of about the size of a ukulele, is played in the same way, and, because of its tambourinelike body, has somewhat the appearance of the banjo.



The New Soft-Toned Musical Instrument, the Ukulele-Banjo, is Shown Here in Front and Back Views

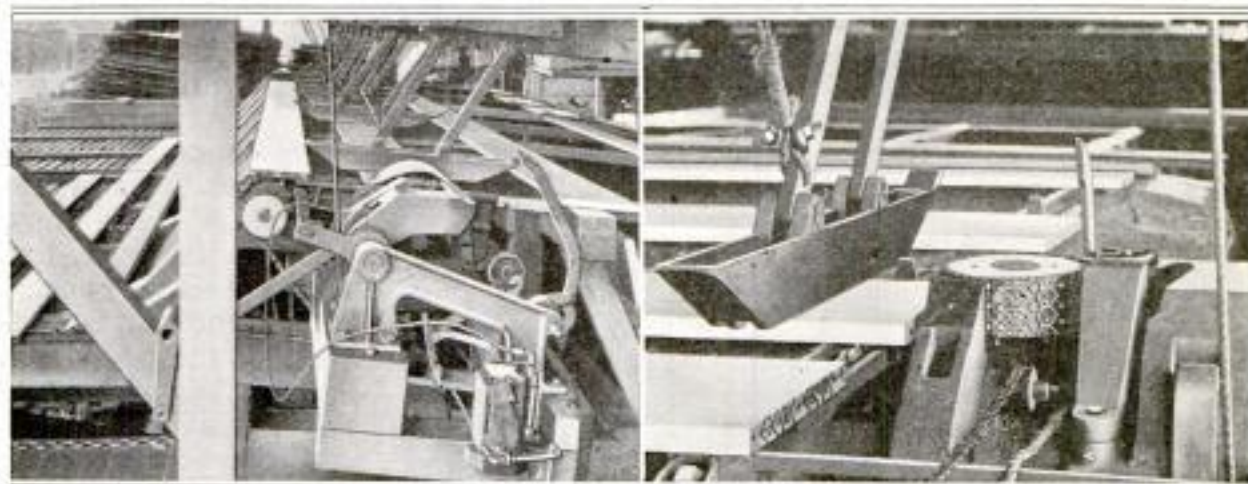

Conveyors Carrying Planks Past the Brander: It will be Noted That the Ends of the Planks to the Left of the Device are Branded and Those to the Right are Not. Right, Close View of Branding Drum Showing the Embossed Marks in Detail: The Shoe Helps Hold the Piece of Lumber Steady While the Drum Presses Against It

MACHINE IMPRINTS BRAND ON ENDS OF TIMBERS

For the same reason that the manufacturers of shoes, canned goods, thread, and thousands of other articles, have found it profitable to mark their products in some distinctive way, so producers of cypress lumber are branding each piece they turn out. A common symbol is used to indicate that the wood is cypress, and other marks designate the mill from which it comes. Each piece of lumber, before being sent to the yard to be piled, is carried by endless conveyors past a revolving metal drum, the entire face of which is embossed with the proper brands. One end of each plank, board, etc., passes this drum and receives the imprint one or more times. A shoe beneath which it is drawn helps to hold the lumber in place while the impression is being made. From the brander the lumber is carried down an incline to the stacking yard.

For the purpose of readjusting its facilities to meet the war emergency, the Pennsylvania Railroad Company has discontinued a total of 102 passenger trains, thus cutting down the passenger movement by an equivalent of 6,500 train-miles every week day. In addition, many parlor cars, restaurant cars, sleepers, etc., have been taken off.

PHONOGRAPH RECORDS PEAL OF LIBERTY BELL

The completion of the nation-wide campaign for funds for the Liberty Loan was most fittingly observed by the ringing of the historic Liberty Bell that hangs in Independence Hall, Philadelphia. In order that its tones be preserved for the future and repeated for the benefit of many now living who have never heard the bell, a phonographic record was made of the sounds. For this purpose an instrument was set up close by the bell. When all was in readiness the mayor of Philadelphia stepped up to the casting and solemnly struck it 13 times. The completion of the last stroke was the signal for whistles and church bells all over the city to join in announcing that the new campaign in the cause of liberty had been won.



LIBERTY BELL AND THE PHONOGRAPHIC INSTRUMENT WHICH MADE A RECORD OF ITS TONES WHEN IT WAS STRUCK TO MARK THE COMPLETION OF THE LIBERTY-LOAN CAMPAIGN

BRICKS, STOVEPIPES, RUGS, HELP MAKE INDOOR LINKS

With the aid of stovepipe, bricks, a barrel, rugs, etc., an 18-hole golf course was laid out in the rooms of the Tele-

phone Club of New York for the benefit of 91 employes of the telephone company who were deprived of the enjoyment of their favorite outdoor sport during the winter months. One half of this most ingenious course was



View in the Club's Gymnasium Showing Several Holes, Including the Fourteenth, at the Right, Partly Surrounded by Bricks, and the Eighteenth, Which Is the Barrel near the Farther Wall

located in the gymnasium and the other half in the assembly room and adjoining quarters. Most of the holes consisted of disklike metal castings with a pocket in the center of each. These disks were placed on rugs scattered about the floor or laid over platforms or tables. In teeing off, in playing the first hole, the player was required to drive through a stovepipe elbow. Two holes were partly surrounded with bricks, and one rug was placed on an incline. Two-by-fours, concealed be-

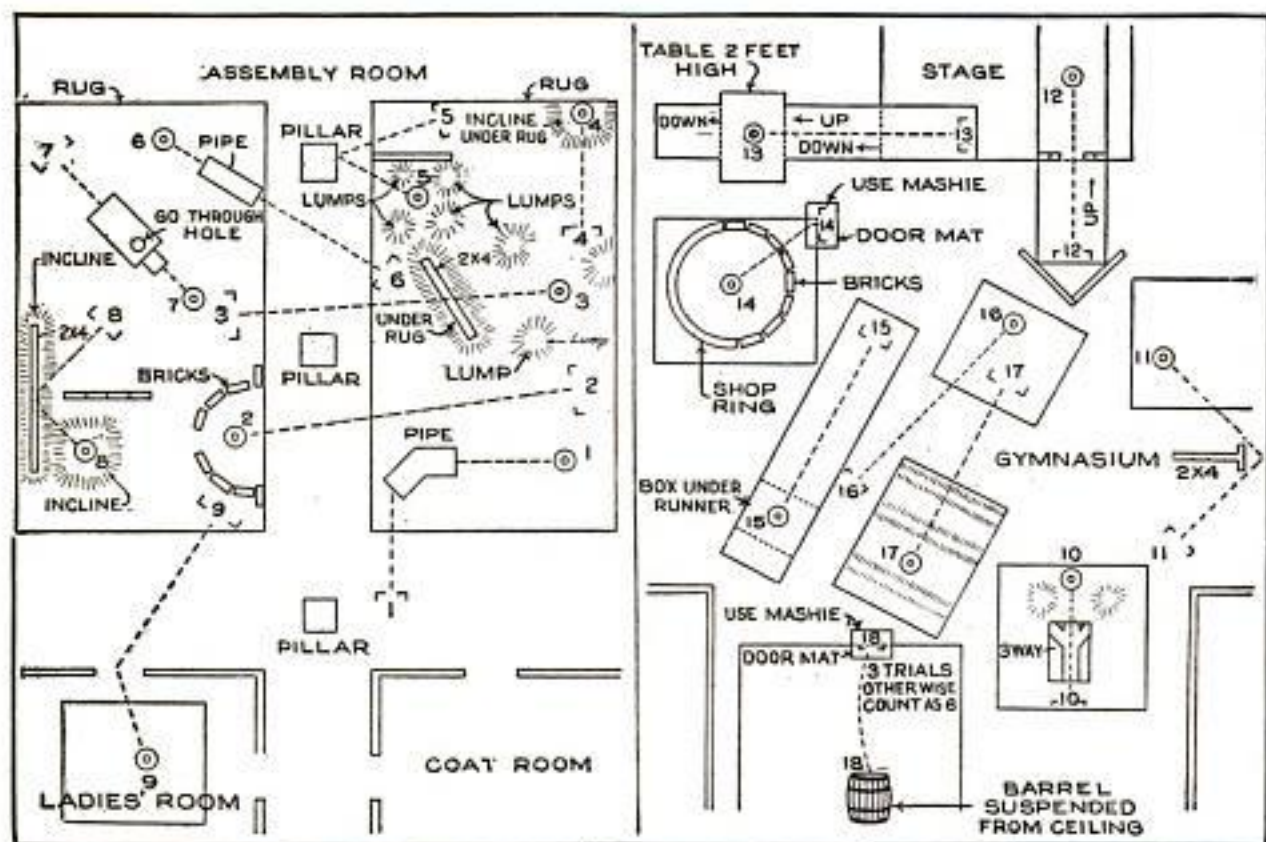

Diagram Showing 18-Hole Golf Course Laid Out in Rooms of a New York Club: A Barrel, Timbers, Tables, Bricks, and the Like, are All Utilized with Amusing Ingenuity

neath the rugs, created hazards. The eighteenth hole was a barrel tilted to one side.

MANY FIRES IN FORESTS CAUSED BY LIGHTNING

An interesting study of forest fires occurring during an eight-year period in the 18 national forests of California, reveals the fact that lightning is the principal cause of these conflagrations, 31 per cent, or over 2,400 fires, being attributable to it. These forests cover nearly 20,000,000 acres, and it has been estimated that the average number of trees struck by lightning is 15,000 per year. If such is the case, only about two per cent of these trees take fire. Extensive observation shows that trees of one species are as apt to be struck as those of another, but a tree's height with relation to surrounding ones, and the degree of its isolation, are important factors in attracting an electrical discharge. It is a well-known fact that lightning is particularly apt to strike in certain regions, the cause being either the condition of the soil or some underlying mineral deposit. While all species of trees seem to be equally liable to be struck, it has been found that certain kinds take fire much more easily than others. It is pointed out that the only way in which the fire hazard due to lightning can be lessened is to provide additional systematic means of discovering and extinguishing the conflagrations as soon as they are started.

Auto

SHIELDED STOVE IN DOOR OF CAMPING CAR

A new convenience for campers is a two-burner gasoline stove mounted in an opening in the rear door of a canvas-covered camping car. The stove swings on pivots situated above and below it, enabling the campers to turn the burners around so that they face the interior or the outside. In either case the sheet-iron protection, which forms the back of the stove and is the

same size as the opening, serves as a windshield. When the stove faces in-

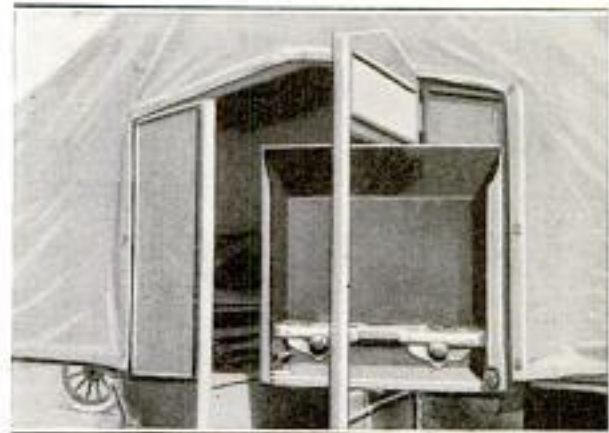

Convenient Cooking Stove Mounted in the Door of a Camping Car: It can be Made to Face Either Inward or Outward. In the Former Position It Completely Closes the Opening

ward the opening is entirely closed, so that the car can be heated.

TRUCK AND DRIVER FALL THROUGH HIGH BRIDGE

While a truck, laden with seven tons of crushed stone, was crossing a high bridge in a middle-western city the structure gave way, letting the big vehicle drop down 30 ft. By a rare chance the dislodged bridge flooring caught between part of the supporting framework and the pier in such a way as to prevent the truck from falling into the water. What was more remarkable, the driver, who clung to the steering wheel during the fall, was not seriously injured and the truck not badly damaged.



Bridge After It Gave Way under Heavily Laden Truck: The View Shows the Strange Manner in Which the Timbers and Pier Caught the Vehicle and Prevented It from Falling into the Water

SICK ELEPHANT INHALES VINEGAR FUMES

A remedy for colds, quite suggestive of the old-fashioned home methods of treatment, is



used by the trainer of a certain motion-picture zoo to cure the colds of the elephants in his charge. He places a bucket of boiling-hot vinegar in a bag and then ties the latter snugly about the indisposed animal's trunk so that he is compelled to inhale the beneficial fumes whether he wishes to or not.

ONE STAGE AND ORCHESTRA SERVE TWO THEATERS

By an unusual arrangement of two theaters, facing intersecting streets and set at right angles to each other, one stage and one orchestra serve two audiences. The screen for the first theater is situated at what is the back of the stage for those in that auditorium, while the orchestra and organ are located in front of the screen, outside the

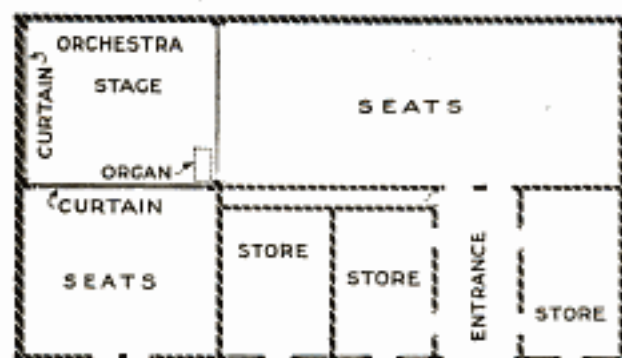

Two Theaters That Use Same Stage: Upper Half of Above Plan Shows One Theater with Curtain at the Extreme Left. In Lower Left-Hand Corner Is the Smaller Theater with Curtain at Side of Same Stage

projecting machine's field. Pictures for the spectators in the second theater are thrown on a screen which hangs at

right angles to the other one, hiding the orchestra and organ from the view of the second audience. However, the music can be heard distinctly through the curtain, and occasionally one audience can hear the applause of the other, but that is not frequent enough to be annoying.

MARKERS PLACED AT STATE LINES ALONG HIGHWAY

For the benefit of overland motorists, slightly, legible signs are being erected along the Lincoln Highway to mark the various state-boundary lines that are traversed. The devices are 22 by 34 in. in size and mounted 7½ ft. above the road on stanch posts. The lettering appears in white on a black groundwork and indicates the names of the abutting states, as well as the general directions of New York and San Francisco.



USE GAS IN STEAM ENGINE IN PLACE OF STEAM

While a company was sinking a well for oil in a rich oil field not long ago the drill struck a flow of natural gas having very high pressure. Since it was oil and not gas that the company sought, the driller determined to utilize the gas as a substitute for steam in the steam engine that furnished power for the drilling rig. After making the proper connections the gas was turned into the boiler, but the pressure was so high that it broke the gauge glass and blew out the safety valve. After replacing these broken parts with steel pipes the gas was again turned on, and it was found that the engine operated very satisfactorily with this novel substitute for steam.

Army

461 **SCHOOL BUILDS HOSPITAL FOR MILITARY USE**

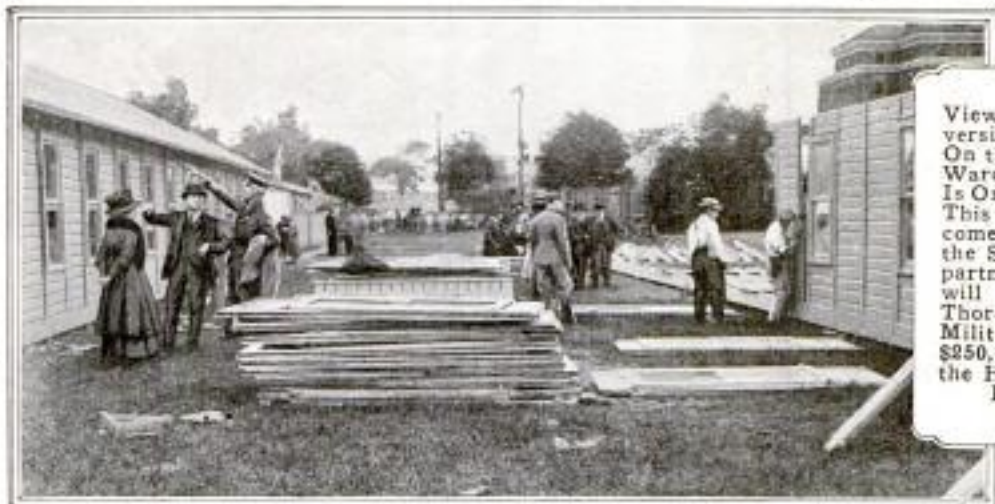

View of Columbia University's War Hospital: On the Left Is a Finished Ward and on the Right Is One Partly Completed. This Institution will Become an Integral Part of the School's Medical Department Where Students will be Able to Take Thorough Training in Military Surgery. About \$250,000 Is the Cost of the Hospital, Which Will Have 500 Beds

One of the Completed Wards, Each of Which will Contain 25 Beds: The Plant will be Run as a Base Hospital, and When Occasion Arises the Entire Institution can be Employed in Caring for Our Sick and Wounded Fighters. It is so Situated That Other Units can be Added as Needed



A Corner in One of the Wards—an American Scene Which Helps Make the Near Approach of Actual Conflict Very Real to Persons in the East: Among Those Invited to Inspect the Hospital Was a Representative of the British Medical Corps Who Well Understands War Needs from a Medical Point of View

Equipped to Prepare the Best of Foods for Wounded Soldiers: This View of the Hospital Kitchen Shows a Dish-Washing and Sterilizing Machine at the Left, While Beyond Ranges with Ventilating Flues can be Seen. Every Effort has been Made to Construct and Equip This Part of the Hospital in the Most Scientific Manner



SELF-CLEANING SPARK PLUG ESCAPES CARBON NUISANCE

One of the advantages claimed for a spark plug of new design is that



it acts as an energizer or intensifier, and ignites exceedingly thin mixtures. The lower extremity of the device is a slotted cage, inclosing a small ball that is continually in motion when the engine is running. The effect of this is to keep the surfaces free from carbon deposit and produce double sparking. The spark leaps from the central electrode to the ball, and from it—since it is constantly jumping about—to the cage wall or grating.

4131

IRRIGATION DITCH USED AS A BICYCLE PATH

An empty irrigation ditch near South Pasadena, Calif., serves as a



2

short cut for several boys who ride their bicycles to and from school. This unusual route saves some of them as much as 15 minutes a trip, and if it were not followed, it would be necessary to traverse a road which is not only circuitous but also hilly. The ditch is several feet deep, is walled in with concrete, and has a floor of cobblestones which are so covered with deposit that they make a satisfactory roadway for bicycles. Water flows through this artificial course only about two months in the year.

3267

ADVOCATE SHIPPING BOXES OF STANDARD SIZES

The manufacturers of women's hats have recently indorsed the proposal to effect an economy by standardizing the sizes of packing boxes. They have found that a great deal of unnecessary expense is entailed because of the many irregular sizes used. It is estimated that the packing cost of trimmed-hat manufacturers is two per cent, and that this item could be cut one-fourth by making the shipping receptacles of standard dimensions.

CASTERS CAN BE ADJUSTED TO AN UNEVEN FLOOR

By using patented adjustable casters, a table, desk, or other article of furniture, can be made to stand securely

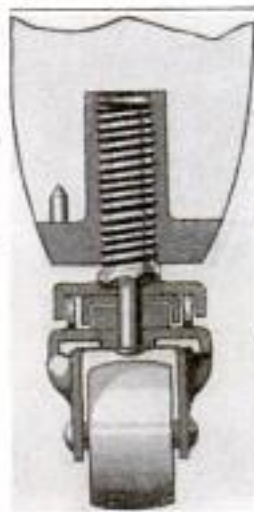

3222

though its legs are of slightly different lengths or though the floor is uneven. The barrel of this caster, which is inserted in the end of the leg, is threaded on the inside to receive a threaded sleeve. The stem of the roller is inserted into this sleeve and turns about freely in it. By screwing the sleeve in or out the caster can be lengthened or shortened as the conditions may demand. Roller bearings are provided which promote easy operation of the article.

CAPACITY OF CAN-FILLING MACHINE IS GREAT

4138

In a large factory that produces enormous quantities of soups, baked beans, and similar prepared foods, a battery of highly efficient can-filling and capping machines is operated. An endless stream of cans is fed to a cylindrical filling apparatus at one end of a connected pair of worktables.

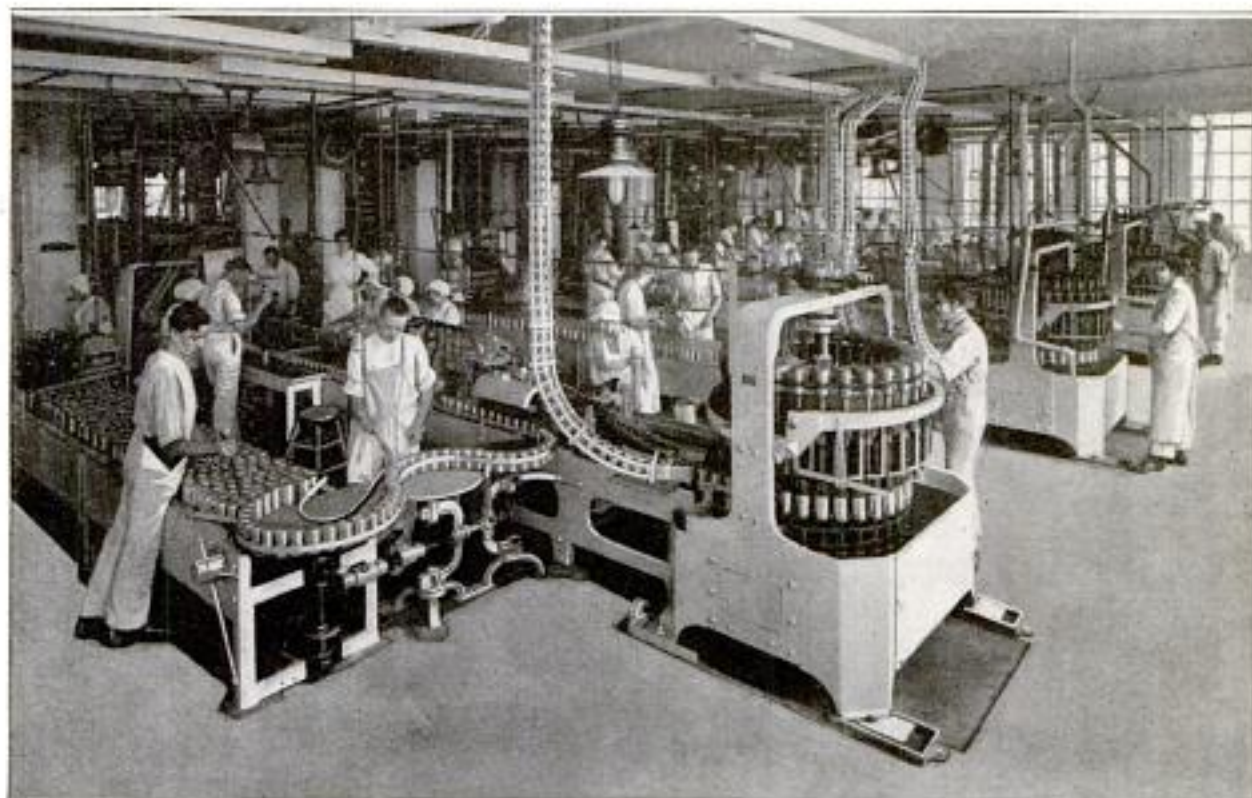

Each of the Machines in This Battery Fills 9,600 Cans an Hour When Operating without Interruption

From there the receptacles are carried by a conveyor belt around the edges of the benches to various workers who do the actual sealing and soldering. The striking point is not the system, but the capacity of the machines. Each of them fills and delivers to the workers 160 cans a minute, which means that in 10 hours of continuous operation it handles 96,000 cans.

SEVEN-PASSENGER DONKEY MAKES OVERLAND TRIP

One lone, well-fed mule is slowly pushing, carrying, and pulling a family of seven persons across the continent. Not long ago it reached Cincinnati on its way from New York to San Diego. Each day it trudges along a few more miles, and each night it grazes by the



Getting Away with a Steam Locomotive's Job: A Lone Mule That is Transporting a Family of Seven Persons across the United States

roadside while the travelers sleep near by in a tent. When on the road, a U-shaped piece of pipe connects the collar about the mule's neck with the back of a tricycle. This is ridden by the crippled head of the transient family. He steers the procession. On its back the mule has a saddle that accommodates a small youngster. At the rear is a large covered cart that carries the rest of the members, one or two of whom take turns walking in order to lighten the load. The family is bound for its home, not making the trip on a bet. It pays its expenses by selling postal cards en route.

ELEVATOR MILEAGE BASIS FOR POWER CHARGE

Electric elevators in Los Angeles buildings are being operated on a mileage basis. Power companies receive a specified amount for each mile that a car travels during a month, in place of being paid a flat rate for the current consumed. Because of this, a special meter is used which registers miles instead of kilowatt-hours.



Local power-rate regulations are understood to have influenced the adoption of this system.

ROAD BUILT ACROSS MARSH BY DREDGING CANAL

Before long a motor highway will be completed which will provide New Orleans a direct route to towns in western Mississippi. The project is one of the most interesting engineering feats of its kind that has been undertaken in southern Louisiana. Much of the district traversed is a salt marsh, which at high tide is practically covered with water. Because of this and other local

conditions that have had to be surmounted, the finished road will stand as a memorial to the enterprise and persistence of its builders. The particularly important section of the artery extends between Chef Menteur and the Rigolets, both of which are channels that connect lakes Pontchartrain and Borgne. To establish a road across the marsh, a 30-ft. canal has been excavated for a distance of about 10 miles, and the material thus obtained used in constructing an embankment along one side of it. This will give the highway, which will have an eight or ten-foot elevation, a 100-ft. base. The crown will be approximately 30 feet wide. The road will connect with an 18-mile artery that reaches from New Orleans to Chef Menteur. This is being surfaced and put in good condition. Steps are also being taken to project at once the road from the Rigolets to Slidell, La., whence it will continue into Mississippi. This third section will necessitate the erection of about seven and a half miles of embankment similar to that just described. For the present the expense of building bridges across the two canals will be avoided by establishing ferry service.

NEW BENCH VISE CAPABLE OF MANY ADJUSTMENTS

The feature of a new adjustable vise is the stem that it is mounted on by means of which the tool can be raised or lowered, turned with the vise handle toward or away from the bench, and tilted to the right or left. A single turn of a lever locks the tool in the desired position. The advantage of this vise is



that it enables the laborer to work in the most comfortable posture and to have his material in the best possible light.

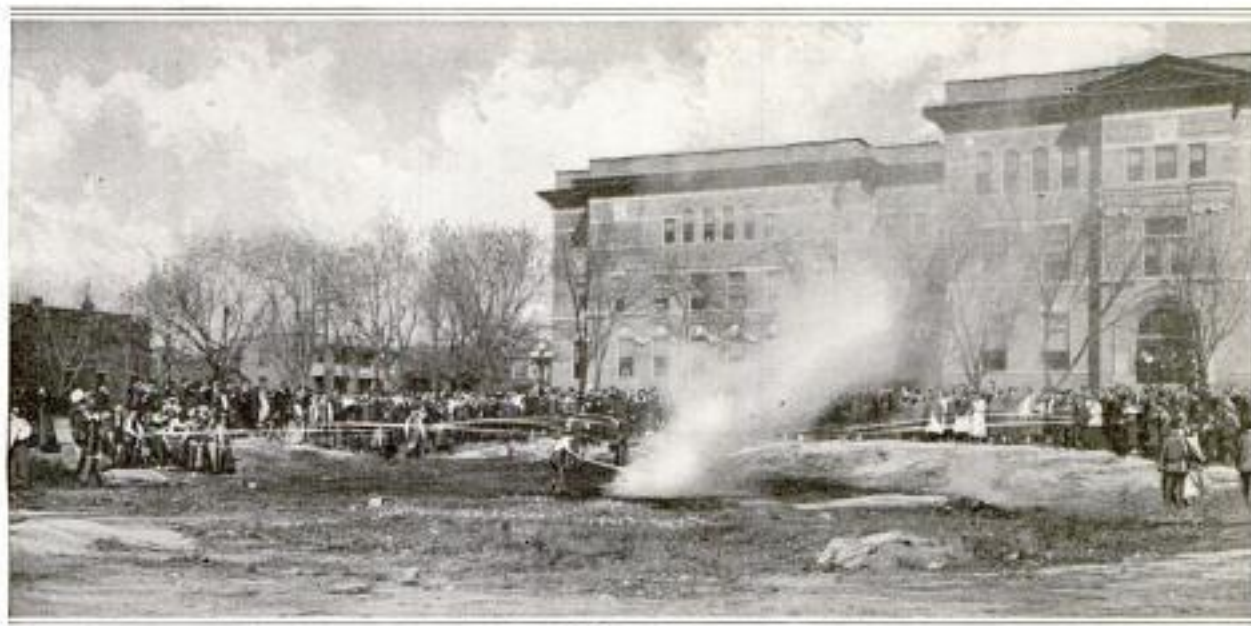

High-School Pupils at Pueblo, Colorado, Using Chemical Fire Extinguishers to Quench Bonfire: This is Done Once Every Year to Ascertain That This Part of the School's Fire-Protection Equipment Is Dependable

EACH YEAR PUPILS EMPTY FIRE EXTINGUISHERS

It is not enough that fire extinguishers hang on the walls of the Centennial High School, Pueblo, Colo. The authorities are determined that they shall at all times contain chemicals that are absolutely dependable, and so the tanks are emptied once a year and refilled with new materials. The emptying and replenishing is done by the students, under proper supervision, and is the occasion of quite a demonstration, as shown here. A huge bonfire is built, and while hundreds are gathered about, the year-old chemicals are turned on the blaze.

BIG RAIL-FORMING PRESS HAS HIGH EFFICIENCY

For forming channel-section rails of great accuracy and absolute uniformity, such as are used for motor-car frames, a powerful press that operates on the toggle principle and prevents warping and buckling, has been developed. The machine is driven by a 125-hp. motor, exerts a pressure of

about 2,000 tons, and is able to handle blanks of steel 17 ft. long and $\frac{3}{8}$ in. thick. It measures 15 ft. from front to back, is nearly 21 ft. long, 31 ft. high, and weighs 325 tons. The press makes about seven strokes a minute and at

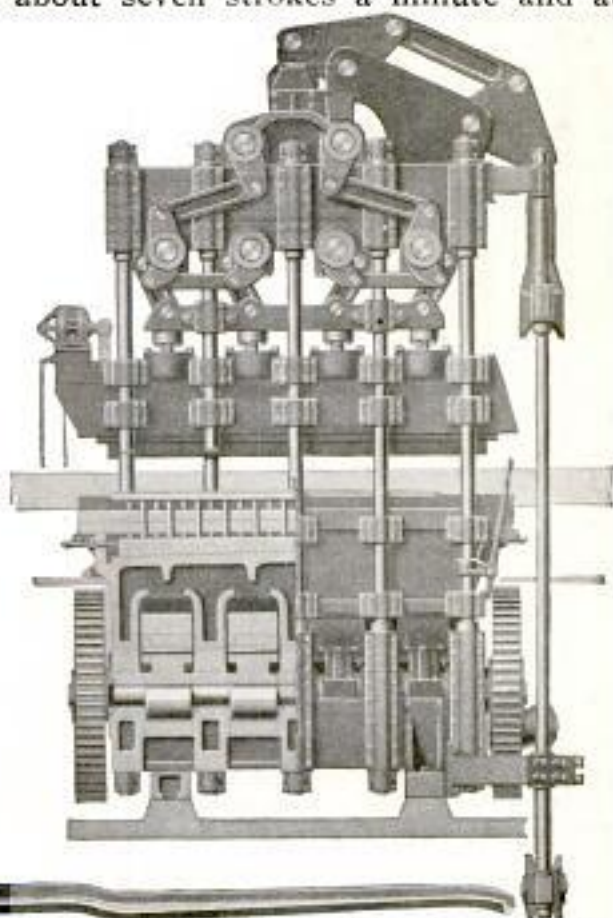

Huge Press That Operates on Toggle Principle and Forms Channel-Section Rails, Such as is Shown at the Bottom, without Buckling the Webs or Twisting the Sides

each of these two complete opposing rails are formed. In the process of production the apparatus employs two motions. One slide moves down and clamps the blank of metal, holding it perfectly flat as the succeeding movement of the machine forms the sides of the channel, or frame. Following this the finished member rests free from obstruction on top of the die ready to

be removed. Neither do the webs buckle nor the sides become twisted when parts are formed in this manner. Therefore it is claimed that the machine eliminates 90 per cent of the labor usually involved in such work, overcoming as it does the need of employing expensive manual methods of straightening the parts after they leave the press.

OLD UNICYCLE RIDDEN IN RECENT PARADE

An entry which attracted special notice in a parade held recently was a



Unicycle Built 35 Years Ago and, after a Generation of Disuse, Ridden in a Recent Parade: The Rider Paddles with His Feet and can Make Good Time on a Level Road

unicycle built over 35 years ago. After having been stored away for a generation, the strange device, said to be the first of its kind ever built, was brought out and ridden through the streets once more. It consists of a huge metal hoop with a saddle mounted on an axle which is suspended at the center by four sets of wires. The rider sits on this saddle and with his hands grasps the ends of two movable lateral braces that can be rested on the ground to

support the cycle when it is not in motion. This wheel bears some resemblance to a unicycle described in Popular Mechanics Magazine for April 1914, but the latter vehicle was driven by an air propeller, whereas this one is driven by paddling with the feet.

LION CUB AND PUPPY LIVE HAPPILY IN SAME CAGE

A lion cub and a Scotch-terrier puppy, both of which belong to a private zoo, live in the same cage and are fast friends. In quite a literal sense theirs is a life-long friendship for they were born only a day apart, early last April, and as soon as the cub opened his eyes, at the age of a week and a half, the two were put in the same inclosure. Each seems to imagine the other is his brother. The two drink from the same pan and the puppy goes so far as to allow his face to be licked by the cub, without manifesting anything but satisfaction. The owners have long wanted to try the experiment of raising a dog and lion together and are watching these two with much interest.



View in Zoo Cage Showing Scotch-Terrier Puppy and Cub Which have Lived Happily Together Since the Day the Cub Opened His Eyes: There Is Only a Day's Difference in Their Ages

HARDY COOLIES SUPPLY WHOLE CITY WITH WATER

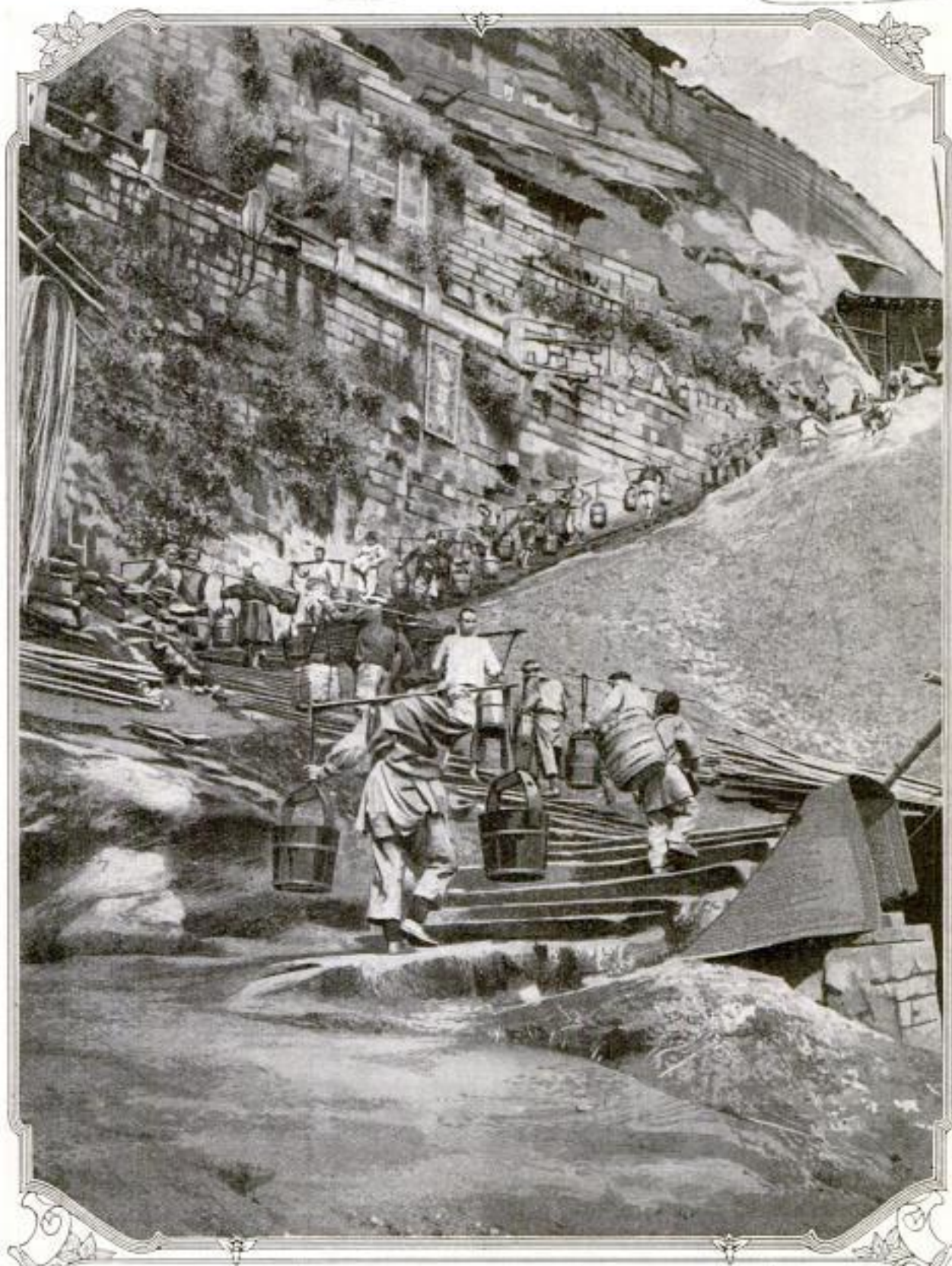

THE remarkable hardihood of Chinese coolies and the primitive conditions that obtain in many inland cities of China, are both illustrated in this picturesque photograph, taken at Chungking. Though having a population of between 600,000 and 700,000, this great commercial center has no modern sewage or water system. The city is situated on a high bluff, and all its water is brought from the near-by Yangtse River by thousands of water coolies, some of whom are here shown at their task. After toiling up the flight of 350 steps that ascends from the river level, the hardy men who offer the water for sale obtain about half a cent a bucket for it.

REPEATING ATTACHMENT FOR PHONOGRAPHS

By means of a phonograph attachment which is serviceable for many occasions, particularly when phono-

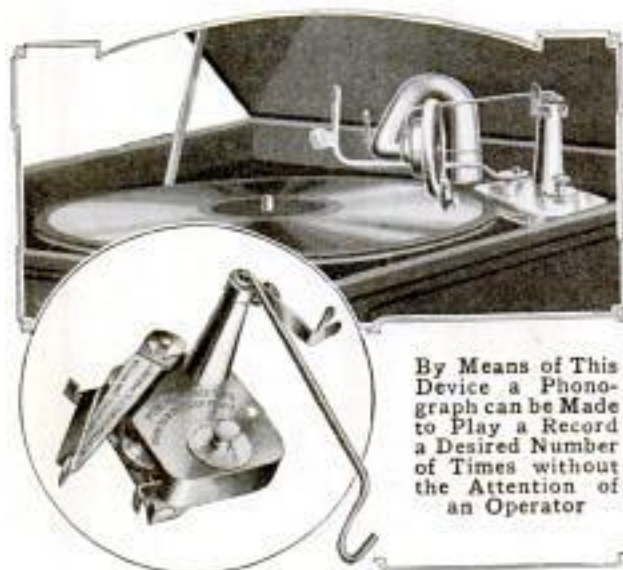

By Means of This Device a Phonograph can be Made to Play a Record a Desired Number of Times without the Attention of an Operator

graph music is used for dancing, any record can be repeated automatically one to five times, or played continuously. The mechanism is nickelplated, having a base about three inches square, which is placed so that a friction wheel projecting from its side makes a contact with the turntable. Extending from an upright column is a hooked swinging arm on which the tone arm rests. A second adjustable member serves as a stop. After setting the latter and also an indicator, the phonograph will play a record the desired number of times without further attention.

DEPTH OF WATER AFFECTS VESSEL'S SPEED

It has been found that to a certain extent the depth of water in which a vessel is running affects its speed. Not only is this true in very shallow water where the "drag" is obvious, but in the case of a 12,000-ton ship, for example, with a draft of 27 ft., the speed is somewhat lessened when the craft enters water 250 ft. deep. Speaking generally, the depth between a vessel's keel and the bottom should be $10\frac{1}{2}$

times the draft in order to avoid all retarding effects. Another factor to be taken into consideration is whether the vessel is moving swiftly or slowly. A boat traveling at high speed requires more depth of water to prevent additional friction caused by the nearness of the ocean bed. Running at 10 or 12 miles an hour, a ship must have between 26 and 27 ft. of depth to escape this retarding tendency. Running at 22 miles an hour, it needs a depth of 104 ft. and in some cases much more.

ODD PLOT OF SUBDIVISION SHOWN ON STREET SIGNS

Large street signs, each of which is in reality a map of the vicinity, are to be found at the entrances to a high-class residence section which has recently been opened near Portland, Ore. The tract is rectangular and is divided by two streets that bisect each other at right angles. Extending diagonally through each of the four quarters so formed are three parallel streets which open onto the principal streets already mentioned. At the central intersection and at four near-by intersections are small parks. While this plan makes

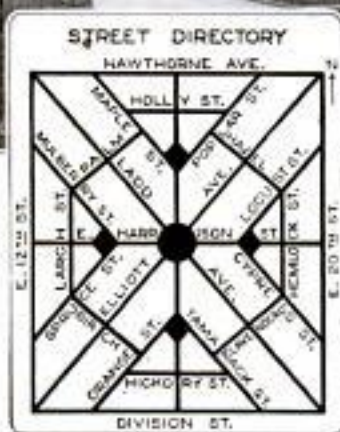

Above is a View of a New Subdivision Showing One of the Street Signs: The Latter Includes a Map of the Oddly Plotted Section, Which is Shown in Detail at the Left

certain central points very accessible to all, it would be most confusing to strangers but for the unusual street signs.



ILLUMINATE DAM TO PROTECT IT FROM ENEMY

WHILE searchlights have been installed at either end of the big power dam at Holyoke, Mass., on the Connecticut River, primarily to protect it from enemy sympathizers who might seek to damage it, and so cripple the near-by mills, this precaution has resulted in producing a beautiful night scene. The manner in which the powerful lights play on the smooth sheet of water and the swirling rapids is well shown in the accompanying night photograph of the dam, with the Hampshire Paper Company's mill on the right. Guards are maintained near the dam at all times.

RELIEF MAPS A BIG AID TO LUMBER FIRMS

Modern lumbering operations are being conducted on so vast a scale that many concerns are finding topographic and relief maps, such as are prepared by logging engineers, essential to the most economical cutting and handling of their timber. These maps give a vivid mental picture of the region to be worked. They show in detail such essentials as the elevations, the slopes, the water courses and the condition of the timber.

Many firms now feel that they are to be preferred to personal visits to the region under consideration because the maps place all the data in the hands of several men instead of one or two. With them a group can lay out the best possible route for the logging rail-

road, which is the central factor in the profitable handling of timber in large areas. Such costly errors as establish-



Relief Map of a Logging Region Which Enables the Owners of This Timbered Region to Plan the Best Railway Route and Other Features of Development

ing railroad grades that are too steep can be avoided, and accurate estimates as to the weight of engines needed can be made. In short, relief and topographic maps enable a lumber firm to lay out at the start a comprehensive plan for developing a tract.

Railroad

LOADING AND UNLOADING CAR WHEELS BY MAN POWER

By J. E. MURPHY

AFTER a railroad car wheel has been in service for a considerable time the tread, or part that bears on the rail, becomes uneven with wear and the wheel must then be sent to a wheel lathe, where the tread is planed down to an even surface. The actual work of replaning the wheels is usually a smaller job than that of getting them to and from the lathe, as each pair of wheels, mounted on their axle, weighs in the neighborhood of two tons. In an industrial district of Chicago, that is busy day and night with the hum of labor-saving equipment, is a wheel-lathe plant where the work of unloading and loading the car wheels is done by "man-power" methods that are as old as railroading itself.

With the carload of wheels set on the track alongside the wheel yard, a skid having a rail for each wheel is placed against the end of the car so that it forms a steep incline down to the track. Each pair of wheels is then worked with steel bars to the end of the car and over the top of the incline. By the time they reach the track the wheels are traveling at high speed, and it takes skill and strength to stop them. This is done by the same method that a cowboy uses in catching a steer or pony—by lassoing. Two men, one on each side of the track, stand ready with wire loops, and as the wheels dash past them each throws his loop over the end of the axle and then runs and pulls

back until the wheels are stopped, this being accomplished usually within a hundred feet. Occasionally only one of the loops holds. In that case the wheels are derailed, with the possibility of broken legs and other injuries for anyone that happens to be in the way. The work of loading is done by an equally primitive method. In this work a steel bar having a fork that fits over the end of the axle, and known as a "wheel stick," is used. Starting two hundred feet from the car, with two men to each "wheel stick," the wheels are pushed along the track with increasing speed until, as they reach the incline, they have the momentum for mounting to the car floor. In spite of their primitive nature these methods are likely to be used for many years, as they are the most economical yet devised for a plant where the number of wheels handled is too small to justify the use of a depressed track or the installation of air-hoist equipment.

MUNICIPAL HALL ERECTED OVER UNSIGHTLY CREEK

An unsightly stream running through the heart of Hutchinson, Kans., has been transformed into a thing of beauty, and what was once an undesirable location has become a site of special value. This change has been brought about by confining the creek in question within artistic walls,



Right: While Dropping down the Incline the Wheels Attain a High Velocity; They are Stopped by the Same Method That a Cowboy Uses in Catching a Steer or Pony — by Lassoing. Left: Starting the Wheels for the Final Rush up the Incline to the Car Floor. The Same Skid is Used for Loading and Unloading

Copyrighted material



Municipal Convention Hall in Hutchinson, Kansas, Built Directly above a Stream: By Erecting This Attractive Structure, Together with Proper Retaining Walls, an Unsightly Location has been Changed into One of Value and Service

adorned with flower boxes and ornamental railings, and erecting a municipal convention hall directly over the water. The building is of reinforced concrete and pressed brick, and will seat 3,500. The rear portion of the main floor is designed so that it can be made to slope toward the stage or made level for dancing. By utilizing the site over the stream in this way, a central location in the city has been obtained at low cost, and what was an eyesore has become a place of beauty and public service. This improvement also made possible the widening of a narrow street.

4678 GUARD FOR BIG BUZZ SAW PROTECTION TO WORKERS

To protect workmen against the danger of serious injuries, a deputy labor commissioner of a western state has designed a steel guard for circular saws which has given satisfaction during several months of use in a shingle factory. The device describes an arc and shields the upper third of a saw's circumference without interfering with its operation. Furthermore, the guard

is arranged so that it may be readily tilted back out of the way to permit the removal of the tool. Its easy adjustment and comparative cheapness

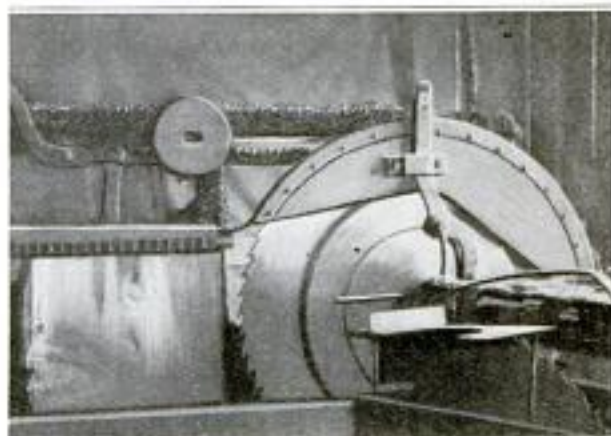

The Shield Covers the Exposed and Unused Part of the Saw's Circumference without Hampering Its Efficiency

make it well suited for saws used for purposes that do not preclude the installation of such equipment.

¶The state of Oklahoma has recently established a bureau of standards which will acquire facilities for testing gas, water, and electricity meters, and may test fuels. Standards of weights and measures will be possessed by it also.

FROG ON AUTO RADIATOR ADMITS MOIST AIR

Acting on the theory that engines in motor vehicles run more smoothly in damp or foggy weather, two inventors

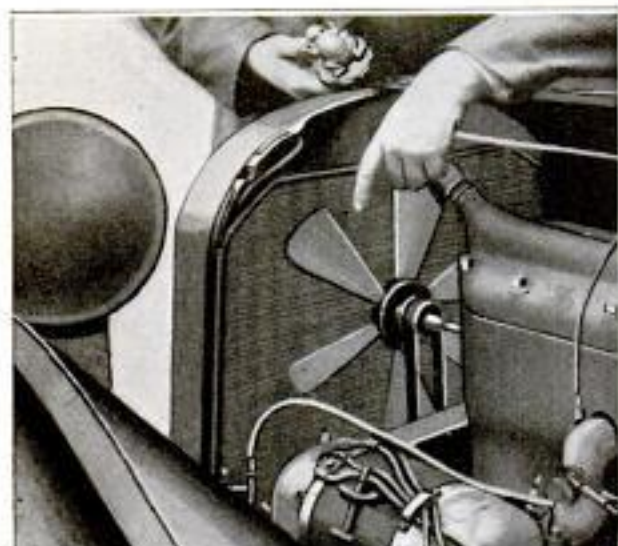

Appliance for Conveying Moist Air to a Carburetor:
The Man at the Left Holds the Brass
Frog Which Admits the Air

have patented a device by which outside air is sucked into the radiator of an automobile, mixed with the moisture therein, and conveyed to the carburetor air intake through a flexible tube. An acid-stained green frog, cast in brass and perched on the radiator cap, is the only part of the device visible. In the frog's throat is a valve which opens when the engine is running and permits the air to be sucked in. Mixed with the radiator steam it then travels downward through the overflow pipe to a water separator, with a trap which permits the discharge of all superfluous water, while the moist vapor travels to the carburetor. Elimination of carbon troubles and increased mileage are among the merits claimed.

ⒸAn electrically operated machine gun has been invented in Switzerland, according to reports, which can fire more shots in a given time than any gun now in use, and fires without detonation.

CORN-PLANTER ATTACHMENT FOR MOTOR CULTIVATOR

Among the farm implements of late design is a corn-planter attachment

place. This change can be effected readily, and the one machine made to serve the two functions with equal facility. The planter itself represents merely a re-assembly and adaptation of the parts of a standard horse-drawn machine.



Side View of the Machine,
Showing It in Use as
a Corn Planter

for a power-driven cultivator. To use the apparatus it is only necessary to remove the cultivator gangs from the bars to which they are fastened, and mount the other outfit in their



The Attachment is Applied by Removing the Cultivator Gangs from the
Bars to Which They are Fastened, and Putting
the Corn Planter in Their Place

STAGING A LION CHASE FOR THE MOVIES

Ingenious Faking for an Unusual Movie Scene: The Scenario Calls for a Lion Pursuing Two Men through a Jungle. While a Third Actor Clings Frantically to the Animal's Tail. The Trainer and Helpers are Here Shown in the Not-Too-Pleasant Task of Getting the Animal into Position on the Stage. Which is Built to Operate Like a Treadmill



The Mechanism That Operates the Scenery: To Preserve the Illusion of Running through a Jungle, the Background is Made to Move in Unison with the Stage, Which Travels to the Right While the Actors, by Running, Keep in Front of the Camera. The Scenery is Constructed Like an Endless Belt

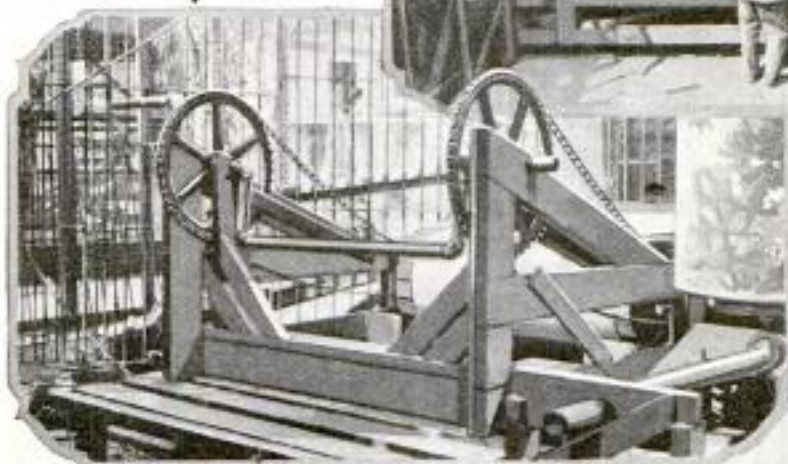

Rehearsing the Chase: In Retouching This Picture the Artist has Brought Out Two Wires That Are Invisible in the Movie Photographs. These Pass over Pulleys (Also Not Shown in the Films) to Attendants Who Are Ready, the Instant the Lion Threatens to Make Trouble, to Draw Him Up off His Feet and So Render Him Powerless



The Arrow Points to a Concrete Pool, Six Feet Wide and Six Feet Deep, into Which, in Time of Danger, the Actors can Plunge and Escape from the Lion, Who will Not Follow Them into the Water

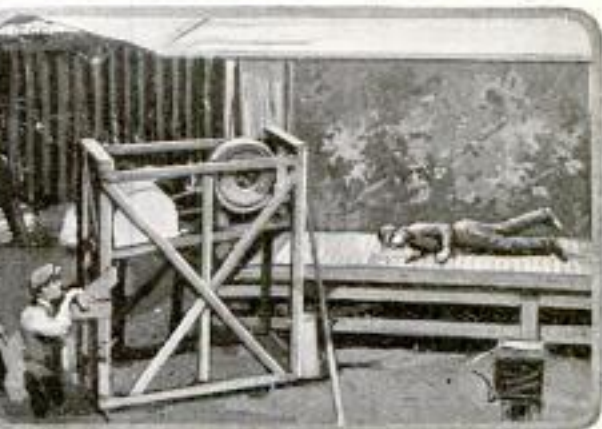

In the Foreground, at the Left, is a Portable Blower Which Directs a Blast against the Actors, Giving Them the Appearance of Running against the Wind. The Player's Posture Involves Risk When the Lion is Present, for the Beast may Seize Him Before He Gets Up

NOTCHED CURB EXCLUDES AUTOS BUT NOT CYCLES

An ordinary driveway leading to a motorcycle garage formerly permitted many motorists to drive into the building by mistake, thinking that it was an automobile garage. To put a stop to this practice, the owner cemented up the drive and installed a regular curb. However, he did not intend to inconvenience his motorcycle patrons, and so provided a 16-in. notch in the curb, which enables them to mount the sidewalk without difficulty.



his motorcycle patrons, and so provided a 16-in. notch in the curb, which enables them to mount the sidewalk without difficulty.

QUICK RESPONSE FEATURE OF TURBINE GOVERNOR

To enable closer regulation and greater stability than are usually attained, a governor for steam turbines and water motors has been designed that possesses a number of interesting points. Simplicity of construction is one of its outstanding features, but more important, perhaps, is its principle of operation. Instead of being the controlling power, centrifugal force is used only for setting the clutches of the regulator. The rapid rotation of the governor shaft operates the valves. Quicker response is said to be obtained in this way than if sole dependence were placed upon centrifugal force. Short fingers project above the pivots



of the fly-ball arms and carry quadrant clutch jaws at their extremities. Between them is a disk clutch and around them a cup clutch. They run smoothly between these members until the speed increases, or decreases, about one per cent. When the former occurs, the jaws grip the inner disk and cause the governor shaft to operate the valve-control rod. A decrease in speed effects the engagement of the outer clutch, and the rotation of the gearing is reversed.

FOLDING CORKSCREW USED IN SEALING BOTTLE

An inexpensive folding corkscrew has been invented which, if desired, can be placed on a bottle at the time that it is sealed in the bottling works, so that the purchaser may have no inconvenience in opening the container whenever

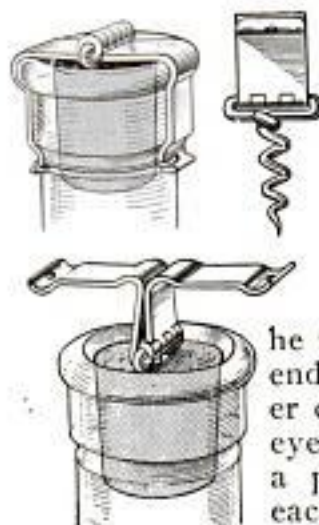

he wishes. The upper end of the screw proper consists of a broad eyelet which serves as a pintle to hinge to each other the two halves of which the handle is composed. These two halves are bent at right angles and fold down against the top and neck of the bottle. If desired a sealing wire can be run through holes and the handle tied down. To use the corkscrew it is only necessary to remove this wire and turn the two parts of the handle up until they form a horizontal bar which can be grasped by the hand.

he wishes. The upper end of the screw proper consists of a broad eyelet which serves as a pintle to hinge to each other the two halves of which the handle is composed. These two halves are bent at right angles and fold down against the top and neck of the bottle. If desired a sealing wire can be run through holes and the handle tied down. To use the corkscrew it is only necessary to remove this wire and turn the two parts of the handle up until they form a horizontal bar which can be grasped by the hand.

Coats can now be discarded by St. Louis motormen and conductors during hot weather without fear of official disapproval. The local street-car company has provided these employes with two gray shirts and two blue ties, each, which they will be permitted to wear without their coats.

CARBON MONOXIDE POISONS MANY IN MODERN PLANTS

4735
In many industries, notably in the steel and other metallurgical lines, the hazard from chronic carbon-monoxide poisoning is increasing steadily, according to a report recently issued by government officials. By chronic poisoning is meant the serious effects resulting from the continued presence of small quantities of this gas in places in which laborers are employed. The final result of such exposure, which causes no acute symptoms and hence is often ignored, is partial or total disabling of the worker. In modern industry carbon monoxide appears frequently as a product or a by-product of numerous processes. For example, gas formerly allowed to escape is now utilized for the production of steam and power. This poisonous gas is also made in large quantities in gas producers and the gas engine is gradually being substituted for the steam engine in modern plants. All of these factors help to increase the probability of gradual poisoning of the men working where the gas is used, and create a condition demanding special study.

NEW PISTON RING HAS NO OUTSIDE JOINTS

4578
A new piston ring, having no outside joints to permit leakage and no exposed ends to score the cylinder, consists of two identical circular members, each with a flangelike extension midway between its ends. The two parts fit together so that each flange overlaps and protects the ends of the other member, thus forming a ring requiring no device to unite the halves.



Two Views of a New Piston Ring, Having No Outside Joints and No Exposed Ends to Score the Cylinder

SMART MOTOR APRONS WORN BY WOMEN DRIVERS

Women motorists in some sections are adopting attractive driving aprons that protect their delicate summer



Dainty Summer Frocks are Protected from Dust and Dirt by Tastefully Designed Aprons Intended for Women Drivers of Open Cars

gowns from dust and grease. They are made of durable linens and crashes, tastefully trimmed, and so designed that they may be put on or removed readily when entering or leaving a machine. Since they are modish and pleasing, they may be worn during shopping tours and similar excursions without being taken off when a car is parked. They have the advantage, also, of being serviceable rather than conspicuous.

READING RACK OF GLASS FOR BED PATIENTS

4097
A glass shelf, fastened by folding supports to the head of a bed, is the essential feature of a book or magazine holder with the aid of which one can read with comfort while lying down. The invention is particularly serviceable to wounded soldiers and in-

valids. The reading matter is laid face down on this shelf so that the person in the bed can look up through the glass



The Shelf of This Reading Rack Is of Glass; Reading Matter is Placed against It, Face Down, Enabling a Person Lying in Bed to Read with Comfort

and see the printed page. When the device is not in use it is folded out of the way, against the head of the bed.

STAR-SPANGLED BANNER MADE OF BRICK

What is undoubtedly one of the most enduring flags that has ever been devised is the national emblem made of red, white, and blue brick to ornament the office of a brick company. The flag measures 48 by 32 in., and is flanked on either side by brick pillars. The red stripes consist of red, vitrified



Stars and Stripes in Durable Form: A Brick Reproduction of the Flag, Measuring 48 by 32 Inches. The Stars were Cut from White Brick with a Chisel

brick, and the white stripes of matt, glazed brick. Dark blue-enameled brick compose the field for the 48 stars. The designer of the flag did not believe it practical to make the stars of the same material as the rest of the flag but the masons insisted that it could be done and painstakingly chiseled out the 48 five-pointed stars from white brick.

SPLICING CLIP FOR CABLE

4705 IS SELF-TIGHTENING

For splicing wire rope, a self-tightening clamp has been devised that seems to have merit. It consists of a U-bolt, in the crotch of which a movable cam is attached, supplied with a base that has high, flat sides. Both the cam and base are scored to match the strands of a cable, much as the threads of a nut fit those of a bolt. This arrangement not only gives the device greater bearing surface than it otherwise would have, but also prevents injury to the rope. When the cable is subjected to unusual strain, the cam may turn slightly so that its grip is increased



As the Pull upon the Spliced Cable is Increased the Clamp Tightens Its Grip

and the spliced ends of the rope are prevented from slipping. A device of similar construction is used as a bar splicer.

WASTED SPACE ONE REASON FOR GREAT CAR SHORTAGE

3 As a means of promoting railway efficiency in the interest of national defense, shippers the country over are being urged to make one car accomplish the work of two by utilizing its maximum capacity instead of wasting half the space it offers. In promoting this campaign, the Pennsylvania Railroad Company has prepared a series of

Keenan, John J. Keenan
 2-10-1918
 3-10-1918

2-10-1918
 3-10-1918
 4-10-1918

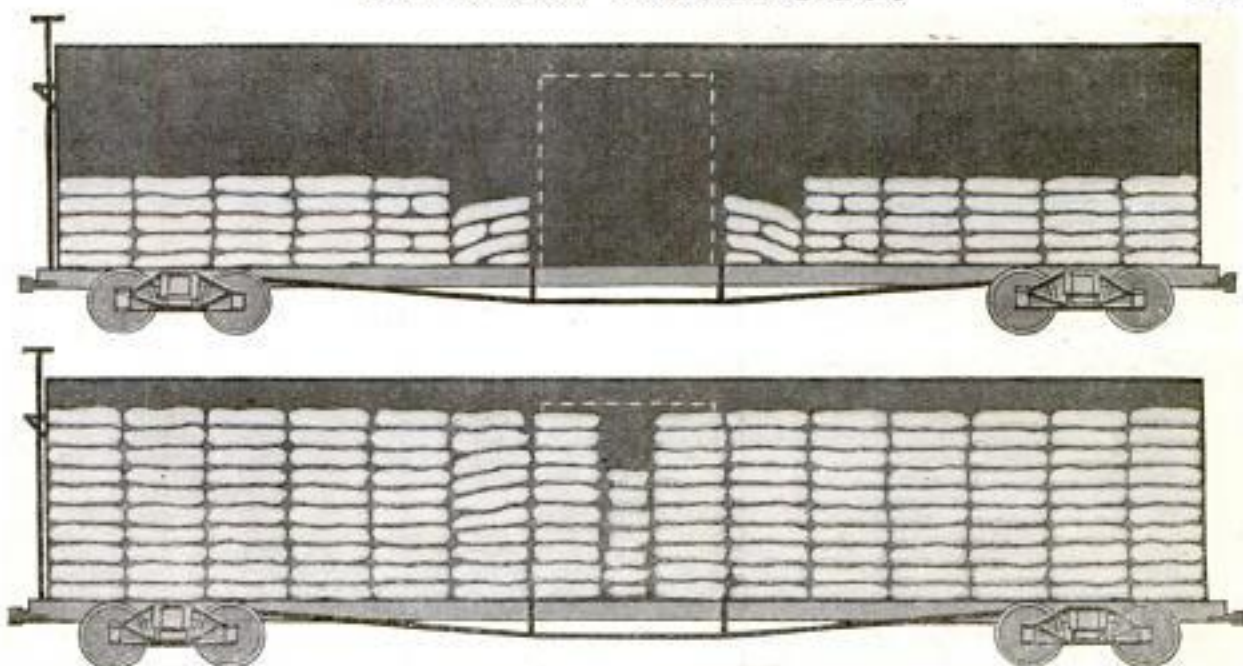

Four Hundred Bags of Sugar are Generally Considered a Carload. The Drawing at the Top Shows Such a Cargo, While That below It Illustrates How the Same Car can be Made to Carry 1,000 Sacks by Simply Utilizing the Available Space

charts that explain one of the reasons for the so-called car shortage and offers tangible suggestions for its solution. It is pointed out, for instance, that the average carload shipment of fertilizer during the month of March amounted only to 250 bags weighing 42,000 lb., while 600 bags, or 100,800 lb., could have been accommodated. In the case of sugar, 400 sacks constitute the commercial selling unit and are considered a carload. The company shows, however, that 1,000 bags can be shipped in one of its cars. Several other illustrations of similar character are offered. To remedy the condition, the railway suggests that, when possible, buyers increase their orders to actual carload lots, or club with other purchasers. Shippers on the other hand are asked to "do their bit" by encouraging larger trade units and urging customers to merge their orders.

ELECTRIC DOOR CONTROLLER FOR PASSENGER LIFTS

Underwriters have passed an electric safety appliance for passenger elevators which eliminates the dangers of operation by controlling the movements of a car and the doors of the shaft in which it travels. It is primarily mechanical in its actions and

entirely automatic in performing them. It prevents a door being opened until an elevator has come to a full stop with its floor within a prescribed number of inches of the landing level, and further prohibits the movement of the car until the gate has been locked. Each door of a shaft is controlled independently, but only one can be opened at a time. In opening it, a door is moved manually about an inch. This action

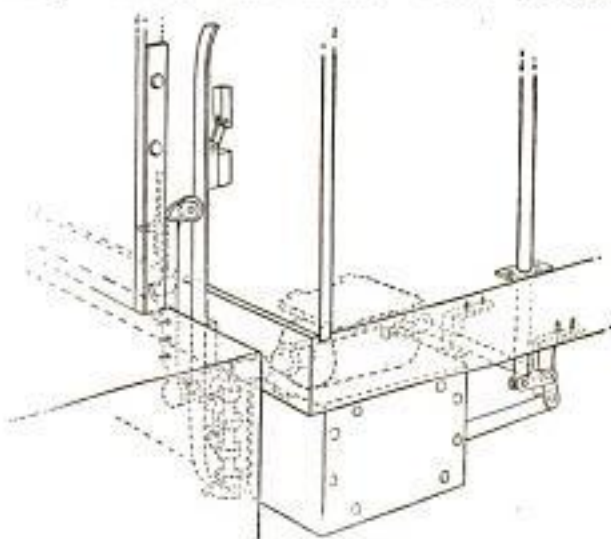

Diagram of Apparatus as Installed on Electric Elevator: The Square Box below the Floor of the Car Contains the Switch, While the Cylinder Shown in Dotted Lines Is a Solenoid, Which Actuates the Cam That Locks and Releases the Latch

operates a switch and actuates a solenoid that releases the lock. When the gate is closed, the cycle is reversed.

SOME NOVEL AND LITTLE-KNOWN ACCESSORIES



There Are a Dozen Different Uses for the Shelf Pictured Above. A Single Nail Holds It in Place. Price 40 Cents



Coins and Other Small Articles may be Sent through the Mails Quite Safely When Placed in This Metal Receptacle, Which Clamps Firmly to a Post Card



When Ice Is Unavailable, This Cooling Chamber Prevents Perishable Foods from Spoiling



For Electric Irons, the Plug Above is Provided with a Small Pilot Lamp That Indicates Whether the Current Is On. Price About \$1.25

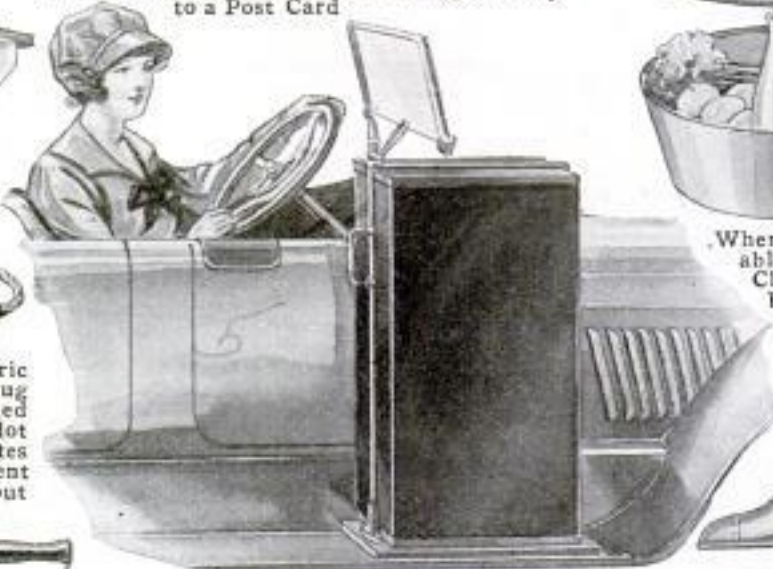

Showing a New Motor-Car Trunk, in Which Clothing Hangs in Natural Position, Locked to Running Board: It Contains Two Trays and a Shoe Box. Price \$60



Small, Unnoticeable Vent That Provides Ventilation for Shoes of Any Type: It Is Waterproof and Readily Attached. Price, Pair, 25 Cents



Sanitary Rolling Pin and Mixing Board Covered with Many Thicknesses of Waxed Paper: Sheets are Torn Off as Used. Price of Each About 50 Cents



Simple Riveting Outfit That Enables One to Mend Quickly and Permanently Holes in Aluminum, Tin, or Other Cooking Utensils



Sanitary, Odorless Garbage Receiver That does Not Spill Its Contents When Overturned: A Rubber Bumper Allows It to be Closed Noiselessly. Price \$7

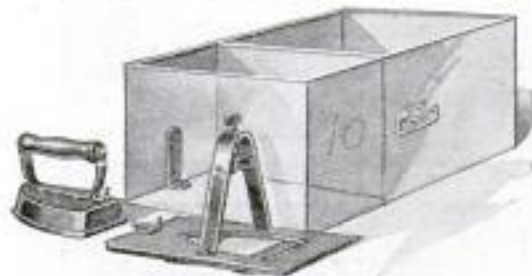

Ingenious Electric-Iron Holder That may be Clamped into Drawer of Wardrobe Trunk: The Device Eliminates the Difficulty Usually Experienced When a Traveler Wishes to Carry an Iron

INTENDED FOR THE HOME AND ITS MEMBERS



White-Enameled Toothbrush Receptacle with Places for Liquid, Powder, and Paste Dentifrices. Price 25 Cents



Something a Bit Out of the Ordinary for Nursery or Porch: Jack and Jill Lamps with Sockets for Connection with Lighting Circuit. Price, Pair, \$7.50



Compact Filter That Minimizes the Danger of Using Ordinary City Water for Drinking Purposes: It Employs Small Filtering Disks That may be Replaced Frequently. Device Rents for 30 Cents a Month



It Is Easy to Keep This Griddle Greaser Sweet and Clean, for the Wick may be Removed and Washed, or Fresh Fabric Substituted. Price 25 Cents



The Flexible Trellis Forming the Artistic Arch Above, Folds Compactly, as Illustrated at the Right. It may be Dismantled Each Fall and Stored for Winter

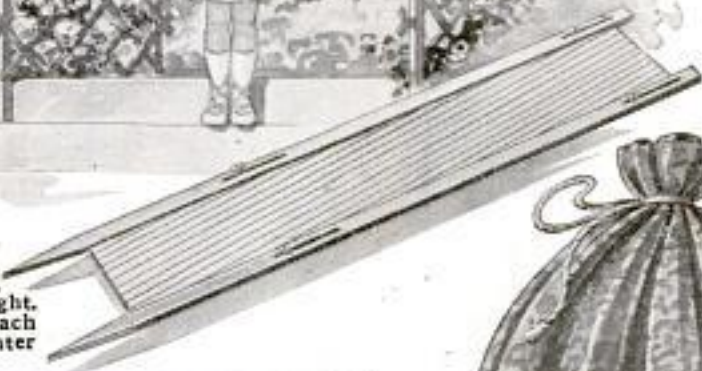

When a Large Number of Bulbs are to be Planted, This Tool Is Convenient. With It a Hole of the Proper Depth and Diameter is Quickly Made. Price \$1.50

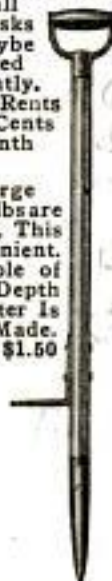

First-Aid Outfit Packed in Strong Metal Box of Convenient Size for Motorists, Campers, and Others: It Contains Antiseptics, Salve, Cotton, Pins, and an Assortment of Gauze

When a Large Quantity of Apple Butter is being Made, This Wooden Stirrer Is Serviceable. The 18-Inch Blade is Provided with a Six-Foot Handle. Price \$1.50



Attractive Knitting Bag with Compartment in Bottom to Hold Needles, Scissors, and Other Necessities: It Is of Convenient Size and Made of Pleasing, Durable Material. Price \$5.50

For Containers of Syrups and Similar Products, a Cover Fitted with a Spout That, When Closed, Seals the Receptacle, Is Convenient. It will Cost About 25 Cents



14-15-16-17-18-19-20-21-22-23-24-25-26-27-28-29-30-31-32-33-34-35-36-37-38-39-40-41-42-43-44-45-46-47-48-49-50-51-52-53-54-55-56-57-58-59-60-61-62-63-64-65-66-67-68-69-70-71-72-73-74-75-76-77-78-79-80-81-82-83-84-85-86-87-88-89-90-91-92-93-94-95-96-97-98-99-100
14-15-16-17-18-19-20-21-22-23-24-25-26-27-28-29-30-31-32-33-34-35-36-37-38-39-40-41-42-43-44-45-46-47-48-49-50-51-52-53-54-55-56-57-58-59-60-61-62-63-64-65-66-67-68-69-70-71-72-73-74-75-76-77-78-79-80-81-82-83-84-85-86-87-88-89-90-91-92-93-94-95-96-97-98-99-100
14-15-16-17-18-19-20-21-22-23-24-25-26-27-28-29-30-31-32-33-34-35-36-37-38-39-40-41-42-43-44-45-46-47-48-49-50-51-52-53-54-55-56-57-58-59-60-61-62-63-64-65-66-67-68-69-70-71-72-73-74-75-76-77-78-79-80-81-82-83-84-85-86-87-88-89-90-91-92-93-94-95-96-97-98-99-100
14-15-16-17-18-19-20-21-22-23-24-25-26-27-28-29-30-31-32-33-34-35-36-37-38-39-40-41-42-43-44-45-46-47-48-49-50-51-52-53-54-55-56-57-58-59-60-61-62-63-64-65-66-67-68-69-70-71-72-73-74-75-76-77-78-79-80-81-82-83-84-85-86-87-88-89-90-91-92-93-94-95-96-97-98-99-100
14-15-16-17-18-19-20-21-22-23-24-25-26-27-28-29-30-31-32-33-34-35-36-37-38-39-40-41-42-43-44-45-46-47-48-49-50-51-52-53-54-55-56-57-58-59-60-61-62-63-64-65-66-67-68-69-70-71-72-73-74-75-76-77-78-79-80-81-82-83-84-85-86-87-88-89-90-91-92-93-94-95-96-97-98-99-100
14-15-16-17-18-19-20-21-22-23-24-25-26-27-28-29-30-31-32-33-34-35-36-37-38-39-40-41-42-43-44-45-46-47-48-49-50-51-52-53-54-55-56-57-58-59-60-61-62-63-64-65-66-67-68-69-70-71-72-73-74-75-76-77-78-79-80-81-82-83-84-85-86-87-88-89-90-91-92-93-94-95-96-97-98-99-100
14-15-16-17-18-19-20-21-22-23-24-25-26-27-28-29-30-31-32-33-34-35-36-37-38-39-40-41-42-43-44-45-46-47-48-49-50-51-52-53-54-55-56-57-58-59-60-61-62-63-64-65-66-67-68-69-70-71-72-73-74-75-76-77-78-79-80-81-82-83-84-85-86-87-88-89-90-91-92-93-94-95-96-97-98-99-100
14-15-16-17-18-19-20-21-22-23-24-25-26-27-28-29-30-31-32-33-34-35-36-37-38-39-40-41-42-43-44-45-46-47-48-49-50-51-52-53-54-55-56-57-58-59-60-61-62-63-64-65-66-67-68-69-70-71-72-73-74-75-76-77-78-79-80-81-82-83-84-85-86-87-88-89-90-91-92-93-94-95-96-97-98-99-100
14-15-16-17-18-19-20-21-22-23-24-25-26-27-28-29-30-31-32-33-34-35-36-37-38-39-40-41-42-43-44-45-46-47-48-49-50-51-52-53-54-55-56-57-58-59-60-61-62-63-64-65-66-67-68-69-70-71-72-73-74-75-76-77-78-79-80-81-82-83-84-85-86-87-88-89-90-91-92-93-94-95-96-97-98-99-100
14-15-16-17-18-19-20-21-22-23-24-25-26-27-28-29-30-31-32-33-34-35-36-37-38-39-40-41-42-43-44-45-46-47-48-49-50-51-52-53-54-55-56-57-58-59-60-61-62-63-64-65-66-67-68-69-70-71-72-73-74-75-76-77-78-79-80-81-82-83-84-85-86-87-88-89-90-91-92-93-94-95-96-97-98-99-100
14-15-16-17-18-19-20-21-22-23-24-25-26-27-28-29-30-31-32-33-34-35-36-37-38-39-40-41-42-43-44-45-46-47-48-49-50-51-52-53-54-55-56-57-58-59-60-61-62-63-64-65-66-67-68-69-70-71-72-73-74-75-76-77-78-79-80-81-82-83-84-85-86-87-88-89-90-91-92-93-94-95-96-97-98-99-100
14-15-16-17-18-19-20-21-22-23-24-25-26-27-28-29-30-31-32-33-34-35-36-37-38-39-40-41-42-43-44-45-46-47-48-49-50-51-52-53-54-55-56-57-58-59-60-61-62-63-64-65-66-67-68-69-70-71-72-73-74-75-76-77-78-79-80-81-82-83-84-85-86-87-88-89-90-91-92-93-94-95-96-97-98-99-100
14-15-16-17-18-19-20-21-22-23-24-25-26-27-28-29-30-31-32-33-34-35-36-37-38-39-40-41-42-43-44-45-46-47-48-49-50-51-52-53-54-55-56-57-58-59-60-61-62-63-64-65-66-67-68-69-70-71-72-73-74-75-76-77-78-79-80-81-82-83-84-85-86-87-88-89-90-91-92-93-94-95-96-97-98-99-100
14-15-16-17-18-19-20-21-22-23-24-25-26-27-28-29-30-31-32-33-34-35-36-37-38-39-40-41-42-43-44-45-46-47-48-49-50-51-52-53-54-55-56-57-58-59-60-61-62-63-64-65-66-67-68-69-70-71-72-73-74-75-76-77-78-79-80-81-82-83-84-85-86-87-88-89-90-91-92-93-94-95-96-97-98-99-100
14-15-16-17-18-19-20-21-22-23-24-25-26-27-28-29-30-31-32-33-34-35-36-37-38-39-40-41-42-43-44-45-46-47-48-49-50-51-52-53-54-55-56-57-58-59-60-61-62-63-64-65-66-67-68-69-70-71-72-73-74-75-76-77-78-79-80-81-82-83-84-85-86-87-88-89-90-91-92-93-94-95-96-97-98-99-100
14-15-16-17-18-19-20-21-22-23-24-25-26-27-28-29-30-31-32-33-34-35-36-37-38-39-40-41-42-43-44-45-46-47-48-49-50-51-52-53-54-55-56-57-58-59-60-61-62-63-64-65-66-67-68-69-70-71-72-73-74-75-76-77-78-79-80-81-82-83-84-85-86-87-88-89-90-91-92-93-94-95-96-97-98-99-100
14-15-16-17-18-19-20-21-22-23-24-25-26-27-28-29-30-31-32-33-34-35-36-37-38-39-40-41-42-43-44-45-46-47-48-49-50-51-52-53-54-55-56-57-58-59-60-61-62-63-64-65-66-67-68-69-70-71-72-73-74-75-76-77-78-79-80-81-82-83-84-85-86-87-88-89-90-91-92-93-94-95-96-97-98-99-100
14-15-16-17-18-19-20-21-22-23-24-25-26-27-28-29-30-31-32-33-34-35-36-37-38-39-40-41-42-43-44-45-46-47-48-49-50-51-52-53-54-55-56-57-58-59-60-61-62-63-64-65-66-67-68-69-70-71-72-73-74-75-76-77-78-79-80-81-82-83-84-85-86-87-88-89-90-91-92-93-94-95-96-97-98-99-100
14-15-16-17-18-19-20-21-22-23-24-25-26-27-28-29-30-31-32-33-34-35-36-37-38-39-40-41-42-43-44-45-46-47-48-49-50-51-52-53-54-55-56-57-58-59-60-61-62-63-64-65-66-67-68-69-70-71-72-73-74-75-76-77-78-79-80-81-82-83-84-85-86-87-88-89-90-91-92-93-94-95-96-97-98-99-100
14-15-16-17-18-19-20-21-22-23-24-25-26-27-28-29-30-31-32-33-34-35-36-37-38-39-40-41-42-43-44-45-46-47-48-49-50-51-52-53-54-55-56-57-58-59-60-61-62-63-64-65-66-67-68-69-70-71-72-73-74-75-76-77-78-79-80-81-82-83-84-85-86-87-88-89-90-91-92-93-94-95-96-97-98-99-100
14-15-16-17-18-19-20-21-22-23-24-25-26-27-28-29-30-31-32-33-34-35-36-37-38-39-40-41-42-43-44-45-46-47-48-49-50-51-52-53-54-55-56-57-58-59-60-61-62-63-64-65-66-67-68-69-70-71-72-73-74-75-76-77-78-79-80-81-82-83-84-85-86-87-88-89-90-91-92-93-94-95-96-97-98-99-100
14-15-16-17-18-19-20-21-22-23-24-25-26-27-28-29-30-31-32-33-34-35-36-37-38-39-40-41-42-43-44-45-46-47-48-49-50-51-52-53-54-55-56-57-58-59-60-61-62-63-64-65-66-67-68-69-70-71-72-73-74-75-76-77-78-79-80-81-82-83-84-85-86-87-88-89-90-91-92-93-94-95-96-97-98-99-100
14-15-16-17-18-19-20-21-22-23-24-25-26-27-28-29-30-31-32-33-34-35-36-37-38-39-40-41-42-43-44-45-46-47-48-49-50-51-52-53-54-55-56-57-58-59-60-61-62-63-64-65-66-67-68-69-70-71-72-73-74-75-76-77-78-79-80-81-82-83-84-85-86-87-88-89-90-91-92-93-94-95-96-97-98-99-100
14-15-16-17-18-19-20-21-22-23-24-25-26-27-28-29-30-31-32-33-34-35-36-37-38-39-40-41-42-43-44-45-46-47-48-49-50-51-52-53-54-55-56-57-58-59-60-61-62-63-64-65-66-67-68-69-70-71-72-73-74-75-76-77-78-79-80-81-82-83-84-85-86-87-88-89-90-91-92-93-94-95-96-97-98-99-100
14-15-16-17-18-19-20-21-22-23-24-25-26-27-28-29-30-31-32-33-34-35-36-37-38-39-40-41-42-43-44-45-46-47-48-49-50-51-52-53-54-55-56-57-58-59-60-61-62-63-64-65-66-67-68-69-70-71-72-73-74-75-76-77-78-79-80-81-82-83-84-85-86-87-88-89-90-91-92-93-94-95-96-97-98-99-100
14-15-16-17-18-19-20-21-22-23-24-25-26-27-28-29-30-31-32-33-34-35-36-37-38-39-40-41-42-43-44-45-46-47-48-49-50-51-52-53-54-55-56-57-58-59-60-61-62-63-64-65-66-67-68-69-70-71-72-73-74-75-76-77-78-79-80-81-82-83-84-85-86-87-88-89-90-91-92-93-94-95-96-97-98-99-100
14-15-16-17-18-19-20-21-22-23-24-25-26-27-28-29-30-31-32-33-34-35-36-37-38-39-40-41-42-43-44-45-46-47-48-49-50-51-52-53-54-55-56-57-58-59-60-61-62-63-64-65-66-67-68-69-70-71-72-73-74-75-76-77-78-79-80-81-82-83-84-85-86-87-88-89-90-91-92-93-94-95-96-97-98-99-100
14-15-16-17-18-19-20-21-22-23-24-25-26-27-28-29-30-31-32-33-34-35-36-37-38-39-40-41-42-43-44-45-46-47-48-49-50-51-52-53-54-55-56-57-58-59-60-61-62-63-64-65-66-67-68-69-70-71-72-73-74-75-76-77-78-79-80-81-82-83-84-85-86-87-88-89-90-91-92-93-94-95-96-97-98-99-100
14-15-16-17-18-19-20-21-22-23-24-25-26-27-28-29-30-31-32-33-34-35-36-37-38-39-40-41-42-43-44-45-46-47-48-49-50-51-52-53-54-55-56-57-58-59-60-61-62-63-64-65-66-67-68-69-70-71-72-73-74-75-76-77-78-79-80-81-82-83-84-85-86-87-88-89-90-91-92-93-94-95-96-97-98-99-100
14-15-16-17-18-19-20-21-22-23-24-25-26-27-28-29-30-31-32-33-34-35-36-37-38-39-40-41-42-43-44-45-46-47-48-49-50-51-52-53-54-55-56-57-58-59-60-61-62-63-64-65-66-67-68-69-70-71-72-73-74-75-76-77-78-79-80-81-82-83-84-85-86-87-88-89-90-91-92-93-94-95-96-97-98-99-100
14-15-16-17-18-19-20-21-22-23-24-25-26-27-28-29-30-31-32-33-34-35-36-37-38-39-40-41-42-43-44-45-46-47-48-49-50-51-52-53-54-55-56-57-58-59-60-61-62-63-64-65-66-67-68-69-70-71-72-73-74-75-76-77-78-79-80-81-82-83-84-85-86-87-88-89-90-91-92-93-94-95-96-97-98-99-100
14-15-16-17-18-19-20-21-22-23-24-25-26-27-28-29-30-31-32-33-34-35-36-37-38-39-40-41-42-43-44-45-46-47-48-49-50-51-52-53-54-55-56-57-58-59-60-61-62-63-64-65-66-67-68-69-70-71-72-73-74-75-76-77-78-79-80-81-82-83-84-85-86-87-88-89-90-91-92-93-94-95-96-97-98-99-100
14-15-16-17-18-19-20-21-22-23-24-25-26-27-28-29-30-31-32-33-34-35-36-37-38-39-40-41-42-43-44-45-46-47-48-49-50-51-52-53-54-55-56-57-58-59-60-61-62-63-64-65-66-67-68-69-70-71-72-73-74-75-76-77-78-79-80-81-82-83-84-85-86-87-88-89-90-91-92-93-94-95-96-97-98-99-100
14-15-16-17-18-19-20-21-22-23-24-25-26-27-28-29-30-31-32-33-34-35-36-37-38-39-40-41-42-43-44-45-46-47-48-49-50-51-52-53-54-55-56-57-58-59-60-61-62-63-64-65-66-67-68-69-70-71-72-73-74-75-76-77-78-79-80-81-82-83-84-85-86-87-88-89-90-91-92-93-94-95-96-97-98-99-100
14-15-16-17-18-19-20-21-22-23-24-25-26-27-28-29-30-31-32-33-34-35-36-37-38-39-40-41-42-43-44-45-46-47-48-49-50-51-52-53-54-55-56-57-58-59-60-61-62-63-64-65-66-67-68-69-70-71-72-73-74-75-76-77-78-79-80-81-82-83-84-85-86-87-88-89-90-91-92-93-94-95-96-97-98-99-100
14-15-16-17-18-19-20-21-22-23-24-25-26-27-28-29-30-31-32-33-34-35-36-37-38-39-40-41-42-43-44-45-46-47-48-49-50-51-52-53-54-55-56-57-58-59-60-61-62-63-64-65-66-67-68-69-70-71-72-73-74-75-76-77-78-79-80-81-82-83-84-85-86-87-88-89-90-91-92-93-94-95-96-97-98-99-100
14-15-16-17-18-19-20-21-22-23-24-25-26-27-28-29-30-31-32-33-34-35-36-37-38-39-40-41-42-43-44-45-46-47-48-49-50-51-52-53-54-55-56-57-58-59-60-61-62-63-64-65-66-67-68-69-70-71-72-73-74-75-76-77-78-79-80-81-82-83-84-85-86-87-88-89-90-91-92-93-94-95-96-97-98-99-100
14-15-16-17-18-19-20-21-22-23-24-25-26-27-28-29-30-31-32-33-34-35-36-37-38-39-40-41-42-43-44-45-46-47-48-49-50-51-52-53-54-55-56-57-58-59-60-61-62-63-64-65-66-67-68-69-70-71-72-73-74-75-76-77-78-79-80-81-82-83-84-85-86-87-88-89-90-91-92-93-94-95-96-97-98-99-100
14-15-16-17-18-19-20-21-22-23-24-25-26-27-28-29-30-31-32-33-34-35-36-37-38-39-40-41-42-43-44-45-46-47-48-49-50-51-52-53-54-55-56-57-58-59-60-61-62-63-64-65-66-67-68-69-70-71-72-73-74-75-76-77-78-79-80-81-82-83-84-85-86-87-88-89-90-91-92-93-94-95-96-97-98-99-100
14-15-16-17-18-19-20-21-22-23-24-25-26-27-28-29-30-31-32-33-34-35-36-37-38-39-40-41-42-43-44-45-46-47-48-49-50-51-52-53-54-55-56-57-58-59-60-61-62-63-64-65-66-67-68-69-70-71-72-73-74-75-76-77-78-79-80-81-82-83-84-85-86-87-88-89-90-91-92-93-94-95-96-97-98-99-100
14-15-16-17-18-19-20-21-2

TREAD OF TIRE REINFORCED BY INTERMESHERD WIRES

Vulcanized near the surface of the tread, four triangular coils of steel wire, arranged parallel with one another, encircle a



new type of non-skid, puncture-resisting tire for motor cars. The points of the wires become exposed after the tire has been given slight use, and are supposed to grip the road and also

prevent pieces of glass and other sharp material from penetrating the rubber and cutting the fabric. The reinforcement which the wires provide, and the heavy weight of the fabric used, contribute to make the casing durable.

VALVE KEEPS RESERVE IN MOTORCYCLE FUEL TANK

A gasoline-supply valve for motorcycles has been invented, which is so constructed that it gives the rider warning when all but about half a gallon of fuel has been drawn from the tank. The valve is in the form of a hollow needle, and has a set of holes a little above the lower end. In it is inserted a second needle, or pin, which can be screwed down to close the outlet in the lower end of the hollow needle. This double device is fitted to the fuel tank so that the outer



needle fits tightly over the tank's outlet. When there is an ample supply of gasoline the outer needle is screwed down tight to this outlet and the fuel flows through the holes in the needle's side and down to the pipe leading to the carburetor. But when the level of the gasoline falls below these holes the

rider knows that his supply is almost gone, for it stops flowing. To draw on the remaining supply he must open the valve in the bottom of the tank. This is done simply by giving the outer needle a few turns upward. This double valve can be completely closed by screwing the hollow needle down into the outlet, and then screwing the pin down as far as it will go, so that it shuts off the flow through the holes.

MOISTURE-PROOF COVERING FOR TENNIS RACQUET



To protect the strings of a lawn-tennis racquet from the injurious effects of moisture, a rubber-treated cloth mitten has been devised. It fits over the head of a racquet and is strapped about the neck so that the gut is not allowed to absorb dampness from the atmosphere and thereby become flabby. The use of the accessory does not prevent one from keeping a racquet in a press.

MEDICINE STAND PREVENTS ERRORS IN TAKING DOSES

In the top of the medicine holder shown herewith are two felt-lined recesses, in which bottles can be placed. At the back side is an upright with a hook on which a watch can be hung, while on the top of the base is a spring to hold memoranda. Also fast-



ened to the base is an oscillating guard with arms so arranged that it prevents the removal of the cork from one or the other of the bottles. On taking one kind of medicine,

the guard can be shifted so that only the other bottle will be accessible for the next dose. Thus, when medicines are taken alternately, mistakes are guarded against.

STEAMER AND STERILIZER FOR BARBERS' TOWELS

For heating and sterilizing towels in barber shops a steaming appliance has been designed which appears to have some serviceable features. It consists of a reservoir mounted on a metal standard and supplied at the top with a white-porcelain receptacle with capacity for about 10 towels. It holds two or three gallons of water and is fitted with a gas, gasoline, or electric heating system, according to the needs of the individual purchaser. Towels are kept in the holder provided for them, and removed as required. Since they are steamed instead of being placed in hot water, they can be handled without discomfort and applied to a customer's face without having to be first wrung out. They are also heated to a sufficient degree to kill all germs, a thing which safeguards customer and barber alike. The boiler is fitted with a gauge and faucet, and supplies hot water for shaving and other purposes in shops not equipped with stationary bowls before each chair.



CONVENIENT VALVE GRINDER FOR AUTOMOBILE ENGINE

For grinding the valves of a motor-car engine, a convenient device has been introduced which lessens the time and exertion usually consumed in such operations. Separate mountings are available so that the tool may be used

on either motors with detachable cylinder heads, or those with removable spark-plug bases. The grinding post is held down by a stanch spring so that the contact of the valve head and seat is true and the pressure adequate. A particularly good feature is that any number of valves may be ground in a single operation by employing several of the instruments and connecting them with a rod so that all of the valves are oscillated on their seats simultaneously.



SELF-LUBRICATING SHEAVE SAVES WORKMEN'S TIME

Because a new type of sheave is self-oiling it is especially suited for use on cableways or machinery difficult of access. It requires replenishing with lubricant but once in about two weeks, whereas many common sheaves need oiling once or twice a day. The portion of the wheel between the grooved circumference and the axle bearing constitutes an oil chamber of about three quarts' capacity. A plug in each side of the reservoir makes it easy to replenish it with oil. There are special bronze bushings, provided with oil holes through which the lubricant flows evenly and continuously from the chamber.



Authorities estimate that during the next 12 months the government will need 2,000,000,000 ft. of lumber for war purposes. Great as this total is, it is only about five per cent of our lumber production for one year.

4753

SCHOOL CHILDREN AT NEW TASKS AND AT PLAY,



Since "Toothbrushing Classes" Like This Became a Feature in All Kansas City Schools the Children are Taking Better Care of Their Teeth, Aches Are Fewer, Health Is Improved, and Lessons are Learned Easier

Four Des Moines School-girls Who have Found That Operating the School's New Mimeograph Is Lots of Fun as Well as Good Office Training. Hence There Is Much Rivalry to See Who shall Run Off School Programs



COURTESY INTERNATIONAL FISH SERVICE

Left: At 16, Delia Damon, a Massachusetts Girl, Is Champion Girl Scout of United States and Canada. She is Wearing Medals Won in a Score of Activities



It Is Oil, Not Water, That is Flowing from This Pipe. The 12-Year-Old Girl Who Stands Close By, Is Owner of This and Other Oil Properties near Cedar Bayou, Texas, That Pay Her Hundreds of Dollars per Week

AND OTHERS, BOTH FORTUNATE AND UNFORTUNATE

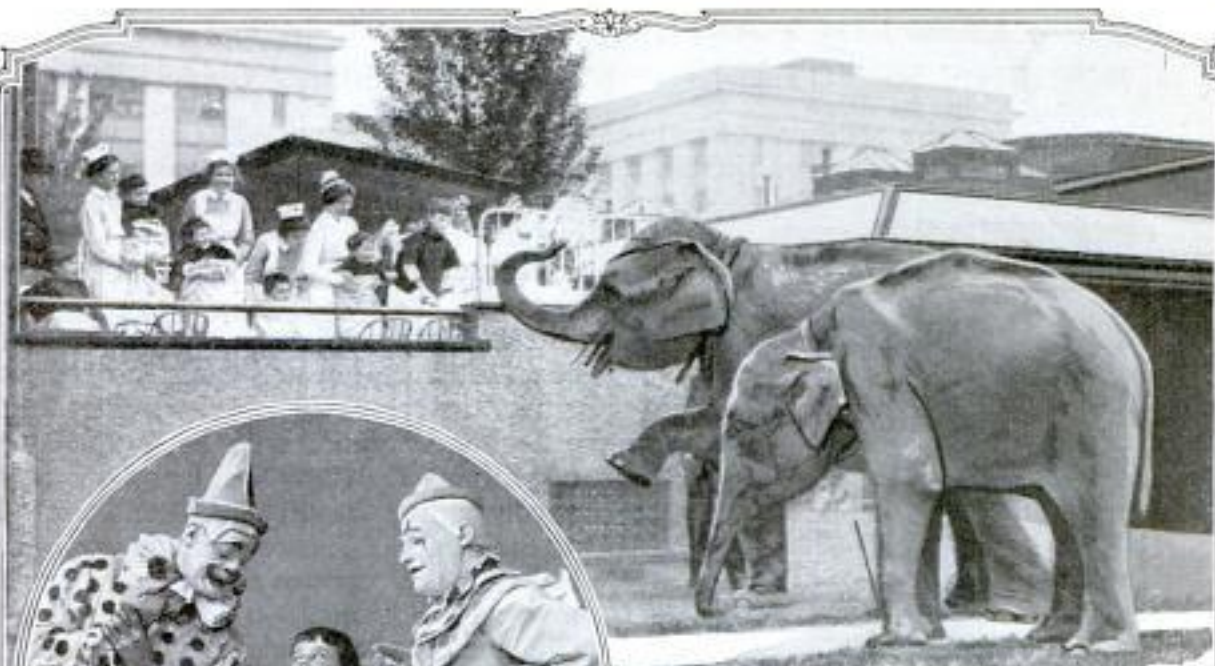

These Circus Elephants are Performing for Sick Little Folks in a Boston Hospital Yard, and the Clowns are Making Fun for a Crippled Child That cannot Leave Its Bed



A Fine Play Shed Like This Enables the School Children of Coupeville, Washington, to Enjoy Fresh-Air Play in Rainy Weather.



These Little Chinese Children Live and Go to School in New York City, Where They are Taught Many Things about Health, as Well as Ordinary Lessons. Here We See Them Learning to Use Toothbrushes

ADJUSTABLE RIM TOOL FOR TIRE REMOVAL

A new tool for the removal of automobile tires consists of two adjustable



Contracting a Rim with a New Tool for Tire Removal: The Tool Is Adjustable to Any Size of Rim

bars connected with thumbscrews to a handlebar, by which the tool is expanded or contracted when the rim is engaged by lug hooks at the outer ends of the bars. The tool may be adjusted to various-sized rims by merely changing the thumbscrews to different holes spaced along each bar. It is made to fit any one-piece split, demountable auto rim, and enables the tire to be removed without injury.

FIRE-EXTINGUISHER POSTS MARKED WITH RED SPOTS

On the back of each post which serves as support for a fire extinguisher

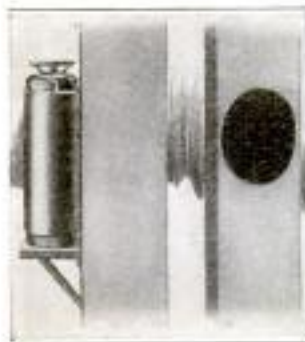

in a manufacturing plant, a red oval has been painted as a guide to employes in case of fire. Because of this conspicuous sign they can instantly locate an extinguisher even though it may be wholly concealed from view by the post against which it stands.

CONTRACTS LET FOR FLEET OF U-BOAT CHASERS

That the Navy Department has made extensive plans for fighting submarines is indicated by the fact that orders recently were placed for the construction of 345 wooden U-boat chasers, each measuring 110 ft. long and having a 15-ft. beam. The total cost of these craft, exclusive of engines, interior fittings, wireless, and other equipment, will be \$32,000,000, of which \$21,000,000 will go to private yards which have contracted for 210 of the boats. The remainder are being built by the various navy yards as follows: New York, 60; New Orleans, 6; Charleston, 8; Norfolk, 21; Mare Island, 15, and Puget Sound, 25. Construction is being rushed at all these points; the New York yard planned to turn out its order at the rate of 10 per month.

Contracts have also been let for 600 engines for the chasers, some of 220 hp. and others of as little as eight horsepower.

RE-INKER LENGTHENS LIFE OF TYPEWRITER RIBBON

A re-inking device which greatly lengthens the life of a typewriter rib-



A Typewriter Ribbon can be Used for an Uncommonly Long Period by Re-Inking It Occasionally with This Simple Device, Which Feeds Ink from a Wick to the Roller

bon consists of an ink-filled tube about the size of a fountain pen, in one end of which is a felt wick that rubs against a roller, when the latter is turned. The ribbon to be treated need not be removed from the typewriter but is fed between a hooked guard and the roller, which transfers the ink from the felt to the ribbon.



A Portable Baseball Backstop Built of Pipe and Wire Netting

By P. P. AVERY

INSTEAD of the common make-shifts, a substantial portable baseball backstop was installed by a ball club, and proved popular and very practical. It may be wheeled to various positions and even transported to a distant field. By turning the front wheel sideways, the stop is securely anchored in place. Construct the frame of 1½-in. galvanized-iron water pipe, with elbows and fittings, as shown. The wheels are cast-iron pulleys of 3-

1½-in. band iron, bent to shape, as shown, and for a bearing use a heavy washer. The top part of the fork is rounded and riveted together to pass through the pipe connections. Drill a ½-in. hole at the top and fasten the fork to the handle, of ¾ by 1¼-in.

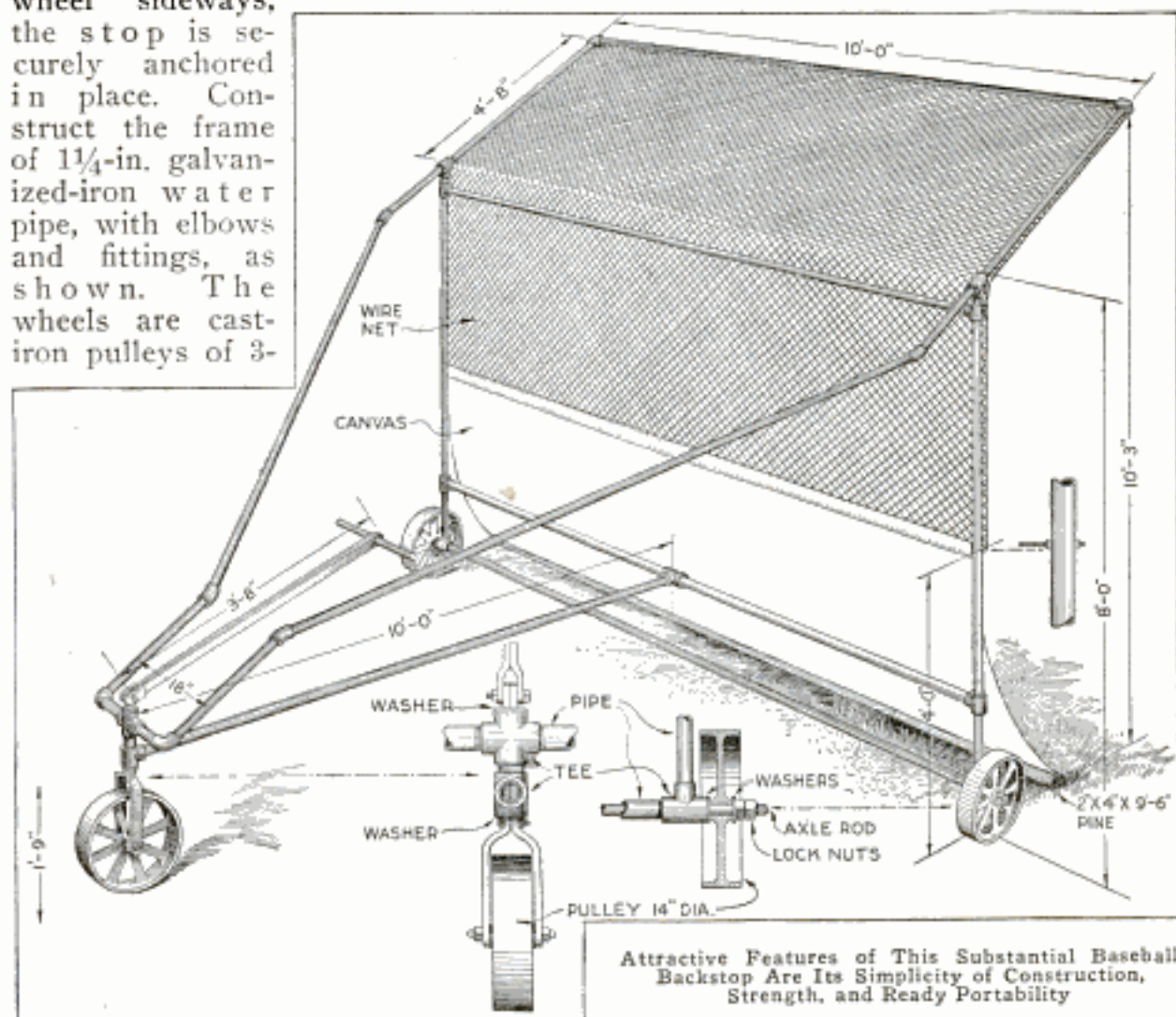

in. face, secured to the bottom cross member, as detailed. Secure the steering wheel by a fork made of ½ by

iron, 3 ft. 8 in. long, arranged to be swung back when not in use.

A net of heavy galvanized-wire mesh

Attractive Features of This Substantial Baseball Backstop Are Its Simplicity of Construction, Strength, and Ready Portability

is stretched over the main frame, and heavy duck, or canvas, is fitted over the lower section. Secure the wire mesh by heavy galvanized-iron wire wrapped around the pipe. The canvas is secured by lapping it over and sewing it. A basket may be slung under the lower front rod, in which baseballs, bats, gloves, etc., may be carried.

Canvas-Covered Wardrobe Protects Workmen's Clothes

Considerable dust collects on the clothes of workmen and employes in

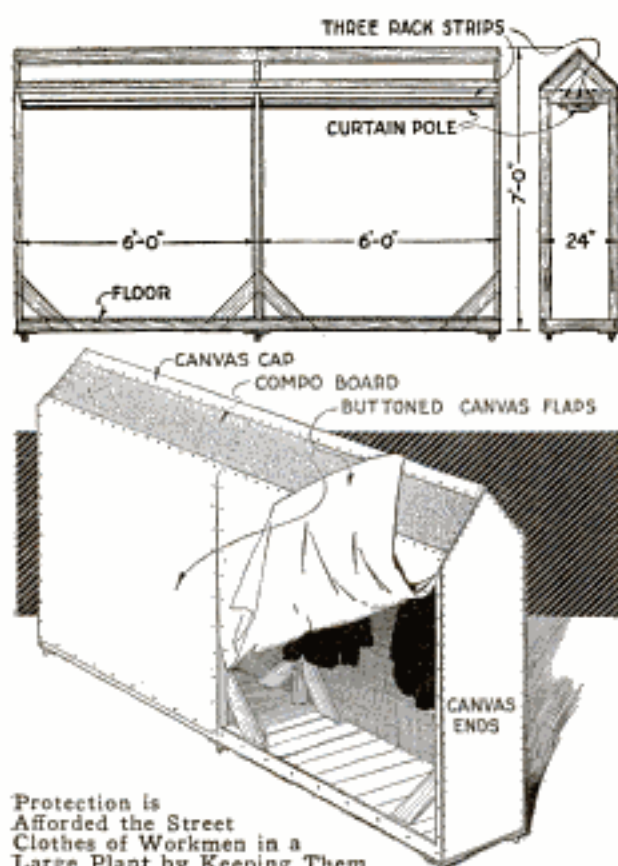

Protection is Afforded the Street Clothes of Workmen in a Large Plant by Keeping Them in Dustproof Wardrobes during Working Hours

shops and workrooms in spite of precautions unless a covered inclosure is provided for them. In a large manufacturing establishment, wardrobes like that shown in the illustration are provided for this purpose. Each employe has a numbered clothes hanger and a portion of a hat rack above its place on the curtain pole, as shown. The clothes are placed in the wardrobe as the employes report for work, and are ordinarily not removed until the lunch hour. The framework for the

wardrobe is built up of 2 by 4-in. stuff, strongly braced. The hat rack is made of three strips set under the gable. The curtain pole is supported by wooden blocks, bolted into place. The dimensions shown may be varied to suit special needs. The frame is set on casters and can be moved handily. The gable is covered with compo board and the sides and ends with canvas. The side curtains are buttoned securely into place when the clothes are placed in the wardrobe.—Charles M. Petersen, Buffalo, N. Y.

Typewriting on Tracing Paper for Blueprint Reproduction

In making duplicate copies of manuscripts having inset illustrations, or in reproducing specifications, the blueprint process is often the most convenient. To letter a considerable quantity of text is tedious, and, if properly done on a typewriter, the result will be more satisfactory. Tracing cloth, or tracing paper, preferably of the unglazed onion-skin variety, may be used. In writing the text on the typewriter, reverse a piece of carbon paper under the tracing paper, so that the impression is made on both sides of the sheet. This will give density, and make the blueprints sharp. If white prints with dark lines are desired, a new sheet of carbon paper should be used, and this taken as the negative in making the prints.

Enlarging Cylinder Fins Aids in Cooling Engine

Repeated overheating of the cylinders of an air-cooled gasoline motor led to experimenting in an effort to prevent this trouble. The result was the fitting of disks, or split rings, of sheet copper, around the cylinder, between the smaller fins cast on the cylinder. The rings were bolted into place, becoming practically a unit with the cylinder. The heat is radiated rapidly, and the cylinder is kept cool in spite of heavy running of the motor.

A Traveling Crane for the Farm

On a large farm, operated with heavy traction engines and other machinery, a method of moving or lifting heavy weights is often necessary. This traveling crane is on a farm at Williams, Calif., and pays for its cost every year in time saved in making repairs or doing other heavy work. The construction can be simplified greatly, to fit the needs of smaller farms, where only a small range is necessary.

The supporting structure is of heavy timber, made in standard braced construction, with posts securely set into the ground. The horizontal beams carry steel rails, on which the carriage rides. It is drawn along by a rope arrangement, which extends, through pulleys, to both ends of the framework, making it easy to move the carriage and load by drawing on the proper rope. The ends of the rails are guarded to prevent the carriage from rolling

off. The carriage consists of a cross I-beam, braced to two wooden supports, in each of which two flanged

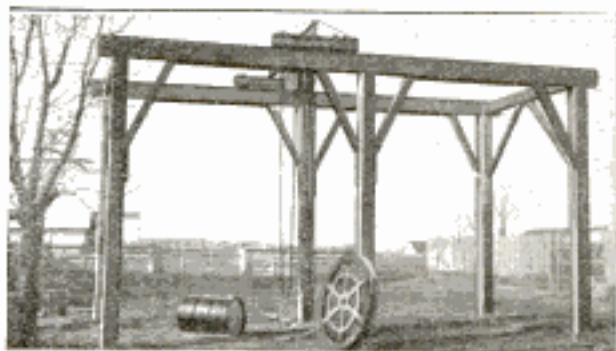

When the Farmer or an Employee Is a Trained Mechanic, Even Heavy Machine Work can be Done on the Farm with the Aid of a Crane

wheels are mounted. These engage the steel rails. The load is supported from the I-beam by a differential pulley, or other tackle. The tackle should be suspended from a trolley, which rides along the I-beam.

A Truck for a Canoe or Small Boat

A canoe must frequently be carried over a trail, or other place, and this work is made convenient by the use of a small truck made of two rubber-tired baby-carriage wheels, suitably mounted. A piece of $\frac{1}{2}$ -in. iron rod is used for the axle, as shown. An old trunk strap, two iron clamps, two small wooden brackets, and a carrying handle of $\frac{1}{4}$ by $1\frac{1}{4}$ -in. band iron are the fittings used.

To make the truck, cut the main piece of $1\frac{1}{4}$ -in. oak, and outline the lower section of the canoe on it, as shown. Make the cross brackets, used to keep the truck steady, and fasten them with screws. Fit the axle into a groove under the main piece, and attach it by clamps,

as shown. Secure the wheels with washers and cotter pins. Attach heavy trunk straps at the ends. To use the truck, set the canoe in place, and buckle the strap around it, as shown. The

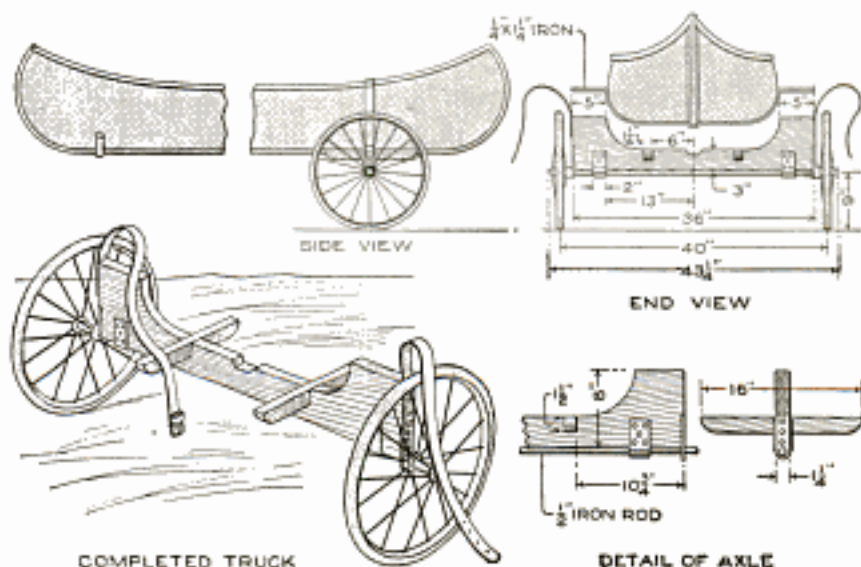

This Canoe Truck, Made of Baby-Carriage Wheels, can be Knocked Down and Carried Handily in the Craft

iron carrying handle is placed under the opposite end. The entire outfit can be carried, knocked down, in the canoe. —J. A. Downs, San Francisco, Calif.

Gong Warning System for Freight Elevator

A simple mechanical safety device that will give returns in the way of immunity from freight-elevator accidents can be

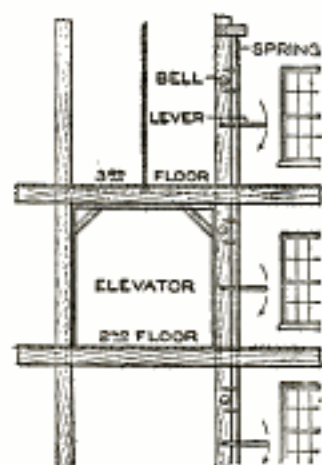

rigged out quickly. Gongs are fitted to the frame of the elevator, at each floor, 6 ft. above it, with the handles below the bells. On the top floor, a coil spring is arranged which pulls the connecting rods

back to the original position after use. A conspicuous card near each handle reads: "Ring Bell before Using Elevator." The bells are the usual tripping pattern. The pull rods and handles are of flat stock, iron or soft steel, $\frac{3}{16}$ by $\frac{3}{4}$ in. Round stock can also be used, but requires more work to make the proper connecting joints. The use of jam nuts makes a better job.—S. A. Seipel, Indianapolis, Ind.

Cutting Floor Openings with Hand Circular Saw

In removing a few sections of flooring to install pipe or wiring, a handy way of cutting the boards, especially across the grain, is to use a small circular saw.

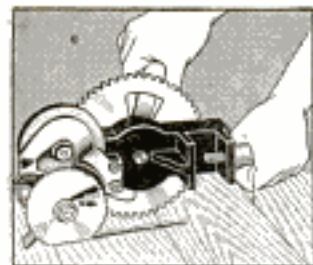

This can be mounted on the spindle of a hand emery grinder, as shown. A handle should be fitted to the frame of the grinder, to steady it, and a projection added to rest on the floor and aid in gauging the depth of the cut. An old plane blade is useful in cutting the tongue from the flooring.—E. C. Galbreath, Denver, Colo.

Wire across Lamp Relights Acetylene Flame

Thin piano wire placed slightly above and at right angles to the acetylene flame of an automobile tail lamp has been found efficient in preventing the light from going out without the knowledge of the driver. The wire becomes incandescent, and reignites the gas when the flame is jolted or blown out. The wire should be drawn taut, so that it is continually in the flame.

Roofing Paper as Emergency Pipe Connection

A quick, cheap, and satisfactory connection for pipes, to carry liquids not under pressure, can be made from

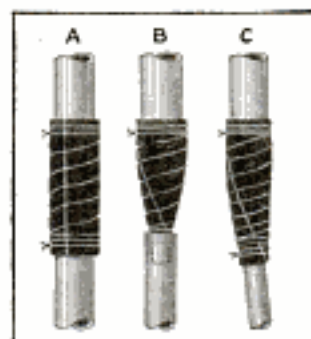

a piece of one-ply roofing paper. Roll the paper into a tube of double thickness, as indicated at A, and tie it into place with wire or cord. Pipes of

different sizes can be joined in this way by the methods suggested at B and C. Pipes that are out of line can thus be connected, as shown at C, and by using heavy paper, and more thicknesses, a connection can be made that will stand being left underground for some time.—Henry Simon, Laguna Beach, Calif.

A Tough Cement for Pipe Joints

A cement which has stood the action of 60 lb. of steam, in a pipe connection where rubber glands and white lead had failed, is made of 10 parts of fine iron filings, and 3 parts of chloride of lime, with water added to form a paste. So tough is this cement, that when two joints of 3-in. cast-iron pipe, which had been secured with it and left one night, were broken apart, the cement scaled off a portion of the iron flange of one of them. The cement is applied in the usual manner.—W. S. Standiford, Youngstown, Ohio.

Equipping Buildings with Lightning Protection



LIGHTNING destroys about \$10,000,000 worth of property annually in the United States, largely on farms. The United States Bureau of Standards estimates that the yearly loss is about \$8,000,000, but it is probable that this is a conservative valuation. Now, it can be shown from unbiased statistics that buildings properly and scientifically equipped with lightning protection are seldom, if ever, damaged. Reliable statistics indicate that lightning rods, even as they are ordinarily installed—and they are not always arranged most effectively—prevent at least 90 per cent of the possible lightning damage. Lightning rods, so the Bureau of Standards report asserts, reduce fire hazard from lightning as much as 99 per cent, in the case of barns. Every individual who owns, or expects to own, property, will find some practical knowledge on this subject valuable, as set forth briefly in this article.

Contrary to general impression, to install lightning rodding so that it will be most effective requires special knowledge, and experience. Any lightning rodding placed on a structure, provided one end is connected with the ground, affords some protection, but the aim is to obtain maximum protection with material purchased at reasonable expense.

Modern lightning-rod practice is largely the result of practical experience, because it is seemingly impossible to duplicate in the laboratory the actual conditions of, and the enormous electrical quantities involved in, a lightning flash. In the appliances for, and in the arrangement of, a lightning-rod installation, simplicity is desirable, and mechanical considerations are al-

most, if not quite, as important as the electrical features.

Some of the terms used are indicated graphically in Figs. 1 and 2. An aerial terminal, a point constituting the upper extremity of an aerial terminal; the conductor, usually a cable or rod interconnecting the aerial terminals and joining them with the earth connections; the earth connections, and other parts, are shown.

Whether iron or copper should be used in the conducting portions of a lightning-rod installation has been a

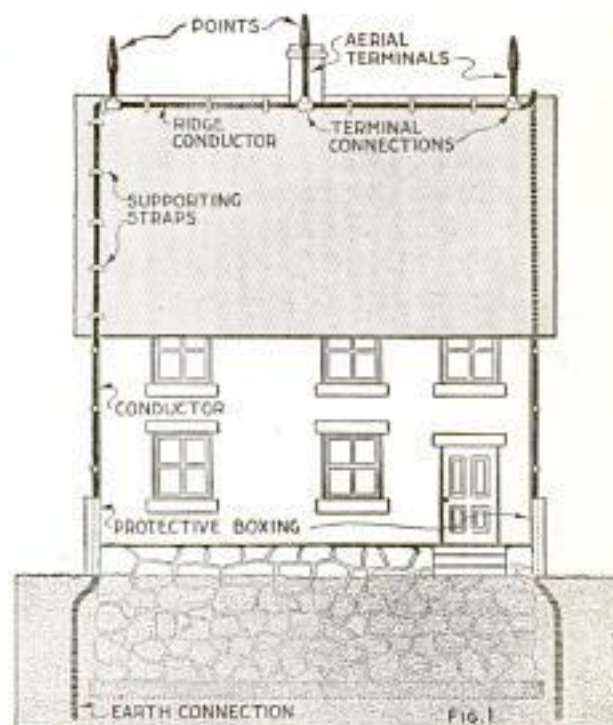

Installation of Lightning Protection on a Small Cottage, the Various Essential Features being Designated

much-debated question, and both sides are partly right. In the light of experience to date, the situation sizes up as follows: Electrically, one may be as good as the other. With either metal, there must be sufficient material

in the lightning conductor—and in the other components of the system that may carry current at the instant of a

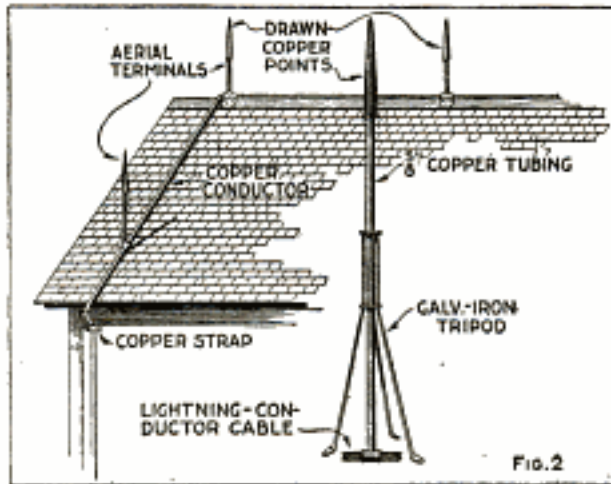

Details of a Roof Installation with Short Aerial Terminals, and a Typical Larger Aerial Terminal

flash—to insure that they will not melt. Because of the fact that iron is a poorer conductor of electricity than copper, it is necessary, from an electrical standpoint, to use a heavier conductor if it is made of iron than if it is of copper. Copper withstands the action of the weather much better than does commercial iron or steel, and has, under practically all conditions, an almost indefinite life. Commercial iron and steel have, relatively speaking, short lives. In certain instances, where iron lightning rods have been installed in dry climates, or where the air is pure, or where they have been kept painted, they have often lasted for many years. From the standpoint of temporary protection it makes little difference which metal is used for the rodding, provided there is enough of it. An iron-rod installation, correctly disposed, will afford much more effective protection while it lasts than will a copper-rod installation applied without regard to the physical facts. Furthermore, flimsy, light-weight, copper-cable conductor comprising very small diameter wires is probably not as good as a heavy-wire conductor because the frail copper is likely to be broken mechanically. It is possible that, with these conditions, the iron would last longer than the copper.

Copperplated or copper-sheathed iron lightning rods and fittings can be distinguished easily from solid copper, but unless one is familiar with the characteristics of metals, the deception may be difficult to detect by superficial inspection. Test the material by its attraction for a small permanent magnet, which will not attract any of the common metals except iron and steel. If the magnet tends to stick to the metal, which appears to be copper or brass, it is evidence that a copper or brass coating is concealing an iron core. The magnet will attract through the deceptive plated-copper, or sheet-copper sheath.

Should or should not the lightning rodding be insulated from a building is answered fairly by this fact: Only a few of the manufacturers of lightning-rod material now recommend and furnish insulators for the rodding. From a physical standpoint, it is undesirable to insulate the rodding from a building, and a great majority of the reliable lightning-rod manufacturers discontinued the use of insulators long ago. However, it is probable that the diminutive insulators, as installed, are almost ineffective as insulators, particularly when they are dirty or moist. These are in certain cases the cause of inductive "side flashes," because they

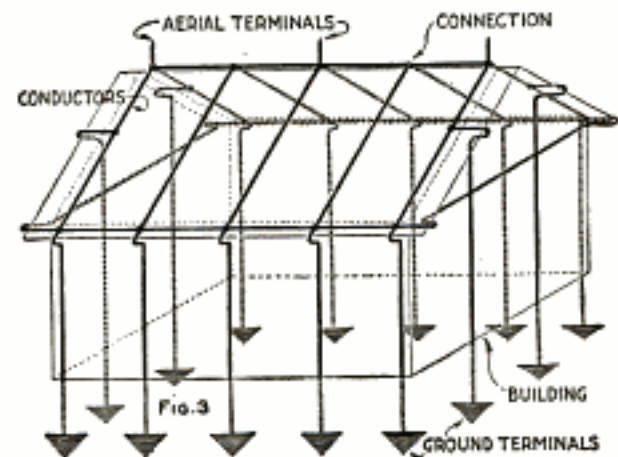

An Ideal Lightning-Conductor Installation, the Structure being Completely Caged

may prevent all parts and the contents of the building from rapidly attaining the same electrical potential as that of the lightning-rod system.

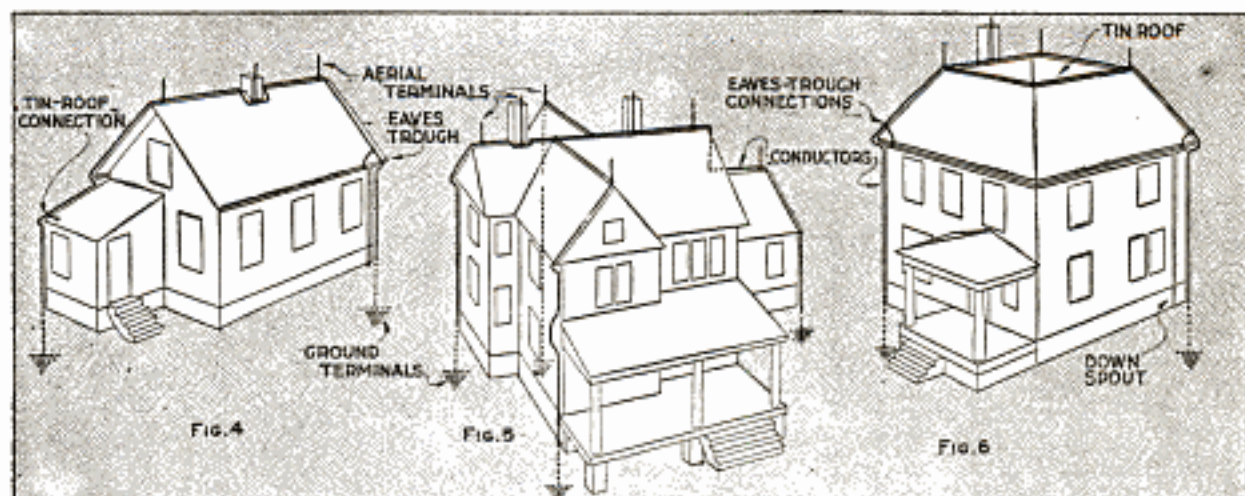

Typical Installation on Various Residential Buildings, the Aim of Maximum Protection with a Minimum of Material being Carried Out Reasonably

The ideal lightning-rod installation would be a metallic cage surrounding the structure. The cage should be electrically connected to the earth and surmounted with metallic points, as shown in Fig. 3. In practice, installations are not made in this way, except where powder magazines, oil tanks, and similar structures, are to be protected. Cheaper methods provide protection which, though possibly not quite so effective, experience has shown to be adequate. The practical problem in arranging protection for a building is so to dispose the minimum amount of material that maximum protection will be afforded by it, and so that it will approximate the ideal grounded-cage arrangement of Fig. 3. Figures 4, 5, and 6 illustrate examples of typical installations.

The conductor should preferably be of copper. It may be round, flat, tubular, or of star section, and solid or woven from wire strands, provided it possesses sufficient mechanical strength, and conductivity. Since stranded cable is mechanically more desirable than a tubular arrangement, it probably presents the best form of lightning conductor. There is no valid practical objection to a solid conductor, except that it is difficult to handle and to install. It must ordinarily be manufactured and shipped in relatively short lengths, which are joined on the job to form the complete conductor. Joints are undesirable, if they can be avoided.

If a stranded conductor is used, no strands should be smaller than .04 in. in diameter. If the strand wires are too small, they will be mechanically weak. There is no reason to believe that "lightning travels in a spiral"; hence, twisted conductors have no advantages, on this ground, over untwisted ones.

In attaching the conductor to the building it should preferably be held thereto with clips of the same metal as that of the conductor. If dissimilar metals are permitted in contact, this may, under certain conditions, cause an electrolytic action between them, which will eat away one of the metals, at the point of their contact. Copper straps, similar to pipe straps, are ordinarily utilized for supporting round-cable conductors. Specially designed fasteners are used where the conductor is not of circular cross section. As a general proposition, the conductor should be supported at least every 5 ft. in vertical runs, and every 2½ ft. in horizontal runs. A conductor should never be supported with nails driven through it, or driven in at one side and bent over, particularly if it is of cable form. Such treatment will certainly sever some of the strands.

⌈The tendency of varnish to "crawl" on the second coat, in cold weather, may be overcome by applying benzine on the first coat, permitting it to dry before applying the second coat.

A Novel Footbridge of Woven Wire

Spanning a small stream on a farm in Missouri is a novel footbridge which a farmer constructed out of woven



A Practical Bridge for a Small Stream on a Farm was Made by Supporting the Footboards on Woven-Wire Fencing

wire supported on heavy fence posts. The bridge will support a load of several persons, but is ordinarily used only for one person at a time. Strong woven-wire fencing was stretched across the stream on posts, set 3 ft. apart and strongly braced with anchored wires. Six-inch boards, 1 in. thick, were fastened on the second horizontal strand of the fencing, and the boards further supported by lacing wire around them, and attaching it at the same time to the several lower horizontal strands of wire, as a safety feature.—George M. Petersen, Buffalo, New York.

Spark Plugs Cleaned with Bag of Shot

A small cloth bag filled with fine lead shot can be carried in the tool chest of an auto without trouble and is of great assistance in cleaning spark plugs. After placing a few drops of gasoline on the plug, the mouth of the bag is tied around the plug body by means of the tie strings. By taking the plug between the fingers and shaking it up and down

a few moments the carbon deposit is removed. The shot does not scratch the glaze on the porcelain, or injure its insulating properties. It may be used repeatedly.—Thomas W. Benson, Philadelphia, Pa.

Rigging for Grinding Screw Threads

Grinding of hardened screws, worms, etc., such as are used in talking machines, sewing machines, and ordnance work, was done by cutting the thread, hardening the work, and straightening it on centers. This method was slow, costly, and inaccurate. The method shown is now in daily use in a large shop, and is very satisfactory.

Of the two spring centers, C and D, the tail center D has a helical spring of about one-half the strength of the spring in the headstock C, and the function of this weaker spring is to keep the centers in place, while the spring in C holds the thread against the flat spring A. These centers and springs fit accurately in the bores of the head and tailstocks, with no lateral play.

The indexing attachment is clamped to the head of the grinder, and the flat spring, at A, is set so that when a point in the thread being ground passes the emery wheel, it reaches the flat spring as soon as possible. The screw to be ground is turned by hand, and as it is turned in the direction of the arrow B, the screw is moved in the

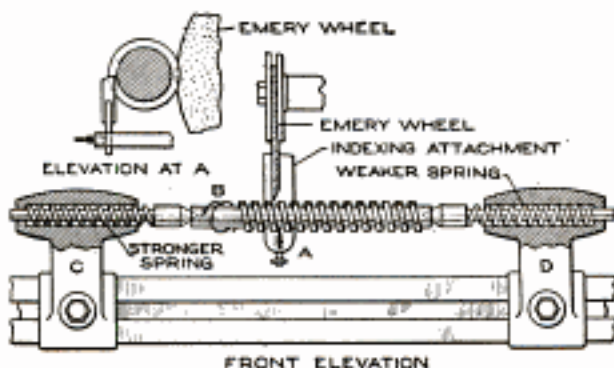

The Emery Wheel Grinds the Threads as the Screw is Turned by Hand

direction of the tailstock, the stronger spring in C compressing the weaker spring in D, and the cut of the emery

wheel is regulated by the flat spring at A.

This method has many applications in taper and spiral dividing-head work, and in some cases where a dividing head is useless, the work may be readily done.—J. B. Murphy, Plainfield, N. J.

Sanitary Shields for Shop Cuspidors

In a large shop, where numerous cuspidors were provided, the floors and walls around them soon became insanitary, and it was decided to provide a standard type of cuspidor and a shield that would overcome this objectionable feature. Enameled basins filled with sand were used, and a shield of sheet metal to fit over the basin was devised. One hundred of these were made cheaply and distributed about the shop. They are easily cleaned with water



Sanitation was Promoted in a Large Shop by the Use of Many Cuspidors Provided with Metal Shields

from a hose, and the results were much better from a sanitary as well as a practical standpoint.—Alfred J. Bell, Detroit, Mich.

Mystery Sailing Ship as Window Display

Devices which excite the curiosity of spectators are often useful as window displays, and it is on this basis that the mystery sailing ship keeps a crowd before a window in which it is displayed. A small wooden ship with sails is placed in a tank, which has rounded ends and is partly filled with water. The ship D sails around the tank A, as indicated in the diagram, because of the draft from two fans, B, hidden

behind screens C. When the ship is forced to the end of the tank, the draft from the fan at that end strikes the



The Ship Sails around the Tank and the Onlookers Are Curious to Learn What Keeps It Moving

sails, shifting them, and driving the craft to the opposite end, where this process is repeated.—R. S. Matzen, Fort Collins, Colo.

Gas-Mantle Fixture Used as a Blowtorch

The portion of a gas-mantle fixture having an air shutter can easily be made into a Bunsen burner, or a blowtorch of considerable force, by flattening the round end A into the form shown at B. The fixture is attached to a gas hose, and the air shutter regulated to produce a sharp blue flame with the desired pressure. This simple arrangement is often useful where a

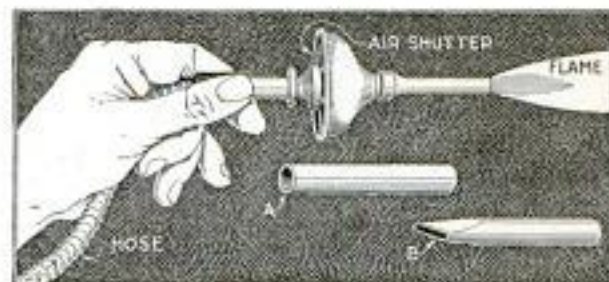

The Mantle Fixture was Quickly Converted into an Effective Bunsen Burner, with a Blowtorch Action, by Flattening the End of the Tube

Bunsen burner of the ordinary type, having a base, is not practical.—M. J. Doyle, Cleveland, Ohio.

Blast for Forge from Stream of Water

For use with a forge, where running water is available, the arrangement shown in the sketch provides a satisfactory blast at small cost. A strong barrel is made water-tight and fitted with a $1\frac{1}{2}$ -in. pipe through the top. The water pipe, in which a valve is set, is passed into the larger pipe, and when the water flows into the barrel, air is drawn in between the pipes, causing a compression in the upper end of the barrel. The compressed air is conducted to the forge by means of a tube. An overflow pipe provides for the excess water.—L. R. Williamson, Astoria, Ore.



Wedge-Shaped Marking Stakes Prove Superior

In the making of marking stakes used by surveyors, builders, and others, a wedge stake, formed as at B, is preferable to one of the straight type, shown at A. The wedge stake is more difficult of withdrawal, and is more likely to remain at the point where it was driven into the earth, a feature of considerable importance because much time and money may be sacrificed when stakes must be relocated. When a straight stake is driven, the hole which it makes in the earth is larger, as shown at H, at the surface of the earth, than it is at the lower end of the stake, and there is not much adhesion between the stick and the soil.

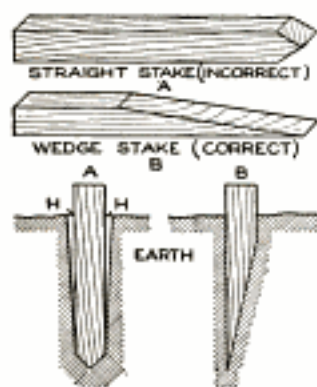

If the stake is cut to form a long

wedge, as shown at B, then all of the surface of the two sides will be in firm contact with the earth, and the resistance to withdrawal will be increased. To determine the relative advantages of the two types, 100 straight stakes were driven in a certain job, and also 100 wedge stakes, under identical conditions. Thirteen of the straight stakes, and only three of the wedge stakes, were lost.

Replacing Broken Foot on Iron Lawn Bench

A bench with metal supports, in a school playground, was broken as indicated, and the foot part was lost.

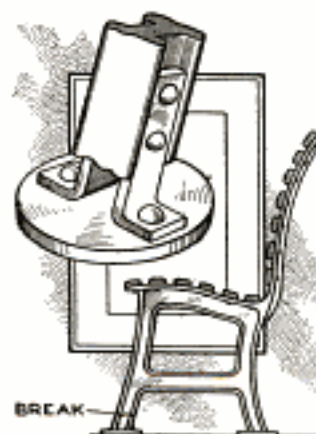

A neat repair was effected by students in the machine shop. Two pieces of $\frac{1}{4}$ by 1-in. strap iron were riveted to the broken end, and to these strips a rounded piece of $\frac{1}{2}$ -in. iron was riveted as a fastening plate, like those on the other legs.—A. L. Braun, New York, N. Y.

Repairing a Hole in a Small Water Tank

A special outlet in a kitchen-range boiler was no longer needed, and, since the locknuts in it were rusted badly, it was necessary to plug the hole by other means. A rubber disk was fitted closely into the hole, and $\frac{1}{8}$ -in. lead washers were placed on each side of it. Iron washers were slipped over these and the entire set was bolted together very firmly, with a $\frac{3}{8}$ -in. bolt. The lead washers were forced into the opening, compressing the rubber, and forming a tight packing.—Fred W. Page, Winfield, Kans.



Compression Coil Spring with Double-Action Case

An arrangement of a coil spring in a case so that the spring will be compressed both when the points of fastening, A and B, are brought farther apart and closer together is useful on doors and on many mechanical devices. A typical housing of a coil spring in a case, such as would be suitable for a door, is shown in the illustration, which is a longitudinal sectional view. When the points A and B are brought closer together, the collar C acts on the spring, compressing it against the collar D, and the bolt head slides in its pocket. When they are brought farther apart, the collar D compresses the

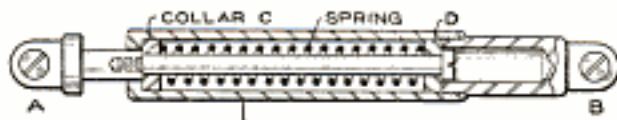

The Feature of This Device Is That the Spring is Compressed When the Distance between the Points of Fastening is Extended or Shortened

spring against the collar C, bearing on the end of the cylinder.—George M. McGinley, Woonsocket, R. I.

Chuck on Emery Grinder Used for Washing Bottles

In a shop and laboratory, an emery grinder was rigged to provide a handy power bottle-washing machine, by mounting a chuck from an old drill on one end of the grinder spindle. The chuck was set on a $\frac{1}{2}$ -in. rod, and this was threaded into the spindle. The bottle brush was gripped in the chuck

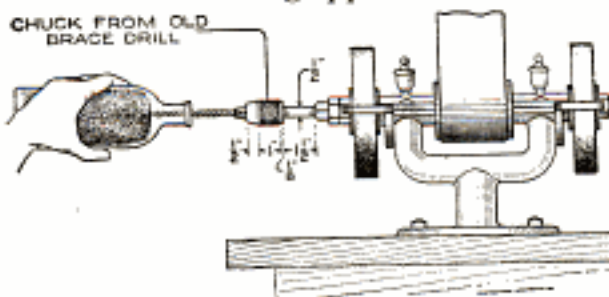

Bottles were Washed Quickly and Thoroughly by the Use of This Improved Washing Machine Attached to the Emery Grinder

and the bottles slipped over it, and held in the hand as shown.—P. F. Jamison, Chicago, Ill.

Pockets on Switchboards for Memos of Special Calls

The traffic manager of a telephone exchange handling a large number of



Telephone Service was Improved by Providing a Code File for Delayed Toll Calls

long-distance messages found that his operators lost considerable time in keeping track of their ticket records of toll calls that could not be completed immediately. To keep the "delayed" tickets constantly before the operators, pockets were constructed along the top face of the switchboard, each pocket marked with the code letters showing the reason for the delay in handling the message, as UDLW: "Party called for is out; left word for him to call." The pockets were made of light tin, painted dull black, and lettered in white. The scheme is very successful in speeding up the service, keeping delayed call tickets in sight of both the operators and the chief operator in charge.—E. C. Blomeyer, Waco, Tex.

Soldering Wrought-Iron Rings by Dipping Saves Time

Certain kinds of machinery require the use of wrought-iron rings, made of cylindrical bar iron of small diameter. It is common practice to solder together the ends of these rings by the use of a soldering iron. When a large quantity of these rings were made at one time, it was found more economical to substitute a dipping process. After the ring is formed, the ends are dipped into a pan of molten solder. This method reduced the soldering time 50 per cent.—Joseph Plogmann, Cincinnati, Ohio.

A Swine Cafeteria in a Barrel

To make this "help yourself" eating house for swine, which was built at the Minnesota Agricultural College at a

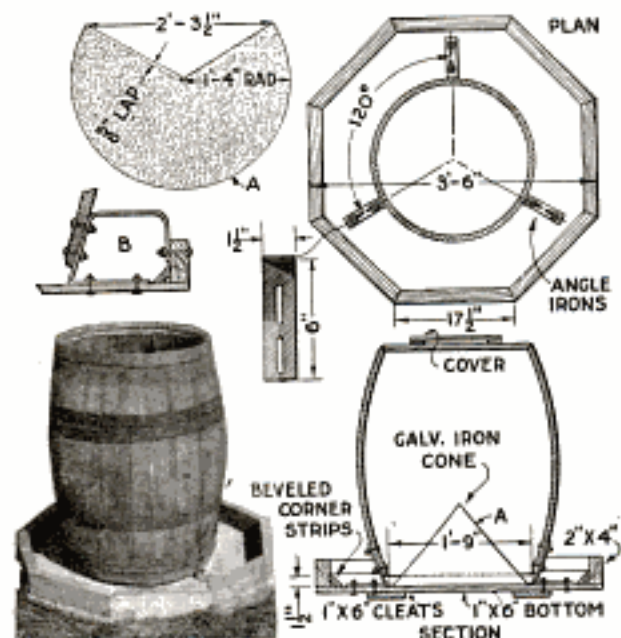

The Construction Is Simple, and the Barrel can be Adjusted Quickly to Increase the Quantity Fed

cost of \$6.50, including labor, obtain an empty barrel, some boards, nails, a piece of sheet iron, and some strap-iron angles. The barrel is supported slightly above the platform, and the grain, or tankage, feeds out around the lower end, from the sheet-iron cone A. Angle irons, as detailed, keep the barrel in position. Two slots permit



Twelve Shoats or Six Full-Grown Hogs are Accommodated by This Self-Feeder

the supports to be slipped out far enough to clear the bolts in the barrel, for easy adjustment of the latter. The

trough and platform are made of 1-in. lumber, and the rim is of 2 by 4-in. pieces. Guards may be attached to keep the pigs from rooting out the feed, as detailed at B. This outfit accommodates 12 shoats or six full-grown animals, at a time. The barrel feeder is cheap and simple in construction, and its durability is limited only by the material used for the trough.—E. R. McIntyre, Madison, Wis.

Builder's Survey Level with Sights from Old Rifle

This homemade arrangement provides a means of ascertaining true levels on buildings, floors, stone foundations, etc., and is made of materials easily obtainable. Make a tripod, using the top plate and the attaching wing nut from an old camera, if possible. Band iron is bent, as shown, and on the top arms an old

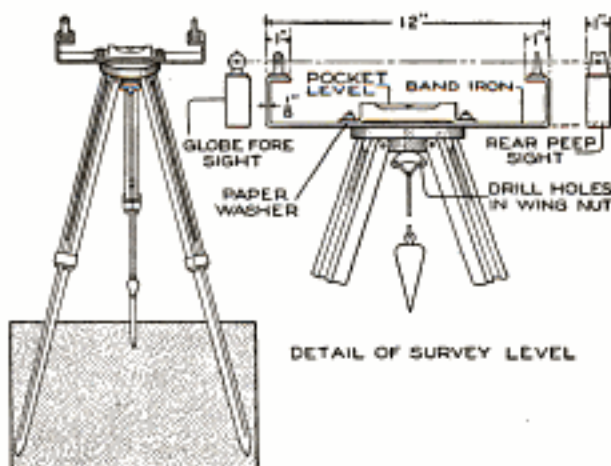

A Serviceable Survey Level, Made at Small Cost, Which Gives Accurate Results

pair of rifle sights are soldered in place, taking care to get them very accurate. Fix a pocket glass level, about 4 in. long, on the direct center of the iron bracket, by the use of two ordinary carpenter's squares. The level in its level position must be absolutely parallel with a line through the peep-sight centers. Insert small paper washers under the pocket-level clamps, and after the sights are soldered to the top ends of the bracket, it will be easy to obtain an accurate parallel. Three

holes are drilled in the iron level bracket, the center one tapped for the camera-tripod thumbscrew, by which the tripod is fastened to the level bracket. The other holes are for securing the pocket level. Old rifle sights are easily obtainable at a locksmith's shop. The plumb bob is suspended as shown.

A Wire-Gauze Stencil

A good background stencil can be made by attaching letters and figures to wire gauze, the color being applied over the lettering, producing a background of the desired color. This stencil is flexible, making it useful on irregular surfaces.

A Tipping Cradle for Carboys

Large bottles or carboys cannot be handled safely while pouring out the contents by tipping, because of their weight and shape. The arrangement shown is built of wood, and makes the handling of carboys safe and convenient. The carboy is placed on the two rockers; the frame of the carboy is gripped by small nails, which protrude $\frac{1}{4}$ in. from the upper edges of the rockers. A strip nailed to the sides of the rockers holds the carboy from slip-

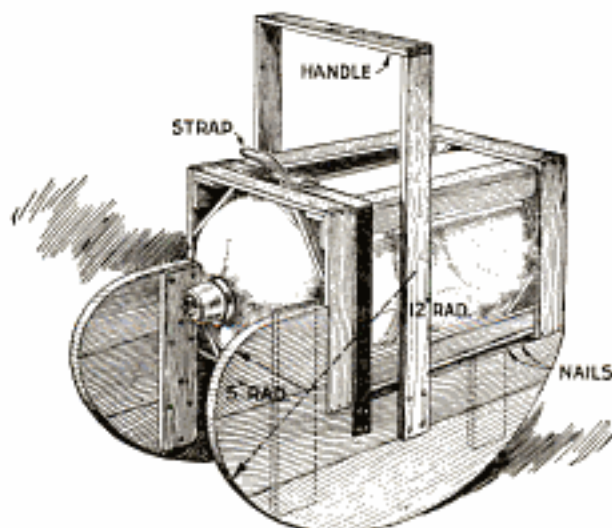

Acids and Other Liquids may be Poured with Safety by the Use of This Carboy Rocker

ping from the cradle. The handle gives a good hold in tipping the device.—John E. Cahill, Jr., New York, N. Y.

Torch for Burning Off Old Paint

A device for burning old paint, or enamel, from automobiles, carriages, passenger cars, locomotive cabs, etc.,

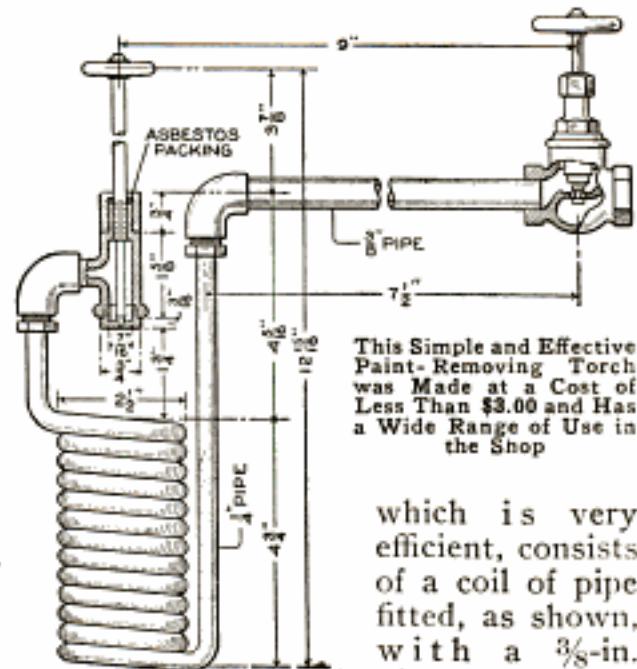

This Simple and Effective Paint-Removing Torch was Made at a Cost of Less Than \$3.00 and Has a Wide Range of Use in the Shop

which is very efficient, consists of a coil of pipe fitted, as shown, with a $\frac{3}{8}$ -in. globe valve and other parts. Gas can be used with it, or a reservoir filled with oil and connected by hose to an air line, which forces the oil out through another hose connected to the $\frac{3}{8}$ -in. globe valve, can be utilized. The globe valve regulates mainly the flow of the oil, and the needle valve controls the size of the flame.

The user holds the device in one hand, and goes over the painted surface, keeping the torch moving slowly, and then holding the burner away, while he removes the burnt paint with a scraper held in the other hand. In using oil, the coil serves a twofold purpose, helping confine the flame to a proper area, and the flame passing inside the coil heats the oil being forced through it to a high temperature by the time it gets to the burner, thus preparing it for combustion.—Joseph K. Long, Renovo, Pa.

Concrete that collects on a mixing machine can be removed easily if a heavy coat of grease is applied to the surfaces where the concrete collects before the mixer is put into operation.

Safety Mirror Attached to Automobile Mudguard

A novel way of mounting traffic mirrors on automobiles, instead of the usual position at the side of the windshield, is on the mudguard of the front wheel, facing the driver, using only ordinary pipe fittings. A crow-foot, or flange, is attached to the back of the mirror, into which is fastened an ell and straight piece of $\frac{1}{4}$ -in. pipe, long enough to extend a few inches below the mirror. A crowfoot is also fastened to the mudguard. The mirror frame and fittings are painted the same color as the car. A better view of what is going on back of the machine is obtained by the mirror in this position.—Harry Slosower, Pittsburgh, Pa.



fastened an ell and straight piece of $\frac{1}{4}$ -in. pipe, long enough to extend a few inches below the mirror. A crowfoot is also fastened to the mudguard. The mirror frame and fittings are painted the same color as the car. A better view of what is going on back of the machine is obtained by the mirror in this position.—Harry Slosower, Pittsburgh, Pa.

Old Steel Columns Reinforced by Concrete Casing

Structural-steel columns, that are rusted to such an extent that further painting is both inadvisable and ineffective, may be kept in a good state of preservation and be strengthened as well by incasing them in concrete, as shown. This system is applicable to many types of columns, and if the concrete is carried to the top, it really becomes a reinforced-concrete column, the steel furnishing the reinforcing for the concrete. Such work has the further advantage of being possible to construct without removing the column from the load it is supporting.—H. P. Roy, Kansas City, Mo.

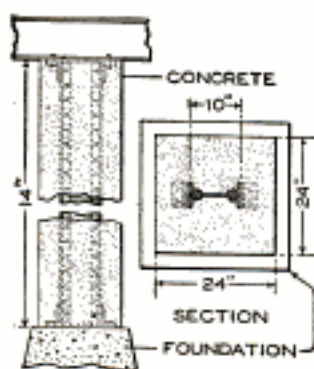

Structural-steel columns, that are rusted to such an extent that further painting is both inadvisable and ineffective, may be kept in a good state of preservation and be strengthened as well by incasing them in concrete, as shown. This system is applicable to many types of columns, and if the concrete is carried to the top, it really becomes a reinforced-concrete column, the steel furnishing the reinforcing for the concrete. Such work has the further advantage of being possible to construct without removing the column from the load it is supporting.—H. P. Roy, Kansas City, Mo.

White Opal Glass Useful for Headlights

An excellent headlight lens that eliminates the glare, gives an ample amount of light when the lights are dimmed, causes no perceptible loss of light on the road in front, while giving more light on the sides of the road and being easy to keep clean, can be provided by using panes of white opal glass cut to the required size. It costs a little more than paper dimmers, but much less than patented lenses. This glass gives a pleasing cream-colored light.—Horace M. Fulton, Washington, D. C.

Ripsaw Cuts Large Nail without Injury

A nail-cutting trick which has many practical uses, and which will interest users of hand-saws, is performed as follows: The performer announces that he will cut off a ten-penny nail with a rip-saw without injuring the saw. He then notches the back edge of

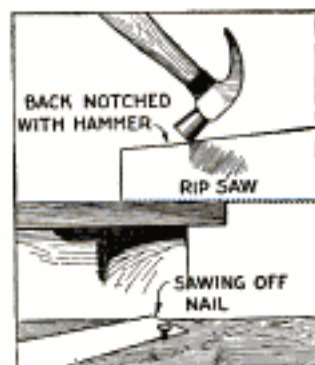

the saw with a hammer, as shown, and, driving the nail into the bench or into a block, cuts it off squarely with the notched edge. This will not deface the saw if the notches are made small, and even adds to the tool's usefulness.—E. Ward, Detroit, Mich.

Pipe Cutter Marks Round Stock for Sawing

Careful work is necessary to saw off round stock with a square end, and the sharp edge resulting is undesirable in many instances. By marking a V-groove in the round bar at the line where it is to be sawed off, a guide is provided for the sawing, and the edge is neatly beveled off, when the cut is finished. Use a pipe cutter for the groove.

A Heavy-Current Radio Transmitter

By EARL C. HANSON AND ALBERT MARPLE

A TRANSMITTER that has withstood heavy and constant service, proving its reliability, is shown in the sketches drawn from photographs. A front view of the transmitter is shown in Fig. 1. The face is 4 in. in diameter. The side elevation, Fig. 2, shows clearly the front chamber A, at the back of which is an insulated slate cup, B, which contains a teaspoonful of carbon grains. These grains are larger than those used in the ordinary transmitter, and do not burn so readily. The rear of the chamber is of fiber insulation, used to conduct the electrodes into the cup containing the carbon grains. The latter may be purchased from stores handling telephone supplies.

This fibre piece B is shown as viewed from the back in Fig. 3. The two setscrews C, at the circumference, hold the electrodes D, shown in the center of the fiber plate, from moving in or out after being once adjusted. One wire of the aerial circuit is connected to these electrodes, the other being fastened to the metal standard E, supporting the transmitter F in various positions. The transmitter is held firm by means of setscrew G. The front half is fastened to the back by two setscrews, near the circumference of the 4-in. diameter piece, and holes, H, are drilled for air circulation, to keep the inner chamber cool.

At the right, in Fig. 4, is shown an inner view of the front half of the transmitter. A ring of thin mica, J, crossed by the ends of the six radial clamps K, holds in place the carbon diaphragm L, at the center. The clamps serve, also, to hold the tension of the diaphragm constant. The two longer threaded screws M are those used in holding together the front and back of the transmitter. At the left is shown the back half, with the inner chamber containing the carbon grains N. The main chamber of slate O, formed by the

raised edge around the back half, is shown, and a ring of soft asbestos, P, may also be seen. This keeps the car-

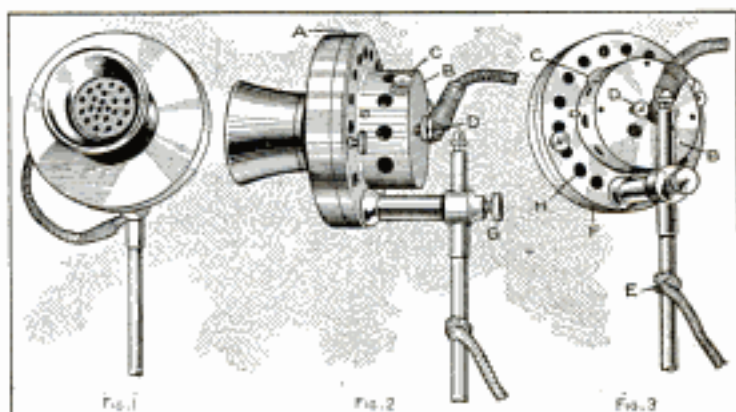

Assembly Views of the Transmitter, Showing the Mouthpiece, the Housing, and the Connections

bon grains from packing under the slate cup and the diaphragm. Across the center of the cup is a thick strip of mica, Q. This is not essential, having been used in experimenting with the carbon grains divided on either side of it.

Figure 5 shows the inner construction of the back portion of the slate chamber, and the electrodes which conduct the current into the cups holding

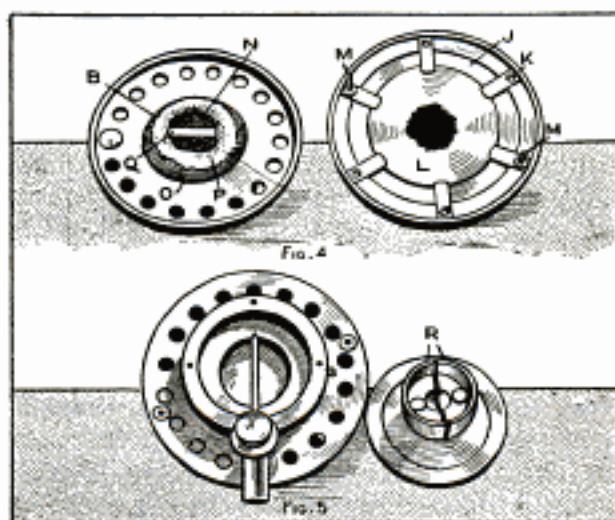

Interior Views Showing the Detail of Construction, the Slate Chamber Being at the Right in Fig. 5

the carbon grains. At the ends of the electrodes are semicircular pieces, R, of ordinary hard carbon. One of the novel features of this transmitter is that the chamber holding the carbon

grains may be increased in size by simply loosening the setscrews C, Fig. 2, which hold the electrodes in place, and drawing them outward, leaving room in the chamber for more grains.

Extension to Drafting Table for Long Radii

Draftsmen often find it necessary to draw arcs of so large a radius that the beam compass cannot be centered on

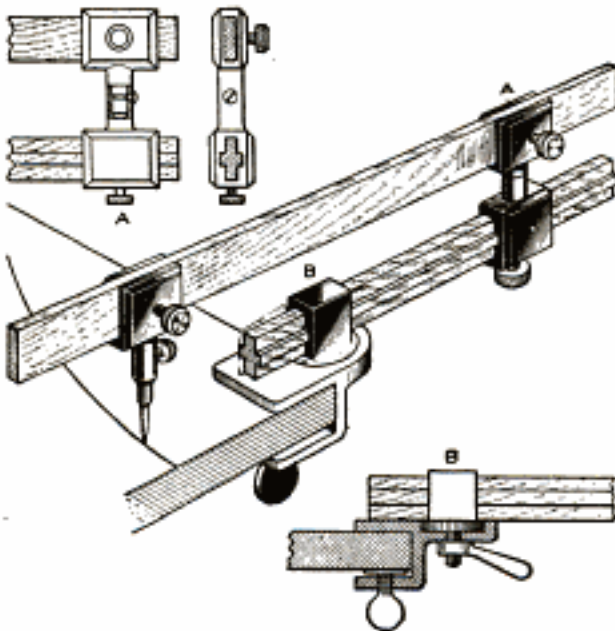

The Drafting-Board Extension is Clamped to the Edge of the Board or Table, and the Necessary Adjustments Made by Sliding the Members A along the Supporting Beams

the drafting table. Various makeshifts are devised, but are more or less unsatisfactory. In an office where much of this work was done, the device shown in the sketch was made out of parts of an old beam compass, and a special clamp made from an old vise casting. This arrangement gave a very substantial job, but simpler devices for the same purpose, and for use in locating centers in perspective drawings, can be made quickly by most draftsmen. In the arrangement shown, the parts A were made from fittings of a beam compass, and a long arm was provided. Because of the shape of the opening in the casting B, the supporting arm was made to conform to it, and proved very substantial.—Gus Hansen, Peachland, B. C., Canada.

Also, this feature assists in making the initial adjustments, while the transmitter is being first tested out. The mouthpiece of this transmitter is similar to those found on like instruments.

Safety Pins Replace Small Cotter Pins to Advantage

On automobile engine parts, such as accelerator control-rod connections, which often must be disjoined, and in other light machinery, where ordinary cotter pins are used, they cannot be removed handily and, in the small sizes, bend under a twisting strain. Strong safety pins proved serviceable substitutes, and had greater torsional resistance than any cotter pins for the same size of hole. They stay on, and can be taken out and put in easily.—Horatio N. Holton, Chicago, Ill.

Hot-Water Supply and Radiator Heat from Hot-Air Furnace

The sketch shows how an installation was made by which hot water was supplied at a faucet, and a radiator was heated, in a cold part of the house, from the hot-air furnace. Most furnaces of this type have an opening beside the fire door for a heater coil. Two lengths of $\frac{3}{4}$ -in. pipe, joined with a return fitting, were used at the furnace, and the pipes connected as shown. The radi-

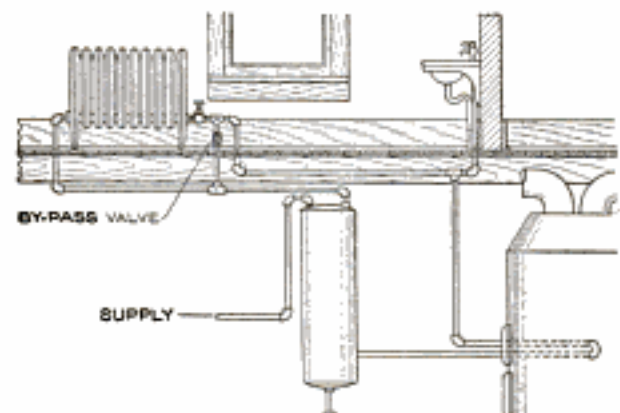

By Adjusting the Radiator and By-Pass Valves the Circulation may be Limited to the Faucet Connections

ator may be shut off without disturbing the circulation to the faucet by means of the by-pass valve.—J. J. O'Brien, Buffalo, N. Y.

Babbitting Mountings for Ball Bearings

When a ball bearing is used in assembling machines, the housing, or mounting, should be finished to close dimensions. This work is expensive. A quicker and cheaper method is to make a dummy of iron, exactly the same size and shape as the inside of the housing. It should be polished, so that no babbitt can stick to it, as shown. The mountings are made in halves. When ready for pouring the babbitt, the dummy is put in one of the halves of the housing so that the shafts of the dummy are resting on the proper bearings in the housing. In order to prevent the hot babbitt from running out at the ends, fire clay, or whiting mixed with asbestos fiber, is used to seal up the ends. The dummy

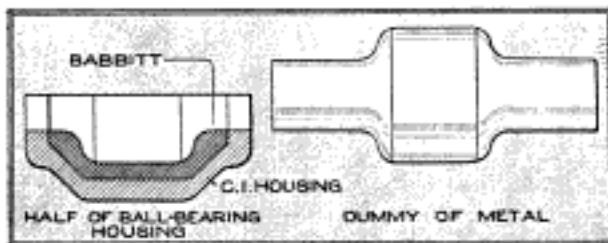

Housings for Ball Bearings can be made Quickly by the Use of a Metal Dummy

is removed when the babbitt has cooled, and the other half of the housing is babbitted similarly.—Joseph Limbrunner, Shelton, Conn.

Wire Protective Screen Increases Usefulness of Vacuum Cleaner

In the cleaning of trays containing small screws, and similar fittings used in shops, it is inconvenient to remove the articles in order to get at the dirt. Especially when the parts are small, such as metal type, the use of a powerful vacuum cleaner is not practical, and blowing out of the dust is not satisfactory. By covering the trays, or other places to be cleaned, with wire screening, and rattling the contents, the dust may be effectively and quickly removed with a vacuum cleaner.—John Robinson, Hillsdale, Mich.

Barrel Truck Made of Pipe and Fittings

Adjustability to various sizes of loads and great strength are features of a truck made of pipe and fittings. To make this truck, obtain two $\frac{3}{4}$ -in. pipe crosses, A; two tees, D; a $\frac{1}{2}$ -in. pipe union, F, and suitable

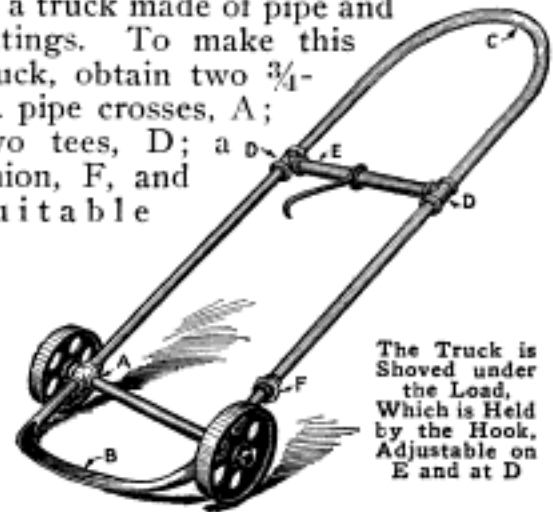

The Truck is Shoved under the Load, Which is Held by the Hook, Adjustable on E and at D

lengths of $\frac{3}{4}$ -in. pipe for the other parts. Bend a section of pipe, 26 in. long, as shown at B, so that the "U" is 18 in. wide. Thread each of the ends and flatten the central portion at B. Join the crosses on this piece, as shown. Thread and shape the piece C, which is $5\frac{1}{2}$ ft. long, to the same width. Slide the tees D, fixed to the pipe E, on pipe C, setting the hook in place. The latter is made of $\frac{3}{8}$ -in. round iron, to slide on pipe E. The hook and the bar and tees D may be moved as desired. Fit the union and a suitable nipple at F. Run an axle through the crosses A, and put on the wheels. To use the truck, run end B under the barrel, or crate, and place the hook over the top, holding the load securely.—S. N. Miller, Denver, Colo.

Emergency Fuse Circuit for Motion-Picture Lanterns

To save time in exchanging fuses in a motion-picture-show lantern room, I devised the plan of wiring shown in

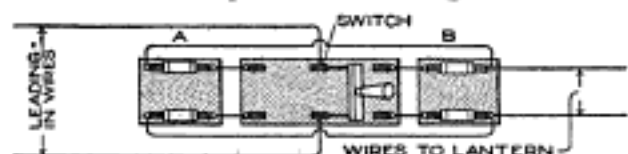

The Operator Simply Throws the Switch into Circuit with the Extra Fuse Block, If the First Set Blows Out

the diagram, consisting simply of a double-throw knife switch connected with two fuse blocks, so as to throw either of them into use at will. Thus, if a fuse burns out, it is only necessary to throw the switch over, and go ahead with a new set of fuses; while the burnt-out one may be replaced at leisure.—Fred Kuhlmann, Peru, Neb.

Hinged Tread Covers Puddle at Worn Doorstep

Often it is desirable to lay a board over a spot where water is apt to lodge just outside the doorstep. An im-

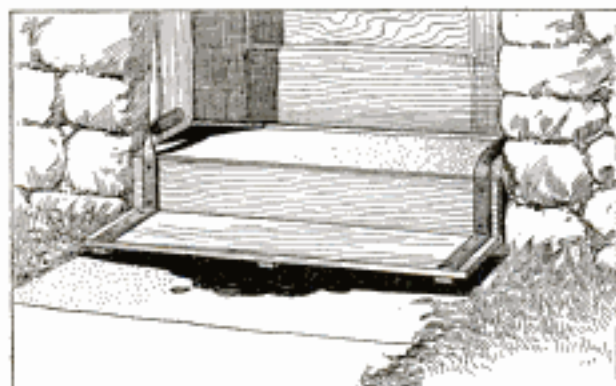

The Wooden Tread Bridges a Worn Place in the Doorstep, Where Puddles Form

provement on this method is shown in the sketch, being a riser and a tread hinged, by means of two bent iron straps, to the door frame. The hinges hold the step in place and permit its being raised when sweeping.—Albert O'Brien, Buffalo, N. Y.

Stereotyping without Special Apparatus

Frequently it happens, in small newspaper or printing offices not pro-

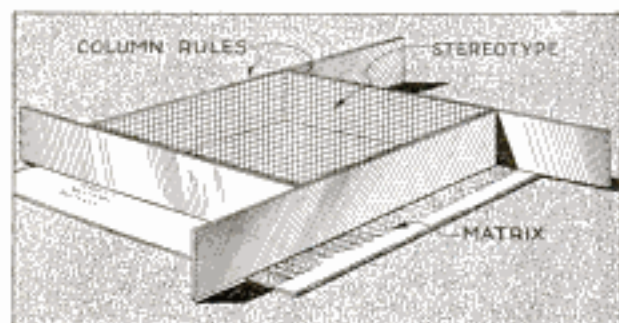

By This Method Small Cuts can be Cast from a Matrix with No Special Apparatus

vided with stereotyping equipment, that some advertiser wants a cut made from a paper matrix, and it can be done with very little trouble, as follows: The mat is warmed, and laid on a previously warmed stone, or other flat surface. A dam of column rule is built around it, and held in position by weights against the outside. The dam is filled with metal, and, after cooling, the casting is cut down to size, and made type-high by pasting paper or Bristol board to the bottom of the cut.—J. S. Hagans, Toledo, O.

Device for Unrolling and Measuring Wire Mesh Handily

Screen wire, when being unwound, has a tendency to roll toward the part that is being unwound, and will not remain still. To remedy this, a hardware man made an arrangement as shown. A counter, about 12 ft. long, was used, on which to unwind the wire. On one end of the counter, two rollers, 2 in. in diameter, were placed, about 4 or 5 in. apart. The rollers were set so that the roll of wire can be placed on them, and then be unwound. The weight of the wire holds it on the two rollers. Rolls of screen

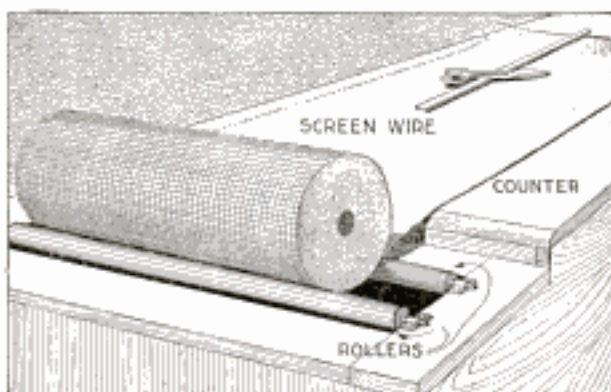

The Awkward Handling of Screen Wire in Rolls is Overcome by This Arrangement

wire can be kept handily under the counter on special shelves.—Lee M. Delzell, Maroa, Ill.

By slitting the point of a pen-filling quill on an ink-bottle stopper and bending it into a cuplike form, ink can be transferred to the ruling pen more handily.

A Folding Cabinet for Drafting Equipment

Provision is made for the storage of a great variety of drawing equipment—instruments, pens, brushes, inks, etc.—in small space, by the cabinet described, and the contents are readily accessible when needed, or in use. It can be placed on a stand or drafting table, but a better arrangement is to mount it on a swinging wall bracket, of such radius that the contents can be swung to the most convenient position. When not in use, the materials are packed into their places, and the cabinet closed up and swung out of the way. No dimensions are given, as these will be governed by the equipment to be housed, and the space accommodations.

The outfit, as shown, consists of three trays and an outer case, the upper and lower trays C and A being movable, while the center tray B is stationary. The various kinds of materials and tools suitable for the compartments are suggested in the photograph. The construction and operation of the trays are shown in the sectional view. When the case is closed the compartment C slides back into its original place. The compartment A folds down as indicated by the dotted line, and the cover D folds forward to its dotted position. The brace E, which is held in place by the clip F when supporting the raised tray A, is released and folds into the cover section D, when the

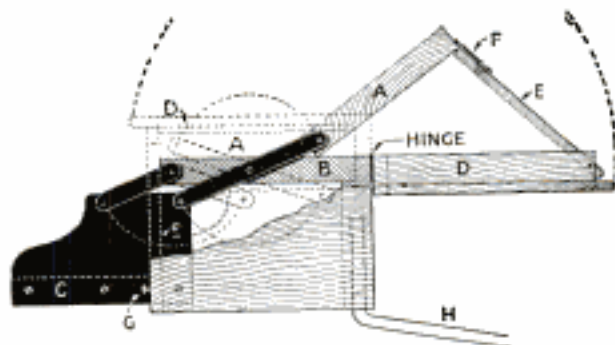
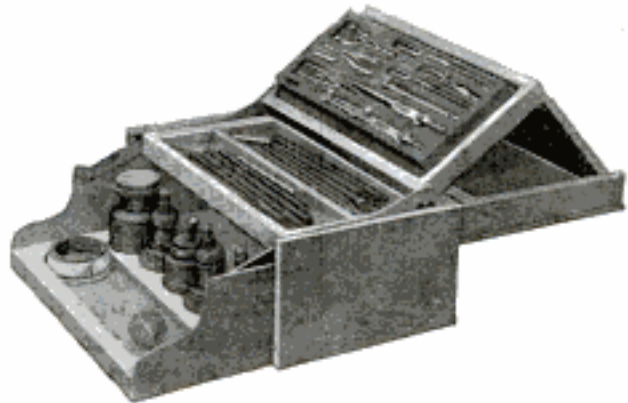

Diagram Showing the Method of Folding the Various Sections into the Cabinet

cover is closed. The compartment C is locked into place by a metal strip engaging the round-head screw G, and

the arm H is set into a hole bored in a block, glued in one corner of the lower



When the Cabinet is Folded Open, the Drafting Equipment is Compactly Arranged, Yet Easily Accessible

section.—T. T. Sturgeon, Los Angeles, California.

Tool for Fitting Piston Rings

When assembling the pistons and cylinders of gasoline motors, trouble is usually experienced in inserting the

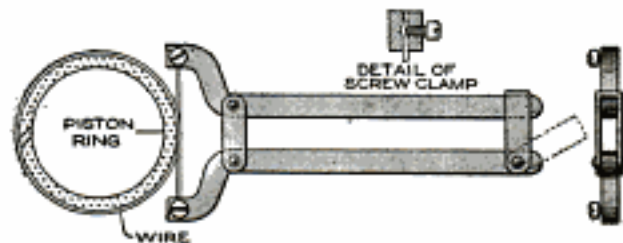

Piston Rings can be Fitted Handily with This Homemade Tool

piston rings. An effective tool for this purpose is shown in the sketch. A piece of music wire, $\frac{1}{16}$ in. in diameter, is given a turn around the piston ring, and the two ends are fastened in the proper ends of the levers, as shown, by means of the clamping screws, with the handles wide apart. When the handles are brought together and clamped in the loop, the wire is tightened up and the piston ring compressed, so that it will readily enter the cylinder. The tool can be made to suit the pistons, and should be made of $\frac{1}{16}$ by $\frac{5}{8}$ -in. strap iron, and about 9 in. long over all.—W. B. Burr, Boston, Mass.

CA good working surface is provided on a drafting table by covering it with smooth, heavy paper.

Cutting Thin Metal Washers by Hand

When washers are needed, heavy metal or tools with which to make them are some-

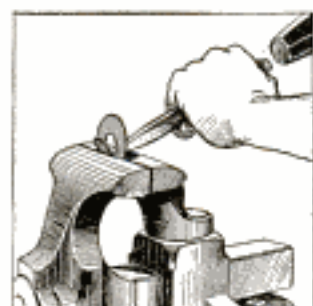

times not at hand. Washers made of thinner metal may be substituted, several being used to build up the proper thickness. An easy method

of cutting these is to mark them on the sheet metal, trim them off on the outside, and cut the centers out with a cold chisel. Turn the washer as the cut progresses, guiding the chisel on the vise.—Hugo Kretschmar, West Nyack, N. Y.

Setting a Rivet Handily in an Awkward Place

To get a rivet into an awkward hole so that it can be riveted from the outside, put soft laundry soap on the end of the finger, press the rivet in firmly, and put the finger at the rivet hole. With the other hand, put the nail in as a leader, and work the rivet into the hole. A small countersunk hole in the end of the rivet makes it easy for the nail to engage the rivet.—Arthur F. Stern, Milwaukee, Wis.

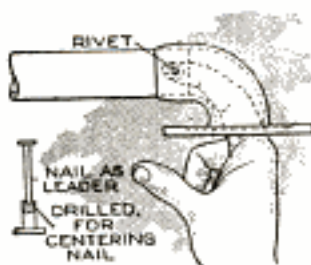

Measuring the Velocity of a Stream

To measure the velocity of a stream, step off or measure 120 ft. along the bank, where a straight course may be found. Throw several floats—tightly corked bottles will do—into midstream, and time them over the 120-ft. course. The average time of all floats divided into 100 is the average rate per minute. Water flows faster at the top of

the stream than at the bottom and sides; the ratio of 100 to 120 is about the proper one to correct for this fact, giving the average velocity at a given cross section. By using the 120-ft. course, the calculation is simplified.—R. Z. Kirkpatrick, Washington, D. C.

Gas Engine Transported by Rolling It on Flywheels

To obtain the maximum hours of daily service from a gas engine, I was obliged to move it from place to place. By using squared pieces of timber under the flywheels on which to roll the engine on the wheels, this work

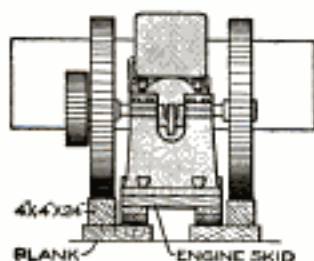

was made easy for one man. By turning the wheels the engine can be moved readily considerable distances, the timber being moved forward as required. The water tank should be empty. Timbers 4 ft. long are handiest, especially in turning corners. Unless in a dusty place, it is well to open the compression-relief cock when moving the engine in this way.—J. E. McCormack, Haliburton, Ont., Can.

Handy Wrench with Drift-Pin Handle

When erecting or installing machinery where cast-iron flanges, with bolts, connect the parts, it is often necessary to draw one of the flanges into place, to get the bolt holes to match. When there is not sufficient clearance to use a mandrel or drift pin, a rod bent to a short right angle is handy. An angle of this kind forged on the handle of a wrench, as shown, combines two useful tools, and has proved quite popular, as indicated by frequent borrowing of it.

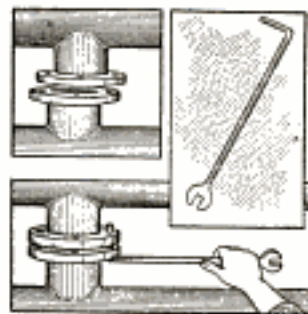



Pivoted Searchlight Made of an Old Milk Strainer

By JOHN J. SPAULDING

BOTH as a safety device and a practical novelty, a homemade searchlight for a canoe, or other small craft, is worth while making. An old milk strainer was used for the reflector of that shown, and many equally serviceable makeshifts can be devised easily from old cans, or formed from sheet metal. The detailed construction, as indicated, is suggestive only, since local conditions and materials available will govern the design of the fittings. The light has a double control, one cord governing the vertical adjustment, and another, arranged like that of a ship's wheel, the horizontal pivotal range. The vertical adjustment is desirable, but not essential. The control cords are run in screw eyes along the coaming of the craft, so that

cells, stored under the bow deck, or in a box set at some other convenient place, supply the current for the 6-volt lamp.

The main dimensions of the fittings, as detailed, are: strainer, 10 in. in diameter and 10 in. long; vertical sup-

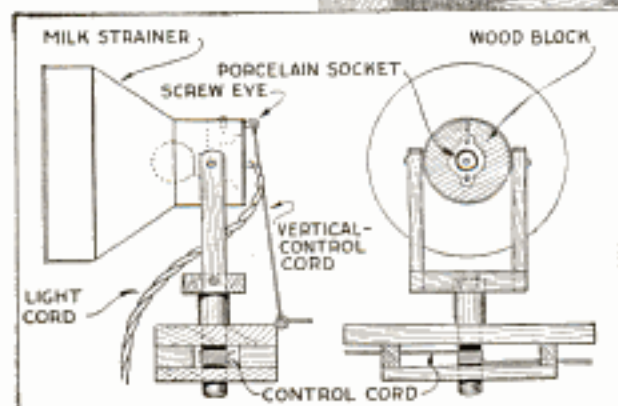
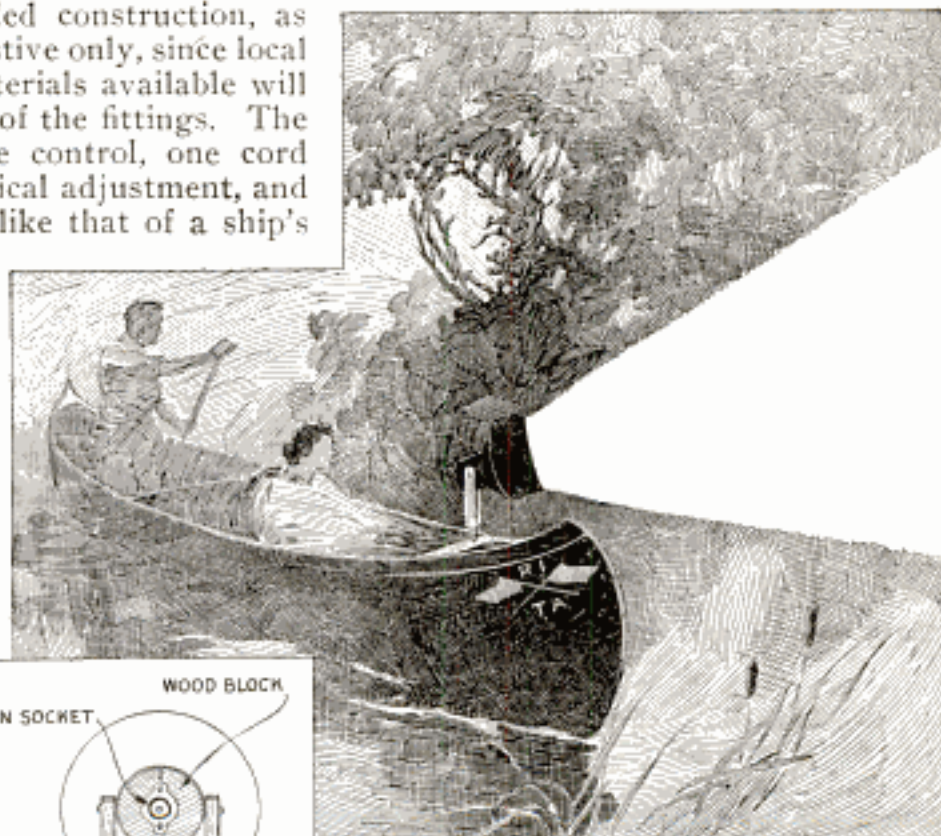

The Support for the Reflector is Pivoted in the Deck, Reinforced as Indicated

one person can paddle the canoe, and adjust the searchlight as well. Dry

Canoeing and Boating at Night Is Safer and More Pleasurable if the Craft is Equipped with a Searchlight. This One was Made of Pick-Up Materials at Small Cost

port, 12½ in. over all, and 6 in. wide at the upper portion; the wood used is ½ and ¾ in. thick, except that for the pivot post, which is 1 in. thick. The reflector is fitted with a wooden block through which the porcelain socket is set, as shown. A knife switch,

placed near the stern of the craft, controls the connection with the battery circuit.

The inside of the reflector should be polished with emery cloth, and if the surface is rough, it may be painted with white enamel. The outer surfaces of the metal part are painted black. The wooden parts may be painted, or given several coats of spar varnish, to withstand the weather.

Gravity-Feed Coal Hopper on Truck

In the large farm kitchen, in the workshop, and even for firing a small furnace, a coal hopper that will hold considerable coal, and that can be rolled along the floor easily, is a convenience. Such an arrangement, made from a section of galvanized-iron pipe, 10 in. in diameter and 30 in. long,

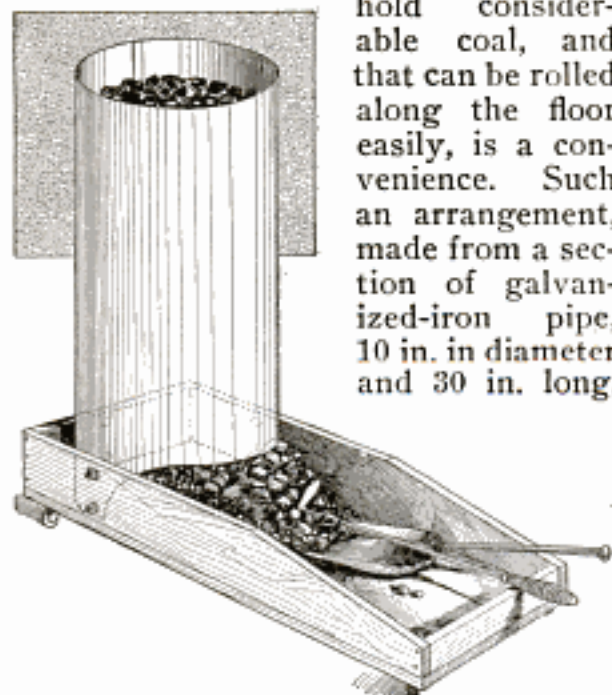

The Large Capacity of the Hopper and the Ready Portability of This Arrangement Are Practical Features

is shown in the sketch. The pipe was cut at one end, as shown, so that when the coal was poured into the hopper, it would feed out. A truck, mounted on casters, was made, 12 in. wide, 5 in. high, and 25 in. long. The hopper was mounted on one end of it, and bolted securely at the sides and end. The coal is shoveled into the hopper at the bin, and the load pushed to the furnace, where it can be easily used as needed. The construction can be made larger for use with a coal scoop, in firing a boiler or large furnace.—L. R. Markwood, Factoryville, Pa.

Taking Photographs in Falling Snow

Falling snowflakes in a camera photograph—the large feathery, slow-falling kind—often make an exquisitely beautiful picture out of a commonplace scene. And while the great majority of the attempts to get them prove failures, the photographer—usually an amateur—needs only to provide an avenue in front of his lens a short distance, that is free from falling flakes, by the use of a shelter such as a tree or porch. The slow snapshot necessary in cloudy weather will not stop the motion of the flakes nearest the camera, and these passing through greater angles of space in equal length of time than those farther away, will blur on the negative. We made some excellent outdoor views in deep snow, while heavy snow was falling, with flakes splendidly decorating the darker regions of figures and foliage, by holding a felt hat and two umbrellas in a line in front of the camera, and above the range of the lens.—J. Cecil Alter, Cheyenne, Wyo.

A Double-Contact Vibrator

A double-contact vibrator, which eliminates sticking contacts, spring troubles, and other sources of annoyance, in addition to producing a fine, high tone, is shown in the sketch. It is an instrument easy to construct, by reason of its simplicity. Special care in making the vibrator D will insure good vibration. The springs, holding the contacts, are of phosphor bronze. The contacts may be made of silver, platinum, or other metals, which will not burn and break contact. The coils

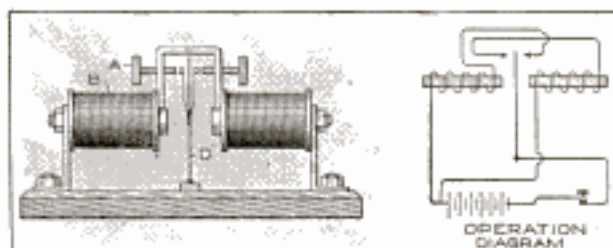

When the Vibrator Touches One Contact, the Coil on the Opposite Side Attracts the Vibrator, This Process Being Repeated Alternately

B are of the common bell-ringing type. The springs on the vibrator should not be too long, nor too weak; experimenting will determine the length at which they will work best. The adjustment is made at the thumbscrews A. The coils are supported on metal brackets, bolted to a wooden base. The method of hooking up the vibrator in the key circuit is shown in the diagram.—J. L. Taylor, Barker, N. Y.

Battery Buzzer Converted into a Telegraph Sounder

An ordinary battery buzzer may readily be converted into a telegraph sounder for use in practicing the Morse code. All that is necessary is to connect the vibrator contact C of the buzzer to the binding post that is not insulated from the frame. The other connections of the key and battery are the same as in any ordinary telegraph or buzzer circuit. In the diagram, C represents the vibrator contact; D, the wire connecting the contact and the

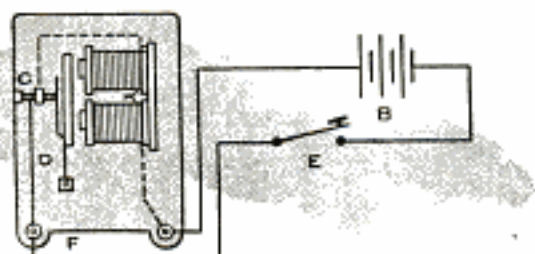

The Amateur can Practice the Morse Code Handily on This Sounder, Made from a Buzzer

uninsulated binding post, and F, the uninsulated binding post; E is the telegraph key, and B, the dry cells.—Clarence F. Kramer, Lebanon, Ind.

Lawn Seats Built on Tree Stumps

A practical use to which stumps, left from the felling of trees, are put in a city park is as supports for lawn benches. This obviates the need of grubbing them out, while the work of preparing them to receive the seats is less than would be required to remove the stumps. Of course, the location of the stump will determine whether it is worth while as a support for a seat, or had better be grubbed out. Many

designs are possible, and the position and size of the stumps available will suggest suitable construction. The



These Practical Lawn Seats Show the Possibilities of Stumps as Supports for This Purpose. The Conversation-Chair Design Is Especially Interesting

woodwork for the seats is simple, and the benches can be made removable for the winter if desired.—C. L. Meller, Fargo, N. D.

A Hinged Box Cover Made without Hinges

When a wooden box with a hinged cover is desired, especially a small one, hinges are not always at hand, and are sometimes difficult to obtain. Under these circumstances a good substitute is to make the box as shown in the sketch, using the extension of one end and nails, or screws, driven through the back corners of the lid, as a hinge arrangement. This makes the use of hinges unnecessary, and is serviceable even for permanent use. Where hinges projecting from the surface of the box are objectionable, this method of construction is especially desirable. It is best to make the hinged ends with the grain vertical, and to round off the hinged corners of the lid slightly.—R. J. Rohn, Chicago, Ill.

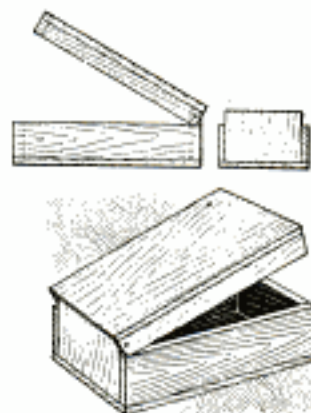

Automatic Flash Light Snaps Chicken-Coop Marauder

After the wire fence around the chicken house had been torn up, and



This Photographic Evidence Was Proof Positive as to the Identity of the Thief in the Night

the place entered 13 nights in two weeks, I decided on more preparedness. Various ways and means failed, so I used

a comparatively slight knowledge of photography in the process.

I mounted my flash lamp on a piece of board, 1 by 4 by 8 in. long, and fastened this to a base, as shown. I attached a weight to the lamp, which was supported by a hinged drop, half-way down the upright board, which in turn was supported by a nail, to which was attached a string. The flash was set off by a slight pull of the string, which dropped the weight. This contrivance I concealed in the chicken yard, and the camera in the chicken house. That night I opened the lens of the camera in the dark, and attached the string to a loose board in the fence. The next morning, before daybreak, I closed the lens again. The flash had been set off during the night. Also there were drops of blood on the ground. I could hardly wait until the plate was developed. The result, as reproduced, was hardly what I expected.—H. U. Scholz, Medford, Ore.

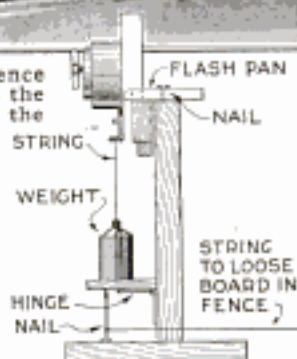

A Fishing-Tackle Outfit in a Shotgun Shell

At the camp or on the trail, an emergency fishing-tackle outfit is almost as handy as matches, compass, and knife, and it may even be the means of saving one's life. A convenient way to carry such an outfit is in two old shotgun shells, telescoped. The hooks, on a cork, and the sinkers are fitted snugly into the shell. Several yards of line are then wound on the outside. This outfit can be stowed into a pocket handily, always ready for use.—E. Everett Buchanan, Jr., Elmira, N. Y.

A Split-Bamboo Lettering Pen

Marking of packages and similar lettering can be done neatly with a pen made in a few minutes from split bamboo fitted with a short section of watch spring. Select a piece of bamboo, $\frac{1}{4}$ by $\frac{1}{16}$ in. and about 7 in. long, and finish the end, as at A. Trim the end to an angle, as at B, and then point it, as at C. Split the point carefully, as at D, and smooth away the tufts at the edges. Cut a piece of watch spring the width of the pen point and bind it into place, arched as shown. To use the pen, insert ink into the arch of the

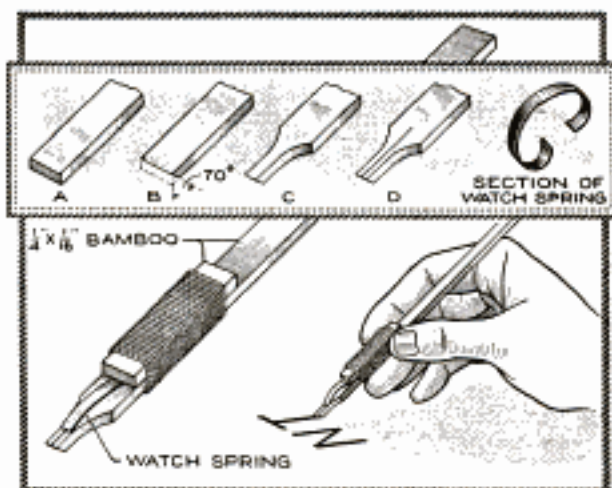

This Pen, Cut from a Piece of Bamboo and Fitted with a Spring Fountain Device, Is Especially Useful for Marking Packages

spring, and it will work much like a fountain pen.—Raymond H. Lufkin, Dorchester, Mass.

Morris Chair with Newspaper Rack, and Smoker's Trays

By J. E. BRONSON

A COMFORTABLE and novel after-dinner chair for the man in the household can be made by fitting a morris chair, or other armchair, with devices which appeal especially to a man. The chair shown is that of the ordinary mission morris type. It is of simple outline and can be made by the home mechanic of fair skill in furniture making. The details of its construction, while not essential to a description of the special fittings, are shown in the several working drawings. The joints used for the framework are of the common mortise-and-tenon variety. The back is a plain frame, fitted with vertical slats, and hinged to a shoulder in the back legs, as shown in the side view. For a substantial piece of furniture, oak or other hard wood should be used; as a piece of porch or summer-cottage furniture, the chair may be made of softer woods. The cushion can be made of various leathers, or upholstery fabrics. It is built over a wooden frame and is removable. The seat bottom may be paneled, and a loose cushion fitted into it, and a similar one bound with thongs to the back of the chair.

The drawer is slightly different from the standard construction in that the front is arranged as a blind rail. It fits snugly between the front legs and is suspended from strips fitted between the pairs of legs at the sides.

No handle is provided, as the drawer can be opened easily by grasping it underneath the front board. Pipes, smoker's supplies, or a variety of other articles may be stored handily in it.

The newspaper rack, as detailed, is made up of strips forming a basket, which is supported by a rod pivoted in

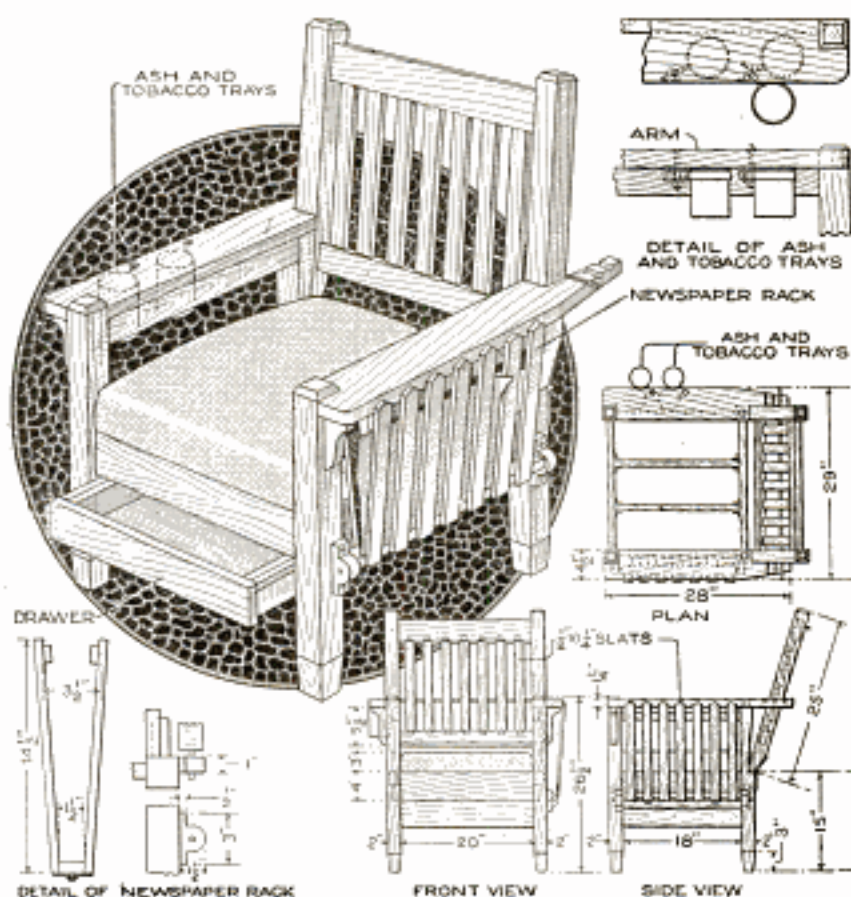

These Novel Features of a Morris or Armchair Increase Its Comfort and Usefulness, and can be Made Easily by the Home Mechanic

wooden hangers, one on each of the side legs, adjoining the rack. When papers are not being taken out or placed in it, the rack is tilted back against the side of the chair arm. The ash and tobacco trays, which may be made large enough for cigars, are suspended under the right chair arm by means of rings made of strips of brass. These holders are pivoted on bolts, and the trays can be removed easily for cleaning. They are ordinarily swung out of the way, under the arm. The special features of the chair may also be adapted to the needs of nonsmokers.

¶The nuisance of soiled fingers and pen grip in lettering, when using a deep ink bottle, can be avoided by filling a bottle up to the neck with cement, and using only the neck as an inkwell.

A Turntable Stand for Potted Flowers

Potted flowers, if kept in the house, tend to grow toward the light. From

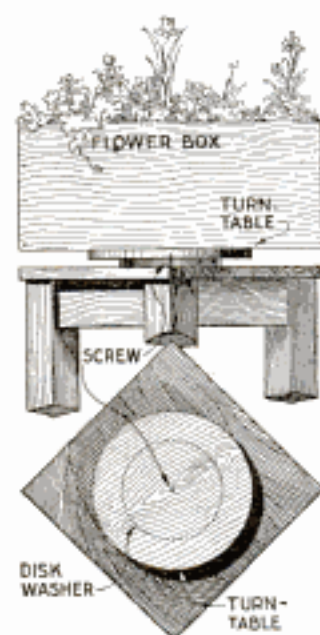

time to time the pot should be turned. To do this more readily, the turntable stand shown in the sketch was designed. It is made up of a low, four-legged table on which a 12-in. disk of 1-in. wood is fixed with a screw. A thin wooden washer, sandpapered and shellacked, insures easy turning.

Rectangular boxes or circular jars look equally well upon the stand, the beauty of which depends much upon its workmanship and finish.—Edward R. Smith, Walla Walla, Wash.

Index for Popular Mechanics Magazine on Bookshelf

As it would be impossible to keep in one's mind all the good ideas given in



Popular Mechanics Magazine, I preserve my back numbers for reference, and, to reduce the amount of index and page searching, I have adopted a convenient plan of indexing any special article to which I expect to refer.

I write, on one end of a strip of paper, the page and date of issue of the article. I place these slips at the proper pages in the magazine, so as to project at the top,

as shown, making reference easy. If a slip drops out, it is quickly replaced. When articles are no longer needed for reference, the slips are removed. By keeping the magazines on an open shelf they can be reached handily, for reference as well as for removing them from the shelf.—J. E. McCormack, Haliburton, Ont., Can.

Trimming Board with Foot Control and Counterweight

A trimming board with the knife operated by a pedal, leaving both hands

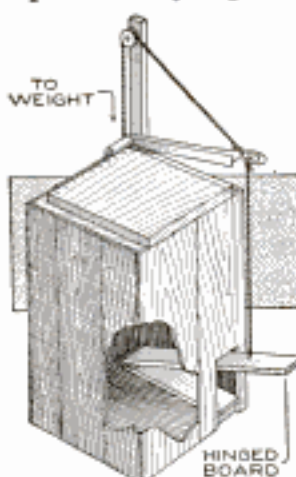

free to handle the work, is a device appreciated by photographers, commercial artists, and others who have more or less heavy paper or cardboard to trim. An ordinary trimming board is mounted on a packing box of suitable

dimensions, as shown. A pedal is hinged to the bottom of the box, and a heavy cord, or wire, runs to the handle of the knife, so that pressure on the pedal operates the knife. The latter is returned by a weighted rope, passing over a pulley attached to a standard at the rear corner.—H. F. Blanchard, New York, N. Y.

Folding Card Table Handy for Invalid in Bed

When it is necessary to serve a meal to a patient in bed, and no invalid table is at hand, use an ordinary folding card or serving table. Unfold one end over the bed, and a splendid substitute table is provided, useful for reading, games, and other purposes. If the table rests too low on the bed, adjust it with cushions. This is far more convenient than using a tray.—John P. Rupp, Norwalk, Ohio.

Winter Bird-Feeding Tray on Inclined Wire

Deep snow covering the ground in winter for days and weeks at a time, makes it exceedingly difficult for birds to obtain food, causing many of them to starve. Food scattered on the snow offers little relief. To provide food for our feathered friends, and at the same time place it beyond the reach of cats and other prowlers, a feeding tray, as shown in the sketch, was made. When in use, it is supported from pulleys on an inclined wire extending from a convenient window or porch to a tree or other support. The wire is inclined away from the window, and the tray is drawn from its position near the tree by means of a cord. Its own weight carries it back down the incline. The body of the tray is supported from the crossarm by double screw eyes, keeping it perpendicular regardless of the angle at which the inclined wire is set. The construction of the tray and covering is simple, the roof and tray being troughs braced at the ends with wooden brackets, and connected by four wooden strips. A good size for

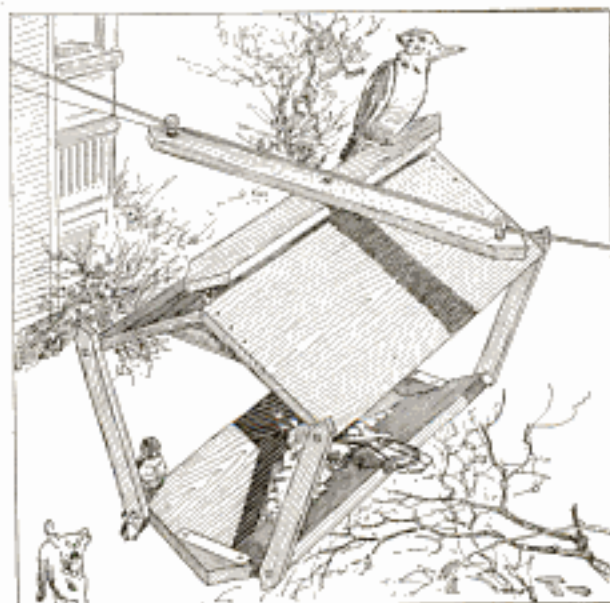

Winter Food is Supplied to the Birds from This Feeding Tray, Safe from Cats or Other Enemies

the device is 12 in. high, 12 in. wide, and 18 in. long.—Ulice Auger, New Bedford, Mass.

An Electric Toaster with Coils on Mica Strips

In the electric toaster described, the hot-wire principle is used. Two standards support two heavy strips of mica,

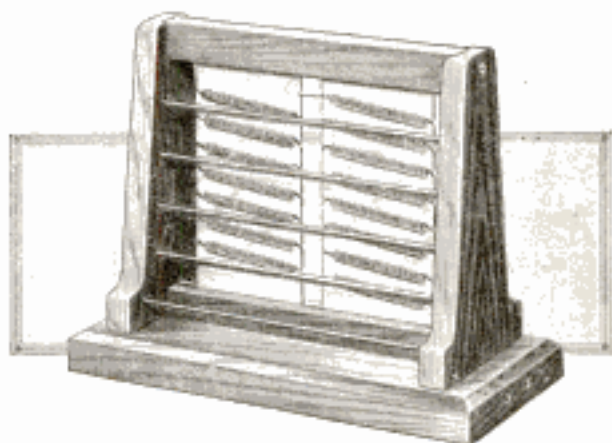

The German-Silver Wire Coils around the Notched Mica Strips are Heated to Toast the Bread

upon which the resistance wire is wound. The wood should be close-grained, and the inner surface covered with thin sheet metal, to protect it against overheating. As the toaster is generally used on the dining-room table, it is not encumbered with outside terminals, but suitable holes are drilled lengthwise of the base for the leads, which are brought out on top and soldered to the ends of the German-silver resistance wire. Accurately mark out and drill the 10 blind holes in each of the ends for the cross rods. Make narrow saw slits to hold the ends of the two strips of mica.

Mild steel is used for the 10 cross rods. About 80 ft. of No. 22 gauge German-silver wire is necessary to form the heating coils, which are $\frac{1}{4}$ in. in diameter, with 16 turns to the inch. No two turns are in contact. Connect one end to the circuit. The other wire is moved along the coil until a point is reached where the wire heats up to a dull red in a room that is not exposed to direct sunlight. Cut it at this point, and then divide the coil into 30 similar parts, spreading each section from its neighbor, so as to provide about $\frac{3}{8}$ in. of straightened wire between. Wrap this long, subdivided coil on the mica strips,

notched as shown, starting at the lower right-hand corner. When the top is reached, cross over and pass to the rear of the left-hand piece, continu-

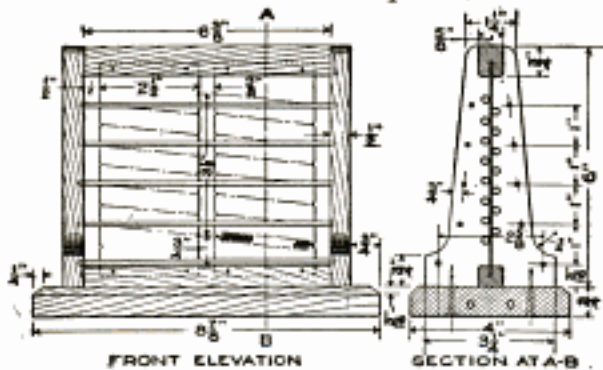

The Parts are Easily Made and Assembled, a Neat Job Being Desirable if the Toaster is to be Used at the Table

ing the wrapping down until the lower left-hand corner is reached.

In assembling the parts, slip in the mica strips with coils in position, and then set on the top bar, securing it with a screw at each end. Put in a small headless nail at each corner of the mica to prevent it from moving about, and then solder the connections with the leads. Finish the wood, preferably before assembling the parts.—John D. Adams, Phoenix, Ariz.

Nested Feeding Pans for Dogs and Other Animals

Dogs, and other small animals, almost invariably upset the feeding pans and roll them around in play. To overcome this nuisance, secure sets of two sauce pans and screw one of each set to the floor or a suitable board. Then

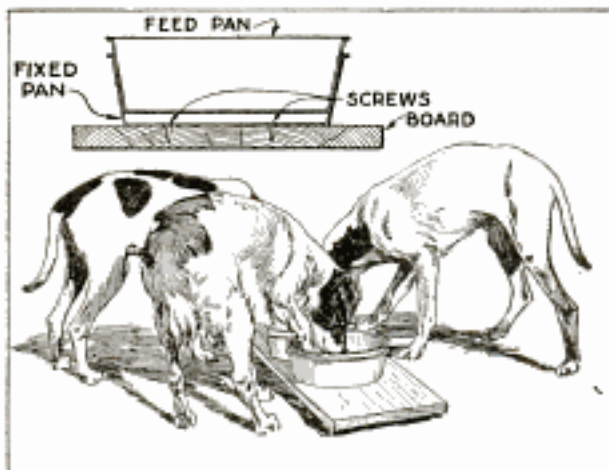

The Animals can Not Spill the Pans, and Quickly become Accustomed to Seek Their Proper Places

nest the other pan inside the first. The animal cannot move the pan, and the food pan can be easily lifted out. I use this method for my dog kennels, and it works fine.—J. Cooper Mott, Great Neck, Long Island, N. Y.

Oats Sprouter for Chicken or Rabbit Feed

Green food is desirable for chickens and rabbits during the winter as well as summer, and the device shown in the illustration was made to provide this cheaply. A box, 15 in. square, is provided with a door, and several shelves of wire mesh set in a frame. A lamp is placed below the bottom shelf, and

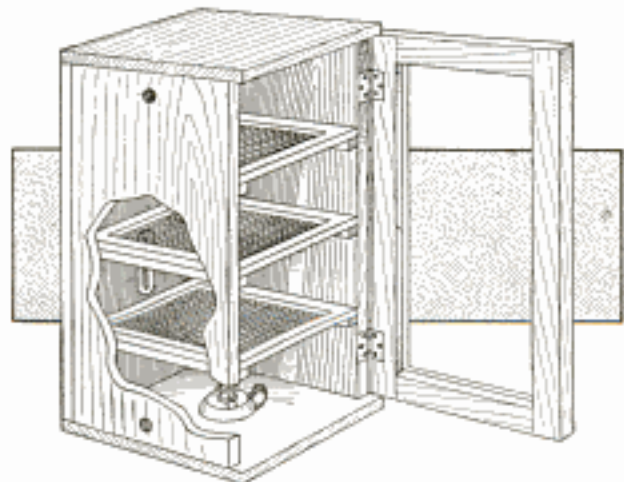

Green Food for Chickens or Rabbits is Provided in Winter by Means of This Sprouter

a thermometer inside the box. The door should be fitted closely and ventilation holes provided as shown. The oats are soaked in lukewarm water for 24 hours, and then spread on the shelves, or trays, to a depth of 1 in. The lighted lamp is set in place and the temperature raised to 90 or 95°. The oats will sprout to a length of about 2 in. in 24 to 30 hours, forming a cake. This is removed and fed as needed. The trays are refilled, providing a constant supply.—R. S. Matzen, Fort Collins, Colo.

To distinguish a raw egg without opening it, place the egg on the tablecloth and twirl it like a top. The boiled egg twirls readily, while the raw egg tumbles over.

Cleaning Celluloid Panes in Automobile Tops

Celluloid lights in automobile tops become soiled quickly, and are tedious to clean. They can be cleaned handily by the following process: Use two pieces of Turkish toweling, 6 by 12 in. long. Wet one piece and wring it out well. Keep the other dry. First dry-dust the surface to be cleaned. On the wet cloth, sprinkle sparsely a light, nongreasy polishing oil. Rub thoroughly with this cloth, and repeat, if necessary.—Horace M. Fulton, Washington, D. C.

A Whirling-Fan Arrow

When shot from a bow, this arrow with a whirling fan at its tip, makes a shrill, buzzing sound. The shaft of the arrow is tipped with an empty shell from a .22-caliber rifle, and a brad is driven into it as a shaft for the whirling fan. The latter is made of cardboard and is cut from a 2-in. square, as shown in the diagram at the left.—F. A. Folds, Portland, Ore.

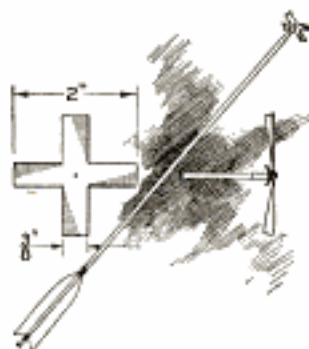

Wedge Kink for Holding Roller Shade

When a roller window shade refuses suddenly to remain unrolled at a certain point, a handy kink is to insert a small wooden wedge, such as a match or toothpick, between the unrolled curtain and the roller. This is only an emergency device, and may injure the fabric if repeated often at the same point.

☞ A handy way to tighten the screws in eyeglasses is to use a stub pen. The point fits into the slot, and because of the split in the pen, the screw cannot be easily damaged.

Thermometer Support in Home Candy Kettle

In the making of certain candies over a gas plate, a candy thermometer did not register the true temperature when clamped to the side of the vessel containing the mixture.

An adjustable support, upon which the thermometer was clamped at the center of the kettle, was made as shown. It is a thin board, into the ends of which two ten-penny nails are driven slightly. A length of No. 12 gauge brass wire, run through the board and twisted, forms a third arm, which folds. The brass wire can be polished readily, and is more sanitary than iron wire.—Lucile Baker, Tacoma, Wash.

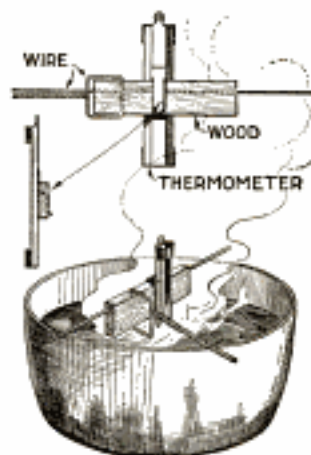

Shutter-Release Attachment for Small Cameras

Low-priced cameras are, as a rule, provided with simple lever shutter releases, operated by pressure of the finger. The flexible-wire shutter release, now in general use on higher-priced cameras, can be easily fitted to a camera not provided with this device in the manner shown.

Procure a wire shutter release, provided with a head about $\frac{1}{8}$ in. in diameter and $\frac{1}{8}$ in. long. Out of a piece of tin or thin sheet brass, cut a support, bend it to the shape shown, and secure it in position on the lens plate, with solder. Then clamp the head end of the shutter release in the support, securing it with solder.

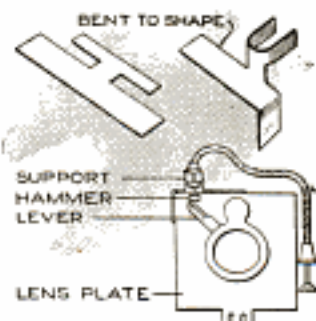

An Egg Candler for Daylight Use

An egg candler used in a light room can be easily made by even a "jack-

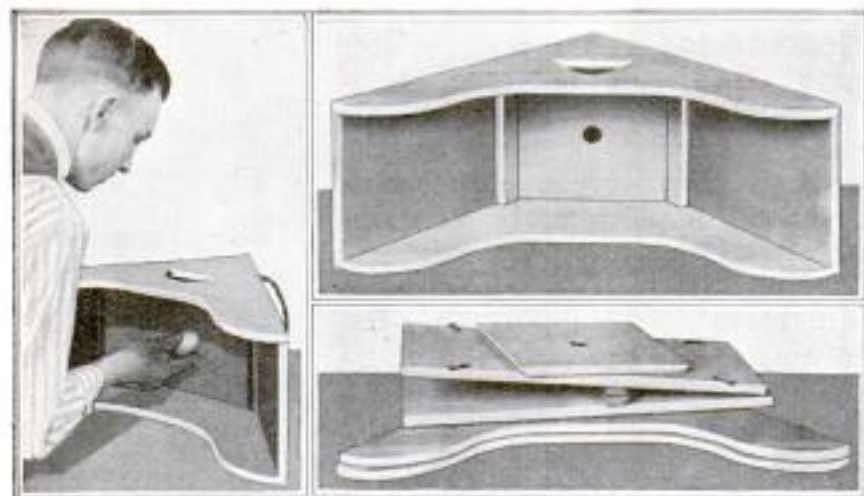

The Eggs are Canded in Daylight by the Use of This Arrangement, Which Is Practical Also for Testing Incubator Eggs

knife carpenter" from $\frac{1}{2}$ -in. lumber. The candler shown was designed in the poultry department of the University of Wisconsin. It can be nailed to-

gether, or made knockdown, to be fastened with hooks. The side pieces are 8 by 18 in. long, and joined at an angle of 35° . The piece with the sighting

hole is 8 by 9 in. long. The electric bulb, or other source of illumination, is put inside, and the light is reflected through the opening, from a tin reflector. In using the candler, the point is placed directly toward the windows, in the light room. By holding an egg with the large end up against the opening in the candler and giving it a brisk turn, the quality of the yolk and the

white, as well as the size of the air cell, can be readily determined. There is less breakage of eggs with this device, than when candled in the dark.

Homemade Swinging Typewriter Stand

Instead of using a typewriter on a table of ordinary height, and packing books or other objects on the chair to make writing comfortable, the home mechanic who has a typewriter will

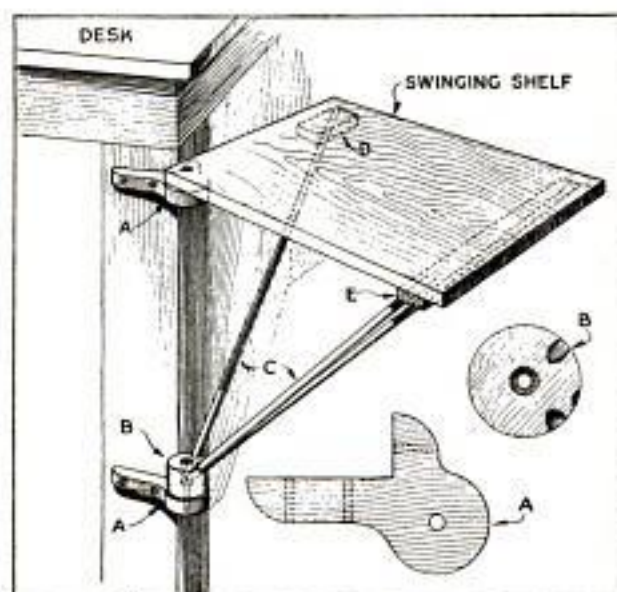

This Wooden Typewriter Stand is Easily Made and Quite Substantial

find it worth while to make a swinging stand, which can be fixed to the corner of a desk or table. The stand is swung out of the way when not in use, and is substantial enough to hold the typewriter safely, and with little vibration. To construct this fitting, make two blocks, as detailed at A, supporting the shelf and braces. The top board is $\frac{3}{4}$ in. thick, and about 10 by 15 in. long. It is supported by three $\frac{1}{2}$ -in. dowel rods, C, which are fitted and grooved into the cross strip E and the block D under the shelf, and in the block B, which is bored as detailed. The arrangement is pivoted on two bolts or screws fastened into the brackets A, as shown. The parts should be smoothed and sandpapered carefully, and the device finished to match the desk or table.—F. E. Tuck, Nevada City, Calif.

To finish several kinds of wood uniformly, first apply a mixture of raw linseed oil and turpentine, in equal parts, with a little japan; when dry, apply an oil and turpentine stain.

An Electric Submarine Droplight

A submarine droplight is useful for many purposes, such as finding articles lost in deep water, locating mooring blocks, or even for night fishing. To construct it, take a clean quart fruit jar, with a screw top, and pour in enough plaster of Paris so the jar will be carried under water by the weight. When the plaster has hardened, clean the sides of the jar thoroughly. Bore a $\frac{1}{2}$ -in. hole through the center, and two smaller holes, one on each side of the center one, in the top. Then fasten to the top, as shown, a cylindrical block of wood, having a $\frac{1}{2}$ -in. hole bored through it lengthwise. Force a piece of fiber insulating tubing through the hole in the block, and leave 3 in. projecting beyond the jar top. To the bottom end of the block attach a porcelain lamp socket, with a bulb. Connect two ends of waterproof insulated lighting cord, through the tube, to the terminals of the socket. Paint the whole with paraffin, run plaster of Paris down the fiber tube, and paint the top of the cover with shellac. By screwing the top on the jar, using a

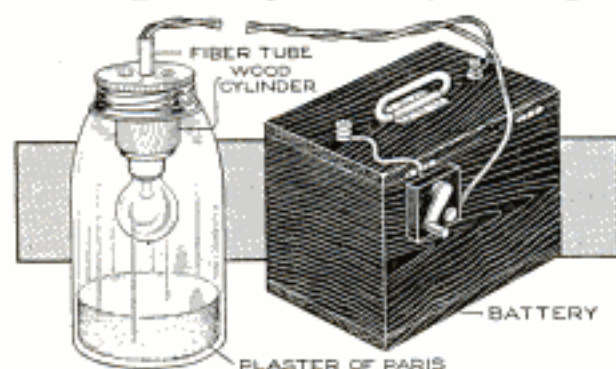

A Fruit Jar is Used to Make This Droplight, for Use under Water

rubber gasket to make it water-tight, this apparatus can be used at a considerable depth.

Practical Uses for Old Horseshoes

Here are a few variations of good-luck signs made from the faithful old horseshoe. Many of them can be made by bending the shoes cold, and boring the necessary fastening holes in them, if the nail holes are not suitable. If a

forge is at hand, the possibilities of the horseshoe are limited only by the skill of the smith. Among the many uses on the farm, and elsewhere, to which

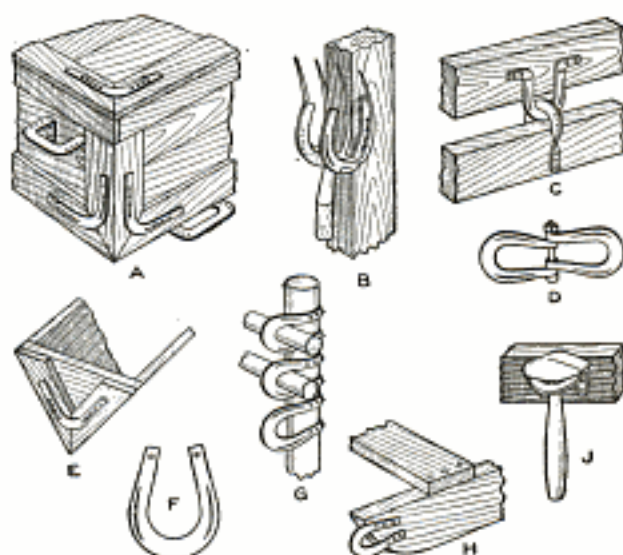

These Uses for the Faithful Old Horseshoe will Suggest Many Others

horseshoes have been put are those shown in the illustration: A, corner braces for tool chests, handles for lifting or carrying boxes, and other heavy objects; B, as a rack for a fork, shovel, or similar handled tools; C, as swinging U-bars for stable fittings, gates, etc.; D, for making swivels, clevises, and similar wagon and draft rigging; E, as braces for troughs and feed boxes; F, drilled for heavy bolts to support hoisting tackle; G, as pole supports for gates; H, as draft loops for sleds, stoneboats, etc.; J, as racks for hand tools.—A. Gloor, Valier, Mont.

An Individual Marshmallow Toaster

Marshmallow toasters, homemade, of wire are useful additions to the camp or fireplace equipment. An ordinary spool, of the size shown, is used as a form on which to build up the wire basket. Use $\frac{1}{32}$ -in. copper wire for the bottom rings and the vertical wires. The upper ring and its continuation, which is the handle wire, should be of $\frac{1}{16}$ -in. diameter. The twisted wire should be long enough to get the wooden handle well out of range of the fire. A common file handle is satisfactory for the handle. Soldering is

dispensed with in the basket construction, as fine copper wire is used to tie all points where the wires cross or join.

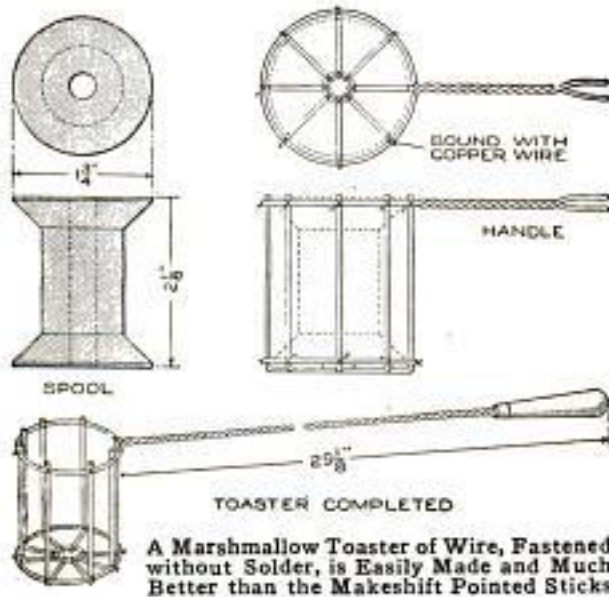

This prevents the wires from separating under the heat, as when soldered.—Livingston Haviland, Buffalo, N. Y.

Dressing Table Made from Old Washstand

This dressing table was once a washstand, banished to the attic when running water was brought into the house.



The screws, which held the curved upright pieces to the back, were removed, leaving a flat-top table, boxed in all around. The thin boards of the back and the paneled ends were taken out, leaving only the top panel on each end. Small drawers and the compartment below were discarded, leaving the top drawer, with the curved supporting strip, raised from below. The openings left on the inside of each leg by the removal of the panels were filled with strips of wood,

leaving the top drawer, with the curved supporting strip, raised from below. The openings left on the inside of each leg by the removal of the panels were filled with strips of wood,

glued in. The application of a coat of white paint and two coats of white enamel finished the table neatly. The dressing-table stool is also homemade, and the mirror above the table serves to reflect one's full length handily.—A. May Holaday, Chico, Calif.

Grinding Glass for a Photographic Screen

The home craftsman, or amateur photographer, who has need for ground glass can prepare it easily from ordinary plain glass, grinding the surfaces with fine knife powder and water. Spoiled negatives, the coating being cleaned off thoroughly, are satisfactory. Fasten one of the pieces to be ground on a flat board, setting two brads at each corner, slightly below the surface of the glass so as to hold it securely. Dust the knife powder over the glass and sprinkle it with water; place the other piece upon the first, and grind the surfaces together, varying the motion. The pressure should be distributed over the glass as widely as possible. Wash the surfaces from time to time, and rub any bright spots by applying a little powder on them and pressing the finger at these spots, one at a time. The fineness of the grinding will depend largely on the grade of powder used and the careful treatment of bright spots.

Screws Soldered on Rods Provide Threaded Connections

Often the amateur finds it difficult to thread the ends of brass rods which he wishes to use in making up electrical apparatus, particularly radio instruments. A soldering outfit being available, this difficulty is easily overcome. Instead of threading the rod, a binding post, or machine screw, may be soldered to it. This post should be the round-head type, for then a firmer joint may be made. After the post has

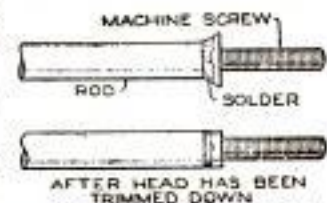

been soldered to the rod, the head of the screw and all excess solder should be filed down to make the joint the same diameter as the rod.—J. L. Taylor, Jr., Madison, Wis.

Lock Knot Useful in Tying Parcels

In tying a package, or bundle, a slip eye is often made at one end of the string, and the other end is run through it. If an extra loop is formed in the eye, as shown, and the free end of the cord is run through it, this loop acts like a buckle, and the cord can be drawn tight and held in that condition without holding a finger on the knot. This is especially convenient in tying parcels that are wrapped in paper, which has an annoying habit of becoming loose while the parcel is being tied.—Hugh Wiley, Portland, Ore.



Keys Held in Rack by Sliding Tags

To keep keys so that they can be gotten at easily and at the same time provide them with a suitable tag so that they may be identified readily and not lost, were the aims in making this novel key rack, in which each of the key tags slide and is locked into place. The rack is built up of $\frac{3}{8}$ -in. boards and provided with three slides for the key tags. The iron strip at the right edge holds the tags in place, and may be locked if desired. The device may be made in units of various sizes, to provide for many keys.—F. D. Coughlan, Dutch Island, R. I.

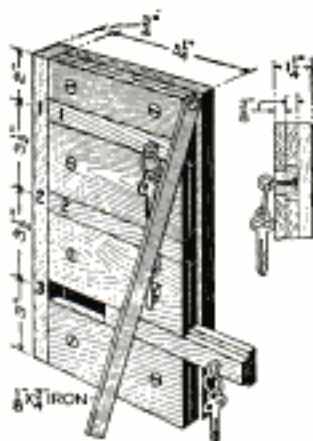

Mountain Snow Glasses Made of Old Bottle and a Shoe

High in a remote mountain range of Nevada, I found a homemade pair of snow glasses that doubtless saved the eyesight of some snowbound prospector. Two strips of leather from the top of an old shoe were placed together, making two layers. Then holes were cut in them for the eyes, and dark amber-colored glass, from a broken bottle, placed between the leather, at the holes, and held in place by sewing close to the edges of the piece of glass. Two tie strings were attached.—Edward B. Warren, Garnet, Mont.

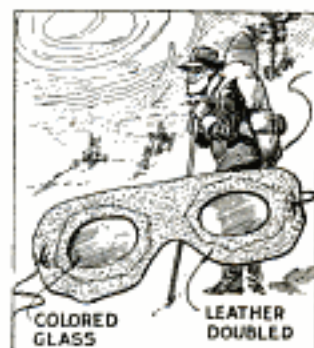

Tension Spring on Bicycle Mudguard Used as Brake

While riding my bicycle down a hill the chain broke, and having both front and rear mudguards on, I could not get my foot in between the frame and the tires to slow up. The result was a very narrow escape from injury. I then made an emergency brake of the front mudguard by arranging a tension spring on the mudguard and the fork, as detailed in the sketch. The mudguard is thus an effective brake, ordinarily held in its proper position by a spring. The bolt was set in a strap, B, riveted to the guard A; the spring C was slipped over the bolt and bears against the nut and the clamping piece D. It fits around the post of the fork, and is tightened by a bolt.—Charles G. England, Washington, Pa.

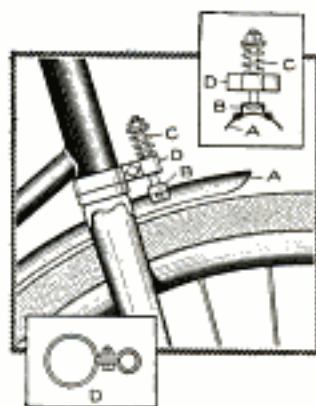

Mirror and Buzzer System for Door Release

The office attendant in charge of the boys' gymnasium, and other rooms of a boys' club, found it annoying to leave



The Attendant Identifies Those Who are Admitted, and Releases the Door by Means of the Push Button

his desk to admit boys at the gymnasium entrance, which was around the corner from his desk, as shown in the diagram. A buzzer system for unlocking the door was installed, but this did not identify the boys who sought admission. By the use of a mirror, set on the wall as indicated, he was able to identify those who entered, and to keep a record of them easily. This method can be used in many other ways, even with several mirrors, properly adjusted.—J. F. T., Chicago, Ill.

Elk Horns as Electric-Light Fixture for Den

A large pair of elk horns, from an enormous animal shot by a hunter,



An Unusual Lighting Fixture in the Home was Made of Elk Horns

were put to a novel use by mounting them over his living-room table as an electrolier. He had an electrician drop small frosted lights from each prong. The effect was so interesting that he soon mounted a pair of large deer horns

on the wall of his den, and arranged them to be lighted in the same way.—Dale R. Van Horn, Milton, Wis.

Atomizer for Spraying Paint on Small Objects

An atomizer, such as is used for medicinal purposes, can be used handily to spray paint on small objects. The paint should be thin and mixed thoroughly, and should be shaken occasionally while spraying. A very clean and even coat of paint can be put on small objects in this manner.

An Alternating-Current Rectifier

Many amateurs and electrical experimenters who use alternating current, have need of an easily constructed device for rectifying, or making the current into direct current. Common uses for such a device are storage-battery charging and electroplating. The magnetic rectifier described is easily made of materials readily available. Its method of operation, as shown in the diagrams, is as follows: The permanent magnet A, Fig. 1, maintains the armature B magnetized with the same polarity, south for example. As the current passes, the armature is attracted by the north pole C, of the electromagnet, and closes the circuit,

making D positive and E negative. As the current drops to zero, the armature is released. The current is reversed, the armature being then attracted in the opposite direction, closing the contacts F and G. Since the current had already been reversed, F and G now have the same polarity as originally, and a direct current is delivered at the adjacent binding posts.

The arrangement is made as follows: Procure a telephone ringer of 1,000 ohms' resistance; remove the bell clapper and rod from the armature, Fig. 2, fastening an insulated contact maker in its place, as detailed. Solder one lead to the armature and the other to the contact maker. The piece H is made from a clock spring, annealed, bored, and rehardened. The piece J is

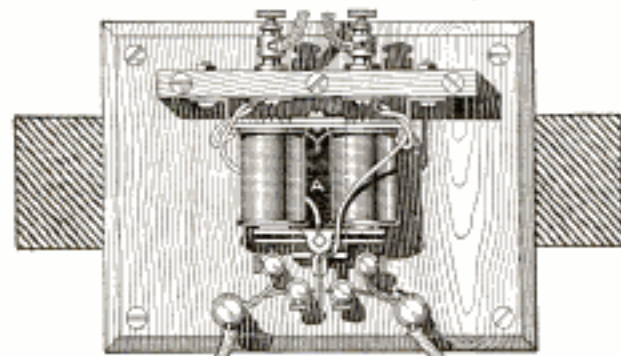

Fig. 1

This Neat Alternating-Current Rectifier was Made of an Old Bell Ringer and Standard Electrical Fittings Easily Obtained by the Amateur

made from the core of an electromagnet. A section of rubber tubing, K, insulates the piece J from L. One of the wires from the electric mains is soldered to the piece J, and the other wire to the armature L.

The other connections are shown in the diagrams, Figs. 3 and 4. If plati-

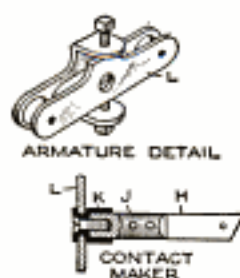

Fig. 2

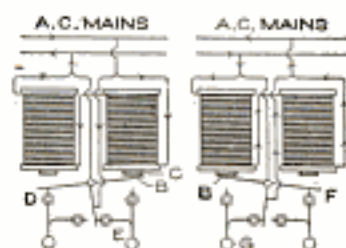

Fig. 3

Fig. 4

Diagrams Showing the Operation of the Rectifier, and Detailed Sketches of the Armature and Contact Maker

num contact points are used they will not oxidize as quickly.

Old Gas Bracket Used as Water Spigot

A blacksmith gave a new lease of usefulness to a cast-off gas bracket by having it soldered to the water can on

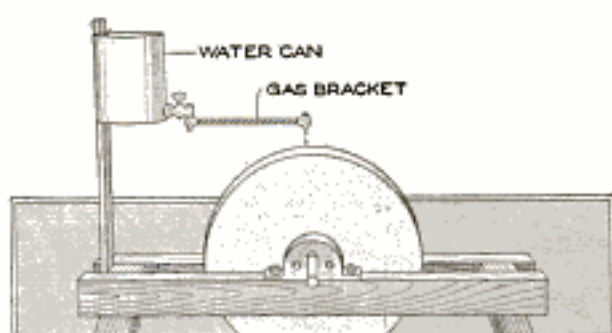

A Serviceable Adjustable Water Spout for a Grindstone was Made Out of an Old Gas Bracket

his grindstone. The bracket was taken apart for easy handling, and the valve section inverted and soldered to the lower edge of the water can, as shown. The burner was removed, and the bracket reassembled. The pivoted joint in the pipe makes it convenient to shift the stream of water where needed, and the valve provides for adjustment of the quantity of water fed from the can.—James M. Kane, Doylestown, Pa.

Making a Rubber-Stamp Impression Appear Like Embossing

Imitation embossed stationery may be made with a rubber stamp, in the following manner: Procure some fine printing ink and spread it evenly on a piece of cardboard; then press the rubber stamp on this as on a stamp pad. Stamp on the stationery, so as to make an even imprint; then cover the impression with finely powdered rosin and shake off the excess rosin. Pass the printed side of the stationery over a gas light, lamp, or stove, until it fuses the ink and rosin; then lay it to dry in a cool place.

Best results can be had by using a light-colored rosin. New or clean rubber stamps make the letters sharp and clean. For bright colors, use a very light-colored rosin and light shades of printing ink.—A. H. Hale, Brooklyn, New York.

Mechanical Toy Alligator of Wood

A toy alligator that opens its mouth and wags its tail as it is pulled along can be made of wood by a boy, with a jackknife. The various parts, as

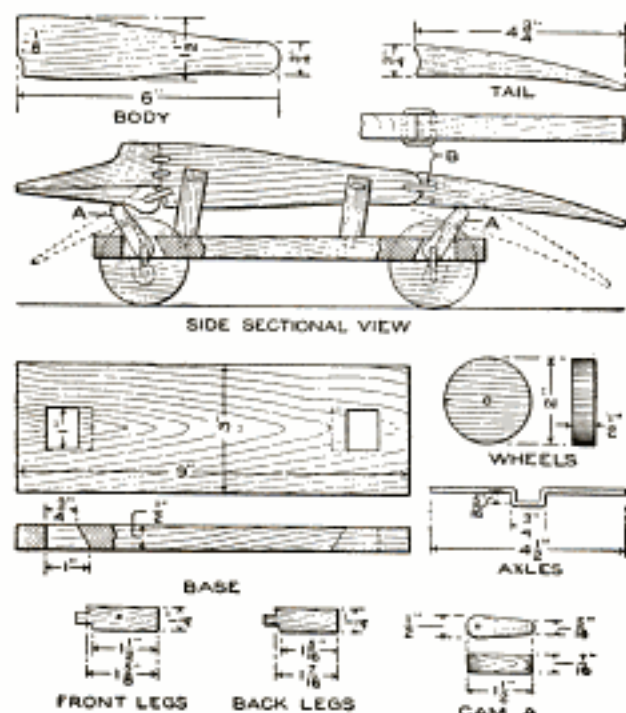

The Alligator is Drawn Along with a String, and the Jaws and Tail Flip Up and Down

shown, are cut from soft wood, $\frac{1}{2}$ in. thick. The method of fastening the parts is shown in the side sectional view. When the wheels turn, the cams A, set on the crank portions of the wheel axles, raise and lower the jaw and tail. The upper jaw is 1 in. wide at the widest part, and 3 in. long. The lower jaw is smaller, and the same length. The body is 6 in. long, and tapering in width from $1\frac{1}{2}$ to $\frac{3}{4}$ in. The tail is $4\frac{3}{4}$ in. long, and $\frac{3}{4}$ in. wide. Holes are drilled in each piece near the edge, at joining points, through which wires are drawn, and clamped, as at B. The legs are shown in detail. They are attached to the body by drilling a $\frac{1}{16}$ -in. hole in each, and a hole through the body, through which the fastenings are passed. The lower end of the legs are fastened to the base, which is 3 by 9 in. long. Square holes, 1 in. wide, near each end, are provided for the cams A. The axles and wheels are made as shown. The axles fit

tightly in the wheels, so that the latter can move the axles around with each turn. The axles are made from $\frac{1}{8}$ -in. wire, bent as shown, and should be long enough, after passing through the bottom, to extend through the wheels on each side.—Charles C. Wagner, Los Angeles, Calif.

Angle Bracket Gives Leverage on Door Spring

Frequently, in placing a coil spring on a screen or other door, the casing is flush with the door, and it is difficult to give the spring the desired leverage. If it is attached to the casing directly, the surface is marred by the rubbing of the spring. A good method is to set a small iron bracket, either homemade of strap iron or one of the commercial type, on the casing and attach the end of the spring to the bracket. This prevents the spring from rubbing on the door and casing, and gives it freedom of action.—Harry L. Dixon, Chicago, Ill.

Combination Indirect-Light Reflector and Mirror

A small mirror combined with a shaded electric lamp affords a nearly perfect shaving lamp, and facial-toilet mirror. The mirror should be 1 in. smaller all around than the reflector. By soldering two lengths of stiff wire to the back of the mirror frame, it can be clamped to the reflector, as shown. The indirect light from the reflector illuminates the face without shadows or glare, adding to the comfort of shaving. The mirror can be removed, and the lamp used for other purposes.—Thomas W. Benson, Philadelphia, Pa.



Steam Hose Proves Economical for Garden Use

Garden or lawn-sprinkling hose is expensive, and depreciates rapidly, so we purchased $\frac{1}{2}$ -in. steam hose, which proved much stronger and more durable, and cost about three-fourths as much as the $\frac{3}{4}$ -in. garden hose. The thicker wall of the steam hose prevents its kinking or collapsing, which are common causes of the first breaks in the larger hose. This hose has been in use three seasons and appears good enough for another, which is better service than we obtained from its predecessor of the ordinary kind.—J. Cecil Alter, Cheyenne, Wyo.

A Hunter's Turkey Call

A turkey call, useful as a toy or for practical purposes, can be made, as detailed, of well-seasoned cherry wood, preferably wood that has been seasoned for at least 12 months. The edges, marked B, are well coated with rosin, then smoothed with fine sandpaper, and given another coat of rosin. The handle is scraped, or rubbed back and forth, across the edges of the sound box, producing various calls of the wild turkey with practice on the part of the operator. The pocket should be chiseled out carefully to the shape shown in order to get the best results.—Roy H. Poston, Flat River, Mo.

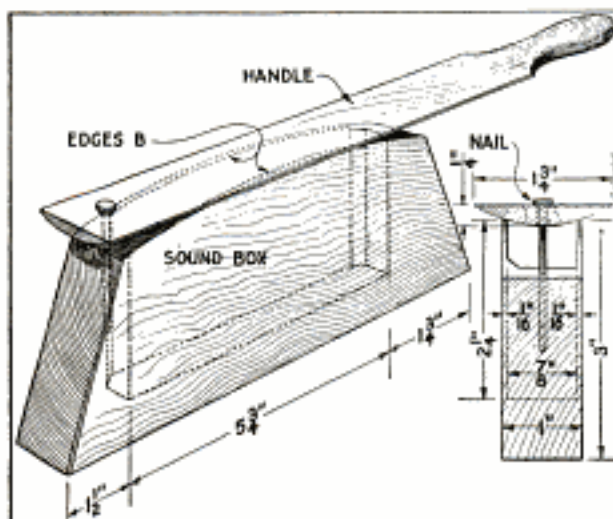

With a Little Practice, Many Peculiar Turkey Calls can be Produced with This Device

Carpeted Tray Turns Incubator Eggs without Handling Them

Turning the eggs in an incubator daily, as is necessary until the eighteenth day of incubation, is a tedious

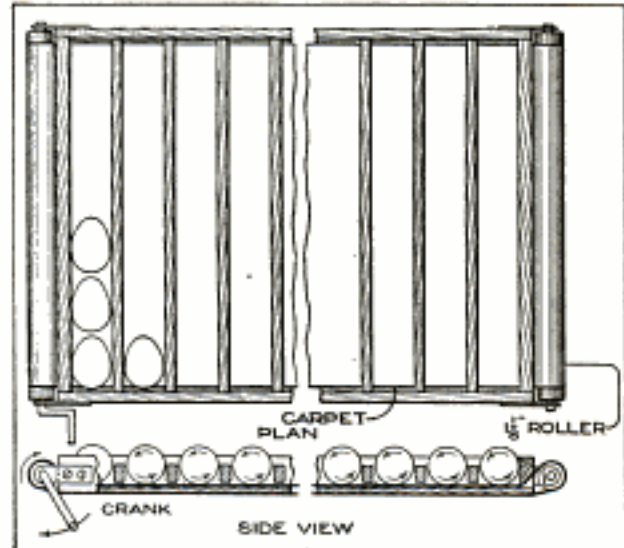

The Eggs are Turned in the Incubator Tray by Means of the Carpet Roll, Making It Unnecessary to Remove Them

job, and often results in the breaking of some of the eggs. To make removal of the eggs unnecessary, I fitted the tray in the incubator with a carpet arrangement so that, by turning a crank, all the eggs in the tray are rolled over without lifting them, and with practically no danger of their being broken. The bottom of the tray was arranged so that a continuous strip of carpet passes under it, over a roller at one end, through a slot in the end of the tray, under the eggs, through a slot at the opposite end, and over a second roller, as shown in the side view. The eggs are separated by small wooden strips, and, when the crank is turned, the eggs revolve as indicated by the arrows. Ordinary end fittings from curtain rollers can be used, or the rollers may be made from broomsticks fitted with nail pivots, set in small strips of strap iron. The crank is made of a bent piece of strong wire.—Winton C. Hilliard, Eldorado, Ark.

Heavy, round shoestrings, such as are used in boots, will not become untied easily if the ends are rubbed with rubber cement.

BUILDING WHERE TOWN ENTERTAINS ITS GUESTS

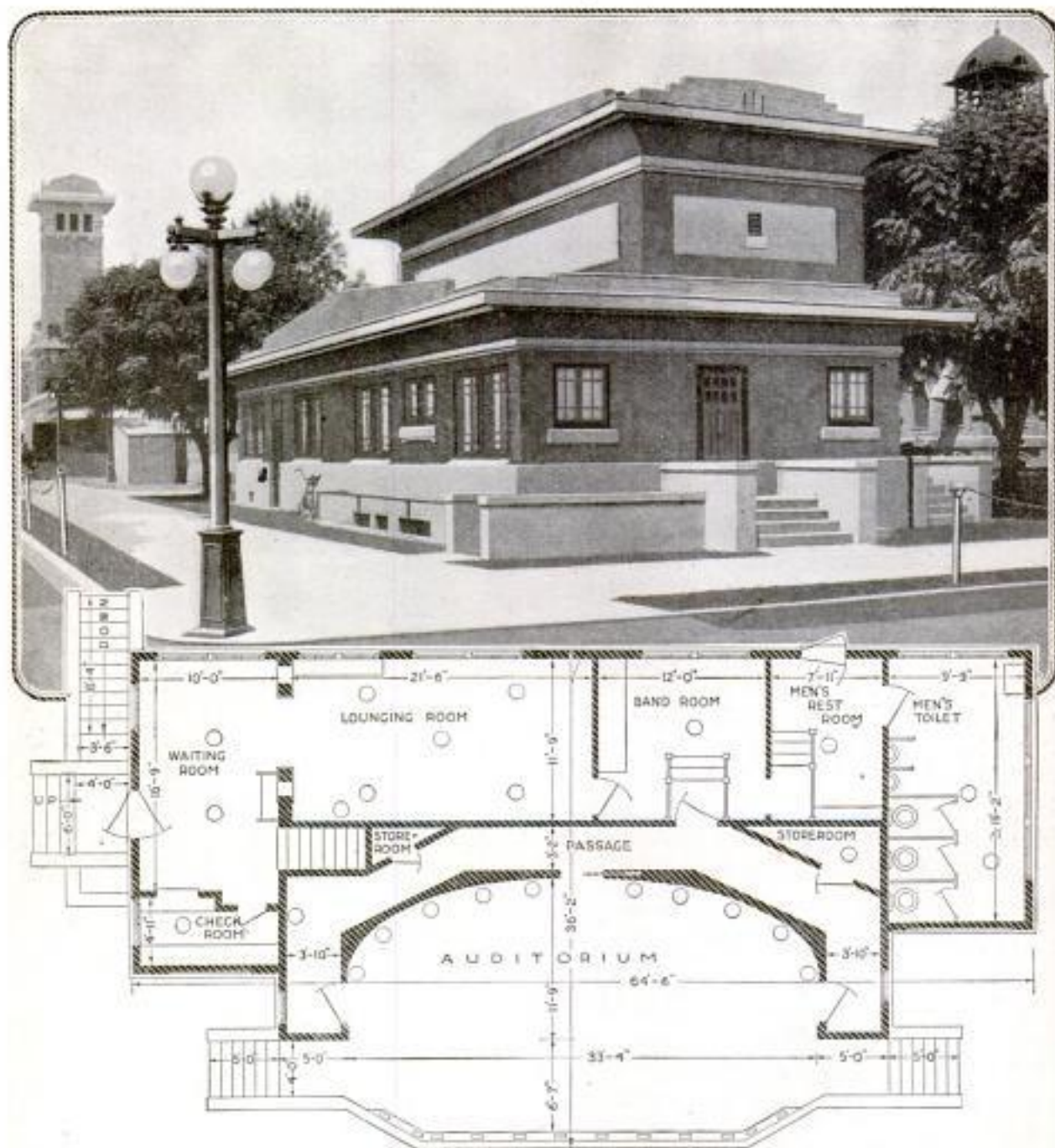

FOR the convenience of tourists and farm people who are the guests of the town, an attractive, pleasantly arranged municipal reception building has been erected at Phoenix, Ariz., which might well serve as a model for other enterprising communities in need of similar facilities. The institution is in charge of a hospitable, competent matron who endeavors to make strangers comfortable. Lounging, luncheon, writing, reading, checking, and comfort rooms are provided, as well as a kitchenette where one may prepare a light meal. When a farmer's wife is shopping in Phoenix, she is able to bring a lunch with her and have it kept in a refrigerator until it is wanted. Purchases she makes at stores can be delivered at the building, where they will be held until her arrival. If she wishes to write letters, materials are at hand; or if she wants to spend a quiet hour in rest, she is able to do so. A branch of the public library is also maintained, so that books are available. The accompanying photograph shows the exterior appearance of the building, while the drawing indicates the arrangement of the ground floor. In one month more than 1,200 persons availed themselves of the institution's privileges.

IN accordance with the editorial policy of this magazine never to accept compensation in any form for what appears in our reading pages, and also to avoid all appearance of doing so, we are obliged to omit the name of the maker or the seller of any article described. This information, however, is kept on file and will be furnished free, by addressing Bureau of Information, Popular Mechanics Magazine, Chicago. [Editor.]

ALADDIN READI-CUT HOUSES

Cut High Building Costs

\$1,088 for this

**7-ROOM
ALADDIN
HOME**



BUILD THIS YEAR—AVOID HIGH PRICES

Don't delay your building plans. Decide to start building now. Building prices are going up. Labor prices will advance. The Aladdin Read-Cut System enables you to build your new home, garage, barn or farm building at a substantial saving in cost. Thousands of Aladdin customers—some near you—will tell you how much they have saved building the Aladdin way. The big book "Aladdin Homes" will show you plans and pictures of over 100 homes. It will also demonstrate the saving you can make by building NOW. Send stamps for your copy today.

Save Waste of Lumber

Ordinary building methods waste on an average of 18 per cent of the lumber you pay for. Think of it! \$18 out of every \$100 goes to the waste pile and is burned up for kindling wood. Of course, the lumber that is wasted costs just as much as the lumber that is used. Are you willing to pay \$180 on every \$1000 worth of lumber for waste? This is an important item to consider, especially when lumber prices are advancing. The Aladdin system saves you this unnecessary expense—puts the \$18 from every \$100 into your pocket. Aladdin Read-Cut Homes are cut-to-fit in our mills. You pay for the material used in your house—no more.

Aladdin Price Includes All Material

Aladdin price includes all lumber, millwork, flooring, outside and inside finish, doors, windows, shingles, lath and plaster, hardware, locks, nails, paint, varnishes. Your home is shipped in a sealed box car, complete, Read-Cut, ready to erect. Safe arrival of the complete material in perfect condition is guaranteed. Floor plan arrangement and complete description of the house shown above will be found in the Aladdin Book of Homes. Send stamps today for the book "Aladdin Homes" No. 130.

Save Waste of Labor

When you receive the material for an Aladdin Home it is all cut-to-fit, marked and numbered. You will make substantial saving in the erection, as it is not necessary for your carpenters to spend their time sawing and measuring. All they do is put the material in place and drive the nails. It is also unnecessary for you to employ skilled labor to erect your Aladdin. Complete instructions and illustrations for erection are sent to you. You can erect it yourself in spare time.

120-Page Book "ALADDIN HOMES"

The big book "Aladdin Homes" shows over a hundred attractive bungalows and dwellings from \$241 for a 2-room home to homes valued at \$3,000 complete. Many attractive low cost garages—from the single car garage at \$64 to the largest size built for three touring cars. Barns of different types from \$250 for a complete barn to the largest and most complete type designed. This big book will help you plan your home, help you to save money on your building, help you to build it in less time than usually required. Let us send you a copy of "Aladdin Homes" No. 130. Send stamps today—it will be sent by return mail.

CANADIAN BRANCH:
Canadian Aladdin Co., Ltd., C. P. B. Bldg., Toronto, Ont.

THE ALADDIN CO. 1465 Aladdin Avenue
BAY CITY, MICH.

\$798



\$1,205



\$756



\$1,170



**Send This
Coupon
Today**

The Aladdin Co., 1465 Aladdin Ave., Bay City, Mich.
Enclosed find stamps for a copy of your book "Aladdin Homes" No. 130.

Name.....
Street.....
City.....
State.....

Please Mention Popular Mechanics



Answering the Nation's Call

IN this "supreme test" of the nation, private interests must be subordinated to the Government's need. This is as true of the telephone as of all other instrumentalities of service.

The draft for war service which has been made upon the Bell System is summarized in a recent Government report.

Government messages are given precedence over commercial messages by means of 12,000 specially drilled long distance operators all over the country.

The long distance telephone facilities out of Washington have been more than doubled.

Special connections have been established between all military headquarters, army posts, naval stations and mobilization camps throughout the United States.

As the war continues, the demands of the Government will increase. And the public can help us to meet the extraordinary conditions by putting restraint on all unnecessary and extravagant use of the telephone.

More than 10,000 miles of special systems of communication have been installed for the exclusive use of Government departments.

Active assistance has been given the Government by the Bell System in providing telephone communications at approximately one hundred lighthouses and two hundred coast guard stations.

Communication has been provided for the National Guard at railroad points, bridges and water supply systems.

A comprehensive system of war communication will be ready at the call of the Chief Signal Officer, and extensive plans for co-operation with the Navy have been put into effect with brilliant success.



**AMERICAN TELEPHONE AND TELEGRAPH COMPANY
AND ASSOCIATED COMPANIES**

One Policy

One System

Universal Service

Please Mention Popular Mechanics

Parents Welcome These New Savings on Goodyear Blue Streak Bicycle Tires

The Goodyear Blue Streak plan of making and selling better bicycle tires cheaper pleases every one—boys and girls as well as their mothers and fathers.

Economical buying is always sensible when the article bought does not sacrifice quality through the saving. And, especially so today, when all America is practicing thrift.

The money saved by buying Goodyear Blue Streak Bicycle Tires at \$3.25 each will come in very handy with prices of everything so high.

Why should any rider pay more when, for \$6.50, he may own a pair of Goodyear Blue Streaks

which in quality will match many other tires at \$10.00 per pair? And Blue Streaks are usually better than tires selling at the same price.

Goodyear gives you these savings by making only one tire—standard quality, always the same. This cuts factory costs. Then Goodyear saves you more money by selling direct to the Goodyear dealer in your town. That cuts out the needless handling-profits that are added to other tires you might buy.

Make these savings yourself. You are entitled to them. See the Goodyear Dealer in your town. Or write to The Goodyear Tire & Rubber Co., Akron, Ohio, for his address.

BLUE STREAKS

TRADE MARK REG. U. S. PAT. OFF



BOYS and girls who ride on Goodyear Blue Streak Bicycle Tires do not go to Dad so often for tire money.

Goodyear Blue Streak Bicycle Tires are rugged and strong. They are built to give long wear.

Pedaling on these tires, is easy. They are so resilient, light and active.

Side-slipping is guarded against by the wonderfully effective non-skid treads. You ride swiftly and safely.



AND fathers are pleased. For careful buying is one of the first lessons of good business.

Blue Streaks, moreover, are handsome in appearance. Be sure and see the bright Blue Streak on the sides, before you buy.

Boys everywhere are wearing Goodyear Bicycle Caps. Ask your dealer. They're especially popular with Bicycle Clubs—name of club printed on the cap.

GOODYEAR

AKRON

Please Mention Popular Mechanics

Non-Breakable—It's All-Steel

A strong, accurate Mitre Box is a necessity for anyone who wants to make clean joints and close fits in cabinet or ornamental woodwork. The Goodell-Pratt All-Steel Mitre Box, with its riveted truss-frame steel construction, is unbreakable and everlastingly accurate. It is made in five sizes to take five different sizes of Disston back-saws; the width of the box is always the same, all sizes having a capacity of $10\frac{1}{2}$ " at right angles. The saw lever swings 45° either right or left from the center, locking at any angle.

Partial List of Goodell-Pratt Tools

Squares	Screw-drivers	Bit Braces
Drills	Hacksaws	Punches
Levels	Saw Sets	Lathes
Vises	Calipers	Grinders
Gauges	Micrometers	

Ask for the Complete Catalog

Goodell-Pratt Company *Toolsmiths*
Greenfield, Mass.
U. S. A.

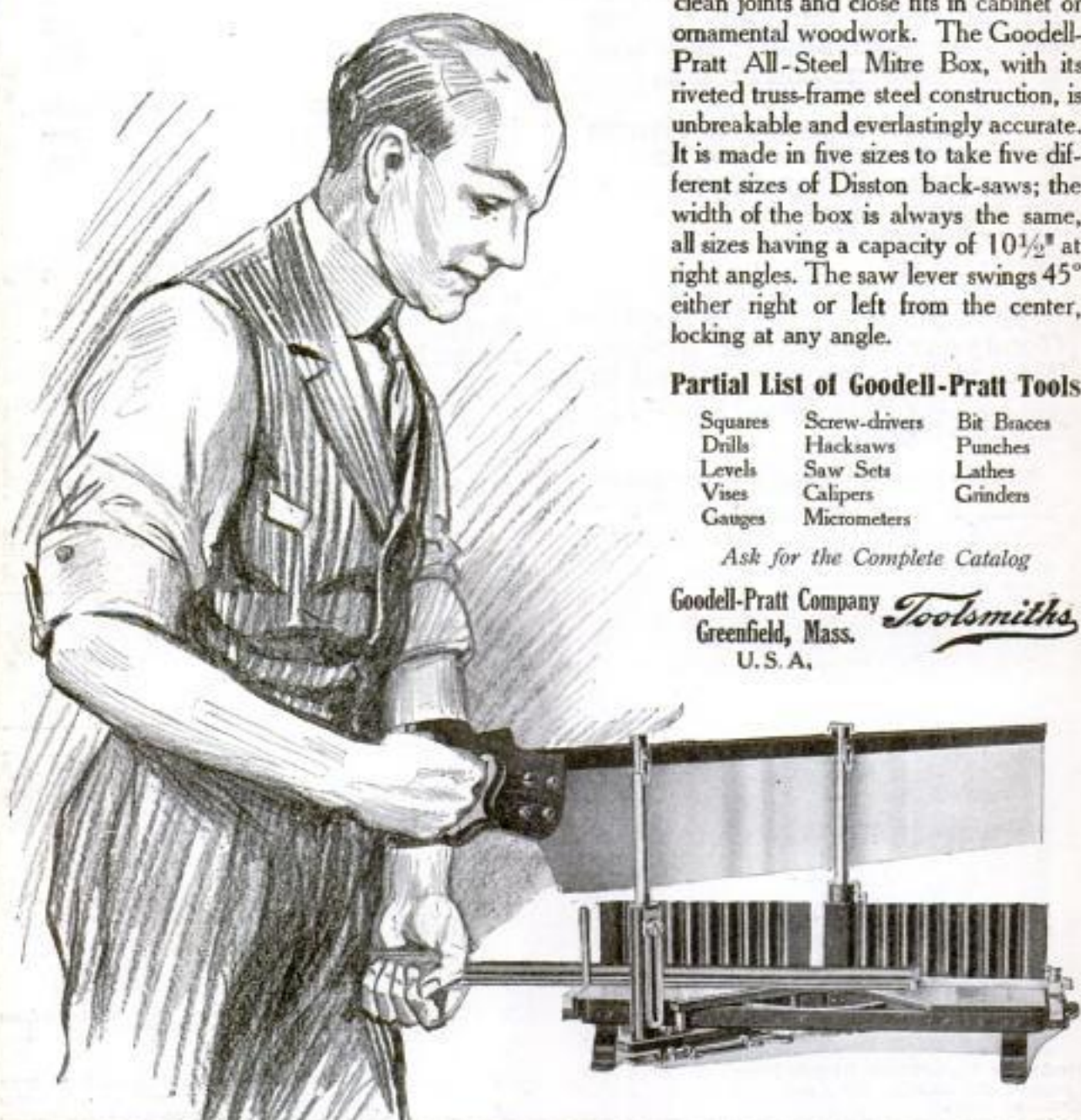

GOODELL PRATT

1500 GOOD TOOLS

Learn to Shoot

Practice trapshooting.

The secret of the fascination of this dandy sport is in the flying targets.

Their constant challenge to the gunner's skill, stirs the blood of pioneer Americans that runs in his veins.

Every man—every woman—should know how to shoot and hit what is shot at. The best place to learn is at the local trapshooting club.

There is a gun club in your own town right now ready and waiting to give you a royal welcome. Go out and enjoy a few hours of this clean, keen sport.

*The Sport Alluring Book 386
on request*

E. I. du Pont de Nemours & Co.

Wilmington, **DU PONT** Delaware



White House Brand Coffee and Teas

Have the "Tang of the Orient"
NEVER VARIES
 A Blend of Selections from the World's Best. Roasted and Packed in one of the most modern and up-to-date, efficient and sanitary Coffee Factories in the World!

Sold by high class Grocers in every State. Our Teas are from the Gardens of the East.

"None Better At Any Price"

DWINELL-WRIGHT CO.
 Principal Coffee Roasters Boston—Chicago



Time To Drink
WHITE HOUSE COFFEE and TEA



This is
John Philip SOUSA

March King and President of The American Trap Shooters' Association, with an

ITHACA GUN

Mr. Sousa knows the lightning lock of an Ithaca improves his shooting; it will improve yours.

Catalogue FREE - double guns, \$24.00 up; single trap guns, \$85.00 up.

Address Box 81

ITHACA GUN CO.
 ITHACA, N. Y.

MAZDA Always etched on electric lamps to which MAZDA Service has been applied.

Bausch and Lomb BALOPTICON

THE PERFECT STEREOPTICON

Bausch & Lomb Optical Co., 576 St. Paul St., Rochester, N. Y.

Standard Wool Bunting FLAGS



Embroidered Stars

We offer you at factory prices the following flags which we guarantee to be made of the finest materials and in accordance with the United States Government regulations.

OUR LEADER

A 5 x 8 foot standard wool bunting flag with double stitched seams, canvas headings, and grommets.

EMBROIDERED STARS

add richness and enhance the color contrast in the field of blue. The flag retails for as high as \$16.00. Price \$10.00 Express Prepaid

Cotton Bunting Flags

Best quality, sewed stripes, printed stars, canvas heading and brass grommets.

Cotton Flag Combination Sets

Flags of best quality with jointed pole, truck, ball, hal-yards and galvanized pole holder.

Size	Postage Paid Price
3x5 feet.....	\$1.00
4x6 feet.....	1.50
5x8 feet.....	2.25

Size	Height	Pole	Price
3x5 feet.....	6 feet.....		\$1.75
4x6 feet.....	7 feet.....		2.25
5x8 feet.....	8 feet.....		3.00

Satisfaction guaranteed or money refunded. Flag Price List mailed on request.

The Victory Flag Manufacturing Co.
 Peoples Gas Building, 125 Michigan Avenue, Chicago

Timely Talk on a Vital Subject



Wife: "If we must cut down expenses, why not drop your life insurance?"

Husband: "Not much. That's *your* insurance, not mine. I figure we can trim about all the other items so as to save at least \$400 a year, and I'm going to take a hundred of that and buy another Postal Life Policy while I can get it. You and the kiddie may be glad some day."

Wife (thoughtfully): "I guess you're right at that, James."

Put life insurance in your family budget —and *keep* it there

In war-time or in peace, the *real* husband always makes a liberal allowance for life insurance whether his wife wants him to or not, but the sensible woman *does* want him to when she considers it seriously. And whether times are hard or easy they both want the most protection possible for their money, and hundreds of them are therefore turning to the

Postal Life Insurance Company

The Postal Life employs no agents, but issues its Policies *direct*. Agents' renewal-commissions and office-expenses are thus saved and go to its policyholders. It is not alone the Company of *Safety* and *Service*, but also of *Saving*, for policyholders receive, among other benefits, an

Annual Dividend of **9½%** Guaranteed in the Policy

Besides this saving, the Company pays the usual contingent dividends each year, depending on earnings. It will pay you to

Find Out How Much You Can Save

at your age on any standard form of Policy—*Whole Life, Limited-Payment Life, Endowment, Joint-Life*, or on a *Monthly-Income Contract*.

The Postal issues all of the standard forms, as approved by the New York State Insurance Department, including Group-Insurance. It is also subject to the United States Postal authorities.

To get exact figures for your age, call at the Company's office or simply write and say: "*Mail insurance particulars as mentioned in POPULAR MECHANICS for September.*" In your letter be sure to give:

1. Your full name. 2. Your occupation. 3. The exact date of your birth.

Remember: No agent will be sent to visit you. The Postal Life employs no agents; resultant commission-savings go to you because you deal *direct*.

Postal Life Insurance Company

WM. R. MALONE, President

511 Fifth Avenue, Cor. 43rd St.

NEW YORK

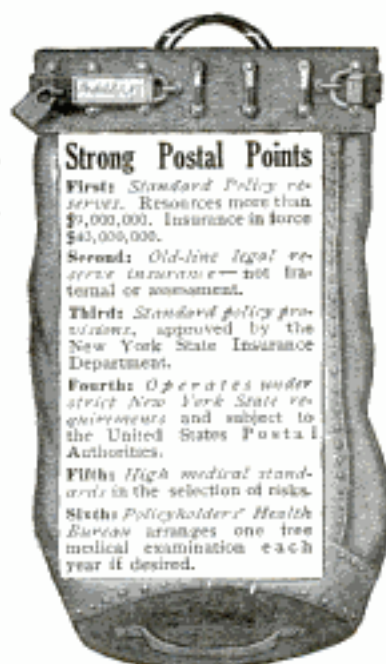

The Men The Navy Needs Now

DURING the first few weeks after the United States entered the Great War, many thousands of patriotic young Americans responded to the call of the United States Navy. So many of these fine young men offered their services who had no special qualifications for the work on board ship, that the capacities of the training stations were soon overtaxed. It shortly became necessary to restrict the enlistments of unskilled men by raising the minimum age limit of apprentice seamen, and to suspend enlistments in certain trades which were in excess, such as shipwrights, shipfitters, blacksmiths, boilermakers, plumbers, printers, painters, general electricians and men of the yeoman (or clerical) branch.

The Navy still needs men, but desires to fill the remaining vacancies in its authorized complement with men who are most needed in the fleet.

An urgent need now exists for competent machinists, ages 21 to 35; for skilled musicians, 21 to 35 (or landsmen for musicians, 18 to 25); and for radio operators, 18 to 25. Other ratings which are still open to enlistment are apprentice seamen, cooks and bakers, coppersmiths, firemen, hospital apprentices, mess attendants, and men specially qualified for the Navy Flying Corps.

An attractively illustrated booklet explaining the naval service, together with circulars describing special branches of the Navy, will be sent upon request.

ADDRESS

RECRUITING DIVISION
NAVY DEPARTMENT **WASHINGTON, D.C.**

There is a Navy Recruiting Office in every large city

I Will Save You More Than 1/2 on a \$100 UNDERWOOD

E. W. S. SHIPMAN, President

EVERYONE knows the reputation of the Underwood Typewriter. I will send you on **TEN DAYS' FREE TRIAL** a High Grade No. 4 Visible Writing Underwood, with Back Spacer, Tabulator, Stencil Attachment, Two-color Ribbon, Waterproof Cover and Special Touch Typewriting Instruction Book, that will teach you to operate this simple Underwood in one day. I will give you a **written** guarantee of **FIVE YEARS' SERVICE** from date of sale and I will save you much more than one-half the manufacturer's price.

25 Years' Experience—Confidence of 200,000 Customers

I am the largest typewriter re-builder in the world, employing the most expert workmen in the typewriter business. I handle only Underwoods, obtaining all my machines and all new parts direct from the Underwood Company.

How I Double the Life of An Underwood

Do not confuse me with a second-hand dealer. I put each machine through a process that I have spent 25 years perfecting. Each machine is taken apart and re-built from top to bottom.

The frame is re-enameled, the bright parts re-nickled. All parts unfit for further service are discarded and replaced by new parts purchased from the Underwood Company. Every machine is equipped with new type, new platen, new ribbon vibrator, front scale, feed roll, ribbon, space bar, key rings, key glasses, rubber feet, etc. Expert mechanics re-adjust and re-align each machine. It will stand any mechanical typewriter test.

You May
RENT APPLYING RENT ON PURCHASE PRICE
OR
BUY FOR CASH OR ON EASY PAYMENTS

My Five Year Guarantee—Ten Days Free Trial

I personally stand back of every machine that goes through my factory with a **WRITTEN FIVE YEAR GUARANTEE OF SERVICE**. I guarantee to send you a genuine Underwood, exactly as illustrated and described here-with. You don't even have to buy the machine at the time you get it. You can try it for ten days **FREE** and then, if you conclude the machine I send you does not look, work and write like new, you may return it and I will refund any deposit or charges paid by you. This guarantee affords you complete protection.

Rent or Buy Mail coupon or post card today for special low price and terms. You can **RENT**, applying six months' rental on purchase price, buy on easy terms or secure discount for cash.

Our Other Plan Brings Underwood FREE

A new plan—our agency plan. You are not asked to do any canvassing or soliciting for orders. You simply co-operate with us, becoming part of our nation-wide organization. You can easily get your Underwood **FREE** in this way. Send name and address on coupon today and learn about Offer No. 52.

E. W. S. SHIPMAN, President

Typewriter Emporium
CHICAGO

SIGN AND MAIL COUPON TODAY
TYPEWRITER EMPORIUM, 34-36 W. Lake Street, CHICAGO
Send me immediately full facts about your Special Offer No. 52.

Name
Street or R. R. No.
City
State

Five
Year
Guarantee

Ten
Days'
Free Trial

Please Mention Popular Mechanics

These Garments Laugh at Wear and Wash-Tub

We've built up a world-wide reputation on Finck's "Detroit-Special" overalls and combination suits simply by spending for your benefit what we might have saved by skimping.

That means more room, more comfort, more wear—and it means a million users who will have no others.

If your dealer hasn't them, send price and size and we'll forward by prepaid parcel post.

Overalls . . . \$1.75 and \$2.00
Jackets . . . 1.75 and 2.00
Combination Suits 3.00

W. M. Finck & Company
1154 Gratiot Avenue, DETROIT, MICHIGAN



FINCK'S
"DETROIT-SPECIAL"
OVERALLS
"They Wear Like a Pig's Nose"

THE "ELECTRO" TELEGRAPH

is not a toy, but a practical, honestly built telegraph outfit, which not only pounds but works like the big commercial instruments. By studying the code for 30 days you can become a first-class telegraph operator. Such operators are in big demand now. Outfit consists of TWO complete telegraph instruments, each measuring 3 1/2 x 5 1/2 in. All metal parts are highly nickel plated, including key lever. Note heavy rubber knob. Telegraph Code Chart, telegraph blanks and connecting wire come with set, but no batteries. Outfit works on two dry cells (one cell for each instrument). The "Electro" is the ONLY outfit that works both ways; each station can call; no switches, no extras. Nothing to get out of order. Guaranteed to please you or money back. Price complete as illustrated.

\$1.00

AT ALL GOOD DEALERS AND DEPARTMENT STORES

If your dealer cannot supply you send us \$1.50 for outfit and add mailing charges for two pounds, otherwise we ship express collect. Goods shown here are only a fraction of our wonderful assortment illustrated and described in our great 224-page **Electrical Cyclopedia**; contains more information than most electrical works. Also contains twenty coupons for free Wireless Course.

Electro Importing Co., 245 Fulton Street, New York City

\$1

Cyclopedia Sent FREE on receipt of 4c in cover postage. **Send for your copy today**

TELEGRAPH CODES:

ALPHABETIC

NUMERIC

FIGURE

SYMBOLS

NUMERIC

ALPHABETIC

FIGURE

SYMBOLS

NUMERIC

ALPHABETIC

FIGURE

SYMBOLS

NUMERIC

ALPHABETIC

FIGURE

SYMBOLS

NUMERIC

ALPHABETIC

FIGURE

SYMBOLS

NUMERIC

ALPHABETIC

FIGURE

SYMBOLS

NUMERIC

ALPHABETIC

FIGURE

SYMBOLS

NUMERIC

ALPHABETIC

FIGURE

SYMBOLS

NUMERIC

ALPHABETIC

Be Sure It's **"POROSKNIT"**
GENUINE SUMMER UNDERWEAR
Cool, elastic, comfortable—**GUARANTEED**
Chalmers Knitting Co., 78 Washington St., Amsterdam, N. Y.

Trap Outfit For 20¢ a Day



COMPLETE trap outfit for 20c a day. Hear the boat whistle, the hen cackle, the baby cry and the horse gallop. Realistic theatre music for 20c a day. Money back if not satisfied.

Send for Catalog

Write for information about trap outfits. Catalogs and circulars—everything free. Write today.

The Rudolph Wurlitzer Company — Dept. 1196
E. 4th Street, Cincinnati, O. — 5. Wabash Avenue, Chicago, Ill.

FREE Wonderful Book

Tells how to learn taxidermy—how to mount birds, animals, game-heads, fishes, tan skins. Learn by mail. A necessity for hunters and nature lovers. Best methods, quickly learned, very fascinating. *Sources guaranteed.* Decorate your home and den with splendid art. Make big profits. **Write today** for this fine illustrated, free book and our amazing offer.

Northwestern School of Taxidermy, 9196 Elwood Bldg., Omaha, Neb.



War Time Means Repair Jobs

We show you how to get the money-making re-flooring jobs and explain how to lay Asbestone, the wonderful flooring material that looks and wears like tile, yet costs less than half as much, and still yields you a handsome profit. Get after these jobs at once. No experience necessary. Hundreds of floor jobs ready to get when you show the samples of Asbestone we supply free.

FRAZ KLYN R. MULLER & CO.
796 Madison Street, WAUKEGAN, ILLINOIS



The Floor That's Laid With a Guarantee



Write for full particulars. Also ask about our Magnesium Scales

Dining



Phoning



Writing



Dressing

CARNES
ARTIFICIAL
ARM

Combing

CARNES ARTIFICIAL ARM

Here is the best substitute ever invented for the natural arm. Users of The Carnes Arm perform efficiently every function of daily life.

The Carnes Arm is the only one that allows full elbow, wrist and finger movements. So natural are its workings and appearances that an artificial hand or arm is not suspected. It is endorsed by leading surgeons, most of the big railroad companies, the Carnegie Steel Company, the press of the country, and thousands of satisfied Users. It not only adds to the wearer's appearance, but gives him a practical, useful member.

Awarded Gold Medal at Expositions

In San Francisco, San Diego, and London, England, the Carnes Artificial Arm has received the gold medal, highest award. Used in nearly every civilized country of the world, the Carnes Artificial Arm ranks high as a work of American genius. Today the British, Canadian and Australian governments are buying Carnes Artificial Arms and Hands for returned soldiers—thus enabling them to work at full efficiency in factories and other occupations.

Armless men and women in any walk of life can use the Carnes Arm. C. P. Illingworth drives an automobile—Ed F. Smith shaves himself—Gladys Bradley sews and sweeps—Marjorie Kirtland plays the piano—Walter Egbert drives a traction engine—Alexander Hardie draws cartoons—Thomas Keenan (boiler maker) drives rivets—Ed F. McWha shoots a gun and rides a bicycle—Lloyd Hobson plays a violin. These are only a few of the wonderful things Users do with The Carnes Arm.

We urge every armless man or woman to write to us today for our big, free, illustrated catalogue B 25 showing the wonders of The Carnes Arm. Sent anywhere in the world. If possible call at either office for a demonstration.

CARNES ARTIFICIAL LIMB CO.

Address: B 25—31 Carnes Bldg., Kansas City, Mo.

Main Office and Factory: 906 E. 12th St., Kansas City, Mo.

BRANCH OFFICES AT

New York, 501 Centurian Bldg.

Chicago, New York Life Bldg.

Pittsburg, 103 Arrot Bldg.

Toronto, Can., Young & Adelaide Sts.

Paris, France, Hotel De France

Choloul, 239 241 Rue St. & Honore

London, England, Queen Mary's Hospital, Roehampton

Australia, General Hospital, No. 11

Canfield, Victoria

Shovelling



Sweeping



Sawing



Drafting



Shooting



Sewing



Shaving



Driving



Cycling



Farming



THE
Carnes Arm
PUTS YOU ON THE
PAY ROLL

WAR

on
Watch
Prices



We are determined to lower watch prices. In remarkable watch values, the BEST and EASIEST TERMS we are leading all. **All Watch Terms Shattered.**

Write today for our special WAR offer. Write for the FREE WATCH BOOK which tells all about our astounding offer, shows in four colors, the beauty of the "Santa Fe Special" Watch.

Look *The ILLINOIS Famous* \$ **2.50**
Santa Fe Special **2** **A**
JEWEL RAILROAD WATCH **MONTH**

The one standard railroad watch that's **GUARANTEED TO LAST YOU ALL YOUR LIFE**, yet priced so low and on such easy terms that any man may own one.

New Case Designs

We want you to know of the marvelous beauty of the three-color inlay work. Think how distinctive your watch would be with your own name or monogram inlaid in solid gold. Our new 52-page watch book shows these and many other beautiful designs, including engraved monograms, special French art designs, or any emblem desired may be done just as you want it.

Are You Interested in DIAMONDS

Write today if you would like to see the FREE DIAMOND BOOK. Select the gem you would like to see. It will be sent to you for your inspection and approval. Ask for Diamond Book B.

Either watch or diamond or both, sent WITHOUT ONE PENNY DOWN

Santa Fe Watch Co.
Department 96 Topeka, Kansas

The Home of the Great Santa Fe Railway

JEWELS

Either 17 or 21 absolutely flawless sapphire and ruby jewels are used in the men's "SANTA FE SPECIAL." Lever set, double roller escapement. The Ladies' watch is fitted with 17 of these perfect jewels.

ADJUSTMENTS

"SANTA FE SPECIAL" movements are **Adjusted** to positions, **Adjusted** to temperature, **Adjusted** to isochronism, **Adjusted** to the least fraction of a second. Factory fitted in case you select.

All Sizes of Watches

A letter, a postal or this coupon will bring the Free Watch Book

**Santa Fe Watch Co.,
Topeka, Kansas, Dept. 96**

Please send me the New 52-Page Watch Book with the understanding that this request does not obligate me in any way.

NAME.....

ADDRESS.....

STATE.....



\$45 Starts You In the Tire Repair Business

Here is your opportunity to get into this big paying, big profit business. A business of your own in which you can be your own boss—a business that runs hand in hand with the automobile business—that grows with it and is fast becoming the biggest paying proposition in the automobile field. You can start now on small capital—only \$45, and cash in this gigantic opportunity. The coupon below will bring you full details—full particulars. Mail it today.

Millions of Tires to Repair—Means \$3,000 a Year for You

It is estimated that more than 30,000,000 tires will be made this year. These, with all the old tires now in use, will need repairing—will demand the expert attention—the expert service that you can give as a Haywood Tire Repair Man. You can learn this business in a few days. You can open a shop and make money almost at once. Auto owners will come to you—tell their friends, and if you are a live-wire, your business will soon grow from a one-man shop to a big complete tire repair shop and accessory store.

Complete \$45

HAYWOOD'S Model D.B. VULCANIZING PLANTS

One Machine Will Start You Making Big Money

This machine at its unusual price is practically the last word in efficient, economical tire repairing. It is simple, compact, quick acting, and requires but little room. It will vulcanize and make tire repairs of almost any nature—will do practically everything in the tire repair business except retreading. Just a small investment—\$45—a trifling amount, places you on this road to prosperity—gives you the start in this wonderful business.

The Only Nationally Known Tire Repair Service

Through National advertising, Haywood Tire Repair Service is known to auto owners everywhere. When you open a Haywood Shop you have the advantage of an established business—a business of unlimited profits—a business you don't have to wait for—that comes to you with scarcely an effort. In this, most wonderful year of the automobile business, is the time for you to start. More tires are to be used than ever before. The cost of operating cars is steadily climbing. Punctures and blow-outs are still common, and every man now, regardless of wealth, knows that keeping his tires repaired, prompt attention to the little cuts and bruises of his tires, is true tire economy. Tires are the biggest item in the up-keep expense of an automobile. You know that.

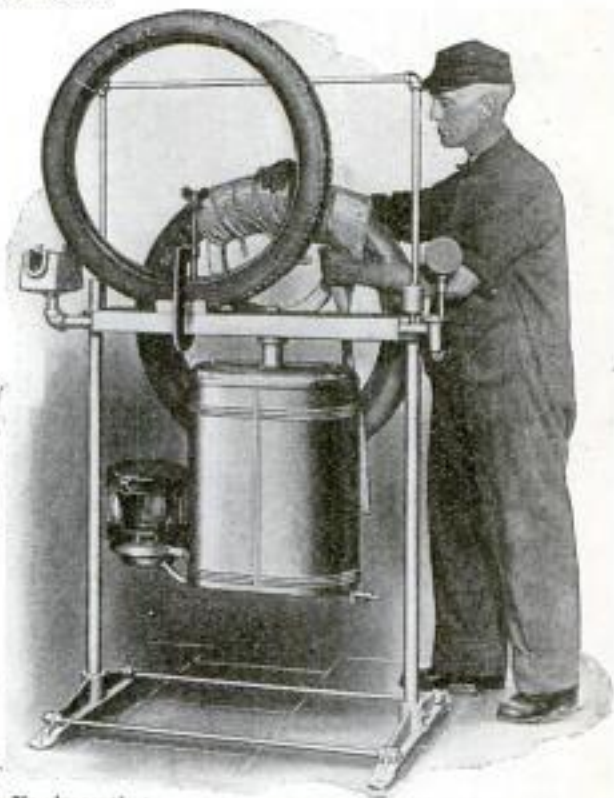

ACT QUICK—MAIL COUPON / FREE BOOK COUPON

I have published a big interesting book—a book all about tires. Tells how they are made—how they are repaired by the Haywood method. Gives complete details of this wonder machine—this new model D-B at its unusual price. Gives inside figures and profits of the tire repair business. Gives proof of success, letters from others who are now operating Haywood shops and making big money. What these men have done you can do. \$2,500 to \$4,000 a year is the ordinary income of live-wire tire repair men. Send no money. Just mail the coupon—a letter or postal will do.

HAYWOOD TIRE & EQUIPMENT CO.
652 N. Capitol Ave., INDIANAPOLIS, IND.

GENTLEMEN: Please send me full details of the tire repair business and complete description of the new Haywood Model D-B Vulcanizing Plant which you are offering at the unusually low price of \$45.

Haywood Tire & Equipment Co.
652 N. Capitol Ave., Indianapolis, Ind.

Name.....

Address.....

Conserve Steel and Iron -Cut Out the Scrap Pile

Prest-O-Lite
PROCESS

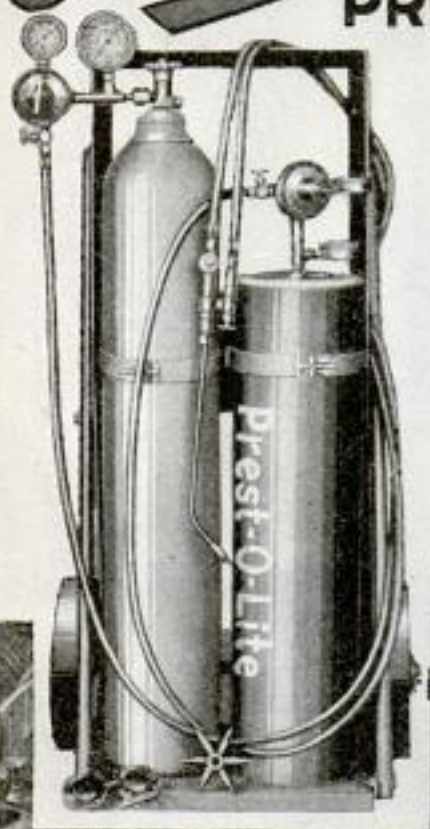

MILLIONS of dollars worth of damaged or worn metal parts, castings and tools lie rusting in the scrap piles of American railroads, factories, mines, foundries, repair shops, etc. By oxy-acetylene welding much of this enormous waste can be eliminated, and losses due to breakdowns—resulting in “tie-ups” of operating equipment—can be greatly reduced.

The Prest-O-Lite Process handles metal repairs quickly and efficiently, —often right-on-the-spot—makes the broken or worn parts strong as new—avoids “scrapping” valuable parts. The welding outfit is portable —available for outside work as well as for shop use.

In the manufacture of war munitions, ships, boilers, metal furniture, implements and tools this same process makes possible many striking economies—gives neater, stronger joints at *less* cost.

Write for special literature and data—NOW.

Job Welding is a Paying Business

Garages and repair shops find job welding a ready money-maker. Makes extra profits—saves time and money for customers— attracts new trade. Write today.

The Prest-O-Lite Co., Inc.
816 Speedway, Indianapolis, Ind.
Canadian Office, Dept. U Toronto, Ont.
World's largest makers of dissolved acetylene

ANY WATCH YOU WANT

On Credit



1918-MODELS
HOWARD
HAMPDEN
SOUTH-BEND
ELGIN
WALTHAM
HAMILTON
ILLINOIS



WRITE FOR GREAT NEW OFFERS

From the Square Deal Miller you can get the watch you want at manufacturer's cash prices—but on the easiest terms. In the new Miller-Hoefer catalog, the latest models of America's best known time-pieces are listed, also **Genuine Diamonds**, and a vast assortment of **Jewelry**—all on **Credit**, all on **Free Approval**, all on **30 Days' Trial**, and all **Guaranteed**. This new book is yours for the asking. The coupon, or your name and address on a post card brings it **Free**.

Factory Prices and Easy Terms

Your Money Back If You Can Buy Cheaper for Cash

Send No Money

You need not send one penny with any order for a Watch, a Diamond, or any Jewelry, unless you prefer. I will send you anything you select for **Free Examination**—even pay the express charges. Only after you find the goods are as represented, need you pay the first payment of my **Easy Credit Terms**.

30 Days' FREE Trial

After a test in your own possession of any Watch, Diamonds, or Jewelry, should you want to return the goods, you can do so, and your money will be refunded. That is the way the Miller-Hoefer Company has taken the risk out of mail order buying—how it assures every customer of a Square Deal, but this is not all—

The Miller-Hoefer Credit Plan

No Reference Demanded — An Open Account

A New Kind of Credit—liberal—dignified—open and above board. You can have an **Open Account**—the same kind of credit you get from your grocer. **No Interest—No Notes—No Bank Guarantee—No Red Tape—No Collectors**—just plain honesty between one man and another.

Send Coupon Today I want you to have my new **Free**

Book if you are interested in Watches, Diamonds, or Jewelry. **It's Free and Postpaid**. Remember—there is no obligation—just the opportunity if you wish, to take advantage of the most liberal, squarest, Watch, Diamond, and Jewelry offer ever made.

SQUARE DEAL MILLER, Pres.
MILLER-HOEFER CO.

33 State St., Dept. 906, DETROIT, MICH.

VALUABLE CATALOG FREE
 Square Deal Miller, Pres. Miller-Hoefer Co.
 33 State St., Dept. 906, Detroit, Mich.
 Dear Sir:—Please send me your **FREE**
 Watch, Diamond, and Jewelry Catalog as advertised.
 NAME.....
 ADDRESS.....



**Buy A
Diamond
On Credit
Better Than
a Bank**

The Miller-Hoefer Company sells only the highest grade, finest quality, perfect diamonds. It is the only kind to buy, the best investment possible. Catalog shows hundreds for your selection. Choose any one for **Free Examination**.



SAXON ROADSTER

A CAR COMPLETELY EQUIPPED WITH EVERY MODERN FEATURE

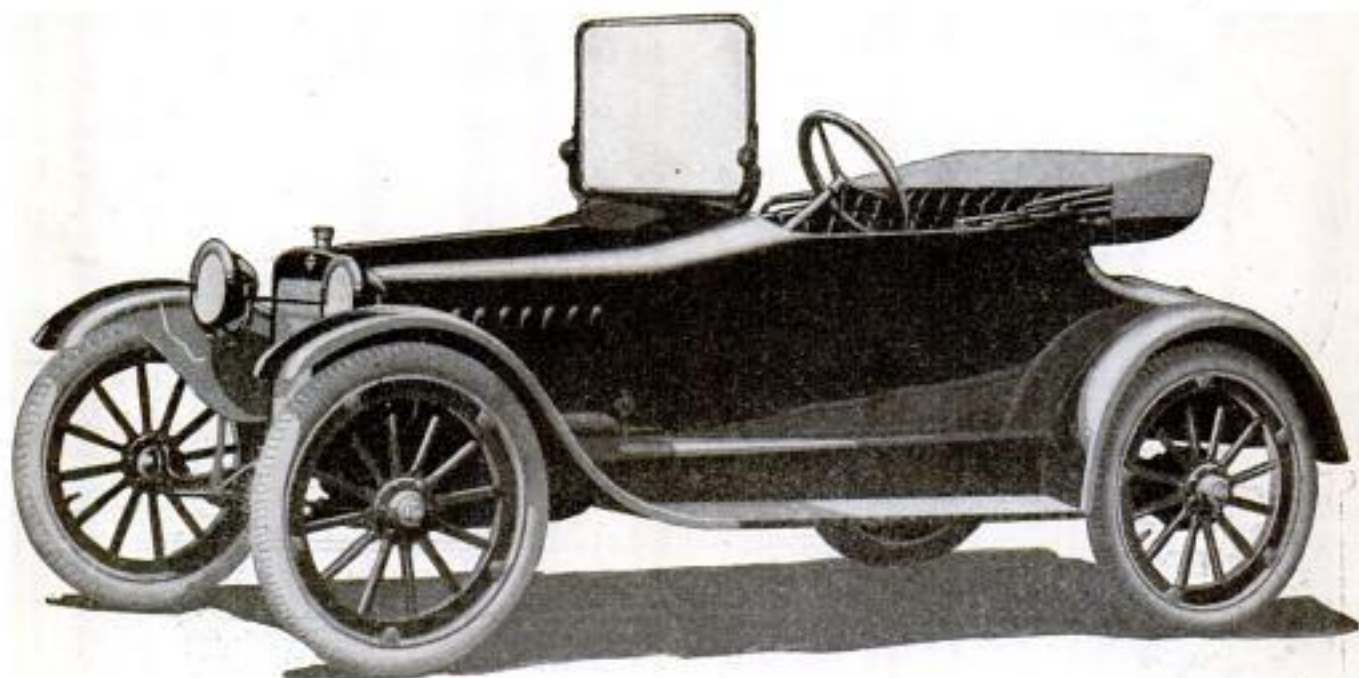

Speaking of Economy

Saxon Roadster owners continually report operating charges of but 3c per mile

Do you realize you can gain all the advantages of motor-car ownership for but little more expense than your present cost of car fare? And do you realize that motor-car ownership today is productive economy?

To make your efforts count most heavily, you must use every possible time-saving instrument. Each one of us must produce more by working harder and making more effective use of our time.

And because Saxon Roadster will give you the greatest number of satisfactory miles of travel for the least money it is the logical car for this purpose.

One salesman writes us he now covers his territory of 42 towns in just one-fourth the time formerly required by railroad, and at an expense of but 2½c per mile. He can now devote the balance of his time to developing new fields. He has multiplied his efficiency by four. He has made Saxon Roadster pay him a time dividend of 400%, and it can do the same for you.

Hundreds of Saxon Roadster owners have voluntarily written us expressing their satisfaction with the economical way in which this car has performed. Saxon Roadster complete, with starting and lighting system, three-speed transmission and demountable rims, is \$495, f.o.b. Detroit.

(173)

SAXON MOTOR CAR CORPORATION, DETROIT

Save 90¢

of every \$1.00
Punctures cost you

DON'T PAY 25 to 50 CENTS more than you need to for puncture repairs. Don't put up with make-shift repairs that cost you twice as much in the long run. Punctures are sure to come. Get ready

now to fix that next one right—to put on a patch the quickest, surest, cheapest way you can ever find—with

Repair
3 Punctures
at our
Expense

Patch
will
outwear
Tube

MARVEL JR. \$1 VULCANIZER OUTFIT COMPLETE 1

MORE
THAN
500,000
NOW
IN USE

REPAIR THREE PUNCTURES AT OUR EXPENSE

Buy *Marvel Jr.* today. Use it for three repairs. If it isn't absolutely satisfactory—if you aren't fully convinced it is worth ten times more than your money—send it back. We'll return your \$1.00 gladly—no argument—no delay.

Remember—material for six complete puncture repairs comes with the *Marvel Jr.* Everything furnished ready to use. Enough material furnished free to more than pay for the entire outfit! And our money-back guarantee on every bit of it.

Don't wait longer—don't spend a single cent more of money *Marvel Jr.* will save you on repairs. Buy from your dealer today. If he can't supply you order direct.

Double Your Tire Mileage with Marvel Sr. Vulcanizer

Save \$1.00 to \$2.00 on every casing repair. Fix tread cuts, sand blisters, etc., without taking tire off wheel. Repair tube blow-outs better than new. Material furnished free for large number of repairs. Outfit complete only \$2.00.

The Marvel Accessories Mfg. Co.
946 E. 73rd St., CLEVELAND, O.

Mail
the
Coupon
Now



MAIL THIS COUPON NOW!!
THE MARVEL ACCESSORIES MFG. CO.
946 E. 73rd St., Cleveland, O.

According to your money-back guarantee send me one *Marvel Jr. Vul.* outfit at all charges prepaid. I enclose \$1.00 herewith. (\$2.00 for *Marvel Sr. Vulcanizer* outfit.)

NAME

ADDRESS

STATE

DEALER'S NAME

Please Mention Popular Mechanics



DODGE BROTHERS MOTOR CAR

A stable institution with a stable policy, a stable product, and a stable demand for the car

Three elements which make the business of Dodge Brothers a permanent, season-proof business.

The gasoline consumption is unusually low
The tire mileage is unusually high

Touring Car or Roadster, \$835 In Canada, \$1185
Sedan or Coupe, \$1265 In Canada, \$1800
All prices f. o. b. Detroit

DODGE BROTHERS, DETROIT

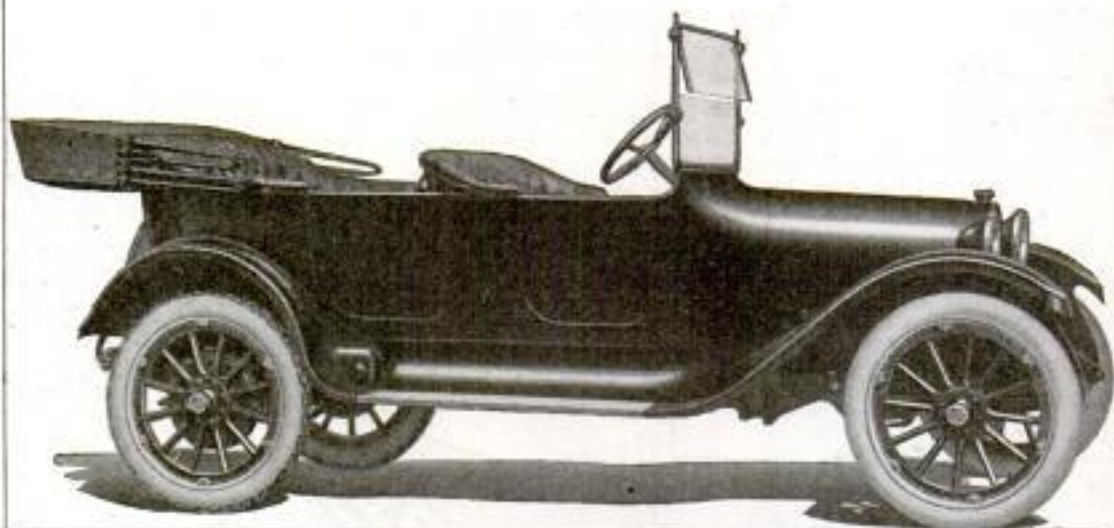

Please Mention Popular Mechanics

The Height of Restfulness

—sleeping comfort supreme
is afforded by the unique pat-
ented elastic hollow strand
construction of the

Way Sagless Spring

Guaranteed not to sag for 25 years.
Noiseless, sanitary. Thirty nights
free trial. Write for delightful
book on "Sleep and Health."

Way Sagless Spring Co.
Minneapolis, Minn.



OCCUPANTS DO
NOT ROLL TO CENTER

Please Mention Popular Mechanics

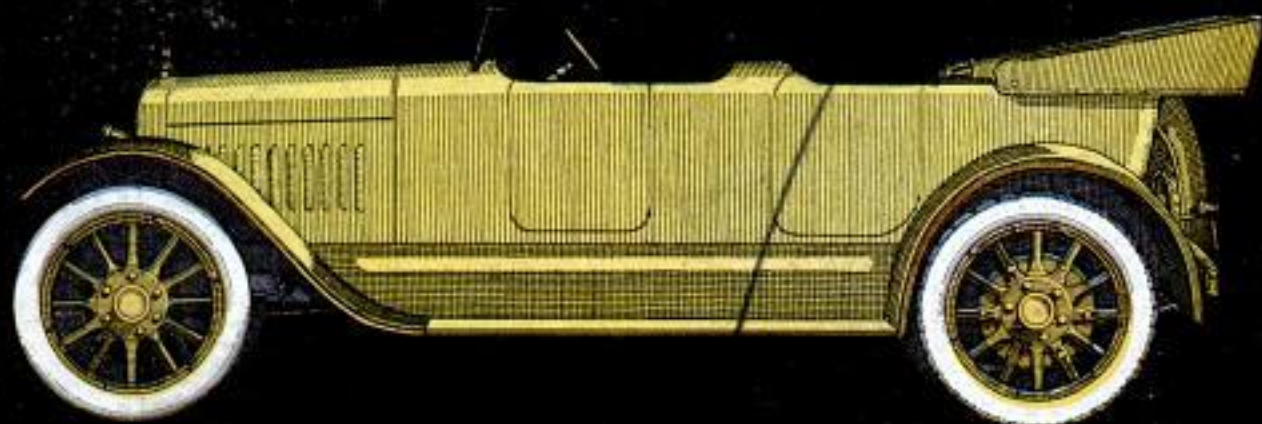

The Hal Twelve

S M O O T H P O W E R

The economy of buying the Hal-Twelve valve-in-head surprises the man who has usually paid \$4000 to \$5000 for his cars. Here at \$2600 he is confronted with an 87 horse power valve-in-head twelve motor, a simple, light, rugged chassis, a large distinctive body, custom built and custom finished in a wealth of colorings—all in size, all in comfort, all in performance that the most cultivated tastes crave. And on his purchase he saves \$1400 to \$2400. Prices: Touring Car \$2600; Roadster (two passenger) \$2600; Shamrock Roadster (four passenger) \$2600; Limousine and Town Car \$4500.

Hal Motor Car Company Cleveland, Ohio

Please Mention Popular Mechanics



CHASE
Plush
Motor Car
Robes

Made by Sanford Mills

Beautiful • Comfortable • Durable

Made to protect you from weather
in the same way Nature protects the
Arctic animals with a coat of fur.

L. C. CHASE & CO.

NEW YORK BOSTON CHICAGO

Leaders in Manufacturing Since 1847

Please Mention Popular Mechanics

Copyrighted material

EVEREADY DAYLO



The light that says
"There it is!"

BRING the trouble to light by bringing the light to the trouble. It's easy when you have an Eveready DAYLO. Its searching rays let nothing escape them. You can use this portable electric light anywhere, with perfect safety—close to the carburetor, near an open gasoline tank, in a closet hung with flimsy garments or in a cellar full of escaping gas. Eveready DAYLO cannot cause fire. Its abundant light is always at your instant command. And because it is fitted with an Eveready TUNGSTEN battery the service is long-lived, economical and always dependable.

Eveready DAYLOS are made in 77 styles, at prices from 75 cents up (in Canada 85 cents up) and sold by the better electrical, sporting goods, hardware, drug and stationery stores everywhere. There's an Eveready DAYLO for your pocket, your traveling bag, your car and your home. Get one today for your greater comfort and safety.

American Ever Ready Works
of National Carbon Co., Inc.
Long Island City New York
Canadian National Carbon Co., Limited, Toronto, Ontario

and saves
fumbling around
in darkness

when something goes
wrong with your motor
at night

when you mislay the
pliers or the wrench

when you've got to
change a tire quickly

when you drop the key
to the garage or the
stable

when a thunder storm
puts your house lights
out of commission

when you must find the
first-aid kit, quick!

when a storm breaks in
the middle of the night

whenever you need
light—safe, dependable,
effective light—that
cannot blow out, set fire
or fall, you need an
Eveready DAYLO.



Don't ask for a flashlight—
get an Eveready DAYLO



Please Mention Popular Mechanics



A dog—and a gun

A dog and a gun go together. They are two of the greatest teachers in the world.

From the dog, a boy learns the meaning of friendship and unswerving loyalty. From the gun, he learns the meaning of responsibility and accuracy. These are lessons that are more valuable to him than all his school books put together.

What a gun will do for your boy

The sport of shooting is the greatest developer of mental resources—mental quickness, fair play, steady nerves, control, and the ability to mix in manly competition with companions.

A boy's natural interest in a gun is going to make him get his hands on one sooner or later, so the sooner you teach him the correct use of a gun the better. Remember that it is just as important for every boy to know how to handle a gun safely as it is that he should know how to swim.

Let your boy earn a Winchester Medal

To encourage marksmanship and the correct handling of a rifle among boys and girls of America, we are awarding Gold Plated and Silver Plated Medals for skill with the Winchester .22 caliber rifle.

These Medals are awarded by the Winchester Junior Rifle Corps, an honorary club with membership among the boys and girls all over the United States.

Model 66. Take-down Repeating .22 caliber rifle, 20-inch round barrel. Shoots three sizes of ammunition. The most popular .22 caliber repeater ever placed on the market.



Model 65. Automatic hammerless take-down rifle. Handles only its own .22 automatic cartridge. Shoots ten shots as fast as the trigger can be pulled.

WINCHESTER

World Standard Guns and Ammunition

Please Mention Popular Mechanics

There are no dues and no military obligations involved.

Get your boy a Winchester rifle. Let him have the benefits that a gun will bring to him. Let him start on this Winchester competition which will teach him the correct use of a gun from the start. Every boy knows the traditions behind the name Winchester, so get your boy the gun he can be most proud of.

What the name "Winchester" means

The name "Winchester" stands for the best traditions in gun making. For over half a century, Winchester has been the standard of pioneers and sportsmen. Winchester rifles built the West. As the need grew, Winchester originated a model and a caliber for every purpose.

Every gun or rifle that bears the name "Winchester" is fired over 50 times with excess loads for strength, smooth action and accuracy. No Winchester barrel varies one one-thousandth of an inch in thickness or diameter.

The same care that is taken with Winchester guns is taken with Winchester ammunition. The two are made for each other.

Let the boy have it now

Don't delay any longer giving your boy the benefits of a Winchester.

Ask your dealer for our catalog and booklet on the proper use of a gun. If your dealer cannot supply you, write direct to us.

WINCHESTER REPEATING ARMS CO.
Dept. 142 New Haven, Conn.



BOYS AND GIRLS Winchester Medals for Skill with the Rifle

The Gold Plated "Sharpshooter" Medal goes to any boy or girl under 16 who makes the first grade score with a Winchester .22 rifle and Winchester ammunition.

The Silver Plated "Marksmanship" Medal goes to the boy or girl who makes the second grade score.

Go to your dealer today; he will give you a sample target and booklet explaining the full conditions of the contest. This booklet also tells you how to get the best results from your Winchester. The dealer will also supply you with targets.

If your dealer cannot supply you, write to the Winchester Repeating Arms Co., Dept. 142 New Haven, Conn.

Model 60. Take-down Repeating .22 caliber rifle, 24-inch octagon barrel. The standard target gallery rifle for 25 years.



Model 64. Take-down .22 caliber single shot rifle. A low priced hammerless, lightweight gun in two sizes.



Replace Your Heating Plant NOW!

SAFEGUARD HEALTH CUT FUEL EXPENSE

If you are about to select a heating system for your new home — or if you intend to replace your present unsatisfactory heating plant with a modern, up-to-date system — *Act Now!* Write us *to-day* for full information regarding the

ROUND OAK MOISTAIR HEATING SYSTEM

The Only Heating System That *AUTOMATICALLY*
Ventilates and Humidifies

Floods the home with comfortable, ever-changing, warm, fresh air automatically humidified. Banishes the dangers of malignant germ attacks on nose, throat and lung tissues broken down by breathing foul, dry-as-a-bone air. Gives plenty of heat upstairs and down, in every room, in any weather.

SAVES FUEL BY THE TON

Properly humidified air at 68° is more comfortable than *dry* air at 75°. This and other exclusive features listed in panel at the left insure an actual fuel-saving of *one ton* in every *nine*.

Easy to operate — requires least attention — holds fire longest — burns all fuels — clean, durable, trouble-proof — *preferable from every angle*.

This system is a result of 46 years of experience, is built by the makers of the genuine Round Oak STOVE and enjoys the confidence of more than 60,000 enthusiastic users! Investigate!

Write for Valuable Book **FREE**
and Heating Plan—

Handsome, illustrated book describes modern plant. With book goes a blank, which, filled out and returned to us, will shortly bring you a scientific Heating Plan drawn by expert Round Oak Engineers to meet your exact requirements. Cost of installation, etc., goes with Plan. And with no obligations to you. Write NOW! With book we also send name of nearest dealer selling and installing Round Oak Moistair Heating Systems. Many dealers sell on easy payments. To get the genuine, look for the trade-mark, which shows the Round Oak Indian.

ESTABLISHED 1871

The Beckwith Company
Round Oak Folks

115 Front Street

Dowagiac, Mich.



Five Star Points of Round Oak Supremacy

***Health** Only heating System that automatically ventilates and humidifies.

***Comfort** Delivers pure, warm, ever-changing moist air, free from dust, gas, smoke — fitted with gas-tight doors and dampers.

***Economy** Longest fire travel all inside casing; improved hot blast Ring; extra deep fire pot; extra large combustion chamber—perfect combustion; most heat on minimum of fuel.

***Convenience** Simple regulator controls entire system. Self-cleaning. Seamless ash pit, has sprinkler — dust proof. Non-leak door frame cast on—not bolted. Easy to operate.

***Durability** Materials used stand highest physical tests. All hinge pieces drilled, not cast. Never a bolt where a rivet will do. Tight fittings guaranteed. Good for generation of service.





YOURS FOR 3 CENTS A DAY

© 1917 S. M. S. Co.

Let Us Loan You Anything You Need for the Home

No Cash Orders

This offer upsets all present ideas of buying and selling. Just tell us what you need for your home. Let us loan it to you for a month. In no case can that month's loan cost you anything. Use the things we send, freely. Treat them just as if they were yours. Get a full, solid month's perfect pleasure from them.

We Wait a Year

If you decide to keep the things we loan you, you merely start paying us—a little at a time. Instead of saving up and waiting, we allow you to have them immediately and we wait for

the money. All accounts run about one year.

Coupon Brings All

Without cost, you may secure a copy of our latest Dollar Bargain Book. With it comes a credit certificate, opening your account. Then all these unusual privileges are yours to enjoy. No red tape—no bother of any kind.

The coupon printed at the bottom of this page awaits your mailing.

One-Profit Prices

We take entire factory outputs. We buy huge surplus lots. We contract for manufacturers' dull-time periods.

We have no salesmen. We employ no collectors. We use no display rooms. We have no end-of-the-season left-overs.

Our price, in most cases, is the maker's price, plus just our own profit. Usually it means a saving of one-fourth or even more.

Desk Chifforobe



Get our Bargain Book showing full line of Chiffoniers and 7000 other things and telling how to order on Free Loan.

Three in One Style. Beautiful, well made and answering any number of needs. A fully equipped writing desk, besides being an ordinary chiffonier and wardrobe.

Solid Oak in entire front and top, in a rich golden color with a high gloss. Sides and back of a selected hard wood, mortised and tenoned.

Sent on Loan

Measurements. 55 inches high, 38 inches deep and 21 inches wide. Coat and trousers hanger. Hat compartment with wood panel door, 14x18x16 inches. Liberal sized writing desk section with pigeonholes and drawers.

Shipped from factory in Central Indiana. Weight about 120 pounds.

No. 46M4B181. Price.....\$14.45

Spiegel, Mau, Stern Co.

845 W. 35th Street, Chicago

A \$1.00 Book Free

Picturing 7000 Home Things

Furniture	Baby Cabs—Cameras
Carpets—Rugs	Silverware—Clocks
Refrigerators	Chinaware—Lamps
Draperies—Linens	Sewing Machines
Curtains—Bedding	Kitchen Cabinets
Oilcloth, etc.	Stoves—Ranges

Send Coupon for it

Ask also for our Style Book picturing
1000 Fall Styles for Women

SPIEGEL, MAU, STERN CO. (1411)

845 W. 35th Street, Chicago

Mail me your Fall Bargain Book.

Also the books I mark below.

.....Stove BookWatches and Jewelry.

.....1000 Fall Styles for Women.

Name

Address

Check which catalogs you want.

Tougher Than Elephant Hide

Old bicycles grow young under the spell of Vitalics. Old riders feel young, once a pair of brisk, resilient Vitalics begin spinning out exhilarating miles beneath them.

The tonic, long-lived performance-power of Vitalics is there because we are putting forth every conceivable effort to make Vitalics give longer uninterrupted mileage, greater resilience and greater resistance to wear than any other bicycle tire made.

VITALIC Bicycle Tires

Three famous tires bear the great name VITALIC

Vitalic De Luxe is made of the choice of the world's best rubber throughout its extra-thick tread and tube. Its two-ply motorcycle tire fabric is built of the strongest cotton thread, triply-twisted. Highest quality friction. Distinctive V-shaped suction non-skid tread. All white. Price \$4.50 each.

Vitalic Cord Racer represents the highest type of racing tire, adapted for both track and road racing. Purest rubber combined with powerful Sea Island cotton cord fabric. All white. Smooth tread. Price \$4 each.

Vitalic Brigadier is a rugged, long-lived performer. Tough, four-ply Egyptian fabric. A ruling favorite with riders who demand long service at a moderate price. Black, heavy studded tread. Extra-heavy inner tube. White sides. Price \$3.25 each.

Vitalic
De Luxe
\$4.50
Each



Send for Testing
Section

FREE Vitalic testing section and booklet, "Tougher Than Elephant Hide." Be sure to give name and address of your bicycle tire dealer.

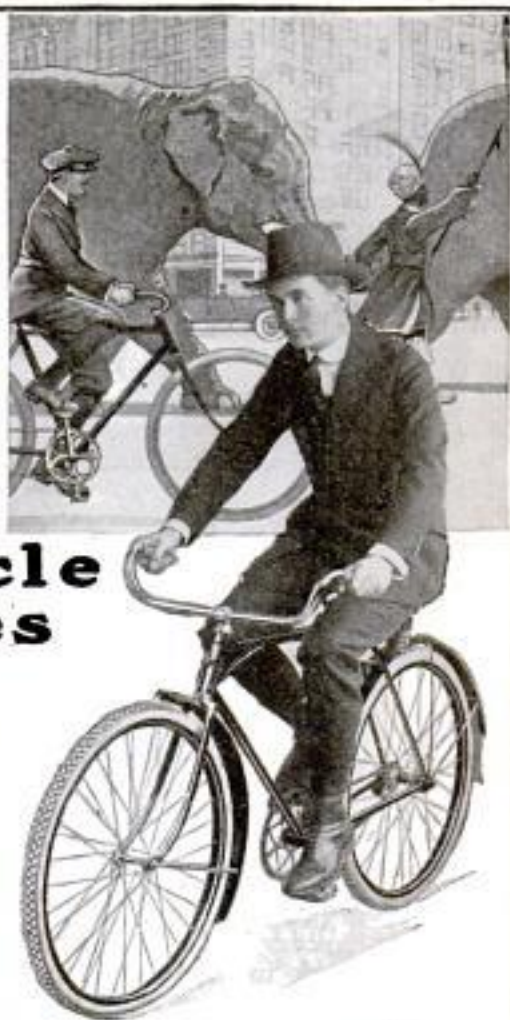

Vitalic
Brigadier
\$3.25 Each



CONTINENTAL RUBBER WORKS, 1964 Liberty Street, Erie, Pa.

MONEY
IN
MUSHROOMS

GROW AND SELL MUSHROOMS

An uncrowded occupation. Exceptional opportunities for live men and women. Raised at home. Only small space needed. Small expenditure will start you in a practical money-making enterprise. Big profits. Booklet telling all free. Write
Nat'l Spawn Co., Dept. 12, Boston, Mass.

50c Trial Order for 10c

Best Kodak Any size roll developed 10c; six prints free with first roll. Or send six negatives, any size, and
Finishing 10c for 6 prints. Beautiful 8x10 mounted enlargements 30c.
ROANOKE PHOTO FINISHING COMPANY, Formerly Roanoke Cycle Co., 208 Bell Ave., ROANOKE, VA.

Hand
Forged
Razor Steel
Blades, No. 57



Direct at Factory Prices

This \$2 KNIFE 88c Postpaid
Hand Forged Razor Steel Blades

Handy shaped blade makes this knife best for mechanics, sportsmen and farmers; light but strong; re-sharpened easily. Stag handle, German silver finish; blades file tested, hand forged from razor steel and warranted.

Sample 88c. 3 for \$2.12 postpaid.

Send for our 100 page List and "HOW TO USE A RAZOR" **FREE**

MAHER & GROSH CO., 106 A. St., Toledo, Ohio



Don't Take Chances!

I own and operate the largest exclusive engine factory in the world selling direct to user.

ED. H. WITTE.

**My Prices are Lowest
On High-Grade Engines
My Terms are EASIEST**

GASOLINE ENGINES
2 to 22 H-P.

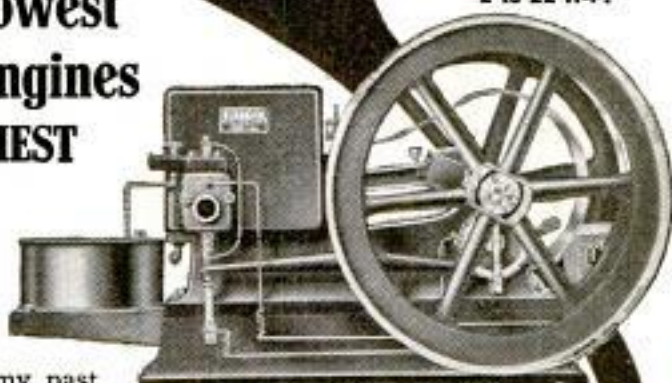

I save you \$15 to \$200, according to the size you select. I save you weeks of waiting when you want an engine quick. I save you the trouble of "trying out" engines you know nothing about. I save you future trouble, because my past record of 31 years selling only high-grade engines is a guarantee in itself, that I will make good to you and to every buyer. I save you putting off buying by having four plans of purchase—Cash—Easy Payments—Bank Deposit or No Money Down, letting the engine you select earn its own cost.

WITTE HIGH-GRADE ENGINES

Are Built to Operate on Kerosene, Gasoline, Naphtha, Distillate Oils, Natural or Artificial Gas.

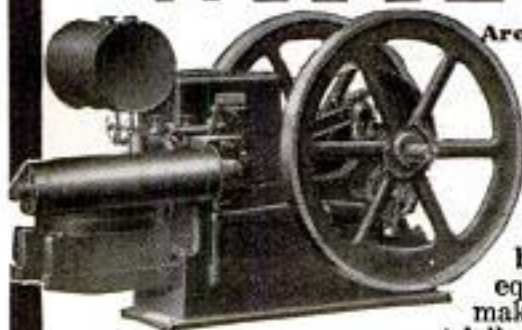

WITTE "KERO-OIL" ENGINES
2 to 22 H-P.

My engines are exclusive in design, different than any other engine sold direct, easy to understand and operate, and proven doubly desirable through 31 years of selling reliable engines for farm and shop power. I make nothing but engines—give you 100 per cent efficiency in engine building. I buy everything for cash. My factory equipment includes the finest engine making machinery obtainable, especially selected to reduce manufacturing cost. You take no more chance in buying an engine from me than in tak-

ing your money from one bank to another. The WITTE 5-Year Signed Guarantee has a million dollar factory back of it, and the factory has a definite future before it. Furthermore, if you want an engine at once,

Write To WITTE

I can ship immediately—any size or style. Kerosene or Gasoline, Stationary or Portable. Don't make any mistake on the engine you choose, or the price you pay. Get my prices and terms. Try a WITTE 90 days. Learn just what a WITTE high-grade engine will do, and why the WITTE is better on account of better factory equipment, better workmanship, better materials, and sold on better terms. Read my Free Copyrighted Book, "How To Judge Engines," which fully explains why and how I save you \$15 to \$300.—ED. H. WITTE,

WITTE ENGINE WORKS,
1745 Oakland Avenue, Kansas City, Mo.
1745 Empire Building, Pittsburgh, Pa.

**BUY
ON YOUR
OWN
TERMS**

FREE BOOK COUPON

ED. H. WITTE, WITTE ENGINE WORKS,
1745 Oakland Ave., Kansas City, Mo.
1745 Empire Bldg., Pittsburgh, Pa.

Please send me your Free Copyrighted Book, "How to Judge Engines."

Name

Post Office

State

St. or R. F. D.

Please Mention Popular Mechanics

Blame Only Yourself for Touchy Corns



BLUE-JAY may be bought at any drug store. This means relief is near, if you want it. Painful corns succumb to these inexpensive, wonderful little plasters. Millions of people have mastered corns this way. The treatment is quick and gentle. The first application ends most corns after 48 hours. The stubborn few vanish with the second or third treatment.

Pared corns keep coming back. Harsh liquids are dangerous. Blue-jay treatment alone is permanent.

Prove tonight that every corn is needless. Get Blue-jay at your drug store. Relief is instant. In 48 hours your corn is gone forever. Try this certain way *once—tonight!*

BAUER & BLACK
Chicago and New York
Makers of Surgical
Dressings, etc.

Blue-jay
Stops Pain—Ends Corns
Instantly Quickly

For Sale by all
Druggists
Also Blue-jay Bunion
Plasters

Don't Wear a Truss

Brooks' Appliance, the modern scientific invention, the wonderful new discovery that relieves rupture will be sent on trial. No obnoxious springs or pads.

Brooks' Rupture Appliance

Has automatic Air Cushions. Binds and draws the broken parts together as you would a broken limb. No salves. No lies. Durable, cheap. Sent on trial to prove it. Protected by U. S. patents. Catalogue and measure blanks mailed free. Send name and address today.

C. E. BROOKS, 126 State St., Marshall, Mich.

Please Mention Popular Mechanics



Deafness Is Misery

I know because I was Deaf and had **Head Noises** for over 30 years. My invisible Anti-septic Ear Drums restored my hearing and stopped Head Noises, and will do it for you. They are Tiny Megaphones. Cannot be seen when worn. Easy to put in, easy to take out. Are "Unseen Comforts." Inexpensive. Write for Booklet and my sworn statement of how I recovered my hearing.

A. O. Leonard, Suite 226, 150 5th Ave., N. Y. City



I will send my 25 cent BOOK

STRONG ARMS

for 10c in stamps or coin

Illustrated with 20 full-page halftone cuts, showing exercises that will quickly develop, beautify, and gain great strength in your shoulders, arms, and hands, without any apparatus.

PROF. ANTHONY BARKER
Studio 648, 137 W. 43d Street, NEW YORK

Have You Got It Yet? What? The Bicycle Bug!



Right in the heart of Summer and beautiful sunny weather, with all Nature luring us out of doors, **Now's** the best time to make good use of your bicycle.

Be sure and write us today about the handsome stick-pin shown here. We'll tell you how to get it *free*.

*Get the
Bicycle
Bug!*

United States Tire Company
1791 Broadway NEW YORK

----- FILL OUT—TEAR OUT—MAIL TODAY-----

United States Tire Company, 1791 Broadway, New York

Gentlemen:

Please tell me how to get one of your beautiful green-gold bicycle bugs free.

Full Name

Address

Name of Nearest Dealer

Address of Nearest Dealer

DIAMONDS ON CREDIT

LOFTIS SOLITAIRE DIAMOND CLUSTER RINGS

The Diamonds are Mounted So as to Look Like a Large Single Stone

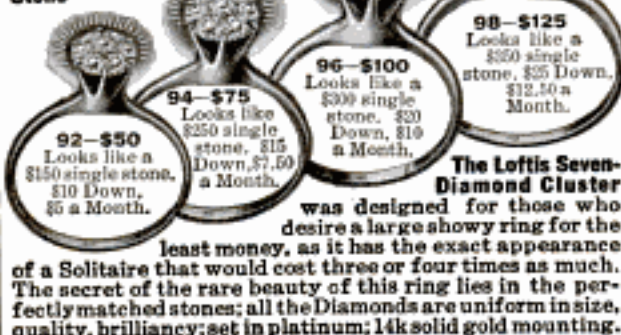

92-\$50
Looks like a \$150 single stone, \$10 Down, \$5 a Month.

94-\$75
Looks like \$250 single stone, \$15 Down, \$7.50 a Month.

96-\$100
Looks like a \$300 single stone, \$20 Down, \$10 a Month.

98-\$125
Looks like a \$350 single stone, \$25 Down, \$12.50 a Month.

The Loftis Seven-Diamond Cluster was designed for those who desire a large showy ring for the least money, as it has the exact appearance of a Solitaire that would cost three or four times as much. The secret of the rare beauty of this ring lies in the perfectly matched stones; all the Diamonds are uniform in size, quality, brilliancy; set in platinum; 14k solid gold mounting.

SEND FOR FREE CATALOG There are over 2,000 illustrations of Diamonds, Watches, Jewelry, etc. Whatever you select will be sent, all shipping charges prepaid. You see and examine the article right in your own hands. If satisfied, pay one-fifth of purchase price and keep it, balance divided into eight equal amounts, payable monthly. Our Catalog shows all the new watches—15, 17, 19, 21, 23 Jewels, adjusted. Guaranteed by the factory and further guaranteed by us. Watches that will pass railroad inspection as low as \$2.50 a month. Send for Catalog today. Don't delay.



LOFTIS BROS. & CO., The National Credit Jewelers
Dept. 8894 100 to 108 North State Street, Chicago, Illinois
(Established 1883) STORES IN LEADING CITIES

ASBESTOS

We are miners and shippers of Crude Asbestos in any quantity. We produce all grades at our world-famous Bell Asbestos Mines, in Canada. We also card fibres, spin yarns, weave cloths, and make all sorts of Asbestos products.

For anything you want in Asbestos, turn to
KEASBEY & MATTISON COMPANY
Dept. S-3, AMBLER, PENNA., U.S.A.
Owners of the world's largest Asbestos Mines



5¢ A DAY BUYS A GIBSON

Terms as low as \$1.00 down and \$1.50 per month. Mandolin or Guitar sent on approval. Get our new FREE BOOK—100 pages, 90 illustrations. Valuable information for player and teacher. Explains wonderful new violin construction with carved and graduated Top and Back and Steadivari's Arching. Also FREE treatise on "How to practice".

TEACH AND SELL THE GIBSON—BIG MONEY
Become a teacher. Splendid opportunities for Mandolin and Guitar teachers—either sex, in every locality, private and class instruction, and sale of Gibsons. The Gibson has made many a teacher professionally and financially. C. A. Tompkins, Sioux City, Iowa, writes: "If it were not for the Gibson I would not be in the teaching business". Wm. Plaza, Jr., Providence, R. I., Star Solist for Victor, uses and endorses the Gibson.

Write Today. If a teacher, better our agent, do business on our capital. Instruments furnished. We help sell. Agents' territory protected. You make the profits. We pay the advertising. You pay for goods when sold; return goods not sold. Try our "Sell Your" Catalog and Thematic List Free.

GIBSON MANDOLIN GUITAR COMPANY
169 Harrison Court, Kalamazoo, Mich.

OPEN—Permanent teaching and business opportunity, either sex. Write now. Other positions pending.

Please Mention Popular Mechanics



Here's the Way to Make Big Money!

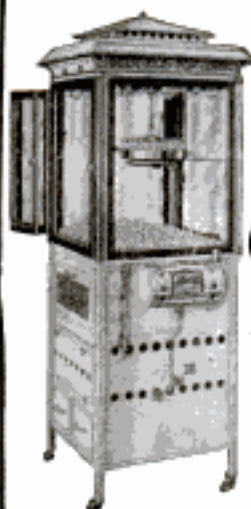

Write us today. See how easy for you to start a money-making business of your own with a Bartholomew Pop-corn and Peanut Machine. Use your whole time or spare time. *Wonderful profits!* Set your machine wherever the business is—on a corner, in a theater or hotel lobby, at baseball or picnic grounds, etc.

On Credit!

Write for free catalog! See our famous big line and our easy payment plan. Terms so easy you won't miss the money. Let the machine pay for itself out of your pop-corn and peanut sales. Here's your chance! Write today—a post card will do.

The Bartholomew Company
106 Heights St.
Peoria, Illinois

Free Catalog



PRINT MY OWN
Cards, circulars, menus, book, paper, etc. Press \$5, Larger \$18. Rotary \$80. Save money. Print for others, big profit. All easy, rules sent. Write factory today for illustrated catalog presses, TYPE, cards, samples.
THE PRESS CO. D-37. MERIDEN, CONNECTICUT.

Chinese rice paper is made from the pith of a tree growing in Formosa.

FREE — **BOOK TELLS HOW TO MAKE \$150 TO \$1000 PER MONTH**

Making celebrated **Flavo Nature-Flavored Flour** in rural communities or small towns with **AMERICAN MARVEL Flour Mill**

(Self-Contained)
You can quickly become a member of Community Marvel Millers. We start you. Help you. 30 days' free trial. Investment and terms easy to handle. Write for fully illustrated book.
ANGLO-AMERICAN MILL CO., Inc.
135-141 Trust Bldg. Owensboro, Ky.

Write today for our 168-page FREE Book on Deafness

and learn how Perfect Hearing is now being restored in every condition of deafness or defective hearing. Our "Little Wireless Phones for the Ears" require no medicine, but effectively replace what is lacking or defective in the natural ear drums. They are simple devices, which the wearer easily fits into the ears where they are invisible. Soft, safe and comfortable.

WILSON EAR DRUM CO., Incorporated
950 Inter-Southern Bldg. LOUISVILLE, KY.

BIG CHANCE FOR AGENTS



You can earn BIG MONEY selling the most complete line of guaranteed transparent handle Knives and Razors with Photo, Name and Lodge Emblem—also full line of cutlery. Write today for catalogue and terms. **Golden Rule Cutlery Co., 212 N. Sheldon St., Dept. 361, Chicago, Ill.**

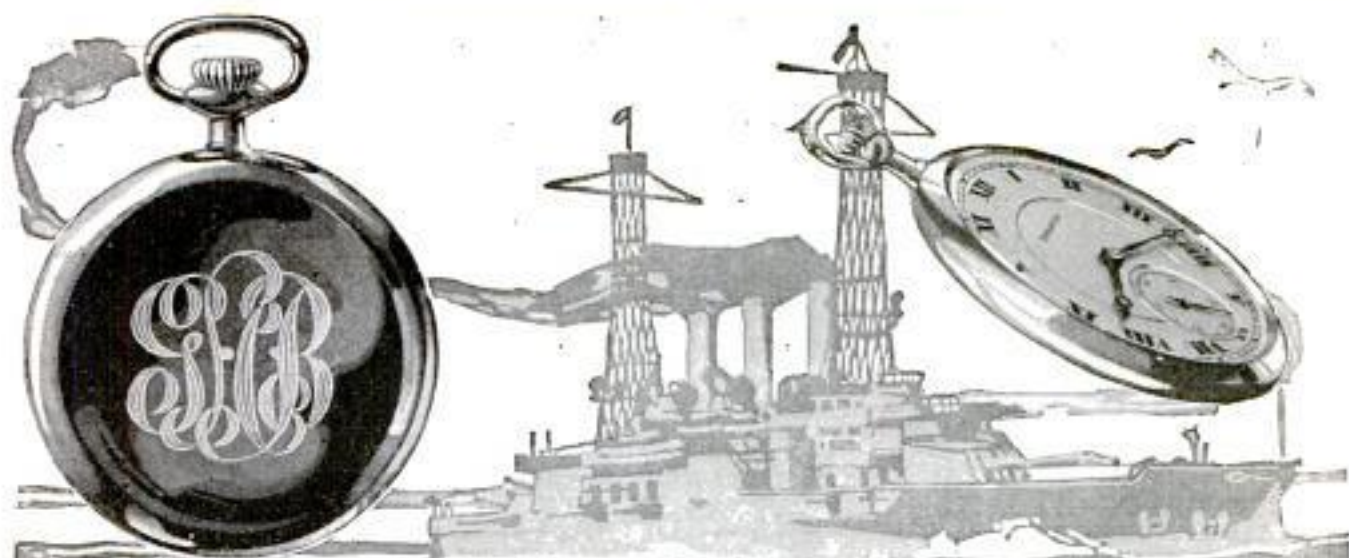

6,003 Burlingtons in the U. S. Navy—

A WATCH has to be made of sturdy stuff in order to "make good" on a man-of-war. The constant vibration, the extreme heat in the boiler rooms, the cold salt air and the change of climate from the Arctic to the Tropical are the most severe tests on a watch. If a watch will stand up and give active service aboard a man-of-war, it'll stand up anywhere.

6003 Burlingtons have been sold to the men aboard the U. S. battleships. Practically every vessel in the U. S. Navy has a Burlington aboard. Some have over 100 Burlingtons. The victory of the Burlington in the U. S. Navy is testimony to Burlington superiority.

21-Jewel \$2⁵⁰ Burlington A Month

And yet you may get a 21-jewel Burlington for only \$2.50 a month. Truly it is the master watch, 21 ruby and sapphire jewels, adjusted to the second, temperature, isochronism and positions. Fitted at the factory in a gold strata case, warranted for 25 years. All the newest cases are yours to choose from. You pay only the *rock-bottom-direct-price*—positively the exact price that the wholesale dealer would have to pay.

See It First! You don't pay a cent to anybody until you see the watch. We ship the watch to you *on approval*. You are the sole judge. No obligation to buy merely because you get the watch on approval.

Write for Booklet!

Put your name and address in the coupon or on a letter or post card now and get your Burlington Watch book free and prepaid. You will know a lot more about watch buying when you read it. Too, you will see handsome illustrations in full color of all the newest cases from which you have to choose. The booklet is free. Merely send your name and address on the coupon.

Burlington Watch Company,
19th St. & Marshall Blvd., Dept. 1196, Chicago, Ill.

Burlington Watch Co., Dept. 1196
19th Street & Marshall Blvd., Chicago, Ill.

Please send me (without obligations and prepaid) your free book on watches with full explanation of your cash or \$2.50 a month offer on the Burlington Watch.

Name

Address

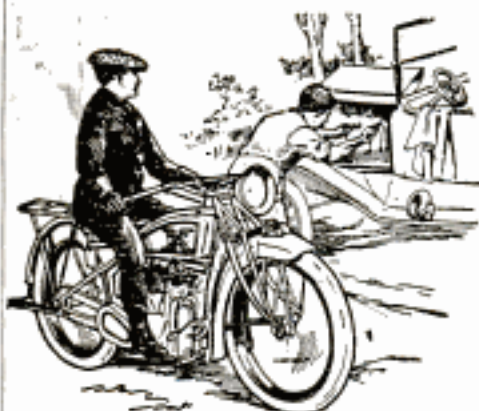

A Comparison

A Few Practical Reasons Why a Good Motorcycle Is a Better Investment than a Cheap Automobile

ANY GOOD MOTORCYCLE

Is a highly developed product, with a high degree of Efficiency, Reliability and Durability. Any low-priced automobile is built under exactly opposite conditions; the proposition being—How cheaply can it be made?

COST OF UPKEEP

The Good Motorcycle thru its high quality in material, design and workmanship is a masterpiece in Power, Durability and Reliability; the same structural conditions result in maximum service at minimum cost. Repair bills, except thru violent accidents, are practically eliminated. Ask the owner of a cheap automobile if that is true of his machine.

ECONOMY OF OPERATION

The motorcycle will carry you wherever you want to go regardless of road or other conditions at a total cost, including Tires, Gasoline, Oil and Depreciation, of 1 1/4 to 1 1/2 cents a mile as compared to a cost of 8 to 20 cents a mile in the automobile. Small size or low selling price in no way insure low mileage cost in the automobile.

UTILITY

There are a hundred places to which a Good Motorcycle will take you that are absolutely out of the reach of any automobile. The Good Motorcycle can be used for business, pleasure or touring, and with a delivery van attached makes the most economical and efficiently reliable means of delivery for any business requiring something light and quick.

CONVENIENCE

The Good Motorcycle can be housed in any small place and can be run into the basement or shop. It is always ready at an instant's notice to take you any place.

The above facts, true in any Good Motorcycle, are most thoroly exemplified in the EXCELSIOR, a Motorcycle that has been on the market for nine years; has always been built on the quality basis and

ALWAYS MAKES GOOD

The Series 18 Line includes Model 18-3 Twin, Three-Speed for Heavy duty and sidecar use; EXCELSIOR Sidecar, the ultimate development in sidecar construction, and the EXCELSIOR Lightweight, the ideal machine for individual service.

Our catalog describes them all or the dealer will show you

EXCELSIOR MOTOR MFG. & SUPPLY COMPANY 3702 Cortland Street CHICAGO

MARBLE'S VEST POCKET SCREW DRIVER

fits the pocket—as easy to carry as a knife—always handy, always ready. Is flat and compact—no loose parts. Handle is steel—strong and rigid—handsomely nickel plated—gives an excellent grip. Has three good long blades that lock open separately. Made of special screwdriver steel—perfectly tempered—guaranteed. It is a great thing for everybody, especially hunters, anglers, motorists, machinists, carpenters, locksmiths, storekeepers, farmers, salesmen and repairers of typewriters, adding machines, sewing machines, guns or any mechanical devices.

Price 50c, by Mail, postpaid, if not at your dealers. Ask for Marble's Pocket Screwdriver and other specialties. Write for catalog. Sample Nitro-Solvent Oil free if you mention dealer's name.

Marble Arms & Mfg. Co., 578 Delta Ave., Gladstone, Mich.

A Bassell Jersey



Be the First in Your Club

School, City or Town, to wear this pure, all wool sweater, double collar and cuffs. Your choice in colors. This jersey was selected by 10,000 of my customers for last season. Your chum will recommend it. Send for my big illustrated catalogue. Write me and learn my offer for your club's order. Popular Prices. Best Grade Sporting Goods—Baseball, Basketball, Tennis, Golf, Football, etc.

WRITE ME NOW.

JACK SHANNON CO., Dept. 46, 54 E. Wacker St., Chicago

GET THIS CATALOG
FULL OF VALUABLE INFORMATION TO EVERY BOAT OWNER ON
RACING PROPELLER WHEELS, REVERSE GEARS AND MARINE ACCESSORIES
LARGE CATALOG FREE. SEND TODAY
MICHIGAN WHEEL CO.
1129 MONROE AVE., GRAND RAPIDS, MICH.

TRAIN TO BE A MARKSMAN

Now's the time. Shoot without disturbing anyone. Get up a club and have fun all the season. Girls like it when there's no nerve-ripping report. Practically no recoil and no noise when a

Maxim Silencer

is on your rifle. No nervous clutching—no heaving of shoulder. Sizes for every rifle at reasonable prices. Write now for book full of stories. IT'S FREE.

FREE!
This Book

The Maxim Silencer Company
93 Homestead Ave.
Hartford, Conn.

Mullins Steel Boats Can't Sink

When you think of buying a boat, whether it be a 16-foot Runabout, a big 26-foot Auto Boat, or something in between—remember that Mullins Steel Boats are guaranteed for life. They cannot sink, leak, water-log, dry out or open at the seams—never require caulking. Designed by America's foremost naval architects—built in the largest boat factory in the world. More than 65,000 in use. Big catalog of steel or wooden motor boats, row-boats or canoes, on request.

THE W. H. MULLINS CO., 52 Franklin Street, SALEM, OHIO

Motor Perfection

is what you get in Watkins Class "B" all iron motors. Especially fine for canoes and light boats. Constant and efficient.

3 H. P. single cylinder	45 lbs.
6 H. P. double cylinder	85 lbs.
12 H. P. four cylinder	155 lbs.

Are light, at the same time strong, accomplished by using semi-steel castings, high carbon steel shaft, bronze bearings, high class workmanship.

THE WATKINS MOTOR CO.
897-899 W. 6th Street
Cincinnati, Ohio

Please Mention Popular Mechanics

PATENTS

IF YOU HAVE AN INVENTION which you wish to patent you can write fully and freely to Munn & Co. for advice in regard to the best way of obtaining protection. Please send sketches or a model of your invention and a description of the device, explaining its operation.

All communications are strictly confidential. Our vast practice, extending over a period of seventy years, enables us in many cases to advise in regard to patentability without any expense to the client. Our Hand-Book on Patents is sent free on request. This explains our methods, terms, etc., in regard to *Patents, Trade Marks, Foreign Patents, etc.*

All patents secured through us are described without cost to the patentee in the *SCIENTIFIC AMERICAN*.

MUNN & CO.

SOLICITORS OF PATENTS

672 WOOLWORTH BLDG., NEW YORK
and 625 F STREET, WASHINGTON, D. C.



Amazing Profits In Mushrooms

Anybody can add \$10 to \$40 per week to their income, in spare time, entire year growing mushrooms in cellars, sheds, barns, boxes, etc. I tell you where to sell, at highest prices. Free illustrated instruction booklet.

HIRAM BARTON
Desk 2, 329 W. 48th St., New York



Erickson Artificial Limb Co., 38 Wash. Av. N., Minneapolis, Minn.

Does Not Chafe, Overheat or Draw End of Stump

Write For Catalog

PATENTED

We are Under Govt. Bond

Relief to Ruptured People

Any appliance is a truss. Ruptured people must wear a support. Our New Sponge Rubber Pad (pat'd) is velvety, soft to the skin, pliable, ~~seems~~ slip, extremely comfortable, adapts itself to ruptured parts with less pressure, is sanitary, long lived, massages and strengthens muscles, allows blood circulation and produces easy cure.

Scrotal Pad Needs No Leg Strap 39 STYLES OF TRUSSES 23 DIFFERENT PADS
Our New Akron Sponge Rubber Scrotal Pad (pat'd) holds 8 out of 10 cases of scrotal hernia perfectly without strap between the legs.

Cures Man of 86
The Akron Truss Co. Gentlemen: I am 86 years and 6 months old and have had a rupture for 27 years. I am an active man, tend to a large garden, saw and split the wood and do the household chores. I bought an Akron Truss and wore it one year and am as sound as a dollar.
Respectfully yours, B. W. Glass, Illinois.

Cured Double Hernia
The Akron Truss Co. Gentlemen: I have worn one of your trusses for some time. All this time have carried two heavy sash cases, notwithstanding this handicap, your truss has cured me of a double hernia.
Yours truly, O. E. Jones, Indiana.

Girl Baby Cured
The Akron Truss Co. Gentlemen: The infant's truss was a perfect success. The child wore it about one year, and the rupture healed so that a person cannot see she was ruptured. Yours truly, J. Haynes, Illinois.

Free Sample Pad A Sample Akron Sponge Rubber Truss Pad will be sent absolutely FREE upon request, also booklet "Relief to Truss Users." It's full of help. Ask your dealer, or write us.

THE AKRON TRUSS CO. 89 TRUSS BLDG. Akron, Ohio

Buy Genuine DIAMONDS

Direct from **BARNARD, the Diamond Headquarters**



14K Engagement Solitaire \$8 and Upwards



14K Mounting Men's Diamond Rings, \$10 up

I eliminate all middlemen—all waste—in the selling of diamonds. Direct buying from the European cutters, then reselling direct to you saves 35% of dealer's prices. Tremendous sales-volume permits smallest profits and makes my price actually less than wholesale!

BlueWhite

\$ **88** Per Carat



Ignatius Barnard President

Send No Money

Merely send for my beautiful Diamond Book—select the diamond and mounting of your choice, and I'll ship it for your inspection—at my expense and without obligating you to buy. As we get all our business in this way our success proves our prices lowest by comparison.

Bankable Money Back Guarantee

The only bankable Money Back Guarantee in the diamond business. You can take it to any bank and cash in your diamond investment. The only guarantee without red-tape, delays or evasions. Allows you to exchange at full value at any time.

\$100 Liberty Bonds Accepted At \$102

Lend to your country and keep the wheels of commerce running at the same time. To encourage both, I will accept \$100 Liberty Bonds at \$102 for entire or part payment of my diamonds.

1917 DeLuxe Book of Diamonds FREE!

Illustrated in colors. Contains thousands of the greatest bargains in diamonds ever shown. Tells facts you've wanted to know in order to buy diamonds intelligently. Tells about diamond qualities, colors, imperfections. A bound volume that you'll be glad to give a permanent place in your library. Free for the asking. Send postal or coupon.

BARNARD

& CO. Dept. 3188C

N. W. Cor. State & Monroe Sts.
Chicago,
U. S. A.

Without expense to you or the slightest obligation please mail 1917 DeLuxe Book of Diamonds as offered in Popular Mechanics.

Please Mention Popular Mechanics

An Easy Way to Make Money

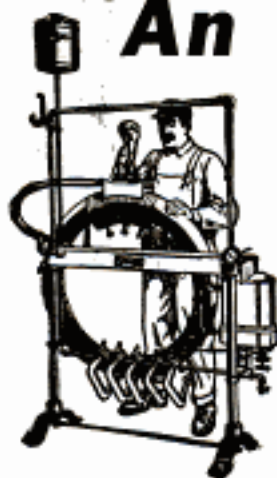

Don't be content to plod along on a small salary. Be independent. Go in the tire repairing business and make \$60 or more a week. One man made \$45 the first day he received his outfit. Others are making \$25 a day and hundreds of wide-awake men are making \$200 to \$500 a month.

No experience needed. We teach you how. Very little capital required. But slight risk, as every car owner in your town is a possible customer. Jobs are plentiful because tires blow out and puncture every day.

SHALER Tire Repair Outfit, \$65

will do as much and as perfect work as the big \$250 to \$500 vulcanizing outfits. A boy can vulcanize perfectly with this simple machine. It's the only vulcanizer that has Automatic Heat Control. It must vulcanize just right. It can't undercure or overcure a tire. Requires no watching or regulating. You can learn to do expert tire vulcanizing in half an hour with the Shaler.

WRITE FOR FREE BOOK "HOW TO OPEN A TIRE REPAIR SHOP" and complete Catalog, which gives full information.

WRITE QUICK BEFORE SOME HUSTLER GETS AHEAD OF YOU.
C. A. SHALER CO., 2008 Fourth Street, WAUPUN, WIS.

Real Bike Joy

because your bike will carry you safely over the hills or through the dales—anywhere when your tires are treated with

NEVERLEAK TIRE FLUID



No stopping by the wayside to fix a leak—no delays—no wearisome pump, pump, pump.

25c Tube Gives \$2.50 Extra Tire Mileage

Save big repair costs—cures porous tires, doubles the life of your tires. GET A TUBE TODAY.

Sold by Repairmen and Bicycle Dealers

Buffalo Specialty Co.
BUFFALO, N. Y.

MAKE YOUR BIKE A MOTORCYCLE

at a small cost, by using our attachable outfit. Fits any Bicycle. Easily attached. No special tools required.

"Used His Four Years"

Harry A. Hyatt, of Boreas River, New York, writes: "About four years ago I received my motor attachment, and wish to say that I am satisfied with it in every way, for it has certainly given me good service. Anyone wanting a motorcycle or attachment, I would recommend them to the Shaw Manufacturing Co."



FREE BOOK Write today for bargain list and free booklet, fully describing the SHAW Bicycle Motor Attachment. Motorcycles all makes, new and second-hand, \$35.00 up.

SHAW MANUFACTURING CO.
Dept. 6 GALESBURG, KANSAS

Standards for a certain type of baskets for grapes, other fruits, and vegetables, and other baskets and containers used for small fruits, berries, and vegetables in interstate commerce are fixed by an act approved by the president recently. The law will become effective Nov. 1, 1917.

1917 Indian Motorcycles With New Power- plus Motor and Cradle Springframe. Write for catalog.
HENDEE MFG. CO., 710 State Street, SPRINGFIELD, MASS.

THE CORBIN DUPLEX COASTER BRAKE is the standard brake equipment assuring absolute control. Equip it now. Send for catalog.
THE CORBIN SCREW CORP. The American Hardware Corporation, Successor
NEW BRITAIN, CONN. BRANCHES: New York, Chicago, Philadelphia



Convert Your Bicycle into a Motor-Cycle Motor fits any wheel. BEST. MOST RELIABLE. Best hill climber. More STEFFEYS in use than all others. Stamp for circulars.
STEFFEY MFG. CO., 5007 Brown Street, PHILA., PA.

IVER JOHNSON

REVOLVERS SHOTGUNS BICYCLES MOTORCYCLES
Send for free books, "A"—Arms, "B"—Bicycles, "C"—Motorcycles.
Iver Johnson's Arms & Cycle Works
307 River Street FITCHBURG, MASS.

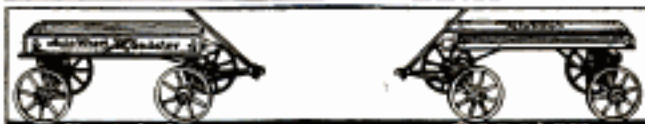

The Auto-Wheel Convertible Roadster

Just invented. Pull up the sides and it's a full-fledged Coaster; push them down and it's a regular Roadster. It's built like an automobile, with ball-bearings, dust-proof hub caps, steel axles, etc. Fast as lightning. Strong as an ox. Patented and can't be duplicated. Look for the name AUTO-WHEEL.

FREE Felt Penman and Booklet for names of 3 local Coaster Wagon Dealers. Mention which handles Auto-Wheel.

THE BUFFALO SLED CO., 137 Schenck St.,
In Canada: Preston, Ont. N. Tonawanda, N. Y.

MIAMI-MADE BICYCLES

Stand at the top of the bicycle world.
RACYCLE, HUDSON, MIAMI, FLYING MERKEL
Write for our catalog.
THE MIAMI CYCLE & MFG. CO., MIDDLETOWN, OHIO

Boy's Junior Auto — 3 H. P. Motor Driven

SPEED, 20 Miles per hour

We furnish parts; build it yourself. Inexpensive. Send 21 cents for blue prints and price list of parts.



SYPPER MFG. CO.
146 Warren St., Toledo, Ohio

Pulls you out of trouble

Carry this little Pull-U-Out in your tool box and you will be independent of road conditions. With it a boy can, unaided, pull a 5000 lb. car out of ditch or mud. Pays for itself on its first job. Besides pulling autos out of trouble it will do all kinds of lifting and pulling in the factory, garage, on the farm or construction job, etc.

Consists of a winding drum, lever crank, 40 feet of steel cable, two 7 ft. chains and 3 stakes. Weighs only 28 lbs. and goes in space 4x8x14 inches.

A pressure of only 30 lbs. on the handle will lift a ton



Cheaper and better than a chain block. Does jobs no other machine can do.

WRITE FOR BOOKLET—VERY INTERESTING
Tells how and why this marvelous little Pull-U-Out works.

Pull-U-Out Sales Co., 1435 Syndicate Trust Bldg., St. Louis, Mo.



MAKE \$3000⁰⁰ THIS YEAR

You can do it in a Tire Repairing Business of your own. The one field where there is more work than men to handle it. Easy to learn—Small investment and big profits for you.

AKRON-WILLIAMS TIRE REPAIR EQUIPMENT

Used and endorsed by 90 per cent of the big tire factories and most successful tire repair shops.

Don't delay. Send for details of our plan to help you start on big-paying basis from the very first day.

The Williams Foundry & Machine Co.
50 Cherry Street AKRON, OHIO



Used Motorcycle Bargains!



Get our wholesale prices on used and demonstration machines. Here's a sample—Indian, 7 H. P. TWIN, 1912 Model, \$35.00. Many others at prices you can't resist. All machines guaranteed to be in first class running condition, including tires. Our prices mean quick sales; don't run the risk of being disappointed, but write us today for prices and full particulars.

Olive Cycle & Motor Co., 1055 N. Grand Ave., St. Louis, Mo.

EVINRUDE



Detachable rowboat and canoe motors. Magneto—Built-In Fly-Wheel Type. Silencer and Automatic Reverse. CATALOG FREE USED BY 25 GOV'TS. OVER 80,000 SOLD

EVINRUDE MOTOR COMPANY
563 Evinrude Block Milwaukee, Wis.

Universal MARINE MOTOR

9-12 H. P. 4 Cycle 4-Cylinder. Speed range 300 to 1800 R. P. M. Adapted to boats from 14 to 30 feet. Write to

UNIVERSAL MOTOR CO.
OSHKOSH, WIS. Dept. P

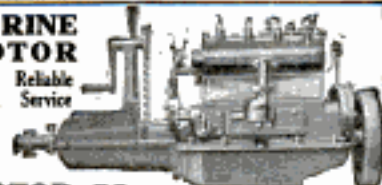

For Bulletin No. 25 giving full description

Get this LA Engine Book



—it gives valuable information about motor boat engines. It also describes the full line of L-A motors and tells of the 30 days' free trial plan. Write for your copy today.

LOCKWOOD-ASH MOTOR CO.
1430 Horton Ave. Jackson, Mich. (22)

Silence Your Creaky Wheels

Those creaking, squeaking or rattling wheels mean more than a nuisance. They are a warning that your spokes have shrunken and are loose. Loose wheels are dangerous as they are apt to fall apart at any moment. A sudden wrench to one side may cause collapse and serious damage if not personal injury. Tighten the spokes—NOW!

Spoktite Does It In 30 Minutes

Spoktite gets right into the wood and swells it to original size. Great for "squeaky bodies." Easily applied and in 30 minutes after application you'll see results. A dollar's worth tightens 4 wheels—get it now at your auto supply dealer's. If he has none, send his name and \$1.00 to our factory for a quantity postpaid.

LIQUID WHEEL TIGHTENER CO.
Dept. O, Modesto, California
Sales Offices: Boston-New York

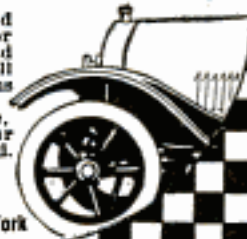

GARGOYLE



Mobiloils

A grade for each type of motor

Increase Your Tire Mileage

Crank Shaft Driven

Taylor Tire Pump



Carried in tool box when not in use, attached in 30 seconds to end of crank shaft (front of radiator). Pumps bone-dry air and pumps fast. Pays for itself in added tire mileage.

\$10 if your dealer cannot supply you, write direct.

Complete with hose and gauge.
TAYLOR MANUFACTURING COMPANY
24 Lahser Ave., Redford, Mich. (Suburb of Detroit)

America's Tested Tires

GOODRICH

BLACK SAFETY TREADS

THE B.F. GOODRICH COMPANY, Akron, Ohio

Driver Agents Wanted



Five-Pass., 34.7 H. P. Drive and demonstrate the Bush Car. Pay for 18 out of your commissions on sales, my agents are making money. Shipments are prompt. Bush Cars guaranteed or money back. Write at once for my 64-page catalog and all particulars. Address J. H. Bush, Pres. Dept. 917

114-inch Wheelbase
Delco Ignition—Elect. Std. & Ltg.
BUSH MOTOR COMPANY, Bush Temple, Chicago, Ill.

TYPEWRITERS



\$10
TO
\$50

WHY PAY MORE?

Any Standard Make AT A BIG SAVING TO YOU

Before investing a cent in a typewriter send for our free book "The Truth About Typewriters." It will save you from \$25 to \$50. We can supply you promptly with any make of machine on the market at a big reduction.

Rebuilt by the Famous "YOUNG PROCESS" Machines Fully Guaranteed. You Run No Risk

After you have read our free book you will know why we can make such astounding bargains — and what the "Young Process" of typewriter rebuilding means. We can sell you a first class machine, good as new, and fully guaranteed, at about half the price you will pay elsewhere. Our machines are sold for low cash, on the instalment plan or rented. Rental applies on purchase price if you decide to keep the machine. Send for Catalog Now. It's Free.

Young Typewriter Company
Dept. 316, 62 W. Madison St., CHICAGO



3 YEARS TO PAY

Meister Piano 30 days' free trial
in your own home

\$1 A WEEK or \$5 A MONTH Price \$210.00

No cash payment down. No interest — no extras. Piano stool and scarf free.

ROTHSCHILD & COMPANY
Dept. G16 CHICAGO, ILL.

STANWELD Cold Drawn Seamless Steel TUBING

Lightest, smoothest, strongest Steel Tubing made. World's largest manufacturers of bicycles, motorcycles and automobiles use it exclusively. Send for Folder "A."

THE STANDARD WELDING COMPANY
Main Office and Factory CLEVELAND, OHIO

FEDERAL BICYCLE TIRES

Off for a Day's Sport

There will be nothing to mar your fun if your bike is equipped with Federals. You may start out on an all day run and be free from tire bother.

Federals will stand by you on any kind of road.

Made in two styles, the "Rugged" with heavy blue studded tread; the "Traffik" with staunch black patterned tread — both fast, sturdy and strong.

Write for booklet and handsome felt pennant free.

THE FEDERAL RUBBER COMPANY
of Illinois
Factories: Cudahy, Wisconsin.

Make Big Money Selling a Fridger a day is making money at the rate of \$25,000 a year. We want more dealers. Investigate our proposition. See our ad, page 58 June issue Popular Mechanics.

FRIDGER THE SILK HAT ICEMAN
WELLS STREET BRIDGE BUILDING CHICAGO

WAR DOUBLES PRICE OF SKELETONS—A perfectly articulated skeleton is now worth \$100 as against about \$50 two years ago, and \$25 about 10 years ago. Most skeletons used by medical men formerly came from France.

GROW MUSHROOMS!



Start right, have good paying business month in and month out, right at home. Costs little to start, grow fast. Mushrooms in big demand everywhere. Men, women and children can grow them, in sheds, cellars, boxes, etc., in spare time. Learn expert facts about successful growing, right spawn, etc., from America's great authority. Send for free illus. publication, "TRUTH ABOUT MUSHROOMS," today.

BUREAU OF MUSHROOM INDUSTRY
Dept. 407 1342 N. Clark St., CHICAGO

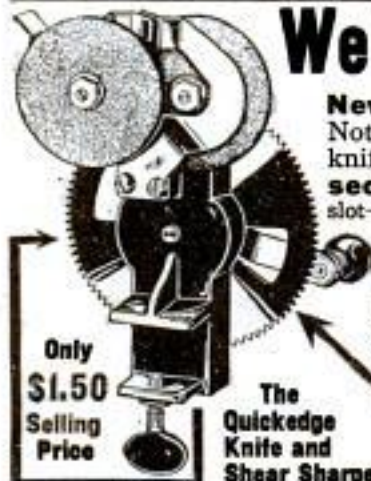

Only
\$1.50
Selling
Price

The
Quickedge
Knife and
Shear Sharpener

We Want Agents at \$30 to \$75 a Week

New Invention—Just out. Needed in every home every day. Patented. Nothing else like it. Low priced—**Sells on sight**. Sharpens any kitchen knife, paring knife, carving knife, bread knife, or shears and scissors in **ten seconds**. Mechanical masterpiece. A child can use it. Just put knife in slot—turn crank—sharpens both sides at once automatically. **We want representatives at once**—men and women hustlers. Get this position where **profits start first day**.

No Experience Necessary — 200% Profit

Make as much money next week as these men are making now. J. C. Lewis, of Kansas, says: "I have sold one hundred sharpeners in four days." Hobart Kerr, of Md., writes: "The women can hardly wait till they get them." Herbert Cain, of Ky., sold nine after supper. At the end of the first day, J. W. Gordon, of Pa., writes: "I sold two dozen and I sold to every one I saw." Wm. G. Hall, of N. J., says: "I think it is great. I sold six in about one-half hour. The machine is a mighty fine proposition. I am a mechanic and I know what I am talking about." You can make this money. **WRITE TODAY. TERRITORY FREE. GET BUSY AT ONCE.**

QUICKEDGE SHARPENER CO., 689 Sharpener Bldg., 215 N. Desplaines St. CHICAGO, ILL.

GET FACTORY PRICES ON GALVANIZED ROOFING



EDWARDS "REO" Metal Shingles

Absolutely rust-proof—edges as well as sides. Not the space of a pin point exposed to weather. Also fire and lightning proof. Reduce insurance. Outlast building. Need no repairs—end all roofing expense. Easy to lay—one man can do the work—hammer and nails only tools needed. Lay over old shingles if desired. Patent interlocking device makes water tight seams—all nail heads covered—no rust or leaks possible.

Exclusive "Tightcote" Process

Put all Edwards Galvanized Roofing in a class by itself. Bend, twist, strike it with a hammer as much as you like—you can't loosen or scale off the galvanizing—due to our "TIGHTCOTE" process which practically makes zinc covering a part of the metal sheet. No other galvanized roofing can withstand this test.

FREE Roofing Book

Don't buy roofing until you get our big free book, describing Edwards famous "Tightcote" Roofing, Siding, and Collings, and our lowest freight paid prices. We sell you direct and save you in-between dealers' profits. Write for Roofing Book No. 980.



Garage \$89.50 and Up
Lowest prices on Ready-Made Fire-Proof Steel Garages. Set up any place. Send postal for Garage Book showing styles.

THE EDWARDS MFG. CO.
900-950 Pike St. CINCINNATI, O.



Corrugated



Patent Side Lock
No nail heads in sight or exposed to the weather



Brick Siding



POULTRY PAPER

44-124 PAGE periodical, up-to-date; tells all you want to know about care and management of poultry for pleasure or profit. Four months for 10 cents. POULTRY ADVOCATE, Dept. 98, SYRACUSE, N. Y.



4 Weeks' Trial

Any
Superb



Piano or Player Piano, choice of 35 styles, on 4 weeks' absolutely free trial. No money down, all freight prepaid. Return of our expense, or keep it at the rock-bottom direct price. Easy terms.

Valuable Book FREE

Write today for "The Book of Complete Information About Pianos." Also free catalog.

Wing & Son (Est. 1868) 9th Ave. and 13th St., Dept. 1198 New York

COIN RINGS, 50 CENTS POST-PAID

Made of new dimes, embossed. Big hit! Agents, big discount. Send 50 cents for sample. Money refunded if not satisfied. WM. COMERFORD, 44 Seneca Street, BUFFALO, NEW YORK

TYPEWRITERS

SUMMER PRICES

Our entire stock of latest models is offered at special prices for the summer only.

Factory Rebuilt Typewriters

All trademarked, and guaranteed for one year. Buy now and save as much as \$75. Branch stores in leading cities.

Write for Catalog and Summer Price-List
American Writing Machine Co., Inc., 339 Broadway, N. Y.



TYPEWRITER SENSATION

\$2⁵⁰ A Month Buys a Visible Writing L. C. Smith

Perfect machines only of standard size with keyboard of standard universal arrangement—has Backspacer—Tabulator—two color ribbon—Ball Bearing construction—every operating convenience. Five Days' Free Trial. Fully guaranteed. Catalog and special price sent free. H. A. SMITH, 510-231 NORTH FIFTH AVENUE, CHICAGO, ILLINOIS

CHALLENGE CLEANABLE COLLARS

Freshened in a jiffy—with a bit of soap and a damp cloth. Cleanable instantly. Challenge Collars laugh at collar smudging, dirt and perspiration. Of course, an exact "linen" collar appearance.

25c each—at your dealers or direct. Try them. State style and (half) size. Illustrative booklet on request.

E. I. Du Pont de Nemours & Co.
The Arlington Works
725 Broadway New York

Eat Tyler's Macerated Wheat

Whole Wheat, Nuts, Raisins, Etc.
Greatest of all Health Foods.

RIGHTLY used is a sure and quick cure for constipation and indigestion, obviates headaches and makes you weigh just what you should. Lowers blood pressure, lessens hardening of the arteries, puts iron and other mineral salts in the blood, so essential in the maintenance of the chemical equation of the body—key to health and efficiency. A boon to old men, nervous women and sickly, puny babies. Insures thrifty growth and sound teeth in children.

Send ten cents for a big sample can, and Tyler's Raw Food Book and Health Guide, or better still send \$1.00 for a 3-lb. can postpaid everywhere. Absolutely guaranteed or money back. Testimonials without number. Write today for convincing proofs.

BYRON TYLER, (Estab. 1899)
60 Gibraltar Bldg., Kansas City, Mo., U. S. A.

MEN

For \$15.00 we hand tailor to your measure and deliver express charges prepaid, a \$25.00 all wool suit or overcoat, absolutely guaranteed to fit and delight you or you don't pay us one cent. Our new Fall-Winter Style book and about 50 samples mailed free on request.

THE RUBY TAILORS, Dept. 41, CHICAGO, ILL.

WEAR

Trade Mark
Registered

B.V.D. U. S. Patent Office
and Foreign Countries

UNDERWEAR

A Scientific Solution of the Sanitary Drinking Water Question

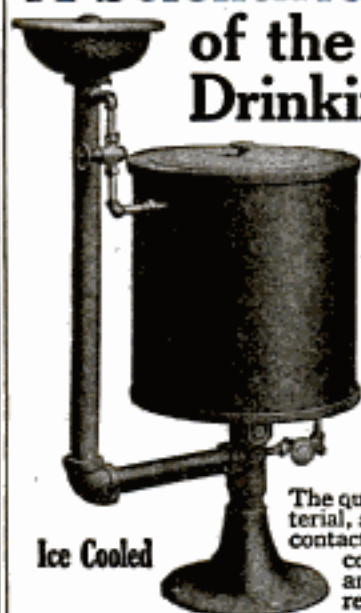

Ice Cooled

Holds 75 lbs. of Ice.
Supplies 150 Men.

Fifteen and one-half circulating coils of pipe in the cork-jacketed ice tank insure an ice-cooled sanitary drink to every employee.

The quality of the ice is immaterial, as it does not come into contact with the water. This construction reduces the amount of ice and water required to a minimum.

Send for Our Complete Catalogue

showing our line of Wash Bowls, Metal Lockers, All Steel Stools and Chairs with Inset Wood Seats, Stock and Storage Racks, Metal Shelving, Metal Vault Fixtures, Improved Soda Kettles, 40 and 60 gallons, Water Heaters and Instantaneous Mixers, Bubbling Drinking Fountains, Work Benches and Bench Legs, Drawing Stands, full line of Plumbing Fixtures, etc.

Manufacturing Equipment and Engineering Co.
136 Federal Street Boston, Mass., U.S.A.
Works and Mail Address, Framingham, Mass.

300 Candle Power of Light at a Cost of 1-8c Per Hour Burns Kerosene or Gasoline

This lamp generates and burns its own gas from ordinary kerosene. "QUICKLIT" gasoline lamps can be lit with an ordinary match like city gas.

Write today for illustrated catalog of our complete line of kerosene and gasoline lamps, lanterns, Agents Wanted and lighting systems.

The Nagel-Chase Mfg. Co.
258 to 270 East Erie St., Chicago



Why Pay Full Prices for Diamonds

Diamond Banking We lend money, taking diamonds as security. When loans are not paid, the diamonds are offered for sale. For over 40 years, we have offered beautiful diamonds 40 to 50 per cent lower than market prices. Some qualities for which full prices are paid. Free examination.

1/2-1/8, 1/64 kt. blue-white, perfectly cut solitaires. Mounted in brand new 14 kt. solid gold engraved engagement ring. Try to match at fully 50 per cent more. Guarantee—\$62.00
Total Loan \$50. Unpaid Loan Price

Write Today for New Bulletin!

Send your name and address. No obligations.
1930 DeRoy Bldg.
Joe. DeRoy & Sons Pittsburgh, Pa.
References by permission: Farmers' Dep.
Nat. Bank Marine Nat. Bank, any
Pittsburgh Daily Newspaper



Use Water Power \$2.50 for Hard Work UP

The Divine Red Devil Water Motor

will operate washing machines, sewing machines, small lathes, small dynamos, do grinding and polishing. No muss—no fuss—nothing to get out of order.

A Simple, Durable, Economical Motor

that costs little or nothing to operate. Improved bucket-wheel construction exactly like big turbines. Power for small shops, mechanics, grocers, doctors and dentists. Money back if not entirely satisfied. Booklet and Prices Sent Free if you will write today and give us size of faucet, water pipe and water pressure and work to be done. You must furnish information to get booklet.

Divine Water Motor Co., Dept. P, Utica, N.Y.



Agents
Wanted

RUNS ON KEROSENE ALCOHOL, GASOLINE OR GAS

A MOST REMARKABLE INVENTION

No electricity, wires or springs. 1917 Improved patented Model. Runs 8 hours for a cent on kerosene. Quiet—convenient. Brings genuine comfort and satisfaction. Ideal for the sick. A proved success. The Wonder Fan, 3 Models, 3 Sizes.
A } 12-in. \$16.50, Alcohol or Gas only (Gas \$1.50 ex)
 } 16-in. \$18.50, Alcohol or Gas only (Gas \$1.50 ex)
B } 16-in. \$19.50, Any Burner (Gasoline \$2.50 ex)
 } 21-in. \$22.50, Any Burner (Gasoline \$2.50 ex)
F. O. B. Chicago. Cash with order only. KEEP COOL.

LAKE BREEZE MOTOR, 546 W. Monroe St, CHICAGO, ILL.



Send for the big Thor Book which describes the Thor Electric Washing Machine and shows how a good sized washing can be done at a cost of only 2 cents.

HURLEY MACHINE CO., Dept. 1196, CHICAGO

UNI-LECTRIC Light and Power for the farm and summer home. Operates on same principle as city electric plant. 110 volt, direct current. No belts—no batteries. Uses standard lamps and fixtures. CATALOG ON REQUEST.

Waterman Motor Co., 182 Mt. Elliott Ave., Detroit, Mich.



ACORN UNI-LITE
Turns night into day. 300 candle power. Carry as a lantern; use anywhere as a lamp. Weather proof. For house, barn, garage, camp and around the farm. Write for big, free offer. Special opportunity to farmers, Stockmen and motorists. Agents make big money.

FREE OFFER
WRITE TONIGHT for new 1914-1917 offer.
ACORN BRASS MFG. CO., 623 Uni-Lite Bldg., Chicago

1900 Motor Washer Electric or Water Power

on Free Trial to Readers of Popular Mechanics
Reduce household expenses by using this great laundry outfit. Cuts cost of washing to 2 cents per week. Write for Free Book, giving full details, to

1900 WASHER CO., 6339 Court St., Binghamton, N. Y.
Address Canadian 1900 Washer Co., 355 Yonge St., Toronto
If you live in Canada

THIS BUNGALOW \$900 CAN BE BUILT FOR

This and many others in my new book, Building Plans for Modern Homes, will save you hundreds of dollars. One of the most complete and comprehensive books of plans ever published by any architect. Fifth edition just off the press. Two hundred and fifty floor plans and photographs of bungalows, etc., costing from \$200 up; gives sizes and cost to build. Sent postpaid for \$1.00



**FREDERICK H. GOWING
ARCHITECT**
18 Tremont St., BOSTON, MASS.

Swear Off Tobacco



Tobacco Tells on
Nervous System



Tobacco Ruins
Digestion



Tobacco Stunts
Boy's Growth



Tobacco Robs
Man of Virility



Tobacco Steals
from You the
Pleasures, Com-
forts, Luxuries
of Life

Tobacco Habit Banished In 48 to 72 Hours

Immediate Results

Trying to quit the tobacco habit unaided is a losing fight against heavy odds, and means a serious shock to your nervous system. So don't try it! Make the tobacco habit quit you. It will quit you if you will just take **Tobacco Redeemer** according to directions.

It doesn't make a particle of difference whether you've been a user of tobacco for a single month or 50 years, or how much you use, or in what form you use it. Whether you smoke cigars, cigarettes, pipe, chew plug or fine cut or use snuff—**Tobacco Redeemer** will positively remove all craving for tobacco in any form in from 48 to 72 hours. Your tobacco craving will begin to decrease after the very first dose—there's no long waiting for results.

Tobacco Redeemer contains no habit-forming drugs of any kind and is the most marvelously quick, absolutely scientific and thoroughly reliable remedy for the tobacco habit.

Not a Substitute

Tobacco Redeemer is in no sense a substitute for tobacco, but is a radical, efficient treatment. After finishing the treatment you have absolutely no desire to use tobacco again or to continue the use of the remedy. It quiets the nerves, and will make you feel better in every way. If you really want to quit the tobacco habit—get rid of it so completely that when you see others using it, it will not awaken the slightest desire in you—you should at once begin a course of **Tobacco Redeemer** treatment for the habit.

Results Absolutely Guaranteed

A single trial will convince the most skeptical. Our legal, binding, money-back guarantee goes with each full treatment. If **Tobacco Redeemer** fails to banish the tobacco habit when taken according to the plain and easy directions, your money will be cheerfully refunded upon demand.

Let Us Send You Convincing Proof

If you're a slave of the tobacco habit and want to find a sure, quick way of quitting "for keeps" you owe it to yourself and to your family to mail the coupon below or send your name and address on a postal and receive our free booklet on the deadly effect of tobacco on the human system, and positive proof that **Tobacco Redeemer** will quickly free you from the habit.

Newell Pharmacal Company
Dept. 300 St. Louis, Mo.



Free Book Coupon

NEWELL PHARMACAL CO.,

Dept. 300

St. Louis, Mo.

Please send, without obligating me in any way, your free booklet regarding the tobacco habit and proof that **Tobacco Redeemer** will positively free me from the tobacco habit.

Name.....

Street and No.....

Town..... State.....

Please Mention Popular Mechanics

The skilled or amateur mechanic should keep a bottle of

LISTERINE

The Safe Antiseptic

Manufactured only by Lambert Pharmacal Company, St. Louis, Mo. U.S.A.



on or near his work bench—immediately available to prevent the infection of cuts or any other small wounds.

NO MONEY DOWN **2 CREDIT \$2 A MONTH**
ALL \$2 MONTH
 Buy a Genuine 15-17-19-21-Jewel Elgin, Waltham, Howard, or any watch you want, rock bottom prices, send for **FREE CATALOG**
 98 pages of wonderful values, diamonds, watches, rings, jewelry, up-to-date designs. Buy the Ware Way, you will never miss the money. Get posted, write today. **ALFRED WARE CO., Dept. 764, St. Louis, Mo.**

FIBRE LEGS
ARMS
4-LB. FIBRE LEGS—ON EASY TERMS
 Orthopedic braces for all deformities. Send for booklet. **MINNEAPOLIS ARTIFICIAL LIMB CO., 636 Dean Bldg., MINNEAPOLIS, MINN.**

NO MORE BALD HEADS



WHEN our VACUUM CAP is used a few minutes daily. We accept no pay until you have tried the Cap 60 days and are satisfied. The Vacuum Cap is an appliance that draws the blood to the Hair Roots and starts a new healthy crop of hair. It stops Dandruff, stops the hair from falling out.

Bought by Doctors and men who know that it is the only reasonable HAIR GROWER known to science. No Drugs Used. Write for application blank, testimonials, and booklet on "HAIR," sent sealed in plain envelope, FREE.

THE MODERN VACUUM CAP CO.
 T. 559 BARCLAY, DENVER, COLO.



For the Feet

To prevent skin-rubs, cal-luses, blisters, etc. Just the thing for the man in khaki.

A medium sized bottle will be mailed by us post paid to any address upon receipt of 25 cents in stamps.

NEWSKIN CO., NEW YORK

The National Board of Fire Underwriters has estimated that the careless use of small electrical household devices is responsible for fires at the rate of 30,000, or more, per year in the United States.

DIXON'S ELDORADO

"the master drawing pencil"

SUPERIOR SINCE 1903
Over 100,000 in Use
 Mostly sold through recommendation. For **PERSONAL DESK** or **GENERAL OFFICE**. It checks mental calculations. Buy through your Stationer. Write for 10-day trial offer.
E. GANCHER, A. A. M. CO.
 148 Duane Street, NEW YORK

Golden Gem PORTABLE \$10 Adding Machine
Multiplies—Subtracts

Red or Black **"Vulcan" Ink Pencils**
 The ONLY perfect, non-leakable ink pencils at moderate prices.
 Two Sizes—
 4 1/4 and 5 1/4 inches.
 Extra Size—8 inches (black only) **\$1.25**.
 Your name in gold today **35c**.
FREE—liberal supply of ink with retail orders. *Agents Wanted. Big Profits.*
J. C. ULLRICH & CO., 27 Thames St., New York

Order today **\$1**

\$500 REWARD
 We will pay \$500.00 reward to anyone who can permanently dim the brilliancy of the RAJAH Im. diamond, dissolved without destroying the stone.
RAJAH Im. Diamonds
 They stand all diamond tests—fire, acid, file, and glass cutting. Their brilliancy is eternal. Guaranteed for a lifetime. Set in solid gold, and sent to you on a **30 Days' Free Trial**. If you can tell it from a real diamond, return it. Send today for our beautiful, FREE illustrated jewelry catalog in colors. Write now. **KRAUTH & REED, 159 N. State St., Dept. P2 CHICAGO, ILL.**

A YEAR TO PAY

Lift Corns out with Fingers



A few drops of Freezone applied directly upon a tender, aching corn stops the soreness at once and soon the entire corn or callus loosens and can be lifted off with the fingers without even a twinge of pain.

Freezone

Removes hard corns, soft corns, also corns between the toes and hardened calluses. Does not irritate or inflame the surrounding skin or tissue. You feel no pain when applying it or afterward.

Women! Keep a small bottle of Freezone on your dresser and never let a corn ache twice.

Small bottles can be had at any drug store in the U. S. or Canada

THE EDWARD WESLEY CO. CINCINNATI, OHIO

STOP USING A TRUSS

Do Away With Steel And Rubber Bands

FREE TRIAL



Inner surface is made adhesive to secure the FLAPAO-PAD firmly to the body, keeping the PLAPAO continually applied and the pad from slipping. No straps, buckles or springs attached. Soft as velvet—easy to apply.

It's the Non-Slip- ping, yet Non-Rigid Pad and What is Within It That Counts

FREE to 5,000 Truss Sufferers

To the extent of 5,000 sufferers who may apply I will send, ABSOLUTELY FREE, a sufficient quantity of the Plapao to positively convince them that this is the only logical, common-sense way of treating rupture. Plapao is a highly astringent medication placed within the Plapao-Pad and being absorbed through the skin, creates a wonderful feeling of relief and at the same time tends to strengthen the weakened muscles and thus permanently close the rupture opening. The process of recovery is natural, so you'll have no use for a truss—you can throw it away forever! Old and young have testified under oath that the Plapao-Pads cured their rupture—many of them long-standing, aggravated cases—without delay from work. Patent allowed in U. S. and foreign countries. Awarded Gold Medal at Rome and Grand Prix at Paris.

Send No Money—for a sufficient quantity of the Plapao is sent without charge to enable you to give it a thorough test; you pay nothing for this trial now or ever. Write for it and full information today. Address: Plapao Laboratories, Block 1427 St. Louis, Mo.

Here's Health and Power—Vim and Vigor



Do you want them?

Strength that is more than mere muscular strength. The strength of better health, abundant nerve force. The strength of keen relish. Write and find out what vibration will do for you. Nine out of ten people are only half alive. How about yourself? Do you feel just right? If you haven't that vigorous "go ahead" feeling all the time, don't fail to send the free coupon today for our big new book that will tell you all about

THE WHITE CROSS ELECTRIC VIBRATOR



Our Combination Outfits give you three of the greatest curative

agents—Vibration, Faradic and Galvanic electricity. We will send this wonderful machine to you on free trial. See it—try it—feel its health-giving vibrations for yourself. White Cross Electric Vibrators can be connected up as easily as electric lamps, or, if your home is not wired for electricity, they will operate on their own dry cells.

Vibration Is Life

In vibration there exists many of the secrets of life. The safest, surest and quickest way to recover normal health is by scientific manipulation of the organs affected and in this way stimulating them to perform their duties, whether it be those of digestion, respiration, circulation, or the nervous system. The rich, red blood will be sent coursing through every vein and artery. Write today—now—for our free book.



Send the Free Coupon

Just your name and address on the free coupon or a letter or a post card is enough. We will send you absolutely free and prepaid, our new book, "Health and Beauty." It's free. No obligations of any kind. Write today—at once.

Lindstrom, Smith Company
1100-1110 South Wabash Avenue
Dept. 1156 Chicago, Illinois

We also manufacture White Cross Electric Stoves, Irons, Hair Dryers, Electric Lamps, Electric Fans, Electric Automobile Horns, Electric Curling Irons, Heating Pads, Small Motors, etc., etc. Dealers write.

Lindstrom, Smith Co.,
1100 S. Wabash Ave.
Dept. 1156 Chicago

Please send me, also, absolutely free and prepaid, your new book, "Health and Beauty" and full particulars about the White Cross Electric Vibrator. I assume no obligation of any kind.

Name.....

Address.....

My Electrical Dealer's Name is.....

Please Mention Popular Mechanics



TO the machinist the limit of accuracy is usually a thousandth of an inch, often less—a distance he can neither see nor feel.

To make accuracy easy and certain he relies on a mechanical device—a Micrometer, Vernier Height Gage or Vernier Caliper. "Starrett" is a make and mark that guarantees his work.

Get acquainted with the 2100 styles and sizes of these fine tools. Ask today for Catalog No. 21AP.



The L. S. Starrett Co.

The World's Greatest Tool Makers

ATHOL, MASS.

42-701



WITH OUR BOYS AT THE FRONT

The "tank" and the armored car form the "flying wedge" of modern warfare. In the forefront of battle where loss of time means disaster, the Crescent Wrench is daily proving its indispensability. The Crescent easily makes adjustments which are a problem or impossible with the ordinary wrench.

The Crescent is built to withstand the hardest use.

CRESCENT TOOL CO.
JAMESTOWN, N. Y.



INVESTING In Good Tools



— tools which he knows will help him to maintain his reputation as a good workman and make promotion sure when the time comes.

He Chooses Brown & Sharpe Tools

because he knows both from his own experience with machinists' tools and the recommendations of his shop mates that B & S Tools are

Accurate — Handy Trustworthy

He knows what their adaptability to hard shop use — their never-failing accuracy — their reliability and the genuine satisfaction that follows their use really means.

He knows because his kit is "B & S Equipped" and it naturally follows that each new tool he adds bears the world-endorsed B & S trade mark.

He keeps a B & S Catalog
27 in his kit. Do you?

Send for **FREE Catalog TODAY**

Brown & Sharpe Mfg. Co.
Providence, R. I., U. S. A.



Flows Straight to Every Friction Point and—

reduces friction to an irreducible minimum! That's why 3-in-One is the universal lubricant for typewriters, sewing machines, magnetos, motors, commutators, cash registers, fishing reels, lawn mowers, clocks, hinges, automatic tools, adding machines, locks. It makes everything with frictional parts work easier and last longer.

3-in-One

is the one right oil for all delicate mechanisms. Because it is a *pure* oil compound that *never* gums and never heats up or smokes at any rate of speed. Because it doesn't collect dirt (as mineral oils do) but actually *works out* dirt and grease.

Also use 3-in-One for wiping all metal surfaces. It prevents rust and tarnish.

Sold at all stores in 3 sized bottles. Also Handy Oil Cans.
FREE — Liberal sample of 3-in-One Oil and Dictionary of Uses.
Three-in-One Oil Co.
165 CNG. Broadway, N. Y.

Three Hands Working Here

Study this operation. Screw-driving brings up many similar situations. Your left hand holds in place the object to be fastened. The "YANKEE" Screw-holder Bit—the third hand—holds and places the screw. Your right hand simply pushes. A spring in the screw-driver brings the handle back—QUICK—and steadies the drive. Not a moment is lost—not a slip made. So, there's a third hand for you in this combination:

"YANKEE"

No. 130

SPIRAL RATCHET
(right, left and rigid)
QUICK RETURN

Screw-driver
\$2.40

with 3 sizes of regular bits

Screw-holder Bit
45c

Other attachments: Screw-eye Holder; Chuck and Eight Drill Points; Countersink.

No. 131—Heavy Size, \$3.15

No. 135—Light Size, \$1.85

with 3 sizes of bits

Your Dealer Can Supply You

"YANKEE" Tool Book
of boring, drilling and
screw-driving tools
free for the asking.

NORTH BROS.
MFG. CO.
PHILADELPHIA

"YANKEE" TOOLS
Make Better Mechanics

Coping Saws
should be good quality saws. For their work they are as important as larger saws.

Simonds Saws
are made in every style, shape and size for sawing wood or metal.

Write for booklet regarding the kind of cutting you want to do.

Simonds Manufacturing Co.
FITCHBURG, MASS.
5 Factories 11 Branches

7 Tell You It's A Great Saw

SIMONDS

THE AWL YOU WANT



Is the genuine MYERS \$1.00 "Lock Stitch" Sewing Awl with the exclusive feature. See thread reel in front of handle under the finger tips. Natural tension. Sews heavy or light material, diamond point, full grooved needles used to protect the thread when sewing.
C. A. MYERS COMPANY, 6339 University Ave., Chicago, Illinois

Duplicate Keys
for all Yale and similar Locks made in one minute with Harrison M.I.P. Key Filing Machine. No misfits. Thousands in use. \$3.50 net. Special diamond-shaped files for angular cut keys, 40c each. Harrison C.K. Key Clamp duplicates all common keys without a caliper. Price, \$1.10. Parcel post prepaid.
Money returned if not satisfactory.
HARRISON & CO., 81 New St., New York

Portable Cases
For Tool Makers and Machinists
Twelve styles, felt lined drawers, solid brass trimmings, best of material, beautiful finish, low prices, satisfaction guaranteed. Ask for booklet of cases built for service.
THE PILLIOD LUMBER CO.
SWANTON, OHIO

LEPAGE'S
GLUE
HANDY TUBES
MEND IT TODAY 10¢



You'll Be Proud of Your New Automatic

Judging from the enthusiastic letters we have received from proud tool users. They all agree that their *Sargent Automatic-Set Bench Plane* is "The Best Plane Yet Out." Made in six sizes; the superior features to be appreciated by tool users are the automatic set, rigidity, ease of adjustment and the single bit. These Planes are intended for both heavy and very fine cuts. They are especially adapted for working against the grain on cross-grained, hard wood where the absolute rigidity of the cutter avoids any tendency to chatter.

Plane catalogue, with full description of these and other Sargent Planes, sent free on request.

SARGENT & COMPANY
49 Water St., New Haven, Conn.

SARGENT



"RED DEVIL" Fence Tool No. 1900 11 Tools in One

Contains 2 staple pullers, 2 hammers, 2 wire cutters, wrench, wire stretcher, tyer, pincher, and pipe grip. Made of steel, 10 inches long. For farmers, householders, gardeners, ranchmen, etc. Sample tool sent for \$1.25, if not obtained from dealers. CIRCULARS FREE.

SMITH & HEMENWAY CO., INC.
97 Coit Street IRVINGTON, N. J.

BUY A UNION TOOL CHEST

and be assured of a place for every tool. You know immediately if one is misplaced or borrowed. Keeps tools clean, safe, free from moisture.

Plain or quartered oak, or leatherette covered, superbly designed drawers, perfectly fitted.

UNION TOOL CHEST WORKS



Style A
Write for
Catalog and
Prices

22 Railroad St.
ROCHESTER
N. Y.

**Stanley
Tools**

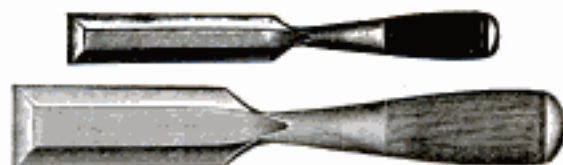

STANLEY "Everlasting Chisels"

☐ Strongest, fastest, most durable chisels manufactured.

☐ Blade, shank and head one piece of steel.

☐ Exceptionally well made and highly finished.

☐ May be had singly or in sets, packed in canvas rolls or fancy hardwood boxes. Made in all standard sizes.

Special circular upon request

STANLEY RULE & LEVEL CO.
NEW BRITAIN, CONN. U.S.A.

OSTER PIPE-THREADING TOOLS

SEND for a free catalog—it will help you to understand why every nation in the civilized world uses Oster U.S.-made Bull-Dog Die-Stocks. Each stock is adjustable and threads from 4 to 8 sizes of pipe. For a full description of the 20 tools, direct and ratchet, of the Bull-Dog line and 27 other hand tools and power machines, write

The Oster Mfg. Co.

2100
E. 61st
Street
CLEVELAND,
OHIO, U.S.A.



Using
Bull-Dog
Die-Stock
No. 102-R
3/4" to 1 3/4"

Please send List 29 to

Name.....

Address.....

City.....State.....

Occupation..... (2100-E)



WHITING-ADAMS BRUSHES

Schools, Public Buildings
and Residential Buildings Require

Floor Sweeping and Dusting brushes which are made of good quality, stiff, elastic bristles. Sanitation demands that dirt and dust be actually removed. Soft brushes, which mat down, will not serve the purpose.

WHITING-ADAMS FLOOR BRUSHES, DUSTING BRUSHES

and other brushes for Household, Mechanical and other purposes, do the work as it should be done. Reliable and economical. Send for Illustrated Literature, Dept. C.

JOHN L. WHITING-J. J. ADAMS COMPANY, Boston, U. S. A. Brush Manufacturers for Over One Hundred Years

Whiting-Adams Brushes Awarded Gold Medal and Official Blue Ribbon, the Highest Award at Panama-Pacific Exposition, 1915



Acetylene Blow Torch Prest-O-Torch

Quicker and cheaper than a gasoline blow-torch for brazing and soldering

For factories, repair shops, linemen, dentists, jewelers, the Prest-O-Torch saves time and money. Used with Prest-O-Lite Tanks—ready-made gas. Intense, concentrated flame instantly lighted. No depreciation, safe and convenient. Style "A", price, 75c (Canada, 85c) will braze up to 3/8 inch round rod. Style "C" for heavier work, \$2.25 (Canada, \$2.75). Special styles for dentists. Write for literature or send order now. Money refunded if not satisfied.

The Prest-O-Lite Co., Inc. 835 Speedway
Indianapolis, Ind.
Canadian General Office, Dept. A4 Toronto, Ont.



SIMPLICITY

in construction, yet embodying all necessary features and backed up by perfect workmanship, is what we offer in a

SEBASTIAN

13-14- and 15-inch Swing

The Sebastian Lathe Co. 107 Culvert Street
Cincinnati, O., U.S.A.

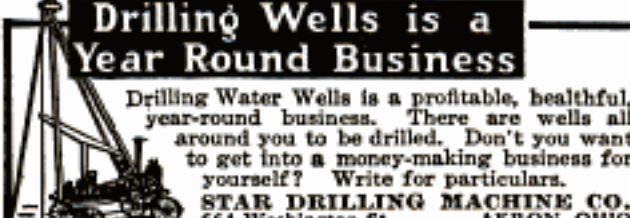

Drilling Wells is a Year Round Business

Drilling Water Wells is a profitable, healthful, year-round business. There are wells all around you to be drilled. Don't you want to get into a money-making business for yourself? Write for particulars.

STAR DRILLING MACHINE CO.
664 Washington St. AKRON, OHIO

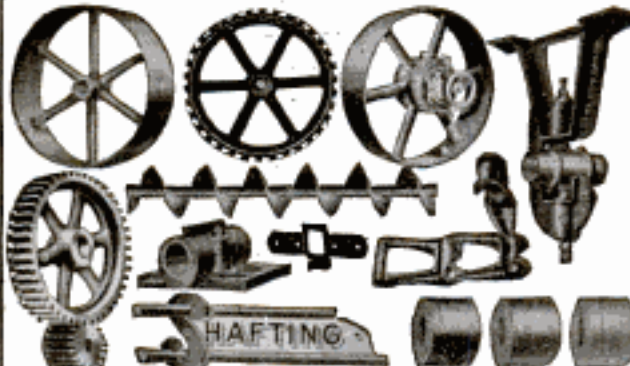

A complete line of appliances for the transmission of Power. Anything from a bolt to a complete mill or factory outfit. Send for catalogue. Largest Manufacturers of Pulleys in the country.

W.A. Jones Foundry & Machine Co. 4400 W. 12th Street
CHICAGO



South Bend Lathes

For the Machine and Repair Shop

How to Run a Lathe
A 50 cent book for 10 cents. Postpaid, stamps accepted.

Straight or Gap Beds. Send for free catalog giving prices on entire line.

SOUTH BEND LATHE WORKS
423 Madison St., South Bend, Ind.



LATHES

9 to 18-inch Swing

List price \$75 and up according to size. When ready to buy send for Lathe Catalog and prices.

W. F. & John Barnes Co.
100 Ruby Street, ROCKFORD, ILL.

Water Pumps Water

with a Rife Ram. Plenty of it for every purpose about your farm and country home — day and night, winter and summer, without fuel, labor, freezing or repairs. The

RIFE RAM

is operated by any small stream having a fall of three feet or more and a supply of three or more gallons per minute. Fills high elevated tanks or operates air pressure system. Easy to install. First cost the only cost. Always on the job; over 11,000 in daily use. Tell us your water supply conditions. Ask for free estimate and catalog. Now is the time to install. Write today.

RIFE ENGINE CO., Dept. F. 90 West St., NEW YORK

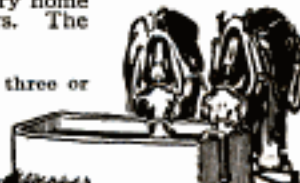
WANTED IDEAS



Inquiries from Manufacturers and Other Buyers of Patents
Who Are Looking for Good Ideas

Protected by Owen Patents

Are constantly being received. Hundreds of ideas are wanted—a market exists for them to-day. YOURS may be one of them. Send for my free books and see for yourself—read the requests for inventions protected by me. Many are simple. You can help supply this demand.

As soon as my clients' rights are protected I aid in every practicable way, without charge, to sell. Their applications are advertised free—their patents are called to the attention of the proper prospective buyers—every necessary thing is done. Get my booklets and see.

THESE ARE FREE

You will incur no obligation by writing me. A simple request will bring them to you—the finest, most reliable and instructive patent books published. A postal will do.

"Successful Patents"—a 72 page guide book, tells how to proceed; describes my advantageous business methods; gives references, testimonials, etc.

"Stepping Stones"—gives hundreds of hints of inventions wanted; articles from interviews of noted authorities; tells the truth about prizes for inventions.

"Patent Promotion"—tells you how to sell; why some inventors fail; discusses the value of your idea; how I aid my clients; manufacturing aids furnished you; recent successful patents, etc.

"Patent Buyers"—Publishes letters, and abstracts of letters, from over 400 of the many manufacturers, and other patent buyers, who wish to buy, or obtain on royalty, Owen Patents on innumerable inventions of interest to them.

You will also be sent from time to time, as new inventions are wanted, full information concerning them. Only in this way can you keep up to date.

WRITE FOR THESE TO-DAY—Advice costs nothing. All communications confidential. Your work will receive my personal supervision—but my fees are no higher than others.

Results Speak Loudest—But Here Are Some References

Columbia National Bank,
Washington, D.C.
National Lockfile Co.,
Washington, D.C.
The Carnahan Press,
Washington, D.C.
Lightning Gun & Cycle Works,
Oklahoma City, Okla.

Antholene Mfg. Co., Hutchinson, Kan.
National Rack Co.,
61 Hanover St., Boston, Mass.
The C. J. Loftus Co.,
13 Spring Common, Youngstown, Ohio.
Whitehead Hosiery Mills,
Berlington, N. C.
Dickinson Mfg. Co., Des Moines, Iowa.

A LARGE NUMBER OF OTHERS IN MY BOOKLETS.

RICHARD B. OWEN 9-303 OWEN BLDG.
WASHINGTON, D. C.

NEW YORK OFFICE: 22nd Floor Woolworth Building

Inventors submitting their inventions to me are protected in a tangible manner until their applications are filed.

Nuts for You to Crack

Invent something for which a demand exists—for which there is a waiting market. Here are abstracts from a few recent requests—hundreds are published in full in my literature. Can you invent any of these? Watch this list each month.

A large middle Western manufacturer states "we are interested in any novelty that has merit and can be manufactured at an attractive profit. We would prefer something selling to the shoe trade; however, will consider any good novelty. We would rather favor the royalty proposition."

An unusual request has just come in, an investor desiring to purchase a patent covering different kinds of Guitar Zithers "such as base and treble attachments."

Can you make even a slight improvement in your suspenders? If so I can refer you to a manufacturer who has just inquired for anything new in this line.

Another unusual request has just come from a man who desires patents "in the line of playthings or dolls made of a new kind of papier-mache composition to be pressed in moulds or cast in same."

SPECIAL FREE REPORT

Send sketch or model of your invention for free report on patentability, practicability, etc.

PATENTS THAT PROTECT and PAY

Send for FREE BOOKS.

Advice free. Terms reasonable. Highest references. Best results.

Send sketch or model for FREE examination and opinion.

BONDED and recommended Patent Lawyer in the Rand-McNally Directory of Bankers and Attorneys, Published by Rand-McNally & Co., Chicago, Ill. Recommended Patent Attorney in the Bankers Register and special list of selected lawyers published by the Credit Company, Pontiac Building, Chicago, Sharp & Alleman's Directory of Lawyers and Bankers, published at Philadelphia, and Martindale's American Legal Directory of New York City.

ALL BUSINESS GIVEN PROMPT AND PROPER ATTENTION

A large list of strong recommendations furnished free

WATSON E. COLEMAN, Patent Lawyer, 624 F St., Washington, D. C.

HIGH-VALUE PATENTS
—the ONLY kind Wanted and BOUGHT by Manufacturers.
Send 6c. postage for new book of Extraordinary Interest to Inventors.
R. S. & A. B. LACEY, 51 Barrister Building, Washington, D. C.

Send for FREE BOOK { WHAT TO INVENT
WHAT NOT TO INVENT
HOW TO SELL YOUR PATENT
Nearest Patents and report in each case to be filed—no charge
H. L. WOODWARD, 9th and G Sts., WASHINGTON, D. C.

"Interlox"

MASTER SLIDE RULE

THE ONLY INTERLOCKING, SLIDING RULE

Quick and accurate for inside and outside measurements. If not at dealer's, send his name and 20c per ft. (all lengths from 2 to 8 ft.), for rule sent prepaid.

DAHL MFG. CO., 841-43 E. 136th St., NEW YORK CITY

For Mechanics, Carpenters, Engineers, Electricians, and All Who Take Measurements.

Dealers and Agents: Write for Attractive Proposition



ORDER TODAY
DON'T DELAY

Cash with order buys this small
\$3 BENCH LATHE

Swing 3 in. 8 in. C. to C. Shipping Wt. 10 lbs.
PETER AUSTIN, 910 W. First PM., MUNCIE, IND.



The Midget Slide Rule

will add, subtract, multiply, divide, solve problems involving even and uneven roots and powers. Also gives the Logarithms of numbers and the Sines, Tangents, Cosines and Cotangents of all angles. Its operation is very simple; quickly solves any mathematical problem. Made of wood and metal. Adapted for shop and office use. Fits the pocket, 3 1/4" in diameter.
Price, with instructions..... 75c

Your money back if you are not satisfied

GILSON SLIDE RULE CO., NILES, MICH.



ToolCases for Toolmakers and Machinists

Keep your tools orderly arranged in a Gerstner Portable Tool Case. There's a place for every tool in one of the felt lined drawers. Every up-to-date mechanic needs one and you'll find our Cases the best built, toughest and most practical on the market. We guarantee to please or refund all money. Write for our free booklet

Gerstner Tools

Mfrs. of Mechanic's High Grade Tool Cases
808 Columbia St., DAYTON, OHIO

Protective Patents

Procured Promptly. No fee refund, no guarantee certificate, no so-called prize or free search schemes used in our business. Inventors 104 page Blue Book sent on request.

Robb & Robb, 211-215A Southern Bldg., Washington, D. C.

HAVE YOU A REALLY GOOD IDEA

Or INVENTION or ARTICLE that you feel would be valuable if properly developed? We are in the position to handle this right. Small, conveniently handled article preferred—Bank references.
PETTINGILL & CO., Box 2685, BOSTON, MASS.



GEARS ALL KINDS SMALL

The most accurate made and prices reasonable. We carry a complete line of gears in stock for immediate shipment. Can also quote on special gears of all kinds. Send us your inquiries.

WRITE FOR CATALOGUE

**CHICAGO STOCK GEAR WORKS
16 S. Fifth Av. CHICAGO**

Models and Gears

Experimenters—Inventors

Developing inventions and making working models our specialty. Well equipped shop and staff of experts at your service. Carry complete stock of gears. Shipments same day order received. ESTABLISHED 1882.

UNION MODEL WORKS, 121 S. Clark St., CHICAGO



Models and Supplies

We make working models of any description and material, also dies, tools and sheet metal stampings. Send your drawing or sample for estimate. Write for catalog of gears and model supplies.

The Pierce Model Works, 3405 Pierce Ave., Chicago, Ill.



MECHANICAL SUPPLIES AND MATERIAL

of all kinds.
EXPERIMENTAL AND LIGHT MACHINE WORK to order.

132 MILK STREET. BOSTON

**DISSTON
SAWS AND TOOLS**

CRESCENT Wood Working MACHINERY

is saving money for thousands of satisfied users all over the world and will do the same for you.

Send today for your CRESCENT catalog telling about our splendid line of band saws, jointers, saw tables, planers, disk grinders, planers and matchers, bores, swing cut off saws, hollow chisel mortisers, variety wood workers, universal wood workers, shapers,
**THE CRESCENT MACHINE CO.
93 Columbia Street, LEETONIA, OHIO**



Wanted—Ideas

Inventors! Send for these Remarkable FREE BOOKS, Today

“Inventions Needed”

This book lays before you a description of the active and profitable field of invention. It tells you the inventions the world needs today, the devices manufacturers are seeking for their business, the ideas for which the public will pay big money.

“How to Get Your Patent”

This book is a guide to the inventor. If you have invented something and desire to learn what it will cost you to get your patent and what you must do to find your market, read this book.

“Special Bulletin of Patent Buyers”

This bulletin contains letters from men who are seeking to purchase patents. We act as intermediary without one cent of charge, between the man who invents and the man who invests.

Send Model or Sketch and description of your invention for Free Opinion as to patentability

Rejected and Difficult Cases are Our Specialty

RANDOLPH & CO.

600 F St., N.W., Washington, D.C.

RANDOLPH & CO.

600 F St., N. W., Washington, D. C.

Gentlemen: Please send me without obligation on my part, the books indicated on margin of this coupon. (Write on margin of coupon, names of books desired.)

NAME.....
STREET.....
CITY.....STATE.....



Inventions Wanted!

Manufacturers constantly writing us for patents. List of inventions actually requested and book "How to Obtain a Patent" sent free. Send rough sketch for free report regarding patentability. Special assistance given our clients in selling patents. Write for details of interest to every inventor.

CHANDLEE & CHANDLEE, Patent Attorneys
Est. 21 Years 1011 F Street, WASHINGTON, D. C.



PATENTS SECURED OR ALL FEES RETURNED

Wonderful 190-page GUIDE BOOK FREE! Greatest book published in 20 years, containing many helpful chapters: "Patents Sold Free—Our Patent Sales Department;" Our "All Fees Returned" System; "Preparedness;" INVENT something for the Army or Navy; "U. S. Government Buys Inventions," etc.

Mail postal today for this 190-page book—FREE! Mr. Inventor, don't miss this book.

Send Data at Once for Actual Free Search and Report

FOREIGN PATENTS GUARANTEED
BEST REFERENCES. PROOF GIVEN!

E. E. VROOMAN & CO., 871 F St., WASHINGTON, D. C.
(Old-Established Firm, and Practitioners Before Supreme Court.)

PATENTS

C. L. PARKER
Formerly Member Examining
Corps, U. S. Patent Office
PATENT LAWYER
MCGILL BLDG.
WASHINGTON, D. C.

Patents, Trade Marks, Copyrights, Patent Litigation

Handbook for Inventors, "Protecting, Exploiting and Selling Inventions," sent free upon request.

PATENTS SECURED OR FEE RETURNED

Compare My SERVICE and TERMS with Those of Any First Class Attorney

Send Sketch, Photograph, or Model of your invention for an ACTUAL SEARCH of the Records of the Patent Office and report as to patentability—FREE. I give every detail of every case my closest personal attention and do not entrust your interests to assistants. Impartial advice on your ideas. I help you sell your patent. Terms moderate. My 90-page book (1917 edition) tells what inventors should know before they apply for a patent.

GEORGE P. KIMMEL, Patent Lawyer, 200 Barrister Bldg. Washington, D. C.

Latest and Most Complete Patent Book Ever Published for Free Distribution

WRITE FOR IT

PATENTS TRADE-MARKS AND COPYRIGHTS

LARGEST PATENT FIRM
IN THE WORLD

SPECIAL OFFER

Free Opinion as to Patentability

Before sending your invention to any attorney or manufacturer or disclosing your invention, write for our free blank form **PROOF OF CONCEPTION** in order to protect your invention and secure your rights. This should be signed and witnessed and returned to us, together with a model or sketch and description of your invention, and we will give a **FREE OPINION** as to the patentability of the invention. If we report the invention patentable we will furnish a Certificate of Patentability.

This Certificate of Patentability, together with our blank form Proof of Conception will protect the inventor and serve as proof of the invention until the case can be filed in the U. S. Patent Office.

Obtaining Assistance for Inventors—Our certificate is of great assistance to inventors who require financial aid to obtain patents.

OUR FIVE BOOKS MAILED FREE

(See Coupon Below)

to any address. Send for these books—the finest publications ever issued for free distribution.

How to Obtain a Patent

Our illustrated eighty-page Guide Book is a book of reference for inventors and contains 100 mechanical movements, illustrated and described. Tells how to invent for profit.

What to Invent

Contains a valuable list of inventions wanted and suggestions concerning profitable fields of inventions; also information regarding prizes offered for inventions amounting to **One Million Dollars**

Millions in Trade-Marks

Shows the value of Trade-Marks and information regarding unfair competition.

We Advertise Our Clients' Inventions Free in a list of Sunday newspapers, in manufacturers' journals and in World's Progress. Sample Copy Free. We save you time and money in securing patents. After the patent is granted we assist you to sell your patent.

WANTED NEW IDEAS

Prepare Now to meet the Demands of Industry in All Fields for New Ideas and New Inventions. We are constantly receiving requests from manufacturers who consult us when purchasing patents for inventions in all lines. We invite manufacturers and promoters to address our Sales Department regarding the purchase or leasing of a number of meritorious patents secured by us.

List of Patent Buyers

Contains requests from manufacturers, mail order houses and promoters for patents secured by us and suggestions as to **New Ideas** they wish to purchase. We place our clients in touch with capital free of charge. We have recently received over 300 requests from manufacturers.

Foreign Patents

We have direct agencies in all the principal foreign countries and secure foreign patents in the shortest possible time and at the lowest cost. Write for our illustrated Guide Book on Foreign Patents, sent free to any address.

VICTOR BUILDING



FREE COUPON!

VICTOR J. EVANS & CO.

New York Offices: 1007 Woolworth Bldg. PATENT ATTORNEYS Philadelphia Offices: 1429 Chestnut St.
Pittsburg Offices: 514 Empire Bldg. Main Offices: 765 Ninth St., N. W., WASHINGTON, D. C.

Name..... Address.....

Please Mention Popular Mechanics

R. MORGAN ELLIOTT & Co.
PATENT ATTORNEYS

MECHANICAL, ELECTRICAL & CHEMICAL EXPERTS
713-721 WOODWARD BUILDING
WASHINGTON, D. C.

Reliable, prompt service by a Competent Attorney. Inquiries invited.

Norman T. Whitaker

Attorney-at-Law and Mechanical Engineer
Former Examining Official of the U. S. Patent Office
27 Legal Building - - Washington, D. C.



EVERY INVENTOR

should have this book, "Patents and Patent Possibilities." It is chock-full of ideas and practical advice, telling what to invent and where to sell. Write for your copy today. It is FREE. I have requests for patents upon sound inventions of all kinds. Can you help supply the demand? My service is individual, prompt and efficient. (14 years' experience.) Every expedient is employed to secure patents at least possible cost.

H. S. HILL, 802 McLachlen Bldg., WASHINGTON, D. C.

Patents on Easy Payments

Send model or sketch for Free Search and opinion as to patentability. Write today for our free book of Inventions Wanted and How to Obtain Patent on Easy Fee Payments. We furnish our clients with list of patent buyers and assist inventors to sell patents.
C. C. HINES & CO., 591A Loan & Trust Bldg., Wash., D. C.

PATENTS PROMPTLY SECURED

I assist you to market your invention. Send sketch or model for my honest advice. Prompt personal service. BOOKLET FREE.

J. R. KELLY 743 Woodward Bldg.
WASHINGTON, D. C.

Abdominal MASSAGE

with the wonderful new **KOLON MOTOR** brings health, strength and energy. Banishes chronic constipation. Write for interesting booklet—"Colon Cleanliness"—mailed free. Send a postal.
MARTIN'S METHOD, Inc., Dept. 89, 105 E. 30th St., NEW YORK

Has The Motor Boat Bug Got You?



Health and happiness are assured with one of the new popular priced Gray motors in your boat. Select your boat from our 1917 Boat Builders Catalog showing products of 200 leading boat builders. Select your engine from our new complete Engine Catalog. Both books FREE. Send today.
GRAY MOTOR COMPANY
946 Oakland Ave., DETROIT, MICH.



PATENTS

Send Sketch or Model of Your Invention for Free Opinion as to Patentability

Our Certificate of Patentability is Evidence of Conception of your invention and may prove valuable to you. Our Credit System enables you to file your application for Patent and proceed without delay. Every case receives personal attention of one or both members of the firm.

Patents we secure advertised at our expense in Popular Mechanics Magazine.

Write today for Free copy of 104-page book, "How to Obtain a Patent and What to Invent"

Talbert & Parker, Patent Lawyers
4683 Talbert Bldg. WASHINGTON, D. C.



PATENTS AND TRADE MARKS

LANCASTER & ALLWINE



204 OURAY BLDG.,

D. C.

WASHINGTON, D. C.

BOOK "Inventions—Patenting & Promoting" FREE

Our co-operation with an inventor is, FIRST, to help him establish his rights before he discloses the idea to ANY attorney; SECOND, to give a frank opinion whether it will pay to patent his idea, based upon our extensive knowledge of manufacturers' wants and facilities; THIRD, to obtain for him a patent which is in reality a valuable monopoly; FOURTH, to advise and assist him in the proffing by outright sale, territorial grants, obtaining royalty, or independent manufacturing of the invention; and FIFTH, aiding him to so profit by conferring with manufacturers, investors or distributors of machinery. Before sending a sketch to anyone, sign, witness and deposit in our fireproof vault our document,

EVIDENCE OF CONCEPTION

— AND ESTABLISH YOUR RIGHTS —

Here's Big Engine Value—1/2 and 1 H.P.

Every young mechanic—every man-of-the-house—every farmer—has often wished for a small, low-cost gas or gasoline engine to run the grindstone, emery wheel, lathe, drill, wash machine, ice cream freezer and other light machinery. Now he can have it in this wonderful little

Maytag Multi-Motor

The lightest, simplest and most reliable little engine made. Easily carried—used anywhere. 1/2 h. p. size only 35 lbs., 1 h. p., 65 lbs. No cams, gears or valves nothing to get out of order. Best low-cost engine you ever saw. Positively guaranteed. Get our special low factory price; also illustrated folder. Send the coupon—now.

THE MAYTAG COMPANY
DEPT. 227 NEWTON, IA.

THE
MAYTAG
COMPANY

Send the
Coupon
Now.

Send me Illustrated Multi-Motor folder, also special low factory price.

Name.....

Address.....

Town.....

State.....



Take Pictures with—

The **EXPO WATCH CAMERA**

A camera that closely resembles a watch in size and appearance—takes pictures $\frac{1}{2} \times \frac{3}{4}$ inches as shown on margin. Easy to operate. It's a camera for both amateur and professional.

Surprise Your Friends

Take their picture in the act of doing some funny stunt. Next time you see them produce the print. You will have a lot of fun over their bewilderment and catching people in queer and awkward positions. Carry the EXPO about in your pocket—easily concealed in the palm of the hand—picture can be taken unobserved. Produces clear, sharp negatives, indoors or outdoors equal to any camera on the market.

One Cent a Picture

The EXPO loads in daylight with a 25 exposure film costing 25c. A whole day's outing picture taking can be had for the small sum of 1c a picture. Films are also made in 10 exposures for 15c. Photos may be enlarged to any size. We have Automatic Enlargers specially made for the purpose, that may be had any time.

Quick as a Flash

The EXPO takes pictures through the stem, where the rapid fire lens is located. Equipped with a time and instantaneous shutter. Weighs but three ounces and is highly nickel-plated. Endorsed and in constant use by the police, newspaper reporters, detectives and general public. Important evidence can be secured with a camera of this kind. Sold under a positive guarantee. Delivered to any address in the world.

\$2.50 For EXPO WATCH CAMERA, postage 10c extra. Films, 25 Exposures, 25c—10 Exposures 15c. Leather Pocket Carrying Case 35c. Adjustable View Finder for Watch Camera 50c. **JOHNSON SMITH & CO., Dept. 81, 7121 N. Clark St., CHICAGO**

Johnson
Smith & Co.

Dept. 81
7121 N. Clark St.
CHICAGO, ILL.

Please send me one EXPO
WATCH CAMERA for which
I enclose \$2.50 and 10c to
cover postage.

Name _____

Street Address _____

City _____

**How to Cut Coal Bills $\frac{1}{2}$ to $\frac{2}{3}$**

Free Book "From Overfed to UNDERFEED" tells how—guaranteed. Tells how to burn cheaper grades of coal cleanly and effectively. No clinkers. No partly burned coal. Ashes few, clean and white. No sifting. A boy can tend the Williamson UNDERFEED Furnace or Boiler with expert results. Coal fed from below. Hot, clean fire always on top. Write for free book today. NOW!

THE WILLIAMSON HEATER COMPANY
65 Fifth Avenue Cincinnati, Ohio

\$5 TO \$10 A DAY

AGENTS—BIG HIT
5-Piece Aluminum Set

Cheaper than enamel ware. Guaranteed 20 years. Retail value \$5.00. You sell to housewives for only **\$1.98**. Sure sale wherever shown. Answer quick for your territory.

American Aluminum Mfg. Co.
Div. K X 5 Lemont, Illinois



Guaranteed perfect cut and brilliant color. Latest 14K Gold Mounting for Ladies or Gentlemen.
PRICE \$25.00

DIAMONDS AT LESS THAN CASH RETAIL PRICE
WEAR AS YOU PAY
WATCHES
50 cents Down and 50 cents a Week. No Interest Charged

Sent on First Payment Anywhere in U.S.A. Why Pay Cash? We can Save You Money. Send for Photograph.

LENOX JEWELRY CO. 373 Washington Street
Boston, Mass.
20 Years of Honest Dealing

Waltham, Fla., Hamilton, Ill., and Rockland, Ad. Justed in 20-year Gold Case.

PRICE \$10.75 to \$28.50

**A Yearly Income for You**

Would you invest a moderate amount in small monthly or semi-annual installments, if you felt assured it would earn for you an income from \$1000.00 to \$5000.00 annually, according to your investment? A Dixie Estate near Tampa, Florida, planted to grapefruit, oranges and avocados, should do this for you. The proof is what you want. We have it and will gladly send it to you free. Write us today for details of this money making opportunity.

The Thomas Nurseries, Inc., Tower Bldg., Chicago

Comfort Indoor Closet

Odorless, Sanitary, Germ-proof. Can be placed anywhere in home. A guarantee of healthy, sanitary conditions. 80 days' Free Trial.

SWAT FLY BREEDING CLOSET
Have city conveniences. Germ-life killed instantly by chemicals. Esgotted once a month. Needs no other attention. Boards of Health endorse. Write for literature.

Agents wanted—exclusive territory
COMFORT CHEMICAL CLOSET CO. 389 Factory Bldg. TOLEDO, OHIO



GREEN AUTOMATIC MACHINE



ADD TO YOUR INCOME WITH LITTLE EFFORT
\$5 to \$10 A DAY MADE EASY WITH
The GREEN AUTOMATIC MACHINE

Sharpens, Honors and Strips all kinds of safety razor blades, in one operation, from four to six blades per minute. For both Quality and Quantity this machine is in a class by itself. There is nothing like it on the market. Let us send you our free booklet explaining everything, including the "AMERICAN" Key Cutter—cuts square, angular or round slots.

AMERICAN SHARPENING MACHINE CO. (Inc.), Dept. 9, 184 W. Washington St., CHICAGO



TWIN FIRE Laughs at Soot and Oil

Twin Fire Spark Plug gives the same result as would two ordinary plugs in each cylinder, because it fires two separate and distinct sparks at same time. And if one point clogs, the other continues to fire—the hot explosions soon clean the fouled point.

Price Only \$1.00

Double-intense sparks mean more power, less carbon and a saving in gas. If your dealer cannot

supply you send direct for a set. You'll say they are the finest plugs you've ever used.

Twin Fire Spark Plug Company

660 Woodward Ave.
DETROIT, MICH.

Dealers: The demand for Twin Fire Plugs is growing rapidly. Our dealer proposition is fair and we want to get in touch with you at once. Write today.



Ordinary plug is dead when even one point is clogged.



Twin Fire always fires—one point cleans the other.



The Harley-Davidson "Master 17"



It sets the pace for 1917. Has more power, more speed, greater flexibility, faster getaway. Equipped with hand-operated, auxiliary brake in addition to regular service brake. Finished in beautiful military drab. Write for 1917 catalog.

HARLEY-DAVIDSON MOTOR COMPANY
509-B Street Milwaukee, Wis.

Producers of High-Grade Motorcycles for More Than Fifteen Years

More Miles From Gasoline—Guaranteed!

The Wilmo Manifold gives your car a flying start at the first few turns of the motor—increases gasoline mileage from 42 to 54 per cent by actual official A. A. A. tests—keeps the engine free from carbon—makes a smoother running motor at all speeds. Quickly and easily applied with a monkey-wrench. No holes to bore. Absolutely guaranteed. Made for various cars. Price \$7.50 up. Ask your dealer or garage man, or write.

THE WHITTIER CO., 808 First National Bank Building, CHICAGO

\$100 a week pays for the Black-Beauty-Bicycle



JUST THINK OF IT—here's the classiest bicycle ever built—and yours at the unusual terms of \$1 a week. What's more, we ship freight prepaid. DIRECT FROM FACTORY—ON APPROVAL. You take no risk, for if you don't like the Black Beauty, send it back at our expense—you're not out a penny. 5-Year Guarantee—All sizes, all styles, and a tool kit free. Get color catalog now.

WRITE US TODAY

Haverford Cycle Co.
Est. 1896. Dept. F, Philadelphia, Pa.

Please Mention Popular Mechanics

Coupon Good for 45 Samples and Style Book

Babson Bros., Dept. 1196, 19th St. and California Ave., Chicago
Gentlemen—Please send me your Fall Style Book and 45 real cloth samples of fabrics for your tailored-to-measure suits and overcoats, also explaining easy credit terms.

Name

Address

Samples Free! Stupendous Value!—



IN our New Fall Style Book you will see illustrated the newest fashions in clothing. The book is free. Just put your name and address in the coupon to get the book that shows the most remarkable clothing values offered in the country today.

\$5.00

And we send you any suit. Take your pick from our fine big style book. Then pay the balance in small amounts each month.

But send the coupon now and get the benefit of our opening prices—before prices go up. Others have already raised their prices. And we may be forced to raise our prices at any time.

You have all the other newest fabrics to choose from—Beautiful Geron, Glenn Urquhart plaids, Tartan plaids, Shepherd plaids, fancy and pencil stripes, two tone stripes. Your choice of fabrics, plain or fancy weaves, rough finish or smooth, all tailored to measure at prices that will astound you.

Send Coupon for Free samples sure. Get these snappy, all wool samples and see what fine clothes we make. Remember made to your measure and guaranteed.

Guaranteed All Wool!

On account of the high price of wool, more cotton and wool mixtures are being used than ever before. Don't buy a suit this season without an all wool label—guaranteeing all wool fabrics. The Government gives you this protection. Use it. Every Babson suit is guaranteed all wool.

Three Months to Pay

See the suit that we tailor to your own measure, before you buy it. Try it on. Compare it with any suit you ever bought. Then if you are not more than satisfied, send it back. If you wish to buy, pay the rock bottom price in small monthly payments. Wear the suit while paying for it.

Write for Fall Style Book

Put your name and address in the coupon or in a letter or post card and get this Fall Style Book now. Find out what the newest fashions in men's clothing are going to be. See 45 real cloth samples of the newest fabrics that you have to choose from and read for yourself the amazing offer that we are making. Read how you can get genuine, all wool clothing tailored to your own measure at these rock-bottom prices. Send the coupon now.

BABSON BROS. 19th St. and California Ave.
Dept. 1196 — CHICAGO, ILL.

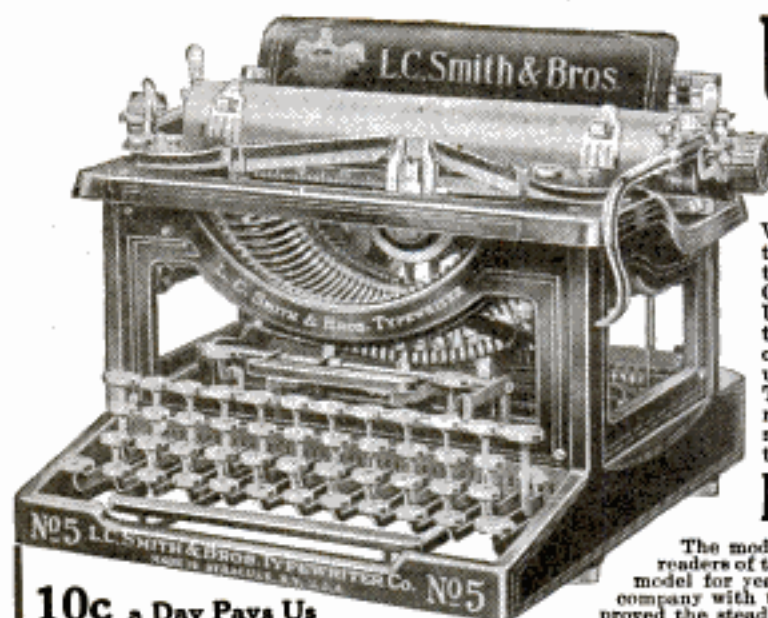

Uncle Sam Drafted This Typewriter

When war was declared, our Government needed thousands of dependable Typewriters. No time to test different makes. No time for experiments. The Government's tests had taken place years before. Under its severe daily usage, the Typewriter which the Government called for to the number of thousands of machines as soon as it went to war, had proven its utmost dependability. In peace times 5000 of these Typewriters were used by Uncle Sam. What was more natural then, for it to turn to the makers of this same Typewriter last spring for thousands more of these same trustworthy writing machines, the

Model 5 L. C. Smith Typewriters

The model here pictured, offered by us for the year past to the readers of this magazine. We have used 500 of the same identical model for years to write to our two million customers. Years ago in company with the Government and other big business institutions, we proved the steadfast qualities of these Model 5s. We counted it a great privilege when the makers of this Typewriter consented to the distribution by ourselves of their rebuilt Model 5s on a direct-from-the-maker plan. It has indeed been fortunate for a host of recent owners of Model 5s that we offered this genuine, fully guaranteed, factory rebuilt Typewriter instead of a new Model 5. For the maker is now on orders for new machines.

7000 Typewriters Back on Deliveries Yet We Can Furnish You This Model 5

This tells in the most forceful way of the popularity of this Typewriter. What other Typewriter maker is unable to keep pace with the popular demand? We could not get a new Model 5 for you today, although over 100 are made each day, if you were to pay a premium above their established price. Our offer is to your advantage. You can get a rebuilt Model 5. You save \$43 compared with the price of the new Model 5. You will have a Typewriter guaranteed for 5 years against defect. Your rebuilt Model 5 will be equal to the new Model 5 in appearance, in construction, in the work it does, and the length of service you get from it. Under these conditions, how would you profit in buying a new Typewriter? Let us quote our low price and give all the facts of this most interesting Typewriter offer.

10c a Day Pays Us

No one who needs a typewriter, and who wants a real, fully tested, guaranteed, high quality, modern writing machine, need pass by our offer. You'll do well, you'll serve yourself best to get it before committing yourself to the purchase of any typewriter.

Get Our Offer First—Then Decide

Here is the coupon. Sign and mail it today. It brings you the details without obligating you to purchase this Typewriter. Buy only when you are convinced you get the best for the money invested.

Sign and Mail the Coupon TODAY

Larkitt Co. Desk TPM-917, Buffalo, N. Y.

I want to know all about your offer on the Model 5 L. C. Smith, the Typewriter tested out by the United States Government. Send me your complete offer.

Name.....

Address.....

Bristol

Steel Fishing Rods

Tournament Bait Casting

"BRISTOL" RODS AND MEEK REELS are winning so many prizes in fishing and casting contests that we have taken the front page of Field & Stream, National Sportsman, Outdoor Life, Outing, Outer's Hook, Recreation, and Forest & Stream to print expert directions in order that all intending contestants may have the benefit of the methods used by the most experienced and successful tournament casters. Tournament casting is the finest training for accuracy and long distance casting in actual fishing. Read these directions carefully. Practice casting every chance you get, and

Write for Illustrated "Bristol" and Meek Catalogues, Free

THE HORTON MFG. CO., 196 Horton St., BRISTOL, CONN.
Pacific Coast Branch: Phil B. Beckett Co., 717 Market St., San Francisco

ERECTOR THE TOY LIKE STRUCTURAL STEEL

BOYS: Write for facts about Gilbert Toys and get Toy Tips, the boys' magazine, FREE.
THE A. C. GILBERT COMPANY, 104 Fox St., New Haven, Conn.

BIG PROFITS IN BATTERY CHARGING

Battery charging pays 15c to \$1.00 per battery. With H B Chargers, using city current, at a cost of about 15c for each battery charged, garage owners are making from \$20 to \$50 clear profit each month. You can put one of these motor-makers in your garage for \$15 cash, balance in ten monthly payments of \$15. Money-back guarantee. Mail this ad with your name for full particulars. Hubert Brothers Company, Box 93, Troy, O.

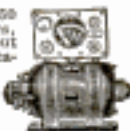

DUCK'S BIG 300-Page No. 11 Electrical and Wireless CATALOG

Mailed on receipt of 8 cents in stamps or coin, which may be deducted on first dollar purchase. Great cost of catalog and low prices prohibit distribution otherwise. Catalog contains 160 pages of wireless apparatus and 140 pages of electrical supplies. No bigger or better values are obtainable elsewhere.
THE WILLIAM B. DUCK CO., 223-227 Superior Street, TOLEDO, OHIO

RECTIFIERS for garages. All sizes. Charge from alternating current 1 to 8 batteries. \$12.00 upwards.
AMERICAN BATTERY CO., 1137 Fulton St., Chicago. (Estab. 1889)

Ask Your Dealer



Red Seal Dry Batteries Are Guaranteed

to give absolute satisfaction for Automobiles, Motor Boats, Gas or Gasoline Engine Ignition, Medical Batteries, Telephone, Door Bells, Annunciators, Wireless Apparatus or any other open circuit work.

Our New Edition Pocket Catalog P28

Ready About July 1st.

It will be pocket size, 8x4 1/2, and will contain 248 pages with over 1,000 illustrations, describing in plain, clear language all about Bells, Push Buttons, Batteries, Telephone and Telegraph Material, Electric Toys, Burglar and Fire Alarm Contrivances, Electric Call Bells, Electric Alarm Clocks, Medical Batteries, Motor Boat Horns, Electrically Heated Apparatus, Battery Connectors, Switches, Battery Gauges, etc.

There exist a thousand and one ways where electrical devices may be used, and to know what is best for your purpose you will need this catalog. It will be in fact a pocket encyclopedia of the most popular and up-to-date electrical appliances in general use, and will cost you nothing.



Send for a Copy Now

MANHATTAN ELECTRICAL SUPPLY COMPANY, Inc.

NEW YORK, 17 Park Place

CHICAGO, 114 So. 5th Ave.

ST. LOUIS, 1106 Pine St.

San Francisco, 604 Mission St.



SAVE MONEY

AND
Grind Your Own Tools
Sharpen Your Own Cutlery
Polish Your Own Silver

ATTACH TO ANY
SOCKET

Cut down the useless expense of sending your tools, etc., away to be sharpened or polished when you can save many a dollar and lots of time by doing it yourself with a

Racine Universal Motor



With Emery Wheel,
Buffer and
Cord **\$7.50**

Guaranteed
for One Year

PAYS FOR ITSELF

Can be attached to any light socket, no fuss—no bolts—no expense. Always handy—never gets out of order. Indispensable for countless small duties—you must be satisfied, or we return your money. Only \$7.50 with all attachments.

Ask your dealer today, or write direct for descriptive circular—It's Free.

RACINE UNIVERSAL MOTOR CO.
53 W. Jackson Blvd., Chicago, Ill.



DEALERS—SEND
FOR SALES PLAN

BOYS! HAVE DAD GET STRUCTO

Structo—Mechanics in miniature—will turn the trick. With it you can build that bridge or derrick, and a hundred other models that really work. Write for Free illustrated book.

STRUCTO MFG. CO., Dept. 118, FREEPORT, ILL.



AETNA-IZE Protect yourself and your family in case of sickness or accident. \$50 a week, and as high as \$15,000 for death. Write for particulars.

AETNA LIFE INSURANCE COMPANY

Drawer 1341

Dept. PM. 9-17

Hartford, Conn.

Super-Sensitive Microphone Only \$7.50



This instrument is offered at an extremely low price. It is excellent for building your own amplifier. Can also be used in many experiments where a sensitive microphone is required.

Detectagraph, \$15

This detecting instrument of marvelous sensitivity can be used for detecting secret conversations. Outfit consists of Sensitive Transmitter, 25-ft. Black Cord, Receiver, Headband, Case and Battery.

Send for One Today and Convince Yourself.



Detectagraph, \$15

THE \$15 MICROPHO DEAF-PHONE

is a super-sensitive instrument which has been developed to meet the demands for a practical and efficient hearing device at an extremely low price. It is equal to any \$35 instrument made and superior to most of them. The outfit consists of One Super-Sensitive Transmitter with cord connector; One Super-Sensitive Ear Piece with small black cord; One Black Single Headband; Black Case and Two Batteries. Write today for free booklet.



MICROPHO-DETECTOR COMPANY
Gaston Boissonault, President
25 DEY STREET NEW YORK
Makers of Super-Sensitive Microphone Apparatus

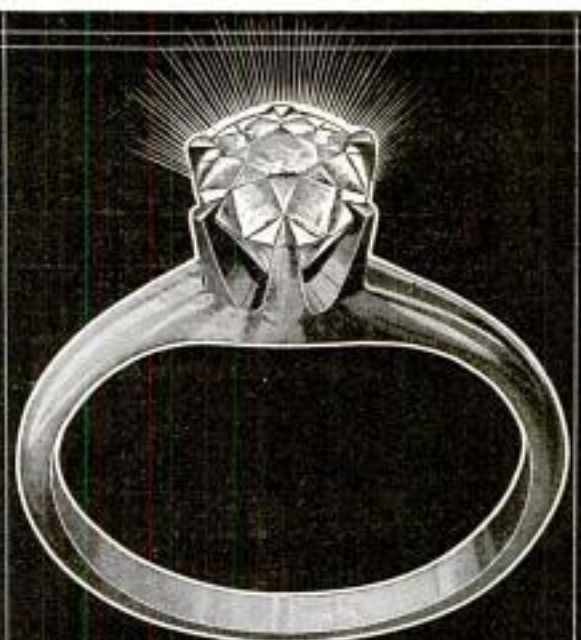

Compare It With a Diamond

*If You Can Tell the Difference
—Send it Back at Our Expense*

THESE new, man-made gems will be a revelation to you. After centuries of research, science has at last produced a gem of dazzling brilliance that so closely resembles the diamond that you'll not be able to distinguish it.

You may see it for yourself—without charge.

We will send you any of the Lachnite Gems that you may select for a ten days' free trial. We want you to put it to every diamond test. Make it cut glass—stand the diamond file, fire, acid—use every diamond test that you ever heard about. Then, if you can distinguish it from a diamond, send it back at our expense. Write for our new, free jewelry book.

Pay As You Wish

If you wish to keep the remarkable new gem, you may pay the rock-bottom price at the rate of only a few cents a day. Terms as low as 3 1/2 cents a day without interest. No notes, mortgages or red tape. You pay only the direct, rock-bottom price—a mere fraction of what a diamond costs.

Set in Solid Gold

Lachnite Gems are never set in anything but solid gold. In our new jewelry book you will see scores of beautiful rings, La Vallieres, necklaces, stick pins, cuff links, etc., etc. from which you have to choose.

Send Coupon For New Jewelry Book

Put your name and address in the coupon or on a letter or post card now and get our new jewelry book absolutely free. You will be under no obligations to buy anything—or to pay for anything. The jewelry book is free. Send your name and address now.

Harold
Lachman Co.
12 N. Michigan Ave.
Dept. 1196
Chicago, Illinois

Harold
Lachman Co.
12 N. Michigan Av.
Dept. 1196 Chicago

Gentlemen: Please send me absolutely free and prepaid your new jewelry book and full particulars of your free trial, easy payment plan. I assume no obligations of any kind.

Name.....

Address.....



For
Fishing
Hunting
Pleasure
Business

Steers
And
Controls
With
Same
Lever

Be a Caille 5 Speed Motor

OWNER AGENT

Hundreds of Caille Owners have asked to become our agents,—they have seen how easy it is to sell Caille 5 Speed Master Motors. They wanted to represent us in their vicinity because everyone who saw the Caille perform wanted one. We are going to give everyone a chance to be an owner agent and sell the Caille 5 Speed Outboard Row Boat motor. No previous selling experience is necessary. No office or shop is needed. Anyone can easily understand and operate a Caille 5 Speed Outboard Row Boat Motor. Be first in your neighborhood.

Special Owner Agent Offer

We will give a special "Owner Agents" discount to one in each community. Our best advertisement is the Caille in operation. Owner Agents sell from 1 to 12 Caille Motors a year easily among friends and acquaintances. Buy yours at discount and sell all you can. We want a Caille Owner Agent in your vicinity.

2 Speeds Forward — Standstill — 2 Speeds Reverse Without Stopping Motor

The Caille 5 Speed Motor Starter operates with a quick, easy pull,—women and children operate it easily. There are two speeds forward—two reverse or standstill without stopping the motor. This makes the Caille so flexible that anyone can use it for hunting, fishing, pleasure in fresh or salt water. The Caille is simple in construction, made of best materials and is fully Guaranteed.

FREE Catalog, Special Owner Agents Discount, Booklet "Installation-Operation and Care of 2 Cycle Motors and Equipment," all absolutely FREE. Here's a chance to earn while you play.

Caille Perfection Motor Co., 29 Caille Bldg., Detroit, Mich., U. S. A.

We make a complete line of Inboard Marine Engines from 2½ to 30 h. p.
If interested ask for catalog, giving dimensions of boat.

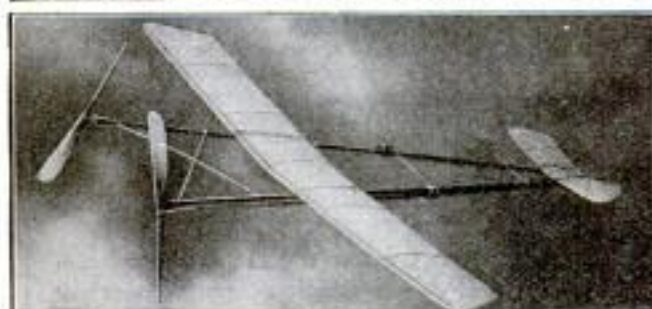

Junior Airplane Flies 3000 Feet

BOYS—men—everyone interested in aviation—write for full description, free. A real model airplane; 34 in. x 32 in.; guaranteed to fly 3000 feet; can be regulated to fly any distance. Has record of over 5000 feet. Models which rise from water and ground also. Great fun for everyone. Write today for full description and details of our offer. Give your toy dealer's name. Dealers and Toy Dept. Buyers write for proposition. JUNIOR AERO CO., Dept. 1198, 29 S. LaSalle St., CHICAGO



AGENTS \$60 WEEKLY

Robinson Folding Bath Tub. Big seller. Costs little, no plumbing, little water. Weight 15 pounds, folds into small roll. Full length bath, far better than tubs. Guaranteed 10 years. \$10 a day easily made. Write for free tub offer. ROBINSON CABINET MFG. CO. 4770 factories Bldg., Toledo, Ohio

AGENTS—KEROSENE (COAL OIL) BURNER

Makes Any Stove a Gas Stove

Free Sample to Workers



Makes its own gas from Kerosene (coal oil). Gives every home a gas stove. Absolutely safe. Cheapest fuel known. Agents just collect money. Women will about it. No coal or tubes to carry. No more danger from gasolene. Every

Wonderful Labor Saver

home a prospect. Low price makes quick sales. **Safe, Clean, Odorless, Cheap** Easy to carry and demonstrate. Big profits. Your territory is open. Write today. THOMAS BURNER CO., 3648 Gay Street, DAYTON, OHIO



SMALL ENGINES

Perfected Gasoline Engines—1, 1 and 1½ h. p.—for Farms and Shop use. Price \$19.50 and up. Also

WASHING MACHINES

We ship on trial. Send for Booklet and Special Offer. SIEVERKROPP ENGINE CO. 1224 18th St. RACINE, WIS.

STARTER for FORD CARS

The
Wellington
THE UNIVERSAL PIPE

DIAMONDS ON CREDIT

BEAUTIFUL DIAMONDS SENT ON APPROVAL

NO MONEY DOWN. Order any diamond from our catalogue; we will send it, all charges paid. After you have made a thorough examination and are satisfied as to the quality and value, pay 20 per cent of the price and only 10 per cent per month thereafter. If not satisfactory, return it at our expense. Don't pay a cent until you are satisfied. Certificate furnished guaranteeing the quality of every diamond. Your diamond purchased from us can be exchanged at a yearly increased value of 1½ per cent on a larger purchase. Own a genuine Diamond. Send for our Catalog De Luxe No. 6C. It's free. L. W. SWEET & CO., Inc., 2 and 4 Maiden Lane, New York City





Do You Need More Money?

To help your husband—to help your children—to help yourself? We can show you an easy way that is dignified, honorable and profitable.

The happy, contented women shown above are all free from worry and with money coming in. Each of them has founded, with our help, a growing and prosperous business and every year sees each of them making more money. And these cases are by no means exceptional, for

In More Than 13,000 Cases We Have Helped

ambitious, deserving women. You can do the same as they have done. Sell World's Star Hosiery and Klean-Knit Underwear in your home town. No previous experience is necessary—we show you how to make money in an easy, congenial and profitable way. We sell direct from the mill to the home through our local representatives, and our lines of hosiery and underwear for men, women and children are famous the world over.

Write today for our free catalog. It tells the whole story.



We have been in business here for more than 22 years

FREE STEEL SHOE BOOK SAVES \$20



Tells all about my Celebrated Steel Shoes. One of the greatest inventions in footwear the world has ever known. Over a million people now wearing them. Wear as long as three to six pairs of leather shoes. Safest, most comfortable shoes you ever had on your feet. No cold, wet feet, therefore Colds, Rheumatism, Grip, Lumbago, Lame Back, and other ailments prevented. No curbs, humpness or tender, tired feet. Write today for my free book.

Investigate this wonderful proposition.

Address: RUTHSTEIN, Steel Shoe Man, Dept. 32, RACINE, WIS.



Be Your Own Boss

Work for yourself. Learn how to make big profits with a Kingery Peanut Roaster and Corn Popper. 50 styles. Easy terms. Write for Catalogue P M, telling what others have done. KINGERY MFG. CO. 302 E. Pearl St. Cincinnati, O.

"I Would Not Part With It for \$10,000"

So writes an enthusiastic, grateful customer. "Worth its weight in gold," says another. In like manner testify over 100,000 people who have worn it.

The Natural Body Brace

For MEN and WOMEN

Develops erect, graceful figure; overcomes WEAKNESS and AILMENTS of Women & Men.

Brings womanly beauty and manly strength, restful relief, ability to work and enjoy life.



For Children Also

Makes You Feel Good and Look Good

Does away with the strain and pain of standing and walking; replaces and supports misplaced internal organs; reduces enlarged abdomen; straightens and strengthens the back; corrects stooping shoulders; develops lungs, chest and bust; relieves backache, curvatures, nervousness, ruptures. Easy to wear.

Wear It 30 Days Free at Our Expense

Write today for illustrated booklet, measurement blank, etc., and read our very liberal proposition.

HOWARD C. RASH, Pres. Natural Body Brace Co. 223 Rash Building SALINA, KANSAS

10 Cents a Day



HERE you can get any known instrument sent to you for a free trial of one week in your own home.

And every article is offered at the rock-bottom price. You will be astonished at these values. And then—this rock-bottom price may be paid at the rate of only a few cents a day. Ten cents a day buys an exquisite triple silver-plated Lyric Cornet. But first write for our new catalog.

WURLITZER

200 years of instrument making

The name "Wurlitzer" stamped on musical instruments has stood for the highest quality for nearly two centuries. We are manufacturers or importers of every known musical instrument and every one is sold direct to you at the rock-bottom, direct-from-the-manufacturers price. We supply the U. S. Government.

One Week's Trial

Try out the instrument of your choice in your own way before you decide to buy. Compare it with other instruments. Test it. Use it just as if it were your own. Then after one week's trial—either pay a little each month or send it back.

Take Your Choice

On this great special offer you have over 2000 instruments to choose from. Any one of these will be shipped to you for one week's free trial in your own home. The Cornet, Violin and Saxophone illustrated here are but three out of the thousands of remarkable offers that we make.

Send the Coupon

But first put your name and address on the coupon now and get our big, new catalog absolutely free. Just state what instrument you are interested in and we'll send you the big 194-page book free and prepaid.

The Rudolph Wurlitzer Co.

Dept. 1186

East 4th Street,

Cincinnati, Ohio

S. Wabash Ave.

Chicago, Ill.

The Rudolph

Wurlitzer Co.

Dept. 1186

East 4th Street,

Cincinnati, Ohio

South Wabash Ave.,

Chicago, Illinois

Gentlemen:— Please send me your 194-page catalog absolutely free. Also tell me about your special offer direct from the manufacturer.

Name.....

Address.....

I am interested in.....

(Name of instrument here)

Please Mention Popular Mechanics



ASTOUNDING CAMERA BARGAIN

No. 2 EASTMAN
Premo Roll Film

\$3.98

This compact folding Eastman Camera takes pictures $2\frac{1}{4} \times 3\frac{1}{4}$. Fitted with a selected Meniscus Achromatic Lens. Easiest camera in the world to operate. To acquaint camera users with our remarkable values, we offer only 2000 of these famous cameras at the remarkable price of \$3.98. So Order Now. New! Direct from the factory.

Save Money on Anything Used in Photography

We are direct Eastman representatives.

Your Money Back If Not Satisfactory

FREE! Our Big Catalog, showing Hundreds of Bargains in New and used Cameras. Largest selection of supplies ever listed. Write at once.

BASS CAMERA CO.

107 Dearborn St. North CHICAGO, ILL.

Delivered TO YOU FREE

No other concern will offer you such values or such terms. Make your choice from

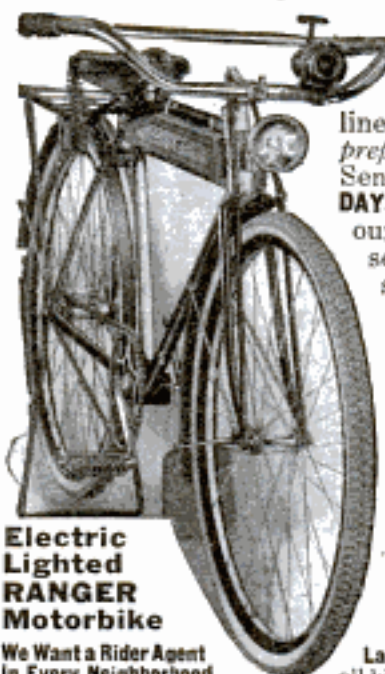

Electric
Lighted
RANGER
Motorbike

We Want a Rider Agent
in Every Neighborhood

Send No Money but write today for this big free catalog, also full particulars of new 30-day free trial offer. Do not buy until you receive it. Write Now.

44 Styles

colors and sizes in the famous "Ranger" line of bicycles, freight prepaid to your town. Sent on approval for **30 DAYS' FREE TRIAL**. From our new big catalog select the particular style of **RANGER** bicycle you desire. We pay return charges if you decide not to keep it. You get one month riding test at our expense. **LOW FACTORY PRICES** direct from one of the largest, oldest and most successful bicycle concerns in the country.

TIRES

Lamps, Horns and parts for all bicycles at half usual prices.

MEAD CYCLE COMPANY
Dept. G-108, Chicago



Made-to-Measure Express Prepaid \$3.25

Pants cut in the latest style. Made-to-your individual measure. Fit, workmanship and wear guaranteed.

NO EXTRA CHARGE

for peg tops, no matter how extreme you order them.

Agents A good live hustler in every town to take orders for our **Wanted** celebrated made-to-measure clothes. Samples of all latest materials **Free**.

WE PAY BIG MONEY

to our agents everywhere. Turn your spare time into cash by taking orders for our stylish clothes. Write today for beautiful **FREE** outfit. **THE PROGRESS TAILORING CO., Dept. 775, CHICAGO, ILL.**

Russel Internal Gear Drive Axle



The most serviceable and economical motor truck axle made. Write for convincing reasons why your truck should be equipped with the Russel Axle.

RUSSEL MOTOR AXLE COMPANY, Central Ave., North Detroit

Bartlett DROP-FORGED Compound Lever Snips \$2.00 to \$4.60

Made for hardest service. Highly tempered crucible steel, drop forged. Cuts keen. Holds the edge. Cuts 18-gauge metal at point easily—cutting power three times that of ordinary straight snip. For sale by dealers or sent postpaid in United States at these prices:

7-inch, stamped	\$1.30
8-inch	2.00
10-inch	3.00
12-inch	4.00
14-inch	4.60



CIRCULAR ON REQUEST

BARTLETT MFG. CO., 20 E. Lafayette Ave., Detroit, Mich.



OSTER

Threading Machines

THREADING straight pipe, bent pipe, nipples and bolts, and requiring only a few square feet of floor space, an Oster

pays big dividends in money saved over hand-threading; three days' work a month pays a profit on the investment.

Twenty-five years of specialized study and experience have made OSTER Machines so simple in design and construction that a boy can operate them.

THE OSTER MANUFACTURING COMPANY

2100 East 61st Street

CLEVELAND, OHIO, U. S. A.

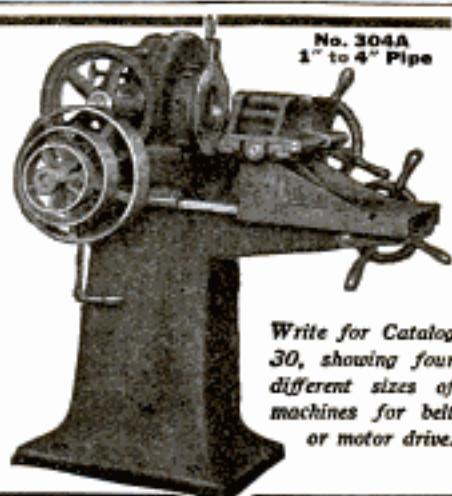

No. 304A
1" to 4" Pipe

Write for Catalog 30, showing four different sizes of machines for belt or motor drive.

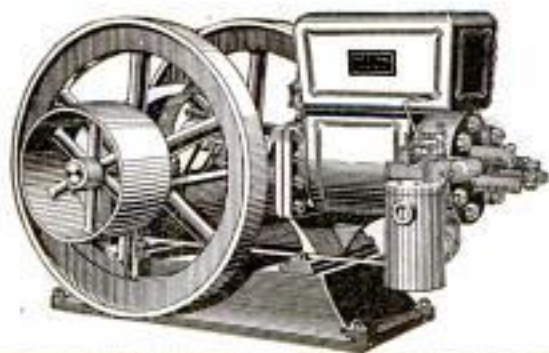

OTTAWA ENGINES

Kerosene Oil, Gasoline and Gas

Let me send you an engine to earn its own cost while you use it — for my Kerosene engine gives more power from a gallon of 6-cent kerosene than you can get from a gallon of 20- or 25-cent gasoline in a gasoline engine — Easy to start; easy to operate; no cranking; no batteries. All sizes—2 H. P. to 22 H. P.—Stationary, Portable, and Sawing Outfits. **10-Year Guarantee on Every Engine.** Write for Latest Prices.

Direct From My Big Factory

Ever since I started my factory, years ago, I have been selling engines direct from the factory to the man in the shop on the farm. Now, as before, any honest man can have my engine on

90 DAYS' TRIAL

Every engine I send out must make good all I guarantee. No need to pay double my price for any good engine, or take an out-of-date engine for any kind of a price. Let me show you how to figure what an engine is worth and

How to Know Better Engines

My newest book helps you choose a safe and value-received engine—How to make simple tests—and all about valve in head motor. Send me your address today. Just a postal card will bring this newest and latest book.

GEO. E. LONG, OTTAWA MFG. CO. 535 King Street
OTTAWA, KANS.

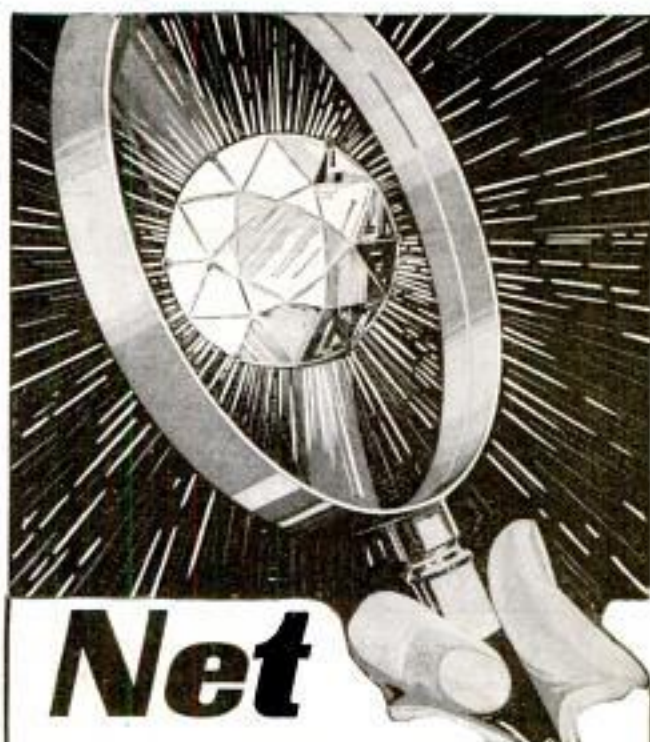

Net

Prices Direct to You

ABSOLUTELY net terms on any diamond you choose. You can now buy direct. No jobbers, no retailers to pay. Write for our net price list and **Diamond Book** showing an exquisite collection of splendid, blue-white

Diamonds

Rings in all styles, Tiffany, Belcher, etc., La Vallieres, brooches and other diamond jewelry. Every diamond a superb gem. Selected by a famous expert. Perfectly cut to give maximum brilliancy. Richly mounted in solid gold and platinum settings.

Free Examination Not a cent down—you see the diamond before you accept it. We want you to compare these diamonds with others at twice their price.

\$2⁵⁰ Monthly Only \$2.50 a month will make you the wearer of a

beautiful diamond ring. Other terms, \$3.50 \$4.50 and up—and middlemen's profits cut out.

Write

For Net Price List and Diamond Book

Shows the different gems, styles of mountings and gives our best net prices with terms of payment. Do it now—today.

BURLINGTON WATCH CO.
Dept. 1196
Chicago, Ill.

Burlington Watch Co.
Dept. 1196
Chicago, Ill.

Without obligations send me your net price offer on diamonds; also send Diamond Book.

Name

Address

BOYS—Build and Fly a Model War Aeroplane



"Ideal" accurate Scale Drawings enable you to EASILY build 3 Ft. Flying Models of Aeroplanes now used in the European War. Students of Aeronautics, everyone with an inquiring turn of mind, should construct one of these fascinating Models.

Prices of 3 Ft. Scale Drawings
Curtis Flying Boat 25c
Curtis Military Trainer 25c
Hydroaeroplane 35c
Nieuport M'n'plane 25c
Bristol Monoplane 25c
Taube Monoplane 25c
Wright Biplane 25c
Curtis Peeli Racer 25c



Taube

Complete Set of Eight, \$1.75 postpaid
Get our 1917 Aeroplane Book, containing full information about models, parts, etc., 5c postpaid.

Ideal Aeroplane & Supply Co., 82-88 West Broadway, New York

INDOOR CLOSET

More Comfortable, Healthful and Convenient than the Out-Door Closet

Eliminates the out-door closet and open vault. They are breeding places for germs. Have a warm, sanitary, odorless toilet right in your house. No going out in cold weather. A boon to invalids. Endorsed by State Boards of Health.

W. M. Davis writes: "Your indoor closet is giving absolute satisfaction. It is certainly the thing for a home without sewerage."

Absolutely Odorless Put It Anywhere in the House

The germs are killed by a chemical process in water in the container, which you empty once a month. Absolutely no odor. No more trouble to empty than dishwasher. Closet instantly guaranteed. Write for full description and price.

Agents Wanted—Big Profits Wonderful opportunities in every town, village and in the country. Best season just at hand. Every home is a good prospect. Sell eight out of every ten you call on. Ernest Rednell writes, "Have ten orders." G. A. Newman says: "Ship at once twenty closets and fifteen washstands. Sold them all in one community." Sells itself. Everybody hates the outdoor closet. Everybody wants a Ro-San Indoor Closet. Write quick for territory and full particulars. We are prepared to ship promptly any quantity of closets—no waiting.

ROWE SANITARY MFG. CO., 905 Sixth St., Detroit, Mich.
Ask about the Ro-San Washstand—Hot and Cold Running Water Without Plumbing

Please Mention Popular Mechanics

Prest-O-Lite

for
Motorcycles



Photo shows J. Warren Kerrigan, noted Universal film star, on his Prest-O-Lite motorcycle, near Universal City, Cal.

Good, Dependable Light at Low Cost

Your safety demands that the lighting system of your machine be good and dependable. Prest-O-Lite gives maximum lighting efficiency at minimum cost—enables you to ride at night with ease, safety and comfort, at any speed.

It furnishes brilliant, steady light—gives a clear vision of the road ahead—penetrates fog, dust or smoke—will not suddenly blow out or fail you at a critical moment.

Prest-O-Lite is sturdy as your motorcycle—road shocks, bumps and jolts do not injure it.

Aside from these big advantages it is very simple to operate and costs little to buy and use.

Easily Attached to Any Make of Motorcycle

No matter what make machine you have or intend to buy your dealer can easily fit you out with Prest-O-Lite. Ask him about this combination—"A Prest-O-Lite, a good lamp and mechanical horn"—he'll make you a special price on this practical equipment.

Insist on Prest-O-Lite—it's your guarantee of maximum safety, economy, efficiency and satisfaction in motorcycle lighting.

Get full information on the perfect service and low cost of Prest-O-Lite. Write today for our special folder. It's free.

The Prest-O-Lite Co., Inc.

U. S. Main Office & Factory, 265 Speedway, Indianapolis
Canadian General Office, Dept. N8, Toronto, Ont.

Prest-O-Lite Exchange Agencies Everywhere

The World's Largest Makers of Dissolved Acetylene

This NEW ELGIN ON 30 DAYS FREE TRIAL



Adjusted

17 Jewel Elgin

This New Thin Model 17 Jewel Elgin is absolutely supreme where Reliability is a factor. Double sunk dial—Double Roller Escapement—Double strata 25 year Gold case. It's just the watch you've always wanted.

Send No Money! \$1.50

—A—
MONTH

Easy Credit Terms As Low As Just send your name and address for this New Elgin with our Special \$5 Gold Chain Free, and our bed-rock confidential price will surprise and delight you.

Sent on Approval You do not risk a cent. We send this Watch and \$5 Chain complete on your own approval—also our 160 page FREE CATALOG, showing all kinds of Watches, Diamonds, etc., all on smilingly easy terms. Send your name and address today.

The House That Sells More Elgin Watches Than Any Other Firm in the World.

HARRIS-GOAR CO., Dept. 166
KANSAS CITY, MO.
WE DO AS WE ADVERTISE!

Build a Body Like This—Only \$6

Other models down to \$2.25. Famous life-size size-fit, Red-Ken, expert-engineer's System of Patterns are marvels of simplicity.

With a few dollars' worth of materials from the hardware store and our simple instructions, you can make a Ford into the classic speedster.

Bodies can be built without chassis. There is no need to lay up the car. Model K9 only \$6.00, built low, rides wonderfully easy. Disc wheel patterns included.

Model 'K9'



Specify for old or new radiator. Order today.

KUEMPEL COMPANY, Design Dept. 32, DUBUQUE, IOWA



CORONA The Personal Writing Machine weighs 6 lbs.

Writes all kinds of correspondence.

\$50 with carrying case. Write for booklet No. 32.

Corona Typewriter Co., Inc., Groton, N. Y.

Ten-Pinnet

The New Bowling Sensation!



Great Special Offer.

Write Quick.

GET into business of your own with this great new automatic bowling game. Has taken the country by storm. Great chance! Big money, quick profits! Cash rolls in every day. No operating expense. Find out quick about this great opportunity. Send for our big FREE book.

\$25.00 to \$75.00 a Week

That's what you can earn with Ten-Pinnet. Get the big money. You can!

Free Book Write today for free book and special offer. Learn how to start with little money—pay for always out of profits.

TEN-PINNET CO., Dept. 1196 Indianapolis, Ind.

Please Mention Popular Mechanics



Do You Like to Draw?

Whether your ambition is to become a second Bud Fisher or whether you draw merely for your own amusement—you will find lots of inspiration in

CARTOONS MAGAZINE

It contains each month the cream of caricature, and cartoon art the world over. The foremost American cartoonists are represented, together with the most famous of the Parisian artists and cartoonists of Berlin, London, Petrograd, and Rome.

Either as an art student or a student of current events you will enjoy seeing how cartoonists are portraying world history in the making. "Cartoons" is a monthly review, but doesn't take itself too seriously.

There are pictures by Ethel Plummer, stories by Helena Smith-Dayton, comics by King, Webster, and others, and Parisian sketches by the artists of Fantasio and La Baionnette. It also tells what the big fellows in the cartoon world are doing.

A two-bit piece together with the following blank filled out, will bring you post haste a sample copy.

CARTOONS MAGAZINE,
6 North Michigan Avenue, CHICAGO

Enclosed find 25 cents for which send me a sample copy of your magazine.

Name.....

Street and No.....

City..... State.....

5 MONTHS TO PAY

Tailor-Made-to-Order

Have your clothes made to order from finest, stylish fabrics by our expert tailors and take 5 months to pay.

Look into this offer—get the facts (all explained in our Style Book.) Try on the suit we make for you and if not an amazing value return it at our expense. Otherwise pay on our easy terms.

As \$1.00 Down
As Little As

You can order by sending as little as a dollar down—and that back if you want to return the suit. Fit, workmanship and quality guaranteed.



\$1000 Reward

Given in gold to anyone who can prove that we do not actually operate our own great tailoring shops and make to order from customer's measure every man's garment ordered from us.

Save \$15 to \$25

See for yourself. Compare our fabrics with any elsewhere and see what our quantity buying and direct selling to customers saves you on high class tailor made-to-order garments.

you will look. Choose from the remarkable 70 cloth samples of the very pick and cream from leading mills. All prices and terms given too. Get this book even if you are not ready to order now. Get posted on the styles and the prices. The Style Book is free. Send coupon or a postal and get it now.

This Big

Style Book

shows pictures in actual colors of garments made by us.

You see exactly how

STANLEY-ROGERS COMPANY

1015 Jackson Blvd. Dept. 936 Chicago, Illinois

Please send me FREE your new Fall Style Book showing latest Metropolitan Styles, also 70 Cloth Samples and full particulars of your great \$1.00 down with 5-Months-To-Pay Offer.

Name.....

Address.....

Please Mention Popular Mechanics

TRADE
STEEL
BUTLER
PRODUCTS
MARK

Gas-Air system

THE Butler System will deliver either gasoline or air or both at the same time. It's a complete, attractive gasoline and air filling station with the work and danger eliminated. Simply turn the lever and gasoline or air is discharged.

The Cabinet is neat and attractive in appearance, beautifully finished in bright red. Built from heavy steel throughout. More substantial than cast iron, yet much lighter to ship and easier to handle.

Equipment—Accurate 100,000 gallon meter. Gravity filter. Overhead hose draining valve. Steel lined gasoline hose with nozzle. Pressure gauge for tank. Underground gasoline cut-off. With or without Electric Lighting System. Lower part of cabinet equipped with air pressure gauge, tire gauge, air hose and connections if desired.

The Tank is made from special heavy metal and painted with special Rust-Resisting Paint. All seams welded. Butler Tanks will stand many times the pressure required.

Write Today on your letterhead for attractive booklet giving full information and showing other styles of outfits.

BUTLER MFG. CO.
504 Butler Bldg., Kansas City, Mo.
899 6th Ave. S.E., Minneapolis, Minn.
Metal Garages, Truck Bodies, etc.



The Cleveland Lightweight



$\frac{1}{2}$ the Weight
 $\frac{1}{2}$ the Cost

One enthusiastic owner after riding 32,000 miles has figured that his *entire upkeep cost* has been *3-5 of a cent* per mile, and his machine, he says, is good for another 32,000 miles.

Do not judge the Cleveland Lightweight by any motorcycle you ever saw or rode—it is entirely new and different.

Write us for the facts.

\$170 f.o.b. Cleveland

to the gallon Cleveland Motorcycle Mfg. Company, Cleveland, O.

BUILD THIS CAR OR BUY IT COMPLETE
Lowest Priced Car in the World



Very fast. Economical. Seats 2 full grown persons. Not a toy. Complete Detailed Drawings, 35c. Catalog 10c. Cycle Car and Light Car parts at low prices. Discount to Agents.

Tribune Engineering Co., Dept. P, Owego, Tioga Co., N. Y.



New Low
Factory Prices

for big new catalog with reduced prices. Mailed free to you.
Piedmont Red Cedar Chest Co., Dept. 68, Statesville, N. C.

Free Trial

PIEDMONT RED CEDAR CHESTS
Your choice of 90 styles of the famous Piedmont genuine Southern Red Cedar Chests. **15 days' free trial.** We pay the freight. A Piedmont protects furs, woollens and plumes from moths, mice, dust and damp. Distinctively beautiful. Finest Xmas gift. **Write today**

Write for FREE Book
on Vibratory Massage

Explains this new scientific way of gaining health and strength with the Arnold Vibrator. Gives the low price with special 10 day trial offer. Write today for this valuable book.

ARNOLD ELECTRIC CO., 1482 12th St., Racine, Wis.

FREE TRIAL



Cut out this ad and mail it to us, with your name and address (no money); and we will send you our **FAMOUS KARNAK RAZOR** by return mail, postpaid. You may use the razor for 30 days **FREE**; then, if you like it, pay us \$1.85. If you don't like it return it. **SEND NO MONEY.**

MORE COMPANY, 355 More Bldg., St. Louis, Mo.



The Perfect Garage Door Hanger
Quickly Installed—Easily Operated

Garage doors are a mean proposition if they don't work right—cause all sorts of trouble and often damage car going in or out.

The Topping garage Set does end your troubles

Moderate in cost—easy to install—no small parts to get out of order—built to stand wear and tear—yet a child can operate.

The result of years of concentrated effort to solve Garage Door Hanger trouble.

Ask your hardware dealer—or write us direct for unusually low price. Do this today—you'll be amazed at Topping performance.

Dealers—No Hanger so satisfactory as the Topping. There's a big demand and a big profit in it. Architects—The one important detail in your plans that satisfy if you specify "Topping Hanger." Write for terms.

Safety Door Hanger Co., 109 Topping Bldg., Ashland, Ohio



**Saves Money
Speeds Work
Raises Efficiency**

The remarkable Temco Portable Electric Drill is the most used tool in thousands of machineshops, garages, automobile factories, ship yards, public buildings, etc.

Many executives, superintendents and foremen have proved its efficiency and quality and their requisitions for new tools always specify TEMCO.

Five sizes—9 to 19 pounds. Capacities to $\frac{1}{2}$ " drilling in steel.

Also Temco Drills, Grinders, Buffers, etc., of larger capacity.

At leading Dealers and Jobbers Everywhere.
Write for our catalog.

The Temco Electric Motor Company
142 Sugar Street LEIPSI, OHIO
Makers also of TEMCO-Auto Shock Absorbers and TEMCO Shock Absorbers, Master Vibrators and Lock Switches for Fords.

Drills by electricity anywhere—direct or alternating current

TEMCO

THE TOOL OF MANY USES

Attractive Catalog Free *Columbia* Bicycles
WESTFIELD MFG. CO. Department 15 WESTFIELD, MASS.

ARE you reading the double-page Westinghouse more-than-advertisements in The Saturday Evening Post, Literary Digest, Collier's, Leslie's, National Geographic, Popular Mechanics and other publications?

1917 Fall Suit

Free A WONDERFUL *amazing* OFFER



If you are a live wide-awake man we want you to get one of our elegant Fall suits, made to YOUR measure, absolutely FREE. All we ask you to do is to wear it, show it to your friends and take a few orders for our high grade, Made-to-Measure Clothes.

\$25 EXTRA A WEEK AND YOUR OWN CLOTHES FREE

Does it look good to you for a little spare time? Write at once to simply send us your name on a postal and we will send details of this "STARTLING OFFER." We will also send you FREE a large assortment of cloth samples and dozens of fashion pictures to choose from. NOTHING LIKE IT EVER OFFERED by any other Tailoring House. We don't ask you to spend your cash profits for your clothes. Ours is a new and better plan. Write at once, be the first in your town to get this FREE suit.

SPENCER MEAD COMPANY
Dept. 1678 CHICAGO

Your Choice For 10 Days' Wear FREE



No. 2. Ladies' Solid Gold Ring. Has a guaranteed genuine Tifnite Gem almost a carat in Price, \$12.50; only \$3.50 upon arrival. Balance \$3 per month.



No. 3. Men's Tooth Gold Ring. Six-prong tooth mounting. Guaranteed genuine Tifnite Gem almost a carat in size. Price, \$12.50; only \$3.50 upon arrival. Balance \$3 per month.



No. 1. Men's Flat Bachelor Solid Gold Ring. 8 claw mounting; flat wide band. Almost a carat, guaranteed genuine Tifnite Gem. Price, \$12.50; only \$3.50 upon arrival. Balance \$3 per month.

Here is the most amazing offer ever made on precious gems. To quickly introduce into every locality our beautiful TIFNITE GEMS—which in appearance and by every test are so much like a diamond that even an expert can hardly tell the difference—we will absolutely and positively send them out and on trial for 10 days' FREE wear.

Only 10,000 On This Offer

Send coupon NOW! We'll send you your choice of these three magnificent rings at once. After you receive the beautiful, dazzling gem and the handsome solid gold mounting—should you then decide that you like it—pay us only \$3.50 upon arrival. If you believe you have a wonderful bargain and want to keep it, pay balance in small easy payments as stated under each item. If, however, for any reason you do not wish it, return it at our expense within 10 days and any money paid will be refunded.

Tifnite Gems Solid Gold Mountings

The nearest approach to a diamond ever discovered. Have the fine pure white color, fire, brilliancy, cut and polish. They stand every diamond test—fire, acid and diamond file. Will cut glass like a diamond, and guaranteed not to be made of glass. The mountings are guaranteed solid gold.

Send No Money Send No References

Just send coupon. You do not obligate yourself in any way. Be sure to give correct number of ring and size wanted. To get the right size Ring, cut a strip of heavy paper so that the ends exactly meet when drawn snugly around the second joint of finger. Send the strip of paper to us with coupon.

Send it now and get a TIFNITE GEM on our liberal 10 days' free trial offer. Then decide whether you want to keep it or not. Send today—sure.

THE TIFNITE GEM CO.,
Rand-McNally Bldg., Chicago, Ill.

Free Trial Coupon

THE TIFNITE GEM COMPANY,
Dept. 222

Rand-McNally Bldg., Chicago, Ill.

Send me Ring No. on 10 days' approval. If satisfactory upon arrival I agree to pay \$3.50 on account and balance at rate of \$3.00 per month. If not satisfactory, I will return same within 10 days.

Name.....

Address.....

Please Mention Popular Mechanics

The Pan-German Plot Unmasked

Berlin's Formidable Peace-Trap of "The Drawn War"

By ANDRÉ CHÉRADAME

A revelation of the depth and extent of the danger that will still exist from the Pan-German idea and purposes even should the war result in a draw or an apparent German defeat. Every statement supported by facts, figures, and documents—the result of twenty years' study by the author of the development of Pan-Germanism in all parts of the world.

MITTELEUROPA!

The Goal of the "Drawn War"

LOOK AT THE MAP



From "The Pan-German Plot Unmasked"

Observe the web reaching from Hamburg to the Persian Gulf. This territory is the backbone of Europe and of a world empire.

It is the territory Germany set out to get in this war. And she has practically accomplished her aim.

Hence Germany is ready for peace.

Something of the menace to America of the success of the Prussian scheme of world domination may be gathered from the following:

"In 1898, before Manila, the German Rear-Admiral von Goetzen, a friend of the Kaiser, said to the American Admiral Dewey:

"In about fifteen years my country will begin a great war. . . . Some months after we have done our business in Europe we shall take New York and probably Washington, and we shall keep them for a time. We do not intend to take any territory from you, but only to put your country in its proper place with reference to Germany. . . . We shall extract one or two billions of dollars from New York and other towns."

The above is quoted from "The Pan-German Plot Unmasked."

A wonderfully informing and interesting work which should be read by every thinking American.—Editor Popular Mechanics Magazine.

Cloth—235 pages—31 maps. PRICE **\$1.25** Postpaid

POPULAR MECHANICS BOOK DEPT.
6 N. Michigan Avenue, CHICAGO



1000 Interesting Things For Boys to Make and Do

are described in this great book

The Boy Mechanic, Vol. II

(A sequel to, but containing nothing found in Vol. I.)

480 Pages. Size 6¾ x 9¾ x 1¾ in. 995 Illus.

Cloth Binding. Price \$2.00 Postpaid.

Boys! Build Things!

This Big Book Tells You How to Make

- | | |
|-------------------------|-------------------------|
| Aerial Gliders | Merry-Go-Round |
| Aeroplane Kite | Mill-O-View Camera |
| Art Craft Work | Model Aeroplane |
| Bicycle Horn | Model Boat |
| Blowgun | Monorail Sled |
| Boats | Motion-Picture Camera |
| Boat Landing | Muskrat Trap |
| Bobsleds | Paddle-Wheel Boat |
| Camps | Pea-Shooting Gun |
| Camp Furnishings | Photographic Appliances |
| Cartridge Belt | Pushmobile |
| Catamaran | Pushmobile for Ice |
| Cyclemobile | Reed Furniture |
| Disk Pistol | Roller Coaster |
| Dog Exerciser | Sail for Wagon |
| Electric Fishing Signal | Scarecrow |
| Electric Fountain | Skates of Wood |
| Electric Horn | Skiff |
| Electric Motor | Skis |
| Ferris Wheel | Snowball Thrower |
| Fish Attractor | Snowshoes |
| Fishing Tackle | Spot-Light Lantern |
| Flymobile | Springboard |
| Footboats | Steam Turbine Boat |
| Games on Ice | Steam Turbine Engine |
| Grape Arbor | Steering Sled |
| Houses of Poles | Stilts |
| Hurdle | Sunlight Flasher |
| Ice Boats | Surveying |
| Ice Gliders | Swimming Raft |
| Indoor Games | Tricks |
| Kites | Vaulting Pole |
| Lawn Tennis Marker | Water Wheel |
| Live Bait Pail | Windmill |

And 932 Others

Sent postpaid to any address upon receipt of price by the publishers.

POPULAR MECHANICS BOOK DEPT.
6 N. Michigan Ave. CHICAGO



JAPANESE ROSE BUSHES

The Wonder of the World

Japanese Rose Bushes bloom all the year round. Just think of it. Six weeks after planting the seed, the plants will be in full bloom. It may not seem possible, but we positively guarantee it to be so. They will bloom every ten weeks, Summer or Winter, and when three years old the bush will be a mass of roses, bearing from five hundred to a thousand roses on each bush. The flowers are in three shades—white, pink, and crimson. The plants will do well both in and out doors. We guarantee at least three bushes to grow from each packet of seed. Price, 10c packet, 3 pkts. for 25c postpaid.

10 Cts.

Shoo Fly Plant



A very remarkable botanical curiosity you should have. Though quite odorless, flies will not remain in a room where it is grown. Bears very pretty blossoms; blooms summer and winter. Grows rapidly from seed.

Weather Plant



NATURE'S WEATHER PROPHECY. By mysterious charges that take place, this remarkable plant accurately forecasts the weather many hours in advance. Will grow anywhere all the year around. An interesting house plant. Bears large, fragrant, pink, butterfly shape flowers.

SEEDS 15c packet, 3 for 40c, postpaid. Seeds, 15c packet, 3 for 40c, postpaid. Johnson Smith & Co., Dept. 89, 54 W. Lake St., Chicago

LUMINOUS PAINT

Make Your Watches, Clocks, Etc., Visible by Night
The very latest discovery in the scientific world. Hitherto, practically unobtainable except at an exorbitant price, we have at last succeeded in producing this remarkable LUMINOUS PAINT, which, applied to the surface of any article, emits rays of white light, rendering it perfectly visible in the dark. THE DARKER THE NIGHT, THE MORE BRILLIANT IT SHINES. Quite simple to use. Anyone—you can do it. A little applied to the dial of your watch or clock will enable you to tell the time by night. You can coat the push buttons or switch plates of your electric lights, match boxes, and innumerable other articles; make your own Luminous Crochets, Luminous Rosaries, etc. Bottle containing sufficient to coat several small articles, Price 25c. Larger sizes 50c and \$1 postpaid. Johnson Smith & Co., Dept. 89, 54 W. Lake St., Chicago

NEW BOOK ON

ROPE SPLICING

Useful Knots, Hitches, Splices, etc.

How Different Knots Are Made and What They Are Used For INDISPENSABLE TO EVERY MECHANIC AND RIGGER

PRICE 20c
A most practical handbook giving complete and simple directions for making all the most useful knots, hitches, rigging, splices, etc. Over 100 illustrations. All about wire rope attachments, lashing, blocks, tackles, etc. 37 Heraldic Knots illustrated. Of great value to mechanics, riggers, campers, boatmen. Price 20 cents postpaid.



INVISIBLE INK

The most confidential messages can be written with this ink. For the writing MAKES NO MARK. Cannot be seen unless you know the secret. Invaluable for many reasons. Keep your postals and other private memorandums away from prying eyes. Great fun for playing practical jokes. Only 15c Bottle

VANISHING INK

Writing written with this remarkable ink vanishes entirely in a few weeks (sooner if desired), leaving the paper QUITE BLANK. 15c 2-oz. BOTTLE. LUMINOUS INK CAN BE READ ONLY IN A DARK ROOM; writing invisible like fire. Quite invisible at daytime. Very remarkable. 15c

Sneezing Powder

Great relief. A small amount blown into the air and the unsuspecting victims begin sneezing without knowing the reason why. Price 12c, 3 for 30c, postpaid.

Stage Money

With a bunch of these bills it is easy to appear prosperous. By flashing a roll at the proper time, the effect will be found to be all that can be desired. 15 Bill 10c, 50 Bill 25c

AMERICAN FLAG GUM STICKERS

These Flags are about same size as a postage stamp. Guaranteed on the reverse side ready for use. Use them on your envelopes, stationery, etc., and let every one know you are an American. Put up in sheets, each containing 100 flags. Tear them apart like stamps. PRICE 10c per sheet, 3 sheets for 25c. J. S. & Co.

All the Latest Surprising and Joke Novelties

- | | | | |
|------------------------------------|-----|--|-----|
| Pharo's Serpents Eggs, box | 10c | Mesmerized Penny (defies the law of gravitation) | 20c |
| Miniature Water Pistol | 10c | Mysterious Tumbler and Vase | 25c |
| Clothes's Spoke (very lifelike) | 10c | Laughing Coin Trick | 25c |
| False Mustache (from rear friends) | 10c | Enchanted Bottle (won't lay down) | 6c |
| Ford Auto Puzzle Gatead | 15c | Magic Photo Letter | 20c |
| Magic Note (anyone can play it) | 15c | Invitation Gold Teeth | 10c |
| Rubber Sazer (very formidable) | 20c | Great Hungry Puzzle | 10c |
| Rubber Dagger (sensational) | 20c | Wave Puzzle (10c, 25 different, \$1.00) | 10c |
| Window Smashers (great joke) | 25c | "Slide-Trick" Push Button | 10c |
| Pocket Detective (see behind post) | 15c | Ekklase Pen (writes with water) | 10c |
| Great Mind Reading Mystery Cds. | 10c | Invitation Red Eggs | 10c |
| Turton's a Mysterious Trick Cds. | 10c | Requid Ring | 10c |
| Fighting Roosters, pair | 10c | Trick Bill Hook | 10c |
| Cover the Spot Trick, a set, nov. | 10c | Glass Revolver | 20c |
| 8 Ray Novelties | 10c | Glass Watch | 20c |
| 8 Trick Pens | 10c | Multiple Billiard Ball Trick | 25c |
| Rubber Tacks (a good joke) | 10c | | |

Johnson Smith & Co., Dept. 89, 54 W. Lake St., Chicago

Automatic Repeating Rifle

Fires 20 Shots in One Loading



This is a regular size automatic revolver. Shoots B. B. shots obtainable anywhere, same as other rifles and guns. Repeats 20 times with one loading. Very handsomely finished.

Only 25c Postpd

No caps or load necessary, as it works with a spring and shoots with rapidity and accuracy. Simply load with 20 B. B. shot, then press the trigger. Nothing to explode—absolutely harmless and safe. Remember, it is not a mere toy, but the same size and shape as a REGULAR AUTOMATIC. Sent complete with a round of shot for ONLY 25c postpaid. Johnson Smith & Co.

GREATEST TOY SENSATION OF THE DAY!

FIGHTING DREADNAUGHT

SENSATIONALLY REALISTIC!!!

Here is a model of Uncle Sam's fighting monsters. Eight big guns, each of which flashes, at correct intervals, from twelve to twenty times. Extra ammunition always obtainable. Absolutely harmless. Can be operated indoors or out. Now, boys! Here's your chance to see a battleship in action, and the best of it is you can OWN the ship and command the firing yourself! By having two or more Battleships, you can arrange EXCITING NAVAL BATTLES in your own home. Price of Warship and Ammunition, 15c, three for 40c, or a fleet of 12 ships for \$1.50 postpaid. Extra Ammunition, 5 cents per pkg.



SONOPHONE CORNET

You can play it if you can talk. No knowledge of music needed

The simplest and most successful musical instrument ever brought out. Any man, woman or child that is able to talk or hum a tune can play it right from the very start without any previous practice whatsoever. Simply place the mouth-piece of the Cornet to your lips, hum through it any tune that you are familiar with, leaving out the words, and you'll have success straight off, and you will be overjoyed with the marvelous results. It's a wonderful acoustic effect it is quite easy to very closely reproduce on the Sonophone the tone of a trumpet or flugel-horn, and with some practice you can imitate a saxhorn or tenor trombone in a surprisingly brilliant manner. Harmonizes well with piano or any other musical instrument. Failure is absolutely impossible. Well made of brass, highly polished, 14 inches long, 8 1/2-inch bell. The outfit includes 1 Sonophone Cornet, 1 Extra package Diagrams, and one book of nearly 100 New and Old Time Favorite Songs, words and music. Price only 50c. The complete outfit mailed postpaid anywhere.



New Vamping Card

NO TEACHER NEEDED—SURPRISINGLY SIMPLE SYSTEM

Persons having neglected their Musical Education need not despair. See with the aid of our new VAMPING CARD (placing the card upright over the piano keys), you can at once Vamp away to thousands of Songs, Ballads, Waltzes, Rag Time, etc., etc., equal to a Professional Musician. No knowledge of music is required. After using it a few times, you will be able to dispense with the aid of the Vamping Card entirely. The price of this very clever invention is only 15 cts. postpaid.

DAISY AUTOMATIC LIQUID PISTOL



The Daisy Improved Automatic Liquid Pistol is the very latest design in Water Guns, and would really be taken for one of the real Automatic Pistols. It is made from steel, with blue finish. Very simple to load and discharge. No rubber bulb to get out of order. Great sport for boys and girls, as it throws a fine stream of water a distance of 25 feet. When diluted ammonia is used, it makes a very effective weapon against vicious men and animals. Measures 6 inches in length, and weighs 6 ounces. Price 25 cents, postpaid.

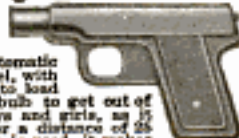

Johnson Smith & Co. Dept. 89, 54 W. Lake St., Chicago
Only Concern of Its Kind in America

Your Opportunity

Dodge High Building Costs

Lewis Machine Cut Houses Solve the Problem

Buy your house *direct* from the factory at the inside price. *Avoid extravagant waste*—All planning is done and all work finished in our modern efficient factory *without waste* of material, time or labor.

Choice of 100 Designs—Houses, Cottages, Bungalows

Select your house from our catalog and we will ship it **complete** to you with full instructions, accurate plans and specifications—All materials are complete, **and** hardware, paint, nails, etc., are included.

Our Modern Efficiency Method of Home Building

Saves 40% of carpenter labor—**Saves Waste**—**Saves time** and any possible disappointment. We will allow inspection of materials before payment. Send 4c postage for catalog of floor plans, pictures and prices. (Also Home Furnishing Catalog on request.)

Lewis Manufacturing Company
Dept. 978, BAY CITY, MICH.



Send for this
Camera
Catalog Today!



The Book That
Chased Waste Out
of Camera Buying
DAVID STERN COMPANY

"Everything in Cameras"—In Business Since 1885
Quality Developing
and Printing.

A Complete Line
of High Grade
Photo Access-
ories and
Supplies.
Motion
Picture
Cam-
eras.

910 Davis Bldg.
1027-1029 W.
Madison St.,
Chicago,
Ill.



NOW YOU NEED A GOOD ATLAS

Never before in the World's History has an atlas been so constantly necessary to an intelligent understanding of the World's News.

Here is the IDEAL ATLAS

Hammond's Comprehensive Atlas is a compact octavo volume, bound in flexible leather. It solves the problem of

Large Scale Maps in a Book of Handy Size

Contains 512 pages, 256 pages of large scale maps of all States, Canadian, Provinces, Countries of the World, etc., also 256 pages of text, index, compilations, gazetteer, statistics of population, etc.

Self-Revising After the War

Each copy contains a certificate entitling the purchaser to a supplement of maps showing the new boundaries after the war is over, making this atlas self-revising.

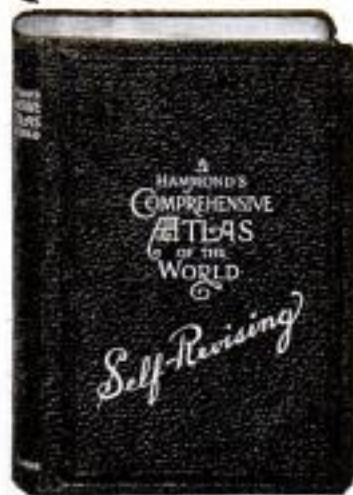

Size 9½ x 6¾ x 1¼ inches

Special New Maps Show the Several War Zones

Get your atlas now. Use it during the great war when you need it most and rest assured it will be up-to-date after the war is over. Price, Leather \$2.50, Cloth, \$1.65 Postpaid

Return Privilege Any purchaser who is not more than satisfied with this atlas may return same and have his money promptly refunded.

POPULAR MECHANICS BOOK DEPT.
6 N. Michigan Ave., CHICAGO



THE
UNITED STATES NAVY
POST- ILLUSTRATED POST-

30c Just off the press, this book of beautiful illustrations of our new war vessels of all types is what you need now. 30c PAID PAID

It includes super-dreadnaughts, battleships, battle-cruisers, cruisers, destroyers, mine-layers, torpedo-boats, submarines, submarine-chasers, with important statistics. 64 pages, 6x9 inches, with attractive cover.

POPULAR MECHANICS BOOK DEPT.
6 N. Michigan Ave., CHICAGO

THE DESTRUCTIVE WORK OF A SUBMARINE

can be best understood by studying our Chart of a Modern Submarine, size 14x28 inches; printed on plate paper and showing and naming over 200 parts. This chart is a cross-sectional view (lengthwise) and shows the entire construction and operation; is really an encyclopedia of a submarine; educational and worth many times its cost.

PRICE 25 CENTS POSTPAID
POPULAR MECHANICS BOOK DEPT.
6 N. Michigan Ave., CHICAGO



DEAF?

Make This Test In Your Own Home

The Acousticon will surely make you hear because it has succeeded with over 300,000 delighted patrons of ours who were so troubled.

You do not know this, however, and we are confident enough to want everyone to know before he spends a cent.

Everyone knows that deafness is progressive—and unless the ears are stirred to activity they grow steadily worse; thousands write us the Acousticon enables them to hear perfectly and has permanently improved their hearing.

Therefore we ask that you write us, saying: "I am hard of hearing and will try the Acousticon"—That's all. We will send you, delivery charges paid, the

Acousticon For Ten Days' FREE TRIAL No Deposit—No Expense

All we ask is that you give it a fair trial in your own home and among familiar surroundings. Then there can be no doubt of whether it improves your hearing.

If it does not do so, we want it back without a cent of expense to you for the trial, because we know it is good business policy to have none but satisfied and enthusiastic customers—That's the only kind we now have. Write for your FREE TRIAL today.

GENERAL ACOUSTIC CO., 1307 Candler Building, N. Y. Canadian Address, 621 New Birks Bldg., Montreal

AGENTS—NEW INVENTION

Ventilated chemical indoor closet, for country, village and suburban homes; no plumbing, no waterworks, no cesspool; absolutely odorless; 30 days' free trial guarantee; every village and farm home a customer; an order at every house; one agent made \$112 commission in 8 hours. Agent's outfit free. Exclusive territory contract. Write today for full particulars of this biggest winner ever offered to salesmen. Address

SHAFER MFG. CO., 484 Colton Bldg., Toledo, O.

Are You an American? USE PATRIOTIC STATIONERY—

Show your colors. 25 beautiful printed envelopes and 25 letter-heads. National flag printed in colors. Send 29c coin or stamps today. ROSE, 359 Trust Building, BINGHAMTON, N. Y.

It's Yours FREE



THIS SUIT made to your own individual measure, from the finest cloth and high grade linings. It won't cost one cent. We simply ask you to show it to your friends, recommend, and take a few orders for our clothes.

NO EXTRA CHARGES

of any kind—All the latest fancy styles, extreme peg tops, fancy golf bottoms, fancy sleeve cuffs, fancy belt loops, pearl buttons—Everything Free!

Earn \$40 to \$60 a Week

in your spare time. It's the easiest thing in the world. Write at once and get this new big offer. Even if you are an agent for another tailoring house, be sure and write for this new and most liberal offer ever made.

Drop us a line at once. We prepay everything. **Don't Wait! Don't Delay!** WASHINGTON TAILORING CO., Dept. 110, CHICAGO

GET YOUR FORD AWAY LIKE THE WINGS OF THE WIND



Equip that Ford of yours with a New Stromberg Carburetor. Then there'll be no more pottering around with "mussy" priming or hard heavy cranking.

THE NEW Stromberg Carburetor FOR FORDS

guarantees quick, sure, easy starting in any weather. Gives the richest of gas mixtures and gives it quick. Shoots this highly combustible vapor into the motor—then at first sign of a spark "off it goes." You get immediate action. No hanging fire. No warming up "exercises." You're away like the wings of the wind—from a standstill up to the highest speed that can be had—in a jiffy. And you get the best "run for your money." Most miles per gallon. No waste. The New Stromberg utilizes every particle of gas power and doesn't lose an ounce of it while giving you top speed and greatest acceleration.

It has established and holds by many miles and minutes the world's greatest Ford economy and speed records. Wonderful feats made under ordinary conditions. Results you can secure. Put it to a test. No risk. 10-day, money-back trial. Order direct from this ad—enclosing \$18 to cover cost, or write for full particulars and descriptive matter, today.

Stromberg Motor Devices Co.
Dept. 914, 64 E. 25th Street
CHICAGO

New STROMBERG Does it! CARBURETOR

Heat Your Home through One Register



Enjoy furnace comfort at lowest cost this winter. Get a Kalamazoo Pipeless Furnace and be able to burn any kind of fuel. Feed but one fire—heat your entire home.

Write for Our New Catalog

and learn what you can save in fuel bills this winter. See how easily this simple and powerful heating outfit can be installed in your home. Read what owners say about it. Kalamazoo Pipeless Furnace outfits where desired, heating plans FREE.

QUICK SHIPMENT, NO WAITING

Our big stocks insure immediate filling of your order. We pay the freight and guarantee safe delivery. Cash or easy payments. Write today.

Ask for Catalog No. 936

Kalamazoo Stove Company, Mrs.
KALAMAZOO, MICH.

We manufacture Stoves, Ranges, Gas Ranges, Furnaces, Kitchen Cabinets and Tables.

A Kalamazoo
Trade Mark Registered
Direct to You



Wonderful New Way of Establishing VIGOROUS HEALTH

The Violetta—Most perfect, most beneficial of violet ray instruments. Building up thousands of run-down men and women. Banishes diseases, strikes straight at the seat of ailments. Speedy in results. Restores natural conditions in amazingly short time.

The Violetta

High frequency generator—is used and endorsed by eminent physicians everywhere. The most successful means of relieving ailments of any nature. Now offered for home use. Places at your disposal a natural most certain way of securing perfect health and beauty—stimulating, soothing, safe. A delight to use. Decided improvement seen and felt almost immediately.

Write Quick for Free Particulars—and proof of astounding benefits obtained by an army of users—and special offer—Today.

BLEADON-DUNN CO.
Dept. C10, 11 S. Desplaines St., Chicago



Make YOUR OWN Will

\$1.

Save lawyer's fees. Our WILL-FORMS are legal in every state. WILL-FORM complete, neatly printed, and copyrighted. Instruction Book containing full information, forwarded for \$1.

SAFETY WILL-FORM CO. 5033 R Springfield Av. PHILADELPHIA, PA.

PHONOGRAPH PARTS

SEND FOR CATALOGUE

ELECTRO MECHANICAL PARTS CO., 57 E. Jackson Blvd., CHICAGO
See our ad on page 183, June issue, Popular Mechanics Magazine.

The Electrical Experimenter



BOYS!

Here is THE electrical magazine for you. For the Dabbler and the "How-to-make-it" fiend. Chuck full of experiments and the latest electrical doings. Non-technical—in plain English. One of the foremost authorities on WIRELESS in the U. S.

200 Illustrations, 90 big pages, over 100 articles.

One Copy Will Convince You.
At All News Stands, 15c.

\$1.50 a year (Foreign \$2.00). Send 25c for 3 numbers.

The Electrical Experimenter
234 Fulton St., NEW YORK

RAISE BELGIAN HARES For U.S.
HUGE PROFITS easily and pleasantly made. We furnish stock and pay you \$5.00 a pair and express charges for all you raise. Contract and book "Fortunes in Hares," 10c. Nothing free.
NATIONAL FOOD & FUR ASSOCIATION
Dept. 19, 557 12th St., MILWAUKEE, WIS.

JOHNS-MANVILLE Asbestos



A Birthday Present

If you are racking your brains to think of a suitable birthday present—stop. Go to any dealer and ask to see Ingersoll watches. There are eleven kinds from a \$1 to \$3.

DIAMONDS, WATCHES ON CREDIT
YOU SHOULD HAVE THE JAMES BERGMAN 180 PAGE JEWELRY BOOK IN YOUR HOME. 4,000 Photos, Diamonds, Watches, Jewelry, Toilet Articles, etc. Anything selected sent on approval, all charges prepaid. If satisfactory, Pay 20 per cent Down—10 per cent Monthly. Write Today for Big Free Catalog No. 5. It tells all about our confidential relations. Binding Guarantee and Liberal Exchange.
37-39 MAIDEN LANE, New York City
Offer, 10 per cent off for cash. **James Bergman** 1800, 1896 NEW YORK CITY

Ford Owners BRIGHT LIGHTS AT ALL SPEEDS

The Aske Regulator solves your lighting problem. It is the only patented device guaranteed to continue the operation of one light without increasing the voltage should one light burn out. Guaranteed not to injure the magneto. The Aske will work satisfactorily on all Ford cars equipped with magnetos adopted with the 1915-16-17 models. **REGULATOR complete for installation, with diagram for tail light, ONLY \$5.00.**

Dimmer, with spot light diagram, \$1.00 extra. Can you afford to be without it?

It costs only \$5.00 to play safe. Take no chances on endangering your life or the lives of the occupants of your car. Get an Aske now. Our guarantee—satisfaction or money refunded.

If your dealer cannot supply you with an ASKE, order direct, and send us your dealer's name. Write for free booklet.

ASKE AUTOMATIC VOLTAGE REGULATOR COMPANY, Manufacturers
Address Dept. D DULUTH, MINN.

The ASKE Ford Lighting System

Tested by the Research Department of the National Ford Owners Club of New York, and endorsed and recommended to users of Ford automobiles.

GRAFLEX—KODAKS

Cameras, Lenses and supplies of every description. **We can save you 25 to 60 per cent** on slightly used outfits. Write at once for our free **Bargain Book and Catalog** listing hundreds of slightly used and new cameras and supplies at money-saving prices. All goods sold on ten days' free trial. Money refunded in full if unsatisfactory. You take no chances by dealing with us. We have been established in the photographic business over 16 years.

CENTRAL CAMERA CO.

124 S. Wabash Ave., Dept. 130-7, Chicago, Ill.



Gages—Taps—Dies

Greenfield Tap and Die Corporation, Greenfield, Mass.

SINGING FISH—In Scottish waters there is a fish, known as the butterman, which, when taken from the sea, emits a sound rather like that of a siren. When a number are taken in nets the noise produced by them is quite astounding and far from agreeable.

LITHOGRAPHIC MODELS

IN COLORS

show and name every part of the following: Mallet Compound Locomotive—Atlantic Type Locomotive—Automobile—Steamship—Steam Engine—Steam Turbine—Dynamo—Gas Engine—Wireless Telegraph. Size 10x14 in.

PRICE 50c EACH. Set of Nine Models \$4.00 Postpaid

POPULAR MECHANICS BOOK DEPT., 6 North Michigan Ave. CHICAGO



JUST PUBLISHED

AUTOMOBILE WELDING

With the Oxy-Acetylene Flame

167 Pages Price \$1 Fully Illustrated
POSTPAID

Explains in a simple manner apparatus to be used, its care, and how to construct necessary shop equipment. Proceeds then to the actual welding of all automobile parts, in a manner understandable by everyone. Aluminum, cast iron, steel, copper, brass, bronze and malleable iron are fully treated, as well as a clear explanation of the proper manner to burn the carbon out of the combustion head.

POPULAR MECHANICS BOOK DEPT.
6 North Michigan Avenue, CHICAGO

Just a Hand-Brush— but SUCH a brush!



This is a photograph of a hand-brush six years old

It is a Pro-phy-lac-tic hand-brush that has been in daily use in an office for six years. A new brush would not look any different.

You never saw a hand- or nail-brush as fine as this one is. It contains bristles short, strong and black, the stub ends of the toughest Bessarabian boar hair, set in an aluminum plate which is riveted with eight rivets to a stout hard-wood back.

Soaking in hot water, use, abuse or violent outrage does not affect it.

Nobody can say how long it will last. The first ones we made ten years ago are still scrubbing away grime and making hands, fingers and nails clean for big and little hands, soft and hard hands, tender hands and hands calloused with toil.

Yet it never has been a big seller because very few people know anything about it, and most stores say with very good reason that the public has never been educated to pay more than 10c or at most 25c for a hand-brush.

Well, this is no 25c brush. It's a dollar brush—costs a dollar and like every article of supreme quality is worth anything you want to say.

It is so sturdy and its simple quality is so convincingly apparent that every time you wash your hands, from the day you bought it to goodness knows when, you will grin and be glad you bought it.

And if you present it to anyone he will bless you. It's nicely boxed.

Send us a dollar and get one and if you ever are in doubt as to whether or not it was a good, sensible purchase, tell us.

We will send you back your dollar and you can keep the brush.

Put a dollar in an envelope and send to us. No risk for you. You don't even have to return brush if you are sorry you bought it.

FLORENCE MANUFACTURING COMPANY

253 Pine Street, FLORENCE, MASS.

We make the Pro-phy-lac-tic Tooth Brush



ATTENTION!

Every soldier, every individual in a Home Defense League, every member of a semi-military organization, and in fact every citizen of the United States will need one or more of the following standard officially prescribed military books all of which have text corrections right up to date.

Infantry Drill Regulations. U. S. Army.

Price, 50 cents

Cavalry Drill Regulations. U. S. Army.

Price, 75 cents

Small Arms Firing Manual.

Price, 75 cents

Field Service Regulations. U. S. Army.

Price, 75 cents

Artillery Drill Regulations.

Price, \$1.25

Manual of Interior Guard Duty.

Price, 50 cents

Engineers' Field Manual.

Price, \$1.25

Manual for Non-Commissioned Officers and Privates.

Price, 50 cents

Manual for Army Cooks.

Price, 75 cents

Blue Jackets' Manual. U. S. Navy.

Price, \$1.00

Boat and Deck Book. U. S. Navy.

Price, 60 cents

Manual of Courts Martial.

Price, \$1.25

Manual for the Medical Dept. U. S. Army.

Price, \$1.25

Army Horse in Accident and Disease.

Price, 85 cents

Drill Regulations for Machine Gun Companies.

Price, 30 cents

Drill Regulations for Sanitary Troops.

Price, 75 cents

Signal Book. U. S. Army.

Price, 35 cents

Manual of Physical Training.

Price, 75 cents

Any of the above books will be sent post-paid to any address upon receipt of price.

Popular Mechanics Book Dept.

6 N. Michigan Ave., Chicago

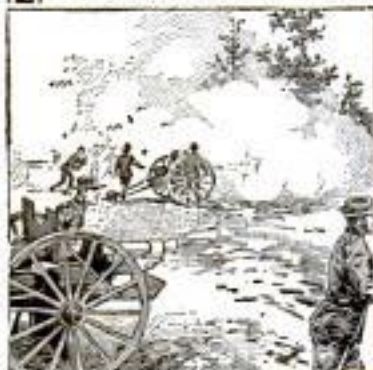

Aircraft of All Nations

Over 40 Photographs, Selected and Described by HENRY WOODHOUSE, with an Introduction by Rear Admiral ROBERT E. PEARY

This book, 6x9 inches in size, contains 32 pages of photographic reproductions of all types of aircraft. These include seaplanes, hydro-aeroplanes, battleplanes, torpedoplanes, flying boats, military kite balloons, Zeppelins, dirigibles and "Blimps." Other interesting illustrations show The Aerial Blockade; the holding up of a ship at sea by a Zeppelin; the Lewis and other anti-aircraft guns; Prince Frederick Karl of Prussia starting for a flight; the instrument board of an aeroplane; view of a battlefield from an aeroplane, etc. **Price 30 Cents Postpaid**

POPULAR MECHANICS BOOK DEPT., 6 N. Michigan Ave., CHICAGO



The Western Front at a Glance

Just off the press, this new war map is designed to satisfy those who desire a complete, large-scale map of the Western Front; scale 10 miles to one inch; size 28x36 inches. Shows forests, fortifications, altitudes, aircraft depots, wireless stations, etc. It contains upwards of 5,000 place names which can be readily located by means of the complete index which accompanies the map.

Paper, \$1 (money refunded if dissatisfied); Cloth, \$2 postpaid

POPULAR MECHANICS BOOK DEPT.

6 N. Michigan Ave., CHICAGO

JUST OUT—Official Auto Wiring Guide

Price
Prepaid
\$7.50



The most valuable book ever offered the automobile world. The result of nearly three years' work of several of the best known electrical experts in the country.

Contains 463 guaranteed accurate blueprint diagrams showing complete wiring circuits of all makes of gas and gas-electric cars, dating back as far as 1912. Miscellaneous wiring diagrams covering all starting and lighting systems are shown, as well as diagrams for re-wiring cars, both grounded and multiple systems. In addition there is a list of fuses to fit all models of gas cars and a complete and practical treatise covering the care, repair and operation of storage batteries, so written that any man, even the newest mechanic, can readily understand it.

The Official Auto Wiring Guide will pay for itself on each and every job where the trouble is electrical, through the saving of from one to five hours' time usually required in tracing wiring circuits preparatory to locating and remedying troubles in the electrical system. This means greater efficiency and profit, and better service to your customer and the building up of your reputation as an expert in ignition, lighting and starting systems.

Send for 8-page descriptive circular.

Popular Mechanics Book Dept., 6 N. Michigan Ave., CHICAGO



Champion Toledo

Dependable
Spark
Plugs



Champion Regular
Price \$1

Perform the Most Important Function in a Car

No matter how fine and costly your car is, it is unable to budge an inch until the spark plugs give it the life that sends it into action.

Unerringly and with mighty vigor, Champion Spark Plugs explode the gas mixture in the cylinders—forcing down the piston—turning the crankshaft—delivering the propelling power back to turn the rear wheels.

Avoid substitution by looking for the name "Champion" on the porcelain of every plug you buy.

There is a special Champion Spark Plug designed for every type of motor car, motorcycle, marine and stationary engine.

You can get Champions everywhere.

Champion Spark Plug Company

419 Upton Avenue

Toledo, Ohio

Canadian Office: *Champion Spark Plug Company of Canada, Ltd.,
Windsor, Ontario*

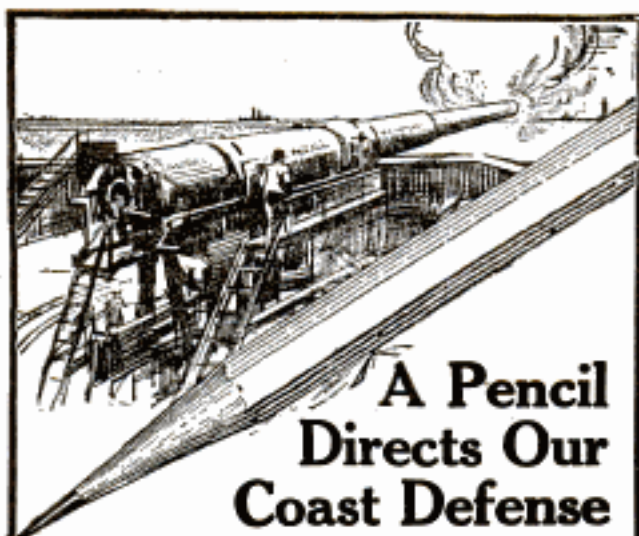

A Pencil Directs Our Coast Defense

Intricate fortification plans and big-gun charts must be drawn with a dependable pencil. The importance of a strong, smooth, long-wearing lead to an engineer can hardly be overestimated.

DIXON'S ELDORADO

"the master drawing pencil"

has proved itself *"the master drawing pencil"* in every case where it has been used. No work is too hard, no lines too fine, no shading too difficult. If it can be done by pencil, there is one or more of the 17 degrees of the Eldorado that can do it best.

Send 16 cents in stamps for samples worth double the money..

JOSEPH DIXON CRUCIBLE CO.

Dept. 10-J, Jersey City, N. J.

DIXON'S BEST WHITE N° 352

writes white on blueprints

DIXON'S ELDORADO - the master drawing pencil - HB

JUST OUT

POPULAR MECHANICS SHOP NOTES

Vol. XIII 1917 50¢
EASY WAYS TO DO HARD THINGS
POPULAR MECHANICS
CHICAGO

**Shop Notes
for 1917**

This is Volume XIII of the series of Shop Notes books reprinted from Popular Mechanics Magazine and comprises

**524 Articles
422 illus.
224 Pages**

**Price 50c
POSTPAID**

The following partial list of contents gives some idea of the wealth of time and labor-saving kinks for all the trades found in this book:

<ul style="list-style-type: none"> Automobile, Turntable Band Saw, Care of Barn Construction, Modern Camp House Dynamo Troubles Electro-Pneumatic Signal Fence, Metal Garage, Private Hammock, Swinging-Chair Ice House, Hollow-Tile Lawn Cleaner and Sprinkler Milk House, Concrete-Block 	<ul style="list-style-type: none"> Motorcycle Trailer and Camp Outfit Multiple Window Opener Oil Gauge Pressure Gauge Range Finder Road Roller Sandblast, Homemade Siphon, Automatic Tent House Tool-Chest Cart Workshop, Small-Farm
--	---

Shop Notes Series of 13 Volumes contain 6795 Articles, 2884 Pages, and 6373 Illustrations.

These books are a perfect gold mine of information for everyone who uses tools for pleasure or as an occupation. They tell easy ways to do hard things.

Price 50 cents per Volume Postpaid

Popular Mechanics Book Department
6 N. Michigan Ave., CHICAGO

JUST PUBLISHED

Storage Batteries Simplified

**Action — Maintenance — Repair — Use
By VICTOR W. PAGE**

The greatly increasing application of storage batteries in modern engineering and mechanical work has created a demand for a book that will consider this subject completely and exclusively.

This is the most up-to-date book on this subject. Describes fully the Exide, Edison, Gould, Willard, U. S. L. and other storage battery forms in the types best suited for automobile, stationary and marine work. Nothing of importance has been omitted that the reader should know about the practical operation and care of storage batteries. No details have been slighted. The instructions for charging and care have been made as simple as possible, yet are technically correct. Send for complete description and synopsis of contents.

320 Pages. Price \$1.50 Postpaid. Fully Illustrated.

POPULAR MECHANICS BOOK DEPT., 6 N. Michigan Avenue, CHICAGO

The Book For the Man With His First Car

How to Run an Automobile

By VICTOR W. PAGE

Price \$1.00 Postpaid 178 Pages
72 Engravings

This treatise gives concise instructions for starting and running all makes of gasoline automobiles, how to care for them, and gives distinctive features of control. Shows the control groups of all popular makes of automobiles and describes every step for shifting gears, controlling engine, etc.

**Makes Automobile Driving Easy
Convenient—Up-To-Date—Inexpensive**

Everything Explained in Simple Language

Send for complete description and synopsis of contents.

**Popular Mechanics Book Dept. 6 N. Michigan Avenue
CHICAGO**



**KEEP PEACE IN THE FAMILY
PAINT YOUR CAR YOURSELF WITH**

Effecto AUTO FINISHES

Make Wife happy by giving the old bus a coat or two of Effecto. Do it yourself — it's easily applied with a brush. Not a wax or polish, but a durable, quick-drying, high-luster auto enamel, made in seven colors.

Sold by paint, hardware and auto accessory dealers. Send for Color Card. Pratt & Lambert-Inc., 153 Tonawanda Street, Buffalo, N. Y. In Canada, 99 Courtwright Street, Bridgeburg, Ontario.

**MADE BY THE MAKERS OF
PRATT & LAMBERT VARNISHES**



Real Merit Proven

through the use of the BUELL by such concerns as the White Co., Pierce-Arrow, Master and Sandow Cos.

Learn what this new signal is. We will ship C. O. D. and, if at the end of 30 days you do not wish to keep it, return whistle to us and we will refund your money. You can only learn its many good features through trial. Interesting circular for the asking.

THE BUELL CO. 1610 Michigan Ave. CHICAGO

POP-CORN FRITTERS MAKE BIG MONEY



Perrine, Cal., says: "One day's sales \$380.00." Start in safe, easy, profitable, fascinating business. Everybody likes fritters — everybody buys. Think of fortunes made in 5-cent pieces. Get full particulars — reports from others. Hurry. WRITE A CARD NOW.

1251 High St. W. Z. LONG CO. SPRINGFIELD, OHIO

ENERGY

**The Kind I Give Restores
Brain and Body Cells**

I can prove to you that you are only half as alive as you must be to realize the joys and benefits of living in full. I can show you how, without drugs or medicines or dieting, without excessive exercise, without giving up any of the pleasures of life, you can revitalize, re-energize, restore every cell, tissue and organ of the body and become a Giant in health and mind.

Send for My Book — FREE

The secret of wealth, health and happiness is fully explained in Swoboda's new book, "Conscious Evolution." In it, hundreds of pupils tell what this great discovery has meant to them in increased earnings, increased ability to live the well rounded, wholly successful life. This great book will be sent free to all who are interested in greater health and mental power. Write today — now — before you forget. **ALOIS P. SWOBODA**, 205-4 Astor Hall, New York City



Do YOUR OWN Plumbing or Heating Our New EASY WAY Buy From Us Direct—Save 1/2



Send for Our Big Valuable "Handy-Man" Book

Shows over 10,000 different fixtures and supplies, in plumbing with our new easy adjustable installing trimmings.

OUR HANDY-MAN BOOK shows and tells you how to properly install our new cut-to-fit STEAM, HOT WATER, or HOT AIR HEATING PLANTS, or plumbing outfits, and how to make any plumbing or heating repairs. Any handy man with a few ordinary tools, with the help of our free planning service, can properly do the work himself.

"Our New Hardin Easy Way"

To avoid sending this large 236 page, well bound, valuable book broadcast we ask a temporary deposit of 25c, which will be refunded on first order. Or if you are not satisfied, return book, and we will refund your money at once.

Every home owner, contractor, farmer, institution, etc., needs this BIG HANDY BOOK. WRITE TODAY.

HARDIN LAVIN CO.

40 Years at
4540-50 Cottage Grove Avenue
Dept. C CHICAGO, ILL.



WEBER Throttle-Governed VALVE-IN-HEAD KEROSENE ENGINES

WILL SAVE YOU HALF IN FUEL COST. All 1917 Weber Engines are equipped with that great engine improvement, the "Weberator."

Makes Kerosene as convenient to use as gasoline. Saves 1/2 cost. Write today for full details and 60 day trial offer. Sold direct to user at factory prices. **WEBER ENGINE CO.** Dept. 1775 KANSAS CITY, MO.



NEW KEROSENE LIGHT

EVERY Home on Farm, in Small Town or suburb, needs and will buy the wonderful Aladdin kerosene (coal-oil) mantle lamp; five times as bright as electric; tested and recommended by Government and 34 leading universities; awarded gold medal; one farmer cleared over \$500 in 6 weeks; hundreds with rigs or autos earning \$100 to \$300 per month; no capital required; we furnish goods on time to reliable men; write quick for distributor's proposition, and lamp for free trial.

MANTLE LAMP CO., 306 Aladdin Bldg., CHICAGO



Engine User-Agents Wanted

Men wanted in every county to U.S.R., demonstrate and sell "BIG BEN" — wonderful new gasoline engine for every work. Big demand. Liberal profits. Free details and introductory offer. G. Birmingham & Sons, Department 611, Hamilton, Ohio.

IF IT ISN'T

AN EASTMAN

IT ISN'T A KODAK

FREE FOR 5 DAYS Orison Swett Marden's best and greatest success-building book

"Everybody Ahead." Thousands of readers say this inspiring book is helping them to become more efficient and successful. Sent to you on 5 days approval. Send no money. If you don't want to keep the book, return it, otherwise remit \$3.00.

Frank E. Morrison, Publisher, Dept. 22, 1133 Broadway, New York, N. Y.

WRITE FOR FREE BOAT BOOK



Build your own boat — From \$3 up for full-sized patterns — \$33 buys complete frame, 12-pass, 25-ft. Motor Boat. Write today.

BRDOKS MFG. CO., 3203 Reef Av., Saginaw, Mich.

Is All You Send

Any article shown here, sent direct to your home, for only \$1.00 now. Use it for 30 days, then if, for any reason whatever, you want to return it to us, we will pay the freight both ways and refund your money. If you decide to keep it, take nearly a year to pay. Order more than one article if you wish, on the same terms direct from this ad or from our catalog.

That is the offer from the House of Hartman which gives you an opportunity to share in the benefits of our great buying power and of our charge account system which means getting the utmost in value and the easiest terms. Also learn by actual experience that you cannot suffer loss or dissatisfaction when dealing here. That "the customer is always right" is the foundation of the policy on which we have built success from a little store to a \$12,000,000.00 concern with hundreds of thousands of customers. It is the policy which we must maintain to increase our success which we trace directly to the satisfaction given to our patrons. No Hartman customer can make an unsatisfactory purchase here.

Send to us for anything you want. Order direct from this advertisement, or get our 454 page book, make your selection from it, and your charge account will be opened. Send coupon.



\$1 Brings This Big Rocker

Frame is made entirely of kiln dried hardwood. Arms and front posts are genuine quarter sawed oak, other exposed parts being fine selected oak in handsome golden oak finish. Seat has four springs and back has six springs all supported on tempered steel bands. Filling is wood fibre and cotton felt. Handsomely upholstered in imitation Spanish brown leather. Height of seat from floor 17 in. Height of back from seat 25 1/2 in. Seat is 19x19 in. Width of chair over all 30 1/2 in. Shipping weight about 40 lbs. Sent from Chicago Warehouse or Factory in Western New York State.

Order by No. 79MA7. Price \$5.48. Send \$1.00 now. Balance in payments of 75c monthly



\$1 Brings 42-Piece Aluminum Set

9-piece combination double roaster with two outer shells, inside pudding pan, 5 custard cups with perforated pan holder. Two outer shells make an excellent roaster for chicken, steaks and other meats; using perforated inset and small pudding pan, it is a combination cooker and steamer. The three pans are also used separately over the fire as cake pan, bake dish, pudding pan or for any purpose where open pans are used; 1-cup coffee percolator with inset (2 pieces); 6-quart preserving kettle; 2 bread pans; 2 pie plates; 1-quart and 2-quart lipped sauce pans; 1 boiler; 2 jelly cake pans, with loose bottoms, (4 pieces); 1 casserole set, salt and pepper shakers, toothpick holder and frame (4 pieces); 1 measuring cup; 1 combination funnel (5 pieces); 3 measuring spoons; 1 strainer; 1 sugar shaker; 1 grater; 1 cake turner; 1 lemon juice extractor. Sent from our Chicago Warehouse. Order by No. 415MA12. Price complete only \$9.75. Send \$1.00 now. Balance in monthly payments of \$1.00 each.

\$1 Brings This Hot Blast Heater

The famous "Perfect" Regent. Burns wood or coal. Hot blast construction uses ALL the fuel. Swedge joint prevents bolts burning off. The double feed doors admit large lumps coal. Two draft dampers. Draw center shaker grate. Mica windows. Nickel-plated trimmings. Heavy cast iron base. Extra strong fire pot. Floor space 21x21 in. Fire pot diameter 15 1/2 in. Shipping weight 156 lbs. Shipped direct from our foundry either in Central Ohio or Michigan.



Order by No. 387MA13. Price \$16.95. Send \$1.00 now. Balance in payments of \$1.75 each.

Send Coupon

to Order Direct or Get 454 Page Book of Bargains

This book brings the furniture markets of the world to your very door. Every page shows values made possible by the great purchasing power of our organization, and by the expert knowledge of our buyers and merchandise men—values in which you as a Hartman customer will participate on our 30 days free trial and year-to-pay terms.

The offerings on this page give you an idea of the thousands of opportunities for thrifty buying presented in this book. Order one or more of these now—direct from this advertisement—sending only a dollar down on each item. Or get the book and select other designs in these articles or other merchandise if you wish. Mark the coupon to indicate what you want to order. Coupon or Postcard brings the book free.

Hartman Furniture & Carpet Co.,
3945 Wentworth Ave., Dept. 820, Chicago, Ill.

Send me the merchandise marked X it being understood that I am to have the use of it for 30 days and if for any reason I do not want to keep it I can return it at the end of that time and you will pay freight both ways and refund my payment. If I keep it I am to pay balance as indicated in this ad.

Aluminum Set
No. 415MA12.

Rocker
No. 79MA7.

Heater
No. 387MA13.

Name..... Address.....

If Catalog only is wanted, write name and address above or send Postcard.

Please Mention Popular Mechanics



Are You Mechanically Inclined?

If so, this list of Practical, Up-to-Date Electrical and Mechanical BOOKS at **25c each, postpaid** WILL INTEREST YOU

Each one is a complete, dependable treatise and worth the price several times over.

	Pages	Illustrations
Practical Electrics	135	126
Study of Electricity for Beginners	88	54
Dry Batteries, Their Construction	59	30
Modern Primary Batteries	105	55
Electric Gas Igniting Apparatus	101	57
Alternating Currents	90	33
Electrical Circuits and Diagrams — Part I	72	217
Electrical Circuits and Diagrams — Part II	80	78
Magnets and Magnetism	94	49
Small Electrical Measuring Instruments	90	59
Woodwork Joints	101	178
How to Build a Bi-Plane Glider	60	31
Model Vaudeville Theatres	90	34
Windmills and Wind Motors	83	76
A. B. C. of the Steam Engine	30	6
Steam Engine Design	102	34
Inventions, How to Protect, Sell and Buy Them	108	1
Simple Soldering, Both Hard and Soft	82	52
Induction Coils, How to Make and Use Them	75	35
Experimenting With Induction Coils	73	26
Wimshurst Machine, How to Make and Use It	112	30
Simple Experiments in Static Electricity	72	51
Making Wireless Outfits	61	27
Wireless Telephone Construction	74	43
Telegraphy for Beginners	63	19
Small Accumulators, How to Make and Use	80	40
Wiring Houses for Electric Light	93	42
Low Voltage Electric Lighting	92	23
Electric Bells, Annunciators and Alarms	95	70
Magneto Telephone	86	23

A uniform series, size 5x7 inches. Paper cover. You will be surprised at how much good reliable information 25 cents will buy.

Any of the above books sent postpaid to any address upon receipt of price by

Popular Mechanics Book Dept.
6 N. Michigan Ave., CHICAGO

YOUNG MAN! LEARN DRAFTING



ONE of the most practical subjects of study today; an essential in most lines of engineering; indispensable in many occupations and often the secret of successful advancement; of no less importance to the farmer than the mechanic. There is bound to come a time when you will feel the need of the ability to "lay out" something in accordance with the rules and conventions used in the drafting profession.

Individual Study

may be successfully engaged in with the aid of our new enlarged edition of the book

A Practical Course in Mechanical Drawing

By WM. F. WILLARD

(For several years instructor in Mechanical Drawing at Armour Institute of Technology, Chicago)

160 PAGES — SIZE 5x7 — 157 DRAWINGS — CLOTH COVER

Price 50 Cents, Postpaid

There has been a real need for a book of this kind, as it clinches each problem in the mind of the student by giving the practical application of that problem to every day practice in some phase of the world's work. It meets every modern requirement and is in advance of any other work on the subject. Excellent for use in shop classes, trade or high schools. A complete detailed description of the contents of this book sent free upon request.

Order of your Book Dealer or direct from the publishers

POPULAR MECHANICS BOOK DEPT.
6 N. Michigan Ave., CHICAGO

YOU WILL NEED

Our New 1917 Handy Reference

Catalog of the Latest and Best Books

on Mechanical, Electrical and Industrial Subjects

128 Pages. More than 400 good books described. Free upon request. Write for your copy today.

Popular Mechanics Book Dept.
6 N. Michigan Ave., Chicago

Mathematics Made Easy by ROPP'S CALCULATOR AND SHORT-CUT ARITHMETIC

Shows the Answer as Quickly as a Watch shows the Time to all Problems likely to occur in the Office, Store, Shop, Bank, Farm, or Factory.



Over 2,000,000 Sold

Explains and simplifies every principle in Arithmetic, Mechanics, and Mensuration.

PRICES, POSTPAID

Desk Size \$1.25

Leather, Pocket

Size \$1.00

Leather, Vest Pocket

Size \$0.50

Pocket Size \$0.50

Send for 4-page description of this work

Popular Mechanics Book Dept., 6 N. Michigan Ave., Chicago



I am having the biggest demand in the history of my school for capable graduates to fill the hundreds of waiting positions in the varied branches of the automobile and tractor business. Join me here and get Practical Training — then your future is assured.

H. J. RAHE,
President

Auto Experts Wanted

This is the biggest year in the history of the automobile business. Millions of new cars, trucks and tractors are being manufactured and sold this year, creating positions for thousands of expert salesmen, demonstrators, repair men, starting and lighting experts, garage managers, chauffeurs, etc. My graduates are in demand because the big employers of all kinds of automobile experts know that my graduates are practically trained in all branches of the business.

This Is the School of Complete Equipment

The Rahe Original Method of Practical Automobile Training and Experience is recognized as the standard and thousands of my graduates in all parts of the world recommend my method as the **most efficient, most thorough, most complete.** I teach you to handle any kind of an auto repair job. You get the benefit of a completely equipped automobile training school with plenty of floor space, expert instructors, all the worth-while equipment and thousands of successful graduates. Students in this school get genuine repair shop training and experience that enable them to step into waiting positions at big pay — or to go into business for themselves. My graduates earn from

\$75 to \$300 a Month!

You can do likewise if you are **properly trained**—but **half trained** will not do. Come to this school of complete equipment—don't bother with any training that is not the result of years of experience, that has not stood the test of time, that has not produced thousands of successful graduates.

My Training Includes All

Students in this school become thoroughly familiar with every branch of the business—repairs, vulcanizing and welding, forging, machine shop work, piston ring fitting, babbitt-ing, battery work, magnetos, ignition, self-starting, etc., etc.

My equipment is the very latest. Here you will find the TWIN-SIX, the EIGHT (V type) the SUPER-SIX motors, lock mounted for my students' practice and training. All kinds of motors—the cheapest as well as the most expensive. Tractors of both types—kerosene and gasoline. Big tractor farm. Two big garages, all kinds of cars at the disposal of my students.

\$50 SCHOLARSHIP FREE

For Tractor, Stationary, Gas Engineering, Power Farming

To Those Who Enroll at Once for My Full Course in Auto Repairing

Limited number of Free Scholarships available. Tractor business growing at a tremendous rate. Big demand for Tractor Experts, Operators, Salesmen, Repairmen, etc.

My 80-Page Catalog Sent Postpaid

My newest and best book filled with fine copper engravings, showing men at work in my big machine shops making repairs of all kinds, the four big buildings, detailed views of equipment, tractor farm and equipment—the finest book ever issued on the subject. Just use the coupon and mail today.

H. J. RAHE, President

Rahe's Auto Training School 612 E. 11th St.
Kansas City, Mo.

Mail This Quick—TODAY!

H. J. RAHE, President

RAHE'S AUTO TRAINING SCHOOL

612 E. 11th St., KANSAS CITY, MO.

Send me your 80-Page Catalog Free and Postpaid — also reserve a Free Tractor Scholarship without obligations on my part.

Name.....

Postoffice.....

Street or R. F. D.....State.....

World's Greatest Auto School. Thousands of Successful Graduates

Please Mention Popular Mechanics

BERNARD-HEWITT & CO.,
Desk F29, 424-434 So. Green St.,
CHICAGO, ILL.

Please send me your new Fall and Winter style book with 70 samples free—also full details of your special lining offer.

Name

Address

MAIL COUPON

For Fall and Winter
STYLE BOOK

70 SAMPLES
FREE



High Grade Blue Serge Suit Made to Measure only \$15

GUARANTEED ALL WOOL

A SPECIAL proposition to introduce the wonderful values offered by our system of tailoring. We have no agents—no dealers—no traveling salesmen—our values make their own customers—and once a Bernard-Hewitt customer always a Bernard-Hewitt customer. That's why, to secure your first order, we are willing to make to your individual measure, a handsome, all pure wool worsted blue serge suit (usual \$25 value) for only \$15 and line it with a

**WE PAY
SHIPPING
CHARGES**

\$4 SATIN LINING FREE

Remember, this suit is strictly hand tailored to your individual measure from the very finest all wool blue, light blue, black or gray serge, in the latest approved Chicago style, and by the very best tailors in this whole city.

But perhaps you don't care for a serge suit. Well, our big book which we will send you free contains generous samples of the latest fabrics; plain and fancy mixtures, the up-to-the-minute offering of leading woolen mills.

The \$4.00 Satin Lining free offer goes, no matter what fabric you select—and we pay all shipping charges. We take all the risk—you none—for this is

OUR GUARANTEE

Complete Satisfaction or Refund of Money

You must be pleased in every particular—in fit—in style—in workmanship and in materials, or we don't want your money. Could anything be fairer? Write today—wear real tailor-made clothes—dress better and save money.

**Take Your Own \$10
Measure—Save \$10**

Write for Your Copy of Our Big Book Today

Our big new Fall and Winter book is ready for you—contains 70 samples latest woollens—also lowest prices on men's hats, shoes and furnishings. It is your guide to correct and economical clothes buying. Mail coupon above or send post card for your copy. Please mention POPULAR MECHANICS so that we can identify this special offer.

BERNARD-HEWITT & COMPANY

424-434 So. Green St.

Desk F29

CHICAGO, ILLINOIS



The Rex

Brand New!

From Factory
to You at
Rock-Bottom
Factory Price

Now \$250

Right *NOW* you can secure the superb Rex Visible—shipped direct from the factory, *brand new*—for only \$2.50 down. Then \$2.50 monthly payments. And we've put the price of the Rex so low, we've made them gasp! But you must act on this offer *at once*—before it is withdrawn.

The Rex is *not* an ordinary typewriter. It was built because the greatest merchandise house in the world wanted a better, stronger, more durable typewriter than any on the market. Guaranteed for ten years; typebars are 50 per cent stronger than those of other machines; built to outlast them ALL! Completely visible writing; ideal check protector; 11-inch carriage for wide documents; and the only typewriter with the famous "Rex Shock Absorber."

But we can't *begin* to tell you about the Rex here. Send for our Big Free Book! No other book on typewriters like it! Brim full of FACTS. Shows everything the Rex will do for you and just *why* it is such a superb typewriter. We will send you the Rex on *trial*. You can see it—use it—prove every claim we make without risking one penny. If you want all that's BEST in a typewriter, you should seize this chance at once and find out all about the Rex.

Mail the Coupon For Free Book

Find out *now* about our special limited offer. Get our amazingly low price and easy terms. Learn how you may have the Rex on trial. Take advantage of this offer before it is withdrawn. Let us send you our big illustrated book—Free. This book will be an education in typewriters—a revelation. Tear off coupon and mail it in today—now.

Rex Typewriter Co. Dept. 1196 LeMoyne Bldg. Chicago

Rex Typewriter Co.,
Dept. 1196 LeMoyne Bldg., Chicago

Please send me your illustrated free book and your special limited offer on the Rex Typewriter. I assume no obligation whatever in sending coupon.

Name

Address



House near Alexandria, Virginia.



"White Pine in Home-Building" is beautifully illustrated and full of valuable information and suggestions on home-building. Send today for this booklet—free to all prospective home-builders.

"The Helen Speer Book of Children's White Pine Toys and Furniture"—a fascinating children's plan book, from which a child may build its own toys and toy furniture. Prepared by Helen Speer, the toy expert. If there are children in your home, sent free on request.

DON'T postpone building your home. Building material experts agree that there can be no decline in building costs for many years after the war.

Build now. But build wisely. Apply thrift standards to woods just as you do to your everyday purchases. Select the woods that have proved themselves best for the uses to which you put them.

WHITE PINE

Any architect, carpenter or lumber dealer will tell you that for the outer covering of a house—subjected to the rigorous onslaught of rain and snow, heat and cold, sun and wind—no other wood is so durable and holds its place so well, without warping, splitting, rotting or opening at the joints, as White Pine.

Address **WHITE PINE BUREAU,**
1926 MERCHANTS BANK BUILDING, ST. PAUL, MINN.

Representing
The Northern Pine Manufacturers'
Association of Minnesota, Wisconsin
and Michigan, and The Associated
White Pine Manufacturers of Idaho

Please Mention Popular Mechanics

Copyrighted material



"The Billiard Hour" Makes Home Folks Comrades

The Brunswick Pocket Billiard Table is the common meeting ground today of thousands. Here fathers get acquainted with their boys and mothers and daughters grow to be chums.

These are natural benefits—not forced effects—of this charming home entertainment.

Such fascinating, changeful contests for supremacy relax the mind, develop skill and the love of clean, fair sport.

BRUNSWICK HOME BILLIARD TABLES

Brunswick Tables are preferred by experts because of their scientific accuracy, live, lightning-like cushions and ever-level playing beds.

More than that, they are built of fine mahogany, oak, and other beautiful woods. All illustrated in actual colors in our free billiard book. Write for free copy today.

Play While You Pay— Balls, Etc., FREE!

Enormous factory output brings prices about half what the cost would be if only a few were made.

Our popular purchase plan (as low as \$3 monthly) makes them easy to own.



"Baby Grand"

DEALERS: Write for attractive agency proposition before your territory is closed.

Complete outfit of Balls, Cues, etc., all included free.

Get Our Trial Offer

Some Brunswick styles can be folded away when not in use; a size for every home.

Full descriptions, color-reproductions, low prices, easy terms and home trial offer all contained in our entertaining billiard book—"Billiards—The Home Magnet."

Write or mail the coupon at once and get one free.

The Brunswick-Balke-Collender Co.
Dept. 53-C 623-633 S. Wabash Ave., Chicago

Send Your Address For Catalog

The Brunswick-Balke-Collender Co.
Dept. 53-C 623-633 S. Wabash Ave., Chicago

You may send a free copy of your color book—"Billiards—The Home Magnet" and tell about your home trial offer.

Name.....

Address.....

Mr. Edison's Wonderful New Phonograph

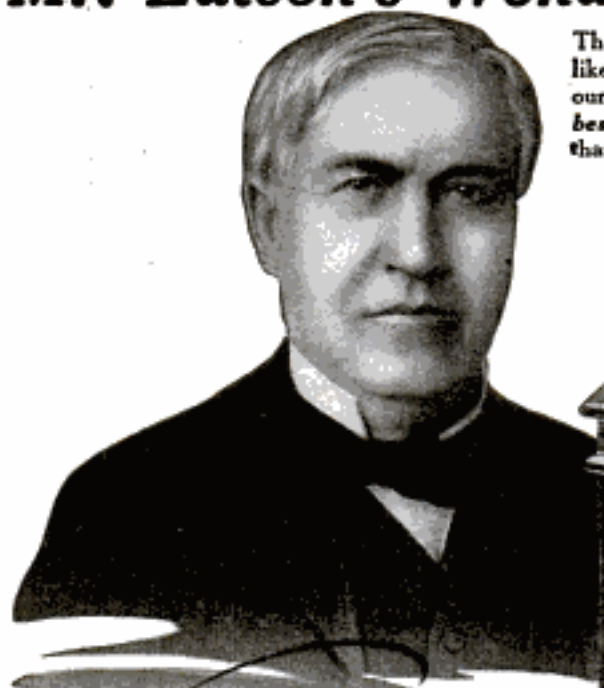

Thomas A. Edison.

The world's greatest inventor has made the music of the phonograph life-like, at last. Success—after years of labor on his favorite invention! Read our offer on his wonderful new phonograph. Now that you can have the best on this liberal offer, you need no longer be satisfied with anything less than Mr. Edison's great instrument.

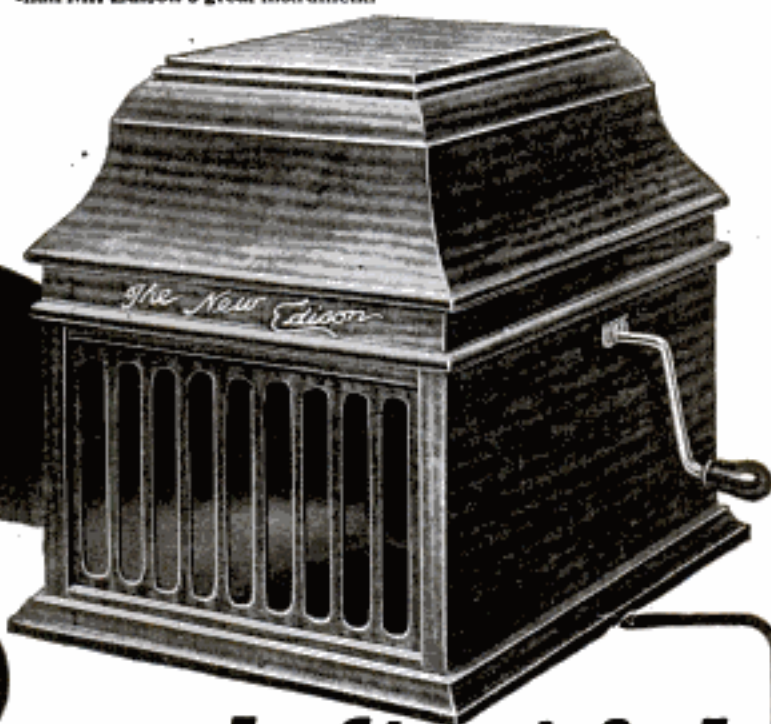

Only **\$1.00** and after trial

Yes, we will send you the New Edison, the product of the world's greatest inventor's genius, the phonograph with the wonderful diamond stylus reproducer and your choice of the best Diamond Amberol Records on free trial without a penny down. On this offer, you can have the genuine Edison, the instrument which gives you real, life-like music, the finest and best of all phonographs at a small fraction of the price asked for imitations of Mr. Edison's great instrument. Seize this opportunity. Send the coupon now for free catalog.

Get the New Edison in Your Home on Free Trial Entertain your family and friends with the latest song hits, with your favorite, old-time melodies—with everything from grand opera to comic vaudeville. Roar with laughter at the side-splitting minstrel shows. Then, after the trial, send it back at our expense if you choose. Or

keep it on our great, rock-bottom offer. Send the coupon today—now.

To F. K. BABSON
Edison Phonograph Distributors
1196 Edison Block, Chicago

Gentlemen: Please send me your New Edison Catalog and full particulars of your free trial offer on the new model Edison Phonograph.

Name.....

Address.....

Rock-Bottom Offer Direct

If, after the free trial, you decide to keep Mr. Edison's superb new instrument, send us only \$1. Pay the balance on the easiest kind of monthly payments.

Think of it—a \$1 payment, and a few dollars a month to get this wonderful new style outfit—Mr. Edison's great phonograph with the Diamond Stylus reproducer, all the musical results of the highest price outfits—the same Diamond Amberol Records—yes, the greatest value for \$1 down, balance on easiest monthly terms. Convince yourself—free trial first! No money down; no C. O. D., not one cent to pay unless you choose to keep the instrument.

New Edison Catalog Free

Your name and address on a postal or a letter (or just the free coupon) is enough. No obligation in asking for catalog. Find out about Mr. Edison's great new phonograph. Get the details of this offer—while this offer lasts. Write today—now!

F. K. BABSON, Edison Phonograph Distributors
1196 Edison Block, Chicago, Ill.

Canadian Office: 355 Portage Avenue, Winnipeg, Manitoba

**FREE
TRIAL
OFFER**

Be Your Own Salesman and Save \$51—

New Oliver Typewriters for \$49

Let us send you a brand new Oliver Nine—the world-famous typewriter—for five days' free trial. Keep it or return it.

That is our plan in a nutshell. Our new plan—besides saving you \$51—makes it easy for every one to convince himself of Oliver superiority. No red-tape—no money down—no C. O. D. No salesman to influence you. No need to ever pay \$100 for a typewriter again.

But here is a warning— all advertisements for *brand new* Oliver Nines at \$49 must be signed by the Oliver Typewriter Company.

**Prices
Cut in
Two—
and Why**

With greater production and huge financial resources, the Oliver Typewriter Company is the pace setter.

Its officials seek to relieve the public of a useless tax. In the past, it has cost \$51 to sell typewriters through an expensive sales force—high rents for offices in 50 cities—and other frills. All are wasteful from an economic viewpoint. That is why Oliver Nines are shipped direct from the factory to the user—on free trial. This permits us to wholesale machines to you for \$49. You get the saving. No middlemen with their tolls.

This plan, we feel sure, is in keeping with modern demands. All will welcome such a sincere effort to reduce the High Cost of Typewriters.

This Is Our Offer

**No Money Down. No C. O. D.
Easy Monthly Payments**

Maker and user deal direct. You are your own salesman. You pay yourself the \$51. Own this master typewriter at the rate of \$3.00 per month.

The Oliver Nine itself must convince you. It is the greatest, the most durable, the most successful typewriter ever built. No finer can be bought for any price. It is a twenty year development.

There is no need now to ever pay \$100 again for a new typewriter. The Oliver rebellion gives everyone an opportunity to own an Oliver. And at the lowest time payments.

This is the same machine used by the largest concerns. It has all the latest improvements. For speed and fine workmanship, it can't be beat.

If after trial of 5 days, you are not satisfied—ship it back at our expense.

MAIL TODAY



Over 600,000 Sold

Do Not Confuse

This \$49 Oliver is *not* a second-hand machine—but brand new, direct from the factory to you. It is not a special model—but the identical machine that was \$100. Reduced selling expenses save you \$51.

Some of the big concerns using Oliver's are: U. S. Steel Corp., Standard Oil Co., Nat'l City Bank of N. Y., Montgomery Ward, Pennsylvania R. R. The Oliver is famous the world over. You can now own one for 10c per day.

10 Cents a Day

Easy payments of \$3.00 per month. This in addition to our cutting the price in two. Could any one go further? Yet we offer this free trial without obligation on your part. The plan is daring—but we believe discerning people will respond.

This is the first time in history that a new, never-used \$100 typewriter of the latest model has been offered at the price of cheaper or second-hand machines. It is cheaper to own than rent.

No Money Down

Simply send in the coupon properly filled in. There is no red tape—no salesman—no collectors—no bother. Keep the Oliver for \$3.00 per month. Or return it. It is up to you.

Mail the coupon today.

The Oliver Typewriter Company
109-C Oliver Typewriter Bldg., Chicago

FREE TRIAL COUPON

THE OLIVER TYPEWRITER CO.

109-C Oliver Typewriter Bldg., Chicago

You may send me a new Oliver Nine on approval. I will keep it five days. Then, if I decide to buy it, I will pay \$49 at the rate of \$3 per month. The title to remain in you until fully paid for.

If I decide to return it, I will turn it over to the express company, properly packed and addressed to you.

Name.....

Address.....

References.....



**Partners: Father Time Ages VELVET
Mother Nature Mellows It**

An unbeatable team: Time and Nature.

When tobacco manufacturers try to substitute hurry-up curing methods for slow, natural ageing of tobacco, you smokers pay the price. There is no better method of bringing out the mellowness and mildness of "Kentucky's best" than two years natural ageing in wooden hogsheads.

THAR ain't a whole lot of difference between a ripe persimmon an' a nearly ripe one—on the outside. Some of these nearly matured tobaccos sorter favor VELVET in looks.

Velvet Joe

Think about that over a pipe of VELVET.

Liggett & Myers Tobacco Co.

