

August

See Page 209

15 Cents

POPULAR MECHANICS

MAGAZINE

WRITTEN SO YOU CAN UNDERSTAND IT

HEILBRONNER

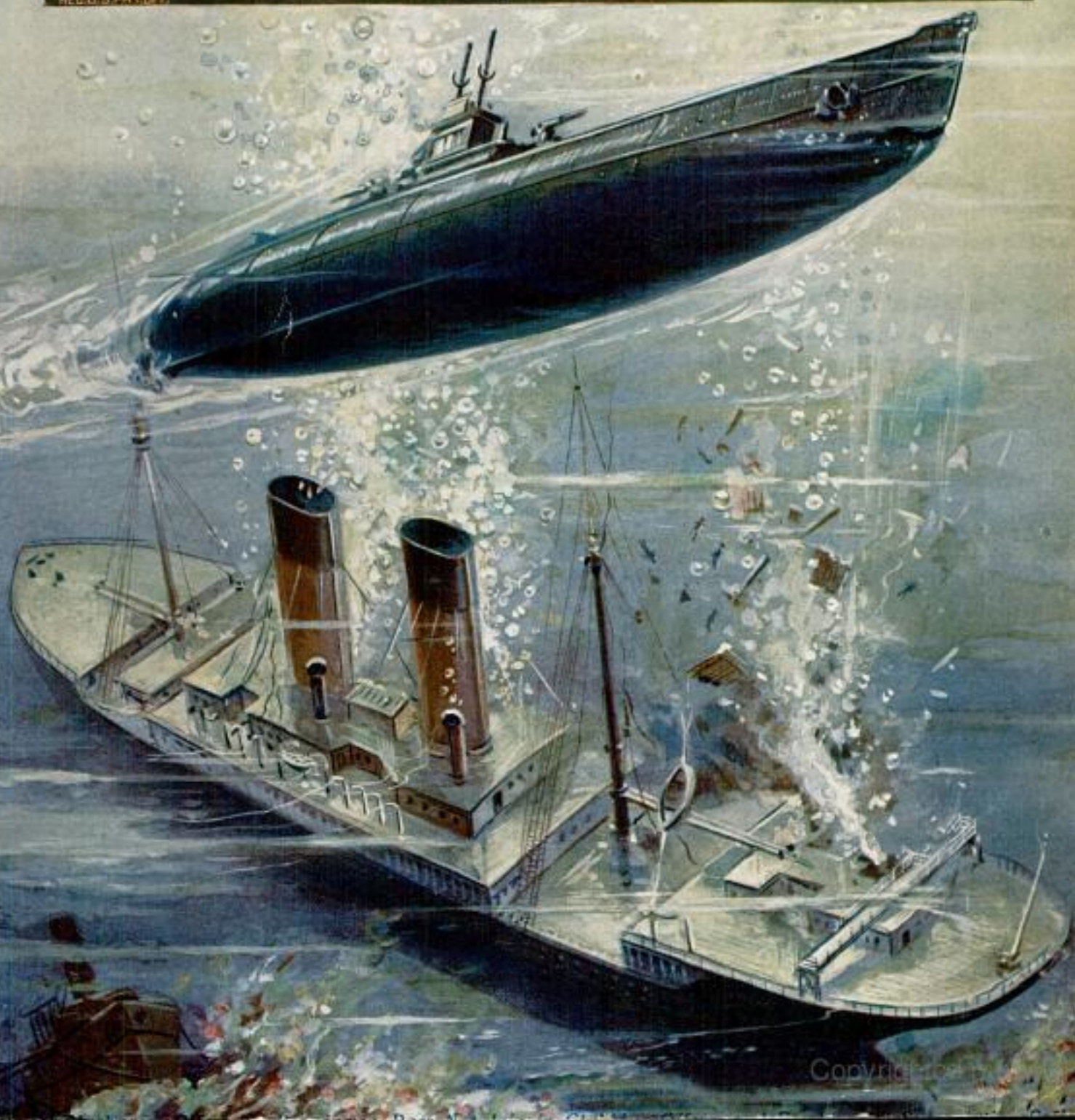

Copyright

HARRIS HOMES



When You Build The Harris Way— you build to stay, and secure the *utmost possible* in Quality, Economy and Service. Why? Simply because you profit directly — *immediately* — by our 24 years experience. You get the benefit of our practical knowledge as the *originators* of the "Direct to You" Home Building Industry. We were the *first* to sell Lumber and Material direct to Home Builders at one small profit. We were the *first* to reduce vitally important industry to a *perfect system* and extend the benefits uniformly to the people of the nation. *The splendid Harris Home below has 6 rooms, bath, pantry, large living room, etc. The size is 30x26 ft. A thoroughly modern American Home in every respect.*

"The Harris Way" has exclusive merits—special advantages for the shrewd and careful Home Builder, possessed by no other plan or method. It is the best, safest and most sensible way to build your ideal home *right* without sacrifice of quality, *or the waste of a single penny!* Thousands have built "THE HARRIS WAY" with profit and satisfaction.

Advance in Prices Our prices are so low that it will be impossible to maintain same for any length of time. They are bound to advance. If you are needing a house, either for investment purposes or for a home, write now. Do not delay another moment if you wish to make a saving.

The Material used in building all Harris Homes is prepared by us complete for your use in a way that is instantly and easily understood. It is sensibly cut-to-fit with *absolute accuracy and positive elimination of all waste.* You pay for nothing you do not get—you pay our bed rock low, one-small profit bargain price *only* for what is needed to do the work *right* "THE HARRIS WAY."

\$10,000,000

Capital Stock and Surplus—stands back of our guarantee to every Harris Home Buyer—you cannot lose.

Free Book of Plans Be sure to mail free coupon for the latest edition of the famous \$10,000 HARRIS HOME PLAN BOOK now ready. A golden guide to Quality, Service and Economy in Building. Explains fully and freely, everything about building economy. Contains 100 modern Harris Home Designs, with descriptions, material, specifications, prices, etc., and explains how we save you \$50.00 to \$250.00 on plans and material. Think twice before you pass this opportunity.

\$1042 Buys The Material To Build This Beautiful Home No. 161 —Best Quality Material Throughout—Best Construction — Sensibly Cut-To-Fit.

CUT OUT AND MAIL

Harris Bros. Co., Dept. FL7
Chicago

Please send me free—without the slightest obligation—the following books checked.

- Book of Plans
- Plumbing and Heating
- Paints
- Presto-Up Ready Made Sectional Houses & Garages

Name.....

Address.....



HARRIS BROTHERS CO. 35TH AND IRON STREETS CHICAGO

The dashing music of the
world's greatest bands
-on the *Victrola*

There's a sparkle and swing to band music that stirs the heart and arouses the enthusiasm.

You will be thrilled indeed by the band music that is brought to you on the Victrola—the music of the world's greatest bands!

Sousa's Band, Pryor's Band, Conway's Band, Vessella's Band, United States Marine Band, Black Diamonds Band of London, Band of H. M. Coldstream Guards, Garde Républicaine Band of France, Banda de Alabarderos of Madrid, Kryl's Bohemian Band. It is just like having these famous organizations actually parade before you.

Hear this inspiring band music at any Victor dealer's. He will gladly play any music you wish to hear. And he will demonstrate the various styles of the Victor and Victrola—\$10 to \$400.

Victor Talking Machine Co., Camden, N. J., U. S. A.
Berliner Gramophone Co., Montreal, Canadian Distributors

Important Notice. Victor Records and Victor Machines are scientifically coordinated and synchronized by our special processes of manufacture, and their use, one with the other, is absolutely essential to a perfect Victor reproduction.

"Victrola" is the Registered Trade-mark of the Victor Talking Machine Company designating the products of this Company only.

Warning: The use of the word *Victrola* upon or in the promotion or sale of any other Talking Machine or Phonograph products is misleading and illegal.



New Victor Records demonstrated at all dealers on the 1st of each month

Protecting Those Who Trust Us

A little "inside story" (clipped from a leading lumber trade journal) about the reasons for — and some deductions as to the results of —

Trade-marked Cypress

"THE WOOD ETERNAL"

The following editorial item is from the May 10th, 1917, issue of the LUMBER WORLD REVIEW. (It is worth reading because it is true—and worth reproducing here because you probably don't read lumber trade papers.) We submit it without further comment.

"Tide-water" Cypress

Note the Emphasis it puts on the

Relative Value of Genuine

Please do not be diverted by the small type—
it's A STORY WORTH READING.

(From the "Lumber World Review," May 10th, 1917.)

"CYPRESS TRADE-MARK WINNING BIG.—THEIR SLOGAN, 'SAFE BUYING MEANS EASY SELLING,' PROVES GREAT MARKET AID TO RETAILERS.

"Cypress, 'The Wood Eternal,' was the first lumber to be exploited through a really large general advertising campaign, and now cypress has 'gone and done it again'—and is winning big by helping its retailers to an 'automatic' market by sponsoring to the ultimate user every piece of cypress made by an Association mill.

"When the Southern Cypress Manufacturers' Association began a campaign of advertising a few years ago, which was to exploit the virtues of cypress, little was known of this venerable wood by present day lumber users.

"But as the stories of its remarkable rot-resisting properties were told time after time, the interest of the lumber buying public in this new-old lumber was aroused.

"It was not long thereafter until the mills of the Southern Cypress Manufacturers' Association were working to capacity to fill the orders for cypress which after more or less neglect had again come into its own.

"And then followed what usually follows any marked success in merchandising in these days of intensive buying and selling. Inferior, or upland, cypress (and some carelessly manufactured cypress) began to share unduly in the results of public faith, and it became necessary to protect the lay consumer and at the same time protect the conscientious manufacturer and the honorable and up-to-date preponderance of retailers.

"The general public was not aware that there was a considerable difference between 'tide-water' cypress and the cypress that grew too far inland—but experience began to teach them that while one was 'eternal' the other was more or less temporal and 'fleeting.' One was truly rot-resisting

while the other failed to justify the confidence of the user in its rot-defying character.

"So the already famous cypress arrow trade-mark was devised as an insurance policy for both seller and user. The value of a trade-mark need not be dwelt upon. The manufacturer who won't sign his product will never get very far with it, in these days. The quality must be maintained if the product is to survive the fierce battle of business.

"And so now genuine 'tide-water' cypress (the most eternal of the Wood Eternal) is no longer bought by name alone or on faith—but by a brand back of which is a group of manufacturers including most of the larger and more responsible producers of cypress. As a further testimony of 'pride in their product,' the output of each mill is being identified by the serial number of that mill incorporated in the trade-mark as applied to each mill. The move is one in the right direction, the most important one ever taken by any lumber manufacturers, and is more than justifying, even this early, the well-known cypress slogan which recites that 'the only permanent safety for the seller is perpetual safety for the buyer.' This is the keynote.

"RETAILERS ARE ALREADY EXTENSIVELY REFUSING TO BUY 'ANONYMOUS CYPRESS,' AND ARE SHOWING THEIR UP-TO-THE-MINUTE ACUMEN BY SPECIFYING THE TRADE-MARK ON ALL THEIR CYPRESS ORDERS. THIS IS THE MARK WHICH IS NOW STAMPED ON THE TIDE-WATER CYPRESS—(THE 'WOOD ETERNAL')—MANUFACTURED BY THE ASSOCIATION MILLS.

"IT MARKS A NEW EPOCH IN LUMBER MERCHANDISING."



Let our ALL-ROUND HELPS DEPARTMENT help YOU MORE.

Our entire resources are at your service with Reliable Counsel.

SOUTHERN CYPRESS MANUFACTURERS' ASSOCIATION
1219 HIBERNIA BANK BLDG., NEW ORLEANS, LA., or 1219 HEARD NAT'L BANK BLDG., JACKSONVILLE, FLA.

INSIST ON TRADE-MARKED CYPRESS AT YOUR LOCAL LUMBER DEALER'S.

IF HE HASN'T IT, LET US KNOW.

Popular Mechanics Magazine

6 N. Michigan Avenue, Chicago, U. S. A.

EDITED BY H. H. WINDSOR

England: The International News Co.
5 Beams Bldg., Chancery Lane, London, E. C.

Australia:
The Australasian News Co.

ISSUED MONTHLY

SUBSCRIPTION:

SINGLE COPY, 15 CENTS

In United States, and its possessions, Cuba and Mexico, per year, postpaid - - - \$1.50
To Canada - - - - - 1.75
To all other countries in the Postal Union - - - - - 2.50

All subscriptions are discontinued at expiration. Please examine the date printed on your wrapper.

Entered as Second Class Matter Sept. 15, 1903, at the Post Office at Chicago, Illinois, under Act of March 3rd, 1879.

Entered as Second Class Matter at the Post Office Department, Canada.

Published monthly by POPULAR MECHANICS CO.

Copyright, 1917, by H. H. WINDSOR.

Copyright, in France.

Contents for August, 1917

Advertisements, Device Writes in Water on Streets.....	175	Cyclometer, Typist's Strokes Counted by.....	230
Aerial Truck Is Fire Department's Newest Addition.....	198	Dam, Big Earth, to Double City Water Supply.....	188
Aeronautic Schools, New, Have High Standards.....	192	Diamond Factories, Many, Closed in Amsterdam.....	244
Aeroplane, Landing Field's Color may Affect.....	231	Dies, Button, Motor Driven Outfit for Regrinding.....	234
Air Craft, Hand Picked Men to Fly America's.....	203	Elephants, Two, Returned to Circus by Express.....	272
Army and Navy, Organization and Insignia of Our, by Searle Hendee.....	167	Elevator, Novel Outdoor, of a Courthouse.....	232
Army Hut, Portable, of English Design.....	279	Engine, New, of Two Cycle Fuel Injection Type.....	263
Automobile Body Packs Flat in Sections.....	257	Excavating Machine, New, Serves Many Purposes.....	172
Automobile Canteen Built in Compact Form.....	174	Explosion, Roar of Great War, is Heard in England.....	202
Automobile Engines, Supplementary Plugs for.....	278	Fan, Electric, Convenient for Wall or Desk Use.....	176
Automobile Stage, Track Laying Drive Used on.....	240	Feeder, Automatic, Teaches Hogs How to Eat.....	277
Automobile Tires, Warning Valves Protect.....	276	Fire Desolates Georgia's Capital.....	190
Automobiles, Combination Rack and Tire Holder for.....	234	Fire Protection Attained at Low Cost.....	240
Automobiles, Improved Bumper Rail for.....	187	First-Aid Work, Sanitary Iodine Swab for.....	176
Automobiles, New Front Axle Design for.....	236	Fish, Floods and Irrigation Cause Loss of.....	179
Aviation School, Million Dollar, near Detroit.....	257	Flag Painted on House Shows Owner's Loyalty.....	164
Ball Park Opening, Novel Symbols Employed at.....	178	Flags, Small, Clever Devices for Displaying.....	205
Barber Chair Attachment Simplifies Shampooing.....	245	Flash Light, Hand, Has Special Cut-Out.....	276
Battleship in City Park Wins Recruits.....	233	Flying Boat Pilot Killed in Making Weird Landing.....	224
Bottles, Machine for Sterilizing.....	254	Flying Corps Device, Red Centered Star Made.....	189
Brake, Simple, in Casting Reel Prevents Backlash.....	273	Foods, Ways to Save for Use in Winter.....	200
Bridge, New, Supports Old Steelwork during Razing.....	180	Frost, Fruit Growers Use Tower to Fight.....	181
Bungalow, Pleasing, Built in Eight Hours.....	179	Furniture of Ingenious Designs for Home or Summer Cottage.....	258
Car Workers' Light, Weak Batteries Utilized for.....	255	Garage Entrance, Safety First Guards at.....	252
Cartridge Case, The Evolution of a, by R. Traut-schold, M. E.....	237	Garages, Portable Wooden, Rented by the Month.....	246
Chair, Convertible, Has Many Uses.....	225	Garbage Burner, Spiral Grate in, Helps Heat Water.....	241
Children, Recreations for, and Ways They can Help Nation.....	280	Garden, City Lot on Hillside Terraced for.....	173
Cigars, Name Printed on by New Machine.....	231	Gasoline Gauge for Auto Takes Place of Tank Cap.....	278
Civic Features Promoting Comfort and Convenience.....	270	Gauge, Serviceable Radius, of Convenient Form.....	221
Coal Mine, Lawyer Has, Next to His Furnace.....	165	Golf Course, Transforming an Ocean Marsh into a, by Stanley W. Todd.....	249
Colleges, Keep Filled Is Patriotic Plea.....	246	Grains, Small, Endless Belts in Contact Hull.....	277
Collision Mars Launching of New Steel Vessel.....	187	Guard on Glove Protects Steel Workers.....	269
Collisions, Thrilling Mid-Air and Underwater.....	163	Gun, American, Continuous Firing.....	161
Comment and Review, by H. H. Windsor: American Women No Slackers.....	195	Horse and Engine Power Combined to Draw Loads.....	184
Cut Out Red Tape.....	193	Hose, Soldiers', in Making, Rules must be Followed.....	204
Essentials in Aviation Corps.....	194	Hospital Train, State's, Ready for War Service.....	173
Evolution of War.....	183	Iceless Food Container Inclosed in Water Bag.....	242
Corn, Frost Proof, Scientists Breeding.....	240	Insects, Bureau Gathers War Data about.....	164
Court Obtains Large Sum for Aid of Dependents.....	277	Knapsacks of Paper, Durable, Germans Make.....	279
Curtain Roller Mountings Held without Screws.....	252	Lamp-Posts Adorned with City's Emblem.....	260

(Continued on Page 6)

Popular Mechanics offers no premiums; does not join in "clubbing offers," and employs no solicitors to secure subscriptions. It is for sale by nearly every newsdealer in the United States and Canada.

This One



HNRL-ZXA-HAQQ Righted material

[Contents—Continued]

Lamps, Street, Disconnecting Hanger for.....	282
Lawn Roller, Spiked, Loosens and Aerates Sod	272
Lawn Sprinkler, Water Wheel Is Feature of New	172
Life Preservers for Use of Children.....	220
Lifeboat with Winglike Raft on Each Side.....	245
Lift, Portable, for Autos Eliminates Pit.....	268
Lock, Motor Car, Combined with Steering Wheel	248
Locomotive, Big, Wrecked by Queer Explosion.	222
Locomotive Leaps from Track Weakened by Fresnet.....	224
Logging Method, "Sky Line," of Western Camps	247
Machine Tests Sandpaper Samples on Steel....	229
Mission, California, Raise Funds to Repair....	264
Motion Picture Studio in Heart of Metropolis...	261
Motor Truck, Hoist Screws Raise Body of Self- Emptying.....	178
Motorcycle Made to Jump Like a Cavalry Horse	229
Movie Drawings, Lifelike, Made by Ingenious Means.....	224
Naval Alarm, New, Reveals Neglect by Man at Wheel.....	240
Novelties for the Home and Its Members.....	274
Nozzle, Revolving, for Fighting Ship Fires....	175
Oil Tank Makes Ten Mile Trip on Open Sea...	231
Ovens, Enameling, Loose Tops on, Neutralize Blasts.....	232
Paper Substitutes for Wood and Tin.....	273
Pavement, Asphalt Block, Withstands Auto Wear	242
Photograph of Eye, Girl's "Reflected" Image in	230
Photograph through Battle Smoke, Allied Airmen	201
Photographic Prints, Tongs for Handling in So- lutions.....	276
Police Station Lighted with Lamps of Auto....	228
Popcorn Cakes, Machine for Crisping.....	278
Potato Bed, Cubical, Enormous Crops Obtained from.....	185
Potato Planters, Car of, Shipped by Express...	278
Poultry Flocks Smaller than Three Years Ago...	225
Power and Pumping House for Country Home...	320
Printers, Registering Projector for.....	294
Printing Job, Patriotic, Done in Record Time...	255
Radiator, Electric, Wired to Any Lamp Socket...	257
Rail Breaking Machine Tears Up Tracks.....	252
Range Electric Cooking for Hotel Use.....	295
Recruit, Personal Comfort for the, by George M. Peterson, 1st N. Y. Cavalry.....	265
Red Cross Building a Memorial to Women.....	233
Report International, on Lake of the Woods....	184
Restaurant Tables, Lighthouse Signals for....	162
Roofing, Tinned Copper, Found to Be Defective.	168
Saw Serviceable as a Square, Attachments Make	239
Seat Arrangement, Novel, of Stage Line-Cars...	245
Shaft Sawing Machine, Portable.....	235
Shell Painter, Simple Rotary.....	174
Shingles, Many Thousand Shipped by.....	176
Ship, Japanese, Brings Envoy's Body.....	192
Ship Ways of Great Size Nearing Completion...	186
Ship's Deck Piled High with Cars for Alaska...	239
Sign, Highway, Perils in Desert Route Told In...	258
Signal, Big Warning, Fills Twofold Purpose....	223
Snow Screens, Railroad Plants Trees for.....	188
Soft Drink Outfit Mounted on Wheel.....	221
Spectacles Protect Eyes at the Movies.....	278
Stadium, Ohio Brigade Finds Space Abundant in	262
Street Car, Convertible, Has Extra Long Win- dows.....	256
Surveyors Build Towers in Primitive Fashion...	244
Swimming, Dry Land Method of Teaching....	177
Switch Button, Cover for, While Plastering...	158
Tables, Church, Serve Also as Benches.....	222
Telephone, Amplifier for, Is Useful Accessory...	272
Theater, Open Air, in Rustic Setting.....	269
Tires, Method of Retreading Travel Worn...	282
Tornadoes Work Havoc in Many States.....	190
Torpedo Shield, New, Flexible Steel Curtain...	182
Tractor, Low Priced Farm, Has Endless Belt Treads.....	164
Tractor Makes Long Haul over Western Moun- tains.....	244
Training Camp, Aladdin's, by Jack Lait.....	197
Trap, Lighted Shows Fish Still in Lake.....	180
Truck and Jack, New, for Handling Heavy Loads	256
Truck, Electric Floor, with New Features....	261
Tunnel Work, Storage Battery Lights Make Safer	248
Turbine, Steam, and Boiler-Feed Pump, Com- bined.....	253
Typewriters, Calculating Attachment for.....	182
Vegetable Vines Trained on Roof and Trellis...	262
Wage Earners, Growing Number of Wives Are...	202
War Breads Now Popular in Homes and Hotels	221
War, European: America Makes Ready to Meet Germans....	216
American and British Flags in St. Paul's....	215
Aspects of, from French Viewpoint.....	218
French Attack upon Enemy Lines.....	209
Life in Dugouts along Western Front.....	219
Our Boys at Work in the Business of War....	213
Side Lights on Fighters and Equipment.....	206
Sinking of French Ship "Sontay".....	210
Steel Shark, Ruthless, and Its Prey.....	209
U-Boats and the Business of Sinking Them...	212
Varied Phases of, Seen from Side Lines.....	217
Watch Dogs of the Sea Waiting for Cue.....	214
Wooden Crosses in Fields and Graveyards....	220
War Geography Depicted by Costly Relief Map	235
War Topics, Commencement Essays on, Sug- gested.....	278
Washing Machine for Car Seats.....	192
Waste Paper, Shredded, Supplants Excelsior...	166
Water Pipe, Pinhole in, Soon Proves Costly...	181
Waterproofing Shoes and Clothing, Method of...	228
Window Sash, Reversible, Cleaned from Within	232
Wool Shortage to Make New Styles Simpler...	234
Wreck of Big Drawbridge Delays Boston Com- muters.....	264
Wreck, Submerged, Fouls Lake Vessel.....	165
Zoo Settings, Concrete Casts of Mountains Used as.....	226

SHOP NOTES

Apple Packing Table Mounted on Wheels.....	297
Asbestos Packing, Liquid Glass Used to Make Stick.....	287
Automobile Tire Economy, Suggestions on....	302
Automobile Tires, Pointers on Care of.....	296
Bench Dog, Handy Sheet Metal.....	286
Blueprint and Roll Paper Box with Sheet Cutter	290
Blueprints, Washing Rack for.....	301
Commutators, Device for Undercutting Mica on	291
Concrete Walk, Wire Mesh for Rough Surfac- ing.....	295
Countershaft Arrangement, Double Drive....	301
Counting Small Parts by Weighing.....	289
Cutting a Glass Tube or Bottle.....	294
Engine Cylinder, Rigging for Reboring by Hand	300
Eye-glass Screws, Device Prevents Loosening of	300
Eyeshade Carried Safely under Shoulder....	289
File Cabinet, Revolving, on Double Desk Saves Time.....	295
Flowerpots, Charcoal Heating Stove Made of...	298
Forge, Charcoal, Made of Washbasin and Con- crete.....	285
Gauge Determines Diametral Pitch of Gears...	298
Gongs, Old Street Car, Used as Hardware Trays	291
Grade Indicator for Motor Vehicles.....	288
Grinder as Winch for Hoisting Countershaft...	292
Hack Saw Frame, Emergency.....	291
Hammer, Automatic, for Light Work.....	284
Hay Doors, Sliding Gable End, Easily Operated	289
Hydraulic Ram, Homemade.....	293
Jig for Piercings on Dies and Machine Parts...	292
Ladder End, Nonslipping.....	286
Ladder, Shop, Made of Pipe and Fittings.....	295
Lamp Standard, High Portable for Shop Light- ing.....	302
Lathe Dog, Steel Roller, for Making Small Spin- dles.....	288
Letter Paper, Economy by Use of Government Size.....	292
Nut, Engine, Recovered with Pill Box on Stick...	293
Oil, Can for Recovering from Chips and Sweep- ings.....	286
Pencil Sharpener with V-Groove Made from Files	294
Pick, Fitting a Handle to a.....	297
Plane, Homemade Rabbit.....	294
Razor Blade, Water, Device for Scraping Paper from Glass.....	300

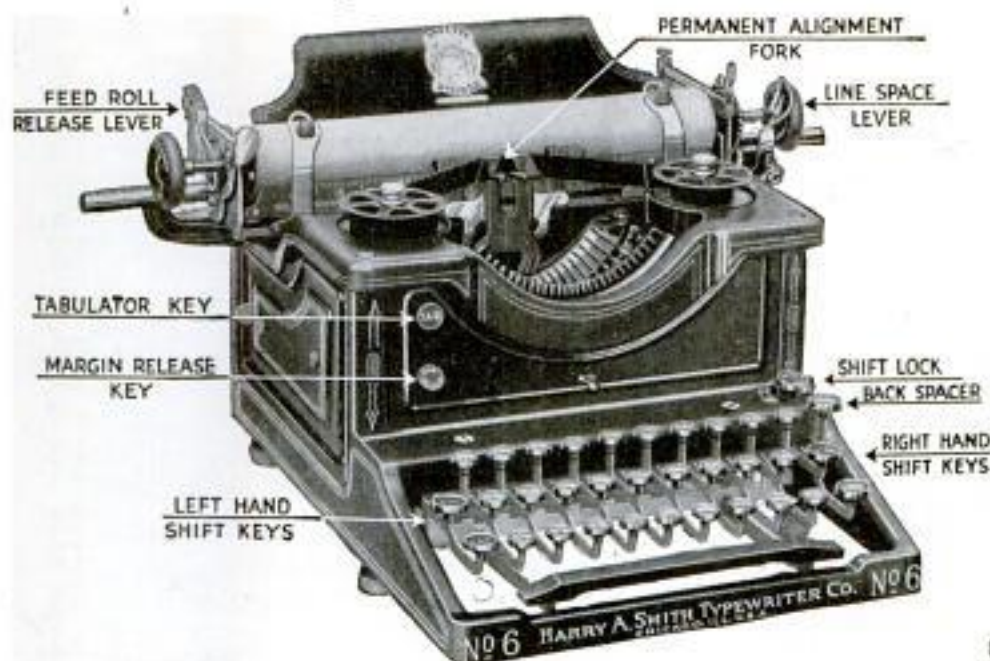

I want, through this advertisement, to establish as friendly business relations with you as I possibly can. I want you to realize also that it is my earnest effort and intention to give you full honest value for every dollar that you spend with me. This is the only way I can succeed. My advertisement has appeared in this magazine continuously for more than four years.

I am building up my business on the foundation of good value and square dealings. I am saving thousands of satisfied customers thousands of dollars, by supplying perfect—late style—visible writing—typewriters, at remarkably low prices.

All my transactions are handled throughout by personal correspondence. I assure you every courtesy and consideration in your dealings with me. Your order will have my prompt, careful, personal attention. I will be glad to do business with you.

Harry A. Smith

TYPEWRITER SENSATION

Free TRIAL—Use As You Pay

Send me only \$2.00 a month until the low total price of \$34.15 is paid, and the machine is yours

This is absolutely the most generous typewriter offer ever made. Do not rent a machine when you can pay \$2.00 a month and own one. Think of it—Buying a \$100.00 model for \$34.15. Cash price, \$32.30. Never before has anything like this been attempted.

Standard Visible MODEL No. 6

Perfect machines, Standard Size, Keyboard of Standard Universal arrangement, writing 84 characters—universally used in teaching the touch system. The entire line of writing completely visible at all times, has the tabulator, the back spacer; in fact, every late style feature and modern operating convenience. Comes to you with everything complete, tools, cover, operating book and instructions, ribbon, practice paper—nothing extra to buy. You cannot imagine the perfection of this beautiful reconstructed typewriter until you have seen it. I have a thousand of these perfect latest style Model No. 6 typewriters at this bargain price, and each purchaser fortunate enough to secure one of these beautiful machines must try it out in home or office for five days before deciding to buy. I will send it to you P. O. B. Chicago for five days' free trial. It will sell itself, but if you are not satisfied that this is the greatest typewriter bargain you ever saw, you can return it at my expense. You won't want to return it after you try it—you cannot equal this wonderful value anywhere.

You Take No Risk—Put In Your Order Now

When the typewriter arrives deposit with the express agent \$6.15 and take the machine for five days' trial. If you are convinced that it is the best typewriter you ever saw, keep it and send me \$2.00 a month until my bargain price of \$34.15 is paid. If you don't want it, return it to the express agent, receive your \$6.15 and return the machine to me. I will pay the return express charges. This machine is guaranteed just as if you paid \$100.00 for it. It is standard. Thousands and thousands of people own and use these typewriters and find them the best ever manufactured.

The supply at this price is very limited, the price will probably be raised when my next advertisement appears, so don't delay. Fill in the coupon today—mail to me—the typewriter will be shipped promptly. There is no red tape. I employ no solicitors—no collectors—no chattel mortgage. It is simply understood that I retain title to the machine until the full \$34.15 is paid. You cannot lose. It is the greatest typewriter opportunity you will ever have. Do not send me one cent. Get the coupon in the mails today—sure.

HARRY A. SMITH, 510-231 N. Fifth Ave., Chicago

H. A. SMITH
Room 510-231 N. Fifth Ave.
CHICAGO, ILL.

Ship me a No. 6 Smith P. O. B. Chicago, as described in this advertisement. I will pay you the \$28.00 balance of the SPECIAL \$34.15 purchase price, at the rate of \$2.00 per month. The title to remain in you until fully paid for. It is understood that I have five days in which to examine and try the typewriter. If I choose not to keep it I will carefully repack it and return it to the express agent. It is understood that you give the standard guarantee for one year.

Name

Address

.....Pop.Mech. Aug.

How to Learn Piano The Modern, Scientific Way

You Save Time, Effort, Money—
and Play More Artistically

Notable improvements have recently been made in teaching piano or organ. Difficulties which for generations have delayed beginners and troubled even experienced players have now been swept away through the scientific discoveries of experts. If you are already taking lessons or are thinking of doing so, be sure to investigate **at once** by writing for free 64-page book, "How to Study Music."

Short Lesson with Expert Better than a Dozen Other Lessons

This is the age of **EFFICIENCY**—in music just as much as in any other Art or Science. Now, more than ever before, your teacher must be an **EXPERT**, or you will waste months and years of time practicing in out-of-date ways. Your teacher must possess more than mere playing ability—**much more**. He must know **MUSICAL SCIENCE** as well—and such knowledge is very rare even in the largest cities. The old-fashioned system of studying with a "private teacher" is rapidly being abandoned. And anybody can see why. If you want the **entire** attention of your teacher, but can afford only a dollar or two for each lesson, you can get only **third-rate-instruction**. Whereas, if you join a **class** at a Conservatory, you can secure the services of a **real expert** at the same or **even less cost**—and you learn **correctly** and thus **more rapidly**.

Learn Right at Home—By Scientific, Guaranteed Method

Dr. Quinn's famous Written Method brings right to your home, **wherever you live**, all the great advantages of Conservatory study. You obtain a complete Course of Music Lessons which has been prepared according to the **latest developments** of scientific teaching and has been successfully used by **thousands** of men and women. **Satisfaction is Guaranteed.**

Easy to Understand—Music Furnished Free

The Course is fully illustrated with photographs showing every position and movement of the fingers, hands and arms. You can refer to these photographs at any time, day or night. You are **certain** of practicing **correctly**. Verbal instructions, given by a "private teacher," are unsatisfactory, because, even if correct, it is impossible to remember them **in full** when you practice. Dr. Quinn instructs and guides you at every step. You cannot go wrong, and no matter how far you continue your music you will never have anything to unlearn. All necessary music is included **FREE**. A diploma of internationally-recognized value is granted. Progress as rapidly or as slowly as you wish.

For Beginners or Experienced Players

The Course is entirely different from any other that you have ever seen or heard of. In thoroughness and in the subjects covered it corresponds to the usual three-year term of study. Yet it can easily be mastered in seventy-five weeks and some students finish it in less than a year. These prompt results are because the Course is systematic, and is carefully planned in advance; **not** because anything is omitted. Not a minute of your time nor an ounce of your effort is wasted. Nothing is forgotten or needlessly covered twice, because errors such as this would have been discovered and corrected long ago. Men and women who have failed by all other methods have quickly and easily attained success when using Dr. Quinn's method. It brings the same surprising results to either beginners or experienced players.

Endorsed by Distinguished Musicians

Among our graduates are thousands of accomplished amateur players, as well as prominent professional players, successful teachers and leading composers. We have enrolled more students so far in 1917 than in 1916 and 1915 combined. This is due to the remarkable results we have produced. The Course is endorsed by many distinguished musicians, educators and men of affairs who would not recommend any Course but the best.

Investigate Without Cost—Special Offer

Write today, using postcard, letter, or Free Book Coupon, for our new 64-page book, "How to Study Music." It is the most complete explanation of modern teaching methods ever published by a Conservatory. It tells how much the lessons cost, gives the records and opinions of our students and much other valuable information. Our Tuition Fee is greatly reduced just now on account of our Twenty-Fifth Anniversary Offer. Investigate without cost or obligation **NOW**.

Marcus Lucius Quinn Conservatory of Music
Studio KU, Social Union Building, BOSTON, MASS.

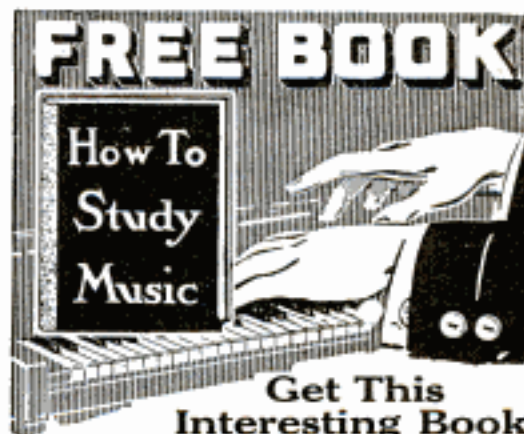

It explains how we teach you piano or organ in your own home by scientific methods which cut the time and the cost in half.

FREE Book Coupon

QUINN CONSERVATORY
Studio KU, Social Union Bldg., Boston, Mass.

You may send me without obligation or expense your 64-page Free Book, "How to Study Music," which describes Dr. Quinn's WRITTEN METHOD of teaching piano or organ at home in 142 lessons. Also tell me how much the lessons cost at the reduced Tuition Fee allowed this month as a Twenty-Fifth Anniversary offer.

NAME

ADDRESS

HAWKINS ELECTRICAL GUIDES

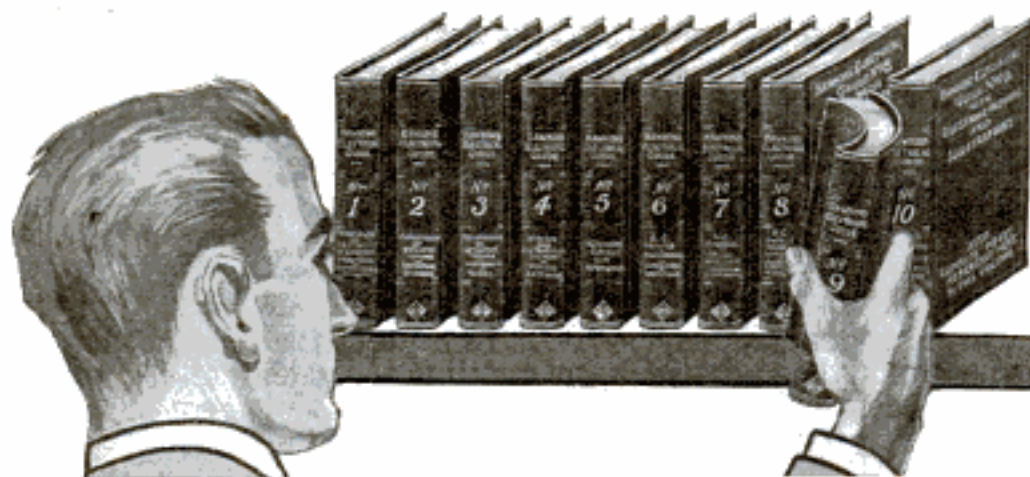

10 Volumes
3500 Pages
4700 Pictures

Pocket Size
Flexible Black
Covers

\$1 Per Volume
\$1 Per Month

An advertisement written entirely by men who have pushed ahead to greater success in Electricity through owning and using the Guides.

Helped Him Make Good

"It is only right for me to recommend highly the Hawkins Guides, for they have been of the greatest assistance to me in placing me in my present position as Superintendent of Construction Department of one of Ohio's largest Electrical Companies. I would like to see every man have a set of Hawkins Guides." Geo. Knecht, Columbus, Ohio.

A Man Who Arrived

"I am a machinist—I never professed to be an electrical machinist. But I received an unsolicited offer of a position in the Steel Works here (by the largest stockholder). And I want to say that I got my 'Juice' from Hawkins Guides. They are the only books for a man who wants to learn without having to wade first thru a lot of technical phrases he doesn't understand."

W. R. Hammer, Connellsville, Pa.

Up the Ladder

"While in Cuba, I applied for the position of Chief Electrician for the Government. I secured it, and though only a machinist I pulled through with the wonderful help of the Guides. With a repair shop, full supplies and three men, I had 100 telephones to care for, part of the system being under water. I also had the lighting system for shops and residences and wiring for power. Before that time I had never taken a transmitter or receiver apart. Owing to the climate, I later left there and have secured a fine position in the Westinghouse Electric Co."

William Cardell, Newark, N. J.

In the Naval Service

"I wish to state to you that I have resigned the position of Chief Electrician of Sears-Roebuck plant here in Dallas, and joined the U. S. Navy as an Electrician. Made a good grade which was largely aided by the Guides of Hawkins. I can highly recommend them."

Frank E. Lane, Dallas, Tex.

Saved Him Money

"Hawkins Guides saved me just \$3.50 the first time I looked through No. 10 Book. I had a spark coil played out, and that book showed me how to rewind it; and I made it as good as new. Hawkins Guides are the best ever."

H. F. Ramey, Piedmont, Mo.

Superintendent

"I am now superintendent of the Dunnville Hydro-Electric Systems, and Hawkins Guides were a great help to me in holding down a responsible position."

W. E. Swartz, Dunnville, Ontario.

Even in College

"I am attending Cornell University, but I use the Hawkins Guides every day for general information which I cannot get in recitation work or in laboratory experiments. I'll always speak a good word for the ever-ready Guides."

J. Winfield Kurtz, Joanna, Berke Co., Pa.

Wireless Operators

"I have worked wireless for ten years—but I wish I had these books years ago, as they have saved me a great deal of trouble."

H. Marshall,
Steamer M & B No. 2, Walkersville, Ont.

HAWKINS ELECTRICAL GUIDES

Help

"My work lately has comprised the supervision of four trucks and other cars; also the wiring and electrification of sundry buildings on our place—the C. W. Munson Farm Assn., Roslyn, L. I., including the Packing House, Hot Houses, etc. There's never a point comes up that Hawkins Guides do not help me to solve."

Jacob Weiss, Port Washington, L. I.

The Trouble With Them

"The only trouble I find with the Hawkins Guides is that everybody is always borrowing them. My set was even borrowed by a high school instructor for reference work in a physics class. I find them highly instructive."

Carl Hasenwinkle, Hettinger, N. D.

First Aid

"Number 10 Guide arrived all O. K. and completes the set, which I am very proud of. I don't think it would be possible to find a better set for either the beginner or the professional electrician."

Elmer A. Stevens,

U. S. S. Nebraska, Postmaster, N. Y.

In the Naval Electrical Dept.

"The Hawkins Guides are great help to me in the Naval Electrical Department, which they cover very thoroughly."

C. J. Cornell,

U. S. Receiving Ship, Brooklyn, N. Y.

Handy to Carry

"The great beauty of them is that you can carry them in your pocket. That suits me, for I

never want to be without them." F. S. Collins,
Richardson Engineering Co., Hartford, Conn.

Look Through This List of Subjects:

No. 1 Contains 348 pages, 388 illustrations. Electrical signs and symbols—static and current electricity—primary cells—conductors and insulators—resistance and conductivity—magnetism—induction coils—dynamo principles—classes of dynamos—armatures—windings—commutation—brushes, etc.

No. 2 Contains 348 pages, 394 illustrations. Motor principles—armature reaction—motor starting—calculations—brake horsepower—selection and installation of dynamos and motors—galvanometers—standard cells—current measurement—resistance measurement—voltmeters—wattmeters—watt hour meters—operation of dynamos—operation of motors, etc.

No. 3 Contains 300 pages, 423 illustrations. Distribution systems—wires and wire calculations—inside, outside and underground wiring—sign flashers—lightning protection—rectifiers—storage battery systems, etc.

No. 4 Contains 270 pages, 379 illustrations. Alternating current principles—alternating current diagrams—the power factor—alternator principles—alternator construction—windings, etc.

No. 5 Contains 320 pages, 614 illustrations. A. C. Motors—synchronous and induction motor principles—A. C. commutator motors—induction motors—transformers: losses, construction, connections, tests—converters—rectifiers, etc.

No. 6 Contains 298 pages, 472 illustrations. Alternating current systems—switching devices—circuit breakers—relays—lightning protector apparatus—regulating devices—synchronous condensers—indicating devices—motors—power factor indicators—wave form measurement—switch boards, etc.

No. 7 Contains 316 pages, 379 illustrations. Alternating current, wiring power stations—turbines: management, selection, location, erection, testing, running, care and repair—telephones, etc.

No. 8 Contains 332 pages, 436 illustrations. Telegraph—simultaneous telegraphy and telephony—wireless—electric bells—electric lighting—photometry, etc.

No. 9 Contains 322 pages, 627 illustrations. Electric railways—electric locomotives—car lighting—trolley car operation—miscellaneous applications—motion pictures—gas engine ignition—automobile self-starters and lighting systems, electric vehicles, etc.

No. 10 Contains 513 pages, 599 illustrations. Elevators—cranes—pumps—air compressors—electric heating—electric welding—soldering and brazing—industrial electrolysis—electro-plating—electro-therapeutics—X-rays, etc.

Also a complete 136-page ready reference index of the complete library. This index has been planned to render easily accessible all the vast information contained in the 10 electrical guides. There are over 13,500 cross references. You find what you want to know instantly.

SEND NO MONEY

The entire set of 10 Volumes

SHIPPED TO YOU FREE

EASY PAYMENTS

Accept the offer now—mail the coupon today. If you decide to keep the books you can make settlement at only \$1 per month until paid for.

THEO. AUDEL & CO.
72 Fifth Ave., New York, N.Y.

Send no money. Examine the books first. Use them for seven days in connection with your work, and decide for yourself that they are the most complete, the most helpful and the clearest written electrical books ever published.

This unusual offer is a sign of our confidence in the Guides.

Since we have not yet had the pleasure of business relations with you, we shall appreciate your giving us name of reference on line below.

Reference..... P. M. Aug. '17

A Short Cut to BIGGER PAY



No Money Down

The machine shops of this country are looking everywhere for trained men. The demand is an urgent one, therefore wages are higher than ever before, and opportunities for advancement were never better. Right now, the Machine Shop Library will help you qualify for the best machine shop positions. As you know, capable machinists are earning from \$35 to \$60 per week and many make twice that amount. The machine shop specialist practically commands his own price.

Records of Actual Machine Shop Practice — Compiled by Experts

The man who is exacting in his choice of books on new working methods will appreciate the Machine Shop Library, because every page is written by practical men, and widely known machine shop experts. The Library contains over 3000 pages of experience — ACTUAL FACTS — plainly stated. These books will save months of apprenticeship at ordinary wages. An hour or less per day is all that is necessary to place yourself in line for early promotion. Act now, by mailing the coupon for a free ten day examination. We pay shipping charges both ways.

10 Days' Free Examination

Let us send the Machine Shop Library to your home address, charges paid, for ten days' free examination. No one can judge the worth of the Machine Shop Library book until he sees it. If you feel that you cannot do without the Library after 10 days, simply send \$2.00 and the balance at the rate of \$2.00 monthly until \$16.00 has been paid. May we receive the coupon at once?

FREE EXAMINATION COUPON

McGraw-Hill Book Co., Inc., 239 W. 39th St., New York

Gentlemen:—I am interested in your Machine Shop Library. You may send me the nine volumes, charges paid, for my inspection. If satisfactory I will send \$2 in ten days and \$2 per month until I have paid the price of the books, \$16. If the books are not what I want, I will write you for shipping instructions.

SIGNATURE.....
 RESIDENCE ADDRESS.....
 CITY AND STATE.....
 NAME OF EMPLOYER.....
 ADDRESS..... PM-8-17

Please Mention Popular Mechanics

16 Easy Lessons

that teach you everything about automobiles. The book that tells it ALL.
The Automobile Instructor

By Clyde H. Pratt, B. Sc., M. E., Member Nat'l Society of Auto Engineers. 156 pages, 230 illustrations, cloth bound. Shipping wt., 22 oz.

New 1917 edition just out. The standard work for home-study, class-room and reference, for amateur and expert. A complete course for all who desire to master this profitable profession.

LEARN AT HOME HOW TO DRIVE AND REPAIR ALL CARS

Invaluable pointers for every car owner, driver, garage man and repair man. Adopted by Cleveland and other Auto Schools and by Boards of Education as their standard text-book. The author will answer your auto inquiries FREE. This book is guaranteed to be just what you want or your money back. (Auto schools, write for quantity prices.)

Price, postpaid \$1.50

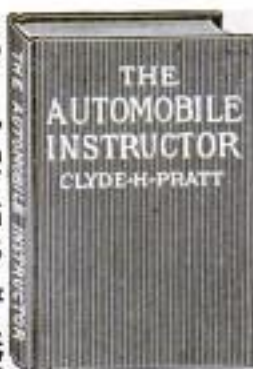

Motor Craft Encyclopedia illustrated. Tells how to build and operate Motor Boats. Best book on boats. Price, \$1.00.

5525 South Boulevard
Shrewsbury Publishing Co., CHICAGO, U. S. A.

Co-Operative Electrical Education

Learn by the thorough approved practical methods which our 13 years of specializing enable us to give you. No entrance examination or high school diploma required. Courses complete and condensed. Unnecessary theory eliminated. **Earn while you learn.** We furnish you with a position in an electrical or manufacturing concern for half a day at good wages. The remaining half day you get regular instruction in our extensive modern laboratories, testing and classrooms. Select one of the courses: One-year Practical Electricity. Two-year Commercial Engineering. Three-year Electrical Engineering.

Write for free illustrated book, mentioning age, education and course interested in. New term opens September 10, 1917.

School of Engineering of Milwaukee, 331 Stroh Bldg., Milwaukee, Wis.

The University of Chicago

HOME STUDY in addition to resident work, offers also instruction by correspondence.

For detailed information address
 25th Year U. of C. (Div. V) Chicago, Ill.



LEWIS INSTITUTE

An Endowed Polytechnic School for Both Sexes

Accredited. College work in Mechanical, Electrical and Civil Engineering, and in Mechanic, Household and Liberal Arts, leading to degree of B. S. High School Instruction in Science, Literature and Technology. Well equipped Shops and Laboratories. Day and Evening Sessions. Fall Term opens Sept. 11. Evening Classes Oct. 9, 1917. For Bulletin, address, Dept. 9

LEWIS INSTITUTE Madison and Robey Sts., Chicago

Learn Watchwork, Jewelrywork and Engraving.

A fine trade commanding a good salary, and your services are always in demand. Address HOROLOGICAL, Dept. P, Bradley Institute, Peoria, Ill., for our latest catalog.

AT HOME
Learn TO SING Send 2-cent Stamp for Helpful Booklet, "The Voice Made Beautiful."
 HARVEY SUTHERLAND, 1832P 49th St., BROOKLYN, N. Y.

COPY THIS SKETCH

and let's see what you can do with it. Cartoonists and illustrators earn from \$30.00 to \$125.00 or more per week. My practical system of personal individual lessons by mail will develop your talent. Fifteen years' successful work for newspapers and magazines qualifies me to teach you. Send sketch of Uncle Sam with 6c in stamps for test lesson plate; also collection of drawings showing possibilities for YOU. State your age.

The Landon School of Illustrating and Cartooning
 1438 SCHOFIELD BUILDING, CLEVELAND, O.





"I have always considered the study of

LAW

as an essential part of the liberal education of every American. I am in it to the finish."

J. Adam Bede

J. Adam Bede, ex-congressman, public speaker, man of affairs, so deeply realized the importance of a training in law that he enrolled with the LaSalle Extension University and is actively pursuing this course of study by mail. "More and more as our country increases in wealth, population and power" says Mr. Bede, "will it need the philosophy of the law as a steady influence in the conduct of its affairs."

The law trained man is today the man who is needed—not only in courts and legislatures—but in BUSINESS. Law gives the power of keen analysis, it develops the judgment and it enables a man to make quick, accurate decisions upon questions of commerce and finance which would confuse the untrained man. The legal expert is found in every large commercial organization as confidential adviser to officers and managers. The man who knows law is naturally preferred for the important executive positions. He often becomes one of the highest officials. The presidents of many of our largest corporations are men who won advancement through their knowledge of law.

And now any ambitious man can obtain, in his leisure hours, a thorough, practical training in this profession by means of the instruction given by

LaSalle Extension University

"The World's Greatest Extension University"

Capital \$1,000,000. Assets over \$2,000,000. More than 125,000 men of all ranks and positions, from office clerks to corporation officials, have benefited from LaSalle training and service. LaSalle students or graduates now can be found employed in the executive departments of practically all of the big railroads, business houses and commercial organizations in the country, such as Standard Oil Company; General Electric Company; Pennsylvania Railroad; Sears Roebuck & Company; Armour & Company; National Cash Register Company; Burroughs Adding Machine Company; American Telephone and Telegraph Company; Wells Fargo Express Company; etc. More than 70,000 officers and employees of business institutions throughout the United States have been enrolled for LaSalle courses.

A University Training in Law by Mail

The LaSalle course in Law gives you instruction by men whose reputations are international. You study under leaders at the bar—men whose works are read by eminent practicing attorneys and accepted as authoritative. You receive a university training in law by quizzes, lectures, text books, and examinations by men who have held or are now holding professorships in the law departments of Yale, Harvard and other famous institutions. The LaSalle course gives you essentially by mail, what you could otherwise obtain only by attending one of the established residence universities, at a much larger expense and at the sacrifice of your present earnings if you are now employed. And, under the Laws of Illinois we are authorized to confer the degree of L.L.B.

We bring the university to you. We enable you to obtain a law training while you hold your present position. This is democracy of education. This is how any man can get a real

chance to succeed by securing training which is in demand. Mr. Bede says: "I have marveled at the work your school is doing. Its influence for good cannot be measured."

Actual reports show that our law graduates pass bar examinations with unusually high averages. Many are successful practitioners while others occupy responsible business positions where their knowledge of law is a daily asset.

The fees are so moderate and the monthly terms so easy that even if your income is small you will not feel the cost—and the reward will come in the broad opportunities which are always open to the law trained man in business.

How better could you use your spare time than to get this training? Why not have law in addition to your present experience and knowledge? Why not prepare to fill a bigger and more remunerative position? At least write for information.

La Salle Consulting Service

Mail the coupon and learn how, as a LaSalle student, you will be entitled to the free use of our General Consulting Service which gives you the privilege of calling on our staff of experts in any department at any time when you need special help or counsel. LaSalle

Extension University is a clearing house of business information and through its highly specialized departments is organized and equipped to render a broad service which is not supplied by any other institution of similar character.

We will also send you our two valuable books "Evidence" and "Ten Years' Promotion In One." Mail the coupon now.

LASALLE EXTENSION UNIVERSITY

"The World's Greatest Extension University"

Dept. 864-F

Chicago, Illinois

LASALLE EXTENSION UNIVERSITY

"The World's Greatest Extension University"

Dept. 864-F

Chicago, Illinois

Please send your two books "Evidence" and "Ten Years' Promotion in One" also information on your University training in Law and on your Consulting Service free to LaSalle Students. This without obligation upon me.

Name.....

Address.....

Age..... Occupation.....



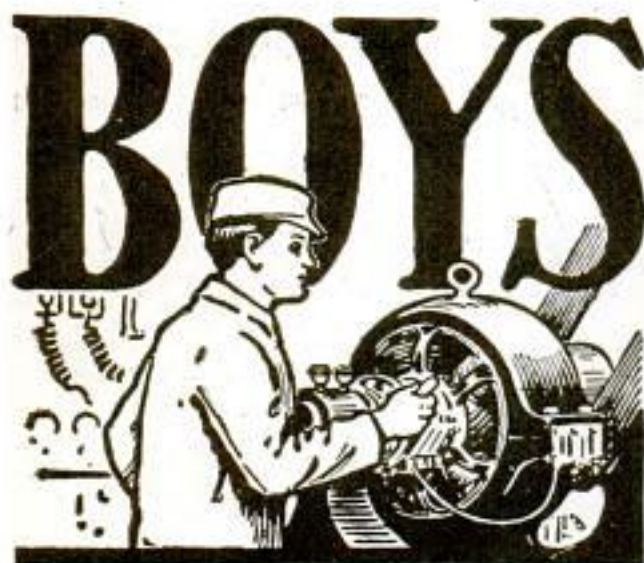

Big Money in Electricity

The Electrical industries offer wonderful opportunities to boys with a liking for Electricity. The salaries paid to trained men are large, promotion comes rapidly and, best of all, the work is fascinating.

The discovery and development of new lines (such as wireless telegraphy and telephony), from time to time, promise attractive and paying fields to those who wish to specialize. The *will to do* and *Special Training* will bring success to you.

The International Correspondence Schools can help you to become an expert in electrical work, no matter what branch you like best. Thousands of young men have already won success through I. C. S. help. You can do as well as anybody, *if you try*. Everything is made so clear that you can learn in your spare time, regardless of where you live or what your work. No books to buy.

There's big money in Electricity. Get after it by marking and mailing the Coupon today. *Finding out costs you nothing.*

INTERNATIONAL CORRESPONDENCE SCHOOLS

Box 5595, SCRANTON, PA.

Explain, without obligating me, how I can train for the position before which I mark X.

- ELECTRICAL ENGINEER
- Electrician
- Electric Wiring
- Electric Lighting
- Electric Car Running
- Electric Machine Designer
- Telegraph Engineer
- MECHANICAL ENGINEER
- Mechanical Draftsman
- STEAM ENGINEER
- GAS ENGINEER
- CIVIL ENGINEER
- Structural Engineer
- CHEMICAL ENGINEER

- ARCHITECT
- Architectural Draftsman
- Mine Foreman or Supt.
- Business (Complete)
- Bookkeeper
- Stenographer
- Advertising Man
- Salesmanship
- Window Trimmer
- Civil Service
- AGRICULTURE
- Poultry Raising
- AUTOMOBILES
- Auto Repairing

Name _____

Present Occupation and Employer _____

Street and No. _____

City _____ State _____

If name of Course you want is not in this list, write it below.

Please Mention Popular Mechanics

ENGINEERING



AND

Mechanical Trade Schools

of Highland Park College, Des Moines, Iowa

SCHOOL YEAR OPENS SEPT. 11, 1917

Civil, Electrical and Mechanical Engineering—Standard four-year courses completed in three years of forty-eight weeks each, and one-year courses in Civil, Electrical and Mechanical Engineering. Graduates holding some of the best engineering positions in the country.

Machinist and Auto-Machinist Courses—One-year Machinist and Auto-Machinist courses. Elaborately equipped machine shops and skilled mechanics for teachers. Graduates secure positions as journeymen mechanics.

Garage and Traction Courses—Twelve weeks' courses in automobile repairing and Traction engine shop work. Everything taught pertaining to the automobile and Traction engine—gas or steam.

Mechanical Drafting—One-year course, which fits students for any sort of drafting work. One of the largest and best equipped engineering and mechanical Trade schools in the country. Expenses most reasonable. Write for catalog. State course in which you are interested. Address

HIGHLAND PARK COLLEGE, 121 Euclid Ave., Des Moines, Iowa

EARN TELEGRAPH

Morse and Wireless—R. R. Accounting (Station Agency) taught. Splendid opportunities. Positions secured. Marconi Co. contracts to employ graduates. We own and exclusively occupy two large modern buildings equipped with R.R. and Western Union wires and complete E. K. W. Marconi Wireless Station. Largest school—established 45 years. Investment \$20,000. Endorsed by Railroad, Marconi and Western Union Officials. Expert practical teachers. Low living expenses easily earned if desired. Tuition low—easy payments. Correspondence courses also. Catalogue Free.

Dodge's Telegraph, Ry. & Wireless Institute
8th Street, Valparaiso, Ind.

LEARN WATCH REPAIRING

Be a watchmaker—you can learn this profitable trade by correspondence in a few weeks in your own home by the DeSelms Chart System. After you complete the course you will know a watch from A to Z. You will know just what the matter is and how to repair one. When you graduate you will be a practical watchmaker and repairer and competent to fill any position. Positions for our graduates.

Ask for our Free Book. It explains our system and terms.

THE DESELMS WATCH SCHOOL
23 Perry Street ATTICA, INDIANA



WM. H. AMELGER Milwaukee Motor School, 217-21 Seventh St., Milwaukee, Wis.

Men Wanted To Learn Automobile Business

EARN BIG MONEY—\$75 to \$300 Per Month

Only a few weeks required to train you. In six weeks I teach you to run and repair properly any automobile made. Learn to be repairman, demonstrator, garage manager and salesman. I teach thoroughly, practically and personally on real automobiles in everyday use. No books used. Tools furnished free. Actual practice on big, powerful cars brought here for inspection and repairs.

SEND FOR BOOKLET, "Making You Master of the Auto." Free upon request.



Draw Pictures that MOVE

The demand for animated cartoonists far exceeds supply. Get into this new, uncrowded profession now and

EARN \$25 TO \$200 A WEEK

Anyone with ordinary ability can quickly learn at home, in spare time. Write today for free book.

HARRY PALMER STUDIOS
25 VANDERBILT AVE., NEW YORK CITY.



Learn Electricity

in the Great Shops of

COYNE!

Practical training is the golden road to quick success. No mere books or theory can fit you to hold the big paying jobs. Here in our great shops you learn Electricity from the bottom up — under actual working conditions — as every great electrical expert must learn to completely master it. Here you handle actual equipment! Here you actually do the work that pays.

U.S. Needs Trained Men

The President says, "The Nation needs all men; but it needs each man, not in the field that will most please him, but in the field in which he is trained to best serve the common good."

The men we are training in these trades will be a big help to our country, whether in government service or private life, and at the same time make good money with splendid opportunities for the future. Start Now, you can finish in a short time.

Day or Evening Courses In

Drafting, Plumbing, Electricity, Bricklaying, Mov. Pic. Operating

Come to the great Shops of Coyne. Enter day or evening courses! Nothing bars you! Our tuition is so low it will astound you. You don't have to pay cash! We arrange acceptable easy payments if necessary. All tools and equipment are furnished free. Think of it! Your opportunity to thoroughly learn Electricity, Drafting, Plumbing, Motion Picture Operating, Bricklaying is right before you.

FREE Employment Bureau!

Don't let anything stop you! We maintain a Free employment bureau. We help worthy—serious young men get work while studying. We also help place graduates in big jobs.

BENNETT WELLINGTON COOKE, Director
COYNE TRADE AND ENGINEERING SCHOOLS

Dept. 119Z, 39-51 E. Illinois St., CHICAGO

Drafting Mechanical, Architectural, Builders' Course

Most thorough and complete Practical Courses in America. No correspondence. No mere copy work. Experts show you every move in our big shops. Check coupon for FREE Book.

MAIL COUPON FOR FREE BOOK

Get this book of Opportunity! From cover to cover it tingles with interest. Tells about our great shops! Covers many jobs open for Coyne trained men! Tells of great successes of Coyne graduates. Get this book by all means! It's free. Merely fill in the coupon, stating which trade you are interested in, and mail it now—at once!



B. W. COOKE Director, Coyne Trade and Engineering Schools
 Dept. 119Z, 39-51 E. Illinois St., CHICAGO

Please send at once your big Free Book of Opportunity. I am interested in—
 Electricity Drafting Plumbing Bricklaying Motion Picture Operating

Name.....
 Address.....
 Town.....
 State.....

Take a Pencil and make an "X"

A LITTLE X, like the one shown here, has marked the starting point for a good many big successes. It's an easy thing to make. Your pencil will make it in a jiffy BUT it may mark the turning point in your life.

These days the thing that puts a man above his fellows is TRAINING.

And this little "X" when marked on the coupon below will bring you a handsome free book that will tell just exactly how YOU can get the training that has put THOUSANDS of men into high positions. It won't be necessary for you to leave your home to get this training. For twenty years the American School has been giving ambitious men practical training that started them on the road to success

Send the Coupon

Take a pencil now and mark an X before the position for which you want to qualify yourself. Let us tell you how we have given other men the training that enabled them to hold these positions. Let us tell you how you can get THIS VERY TRAINING right in your own home during your idle hours. You will be under no obligations by sending the coupon.

Find out for yourself what the American School will do for you. Make your mark in the coupon now for the sake of your ambition and the man you want to be. Opportunity is calling. Your ambition is saying, send the coupon. Do it now.

American School
of Correspondence, Chicago, U.S.A.
Dept. G119C, Chicago, U.S.A.

Mark an X and Mail Today

- | | |
|---------------------------------|------------------------------|
| Electrical Engineer | Business Law |
| Elec. Light & Power Supt. | Business Manager |
| Hydroelectric Engineer | Auditor |
| Telephone Engineer | Accountant |
| Architect | Cert. P'd Public Acc't |
| Architectural Draftsman | Stenographer |
| Building Contractor | Bookkeeper |
| Building Superintendent | Fire Ins. Inspector |
| Structural Engineer | Fire Ins. Adjuster |
| Structural Draftsman | Fire Ins. Expert |
| Mechanical Engineer | Sanitary Engineer |
| Mechanical Draftsman | Master Plumber |
| Civil Engineer | Heat and Vent. Eng. |
| Steam Engineer | Plumb. and Heat. Est. |
| Shop Foreman | Reclamation Engineer |
| Shop Superintendent | Automobile Engineer |
| Sheet Metal Draftsman | Automobile Repairer |
| Lawyer | High School Course |

We also prepare for civil service examinations in all engineering subjects.

Name.....
Address.....

This Fob FREE

Are you interested in the mechanical side of an automobile, its proper operation and economical maintenance?

Owners—Garagemen—Chauffeurs

The *American Chauffeur* is a live monthly magazine featuring articles in common sense language, by "men who know," on instructive topics, which will be interesting and of great value to every auto owner, chauffeur and garageman.

FREE OFFER

To introduce the *American Chauffeur*, we are offering this plated lacquered watch fob, with seal grain leather strap, as illustrated, ABSOLUTELY FREE, with a 3 months subscription to the *American Chauffeur* at the regular price of 25c.

Your money refunded if either the magazine or fob does not come up to your expectation.

THE AMERICAN CHAUFFEUR
88 Butler Bldg., CINCINNATI, OHIO

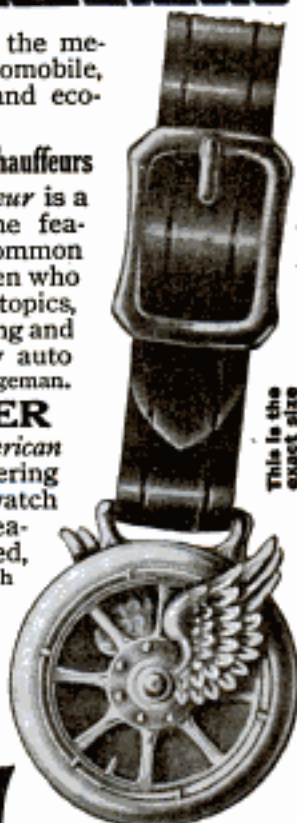

This is the exact size

Improve Your Voice

Send now for information on the famous Feuchtinger Method. A course of easy, silent exercises for the vocal organs. Used at home. Makes weak, harsh and husky voices strong and clear. Special attention to stammering and lipping. Recommended by greatest singers and speakers of Europe. No matter how hopeless your case may seem, send for literature.

Write Today for our literature, absolutely FREE and postage prepaid. Send for it now. Perfect Voice Institute, Studio C119, 1810 Wilson Ave., Chicago

IF YOU STAMMER

attend no stammering school till you get my large FREE book and special rate. Largest and best school in the world curing by natural method. Write today. Lee Wells Millard, Pres., North-Western School, Inc. 2317 Grand Avenue Milwaukee, Wis.

LEARN WATCHMAKING AND ENGRAVING

Earn while learning. Most practical watch school. Individual instructions. Graduates in great demand. Book free. Chicago School of Watchmaking, 63 E. Van Buren St., Chicago

Be an Artist
Comics, Cartoons, Commercial, Newspaper and Magazine Illustrating, Pastel and Crayon Portraits. By Mail or Local Classes. 10 FREE LESSONS. Write now. ASSOCIATED ART STUDIOS 30A Flatiron Building, New York

LAW High-Grade Instruction by CORRESPONDENCE

Prepares You for the Bar—Est. 1892

Four Courses: College, Post-Graduate, Business Law and Bar Ex. Review. Classes begin each month. Approved by Bench and Bar. University Methods, Unabridged Text-Books, Cases, Course in Oratory, Public Speaking and Most Court FREE with regular course. Graduates now practicing in every State. Write today for Catalog and Rules for Admission to the Bar. CHICAGO CORRESPONDENCE SCHOOL OF LAW, 520 Ruper Bldg, CHICAGO



Please Mention Popular Mechanics

Don't Envy Successful Men Be One!



BE AN EXPERT ACCOUNTANT

500,000 Firms Need Them—Only 2,000 in America

Today, in America alone, there are over 500,000 large firms that need annual or semi-annual audits. In every large city there are hundreds of openings for trained accountants. As there are only about 2,000 certified public accountants in America, the demand far exceeds the supply. For this reason the incomes and salaries paid are good. Just as soon as you complete the LaSalle Course, your chances for obtaining immediate employment will be excellent—no weeks or months hunting for a job—the position will seek you. If you complete the course with satisfactory grades you will be fully qualified for one of these positions.

We Will Train and Coach You In Your Home—By Mail—in Your Spare Time

Hold your present position. Earn while you learn. Study when you feel most like it. Advance as rapidly or as slowly as you desire. Study a little every day in your leisure time—part of which is now wasted. You can complete our entire course, become a master accountant—in less time than any other because our system will teach you the "working-knacks" and "short-cuts" employed by experts. In this our course differs from all others.

Quit—The "Shirt Sleeve" Class Why "grind" along, day after day, with the other untrained "help" waiting for a raise that may not come—and will be small even if it does? Determine to get out of the "shirt-sleeve" class. Resolve to bid goodby forever to hard work, long hours, and low wages. Decide to become a trained accountant—to direct others—and to draw a "man's" salary.

Choose Your Future Today—The first thing to do is to mail the coupon. If you don't do it today the chances are you never will. Quit dreaming—act. Write your name and address on Coupon. Mail it. We will send you by return mail the Free Booklet: "Ten Years' Promotion in One," also complete information concerning the course and 112 page catalog which explains state examinations, salaries, etc.

La Salle Special Guarantee

We give the student a written agreement signed by our Treasurer, that if the student completes the course with satisfactory grades, and fails to pass the Certified Public Accountants examination held in any state, we will give him special instructions and help—without additional charge—until he does pass.

La Salle Extension University, Dept. 864-H, Chicago
"The World's Greatest Extension University"

Under Personal Supervision of William Arthur Chase, C. P. A.

You will receive your training under the direct personal supervision of William Arthur Chase, an accountant of National prominence, who is Ex-Secretary of Illinois State Board of Examiners in Accountancy.

The Course was prepared by some of the world's most noted accountancy experts. It fully covers the field—Theory of Accounts—Practical Accounting—Cost Accounting—Auditing—Business Law, etc. It will prepare you for the C. P. A. Examination in any state.

The WAGES

Of Bookkeepers, Clerks and other untrained help is from \$12 to \$20 a Week

As long as you neglect to obtain special training you will belong to this class. You will be one of the "help." You must "keep your nose on the grindstone." You can't demand a raise because hundreds of men are willing to take your job—and for less money. No matter how honest or how faithful you are—or how hard you work—the wages will be not more than \$20 a week. That is the limit—you can take it or leave it. If you want more salary you must obtain special training—there is no other way. Why work hard for wages of from \$12 to \$20 a week when you can become a Trained Accountant and draw a real salary instead of mere living expenses.

The SALARY

Of Many Trained Accountants is from \$3,000 to \$10,000 a Year and up.

Trained accountants get large salaries because there are only a few hundred of them—while thousands of firms need them. For this reason an expert can demand and get big pay. Then why don't you become a trained accountant? It is not very difficult, after all. The La Salle System will make it easy for you. Our course is written in a clear and simple manner. Everything is fully explained. You cannot help but learn. Under the personal supervision of our instructors—and the coaching of our experts—you will soon be qualified to earn a good salary. With our help—if you have average intelligence, and are determined—failure is impossible.

La Salle Extension University
Dept. 864-H Chicago, Ill.

Send at once your Free Book "Ten Years' Promotion in One" and Catalog of your Course in Higher Accountancy and C. P. A. training. I am obligated in no way.

Name.....

Street No.....

City..... State.....

Please Mention Popular Mechanics

\$2⁰⁰ Per Day

Salesmen Get the Big Pay

\$2⁰⁰ Per Hour

The Man Who Makes the Goods

—and the Man Who Sells Them

Salesmen Earn \$2,000—\$5,000—\$10,000 a Year

Inside workers are a part of a non-business producing machine — their earning capacity is limited. Men who can sell, who have the power to persuade people to purchase their products, always command big incomes. They are the direct producers of profits — the life blood of any concern. It is the trained Salesmen who bring in the orders — whose services thousands of concerns today are seeking — and to whom they are willing to pay large commissions and salaries.

Be a Salesman—Earn While You Learn

Our Home Study Course in Scientific Salesmanship gives you the necessary training. It tells you how to prepare a "Selling Talk"—how to approach the prospect—how to manage the interview—how and when to close. It is the one system of practical training that links ability to opportunity and fits you to **earn while you learn**. Employers everywhere recognize the value of N. S. T. A. training. Our Employment Bureau has constantly on file more requests for salesmen than we can possibly fill.

64 Page Book

Write today for Free book "A Knight of the Grip" and list of hundreds of good openings offering opportunities to earn Big Pay while you learn. Address nearest office. Dept. 5078.

FREE

NATIONAL SALESMEN'S TRAINING ASSOCIATION

CHICAGO

NEW YORK

SAN FRANCISCO



You Have Natural Ability

THERE is one kind of work that you can do better than any other. Your natural ability fits you for it. And too, you will make more money in this job than in any other. To fit yourself into the right job that utilizes your natural ability is a difficult task. Some men never find the right jobs. But you can get help.

Analysis Free

We have helped thousands—and will give you the same analysis free. Will tell you how to line up your natural talents with your practical experience. The analysis is free.

Write today for the personal examination blank. Just send name and address. You'll be under no obligations.

**American School of Correspondence
Dept. G-819C Chicago, U. S. A.**

Learn to **PAINT SIGNS and SHOW CARDS**

I teach you personally, by mail, in a short time. Oldest and largest School. Big field, work interesting. You can **EARN \$18 TO \$45 A WEEK**

Wittmer, Minn., writes: "Did job after first lesson, got \$10, profit \$1.05." Crawford, N. C., says: "Earned \$200.00 while taking course." Get literature, samples, guarantee—all FREE.

DETROIT SCHOOL OF LETTERING
Established 1899. 208 D. S. of L. Bldg. DETROIT, MICHIGAN

LEARN WATCH REPAIRING



You can learn by our modern and original system of instruction every part of the Watch Repairing Trade at home as good or better than at a shop. You can earn money while learning and secure a well paying position or start in business after completing our course of instruction. Good watch repairers are always in demand and earn from \$20 to \$35 per week. For particulars apply to the Wisconsin School of Watchmaking, 517th Bldg., Milwaukee, Wis.

ELECTRICAL

Electricity, **THE BLISS ELECTRICAL SCHOOL**, with its well-equipped shops and laboratories, is peculiarly well qualified to give a **condensed course in Electrical**

ENGINEERING

including Mathematics, Steam and Gas Engines, Mechanical Drawing, Shop Work, and Theoretical and Practical Electricity, in all branches. Students actually construct dynamos, install wiring and test efficiency of electrical machinery. Course, with diploma, complete

IN ONE YEAR

For practical young men with limited time. 25th year opens Sept. 26th. Catalogue on request. 304 Takoma Ave., Washington, D. C.



These Are The Hours That Count



MOST of your time is mortgaged to work, meals and sleep. But the hours after supper are yours, and your whole future depends on how you spend them. You can fritter them away on profitless pleasure, or you can make those hours bring you position, money, power, *real success* in life. Thousands of splendid, good-paying positions are waiting in every field of work for men *trained to fill them*. There is a big job waiting for you—in your present work or any line you choose. Get ready for it! You can do it without losing a minute from work or a wink of sleep, without hurrying a single meal, and with plenty of time left for recreation. You can do it in one hour after supper each night, right at home, through the International Correspondence Schools.

Yes—You Can Win Success in an Hour a Day

Hundreds of thousands have proved it. The designer of the Packard "Twin Six," and hundreds of other Engineers, climbed to success through I. C. S. help. The builder of the great Equitable Building, and hundreds of Architects and Contractors, won their way to the top through I. C. S. spare-time study. Many of this country's foremost Advertising and Sales Managers prepared for their present positions in spare hours under I. C. S. instruction.

For 25 years men in offices, stores, shops, factories, mines, railroads—in every line of technical and commercial work—have been winning promotion and increased salaries through the I. C. S. Over 130,000 men are getting ready *right now* in the I. C. S. way for the bigger jobs ahead.

Your Chance Is Here!

No matter where you live, the I. C. S. will come to you. No matter what your handicaps, or how small your means, we have a plan to meet your circumstances. No matter how limited your previous education, the simply written, wonderfully illustrated I. C. S. textbooks make it easy to learn. No matter what career you may choose, some one of the 280 I. C. S. Courses will surely suit your needs.

Make Your Start Now!

When everything has been made easy for you—when one hour a day spent with the I. C. S. in the quiet of your own home will bring you a bigger income, more comforts, more pleasures, all that success means, can you afford to let another single priceless hour of spare time go to waste? Make your start right now! This is all we ask: Without cost, without obligating yourself in any way, put it up to us to prove how we can help you.

Just Mark and Mail This Coupon

INTERNATIONAL CORRESPONDENCE SCHOOLS BOX 5594, SCRANTON, PA.

Explain, without obligating me, how I can qualify for the position, or in the subject, before which I mark X.

- | | |
|---|--|
| <input type="checkbox"/> ELECTRICAL ENGINEER | <input type="checkbox"/> SALESMANSHIP |
| <input type="checkbox"/> Electric Lighting | <input type="checkbox"/> ADVERTISING |
| <input type="checkbox"/> Electric Railways | <input type="checkbox"/> Window Trimmer |
| <input type="checkbox"/> Electric Wiring | <input type="checkbox"/> Show Card Writer |
| <input type="checkbox"/> Telegraph Engineer | <input type="checkbox"/> Sign Painter |
| <input type="checkbox"/> Telephone Work | <input type="checkbox"/> Railroad Trainmen |
| <input type="checkbox"/> MECHANICAL ENGINEER | <input type="checkbox"/> ILLUSTRATING |
| <input type="checkbox"/> Mechanical Draftsman | <input type="checkbox"/> Cartooning |
| <input type="checkbox"/> Machine Shop Practice | <input type="checkbox"/> BOOKKEEPER |
| <input type="checkbox"/> Gas Engine Operating | <input type="checkbox"/> Stenographer and Typist |
| <input type="checkbox"/> CIVIL ENGINEER | <input type="checkbox"/> Cert. Public Accountant |
| <input type="checkbox"/> Surveying and Mapping | <input type="checkbox"/> TRAFFIC MANAGER |
| <input type="checkbox"/> MINE FOREMAN OR ENGINEER | <input type="checkbox"/> Railway Accountant |
| <input type="checkbox"/> Metallurgist or Prospector | <input type="checkbox"/> Commercial Law |
| <input type="checkbox"/> STATIONARY ENGINEER | <input type="checkbox"/> GOOD ENGLISH |
| <input type="checkbox"/> Marine Engineer | <input type="checkbox"/> Teacher |
| <input type="checkbox"/> ARCHITECT | <input type="checkbox"/> Common School Subjects |
| <input type="checkbox"/> Contractor and Builder | <input type="checkbox"/> Mathematics |
| <input type="checkbox"/> Architectural Draftsman | <input type="checkbox"/> CIVIL SERVICE |
| <input type="checkbox"/> Concrete Builder | <input type="checkbox"/> Railway Mail Clerk |
| <input type="checkbox"/> Structural Engineer | <input type="checkbox"/> AUTOMOBILE OPERATING |
| <input type="checkbox"/> PLUMBING AND HEATING | <input type="checkbox"/> Auto Repairing |
| <input type="checkbox"/> Sheet Metal Worker | <input type="checkbox"/> Navigation |
| <input type="checkbox"/> Textile Overseer or Supt. | <input type="checkbox"/> AGRICULTURE |
| <input type="checkbox"/> CHEMIST | <input type="checkbox"/> Poultry Raising |

Name _____
 Present Occupation _____
 Street and No. _____
 City _____ State _____

Please Mention Popular Mechanics

Be an Auto Expert



H. J. RAHE
President

Earn Big Money in Work You Like!

I can teach you to drive and repair automobiles and tractors in a few short weeks. Earn Big Money and be doing work you like. My graduates draw from \$75.00 to \$300.00 a month. Many are running big garages and repair shops of their own. A thorough mechanical knowledge means a great

future for YOU. NOW is the time to start. Soon YOU'LL be earning from \$75 to \$300 a month or **RUNNING A BUSINESS OF YOUR OWN**. Right now Trained Men are Needed more than ever before. I have

calls on my desk all the time for my trained graduates. Thousands of mechanics, electric starter experts, chauffeurs, tractor operators, demonstrators, garage managers, etc., needed right away. Get this training now and you can fill any of these positions and earn a big salary right from the start. **Don't waste your time and effort in work you don't like.**



Corner in My Large Motor Room I have scores of the latest types of automobiles right here in school—"Twin Six," Eight Cylinder, Willys-Knight Sleeve Valve and other latest makes, and they are here just for you to work on and get real practice and repair experience.

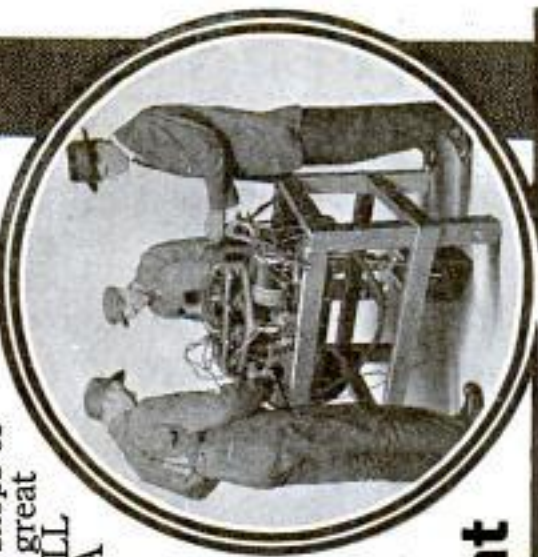

Learning to "Wire Up" Electric Starter Electrical work on automobiles is where most mechanics fall down. That's the reason my Electrical Department is one of the finest in the school. All the different types of electric starters, storage batteries, magnets, etc., mounted on live block motors for you to practice on.

Latest and Best Equipment

I have scores of the latest types of automobiles here for you to work on, lots of block motors, all types of electric starting and lighting systems, 28 Oxy-Acetylene Welding and Oxy-Hydrogen cutting outfits, big machine shops, automatic forges, driving cars, etc. You get real practice on these machines and this is what makes you an expert.

More Floor Space—More Instructors

Besides having more and better equipment in my school, I also have more floor space and more expert instructors. I have Three Large Buildings and a Large Tractor Farm. Plenty of room for each student, plenty of equipment to work on and Plenty of Instructors to give you personal instruction. Every one of my instructors is personally interested in each student. I have enough instructors and equipment and room so I see that each student gets Special Instruction if he needs it. I know you want to come here and learn this business and get a good position. We all want to do our level best to help you realize your ambition.

No Books Used—No Tools to Buy

I do not use any text books or printed lessons. EXPERIENCE is the best teacher. My Original Practical Method of Automobile Training means that you get real experience and actual practice all through the school. My graduates are very successful because of this thorough training. Line up with these thousands of successful graduates and you'll be a success in this business too. My graduates get Big Pay at steady employment in automobile work, and as tractor experts. You can learn just as quickly as they did. **Start NOW while the demand for men is so big.**

\$50.00 Tractor Course Free

For a very limited time I will give a Free \$50.00 Course in Gas Traction Engineering, Stationary Engines and Power Farming, to every man who enrolls for the regular automobile course. This is a big opportunity for you. Take advantage of it right away. When you enroll in my school you get a LIFE SCHOLARSHIP. This means that you can stay as long as you want to and come back at any time without paying another cent. Enroll now and get a life scholarship in both the gas tractor and automobile courses for the price of the automobile course alone.

H. J. Rahe, President

RAHE'S AUTOMOBILE & TRACTOR SCHOOL

593 E. 11th Street

Kansas City, Missouri

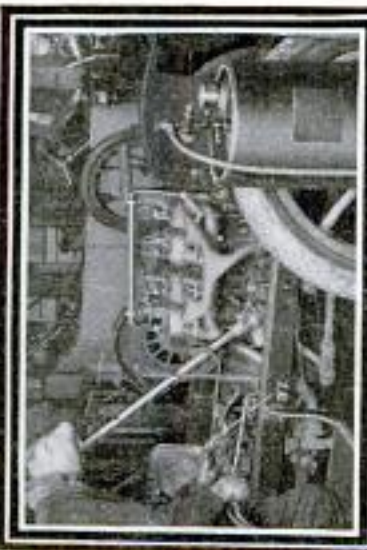

Student Welding Automobile Frame

I teach you Oxy-Acetylene Welding and Oxy-Hydrogen Cutting by my original practical methods. You do the actual work yourself with an expert to show you how. Thousands of good welding jobs open and I'll teach you so you can hold any of them.



Students Learning to Vulcanize

I was the first man to teach vulcanizing in my school, and I now have the largest equipment of this kind. I get a great deal of outside vulcanizing to do and you do the actual work on large casings, etc., so you learn quickly and thoroughly.

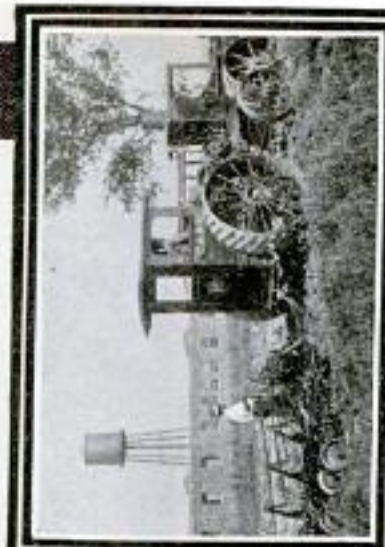

Complete Tractor Instruction

This just shows one of my big Tractor Engines on my Tractor Farm. The course here includes actual field practice on the different tractors as well as inside repair work. You learn to drive and repair tractors, both oil and gas.

Send for Free 80-Page Catalog—All I ask is a chance to show you my school by sending you my big, illustrated catalog. Full of pictures of students at work in my different shops; letters from graduates telling how they got started in this business through my school and made a big success. Send the coupon on this page and I'll mail you this book free of charge, also a Free Tractor Course Certificate.

Mail This Quick TODAY!

H. J. RAHE, President

RAHE'S AUTOMOBILE SCHOOL

593 E. 11th St., KANSAS CITY, MO.

Send me your Free 80-page catalog and reserve Free Tractor Scholarship without obligation on my part.

Name.....

Postoffice.....

Street or R. F. D..... State.....

Be A Certificated ELECTRICIAN

Your Future
is in Electricity—Obey
that "Hunch."
Get a Move on Yourself
—Here's Your Chance—
If You Act Quick I Will
Give You Special Per-
sonal Training at Home.
Only a Limited Number
of Students Can Secure
My Special Instruction
—ACT NOW.



CHIEF ENGINEER
Your Instructor

Qualify at Home
—With My Help
STUDY BY MAIL
My New Course and a
Common School Edu-
cation All You Need.
Fit Yourself in Spare
Time to Earn \$50.00
a week and Up.

SPECIAL

Earn While You Learn
Right After You Are Enrolled
I Will Give You a Short Course
in Quick Money-Making Elec-
trical Branch—FREE.

MY OFFER TO YOU:

If you act quick I will accept you among a few more students to complete Home Study class now forming. Grasp this wonderful opportunity. Fit yourself by a few months' fascinating Home Training to be a **REGULAR CERTIFICATED ELECTRICIAN**.

I have a splendidly attractive proposition for you. I **GUARANTEE** you satisfaction in the study of this great profession. Decide to enter it while you can do so on terms especially advantageous to you. Plan a glorious future. Secure for yourself the assured independence, the handsome income, the agreeable working conditions, the easy professional hours and the unlimited opportunities of trained and experienced Electrician.

FREE ELECTRICAL OUTFIT

For the next 30 days I am giving each student an Outfit of Electrical Testing Instruments, Tools, Electrical materials and Motor absolutely Free.

My instruction is by practical methods and this outfit is used in working out the lessons. Practical training with the theory makes perfect.

I am Chief Engineer of the Chicago Engineering Works, and I can give you the training that will land the big jobs and hold them.

I haven't the space here to tell you all the advantages, benefits and privileges **GUARANTEED** to my students. If you are

ambitious to make a big success in the greatest profession on earth—if you are ready to start right in and study Electricity the "easy" way—at home—mail me the **FREE "OUTFIT"** coupon without delay. I will send you full particulars of my personal instruction plan, my splendid laboratory and educational facilities, my wonderfully complete and fascinating course of bed-rock lessons, and my thoroughly practical method of making Electricity easy to understand and master. Write me **NOW**.

CHIEF
ENGINEER
424 Cass St.
Chicago, Illinois

Without obligation
on my part kindly
send at once, fully pre-
paid, particulars of your
complete Practical Home
Study Course in Electricity.

NAME.....

ADDRESS.....

TOWN..... STATE.....

CHIEF ENGINEER
Chicago Engineering Works
424 Cass Street, CHICAGO, ILL.

CLASSIFIED ADVERTISEMENTS

WORLD'S BEST WANT AD MEDIUM

We have records to prove that a classified ad in these columns will find a buyer for almost anything which can be sold. Doubtless you have some article of value to some one else which you no longer need. Why not turn it into money?

Advertisements in this section, 18 cents per word, each insertion, minimum 10 words, payable in advance. To insure ads being inserted under proper classified head in the September issue, copy must reach this office not later than July 30th.

Popular Mechanics Magazine, Chicago, Ill.

Gentlemen: We have been using your classified columns for some time and find them very satisfactory indeed. Your magazine is one of the few that we use practically every month of the year, winter and summer. We never continue to use a magazine unless it pays—and by paying, we mean in actual money, as we do not pay a great deal of attention to mere inquiries, and the fact that we continue to use your publication shows just what we think of it better than words could do.

Yours very truly,

LAKE COUNTY LAND OWNERS' ASSN.

AUTOMOBILES

PACKARD Runabout 5x5½, white enamel, top and bucket seat, perfect order, very fast 1908 Model, New rear tires. Make offer. Dampman, P. O. Box 109, New York City.

PAINT your own car for \$5. One afternoon of your time using Autonomel. Drive car next day. Send for booklet "B" and color card. Tells all. Autonomel Company, Rochester, N. Y.

HENRY FORD'S Tractor illustrated and described in detail in Motor Mechanics, Cleveland, Ohio. A big, interesting, profusely illustrated monthly magazine. Also covers autos, motorcycles, trucks, mechanics, lighting outfits, etc. Full of valuable information you need. \$1 per year, six months 50c.

INVENT Something; your ideas may bring wealth; free book tells what to invent and how to obtain a patent, through our credit system. Talbert & Parker, 4657 Talbert Bldg., Washington, D. C.

THE Modern Gasoline Automobile—Most complete and up to the minute automobile book published. Recognized as the standard book on construction, operation, maintenance and repair, showing every recent improvement. Over 700 pages, 500 illustrations. Cloth. Price, \$2.50 postpaid. Send for complete description of this and other reliable automobile books. Popular Mechanics Book Dept., 6 N. Michigan Ave., Chicago.

STORAGE Batteries Simplified—A complete new treatise on action—maintenance—repair—use. Describes fully the Edison, Edison, Gould, Willard, U. S. L. and other forms. Only complete and up-to-date book on subject. 329 pages, fully illustrated. \$1.50 postpaid. Complete description sent upon request. Popular Mechanics Book Dept., 6 N. Michigan Ave., Chicago.

GET into the Automobile business, as salesman, chauffeur, garage manager, mechanic. Automobile instruction in four weeks' residence course. Send for booklet P. M., West Side Y. M. C. A. Auto School, 218 West 57th St., New York.

CYLINDERS reground, new pistons and rings fitted. Restores lost power. Write for prices, giving make and model. The Everts Machine Co., Hartford, Conn.

PATENTS for Automobile Improvements are in great demand. We have special Automobile Department in charge of experts who are in touch with demands of trade. Write for "What To Invent and List of Patent Buyers," sent free. Victor J. Evans & Co., 158 Ninth, Washington, D. C.

AUTOMOBILE SUPPLIES

TIRES—Double Tread Guaranteed for good service. Absolutely Puncture-Proof. Big—Strong—Extra heavy. 30x3 tire, \$5.00; 30x3½, \$6.00; 33x4, \$9.00; 34x4, \$9.25; 36x4½, \$12.00; 37x5, \$13.00. Big saving on other sizes and tubes also. Trade in your old tires. Discount to dealers. 10% deposit required on C. O. D. orders. Send for list now! State size and head of tire. Max Liben & Co., 205B West 48th Street, New York.

MAKE \$15 daily profit selling our auto washer and other brush specialties; every car owner buys on sight. This is the best season for big sales. Every sale 100% profit. Puritan Co., Dept. M, 1963 Broadway, N. Y.

HB BATTERY Charging Pays Big Profits. City current or engine operates. Easy terms. Hobarts, Troy, Ohio.

AUTOMOBILE Mirrors—Carsafe, the only mirror on the market that can be turned on and off in a second without moving from the seat and will not lose its adjustment. Protects the eye of the driver from the blinding glare of the car coming from behind. Beautifully nickel plated. Standard type \$3.50. Ford type \$1.50. Very attractive proposition for agents. Samples prepaid for price. Western Atlantic Engineering Co., Sales Agents, 35 West 32nd Street, New York City.

AUTOMOBILE parts for most all makes of cars: Buicks, 10, 17, 19, 27, 29, 25 and 39. Maxwells, E. M. F., Flanders, Paige 25 and 35. Overlands 37, 38, 42, and 59; Cadillacs '09 to 1912. Parry, Regals '09 to 1913; Oakland, Jeffery, Mitchells '07 to 1913; Empire, Elmore, Chalmers '00 to 1913; Auburn, Jackson 35, Interstate 30, Hudson 20, Hupp 20, Ohio, Staver, Marion, Cole, Moline, Stearns and many others. Pistons, Connecting rods, Cam Shafts, Crank Shafts, Cylinders, Axles, Bearings and gears for most any make of car. Write us your needs. Satisfaction guaranteed. Auto Parts Company, 4116-18 Olive St., St. Louis, Mo.

UNUSUAL Bargains in Automobile Repair Parts. Axles, Bearings, Carburetors, Complete Engines, Cylinders, Differentials, Magnets, Pistons, Radiators, Springs, Valves, Wheels and other parts for Buick, Cadillac, Chalmers, Interstate, Maxwell, Mitchell, Moon, Overland, Packard, Peerless, Regal, Studebaker, Thomas and other cars. At a discount of 50% to 75% off manufacturer's list price. Maxwell Bros., 2931 Olive St., St. Louis, Mo.

AUTO Top Roof Covers Save you two-thirds price of new top; tailored to fit any car; easy to apply; \$6 to \$15, parcel post paid; seat covers \$5 and up; catalog and samples free. S. & H. Top Co., 430 Hunt St., Cincinnati, O.

GEARS for all purposes; transmission gears, bevel-drive gears, sprockets, axles. Special machine work. Must have old parts or drawing. Turley Gear Plant, 1565 N. 10th St., St. Louis, Mo.

GET into biggest money-making end automobile business—replacing necessary equipment. Live, ambitious men wanted as special factory representatives, exclusive territory, taking orders for tops, top coverings, seat covers, "Stik-Tite" Windows. No experience necessary. No capital required. No competition. Copyrighted system protects you. Free catalog, samples, full details. Cincinnati Auto Specialty Company, Dept. MA 87, Cincinnati, Ohio.

23% PROFIT selling Jubilee Spark Intensifiers to automobile owners, garages. Sure cure for Spark Plug troubles. Sells like wildfire. Brand new. Exclusive territory. Write today. Jubilee Mfg. Co., Dept. N-6, Omaha, Nebraska.

VULCANIZE your own tires; save money; full particulars free. Superior Vulcanizer Co., 16B Fulton Ave., Rochester, N. Y.

TIRES at wholesale. Send at once for our price list of Standard 4,900 mile tires at wholesale prices. We ship C. O. D. for examination. Overton Tire Co., Box 5, Osceola, Iowa.

VULCANIZE auto tires. Make big money. Learn with our book 50c. Vanderpools, Springfield, Ohio.

SPARK Plug Trouble?—Pronto Spark-Gaps Shoot any spark plug any condition. Pronto Spark-Gap Plugs, new combination; last forever. Wonderful demonstrations. Splendid proposition. Pronto Manufacturing Co., Omaha, Nebraska.

CUT your fuel bills in half. Install the economy gasoline saver, \$3.50. Agents wanted. Stephen Mack, Trenton, N. J.

DOUBLE Service Tires. Guaranteed to give good service. Size, 29x3, \$5.50; 30x3½, \$6.60; 33x4, \$8.80; 34x4, \$9.90; 36x4, \$9.90; 36x4½, \$11.00; 36x5, \$12.10; 37x5, \$12.10. Non-skid \$1.00 extra. 10% required on all C. O. D. orders. State if Q. D., straight side or clincher type. 5% discount if cash accompanies order. Also special discount to dealers. I. Jaffess, 1319-5th Ave., New York. Branch—241 West 54th St., New York.

HERCULES Carbon Remover—Equals 10 Gasoline. Increases Mileage. Sample Mailed, 15c. G. W. Ashton Co., Clinton, Iowa.

SAVE 50% to 70% on your next tire purchase. Our tires are practically blow-out and puncture-proof. Guaranteed for 3,500 miles. Send for illustrated catalog No. 4 and Price List. Tuxedo Auto Tire Exchange, 305 W. 54th St., New York City.

AUTO Necessity. Greatest Patented Gas-saving device known. One user means dozens. Exclusive territory to salesmen with autos. Rush. Valhalla Products Co., 1213 Carmen Ave., Chicago.

AUTO and marine engines, magnetos and carburetors; repair gears for all cars, steering wheels, tires and tubes. Prices on request. Atlantic Supply Co., Long Branch, N. J.

MOTORISTS Save Money Using "Glad." After testing, one firm purchased 14,400 cans. There's a reason. It satisfies. "Glad" is not a sell-once proposition. It repels. Representatives and dealers wanted. Fine protective contract. Write to-day. "Glad" Mfg., Galesburg, Illinois.

POWER increased; carbon eliminated; results guaranteed. Write for folder. Automobile Accessories Co., (G.) Baltimore, Md.

AUTOMOBILE Repairing Made Easy—The most needed and useful book on automobiles ever written. Only book of its kind—just out. Covers every phase of automobile repairing practice. 1,856 pages (5½x8 in.), 1,000 engravings. Cloth. Price \$3.00 postpaid. Send for complete description of this and other reliable automobile books. Popular Mechanics Book Dept., 6 N. Michigan Ave., Chicago.

EXPLOSION Whistle—Fits priming cup. First whistle adopted as standard equipment on any automobile. See display ad. Page 158. Buell Co., 1610 Michigan Ave., Chicago.

ENGINES, all makes, Carburetors, Magnets, Steering Wheels, Repair Gears, Tires and Tubes for all cars. Parts required at cheapest prices. Write Haviland Supply Co., Long Branch, N. J.

WELDING—Automobile Welding with the Oxy-Acetylene Flame—Just Out—187 pages, fully illustrated. Price, \$1.00 postpaid. Explains the actual welding of all automobile parts in a manner understandable by everyone. Popular Mechanics Book Dept., 6 N. Michigan Ave., Chicago.

SAVE 50% to 70% on your next tire purchase. Our tires are practically blow-out and puncture-proof. Guaranteed for 3,500 miles. Send for illustrated catalog No. 4 and Price List. Tuxedo Auto Tire Exchange, 305 W. 54th St., New York City.

JUST Out—Modern Starting, Lighting and Ignition Systems—A new book on automobile electricity without an equal. Nearly 400 Pages. 250 Engravings. Cloth. Price \$1.50 postpaid. Complete description sent on request. Popular Mechanics Book Dept., 6 N. Michigan Ave., Chicago.

ENGINES, Transmissions and Parts. State your requirements. Bertschy, Omaha, U. S. A.

AUTOMATIC Gear Cutting. Exchange your stripped fly wheel for one with steel ring gear attached. All kinds of gears made. We wreck all makes cars, sell the parts. No catalogues. Kent Auto Parts, Denver, Colo.

INSYDE Tyres. Inner armor for Automobile tires, double mileage and prevent punctures and blowouts. Quickly applied. Cost little. Demand tremendous. Profits unlimited. Details free. American Automobile Accessories Co., Dept. P2, Cincinnati, O.

FORD ACCESSORIES

DEMOUNTABLE wheels at \$5. Fords, Maxwells and Chevrolets. Quick, clean, cheap. Box 36, Wataash, Pittsburgh, Pa.

ELECTRIC lighting system, generator, complete, \$14.00. Croft Electric Co., Toledo, Ohio.

"HUNCHES"—thirty-eight helps for your Ford postpaid for quarter. Kuepfer Company, Dubuque, Iowa.

TO FORD OWNERS

ONE Dollar buys the best Gas Saver made for a Ford Car. Symons Brothers Company, 2611 E. Railroad Ave., Evanston, Ill.

\$1.25 LITTLE Wonder Gas Saver. Agent retails \$2.00 for Ford and Metz; runs 30 miles on gallon; applied one minute. Vanderpool's, Los Angeles, Calif.

PEUGEOT type Ford speedster. Lifesize patterns, blueprints, instructions, \$3. Photographs 10c. Peugeot-Ford Speedster Pattern Co., Omaha, Ill.

FORD Electric Lighting systems. \$37.50 complete. Goodlite Company, Indianapolis, Ind.

FORD Top Roof Cover \$6 and up. Easy to apply. You save two-thirds price of new top. Seat covers \$3 and up. Samples and catalog free. S. & H. Top Co., 429 Hunt St., Cincinnati, O.

BE our agent. Buy a Safety Ford Starter for \$3.00. Details for \$15.00. Try one, write for particulars. Safety Ford Starter Corporation, Columbia Theatre Bldg., New York.

MOTORCYCLES, BICYCLES & SUPPLIES

MOTORCYCLES \$50.00 and up. We are cleaning up all 1916 stock and offer you a real bargain in every machine listed. The first check or money-order gets each machine, no reserving. 23 single cylinder 1916 Flying Merkle Machines, complete, each \$120.00. 6 twin cylinder 1916 Flying Merkle Machines complete, each, \$165.00. Ten-speed for either item, \$20.00 extra. All the above have regular catalog specifications with Firestone or Federal Tires, 30 Model 15, 1916 design. Miami Power Bicycles, catalog specifications, all guaranteed, each \$30.00. 5 twin chain Merkle, second hand with Splittorf Mag. and Fed. Tires, worked over models, better than new, each \$110.00. 1 twin belt Merkle, second hand, with same specifications as above, in A-1 condition, \$85.00. 1 1913 Harley twin, chain drive, single speed, not run over 100 miles, a good buy at \$80.00. 1 Special Overhead Valve, Twin Chain Drive Merkle, motor built for racing. Has gone 80 miles per hr., \$135.00. Remember every machine is in first-class condition and the first money order received for each machine takes it. Specify a substitute in ordering. The Miami Cycle & Mfg. Co., 1520-1536 Grand Ave., Middletown, Ohio.

MOTORCYCLE Bargains: Fine line, Indians, Harleys, Excelsiors. These machines taken in on new machines and priced very low. Ship subject to inspection. Write for Free list 300, Clymer Motorcycle Garage, Greeley, Colorado.

BIG bargains in good motorcycles we have taken in exchange on new ones. Send for special bargain list. Shaw Mfg. Co., Galesburg, Kansas.

MOTORCYCLE Catalog and Encyclopedia of Accessories, Parts, Tires. Saves you money. Send for No. P-25, Sauley Supply Company, Gateway Station, Kansas City, Mo.

GET your Motorcycle or Bicycle at your price. Motorcycles \$25.00 up. Bicycles \$5.00 up (Guaranteed). Parts for all motorcycles and bicycles carried in stock; repairing. Send for big Bargain Bulletin. American Motorcycle Co., Chicago.

INDIAN 1915, Three Speed, and Side Car, \$215. Indian 1916, Three Speed, and Side Car, \$265. Claude H. Hawkins, Auburn, Pa.

FOR Sale—1913 Harley-Davidson twin. Guaranteed excellent condition, \$145. Everett Hough, Weston, Iowa.

MOTORCYCLE Bargains. Single and Twins, Hendersons, Harleys, Indians, Excelsiors, Kulturas, Emblems, Thors, Pops. All makes guaranteed. A-1 Shape, tuned up ready to ride, \$35 to \$100. Motorcycle tires, \$3. Lamps, \$5. Automobile tires, \$3. Bicycles, \$5. Tandems, \$30. Bicycle tires, \$1. Bicycles and motorcycles at Factory Prices. Old motorcycles taken in trade. Highest prices allowed for them. Soap in yours. Deninger, the Price Cutter, Rochester, N. Y. Send for Catalog. Free.

1916 INDIAN Twin Motorcycle. Never used. Agency discontinued. Price \$200. C. A. Merrill, 22 Central St., Winchendon, Mass.

25 NEW and used Indian motorcycles at a sacrifice, to close estate. Write for list. Albert Hanson, 212 Shukert Bldg., Kansas City, Missouri.

BICYCLES, Tires, all Accessories and things you want. Our new catalog saves you money. Write for Catalogue B-31 today. Sauley Supply Company, Kansas City, Mo.

SEND for our catalog. Hundreds of Used and Rebuilt Motorcycles, \$25 up. Myerow Bros., 149 Berkeley St., Boston, Mass.

SUMMER Unloading Sale in second-hand motorcycles. We have an overstock of all makes, such as Indians, Harley-Davidsons, Excelsiors, Pops, Merks and 4-cylinder Hendersons. All are in A-1 condition and fully equipped. If interested in buying a motorcycle write for our Bargain Bulletin No. 5 giving description and prices from \$35 up. Gotham Sporting Goods Co., 57 Warren St., New York City.

1913 INDIAN Twin, \$40.00. 1914 Two-speed Harley-Davidson, \$70.00. 1915 Harley-Davidson Speedster, \$100.00. Box 1080, Atlanta.

I SAVE you half on parts and accessories for all makes. Jones "The Parts Man," Box 691, Brockton, Mass.

CRADLE Spring Indian Twin equipped \$93.00, without equipment \$75.00. Indians, Thors, Harleys, Excelsiors, \$25.00 up. Everything guaranteed. Stamp brings list. Gleason, King Street, Worcester, Mass.

EASY Terms on new and rebuilt motorcycles, side cars, tandems, and lighting outfit. Motorcycle Investment Company, 808 Centre St., Brockton, Mass.

FIRST draft for \$50 takes 1914, 9 H. P. De Luxe. Will guarantee. Orville E. Miller, New St., Bernice, Indiana.

1917 EAGLE Motorcycles now ready. Get Circular M8, and agency proposition. Eagle Motorcycle Company, Brockton, Mass.

BARGAINS in used motorcycles—all machines guaranteed and in A-1 condition ready for use. Write for terms and new bulletin. Photos free. Harley-Davidson Sales Company, Birmingham, Alabama.

DON'T buy a Bicycle Motor Attachment until you get our catalogue and prices. Shaw Mfg. Co., Dept. 27, Galesburg, Kans.

MOTORCYCLES from \$25 up—New and second hand—easy terms—large list to choose from—all makes. Send 4 cents stamps for Bulletin "K." Peerless Motorcycle Co., Boston, Mass.

LARGE stock of rebuilt motorcycles, new parts for all makes 25% discount; second-hand parts, good as new, 50% discount. Motorcycle Parts Mfg. Co., Chicago.

BIG bargains in second-hand motorcycles, \$25 up, Indians, Harleys, Thors, Excelsiors and Merks. Write for description. Howard A. French & Co., Baltimore, Md.

MOTORCYCLE cylinders reground, fitted with new piston and rings, \$5.00, guaranteed. Muncie Piston Co., Muncie, Ind.

WANTED: We pay cash for used motorcycles or take them in on exchange for new machines. Write with complete description, State condition of tires, frame, motor, make and model. Shaw Manufacturing Co., Dept. 157, Galesburg, Kans.

WELDING

OXY-ACETYLENE Welding and Cutting, Electric and Thermit Welding. Brand new book of practical instruction in this process. The workman will find all necessary information for handling any kind of welding. 215 pages, fully illus. Cloth, \$1.00; Leather, \$1.50 postpaid. Popular Mechanics Book Dept., 6 N. Michigan Ave., Chicago.

AERONAUTICS

AVIATION. Send for free and prepaid literature on Aviation. Courses in Practical Aeronautics and Flying. Learn how you may prepare yourself for this fascinating and big paying profession at home. Special Limited Offer to all who write immediately. American School of Aviation, Dept. 7918, 431 South Dearborn St., Chicago.

WANTED—Prices on developing and making my Soaring Aeroplane, Patent No. 1,239,620. Also prices on Aeroplane motors from 4 to 20 H. P. Frank Summers, Memphis, Mo.

THE American School of Aviation offers new and complete Courses in Aviation. Exceptional opportunities open for men who write today for our Special Reduced Price Offer. American School of Aviation, Dept. 7928, 431 South Dearborn St., Chicago.

SUPPLIES: Sale of well-known manufacturer's obsolete stock. Rare opportunity. Everything. Radiators to Fuselage Fittings. All Bargains. Finest material only. Write for list. H. Doyle, 102 Brindley Street, Ithaca, New York.

PATENTS Wanted in Aeronautics—U. S. Government spending millions in this class for Army and Navy. Our Aeronautic Department will give full information on this subject upon inquiry. Write for "What to Invent," sent Free. Victor J. Evans & Co., 169 Ninth, Washington, D. C.

PROPELLERS for air Propulsion. Write for information and prices. The Crawford Motor and Aeroplane Manufactory, Pittsburgh, Pa.

AVIATION Dictionary \$1. cloth \$1.50. Languages Publishing Company, New York.

AEROPLANE Instruction—Thousands of aeroplane mechanics needed, right now. Will give 4 weeks' course on full-sized airplanes for \$110. No book study, but actual work. G. P. O., Box 1166, N. Y. C.

GET our latest Aeroplane Book containing full information about "Ideal" Model Aeroplanes, parts, plans, etc. 5c postpaid. Ideal Aeroplane Co., 82½ West Broadway, N. Y.

TANDEM Monoplane Glider, full size, how to make—Our book "Amateur Mechanics No. 6" contains a complete detailed description of how to make one and also over a hundred other interesting articles. Price, 25c postpaid. Popular Mechanics Book Dept., 6 N. Michigan Ave., Chicago.

BI-PLANE Glider, full size, how to make—Our book "Amateur Mechanics No. 2" contains a complete detailed description of how to make one and also over a hundred other interesting articles. Price, 25c postpaid. Popular Mechanics Book Dept., 6 N. Michigan Ave., Chicago.

BUILDING and Flying an Aeroplane—160-page handbook covering the building of small models and full-sized gliders and machines. In both biplane and monoplane models the well-known Curtiss and Bleriot types are followed. Fully illustrated with detail drawings. Price, \$1 postpaid. Popular Mechanics Book Dept., 6 N. Michigan Ave., Chicago.

HEATH Aerial Products and Supplies. Why are they the best and cheapest? It's the old story—quantity production. Aeronautical supply catalogue, 6 red stamps; propeller catalogue, 3 red stamps. Heath Aeroplane Co., formerly Heath Aerial Vehicle Co., Chicago.

AVIATION Motors, all makes, up to 150 H.P., \$250 up. Complete aeroplanes, all types, \$500 up. State your needs. Aero Exchange, 38 Park Row, N. Y. C.

BOOKS AND PERIODICALS

100,000 USED Books; catalogues 10c. McCarthy, 1236 Arthur, Chicago, Ill.

WORLD-ROMIC. Languages Masterkey, 55c. Languages Publishing Company, New York.

UTILIZE Your Table Scraps. Learn how to turn scraps into profits. Eat more poultry and eggs. Little space, big returns. Practical magazine tells how to house, feed and raise poultry at minimum cost. Only 50c a year. Sample copy 5c. Big Four Poultry Journal, 442 So. Dearborn, Chicago, Ill.

U. S. ARMY Infantry Drill Regulations, 58 cents. Field Service Regulations, 80 cents. Cavalry Drill Manual, 80 cents. Small Arms Firing Manual, 80 cents, cloth, postpaid. Also send for complete list of over fifty standard military and naval books. Popular Mechanics Book Dept., 6 N. Michigan Ave., Chicago.

ENGINEERS' questions and answers for license by Hobson, for twenty-five cents, postpaid. Send stamps. Helly's Book Store, Philadelphia, Pa.

BINDER for Popular Mechanics magazines. Best adjustable magazine binder on the market made especially to hold any number from one to six copies of this magazine with name "Popular Mechanics" in gold letters on front cover. No laces or cutting or perforating of pages necessary. Simple, unique adjustment; handsome, durable and neat. We buy in quantities and can offer our readers this regular \$1.50 binder for \$1.25, all shipping charges prepaid. Address Popular Mechanics Book Dept., 6 N. Michigan Avenue, Chicago.

NEW 1917 Catalog of Latest and Best Books on Mechanical, Electrical and Industrial Subjects, comprising 123 pages and adequately describing more than 400 works. Sent free upon request by Popular Mechanics Book Dept., 6 N. Michigan Ave., Chicago.

FIND Out for Yourself what to invent and how to procure and sell a patent for the same. My book, "Inventor's Universal Educator," covers the matter from A to Z. 140 pages, elegantly bound. Also contains 600 mechanical movements and 50 perpetual motions. Price \$1.00, postage free. F. G. Dieterich, 651 Ouray Bldg., Washington, D. C.

USED Books, Bargains. Catalog. Higgins's, A-2441 Post, San Francisco. (Books Bought.)

EDUCATIONAL AND INSTRUCTION

FREE Tuition by Mail: Normal Grammar School, High School, Bookkeeping, Shorthand, Typewriting, Civil Service, Agricultural, Drawing, Domestic Science, Engineering, Automobile, Salesmanship, Law and Real Estate Courses thoroughly taught by mail. Membership Fee, \$10.00; tuition free. For "Free Tuition Plan," address, Carnegie College, Rogers, Ohio.

ELECTRICITY—Learn it at America's largest and best equipped trade and Engineering School. Here you are taught by practical work on finest equipment. No books, no classes, no useless subjects to waste your time. 18 years of success. Write for our big free book of trades. Coyne Trade & Engineering Schools, Dept. 7102, Chicago, Ill.

"PRACTICAL bookkeeping and stenography boiled down," 50c. Marr, B-285, Nashville, Tenn.

CLYBER Invention. Samples 10c. Worth 50c. DeLoof, 8-247 Harmon, Detroit.

ARTISTS in big demand. \$30 paid for one drawing. Learn quickly at home, in spare time. Commercial Art, Cartooning, Illustrating, Designing. Outfit Free to new students. Handsome book free explains. Write now. Washington School of Art, 7108 H. St., N. W. Washington, D. C.

SHOW Card Writers in big demand. Men and women, we can teach you in six weeks if you can qualify. Send 25c for specimen lesson and analysis blank. Teen Brothers, Frankfort, Indiana.

CHEMICAL Plants, grow before your eyes; scientific wonder; materials 20c. L. Morrison, 47 Langdon St., Cambridge, Mass.

SPANISH Alphagam. Pronunciation Masterkey, 37c. Languages Publishing Company, New York.

GOOD Opportunities for Veterinarians. Send for Catalog. Grand Rapids Veterinary College, Grand Rapids, Michigan. Dept. Z.

WAR Atlas—Large 20-page (11x15 in.) Atlas of the War in Europe, containing large colored scale maps of the Battle-ground, showing Europe, Austria, Servia, Germany, England, Belgium, France, Russia, Italy, Greece, the World, etc. Special data showing comparison of armies and navies involved, pictures of rulers, etc. Price 30 cents postpaid. Popular Mechanics Book Dept., 6 N. Michigan Ave., Chicago.

IDEAL Atlas—Just Published—Contains large scale maps, yet is a book of handy size. Has special maps of all war zones in addition to all regular maps found in a good atlas. Is self-revising, that is, contains a certificate entitling the purchaser to a supplement of new maps after the war is over. Genuine flexible leather binding. 512 pages, 256 pages of maps, 256 pages of text. Price \$2.50. Cloth binding \$1.45 postpaid. Popular Mechanics Book Dept., 6 N. Michigan Ave., Chicago.

WANTED—New Ideas. Write for list of Patent Buyers and Inventions Wanted. \$1,000,000 in prizes offered for inventions. Our Four Books sent free upon request. Victor J. Evans & Co., 167 Ninth, Washington, D. C.

FINGER Print Instructor—A text book for the guidance of finger print experts and an instructor for persons interested in the study of finger prints. Book based on the Henry System and prepared by an expert. Cloth, 155 pages, illustrated. Price, \$2.00 postpaid. Popular Mechanics Book Dept., 6 N. Michigan Ave., Chicago.

MOULD making for ornamental casting. Particulars, 203 illustrations, free. Mahler, Woodhaven, N. Y.

ARTIFICIAL Marble, sanitary flooring, complete instructions, \$1. Ornamental casting, concrete, plaster, papiermache, decorations, garden furniture, statuary, rubber moulds, electrometallurgy. Particulars, 203 illustrations free. Mahler, D-721 Woodland Ave., Woodhaven, L. I., New York.

ROPP'S Calculator and Short-Cut Arithmetic—Shows the answer as quickly as a watch shows the time to all problems likely to occur in office, store, shop, bank, farm or factory. Over two million sold. Price, vest pocket size, 50 cents; leather, pocket size, \$1.00; large, desk size, \$1.25 postpaid. Complete description sent upon request. Popular Mechanics Book Dept., 6 N. Michigan Ave., Chicago.

LEARN Drafting—One of the most practical subjects, and indispensable in many occupations. Individual study at home without an instructor may be successfully carried on with the aid of our book, "A Practical Course in Mechanical Drafting," 169 pages, 157 drawings. Cloth. Price 50 cents postpaid. Popular Mechanics Book Dept., 6 N. Michigan Ave., Chicago.

TRADE SCHOOLS

ELECTRICITY, Plumbing, Bricklaying, Mechanical, Architectural and other Drafting Courses. Motion Picture Operating taught by practical work. Largest, best equipped practical trade school in America. Short time to learn. Small cost, easy payments. Write for big illustrated book; it's free. Coyne National Trade Schools, Dept. 1892, Chicago, Ill.

PRACTICAL Training in Paperhanging, Graining, Sign Painting, Showcard Writing. Chicago Painting School, 131 North Fifth Avenue, Chicago.

HILLES' Watchmaking and Engraving School, the largest and best equipped school in the West, 717 Market Street, San Francisco, Cal.

TELEGRAPHY

TELEGRAPHY—Morse and Wireless—also Station Agency taught. Graduates assisted. Cheap expense—easily learned. Largest school—established 42 years. Correspondence courses also. Catalog Free. Dodge's Institute, 15th St., Valparaiso, Ind.

THE Telegraph Instructor—Sixth and Revised Edition, just from the press—containing 348 pages of valuable information pertaining to railway and commercial telegraphy. Many illustrations showing how to erect a line, the different telegraph instruments, switch-boards and their different connections; numerous colored illustrations of train movements and semaphore signals as used by all railroads. Complete in every detail and written in language easily understood. Used by many telegraph schools as a text book. No student of telegraphy or telegraph operator can afford to be without this book. Price \$1.25 postage prepaid. Money returned if it doesn't please. Popular Mechanics Book Dept., 6 N. Michigan Ave., Chicago.

TELEGRAPHY—Morse and Wireless—taught at home in half usual time and at trifling cost. Omnigraph Automatic Transmitter will send, on Soudner or Huxzer, unlimited messages, any speed, just as expert operator would. Adopted by U. S. Govt. and used by leading Universities, Colleges, Technical and Telegraph Schools throughout U. S. Catalog free. Omnigraph Mfg. Co., 41-G Cortlandt St., New York.

PICTURES, POSTCARDS, PENNANTS

PRETTY view cards from everywhere. Membership and 6 pretty cards, 10c. Riverside Club, Knoxville, Md.

EXCHANGE postcards. Make many friends, 10c. Popular Exchange, Goshen, Ind.

WANT Postcards? Join Best Club. Trial 10c; six months 25c. Jolly Card Exchange, Decatur, Indiana.

IF you really want to exchange postcards, try our splendid club. Lists circulate in many countries. Membership, 10c. Halcyon Club, Box 133, Erie, Pa.

MEMBERSHIP 10c. TaLip Exchange, 74 Hook Ave., West Toronto, Canada.

CROSS-SECTIONAL view of ocean liner "Britannic," showing interior arrangement of ship in colors, size, 14x20 inches, on heavy plate paper for framing or hanging. Very interesting. Reproduced from front cover design of July, 1914, Popular Mechanics. Will be sent postpaid to any address in the world on receipt of 4 cents in stamps to cover packing and mailing. Popular Mechanics Magazine, 6 N. Michigan Ave., Chicago.

PATRIOTIC NOVELTIES

THE Declaration of Independence. Fine studio of the original, 19x28 inches for framing, 10 cents, postage paid. Lincoln Publishing Company, Dept. B, Cincinnati, O.

CAMERAS AND PHOTO SUPPLIES

ONLY purest ingredients used in manufacturing scientifically "Solo" Flash Powder. That's why sitters "look so natural"—not scored. Noiseless, smokeless, wasteless. Send \$9.50 for 20 oz. in 1/2 oz. moisture-proof boxes. \$1.00 for a 2-oz. "trial" box. Frank Harrison Co., Lock Box 96, Penn. Station Post Office, New York.

SAVE 25 to 60% on slightly used Kodaks, Graflex Ansco, Rexo and Premo Cameras, also Lenses of every description fully as good as new. Money back if unsatisfactory after ten days' trial. Write at once for our free Bargain Book and Catalog listing hundreds of slightly used and new cameras, also supplies at extraordinary low prices. Just out, the Rexo Vest Pocket, neatest little camera on the market. Special price, with high grade Meniscus Lens, \$8.45. Brand new, \$35—3 1/2 x 4 1/2 Auto Graflex with 6x7 Tessar to f:4.5 Lens \$59.75. \$9—No. 1 Kodak Jr., \$6.75. \$9—1A Promotee Junior RR Lens \$4.75. No matter what camera you want we can save you money. We carry a complete stock of Motion Picture Cameras and accessories. First-Class Developing, Printing and Enlarging at moderate prices. Our prompt and fair dealing will please you. Central Camera Co., Dept. E-3, 121 So. Wabash Av., Chicago, Illinois.

CAMERA—Kodak Bargains. New—right from the factory—Eastman 2 C Auto-graphic Kodak Jr. with R. R. Lens, \$14.00 model—our price, \$11.85. Ansco No. 2 V.P. with f:7.5 lens, regular \$18.00 model—our price, \$15.00. 3A Rexo Jr. with R. R. lens and special Ilex shutter, \$12.00 model—our price, \$10.80. Our big camera catalog shows new—right from the factory—and slightly used articles at from 10% to 50% saving. Every item guaranteed—10 days' free trial to insure your complete satisfaction. Save money—write for catalog now. See our display ad on page 158. David Stern Company. Everything in Cameras—in business since 1885. 718 Davesco Bldg., 1047 Madison St., Chicago.

SAVE Camera Money. Deal with Specialists. Everything in Photography. You save nearly half. Everything guaranteed and sold on our Liberal 10 Days' Free Trial Plan. Note these sample Bargains: No. 2 Premo Cart. Roll Film, New, \$4.50, \$2.50 No. 3 Ansco Roll Film, R. R. lens, New, \$12.75, \$9.00 1-A Graflex with Velostigmat f:4.5 lens, used, \$55.00. Write your camera problems to "America's Camera Headquarters." Send today for our famous Book of Bass Bargains. Bass Camera Co., Dept. 55, 109 N. Dearborn St., Chicago.

FREE Send negative for sample print. Film developed 5c per roll, print 2 1/2 x 3 1/4 3c each, 3 1/2 x 4 1/4 4c each. 8x10 enlargement 25c each for your own negative. Send for price list. M. A. Leese, 611 9th St., Washington, D. C.

ROLLS always developed and printed 15c. Cards 2 1/2c; guaranteed. Prepaid. Emil Sprauer, Hamilton, Ohio.

KODAK Prints Wanted. Make money with your camera. Send stamp for full particulars. Henry Shaw, Dept. 30, 44 Boylston St., Boston.

BEAUTIFUL transparent Photos easily reproduced on Watch Dials, Cases, etc. Formula and working instruction 25c. Restovall Formula Service, Irving Park Station, Chicago.

KODAK Films Free: Send 2 negatives for samples and Free Film Offer. Roll developed and 6 prints 25c. 10x12 Enlargements 50c. Homer Henry Co., Los Angeles, Cal.

FILMS Developed Free. High Class work. Perfect Prints. No charge for developing. Prints 3c to 7c. We do the best work in the Photo City. Send us your films and remit with order and get returns same day. Bryans' Drug House, Rochester, N. Y.

INVENTIONS Wanted in Motion Pictures and Photography. Special department for these classes of invention. Advice. What to Invent and List of Patent Buyers Sent Free. Victor J. Evans & Co., 159 Ninth, Washington, D. C.

FILMS developed 10c; prints 3c. G. W. Perkins, Tusculum, Ala.

DRY Plates Home-Made. Simple and easy process found after 29 years' experience. No special apparatus nor washing. Postal brings particulars. F. N. Blake, North Adams, Mass.

KODAK Films Developed Free. Prints from same 3c each. Only one roll developed at this price to show work. Bennett Studio, Sta. O., Cincinnati, Ohio.

FILMS Developed 10c roll. Six prints free. Ask for descriptive booklet. Roanoke Photo Finishing Company, 209 Bell Avenue, Roanoke, Virginia.

EQUIP your camera or Kodak with a Wellensak lens and shutter and obtain the best possible results. Beautiful descriptive catalogue "B" sent on request gratis. Wellensak Optical Co., Rochester, N. Y.

FILMS Given Free to introduce our superior developing, printing, finishing. Particulars for stamp. Artists Finishers, 850 Lockwood Avenue, Chicago.

THE Photo-Sketch: Combination of pencil work and the photographic image. Illustrated instructions for making these negatives, now 25c. Corydon G. Snyder, 3248 48 Ave. So., Minneapolis, Minn.

EVERYTHING for Flashlighting. Don't waste cash and invite accidents, when you can buy Prosch's patented Envelope Cartridges (plain or electric.) Give perfect results on sunless days. No nervousness, because they are virtually noiseless, smokeless, wasteless. Send for catalog. Outfits from \$5.00 up. Prosch Mfg. Company, Inc. (The Pioneers, in '62), 334 Fifth Ave., New York.

ENLARGEMENTS made from your negatives at low prices. Write for particulars and catalogue on photo supplies. Fahrwald Bros. & Co., Kildare & Cortland, Chicago.

FILMS developed, 10c; prints, 3c to 5c. A reputable Incorporated Company conducting largest existing plant. Price list and special offer. Enlargements our specialty. Chicago Photo Finishing Co., 54 W. Lake St., Dept. A, Chicago.

FILMS developed 5c, any size. Prints 2c each, all sizes. Free enlargement with first \$1.00 order. Johnson's Studio, Oswego, N. Y. 3 months' instruction in Photography \$10.00 at studio.

FILMS Developed, 10c, all sizes. Prints 2 1/2 x 3 1/4, 3c; 3 1/2 x 4 1/4, 4c. We give you Profit Sharing Coupons. 24-hour service, all work guaranteed. Send negatives for samples. Girard's Com'l Photo Shop, Holyoke, Mass.

"ECONOMIZE." Attach a film Economizer to your camera; use all of film for exposure and get seven pictures on six-exposure film. Pays for self many times over. Price One Dollar. State name of camera, film used and size. Satisfaction guaranteed. Voltz Mfg. Co., Sheboygan, Wis.

FILMS developed, 10c roll. Packs 20c; Prints, Brownies, 2c; 1a, 3x4, 3x5 and Post Cards, 3c. Returned next day. Prepaid. Kodak Film Finishing Co., 112 Merchants Station, St. Louis.

FILMS Developed, any size 5c. Any size prints 3c. 8x10 enlargements 25c. Work returned same day received. Address Camera Shop, Box 69, Ann Arbor, Michigan.

BIG Money Saved on Photographic Lenses and Apparatus—goods exchanged; repairing done. Ralph J. Goben, 5123 Kenmore Ave., Chicago, Department P.

MOTION PICTURES

EDISON Moving Picture machine, New, \$75.00. F. E. Russell, Bataria, N. Y.

SPECIAL Arc Generator produces current for half. Your engine operates. Easy monthly payments. Hobart, Troy, Ohio.

EDISON picture machine, good condition, cheap. Joe Dorothy, 271 West 141th, New York.

MOTION Picture Operation, Stage Electric and Illusions—The only practical handbook and guide published for motion picture operators, theater electricians and managers. A thoroughly practical and useful book, covering the subject comprehensively. Pocket size, leather. 393 pages, fully illustrated. Price \$2.90 postpaid. Popular Mechanics Book Dept., 6 N. Michigan Ave., Chicago.

WRITE for Free Copy "Hints on Writing and Selling Photoplays, Short Stories, Poems." Atlas Publishing Co., 271, Cincinnati.

MAKE Big Money in moving-picture business. We start you and furnish guaranteed outfit on easy payment plan. Easy to accomplish. Catalog free. Monarch Film Service, 228 Union Ave., Dept. P, Memphis, Tenn.

MAKE a complete Motion Picture Camera and Projector from instructions given in our book Amateur Mechanics No. 4. Full details given. Not hard to construct. Worlds of enjoyment taking and exhibiting subjects dear to the heart. Price of book only 25c, postpaid. Popular Mechanics Book Dept., 6 N. Michigan Ave., Chicago.

ARE You a Movie Type? Many of the greatest stars were discovered by accident. You want to know if you have the natural qualifications that bring \$53,000 salaries. The book Motion Picture Acting tells you this, also 191 screen favorites show you how they register 499 human emotions. Use of cosmetics, costume requirements and color schemes also treated. Price cloth 75 cents postpaid. Popular Mechanics Book Dept., 6 N. Michigan Ave., Chicago.

MAKE money writing Photo-plays; details free to beginners. No correspondence course. Producers League, 239 Wainwright, St. Louis.

BIG Profit Nightly—Moving Picture Business—small capital starts you, easily accomplished. Teach you—furnish everything. Ralph J. Goben, 5123 Kenmore Ave., Chicago, Dept. M.

BUSINESS OPPORTUNITIES

PATENTS and Inventions for sale or on royalty. My clients have valuable inventions for market. No better investment for manufacturers or individuals. Full information without charge. Mention line of invention interesting you and data will be sent. Richard B. Owen, Patent Lawyer, Owen Building, Washington, D. C.

PARTY in Brazil will act as buyer agent for dealer or user of Mica; want full instructions; sample on application. Gargasso-Caixa Postal, 1401 Rio de Janeiro, Brazil.

INVENT Something. Your ideas may bring wealth. Free book tells what to invent and how to obtain a patent through our credit system. Talbert & Parker, 4691 Talbert Bldg., Washington, D. C.

I MADE Good income last year as Business Broker. You can too, with small capital. Particulars free. Miss Jack Eydman, Chemical, St. Louis, Mo.

MAIL Order Business is your opportunity. Start as side line, the Brenner way, gradually earn good income. Business-like dealings, common sense, honest help, exclusive plan to every client; proved successes. Send 25c for information worth \$1; no free circulars. Brenner, 302 A Walnut, Philadelphia. \$1 brings all the above, also big collection of Mail Order handbooks.

ADVERTISERS—Mail Order Dealers—Increase your business and profits. Write for advice and book Successful Advertising, free. Warder Advertising Agency, 127 Warder Building, Washington, D. C.

RELIABLE Home Employment. Particulars for stamp. Delana Walton, Prairie City, Ill.

DON'T pay commissions. Get our plan of selling property, any kind, anywhere, without paying commissions. Co-operative Sales Agency, Minneapolis.

PRACTICAL Manufacturing Formulas—All Kinds. Claus, 1864 Harman St., Brooklyn.

BIG Profits Manufacturing Gas Tonic—Carbon Remover—Puncture Plugger—Automobile Polish—Mechanics Hand Soap—Non-Inflammable Clothes Cleaner—Rust Remover—Polishing cloths—Non-alcoholic tube flavors.—Formulas 25c each. 10 Luminous Paint formulas (different colors) 25c. Complete collection above \$1. Satisfaction Guaranteed. Bestvall Formula Service, Irving Park Station, Chicago.

GOOD monthly income easy in spare time manufacturing letters for signs. Free particulars. J. F. McPherson, 677 Brown Avenue, Butler, Pa.

ADVERTISE! 20 words in 120 monthlies \$1.00. Southwestern Agency, 1413-1 Berendo, Los Angeles.

INCREASED Income. No matter what your present employment may be, we can show you how to get more money for your services. Postal will do. National Efficiency League, 44 Boylston St., Boston, Dept. 11.

BE Your Own Boss. Easiest thing—right in your town. Small investment—sure profit with a Kingery Peanut and Popcorn Machine. Prices \$40 to \$400. Liberal terms. Ask for particulars and Catalog No. 61. Kingery Mfg. Co., 411 Pearl St., East, Cincinnati, Ohio.

500 FORMULAS, including Bestilvering Mirrors—Renewing Dry Batteries, Luminous Paint, Luminous Ink, 25c. Ideal Book Shop, 3315-C8, Belleplaine Ave., Chicago.

WANTED—In every town and city—men anxious to get into paying automobile accessory business. Protected territory; close co-operation; new plan; great demand; quick sales; large profits. Small capital. Write now for territory. Orolo Manufacturing Company, Dept. A, Louisville, Ky.

MEN aspiring to better positions. "I tell you how!" Write me, J. G. Weatherly, Troy, Ohio.

25 WORD advertisement in 100 monthly magazines, 3 months, \$1. Bennett, 426 East 149th St., N. Y.

THOUSANDS of Dollars will be made out of Fibro-Vac Guaranteed Puncture Plugger for Automobile Tires—I supply exclusive Formula for preparing this and Carbo-Cide, the only recognized Gasoline Intensifier-Decarbonizer—25 other Automobile Specialties—exclusive territory—particulars for stamp. Muller, Chemist, Tampa, Florida.

ERECT chain six-foot Advertising Thermometers in public places. Each nets you \$129 first year; \$170 succeeding years. Valuable "Opportunity" booklet telling how sent for dime. Winslow Cabot Company, 32 Congress Bldg., Boston, Mass.

CONDUCT a profitable Candy Kitchen; very small capital required; booklet free. Kennon School, 509 Wells St., Dept. A, Chicago.

INDEPENDENCE and fortune quickly attained in the Manufacturing Mail Order business. I furnish Formulas, Manufacturing processes and Trade Secrets in all lines. Sold under positive guarantee; 18 years' practical experience. Revision and improvement of Formulas and Processes—reduction of manufacturing cost—utilization of waste materials, etc., a specialty. Booklet, Formula List, and Valuable Information Free. W. L. Cummings, Ph. D., 127 Standard St., Syracuse, N. Y.

PATENTABLE Ideas Wanted—Send for 4 free books. R. B. Owen, 30 Owen Bldg., Washington, D. C.

MAIL Order Dealers. Let the 4 in 1 coupon plan increase your profits. Sell valuable instruction systems by cut price coupon under money back guarantee. Big margin. Small selling expense. Complete plan, sample coupons and bargain bulletin sent on request. Mail Dealers' Coupon System, 519 So. Dearborn St., Chicago.

MANUFACTURERS, Promoters and Patent Buyers are invited to write us stating the line of invention in which they are interested, as we can supply their wants in any class of patents. Victor J. Evans & Co., 162 Ninth St., Washington, D. C.

BIG money in promoting inventions. Write Adam Fisher Mfg. Co., 20612 Railway Exchange, St. Louis, Mo.

ENTER a new business. Earn \$3,000 to \$6,000 yearly in professional fees making and fitting a foot specialty, openings everywhere, with all the trade you can attend to; easily learned by anyone at home in a few weeks, at small expense; no further capital required, no goods to buy, job hunting, soliciting or agency. Address Stephenson Laboratory, 11 Back Bay, Boston, Mass.

WE start you in business furnishing everything; men and women make handsome income weekly operating our "New System Specialty Candy Factories" home or small room anywhere; no canvassing. Opportunity lifetime; booklet free. W. Ragsdale Co., East Orange, N. J.

INVENTORS: We develop and perfect inventions, make models, dies, tools. Metal stamping and special manufacturing. Gerding Bros., Lion Bldg., Cincinnati, O.

ADVERTISERS, Mail Dealers. Our New Rate Book lists 2,000 Principal Publications, rates, circulation. Includes 30 Mail-Order Plans. Free. Dearborn Advertising Agency, 210 Franklin Bldg., Chicago.

LEARN the real estate business; our enlarged instruction book teaches listing, appraising, management, salesmanship, insurance, brokerage, advertising, renting, agency, estates, titles, rights, forms, etc.; revised edition; 240 indexed subjects; excels \$25 correspondence course; buckers cover, \$1; silk cloth, \$1.25, postpaid. Realty Book Co., Dept. No. 29, Cleveland, Ohio.

MAIL-ORDER SUPPLIES

ARTICLES of genuine utility mean success for the Mail Dealer. Choice of hundreds. Write Merchandising Service Company, 309 Broadway, New York.

PRACTICAL manufacturing formulas, all kinds. Claus, 1864 Harman St., Brooklyn.

INCREASE your sales. Place your proposition before the readers of "Cartoons Magazine," 20,000 copies guaranteed every month. Classified rate 5c per word. Mail in a trial ad today. Cartoons Classified Dept., 78 E. Madison St., Chicago.

FOR ADVERTISERS

ADVERTISERS—Here's your opportunity. Your proposition placed before the readers of "Cartoons Magazine" for only 5c per word. Circulation 20,000 copies guaranteed. Send a trial ad for our next issue. Cartoons Classified Dept., 6 N. Michigan Ave., Chicago, Ill.

BUSINESS SERVICE

INCORPORATE. Our lawyers do the work, saving you time, annoyance and money in incorporating under the most liberal laws of Arizona. Laws and forms free. Southwestern Securities & Investment Co., Box D488, Phoenix, Ariz.

COLLECTIONS

DEBTS Collected Anywhere, Quickly! Established 25 years. William H. Dodd, 87 Nassau Street, New York.

AGENTS WANTED

AGENTS. Sell wholesale and retail. New Dimmer switch for automobiles. Just out. Large commissions. Easy sales. Apply immediately. Sills & Amidon, Omaha, N. Y.

AGENTS—Telephone appliance. The only instrument not an attachment. Approved by telephone companies. Big seller. Sensation of last business exposition. Write now for selling rights! Wellaphone, Inc., 1 Madison Avenue, New York City.

INVENT Something. Your ideas may bring wealth. Free book tells what to invent and how to obtain a patent through our credit system. Talbert & Parker, 4663 Talbert Bldg., Washington, D. C.

1917's GREATEST Sensation. 11-piece toilet goods combination selling like blazes at \$1.00 with \$1.00 Carving Set Free. Everybody buys. Eagle's profit first week \$51.00. Great crew proposition. Pierce Co., Dept. P, 906 Lake St., Chicago.

AGENTS financially responsible who understand heating plants to sell Blasco Fuel-Saving Devices on monthly payment plan. Every heating plant a prospect. Guaranteed to save 20%. Evaporation tests at two universities averaged 25% saving. Wolf Fuel Saver Company, 14 East Jackson, Chicago.

\$61.50 WEEKLY. Introducing and selling a new gas light burner for kerosene lamps. Beautiful light. No chimney. No mantle. Samples free. Luther Manufacturing Co., Dept. 314, Cincinnati, Ohio.

GOOD income refinishing chandeliers, brass beds, automobiles by new method, producing amazing results; no capital or experience necessary; particulars free. Gunmetal Co., Ave. H, Decatur, Ill.

PREPAID—2 dozen calling cards for 15 minutes' work. Become our agent. Majestic Printing Co., 3044 Leeward Ave., Los Angeles, Cal.

49 DAILY Easy—New Seller—Agents Wanted—Either Sex—Particulars Free. G. W. Ashton Co., Clinton, Iowa.

\$40 WEEKLY—Our patented cake mixer fits any suitable pan; solves the mixing problem, beats eggs, etc. Every housewife wants it, can afford it. Sells for \$60. Sample and particulars 35c postpaid. Beck & Co., Sullivan, Wis.

START an All-profit Mail-order Business. Add several dollars weekly to your income. Explanatory booklets for dime. No free particulars. Cutler Sons Co., Reading, Pa.

AGENTS. By my plan you get the latest offers of ten leading dealers every month free. Henry Shaw, Dept. 31, 44 Boylston St., Boston.

TRANSFER Initials for monogramming automobiles, motorcycles, trunks, etc., at wholesale prices. Write for samples. Globe Decalcomania Co., Dept. 7, Jersey City, N. J.

LIVE, awake agents for selling novelty Check Protector. Some good territory open; every person who has bank account wants one. Sample sent for \$1.50. Greer, 3339 East Colfax, Denver, Colo.

WORLD'S Fastest Selling Auto Accessory. County distributors wanted. Good profits. Write today. G. L. W. Spring Oiler Co., San Diego, Calif.

TAILORING Agents Wanted—Big complete outfit and case, nearly 200 large cloth samples, 3 piece lists and everything needed for canvassing, or use in store, free to live agents. \$25.00 to \$50.00 a week; may make more. Write us today for free elegant outfit to begin, cloth samples, wholesale prices, special offer on a suit for yourself and full information—see our wonderful values, beautiful fabrics and styles. Established 28 years. Every garment made to measure—everything guaranteed and express prepaid. Just send a postal. American Woolen Mills Co., Dept. 814, Chicago.

FREE sample of Famous product. Guaranteed proposition. Famous Products Co., 262 Citizens Bank Bldg., Decatur, Illinois.

PRACTICAL manufacturing formulas, all kinds. Claus, 1864 Harman St., Brooklyn.

AGENTS Wanted—To advertise our goods by distributing free samples to consumer, 90 cents an hour. Write for full particulars. Thomas Mfg. Co., 562 North St., Dayton, O.

EXCEPTIONALLY Good business proposition for agents—ladies or gentlemen—any color. The Rappe Company, Box 836K, Los Angeles, California.

AGENTS can make \$15.00 daily selling our sifter Wall Flour Bin. Sample prepaid \$2.00. Coffman Mercantile Co., Warsaw, Ohio.

SELL Fritz's Wizard fly and insect destroyer; 100% profit. Particulars and sample 25c. Fritz Chemical Co., Chicago, Ill.

AGENTS, 500% Profit. Sign-Letters for office and store fronts. Samples and particulars Free. Inter-States Letter, 2424 N. Halsted St., Chicago.

GENTLEMEN: Mason sold 18 Sprayers and Auto Washers one Saturday. Profits \$2.00 each. Square Deal. Write Rusler Company, Johnston, Ohio.

KETCH the Kaiser Checkerboard of War. New Game Novelty. Harvest for Agents, both sexes. Act quick. Particulars free. Checkerboard Mfg. Co., Fay Bldg., Los Angeles, Cal.

AGENTS. New \$2.50 Automatic Adder. Sell every business man. Big profits. No competition. Does work of high priced machines. Bassett, 5921-N Indiana Ave., Chicago.

AGENTS—with selling experience—to sell direct to consumer made-to-measure suits and overcoats, \$13.50 and \$17.50. If you want an independent business with Big Money, answer at once before territory is taken. Outfits furnished. Midland Tailors, Dept. 6, 19 So. Fifth Ave., Chicago.

QUICK—Snap this winner; brand new; big profits; sells on sight; unlimited field; free particulars. Sunnyside Co., 614 Sunnyside, Danville, Va.

AGENTS, \$60 a week to travel by automobile and introduce our 300 candle power coal-oil lantern. Write for particulars of our auto offer. Thomas Co., 862 North St., Dayton, Ohio.

SAFETY Paper Cutter, holds any razor blade. 40% Profit. Sample 25c. E. P. Wilson Co., 828 Francisco St., Los Angeles, Calif.

LUMINOUS Paint! Shines in the dark. Big seller to hotels, garages, etc. Any article can be coated with splendid results. Watches, clocks, electric switch plates, crucifixes, match boxes, etc. (Everlasting.) Only 25¢ a bottle. Luminous Paint Co., B-17, Douglas Park Station, Chicago, Ill.

AGENT-Dealers Join Manufacturing Syndicate. Manufacturing list mail for 10c. Manufacturers Syndicate Co., 2123 Madison Ave., New York City.

NACMA repeat order household products are big money makers. Catchy selling plan gets and holds the business. Free selling helps and samples. Exclusive territory. The Nacma Co., Dept. M-7, 20 W. Lake, Chicago.

NEW Knife Sharpener puts razor edge on any knife instantly without grinding. Demonstration creates sensation. 30 sales a day easy. Carry right in pocket. 100 per cent profit. Write for free sample offer now. American Products Co., 8639 Central Ave., Cincinnati, O.

AGENTS: Biggest moneymaker ever put on the market, "Eggette," the original egg substitute. Takes place of eggs in baking and cooking at less than ten cents per dozen. Sells rapidly to homes, stores, bakers, etc. A Guaranteed pure food product. Good opportunity to build permanent business with big income. No competition. Regular size package 10c equal to 12 eggs. Attractive moneymaking proposition free. Write quick. Bestever Products Co., B-4 Douglas Park Station, Chicago, Ill.

AGENTS: You can make big money taking orders for our fine made-to-measure clothes, so write quick for 60 beautiful cloth samples, 32 smart styles in rich colors, wholesale and retail price lists, lowest prices and best offer to agents, \$5.00 to \$10.00 a day easy. Big outfit, over 250 samples free to live wires. No experience needed—no capital. We furnish everything free—pay postage or express charges—back you, boost you, show you how and clearly explain everything. Costs nothing to try. Let us make you a stylish suit to measure to prove our fine quality and style. Send postal or letter today. Paragon Tailoring Co., Dept. 814, Chicago.

THE Ray Adding Machine—Complete for \$15, handsome desk stand free. Adds with speed and accuracy of highest priced machines—also actually subtracts. Saves time, money, labor. Convenient to have on desk or to carry wherever needed. Used by Hershey Chocolate Co., Barrett Manufacturing Co., etc. Order today. Money returned at end of 30 days if not satisfactory. Or write for further information, Ray Company, 1431 Power Bldg., Richmond, Va.

LARGE Manufacturer wants agents to sell guaranteed custom-made raincoats. We deliver to customer. Enormous profits. Defy competition. 1917 Outfit Free. "Aereo," 175 East Broadway, Desk P, New York.

\$1,000 PER Man per county. Strange invention startles world—agents amazed. Ten inexperienced men divide \$40,000. Korstad, a farmer, did \$2,200 in 14 days. Schlichter, a minister, \$195 in first 12 hours. \$1,200 cold cash made, paid, banked by Stoneham in 30 days; \$15,000 to date. A hot or cold running water bath equipment for any home at only \$6.50. Self-heating. No plumbing or waterworks required. Investigate. Exclusive sale. Credit given. Send no money. Write letter or postal today. Allen Mfg. Co., 311 Allen Bldg., Toledo, Ohio.

WANTED. General Agent to represent us in your locality. Exclusive territory. Big inducements. Chicago Agency Co., 840 Altgeld St., Chicago.

GET into biggest money-making end automobile business—replacing necessary equipment. Live, ambitious men wanted as special factory representatives, exclusive territory, taking orders for tops, top coverings, seat covers, "Stik-Tite" windows. No experience necessary. No capital required. No competition. Copyrighted system protects you. Free catalog, samples, full details. Cincinnati Auto Specialty Company, Dept. MC-87, Cincinnati, Ohio.

AGENTS. We have a good proposition for you. Write for particulars and samples. Chicago Agency Co., 838 Altgeld St., Chicago.

23% PROFIT—\$2.80 on each set sold. Newly invented Jubilee Spark Intensifier. Banishes spark-plug trouble forever. Sells on sight. Huge profits. Exclusive territory. Harry! Jubilee Mfg. Co., Dept. M-9, Omaha, Neb.

EASY, pleasant work for Mechanics. Shop Men, Clerks, during spare hours, will add many dollars to their salaries. Also want persons who can give full time. Big wages assured. Novelty Cutlery Co., 67 Bar St., Canton, Ohio.

PORTRAIT Agents, new and old, write us. We know what you want and need. Established 17 years. Pioneer, 1252 W. 63rd St., Chicago.

AGENTS Wanted! Sell Polishing Cloths, Rust Remover, Food Flavors, etc. 170 household necessities, guaranteed line, big profits, quick repeater, permanent business. Stuart & Co., 16 Main St., Newark, N. Y.

SAMPLE—5c for 15c water filter; be first; catalogue free. Suvio, 696 East 161st St., New York.

AGENTS sell Reliable Custom-Made Raincoats and Gabardines. Big commission. Complete sample line free. Temple Raincoat Company, Templeton, Mass.

AGENTS: Patriotic Novelty. Send time for 100 American Flag Stickers and Price List. Havitt Sales Agency, Grafton, W. Va.

AGENTS Wanted Everywhere—Best selling household article; large demand for goods; \$25 to \$50 a week; success assured; investigate to-day. Globe Supply Co., Keota, Iowa.

\$1.25 LITTLE Wonder Gas Saver. Agent retails \$2.00 for Ford and Metz. Burns 30 miles on gallon; applied one minute. Vandervoort's, Los Angeles, Calif.

SELL Old Glory stamps; big profits; sample 10c. Queen Novelty Co., Sta. F, Cincinnati, Ohio.

AGENTS Wanted—Tolliver Puncture-Proof Inner Tubes sell easily—our Agents make \$5.00 to \$50.00 a day net profit—no competition. If you wish to establish a business of your own with unlimited possibilities for profit, write us for complete details. Tolliver Tube & Tire Co., 523-C Foster Bldg., Denver, Colo.

BIG Profits selling our goods. Startling! Novel! Mysterious! Useful! Ornamental! Everybody interested. No experience necessary. Steady Work. Write Box 304, Yankton, S. D.

AGENTS—Send for sample "Fretnot"—the wash day wonder. Be convinced you can do a whirlwind business. You can clear at least \$20 to \$100 weekly, according to spare or whole time. You don't have to talk; if she doesn't buy at sight, leave sample; she will be looking for you long before you are able to make the rounds again. Samples furnished free. Premiums for your customers. Exclusive territory granted to agents who can produce. Credit given. Don't call. P. M. Metter & Sons, 3213 Warren Ave., Chicago.

ALL but millionaires buy on sight. Write or send dime for sample. Aero Supply, 37 Liberty St., New York.

500% PROFIT putting initials on automobiles. New transfer method, Particulars free. Auto Monogram Co., 2025 East Monmouth St., Philadelphia, Penna.

RUSH postal for Free Sample "Spik & Span". Wonderful new washing tablet. Washes clothes spotless, without rubbing. Tremendous seller. 200% profit. Free Samples to boost sales. Newberry Co., 212 Peoria, Chicago, Ill.

PHOTO Pillow Tops, Portraits, Frames, Sheet Pictures, Photo Plates, Pennants. Rejects credited. Prompt shipments; samples and catalogues free to agents; 30-days' credit. Jas. C. Bally Co., Desk 8, Chicago.

PORTRAIT Agents: Our goods will make you big profits. Delivery guaranteed. Rejects credited. Prompt shipments. Send for latest catalogue and prices. Adam J. Kroll & Co., 602 Blue Island Ave., Chicago, Ill.

SNAP this quick agents, brand new, big money, large field, sells everywhere; free particulars. Olive Home, Stickney, S. D.

AGENTS—Show our made to order guaranteed \$15.00 suits, real \$25.00 values. No experience necessary. Wonderful selling plan—you furnish prospects—we make the sale. Chicago Woolen Mills, Dept. A, Chicago.

THE Peoria Starter for Ford Cars. Practical, durable and guaranteed. The best mechanical Starter on the market. Some territory still open. Money maker for hustlers. Write for particulars and territory. The United Co., Peoria, Illinois.

AGENTS—Exclusive territory to sell Auto Headlight Glare Removers. Retail 35c per pair. 100% profit. Easily sold. Auto Glare Remover Co., Fisher Bldg., Chicago.

HUNDREDS of Agents are now making goods to sell from Miller's Guaranteed Manufacturers' Formulas. Wizard Washing Tablets—no wax, potash, lye. Costs 5c per pound. Brings 60c. Eggolene, only pure food substitute for eggs at 3c a dozen. Non-Alcoholic Tube Flavors. Ice Saving Cloths, many new sellers including latest Automobile Specialties. Carbo-Cide, the only recognized Gasoline Intensifier-Decarbonizer—80% profit. Enormous sales. Fibro-Vac Guaranteed Puncture Plugger. Exclusive territory. Particulars for stamp. Miller, Manufacturers' Chemist, Tampa, Florida.

SELL New, Martelous, Ballhorne. Sharpens old style or Safety Razors in 20 seconds. Retail \$1.00. Average 30 a day easily. Profit \$15.00. Enormous demand. Outfit to workers. Address, Ballhorne Co., 1403 Conway Bldg., Chicago.

AGENTS—Stamping names on Pocket Key Protectors; sample check with your name and address, 12c. Stamping Outfits, Emblem Checks, Check Pouch, Name Plates. Hart Mfg. Co., Desk 2, 303 Degraw St., Brooklyn, N. Y.

SIGN Letter Agents and Painters: 500% Profit Gold and Silver Sign Letters for Stores and Office Windows. Anyone can put on. Big demand. Free samples. Metallic Letter Co., 404 N. Clark St., Chicago.

HUGE profits selling Nibco Sanitary Brushes, Auto Washers, Brown Beauty Adjustable Floor Mops, Dustless Dusters, and other specialties. Big line. Fast sellers. Write today. Silver-Chamberlain Company, Department M, Clayton, New Jersey.

FREE sample with particulars. No splashing water strainers. Easy seller. Returns big. Experience unnecessary. Union Filters Co., New York.

"MO-BE-CO" Agents make \$10 per day easily selling toilet preparations. Moen-Berg, Fosston, Minn.

MAN Wanted in each country community and every small town, to wear beautiful new tailored-to-order suit of clothes and be Agent in spare time among friends, relatives and neighbors. Confidential wholesale prices given, good profit on each order. No experience required, we teach you all you need to know. Write at once and get gorgeous, illustrated book of cloth samples free, and full instructions. Banner Tailoring Co., Dept. 695, Chicago.

STATE Representatives and Agents—We want men of known ability for best line of Cutlery offered for salesmen. Extremely liberal margins. Dept. P, Aerial Cutlery Manufacturing Company, Marinette, Wisconsin.

LARGE Manufacturer wants representatives to sell shirts, underwear, hosiery, dresses, waists, skirts, direct to homes. Write for free samples. Madison Mills, 503 Broadway, New York City.

AGENTS make 500 per cent profit selling our Auto Monograms and Initials. Window Sign Letters, Changeable Signs, and Show Cards. 1,000 Varieties. Enormous Demand. Sullivan Co., 1123 Van Buren St., Chicago, Ill.

WASHING Compound Agents—Ho-Lol-Hu-Na, Great Hawaiian Washing Secret (Improved)—Washday Wonder of the Age. Become District Sales Agent and make \$2,500 to \$5,000 a year. Cinch exclusive territory now. Get twice the money for your work. Opportunity is knocking. Adam Fisher Mfg. Co., Agency Dept., 2061, Ry. Exch. Bldg., St. Louis, Mo., U. S. A.

NINETY Per Cent of Your Calls Turned into Sales! Wonderful Enthusiasm Follows Every Demonstration! Write at Once for Full Particulars of Our Line of Eradium (Luminous) Articles. Startling! Mysterious! Everlasting! Novel! They Shine in the Dark. Crocifixes, House Numbers, Bulbs, Match Boxes, Pictures, Switch Plates. Sole Manufacturers, The Pioneer Corporation, 1259 W. 63rd, Chicago.

A \$2.50 PREMIUM with every \$1.98 sale and 70 cents profit for you means Big Daily Profits. Free Sample. Box 500, Shreveport, La.

AGENTS for newly invented article, novel, useful. In demand among all classes everywhere. Fast seller, popular price, no competition, big profit. The Geo. W. Clark Co., Clark Building, Jacksonville, Fla.

MAN or Woman to travel for old-established firm. No canvassing; \$1,170 first year, payable weekly, pursuant to Contract. Expenses advanced. G. E. Nichols, Philadelphia, Pa., Pepper Bldg.

YOU can be your own boss with our Key Check outfit. Good for \$5 a day stamping names on pocket key checks, fobs, etc. Sample check with your name and address, 15 cents. Pease Die Works, Dept. M., Winchester, N. H.

NEW Patriotic War Atlas Free with my 1917 "Business Guide". Sells everywhere. Beginners clear \$7 daily. 50% commission. Outfit free. Prof. Nichols, Box P. M. 3, Naperville, Ill.

AGENTS Wanted. To Handle Our Hair and Fibre Broom that Takes the Place of the High-Priced Corn Broom. Write for Protected Territory. 100% Profit. Jos. Henssler & Son, 57 E. 43d St., Chicago.

AGENTS, \$50 a week. Will show you how. Genuine Gold Leaf Window Letters. Chicago Agency Co., 812 Alameda St., Chicago.

DECALCOMANIA Transfer Initials and Flags: You apply them on automobile while they wait; cost 2c each; profit \$1.38 on \$1.50 job; free particulars. Auto Monogram Supply Co., Dept. J, Niagara Bldg., Newark, N. J.

INSIDE Tyres, inner armor for Automobile tires, double mileage and prevent punctures and blowouts. Quickly applied. Cost little. Demand tremendous. Profits unlimited. Details free. American Automobile Accessories Co., Dept. P, Cincinnati, O.

GET Davis' Latest Proposition, \$15.00 daily a cinch. No matter how many times you have answered my ads in last 20 years, write again. E. M. Davis, Dept. 506, 900 Lake, Chicago.

MEDALLIONS—500% profits. Make up your own goods and be independent. Catalogue free. Resag Co., 1235 Randolph St., Chicago.

AGENTS—Our gold window letter proposition beats 'em all. Staibrite Co., Dept. P, 1115 Second Ave., N. Y. Established 1895.

AGENTS make 500% profit handling Auto Monograms, Patriotic Pictures, Flag Novelties, Window Letters and Changeable Signs. Catalogue free. Hinton Co., 6142 40th Court, Chicago, Ill.

RELIABLE People Wanted—Place Eggine in stores and appoint agents. Takes place of eggs in baking and cooking at 9c doz. Large package and particulars 10c postpaid. Morrissey Company, 4403-5 Madison, Chicago.

AGENTS: Big Hit! Our 5-Piece Aluminum Set is all the rage. Cheaper than Enamel Ware. Sells like wildfire. Guaranteed 20 years. Retail value \$5.00. You sell to housewives for only \$1.98. Biggest seller of the age, 9 sure sales out of every 10 shown. Others cleaning up \$10.00 to \$20.00 a day. Answer this quick to secure your territory. Div. GG5, American Aluminum Mfg. Co., Lemont, Ill.

WHO wants to make more money selling brushes that every household needs? Special method of getting entrance to demonstrate. Fuller Sanitary Brushes are nationally advertised—largest output—best terms and prices—western distributing stations. Your territory is valuable. Write, Fuller Brush Company, Hartford, Conn.; Rock Island, Ill.

AGENTS: \$50 to \$100 a week. Free samples. Gold sign letters for Stores and Office Windows. Anyone can do it. Liberal offer to general agents. Metallic Letter Co., 407 N. Clark, Chicago.

EXCEPTIONAL opportunity selling Sanitary Brushes. Large profits, no permanent capital required. Every home a customer. Special selling help for agents. Proposition free. Sample ten cents. Puritan Sales Company, Dept. M, 1866 Broadway, N. Y.

DISCOVERED! Extraordinary New Proposition. Supreme Opportunity. \$200 per week Easy, demonstrating marvelous Adding Machine. Retail \$7.50. Work equals \$500 machine. Subtracts, Multiplies, Divides, automatically. Whirlwind in speed. Guaranteed Five Years. Used by U. S. Government. Sells everywhere. Amazing profits. Write quick for exclusive territory. Calculator Corp., Dept. PM, Grand Rapids, Mich.

\$50 WEEKLY and up selling Mexican Diamonds. Exactly resemble genuine; Same Rainbow Fire; Stand tests; sell at sight; Repeat orders. Write quick for Sample Case offer free. Mexican Diamond Importing Co., S. W. Las Cruces, New Mexico.

AGENTS. Make Big Money; fast office seller; particulars and samples free. One Dip Pen Co., Dept. 2, Baltimore, Md.

CALIFORNIA Flower Bed Necklaces beat anything for quick sales and profits. Absolutely new. Write for agent's proposition. Mission, 2819 PM, West Pico, Los Angeles, Calif.

"GOLDINE" Sign Letters—1,000% profit. Particulars free. Johnston Co., Quincy, Ill.

MARRIED Salesmen and Agents—Wives to demonstrate in dept. stores, on salary. Easy sales to jobbers, dealers, consumers. All or part time, or side line. Appoint sub-agents. Silveron, the Silver-plating polish—needed in every home, hotel, restaurant, and garage. Guaranteed to Deposit Pure Silver. Write for proposition and sample. Exclusive territories open. Silveron, 157 Cedar St., N. Y.

AGENTS—Ho-Bo-Co Skin Soap and Toilet Goods plan beats everything for agents' profits. "Ho-Bo-Co," 112 Locust St., St. Louis, Mo.

WANTED—New Ideas. Write for list of Patent Buyers and Inventions Wanted. \$1,000,000 in prizes offered for inventions. Our Four Books sent free upon request. Victor J. Evans & Co., 163 Ninth, Washington, D. C.

SALESMEN WANTED

SALESMEN Wanted! New food product. Big profits. Wonderful reseller. Territories going fast. Write quick. Bestever Products Co., B-3 Douglas Park Sta., Chicago, Ill.

SALES-MANAGER Wanted for Branch Office. Complete line 30 fast-selling auto specialties, including Permatite, Vulcanizing Substitute, the original fabric-back tire patch. Big profits to competent men. Write for liberal proposition and samples. Motor Supplies Mfg. Co., 35 N. E. 5th St., Minneapolis, U. S. A.

\$75.00 OR more can be made weekly selling our wonderful new expanding cuff buttons which permits soft or hard cuffs to be raised in a jiffy above the elbows without unbuttoning. When lowered they close automatically. Experienced sideline salesmen preferred. Commissions liberal and paid promptly. Sell to Department Stores and Jewelers. Flexo Links, Sheboygan, Wisconsin.

SALESMEN calling on Manufacturing and Factory Trade to sell High-Grade Legitimate product as a side-line. No samples to carry. Liberal commission proposition. Write North American Linseed Products Co., Cleveland, Ohio.

TRAVELING Salesmen Wanted—Experience unnecessary. Earn while you learn. Hundreds of good positions open. Write today for large list of openings and testimonials from hundreds of members we have placed in positions paying \$100 to \$500 a month. Address nearest office, Dept. 125K, National Salesmen Training Association, Chicago, New York, San Francisco.

SALESMEN—Acquainted with grocery trade. Large demand; liberal commission; pocket sample. Wirth Salesbook Co., Dept. P., Chicago.

WE want Traveling Salesmen in all parts of the country to call upon Garages, Auto, Hardware and Implement dealers and appoint sub-agents for our 550 Ono-Ton Ford Truck Unit. Men established with trade preferred. No objection to side line. Over 12,000 sold first 4 months. Liberal commission basis, \$2,000 to \$6,000 yearly easily made. Exclusive territory and commission paid on reorders. Write or wire for particulars at once, Stableford Truck Mfg. Co., 1439 S. Michigan Ave., Chicago.

EXTRAORDINARY opening for live traveling salesman calling on trade, regular or side line, \$20-\$40 weekly. Apply now. Carl D. Heyer Co., Laird, Colo.

BIG opportunity for traveling salesman for side line to establish agencies for a fuel-saving device. University tests show 25% saving. Commission basis. Wolff Fuel Saver Co., Lytton Bldg., Chicago.

SALESMEN—Do you want a real live up-to-date side line? Especially good for small towns. Commissions paid same day merchant acknowledges receipt of goods. Pioneer Novelty Company, 1306 Wells St., Chicago.

YOUNG men everywhere as cigar salesman. Start \$20 weekly. Neway Sales Co., Hartford, Conn.

WANTED—Representatives everywhere. Exclusive territory. Gold sign letters for stores and office windows. Any one can put on. Write today for free sample. Metallic Letter Co., 403 N. Clark St., Chicago.

EARN \$5,000 to \$20,000 yearly. New business necessity. Retail \$5 to \$200. 100-200% profit. Purchaser satisfied or money refunded. No competition. Exclusive territory. Free samples. Sayers, 408 Wainwright, St. Louis.

SALESMEN—Get our plan for Monogramming Automobiles and motorcycles by transfer methods. Very large profits. Motorists' Accessories Co., Mansfield, O.

HELP WANTED

AGENTS Wanted—Standard patriotic flag holder for Autos and Motorcycles. Sells at sight; every one sells another; neatest, best; nearly 200% profit. Send 30 cents for agents' sample. I. G. Burton, 1482 Broadway, New York.

UNCLE SAM has thousands of jobs open this year. I will help you get one. Write for my big free book, DX-29. Earl Hopkins, Washington, D. C.

GOOD income refinishing chandeliers, brass beds, automobiles by new method, producing amazing results; no capital or experience necessary; particulars free. Gunmetal Co., Ave. G, Decatur, Ill.

STENOGRAPHERS Wanted: War opened thousands big paying Government and business positions. \$2.00 brings our five lesson, self-taught course; quickly learned; accurate, reliable. Satisfaction or refund. H. McKinley, 708 Buckingham, Chicago.

GET a sure job with big pay, steady work, short hours, regular vacations, rapid advance. Thousands of positions open with Uncle Sam. I will prepare you in a few weeks at small cost. Write immediately for big Free Book DU-29, with special offer. Earl Hopkins, Washington, D. C.

GOVERNMENT Positions are easy to get. My free booklet BY-29 tells how. Write today—Now. Earl Hopkins, Washington, D. C.

EARN One Dollar every hour during spare time, calling on doctors, coal dealers, general stores. Nothing to sell. Everything furnished. No money needed. National Credit Reporter, Delphos, Ohio.

FREE Illustrated Book tells of about 300,000 protected positions in U. S. service. Thousands of vacancies every year. There is a big chance here for you, sure and generous pay, lifetime employment. Just ask for booklet CE-29. No obligation. Earl Hopkins, Washington, D. C.

WAR Clerical Jobs open. \$90 month. List free. Franklin Institute, Dept. E-21, Rochester, N. Y.

CIVIL Service Examinations Lead to good government positions; railway mail pays up to \$1800; postoffice clerk, carrier, \$1200; customs, \$2500; internal revenue, \$2100; bookkeeper, \$2500; stenographer, \$1800; clerk, \$1800; technical, \$4000; rural carrier, \$1200; women, \$1800; guard \$840 up. I can coach you by mail at small cost and give bond guaranteeing success or money refunded. Particulars free to American citizens over 17. Ask for booklet QE-29, naming position wanted. Earl Hopkins, Washington, D. C.

CIVIL Service Examinations everywhere soon. War causing thousands of vacancies. Men desiring Clerkships, Departmental, Postoffice, Railway Mail, Customs, write for free particulars to J. W. Leonard (Former Government Examiner), Kenosha Bldg., Washington.

WANTED. Men and women to qualify for Government positions. Several thousand appointments to be made next few months. Full information about openings, how to prepare, etc., free. Write immediately for booklet CG-29. Earl Hopkins, Washington, D. C.

CASH paid for butterflies, insects. Some \$1 to \$7 each. Easy work. Even two boys earned good money with mother's help and my pictures, descriptions, price list, and simple instructions on painless killing, etc. Send 2c stamp at once for prospectus. Sinclair, Box 244, D. 6, Los Angeles, Cal.

FOREMEN, Shopmen, and Office men Wanted to work spare time as special representative of large well-known mail-order house, selling Watches, Diamonds and Jewelry on Credit. Liberal commissions and exclusive rights granted. No investment or deposit required for outfit or samples. Write at once for details. Address S. D. Miller, Dept. 14, Agency Division, Miller Bldg., Detroit, Mich.

DO you want a sure job with big pay, easy hours and rapid advancement? Write for my big free book, DW-29, which tells you how you can get a good government position. Earl Hopkins, Washington, D. C.

U. S. GOVERNMENT needs thousands clerks (men-women) for war preparations, \$150 month. Life jobs. Write immediately for list positions obtainable. Franklin Institute, Dept. E-21, Rochester, N. Y.

FIREMEN, Brakemen, railroaders everywhere, beginners \$100-\$150, positions guaranteed. Railways Association, Dept. 254, Brooklyn, N. Y.

HUNDREDS Clerks (men-women) wanted by Government for war preparation, \$90 month. List positions free. Franklin Institute, Dept. E-21, Rochester, N. Y.

A POSITION is open for you in the Government service after we have helped you to qualify. My money back offer guarantees it. Write quick for big free book, DA-29. Earl Hopkins, Washington, D. C.

GOVERNMENT pays \$900 to \$1,800 yearly. Prepare for coming "exams" under former Civil Service Examiner. New Book Free. Write Patterson Civil Service School, Box 3020, Rochester, N. Y.

WORK for Uncle Sam—He is the best employer. Big pay, sure work, easy hours, long vacations, rapid advance. Thousands of jobs open this year. I will help you get one. Write for my big free book DY-29, today. Earl Hopkins, Washington, D. C.

RAILWAY Mail clerks wanted, \$75.00 month. Examinations soon. Also Salesmen wanted, Civil Service and Salesmanship Courses by mail. For "Free Tuition Plan," address Carnegie College, Rogers, Ohio.

WEEDS wanted, seeds, berries, leaves, bark, roots. We pay 3c to \$2.50 per lb. National Drug Co., North Yakima, Wash.

WANTED—Men, 18 or over, as Railway Mail Clerks. Sample examination questions free. Franklin Institute, Dept. E-21, Rochester, N. Y.

THE Way to Get a Government Job is through the Washington Civil Service School. We prepare you and get a position or we guarantee to refund your money. Write to Earl Hopkins, President, Washington, D. C., for Book FK-29, telling about 292-296 Government Positions with lifetime employment, short hours, sure pay, regular vacations.

MAKE money, getting lodge members. The Owls, South Bend, Indiana.

CIVIL Service Examinations open the way to good Government positions. I can coach you by mail at small cost. Full particulars free to any American citizen of eighteen or over. Write today for Booklet CE-29. Earl Hopkins, Washington, D. C.

THOUSANDS Government War Positions Open. \$100.00 month. Examinations everywhere. List free. Franklin Institute, Dept. E-21, Rochester, N. Y.

DO you want a position for life, with big pay, short hours and sure advancement? Then work for Uncle Sam. My free illustrated book, DK-29, tells how to get an appointment. Earl Hopkins, Washington, D. C.

RAILROAD Traffic Inspectors Wanted. \$125 a month and expenses to start; short hours; travel; three months' home study under guarantee; we get you position. No age limit. Ask for booklet L-4. Frontier Prep School, Buffalo, N. Y.

GOVERNMENT Examinations. Most thorough preparation, \$5; returned if not appointed; particulars free. American Civil Service School, Washington, D. C.

INVENT Something; your ideas may bring wealth; free book tells what to invent and how to obtain a patent, through our credit system. Talbert & Parker, 4102 Talbert Bldg., Washington, D. C.

BE a Mirror Expert. Good income; spare time home at first; no capital; we train, start you making and silvering mirrors; French method. Free prospectus. W. P. Dorr, Pres., 579 Decatur, Brooklyn, N. Y.

MAKE money writing Photo-plays; details free to beginners. No correspondence course. Producers' League, 230 Wainwright, St. Louis.

WANTED—An Ideal! Who can think of some simple thing to patent? Protect your ideas; they may bring you wealth. Write for "Needed Inventions," and "How to Get Your Patent and Your Money." Randolph & Co., Patent Attorneys, 629 F. St., Washington, D. C.

FOR SALE

BEST private collection of autographs, letters, and photographs of famous men and women of America and of other nations! The nobility of England and Europe, the famous generals now engaged in the World War and others, statesmen of many lands, famous authors are represented. King George, present King of England, President Wilson and other rulers are in the collection. Price for entire collection, \$40,000. Chas. Gorsuch, Martinsburg, Penn.

NEW 10 volumes I. C. 8 Mechanical Engineering books. New complete tool-maker's kit. Write for list. Box 12, Smithboro, N. Y.

ENGINEERS Y Level, 18 in., with rod, \$80.00. F. Warren, Warrens, Wis.

UNIVERSAL Knitting Machines. Many styles, hand or power. For Catalogue, address Daniel Hooker, Peabody, Mass.

SALE OR EXCHANGE

MULTIGRAPH, Printing Presses, Phonographs, Bicycles, Guns, Cameras, Musical Instruments, etc. We Buy, Sell, and Exchange. State your wants, send for list. Kendall's Store, Dundee, N. Y.

WANTED: Machinery: Planer, Shaper, Miller, Drill, Bor. Mill, Radial, etc. Cash or trade 5 Pas. 16 Auto. Williams, 123 S. Ridgeland Ave., Oak Park, Ill.

WANTED: Ica Cameras for Memory Training System (\$20.00), and Personal Efficiency System (\$30.00). Box N. N. N., Valley City, N. Dak.

WANT to Swap? Send 10 cents for "The Market for Exchange" to Pierre Notley, 141 Milk Street, Boston, Mass. It gives a long list of those who have things to trade or sell. Send list of things you have to trade or sell.

WANTED

SEND us your old clothes and we will send you the money. We buy gentlemen's slightly worn clothing of all descriptions. David Rosenberg, 2908 South Street, Philadelphia, Pa.

MIXER wanted for mixing powdered materials. Address A. B., Room 925, 78 E. Madison St., Chicago.

FLOUR & FEED MILLING MACHINERY

SPECIAL bargains in second hand Attrition mills, burr mills, crushers, corn shellers, bran dusters, dust collectors, purifiers, reels, double, single, 2 and 3-pair high roller mills, sieve bolters, receiving separators, scourers, etc. Write for description and prices. Sprout, Waldron & Co., P. O. Box 429, Muncy, Pa.

MACHINERY, TOOLS AND SUPPLIES

PULLEYS, Gears, Sprockets, Shafting, Hangers. See page 123. W. A. Jones Foundry & Machine Co., Chicago.

"RED Devil" 4 1/2-inch nickel-plated steel combination Piler with screwdriver and prestolite key. Style 1324, sample 65c. Smith & Hemenway Co., 97B Chambers St., New York.

WOOD Lathe, saw attachments, tools, motor, \$12.00. 1316 Madison, Denver, Colo.

TOOLS—for shop, factory, garage and home—many high-class tools attractively priced in our "Odds and Ends" pamphlet—which is mailed free on request by Montgomery & Co., Inc., 165 Fulton St., New York City.

WIRE—all sizes—3/4 to No. 16. Coppered, tinned, galvanized and plain steel wire for sale. Cooley Mfg. Co., 553 W. Monroe St., Chicago, Ill.

ENGINES, MOTORS AND DYNAMOS

EXCEPTIONAL values, alternating and direct current motors from 1/30 H. P. upwards. Tell us your needs. Special fan bargains. Motors bought and repaired. Illustrated catalog supplies and motors. Hyre Electric Co., 615-MH South Dearborn St., Chicago.

OTTO gas engine. Six Horsepower in good condition, can be seen running, must sell at once to make room for new one. The Gasket Supply Co., 1729 Ludlow Street, Philadelphia, Penna.

GENERATORS, Ball-bearing, 32 volt, 11 to 35 amperes, complete with base and pulley. Prompt shipments. Goodlite Company, Indianapolis, Ind.

FOUR cylinder 35 H. P. Buick engine complete, \$125. Henderson, Naval Radio Station, Rockland, Me.

ENGINE User Agents Wanted to use, demonstrate and sell "Big Ben," wonderful new 2 1/2 H. P. gasoline engine. Free introductory offer and free details. C. Benninghofen & Sons, Dept. P., Hamilton, Ohio.

NEW Gasoline Engines, 1 1/2 to 8 H. P. About 1/2 price while they last. Williamson, 221 N. Crawford Ave., Chicago.

REBUILT Engines—We have rebuilt "Buffalo" Engines, guaranteed, at greatly reduced prices. Write for bargain list. Buffalo Gasoline Motor Co., 1293-1305 Niagara Street, Buffalo, N. Y.

FOR MECHANICS

PATENTS Wanted. Write for list of Patent Buyers who wish to purchase patents and what to invent with list of Inventions Wanted. \$1,000,000 in prizes offered for inventions. Send sketch for free opinion as to patentability. Write for our four Guide books sent free upon request. Patents advertised Free. We assist inventors to sell their inventions. Victor J. Evans & Co., 184 Ninth, Washington, D. C.

HAND Cleanser, wonderful remover of dirt and grease. Guaranteed not to contain injurious substances and to last 1 year, 25c. Handcleanser Co., 173 Umland Ter., N. E., Washington, D. C.

TOOL Cases. For Carpenters and Machinists. Write for catalog. Keystone Case Co., 4920 Lake St., Chicago.

GUNS, SPORTING GOODS, ETC.

BUY, sell, exchange old-time and modern Fire-arms. Antiques wanted. Stephen Van Rensselaer, 305 Madison Avenue, New York.

BLACKSMITHS

BLACKSMITHS, Listen! Prepare for big wages in Navy and Arsenal with Toy's Modern Methods doing hard jobs easy. Forging and making solid welds, hardening and tempering to a standard, with colored tempering charts. All for one dollar. Samples free. W. M. Toy, Sidney, Ohio.

FOR THE SHOP

SHOP Notes for 1917—Just Published—524 Articles, 422 Illustrations, 224 Pages. Easy Ways to do the Hard Things in every trade and calling. Price, 50 cents, postpaid. Also all previous numbers in Shop Notes series Volumes 1 to 12 inclusive at 50 cents each, postpaid. Send for description. Popular Mechanics Book Dept., 6 N. Michigan Ave., Chicago.

ELECTRICAL

ILLUSTRATED catalog, just issued. Electrical supplies and motors, wire, switches, loom, plugs, tape, sockets, lamps, fuses, sockets. Send for free copy today. Hyre Electric Co., 613 TB South Dearborn St., Chicago.

TATTOOING Outfits, \$1 up. Electric and hand. Roberts Company, 635 West Ave., Buffalo, N. Y.

DRY Batteries and Their Construction for All Purposes. A practical handbook of 60 pages with 30 illustrations dealing with batteries for automobiles, gas engines, medical and coil work, electric bells, alarms, telephones, experiments, etc. Price, 25 cents postpaid. Popular Mechanics Book Dept., 6 N. Michigan Ave., Chicago.

TO MANUFACTURERS

MANUFACTURERS Wanted—Small useful article—5 to 25 cents, by "Distributors" in Philippines. Walter Wing, P. O. Box 1277, Manila, P. I.

STAMP COLLECTING

STAMPS Free. Choose one, 200 different international stamps, 101 United States, 25 Persia, 50 Norway-Denmark. Remit 25c, six months' subscription McKee's Stamp Weekly, Beverly, Mass.

FREE—Chile One Peso Cat. 15c to approval applicants sending reference. J. R. Nichols, 1707 Nelson Ave., New York.

PACKET "A" 100 varieties foreign stamps, 29c. F. J. Pope, Charlotte, Vermont.

STAMP Collections bought wholesale; list free. Beebe Company, Yonkers, N. Y.

FREE—60 different stamps, including Newfoundland, China, Japan, Mexico, etc., to applicants for our high-grade approvals. Send 2c stamp for return postage. The Edgewood Stamp Company, Dept. H, Milford, Conn.

300 STAMPS, U. S. and foreign mixed, only 10c. J. Henry Orr, 717 West Main St., Muncie, Ind.

SPECIAL bargain! 1,000 different postage stamps, \$1.75. Nickles, 122 Florida Ave., Washington, D. C.

20 UNUSED stamps free. All different. Postage, 2c. Fisk Stamps, Toledo, Ohio.

STAMPS 58, all different: Malay (tiger), Bolivia, China (junk ship), Mexico, etc.; an album and Perforation Gauge, all for 5c. Interesting List Free. Payn Stamp Co., 138 No. Wellington St., Los Angeles, Calif.

SELLING Out! 1-2-3c net approvals. Scarce British Colonials cheap. War stamps premium. Hiedell, Schenectady, N. Y.

STAMPS sent on approval at 70% discount. Reference required. Emory Renoll, Hanover, Pa.

STAMPS—50 fine foreign incl. Mex. War, Salvador, incl. officials, Guatemala, China, etc., only 10c. Best App. Sheets 40 to 80¢ dis. We give valuable extra Presents free! Big 129 pg. catal. free. We buy stamps. Hussman Stamp Co., St. Louis, Mo.

PACKET of 23 stamps; no two countries alike, 500 hinges. Set of \$1 and \$2 U. S. Rev., all for 5c. Mention paper. Miami Stamp Co., Toledo, Ohio.

THE way to build your Stamp Collection. Send 50 cents for one of my approval Books. Select the stamps you want, to the value of Fifty Cents, and return me the Book. F. J. Pope, Charlotte, Vermont.

24 VARIETIES Cuban stamps, 10 cents. List of 6,000 low-priced stamps free. Chambers Stamp Co., 111 P. Nassau St., New York City.

STAMPS, 75, all different, free. Postage, 2c. Mention paper. Quaker Stamp Co., Toledo, Ohio.

105 CHINA, etc., stamp dictionary, list, 2c. Album (500 illustrations) 3c. Bullard, Sta. A., Boston.

RARE COINS

VILLA money. Have just returned from Mexico. Will send package of \$5.00 and \$1.00 currency assorted, postpaid for 15c. Maurice Grossman, 586 East 102nd, Cleveland.

FIVE Villa Coins and Bills 35c. Moore Coin Company, Commerce, Texas.

WILL pay \$100.00 for Trade Dollar 1885; \$7.00 for 1853 Quarter without arrows; \$750.00 for certain \$5.00 gold without motto. Cash premiums for rare coins to 1912. Get posted. Send 4c. Get our Large Descriptive Circular. Numismatic Bank, Dept. B, Fort Worth, Texas.

CALIFORNIA gold, quarter size, 27c, 3/4 size, 53c. \$1.00 size, \$1.10. Large cent before 1821, Columbian Nickel and Catalogue 10c. Norman Shultz, King City, Mo.

ALL for 30c. a 25c California gold token, 5 foreign coins and price list. V. Walter, New Rochelle, New York.

OLD Coins, Large Spring Coin Catalogue of Coins for Sale, free. Catalogue quoting prices paid for coins, ten cents. William Heschel, 101 Tremont St., Boston, Mass.

\$4.25 EACH Paid for U. S. Flying Eagle Cents dated 1856. We pay cash premiums on hundreds of Old Coins. Send ten cents at once for New Illustrated Coin Value Book 4x7. It may mean your fortune. Clarke & Co., Coin Dealers, Box 15, Le Roy, N. Y.

GAMES AND ENTERTAINMENTS

TRICKS, Puzzles, Jokes, Magical Apparatus, Plays, Stage Supplies, Mind-reading Acts, Sensational Escapes, and Illusions. Free large illustrated 1917 catalog. Oaks Magical Co., Dept. 427, Oshkosh, Wis.

MAGIC Goods, Card Tricks, Mind-reading Acts, Sensational Escapes and amusements. Catalog free. Heaney Magic Company, Desk 80, Berlin, Wisconsin.

MAGIC—Tricks, Books and Supplies. For Amateurs as well as the Great Professionals. Any one can learn through our instructions. Feature Acts in Mind Reading, Spiritualism, Rope Ties, etc. Large illustrated Professional Catalogue, 10c. Chicago Magic Co., Dept. B, 72 West Adams St., Chicago, Illinois.

THEATRICAL GOODS

SCENERY for Hire and Sale. Amelia Grain, 819 Springgarden Street, Philadelphia, Pa.

FOR BOYS

JUST Issued—Amateur Mechanics No. 8. How to make 132 different interesting things such as electric fountains, bird houses, model monoplane, porch swing, kites of various kinds, fishing rods, camp outfits, scarecrow, shocking machine, etc., 125 pages, 234 illus. Price 25 cents, postpaid. Also all preceding numbers in the series at same price. Popular Mechanics Book Dept., 6 N. Michigan Ave., Chicago.

BIG New Book for Boys—The Boy Mechanic, Vol. II—Just Out—A sequel to, but containing nothing found in Vol. I. Tells all about 1,000 interesting things to make and do. 480 pages; 995 illus. Cloth. Price, \$2.00, postpaid. Send for descriptive circular. Popular Mechanics Book Dept., 6 N. Michigan Ave., Chicago.

FOR MEN

HEDGEHOG Pipe Bowl Reamer. Keeps pipe clean, sweet, 25c. Strait, 184 Front St., Oswego, N. Y.

STROPOIN. Barbers' Delight, Finest Edge, Improves Strop, Pleases Self-shavers. 10c. E. Uhlmann, Peoria, Ill.

PHILIPPINE cigars, 50 choicest famous Cagayan tobacco, prepaid, \$3.00, money order. Walter Wing, Distributors, P. O. Box 1277, Manila, P. I.

SEND 50c for pair most wonderful soft shirt cuff buttons yet invented. If not satisfactory, return and get money. Z. Biddle, Dunsmuir, Calif.

RAZORS AND BLADES SHARPENED

WHY buy Safety Razor Blades or pay for honing razors? Use Sharp-Hens, guaranteed to sharpen any razor or blade quickly. Year's supply 25 cents. Triangle Specialty Co., 2814 N. Marston St., Philadelphia.

SAFETY Blades sharpened. Gillette and other double blades 35c per dozen. Single 25c. Fifteen years' experience. Best machines. Send by mail from any postoffice, mailing case free. Money back if I fail to make good. C. K. Berg, Razor Specialist, Los Angeles, Calif.

SAFETY razors sharpened; two cents each. Guaranteed. Blade box free. Electro Strapping Co., 134 Shelby St., Detroit, Mich.

FOR WOMEN

LADIES' breastpin, given name in gold on pearl shell, \$1.00. L. E. Schmitt, 408 W. Saratoga St., Baltimore, Md.

FOR THE HOME

SANITARY Automatic Dumb-Waiters will assist in preparing each meal, saving many steps to and from the basement. Shipped assembled. Inexpensive. Illustrated catalogue. York Automatic Dumb-Waiter Works, York, Pa.

MISSION Furniture—Make your own at little expense. Complete instructions, working drawings and stock lists for 94 different pieces. Price \$1.50 postpaid for set of three books. Send for complete descriptive matter. Popular Mechanics Book Dept., 6 N. Michigan Ave., Chicago.

PIANOS AND MUSICAL INSTRUMENTS

MILITARY Music is the backbone of Patriotism. Send for our free catalog of Bugles, Drums, etc. Reasonable prices. The Dixie Music House, 195 W. Madison St., Chicago.

YOU can tune and keep your own piano or player piano in perfect condition. Van Atta's book on The Piano and Player Piano not only tells you but shows you every movement in their care, repair and tuning. 156 Pages. 51 Illustrations. Cloth. Price, \$1.50 postpaid. Popular Mechanics Book Dept., 6 N. Michigan Ave., Chicago.

BEER Violins, deep, mellow tone, easy payments. Colored photo and particulars. 156 Clinton St., Muskegon, Mich.

PHONOGRAPHS AND RECORDS

BUILD Your Own Phonograph. Any type. Big saving. Patents expired. Profits making and selling them. We furnish parts you can't make. Full instructions, dimension drawings, illustrations, parts—price-list only 25c. Circular Free. Associated Phonograph Co., Dept. P, Cincinnati, O.

MUSIC

FAMOUS Century Edition Sheet Music, 10c per copy. Catalog free. New Jersey Sales Co., Dept. F, Box 243, Passaic, N. J.

FAVORITE Old Home Songs—No home in the land should be without this book of 200 of the familiar old songs everybody loves. Words and music complete in a substantial volume 9 1/2 x 7 inches in size. Price 50 cents postpaid. Popular Mechanics Book Dept., 6 N. Michigan Ave., Chicago.

SHEET Music! Four Famous Selections, 25c. Peverly Specialty House, Atchison, Kansas.

"**WHERE** the Black-Eyed Susans Grow," Great Popular Song, with Catalogue, 15c. R. C. Ross, Abingdon, Ill.

"**SWEET** Luana" and "Honolulu Pa-kiki," popular Hawaiian songs, 25 cents brings both. Money refunded if dissatisfied. Request catalog. Quincke Company, Majestic Theater Bldg., Los Angeles, Cal.

FORMULAS AND TRADE SECRETS

1,000 FORMULAS, 25c. 75 Manufacturing Secrets, 10c. Resilvering Mirrors—Inventing Dry Batteries—Gas Tonic—Mechanics Soap—Luminous Paint—20c each. Entire Collection, 50c. Satisfaction guaranteed. Ideal Book Shop, 3315-F8 Belle-plaine Ave., Chicago.

LIQUID Ice. Keeps milk, cream, etc., sweet in hot weather. Cuts down ice expenses. Formula 25c, coin. G. Braun, 725 King Street West, Kitchener, Ont., Can.

WINE—Make it home in kitchen out of rhubarb. An old Belgian formula obtained since war. Send your address for particulars; better still, if you wish, be first in field; act quickly; enclose \$1.00 for formula; thousands been made out of this wine in Belgium. Loran Specialty Co., P. O. Box 40, Dartmouth, Hx. Co., Nova Scotia.

GAS Tonic; Carbon Remover. Standard commercial formulas. 75c each, both dollar. F. Whitmore, Gilman, Montana.

THE Inkless Pen—20th century wonder. Writes with cold water. Instructions how to make 25c, no stamps. G. Braun, 725 King Street West, Kitchener, Ont.

PRACTICAL manufacturing formulas, all kinds. Claus, 1864 Harman St., Brooklyn.

TYPEWRITERS AND SUPPLIES

STARTLING Values in Typewriters. \$10 to \$15, up. Factory rebuilt. All makes. Shipped on trial. Write for our special offer No. 126H. Whitehead Typewriter Co., 185 N. La Salle St., Chicago.

NEW, Rebuilt and Slightly Used Typewriters, \$8 up. Portable Machines, \$10 up. Write for our catalog 50-1. Boran Typewriter Co., 58 W. Washington St., Chicago.

WE have a number of second-hand machines traded in on the new model Victor No. 3. All overhauled and in perfect condition. Like new. Write for list and particulars. Victor Typewriter Sales & Supply Co., 69 W. Washington, Chicago.

LARGEST Stock of Typewriters in America. Underwoods, one-fourth to one-half manufacturer's prices; rented anywhere, applying rent on purchase price. Free trial. Installment payments if desired. Write for catalogue 70. Typewriter Emporium, estab. 1892, 34-36 W. Lake St., Chicago, Illinois.

DUPLICATORS AND DEVICES

"**MODERN**" Duplicator—a Business Get-ter. \$1 up. 50 to 75 copies from pen, pencil, typewriter; no glass or gelatine. 35,000 firms use it. 31 days' trial. You need one. Booklet Free. J. E. Durkin & Reeves Company, Pittsburgh, Pa.

\$300 MULTIGRAPH like new for \$100. Guaranteed. Russell Baum, Philadelphia Bourse, Philadelphia.

MAILING LISTS

250,000 NAMES and Addresses of Iowa Farmers. Classified by counties. Write to-day. L. C. Scott, Bloomfield, Iowa.

115 RELIABLE firms that buy names \$1.00. Lieban, Drawer 385, Erie, Penna.

PRINTING, ENGRAVING AND MULTIGRAPHING

100 GOOD Business Quality Envelopes printed, 50c. Envelope Printing Department, Box 382, Marshalltown, Iowa.

GOOD Printing at low prices. 1,000 good letterheads, envelopes, cards, billheads, labels, circulars, \$2.50. Samples free. Catalogues, booklets and circulars our specialty. Ernest L. Pantus Co., 523 S. Dearborn St., Chicago.

ADVERTISING pencils all kinds. Gross \$5; 1,000—\$15 up. Stamp brings samples. Jack Shattuck Williams, Aurora, Indiana.

GOOD Printing cheap. Estimates. Gummed labels. P-P Printers, Kalida, Ohio.

1,000 BUSINESS Cards \$1.85. Samples. Printer, 41 Webster St., Malden, Mass.

ARTISTIC printing. Prices right. Franklin Press, Richmond Hill, New York.

WE print anything. Cuts made from photograph \$1.00. Samples. Commercial Press, Batavia, Ohio.

LABEL Catalog "A" free. Irvin Wolf, 3128 Jasper Street, Philadelphia.

LOOK! 1000 each Bond Letterheads, Envelopes, Business Cards, embossed, all for \$0.75 prepaid. Embossing Press free with orders for 2000. This offer ten days only. Cut this out now. C. & C. Sales Co., Atlanta, Ga.

250 LETTERHEADS or envelopes \$1.00. Moyer Supply House, Milton, Pa.

500 SWELL Linen Finish Letterheads, printed two colors, \$2.50. Bond \$2.00. Portfolio of samples 10c. Starb Printing Co., Hamilton, Ohio.

INCREASE your business! Suggestions free. Edward Harrison, Printing, Baltimore, Maryland.

NEW Large Catalog of Attractive Gummed Labels and Advertising Stickers Free. 3,000, 75c upwards. Royal Label Company, 419 Cherry, Philadelphia.

NEW large catalog of attractive gummed Labels and Advertising Stickers Free. 3,000, 75c upwards. Royal Label Company, 419 Cherry, Philadelphia.

"**SHOW** Your Colors." Flag labels 75c per 1,000 or 100 samples 10c. Helmers Company, Hoboken, N. J.

QUALITY Printing Prepaid. 500 other envelopes, noteheads, cards, statements, \$1.35; 1,000, \$2.25; 500 linen-finished letterheads or envelopes, \$2.25; 1,000, \$3.50. Prepaid. Typewriter letters. Stamp brings samples. Model Company, Manchester, Iowa.

PERFECTION Letter Company, Muncie, Indiana. Multigraphs 500 purple letters with black letter heads, \$2.15. Samples for stamp.

PRINTING Outfits—Presses, type, supplies, type novelties. Send stamp for catalogue. Model Press, York, Penna.

AT Last! Beautiful Lithography for small users. 1,000 Letterheads, 1,000 Billheads and 1,000 Statements, \$3.99. Engraving Free. Kaydoe Lithographing Co., 764 Teutonia, Milwaukee.

PRE-USED Printing presses, Type, Supplies, cheap. List for stamp. Popular Bargains, Richland, Pa.

PATENT ATTORNEYS

PATENTS—Send sketch for free search and report. Books on patents and book of reference letters sent free. John S. Duffie & Co., 610 F St., Washington, D. C.

INVENTORS: Let us sell your patent. Send for our liberal proposition. Atlantic Supply Co., Long Branch, N. J.

INVENTORS: Write our Patent Dept. Adam Fisher Mfg. Co., 2961 C Railway Exchange, St. Louis, Mo.

PATENTS obtained through D. Swift being promptly sold to manufacturers. Write today for free books of "Inventions Needed" and surpassing references. D. Swift, 317 Seventh St., Washington, D. C.

PATENTS on easy payments. Send model or sketch for Free Search and Certified Registration of Your Invention for Your Protection. Free Book Tells What to Invent and How to Obtain a Patent on Easy Payments. C. C. Hines, 591A Loan & Trust Bldg., Washington, D. C.

INVENT Something. Your ideas may bring wealth. Free book tells what to invent and how to obtain a patent through our credit system. Talbert & Parker, 4622 Talbert Bldg., Washington, D. C.

PATENT secured or fee returned. Hundreds of inventions sold yearly. We will help you sell yours. Send model or sketch. Books and advice free. Sues & Co., Est. 20 years. 330 7th St., Washington, D. C.

HIGH-VALUE Patents. See R. S. & A. B. Lacey's advertisement on page 150.

FITZGERALD & Co., Patent Lawyers, 803 F St., Washington, D. C. Est. 1880. "The Old Reliable Firm." Our Specification Department in charge of former member examining corps U. S. Patent Office.

PATENTS secured. Write for our booklet, it tells how to protect your ideas and how to proceed with your invention to make money. Featherstonhaugh & Co., 440 Victor Building, Washington, D. C. 35 years' practice in U. S. and Canada.

THE Patentsome is free. An education in obtaining patents. Established 1865. Anderson & Sons, Attorneys, 707 7th St., Washington, D. C.

PATENT applications filed on partial payment plan. We help sell the patent. Trademarks, copyrights, etc. Milo B. Stevens & Co., 685 F St., Washington, D. C. 353 Menadnock Bldg., Chicago. Estab. 1864.

"**PATENTS** and Patent Possibilities" is a 72-page treatise which tells all about patents, what to invent and where to sell it. It gives honest advice to inventors and tells about the successes of some of my clients, also explaining what are frequent causes of failure. Manufacturers are constantly writing for protective patents and upon all kinds of sound inventions. Can you help supply their wants? The book is free. Write for it today. H. S. Hill, 905 McLachlen Bldg., Washington, D. C.

PATENTS. R. Morgan Elliott & Co., Patent Attorneys, Electrical, Mechanical, and Chemical Experts, 713-721 Woodward Building, Washington, D. C.

PATENTS Secured or All Fees Returned. See E. E. Vrooman & Company's advertisement, page 147.

PATENTS without advance attorney's fees. Send sketch for free report. Books free. Frank Fuller, Washington, D. C.

PROTECTIVE patents procured promptly. 104-page blue book on patents sent on request. Trade-marks registered. Robb & Robb, 211-215 Southern Bldg., Washington, D. C.

PATENTS Secured or Fee Returned. Actual search free. Send sketch or model. 1917 Edition, 98-page patent book free. My patent sales service gets full value for my clients. It should never require more than two days to report upon the patentability of your invention; nor longer than ten days to prepare your application for filing. Longer delay amounts to gross neglect and the jeopardizing of your rights. For prompt personal service write, George P. Kimmel, 212 Barrister Building, Washington, D. C.

PATENT What You Invent. It may be valuable. Write me. No attorney's fee until patent is allowed. Estab. 1882. "Inventor's Guide" Free. Franklin H. Hough, 522 Loan & Trust Bldg., Washington, D. C.

PATENTS—Herbert Jenner, patent attorney and mechanical expert, 606 F St., Washington, D. C. I report free of charge if a patent can be had and its exact cost. Send for circular.

PATENTS that protect and pay. Advice and books free. Rates reasonable—highest references; best results. Watson E. Coleman, Patent Lawyer, 624 F St., N. W., Washington, D. C.

PATENTS: Send model, sketch or drawing. Advice, 189 Mechanical Movements and 50 Perpetual Motions, Free. Fred G. Dieterich & Co., 61 Ouray Bldg., Washington, D. C.

H. L. WOODWARD—Safe methods. Paying patents. Write today. 992 G. St., Washington, D. C.

PATENT Your Ideas—\$9,000 offered for certain inventions. Books, "How to Obtain a Patent," and "What to Invent," sent free. Send rough sketch for free report as to patentability. Manufacturers constantly writing us for patents we have obtained. We advertise your patent for sale at our expense. Established 20 years. Address Chandler & Chandler, patent attorneys, 1990 F. St., Washington, D. C.

DON'T lose your rights to patent protection. Before proceeding further send for our blank form "Evidence of Conception" to be signed and witnessed. Book, suggestions and advice free. Lancaster & Allwine, 221 Ouray Bldg., Washington, D. C.

PATENTS Wanted. Write for list of Patent Buyers who wish to purchase patents and what to invent with list of inventions wanted. \$1,000,000 in prizes offered for inventions. Send sketch for free opinion as to patentability. Write for our four Guide books sent free upon request. Patents advertised free. We assist inventors to sell their inventions. Victor J. Evans & Co., 166 Ninth, Washington, D. C.

KEEP Up with Progress. Promote Your Patent. Send \$1.00 for Year's Subscription to Best Inventor's Magazine, "Invention and Manufacturing," United States Patent Corporation, Washington, D. C.

PATENTABLE Ideas Wanted—Send for 4 free books. R. B. Owen, 30 Owen Bldg., Washington, D. C.

FOR INVENTORS

WANTED—An Idea! Who can think of some simple thing to patent? Protect your ideas; they may bring you wealth. Write for "Needed Inventions" and "How to Get Your Patent and Your Money." Randolph & Co., Patent Attorneys, Dept. 144, Washington, D. C.

INVENTIONS commercialized on cash and royalty basis. Patents secured. Models, experimental work and contract manufacturing. Inventors should write at once. Adam Fisher Mfg. Co., 2861A Railway Exchange, St. Louis, Mo.

WANTED—Good inventions—manufacture on royalty or buy outright. The Gasket Supply Company, 1729 Ludlow St., Phila., Pa.

PATENTS, Trade-Marks and Copyrights. Our handbook on patents will be sent free on request. All patents secured through us are described without cost to the patentee in the Scientific American. Munn & Co., Patent Attorneys, 623 Woodworth Bldg., N. Y. Washington, D. C., office, 625 F. St.

WANTED—Successful method for bending brass tubing without filing. M. Lamsley, 9439 Burnside Ave., Chicago.

DON'T Sell Your Patent. Manufacture it yourself; get all the money; my guaranteed, successful plan shows how I raised capital and succeeded; you should do same. Price 25c coin. Holston, P. O. Box 1543, St. Louis, Mo.

INVENTORS: Experimental Work a specialty. Machines, devices, and models perfected and built. L. Darby, 189 Mulberry Street, Newark, N. J.

INVENTIONS—How to protect, sell and buy them. If you are inventive, read this book, 168 pages, 25c, postpaid. Popular Mechanics Book Dept., 6 N. Michigan Ave., Chicago.

PATENTS on easy payments. Send model or sketch for Free Search and Certified Registration of Your Invention for Your Protection. Free Book Tells What to Invent and How to Obtain a Patent on Easy Payments. C. C. Hines, 591A Loan & Trust Bldg., Washington, D. C.

PATENTS secured or all fees returned. See E. E. Vrooman & Company's advertisement, page 147.

INVENT Something. Your ideas may bring wealth. Free book tells what to invent and how to obtain a patent through our credit system. Talbert & Parker, 4180 Talbert Bldg., Washington, D. C.

HIGH-VALUE Patents. See R. S. & A. B. Lacey's advertisement on page 150.

HOW to determine value of any invention or patent, \$1. Buchanan, Columbus, Ga.

INVENTORS: Invent for profit. Write for list of needed inventions. Sanders, 7 Webster Bldg., Chicago.

WANTED, to buy inventions. State price and full particulars. Howard Smith Company Inc., Washington, Penna.

NO Attorney fees until patent allowed. Send sketch for free report. Books free. Frank Fuller, Washington, D. C.

HAVE You An Idea? If so, you should protect it by a patent. Send us a model or sketch for free opinion as to patentability. Write for our Four Books sent free to any address. Victor J. Evans & Co., 157 Ninth St., Washington, D. C.

INVENTORS—We specialize in manufacturing new patented articles—make models—dies—and do experimental work. Leo J. Gerding Mfg. Co., Dept. D, Opera Place, Cincinnati, O.

INVENTIONS—Patenting and Promoting. A book containing practical advice and directions for inventors and manufacturers. Book, suggestions and advice free. Lancaster & Allwine, 221 Ouray Bldg., Washington, D. C.

PATENTABLE Ideas Wanted—Send for 4 free books. R. B. Owen, 30 Owen Bldg., Washington, D. C.

PATENTS FOR SALE

"**FIRE** Alarm Box Device" positively prevents false alarms. Can be attached to any Alarm on the market. Royalty or outright considered. A. C. Vanadia, 993 Mary St., Flint, Mich.

FOR Sale or on Royalty—Patent No. 116,292, adjustable nursing bottle holder, with full set of tools and dies for manufacturing same. For full information, write to F. H. Schumacher, 33 Grant Ave., Jersey City, N. J.

PATENT No. 1,187,558, Improved miner's Acetylene Gas Lamp. Anthony Messina, Bend, Ill.

PATENTS and Patterns, on improved iron porcelain barber chairs, outright or on royalty. J. Mathews, 545 Princeton Ave., Trenton, N. J.

POSITIVELY the best Window Screen and Awning ever offered to the manufacturer on royalty. Public now waiting for it. Carl S. Johanson, 92 Walnut St., Montclair, N. J.

PATENTED gas engine for sale. A good buy; best offer takes it. Dave Kingery, Yencala, Oreg.

BOAT propelling patents Nos. 1,228,268 and 269. Cash, royalty or both. R. C. Hill, 303 W. Illinois, Memphis, Tenn.

MY invention relates to an improvement for insulated wire. Wire manufacturing concerns will find it very profitable. Will sell or give license to use it. Investigate. Floravante Guida, 222 Hamilton St., New Haven, Ct.

AUTOMATIC Safety Raft. Titanic fame, two patents. Olesner, Riverton, Wyoming.

PATENT of merit for sale, No. 1,199,456, water-heating device, suitable for mail-order business. Write quick. A. S. Carlson, Los Angeles, Calif.

SCARF Pin Clutch, key ring and trousers attachment. All articles manufactured of sheet metal by dies. Beautiful in appearance and practical. Just patented; for sale or royalty. M. Sago, 49 W. 28th St. N. Y. C.

PATENT Buyers are invited to address our sales department for information on any class of Patents they wish to purchase or lease on a royalty. We have secured a number of valuable patents in all lines of invention. Mail Order, Department Store and Household Novelties a specialty. Victor J. Evans & Co., 169 Ninth St., Washington, D. C.

WANTED—First-class live broker to sell several patents outright on liberal commission. No \$10 down concern need apply. Geo. M. Bacon, Salt Lake City, Utah.

RAPID Bevel joint computer. An efficient and practical device. Patent offered at any reasonable price. Otto Nielsen, 159 Anderson St., Trenton, N. J.

FOR Sale—Patent on engine primer for motorcycles. Time and labor saver. Operated from top of gasoline tank. Cheaply manufactured. John Graf, Hollister, California.

PATENT Pending on Fence Post; have order for 2,000 of these posts. Best out; good seller. For sale outright. Leon Shoecraft, Raymond, South Dakota.

SELF-FEEDING Clothes-Pin Holder. Slides along line; proven success. Royalty preferred; would sell outright. E. P. Smith, 183 Elizabeth St., Pittston, Pa.

PATENTS for sale on Cylinder Grinding Machine. 3695 Carlyle Ave., Cleveland, O.

PATENT Buyers. New thing. Crank holder and crank lock for Ford car. Patent pending. If interested and mean business, address F. J. Eckert, Lorain, Neb.

WANTED—Some one to manufacture on royalty the latest and best invention in calk attachments for horseshoes. Full particulars free. Write now. Harry H. Landis, R. D. No. 1, Telford, Pa.

HYDRAULIC Guns, air or electric powered. Nos. 1,183,644 and 1,167,178. Canadian patents for same. Sale to best offer. R. C. Hill, 303 W. Illinois, Memphis, Tenn.

SOLDERING Outfit—Practical and efficient. Eliminates Gasoline torch. Ordinary fire sufficient. Every mechanic and home owner needs one. Circular free. Hugo F. Leitner, Nipomo, Cal.

PATENT for sale—cheap. New invention absolute necessity; commercially valuable; unlimited possibilities. Address Lock Box Forty-nine, Hoopeston, Illinois.

FOR Sale—Locking means for sectional crosscut saws; no rivets, screws, or bolts to take out or put in. Late patent. F. P. Rowland, Bonnelly, Idaho.

FOR Sale for cash or royalty. Suitable for light manufacture. Mail Order or Novelty Business. Our Number 10649, Game; and 10515 Lock Nut Patented in U. S. For particulars write Talbert & Parker, 4687 Talbert Building, Washington, D. C.

FOR Sale, patentable program clock; meets demand for schools, colleges, stores, etc.; inexpensive construction, perfect operation. Watch Hospital, Lexington, Ohio.

OUTRIGHT or Royalty, new device for flag; patent pending, best offer accepted. Particulars from John Bertenshaw, 696 Front St., Woonsocket, R. I.

GALVANIZED Clothes Pin. Patent Pending. Sale or Royalty. Give References. K. A. Schless, Oyster Bay, New York.

EUREKA—Check Protecting Attachment for Fountain Pens. Something new—practical—attractive. Write J. J. Guerra, Box 421, El Paso, Texas.

RICKLESS Automobile Crank. Patent Pending. Clifton H. Schul, 1221 N. Santa Fe, Wichita, Kans.

TENT Peg—Metal; no hammering, never misplaced, light, strong. Cash or royalty. Geo. B. Bergen, Springfield, Ohio.

REVERSIBLE window patent 1,222,864. J. Hasselmeier, 1074 Intervale Ave., New York.

PATENT on game board for sale. Address E. Leonard, Thompson, Pa.

Additional Classified Ads Page 34

Aviation

Learn Practical Aeronautics By Mail

FOR the first time in the History of Aviation, a Practical and Efficient Correspondence Course is waiting for you under the direction of Qualified Aviators and Aeroplane Builders, and a **Special Offer of Great Importance** is yours, if you will send the coupon at once.

Aviation is in its infancy. It stands today where the automobile and moving picture business did ten years ago. And the big men, the money kings in these colossal enterprises were ten years ago obscure mechanics with less opportunity than you have today with this wonderful Course in Practical Aeronautics. Now is the time to rise with the tide that means to you both fame and fortune.

Earn \$50 to \$500 a Week!

Today there is a great demand for men in all branches of Aviation. Experts in Aeronautics command tremendous salaries. Government Branches, Aero Societies, Aeroplane Builders, Repair Shops and others are clamoring for trained men.

We prepare you by mail to train for flying—at home—in spare time to fill any of these positions:

Aeroplane Mechanic
Aeroplane Builder Aeronautical Engineer
Aeroplane Salesman
Aeroplane Assembler Aeroplane Repairman
Aeronautical Contractor
Aeronautical Instructor Aeroplane Inspector

No matter what your present business may be, equip yourself **NOW** to take up the new profession of Practical Aeronautics. Send the Coupon today for full particulars of our Course and the Special Offer we are now making. This is your opportunity.

Highest Endorsement By Aviation Authorities

This wonderful Course is highly endorsed by leaders in Aviation and Flying Organizations. It has their unqualified approval as a quick and reliable basic training for the business of Aviation. Under the personal direction of Mr. Bud Morriss, well known Aviator and Instructor, assisted by a distinguished Staff of Aviators, Aeroplane Manufacturers, and Aeronautical Engineers, you learn all about this fascinating, profitable profession. Every Lesson, every Lecture, every Blue Print and Bulletin self-explanatory, in plain terms, for quick understanding. Your training is thorough and complete. A common school education is all that is necessary to thoroughly understand the Course. Get the facts today. Send the Free Coupon.

Special Limited Offer-- Write Now

Send the coupon at once for full particulars of our remarkable special offer open to you now. Find out all about the marvelous

opportunities that are opening in the Aviation game. This offer is the greatest stepping stone to bigger opportunities ever known. Write today for complete literature, all free and prepaid. You are not obligated in any way. Do not waste time in thinking about it. Act! Send the coupon or a letter or a post card will do. **WRITE AT ONCE.**

AMERICAN SCHOOL OF AVIATION
 431 So. Dearborn St., Dept. 2628 Chicago, Ill.



EXHIBITION FLYING



AERONAUTICAL ENGINEER



AEROPLANE BUILDER



AEROPLANE REPAIRMAN



AEROPLANE INSPECTOR

American School of Aviation
 431 So. Dearborn St.
 Dept. 2628
 Chicago, Ill.

Gentlemen: Please send me free and without obligation, full particulars of your Course in Practical Aeronautics and your Special Offer to those who write at once.

Name

Address.....

Please Mention Popular Mechanics

Continued from Page 32

PATENTED improved "Article-Carrier." Cash or royalty basis. Reasonable terms. U. S. Patent No. 1,177,692. Canadian Patent No. 375,789. For full particulars address Joseph Fallis, Gunn, Wyoming.

PATENT secured or fee returned. Free Patent Book and Selling Guide. We will promote your patent. Write Sues & Co., Atty., 530 7th St., Washington, D. C.

WE have some money-making inventions for placing on royalty; outright sale or trade. Write Adam Fisher Mfg. Co., 2061B Railway Exchange, St. Louis, Mo.

MODELS AND MODEL SUPPLIES

PRODUCERS of Results: Inventions developed. Models, Experimental work, anything special in metal to order, novelties, spinning, forging, castings in any material, electrical devices, patterns of all kinds, plating, general manufacturing, designing, special tools, punches and dies, stampings. Send drawing or sample. Expert information free. The John's Machine & Stamping Works Company, Dept. C, Cleveland, Ohio.

MODELS, Punches and Dies. Patents Perfected. The Sachs-Lawler Co., Inc., Established 1881, 1543 Larimer St., Denver, Colo.

WANTED—New Ideas. Write for list of Patent Buyers and Inventions Wanted. \$1,000,000 in prizes offered for inventions. Our Four Books sent free upon request. Victor J. Evans & Co., 163 Ninth, Washington, D. C.

WE make working models for inventors; also dies and stamping of specialties, and carry a complete stock of brass gears and model supplies. Send for catalogue. The Pierce Model Works, 3405 Pierce Ave., Chicago, Ill.

PERFECT models sell inventions. We make them. Write Adam Fisher Mfg. Co., 2061E Railway Exchange, St. Louis, Mo.

MANUFACTURING

WIRE Goods, all kinds, made to order. Cooley Mfg. Co., 553 W. Monroe St., Chicago.

INVENTIONS manufactured under contract. Write Adam Fisher Mfg. Co., 2061P Railway Exchange, St. Louis, Mo.

GET Our Prices on Woodwork and Finishing. Keystone Furniture Co., Columbus, Ohio.

PRACTICAL manufacturing formulas, all kinds. Claus, 1864 Harman St., Brooklyn.

REAL ESTATE AND FARM LANDS

FARMING is pleasant and profitable in Virginia and North Carolina. Good land \$15 acre up, easy payments. Climate, schools, churches, roads and neighbors that make life worth living. Close to markets. Fruit, Dairy and Stock Farms pay big here. Farm lists, magazine and interesting literature free. Address—F. H. LaBaume, Agrl. Agt. N. & W. Ry., 259 N. & W. Bldg., Roanoke, Va.

OWN your own Orange or Grapefruit grove in beautiful Fruitland Park. Let me tell you how melons, peaches, hay, your first crops, should pay for your land and grove. J. Q. Lloyd, Desk 93, Fruitland Park, Florida.

SELL your property quickly for cash, no matter where located. Don't pay big commissions. Particulars free. Real Estate Salesman Co., Desk B, Lincoln, Neb.

A **SMALL** farm in California will make you more money with less work. You will live longer and better. Delightful climate. Rich soil. Hospitable neighbors. Good roads, schools and churches. Write for our San Joaquin Valley illustrated folders free. C. L. Seagraves, Industrial Commissioner, AT&SF Ry., 1933 Ry. Exch., Chicago.

\$5.00 DOWN, \$5.00 monthly; seven acres fruit, poultry, fur farm; river frontage; Ozarks; \$150.00; hunting, fishing, trapping. Harvey Hubbard, 1913 North Fifth, Kansas City, Kansas.

GOVERNMENT Lands Free Booklet. Joseph Clark, Sacramento, California.

GINSENG

GINSENG, extra fine seed and plants very cheap, in large quantities. Culture instruction pamphlet free. Daniel Wyss, New Philadelphia, Ohio.

DOGS, BIRDS, POULTRY, PETS

MILCH Goats are profitable. Get best book on subject. 23 illustrations, all breeds, 35 cents prepaid. Fred C. Lunsbury, Plainfield, N. J.

COONHOUNDS, Big Game Hounds, Rabbit Hounds, Pointers, Setters, Airedales, Fox Terriers. Catalog 4 cents. Stephenson Kennels, Covington, Tenn.

REGISTERED Russian Wolfhound pups \$20. Coyote pups \$5. Idle Hour Kennel Co., Guyton, Okla.

FOR Sale: High class registered Pit Bull Terriers and Setters. Randle & Turner, Thorndale, Texas.

AIREDALE Puppies: pedigreed, typical, vigorous. Write for description, prices. A. C. Cottell, Sunny Crest Farm, New Buffalo, Mich.

AIREDALE puppies, mother trained hunter and retriever; males \$15.00, females \$7.50. Geo. Groves, Viroqua, Wis.

RAISE Guinea Pigs for us. We buy all you raise. Pay better than poultry. Contract, particulars, booklet how to raise free. Cavies Distributing Co., 3102-A Grand Ave., Kansas City, Mo.

BEAUTIFUL White Collies—Registered. Satisfaction guaranteed. Thos. Shower, Monticello, Iowa.

RAISE skunks in city or country. Odorless method. Illustrated circular P free. Skunk Development Bureau, Chicago.

SQUABS are raised in one month, they sell for fancy prices. Write at once for big free book telling how to make money breeding squabs. Plymouth Rock Squab Co., 634 Howard St., Melrose Highlands, Massachusetts.

RAISE Belgian Hares for Us. Big profits. We furnish stock and pay you \$2.00 each. Also Cavies, mink, skunk, fox, squabs, frogs, etc. Two booklets and contract for dime. None free. Address the Belgian Hare, 31 Main Street, Holmes Park, Mo.

PERSONAL

TOBACCO habit cured by harmless recipe. Sent free. Superba Co. (BS), Baltimore, Md.

GOLD Seal No. 10 completely kills the desire for tobacco and snuff. A fully guaranteed vegetable treatment sent for \$2.25. Wonderful success. Wonderful testimonials. Send for our book "A." It tells you why you should quit tobacco and snuff. It is free, free. Send today sure. Inland Chemical Company, Bismarck, North Dakota.

BROTHER—Discovered root cures tobacco habit. Gladly send particulars. F. Stokes, Mohawk, Florida.

FREE—Stop using tobacco. We will give free information how to conquer habit easily and permanently. Results Guaranteed. Anti-Tobacco League, Box 370, Omaha, Neb.

ANTIQUES AND RELICS

POMO Indian Star Baskets. Prices free. Gilham, Highland Springs, Cal.

ANCIENT Indian arrow heads. Send for lists. A. Ruby, Middletown, Pa.

MISCELLANEOUS

SHINES in the dark. Our Luminous Paint, coated on any article, makes them visible at night. Watches, clocks, electric switch plates, crucifixes, match boxes, etc., can be coated with splendid results. (Everlasting.) Only 25c bottle. Luminous Paint Co., Douglas Park Station, B-18 Chicago, Ill.

CASH paid for butterflies, insects. Some \$1 to \$7 each. Easy work. Even two boys earned good money with mother's help and my pictures, descriptions, price list, and simple instructions on painless killing, etc. Send 2c stamp at once for prospectus. Sinclair, Box 244, D6, Los Angeles, Cal.

GRANDFATHER'S Clocks. Build your own Grandfather's Clock with our free blue prints. Works, Dial, etc., \$5 and up. Others with chimes at all prices. Write for free offer. Clock Co., 1671 Ruffner St., Philadelphia, Pa.

HEATING System which saves you hundreds of dollars. Adapted to any furnace for heating Libraries, Schools, Churches, Hotels or wherever heat or steam is required. Easily installed. Patented. Burner and Steam-generator \$50. We employ no salesmen. Root Crude Oil System, 2025 C Street, Eureka, Calif.

AVOID sleepless nights. Send one dollar for instant toothache relief. Dr. Koch, 4250 St. Louis Ave., St. Louis, Mo.

PEARLS, baroque, slugs, bought and sold. Designing, mounting, repairing jewelry done. "Pearls and Pearling"—best book published \$1.00. Laverne Mapes, Indiana Harbor, Ind.

METAL Badges, rubber stamps, seals, stenics. Catalogue 15c. Walter Karstaedt, Dayton, Ohio.

MUSIC especially, or drawings printed from original, 5 cents page. Felix Viola, Los Angeles, Cal.

TATTOOING machines \$1.25. Hand outfits 50c. Illustrated catalog free. Werner Co., 1321 Bremen, Cincinnati, O.

CUTS anybody can make. Simple, cheap process. Specimens, particulars for stamp. M. Day, Windfall, Ind.



TRAVEL AND EARN \$125 a Month

YOU can see the world, with all expenses paid, and a salary to start of \$125 a month. Railroads need trained men between 18 and 55 for Traffic Inspectors. You can go any place you like and stay as long as you wish. Your work brings you in personal contact with railroad officials. Many of our graduates have risen from traffic inspectors to executives.

We train you by mail in a few weeks. We assure you a position immediately. Special Summer course just starting. Send today for booklet K2 and printed record of what our graduates have done.

FRONTIER PREP. SCHOOL
Buffalo, N. Y.

Please Mention Popular Mechanics

60 BOOKS Bound in Leather \$100 AFTER TRIAL

Not a penny in advance. The masterpieces of Kipling, De Maupassant, Stevenson, G. Bernard Shaw, Victor Hugo and dozens of others. Each book bound in genuine limp leather, pocket size. Write postal now for offer.

LITTLE LEATHER LIBRARY, 180 Menzies Bldg., 23rd St., New York

FREE FOR 5 DAYS

"Everybody Ahead." Thousands of readers say this inspiring book is helping them to become more proficient and successful. Sent to you on 5 days approval. Send no money. If you don't want to keep the book, return it, otherwise remit \$3.00.

Frank E. Morrison, Publisher, Dept. 22, 1133 Broadway, New York, N. Y.

FREE!

A flying model aeroplane and all materials to build your own scale model. Free with our great Home Course in the Principles of Aviation. Write at once—before this offer is withdrawn. Learn the Science of Aviation at Home—under guidance of Experts. Tremendous demand for men who know aviation. Wonderful future. Prepare now. Write us today.

NATIONAL AERO INSTITUTE, Dept. C102, Morton Bldg., CHICAGO



Gasolene is high, but THE COMING FUEL IS ALCOHOL



Wright's BOOK
gives full directions
for making Alcohol
and De-Naturing.

Fully Illustrated. 283 Pages. Cloth. By Mail \$1.15

SPON & CHAMBERLAIN
120 P. M. Liberty Street NEW YORK

BOOKKEEPING — in 40 hours

Prepare immediately for the positions left vacant by conscription. Men and women are needed by the thousands as bookkeepers.

Endorsed by Treas. of Pennsylvania

We guarantee that after 40 hours of easy study you can successfully fill a well-paying bookkeeping position. Course endorsed by Pennsylvania Treasurer, bankers, etc.

2/3 Cheaper The Hoffman Course saves you 66% of your money, as well as more time than any other course ever perfected.

Write today for free literature.
NO OBLIGATION OR SOLICITORS.

The Hoffman Correspondence School of Bookkeeping
508 Dispatch Bldg., Fifth Ave., Pittsburgh, Pa.

ENGINEERING MECHANICAL ELECTRICAL

One Year Practical Courses. Day and Evening classes. Splendid equipment and instruction. Low tuition. For particulars address

DETROIT TECHNICAL INSTITUTE
Box 308, Y. M. C. A. Building, DETROIT, MICH.



SEND 2 CENTS

in United States stamps to pay postage and we will send you FREE a SAMPLE COLLAR of our New Style "Copley." State size wanted.
REVERSIBLE COLLAR CO., Dept. U, BOSTON, MASS.

STAMMERERS

Our course of private lessons will correct your impediments.
BOSTON STAMMERERS' INSTITUTE
Founded 1897. Samuel D. Robbins, Principal.
246 Huntington Ave. BOSTON, MASS.

SHORTHAND IN 30 DAYS

THE NEW WAY. Learned at home in 30 DAYS. Boyd Syllabic System, based on Syllables. No shading—no position. Writers hold World's Record. Two of the largest Mail Order Houses have installed the Boyd System. 100 to 150 words a minute guaranteed. Write today for Special Offer, Free Catalog and Sample Lesson.

Chicago Home Study Schools, 504 Reaper Bldg., Chicago, Ill.



"I Can Succeed!"

"What other men have accomplished through I. C. S. help, I can. If the I. C. S. have raised the salaries of other men, they can raise mine. If their positions have been bettered, mine can be. To me, I. C. S. means 'I CAN SUCCEED.'"

Get the "I Can Succeed" spirit, for the International Correspondence Schools can raise your salary—whether you're a dollar-a-day man or a dollar-an-hour man, a long-hour man or a short-hour man, young or old.

No matter where you live, what you now do, or how little time or money you may have, the I. C. S. have a Course of Training to fit *your* needs.

Hundreds of thousands of ambitious men have achieved success through I. C. S. help in the past 25 years—over 130,000 are now studying, getting ready for the big jobs ahead. Join them and make your life something to be proud of—you *can* do it.

Mark and mail the coupon TODAY and find out *how*; it won't obligate you in the least.

TEAR OUT HERE INTERNATIONAL CORRESPONDENCE SCHOOLS BOX 5600, SCRANTON, PA.

Explain, without obligating me, how I can qualify for the position, or in the subject, before which I mark X.

- | | |
|---|--|
| <input type="checkbox"/> ELECTRICAL ENGINEER | <input type="checkbox"/> SALESMANSHIP |
| <input type="checkbox"/> Electric Lighting | <input type="checkbox"/> ADVERTISING |
| <input type="checkbox"/> Electric Railways | <input type="checkbox"/> Window Trimmer |
| <input type="checkbox"/> Electric Wiring | <input type="checkbox"/> Show Card Writer |
| <input type="checkbox"/> Telegraph Engineer | <input type="checkbox"/> Sign Painter |
| <input type="checkbox"/> Telephone Work | <input type="checkbox"/> Railroad Trainman |
| <input type="checkbox"/> MECHANICAL ENGINEER | <input type="checkbox"/> ILLUSTRATING |
| <input type="checkbox"/> Mechanical Draftsman | <input type="checkbox"/> Cartooning |
| <input type="checkbox"/> Machine Shop Practice | <input type="checkbox"/> BOOKKEEPER |
| <input type="checkbox"/> Gas Engine Operating | <input type="checkbox"/> Stenographer and Typist |
| <input type="checkbox"/> CIVIL ENGINEER | <input type="checkbox"/> Cert. Public Accountant |
| <input type="checkbox"/> Surveying and Mapping | <input type="checkbox"/> TRAFFIC MANAGER |
| <input type="checkbox"/> NINE FOREMAN OR ENGINEER | <input type="checkbox"/> Railway Accountant |
| <input type="checkbox"/> Metallurgist or Prospector | <input type="checkbox"/> Commercial Law |
| <input type="checkbox"/> STATIONARY ENGINEER | <input type="checkbox"/> GOOD ENGLISH |
| <input type="checkbox"/> Marine Engineer | <input type="checkbox"/> Teacher |
| <input type="checkbox"/> ARCHITECT | <input type="checkbox"/> Common School Subjects |
| <input type="checkbox"/> Contractor and Builder | <input type="checkbox"/> Mathematics |
| <input type="checkbox"/> Architectural Draftsman | <input type="checkbox"/> CIVIL SERVICE |
| <input type="checkbox"/> Concrete Builder | <input type="checkbox"/> Railway Mail Clerk |
| <input type="checkbox"/> Structural Engineer | <input type="checkbox"/> AUTOMOBILE OPERATING |
| <input type="checkbox"/> PLUMBING AND HEATING | <input type="checkbox"/> Auto Repairing |
| <input type="checkbox"/> Sheet Metal Worker | <input type="checkbox"/> Navigation |
| <input type="checkbox"/> Textile Overseer or Supt. | <input type="checkbox"/> AGRICULTURE |
| <input type="checkbox"/> CHEMIST | <input type="checkbox"/> Poultry Raising |
| | <input type="checkbox"/> Spanish |
| | <input type="checkbox"/> German |
| | <input type="checkbox"/> French |
| | <input type="checkbox"/> Italian |

Name _____

Present Occupation _____

Street and No. _____

City _____ State _____

Please Mention Popular Mechanics



Music Lessons

Book Sent FREE Wonderful home-study music lessons under great American and European teachers given by the University Extension Method. The lessons are a marvel of simplicity and completeness, endorsed by Paderewski and other great authorities. You, too, can now quickly and easily satisfy your musical ambitions.

Any Instrument or Voice

Write, telling us the course you are interested in, age, how long you have taken lessons if at all, etc., and we will send you our Free Book containing text and illustrations covering Lessons in PIANO (students' or teachers' courses) by the great Wm. H. Sherwood, HARMONY by Dr. Protheroe and Rosenbecker, VOICE COURSE (with aid of Phonograph) by Crampton, PUBLIC SCHOOL MUSIC by Frances E. Clark, VIOLIN, CORNET, MANDOLIN, GUITAR, BANJO, REED ORGAN, CHORAL CONDUCTING, by equally eminent teachers.

Send NOW for Free Book and learn how easily you can become successful. Our Free Book tells you how. Write for it today. A few Special Introductory Scholarships now being awarded by our faculty. Full particulars sent with Free Book. Investigate without cost or obligation. Write today.

University Extension Conservatory

Proprietor Siegel-Myers School of Music

2896 Siegel-Myers Building Chicago, Ill.



PAY \$75 to \$150 MONTH

U. S. GOVERNMENT WANTS

Railway Mail Clerks—City Mail Carriers—Postoffice Clerks—Clerks at Washington, D. C.

War Necessitates
Thousands Appointments

Common education sufficient. Send coupon immediately.

SEND
COUPON
BELOW

FRANKLIN INSTITUTE

Dept. E 105, ROCHESTER, N. Y.

This coupon, filled out as directed, entitles the sender to (1) free sample examination questions; (2) a free copy of our book, "Government Positions and How to Get Them;" (3) free list of positions now easily obtainable; and (4) to consideration for Free Coaching for the examination here checked.

COUPON

.. Railway Mail Clerk	(\$900 to \$1800)	.. Customs Positions	(\$800 to \$1500)
.. Postoffice Clerk	(\$800 to \$1200)	.. Internal Revenue	(\$700 to \$1800)
.. Postoffice Carrier	(\$800 to \$1200)	.. Stenographer	(\$900 to \$1500)
.. Rural Mail Carrier	(\$500 to \$1200)	.. Clerk in the Department	at Washington
.. Bookkeeper	(\$900 to \$1800)		(\$800 to \$1500)

Name.....

Address..... E 105

Use this before you lose it.

Write plainly.

What the WAR means to Electrical MEN

"The Nation needs each man in the endeavor that will best serve the common good. The Nation is being served only when the sharpshooter marches, and the machinist remains at his levers," said President Wilson in his proclamation of May 17th.

Men with electrical training are needed now more than ever before, both at home and at the front. But America needs experts in electricity—not dabblers. You can't learn electricity out of a book.

The Only Way to Learn Electricity

The only way you can become an expert is by doing the very work, under competent instructors, which you will be called upon to do later on. In other words, *learn by doing*. That is the method of the New York Electrical School.

Our concentrated work with actual apparatus under actual conditions will put you abreast of men with from 5 to 10 years' experience in the electrical field. 4,500 of our students have gone forth into electrical success.

Learn by Doing This method makes you an expert, able to command a high salary. All instruction is individual. You go ahead as fast as you can learn. Good students complete the course in seven months. Send today for FREE 64-page book. Tear out this advertisement and mail it with your name and address.

NEW YORK ELECTRICAL SCHOOL
44 W. 17th Street, NEW YORK, N. Y.



ARMOUR Institute of Technology CHICAGO, ILL.



Main Building

Offers complete courses in Mechanical, Electrical, Civil, Chemical, Fire Protection Engineering, Architecture, and Industrial Arts. All courses four years in length, and lead to the degree of Bachelor of Science. Fully Equipped Shops and Laboratories. First Semester begins September 10, 1917. Bulletins sent on request. **Armour Institute, Box 12 -33rd and Federal Streets, Chicago, Illinois**

COLLEGE OF DENTISTRY University of Illinois

Four year curriculum leading to the degree of Doctor of Dental Surgery. Fifteen units, accredited high school, for admission. Infirmary unexcelled in point of equipment and operating facilities.



Demand for dentists greater than the supply. U. S. Government needs more than 2,000 dentists for military service. Unprecedented opportunities for dental students. Write for catalogue. Box 70.

The Dean, College of Dentistry
University of Illinois

1838 W. Harrison St. Chicago

LEARN TO WRITE EARN \$25 to \$100 ADVERTISEMENTS A WEEK

We can positively show you by mail How to increase your salary. BOOK MAILED FREE. PAGE-DAVIS CO., 112 Page Building Chicago, Ill., or 154 Nassau St., New York



New Book Free

Write today for the book that tells about the opportunities in the profession of Signal Engineering. Men are needed. Learn, too, how you can get the training that you need to fill the big job.

\$125 to \$300 a Month

The free book will give you just the information you want. Write for it now—immediately. Here is a golden opportunity.

Dept. C119 -1810 Wilson Ave.
Riverside Sta., Chicago, Ill.

LEARN AUTOS

WHERE AUTOS ARE MADE



Enlarged
Facilities

Freely Endorsed by
Automobile Manufacturers

Detroit is the training camp for men who make good in the automobile and allied lines. Never has the call for men skilled as mechanics, testers, inspectors, repair-men, bearing scrapers, welders, chauffeurs and salesmen been as great as it is today — *and the demand is growing.*

The Y.M.C.A. Auto School

is organized to train men. A Course in this School will quickly fit the beginner to do well-paid work, and get in line for advancement in the rapidly growing automobile industry. Tuition fees go to procure the highest class of instructors and best of equipment.

Growth Brings Added Facilities

The Y. M. C. A. Auto School is now in its New Building. Among the manufacturers who have contributed liberally toward our equipment are: Studebaker, Buick, Hupp, Chalmers, Ford, Packard, Hudson, Gray & Davis, Delco, Cutler-Hammer, Zenith, and many others. Can you ask stronger proof of the school's standing than the fact that men who know give freely of their time and money to co-operate with us.

Tuition includes membership in the "Y" and free service of Employment Bureau for one year. Our big Club House, adjoining our New Building, is at your disposal. Reading rooms, lounging rooms, gymnasium, swimming pool, billiard and pool tables, bowling alleys, with five floors of dormitories and restaurant at low rates. You are assured of not only thorough and competent instruction, but good companionship and clean living conditions with the comforts of home and club life combined.

Don't Visit Detroit Without Seeing Us. You want to consider everything carefully before you enroll for any course of instruction. Come and look us over, whatever purpose brings you to Detroit. Get all the particulars of this school, get the records of our instructors, hear what auto factories and automobile men have to say about us, see for yourself our comfortable quarters and big equipment. We will be glad to see you and show you around whether you enroll or not. Day and night classes. Start at any time.

Write today for full particulars. Address

EDUCATIONAL DIRECTOR

Box 305, Y. M. C. A., DETROIT, MICH.



NEW HOME OF Y.M.C.A. AUTO SCHOOL

Please Mention Popular Mechanics

414 PAGES 145 ILLUSTRATIONS



I.C.S.
ELECTRICAL ENGINEER'S
HANDBOOK

50^c

ELECTRICITY!

HERE'S just the book on Electricity that you need to answer your many questions—to solve your knotty problems, to teach you new kinks, to be your memory for tables, rules, formulas and other Electrical and Mechanical facts that some people try to carry in their heads—and fail.

With this "Little Giant" I. C. S. Electrical Engineer's Handbook in your pocket, tool chest, on your work bench, drawing table or desk, an hour or a day need not be lost "digging up" some forgotten rule, some unfamiliar fact; you'll just turn to the very complete index and get

it "in a jiffy." Just a few of the subjects treated are:

Electricity and Magnetism; Electrical Symbols; Batteries; Circuits; Magnets; Direct and Alternating Currents; Dynamos and Motors; Belts; Shafting; Electroplating; Electrical Measurements; Meters; Arc and Incandescent Lamps; Mercury Arc Rectifiers; Transformers; Insulation; Electric Cars; Single and Multiple-Unit Control; Transmission; Rail Welding; Tables of Wires—Sizes, Capacities, etc.—Mathematical Rules, Formulas, Symbols; Tables of Constants, Equivalents, Roots, Powers, Reciprocals, Areas, Weights and Measures; Chemistry; Properties of Metals; Principles of Mechanics; First Aid, etc.

The Electrical Engineer's Handbook is one of 22 I. C. S. Handbooks covering 22 Technical, Scientific and Commercial subjects, all crowded with value. They have the contents of a full-size book condensed into pocket-size ready to go with you anywhere and be at your instant command. They are substantially bound in cloth, red edges, goldleaf stamping, printed from new, clear, readable type on good quality book paper. There is an illustration at every point where a picture will help. Hundreds of thousands have been sold on a money-back guarantee of satisfaction.

The former price of these Handbooks was \$1.25, but **THIS MONTH** you can buy **50c** each, the ones you want for only **50c** postpaid

(For 10c extra we will send a cloth-covered protecting case.)

You Run No Risk! Money Back if Desired!

International Correspondence Schools

Box 5596 Scranton, Pa.

INTERNATIONAL CORRESPONDENCE SCHOOLS

Box 5596 SCRANTON, PA.

I enclose \$_____ for which send me postpaid the Handbooks marked X, at 50c. each. I may return any or all and get my money back within ten days from receipt:

- | | |
|--|---|
| <input type="checkbox"/> Electrical Engineer's | <input type="checkbox"/> Advertiser's |
| <input type="checkbox"/> Teleph. and Teleg. Engineer's | <input type="checkbox"/> Business Man's ★ |
| <input type="checkbox"/> Mechanic's | <input type="checkbox"/> Bookkeeper's |
| <input type="checkbox"/> Steam Engineer's | <input type="checkbox"/> Steno. and Correspondent's |
| <input type="checkbox"/> Westinghouse Air Brake | <input type="checkbox"/> Salesman's |
| <input type="checkbox"/> Civil Engineer's | <input type="checkbox"/> Window Trimmer's |
| <input type="checkbox"/> Coal Miner's | <input type="checkbox"/> Cotton Textile Worker's |
| <input type="checkbox"/> Concrete Engineer's | <input type="checkbox"/> Farmer's |
| <input type="checkbox"/> Building Trades | <input type="checkbox"/> Poultryman's |
| <input type="checkbox"/> Plumber's and Fitter's | <input type="checkbox"/> Mariner's |
| <input type="checkbox"/> Chemist's | <input type="checkbox"/> Automobile |

Name _____

Street and No. _____

City _____ State _____

Please Mention Popular Mechanics

A 'Steel Trap' Memory

One that takes a tight grip on facts, figures, names, details of every kind and hangs onto them through life—that's the kind of memory you ought to have and the kind you can have if you will give me ten minutes of your spare time daily for a few weeks. I will make your mind an infallible classified index of the things it is to your advantage to remember—give you power to concentrate, overcome self-consciousness, enable you to think on your feet, and address an audience intelligently without hesitancy and without notes.



The Key to Success

Stop forgetting

Henry Dickson,
Principal,
Dickson
School of
Memory

During the past 19 years I have trained thousands of people to STOP FORGETTING—aided them to greater business and social success—I know positively that the person with a strong, tenacious memory, though he be far behind at the beginning of the race for success, advances and soon outdistances his forgetful rival. The demands of commercial and professional life are so exacting in their details of facts and figures to be remembered, that to succeed or even hold your own you simply must possess a good memory.

Get My Remarkable Memory Test Free

I've had this test—most ingenious and most exclusive memory test ever devised—copyrighted. I'll send it to you, free, also a copy of my book "How to Remember" and tell you how to obtain a copy of my De Luxe edition, "How to Speak in Public," a handsomely illustrated 42 book, absolutely free.

HENRY DICKSON, Principal,
Dickson School of Memory, 1765 Hearst Bldg., Chicago

CIVIL SERVICE

positions are in all parts of the country. Good pay, steady work, life positions, congenial surroundings, promotions on merit, short hours, annual vacation and sick leave with pay. Many thousands appointed yearly. Both sexes. No political pull. Nearly 300,000 classified positions. Common school education sufficient. Full information and questions used by the Civil Service Commission free.

COLUMBIAN CORRESP. COLLEGE, WASHINGTON, D.C.

DRAWING

Learn by Mail in YOUR OWN HOME

Newspaper, Magazine and Commercial Illustrating, Cartooning, Water Color and Oil Painting. Learn drawing or painting for profit and pleasure. We can develop your talent. This school has taught thousands. Free Scholarship Award—special limited offer. Your name and address brings you full explanation and our handsome illustrated Art Annual by return mail. Don't delay, write to-day. Fine Arts Institute, Studio 56Z, Omaha, Neb.



Advertising Manager—\$5000 a Year YOU CAN BE ONE

If our Vocational Director will accept you, then you can succeed in advertising. Ten practical business men will teach you. Write for booklet, "Poverty to \$10,000 a Year" and "Free Personal Analysis blank."

BRYANT & STRATTON COLLEGE, 1023 Bryant & Stratton Bldg., CHICAGO, ILL.

STUDY LAW 30 Days FREE

Let us prove to your entire satisfaction, at our expense, that the Hamilton College of Law is the only recognized resident law school in U. S., Conferring Degree of Bachelor of Laws—LL. B.—by correspondence. Only law school in U. S. conducting standard resident school and giving same instruction, by mail. Over 500 class-room lectures. Faculty of over 30 prominent lawyers. Guarantee to prepare graduates to pass bar examination. Only law school giving Complete Course in Oratory and Public Speaking. School highly endorsed and recommended by Gov. Officials, Business Men, Noted Lawyers and Students. Send today for Large Handsomely Illustrated Prospectus and Special 30-Day Free Trial.

HAMILTON COLLEGE OF LAW, 1255 Advertising Bldg., Chicago, Ill.

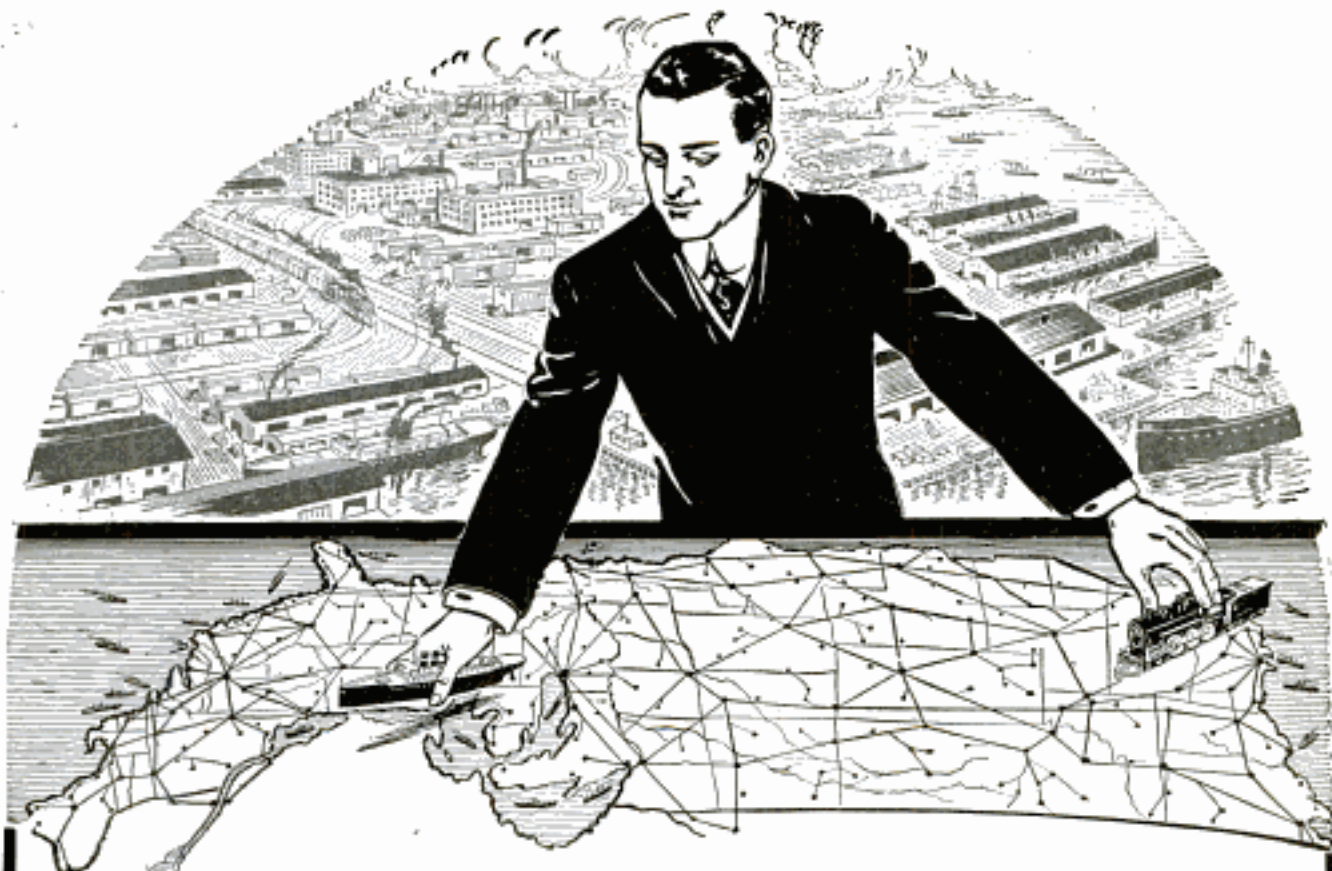

This Man Earns \$100 a Week

He knows how to open up large markets and help his employers outstrip competition in business because he knows how to route shipments, obtain shortest mileage, lowest rates, and quickest deliveries. He knows how to classify goods and reduce transportation costs. His knowledge of traffic laws and transportations saves his employers thousands of dollars annually.

Here's your chance to qualify for the same kind of a position at the same salary. Don't let this chance go by. Few men have this traf-

fic knowledge. The demand far exceeds the supply. In fact, over half a million firms need men who can classify commodities and secure ratings most economically. You can be able to answer this call for trained traffic men quickly by means of the LaSalle Home Study Course. We guide you step by step. With the LaSalle Extension University behind you, you can qualify in a comparatively short time. The expense is so small and the terms so easy you will scarcely miss the money. Qualify for a bigger job—at home—in spare time.

Be a Traffic Man

At \$35 to \$100 a Week

There seems to be no limit to the salaries expert traffic men are paid. Some concerns pay their directors of traffic \$10,000 or more a year. Salaries of \$35 to \$100 a week are commonly paid to traffic managers. Splendid positions with high salaries for competent, trained men are open everywhere.

We Train You By Mail For a Big Traffic Job

You need not leave your present position. You may keep on earning while learning.

Our course is recommended and endorsed by railroad executives and big business concerns throughout the country. Your training is under the supervision of a large corps of the most prominent traffic experts in the country, headed by N. D. Chapin, until his present connection with us, Chief of Tariff

Bureau New York Central Lines. The Course gives you also a thorough understanding of Interstate Commerce Laws and prepares you for every duty required of a high grade traffic manager—how to route shipments, obtain shortest mileage, classify goods, secure quickest deliveries and lowest rates—in fact, trains you so that you can qualify for an immediate high salaried railroad or industrial traffic position.

LaSalle Extension University,
"The World's Greatest Extension University"
Dept. 864-C Chicago, Ill.

Send In the Coupon

For proof that our graduates, because of the thoroughness of their training through our course, qualify for the best positions and increase their earning capacity. Let us send you letters from students and full details concerning the LaSalle University Home Course in Traffic Management. Send in the coupon now and receive our free book "Proof," letters and full details by return mail.

Free Book Coupon

LaSalle Extension University,
Dept. 864-C Chicago, Ill.
"The World's Greatest Extension University"

Send Free Book about opportunities now open to TRAFFIC EXPERTS with LaSalle University Training. It is understood that I am not obligating myself in any way.

Name

Address

City..... State.....

Please Mention Popular Mechanics

Auto Books



50c a Week

Only 50c a week buys this brand-new automobile library. It is called **Automobile Engineering**, and in it you will find everything about modern automobiles. Almost two entire volumes are devoted to the new systems of ignition, starting and lighting, Welding, vulcanizing, and public garage equipment and operation are thoroughly covered. Five thick volumes, 6½x8 inches, flexibly bound in genuine morocco leather, gold stamped. 2,400 pages; 2,000 illustrations, tables and diagrams. Written in simple, easily-understood English, and carefully cross-indexed for quick reference.

Shipped Free

Don't send a penny. Just put your name and address in the coupon and we'll send all five volumes to you, express prepaid. Read them—study them—examine them carefully before you decide to buy. If you don't like them after 7 days—write us and we'll take them back at our expense. If you keep them, send only \$2.00 within 7 days, and then \$7.00 a month—50c a week—until the introductory price of \$16.80 has been paid. The regular price of this set will be \$25.00.

Consulting Service FREE

In addition to the books you get free of all charge a \$12.00 Consulting Membership. If any question puzzles you—write us. Our corps of auto experts will solve any auto problem. Ask all the questions you want for a whole year. This service is absolutely free.

Partial List of Subjects
Motors, Welding, Motor Construction and Repair, Carburetors, Valves, Cooling, Lubrication, Fly-Wheels, Clutch, Transmission, Final Drive, Steering, Tires, Vulcanizing, Ignition, Starting and Lighting Systems, Wiring Diagrams, Shop Kits, Commercial Garage Equipment, Electricity, Storage Batteries, Motorcycles, Commercial Trucks, Glossary.

American Technical Society,
Dept. A119C, Chicago, U.S.A.

Please send me a set of Automobile Engineering for 7 days' free examination. If I decide to buy, will send \$2 in 7 days and balance \$2 a month until \$16.80 has been paid, when books and Consulting Membership will be mine. Otherwise will notify you and hold books subject to your order. Title not to pass until fully paid.

NAME

ADDRESS

REFERENCE

MAIL This Coupon

See these books before you decide to buy. Remember—don't send us a penny. Just fill in and mail the coupon. This offer is open to any person living within the boundaries of the U. S. and Canada.

AMERICAN
TECHNICAL
SOCIETY
Dept. A119C
CHICAGO, U.S.A.

Learn to Write

GOOD hand-writing has been truly called the "Bread and butter of a business education." It should be the determination of every body to learn to write at least a good business hand. **Good writing is the very foundation of business success.**

Easy to Learn By my system you can become a good penman at home, in your own room during spare time. Don't be content with the notion that good penmen "are born" such. Because one's ancestors may have been noted for poor penmanship, is no excuse for him to remain an illegible scribbler. My system is original, unique, and highly successful—the result of 25 years' experience.

Your Spare Time Just your spare moments—that's all I ask. If you follow my instructions you will soon be able to write a beautiful hand that will be a source of pride to yourself and envy to your friends. Notice the improvement shown in Mr. Campbell's writing below.

Leland M. Campbell

"I am astonished at the improvement I've made by means of The Tambllyn System in so short time."

LELAND M. CAMPBELL,
Campbelltown, Ohio.

Leland M. Campbell

Mr. Campbell wrote his upper signature July 20, and the lower one November 10—a little less than 4 months apart. Hundreds and hundreds of others in all parts of the world are doing as well with my system.

I have had unbounded success in making poor writers good ones and good writers better penmen than they thought possible.

32 PAGES
HIGHLY ILLUSTRATED

How to Become a Good Penman

FREE BOOK
WRITE FOR IT TODAY

Penmanship is particularly adapted to correspondence instruction, and I absolutely guarantee satisfactory improvement. Distance no barrier. Ladies taught just as successfully as men.



Don't wait, don't delay, begin now to prepare for that position where good penmanship will be required. Send today for my **Free Book**, "How to Become a Good Penman," which contains copies and beautiful specimens and tells how others have become good penmen by means of the Tambllyn System. Your name will be beautifully written on a card with white ink if you enclose stamp.

F. W. TAMBLYN,
418 Meyer Building,
Kansas City, Mo., U.S.A.

FREE BOOK COUPON

F. W. TAMBLYN, 418 Meyer Bldg., Kansas City, Mo., U. S. A.
I am interested in improving my penmanship. Please send me free your Book "How to Become a Good Penman."

Name

Address

Sign and mail this today, before you forget it.

Electrical Meter Engineering

"The Profession With a Future"

Now learned at home. Big demand for competent men. Pleasant, interesting, fascinating employment all the year 'round, with exceptional opportunities for advancement. Success guaranteed. High salaries offered. No experience necessary.

Special Offer! In order to get more men in training for good positions, we are making a great special offer to a limited number. Write today for full particulars—FREE. No obligations. Be a Meter Engineer, the man who fixes, not the one who is fixed. Be boss. Write today. Fort Wayne Correspondence School, Dept. C119, Fort Wayne, Indiana.

Typewrite the New Way.

80 to 100 Words a Minute GUARANTEED

Totally new system. Based on Gymnastic Finger Training! Brings amazing speed—perfect accuracy—BIG SALARIES. Easy for anyone. First day shows results. Learn while working. Write postal today—NOW—for full particulars. Tulloss School of Typewriting, 128 College Hill, Springfield, O.

SPEAK A FOREIGN LANGUAGE!!!

The War has created unlimited opportunities for those who know Spanish, French, German or Italian. Better your position or increase your business. You can learn quickly and easily, at home, during spare moments, by the

**LANGUAGE-PHONE METHOD
And Rosenthal's Practical Linguistry**
(Highest Award Panama-Pacific Exposition, 1915)

You listen to the living voice of a native professor pronounce the foreign language, once and once, until you know it. Our records on all talking machines. Write for Booklet, particulars of Free Trial. The Language-Phone Method, 661 Putnam Bldg., 2 W. 45th St., N.Y.

A GOOD POSITION

with UNCLE SAM is most desirable. Life positions, pleasant surroundings, good pay, steady work, short hours, promotions on merit. Both sexes. No political pull. Thousands of appointments yearly. Most thorough preparation \$5. Returned if not appointed. Full information and questions used by the Civil Service Commission free.

AMERICAN CIVIL SERVICE SCHOOL

WASHINGTON, D. C.

Learn MOTION PICTURE Reporting

Trained operators needed in every locality. Profitable, fascinating employment out of doors for "live" men and women.

We train you. Write for free book.

MOTO-GRAPH SYNDICATE
Clark and Halsted Sts., CHICAGO, ILL.

LEARNED BY
ALMOST
ANYONE

VENTRILOQUISM AT HOME

SMALL COST
Send today 2c stamp for particulars and proof.
O. A. SMITH, Room D 153, 823 Bigelow St., PEORIA, ILL.

LEARN WATCHMAKING

and become independent. Good-paying positions secured. Easy to learn. Send for FREE CATALOG.
ST. LOUIS WATCHMAKING SCHOOL, Dept. 5, ST. LOUIS, MO.

Learn Electricity! 20 Lessons Free!

Let me give you 20 regular lessons in Electricity FREE. Write postal for my great book and sensational offer. Read about my new method of teaching you by mail in your own home. Earn \$2000 to \$4000 a year! SEND POSTAL TODAY. Let me show you what I have done for thousands of others. My guarantee gives you entire Course Free unless satisfied. Get my 20 Lessons. Write for Book and Offer NOW. Address: Albert Wood Wicks, B.S., E.E., President Wicks Electrical Institute, Dept. 488, 61 W. Randolph Street, Chicago

CHICAGO AERO MEN ORGANIZE NATIONAL AERO INSTITUTE

Now Teach the Principles of Aviation by Mail

CHICAGO.—The prospect of the United States spending a billion dollars in aviation and sending 30,000 flyers to Europe within a year has created a stir in aeronautical circles. It means an immense demand not only for flying men, but for men to serve as airplane engineers, designers, builders, contractors, mechanics, repairmen, instructors and inspectors.

To help meet the situation prominent aero men of Chicago have organized the National Aero Institute. This institute furnishes a complete mail course in the principles of aviation. The course enables young men to secure training at home without giving up their present employment, and does not require a college education.

Instruction is under the direction of aeronautical experts. At the head of the Institute's Advisory Board is Walter L. Brock, the famous engineer and aviator who won the great London to Paris race. Glenn Muffly, the American aeronautical engineer, is chief instructor. Other members of the board are: E. C. Cook, formerly with Wright-Martin Co. of Dayton, O.; James S. Stephens, Vice President of the Aero Club of Illinois; Arthur E. Nealy, President of the Illinois Model Aero Club; and John A. Tenney, of the Aero Club of Illinois.

Wonderful Future in Aviation.

A home course in aviation, such as this, has certainly been urgently needed. After the war the airplane is bound to become a vast means of transportation—passenger, freight, mail. Aviation was long known as the fastest method of travel. Now we are told by Orville Wright that "there is no means of transportation so safe." Flying men in the U. S. Army, last year, made 7,087 flights for a total distance of over 250,000 miles, without a single fatality. As Rear Admiral Peary says, "Aeronautics will go on forever, becoming more important day by day."

Those wishing to know more about the home course offered by the National Aero Institute should mail the coupon below. Just now the Institute is granting a specially low tuition rate and is giving, free, to every new student, a complete flying model and all materials for a scale model. So those interested are advised to mail the coupon for information, at once.

National Aero Institute,
Dept. C119, Morton Bldg.,
Chicago.

Gentlemen:—Please send me, free and prepaid, full particulars of your mail course in the principles of aviation, and details of your special limited offer.

Name

Address

Please Mention Popular Mechanics



"Don't tell me you never had a chance!"

"Four years ago you and I worked at the same bench. I realized that to get ahead I needed special training, and decided to let the International Correspondence Schools help me. I wanted you to do the same, but you said, 'Aw, forget it!' You had the same chance I had, but you turned it down. No, Jim, you can't expect more money until you've trained yourself to handle bigger work."

There are lots of "Jims" in the world—in stores, factories, offices, everywhere. Are you one of them? Wake up! Every time you see an I. C. S. coupon your chance is staring you in the face. Don't turn it down.

Right now over one hundred thousand men are preparing themselves for bigger jobs and better pay through I. C. S. courses.

You can join them and get in line for promotion. Mark and mail this coupon, and find out how.

I. C. S., Box 5598, Scranton, Pa.

INTERNATIONAL CORRESPONDENCE SCHOOLS

Box 5598, SCRANTON, PA.

Explain, without obligating me, how I can qualify for the position, or in the subject, before which I mark X.

- | | |
|---|--|
| <input type="checkbox"/> ELECTRICAL ENGINEER | <input type="checkbox"/> SALESMANSHIP |
| <input type="checkbox"/> Electric Lighting | <input type="checkbox"/> ADVERTISING MAN |
| <input type="checkbox"/> Electric Car Running | <input type="checkbox"/> Window Trimmer |
| <input type="checkbox"/> Electric Wiring | <input type="checkbox"/> Show Card Writer |
| <input type="checkbox"/> Telegraph Expert | <input type="checkbox"/> Outdoor Sign Painter |
| <input type="checkbox"/> Practical Telephony | <input type="checkbox"/> RAILROADER |
| <input type="checkbox"/> MECHANICAL ENGINEER | <input type="checkbox"/> ILLUSTRATOR |
| <input type="checkbox"/> Mechanical Draftsman | <input type="checkbox"/> DESIGNER |
| <input type="checkbox"/> Machine Shop Practice | <input type="checkbox"/> BOOKKEEPER |
| <input type="checkbox"/> Gas Engineer | <input type="checkbox"/> Stenographer and Typist |
| <input type="checkbox"/> CIVIL ENGINEER | <input type="checkbox"/> Cert. Public Accountant |
| <input type="checkbox"/> Surveying and Mapping | <input type="checkbox"/> Railway Accountant |
| <input type="checkbox"/> MINE FOREMAN OR ENGINEER | <input type="checkbox"/> Commercial Law |
| <input type="checkbox"/> Metallurgist or Prospector | <input type="checkbox"/> GOOD ENGLISH |
| <input type="checkbox"/> STATIONARY ENGINEER | <input type="checkbox"/> Teacher |
| <input type="checkbox"/> Marine Engineer | <input type="checkbox"/> Common School Subjects |
| <input type="checkbox"/> ARCHITECT | <input type="checkbox"/> CIVIL SERVICE |
| <input type="checkbox"/> Contractor and Builder | <input type="checkbox"/> Railway Mail Clerk |
| <input type="checkbox"/> Architectural Draftsman | <input type="checkbox"/> AGRICULTURE |
| <input type="checkbox"/> Concrete Builder | <input type="checkbox"/> Textile Overseer or Supt. |
| <input type="checkbox"/> Structural Engineer | <input type="checkbox"/> Navigator |
| <input type="checkbox"/> PLUMBING AND HEATING | <input type="checkbox"/> Poultry Raising |
| <input type="checkbox"/> Sheet Metal Worker | <input type="checkbox"/> AUTOMOBILES |
| <input type="checkbox"/> CHEMICAL ENGINEER | <input type="checkbox"/> Auto Repairing |
| | <input type="checkbox"/> Spanish |
| | <input type="checkbox"/> German |
| | <input type="checkbox"/> French |
| | <input type="checkbox"/> Italian |

Name _____

Occupation & Employer _____

Street and No. _____

City _____ State _____

If name of Course you want is not in this list, write it below.

Please Mention Popular Mechanics

Mr. A. R. Patterson, whose advertisement appears below, was for eight years a Civil Service Secretary-Examiner, and is well qualified to help YOU secure a Government Position.

CIVIL SERVICE NEEDS MEN

Send for Free Book

Show Your Patriotism

By Working for Uncle Sam.



Men in Civil Service do as great a service as those in the field of battle. Positions pay \$75 to \$150 a month. Short hours. Easy work. No strikes, no hard times, no layoffs. No petty bosses. No politics—no pull. Ordinary education sufficient. 15 and 30 day vacations each year with full pay. Sick leave with full pay. Positions for life.

RAILWAY MAIL CLERK, POSTAL CLERK, REVENUE OFFICER, CUSTOMS SERVICE

and many other divisions of Government Service offer splendid opportunities for big pay and rapid advancement. If you are an American Citizen, 18 or over, send in your name for all facts about Government Positions and how to get one.

NEW BOOK FREE!

Mr. Patterson was U. S. Civil Service Secretary-Examiner for 8 years, and has students and graduates in practically every State in the Union in all branches of Government Service. Not one cent, if you do not secure a position. Mail postal NOW for Free Book and special 30-Day Offer! Address

PATTERSON CIVIL SERVICE SCHOOL
88 News Bldg., Rochester, N. Y.



MEN WANTED

Prepare as Firemen, Brakemen, Electric Motormen, and colored Train Porters. First Class Standard Roads. Hundreds put to work—\$65 to \$150 a month without any experience. 500 more wanted. Uniforms and passes arranged for when necessary. Enclose stamp for Application Blank. Name position you want.

I. RAILWAY C. I., Dept. 35, Indianapolis, Ind.

Be a Cartoonist—Illustrator—Commercial Artist. Earn \$25 to \$100 a week in fascinating profession.

LEARN ART AT HOME

New, easy Course. Outfit FREE to new students. Easy terms. Write for Booklet FREE. WASHINGTON SCHOOL OF ART 1028 H ST. N.W. WASHINGTON, D. C.

SHORTHAND IN 30 DAYS

We absolutely guarantee to teach shorthand complete in only thirty days. You can learn in spare time in your own home, no matter where you live. No need to spend months as with old systems. Boyd's Syllabic System is easy to learn—easy to write—easy to read. Simple. Practical. Speedy. Sure. No ruled lines—no positions—no shading as in other systems. No long lists of word signs to confuse. Only nine characters to learn and you have the entire English language at your absolute command. The best system for stenographers, private secretaries, newspaper reporters and railroad men. Lawyers, ministers, teachers, physicians, literary folk and business men and women may now learn shorthand for their own use. Does not take continual daily practice as with other systems. Our graduates hold high grade positions everywhere. Send today for booklets, testimonials, etc.

Chicago Correspondence Schools
969 Unity Bldg., CHICAGO, ILL.

TRAINED MEN WANTED

We are just completing an immense new building—owned and used exclusively by us—fully equipped with all the best and most modern appliances for learning the auto business *from the ground up*.

Our course—always recognized as the most thorough and practical—will be increased *many times* in value, and we must train men to meet the vast demand for our graduates.

Our Graduates are regularly earning from \$100 to \$300 and more per month as Race Drivers, Expert Engineers, Final Testers, Shop Foremen, Tractor Experts, Chauffeurs, Sales-

men, Garage Owners and Managers, House-Lighting Experts; and many are in Government employ as Aviators, Truck Drivers and Dispatch Bearers—all because of the *practical* training we give.

Opportunities for *practically* trained men were never better. We have constant calls for more men than we can furnish.

Cleveland Auto School

Established 1903
Individual Instruction

Up-to-date Equipment
13 Years of Success

Over 4,000 Graduates Making Good OUR EQUIPMENT

includes all types of motors, including Knight type, and 4, 6, 8 and 12 cylinder; a dozen cars at the disposal of students; latest starting and lighting equipment; Akron-Williams tire repair outfits, oxy-acetylene welding and cutting outfits; all the latest electrical testing outfits; and everything necessary to give you a thorough and practical training.

CLEVELAND LEADS

in the manufacture of parts, accessories and high grade cars, and is gaining faster than any other city in new factories. Up-to-date training in 4 to 8 weeks; board and room only \$6 per week near school; we help you get located in congenial surroundings and feel at home. We Absolutely Guarantee to qualify you for a good paying position in the Auto business on completion of our course.

Join Now! Be ready to take advantage of the unlimited opportunities that are now opening faster than ever before.

Cleveland Automobile School

CLYDE H. PRATT, President, Dept. 8, 1814 E. 24th St., CLEVELAND, OHIO



Auto Dealer or
Salesman



Tire Repair
Shop



Garage Owner
or Manager

Your Own Business

Call
or write
us
TODAY

Please Mention Popular Mechanics

We Teach



Race
Driver



Truck
Driver



Master
of 12-cyl.
Motor



Private
Chauffeur



AFTER THE WAR YOUR OPPORTUNITY BE PREPARED!

LEARN A LANGUAGE NOW! SPEAK-READ-WRITE 30 Easy Lessons

Wealth—Position—Social Standing—All are yours. Big Jobs—Lucrative Salaries—Foreign Travel, all are offered the accomplished linguist, now and after the War.

Europe—A million men from every industry will be called to rebuild war-torn Europe. Big employers, extending their trade, now look for men to deal with Foreign Business Men, personally and by mail in their own language.

South America—deprived of European trade depends on U.S. Big jobs open, big salaries paid, at home and abroad, to men who can speak, read and write Spanish.

U.S.A. Offers Big Pay Men called for government service, civil or military, win rapid promotion if they know a Foreign language. Interpreters, Attaches, Correspondents by thousands are being called and paid Big Money. Never has there been such a demand for representative young men with a foreign language at their tongue's tip.

Learn Now to Speak, Read, Write French, Spanish, Italian, Russian, German, Japanese in Thirty Easy Lessons by new Gentilini Method, Native Professors. Easy to master—Success Guaranteed. Personal private instructions at home by mail. Largest Established Foreign Language School in the U.S.

Special Scholarship Offered to Those Enrolling Now

\$7.50 Spanish THIRTY EASY LESSONS All Other Languages Equally

Send the Coupon Now! Low. Success Guaranteed

THE CHICAGO INSTITUTE, 123 W. Madison, Chicago.

GENTLEMEN: Without obligation on my part tell me how to learn language checked below, and details of your Special War-Time Scholarship Offer!

French German Spanish Italian Russian Japanese Correct English

Name.....

Address.....

Learn to Concentrate

Prof. Theron Q. Dumont's famous 20 Lesson Course in Concentration, now sent in handy book form, for 5 days' FREE examination. Gives every principle and method. Also practice exercises. Tells you just how to concentrate. Get it now—while offer lasts. Send no money. Read it 5 days. Then, if satisfied, send only \$2. Otherwise return to us. Write for it today on this FREE offer. ADVANCED THOUGHT PUB. CO., Dept. 839, 168 N. Michigan Ave., Chicago

Learn to Concentrate

Prof. Theron Q. Dumont's famous 20 Lesson Course in Concentration, now sent in handy book form, for 5 days' FREE examination. Gives every principle and method. Also practice exercises. Tells you just how to concentrate. Get it now—while offer lasts. Send no money. Read it 5 days. Then, if satisfied, send only \$2. Otherwise return to us. Write for it today on this FREE offer. ADVANCED THOUGHT PUB. CO., Dept. 839, 168 N. Michigan Ave., Chicago

NATIONAL TRADE DENTAL SCHOOL

506 S. Wabash Ave., CHICAGO, ILL.
LEARN MECHANICAL DENTISTRY—DEMAND UNLIMITED
Earn \$1200 to \$4800 yearly in mechanical dentistry. A big and growing demand everywhere for mechanical dentists—like a gold mine, unexplored. Attend this school any time of the day or evening; be taught individually and learn by actual practice, without book study. Our system, the most complete in the world, is used exclusively in this school. We are constantly called upon to fill high-salaried positions. Why not qualify for one? Be fair to yourself! Find out more about exceptional opportunity we offer. Visit the school or write for booklet B.



Uncle Sam Wants Aviators

Uncle Sam is building thousands of aeroplanes, and thousands of men are needed to fly them. Prepare yourself—before it's too late—to enter the aviation corps and win honors in the air. Haywood's Practical Aeronautics, including Building and Flying an Aeroplane, covers the entire field of aeronautics in simple, non-technical form. SPECIAL SECTION ON MILITARY AVIATION, 750 pages, 7 by 10 inches; 350 illustrations, diagrams, etc. Substantially bound in cloth, gold stamped. Send only \$2.00 and the book will come to you prepaid. If, after five days' examination, you are at all dissatisfied, return it and get your money back. Our reference: Union Bank of Chicago.

AMERICAN TECHNICAL SOCIETY, CHICAGO, U. S. A.

Big Money for You

There's Money in the Automobile Business and all it takes to get it is experience. We give you the experience. Eight weeks in our school is worth more than two years of figuring it out for yourself. The cost is light, the reward great—there's a job waiting for you as soon as you're through. Don't delay—Act Now.

INDIANAPOLIS MOTOR SCHOOL
108 Southeastern Ave., INDIANAPOLIS, IND.

MUSIC TAUGHT FREE

IN YOUR OWN HOME
You can read Music like this quickly
Piano, Organ, Violin, Mandolin, Guitar, Banjo, etc.
Beginners or advanced players. One lesson weekly. Illustrations make everything plain. Only expense about 2c per day to cover cost of postage and music used. Write for FREE booklet which explains everything in full.

AMERICAN SCHOOL OF MUSIC, 51 Lakeside Building, CHICAGO

30 DAY COURSE FREE

IN TIRE REPAIRING

Write Today for remarkably low price and particulars about our free course in tire repairing. Let us show you how to make \$3,000 to \$5,000 a year.

RELIABLE TIRE REPAIR SCHOOL 108 Reliable Bldg. DETROIT, MICH.

FREE This Complete Set of Drawing Instruments

\$12.00 Draftsman's Complete Working outfit free to students. They do not cost you a penny on this offer. Write today for particulars. Do it NOW.
\$150 to \$300 a Month
My graduates are earning from \$150.00 to \$300.00 a month and more. WRITE TODAY. Send for my free book on drafting. No obligations. Write now.
Chief Draftsman Dobe, Div. C119 Engineer's Equipment Co. Chicago

ARE YOU AMBITIOUS? GET THIS BOOK!

"I did, and advanced in two years from draftsman to Advertising Manager," says Hugh G. Cargo, who now holds that position with a big manufacturing concern. (Name on request.)

If You Like to Draw This book points the way to success for you, as it did for Mr. Cargo. Enter the uncrowded, well-paid profession of Commercial Illustrating—where, with proper training, artists readily earn \$25, \$50, \$75 a week and more. Develop a high-salaried ability in spare time by "Federal home-study"—a method highly endorsed by such nationally known illustrators and designers as Chas. E. Chambers, Franklin Booth, Harold Gross and Edwin V. Brewer.

This Beautiful 56-Page Book Handsomely printed in colors, shows how to start—how to make the very most of your ability. Every ambitious young man and woman should read it. It's free for the asking—SEND FOR IT NOW.

FEDERAL SCHOOL OF COMMERCIAL DESIGNING 622 Warner Building MINNEAPOLIS, MINN.

TRAIN YOUR ABILITY—AND WIN!

The MILLION DOLLAR AUTOMOBILE and TRACTOR SCHOOL

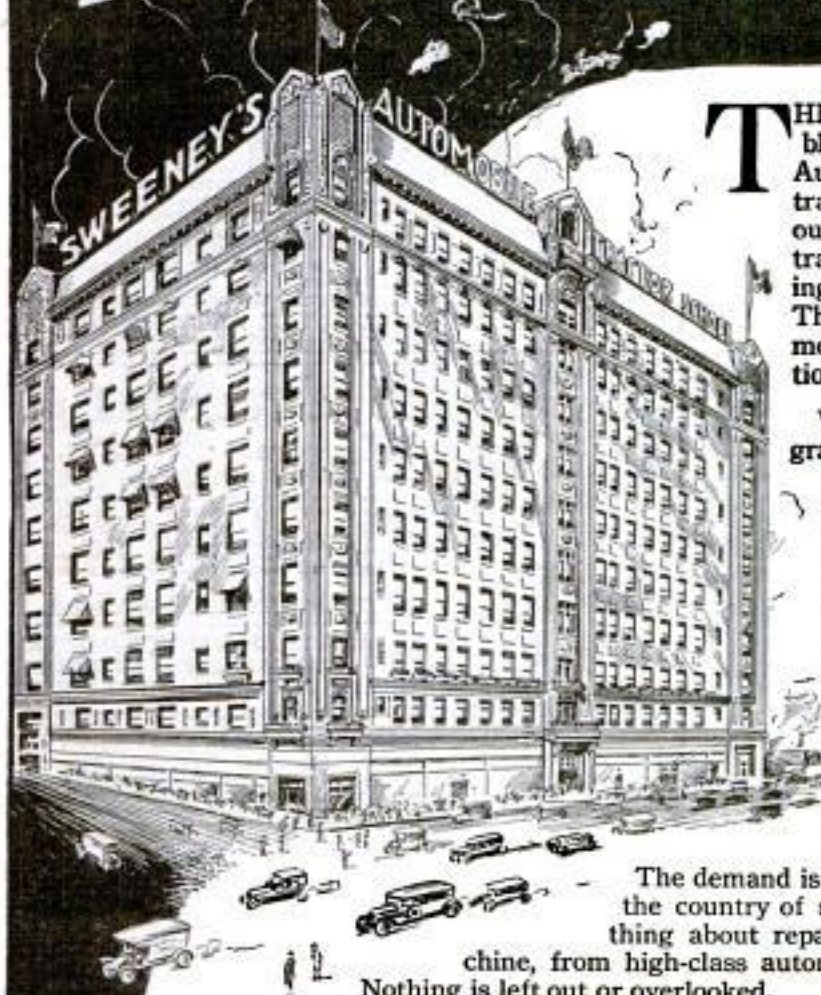

THIS immense ten-story building, nearly a block long, is the new home of the Sweeney Automobile and Tractor School, the greatest trade school in the world. We have turned out thousands of skilled automobile and tractor mechanics every year who are living, walking, talking advertisements for us. Their success has been our success, and the means of building up this immense institution to its present size and importance.

When people see the efficiency of our graduates and the big salaries they are able to command, they want to know all about the school, and how we teach the automobile and tractor business so thoroughly in such a short time. A successful graduate is the best advertising we can get, and the cheapest.

Do you know that there never has been an opportunity like the present for expert automobile and tractor men?

The demand is increasing daily, for the war is stripping the country of skilled mechanics. We teach you everything about repairing and operating every kind of machine, from high-class automobiles to the farm tractor and truck.

Nothing is left out or overlooked.

It is just as easy to become a battery, starting and lighting system expert, as it is to be an ordinary mechanic, and the Sweeney School gives the electrical or so-called complicated equipment on cars the attention it deserves.

Qualify Yourself to Make More Money and make it easy. In this school you actually do the work, and learn by experience, and prove that you have learned the business before you leave. It is not theory, it is practice that makes you a valuable man.

E. J. SWEENEY, President

SWEENEY AUTOMOBILE and TRACTOR SCHOOL

1166 E. 15th Street, KANSAS CITY, MO.

**Send Today for My Big
FREE Catalogue**

fully illustrated, that will tell you how to become an expert automobile and tractor mechanic, and command an expert salary. Today is the day to investigate the possibilities in this business.

Write Now!

Send me free illustrated catalogue that shows the way to success in the Automobile and Tractor Business.

**Cut
This
Coupon**

Name

Address

A New Book on the Ford PUBLISHED JUNE 15, 1917 The Ford Motor Car AND Truck and Tractor Attachments

By H. P. MANLY

Author "Automobile Starting and Lighting," "Oxy-Acetylene Welding and Cutting."

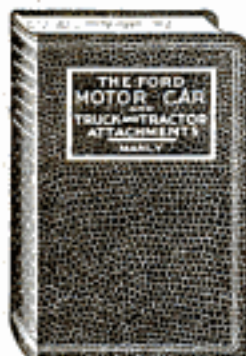

A complete instruction book on every feature of the Ford car, including Truck and Tractor Attachments. It covers the Ford power plant; transmission system; running gear; control; adjustment and repair; upkeep and care; trouble symptoms and remedies; driving; starting and lighting; truck attachments; tractor attachments. Fully illustrated.

Limp cloth, prepaid . . . \$1.00
Leather, prepaid . . . 1.50

Send for our catalogue of practical mechanical books for Electricians, Engineers, Telephone Men, Machinists, Railroad Men, Automobiles, Carpenters, Plumbers, Sign and Card Writers, Scene Painters, etc. It is Free
FREDERICK J. DRAKE & CO., 1008 Michigan Ave., CHICAGO

The Art of Living Long Guide to Health and Long Life

Luigi Cornaro's Complete Works
(Translated from the Italian)

"A Sure and Certain Method of Attaining a Long and Healthy Life."

Cornaro was a Venetian nobleman, sickly from day of birth, given up by physicians at age of forty. He discarded forever all drugs, adopted simple method of life fully described by him in his book, recovered complete health of body and mind, finished his book at 96, lived to be 108. His complete work is contained in one large beautiful volume endorsed by Woodrow Wilson, Thomas A. Edison, Henry Ford, Joseph H. Choate, Dr. J. E. Murray, Cheever M. Depew, Loren J. Gage, Charles W. Fairbanks, Admiral Dewey, General Miles, and hundreds of others.

WRITE FOR FREE BOOKLET

We will mail free descriptive circular giving recommendations from prominent men above mentioned and hundreds of others. The price of the book complete, charges prepaid, is only \$2. Send money with order or write for descriptive booklet. It is free.

RIVERSIDE PUB. CO., 142 SO. DEARBORN ST., CHICAGO

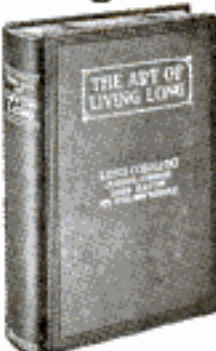

Do You Like to Draw? Cartoonists Are Well Paid

We will not give you any grand prize if you answer this ad. Nor will we claim to make you rich in a week. But if you are anxious to develop your talent with a successful cartoonist, so you can make money, send a copy of this picture, with 2c in stamps for portfolio of cartoons and sample lesson plan, and let us explain.

The W. L. Evans School of Cartooning
821 Leader Bldg., Cleveland, O.



Attend
Chicago TECH

Courses for non-residents. Write, state which subject and course interests you.
CHICAGO TECHNICAL COLLEGE
830 Chicago "Tech" Bldg. Chicago, Ill.

New college building, new equipment. Location in America's leading industrial center affords opportunity for inspection and research work. 2-year courses. Special Short Courses. Day and Evening Classes. Home Study Coaching for the examination here checked.

Day and EVENING Classes

No special strange requirements. Low tuition. Experts in charge of big work instruct you in all branches of

**ARCHITECTURE
ENGINEERING
DRAFTING**

Make this car your office—

there is \$900.00 to \$1800.00
a year in it for you

Examinations will likely
be held everywhere soon

Rapid advancement to higher Government Positions. "No layoffs" because of STRIKES, FINANCIAL FLURRIES or the WHIMS OF SOME PETTY BOSS. THE POSITION IS YOURS FOR LIFE.

Country residents and city residents stand the same chance for immediate appointment. Common-sense education sufficient. Political influence NOT REQUIRED.

We will prepare 25 candidates FREE! Write immediately for schedule showing the places and dates of all coming Gov't examinations. Don't delay. Every day you lose means the loss of just so much coaching before the rapidly approaching examinations.

FRANKLIN INSTITUTE, Dept. E96, Rochester, N. Y.



Government wants hundreds of
clerks for war work.

COUPON

Franklin Institute (The pathway to plenty), Dept. E96, Rochester, N. Y.

This coupon, filled out as directed, entitles the sender to (1) free specimen questions; (2) a free copy of our copyrighted book, "Government Positions and How to Get Them"; (3) a list of positions now easily obtainable; and (4) consideration for Free Coaching for the examination here checked.

..... Railway Mail Clerk (\$900 to \$1800) Customs Positions (\$800 to \$1500)
..... Bookkeeper (\$800 to \$1300) Stenographer (\$800 to \$1500)
..... Postoffice Clerk (\$800 to \$1200) Internal Revenue (\$700 to \$1800)
..... Postoffice Carrier (\$800 to \$1200) Clerk in the Departments
..... Rural Mail Carrier (\$500 to \$1100) at Washington (\$800 to \$1500)

Name..... Address..... E96

Use this before you lose it. Write plainly.

Are You Earning Less Than \$3000 Yearly?

If you are,—you're on the wrong job. You're in a rut. Why waste a lifetime working for animal wages,—when it's so easy to get into a Man's Job and earn a Man's Salary?

Be a Traffic Manager

Get into a new—clean—fascinating—high salaried—significant profession that assures you a place on Easy Street. Traffic Managers needed everywhere. Field can't be crowded for years to come. A POSTAL BRINGS FULL INFORMATION.

INTERSTATE TRAFFIC SCHOOL 28 TRAFFIC BLDG. FT. WAYNE, IND.

The Salaries

of TRAINED TRAFFIC MEN range from \$2,500 to \$10,000 a year. There are thousands of positions open. Train yourself to be a Traffic Manager—in your spare time—at home. Our experience method of training—our traffic library, compiled through the co-operation of more than 300 Traffic Experts of national reputation—the members of our association will make it easy for you to qualify yourself for one of these positions.

Write TODAY for Free Particulars. We will show you how THE AMERICAN COMMERCE ASSOCIATION
Dept. 142 206 South Wabash Ave. CHICAGO, ILL.

A Legal Training In Two Years

Study at home—during your spare time and get a thorough legal training in two years. That is what American School students are doing. New, practical and intensely interesting course. Successful graduates everywhere.

Write for New Book

Send your name and address today for our new free book. Read about the new opportunities open to law trained men and how you can fit yourself in two years. Write today.

American School of Correspondence, Dept. L 119C, Chicago, U. S. A.

FINLAY Engineering College

KANSAS CITY, MISSOURI
ONLY SCHOOL OF THE KIND IN THE WEST

Specialties: Electricity, Steam, Gas. Six weeks, three months, year, and two year courses. Auto-Tractor, Armature Winding, Conduit Work, Lathe Work, Oxy-Acetylene Welding, Corliss Valve Setting, Operation of Steam, Gas Electric Machinery. Anything you want, any time you want it, night or day, from a week to two years. Write for Catalog T.

POWER of WILL

By FRANK CHANNING HADDOCK

contains 28 fascinating lessons on how to strengthen the Will. Write for free trial offer. Pelton Publishing Company, 13 Wilcox Block, Meriden, Conn.

Come to Akron, Ohio
The Tire Center
 and

LEARN THE TIRE REPAIR BUSINESS

Big money in this big field. No other field offers such opportunities. Autos run the year around. Tires need constant repairing. Profits are large and work comes easily. Every job is easily and quickly done. There are locations everywhere, right in your home town. We show you how to find best locations. Help you get jobs paying from \$3.00 to \$6.00 a day if you don't want to open a repair shop. Tire repair shops are as necessary as gasoline stations. Over a Million New Autos put in use this year. Get into this big profitable business and become independent.

Earn \$100 to \$500 Monthly

There is no limit to what a man can make. Men are becoming rich in this business. Start business with small capital. Graduates are qualified to handle all makes of Cord Tires and get factories' O. K. School open all the year. Enter classes any day. Graduate in four to six weeks.

Tire Factories Now Employ Both Students and Graduates

We have a deal with large Tire Factories so that we can get jobs for students while they are taking Tire Repair Course or after they have graduated. The factories will employ students and when they graduate will tell them where best locations are for tire repair shops, or will get them a good high salaried position in a Service Station or Tire Repair Shop. Factories pay \$15 to \$35 a week and will give students jobs so they can earn while they learn. We have placed men in positions at the factories with salaries enough to pay for course and living expenses. We help every worthy earnest man who will live up to the factory rules and regulations. We can now get you a good job in the factories to pay your expenses, put you in touch with best locations or get you good Tire Service Station or Tire Repair Shop jobs.

FREE Write for School Literature, Letters from Satisfied Students, "Blow Out" (School News), all absolutely free. Or better still, jump on the train and come to Akron, as many have done. Get started in this money-making business NOW.

THE AKRON TIRE REPAIR SCHOOL
 A. G. ZELLER, Exclusive Tire Repair School, President, Complete Equipment.
 68 Tim Bldg., 46-48 Main St., AKRON, O.

Money-Back Guarantee
 We guarantee to qualify our students to go into business for themselves or to hold positions paying \$18 to \$40 weekly or return their money. The demand for trained repairmen is greater than the supply.

AKRON, OHIO
 THE HEART OF THE TIRE INDUSTRY

MADE WITH \$100,000 TIRES ANNUALLY

Get This CAR And the AGENCY For YOUR Territory

Drive a new 1917 Model Birch Motor Car. Pay for it out of your commissions and make big money on sales. Special offer now. Write quick for Big Free Book and full information. Address **Ralph Birchard, Pres.**

Birch Motor Cars, Dept. 819, 81 E. Madison St., Chicago

STUDENTS ART MAGAZINE

Publishes each art assignments, articles on Cartooning, Designing, Illustrating, Lettering, and Chalk-Talking. Criticizes amateurs' work. Full of interesting and helpful information for artists and art students. Satisfactory or money refunded. 10 cents a copy, \$1 a year. Send \$1 NOW, stamps or bill.

STUDENTS ART MAGAZINE, Dept. 250, Kalamazoo, Mich.

Learn a Paying Profession

that assures you a good income and position for life. For twenty-four years we have successfully taught

PHOTOGRAPHY

Photo-Engraving and Three-Color Work

Our graduates earn \$20 to \$50 a week. We assist them to secure these positions. Learn how you can become successful. Terms easy—living inexpensive. Write for catalogue—NOW!

ILLINOIS COLLEGE OF PHOTOGRAPHY, Dept. 999 Wabash Av., Effingham, Ill.

Tear Off That Blindfold!

Your chance to be somebody, to hold a position of responsibility, to have an income that will provide every comfort of life, is within your reach.

Just one thing keeps you from finding it, grasping it: you're not prepared. Through the door of opportunity big jobs are waiting in every field of work. But only trained men will get them. Don't play blindman's buff with your future! Start today and train yourself to do some one thing better than others.

You can get that training in spare time through the International Correspondence Schools, just as others have done for twenty-five years—just as more than 130,000 ambitious men and boys are doing right now.

Choose your own career. The I. C. S. will train you for the position you want in the work you like best. And you need not lose a day or a dollar in your present occupation.

Tear off that blindfold! Your chance is here. The time to start is now. The way is to ask the I. C. S. to show you what they can do for you. Mark and mail this coupon—it costs nothing, but the evidence it will bring you will open your eyes.

TEAR OUT HERE

INTERNATIONAL CORRESPONDENCE SCHOOLS
 Box 5599, SCRANTON, PA.

Explain, without obligating me, how I can qualify for the position, or in the subject, before which I mark X.

<input type="checkbox"/> ELECTRICAL ENGINEER	<input type="checkbox"/> SALESMANSHIP
<input type="checkbox"/> Electric Lighting	<input type="checkbox"/> ADVERTISING MAN
<input type="checkbox"/> Electric Car Running	<input type="checkbox"/> Window Trimmer
<input type="checkbox"/> Electric Wiring	<input type="checkbox"/> Show Card Writer
<input type="checkbox"/> Telegraph Expert	<input type="checkbox"/> Outdoor Sign Painter
<input type="checkbox"/> Practical Telephony	<input type="checkbox"/> RAILROADER
<input type="checkbox"/> MECHANICAL ENGINEER	<input type="checkbox"/> ILLUSTRATOR
<input type="checkbox"/> Mechanical Draftsman	<input type="checkbox"/> DESIGNER
<input type="checkbox"/> Machine Shop Practice	<input type="checkbox"/> BOOKKEEPER
<input type="checkbox"/> Gas Engineer	<input type="checkbox"/> Stenographer and Typist
<input type="checkbox"/> CIVIL ENGINEER	<input type="checkbox"/> Cert. Public Accountant
<input type="checkbox"/> Surveying and Mapping	<input type="checkbox"/> Railway Accountant
<input type="checkbox"/> MINE FOREMAN OR ENGINEER	<input type="checkbox"/> Commercial Law
<input type="checkbox"/> Metallurgist or Prospector	<input type="checkbox"/> Traffic Management
<input type="checkbox"/> STATIONARY ENGINEER	<input type="checkbox"/> GOOD ENGLISH
<input type="checkbox"/> Marine Engineer	<input type="checkbox"/> Teacher
<input type="checkbox"/> ARCHITECT	<input type="checkbox"/> Common School Subjects
<input type="checkbox"/> Contractor and Builder	<input type="checkbox"/> CIVIL SERVICE
<input type="checkbox"/> Architectural Draftsman	<input type="checkbox"/> Railway Mail Clerk
<input type="checkbox"/> Concrete Builder	<input type="checkbox"/> Textile Overseer or Supt.
<input type="checkbox"/> Structural Engineer	<input type="checkbox"/> Navigator <input type="checkbox"/> Spanish
<input type="checkbox"/> PLUMBING AND HEATING	<input type="checkbox"/> AGRICULTURE <input type="checkbox"/> German
<input type="checkbox"/> Sheet Metal Worker	<input type="checkbox"/> Poultry Raising <input type="checkbox"/> French
<input type="checkbox"/> CHEMICAL ENGINEER	<input type="checkbox"/> AUTOMOBILES <input type="checkbox"/> Italian

Name _____
 Occupation _____
 & Employer _____
 Street _____
 and No. _____
 City _____ State _____
 If name of Course you want is not in this list, write it below.

Please Mention Popular Mechanics



33,000 sq. ft. of
Additional
Floor
Space

Come to Detroit The Automobile Center and

DETROIT

trained men get preference and get jobs quickly. No other city can give what Detroit offers. Think what it means to learn in the Michigan State Auto

School. Factories endorse our school, glad to employ our graduates or offer them territory in which to sell cars and start garages. Unlimited opportunities.

71% of Automobiles are made in Detroit. You're right in the Heart of the Auto Industry. Men are needed everywhere as testers, repairmen, chauffeurs, garage men, and salesmen. Hundreds of our graduates start in business for themselves.

Earn \$75 to \$300 a Month

We teach you to handle any auto proposition. You graduate in from ten to twelve weeks. Our equipment is new, up-to-the-minute, and complete. No old, obsolete motors, chassis or electrical equipment used. Students actually build cars from start to finish, getting factory training in assembling, block-testing, road-testing, everything. Special complete course in Oxy-Acetylene brazing, welding and cutting, separate from regular course. Learn to time motors, rebore cylinders, adjust carburetors, magnetos, valves and bearings quickly and accurately. Six-cylinder Lozier, Chalmers "6," Detroit "6," Overland, and 8-cylinder King

are used for road instruction. We have the following completely equipped chassis:

Chalmers "6-30" 1917 chassis
Detroit "6-45" 1917 chassis
Buick Light "6" 1917 chassis
Willys-Knight 1917 chassis
Studebaker "6" 1917 chassis
Hudson Super-Six 1917 chassis
Cole "8" 1917 chassis
King "8" 1917 Chassis

Mets "4" 1917 Chassis
Detroit Electric 1917 chassis
G. M. C. 2 Ton Truck
Saxon "6" 1917 chassis
Maxwell 1917 chassis
Oldsmobile "8" 1917 chassis
Winton "6" chassis
Packard Twin "6" 1917 chassis
Chalmers "4" 1913 Chassis

All completely equipped for students to work on. We have more than 20 motors in our block test department—2 cyl., 4 cyl., 6 cyl., 8 cyl., and 12 cyl. Our electrical department is complete, having every standard starting, lighting, and ignition system, including Delco System as used in Buick, Hudson, and Packard Twin "6."

Detroit Is the Place to Learn—Start Any Time

There are 44 auto factories in Detroit and vicinity and 140 accessories and parts factories. Our students have the privilege of going through any or all of them. We operate Starting, Lighting, Ignition Service Station. This has added thousands of dollars' worth of equipment and makes our electrical department unequalled. Students get actual experience in handling all kinds of electrical auto equipment and taking care of trouble. We have just installed a Sprague Electric Dynamometer for block-testing purposes for students' use. Ours is the only Auto

school having this equipment. Auto factories need Dynamometer men constantly. Factories and garages are paying big salaries to men who know how to handle electrical equipment quickly and properly. Detroit is the automobile center. You get practical instruction. School open all the year. Enter classes any time, any day. Three classes daily: morning, afternoon, evening. All instructors are members of the Society of Automobile Engineers (S.A.E.) There is a great demand for Michigan State Auto School students. Auto factories write and phone for men constantly.

Follow the Crowd to the Michigan State Auto School. Come to Detroit

MONEY-BACK GUARANTEE

We guarantee to qualify you in a short time for a position as chauffeur, repair man, tester, demonstrator, auto electrician, garage man, or automobile dealer, paying from \$75 to \$300 monthly or refund your money. We have constantly more requests for Detroit trained men at GOOD salaries than we can supply.



THIS IS ONE OF THE FEBRUARY 1917 CLASSES



Additional Building and Equipment Factory Co-Operation

Thousands of dollars' worth of new equipment, plenty of room for students to work, at 687-89-91 Woodward Ave., in addition to our building at 11-19 Selden Ave. Our school has grown by leaps and bounds, students come from all over the world. We are constantly adding new equipment. Our electrical department is thorough and complete.

We have completed arrangements with the Auto factories to put them in touch with men who intend going into business for themselves. Men who know the auto business from A to Z are in biggest demand. Remember, the price of course is based on giving full value. Graduates in the complete auto course are competent to handle farm tractors.

Auto Factories Endorse Our School

The Leading Automobile factories in Detroit, as well as in other cities, endorse our school. They have been watching our school and graduates for years and are satisfied. They are putting their latest model, complete chassis in our school for students to work on. They are employing our graduates in their factories and service stations and assisting them in opening garages and salesrooms. They allow our students to go through their factories. They need trained, competent men and are asking for more of our graduates constantly. The Michigan State Auto School in Detroit, the heart of the Auto Industry, is endorsed by the Leading Auto Factories, is receiving their hearty co-operation. What better endorsement could you ask?

Act Quickly—NOW! Fill in the coupon; get full particulars, Illustrated Catalog. All absolutely free. Or better still, jump on the train, as hundreds have done, and come to the "Heart of the Automobile Industry," and learn right. We have no branches. Write or come direct to this school.

Michigan State Auto School

The Old Reliable School
308 Auto Building
687-89-91 Woodward Ave.

A. G. ZELLER, Pres.
DETROIT, MICHIGAN, U. S. A.

SEND THIS COUPON TODAY

MICHIGAN STATE AUTO SCHOOL
308 Auto Bldg., 687-89-91 Woodward Ave.
DETROIT, MICHIGAN, U. S. A.

Gentlemen: Send me absolutely FREE "Auto School News" and New Catalog, or better still, you can expect

me about.....

Name.....

Street.....

Town..... State.....

Our Country needs competent trained
Auto Mechanics in the
Quartermaster's
Dept. and Signal
Corps



A Packard Truck
Used By The
U.S. Government

The United States needs thousands of trucks, transport, aeroplane and motorcycle drivers. Trained competent men are needed, men who can take care of the machines, men who know how to keep them in service. Any piece of motor driven machinery the government owns or will own must be in service. Preference will be given to trained men. No matter what service the Army is doing it must be fed. If it is on the firing line it will need thousands of rounds of ammunition. The importance of trained men is very evident. Food and ammunition must be delivered regularly. Then too, the army must often be transported.

Quartermaster Department and Signal Corps Needs Trained Men

The Michigan State Auto School trains men thoroughly.

Every student learns pleasure cars, trucks, motorcycles and gasoline motors of every kind from A to Z. Graduates of the Michigan State Auto School are in big demand by the leading Automobile plants in Detroit. These factories know from actual experience that our men are thoroughly, completely and practically trained. No matter what happens to a truck or pleasure car, a Michigan State Auto School graduate is competent to repair it. Cars in the care of a graduate give highest efficiency.

This is the kind of men Our Government wants and is daily enlisting. Trained men who will be efficient themselves and keep every bit of motor driven equipment in the most serviceable condition.

This branch of the Army Service pays good salaries. There are wonderful opportunities for clean, clear headed, trained men to advance in the service and certainly now is the time to train.



Aerial View of Motor Truck Group at Ft. Sam Houston, Texas, Major F. H. Pope, Cavalry, Commanding

This view gives an idea of the large number of transport trucks that will be used in our Army. Thousands of trained men are needed and will be needed to care for these machines and keep them operating up to their highest efficiency. Trained men will be given preference and men who graduate from the Michigan State Auto School are now and have been holding big, responsible jobs in Detroit and over the country and will be able to serve their country in the most efficient way.

Thousands of Trained Motor Mechanics Needed in Army

Thousands of Motor Mechanics are needed in the army in the Quartermaster's Dept. and the Signal Corps. Nearly every man must be trained. Hundreds of thousands of men will be taken from every branch of the automobile business. Factories, garages and service stations will be depleted. There will be a crying need for trained men, both in the Army and out of it.

It is essential that an army be made up of the ablest fellows. It is absolutely necessary for men not of conscription age to fill the places left by men going to the front. Never were there such opportunities for men to get ahead in the Auto business. And never were trained men in such demand both in and out of the Army.

Thousands of Trained Motor Mechanics Needed at Home

With the army taking a million and a half men, there will be an enormous drain on the Automobile business. Trained men will be needed to fill the vacated jobs. Men older and younger than 21 to 31 years will step into the work. Trained Auto Mechanics will get the big paying jobs. Factories, service stations, garages, will be paying even higher salaries than ever. Thousands of new cars

are going into service daily. The United States and her Allies are ordering trucks and Autos by the thousands. Can you imagine a better chance to get into a money-making business? The Auto business has been good for years. It is getting better constantly. But right now is the opportunity of a lifetime — Get busy — write for catalog — train now to help Uncle Sam or yourself.

No matter whether you join the colors or stay at home,
you can do your bit best as a trained Auto Mechanic.



*Southern
Pine*

and Interior Beauty.

THE interior beauty of any home depends largely upon the kind of wood selected for the trim, woodwork, and flooring. These three are necessary to properly set off the home furnishings—to make a successful interior.

Southern Pine

"The Wood of Service"

is suitable for all interior work because of its striking grain and soft, beautiful texture. No other wood that grows offers a wider range of choice in figure—there is no monotonous sameness—some of it is large and bold, some fairly uniform, and some delicately engraved.

Southern Pine is bright and attractive, and its general beauty and utility are not surpassed by the most expensive hardwoods. It takes and holds perfectly and permanently, paints, varnishes, and stains.

No effect of richness and beauty in color and tone is beyond the possibilities of the builder with Southern Pine, and all at small cost when quality is considered.

Send today for free booklets—"Directions for Finishing Southern Yellow Pine," and "Beauty Plus Service in Floors." Address Department F-5.

Southern Pine Association

New Orleans, La.



Please Mention Popular Mechanics

Popular Mechanics Magazine

WRITTEN SO YOU CAN UNDERSTAND IT

Vol. 28

AUGUST, 1917

No. 2

Continuous Firing Feature of American Gun

ANNOUNCEMENT has been made of the development of an American machine gun capable of continuous firing. Ammunition is carried to its feed block by an endless belt kept filled by an automatic reloading mechanism. Supply hoppers contain from 2,500 to 10,000 cartridges and are replenished or replaced without interfering with operation. Most machine guns fire about 500 shots a minute and are supplied with ammunition by belts holding approximately 250 cartridges. Thus they are able to fire uninterruptedly for only 30 seconds, while the new instrument spits thousands of missiles with-

out pausing, and thereby does the work of two ordinary pieces.



Two Types of the New Machine Gun and Their Respective Use are Illustrated Herewith. The Outstanding Feature of the Rifle Is That It may be Fired Continuously, a Thing Which is Made Possible by a Reloading Mechanism That Keeps the Feed Belts Filled with Cartridges. The Control System Employed Enables an Operator to Aim and Fire the Gun While Concealed in a Protected Place Some Distance from It

REDRAWN FROM PHOTOGRAPH COPYRIGHTED BY A. S. FORD

Somewhat similar to that provided for a motor-car engine is the cooling system that permits prolonged firing of the gun. Water contained in a jacket incasing the barrel is circulated through spiral radiator tubes by a centrifugal pump and cooled by a fan.

For specific purposes the gun is built integral with some vehicle, such as a motorcycle, aeroplane, or motorboat. Instead of being manually operated, its mechanism is motor-driven. The machine that rushes it into action, also mounts and operates it. No time is consumed in assembling or dismantling the piece when seconds are precious. An aeroplane pilot can be his own gunner, for by touching a button with a

finger or foot, the instrument is put into action. For trench use, a special mounting with creeper wheels is provided and an electric-cable control used. This arrangement allows an operator to remain in a protected position and dispatch the gun across "No Man's Land" on its deadly mission. The direction and speed of its movements, as well as its angle and rate of fire, are regulated with buttons. For protecting strategic positions, still another form—this with a tripod mounting—is used. It is possible for the gunner to station himself several hundred feet away, for in this case, also, a control cable may be employed. Such a gun is, of course, not made a part of a vehicle.

4623
**TINY LIGHTHOUSE SIGNALS
 FOR RESTAURANT TABLES**

When patrons in a well-known metropolitan restaurant wish to summon a waiter they are no longer re-



Ornamental Signal for Restaurant Table: By Turning the Button at the Top a Light is Flashed On, Indicating That Service is Desired

quired to wave their hands or call out loudly, for each table is provided with an artistic signal in the form of a miniature lighthouse less than a foot high. Any patron desiring attention merely turns the button at the top, and a red light shows in the lighthouse windows, indicating that service is desired. Either side of the base are holders for matches. The broad support on which the two match holders and the tower rest is fashioned and suitably colored to represent a portion of a cliff or a reef.

4644
NEW AERONAUTIC SCHOOLS

HAVE HIGH STANDARDS

High standards of scholarship are to be maintained in the six government schools in military aeronautics which have recently been opened at the universities of Illinois, Ohio, Texas, California, Cornell, and Massachusetts Institute of Technology. As a special incentive, those who attain a certain grade will be awarded a certificate marked "Passed with Honor." During the first eight weeks of the course, while the pupils remain on the ground, they will study such subjects as the care and operation of engines for air craft, the theory of flight, cross-country and general flying, including meteorology, astronomy, and photography, as well as gunnery and bombing, signaling, and wireless. Each student will be required to pass a written examination before he graduates.

With a view to improving the housing conditions of the poor, the Philippine Health Service has constructed a number of model houses of new fire-proof material consisting of cement, sand, and ipa, or rice husks. These can be built for a little more than the present insanitary dwellings and, it is estimated, will last more than twice as long.

Ernest B. Peiffer
 Hotel Sherman Co.,
 Randolph at Clark St.,
 Ernest Peiffer, Chicago.
 Sec. 11

② Sergeant N. Frey & Flying Instructor
N.B. Robbins, North Island Aviation Sta. 4660
THRILLING MID-AIR AND UNDERWATER COLLISIONS
San Diego, Calif.

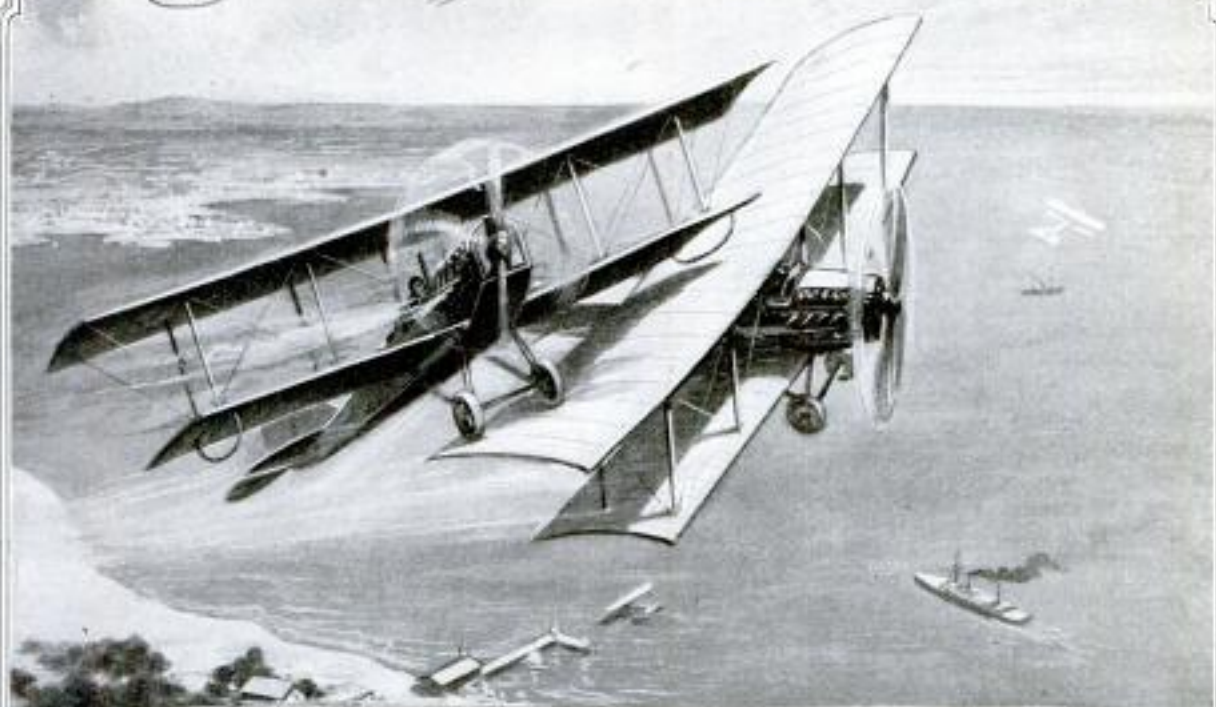

ONE of the most remarkable and unusual aviation accidents on record—a collision in the air—occurred recently above San Diego Bay when an officer, flying alone at a 90-mile rate, started to descend. Unaware of another aeroplane just beneath him, he crashed into it. This caused his tractor to dive tail first and then head first, finally plunging into shallow water. The flier almost miraculously escaped injury, while the other machine, after a perilous descent, also alighted in safety.

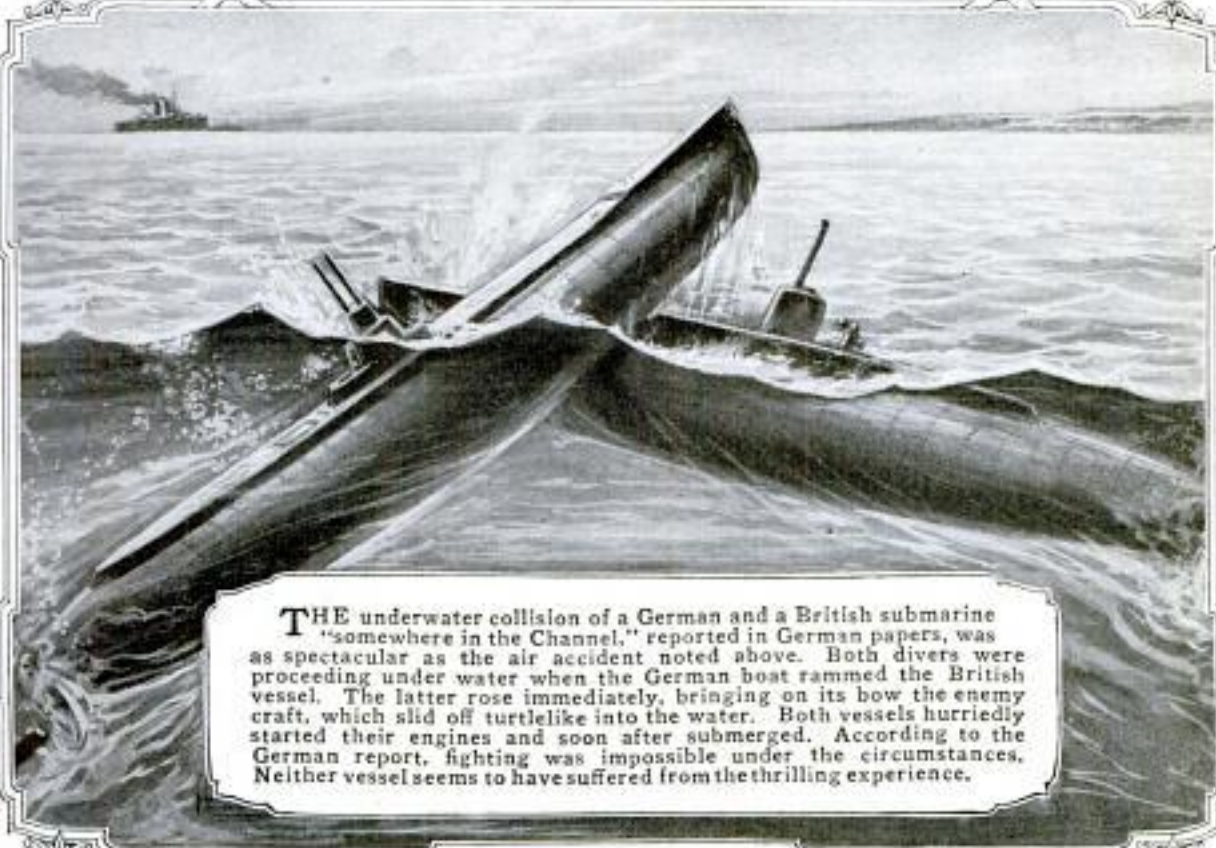

THE underwater collision of a German and a British submarine "somewhere in the Channel," reported in German papers, was as spectacular as the air accident noted above. Both divers were proceeding under water when the German boat rammed the British vessel. The latter rose immediately, bringing on its bow the enemy craft, which slid off turtlelike into the water. Both vessels hurriedly started their engines and soon after submerged. According to the German report, fighting was impossible under the circumstances. Neither vessel seems to have suffered from the thrilling experience.

**LOW-PRICED FARM TRACTOR
HAS ENDLESS-BELT TREADS**

Low first cost and also economy of operation have been sought in the de-

signing of a new tractor for year-around use on farms, in construction camps, etc. The machine is 8 ft. long and approximately 4 ft. wide by 4 ft. high, and can be driven over uneven

ground or through mud and sand, since it travels on two endless corrugated steel belts, 6 in. wide. It is equipped with a four-cylinder engine which delivers 16 hp. to the drawbar. The usual plowing speed is three and one-half miles per hour. Under good conditions the tractor can draw three 14-in. plows, and two when conditions are bad. It is steered by the power of the engine, the steering wheel serving as the means of control. The machine may also be used in many ways as a stationary engine.

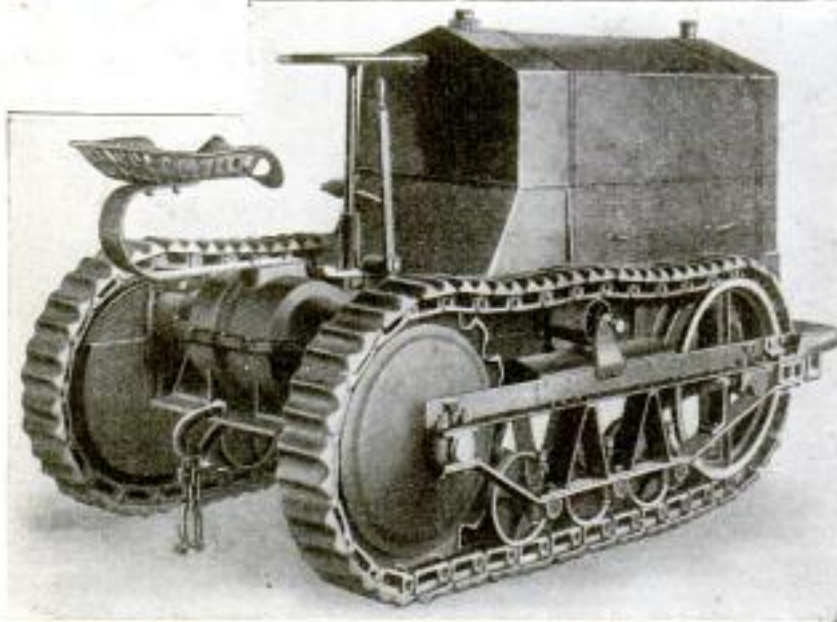

Low-Priced Tractor for General Farm or Construction Purposes, Having a Plowing Speed of Three and One-Half Miles per Hour: It can Travel over Uneven Moist Soil or through Sand, and can Draw Two or Three 14-Inch Plows

4613
**FLAG PAINTED ON HOUSE
SHOWS OWNER'S LOYALTY**

A resident of this country, who is a German by birth and not yet a naturalized citizen, is determined that there

shall be no doubt as to where his sympathies are in the present war. Some time ago he hung a large American flag in front of his home, but this was



Flag Painted on Front of Home: Unmistakable Means Which a Foreigner, Residing in This Country, Took to Show Where His Sympathies Are in the Present War

stolen, and so he has gone to the trouble to paint the stars and stripes in a conspicuous space on the front of his residence.

4706
**BUREAU GATHERS WAR DATA
ABOUT INSECTS**

Entomology, that branch of zoölogy which treats of insects, has a much closer relation to war problems than most people realize, and the Bureau of Entomology has asked that pamphlets, circulars, posters, leaflets, etc., pertaining to war phases of this field of science be sent to its offices in Washington, so that they can be assembled and classified for future reference. Among the questions that properly come under this head and have a bearing on the war are those pertaining to the attacks of insects on crops, the prevention of mosquitoes, insects in food and water, and so on. While many publications will not possess material of special scientific value, all will at least have a historic interest.

Wash
D.C.

Edward Arntwein,
New Brunswick, N. J. Copyrighted material

LAWYER HAS COAL MINE NEXT TO HIS FURNACE

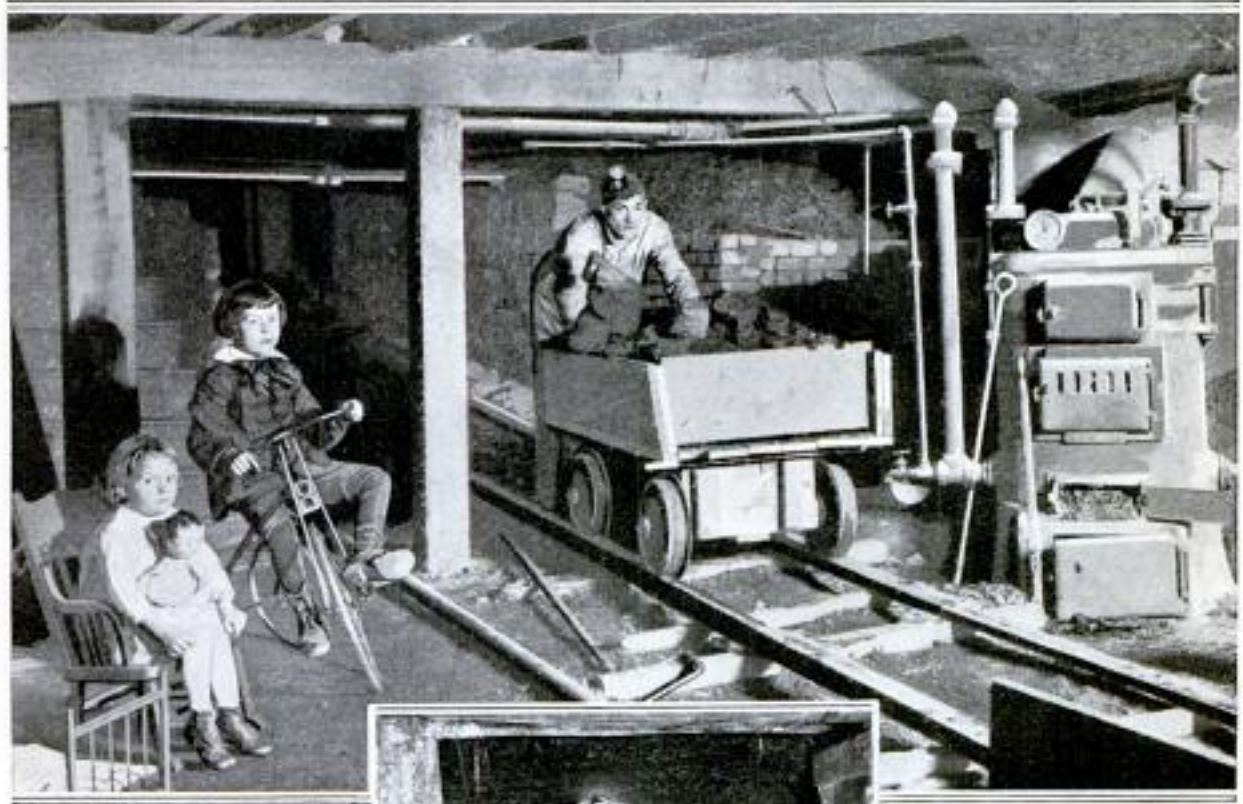

Hauling Coal from the Private Mine to the House Furnace: The Wooden Track Leads from the Cellar to the



View in the Gallery Which Now Extends from the Lawyer's Cellar Out toward His Garden

Vein of Coal Discovered When the Cellar was Enlarged. The Children have Come Down to Watch the Miner

A turn of good fortune that has come to a Virginia lawyer, and one which is truly enviable in these times of high prices, is the discovery of a rich coal vein within a few feet of his furnace door. The surprising find was made by a workman who, while enlarging the lawyer's cellar, saw that the character of the dirt in which he was working indicated the presence of coal near by. A little extra digging revealed a vein, 5 ft. high and 4 ft. wide, within 30 ft. of the furnace. To lay in his fuel supply, the lawyer borrowed a mine car from one of the many mining companies in the town and laid a wooden track from his cellar to the vein. The first 15 tons which he mined cost him 30 cents per ton. The entry, or gallery, which has been dug now extends well out toward the lawyer's garden. Unfortunately

all the mining rights in the district are owned by certain concerns and this man is prohibited from selling the coal. He can mine it for his own use, however. A rainy-day pastime of the lawyer's children

has been to watch a miner bring coal from the near-by vein to the cellar.

4579 Ship
SUBMERGED WRECK FOULS LAKE VESSEL

Several weeks ago a car ferry collided with the wooden freighter "John Plankinton," laden with coal, and sent it to the bottom of the river at Detroit. The location of the wreck was marked, but in some strange manner the steel steamer "Wissahickon," bound for Buffalo with a cargo of grain, failed to avoid the danger point one night shortly thereafter. It ran squarely atop

the submerged vessel, crushing what superstructure there was and became fast, its keel extending from stern to bow above the hidden deck. All efforts to release the vessel without assistance were unavailing, and the lighter "Res-



Showing the "Wissahickon" atop the Submerged Coal Boat, and the "Rescue" Alongside, Taking Over Its Cargo

cue" was called upon for aid. The craft came alongside and worked until a large part of the cargo had been removed and the "Wissahickon" lightened sufficiently to float free.

— 4704 —

SHREDDED WASTE PAPER SUPPLANTS EXCELSIOR

A machine has been brought out recently which shreds various kinds of paper that are fed into it, making it into soft material which can be used for packing in place of excelsior, and the like. By utilizing their waste paper in this way, many firms are reducing the cost of preparing fragile goods for shipment.

4590

TINNED-COPPER ROOFING FOUND TO BE DEFECTIVE

An investigation which has been conducted by the Bureau of Standards seems to indicate that tinned copper is not superior in any way to tinplate for roofing material, and in view of the fact that its cost is greater, can no longer compete with it. The examination which led the bureau to this conclusion had to do with the roof of the Library of Congress, which about 1893 was covered with sheet copper, tinned on both sides. Within the last 10 or 15 years a large number of small pits have appeared, some of them extending entirely through the sheets.

Special interest attaches to the case because Washington, and particularly that section of it in which the library is located, is uncommonly free from smoke, and smoke is often a principal factor in hastening the corrosion of such roofing.

Examination showed that the defects were not due to accidental inferiority of the material but are such as may naturally develop in any case. Variation in resistance to corrosion was due in part, it was pointed out, to mechanical abuses, such as scratching and indenting, as well as to variation in the thickness and structure of the coating.

ⓈThe Public Health Service reports that there has been an unusual prevalence of cerebrospinal meningitis and calls attention to the special danger which might result from an epidemic of this malady at this time, since the disease frequently gains entrance to and spreads in troop encampments.

Chas. Expointer
June 1912

Bloomfield & Rabb Co.
108 No. Jefferson St.
Chicago

THE ORGANIZATION AND INSIGNIA OF OUR FIGHTING FORCES

BY SEARLE HENDEE

IN no first-class nation are civilians so grossly unfamiliar with army and navy organization as in America. Our lack of training, and our characteristic indifference to military matters, have brought about a striking situation. We are at war, yet comparatively few of us know what an infantry battalion is, or are able to distinguish between the insignia of a brigadier general and a major. When it comes to the navy, our ignorance is even more profound.

A few moments' study, followed by ordinary observation, will enable almost anyone to overcome his confusion and obtain a rudimental understanding of these subjects.

To commence with, the commissioned line officers of our army and navy rank, in relation to each other, as follows:

General	—Admiral
Lieutenant General	—Vice Admiral
Major General	—Rear Admiral
Brigadier General	—Commodore
Colonel	—Captain
Lieutenant Colonel	—Commander
Major	—Lieutenant Commander
Captain	—Lieutenant
1st Lieutenant	—Lieutenant, Junior Grade
2nd Lieutenant	—Ensign

In the army the rank of general is not held at present. The "Admiral of the Navy" was a title conferred upon George Dewey by a special act of congress. It died with him. Commodores are on the retired list only. Right now the highest ranking officer of our army is a major general. The office of general exists only when specially created by congress, and has been filled but four times in our history. In 1903, an act was approved that created the general-staff corps and the office of chief of staff. It provided that the latter should have supervision of all troops of the line and of certain enumerated staff corps. As a result of

this legislation, no person has held the office of commanding general of the army since the act became effective. Four years later legislation was enacted that abolished the office of lieutenant general.

A field army, which theoretically consists of headquarters, two or more infantry divisions, one or more cavalry brigades or a cavalry division, a field-artillery brigade, one telegraph battalion, one field-signal battalion, and ammunition, supply, engineer, and sanitary trains, is under the command of a major general. An officer of the same rank is at the head of an infantry division. The latter, as described by the recently enacted Hay bill, is composed of a headquarters, three infantry brigades, a cavalry regiment, an artillery brigade, an engineer regiment, a field-signal battalion, one aero squadron, and various trains.

In the cavalry the structure is similar, a division representing, in addition to headquarters, three cavalry brigades, a regiment of field artillery (horse), a battalion of mounted engineers, a mounted signal battalion, an aero squadron, and trains.

As his title implies, a brigadier general has charge of a brigade. The unit is typically composed of headquarters, three infantry regiments, or three cavalry regiments, according to the branch.

A regiment of infantry is commanded by a colonel, and made up of one headquarters company, a machine-gun company, one supply company, and three battalions. Each of the latter is in charge of a major, and consists of four companies composed of 100 enlisted men, including noncommissioned officers, who are divided into several platoons commanded by lieutenants or sergeants. A corporal, in rank the lowest noncommissioned officer, has charge of a squad consisting of eight men, including himself. In the cavalry the troop and the squadron correspond,

respectively, to the company and the battalion in the infantry. The term battery in the field artillery is analogous to the company in the infantry.

Established regulations specify the duties that may be assumed by naval officers of each grade. Thus, for instance:

An admiral commands a fleet, or may be chief of naval operations.

A vice admiral commands a squadron, or a large force or detachment on important, independent duty, or may be second in command of a fleet.

A rear admiral has charge of a squadron, division, or a force or detachment on independent duty, or a naval station.

To a captain may fall the command of a division, squadron, destroyer or submarine flotilla, naval station, battleship, armored cruiser, or first-rate ship. He may also be chief of a flag officer's staff.

A commander may be in charge of a division, squadron, naval station, battleship, armored cruiser, or a first, second, or third-rate ship. Furthermore, he may be placed in charge of a destroyer or submarine flotilla, an unrated ship, or be assigned to serve as chief of staff for some flag officer, as fleet engineer, or as executive officer of an armored cruiser or battleship.

The lieutenant commander may take control of a destroyer or submarine flotilla or group, or command a third or fourth-rate ship, or a destroyer. On battleships or cruisers in charge of captains, he may act as navigator, or executive, gunnery, or engineer officer. Lieutenant commanders also act as flag secretaries on a commander-in-chief's staff, or as gunnery officers of fleets.

A fourth-rate ship may be under the command of a lieutenant. This rank also permits an officer to take charge of a torpedo boat, a submarine, or a division of them; to command a destroyer, unrated ship, tender, or tug; to be navigator, or executive, gunnery, engineer, or watch officer on a vessel commanded by a superior, and to act as a flag officer's aide, or be a flag lieutenant.

For the lieutenant of the junior grade is the command of a torpedo boat, submarine, unrated ship, a tug, or a tender. He may also be assigned to a ship commanded by a superior and given such posts as fall to a lieutenant under like circumstances, or be made aide to a division commander. An ensign, a commissioned officer of the lowest rank, may command the same list of vessels, or serve aboard a superior officer's vessel in about the same capacities as a lieutenant, or as a junior officer under a lieutenant.

Midshipmen on duty afloat outrank all officers who are not commissioned. They may be given watches, or assigned to division or other duties.

Boatswains, gunners, and machinists are classified as warrant officers of the line and appointed by the secretary of the navy from among those who successfully pass certain examinations. Commissions raising them next to the ensign in rank and prefixing "chief" to their titles, are given by the president after they have spent six years in the service and qualified themselves for promotion. A boatswain has charge of the rigging, anchors, cables, and cordage on a war vessel, and summons and directs members of the crew when certain duties are to be performed.

Gunners have charge of a ship's ordnance. The machinist is an assistant to the senior engineer officer, who may be a lieutenant commander, lieutenant, or ensign. Most of the warrant officers are former enlisted men. By passing examinations and receiving appointments it is possible for them to obtain commissions as ensigns, which place them on a footing with graduates of the naval academy and in line for promotion to higher ranks.

At the top of the enlisted personnel are the chief petty officers and first, second, and third-class petty officers, who are analogous to the noncommissioned officers of the army. They are appointed by a captain and may be disgraced by him. In addition to these, in the seaman's branch just indicated, there is the master-at-arms, who is responsible for the maintenance of order,

INSIGNIA WORN BY SOLDIERS TO INDICATE BOTH THEIR RANK AND BRANCH OF SERVICE



Cap Device, Com-
missioned Officers

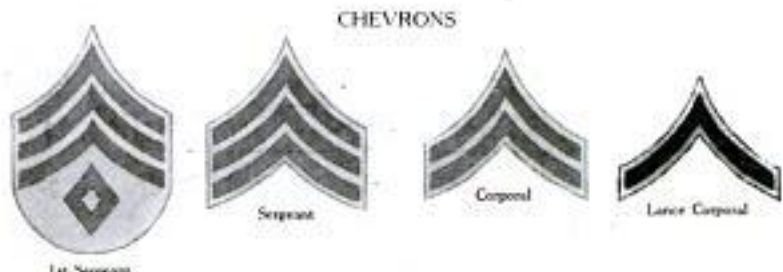
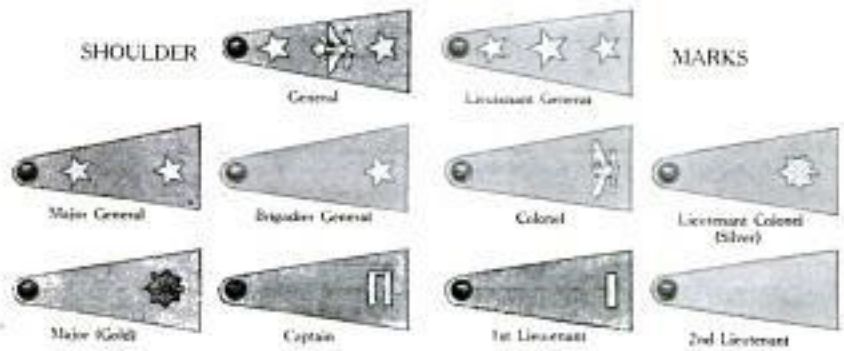

* Coast Artillery Corps





MARKS SHOWING RANK OF COMMISSIONED AND WARRANT OFFICERS IN U. S. NAVY

Cap Device, Commissioned Officers



NAVAL OFFICERS' COLLAR DEVICES



COLLAR DEVICES

Admiral



Vice Admiral



Rear Admiral



Captain



Commander



Lieutenant Commander



Lieutenant



Lieutenant, Junior Grade



Ensign



Chaplain



Chief Boatswain



Chief Gunner



Chief Mechanic

SHOULDER MARKS



Admiral



Vice Admiral



Rear Admiral



Captain



Commander



Lieutenant Commander



Lieutenant



Lieutenant, Junior Grade



Ensign



Chaplain



Chief Boatswain



Chief Gunner



Chief Mechanic

SLEEVE MARKS

MARKS



Vice Admiral



Rear Admiral



Admiral



Commander



Lieutenant Commander



Lieutenant



Lieutenant, Junior Grade



Captain



Chief Boatswain, Gunner, Machinist



Boatswain, Gunner, Machinist



Ensign

for the discipline, and for the custody of prisoners on a man-of-war. The chief master-at-arms, who is a chief petty officer, is the head of a vessel's police. A coxswain has command of a ship's boat in the absence of a higher officer, and steers when it is in the water. In the navy, a quartermaster is a petty officer and therefore of widely different rank from that of the commissioned officer in the army who bears a like title. He is under the direction of the navigator and looks after the helm, binnacle, signals, and similar things. A gun captain is appointed by the commanding officer of a ship and is in charge of a gun's crew. In command of a turret crew is a turret captain, a chief or first-class petty officer who ranks next to the officer while on duty. An electrician can also be given rank. All of these officerships are grades to which capable seamen in good standing are eligible for appointment. It will be remembered, however, that a recruit is an apprentice seaman, and through promotion must become an ordinary seaman, and then a seaman, before he

is due for elevation to the rank of petty officer.

The engineer force, which is now included in the line, is separated into the engine-room and fire-room divisions.

Under the first group come the machinist's mates, who are petty officers of the chief, first, and second classes. Chief water tenders and water tenders are chief and first-class petty officers in the fire room charged with the duty of attending to the water in the boilers and seeing that the firing is done properly.

Our sea force is divided into three fleets, the Atlantic, with headquarters on the east coast; the Pacific, detailed on the west coast, and the Asiatic, stationed at the Philippines. Theoretically, a fleet consists

of two or more squadrons. A squadron, in the United States Navy, is regarded as a tactical unit and comprises about eight ships. Fleets and large squadrons are separated into divisions, consisting usually of four vessels. A flotilla is an organization of divisions or groups of destroyers, submarines, or other small craft.

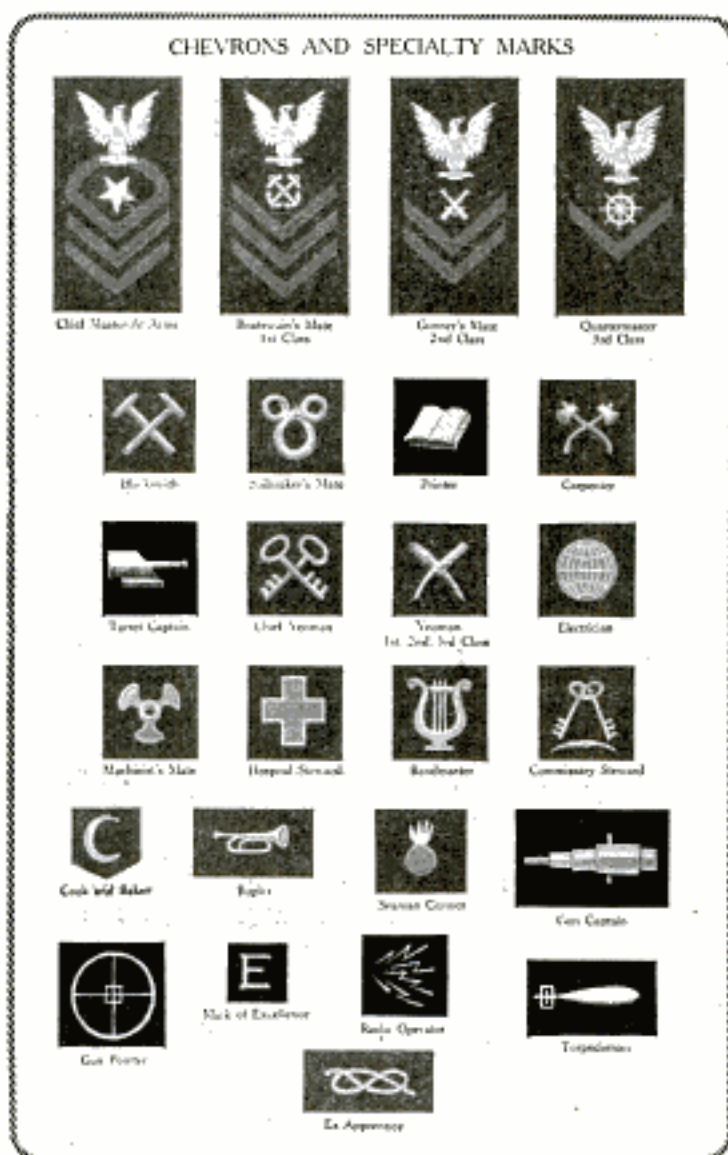

COPYRIGHT, H. H. WINDSOR

At the Top are Illustrated in Order the Chevrons Worn by Chief, First, Second, and Third-Class Petty Officers of the United States Navy. Enlisted Men of Such Rank Correspond to the Noncommissioned Officers of the Army. The Devices Worn with the Chevrons Are Specialty Marks, Others of Which Are Also Pictured

WATER WHEEL IS FEATURE OF NEW LAWN SPRINKLER

A distinctly new type of lawn sprinkler has been brought out, which, it is claimed, will cover times as much

four or five ground at one setting as the ordinary sprinkler, and throws the



Lawn Sprinkler Which will Cover Four or Five Times as Much Ground as an Ordinary Sprinkler: The Curved Arm and Water Wheel are Swung Round in a Circle. The Hose is so Attached That It does Not Become Twisted

water in small drops in such a way that it falls much like rain. The spray is produced by a water wheel which is revolved by directing a stream from the hose against its upper edge. The wheel is mounted at the end of a curved arm, to which the hose is also attached, and as it turns it operates gearing connected with the upright

standard of the sprinkler. This gearing causes the arm to revolve so that the area within a large circle is sprayed repeatedly.

— 4558

NEW EXCAVATING MACHINE SERVES MANY PURPOSES

To take the place of the time-honored scraper for road grading, and similar work, a self-loading excavator has been developed that appears to have merit. It is claimed to reduce by about two-thirds the usual cost of making cuts and fills. Four horses, or a light tractor, pull the machine, and one man is able to control it. Essentially the outfit is a low-swung wagon with an adjustable bed, the bottom of which is an endless-belt conveyor. At the front is a scraper that peels the ground when the apparatus is inclined. One and three-fourths cubic yards of earth can be excavated and loaded, it is said, in about 20 seconds. The machine is designed to dump in one spot, or distribute dirt evenly across some low place that needs filling. This feature makes it useful as an agricultural implement, for it enables rich soil, that has been washed into depressions, to be recovered and deposited on thin spots, and manure to be spread for fertilizing purposes.



The Self-Loading Excavator, Which Peels Up One and Three-Quarters Cubic Yards of Dirt in About 20 Seconds, is Said to Reduce the Cost of Road Grading, Making Cuts and Fills, and Doing Similar Work, Nearly Two-Thirds. A Battery of the Machines in Use, and a Close View of One of Them, Appear Above

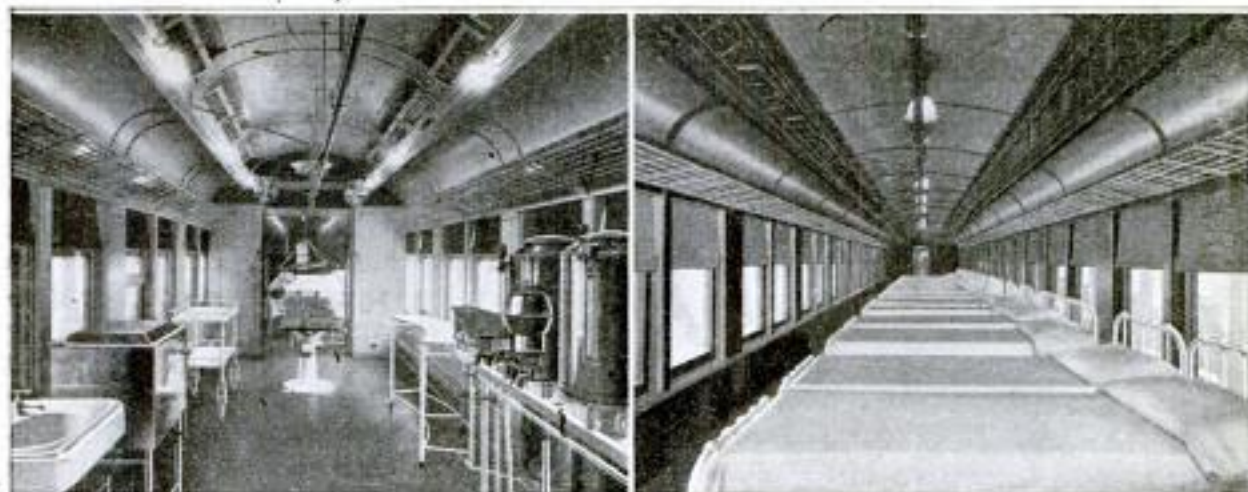

Left: View of Operating Room in Maryland's Hospital Train. Showing the Overhead Trolley and a Suspended Stretcher, at the Far End, by Which a Patient can be Conveyed to and from the Operating Table. Right: Interior of the Dormitory Car of the Hospital Train

4588

STATE'S HOSPITAL TRAIN READY FOR WAR SERVICE

A complete hospital train, equipped in an up-to-date manner for modern war service, has been furnished by the state of Maryland to carry wounded soldiers, sailors, and others, to our base hospitals. The train consists of a Pullman express and dining car, a dormitory coach, and an operating car. A special feature is an overhead trolley running through the cars, by which a patient, when placed on a suspended stretcher, can be conveyed with ease to or from the operating room. The same apparatus can be used in conveying trays back and forth. Electric lights and fans, a call bell for each bed, and screens for the doors and windows, are provided for the comfort of the sufferers in whose service the train will be employed. In the operating room are a regulation operating table, sterilizers, linen chests, etc. The cars are the gift of the Western Maryland, the Pennsylvania, and the Baltimore and Ohio railroads.

4631

CITY LOT ON HILLSIDE TERRACED FOR GARDEN

An example of gardening which should be a stimulus to the owners of sloping plots of ground, is a lot, 150 ft. deep, on a steep hillside in the heart of a city of 500,000 people. This piece has been terraced its full length,

secondhand lumber being used in making the retaining walls. Vines have been set out next to the walls to help hold the soil back, and most of the



City Lot on Steep Hillside Terraced Its Full Length and Utilized for Raising Fruit and Vegetables: Being a South Exposure, the Vegetation Grows Rapidly

level spaces have been planted with vegetables and fruit trees, except at the top where there is a poultry yard.

☞ An automobile concern has offered to accept Liberty Bonds in payment for cars bought, a premium of \$2 per \$100 being allowed to the purchaser.

National Clock & Mfg. Co.
20 W. Lake St. Chicago.
4605 POPULAR MECHANICS

Camping
174

MOTOR-CAR CANTEN BUILT IN COMPACT FORM

For the motor tourist, camper, or power-boat enthusiast, a fireless-cooker kitchenette outfit, completely equipped

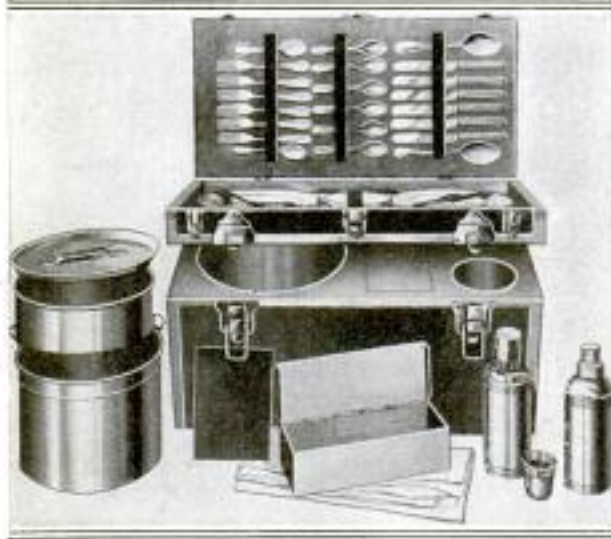

With 14-Quart Cooking Capacity and Table Accessories for Six Persons, This Lunch Outfit Is Only 25½ Inches Long, 13 Inches Wide, and 15 Inches High

to meet the needs of six persons, is a serviceable and convenient accessory. Such a unit has been introduced lately and is so constructed that it may be satisfactorily carried on the runboard of a car. It provides a 10-qt. kettle and a 4-qt. inset for the preparation of different foods; a cold box for meats, butter, and similar things, and vacuum bottles for hot and cold beverages. In addition, a special compartment is supplied with silverware and dishes. Compactness is another of its agreeable features.

— 4663

A SIMPLE ROTARY SHELL PAINTER

The manufacture of high-explosive shells and shrapnel is by far a bigger proposition than the loading of such projectiles, and entails many painstaking and delicate operations, some of which, though apparently simple, have necessitated the development of many unusual processes of performing certain tasks.

Just prior to the shipment of the completed shells to the plant, or ar-

senal, at which they are to be loaded with explosives, the inside of the shells is given a thin coat of varnish, primarily to guard against rusting of the carefully finished surfaces within the shell. This is one of the apparently simple tasks which has proven to be exceedingly annoying, and hard to reconcile to the high efficiency developed in the more difficult machining processes performed during the stages of the evolution of a finished shell from the crude forging or block of metal. The coating of varnish must be uniform and thin and must be carefully applied.

A machine has been constructed whose simple operation has been accomplished by two boys, not necessarily unskilled, but just ordinary shop boys. Briefly, the machine consists of a horizontal rotating shaft, carrying four shell-holding spindles. Each spindle is kept turning by the revolving shaft, through suitable gearing. At the end of each spindle is a cuplike receptacle in which the shell is inserted for the painting process.

The operation is even more simple. One boy inserts the shell into the cup, while a second boy sprays the inside, using a sort of atomizer supplied from a tank under pressure. The first boy then removes the painted shell and inserts another while the sprayer is doing the second, and so on. The steady rotating of the shells permits a very fine spray of varnish to be evenly distributed over the inside of the shells. These two boys can varnish about 400 shells in an hour.



COURTESY OF MACHINERY
With This Machine Two Boys can Spray a Varnish Coating on the Inside of 400 Shells per Hour

Vermont Cannon Works.
Bellevue Falls, Vt.

Copyrighted material

Jas W. Hefferman, Chf. 3rd Battalion
533 1st St. Brooklyn
4617 **POPULAR MECHANICS** *175*
N.Y.

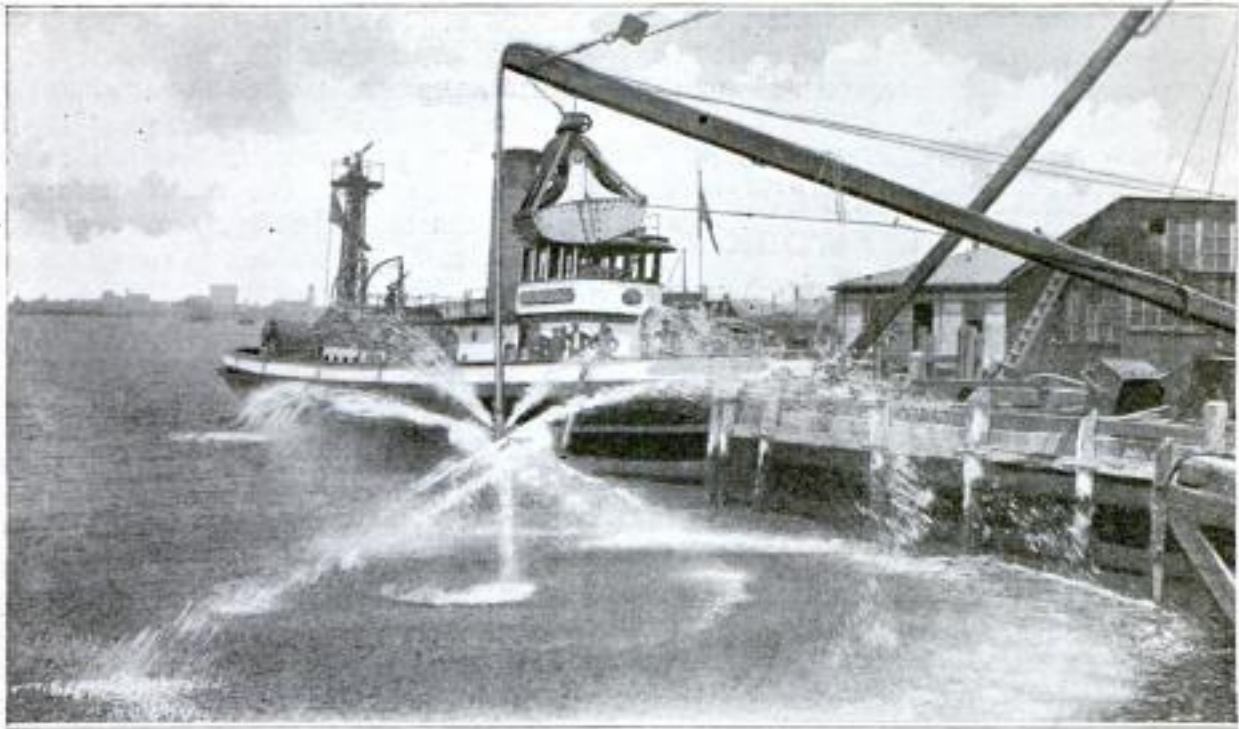

COPYRIGHT BY INTERNATIONAL FILM SERVICE
Putting the New Revolving Fire-Fighting Nozzle through Tests: It is Designed for Combating Blazes in the Holds of Ships and Spreads Water over an Area 125 Feet Square

True Note
REVOLVING NOZZLE HURLS WATER OVER LARGE AREA

Although intended particularly for fighting fires in the holds of ships, a revolving nozzle, lately subjected to tests, seems well adapted for combating conflagrations in other places difficult of access. When fire starts below a vessel's main deck it is sometimes impossible to direct a stream of water upon all parts of it through a hatchway with ordinary equipment. Because of its angle, the water strikes the lower decks only a short distance from the hatch opening and thus fails to reach a blaze that is back near the bulkhead. The new nozzle is especially designed to meet this problem. Radiating at different points about its periphery are nine outlet pipes of diameters ranging from $\frac{1}{2}$ to $1\frac{1}{8}$ in. that discharge at various angles. When attached to a $3\frac{1}{2}$ -in. hose with the water at a pressure of 40 lb., the nozzle delivers about 1,400 gal. a minute. It has proved most efficient when making one revolution every four seconds.

4655
DEVICE WRITES JAPANESE ADS IN WATER ON STREET

That the ingenuity of people in the Orient sometimes finds expression through thoroughly modern channels is demonstrated by a sprinkler, employed in Osaka, Japan, which writes advertisements in water on the road-



Water Sprinkler Provided with Perforated Revolving Drum That Traces Advertisements in Water on the Roadway

way, as it is drawn along by man power. Solidly mounted on the axles of a two-wheel cart is a per-

H. H. Hibberd
Glasgow, Pa.
67 d
 Copyrighted material
1911

forated drum, filled with water, which revolves with the wheels and as it does so, traces oriental characters along the thoroughfare.

4636
SANITARY IODINE SWAB FOR FIRST-AID WORK

A first-aid appliance of much value, both to the surgeon at the front and the physician engaged in private prac-

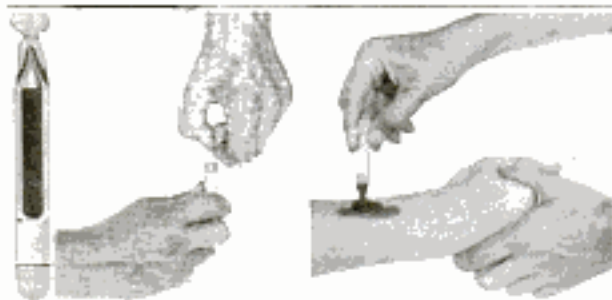

Iodine Swab Consisting of Hermetically Sealed Phial Inclosed in a Woven Case, One End of Which Serves as a Brush: To Use, the Pointed End is Broken, Releasing the Liquid

tice, is a swab consisting of a hermetically sealed phial containing enough iodine for one application and inclosed in a woven case, one end of which serves as a brush. When the sterilizing liquid is wanted, the brush end of the tube, which is pointed, is broken between the thumb and finger, after which the iodine can be painted over as large an area as desired.

4638
CONVENIENT ELECTRIC FAN FOR WALL OR DESK USE

An electric fan of new design has recently been brought out, which will run on either alternating or direct current and is especially convenient, be-

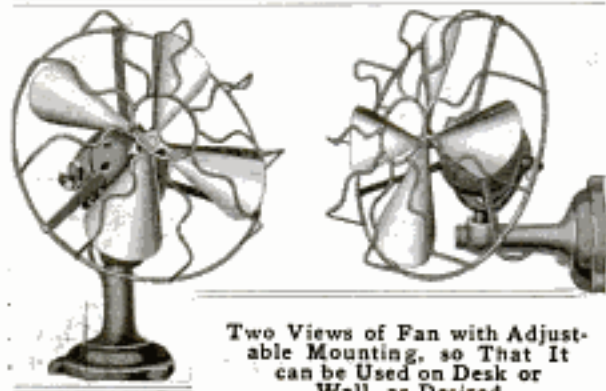

Two Views of Fan with Adjustable Mounting, so That It can be Used on Desk or Wall, as Desired

cause it can be instantly converted from a desk fan to a wall fan without using additional parts. When screwed to the wall a special locking device with which it is provided, holds the fan at the proper angle. The mechanism has full trunnion-and-swivel movements, and a two-speed switch is provided in the base.

4658
FLOODS AND IRRIGATION CAUSE LOSS OF FISH

Because a large number of fish were killed by being carried over the Roosevelt dam during last spring's floods it has been suggested that a screen be placed several hundred feet upstream from the dam to prevent such loss in the future. By such means the fish would be kept from getting too close to the spillways. Large quantities of fish have been killed also by diverting water from the Colorado River for irrigation purposes. The Bureau of Fisheries found that in one locality the bed of the stream had been left entirely dry, causing a loss, it is said, of tons of fish. An investigation of the Salt River irrigation project in Arizona showed that no fish were lost there because the ditches always contained sufficient water to enable the fish to return to the river.

Was
 etc

4695
MANY THOUSAND SHINGLES SHIPPED BY PARCEL POST

A western lumber company made exceptional use of the parcel-post system not long ago when it shipped a consignment of 30,000 shingles through the mails. The destination of the shingles was 52 miles from the shipping point, and the postal charges were less than \$50. Although a shipment of this size is uncommon, the parcel post is frequently used in the western states to send supplies to remote places in the stock-raising country as well as to the mines, many of which are far from the beaten paths of travel, and so have no adequate railway facilities. The lot of shingles referred to went via a star rural-delivery route.

M. Boker & Co., Inc.,
 101 Duane St.
 New York

Madison Lbr Co.,
 Brangerville
 Idaho.
 Copyrighted material



A Dry-Land Swimming Lesson—First Position: Body of Pupil is Supported so That She can Extend Her Hands Forward, While Rings Support the Feet



Learning the Leg Movements: After This Group Training, Each Pupil Uses the "Waterless Swimming Device," First on Land and Later Suspended above the Water. Finally He is Let Down into the Water and Goes Through the Exercises. With Such Preliminaries Real Swimming Soon Becomes Natural



Second Position: Arms are Swung Back so That They Extend Horizontally and at Right Angles with the Sides, Palms toward the Feet, Which Remain in First Position



Third Position: Hands are Drawn Up under Breast, with Palms Together, While Knees are Drawn Forward. Note Position of Feet Also



Fourth Position: The Kick has Just been Made, Spreading the Legs Apart. Arms are Extended Downward, Preparatory to Assuming First Position



An Elementary Swimming Lesson: A Physical Instructor in the Schools at Belleville, Ill., has Had Excellent Results in Carrying Out His Theory That Children could More Easily Learn to Swim if They were Taught the Fundamentals on Land. Here Is a Group of Children Practicing the Arm Movements, Which Each will Apply Later While Suspended in the Device Shown in the Smaller Views

NOVEL SYMBOLS EMPLOYED AT BALL-PARK OPENING

A huge plaster-of-Paris baseball, filled with sparkling liquid, took the



Christening a Ball Park for Employees of Shipbuilding Firms: Above, the Tiny Ship, Sliding down a Wire Leading from the Grand Stand to the Home Plate. The Lower View Shows Result of Collision with Liquid-Filled Ball

place of a bottle of champagne, and a model of an ocean liner served in place of a real boat, in a most unusual christening which marked the recent opening of a ball park, laid out for teams representing large shipbuilding firms at Seattle. The ball was placed on the home plate and the ship concealed behind a flag on top of the grand stand. When the flag was unfurled, revealing the ship, the latter was released from its support and began to slide down a wire which extended to the home plate. As the ship neared the ground it struck the big ball and broke it, spilling its contents on the diamond, which was thereupon turned over to the players representing the shipbuilding concerns.

4211

HOIST SCREWS RAISE BODY OF SELF-EMPTYING TRUCK

The important feature of the six-ton self-emptying electric truck shown in the accompanying illustration is

that the hopper body can be lifted in a level position to a height of 10 ft. by means of hoist screws situated near

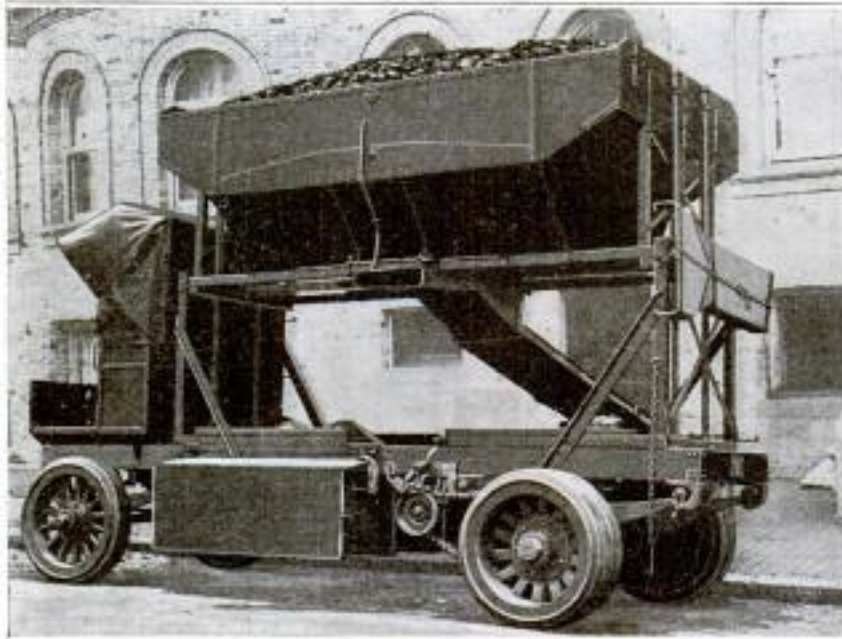

View of Six-Ton Electric Truck Showing Body Elevated by Hoist Screws to a Height of 10 Feet, so That It can be Emptied by Gravity

the four corners. These screws are operated by a special electric motor. The advantage of this form of construction over the common tilting body is that even when a long chute is employed it can be set at enough of an incline to feed the coal by gravity. Thus, when the truck is placed at the curb the coal can be fed across a wide sidewalk or strip of lawn and no carrying or shoveling is necessary. The amount of time saved in this way is also of importance.

General Vehicle Co., Inc.
Long Island City, N. Y.

Sidney E. Gordon, 628 Elmira st.

4586

POPULAR MECHANICS

179

San Antonio, Tex.

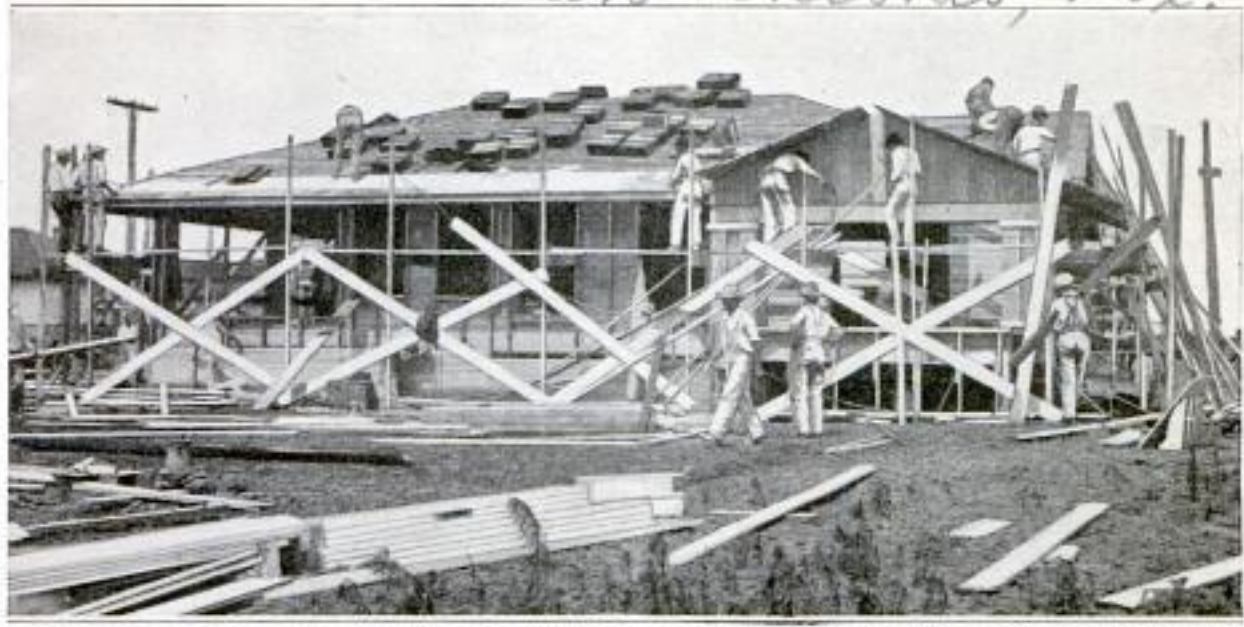

A "Built-in-a-Day" Bungalow as It Appeared Two Hours After Its Construction had Begun: Among the Big Crews of Workmen Employed Were 31 Carpenters

PLEASING BUNGALOW BUILT IN EIGHT HOURS

A bungalow, valued at \$6,000 when furnished, sprang up like a mushroom in a southern city not long ago, only eight hours and 15 minutes being required to construct it from foundation to shingled roof. Work on the dwelling began at eight o'clock in the morning, and during the busy hours that fol-

lowed, 31 carpenters, 14 common laborers, five plumbers, four electricians, and three painters were employed on the job. The bungalow was offered as a prize for the best discussion of the topic, "Why I should Own My Own Home," and was a prominent feature of a home-ownership campaign. Only



The Bungalow at Four O'Clock on the Same Day: All Materials and Furnishings were Donated by Local Concerns. The Completed Home is Valued at \$6,000

those who had families dependent on them and did not own their homes were allowed to compete. All materials used in the construction, the fixtures, and the furnishings were donated by local merchants and manufacturers.

4484
**LIGHTED TRAP SHOWS FISH
 STILL LIVE IN LAKE**

In recent years practically no fish have been caught or seen in Devils Lake, N. D., though 20 years and more ago many varieties were plentiful there.



This View Shows the Screen Funnel Removed and the Electric Light Which Lures the Fish into the Trap

The present condition appears particularly strange in view of the fact that during the past three years the state Bureau of Fisheries has placed some 20,000,000 pike, yellow-perch, and black-bass fry in the lake. Some investiga-

tors have come to the conclusion that the older fish, at least, have escaped through a newly formed subterranean outlet. But that many of the fish put in by the bureau still remain has been proven by the use of an especially constructed fish trap. It consists of a wooden box, 2 ft. long, 1 ft. wide, and



The Six Concrete Tanks, Each Containing a Different Proportion of Brackish Lake Water, in Which the Minnows are Placed Successively to Acclimate Them to the Lake

1 ft. high, in one end of which is inserted a wire-mesh funnel with its small end, 3 in. in diameter, pointing inward. Within the box, directly opposite the entrance, is an electric light supplied with current by an automobile storage battery. All the electrical connections are made thoroughly waterproof. By lowering the trap into the water and turning on the light, small specimens of all the varieties that had been placed in the lake have been secured, many being caught in the deepest parts. It is believed that, in time, systematic restocking will make the lake a good fishing place once more. The water is brackish, however, and to acclimate the hatchery minnows to it, it is necessary to provide a series of six concrete tanks. The tank in which the minnows are placed first contains a small proportion of lake water, while in each succeeding reservoir the proportion is increased. The fish reach the last tank at the end of six days, after which they can be placed in undiluted lake water without injury.

4545
**NEW BRIDGE SUPPORTS OLD
 STEELWORK DURING RAZING**

After the new superstructure of the Union Pacific bridge across the Missouri River, at Omaha, had been slipped into place on the original stone piers some months ago, the dismantling of the former one, which had been moved onto timber supports alongside, presented an interesting problem. It was realized that, at its flood stage, the river would sweep away the temporary falsework and any additional piling that might be driven. The period of high water was near, and the danger of the old superstructure falling and damaging the bridge was therefore imminent. In working out the engineering puzzle, each span of the new bridge was made to help support the discarded one corresponding to it. At regular intervals, heavy trusses were placed beneath both. This amounted to putting the old spans on brackets extended out from the new ones. A track was built along the top chords of the bridge for



Showing Operations in Progress before Flood Time: The Old Superstructure is Supported on Temporary Piers and by Trusses Anchored to the New Bridge

the accommodation of a traveling crane. As the steelwork was dismantled, the parts were swung to cars waiting on the tracks below. Much of the work was accomplished in this way before the river reached its high level. One of the temporary piers was eventually washed out, however, and two of the old spans fell into the water, but without injuring the bridge.

4669

PINHOLE IN WATER PIPE SOON PROVES COSTLY

Information recently circulated by the water department of a small municipality where meters are used, shows the importance of discovering and mending leaks that may occur in a piping system. Under a pressure of 40 lb. it is estimated that, in 24 hours, 170 gal. of water will pass through a hole a shade larger than the period at the end of this sentence. An orifice slightly bigger than the head of a pin will permit 3,600 gal. to escape in a similar length of time. Thus, ever so slight a hole may cause the wastage of a great volume of water if it fails to receive immediate attention. It is easy to test a plumbing system and ascertain its condition. This may be done by closing all cocks and then reading the meter. If, after a half hour or more, the meter reads the same as originally, the pipes are free from leaks.

Water Dept.,
Evanston, Ill.

FRUIT GROWERS USE TOWER TO FIGHT FROST

Frost fighters of the Rogue River Valley, Ore., recently used a wireless tower to obtain information concerning the probable amount of fuel and labor necessary to heat their orchards on cold nights.

Sets of carefully housed recording thermometers and thermographs were exposed at the top of a 300-ft. wireless-sta-



Placing Instruments in Shelters for Hoisting to the Top and Middle of Wireless Tower Used as a Meteorological Observatory by Oregon Fruit Growers; Below are Shown the Housings Used for the Instruments

tion tower; another set at the middle, and still another at the base. On nights when all three sets of instruments recorded nearly alike, the inference was that there was a great depth of air to heat, as cold air from aloft would constantly descend to replace the heated air. On such nights the frost could not be successfully combated, if severe.

However, if the instruments on the tower showed temperatures progressively warmer with altitude, the inference was that the surface cold air was a thin layer, due to radiation, and it was only necessary to heat this to obtain safety.

The latter is the usual, or average, condition according to meteorologists,

4544

CALCULATING ATTACHMENT FOR TYPEWRITERS

A new mechanical calculator has been brought out, which is intended to be used as an attachment for practically



The Calculator Shown at the Right Attaches to Any Ordinary Typewriter, Serving as a Base in the Manner Illustrated at the Left

any typewriter, making the latter perform the service of both a writer and an adding and subtracting machine. It serves as a permanent base for the machine with which it is used, and is contained in a shallow metal case, as wide as a typewriter and a little longer, with three slots on the front side in which appear the results of the calculations made. Arms projecting upward from the device are joined to corresponding parts of the typewriter so that all calculations are made by using

while the former condition is of only occasional occurrence, due principally to an influx of cold air from other regions, and not to local radiation.

Incidentally it was noted that the daytime maximum temperatures were about one degree cooler at the top of the tower than on the ground, while the minimum temperatures at night averaged nearly five degrees higher at the top of the tower. Also the minimum temperatures occurred half an hour later at 150-ft. altitude, and an hour later at 300-ft. altitude during the period of records. And the low temperatures lasted half an hour longer at the top of the tower, the duration of the extreme lowest at the surface being comparatively brief.

the regular numerical keys. The latter can be disconnected from the attachment whenever desired, by pressing a button. Operations involving as many as three or more columns of figures and fractions can be performed with ease.

4641

FLEXIBLE STEEL CURTAIN NEW TORPEDO SHIELD

To render merchantmen and transports immune to submarine attacks by means of floating steel curtains towed alongside, is an interesting proposal that has been submitted to the government for consideration. One of the flexible barriers would consist of a series of air-tight cylinders, each supporting a large 8-in. steel plate fastened to it longitudinally like a keel. The latter would extend to a depth slightly below that at which a submarine's missile travels. The buoys would be of the same length as the metal sheets attached to them and placed end to end along a connecting cable. Upon being struck by a torpedo, one of these units, and possibly one adjacent to it, might be destroyed. It then would devolve upon a repair tug behind the screen to mend the gap quickly by inserting new members, or by drawing an auxiliary curtain across the opening. The barriers would be towed on either

Jan. Russell
1254
Copyrighted material
Chgo.

Typewriter Calculator Attachment + Co.,
338 De Baliviere Av., St. Louis, Mo.

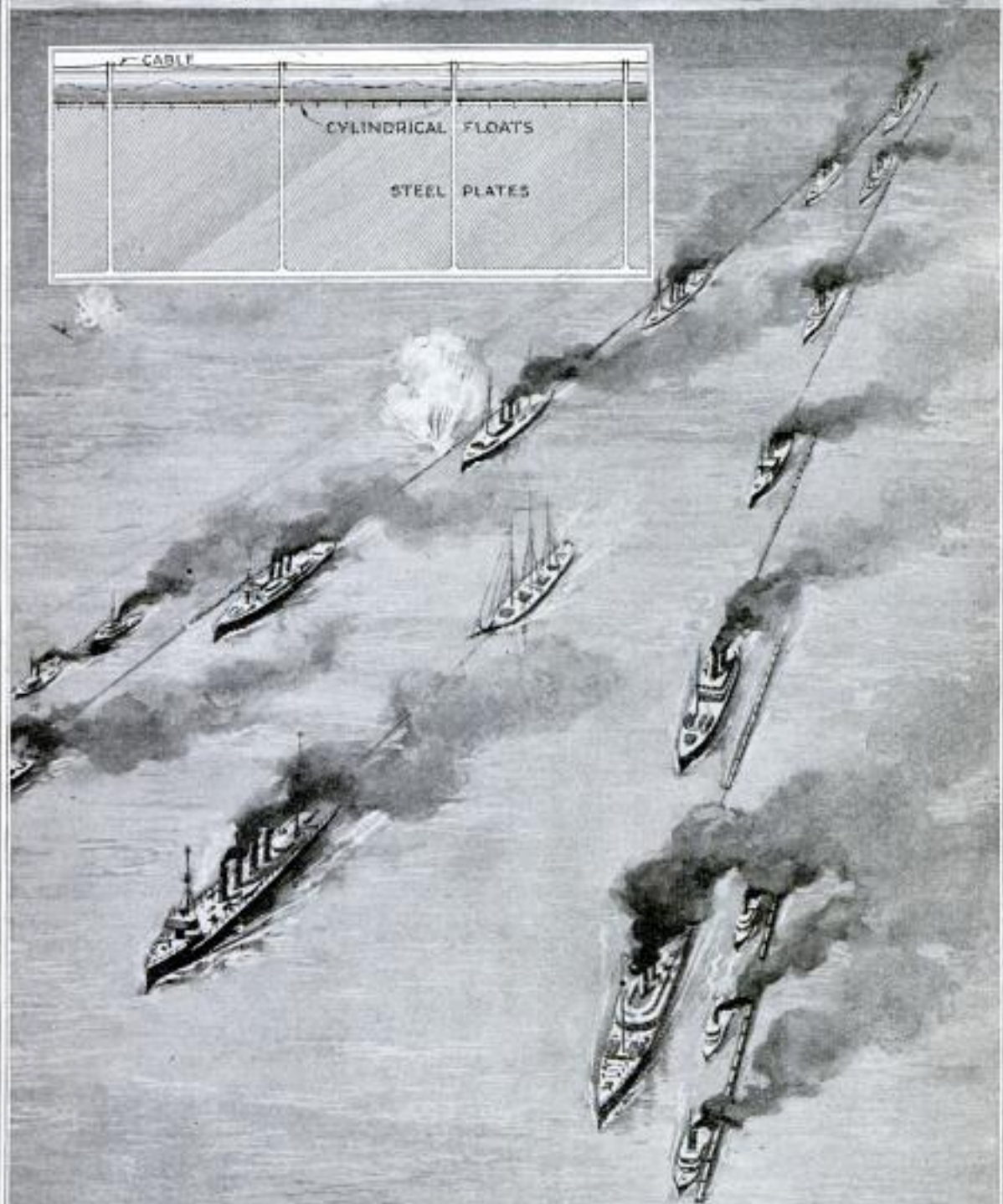
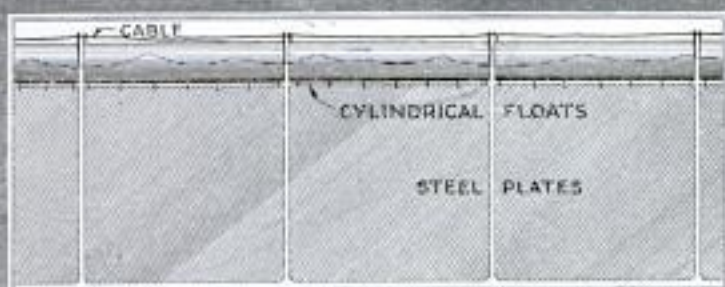

Herewith the Artist Illustrates How It is Proposed to Protect, by Means of Flexible Steel Barriers, Fleets of Merchantmen Passing through the Submarine Zones. By Steaming in the Formation Indicated, and Each of Them Towing One of the Screens, the Vessels would Shield Each Other from Torpedoes. The Character of the Floating Barrier is Described by the Insert at the Top of the Page

side of a vessel, or fleet, at a distance of 200 or 300 ft. For this purpose sea-going tugs, or stanch yachts of slight draft, could be employed. It is estimated that in good weather a powerful tug could tow a 600-ft. barrier at a rate of about 15 miles an hour. A fleet could protect itself by sailing in two staggered rows, each vessel tow-

ing a screen which would shield the ship following it. The curtains guarding the leading steamers, of course, would be handled by tugs. Under present conditions the plan would only be employed in the submarine zones, but, if necessity dictated, ships could be convoyed all the way from port of departure to destination.

4410

HORSE AND ENGINE POWER COMBINED TO DRAW LOADS

When it was found that auto trucks employed in making an excavation for

steep incline the team was hitched to the front of the machine and by thus combining horse and engine power the ascent was made without delay.



The Team Shown Here was Regularly Employed in Helping Six-Ton Motor Trucks Make the Steep Ascent from the Bottom of This Excavation to the Street Level

a department store did not have enough power to carry their loads up a 30-per-cent grade that led from the pit to the street level, a heavy team of horses was brought into service and overcame the difficulty. When a truck, loaded with six tons of dirt, approached the

4705

INTERNATIONAL REPORT ON LAKE OF THE WOODS

6/13/17
Off Bulletin

On the boundary between the United States and Canada, about midway between the coasts, lies the little-known Lake of the Woods, one of the most picturesque bodies of water in America and one of large economic importance to the United States and Canada. Because various problems pertaining to the lake and its level have arisen, an international joint commission was appointed some years ago and recently, after extensive investigations and hearings, has reported to the two governments concerned. This report recommends, among other things, that a certain water level be maintained. This level is established with due regard to the water power which the commission recognized as the dominant interest of the region. The recommendations provide for the utilization of this lake, and others, as immense reservoirs for power purposes. While this will damage some farm land it is purposed to fully compensate those who suffer. It is proposed also to fully safeguard navigation and the fisheries.

¶The Council of National Defense has ordered the compilation of data regarding all firms in this country which can in any way aid in making air craft. A list of industrial engineers whose knowledge would be of value to the government, will also be prepared.

**ENORMOUS CROPS PROMISED
FROM CUBICAL POTATO BED**

Ind. Star 5/25/17

A new and truly remarkable method of raising potatoes, by which it is claimed one can produce as much as 40 bu. on a plot of ground 6 by 8 ft., has been tried for three summers with such success that the originator of the plan believes that it will revolutionize potato raising. The method is described by a writer in the Indianapolis Star. Calculating on the basis of the three crops obtained, an acre of ground could be made to yield several thousand bushels.

The plan involves little cost except for seed and, in some cases, fertilizer. The first step is to construct a bin, measuring 6 by 8 ft. and 6 ft. high, the sides of which are composed of strong boards, or slats, placed horizontally, 2½ in. apart. In this bin the gardener spreads a 6-in. layer of dirt. The surface is then marked off with lines drawn length-

wise and crosswise every foot, with no lines closer to an edge than 6 in. A piece of seed potato is placed at each intersection, the pieces being cut with at least two eyes each. The seed and earth are then covered with an inch or two of well-rotted manure, and thoroughly sprinkled. Another 6-in. layer

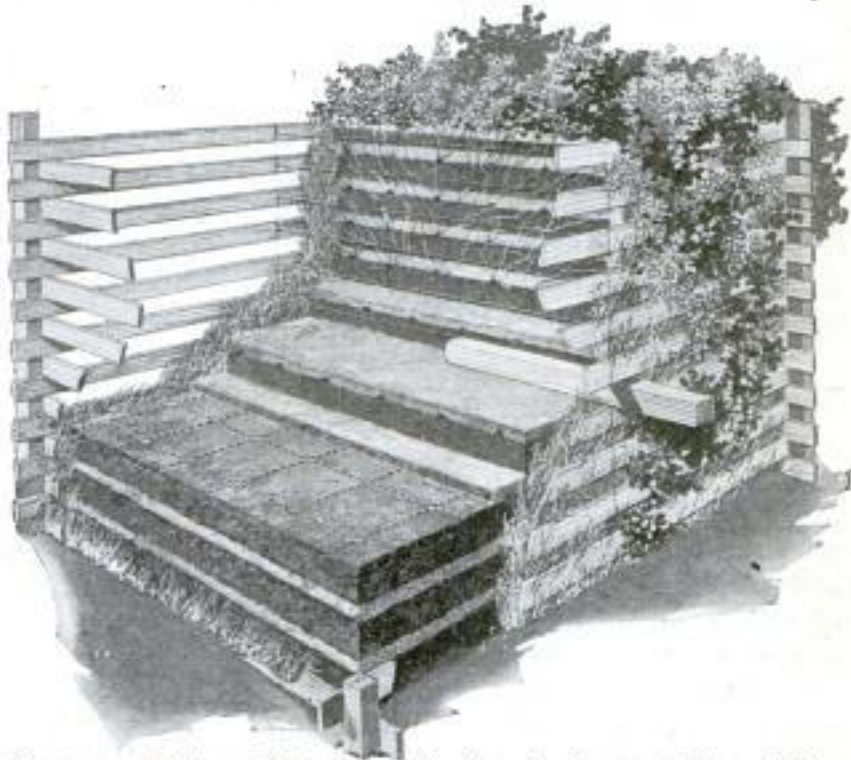

Diagrammatic View of Potato Bed Showing the Layers of Dirt and Fertilizer and the Plan for Planting Each Layer: The Beam Projecting from the Center of the Side at the Right Is the Moisture Tester

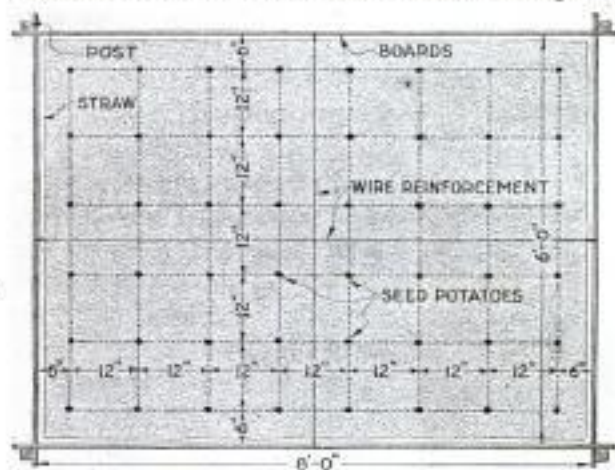

Plan of a Layer Showing Dimensions: This Potato Bed Measures Eight by Six Feet and Is Six Feet High. Wire Reinforcing is Used to Keep the Sides from Bulging. In Planting the Seed as Shown, the Pieces are Set 12 Inches Apart

wise and crosswise every foot, with no lines closer to an edge than 6 in. A

of earth is then added, and the process is repeated until the bin is full. Straw can be used at the edges to keep the dirt from running out. At the fourth layer a large stick, or timber, should be inserted about two feet, to serve as a moisture tester. The earth on the top should be slanted toward the center to prevent rain from draining off. By sprinkling about twice a week, except in rainy weather, the soil is kept moist. Its condition can be ascertained by temporarily removing the tester and inserting the hand into the hole. The potato vines will take the shortest route toward the light, in time issuing from the top and sides. About 90 days are required for the maturity of the tubers. To harvest the crop, the bin is taken down, and the potatoes raked out. With this method the planting can be done much later than usual, since moisture, ventilation, and drainage are all under the gardener's control.

RED-CENTERED STAR MADE FLYING-CORPS DEVICE

As the insignia for all of our air craft, the government has ruled that a five-

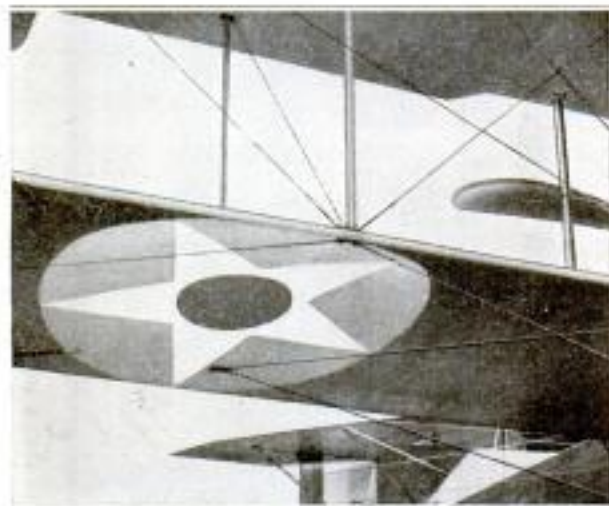

Showing the Red-Centered Star of the United States Flying Corps Painted on the Lower Side of an Army Biplane

pointed star with a red center be painted on a circular background of blue. In addition, the rudder of a machine carries on both sides the national colors in three wide bands arranged vertically, the blue one appearing next to the rudder post. The star design

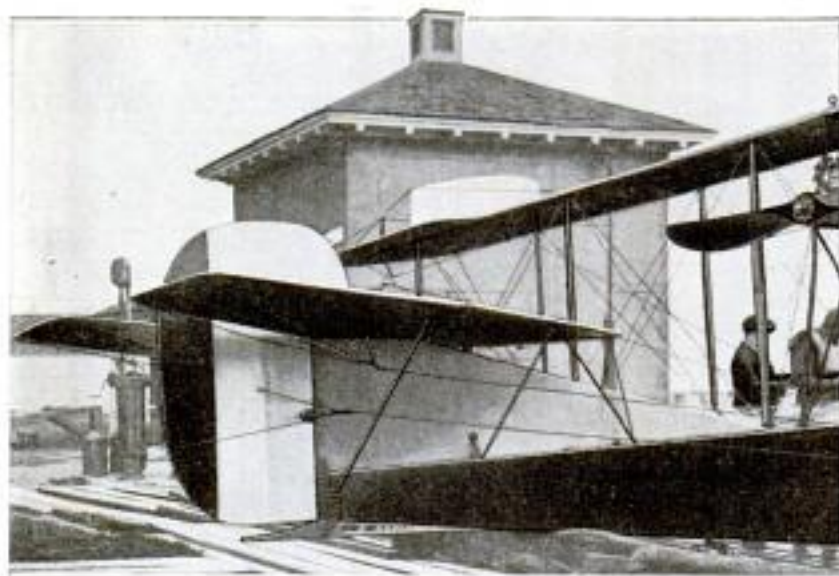

Red, White, and Blue Bars Applied to the Rudder of a Military Air Craft

appears on the under side of the two lower wings, and on the top of each of the upper ones. Its diameter is the

same as the width of the chord of the wing on which it is placed. The colors are of the same shade as those used for the flag. The device is also displayed on the top and bottom sides of dirigibles and captive balloons.

SHIP WAYS OF GREAT SIZE NEARING COMPLETION

To facilitate the construction of one of our big battle cruisers, an eastern shipbuilding company is erecting a special set of ways at a cost of about \$500,000. The fact is particularly interesting because the structure will be 990 ft. long, which will give it the distinction of being, so far as is known, as large as any in the world. It will be provided with electric cranes of great power and other equipment of the most modern type. The foundations, keel-supporting crib, launching ways, and blocks are to be of concrete.

RAILROAD PLANTS TREES FOR SNOW SCREENS

As an experiment, the Minneapolis, St. Paul, and Sault Sainte Marie Railway has planted trees along its right of way to serve as snow screens. On the south side of the tracks, at the sheltered points, there are four rows and on the north side eight rows, 8 ft. apart. The four rows farthest to the north are willows and the other rows on that side, in their order, are box elder, green ash, poplar, and another hardy variety. The tracts devoted to these living snow fences were plowed and twice harrowed, and then allowed to stand a year before the trees were set out. A tree-planting machine which, it is said, is able to plant as many as 20,000 trees a day, is used to expedite the work.

Albert H. Allen - Boston Construction Co.

4731

4703

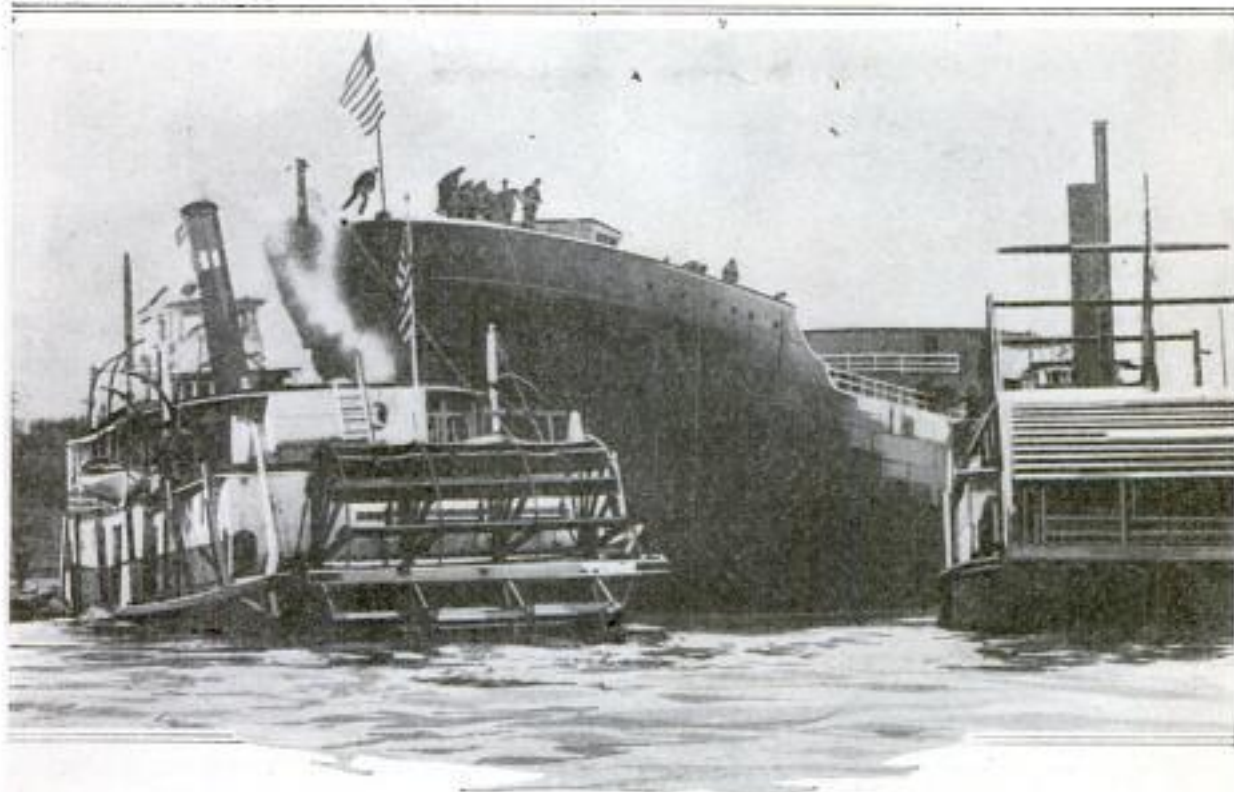

After Leaving Its Ways, the Steel Ship Shot through the Water for a Half Mile and Smashed into a Stern-Wheeler at the Opposite Side of the River

4373

COLLISION MARS LAUNCHING OF NEW STEEL VESSEL

As a stanch steel freighter left the ways for its maiden plunge, at Portland, Ore., some weeks ago, it shot across the Willamette River and crashed into a stern-wheeler. The latter, a wooden wrecking craft, was fully a half mile away from the place of launching, and was supposed to be safe. Three men were seriously injured in the collision. The ship, originally named the "Vesterlide" and intended for Norwegian interests, passed into the hands of the Cunard Line before its completion, and since has been rechristened the "War Baron." The company in naming its new vessels is using the word "war" as a prefix. Thus two other ships under construction for it on the Pacific coast are to be named the "War Lord" and the "War Knight." The submarine menace has so taxed shipyards in Great Britain that English shipping companies are in the unfamiliar position of seeking bottoms in America. Much of this business is going to the Pacific

coast. The "War Baron" is 425 ft. in length, has a dead-weight carrying capacity of 8,800 tons, and a speed of about 12 miles an hour. It mounts a steam-turbine engine that is designed to operate at 3,200 revolutions a minute.

4431

IMPROVED BUMPER RAIL FOR MOTOR CARS

A new bumper, or buffer rail, for automobiles is clamped to the front springs so that the rail protects the whole forepart of the car. It comprises a channel bar, which is the guard rail, two special springs, and two heads or frame connections, and combines lightness with great strength. The springs are full-elliptic and have a range of spring action of approximately three inches, a feature not found in the ordinary bumper.



Stewart-Harrison
Frederickson & Co. Inc.
1848 River Street
Copyrighted material
1317 S. Alameda



Panorama of the Calaveras Dam, Now under Construction near San Francisco, Which will More Than Double the Width at the Base, 1,300 Feet. Steam-Shovel Operations are Shown, also the

4414 *Electric*
**COVER FOR SWITCH BUTTON
 WHILE PLASTERING**

Contractors will find that a distinct need is filled by small steel covers designed to protect electric switch buttons and switch boxes while plastering and decorating are being done. They are held in place by screws in the regular screw holes and are removed when the face plates are put on. These covers can be used repeatedly.



4200
**BIG EARTH DAM TO DOUBLE
 CITY WATER SUPPLY**

When a huge earth dam now under construction in the coast mountains of California has been completed, the resulting reservoir will more than double the supply of water for domestic use in San Francisco. This supply is now 44,000,000 gal. daily. The new Calaveras reservoir will have a capacity of 165,000 acre-feet, or an amount of water sufficient to cover 165,000 acres to the depth of one foot, and will insure an additional supply of 57,000,000 gal. a day, which will take care of the needs of a population more

than twice as large as the present population of the city. In point of height and volume in proportion to its length, the Calaveras dam will be the largest earth dam in the world, exceeding in these respects even the great Gatun dam of the Panama Canal, although not comparable with the latter in length. Its height will be 240 ft.; width, one-quarter of a mile at the base, and length at the crest, 1,300 ft. When completed, it will contain 3,000,000 cu. yd. of earth.

The work of construction was begun by the water company in 1913, and it is expected that the dam will be finished by May, 1918, at an ultimate cost of about \$2,500,000. At the present time the dam is completed to an elevation of something over 170 ft. above bed-rock. The remaining 70 ft. will require about 1,000,000 cu. yd. of hydraulic fill, the material used being graded from a coarse rocky mixture to rock, sand, and clay, with a final core of pure clay in the center of the dam. Practically all of the fill has been pumped into place, gravel, sand, shale, sandstone, and clay being obtained in the neighboring hills and pumped for a distance varying from 1,000 to 4,500 feet.

Situated on Calaveras Creek, one of the tributaries of Alameda Creek, about 45 miles southeast of San Francisco,



the City's Water Supply and will Be the Largest Earth Dam in the World: The Length at the Crest will Equal Outlet-Control Tower, 239 Feet High, and Working Camp in the Background

the new dam will convert the Calaveras Valley, once the home of a number of prosperous farmers engaged in the raising of hay, into a veritable lake, four miles long and one and one-half miles wide. The Calaveras basin has a direct drainage area of 100 square

miles. This will be increased to 138 square miles by the construction of a tunnel, 9,000 ft. in length, which will divert the water from what is known as Upper Alameda Creek into the Calaveras reservoir formed by the big earth dam.

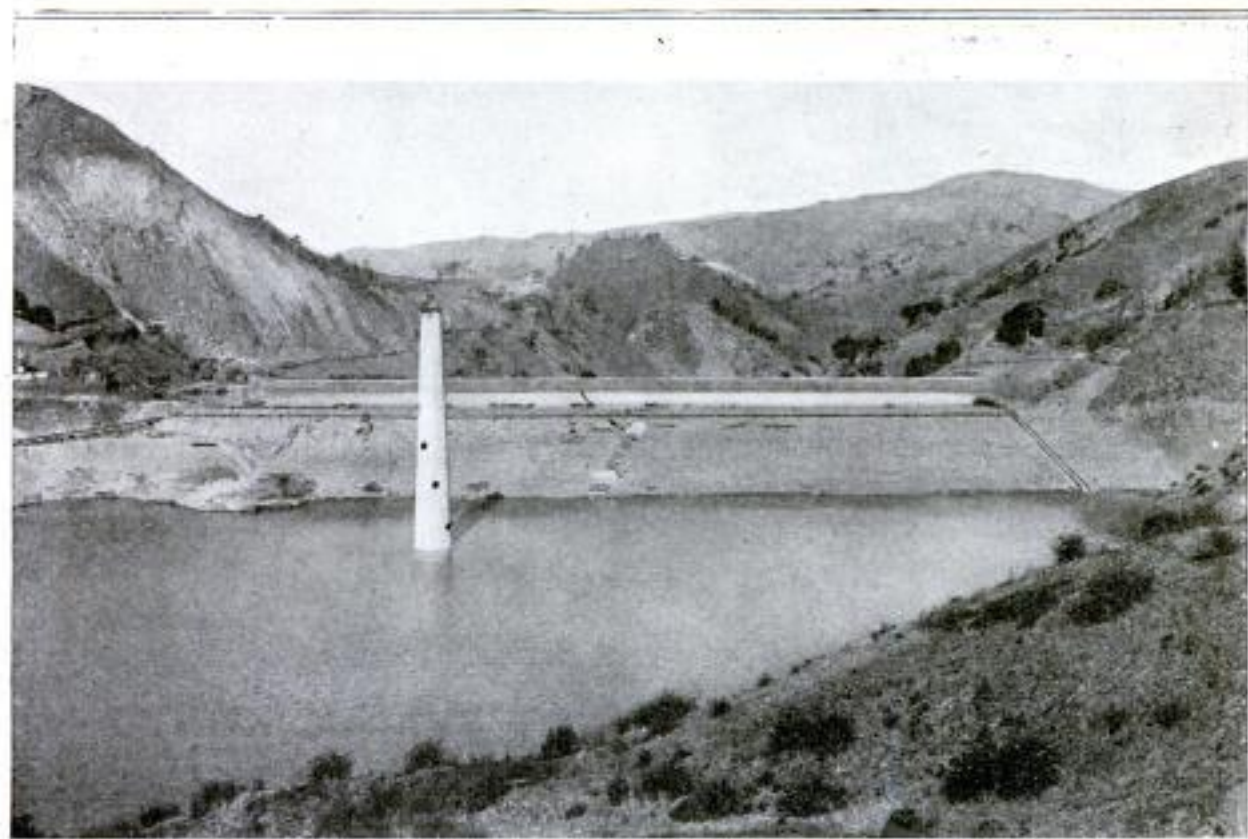

Near View of Calaveras Dam, as Far as Finished Early This Year, Its Height at the Time Being About 170 Feet above Bedrock. The Outlet-Control Tower in the Foreground Is of Reinforced Concrete

CONFLAGRATION DESOLATES GEORGIA'S CAPITAL,



COPYRIGHT INTERNATIONAL FILM SERVICE

A View of Desolated Mattoon, One of the Chief Illinois Cities to Suffer Wholesale Destruction from Tornadoes That Swept Middle Western States from Kansas to Tennessee a Few Weeks Ago: In Mattoon Alone More Than 50 Persons were Killed and 500 or More were Injured. Not Only were Cities and Towns Reduced to Wreckage, but Farms Suffered Greatly in the Loss of Houses, Barns, Implements, and Stock

A Close-Up View of the Destruction Wrought: The Force of the Wind Was so Terrific That at Mattoon It Picked Up This Cow and Hurlled It against the Tree, the Body Almost Encircling the Trunk

A Fallen Tree in the Vicinity of Mattoon, Illinois, Which Shows the Power of the Storm: About 140 Blocks in That City were Swept by the Wind That Razed 500 Homes and Rendered Nearly 2,000 Persons Homeless. Many of These Sought Shelter in Tents in a Park

AND TORNADOES WORK HAVOC IN MANY STATES



Doll Views Destruction Serenely: This Plaything Passed through the Tornado Unharmd and was Found Seated on a Gasoline Tank in an Andale Front Yard with Wreckage All about It

All That was Left of the Schoolhouse at Andale, Kansas: The Series of Storms Which Did Such Damage in Illinois and Neighboring States were First Felt in Kansas and as Far Southwest as Arkansas. All Told, Over 150 Persons were Killed and Over 1,000 Injured



Dynamite Spares Mirror: Remains of an Atlanta Home Which was Destroyed to Check the Fire, Showing the Chimney Standing Intact and, over the Fireplace, a Mirror That was Not Even Cracked



A Forest of Chimneys in Fire-Swept Atlanta: A Conflagration, Which Raged for 12 Hours, May 21, Destroyed More Than 1,500 Buildings and Caused a Property Loss of Over \$3,500,000 in Georgia's Capital. One Woman Lost Her Life from Shock and Many were Injured. Over 3,000 Men in an Army Training Camp Near By were Rushed to the Scene and Aided in Guarding Property and in Dynamiting Homes, to Check the Wall of Flame That Leaped from Block to Block

4665

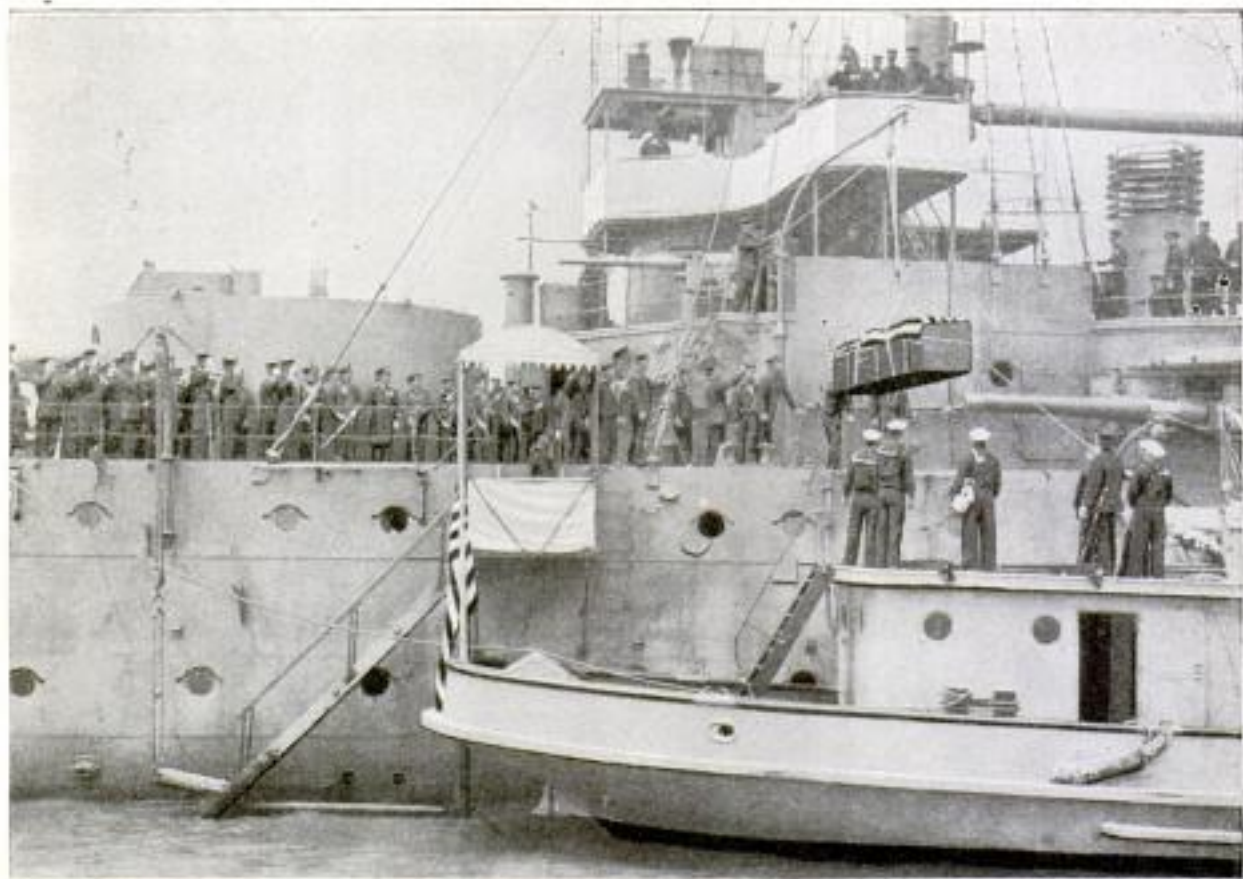

COPYRIGHT, INTERNATIONAL FILM SERVICE

JAPANESE SHIP BRINGS HOME ENVOY'S BODY

THIS solemn scene marks the end of a journey across the Pacific made by one of Japan's first-class cruisers, the "Azuma," to bring home the body of George W. Guthrie, the late American ambassador to Japan. Within San Francisco's harbor the big fighting ship came to anchor, and when a tender had drawn alongside, the coffin, covered with the Stars and Stripes, was slowly lowered to the deck of the waiting craft, while the crews of the two vessels stood at attention. From San Francisco the body was carried overland to Pittsburgh, the ambassador's former home.

4570 *Street Car*
WASHING MACHINE USED FOR CLEANING CAR SEATS

Periodically the cane seats in cars operated by a western traction com-

pany are thoroughly scrubbed. The operation is made comparatively easy by a washing machine especially built for the work. It consists of a long tank spanned by a series of horizontal rollers and provided at intervals with power-driven rotary brushes. As the seats are removed from a car, they are placed, one at a time, on the washer and pushed across the rollers to the first brush, which applies a liberal amount of liquid soap. The scrubbing is accomplished by the second brush. After a seat has then been rinsed and dried, it is returned to the car.

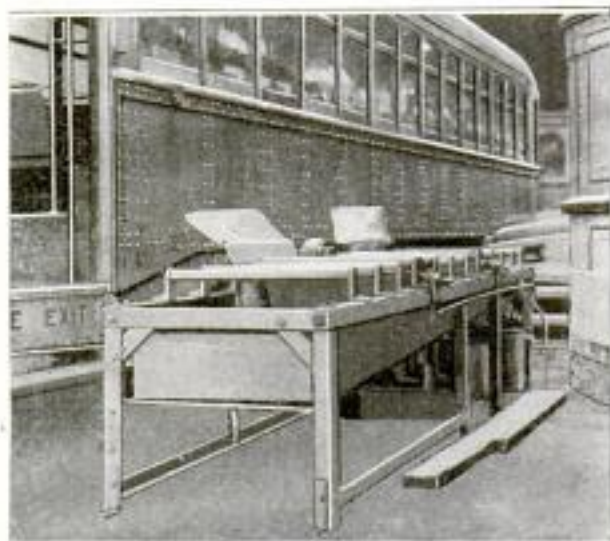

The Cane Seats are Moved across the Rollers to Revolving Brushes, Which Apply Soap, Water, and Plenty of Scrubbing Force

ⒸThe United States has arranged to buy the privately-owned Tanana Valley Railroad in Alaska and will make it part of the government's line.

COMMENT AND REVIEW

IN the departments at Washington and throughout the country many of the nation's best business executives are hard at work; men who have successfully built up and managed our greatest industries.

*Cut Out
Red Tape*

Others are ready to serve in similar capacities and will be called as the work expands. Generals in administration at home are every bit as essential as generals at the front, and their services are being given as gladly and unselfishly. Accustomed as they have been to quick action in business emergencies, and to cutting through trifles and etiquette at one stroke to reach the result which is the final aim of effort, they frequently are finding themselves hopelessly entangled in old-time regulations and methods of procedure which are the inheritance of two generations. While a reasonable amount of safeguarding is admittedly necessary, this is no time for quibbling over any ideals of official etiquette which have always been incomprehensible to business men in times of peace, and which simply clog the wheels of progress in such a time as the present. Department officials may well profit by listening to these generals of industry, and feel no humiliation in learning and adopting the modern and better way which business has found absolutely necessary to its success. Our Government is a great business enterprise, entrusted with the management of national affairs, and the sooner modern business methods replace much of the time-honored and obsolete departmental system, the better it will be for all of us.

Already there are rumors of delays occasioned by those old-time handicaps of politicians and hangers-on with selfish interests to serve and promote, and even of graft. The temper of the people is in no mood to tolerate these two evils which, in peace times, are condemned but go unpunished for lack of widespread public sentiment. These are days when the citizen body is alert and sitting up, and will insist on a square deal and right doing all along the line. The first provable instance should be made a noteworthy example, regardless of who is hit; there is yet room and a place in our Federal prisons for all such, who are even worse than avowed traitors.



DURING the past three years the science of war has undergone radical changes, rendering obsolete much which past effort and study had established as standard. Cavalry has largely given way to

*Evolution
of
War*

infantry, which now moves farther and faster in motor cars than was ever possible with animals. Machine guns have changed the conditions of infantry attacks. Heavy artillery at long range now accomplishes much of what formerly was assigned to an infantry charge. The difficult and always perilous work of the field spy and scout has been left behind by the airman who goes forth openly and noisily, sweeping over enemy lines at a mile a minute. On sea, it is no longer the ship which can shoot the farthest, or the fast cruiser which cannot be overtaken, that sinks the most enemy ships, but the submarine whose underwater missiles are often unseen and never heard.

Trench warfare as practiced today is an evolution of the old earth-work idea, but so changed and expanded as to have little resemblance. It was a German invention, worked out to include streets and alleys with main arteries of communication from the rear, and complete underground habitations capable of housing men by thousands. These underground rooms are not only one but often two stories deep, the lower level being reached by concealed trapdoors. In the Japanese-Russian war the Japanese made use of zigzag open trenches as a means of approach to a fortress, but to nothing like the extent employed now.

The development of both the submarine and aeroplane has requisitioned abilities, training and qualities which are largely new, and uncalled for in the past. Especially is this true as regards the aviation corps, which demands the best in the superman. So essential and rigid are these requirements that our public, unacquainted with modern warfare, has little conception of the qualifications. One would naturally suppose the ability to successfully loop the loop time on time would indicate an airman abundantly able to leave the fair grounds, report himself at headquarters, be assigned to a machine and go aloft on a military mission. As a matter of fact, such a one is merely an air chauffeur and nothing more. It is not only a question of undaunted courage—there are plenty such—nor ability to guide a plane through all manner of pyrotechnic maneuvers, though these two things are required. The army airman must be, and know, and do, ever so much more. Indeed the operating of a plane under normal conditions is only the first reader in the aviation corps.



ONE would naturally expect, on joining the flying division, to board a plane and joyride skyward with an experienced pilot, then go through the motions with the various controls and levers in a dummy machine on earth; a few days later go up again with a teacher; and the next to fly with the instructor as a passenger. But not so fast, son, notwithstanding your ambition to distinguish yourself is most noble and praiseworthy. Remember, the qualifications for the air corps include not only all the physical conditions of both army and navy, but a great many more.

*Essentials
in Aviation
Corps*

The candidate must be sound in every part of his body; possess internal organs equal to the rapid change in altitude, for he will often drop a mile in a minute; perfect vision, which will instantly and unfailingly adjust itself one instant to objects far away and the next to ones close by; and he must have no failing as to colors; his hearing must be faultless; he must possess a mental balance which will remain true and undisturbed when shells from the air guns are bursting uncomfortably close by; and, finally, that difficult-to-describe natural gift which turns his face toward his own lines instead of the enemies', when clouds or smoke blot out all landmarks. It is the same kind of intuitive quality which in a newspaper man is termed "a nose for news," and which leads the skillful physician to correctly diagnose a patient when the usual symptoms are absent, or the navigator to head his vessel into port when fog shuts him in and tide swerves him from his course.

The responsibility attaching to the aviation corps is almost beyond estimate, and the ability of a single air scout to discern and comprehend, or failure to do so, may easily win or lose a battle. His signals bring the artillery into action dropping shells in the right place, and correct the fire of those guns whose faulty range is throwing away tons of projectiles each minute. The airman is more than the familiar term, "the eye of the army"—he must be a thinking eye. The submarine may even better do without its periscope than the army without its aeroplane.

Thus it will be seen that, setting aside all the other numerous and radical changes which the present war has called into being, the submarine for the sea forces and the aeroplane for the land forces are the two weapons which stand out preëminent; and of the two, the aeroplane is the more essential. A service so thrilling, so responsible, so possible of great accomplishment, cannot fail to appeal to the best there is in the young American; and while all service at the front is fraught with danger, it will comfort the airman's mother to know that, contrary to generally accepted belief, service in the air fleet is several degrees removed from the most dangerous military occupations.

Our ability to win this war will lie largely in two efforts: to defeat the submarine, and to produce at the earliest possible moment a fleet of aeroplanes which shall be numbered by tens of thousands.



THESSE are days when we may well be proud of our American girls and women. The fields of France for countless miles are this moment being cultivated by the French women with never a man to assist. That American women would as promptly, resolutely, and effectively take up the same burden, did the same necessity exist here, there is not the slightest doubt. The voice of the scoffer at the suffragette is hushed in admiration at what the women are doing in the demands of the moment. In crowded cities and by the isolated farm side the American girl and woman without regard to wealth or social distinction is employing every spare moment in Red Cross work. Without any brass bands to call a crowd they flocked to the training places to learn and to do, nor has their interest and enthusiasm waned; on the contrary it has steadily grown.

*American
Women No
Slackers*

The subscription to the Liberty Loan afforded another opportunity to show of what stuff the patriotism of the American woman is made. In countless shops, stores, factories, and offices, girls receiving only a few dollars per week, and too often responsible for the support of widowed mothers and younger brothers and sisters, loyally made their subscription for a bond, when to do so meant actual sacrifice and even privation for 50 weeks. But no one hears them complain of this, and their only expressed regret is their inability to take a larger amount.

These are days when the American man and boy has greater occasion than any time in the past half century to revere, love, and honor his mother, sister, and sweetheart.

June 25

H. H. WINDSOR

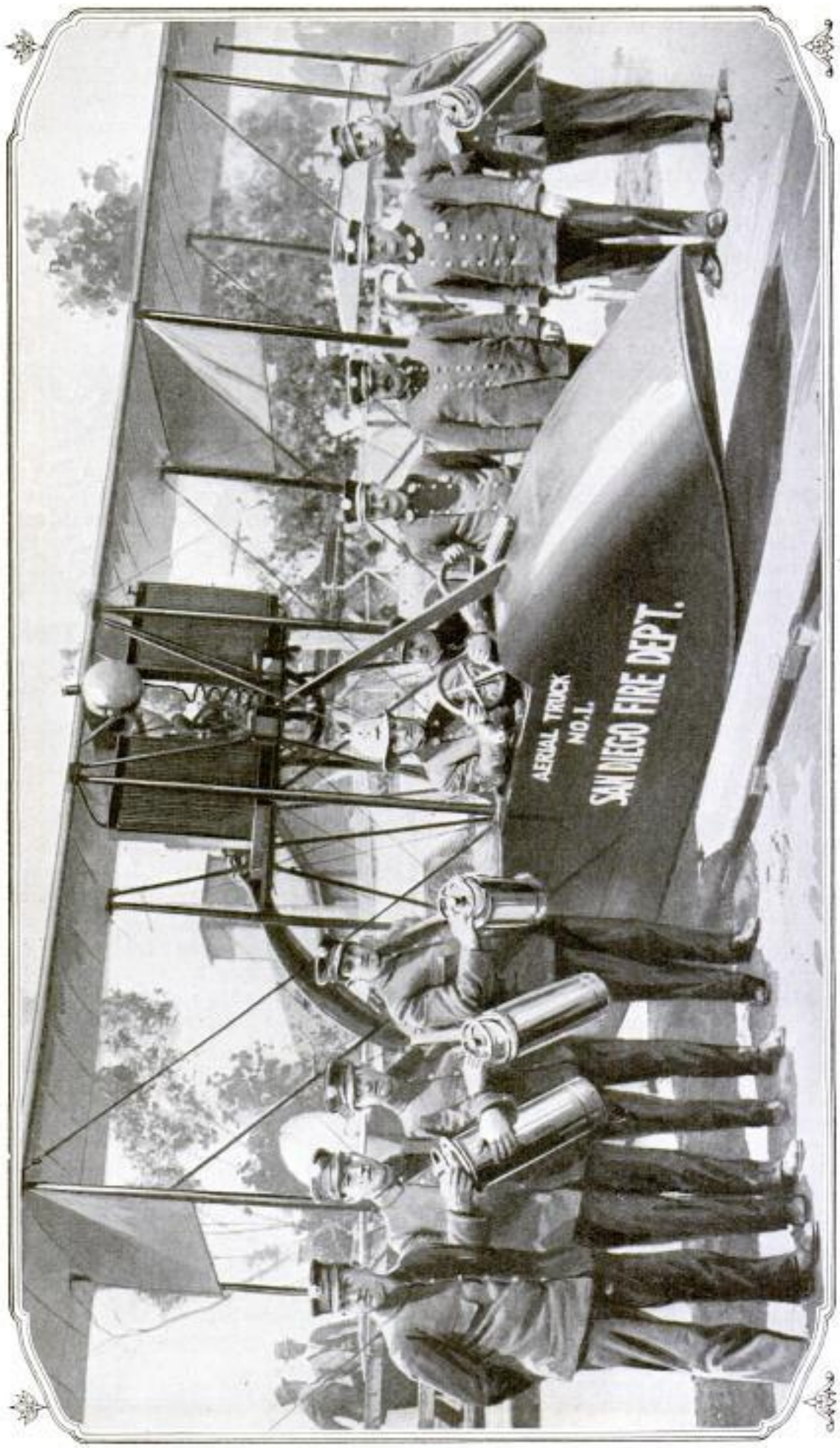

AERIAL TRUCK IS FIRE DEPARTMENT'S NEWEST ADDITION

An addition to the fire department of San Diego, California, which is a decided innovation, consists of two 100-hp. flying boats, one of which is shown here. These craft, intended especially for fighting wharf fires, are built so that they can light on land or water. Each is equipped with eight chemical extinguishers, and searchlights for night work.

COPYRIGHT, INTERNATIONAL FILM SERVICE

ALADDIN'S TRAINING CAMP

Save American Lives by Utilizing Canadian Experience!

Dominion Has Vast Specialized Training Ground and
Many Incapacitated Officers, but No More Recruits

By JACK LAIT

70 The Herald, Calgary.

AS though Woodrow Wilson had rubbed a magic lamp and commanded genii to lay out, equip, and perfect an unsurpassable training institution for the vast army that is to rise in American khaki and enter the greatest game of all ages, the contest for the championship of the world, stands Camp Borden.

Fifty miles from Toronto, situated on two trunk railroads that run from populous American centers to every corner of the camp, is this superdeveloped institution dedicated to the mission of making expert European soldiers out of the raw stuff which is the courage of this hemisphere plus the patriotism of loyal men.

Through its gates have poured 150,000 of the bravest and finest soldiers that history has known, the Ontario contingent of the Canadian expeditionary forces. And now there are no more for Ontario to give, for it has exhausted its givable volunteers. Should conscription carry in the Dominion, Borden may need to train conscripts; but that is now in abeyance, and, if it be passed, winter will have frozen this continent stiff before Canada can again use its superb drill college for its own.

Meanwhile, the United States, just frantically starting what Canada has gallantly finished, not only has not nearly enough camps ready, and will not have for months, but, should she employ her sternest efforts and eat up any reasonable measure of precious time, she will not then be able to provide facilities that will be comparable with Borden's matchless training opportunities.

We have not the experience. We have everything else. But the difference between thorough preparedness

and inefficient incapability is contained entirely in that one word—experience.

Canada has been all through what we are just entering. It has cost her billions of dollars and thousands of her best sons. But now she knows and she has. And we are her ally. She does not want us to pay the tax she paid; she is eagerly, graciously, generously willing that we mount to glory and to accomplishment over the mounds of her dead, over the mountains of her prodigally given gold.

Camp Borden is manned today by Canada's and England's heroes, invalidated officers, and noncommissioned officers, who have been through hell and have come back, their souls bounding as before with zeal to help, but their bodies slashed and gashed, their lungs and eyes seared by venomous gases.

These men have thrown into their present work the task of sending new men on to do the work that they had to lay down, the same spirit and the same knowledge which has made Canada's page in the great European war a record of bravery and achievement. They have reconstructed Camp Borden into a miniature French battle field, a transplanted section of the vital arena "over there" where humanity stands at bay, giving its last ounce against the most cruel and atavistic and supermodern murder machine that depraved ambition and cold aggression ever conceived.

Camp Borden has about eleven miles of trenches, built by the experts who came back from overseas, who helped build the historic ones abroad, who saw them under the indescribable fire of Titanic artillery, in the "up-and-over" rushes of immortal charges, in every manifestation and in every ramification of the unheard-of system of

warfare now being waged in Europe, the like of which until this struggle had been unknown.

These officers have seen the effects of all manner of training, and they have eliminated, with the true eye of the expert observer and intimate participant, the needless; and they have substituted the intensive essential elements, the specialized branches which give a man a chance for his life against Germany's brilliant barbarian butchers.

What do we know of these things? We have read, we have heard. But Canada, in the war, armed with the same infantile knowledge of these things that we now possess, spent its richest blood in oceans to learn how tragically little she knew. Must we, too, scorning the lesson of that sacrifice, have our textbook written in the martyr blood of our sons?

Camp Borden can accommodate at one time 100,000 American soldiers. It is a field of 22,000 acres, more than 25 square miles of plain and hills and ravines and woods—every kind of ground on which men can fight—with two navigable rivers traversing it, with a system that pumps 1,000,000 gal. of purest water daily, electric-lighted, paved at crisscross intervals with highways of asphalt, ready with drill fields, tenting areas, sanitary sewage plants, shooting ranges, hospitals, buildings for every conceivable military need, and all those individual refinements beyond standard training-camp utilities which have been the immediate outgrowth of the new and terrifying methods of this war.

Not on this side of the Atlantic are there trenches such as those at Borden, laid out, built, tunneled, and fortified in accurate replica of the types abroad where the fierce fight itself is being driven. Nowhere else except upon the western front in France can one see barbed-wire entanglements such as those between the two sets of opposing trenches.

Moreover, while our American recruits doubtless respect their officers, war is war; and war cannot be fought except where war is. Therefore our

boys, who are as human as anybody's boys, reserve in their own hearts some misgivings as to the depth of wisdom behind the teachings of their superiors, who have, themselves, seen nothing of what they are telling others. But at Borden the instructors wear service stripes—they wear more, for many of them have the Distinguished Service Order or the Military Cross, some of them both. And when one of these illustrious veterans says this is done this way or that must be the other way, his words have a weight beyond the code-book dictum of the mere soldier.

This war has eliminated the soldier. There is no such thing in France as a soldier. Every man there who wears a uniform must be a specialist, and he must be a specialist in a new specialty born and developed right there on the ground since 1914.

For three years 10,000,000 men, the brains and the souls and the bodies of many nations, composed of units from every walk of society and every trade and profession of science, have engaged night and day in the sole business of killing one another. Have they learned things and discovered ways which one who has not been of them cannot know? Hundreds of thousands of dead men, could they utter one word, would give the answer in one voice.

Can one doubt the imperative necessity, not to say the plausible feasibility, then, of training a goodly contingent of our men at Camp Borden?

Drilling soldiers on foreign soil is not a new or revolutionary idea in this war. Britain trained many of her men, and is today doing so, on French territory; it is our own plan, now, to give many of our battalions weeks of preparatory work in France. If in France, at the tail end, why not in Canada from the start?

Camp Borden can receive 6,000 raw soldiers a day without straining its ready resources. It can give them room and all needs up to a quota of 100,000 at once. It can turn out a comparative veteran, as new troops are judged, from the primary product in 12 weeks. If we started sending our

boys there now, we could make 150,000 superior soldiers there before snow-fall.

The moral surroundings cannot be surpassed. There is not a saloon within 180 miles of the gates, and every other problem correlated with the guardianship of the character of men is thoroughly solved. And the morale of the men would be intensified in that they would be "at it" instead of only on the way. Every military expert will tell you that the first big step toward making a soldier is to get him away from home, where he has no distractions, where he worries little about the "home papers," where he settles down to the business, not the pastime, of the army. And Canada would be "abroad," and Camp Borden, with its complement of war-made heroes, would give the zesty atmosphere to create a perfect vibration for this deplorable but indispensable fighting viewpoint, the factor which makes armies invincible.

When Camp Borden was full of Ontario brigades, at times holding more than 50,000 troops, the cadets stood guard and did their tasks and enacted their sham fighting with all the grim earnestness of reality.

They took their tricks in the trenches through the full periods of active regulations, living, sleeping, feeding, fighting in them, night and day for eighteen days of hours crammed with the actual existence of modern war. They scouted and they sniped, they bombed and they bayoneted, and they charged and they operated all the lines of communications, they burrowed dugouts and they constructed wire barricades, they took the rehearsals with the full vim and deadly intensity of life-and-death combat, not of high-school maneuvers.

Before they entered the trenches they were put through the intricacies of bombing and of grenade hurling and of grenade shooting and of rapid-fire-gun operation and of machine-gun manipulation.

And these are sciences in themselves.

No throwing, in all the variations of throwing from David's slung stone to

Walter Johnson's curved third strike, ever resembled the tossing of a hand bomb, the egg-shaped little contrivance of shrapnel and explosive which has taken so many lives of late.

The man who throws it stands down in a fissure, seven feet deep. He cannot, of course, see above it. He must fling it into another ditch, from sixty to more than a hundred yards away, which also is not more than three feet wide. His projectile must describe a parabola that takes into account not only distance and sending and arriving angle, but time, for some of the destroying things go off with burning fuses instead of on contact, and they must strike just in time—the lapse is five seconds. And woe unto the thrower—and to those about him—who grows panic-stricken and cannot let go, or who drops his can of carnage from a trembling hand, or who bumps his fist in the backward motion against the rear wall of his trench, for he and his comrades will be torn to flinders.

Bayonet work has been found the straw which breaks the back of the Hun defenses in France. One might scarcely fancy that with artillery which shoots accurately, as guided by aerial monitors over enemy trenches, at from 12 to 14 miles, hand-to-hand fighting would be of much account. But it is the bayonet after all which drives the enemy from its positions, which takes territory, and which, therefore, stabs in its crude orthography the records of fate and history.

The German hates a bayonet like a mad dog does water. Those who have been in the big mix-up will tell you, to a man, that the kaiser's troopers will stand and give life for life, will go where death is certain if they know they can cause death—except where they stand facing the points of bayonets. That is where the Prussian hands fly up and the hoarse Prussian throats cry "Kamerad."

The British Tommy and the French poilu, in direct and grateful antithesis, love the bayonet and swing it jocosely.

But bayoneting must be learned. It must be learned all over again, for it

differs down in the furrows from its technique as standardized through the centuries on straightaway surface fighting.

At Borden there are bayonet teachers who have worked out from the remotest to the seemingly most obvious tricks of wielding the "pig sticker" in defense and attack at every angle in the subterranean labyrinths, the damp catacombs which now are the channels of war.

We know nothing about these tactics.

At Camp Borden there is an aviation school. At its head is an American-born British flying hero, Major Filley, a Virginian and a Harvard man. He, his fellow officers tell me, did more than any other single flier during the period of his active service to bring down enemy planes.

To hear him lecture and to see him demonstrate the myriad duties of the overhead soldier of nowadays is a revelation in modernity and a rushing of blood to the heart in realizing how minutely the masters of the western front have worked out the finesse of the slaughtering trade.

The airship in this war serves as the vehicle of the fighter, the defender, the observer, the scout, the photographer, the artillery eye, the reconnoitering binocular, the message bearer—it is the air dreadnaught.

The biplane is an American invention. But it is an English improvement and a French perfection.

To illustrate, let us point out that the best machines that we manufacture today in the United States could not pass inspection as practice planes at Camp Borden. Our equipment will do between 60 and 80 miles an hour and will climb 3,500 ft. in 10 minutes. The pony biplanes now used at the front do 160 to 175 miles an hour and will climb 15,000 ft. in 10 minutes.

And the climb is more telling than the traveling speed across the map. Airmen cannot kill upward. They can only shoot on the level, through machine guns opening between synchronized propeller blades, or they can drop

bombs by pressing foot levers, releasing the missiles through the bottom of the carrier. Therefore the highest machine wins.

The officers at the Borden aviation school have all been through the overhead hell. They have brought down their men and they have been sent to earth. They have sounded the psychology and the physiology and the mechanics and the strategy of the clouds. We know how to fly—that is all we know about aviation. The messengers for the British pilots know that. They run errands in air-planes. But fighting in them is a study not to be acquired from books or even from the lips of lookers-on. It must be learned, in truth, from the ground up—up to the sky—in faithful and enthusiastic apprenticeship under the veterans who have helped to solve its unknown quantities by tragedies, who have had much of the secret mysticism of it demonstrated with bombs and bullets, who have invaluable information and bits of shrapnel in their heads.

Yet America is teaching its fliers simple navigation and wireless operating and wigwagging. The graduates of such a school, after they will have learned in France to guide machines which go about three times as fast as the ones they are now using, will be competent to serve as note runners or relief "trouble men" for the seasoned air battlers of our allies. Can we stand for this? Can we look such a condition in the eye when at Camp Borden the bullet-scarred returned corps men are twiddling their thumbs in impatient petulance because they have the machines, the knowledge, the grounds, the zeal, but nobody to use any of these life-saving assets on?

A few days ago I visited an American training camp. It was a standing barracks, long in use as a regular military post. It was officered by our best commissioned men, West Pointers largely.

Honest and well-meaning army men, these, they were drilling the volunteers who are going to carry our banner in France by the rule books that obtained

for fighting Indians, Mexicans, Spaniards, and Filipinos.

The result was not only that our recruits were not learning the bedrock lessons of today's warfare, but they realized that they were being trained for a preliminary to a preliminary, that what they were getting was the primer-class A B C, and that they must, when they get to France, begin to be taught what fighting is like. So they went whistling at their tasks, like grammar-grade kids on a fire drill. Some of them had carnations stuck down the barrels of their rifles.

It sickened me. It almost made me weep. Over in France there is a war in which these misguided boys must participate, in which their lives are to be staked, which is no carnation festival. I had seen men—men just like our own, in the same comparative stage of training—at Camp Borden. There were no flowers and there was no whistling there.

The Canadians, looking up to their officers who had heard the bombardments and who had seen the star shells of the night and who had been into the bowels of doom and out again, were tensely earnest. The spirit of the war into which they were moving had been translated to them. Their practice work was showing them what a deadly, homicidal, know-how-or-die thing they were going against.

They realized, they understood, they felt. It had all been visualized by the replica paraphernalia, by the recited first-hand experiences of the men who had "been there."

It was no picnic. No women and children were to come on the week-

ends with jam and with gossip. They were at war; and war was a science that demanded specialization, concentration, application. They knew of the first Canadian contingent, the pre-Borden-trained volunteers who had gone at the first bugle, who, stunned by the unsuspected methods of their enemies, were slaughtered without a chance to fight, to run, or to hide.

The Borden graduates went into battle with the respect of the powder-burned legions that had been through action. They knew. They had but to transpose the realistic dummies into living, moving actuals. They were no rookies fighting baffling demons. They were veterans of three months' war.

Our men, trained as they are now being trained in our old-style camps—not to speak of those who are on reserve because there isn't even that kind of camps for them yet—will not be the match, man for man, of the vengeful foes against whom they are to be flung. Isn't it a pity? Our intentions are so sincere and so hearty. Yet our ways and our wherewithal are so insufficient, so obsolete.

America must learn all that Canada has learned. It must do more: It must improve on all that, for it is going in to win the war, not merely to help carry it on. To do things one—a nation or a man—must learn how. If there were a civil institution in Canada where we could get superior education in commercial or industrial affairs our fathers would send their sons there a-flocking. We must not overlook the parallel case in this critical military exigency, when so much more is involved.

4732
**ALLIED AIRMEN PHOTOGRAPH
 THROUGH BATTLE SMOKE**

To the American inventor of the "tear gas," that has been used with great success by our allies, belongs credit for another war-time invention of importance. By the use of an infrared screen, the scientist has provided a means by which airmen are enabled

to photograph clearly the enemy's positions when they are hidden from vision by thick clouds of smoke. The device absorbs all but the ordinarily invisible infrared rays, which are capable of penetrating smoke and gases. Impressions are made upon specially prepared plates sensitive only to the particular ray that passes through the screen.

*Robert W. Wood Prof. of Experimental Physics
 Johns Hopkins University
 Baltimore, Md.*

ROAR OF GREAT WAR BLAST IS HEARD IN ENGLAND

When the British, early in June, reopened their drive against the Germans

the signal for "Tommy Atkins" to advance. This terrific stroke was the culmination of months of difficult work successfully executed. An interesting side light involves the British premier.

David Lloyd George was spending the night at his country estate in England, 140 miles from the firing line across the water. He had been notified of the exact moment that the Titanic charge would be touched off, and therefore left instructions that he should be awakened at 3 o'clock in the morning. With other members of his household, he heard the blast that shook the battle front for miles. The roar, probably the greatest ever produced by man, was also heard at London and other British points. According to mathematical calculations, it was 11 minutes and 18 seconds after the explosion actually occurred that

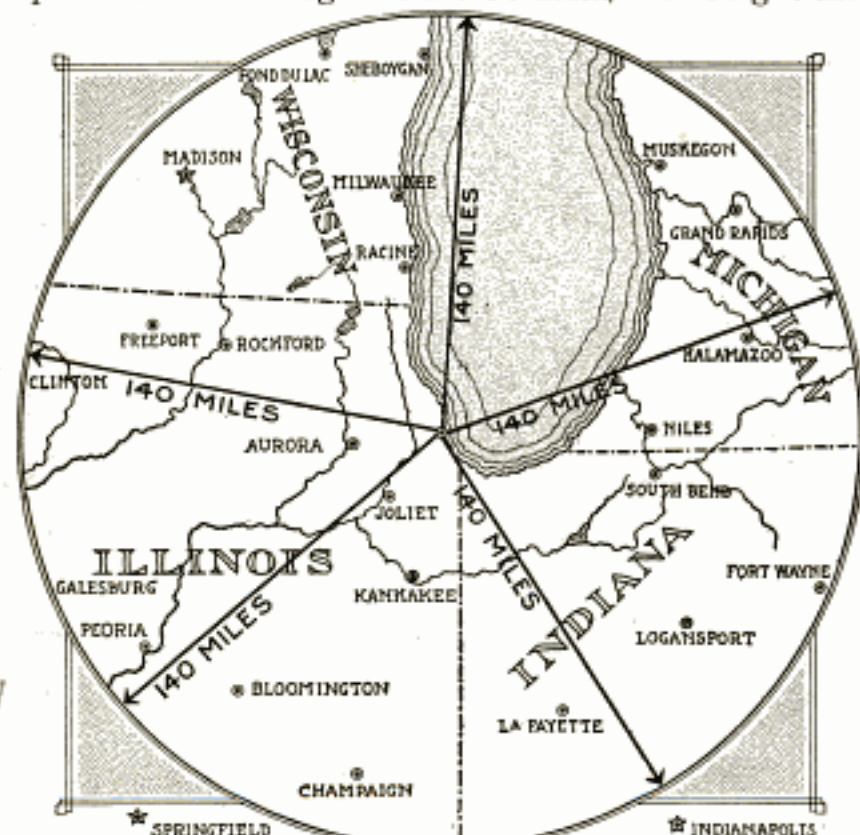

The Map Shows Towns and Cities Situated in Four States within a Radius of 140 Miles of Chicago, and Illustrates Graphically the Distance David Lloyd George Was from the Battle Front When He Heard the Terrific Report of the 1,000,000 Pounds of Explosives Discharged beneath the German Trenches by the British

in Belgium, the climax of seven days of continuous artillery bombardment was the detonation of a million pounds of high explosives planted beneath the enemy's trenches. The colossal upheaval, which rocked the earth and annihilated hundreds of soldiers, was

the premier heard its sound. For purposes of illustration, a similar blast at Chicago would be heard in about the same number of minutes at Galesburg, Bloomington, and Peoria, Illinois; Ft. Wayne, Indiana, Muskegon, Michigan, and Fond du Lac, Wisconsin.

4493 GROWING NUMBER OF WIVES ARE WAGE EARNERS

More than one-tenth of the married women of the United States were engaged in gainful occupations in 1910, according to figures recently given out by the Bureau of the Census, and over 25 per cent of all women 16 years old or over were wage earners, business women, etc. Since 1910 the percentages undoubtedly have increased rather than diminished, for the tendency of

women in this country has been toward greater economic freedom for many years. In 1900 the number of married women in gainful occupations was only 769,000, while in 1910 it was 1,890,000. The statistics referred to show that the proportion of women—married, single, and widowed—who are earning their living, is greater than ever before, but it is particularly interesting to find that of all the groups cited, the proportionate increase in the number of married women is the greatest.

Dept of Commerce.

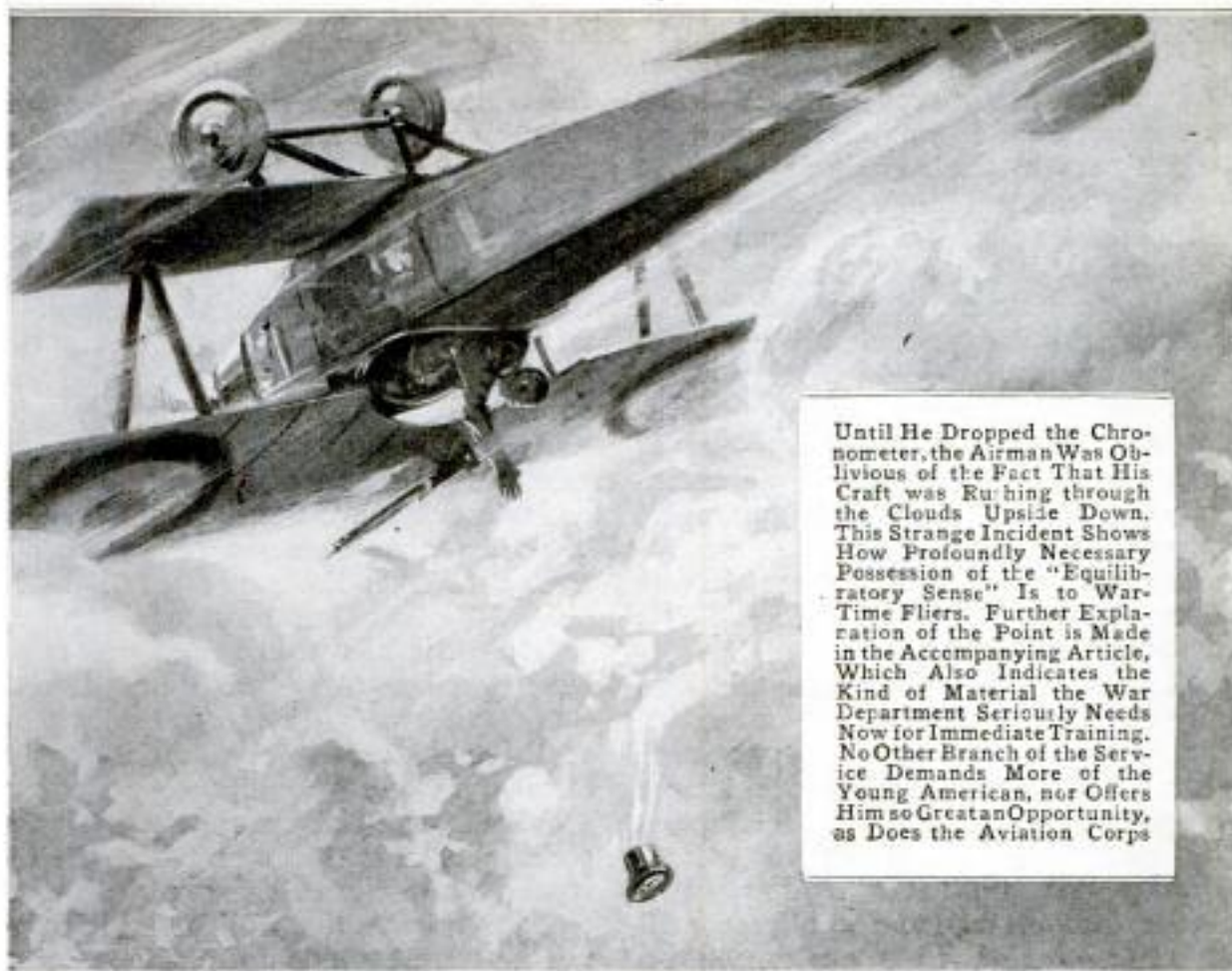

Until He Dropped the Chronometer, the Airman Was Oblivious of the Fact That His Craft Was Rushing through the Clouds Upside Down. This Strange Incident Shows How Profoundly Necessary Possession of the "Equilibratory Sense" Is to War-Time Fliers. Further Explanation of the Point is Made in the Accompanying Article, Which Also Indicates the Kind of Material the War Department Seriously Needs Now for Immediate Training. No Other Branch of the Service Demands More of the Young American, nor Offers Him so Great an Opportunity, as Does the Aviation Corps

HAND-PICKED MEN TO FLY AMERICA'S AIR CRAFT

ANNOUNCEMENT that the War Department's aerial program contemplates the immediate expenditure of some \$600,000,000 for the construction of thousands of aeroplanes for early service at the front, has raised the popular query as to the government's ability to provide pilots, in the necessary numbers, quickly.

Despite all that has been printed regarding the severe requirements to be met before one can qualify for admission to the aviation service, the youth of America still clamors for application blanks. This is encouraging, for men are needed, but it is strikingly apparent that the average boy with aeronautic aspirations has a poor conception of the type of physical and mental material the work demands.

There is no branch of the service that is so exacting in the selection of its personnel as this one. A man ideally equipped for other kinds of difficult

work that call for a sound body and a healthy mind, might easily lack some of the essential qualities necessary to the war-time flier. The enormity of the government's task in acquiring the number of pilots that undoubtedly will be wanted, can scarcely be overestimated, but there is reason to believe that the War Department knows how the situation is to be handled.

Good sight, sound ears, a strong, healthy body, an alert, decisive brain, a perfectly tuned nervous system, delicate sense of balance and direction, ability to resist fatigue and maintain absolute poise in the midst of confusion and excitement are a few of the absolute prerequisites. Deficiency in one of them means incapacity. Possession of all of them labels a young fellow a possible candidate, providing his education is good and he shows ready response to training.

Failure to pass the iron-bound re-

quirements has already caused some professional and amateur airmen to lose berths in the aviation corps. It will be clear, therefore, that the man who hopes to fly an American aeroplane at the front must be more than a clever exhibition birdman, more than a conscientious and determined defender of our national liberty. An ability to fly, a reserve supply of death-ignoring nerve, a true wish to serve; these are mere incidentals. For instance, an airman not long ago was before an examining board. He appeared to be a fit subject until it was found that his hearing was poor. This incapacity ruled him out.

The reason for stringent regulations may not be patent to all at first sight. But when it is considered that three years of modern warfare have taught every one of the belligerent nations the profound importance of scientifically determining a man's fitness before permitting him aloft, it will be realized that they are based on sound principles. One airman is characterized as worth a troop of cavalry; he is one of the many eyes of an army. No eye that is faulty is efficient; no airman, whose capacity is questionable, is safe to the lives of those depending upon his hazardous, difficult work.

Some slight indication of how severely aviation in war time tests a man's powers may be afforded by the story of a British airman's peculiar experience. He had successfully passed through an aerial combat with an enemy plane and was gliding through a dense cloud bank when he had occasion to note the time. Instead of

4546

204

IN MAKING SOLDIERS' HOSE RULES MUST BE FOLLOWED

There is misapprehension among many regarding the task of knitting hose for our boys in khaki. The work, unless properly done, may do more harm than good. It is expedient that the regulations be followed. According to the superintendent of a Red Cross workroom at Chicago, hand-

referring to his wrist watch, he unthinkingly removed his chronometer from its case. In doing so it slipped from his fingers and fell. He was puzzled at the direction it took, for it appeared to float "up" and away from him, as if it were lighter than air. The truth was that it shot straight for the earth and that the airman had been completely oblivious of the fact that he was flying upside down.

Interesting as an illustration of an odd phenomenon, the case also serves to stress the keenness of perception and the splendid sense of balance needed by war-time birdmen.

Of late it has been found that man has special senses other than the five that are universally recognized. One of these, particularly essential to the airman, is the "equilibratory sense," provided by an extremely delicate stabilizing organism situated in the internal ear. It is this that plays a tremendous part when a birdman is driving through clouds or darkness at a great height, where he can see nothing of the earth, feel nothing of it, or hear nothing of it. At such times, without this "sixth sense" an airman would be lost. With it, he knows intuitively whether or not he is rising or falling, turning to right or left, or proceeding straight ahead. For this reason the man who would be a flier must possess a normally acute equilibratory sense, in addition to being physically acceptable for military service. To determine certainly that one is fit in this respect, scientific tests have been devised by which the special quality can be measured as accurately as can vision.

knitted socks last a soldier in the trenches about three weeks, while the average life of machine-made ones is only one week. Thus the former, although requiring more time for production, are much preferred. The color of yarn, uniformity of knitting, size, and weight are other things that must be distinctly understood. Rules for doing the work, as well as instructors for teaching it, are available.

Order - 4743
 Hollander Bldg. 4743
 St. Louis Mo.

CLEVER DEVICES FOR DISPLAYING SMALL FLAGS

18 Co. 211 Third St. Arcach
 Dayton O.
 29 Chambers St. N.Y.C.
 Handel Bros
 102 set

Manhattan Bricol & Co's Bldg.
 5th fl.
 Smith-Hoelt & Sign Co.
 Incleavenyhol's, Ind.



Tiny Rifles, Stacked about Shot, Serve as Flag Holder for a Table



By Spinning This Two-Faced Charm, "I Love You" Appears Beside Flag

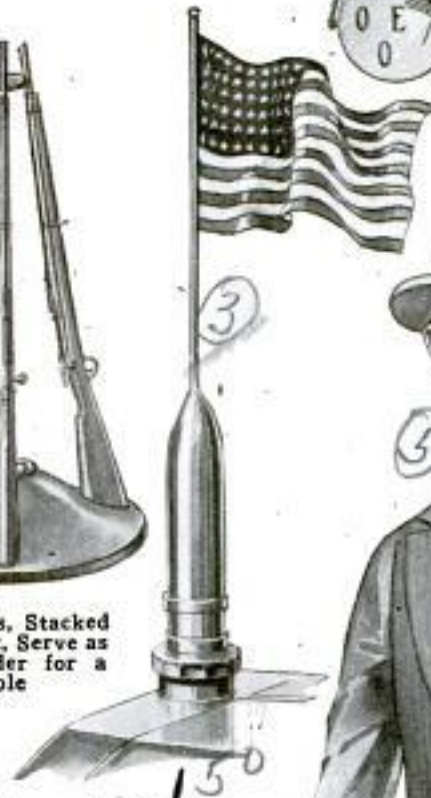

Suggestive Flag Support for Auto Radiators, Being a Rustproof Reproduction of a Five-Pound Shell



Flag on This Lapel Button, Which is Connected with a Concealed Battery, can be Lighted at Wearer's Will



An Inverted Bulb Connected with Car's Lighting System Beautifully Lights the Flag Fastened to This Metal Staff



Tiny Staff for a Desk, Having Cord for Raising and Lowering Flag



Device Attaches below Radiator Cap and Holds Flagstaff Securely



Electrically Lighted Transparency: Concealed Moving Reflectors Light Frosted Glass with Changing Hues



Headlight Dimmed with Red-White-and-Blue Sheet, Held in Place by Lamp Door

At Back of Headlight Is Easily Attached Wire Holder for a Flag



9 W. H. Cogger Port Clinton, C.
 10 Seng Auto Device Co., 1305 Michigan, Chicago.

STRIKING WAR VIEWS FROM FRANCE SHOWING



COURTESY, MOTOR CYCLE, LONDON

The Gallant Fellows Who Man the Terrifying British "Tanks" are Distinguished by a Special Insigne. It is Worked in Black and White Silk and Represents a "Tank"

In Actual Practice Apparently Nothing has Proved More Effective in Protecting a War Vessel from Enemy Torpedoes than Nets. The Photograph Reproduced Above Gives One a Close View of French Seamen aboard "La Provence" Preparing for Eventualities. They are Unrolling a Heavy Net Preparatory to Suspending It at the Extremity of Outriggers



So Successful have the British "Tanks" Been in Operations against the Germans, That the French Army has Also Adopted Their Use. Above is Pictured One of the Creeping Machines of the Tricolor and Its Crew. The Photograph was Taken Just Before the Engine Made Its Last Attack. Becoming Disabled within the Enemy's Lines, the Commander Prevented Its Capture by Blowing It Up at the Cost of His Life

SIDE LIGHTS ON FIGHTERS AND EQUIPMENT

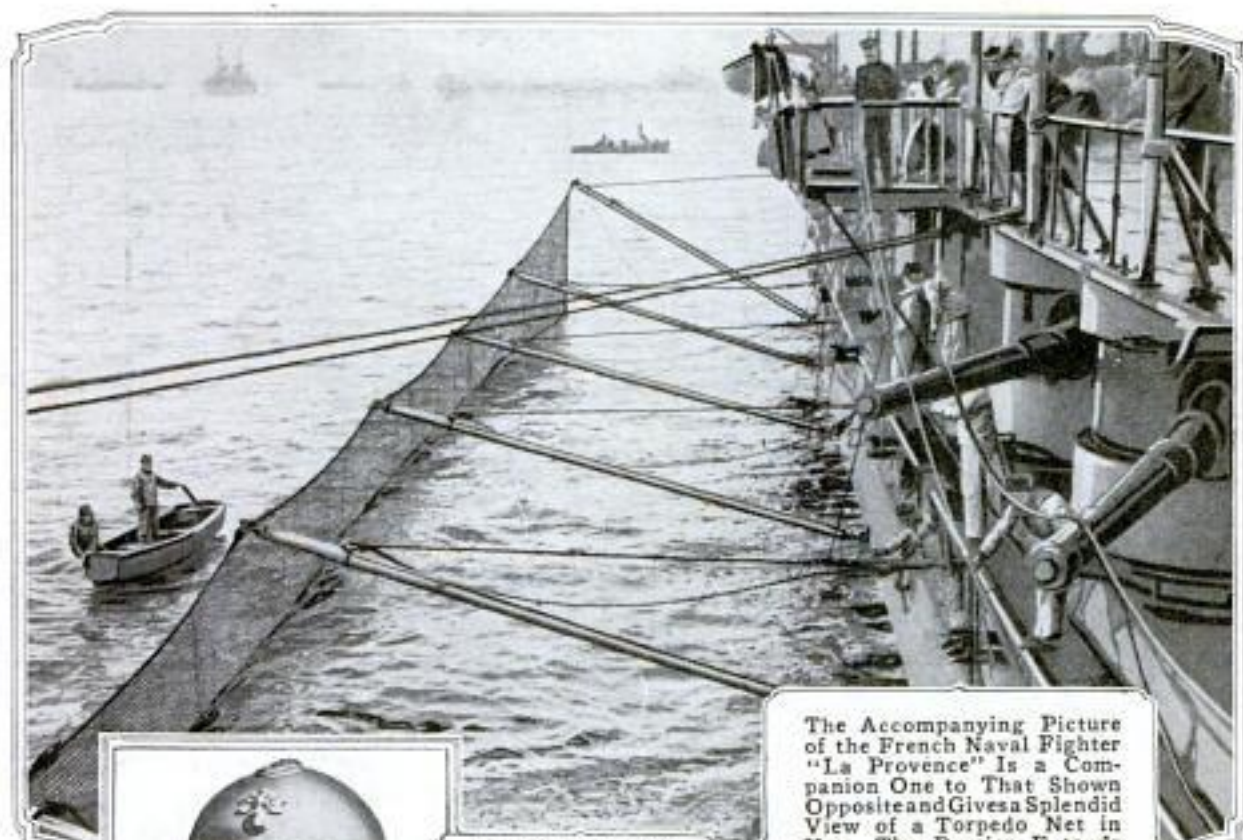

COPYRIGHT, INTERNATIONAL
FILM SERVICE
So Many Soldiers
have been Blinded and
Otherwise Injured
about the Face by
Shrapnel Fragments,
That the French have
Devised a Protecting
Visor, Which Fits to
the Front of the
Trench Helmet

The Accompanying Picture
of the French Naval Fighter
"La Provence" is a Com-
panion One to That Shown
Opposite and Gives a Splendid
View of a Torpedo Net in
Use. The Barrier Extends
beneath the Surface of the
Water to a Point Safely be-
low the Depth at Which
Torpedoes Travel, and There-
by Prevents Such Missiles
from Striking the Ship's Hull



COPYRIGHT, UNCLEWOOD & UNDERWOOD
Captain Guynemer, One of France's Famed Airmen, Aloft: The Much-Admired
Pilot, Whose Feats are Widely Known, has Ascended to a Height of 10,000
Feet to Assist in Guarding Some Observation Planes. The Birdman's Mastery
of Flying has Made Him a Greatly Feared Antagonist

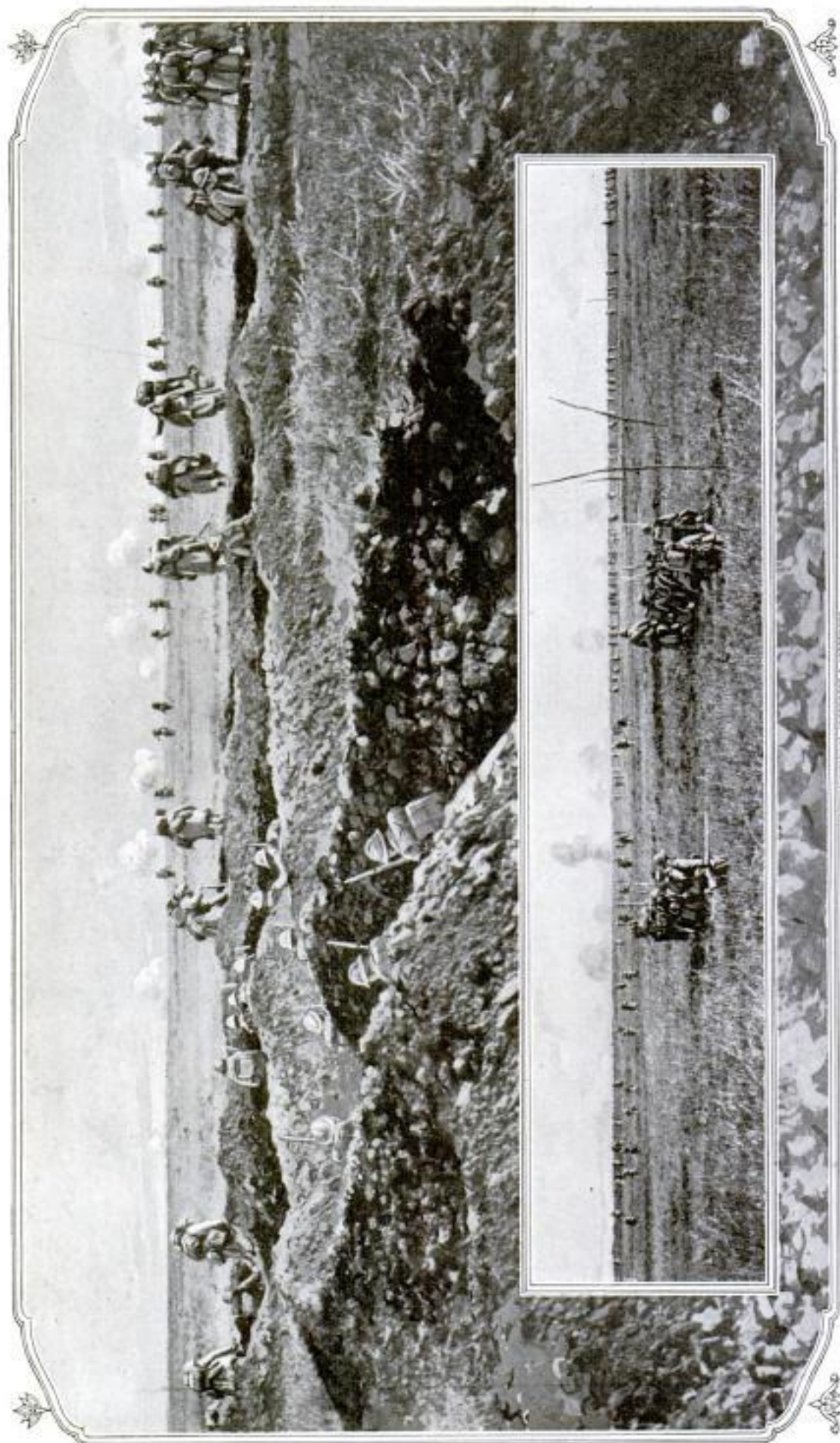

FRENCH IN FIERY ATTACK UPON ENEMY LINES

Two Remarkable Photographs Depicting the French Attack of May Fifth upon the German Positions at Chemin des Dames, are Presented Herewith. The Upper One Shows the First "Wave" of Infantrymen Leaving the Trenches and Pressing Forward, under Protection of the Artillery's Barrage Fire, toward the Ridge Commanding the Ailette Valley. The Insert Shows Members of "La Liaison," Who are Charged with the Hazardous Duty of Keeping the Advanced—or Advancing—Lines in Constant Communication with Those Behind. In the Background the First Wave is Just Reaching the German Works

THE RUTHLESS STEEL SHARK AND ITS PREY

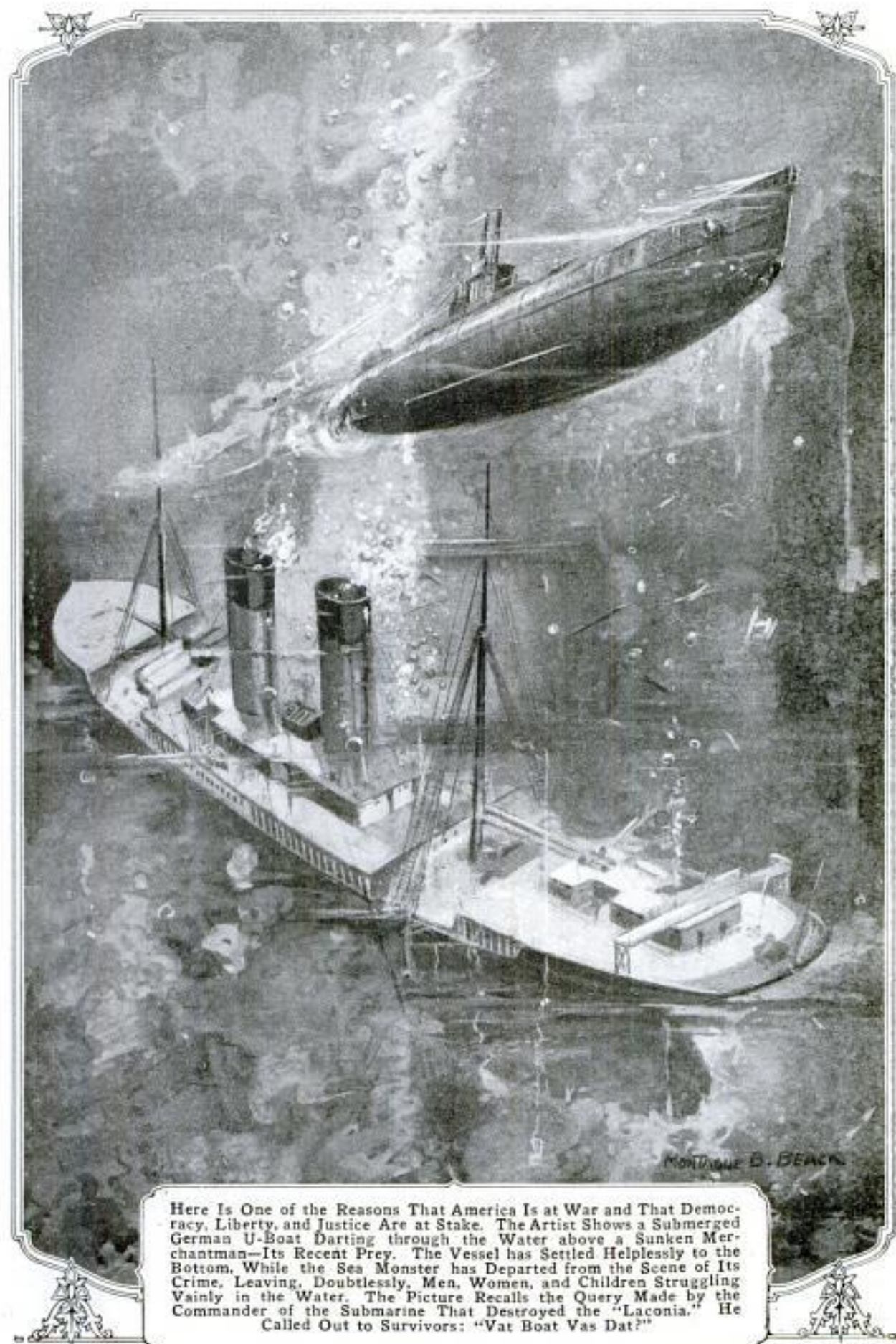

Here is one of the reasons that America is at war and that Democracy, Liberty, and Justice are at stake. The artist shows a submerged German U-boat darting through the water above a sunken merchantman—its recent prey. The vessel has settled helplessly to the bottom, while the sea monster has departed from the scene of its crime, leaving, doubtlessly, men, women, and children struggling vainly in the water. The picture recalls the query made by the commander of the submarine that destroyed the "Laconia." He called out to survivors: "Vat Boat Vas Dat?"

REMARKABLE PICTORIAL STORY OF SINKING



There Are Some Individuals Who Still Ask Why America Is at War. For Such, This Picture Should Be an Eloquent Answer. It Shows a Few Poor Souls Slipping Down the Ropes from the Upturned Stern of the Sinking Vessel. Possibly They Live Today; Probably They Do Not

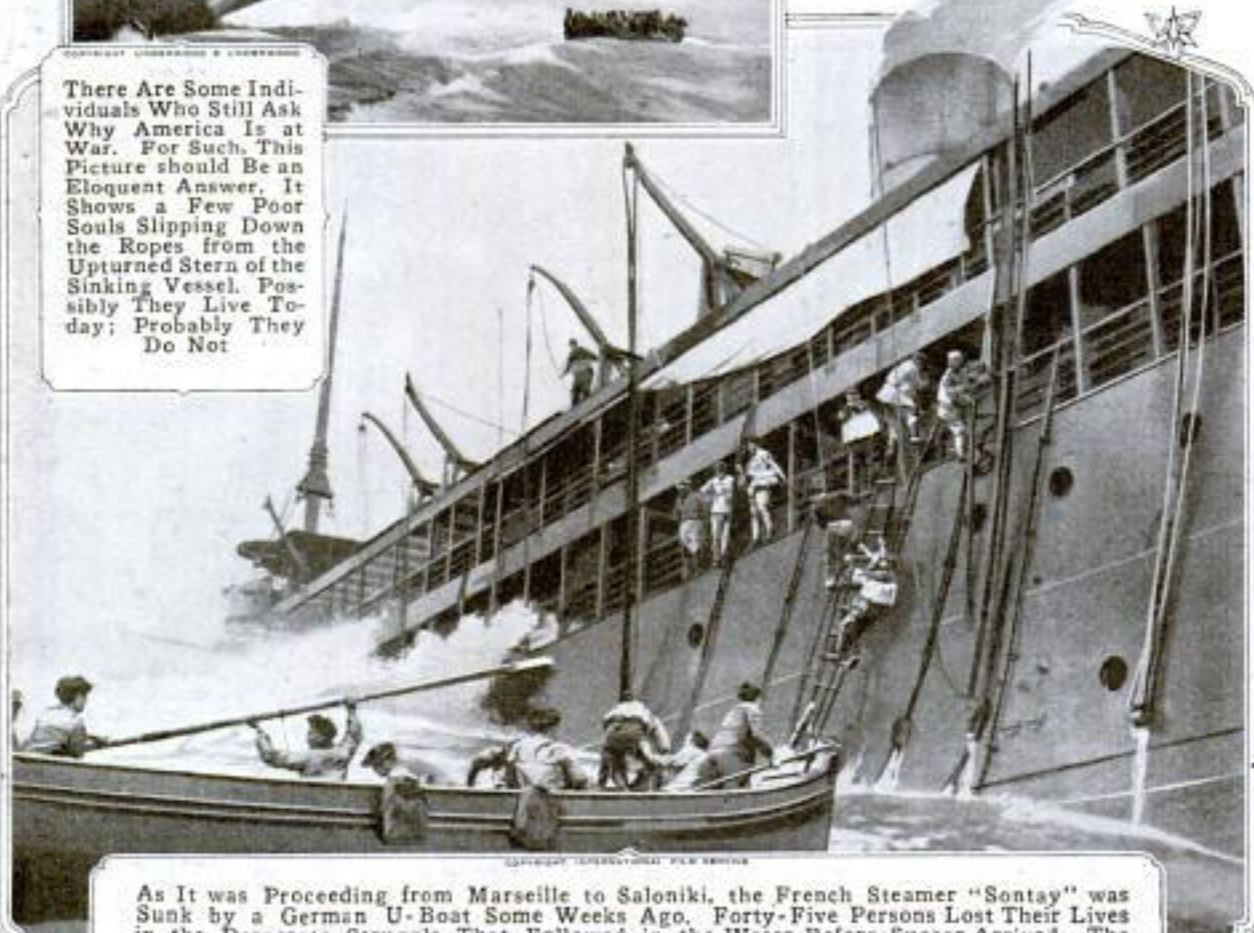

As It Was Proceeding from Marseille to Saloniki, the French Steamer "Sontay" was Sunk by a German U-Boat Some Weeks Ago. Forty-Five Persons Lost Their Lives in the Desperate Struggle That Followed in the Water Before Succor Arrived. The Photograph Presented Herewith Shows the Sinking of the Big Boat and the Escape of the Last to Leave It. The Water Breaking over the Inclined Deck Gives One an Impression of the Character of the Sea at the Time and of the Difficulties Encountered by Those Who Were Not Fortunate Enough to Gain Places in the Small Boats.

OF FRENCH SHIP AND RESCUE OF SURVIVORS



Adrift amid the Wreckage, the Survivors of the Liner "Sontay" Battling for Their Lives While a French Gunboat Approaches to Take Them Aboard: Had It Not Been for the Timely Arrival of This Vessel, the Death List would have Been Much Longer than It Was. Although Such Pictures as the One Above have Become Alarmingly Numerous during the Present War, Each New One Serves to Impress upon All Lovers of Justice and Humanity the Horror of Ruthlessness



Rescue of Passengers and Crew after Their Harrowing Experience in the Mediterranean Following the Torpedoing of the French Steamship by a German Submarine: The Photograph Shows a Boatload of the Survivors alongside the Gunboat being Assisted Aboard, and Other Small Craft in the Background Yet to be Picked Up. Many Persons Nearly Exhausted from Exposure were Taken from the Water, While Others were Released from the Floating Wreckage to Which They had Clung Tenaciously

U-BOATS AND THE BUSINESS OF SINKING THEM

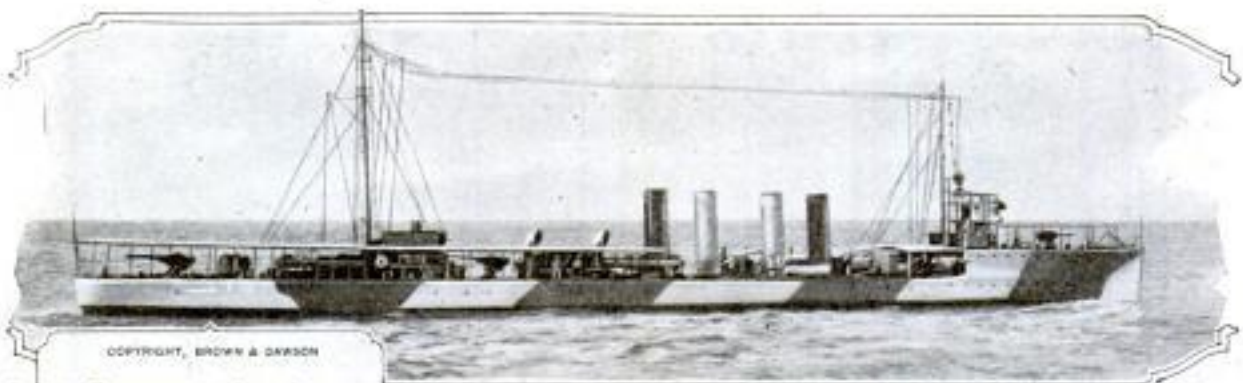

COPYRIGHT, BROWN & DAVISON

Destroyers—American No Less than Others—Are Alert Enemies of Germany's Mad Dogs of the Sea, Its Depraved Submarines. The Trim, Businesslike Little Vessel Above, Spotted with War Paint So as to Render It as Inconspicuous as Possible, Is One of the Many Similar Craft Flying Our Flag and "Doing Their Bit" to Rid the Atlantic of Steel Sharks



In a Crisis, the Value of Discipline Is Self-Demonstrative. When the Australian Troop Ship "Ballarat," a Deck View of Which is Given at the Right, was Torpedoed Some Time Ago, It Sank within a Few Minutes, but Carried No Man with It. The Picture Shows the Orderly Manner in Which the Soldiers Took to the Boats and Escaped from the Doomed Vessel

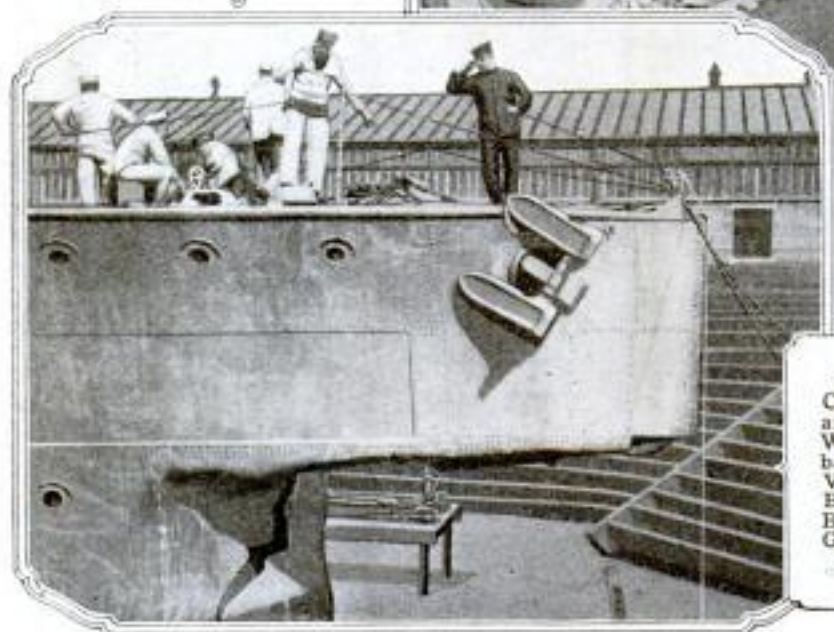

Battle Scars Earned in Honest, Clean Fight Are as Good as Medals and Official Mention, Particularly When They are Sustained by a Combatant So Easily Repaired as a War Vessel. At the Side is Pictured the Badly Smashed Prow of a Game British Destroyer That Rammed a German Submarine Unwise Enough to Show Itself in the North Sea

OUR BOYS AT WORK IN THE BUSINESS OF WAR

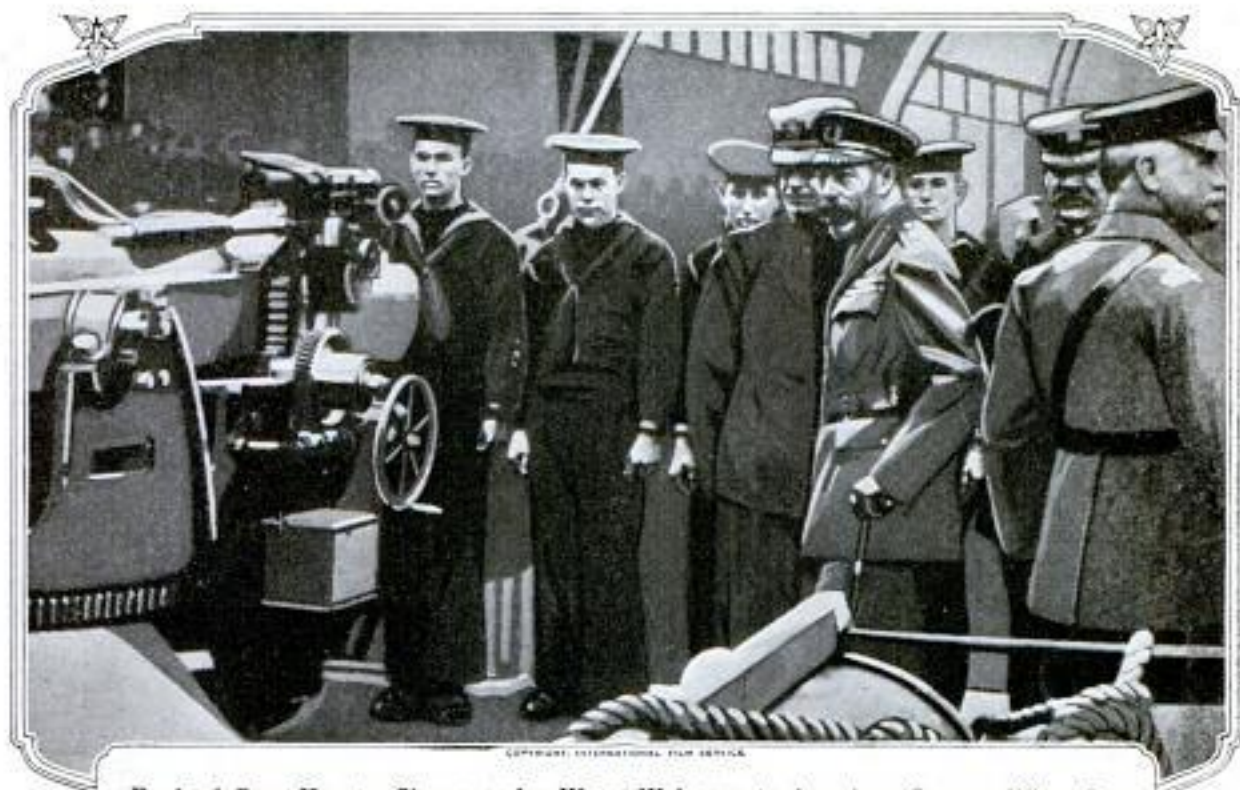

England Gave Hearty Cheers and a Warm Welcome to American Seamen When Our Destroyers, Commanded by Vice Admiral Sims, Reached British Waters to Lend a Hand in the Campaign against Germany's Murderous Submarines. Since That Occasion Our Jackies have Given a Good Account of Themselves and have Helped Much in Relieving the Shipping Situation. The Picture Above was Taken When King George was Paying His Respects to the Commander



Porto Ricans at San Juan have on Several Occasions of Late Demonstrated Their Loyalty to Their Protecting Flag Most Fittingly. This Picture Shows the Great Crowd That Gathered Recently to Give a Hearty "Send Off" to the Soldiers Departing on a Transport for Important Duty Elsewhere. No City could have Shown Its Spirit More Clearly than Did This One. Thousands of Cheering Men and Women Thronged the Line of March

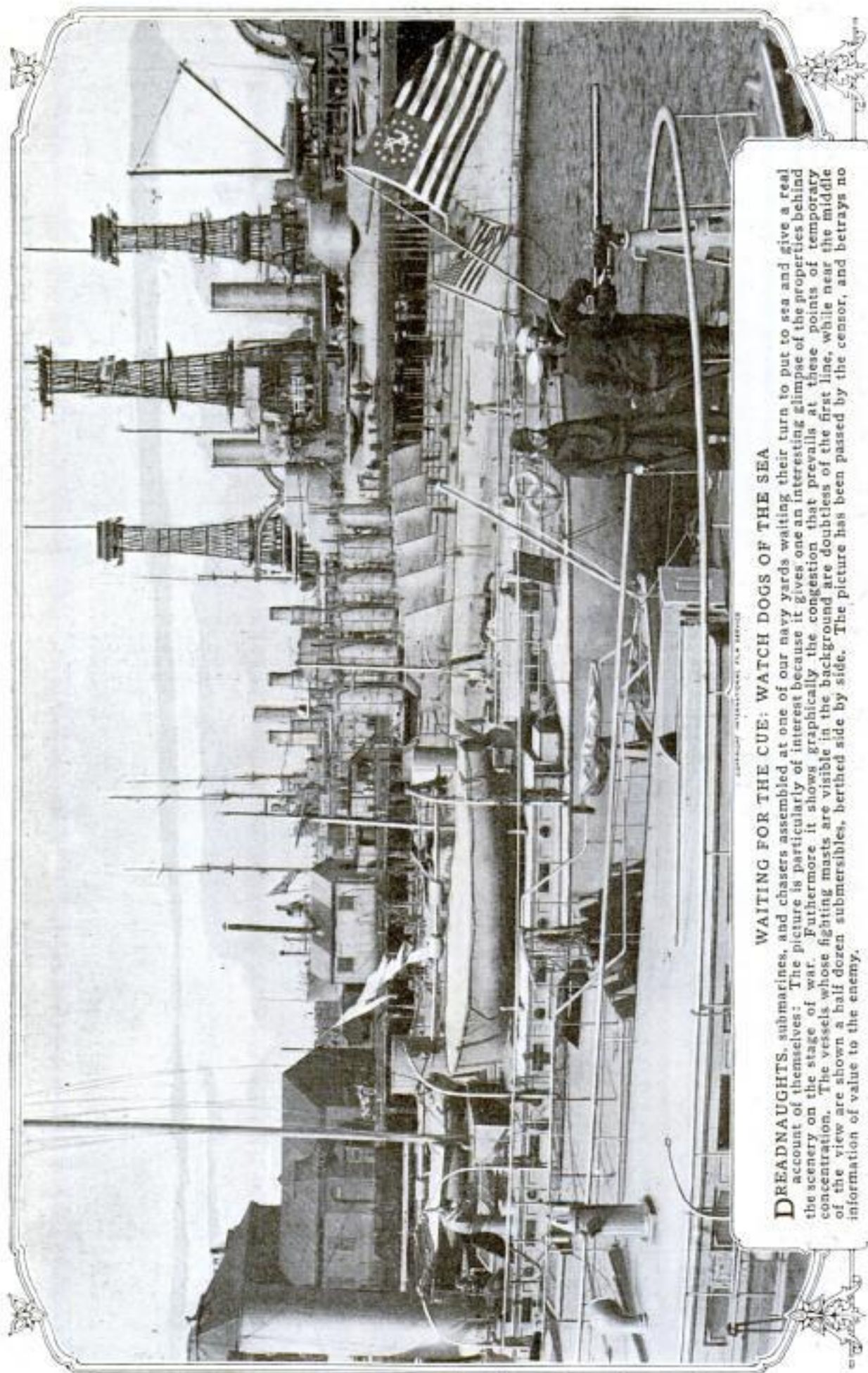

WAITING FOR THE CUE: WATCH DOGS OF THE SEA

DREADNAUGHTS, submarines, and chasers assembled at one of our navy yards waiting their turn to put to sea and give a real account of themselves: The picture is particularly of interest because it gives one an interesting glimpse of the properties behind the scenery on the stage of war. Furthermore it shows graphically the congestion that prevails at these points of temporary concentration. The vessels whose fighting masts are visible in the background are doubtless of the first line, while near the middle of the view are shown a half dozen submarines, berthed side by side. The picture has been passed by the censor, and betrays no information of value to the enemy.

AN OCCASION OF PRAYER AND THANKSGIVING



Old Glory and the Union Jack Hung Side by Side While the "Star-Spangled Banner" and the British National Anthem were Sung Solemnly but Joyfully during the Impressive Service at St. Paul's in London on the Occasion of the Entry of the United States into the World's War for Liberty. Of the Ceremony an English Magazine Said: "St. Paul's has witnessed many solemn services, but never one of such momentous import, or so charged with historic memories and racial aspirations, as that which was held on Friday, April 20."

4153 U + U, 417 Hych ave. New York City.

AMERICA MAKES READY TO MEET THE GERMANS

Cont. Film Service 238. Williams St. New York

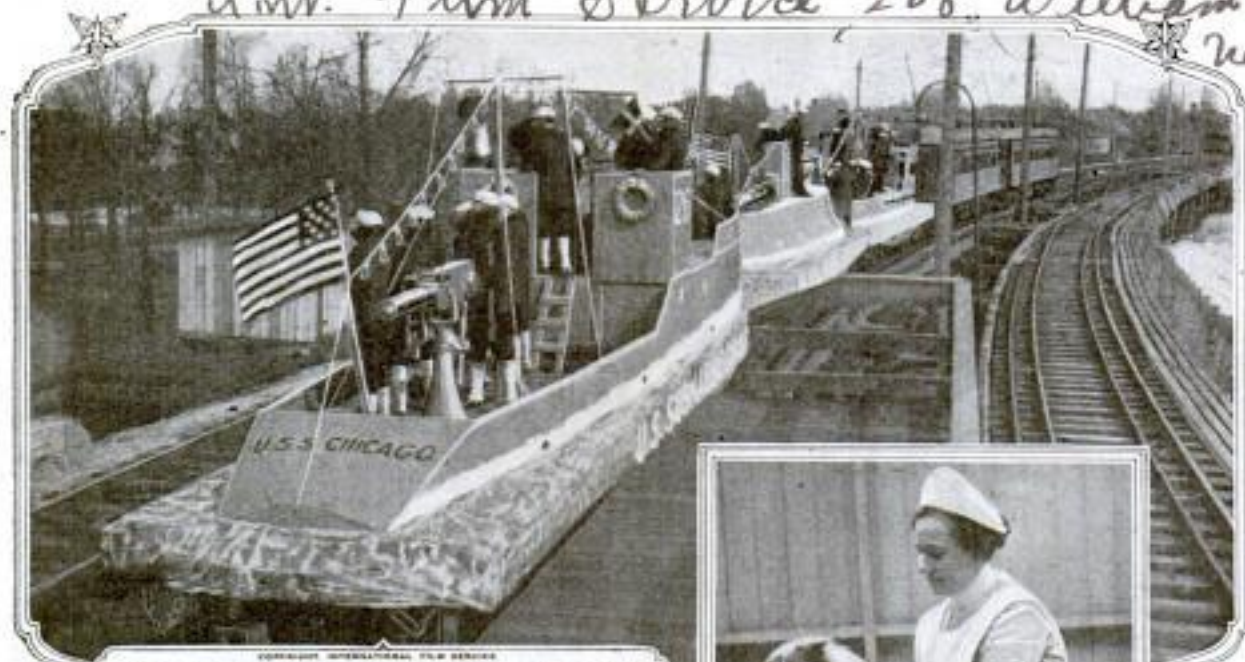

COPYRIGHT INTERNATIONAL FILM SERVICE

To Assist in the Campaign for Naval Recruits, This Fleet of Dummy Vessels was Recently "Navigated" over the Elevated Railways at Chicago. Manned by Apprentice Seamen from the Great Lakes Training Station, and Equipped with One-Pound Guns That Roared Thunderously When Fired in the City's Loop District, the Trains Attracted Attention and Doubtless Many Volunteers



COPYRIGHT UNDERWOOD & UNDERWOOD

War Dogs get Wounded and Sick as Do Soldiers, and Therefore Need Tender, Intelligent Treatment. Nurses are Trained to Care for These Plucky Little Fellows When They are Injured, and the Picture Above Illustrates One Phase of the Instructor, That of Applying Bandages



Despite Machine Guns, High-Powered Rifles, and Other Instruments of Modern Warfare, the Bayonet Continues to Be as Deadly and Important as Ever. All Fighters are Drilled Painstakingly in Its Use. Above, a Squad of Marines is being Given a Work-Out



COPYRIGHT INTERNATIONAL FILM SERVICE

Cooks are Needed for the Army, and the Business of Teaching Enlisted Men to Assume the Work is Undertaken in an Eastern City by a League Organized by a Number of Prominent Women. The Organization Has a Corps of Instructors and is Equipped with the Regulation Ranges and Field Outfits. Potato Soup Is under Consideration in This Picture

WAR'S VARIED PHASES SEEN FROM SIDE LINES



Students of Economics Realize That the War's Effect upon Industry will be Profound After Peace is Established. In This Connection the Picture Above Is Noteworthy. It Shows a Group of English Girls and Women Employed in One of the Railroad Yards

One of the Sordid Clearing Houses Back of the Trenches on the Western Front, Showing German Prisoners at Work as Stretcher Bearers: The Point Is an Ambulance Station Where Seriously Wounded Soldiers Receive Surgical Aid. When This Is Not Necessary, the Men are Placed in Ambulances That Take Them to Hospital Trains Bound for Bases



The Caution Imparted by the Sign in the Accompanying Photograph might Well be Heeded Elsewhere than at Europe's Battle Front Alone, for Many a Horse is Injured by Nails in the Cinders Scattered on Driveways and Public Roads



British Officers Making a Tour of Inspection in a Newly Captured Village Somewhere along the Western Front Following the Enemy's Retirement: It will be Observed That at the Right of the Motor Car There Is an Alarm Station from Which Warning is Given upon the Approach of Clouds of Poison Gas

ASPECTS OF WAR FROM FRENCH VIEWPOINT



Colonial Gunners Operating a Highly Efficient Quick-Fire Rifle That is Now Employed by the French: The Cartridge Held by One of the Soldiers Indicates the Size of Projectile Used



Herewith is Shown the Fence-Climbing Proclivity of a Sentinel Dog Whose Agility, Willingness, and Sound Sense Make Him Valuable for Military Work. In No Previous War have Dogs Played the Important Roles They have Assumed and Carried Out with Remarkable Ability in This One

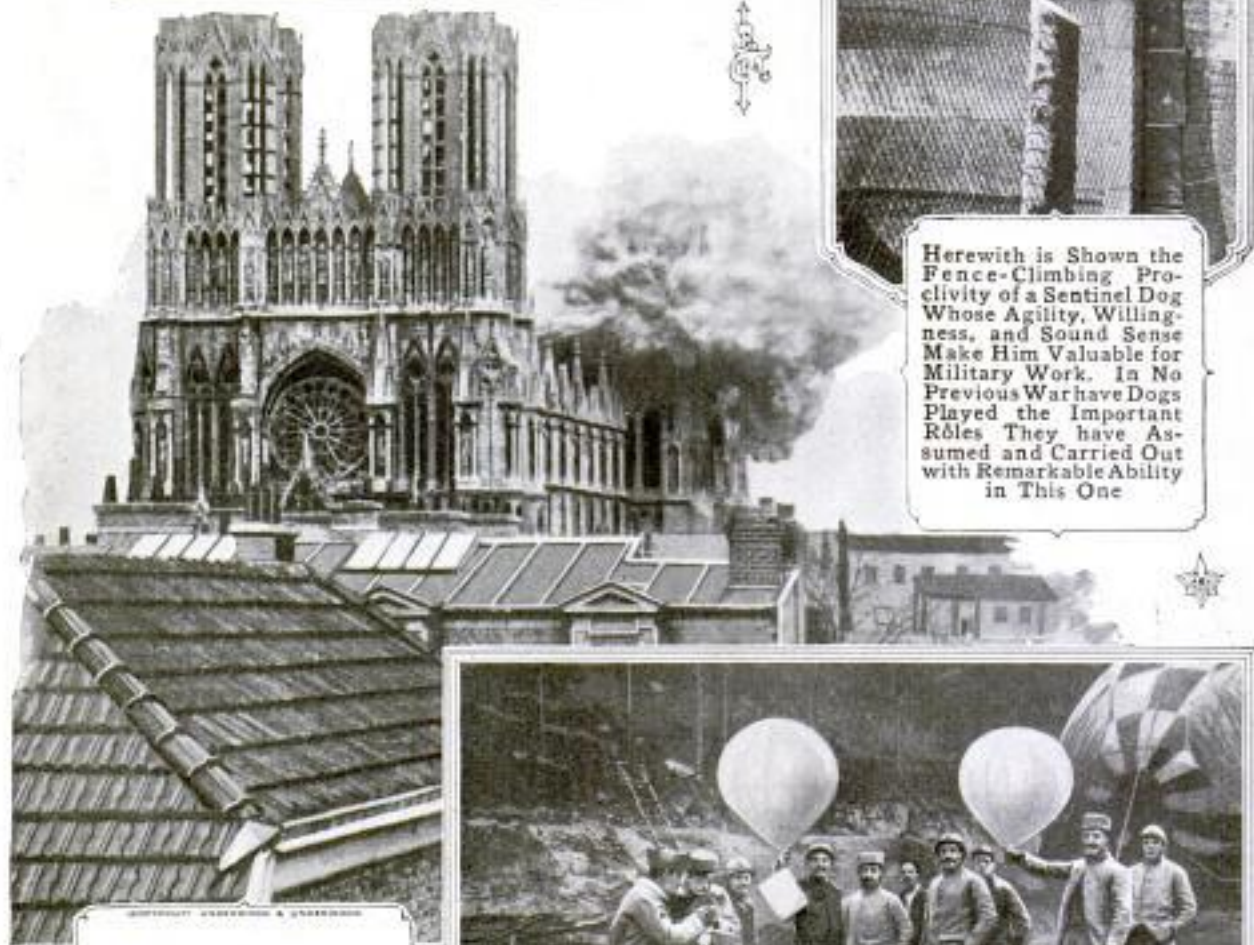

In View of the German Outrages That have been Perpetrated under Its Guise, the Term "Military Necessity" has Grown to Mean Wanton Destruction and Dastardly Vandalism. Above is Rheims Cathedral, Still a Target for Boche Shells, One of Which is Here Seen Bursting over It. Precious as is Ammunition, the Teutons Continue to Have Plenty of It for Churches



Small Balloons, Carrying Pamphlets That Tell of the Progress Made against the Enemy, are Sent Up by the French on the Western Front so That They may Fall behind the German Lines and Give Cheer to Countrymen under German Control in Occupied Territory. The Picture Shows "Poilus" Preparing to Release Some of the Gas Bags

LIFE IN DUGOUTS ALONG WESTERN FRONT



Above is Given a Glimpse of One of the Nerve Centers in the Important Defense System That Protects Paris from the German Hordes. It Is a Headquarters Chamber Situated Underground behind the Lines. Equipped with Electric Lights, Telephones, and Telegraph, It Has All of the Facilities Needed by the Staff That Occupies It



Photographs Usually Give One the Impression That, When in a Dugout, a Soldier is Comfortably Quarters and Has Little to Worry Him. This Is Not Always the Case, as the Picture Reproduced Herewith Indicates. It was Taken Following a Heavy Rain and Shows a Group of Men Pushing Back a Flood of Chalky Mud from Their Subterranean Quarters

WOODEN CROSSES IN FIELDS AND CHURCHYARDS



Propeller Blades, Bearing Inscriptions and "Iron" Crosses, Mark the Burial Places of Two Boche Airmen Killed in Macedonia. Their Machines Were the Targets of Successful French Gunners and Fell on Ground Then in the Possession of the Bulgarians



Each Soldier Wears an Identification Disk, but This Device is Often Lost or Destroyed When a Shell Bursts and Kills a Fighter. Such Was the Case in the Above Instance; so the Cross Bears the Information: "Here Lies a Hero of the 121st Regiment. The Number of His Bayonet P.33619 P. P. L." The Initials Mean, "Pray for Him"



A Ruined Church, a Grave, and a Sorrowing Mother. Three Phases of the War That Are to be Found at Every Hand in Outraged Belgium and France. One Has but to Study the Expressions of the Two Figures in This Picture, the Peasant Woman and the Little Child, to Read a Story of Hopelessness and Grief. The Woman has Returned to Her Village, Following the Retreat of the Germans, to Find—the Grave of Her Son



*Hotel Marlborough
 74. Chandler, S. Ave., Broadway, #32nd
 4702 POPULAR MECHANICS N.Y.C. 221*

**"WAR BREADS" NOW POPULAR
 IN HOMES AND HOTELS**

In the face of a serious food shortage occasioned by the war, American housewives, bakers, and hotel chefs are discovering that there are many satisfactory ways of making bread by which a saving of wheat flour can be effected. An effort is also being made to check America's wastefulness in the matter of food products. Bakers are trying to educate the public to the fact that stale bread is as wholesome as fresh bread, and in many cases more digestible. At present, vast quantities of stale loaves are collected periodically from the bakeries and sold at a fraction of the original price, as a base for stock foods. With a view to utilizing clean stale bread in making new loaves, an organization representing leading hotels has issued a "war-bread" recipe which calls for a thorough soaking of stale bread and crusts in water. This base, after it has been properly salted, is strained through a flour sieve and to it are added yeast and enough flour to make a very stiff dough.

A prominent New York hotel has recently added to its menu a bread containing rye flour and whole-wheat flour in addition to white flour. Another method of saving wheat flour which is being well received, is to use one part of cottonseed meal to four, five, or six parts of wheat flour. A United States senator not long ago served bread made from these ingredients to several of his colleagues in Washington, and they seemed much pleased with it. Government chemists have demonstrated that flour can also be made from peanuts, dried peas, sweet potatoes, etc., and that such flour can be mixed with wheat flour to make excellent bread.

4602
**SMALL SOFT-DRINK OUTFIT
 MOUNTED ON WHEELS**

A dispenser of cold drinks has altered his bicycle so that he can use it to carry all his supplies from his home to the park where he plies his trade. Between the rear wheel and a third wheel, placed

to one side, he has mounted a box having two compartments. One of these is



Portable Soft-Drink Stand: The Box is Divided into Two Compartments, One Containing Ice and the Other Various Utensils. Holders are Provided on Top for Bottles and Glasses

for ice and the other for utensils, while on top are holders for bottles and glasses.

4583

**SERVICEABLE RADIUS GAUGE
 OF CONVENIENT FORM**

For gauging the concave and convex surfaces of tools and determining their radii, an instrument of convenient arrangement has been introduced. When round-nosed implements are being ground, the gauge is particularly useful to a workman. It consists of eight small leaves, convex at one end and

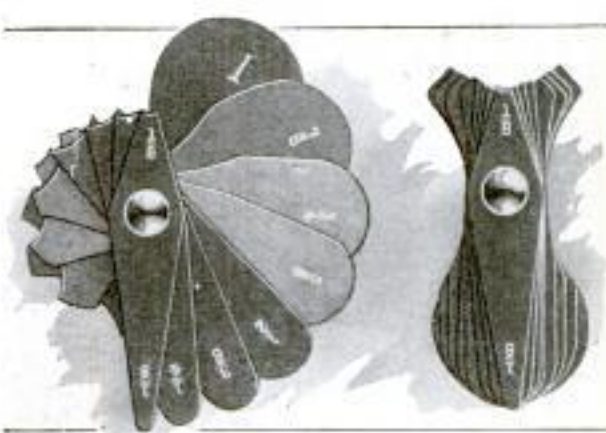

Radius Gauge Designed for Determining the Concavity and Convexity of Round-Nosed Tools

concave at the other, that are pivoted together. Their sizes range from an eighth of an inch to one inch.

*Mass-Ochlo
 3387 E. 116th St.
 Kalamazoo
 Mich. S. H. O.*

*Mr. T. ...
 5th - ...
 Los Angeles.*

CHURCH TABLES SERVE ALSO AS BENCHES

The pastor of a church which maintains a much-used parish house has

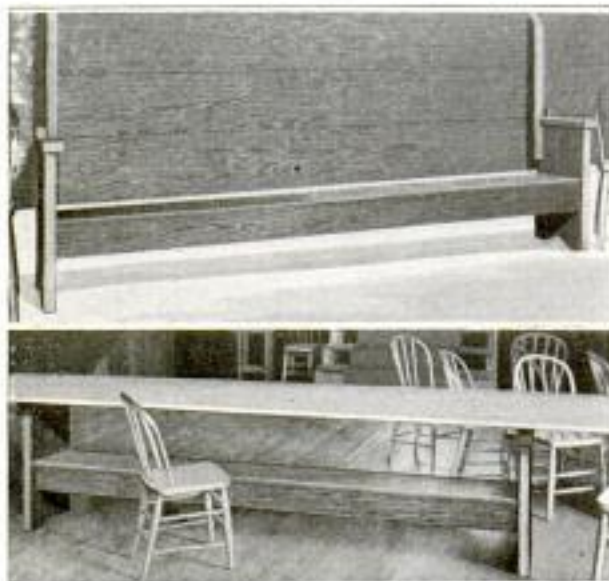

Parish-House Table Which can be Converted into a Bench by Tilting Up the Top: Upper View Shows the Table Set against the Wall and Transformed into a High-Back Bench

devised a very serviceable type of table that can be converted into a wall bench. The top is composed of three planed

boards fastened together and hinged to one side of the broad supports at either end, which take the place of legs. By lifting up the free edge of the top it can be swung to one side and into a vertical position, revealing a seat extending between the two supports, which then serve as ends of a bench. At social events the tables can be used first for a repast and afterward moved to the sides of the room and converted into benches.

BIG LOCOMOTIVE WRECKED BY QUEER EXPLOSION

4571
While taking water near Lester, Wash., the boiler of a powerful Mallet locomotive exploded with such terrific force that it was torn free from the drivers and hurled 195 ft. Examination showed that from some strange cause the boiler had been burned down nearly to the mud rings, in spite of the fact that it contained, according to the fireman, a liberal amount of water. The remains of the engine were loaded on five freight cars and moved from the scene.

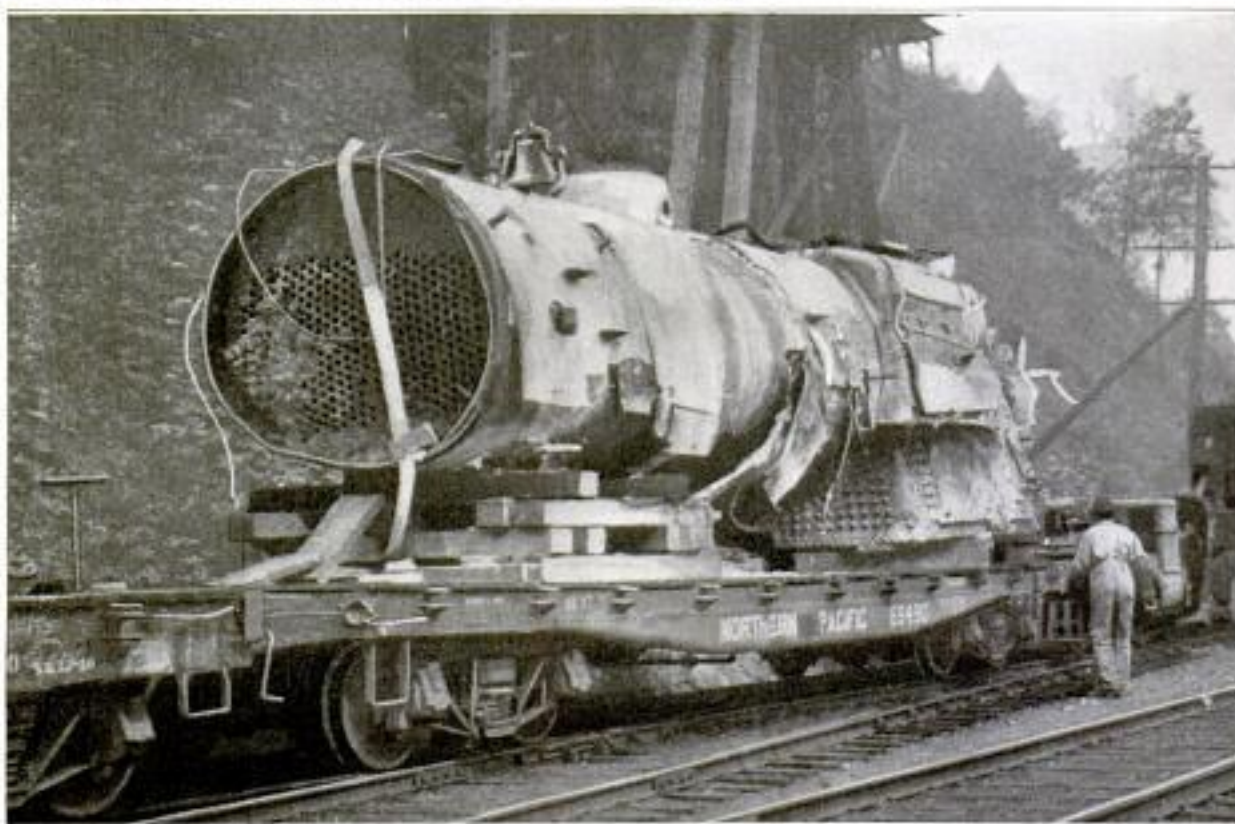

What Remained of the Boiler of a Big Mallet Locomotive After It had been Torn by an Unusual Explosion



COPYRIGHT, UNDERWOOD & UNDERWOOD

BATTLESHIP IN CITY PARK WINS RECRUITS

ON the greensward of Union Square, New York, in the midst of giant skyscrapers, rests the U. S. S. "Recruit"—the first wooden battleship to be used by the United States Navy in more than a generation. It is 200 ft. long, and with fighting tops and big guns, four of which are of 12-in. caliber, it is an appropriate headquarters for the recruiting activities of the Navy and Marine Corps in New York. Though without motive power and built only of wood, it has become, since its christening and "launching" a few weeks ago, an important addition to our fighting forces, because of the men who have enlisted under its flag.

4578

BIG WARNING SIGNAL FILLS TWO FOLD PURPOSE

Near a dangerous curve in Loring Avenue, at Salem, Mass., a conspicuous warning signal has been erected for the benefit of motorists. It consists of a tall, brightly painted wooden figure, representing an officer with one hand raised and the other holding a red flag. Because of its size and color, the sign cannot escape notice, and therefore doubtless has a greater effect than would a more conservative sign. It was installed by a tire company beside one of the latter's billboards, and thus performs the twofold function of calling attention to the curve and so-and-so's products. Somewhat similar advertising schemes have been used elsewhere to good advantage.



In Addition to Warning Motorists of a Dangerous Curve, This Conspicuous Wooden Figure Calls Attention to What Appears on the Billboard

464

ENGINE LEAPS FROM TRACK WEAKENED BY FRESHET

A sudden rise of water in an Oregon creek so seriously undermined a



View of Railroad Wreck That Occurred When a Freight and Passenger Train Started to Cross the Wooden Bridge, Which had been Weakened by a Freshet

wooden railroad bridge recently that, when a train composed of freight and passenger cars started to pass over it, the structure gave way, and the engine plunged 20 ft. into the stream below. One freight car followed and landed on end next to the overturned tender. But for the slow speed of the train many cars would have been piled up in the creek. Two members of the crew were drowned, pinned under the engine.

4696

FLYING-BOAT PILOT KILLED IN MAKING WEIRD LANDING

When an aerial instructor recently wrecked a flying boat in attempting to make a landing at Buffalo, he was killed instantly and his pupil critically injured. The mishap was apparently due to a misjudgment of distance. The airman, navigating at a height of only 1,500 ft., began a spiral descent, while some distance from the river where the hangar was situated. When about 200 ft. from the ground, he seemingly discovered his danger and attempted to

alight on a narrow canal extending parallel with the larger stream. The machine, however, was at too low an altitude for this to be accomplished. The tragic end came when the craft collided with a telegraph pole and was deflected from its course so that it struck the top of a motor car. Otherwise the flying boat might have settled to the ground without fatal results.

4413

LIFELIKE MOVIE DRAWINGS MADE BY INGENIOUS MEANS

Certain methods employed rather crudely in making animated cartoons have been refined to produce "animated drawings" that have almost the realism of motion-picture photographs. A noteworthy achievement in this line, a 500-ft. film showing the sinking of the "Lusitania," suggests that here is an interesting field for artists. Though several thousand exposures were necessary to make this film, the amount of drawing required was materially reduced by using two sets of backgrounds in front of which were held transparent celluloid sheets. On these the objects in motion were drawn. One set of background pictures showed the sky, and the other, consisting of about 200 drawings designed to be used in order over and over again, showed the tossing sea.



This arrangement left the sinking ship, the passengers, the submarine, etc., to be drawn on the celluloid sheets, which were held, one after another, in front of the proper background when the exposures were made. One of the artist's difficult problems was to determine the correct relative motion of falling and flying bodies, timbers, etc., in the explosion scene. The rate at which objects fall, the film's speed, and the distances represented, all had to be considered to make the picture true to life.

Minidown the Tay (Amv.)

Curtiss Aeroplane & Motor Corp in Buffalo, N. Y. Copyrighted material

4477

POULTRY FLOCKS SMALLER THAN THREE YEARS AGO

Reports recently gathered concerning 5,298 flocks of poultry on farms and in small towns in all parts of the country show that the average number of hens per flock this year is 107, as compared with 146, in 1914. This information, which was obtained by an incubator manufacturer in the middle West, indicates that shortage of supply has been an important factor in producing present high prices for poultry and eggs. It appears that a very considerable number of poultry raisers have sacrificed many of their hens for the sake of immediate profits—a policy the effects of which are now being felt by the entire country.

4462

CONVERTIBLE CHAIR HAS SEVERAL USES

The mechanical ingenuity of a western man was brought into play lately, during his spare time, in the construction of a chair which is convertible into several forms, for a variety of purposes. Primarily it is a comfortable armchair of mission type, with back and seat upholstered. An adjustable back converts it in a moment into a reclining chair, and a slight pull brings a padded foot rest into place. The top of the foot rest being removed, a shoe-shining stand is disclosed; a shelf swinging from the right arm, when raised, forms a small desk for writing, and when the chair back is folded forward onto the arms, the result is a table suitable for several uses.

ELECTRIC COOKING RANGE FOR HOTEL USE

The advantages of an electric oven and various other electric cooking appliances have been combined in a new



Electric Range for Hotels: The Four Plates on the Top Serve the Same Purpose as Gas Flames or Burning Coal and, of Course, Produce Less Dirt and are Easily Controlled

electric range, designed for hotel use. It consists of an oven and four hot plates, each provided with a three-heat switch, cut-out, and inclosed fuses. The plates are situated on the top of the range and, at high temperature, serve the same purpose as gas flames or burning coal, without such undesirable features as smoke, fumes, etc. In the oven the heaters are located at the top and-bottom, leaving a large clear space for baking and roasting. Approximately 12 kilowatts is the maximum current that this range will use at one time.

1616 Macmillan St., Portland, Ore.

Design by Electric Heating Co., Lowell, Mass.



The Four Uses of the Convertible Chair Illustrated Here Are, from Left to Right: Desk or Table; Shoe-Shining Rest and Writing Leaf; Morris Chair, and Ordinary Armchair

E. G. MacMecken
4481 City Service Bureau,
Denver, Colo.

CONCRETE CASTS OF MOUNTAINS USED AS ZOO SETTINGS

THE city of Denver has moved a replica of a mountain top to its city limits, a distance of 20 miles. The demand by museums for scientific ac-

animals and birds behind their bars and wire fences have so long reminded the visitors of convicts.

For a considerable number of years natural settings of a kind have been used in some cities, notably Hamburg. Even in Hamburg the rock formations were modeled by hand. When the park authorities of Denver determined to abolish bars from the city zoo they sent an expert taxidermist and nature student to copy a mountain top and remove it to the city.

This taxidermist, the inventor of the system, packed cement, clay, glue, hemp, food, and even water, to the top of this mountain, near Morrison, Colo., and with four companions,



Two of the Makers of Mountain Replicas, with Burros Carrying Cement, Hemp, Clay, Glue, Food, Water, and Other Necessaries, to the Rocky Site of Their Activities

curacy in group mountings of wild animals, which led from the ungarnished show case to colored photographic transparencies for backgrounds, has extended to the zoo, where the live

spent three weeks in recording an exact replica of the rocks and crags in plaster. This was done by marking out a cliff section with a raised band of cement. Within this was pressed half an inch of clay. A mixture of cement and hemp fiber covered the clay and rested upon the raised boundary. When the cover dried, the modern nature fakers removed the cover, scraped the clay away, replaced the cover and filled the space between it and the rock surface with a mixture of hot glue. Nail holes in the cement cover were filled with clay as the glue oozed out, thus eliminating all air spaces. From this glue cast, when removed, was



The First Step in Preparing a Replica of a Cliff: Covering It with a Layer of Clay One-Half Inch Thick

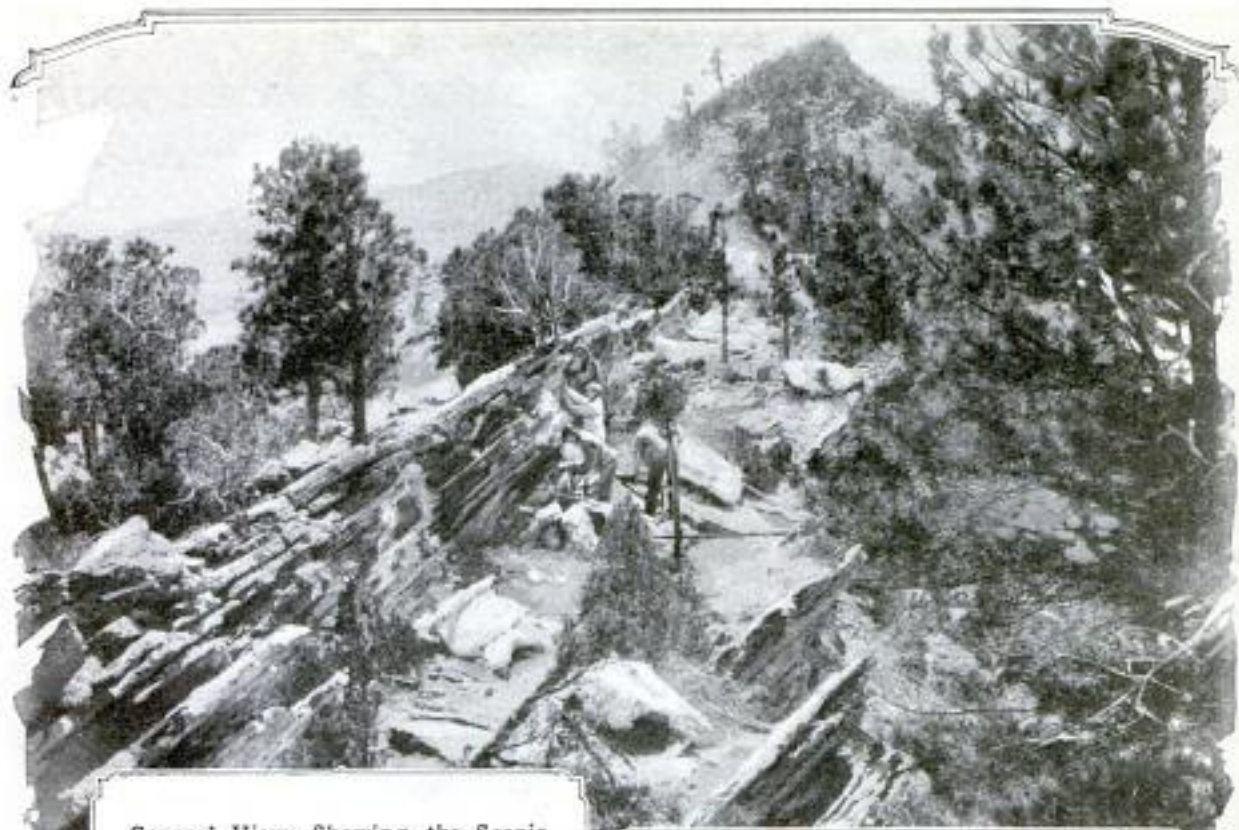

General View, Showing the Scenic Sculptors Copying the Mountain Top to Supply a Realistic Setting for the Denver Zoo: Even Pockets and Recesses were Duplicated, Thereby Furnishing Places in Which Trees could be Planted



This Is the Small Model of the New Zoo Which Won the Park Authorities Over to the Idea That Captive Animals Should, as Far as Possible, be Kept amid Natural Surroundings Instead of behind Iron Bars



Pouring the Glue: After the Clay Layer and Its Cement and Hemp Cover have Hardened, the Clay is Removed, the Cement Cover is Then Replaced and the Space between the Cover and the Cliff is Filled with Glue

Permanent Cast Made from Concave Side of a Glue Cast: This Picture Also Shows the Cover of Cement and Hemp and the Face of the Rock That was Copied. The Latter is Bounded by a Band of White Cement



made the plaster cast, or permanent model, the glue cast, of course, being an inverted copy of the cliff.

The molds, from which the concrete construction was made, were taken from the plaster cast. Pigments were used to stain the concrete, before pouring, this imparting the natural colors of the rock to the concrete. The inclosures for the carnivorous animals were poured in one piece, caves being opened in the surface, which led to the dens of the animals in the concrete work. Pockets in the concrete also permitted the planting of pine trees, quaking aspen, mountain underbrush, and native grass.

When completed, the inclosure showed a series of basins, hemmed in by overhanging cliffs, 35 to 40 ft. high, open on one side. A moat, filled with six feet of water and topped on the side where the public walked by a straight concrete wall, prevented any escape by the animals. Every tiny crevice and water erosion was faithfully reproduced in the model.

The accurate cliff definition makes the work of a high educational value, which is added to, in the monkey inclosure, by an exact replica of a Mesa Verde cliff dwelling.

METHOD OF SHOES

A French se commended a formula for wa clothing. It is and gasoline, th proximately or paraffin to one shoes it can b brush, while cl it cold. The so the softness an Uniforms can b out removing t

POLICE STATION WITH LAMPS

For a period geles police st tric lights a f water in an e a short circuit. The building was not piped for gas and most of the offices remained in darkness, or were dimly lighted with candles. In order that the police service might not be too seriously handicapped an officer decided to light the lieutenant's room with the aid of the lamps on a car belonging to

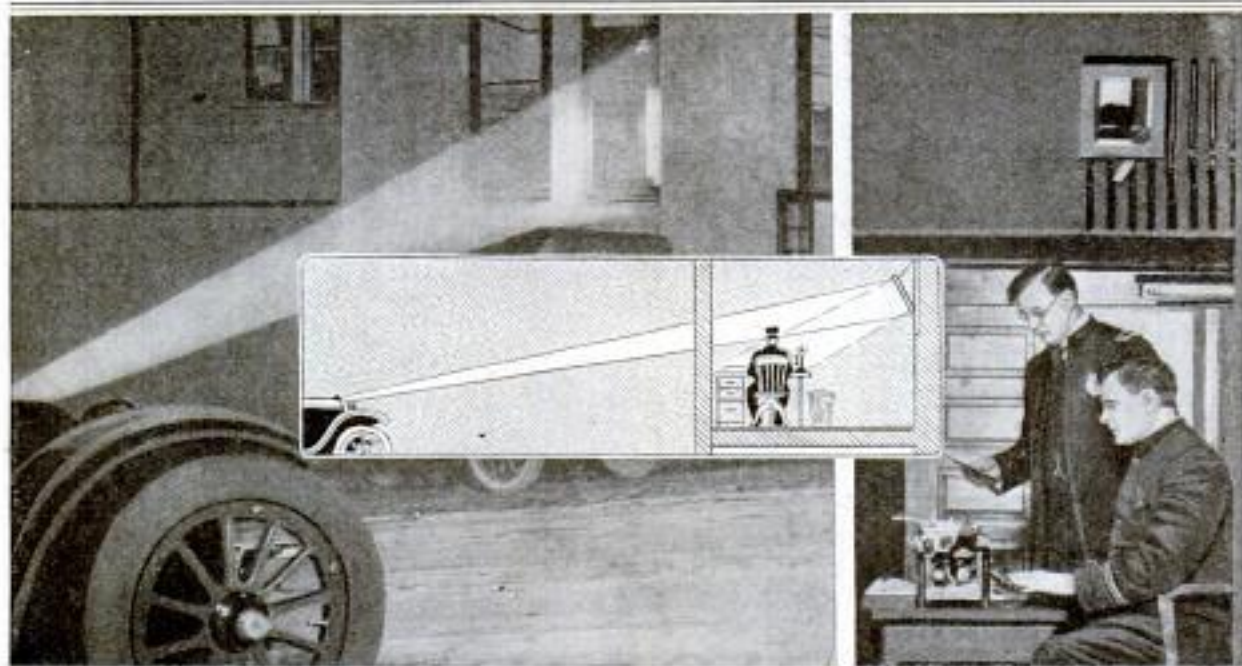

Illuminating Police Station with Automobile Lights: The Entrance was Lighted by the Head Lamps, While a Beam from the Searchlight through a Window was Reflected by a Mirror onto the Lieutenant's Desk, as Shown in the Diagram. At the Right Is an Interior View of the Station, Showing the Mirror

the force. The automobile was stationed across the street with its headlights shining into the station's entrance hall so that even strangers could find their way in without difficulty. The searchlight was directed through a window into the lieutenant's office and against a mirror on the wall, which reflected the powerful rays onto a table that temporarily served as a desk.

4078 —
LIFE PRESERVERS FOR USE OF CHILDREN

Nowadays the question of life preservers for use in an emergency at sea is properly classed among the all-important. Some large passenger ships furnish special equipment of this kind for children, made to fit about the chest, with armholes and buckled fastenings. They range in size from 29 to 33 in. chest measure, and are usually

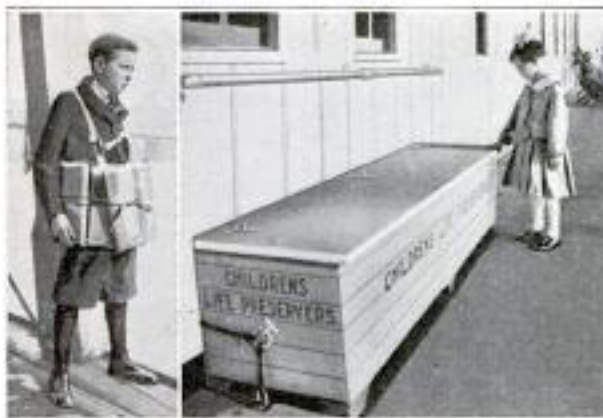

How the Special Life Preservers for Children are Stored on Board Ship Ready for Instant Use

kept in large chests or lockers secured to the decks, with prominent signs showing their location.

4486 —
MACHINE TESTS SANDPAPER SAMPLES ON STEEL

An automobile plant has found it profitable to employ a simple machine to test samples of sand and emery paper before purchasing the large quantities of that material needed in the establishment. The samples are attached to the bottoms of several shoes, all of which are weighted alike. Beneath the samples are placed steel plates of uniform hardness and known

weight. The paper is driven back and forth across these plates by means of a crankshaft with which each shoe

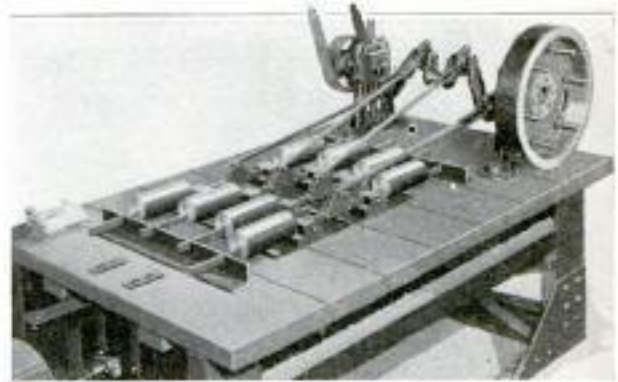

Machine for Testing Sandpaper: The Crankshaft Drives Four Shoes Which Rub Samples of Sandpaper on Steel Plates

is connected. At the end of the test accurate weighing shows which piece of paper has removed the most steel per unit weight of lost emery.

4515
MOTORCYCLE MADE TO JUMP LIKE A CAVALRY HORSE

That messengers and scouts mounted on motorcycles can be of special service at the front because of their ability to pass through shell craters and, in some cases, jump trenches, without dismounting, is the contention of a group of motorcyclists who are seeking to enlist. At a recent demonstration one of their number jumped his machine from embankments and over depressions in a way that strikingly resembled cavalry feats.



Photograph of a Motorcycle and Rider in Mid-Air, Taken While a Jump was being Made from an Embankment: This and Other Feats were Performed to Demonstrate the Type of Service Motorcyclists could Perform at the Front

Dodge Bros.
 Metallurgical Dept.
 Detroit, Mich.
 Copyrighted material

GIRL'S "REFLECTED" IMAGE IN PHOTOGRAPH OF EYE

Ingenious photographic work is always interesting, but particularly so,

Am. Press Ass'n



Necromancy in the Movies: A "Doctored" Picture That Apparently Shows the Reflected Image of the Heroine on the Hero's Left Eye

little who—shows the image of a "smiling favorite" appearing as a reflection on the ball of his eye. While it amounts only to a freak bit of faking, it might easily cause a spectator unthinkingly to consider it a legitimate, and therefore remarkable, reflection portrait. As is proverbially the case, when technical points are involved, a mistake was made which brands the picture for what it is. It was seemingly forgotten that although an image may be clearly mirrored on the pupil of an eye, it is almost impossible for a reflection to be seen on the iris. In this particular

to many, when it involves the movies. In a film play of recent release, a close-up of the hero, or villain—it matters

picture, the so-called reflection extends across both the pupil and iris, completely blotting out the former.

4487

TYPIST'S STROKES COUNTED BY CYCLOMETER

Mechanical means have been found for measuring accurately the work of a typist, consisting of a cyclometer attached by a steel bracket to the rear of a typewriter so that it engages the escapement wheel. It is gauged to register one point for each 180 or 240 strokes, according to the make of the typewriter. It has been found that the average typist receiving, for instance, \$16 per week, is paid about \$4.11 per 100,000 strokes. Calculating on some such basis, a reasonable piecework rate can be established, where the cyclometer is used. The result is that many typists are stimulated in their efforts by the accurate daily records which the attachment supplies. The device is useful also to the writer who is paid at space rates, for it enables him to esti-

mate very accurately the number of words he writes.



The Cyclometer Attached to This Machine, Engaging the Escapement Wheel, Records the Number of the Typist's Strokes, Thereby Furnishing an Accurate Measure of the Work Done

used by Simmons & Hales Co. St. Louis, Mo.

*St. Elias Oil Co. -
 Moved by Capt. Dan Decker, Katalla Lighter
 age Co. 4482 POPULAR MECHANICS 231
 all of Katalla, Alaska*



Towing an Oil Tank along the Alaska Coast to a New Location: The Tank Is 45 Feet in Diameter and Drew Only Six Inches of Water When Floated for the Voyage

OIL TANK MAKES TEN-MILE TRIP ON OPEN SEA

Floating upon its own bottom and drawing only six inches of water, an oil tank, 45 ft. in diameter and 20 ft. high, was successfully towed over 10 miles of open sea recently, to a new location at Katalla, Alaska. When it became advisable to remove the tank from its original location to the refinery of its owners in the Katalla oil field, a lighterage expert decided upon the towing plan, instead of taking the tank to pieces. It was then skidded down a hill to tidewater, and after waiting five weeks for favorable weather put to sea in tow of two launches, crossing two dangerous bars during the unusual voyage. The tank weighs 15 tons and has a capacity of 5,200 bbl. of oil.

4651 —

LANDING FIELD'S COLOR MAY AFFECT AEROPLANE

Strange as it may seem, the color of a landing field may have an effect on an aeroplane that is about to alight on it. For example, an area which is dark from being plowed or burned over will make the air above it several degrees warmer than that over land of lighter color, such as a stubblefield, thus causing a disturbed condition of the atmosphere, which may make landing difficult if not dangerous.

*Naval Flying Corps Monthly,
 May, 1917.*

NAME PRINTED ON CIGARS BY NEW MACHINE

4501

Names of cigars can be printed direct on the tobacco-leaf wrapper by means of a machine of late invention, not yet placed on the market. The freshly rolled cigars are fed into the machine at one end and conveyed side by side on a belt to the printing stamp, at the end of an arm that is operated by a hand crank or may be run by a motor. The name is printed lengthwise on the cigar in ink, without injuring the wrapper. The machine is designed to replace the perforating devices now in use for the same purpose. It will brand 25,000 cigars a day, it is said,

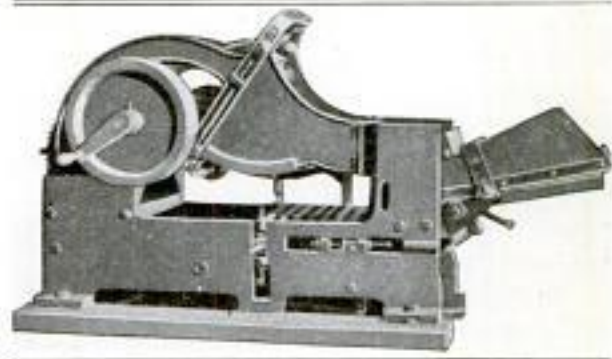

A Machine That Labels Cigars: It Prints the Name in Ink on Each Cigar without Injury to the Wrapper

at a considerable saving in cost over that of cigar bands, put on in the usual manner by girls.

Sm. - John Decker, St. Louis, Mo.

Harold Motor Co., Detroit, Mich.
W. L. Graham Legal Dept.

4471

LOOSE TOPS ON ENAMELING OVENS NEUTRALIZE BLASTS

The tops of all enameling ovens in a well-known automobile plant have

sions that may occur in the heated chambers. Since it seemed impossible to prevent occasional blasts, an attempt was made, by way of experiment, to render them harmless by

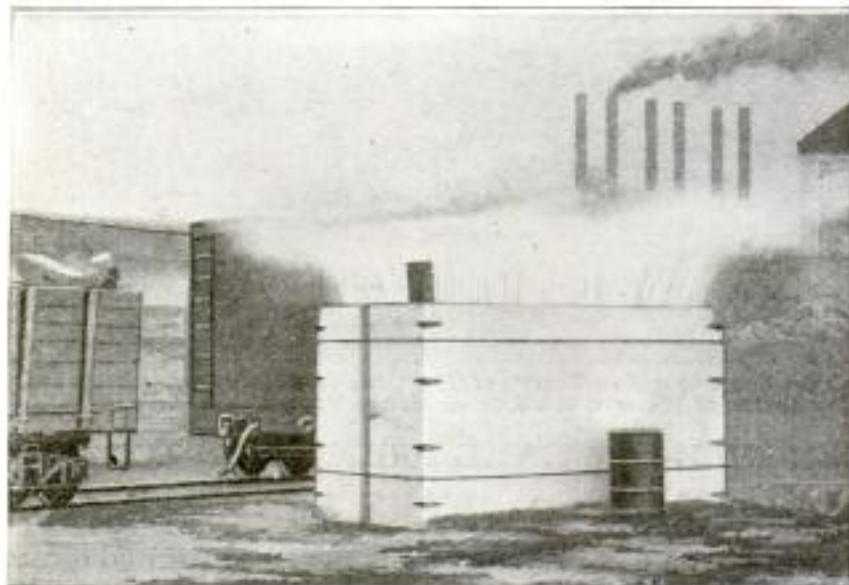

Photograph of Test Explosion being Made in an Enameling Oven, Showing How, by Having the Top Loose, the Blast is Rendered Harmless

providing safety lids on the top of an oven. But these vents did not prove sufficiently large when the tests were made. Consequently the entire top was loosened and its own weight, which is 7 lb. per square foot, was relied on to keep it in place ordinarily. Then, with locked doors, tests were conducted and it was found that the explosions lifted the top from 3 to 15 in. into the air but did not harm the oven. Hence all oven tops in the plant were loosened in

been loosened to permit the harmless dissipation of the force of any explo-

a similar manner, and the remedy has, so far, proved effective.

4135

NOVEL OUTDOOR ELEVATOR OF A COURTHOUSE

A curious example of elevator construction is seen at the courthouse in

Los Angeles, Calif., where, owing to the architectural design of the building and its location on a hill, the elevator is placed outside the walls. One of the streets on which the building fronts is

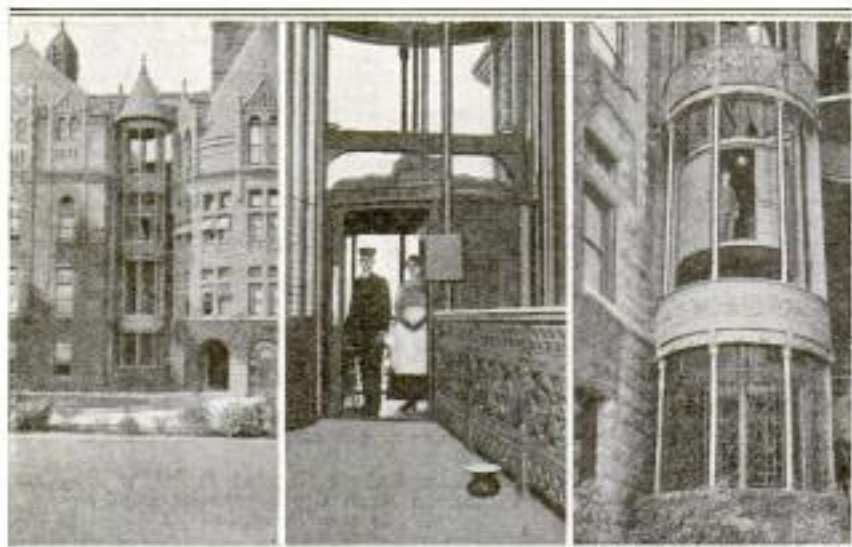

Los Angeles Courthouse Fresh-Air Elevator: Three Views of Unique Lift That Carries Passengers to and from a Tunnel Connecting with a Street Two Stories below the First-Floor Level. Center View Shows Passage-way Leading to Elevator

two stories lower than the courthouse, and the elevator shaft runs down to the level of this street, access from which is gained by means of a tunnel beneath the courthouse lawn. The shaft is of steel construction, with a circular front and ornamental ironwork at each floor. The design would not be practical in any but a mild climate, and the elevator is said to be the only one of its kind. It serves four stories above the higher street.

Llewellyn Iron Works
Los Angeles.

4521

RED CROSS BUILDING A MEMORIAL TO WOMEN



TO the large number of imposing public buildings in Washington has been added this handsome headquarters of the Red Cross, which has been completed at a cost of \$300,000. In the minds of those sharing in the recent dedication it seemed to symbolize the reunited devotion of the women of the North and the South. Over the portico are carved these words: "In Memory of the Heroic Women of the Civil War."



THESE three stained-glass windows convey some idea of the beauty of the interior of the Red Cross building, which on its completion immediately became the center of nation-wide preparation for war sufferers. In these panels the artist has depicted ideally scenes expressing the spirit of mercy and the love of humanity which underlie all the work of the organization. It will be noted that a cross appears in each composition.

Int. Film Series

COMBINATION RACK AND TIRE HOLDER FOR CARS

A new motor-car attachment having many uses is a combination tire holder and rack on which baggage, milk cans,



Steel Rack Which can be Easily Attached to the Rear of an Automobile: It can be Used to Hold Tires Only or to Carry Sacked Grain, Baggage, or Other Articles in Addition to the Tires

sacked grain, etc., can be carried. It consists of a steel frame that is attached by two arms to the rear of the chassis and by two adjustable braces to the members that support the car's top at the rear. The tire holders are situated on the under side of the rack, and when the latter is not in use the entire attachment folds up against the body, bringing the tires into an almost vertical position.

4661
WOOL SHORTAGE TO MAKE NEW STYLES SIMPLER

Because of the threatened shortage of wool, the styles for 1918 promise to be very simple indeed. This change is one which is not being dictated so much by fashion as by the grim necessity of war. The commercial economy board of the Council of National Defense has urged representatives of the

woolen and worsted manufacturers to conserve the wool supply by eliminating patch pockets, flaring skirts, cuffs on coats and trousers, unnecessary pleats, etc. No effort will be made to curtail the sale of goods already in stock, for such a move would lead to loss, it is thought, but undoubtedly in next year's output the board's recommendations will be widely adopted. It is proposed also to cut down the number of styles of woolen fabrics, to reduce the number of models of garments, and to simplify the weaving of cloth.

4451
MOTOR-DRIVEN OUTFIT FOR REGRINDING BUTTON DIES

A motor-driven grinder especially suited for regrinding button dies, such as used in cutting screw threads, has been put on the market to meet the demand caused by the scarcity of cutting tools of this kind. This compact outfit is designed to be set in a vise and consists of a motor with an extended shaft, on one end of which is a belt pulley, while on the other is an emery wheel. The belt over the large wheel drives a spindle and carborundum pencil, mounted above the motor, at a very high speed. The teeth, or

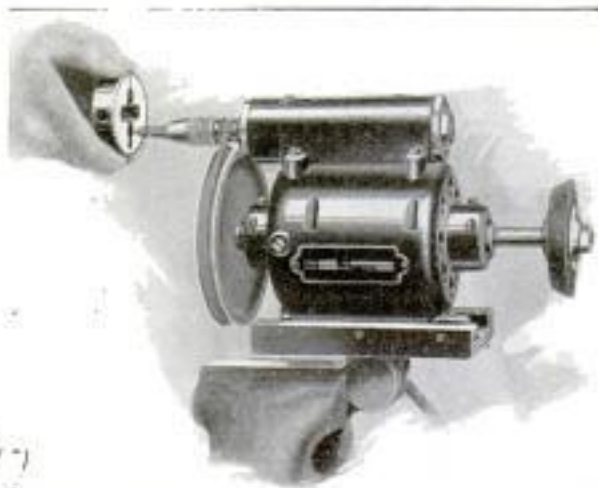

Motor-Driven Outfit Especially Serviceable for Regrinding Button Dies: The Chuck Holds a Carborundum Pencil That can be Dressed Down to Any Desired Size

cutting edges, of the die are ground by inserting the pencil in each of the four holes of the cutting tool, in turn.

Wisconsin Electric
Racine
Copyrighted material
1918



COURTESY OF HOWELL'S MICROCOSM AND THE CHICAGO DAILY NEWS

Curved Relief Map of Europe Measuring 15 by 20 Feet: The Location of 200 Places is Indicated by Electric Bulbs Which can be Lighted as the Demonstrator Desires. The Names and Numbers of the Index are Illuminated Simultaneously with the Corresponding Bulbs

4570

WAR GEOGRAPHY DEPICTED BY COSTLY RELIEF MAP

A remarkable war map, the construction of which required skill in draftsmanship, carpentry, modeling, casting, painting, and electrification, has been put on exhibition in this country. It depicts the greater part of Europe, showing the topography of the country in vivid relief. The chart measures 15 by 20 ft., and one of its unusual features is that it is curved to represent the curvature of the earth's surface. The horizontal scale is 7.8 miles to the inch, and the vertical scale is 8 miles to the inch. Not only are the plains, mountains, and bodies of water painted in realistic colors, but the location of some 200 places, many of them being points of interest on the eastern and western war fronts, are indicated by electric bulbs. While a demon-

strator is explaining the map he can light any one of these lamps to show the location of any city under consideration. At the same time a bulb is lighted, the name and number of the town is illuminated on a large indicator that stands beside the map. The electrical apparatus can also be set to run automatically.

— 4550

FACTORY CUSTOM REVERSED AND EFFICIENCY GAINED

Time and labor have been saved at a Chicago manufacturing plant by the adoption of a novel plan for handling heavy shafting. Instead of following the usual practice of moving the long steel rods to a motor-driven hack saw when they are to be cut into specified lengths, the work is carried out at the racks where the material is stacked. A saw is mounted on a portable tier-

Mechanical Appli-
cations Co. Copyrighted material
327 S. La Salle, Chgo.

ing machine built especially for the purpose, and is readily raised to any desired level. All unnecessary handling

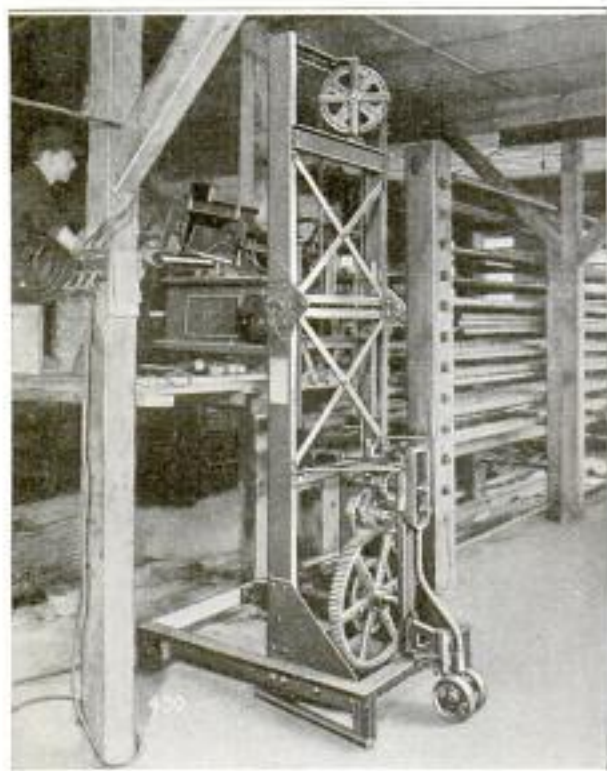

Sawing Shafting at the Racks in Which It is Stacked: A Novel Scheme That Saves Labor

of the shafting is thus eliminated. Only one operator is needed, although formerly six men were employed in carrying large sizes of shafting to the cutting machine.

1382

NEW FRONT-AXLE DESIGN FOR MOTOR CARS

Motor enthusiasts will be interested in a front axle of distinctively new, and mechanically good, design for automobiles. It involves a radical departure from standard practice and is intended to overcome certain inherent disadvantages of the conventional arrangement. Safety features, power economy, and tire protection are offered by it. Essentially the invention consists of pivoting the spindles at their exact centers to the circular ends of a straight axle. The members are constructed with V-shaped openings in their inner ends to permit oscillation of about 30° forward and backward. By this arrangement no leverage is exerted, and

the front wheels are held parallel in a vertical plane so that at all times they rotate in the line of motion, instead of across it. This is one of the big features of the invention, for as will be seen, the necessity of toeing in, or inclining, a wheel to bring the center of the tread as nearly as possible in line with the steering pivot, is obviated. Thus the wheels rotate smoothly in a straight line, instead of being pushed along. This reduces friction and lessens tire wear materially. Important also is the fact that the major force of a shock is borne directly by the axle, instead of being transmitted to the steering wheel. It is this feature that promotes safety, for an impact that might ordinarily cause a machine to swerve from its course has little effect in this case. The invention is suited for both pleasure cars and commercial trucks, and may be adapted to vehicles using four-wheel drive. As may be appreciated, the use of larger bearings, than those usually employed, is necessitated.

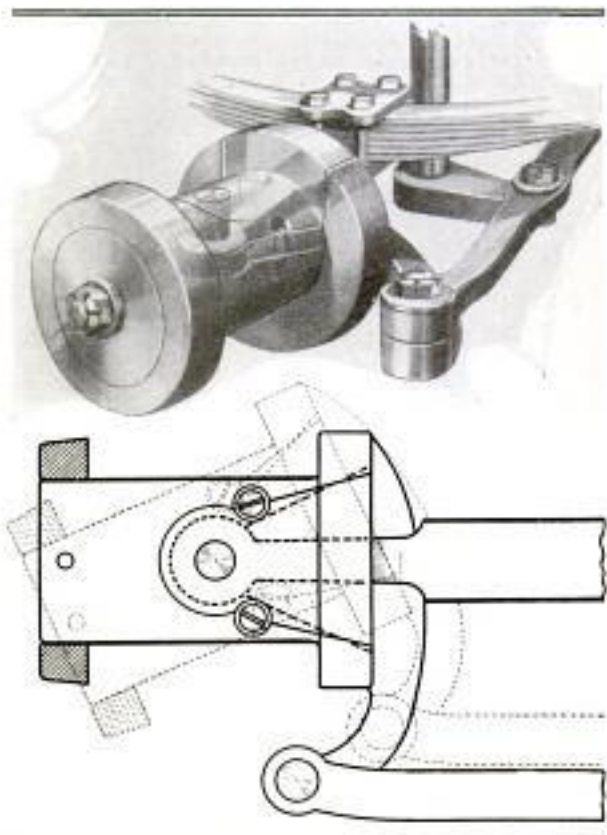

Phantom View at Top Shows How the Spindle is Pivoted to the Axle End, While a More Detailed View of the Construction is Given by the Diagram

Inv. Wm. Lincoln
562 W. Adams, Cal.

4625

THE EVOLUTION OF A CARTRIDGE CASE

By REGINALD TRAUTSCHOLD, M. E.

39 Charles St. New York

NEARLY every one knows what a cartridge case is—it is the brass shell holding the charge of powder which propels the projectile—but how a cartridge case is made is a mystery to many. The transformation of a flat brass disk, as shown at the left in Fig. 1, into a completed cartridge case, such as shown at the right of the same illustration, cannot fail to be, to the uninitiated, a source of wonderment.

Just consider the metamorphosis of a brass disk somewhat less than 3 in. in diameter and considerably less than $\frac{1}{4}$ in. in thickness into a cartridge case nearly $5\frac{1}{2}$ in. long, slightly more than $1\frac{1}{2}$ in. in diameter, and destined to accommodate a projectile weighing one pound and the powder charge capable of projecting the missile for miles. Or, take a brass disk, $6\frac{3}{8}$ in. in diameter and about $\frac{3}{8}$ in. thick, and therefrom may be manufactured a cartridge case 12 in. long and of the proper diameter to hold an 18-lb. projectile. For a $4\frac{1}{2}$ -in. howitzer cartridge case, a brass disk less than 6 in. in diameter is required. And the processes by which these remarkable transformations are brought about are quite simple.

The first step in the making of a cartridge case consists in stamping out a round, flat disk of brass of a diameter which appears small when compared with the dimensions of the finished shell, and which is actually little thicker than the base of the finished case. This flat disk is placed in a powerful press and squeezed into the shape of a shallow cup—a simple enough operation, but one which materially affects the physical properties of the brass. The flat disk is comparatively soft and ductile, but on being forced into cup shape, the metal becomes much more brittle, harder, and less pliable—much as does a rubber band after it has been stretched—so

that any further squeezing or stretching of the cup would be liable to cause breakage or the formation of cracks. Therefore, before any further operations can be successfully performed on this brass cup, the metal must be returned to its original condition of softness and ductility.

To accomplish this, the cup is placed in a furnace, or oven, maintained at a high temperature, usually in the neighborhood of $1,250^{\circ}$ F., for from half to three-quarters of an hour. This sweating process is known as annealing, and during it the metal limbers up. The intense heat, however, scorches the skin of the cup, and this scorched skin has to be removed. So the heated cup is taken from the furnace and placed in a hot acid solution—hot, in order that the metal may not be chilled, and acid for the purpose of removing the charred skin, or scale. Any acid that may adhere to the cup after this process is removed by a hot-water bath. The brass is now as pliable and ductile as it was in its original form of a flat sheet.

The cup is then taken to another press, where, by the process technically known as drawing, the depression is made deeper, the walls at the same time becoming thinner. Great care must be taken not to overstretch the metal. When the brass has been stretched as much as is practical, the cup is passed back to the furnace for

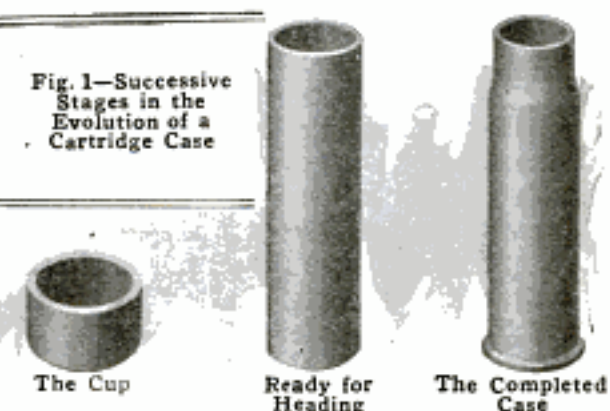

another annealing. Thence back to the acid tank for pickling—that is the name applied to the process of remov-

ing the scorched skin—and then back to a press for another stretch.

These steps of stretching, annealing, and pickling are repeated until a deep cup, slightly longer than the finished cartridge case, is obtained, with walls as thin as those of the finished product; its base, however, not much thinner than the thickness of the original brass disk.

Interposed between the drawing operations, it is customary to perform what are known as *i n d e n t i n g* operations. These simply consist of indenting the bottom and distributing the metal so as to form a hump, through which, later, is bored a hole for the accommodation of the primer cap—that little device for igniting the powder charge with which the cartridge case is subsequently filled.

On the completion of the necessary number of drawing operations, the protruding flange at the base of the case is formed. This is also done in powerful presses and is known as heading. Annealing is not necessary for the heading operations, as the metal in the base of the deep cups is quite ductile, having been little affected by the draws. To guard against possible cracking of the base, however, the heading is done gradually, two, and sometimes three, partial heading operations being performed before the flange is completed.

At this point in the evolution of the cartridge case, the walls have been reduced to their final thinness, and the base needs only the primer hole to complete it. The walls, however, are virtually straight, or, perhaps, with a

slight flare toward the top. In the completed case, the top has to be contracted to hold the projectile, sometimes with a shoulder, as shown in the illustration, or, in other cases, with a gradual taper from the bottom, or head, end of the case to the top.

To prepare the metal for this tapering, it must be again made ductile by another annealing or semi-annealing process. In this case, however, the previous methods are too drastic, for now the annealing must be accomplished without formation of scale, the walls being of just the required thickness for the finished case.

To anneal without scorching and forming scale is a ticklish undertaking and is performed in various ways. The heated cases are sometimes plunged, open end down, into a solution of saltpeter, heated to about 760° F.

Such heat is not sufficient to scorch the metal, and yet the hot solution possesses the requisite properties for softening the brass.

Another simple way of performing the same task is to place the cases inside of red-hot iron pipes, extending into an oil or gas furnace. The cases are thus prevented from coming into direct contact with flame, and the temperature is not sufficient to scorch their skins.

One of the most interesting methods that has been developed during the present activity in the production of war munitions is the variety of flash-annealing, shown in Fig. 2. The case to be softened is placed, base down, in the cup of the revolving spindle and flames of burning gas are directed

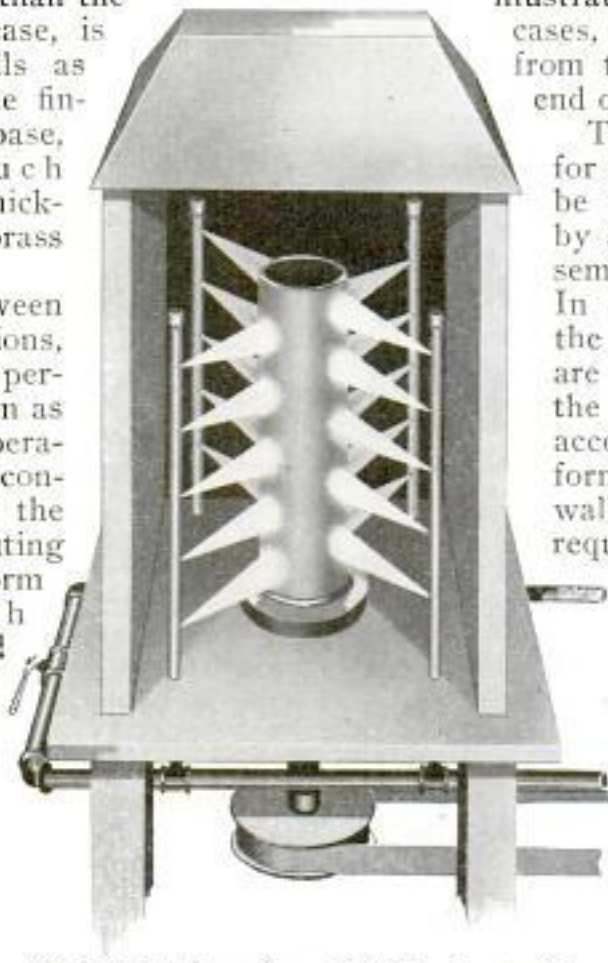

Fig. 2—Flash-Annealing a Cartridge Case: This Method Has Greatly Increased Production

*Inv. Mr. Shelby, Bldg
670 Metropolitan
Los Angeles*

against it from all sides. The cases remain on these revolving spindles only until they become red-hot, when they are removed with tongs and allowed to cool gradually. A high rate of production and excellent results have been secured by this flash-annealing method. The operators soon learn to judge accurately the proper duration of heat treatment by the color of the shells.

Following this last softening of the metal, the cases are tapered and brought to final form, after which the primer hole is made in the base and any other necessary machining operations performed.

4453

SHIP'S DECK PILED HIGH WITH CARS FOR ALASKA

There steamed into Seattle harbor a few weeks ago a freighter that attracted much attention because of its enormous deck load, consisting of the tops of 74 flat cars, securely tied down by cables. These cars were used in the construction of the Panama Canal and were being transported to Alaska where they will be utilized in building the government railroad. Below deck, the vessel carried car wheels and eight locomotives, knocked down, while a large barge towed behind was loaded with

similar equipment—all of which shows that the great government project in Alaska is rapidly assuming tangible form.

4474

ATTACHMENTS MAKE A SAW SERVICEABLE AS SQUARE

By riveting two properly fashioned steel plates close to the handle of a saw with a straight back, that tool can be used as a square, the metal parts serving to hold the saw at an angle of 90°, or 45° with relation to a given edge. The combination not only effects a saving in money but also a saving of space in a tool box.



Government authorities have rented a large hotel in North Carolina to provide accommodations for nearly 2,000 German civilians now interned at various immigration stations. These groups consist chiefly of the crews of formerly interned German ships.

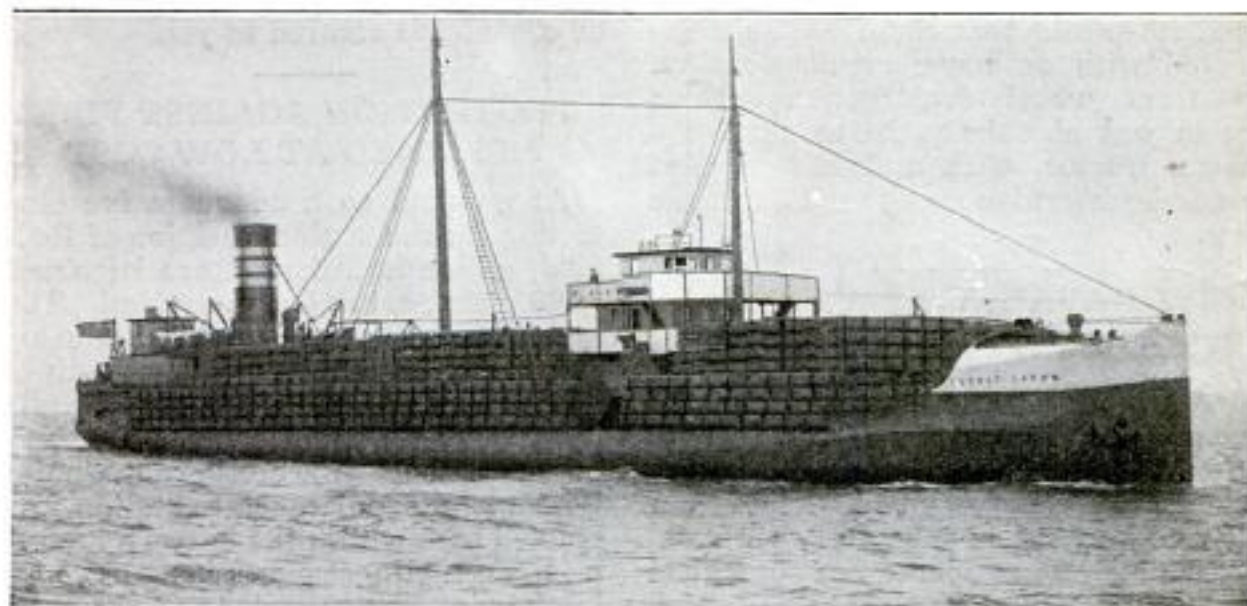

Freighter Traveling Northward from Panama Canal with an Enormous Deck Load of Flat Cars to be Used in the Construction of the Government Railroad in Alaska: Below Deck the Vessel Carried Car Wheels, and Eight Locomotives, Knocked Down. The Ship Also Towed a Barge Loaded in a Similar Manner

TRACK-LAYING DRIVE USED ON AN AUTO STAGE

Special wheels of the track-laying type were installed on an automobile

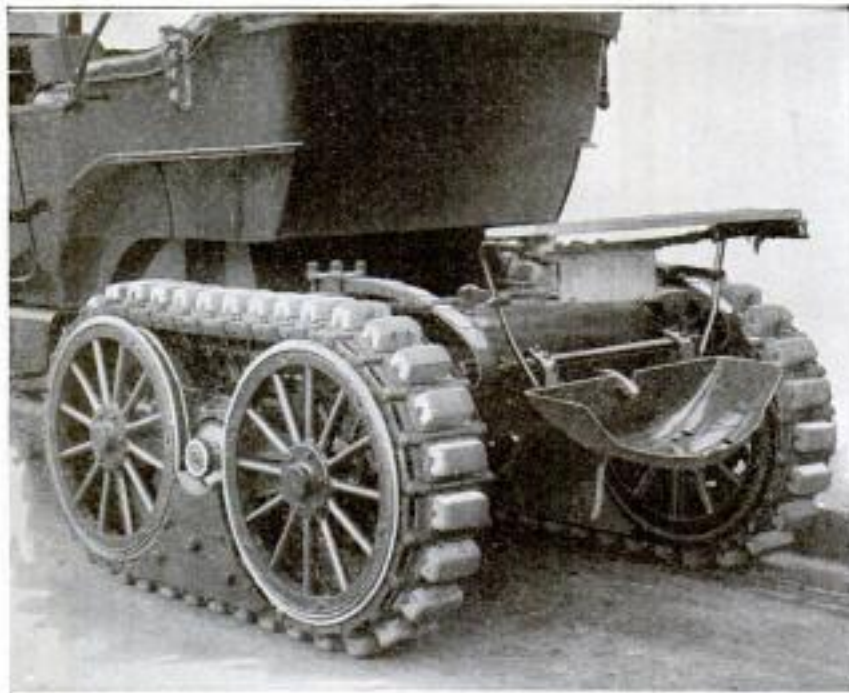

Track-Laying Drive Designed for This Automobile Stage, Which Runs over an Alaskan Route Comprising Hundreds of Miles of Bad Roads

prepared in Seattle for use over the Chitina-Fairbanks stage route in Alaska, a distance of 320 miles. This form of drive was rendered advisable by the nature of the roads encountered on the route, including deep snow, stretches of ice, mud, gumbo, rocks, and steep hills that could not be negotiated with ordinary pneumatic tires. The rear-wheel construction decided upon was as substantial as that of a farm tractor, with a double-wheeled track-laying drive on either side of the car.

NEW NAVAL ALARM REVEALS

NEGLECT BY MAN AT WHEEL

An automatic alarm has been invented by a young naval officer in Ecuador which serves to notify the master of a vessel of any deviation from the course. It is intended as a safeguard against accidents due to neglect on the part of the man at the wheel. The device recently underwent satisfactory tests.

SCIENTISTS BREEDING FROST-PROOF CORN

Investigators for the Department of Agriculture are in a fair way of developing a variety of corn that will withstand frost and will grow at low temperatures. In fact, they have already achieved results along this line, and if their efforts prove wholly successful, the outcome will be to increase greatly the amount of this grain raised by extending the corn belt. The investigators for the government planted a special variety of corn in February, 1917, and found that plants which were several inches high withstood a drop in temperature, on March 5, that froze the

ground to a depth of 2 in. Of even more importance is the fact that some of the individual plants continued to grow during periods of low temperature when ordinary corn would have been at a standstill. Experimentation continues, however, as success cannot be considered assured as yet.

PROTECTION AGAINST FIRE ATTAINED AT LOW COST

At nominal cost, adequate fire protection for the business section of Redfield, a South Dakota town of about 3,500 persons, has been provided. The system is one that might prove valuable as a model for other small communities where similar conditions prevail. At the foot of the main commercial thoroughfare there is a creek. On one of its banks a small concrete station was erected and, within the latter, a motor-driven centrifugal pump installed. An intake pipe was extended to the middle of the stream and a 10-in. main projected, for a distance of some four

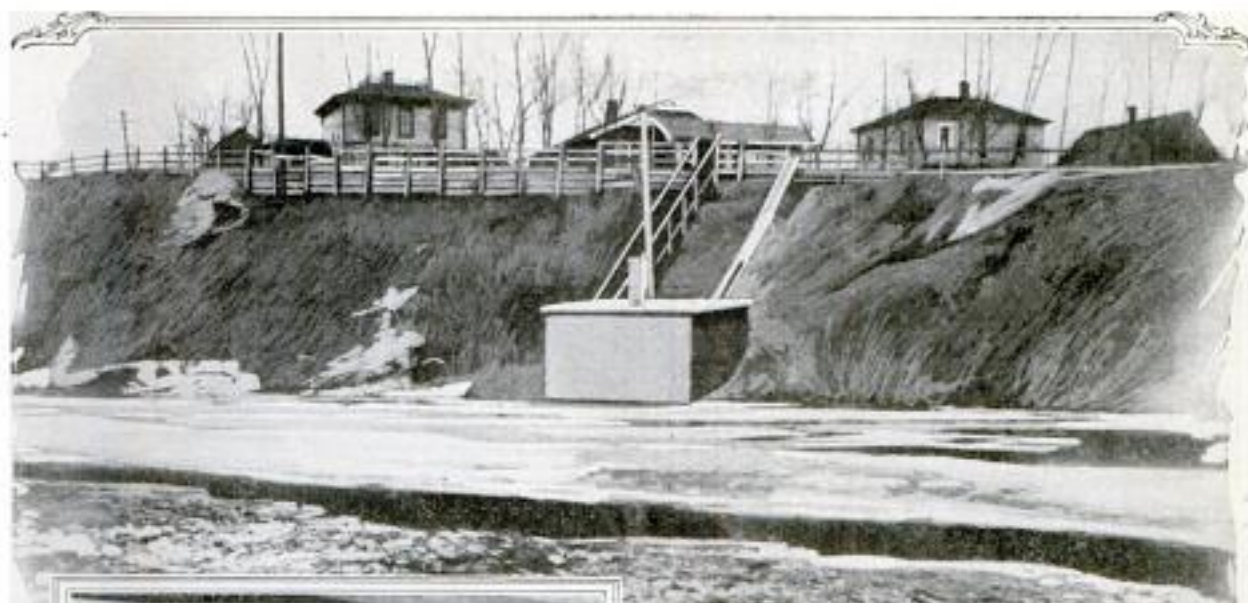

Small Concrete Pump House on the Creek Bank at Redfield, South Dakota: It Serves a Main Used Solely for Fire Protection in the Business District of the Town

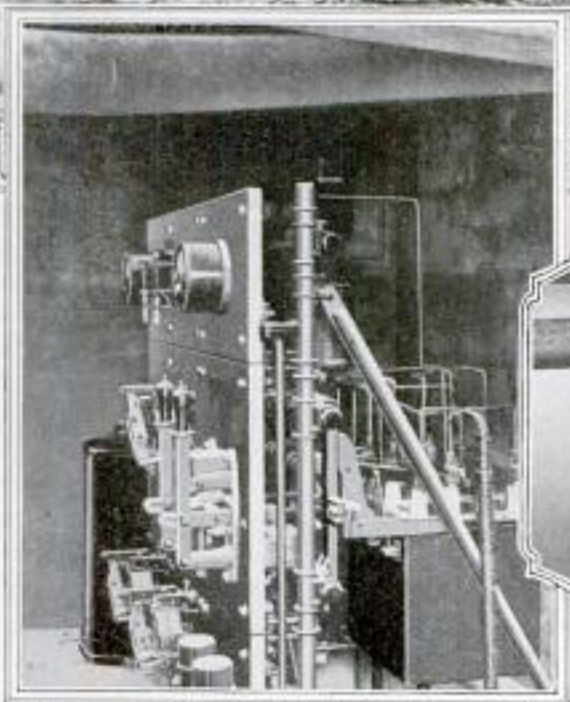

Switchboard Installed in Pumping Plant at the Creek: All Connections are Made so That Current can be Turned On from an Electric-Light Station a Few Blocks Distant

blocks, beneath the business street. Essentially, this constitutes the system, which was provided at a cost of \$8,200. In case of fire, a call is sent to the local electric-power house, where the pumping-plant circuit is controlled. By the time the town fire fighters can assemble, water at a pressure of 110 lb. is available. Otherwise, Redfield's chief source of water is artesian wells. These do not deliver a flow of sufficient pressure for protective purposes. A gasoline pump mounted on a cart is used as a substitute fire engine, and water taken from the regular supply

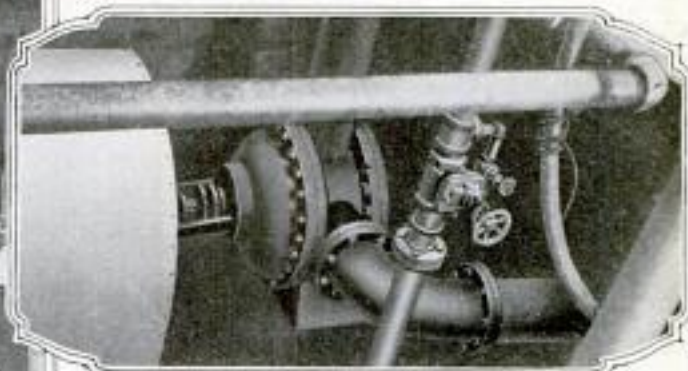

Interior of the Station, Looking into Pumping Pit: The Equipment Is Capable of Supplying Water at Good Pressure for Eight Leads of Fire Hose

mains, when a conflagration occurs in a residential district. If the pumping is continued for long, however, mud and sand are drawn into the pipes in large quantities. The inadequacy of this scheme, for combating large fires, brought about the installation of the special system for the business section.

— 4223 — SPIRAL GRATE IN GARBAGE BURNER HELPS HEAT WATER

A combined incinerator and water heater is provided with a special grate made of brass pipes, on which the garbage is consumed and as it burns helps heat water, thereby effecting a con-

Andrews Hy. Co.
Mpls. Minn.
Copyrighted material

siderable saving in fuel. The burner consists of a vertical boiler having a deep fire pot, above which are numer-

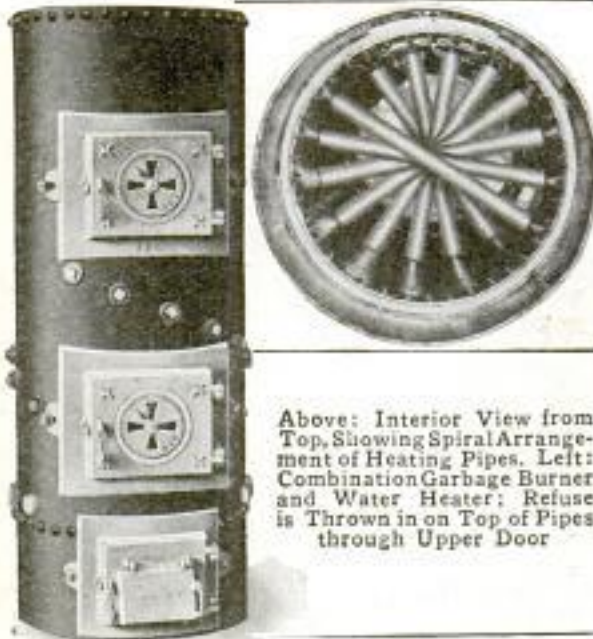

Above: Interior View from Top, Showing Spiral Arrangement of Heating Pipes. Left: Combination Garbage Burner and Water Heater; Refuse is Thrown in on Top of Pipes through Upper Door

ous brass pipes that are arranged spirally and connect opposite sides of the boiler. Waste to be burned is thrown into the uppermost of three doors and spreads out over the spiral grate, gradually dropping lower and lower as it is consumed. Much of the heat generated in this way is utilized in warming the water which passes through the pipes.

ICELESS FOOD CONTAINER INCLOSED IN WATER BAG

A refrigerator which is kept cool by a water bag is one of the recently invented substitutes for an ice-cooled food container. The provision chamber consists of a water-tight copper, or galvanized-iron, box surrounded on all but one side by a canvas water bag

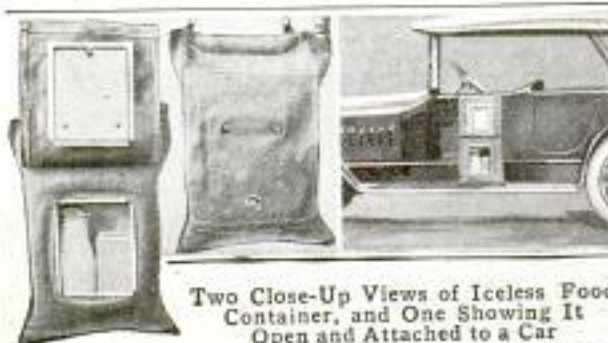

Two Close-Up Views of Iceless Food Container, and One Showing It Open and Attached to a Car

which is kept cool by the evaporation that continually takes place on its moist surface. The lid of the box is fastened to the inner side of a canvas flap which is kept moist by contact with the rest of the bag. A small-sized container of this type measures 8 by 12 by 18 in., while a larger one is made to be attached to the running board of an auto. The latter is provided with a faucet at its lower end, in addition to a capped mouth with which the small bag is also equipped.

ASPHALT-BLOCK PAVEMENT WITHSTANDS AUTO WEAR

Asphalt blocks are now being used in various parts of the country for paving, because they are especially suited to withstand the destructive friction and suction which motor tires exert on a street surface. This paving material is factory-made and produced under conditions more uniform than those of ordinary asphalt surfacing. Each block measures 5 in. wide, 12 in. long, and from 2 to 3 in. thick. The material used is crushed trap rock mixed with asphalt cement at a temperature of 300° F. and fashioned into blocks at a pressure of 7,000 lb. to the square inch. The blocks are laid like bricks in cement mortar on a 6-in. concrete base, no heating plant being required. The cost of the pavement, in place, is about the same as that of brick. As much as 1,600 sq. yd. has been laid in one day by a gang of 16 laborers. Every 15 feet, anchor blocks having strips of steel projecting from their under sides, are laid across the street to prevent creeping of the surface layer. The blocks at the ends of the rows are cut by a machine into the desired lengths. After the pavement has been laid, fine sand is scattered over the top and swept into the cracks. A convenient revolving brush has been designed to do the sweeping. It is mounted between two wheels, driven by gearing connected with the revolving axle, and drawn by a horse. Traffic is kept off the street for a week after the work is finished.

*Barringer Water Bag Refrigerator Co.
Denver, Colo.*



Laying Pavement of Factory-Made Asphalt Blocks: The Blocks are Set in Damp Mortar Made of One Part Cement and Four Parts Sand, and Rest on a Six-Inch Concrete Base. The Anchor Blocks, Which are Used Every 15 Feet and Have Strips of Steel Projecting from Their Lower Surfaces, are Shown in Insert at the Left

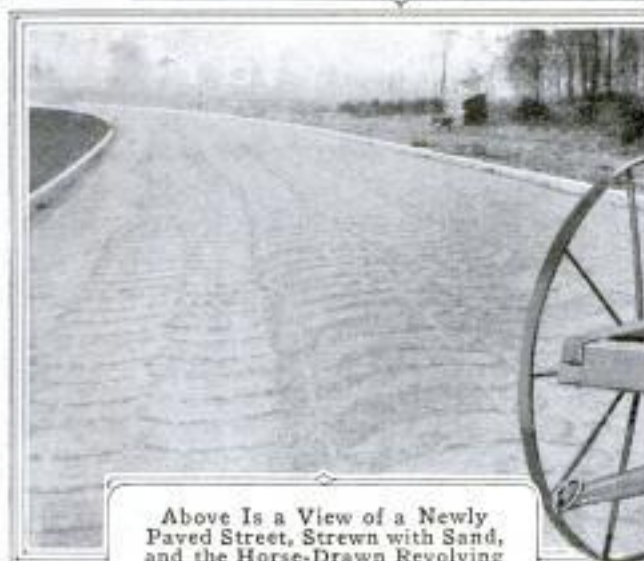

Above is a View of a Newly Paved Street, Strawn with Sand, and the Horse-Drawn Revolving Brush That Sweeps the Sand into the Cracks. Formerly This Work was Done by Hand and Consumed Much More Time

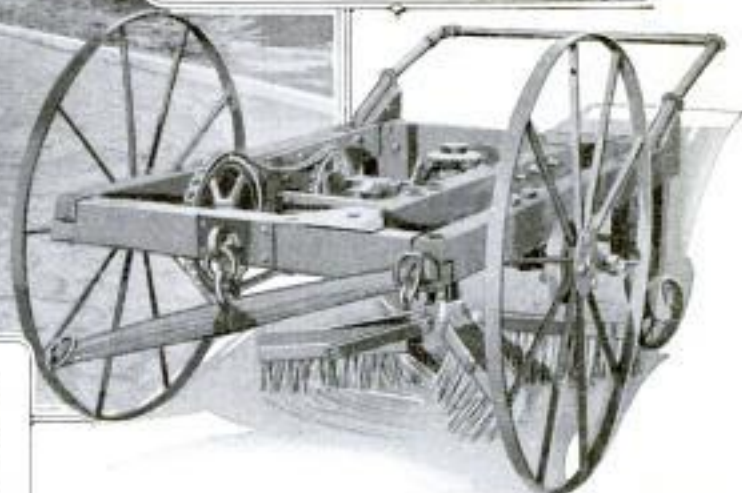

Unloading of the Blocks is Shown at the Right. After the Portable Derrick has Lifted the Cages, Filled with Blocks, from the Truck They are Wheeled to the Crew of Layers

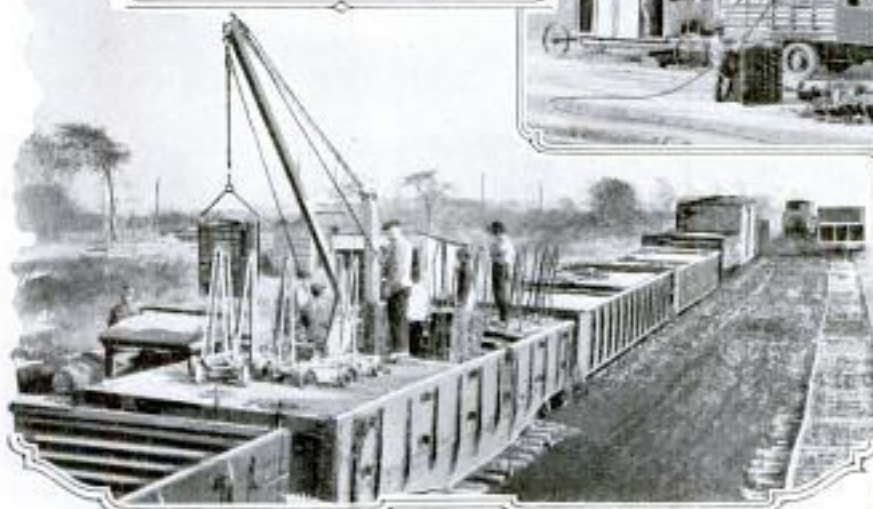

Unloading the Asphalt Blocks from the Cars: To Reduce the Handling of Material to a Minimum, the Blocks are Piled into Low-Wheeled Cages, Some of Which are Shown on the Top of the Car. The Derrick Transfers Them Bodily to the Waiting Truck, from Which They are Eventually Unloaded, by Similar Means, near the Pavers

SURVEYORS BUILD TOWERS IN PRIMITIVE FASHION

The ingenuity of government surveyors to whose lot it falls to make observation records



for triangulation in wooded tracts in the far West or in our distant possessions, is often severely taxed, for if no natural observation points can be found, high towers must be built. In the remote regions where these men work, the facilities for such construction are very limited. In the Philippines, for example, the

surveyors have sometimes been compelled to build crude tall frameworks of slender poles, fastened together with such means as are at hand. The accompanying photograph shows such an observation tower in process of construction. Here tackle has been at-

tached to the top of a giant dead tree, and one of the crew can be seen suspended in mid-air, 100 ft. above the ground.

4657 MANY DIAMOND FACTORIES CLOSED IN AMSTERDAM

Com. Rep. 5-19-17
The cutting and polishing of diamonds, which is one of the important industries of Amsterdam, Netherlands, has been concentrated in 24 of the larger factories in that city so that about 80 of the smaller ones are closed. This move has been taken following a government order that the amount of coal used must be materially reduced. The men employed in the smaller establishments have not been thrown out of work but have merely changed their place of work. However, except for the present depression in the diamond business, such a change could not have been made. Because the war has seriously curtailed the diamond trade, over 5,000 men, out of a total of 11,500, have been idle this spring.

¶ In England men may soon be forced to wear soft collars in place of stiff ones, for it is proposed to prohibit the extraction of starch from cereals.

4502 TRACTOR MAKES LONG HAUL OVER WESTERN MOUNTAINS

The ability of four-wheel-drive trucks to perform reliable service in



Tractor of Four-Wheel-Drive Type and the Load Which It Drew from the Pacific Coast to the Utah State Line in Spite of Miry Roads and Swollen Mountain Streams

a machine of this type, which drew a load of several tons from the Pacific coast to the state line of Utah. The load consisted of two good-sized construction-crew houses mounted on running gears and carrying a large amount of telephone equipment that was distributed along the way. At several points the rough trail which was followed ascended to an altitude of 10,000 ft. and in many places swollen streams and miry roads blocked the path. But in spite of all obstacles the overland train arrived

in spite of great handicaps is vividly illustrated by a trip recently completed by

at its destination in safety after having been on the road several weeks.

*Grady Motor Car Co.
Salt Lake City, Utah.*

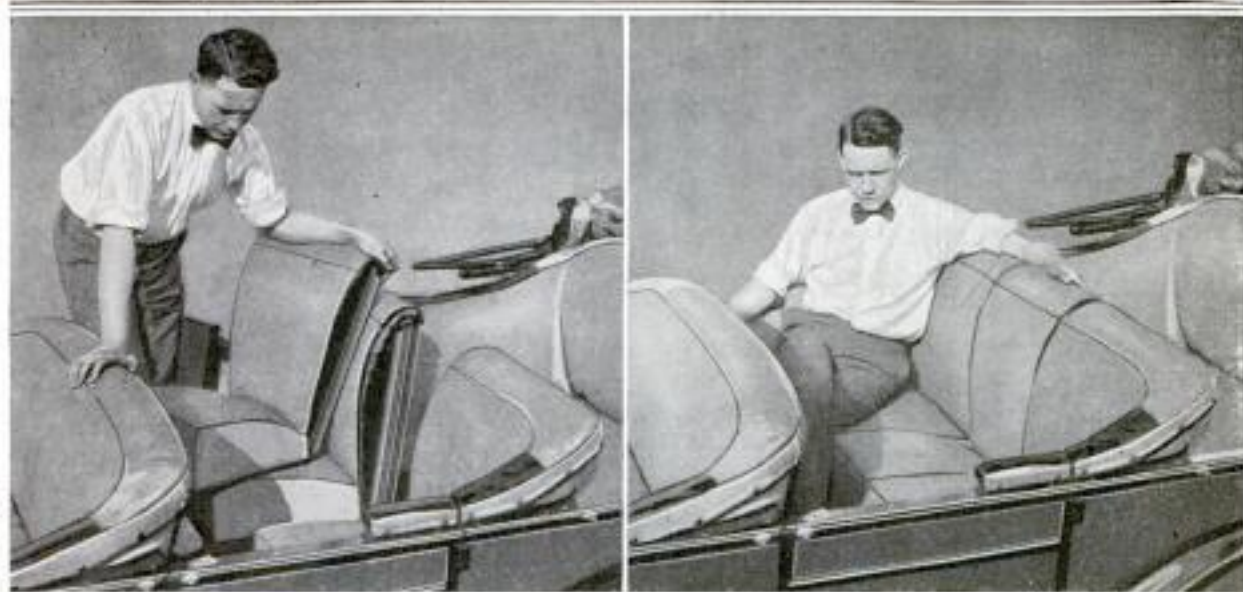

Seating Arrangement of New Automobile Stages in California: Removal of the Central Seat in the Middle Row Allows Access to the Rear Seats. The Car Holds Eight Comfortably

NOVEL SEAT ARRANGEMENT OF STAGE-LINE CARS

The motor cars for a new stage line in California are of the seven-passenger type, but comfortably accommodate eight by the installation of a deeply upholstered middle section instead of the usual auxiliary seats. The central part of this section is removable, to provide access to the rear seats. When in place, its tongued edges fit snugly into grooves in the middle section. The cars of the new line have distinctive names, as "Bret Harte," "Mark Twain," and "Roaring Camp," to serve as a sort of link between the new means of transport and the stage-coach period of the Golden State.

LIFEBOAT WITH WINGLIKE RAFT ON EACH SIDE

Rafts that spread out on either side of a lifeboat like wings have been devised for a life-saving craft of new design, for the purpose of increasing its capacity and stability. These wings are hinged to the sides close to the water line, and are provided with metal floats on their under sides to give the craft additional buoyancy. On deck these boats occupy no additional room, for the rafts fold down against the sides of the hull and serve as sup-

ports. When the boats are lowered the wings spread out in the water automatically. The outer edges of the rafts on each boat are connected by cables which extend under the hull, passing through pulleys at the keel. When a wave raises one wing up, the opposite one is drawn down correspondingly. The object of this arrangement is to help keep the boat stable. The wings also act as buffers. While a lifeboat stands close beside a vessel at sea, the rolling motion of the big hull will have less tendency to upset the little craft because of the up-and-down play of the raft. Small boats of this sort would be rowed, larger ones driven by motors.

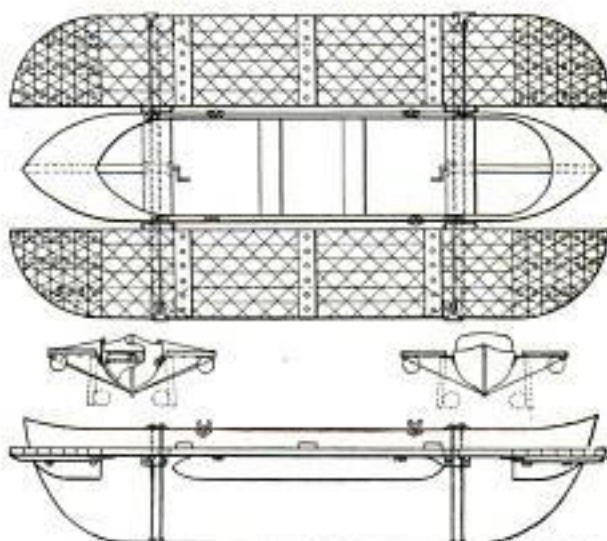

Top, End, and Side Views of Lifeboat with Hinged Side Rafts, Which can be Used as Supports on Deck

Ed. L. Kellan (Inventor)

661 Riverside St., Copyrighted material

Pat. No. 1,311,300, Board Co.
Attention F. B. Elliott
 216 **4470 POPULAR MECHANICS**
 331 *H. K. Dr. Pittsburgh, Pa*

**BARBER-CHAIR ATTACHMENT
 SIMPLIFIES SHAMPOOING**

A narrow drain board of aluminum has been devised which attaches to a barber's chair in place of a headrest and

Patented April 17-1917.

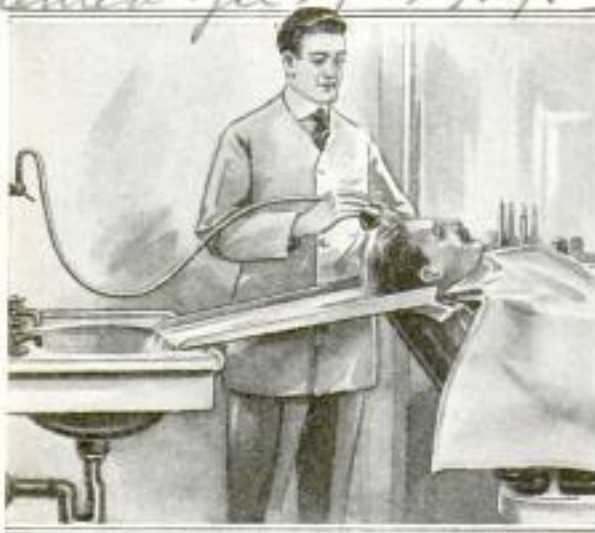

An Aluminum Drain Board Which Attaches to a Barber Chair in Place of the Headrest, Enabling the Customer to have His Head Shampooed without Leaving His Seat

enables the barber to give a customer a shampoo without the latter's leaving his seat. After the back of the chair has been lowered to an almost horizontal position the customer rests the back of his head on the end of this board. The outer end of the attachment slants down to a washstand, and as the barber cleanses and rinses the hair the water drains off into the bowl.

4629

**KEEP COLLEGES FILLED
 IS PATRIOTIC PLEA**

Off. Bulletin 5/25/17

Instead of being diminished, as now seems probable, the number of men attending college ought to be larger than usual next fall, according to government officials who have made a study of the country's educational needs and are looking to the future and the relation of the present great emergency to it. It is pointed out that, for patriotic reasons, as large a number as possible should enter higher institutions of learning and thereby gain the advanced training so necessary for future leadership in various lines. In normal times, there are about

350,000 students in the colleges, normal schools, and technical and vocational schools of the higher grade. It is inevitable that the number in the upper classes will be diminished, but this deficiency should be made up by increasing the enrollment of the lower classes. In a short time there may be a great need for more trained officers, and after the war there will be a tremendous demand here and abroad for young engineers and scientific men, in industry, transportation, etc. The war has already greatly enlarged the field of women's endeavor, and there is sure to be an unprecedented demand for trained women.

4525

**PORTABLE WOODEN GARAGES
 RENTED BY THE MONTH**

Portable garages, which can be rented by the month or bought on the installment plan, are among the latest conveniences devised for the motorist. The idea originated with the wife of a milling company's manager. Should a car owner, living in the city where these structures are made, decide that he needs one, all he has to do is to call the manufacturers on the telephone and in a short time the garage is delivered and set up in his back yard. It is transported either knocked down or with the parts assembled, according to the accessibility of the site selected for it. Each shelter measures 17 by 9 by 8 ft., and has two windows in the double doors constituting the front end. The

W. D. McGowan, Milling Co. Car Parts & Milling Co. Portland, Ore.



Type of Portable Garage Which Measures 17 by 9 by 8 Feet and Rents for \$2.50 per Month: It can be Transported Either Knocked Down or with Parts Assembled

Dr. P. P. Claxton
U. S. Commissioner of Education



Hauling a Log Out of the Woods with a Sky-Line Trolley: The Top Cable is Held Fast by a Donkey Engine, Which Also Pulls the Log Out by the Line Attached to Its Forward End

lower portion of the sides are clap-boarded and the remainder shingled. Tar paper is used for the roof and the sills are of redwood, which does not decay easily.

“SKY-LINE” LOGGING METHOD OF WESTERN CAMPS

In the logging camps of Oregon and Washington a “sky-line” method of logging is proving much cheaper and more efficient than the former method of dragging out logs from the forest by a donkey engine and cables operating on the ground. The sky-line plan is to run a cable through blocks or pulleys suspended at a great height on giant trees, so as to form a sort of trol-

ley line, by which the logs are hoisted into the air and then hauled over the tops of ordinary trees and other obstructions to the rollway, where they are loaded aboard freight cars for shipment. The donkey engine which operates the sky line has five drums, including two for main lines and two for trip lines. The top cable, from which the log is suspended, is one of the main lines, while the other is used to haul the log. In operation the top cable is lowered with its block, or trolley, directly over the log to be picked up; it is then pulled taut, raising the log with it by means of a “choker,” or steel tongs. In the air a log can, of course, be moved much faster than on the ground.

STORAGE-BATTERY LIGHTS MAKE TUNNEL WORK SAFER

As a special safety measure, storage-battery lights have been provided for

and the resulting explosion killed nearly a score. The cap of each worker is now equipped with a storage-battery lamp, which is locked with a key to which the men do not have access.



Group of Tunnel Workers in Cleveland with Portable Storage-Battery Lights in the Foreground. Some of the Men's Caps are Equipped with Electric Lamps Also

Powerful portable lights are also used. These were constructed by installing storage batteries and automobile headlights in heavy cases that are locked so the men cannot tamper with them. Some of the cases have two lamps and others one. The former are recharged every eight hours, while the latter will run 18 hours. It is believed that this means of lighting provides an adequate safeguard against further explosions. At the same time the advantages of electric lighting have been retained.



The Portable Lights, Showing the Storage Batteries in the Center and the Lamps Installed at Either End

the men that are digging the Cleveland water-works tunnel under Lake Erie. Formerly the lights used were on an ordinary circuit, but last July a chance

electric spark ignited the marsh gas that had accumulated in the tunnel,

4352

MOTOR-CAR LOCK COMBINED WITH STEERING WHEEL

A steering wheel is now being installed on cars of various makes which is provided with a special lock at its center, comprising a hexagonal hub and a set of tumblers.



When a car so equipped is to be used, the hub is locked rigidly to the rest of the steering apparatus, giving

the driver complete control. A turn of the key with which the lock is provided disengages the steering wheel from the hexagonal hub so that the former can be made to spin freely on its axis, leaving the front wheels entirely without means of control.

Designs for a low-priced tractor of a well-known American make have been adopted by British authorities, who are asking English manufacturers to cooperate in producing uniform parts according to the plans and models furnished by the American owner.

Perry Auto Lock Co.
1238-40 Mich. Av., Chgo.
Copyrighted material

Westinghouse, Church, 12000 St.,
37 Wall St., New York.



View of Marshy Shore of Long Island That was Made Over into a Golf Ground

TRANSFORMING AN OCEAN MARSH INTO A GOLF COURSE *Link*

By STANLEY W. TODD

AS a rule, the average golf course is located many miles from the ocean front. The low, level land along the Atlantic coast, particularly, does not lend itself very readily to the uses of golfers, who prefer hilly slopes and advantageous mounds for tees and hazards. Handicaps such as these, however, did not deter a group of wealthy landowners from establishing a golf course on a 200-acre plot facing the ocean near Long Beach, L. I., when the matter was first considered two years ago.

Today, the course is in the last stages of completion, and promises to be one of the most difficult

in the country. But the undertaking was not a simple one, and it stands out prominently as a golf-club exploit, for there are not many clubs willing to go to the heavy expense involved, to have the ocean on one side of their course.

When the course was planned as the major part of the exploitation of the plot, it was nothing more nor less than a sandy marsh. On the north was a shallow channel; on the south, the ocean. Otherwise, the plot was like hundreds of acres of beach land to be found almost anywhere along the Atlantic. The engineers had a big problem before them. The highest sand dunes were a little above the high-water mark; much of the land was covered with water, and filling in by the ordinary hydraulic methods was undertaken at once.

Five dredges of various suction types were installed in the channel. Galvanized-iron sheets were placed at convenient points to hold the sediment and, piping being carried to the most

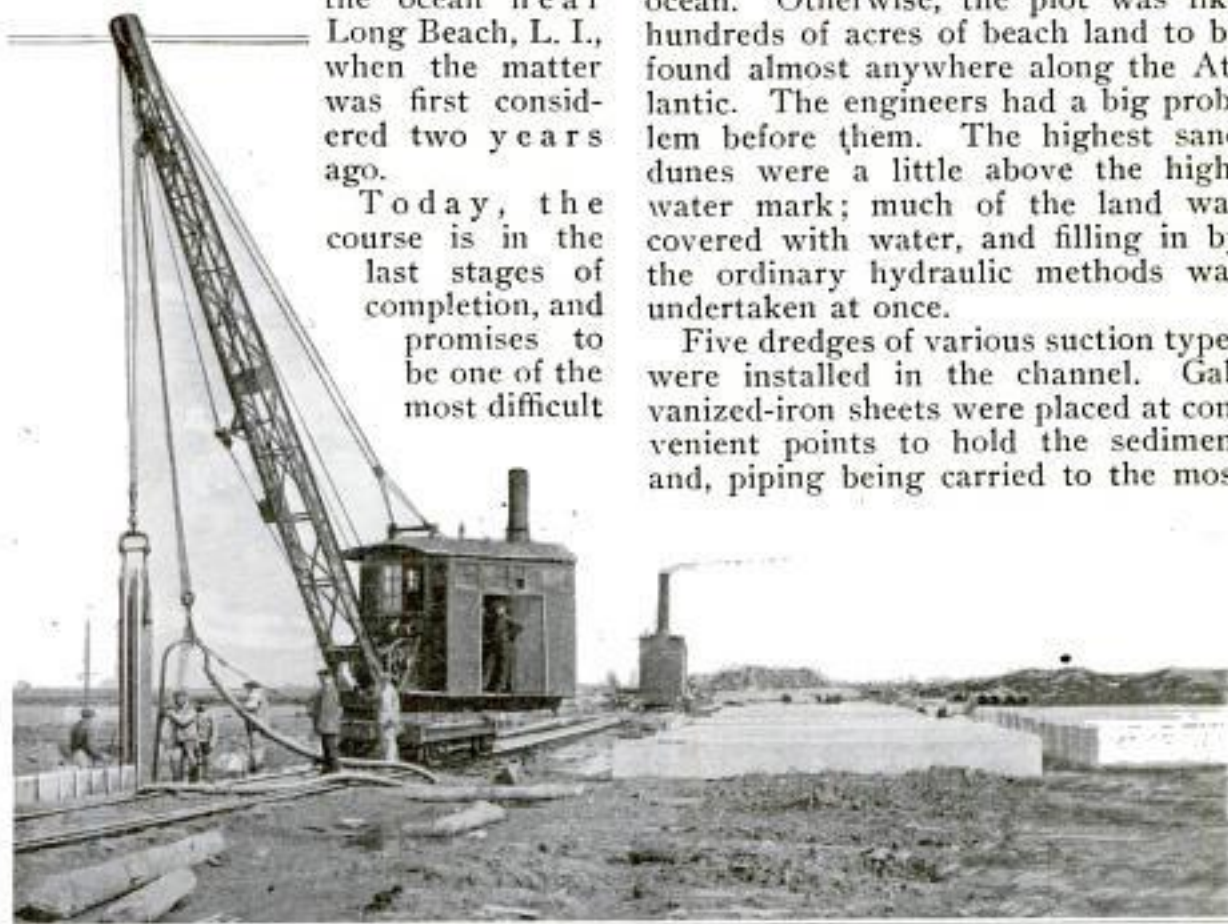

Sinking the Concrete Piles Forming the Bulkhead Which Permitted the Dredging of the Adjacent Channel to the Desired Depth: The Piles were Lowered with the Aid of High-Pressure Water Jets

suitable places, the pumping started. By this hydraulic fill, which delivered 20-per-cent solid material, the land was slowly filled in and the pools and bays began to disappear. Over a space 2,360 by 4,000 ft. in extent the land level was raised from 5 to 8 ft. with mounds at certain points as high as 25 ft. At the same time, the channel was being deepened from 8 ft. to 60 ft., although half the latter depth would have been enough for waterway purposes.

In order to keep the land from washing into the channel, it was necessary for the engineers to construct a reinforced-concrete bulkhead of the ordinary tongue-and-groove style, and then dredge the shore in front of it. The concrete piles, which were made on the ground, were lowered into position by means of a locomotive crane and high-pressure water jets. When this was completed, the northern boundary of the course was a solid concrete wall abutting on Reynolds Channel.

Then came another improvement, namely a lagoon, more for ornament than for practical use, not very far back of the concrete channel abutments. A converted dredge of the

dipper type, adapted for movement on tracks, was brought into position and loaded excavated soil upon small dump-carts for filling in at other points in

the development. The completed lagoon is quite extensive and has as a distinctive feature a picturesque island in the middle.

While all of this was going on, the ocean front needed attention. The heavy seas characteristic of the

south shore of Long Island threatened to wash away, or shift, the sand in a way to interfere with the development. The engineers decided to forestall trouble by sinking rows of wooden piles, all along the 2,360 ft. of beach, 12 ft. apart, in rows of a dozen every 300 ft. But instead of planking up the piles in rows of solid walls, as is sometimes done, only the bases of the rows were boarded up, thus avoiding the creation of eddies which do more to tear down the beach through the action of the waves, than to protect it and build it up, as intended in this particular case.

With the completion of the filling-in operations



The Dredging of This Lagoon, with the Island in the Center, Was One of the Costly Features of the Big Reclamation Project



Protecting the Ocean Side of the Golf Course from the Action of the Waves: Wooden Piles were Sunk at Intervals and Boarded Up in Such a Way as to Avoid Producing Destructive Eddies



Leveling with Scrapers After the Filling-In had been Completed: This View Gives a Good Idea of the Large Scale on Which the Operations were Conducted

came the large task of leveling the tract as much as feasible. Teams of plow scrapers were employed to make certain selected portions suitable for subsoil and eelgrass, to hold the sand in windy weather. Then, too, there



A Finished Tee: The Work of Reclaiming the Big Tract, Begun in the Latter Part of 1914, is Now Nearly Completed

were places to be tufted and covered with grass, according to the plans. Now the golf course is assuming shape, with the green-covered tees and bunkers looking like veritable islands in oceans of sand. Eventually it will all be covered



Preparing Subsoil and Putting In Eelgrass: The Latter was Employed at Various Points to Prevent the Sand from being Swept Away by the Strong Winds. Other Parts were Tufted and Covered with Grass to Serve as Tees and Bunkers

like the ordinary course, but top soil has to be brought a great distance, and grass does not grow on ocean shores very readily. In addition to all these operations, it was necessary to pipe the course with a sprinkler system, to keep the ground in good condition for play.

The southern portion of the develop-

ment is given over to a residential area, but the golf course will probably remain for many years. In the meantime, it will be unusual, if not unique, in having an ocean frontage, and a channel on the north side that will permit the members to journey to the course in motorboats.

3115
**SAFETY-FIRST GUARDS AT
 GARAGE ENTRANCE**

Because many motorists are apt to mar or bend the fenders of their cars by



driving through a doorway carelessly, a garage owner in Los Angeles has so placed strong guards at either side of his garage entrance, next to the floor, that injury to fenders is quite improbable. The

guards are big, rounded iron castings which project far enough from the walls to turn a wheel to one side before any part of a car body strikes the door frame. Each is painted white and bears the words "Safety First" in red letters.

3564
**CURTAIN-ROLLER MOUNTINGS
 HELD WITHOUT SCREWS**

Mountings for roller shades have been invented by means of which win-



These Mountings Hold the Curtain Roller in Position by Means of Buffers That Press against the Window Jambs but do Not Mar Them. It Is Only a Matter of a Moment's Work to Put Up a Roller or Change Its Position

dow shades can be installed without tools and without marring the woodwork. Each set of mountings consists of a pair of small cylinders, one with an opening in one end to receive the roller spindle, and the other similarly made to fit over the key at the opposite end of the roller. The outer ends of the mountings are provided with buffers that are pressed against the window jambs by a coil spring contained in each cylinder. To install a roller the mountings are fitted on its ends and pressed inward so that the roller can be inserted between the sides of the window frame.

4500
**RAIL-BREAKING MACHINE
 TEARS UP TRACKS**

When new street-car tracks are to be laid on any of the business thoroughfares of St. Louis, the work of tearing up the old tracks laid in concrete is facilitated by the use of a rail-breaking machine that saves much time on the job. This machine was built in the street-railroad shops by the company's own men and has proved very effective. It is a strongly built wooden work car, weighted down at one end with scrap iron to give it stability, and equipped with a powerful electric motor. This runs a drum, around which wind heavy chains that pass over a pulley and are hooked on to the rails to be removed. Two posts with steel tips rest on the track in front of the car and as the chains pull up the ends of the rails, the latter break under these posts. Rails and ties are torn out of the concrete at one operation, the rails being broken into lengths of about eight feet, which makes them easier to handle and to dispose of as old iron. Ten blocks of

Eugene N. Stern
 225 N. Main, Boston, Mass. Copyright 1914

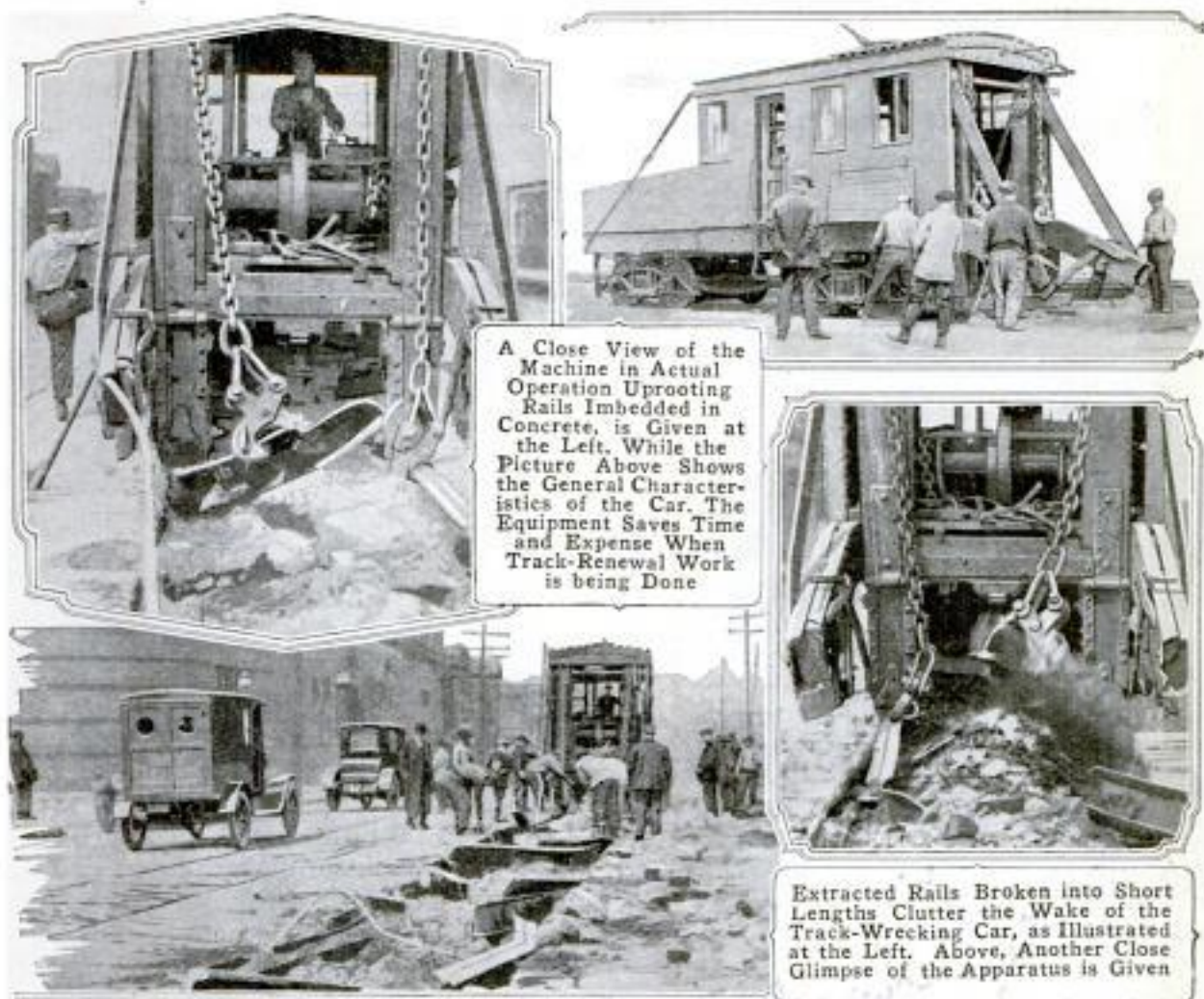

A Close View of the Machine in Actual Operation Uprooting Rails Imbedded in Concrete, is Given at the Left. While the Picture Above Shows the General Characteristics of the Car, the Equipment Saves Time and Expense When Track-Renewal Work is being Done

Extracted Rails Broken into Short Lengths Cluster the Wake of the Track-Wrecking Car, as Illustrated at the Left. Above, Another Close Glimpse of the Apparatus is Given

track have been torn up and relaid in about two weeks when this machine was used, it is stated, whereas, when manual labor, picks, and shovels were employed in the work of removal, the time required was nearer two months. Only a small crew is needed to operate this machine.

4387— COMBINED STEAM TURBINE AND BOILER-FEED PUMP

By a recent development of the centrifugal boiler-feed pump in the direction of compactness and simplicity, a 3,000-hp.-boiler feeder is combined in one casing and on one shaft with a steam turbine. This combination weighs only about one-tenth as much as an ordinary duplex reciprocating pump of the same capacity, and occupies only about one-eighth as much floor space and one-fifteenth as much

cubical space. The pump end contains two single-suction impellers cast from special bronze. The steam end consists of a turbine with either two or three rows of moving buckets, according to the extent of steam economy desired.

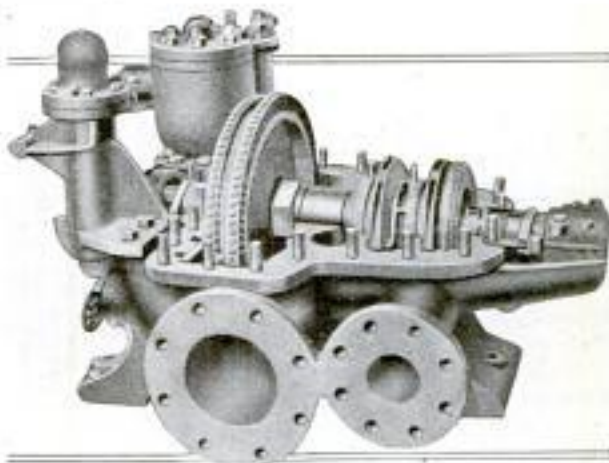

Combined Steam Turbine and Centrifugal Boiler-Feed Pump, with Casing Cover Removed, Exposing the Turbine Rotor and Pump Impellers

*De Laval Steam Turbine Co.
Trenton, N. J.*

*#Geo. H. Gibson Co. Tribune Bldg, N. Y. C.
Advertising Engineer.*

Taylor Registering Projector Co.,
717 Title Bldg.

4353 POPULAR MECHANICS Baltimore Md

REGISTERING PROJECTOR FOR PRINTERS

A new machine for use in printing establishments utilizes the principle of



Registering a Printer's Form for the Press by the Aid of a New Projector, Which Throws an Image of the Copy Downward from Above: The Man Works inside a Curtained Inclosure While Adjusting the Plates

the opaque optical projector—the kind that projects post-card pictures and the like—for the purpose of registering plates in a form; that is, adjusting them accurately in position, so that

line falls upon line, or edges correspond, as in color printing. A copy of the registering plan, or detail, is placed on a glass plate facing downward, at an angle, at the top of the machine, and an image of this detail is projected onto the form below. The image is stationary, and the plates are moved by the operator until they coincide with it in the form.

MACHINE FOR STERILIZING BOTTLES

Bottles which have contained mineral water or other liquids are prepared for refilling by a machine, manufactured in Milwaukee, which automatically performs the six operations of soaking, brushing, washing, sterilizing, rinsing, and cooling them, untouched by human hands. The bottles are placed in carriers, or racks, at the loading end of the machine, each carrier consisting of a series of pockets, from 8 to 20 in a row according to the capacity required. By the power of a motor of from 2 to 4 hp., the bottles then pass over a series of sprocket wheels into successive compartments of the soaker, three of which contain solutions of caustic soda at increasing temperatures, and the fourth fresh water at 200° F. Thence they go to revolving brushes which scrub them

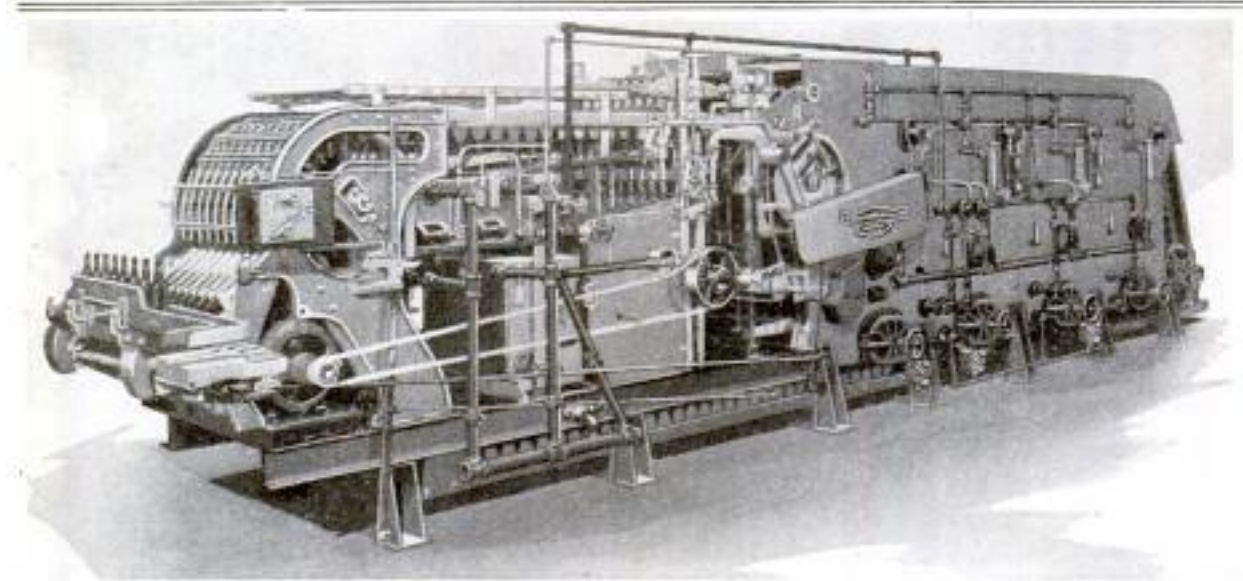

Soaking, Washing, and Sterilizing Machine Which Automatically Cleanses 100 Bottles a Minute: Several Soaking Compartments Contain Hot Solutions of Caustic Soda

20th Century Mch Co.
Milwaukee, Wis.

thoroughly outside, and then they are brushed internally and rinsed twice with water at 170°. After this they receive four more rinsings at decreasing temperatures before going to the filling machine.

— 4645

PATRIOTIC PRINTING JOB DONE IN RECORD TIME

Chgo. Tribune 6-5-17

A patriotic desire to place the president's historic war message in the hands of every young man who was to register for the draft June 5, was the stimulus that made possible an achievement in printing which is believed to be a record in many respects. At a late date it was learned that the government's printing establishment would be unable to print copies of the message for nation-wide distribution, and in the emergency a printing firm in the middle West undertook the task. The type for the printed matter was received at 11 a. m., May 31. At 4 p. m. the same day 16 plates of each of the two pages into which the message was divided, had been received from the foundry and were on a press. Soon after, two other presses were started, each with 32 plates of each page. In a continuous run, which lasted 79 hours, the three presses turned out over 10,000,000 copies of this memorable address. As fast as they were printed they were bound in bundles and expressed to registration officials in every state in the union. The undertaking, which cost about \$50,000, was financed by Mrs. Emmons Blaine of Chicago.

— 3822

WEAK BATTERIES UTILIZED FOR CAR WORKERS' LIGHT

An electrician employed by a railway in Portland, Me., has devised a very serviceable lighting outfit for use by car inspectors and repair men, which is supplied with current from the storage batteries belonging to the car on which the men are working. The outfit displaces kerosene lamps, formerly used. It includes a low-voltage bulb set in a reflector mounted on a tripod and connected by a cord with a resistance coil.

The latter is connected with the storage batteries under the floor of the car. When the charge in the batteries



Portable Lighting Outfit for Repair and Inspection Crews Supplied with Current from the Car's Storage Batteries: The Resistance Coil Shown is Employed to Keep the Light Constant as the Supply of Electricity Diminishes

gets low the adjustable contact on the coil is moved along so as to lessen the resistance. Thus, with a diminishing supply of electricity the power of the light can be kept constant by adjusting the coil from time to time.

— 4517

PERILS OF DESERT ROUTE TOLD IN HIGHWAY SIGN

The warning sign shown herewith has been erected lest motorists enter unaware upon this desert road in the Southwest, along which neither drinking water, oil, nor gasoline can be ob-



Warning Sign at One End of a Stretch of Desert Road along Which Neither Drinking Water, Gasoline, nor Oil can be Obtained for a Distance of 40 Miles

tained for a distance of 40 miles. At the opposite end of the barren stretch is a similar notice. The signs were erected by an automobile club.

*Inw. - Wm. L. Foss,
684 Forest Av., Woodford, Me.*

3483 POPULAR MECHANICS *Unusual*
CONVERTIBLE STREET CAR HAS EXTRA-LONG
WINDOWS

A New England street-railway company is experimenting with a type of street car for summer and winter use, the sides of which are practically all glass.

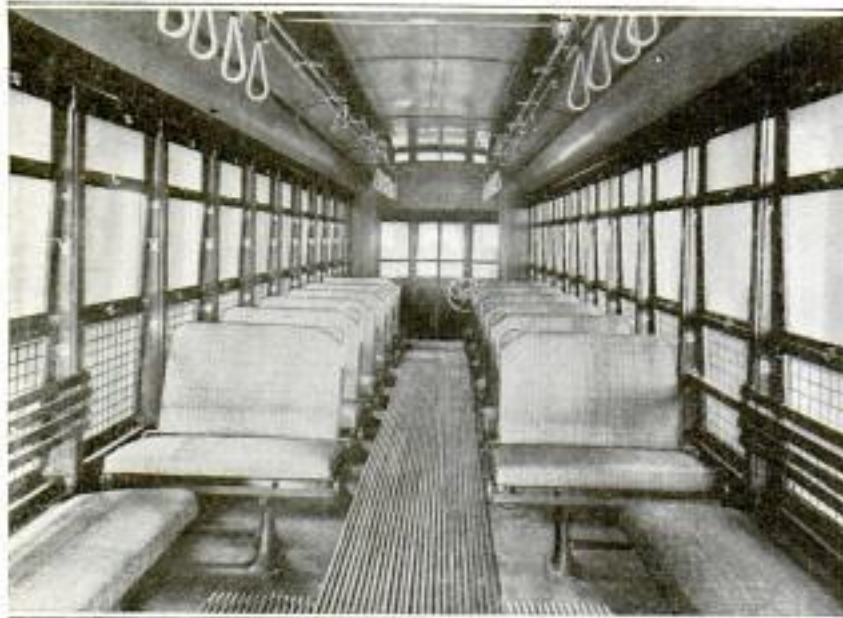

Convertible Street Car Having Windows That Extend Down to the Level of the Seats and so Flood the Conveyance with Light: This Arrangement Makes a Maximum of Fresh Air Available for Summer Service

The windows are made in three sections and extend down to within about 18 inches of the floor. The lowest section in each window is composed of small square panes, leaded. The seats placed lengthwise at either end of the car are provided with backs consisting of sets of slats fastened in front of the lower portion of the windows. With so much glazed wall space a conveyance of this type can be converted into what is practically an open car, for summer use.

4341 Industrial
NEW TRUCK AND JACK FOR
HANDLING HEAVY LOADS

A new three-wheel truck, with which heavy machinery can be moved with

"U" at any point desired. The frame is backed around the object and one end of the latter raised by the jack. A strong rod is then placed under the load, close to its lower end, in such a position that it passes through the hollow axles of the two wheels. By lowering the load the heavy object is automatically lifted off the floor, the rod serving as the fulcrum, so that the truck then bears the whole weight of its load.

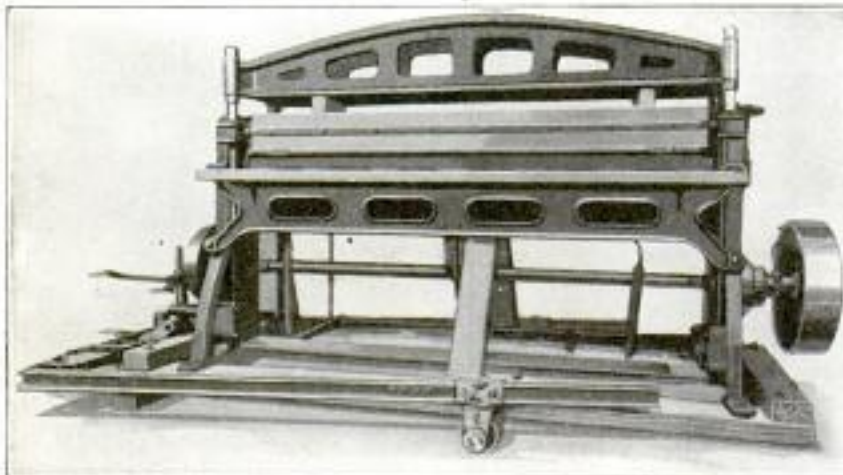

An 8,500-Pound Machine Which was Lifted onto the Truck Shown in 10 Minutes

ease, has a U-shaped steel frame, at the closed end of which is a powerful jack mounted above one wheel. The other two wheels have hollow axles and can be attached to the arms of the



The Jack by Which the Load is Tilted is Shown at the Right-Hand End

F. J. Bloodgood Co., Binghamton
(Inv.) V. E. Beagle
Copyrighted material

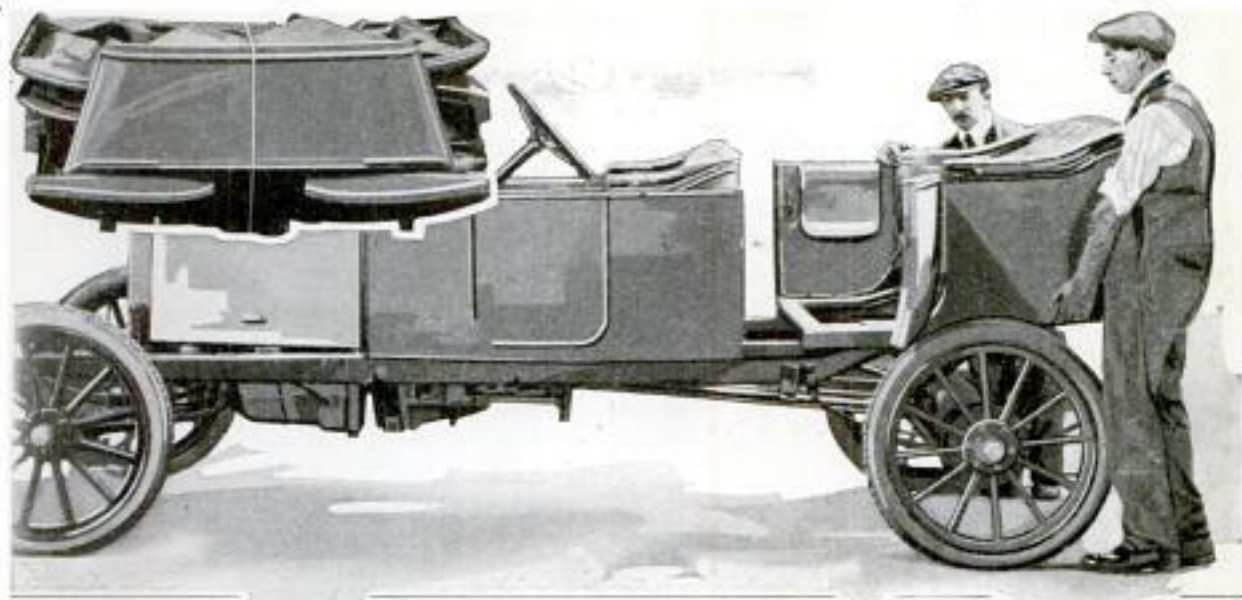

Auto Body Made in Sections, so That It Packs Flat for Shipment: The Men are Removing the Rear-Seat Section Bodily, Though It Consists of Three Parts. Above is Shown a Car Body Taken Apart for Shipment in a Box

4391

AUTO BODY PACKS FLAT IN SECTIONS

A motor-car body made in sections, so that it will pack flat and occupy little space in shipment, is an idea recently introduced from South Africa, where it originated. The parts are made with upholstery attached, and a few bolts hold the sections firmly together without rattling, while the appearance is that of a standard body. A four-passenger body of this kind reached the United States in a packing case of only 66 cu. ft. capacity, and it is claimed that this form of construction will enable 12 packed bodies to be shipped in a box car that would contain only six of the ordinary bodies.

4646

MILLION-DOLLAR AVIATION SCHOOL NEAR DETROIT

A small army of laborers, representing many lines of construction, have been working with all possible haste on the government's new \$1,000,000 aviation school, which is being built not far from Detroit, on the shores of Lake St. Clair. The school will be what is known as a one-squadron plant, with 12 hangars, each capable of sheltering 12 machines, and with six barracks, which will house 150 men each. The equipment will include

separate quarters for the officers, a club, a school building, measuring 200 by 60 ft., a hospital, a heating plant, and a sewer and water system. Though much of the construction will be of a semitemporary character, it will be thoroughly modern and sanitary.

4385

ELECTRIC RADIATOR WIRED TO ANY LAMP SOCKET

A portable electric radiator has appeared in the market, furnished with a cord and plug for attachment to any lamp socket. It is made with a dull-black casing and a screen through which coils of wire glow, when heated, against a polished reflector.

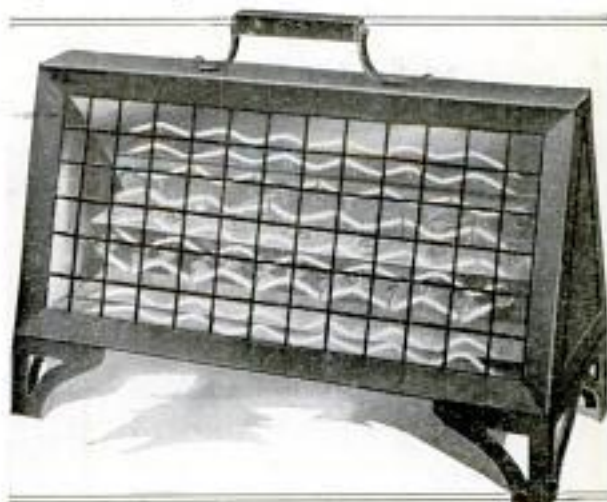

This Portable Electric Radiator Is 12 Inches High and Weighs Only Five and One-Half Pounds

Worcester Electric Htg. Co.
Cambridge, Mass.

Copyrighted material

INEXPENSIVE FURNITURE OF INGENUOUS DESIGNS

Chs. 2.50, 3.50, 4.50

2.80 4.00 5.00



Hexagonal Table, with Drop Leaves, and Odd Chair: Flower Holders Are Test Tubes Set in Holes. Underneath Are a Compartment, a Shelf, and a Linen Drawer

There Is a Place for Everything in This Child's Costumer. Each Hook and Shelf Has a Special Use

2.50
3.50
4.50



Simple Candelabra Suitable for Use over Table Shown Above: Cords Are of Knotted Hemp Rope



Triangular Dressing Table Built for a Corner: Behind Middle Mirror and in Candle Posts Are Shelves. Under Chair Seat Is a Compartment



2.28
3.20
4.20

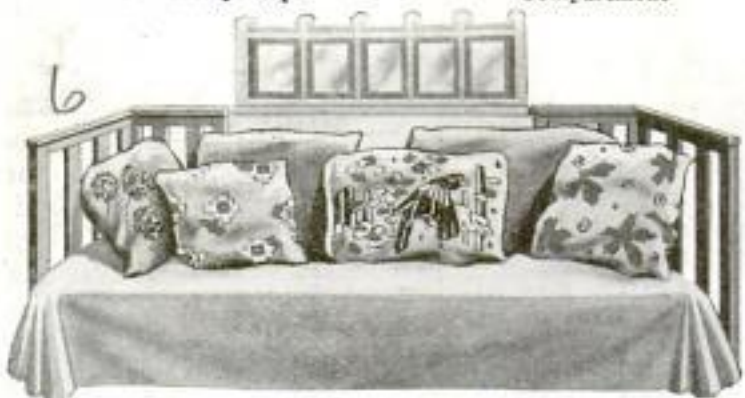

By Reason of the Mission-Style Davenport Ends on This Couch It can be Used with Pleasing Effect under a Window



Above Are Two Views of a High Chair That can be Changed into a Low Chair and Table. Under the Seat Is a Place for Baby's Things

5.50
7.75
9.50

APPROPRIATE FOR A HOME OR SUMMER COTTAGE

3 50
5 20
6 25



Chair with Colorful Panels of Chintz and a Handy Storage Place under the Seat

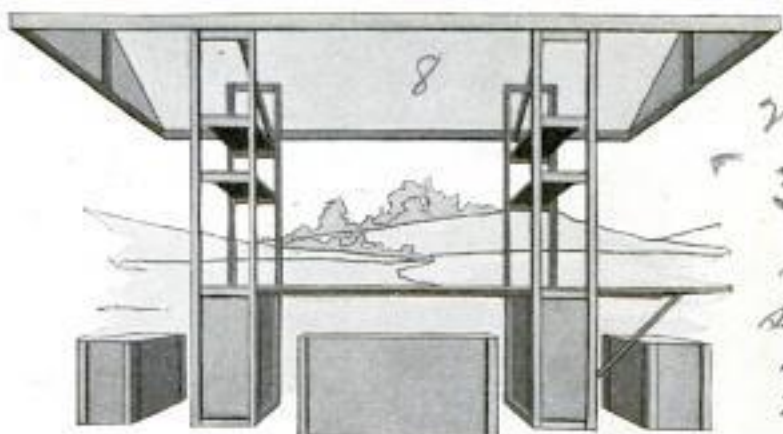

Artistic and Very Useful Camp Table and Canopy: Shelves in the Upright can be Used for Dishes, and the Compartments in the Benches for Luggage or Provisions

21 50
39 00
set (6)
15 50
22 00

16.
22.
28.
Ch
3 50
To
6 25



At Either Side of This Very Unconventional Dresser Are Shelved Compartments, with Slatted Doors to Match the Chair



Chairs and Greek-Cross Dining Table with Four Hinged Leaves. Made in Striking Designs Embodying Only Straight Lines and Right Angles

To
7 00
To
12 50
C. Stier
85.
To
175
Ch
1 75
To
3 12

To.
7 50
11.
13 75
Ch.
2 50
2 75
2 25



Child's Octagonal Table with Very Convenient Shelves and "Cornerwise" Chairs That can be Stood Close Up under the Table Corners

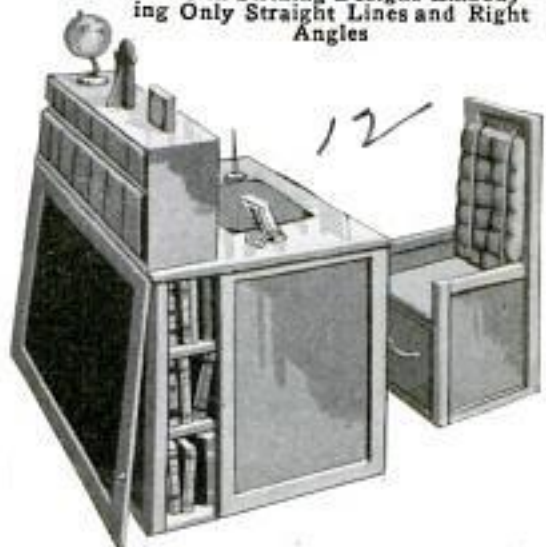

Desk That would Delight Any Boy or Girl Because of the Hinged Blackboard, Post-Card Rack, and Shelves: The Chair Has a Drawer under the Seat

Desk
12 75
17 50
22.
Ch.
2 50
3 50
4 50

4216
**LAMP-POSTS ADORNED
 WITH CITY'S EMBLEM**

Artistic lamp-posts of concrete and iron have been erected in Alhambra,



DESIGN COPYRIGHTED BY ALHAMBRA,
 CALIF.

Calif., which were made especially for the city according to a design that has been copyrighted, so that posts of this type cannot be used elsewhere. The insignia of the city is a crescent and star, which is suggestive of the Moorish palace in Spain bearing the same name as this California town. This emblem has been used very effectively in designing the arms which support two of the three lights on each

post. It also appears on the sides of the base. Above each of the latter ornaments is a mission bell. One of these bells serves as a door to the fuse box situated within.

4534
WAYS TO SAVE FOODS

FOR USE IN WINTER

U.S. Dept. of Agric.
 Now that the entire nation has awakened to the need of increasing our food supply it is exceedingly important that means be employed to conserve all surplus products for use the coming winter. The following suggestions for the various foods indicated will be found so simple and practical that they can be used in almost any household.

CARROTS: Carrots gathered shortly before the frost may be preserved in a condition practically as fresh as when taken from the ground. Take

a box of convenient size, spread a layer of moist sand or garden earth in the bottom about two inches thick, and on this place the carrots as close together as possible without their touching. Then sift on an inch of earth packed fairly tight with the hands, and proceed to the next layer. If the earth becomes dry during the winter it can be sprinkled occasionally. Carrots packed in this way should be perfectly fresh until the last of March. Place box in dark, cool spot in basement.

EGGS: Eggs, if properly put down in water glass (sodium silicate), can be kept for use practically all winter. They must be perfectly clean and preferably not more than two or three days old. A washed egg is apt to spoil because its gelatinous coating has been removed. The eggs must be free from the smallest cracks, and the crocks in which they are stored should be scalded and allowed to cool before use. The solution used consists of one part of water glass to nine parts of cool boiled water. The crocks should be covered and set in a cool place where they will not be moved. Up to November the eggs can be used for soft boiling and poaching. They are satisfactory for frying until about December. After that they can be used chiefly for omelets, custards, cakes, and general cookery. Limewater can be used instead of water glass and in a somewhat similar way.

TOMATOES: Ripe tomatoes may be had until New Year's or even later by pulling up the vine by the roots just before frost, and hanging in the basement. First pick off all ripe tomatoes and leave only the green ones. Hang vine on a nail driven into the side of wall, with the roots up, and the green tomatoes will gradually ripen from week to week, and be almost as good as ripe tomatoes when first gathered.

WATERMELONS: Watermelons may be kept some time with a fair degree of success by sealing the end of the stem, where it is cut from the vine, with wax.

NEW FILM CITY IN HEART OF THE METROPOLIS

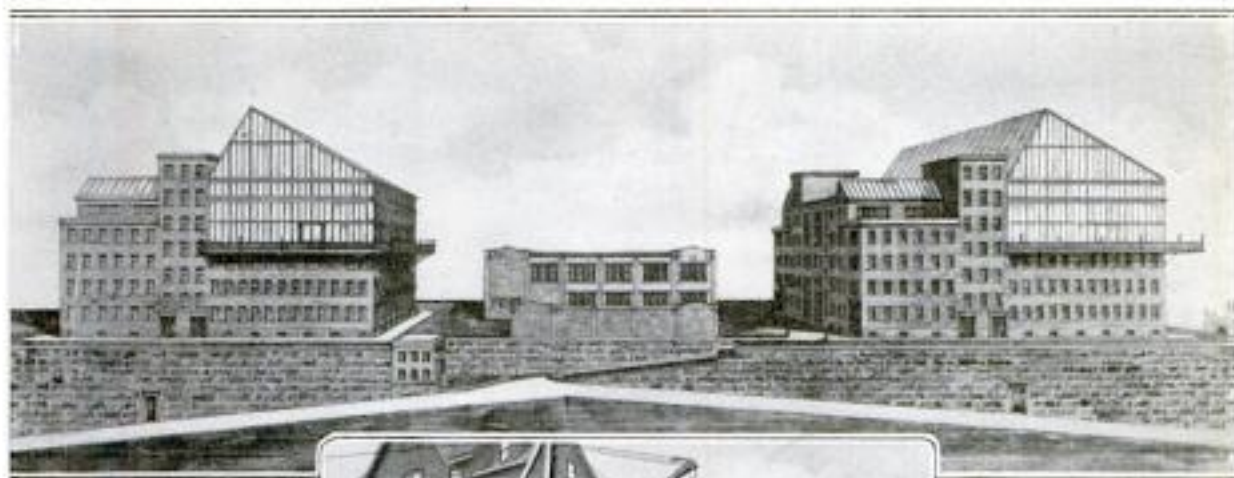

Right in the heart of New York City, a \$2,000,000 motion-picture studio is to be built, on a block of ground elevated 40 ft. above the level of the street on which the buildings will front. This is a new street recently cut down to the city-datum line, leaving up in the air on the edge of a rocky cliff some of the old-time residences of the block. These



PHOTOS COPYRIGHT, BROWN & DAWSON
 The Architect's Drawing Reproduced at the Top Shows the Big Movie Plant as It will Appear When Construction is Completed. The Lower Picture Gives a Glimpse of the Block of Ground Left High in the Air by Street Graders and Shows the Difficulty Encountered at the Outset in Getting Fuel and Other Materials to Residences Above

will be removed to make way for the new film city, which will be the largest of its kind within urban limits anywhere. The reason for selecting the elevated site was that no shadows can fall upon the skylights of the studio from any surrounding buildings, making it an ideal site in that respect. The plant will be operated as soon as construction can be completed.

4443

ELECTRIC FLOOR TRUCK WITH NEW FEATURES

Among the new features of an electric floor truck and tractor for industrial purposes is that the motor employed is attached to a 16-in. front caster wheel, which enables the truck to turn in its own wheel-base length. It will carry on its low platform a ton of freight, such as lumber, bricks, or machinery, and tow on trailers several tons more. The motor is mounted on

the yoke over the traction wheel. A 14-cell battery is supported under the truck.

In an effort to find additional sources of leather supply the Bureau of Standards is conducting experiments in the tanning of hides of sharks, porpoise, grayfish and grouper.

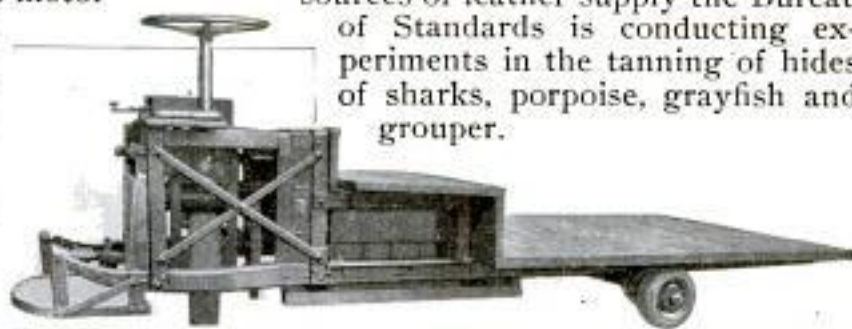

Electric Floor Truck That will Turn within Its Own Wheel-Base Length, Which Is 66 Inches: It will Run from 25 to 40 Miles without Recharging the Battery

Enterprise Machine Works,
 115 W. Redondo St.,
 Los Angeles.



Second Brigade, Ohio Infantry, Consisting of the Fourth, Fifth, and Eighth Regiments, Commanded by General Picture Gives One a Fairly Good Idea

4632
#6. L. Edholm 68 W 97th N.Y.C.
**VEGETABLE VINES TRAINED
ON ROOF AND TRELLIS**

In the roof garden for vegetables and the laden trellis, shown herewith, there is a suggestion for many who have only small tillable plots and yet wish to raise the maximum amount of foodstuffs for the coming year. In these instances pumpkin vines were trained up onto a shed roof and an overhead trellis, thereby lifting them out of the way and leaving more ground for other uses. It will be noted that blocks have been placed beneath some of the pumpkins on the sloping roof to prevent their rolling off. The blossoms below the level of the eaves

were picked off so that only those would mature which had a satisfactory resting place.

4611
**OHIO BRIGADE FINDS SPACE
ABUNDANT IN STADIUM**

When the second brigade of the Ohio infantry, composed of the fourth, fifth, and eighth regiments, occupied the concrete stadium at El Paso's new high school some months ago, a striking conception of the structure's proportions was afforded. The hundreds of men and scores of horses and pack mules left abundant space for about three more units of similar size, or an army division. And even then the ex-

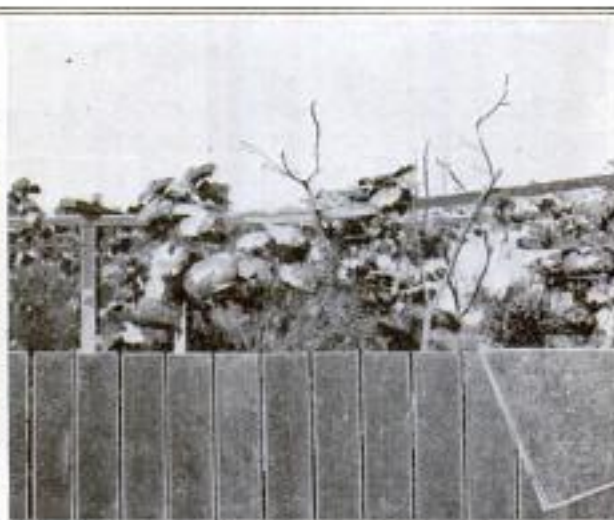
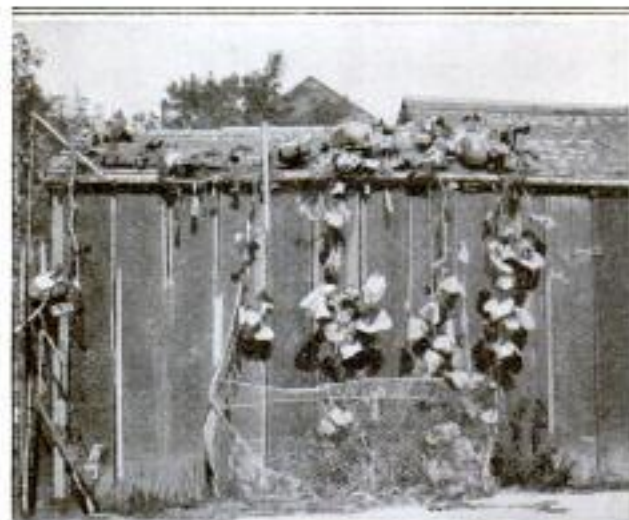

Roof Garden for Vegetables: Pumpkin Vines Grown Next to Old Shed and Trained Up onto the Roof. At the Right: View of Garden Trellis Used as Support for Pumpkin and Other Vegetable Vines

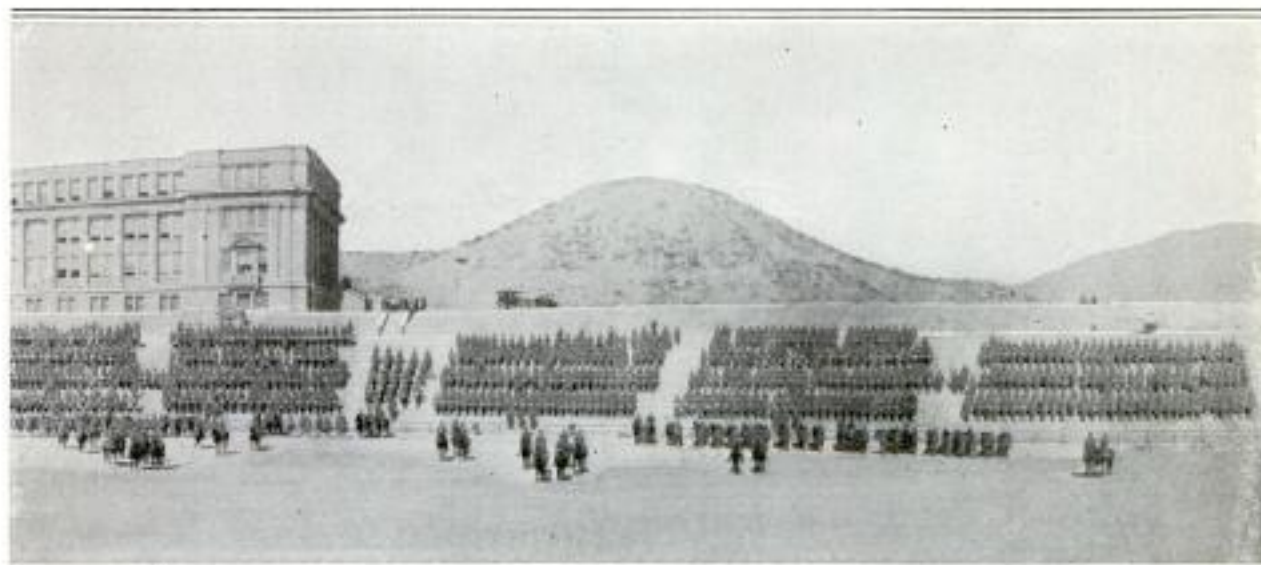

John C. Speaks, Occupying a Sector of the Big Concrete Stadium at the New El Paso High School: The Immense Size of the Structure

pansive athletic field below the encircling tiers of seats would have been almost vacant. The big bowl, which is spoken of as the largest amphitheater in the Southwest, seats about 12,000 persons and is comparatively new.

4506

NEW ENGINE OF TWO-CYCLE FUEL-INJECTION TYPE

A radical departure in gasoline-engine design is seen in a motor of recent development, which combines the two-cycle and fuel-injection principles in such a way, it is claimed, as to secure double the power of the ordinary four-cycle engine with half its weight. This makes the motor available for aviation as well as for automobile and marine work. Its main feature is a double "pneumatic" piston, or sliding valve, which opens and closes ports in each of two cylinder heads, regulates the amount of gas left in the explosion chambers after each stroke, and also, by means of cams, the amount of atomized gasoline injected into the head. This horizontal piston operates in a special cylinder on top of and cast integral with each pair of engine cylinders, its ends being sealed by caps bolted direct to the casting. Compression spaces at each end form pneumatic cushions which cause and also check the travel of the piston back and forth

above the engine cylinders, the compression and exhaust of which supply the gas cushions. It is possible to throttle the engine down to the lowest speeds, or as slow a rate as 100 r. p. m. The carburetor is eliminated, also poppet valves, lifters, cam shafts, and other complications.

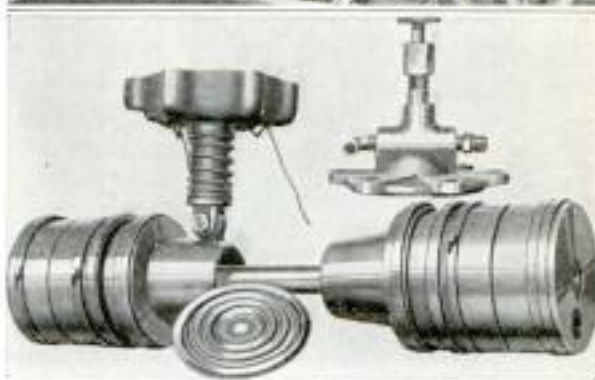
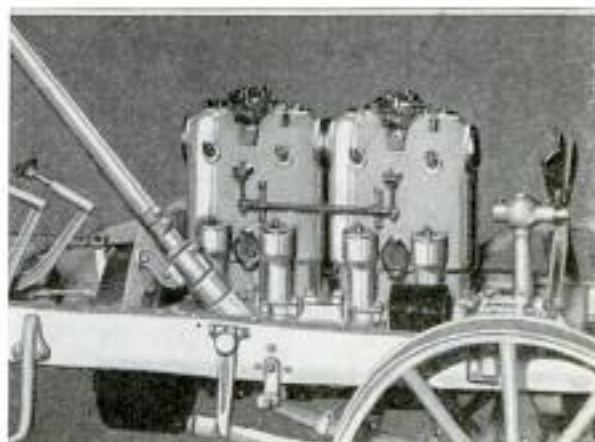

Four-Cycle Automobile Engine Transformed into a Two-Cycle by the Installation of Cylinder Heads of New Design: Below are Shown the Pneumatic Piston, Fuel Pump, and Injector

William Motor Co.,
1414-16 Commercial
attention Mr. Rose.

Copyrighted material

WRECK OF BIG DRAWBRIDGE DELAYS BOSTON COMMUTERS

A fortnight after the installation of three new spans of an important rail-

the spans snapped, and the heavy steel parts plunged into the river. As a result rail traffic was tied up during the evening rush hour and the river channel was closed for several days. Officials immediately began an investigation to ascertain if the bridge, which had been under military guard for some time, had been tampered with. The third span, which was only slightly damaged, was soon utilized in relieving the rail congestion. So many Boston commuters were delayed by the mishap that certain telephone exchanges had to hurriedly summon additional operators to serve the large number that sought to communicate with their homes. Extra elevated



Railroad Drawbridge over Mystic River near Boston. Wrecked by the Snapping of the Cables of Two Spans: The Third Span, the Most Distant One Shown Here, was Utilized as Soon as Possible in Relieving Traffic Congestion

road drawbridge over the Mystic River, near Boston, the lifting cables of two of

trains were also rushed into service to relieve the traffic congestion.

3321 RAISE FUNDS TO REPAIR CALIFORNIA MISSION

The increased interest in the history of the Spanish missions of California

to preserve these picturesque buildings from decay and further destruction.



A Portion of the Historic San Fernando Mission in California, Funds for the Repair of Which have been Raised Recently

which has been manifest in recent years, has resulted in various efforts

aside for making improvements and restoring various parts.

4436

PERSONAL COMFORT FOR THE RECRUIT

W. M. K.

By GEORGE M. PETERSEN

117

18th St Bflo N.Y.

1st N. Y. Cavalry, National Guard, U. S. A.

COMFORT for the soldier in service consists in an equipment which contains the essentials in their most compact form. What the essentials are is not a simple question. The following suggestions are made by a man who saw service on the Mexican border last year. They may prove helpful to many.—Editor.

THE man who desires to live on his monthly stipend and be a real soldier, cannot afford to pay a tailor to make repairs even though his regiment happens to have a tailor, which is not always the case while in the field. To meet emergencies of this kind a sewing kit, called a "housewife," is the proper article. This part of the soldier's kit may be purchased at prices ranging from 25 cents upward, although the writer made his own from a piece of condemned canvas and purchased the articles which he needed to make it exactly meet all requirements.

The housewife is shown in Fig. 1, the contents being held in place by means of quarter-inch elastic. The various articles shown are listed underneath the illustration. The cable splicer's shears can be used for manicure purposes, cutting wire, opening cans, repairing clothing, trimming a horse's mane and tail, and for numerous other purposes; the monogram or initial tape is invaluable for identifying one's clothing when every one's wearing apparel is identical; the white tape is useful for making loops on towels, wash cloths, etc., as well as reinforcing weak spots in garments; and the piece of sheet celluloid is used

to carry white, black, and olive-drab thread, as the regular round spools are too cumbersome to carry in the field. Extra safety pins are stuck in the flap of the upper pocket, for ready use, and bachelor buttons are stuck through the edges of the cover flaps. In the upper pocket are six 4-in. blanket safety pins, which are very desirable for making a bed sack from a regular army blanket. The lower pocket contains a small ball of beeswax for waxing the thread before sewing on buttons, and a small bag of assorted buttons in which should be several olive-drab buttons for the regulation army shirts, as these buttons are extremely difficult to obtain in the field. In the needle flap are kept the needles which are being constantly used. The writer keeps four loaded needles in this flap at all times, one threaded with

darning cotton and one threaded with each of the following: white, black, and olive-drab thread. To close the roll the flaps of the housewife are laid over the body so that the whole becomes a strip 6 in. wide and 14 in. long. It is then rolled tightly and tied with the tapes attached to the pointed end.

The subject of toilet articles is one of considerable importance, as "clean-

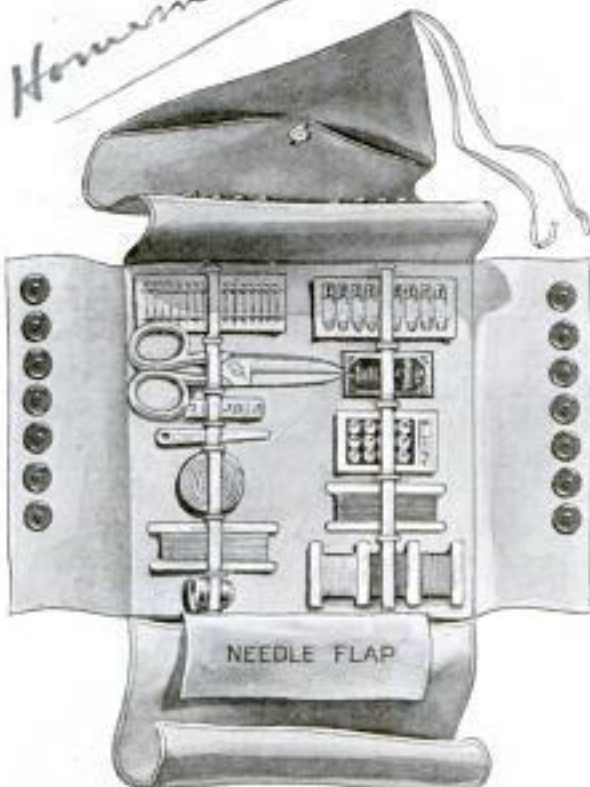

Fig. 1—A Carefully Planned "Housewife": Left Row Contains Common Pins; Cable-Splicing Shears; Initialed Tape; Tape Needle; Roll of Tape; Celluloid Thread Holder, Thimble. Right Row: Safety Pins; Needles; Underwear Buttons; White, Black and Olive-Drab Thread. The Pockets Contain Safety Pins; Beeswax; Buttons, etc. Bachelor Buttons are Fastened to the Flaps

Another Housewife - 5⁰⁰ - contains 18 articles
Nathan Novelty Mfg Co. 84-90 Reade St.
N.Y.C.

liness is next to godliness" even in the army. The great majority of the civilian soldiers on the border preferred safety razors to the old-fashioned kind for several reasons, principal among them being the fact that it was next to impossible to get a razor properly honed and a razor strop was an unnecessary bother. The thin safety-razor blades worked to much better advantage in the cold water than did the heavier blades of the old-style tool. Shaving soap was also somewhat of a problem until decided by a process of elimination.

Liquid soaps are practically out of the question because of the weight of the container and the liability to breakage. Shaving sticks have a tendency to get hard and dry up in hot climates so that they are hardly desirable. Collapsible tubes of shaving cream are liable to become punctured and allow the contents to distribute itself over the other articles in the roll and, also, the cream has the same tendency to harden as the shaving stick. The only disadvantage to the shaving powder lies in the size of the container, but it is more than likely that the manufacturers of this article will eventually put it up in small screw-top boxes, say, about four inches long and a half or three-quarters of an inch in diameter, for convenience in packing. There is no one thing which will freshen a man after a hard day's work as will a good shave. Personal appearance also goes a long way toward gaining promotion, and no man makes a good appearance if he needs a shave.

The best method of carrying a tooth-

brush in a blanket roll is somewhat of a problem. Many persons have a liking for aluminum tubes, with a screw cap, in which the wet brush is placed to dry. This tube affords excellent protection but the bristles discolor because of the lack of air. Probably the most desirable means of handling the wet brush is to cover the bristles with a little metal or composition cap which is freely perforated so that the air may readily circulate and dry the bristles quickly, thus preventing decay. The dentifrice used is

preferably a powder or a small tube of paste.

The toilet soap should be chosen for its cleansing and antiseptic qualities. A heavy metal soap box is undoubtedly the most desirable container, as it will withstand the rough usage to which it is subjected. For use after shaving, for chafing, etc., plain boric antiseptic powders are far superior and much more healing than the highly scented ones. Few men bother with hairbrushes, as the hair is usually kept pretty short and a comb is all that is needed to straighten it out, so that a small pocket comb which takes up practically no space is all that is necessary, although a small military brush may be taken if desired. When it is known that a soldier is going to be in a permanent camp for some time it is sometimes advisable to use a regular camp

toilet kit, which is a canvas roll having compartments for soap box, brush, comb, mirror, talcum powder, etc., but the roll is hardly suitable for men who are on the move, as the separate ar-

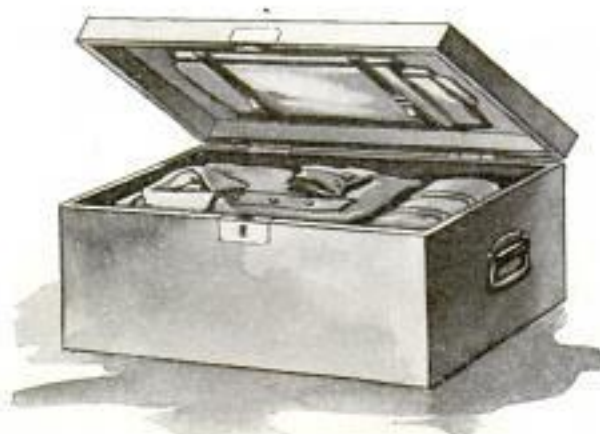

Fig. 2—Foot Locker for Surplus Clothing: The Bottom is Raised One-Half Inch so That Clothing may Not Become Moist



Fig. 3—Trousers Laced in This Way may be Removed without Unlacing—a Time-Saving Feature

ticles may be packed to much better advantage than can the camp kit. The shaving mirror may be one of the small round ones which can be obtained about three inches in diameter and about a quarter inch thick, the stand being used for a cover when the mirror is not in use. A wash cloth is a great convenience, especially when water is scarce, and it should be carried in a little rubberized bag to prevent the dampness from invading the adjoining articles. The recruit should also provide himself with two medium-weight Turkish towels, preferably the brown ones, as the inability to boil them when washing makes

the white ones a brown color so that they look dirty all the time even when they are really clean.

Surplus clothing is carried either in individual foot lockers or squad bags. The regulation locker is 30 in. long, 17 in. wide, and 13 in. high, and is provided with handles and lock. For field service the squad bag, furnished by the government, is usually used, and eight men put all of their surplus clothing and personal equipment into the one bag. It is advisable, therefore, for each man to buy a small duffle bag, into which he can put all of his personal kit and then put this bag into the squad bag for transportation. The duffle bags are merely canvas tubes having a draw string at one end and sometimes a handle to carry them by. The foot locker, shown in Fig. 2, has the bottom raised $\frac{1}{2}$ in. from the ground so that all moisture is excluded. The cover is made 2 in. deep and provided with canvas straps so that shirts, breeches, underwear, etc., may be secured to it and kept from becoming wrinkled.

The best method of lacing the regulation issue breeches is shown in Fig.

3. The laces need never be touched after they are once run in, and at the same time the breeches are held snugly in place on the legs without binding. The legs of the breeches stretch while



Fig. 4—Using a Poncho as a Bathtub: A Trench is Dug and the Rubber Poncho Used as Lining into Which Water is Poured

being pulled on or off, but fit snugly as soon as they are in position, and the amount of time saved by not having to lace them up is greatly appreciated when the sleepy soldier is trying to get dressed in time to stand reveille.

A few articles which will be found of great usefulness are a pair of sneakers, or moccasins, to be worn about camp so as to rest the feet; a can of solidified alcohol with which one can prepare a cup of hot coffee, tea, soup, etc., in about three minutes; a small pocket oilstone to keep the knife sharp; an absolutely waterproof match box; and a pocketknife. The soldier's pocketknife is not by any means the gentleman's penknife, nor is it the big jackknife, as many persons imagine. The ideal knife for a soldier is one made along the line of the boy scout's knife, one with a cutting blade, a cap lifter, leather punch, can opener, and screwdriver. The screwdriver is often valuable for adjusting the screws in the rifle or pistol, and no one who has not been through the mill can appreciate the great value of a can opener in the army. A knife of this type can be bought for about \$1, and another knife

made along similar lines can be obtained for \$2.50. This latter knife is provided with two cutting blades, a hoof hook, leather punch, corkscrew, can opener, screwdriver, pliers, and hammer, and is especially suitable for mounted men, such as cavalry or artillery. The leather punch is handy for shortening or repairing straps, the hoof hook for pulling stones, etc., from the horse's hoof, the pliers for breaking off or bending horseshoe nails, and the like.

Another desirable article, when the means of transporting it can be obtained, is known as the self-cooling water bag. These bags work on the principle of refrigeration by evaporation, and the bag material has a peculiar property of holding water and yet exuding just enough to present a continuous water surface to the air. These

bags are made in various sizes, but the gallon size is considered the best for this purpose. They can be easily handled if slung under the combat wagons where they will be out of the direct rays of the sun.

Bodily cleanliness is necessary at all times, but especially so when large bodies of men are thrown together in close contact with one another. In permanent field camps facilities are usually provided for bathing, but on the march the situation is entirely different. Of course, one can take a bath in a single pailful of water, though it could hardly be called a real bath, but men who are provided with the issue poncho can generally have a regular tub bath by digging a trench and lining it with the poncho and then filling it up with water, the poncho preventing the water from getting muddy.

4361 Garage Equip.

PORTABLE LIFT FOR AUTOS ELIMINATES THE PIT

No garage pit is needed to make repairs beneath an auto conveniently,

and a workman can make repairs while seated beneath the chassis.

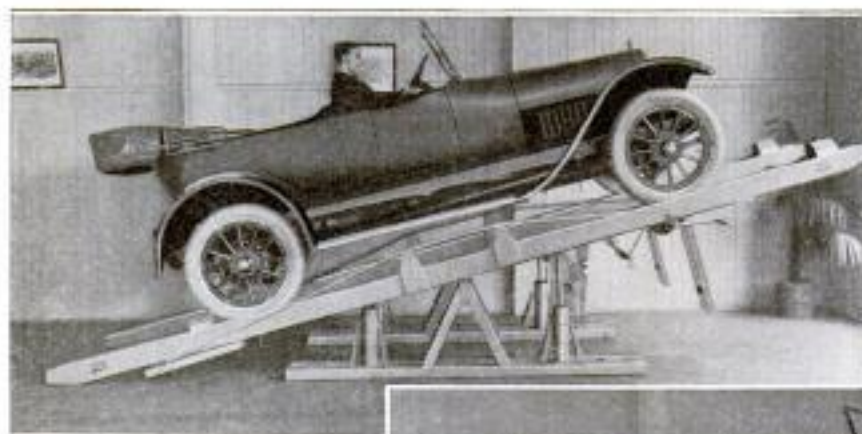

Driving Car up the Inclined Runways of New Portable Automobile Lift, Which Eliminates the Usual Garage Pit

if an automobile lift of recent invention is available. This lift is a demountable and portable device which raises and lowers the vehicle by its own weight, and will hold it safely at a conven-



The Runways Take a Horizontal Position When Car Passes Center; Oil-Cushioned Plungers Bring This About without Shock

It consists of two independent units, each consisting of a tilting runway mounted on a horse, which in turn is supported by a wooden base. Across the horse the trackway is centrally hinged. It has flanges to guide

Inv. Albert P. Sollenber, Portland, Ore
 Sold to: Murphy & Murphy (Pat. Attys).
 Portland, Ore. Chamber of Commerce Bldg.



Entrance to the Open-Air Theater, with Rustic Seats in the Background



A View of the Stage with a Dancer Descending the Stone Steps

the wheels and is of sufficient length to reach the floor and form an incline of suitable pitch. Two cylinders with pistons cushioned on heavy oil support each runway, these cylinders being connected with a pipe which allows the oil to flow from one to another as the car is raised or lowered. In operation the car is either driven up the inclined runways under its own power, or hauled up by pulleys. When its weight passes center, the runways automatically level themselves.

2543

OPEN-AIR THEATER IN —RUSTIC SETTING

An unusually picturesque open-air theater has been opened at a seaside resort about 25 miles north of San Diego, Calif. It is so situated that a beautiful rocky bluff serves as a background for the rustic stage. Eucalyptus and pepper trees afford shade for the spectators, who occupy rustic benches. Flowers of many varieties add to the attractiveness of the scene. Approach to the theater is through a gateway made of logs and over a bridge built in a corresponding style. The spacious stage is bordered with

rough stones, and steps of the same material lead up from the rear of the stage. The place has proven particularly well adapted to exhibitions of artistic dancing and is much patronized by motorists.

GUARD ON GLOVE PROTECTS WORKERS IN STEEL

A glove, to the back of which is riveted a screen guard that projects from the side opposite the thumb, is one of the newer safety devices for workers in steel foundries. The glove is worn on the left hand, and the guard extends down beside the point of the chisel, or other tool being used, so that it effectually obstructs flying chips of steel. Without a guard, flying particles of metal are a source of serious danger to users of various cutting tools and those close by. The shield does not materially obstruct the view.



Stratford Theatre
Dec Mar, Calif

Bureau of Safety
National Trade Lab.,
Washington, Pa.

CIVIC FEATURES THAT PROMOTE THE COMFORT

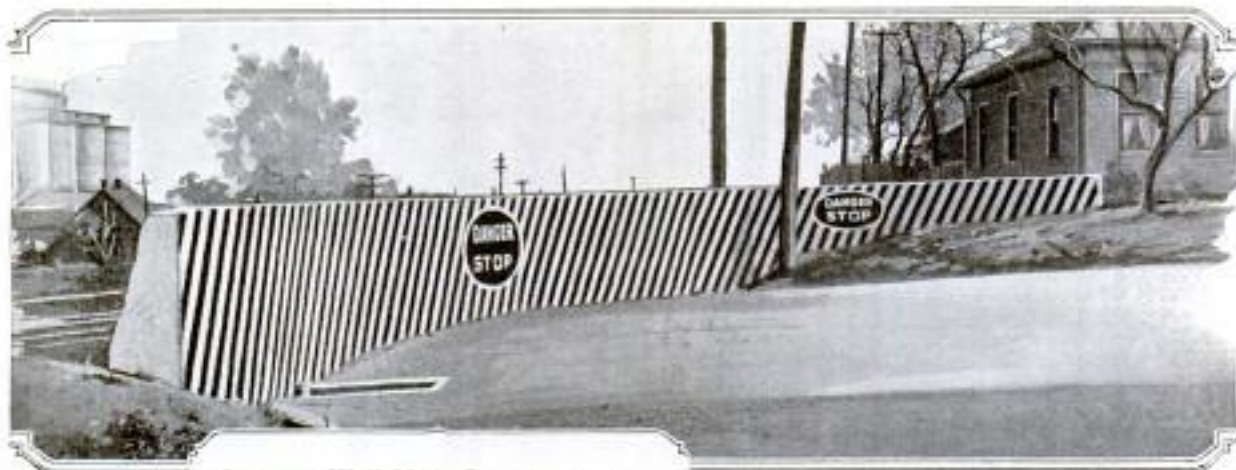

Concrete Wall Made Conspicuous with Stripes to Prevent Accidents: The Barrier Stands at the End of a Fort Worth, Texas, Street and Next to Railroad Tracks. Before It was Painted Several Automobiles Ran into It, but Now It is Illuminated at Night and is Always Noticeable

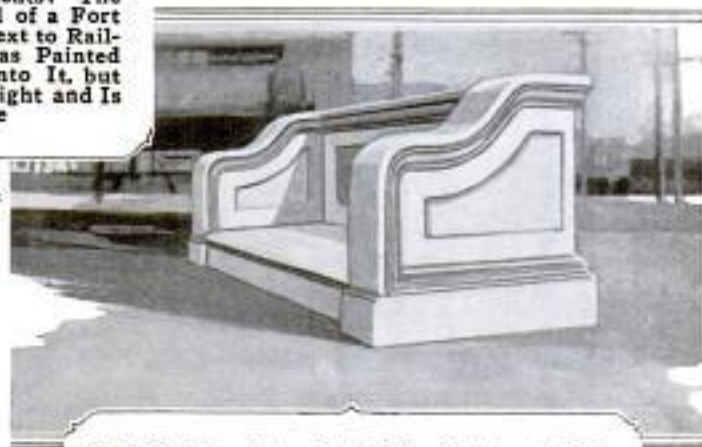

This Substantial and Artistic Outdoor Pulpit has been Erected in Los Angeles for Use Free by Anyone. Formerly Impromptu Speakers Caused so Much Congestion in Park Paths That Two Rostrums Like This were Built, in Suitable Spots, to Accommodate the Orators

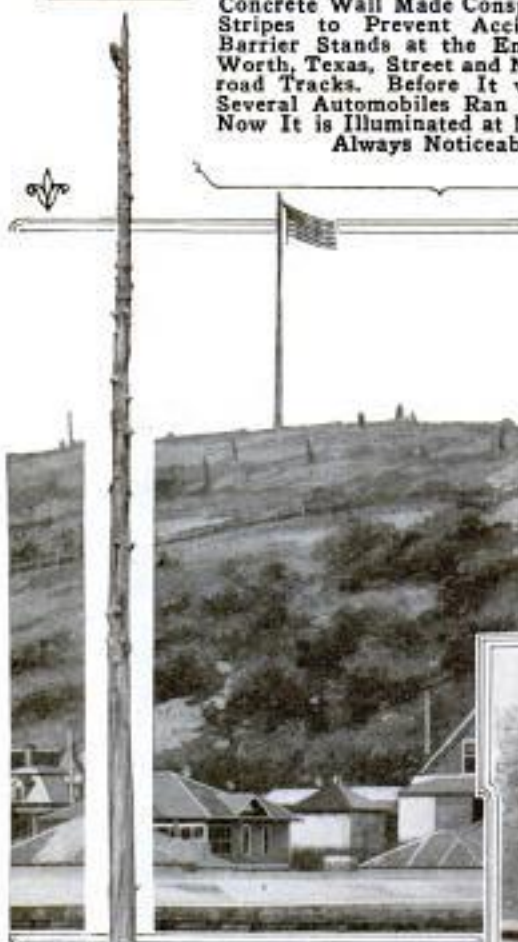

On a Hill 400 Feet High, Overlooking Chehalis, Washington, Nature Planted This 150-Foot Flagstaff. It is a Dead Fir Which Stood Uncared For Until War was Declared, When a Man Climbed to Its Top, as Shown in the Near View, and Trimmed It. Soon After, While the Whole Town Looked On and Cheered, Old Glory was Raised to the Breeze



In Des Moines, Picnics are No Longer Pastimes for Warm Weather Only. Folks in That City have Learned the Fun of Outings in Cool and Even Cold Weather, Since Union Park Authorities Built This Old-Fashioned Log Cabin. It is Heated with a Big Camp Stove for Which Firewood is Furnished Free, and Cooking Utensils can be Had on Application

AND ENJOYMENT OF RESIDENTS AND VISITORS



House Number on Street Curb: In a Residence Section of Pasadena the Houses Are so Far Back from the Street That, for the Public's Convenience, Blocks Bearing the Numbers on Two Sides have been Set at the Curb



Despite the Fascination of Motoring, Many City People are Taking Up Horseback Riding, Which Has a Charm Possessed by No Other Exercise. Evidence of the Pastime's Popularity is Found in This Inviting Bridle Path, Here Shown at the Point Where It Passes beneath a Concrete Bridge in a Brooklyn Park

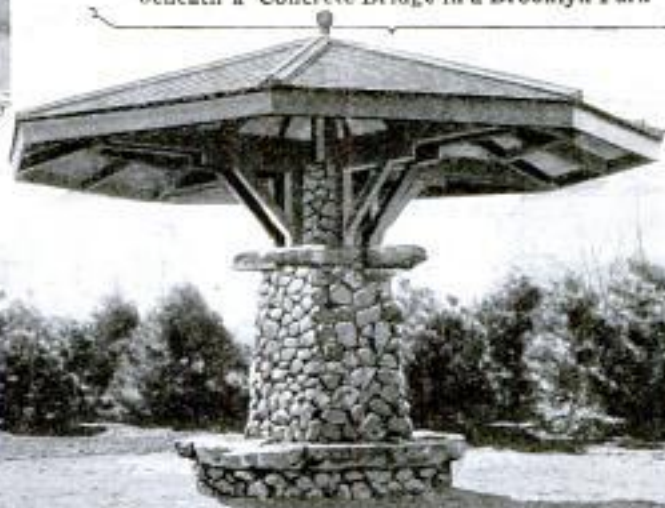

In a Portion of a Denver Park Given Over to Rugged Natural Beauty, Stands This Picturesque Sun Shelter, Whose Appearance Is Quite in Keeping with Its Surroundings. The Combined Column and Circular Bench is Made of Concrete, in the Surface of Which Varicolored Smooth Stones are Imbedded

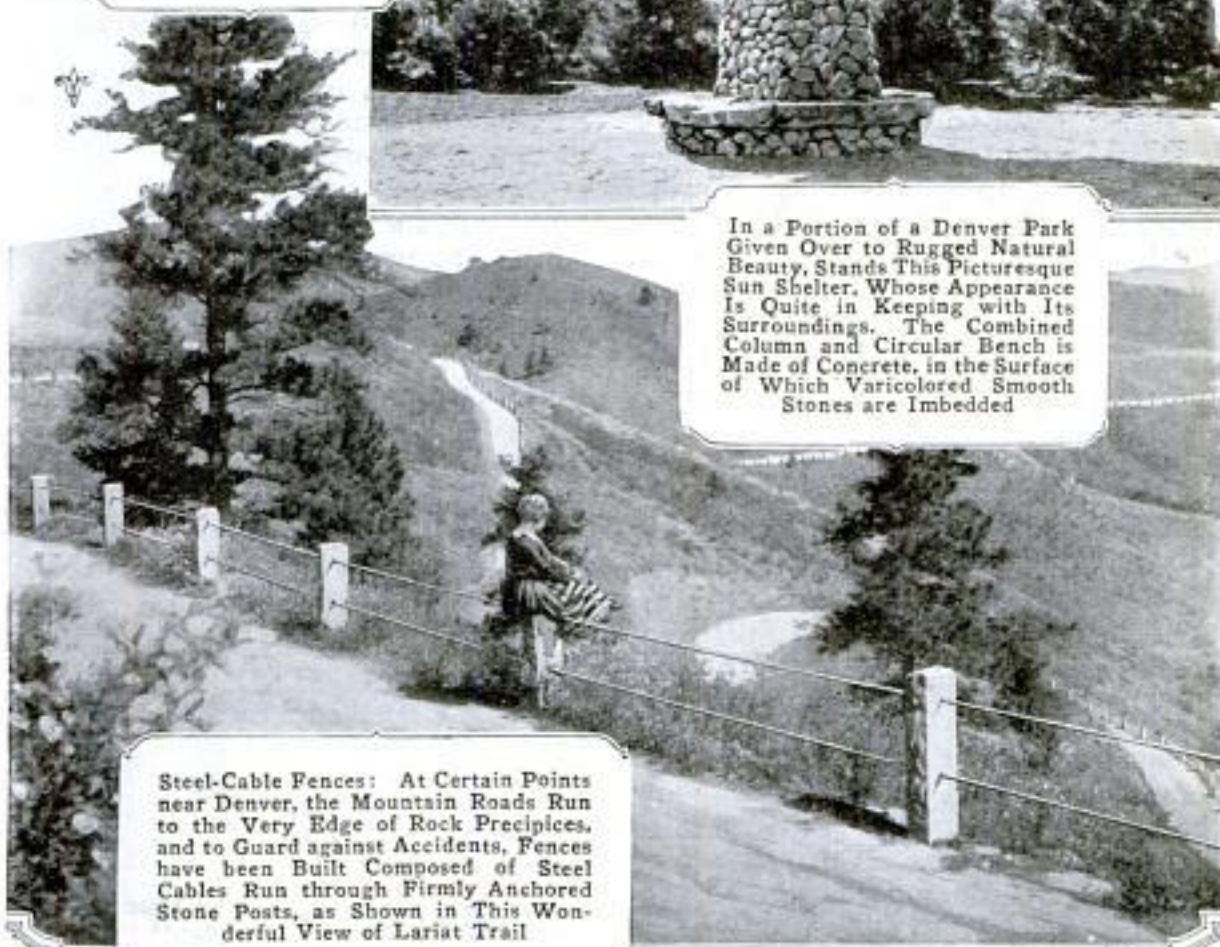

Steel-Cable Fences: At Certain Points near Denver, the Mountain Roads Run to the Very Edge of Rock Precipices, and to Guard against Accidents, Fences have been Built Composed of Steel Cables Run through Firmly Anchored Stone Posts, as Shown in This Wonderful View of Lariat Trail

272

4577 **POPULAR MECHANICS**
AMPLIFIER FOR TELEPHONE
IS USEFUL ACCESSORY

For the telephone user in a noisy office, a sound amplifier of compact



In Addition to Magnifying the Sound Vibrations, the Device Excludes Foreign Noises from the Telephone User's Ears.

and convenient form has been introduced. It is particularly suited for the person who receives many important toll calls, since in addition to magnifying the vibrations, it excludes foreign noises. The device consists of a small resonator to which an adjustable branched ear tube, such as is employed with a stethoscope, is attached. In use, the receiver is placed on top of the amplifier. A further convenience is that both hands are left free when telephoning.

4519
TWO ELEPHANTS RETURNED TO CIRCUS BY EXPRESS

Express companies have from time to time handled many curious and unusual live consignments, but probably no shipment has ever aroused more interest locally than the recent sending of two full-sized elephants by express a distance of nearly 100 miles, in northern Ohio. Shortly before this unusual shipment was made several elephants escaped from a circus, and the two in question eluded capture so long that the show had to proceed on its itinerary without them. In the meantime the countryside was aroused and terrified by the big beasts, which

Metropolitan Tower N.Y.C.
 crashed through fences and trampled down fields, some of the scenes enacted being humorous and others serious. The capture was finally accomplished by a large body of men, to most of whom elephant hunting was a new, not to say exciting, occupation. On being taken into custody the animals were held by authority of law until proper settlement had been made for damage done. Then, in order that they might be returned to their places in the circus as quickly as possible, they were shipped to their owners by express, the charges being \$100.

A few days after this costly episode, a fire, started by the explosion of an oil lamp in the elephants' car, burned to death three of the elephant herd of five. The two animals that had enjoyed the express ride were not among those lost.

4601
SPIKED ROLLER LOOSENS AND AERATES LAWN SOD

An implement which perforates sod, thereby aerating and loosening it in a beneficial way, without seriously marring its appearance, is now coming into use on golf courses, large lawns, polo grounds, etc. It consists of a roller made up of a number of sections from which project steel spikes at frequent intervals. The roller is supported at either side by small broad-tired wheels, and can be raised or lowered so that the spikes penetrate the turf to any desired depth as the roller revolves.



Lawn Roller Provided with Spikes Which Perforate and Loosen Sod as It Moves Along: It Is Especially Serviceable on Golf Courses and Other Much-Trodden Turf

R. W. Whitehurst & Mfg. Corp.
Norfolk, Va.
 Copyrighted material



Some of the Numerous Forms of Paper Containers, and Other Articles, Now being Manufactured of Hard Paper at Lower Cost than Similar Articles of Wood and Tin

4459
**HARD-PAPER SUBSTITUTES
 FOR WOOD AND TIN**

Many containers, and other articles, formerly made exclusively of wood, tinplate, vulcanized rubber, and metal or fibrous materials, can now be made of paper, at lower cost and equally serviceable, by means of special machinery which winds paper with an adhesive on one side, into tubes or barrels in an infinite variety of sizes and shapes. The times being especially opportune for such substitutes, hard-paper products may soon replace wood for shipping packages, large and small; also for machine accessories such as split pulleys, harvester rolls, tool and other handles, and many purposes in the electrical industry.

Paper containers may also replace tin for canning fruit and vegetables, thus solving an urgent war-time problem. The one-quart size with a thin interior coating of some milk preparation is said to make an ideal can for preserved fruits. Moisture-proof shipping barrels of hard paper are much cheaper as well as much lighter than those of wood, a half-hogshead in wood costing \$1.25, while the paper cask can

be furnished for 80 cents. The shipping advantages of paper containers are obvious. Oils, paints, and the like, can be shipped in them as well as in galvanized or steel drums. Even the steering wheels of a familiar automobile, it is said, are soon to be made of hard paper.

4342
**SIMPLE BRAKE IN CASTING
 REEL PREVENTS BACKLASH**

A new device for preventing backlash in casting, now incorporated in certain fishing reels, consists of a bar to which is attached a wire bail that serves as a brake lever. Whenever the fishline is taut it draws the bail up into such a position that it releases the reel brakes, but when the line slackens, as when the bait strikes the water, the bail drops down, setting the brakes so that the reel's speed is lessened and no backlash occurs.



Fishing Reel with Automatic Brake: Position of Bail Governing Brake is Determined by Line's Tightness

South Bend Bait Co.
 South Bend, Ind.
 Copyrighted material

4579

SOME NOVEL AND LITTLE-KNOWN ACCESSORIES



1
Tough, Stringy Tissues in Coarse Cuts of Beef are Severed and the Meat Made Tender by the Revolving Toothed Knives of This Instrument. Price \$3.50



2
Particles of Dust are Quickly Removed from the Grooves of Phonograph Records with This Brush Made of Long-Napped Carpeting. Price 15 Cents

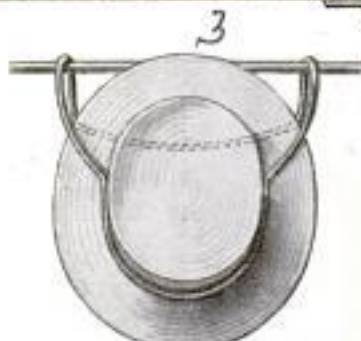

3
The Wire Hanger Provides a Means of Suspending a Straw Hat from the Robe Rail of a Motor Car. Price 25 Cents



4
An Extension Lamp for the Garage: The Pulley Is a Spring Reel That Pays Out the Desired Length of Wire and Rewinds It Readily. Price \$8.00



5
This Lawn Swing does Not Have a Sickening Rocking Motion, but Moves Forward and Backward in a Horizontal Plane. Equipped with a Canopy and Removable Table, It Costs \$18



Neat Shoe-Polishing Outfit Especially Suited for the Traveling Bag: The Brush is Formed by Reversing the Cover and Snapping It around the Box, as Shown Herewith. Price 50 Cents



8
Three Cups, Instead of One, are Provided with This Vacuum Bottle. They Nest Compactly and Fit over the Bottle's Neck. Quart-Size, \$3

Receptacles for Red and Black Ink are Mounted on the Base of the Lamp, Which Forms an Attractive Part of a Desk Set

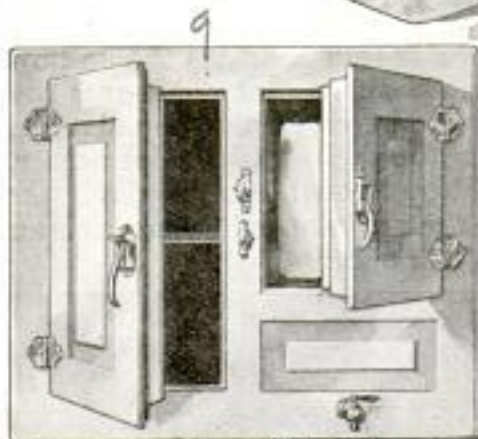

9
Enamelled Refrigerator of 25-Pounds' Capacity. Beneath the Ice Compartment is a Drip Tank. Price \$12



For the Hotel Apartment, Light-Housekeeping Suite, or Motorboat: Well-Built White-

INTENDED FOR THE HOME AND ITS MEMBERS



This Hinged Brush Makes It a Simple Matter for the Laundry to Clean a Clothesline Thoroughly before Hanging Garments upon It

The Convenient Feature of This Swinging Crib Is That It can be Suspended Wherever a Hook is Provided. It Costs \$2

Glass Elephant Aquarium, a Striking Novelty: A Small Opening is Provided at the Top. The Price Is \$30



Powder, Contained in a Small Pocket, is Sifted through the Perforated Opening as Needed. The Glove Protects the Hand While White Shoes are Cleaned. Price 25 Cents



Each Time the Cover of This Sanitary Garbage Receptacle Drops into Place, a Deodorizing and Disinfecting Preparation is Discharged through the Perforations. Price \$4; West of Mississippi, 50 Cents Extra



When Placed in This Machine, Which is Equipped with a Gas Burner, Clothes are Boiled, Steamed, and Washed in One Operation. The Position of the Suction Plunger Changes as the Crank is Turned. Price \$25

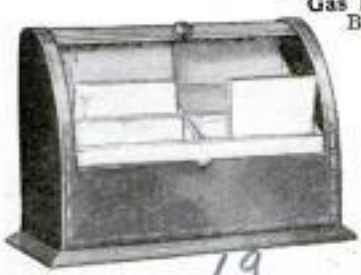

Attractive Roller-Top Stationery Case Covered with Delicate Glazed Calfskin and Lined with Silk: It is about a Foot in Length and Costs \$30



When Eggs are being Boiled, a Sandglass Such as This One Serves Conveniently as a Timer. The Device Also Has Other Uses in the Kitchen. Price, Postpaid, 55 Cents



When Summer Beverages are Concocted, This Provides the Much-Needed Shaved Ice without Causing Needless Waste. As a Hole is Bored, the Receiver Fills with "Snow"



When Pinned to the Waist or Skirt at a Convenient Point, This Thread Cutter Proves Useful to the Woman Who Has Much Sewing to Do. Price 25 Cents



Batteries are Not Needed, for This Electric Bicycle Lamp is Provided with a Small Dynamo Which is Driven by the Front Wheel. The Price Is \$6.50



**MACHINE FOR CRISPING
 POPCORN CAKES**

An automatic machine for making crisp cakes of popcorn has been placed on the market lately by an Ohio concern. The crisping device is operated electrically, being easily connected to any lighting circuit. It comprises a circular revolving metal table, with molds of the required size on its outer edge, these passing

beneath two automatic plungers, one of which presses the hot corn, coated with sirup, into uniform disks, while the other taps the crisp cake as the table revolves, causing it to fall through a guide channel onto a conveyor belt which carries it to a wrapping table. The operator simply feeds the hot corn into the molds, and the machine does the rest.

4372 ———
**WARNING VALVES PROTECT
 TIRES OF MOTOR CAR**

Signaling valves that warn a driver when the tires of a car, because of slow punctures or other leakage, become underinflated, and also prevent them from being pumped to excessive pressures, are late accessories for the economical motorist. One of the devices is permanently attached to the valve of each tire and adjusted with reference to the advisable maximum and minimum pressures of the tubing and casing in question. If 90 lb. is the desirable pressure, for instance, the valve whistles loudly when that point is reached and automatically

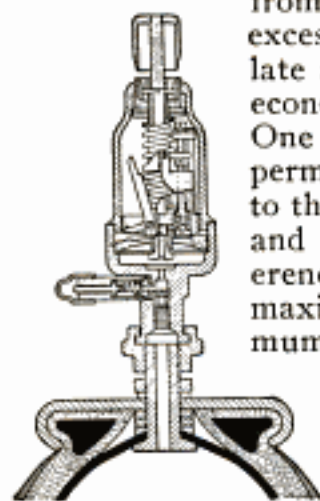

prevents the admission of more air. In case the pressure drops to 60 lb.—assuming that to be the minimum at which the gauge is set—the signal sounds again, warning the motorist. The whistling continues until 15 lb. of air have escaped. Then it stops. The period gives a driver time to halt his car and determine which tire needs attention. In addition to increasing the mileage of a tire by preventing improper inflation, the valves give a motorist assurance.

4349 ———
**HAND FLASH LIGHT HAS
 SPECIAL CUT-OUT**

A hand flash light has been patented that can be operated at will by pressing a button, providing the lamp is held horizontally. A movable bar forms a part of the electric circuit, and when

the lamp is tilted into an upward direction the bar swings out of position, thereby breaking the circuit. To make the light usable in any position a small pivoted stop must be adjusted to lock this bar in place.

4409 ———
**TONGS FOR HANDLING PHOTO
 PRINTS IN SOLUTIONS**

Flat wooden tongs are now available for handling photographic prints in the developer and hypo solutions. They obviate the necessity of placing the hands in the solution and aid in making clean prints. Knob ends prevent their slipping into the tray when not in use.

ⓄThe "bowfin," otherwise known as the "grindle" or "mudfish," has always been shunned because of the softness of its flesh. The Bureau of Fisheries has lately discovered that this objection may be overcome by smoking and salting the fish, and when thus prepared it is declared to be a delicacy.

*Deliveries about June 1st.
 Price about 10¢*

*Dr. J. W. White,
 300 So. 54th St.
 Birmingham, Ala.*

*Dr. R. E. McKee,
 374 E 31st St.,
 Chicago*

*Burns & Harris
 240 E. Ohio St.,
 Chicago.*

1000 - A. E. Sanford
918 Sixth Av.
Great Falls, Mont.

4581 POPULAR MECHANICS 4343 277

COURT OBTAINS LARGE SUM FOR AID OF DEPENDENTS

A practical illustration of the social service which a court of justice can perform in ameliorating the wrongs that women and children suffer because of improper treatment by delinquent husbands and fathers is found in the work of Chicago's Court of Domestic Relations, which is one of several specialized branches in the city's famous Municipal Court. During the first four months of the present year this court collected over \$46,000 from defendants in nonsupport and bastardy cases, and distributed it to the women and children of the families affected. A staff is maintained under the judge's personal supervision, which sees to the systematic collection and distribution of such funds as are assessed upon those found guilty. A careful check is kept from day to day on the men who have been ordered to contribute to the support of their dependents, and any neglect on their part is quickly followed by court action.

Judge Stearns

4433 AUTOMATIC FEEDER TEACHES HOGS HOW TO EAT

An automatic hog feeder of recent invention is so arranged that after the hog has eaten the grain contained in an individual oval metal trough, he discovers a small quantity lodged between rooting prongs at the upper side of the bowl. In trying to get at this remnant of grain, he pushes the bowl upward and operates a valve in the bottom of a hopper, which lets down another small quantity of food. Perfect mastication is thus encouraged, the grain is kept clean, and the hog soon learns to feed himself small quantities at a time, which means a considerable saving of feed.



ENDLESS BELTS IN CONTACT HULL SMALL GRAINS

Two endless friction belts, held in close contact by rollers, are the essential parts of a simplified machine lately



The Arrangement of the Rollers, Which Hold the Two Belts in Close Contact, is Illustrated at the Top. The Second Drawing Shows How the Tension is Maintained and Illustrates the Gearing That Causes the Belts to Travel at Different Speeds

designed for hulling small grains. Threshing is accomplished by the attritive action of the canvas bands, which move in the same direction, but at different speeds. They perform the two-fold function of conveying material through the apparatus and removing the coats from the kernels. Instead of being smooth, the faces of the belts are provided, in one case with transverse, and in the other with longitudinal, welts which increase the rubbing effect. The rollers are staggered so that the belts are held in proper contact at all points. This arrangement also causes the lower roller at the intake end to project, and the upper one at the opposite end to overhang and effect the downward discharge of the material. Proper longitudinal tension is maintained by screw-and-nut adjustment of the last two rollers at the discharge end. These members do not rotate about fixed axes, and therefore are capable of moving apart in case the material tends to become massed in the machine. The bearings of the middle, or idler, rollers are acted upon by coil springs that provide the transverse tension.

R. H. Bloomer Co.,
600 So. Main St.,
Council Bluffs, Ia.

Stenopaic Optical Co.
437 5th Av., N.Y.C.

278

4508 POPULAR MECHANICS

4561

SPECTACLES TO PROTECT EYES AT THE MOVIES

In order to protect the eyes of those who frequently attend movie shows, a special form of spectacles has been devised. It consists of a pair of opaque disks mounted in regular spectacle frames, each disk having a narrow slit or opening through which the wearer peers at the pictures, while most of the eye is covered by the disks.



The principle is that of an old method of testing the eyes for astigmatism, called the "stenopaic" method, which consisted in trying the patient's vision with spectacles having opaque plates and small central slits somewhat like those of the new protective movie device.

4419 —
GASOLINE GAUGE FOR AUTO TAKES PLACE OF TANK CAP

A new type of gasoline gauge, illustrated herewith, can be installed in any automobile tank merely by substituting it for the regular cap. As the ball-bearing float rises and falls it is turned on its axis by the spiral groove in the side of the cylinder and the indicator which is attached to it moves correspondingly.



Because our facilities for manufacturing Springfield rifles are not adequate to meet the enlarged demands, the Enfield rifle, now made here in large numbers for British troops, will be supplied to our force going to Europe. The ammunition will be interchangeable with that of the Springfield.

Eugene Mfg Co.,
Camden, O.

CAR OF POTATO PLANTERS SHIPPED BY EXPRESS

An incident which illustrates how seriously the country is taking the proposal to raise more foodstuffs is found in the fact that in a certain New England district there was such an insistent demand for additional potato planters that the makers sent a \$4,000 consignment of these machines by express. The box car containing the consignment was hurried to its destination attached to passenger trains. The express charges amounted to several hundred dollars.

4357

SUPPLEMENTARY PLUGS FOR AUTO ENGINES

Secondary, or supplementary, spark plugs now on the market are designed to be inserted in the cylinder heads of an automobile engine alongside the regular plugs, the purpose being to make ignition more certain and combustion more complete by providing two points in each cylinder at which sparking takes place simultaneously. The extra plug is connected directly with the regular plug and is so insulated that the current passes through it without being grounded.

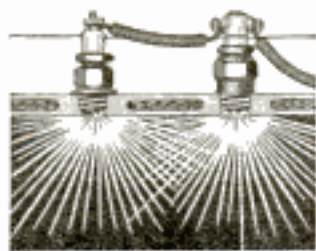

4589 —
COMMENCEMENT-DAY ESSAYS ON WAR TOPICS SUGGESTED

Off. Bulletin 5/16/17

As one means of stimulating a widespread and intelligent understanding of the many aspects of the present war a list of about 50 subjects, suitable for commencement essays and orations in schools, universities, and colleges, was issued at commencement time by the Secretary of the Interior. Among the themes suggested were the following: "Autocracy versus Democracy"; a comparison of the governments of the belligerents; "Education and War"; the

INV-Dr. F.C.A. Richardson,
414 W. 120th St.,
N.Y.C.

J.P. Ruffin,
Newark, O.
Superior Motor Power
3-Blading Place,
N.Y.C.
135 St. Apt. 2nd

direct relation between education and industrial efficiency, and therefore between education and war; "The National Food Problem," "Preparation for Peace at the Close of the War," "Wealth of the United States," "Belgium's Wrongs," "Treatment of Our Alien Born," "The President's Reasons for Entering the War," "Women and War," "The Red Cross—Its History and Work," and "The Russian Revolution—a Forward Step in Democracy."

4476

PORTABLE ARMY HUT OF ENGLISH DESIGN

Because the methods of modern warfare call for many shelters more permanent than tents, various portable huts have been devised, one of which—an English invention—is shown herewith. This shelter is of wood and is wide enough to permit two rows of soldiers to lie with their feet toward a central aisle and their heads next to the side walls which slant at quite an angle in such a way as to increase the structure's stability and floor space. Uprights inside the hut help support these walls. The roof is without rafters or purlins, being supported by a trussed ridge girder that rests on the end frameworks. There are racks for the rifles, and windows are provided at



Wooden Hut Made of Sections That can be Quickly Assembled: Its Spreading Side Walls Allow Sleeping Space on the Floor for Two Rows of Soldiers. Rifle Racks are Provided Adjoining the Side Walls

either end. The various wall sections and beams composing the hut can be quickly taken apart or assembled.

1816
GERMANS MAKE DURABLE KNAPSACKS OF PAPER

Woven paper fabric, for which Germany has found several uses as already described in Popular Mechanics Maga-



German Knapsack Made Chiefly of Woven Paper Fabric, as It Appeared after being Used a Year

zine, has proven a good substitute for leather and canvas in the making of knapsacks. Some 2,000 folding cases made of this material were delivered to the German army in 1914 and have given excellent service. They are gray-green in color, and the only leather portions are the broad edge at the top of the knapsack, which rubs against the back, and the inside and outside straps for closing the compartments. The paper substitute used is of a coarse, firm weave, which apparently is especially treated so as to withstand the weather and severe usage.

Our government has recently placed an order in France for 1,800 aeroplanes for use in the army, it is said, because American firms were unable to meet the War Department's requirements, particularly in the matter of time.

Mr. - Ferd. Emil Tagerberg, Niedermad, Frankfurt a/M., Germany.

W. G. Tarant, Lucia Hauer, Byfleet, Surrey, Eng.

RECREATION SUGGESTIONS FOR BOYS AND GIRLS,



Homemade Aerial Tramway in a Roscoe, California, Yard: The Cable, Set at an Incline, Carries the Young Passenger on a Thrilling Glide of About 100 Feet



A Big Harvest of Gopher and Mole Scalps Trapped by Cleland Harris, Aged 16, and His Younger Brother, of Salem, Oregon: The Bounty and Bonus of 20 Cents a Scalp Paid These Two About \$4 Each, per Day



It Used to Be Pins, but in Portland, Indiana, It Was Seven Cans Each That Admitted Children to a Show—a First-Class Movie. The Picture Tells Vividly Why This Town Had One of the Best Clean-Up Days on Record



In Philadelphia They have Started a Big War on Dirt, Rats, Flies, and Germs, in Which Hundreds of Boys and Girls have Enlisted, as was Shown in an Enthusiastic Parade Held Recently

AND WAYS IN WHICH THEY CAN HELP THE NATION



Waste Paper Is Valuable Now: Peoria, Illinois, School Children Collected 52 Tons of It in a Five-Day Contest That Netted \$1,014, One School Averaging 63 Pounds of Paper per Pupil



REPRESENT UNDERWOOD & UNDERWOOD

Flag Raising at Opening of One of New York's Municipal Gardens. Many of Which are being Tilled by Patriotic School Children: The Plots are Guarded by Boy Scouts Who have been Allowed to Camp Close By

A Real Screened-In Summer-house Made Especially for Little Folks: It can be Set Up Anywhere in the Yard and is Furnished with Cute Chairs and a Table, as Shown Below

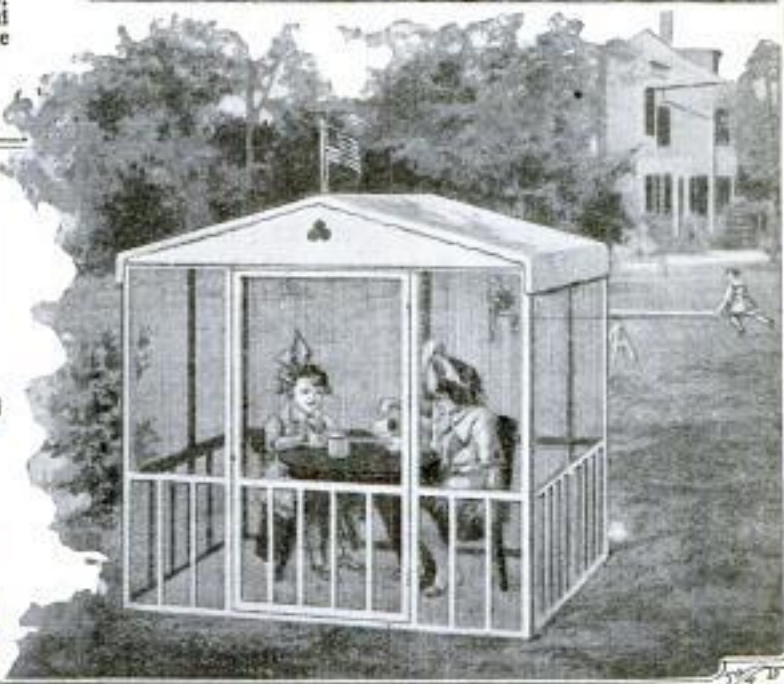

Valley - 20.00
Table - 3.00
Chair - 1.50
Screen Board - 5.00

The E. J. Burrows Co.
Portland, Maine.

Electric Tire Treading Co.
207 No. Mich. Av., Chicago.

282

4395 POPULAR MECHANICS
Repair
METHOD OF RETREADING TRAVEL-WORN TIRES

Automobile tires that are apparently worn out may have a new tread put on



the old casing, by an electrical retreading process recently patented. The cost is said to be about half that of a new tire. The process includes the removal of the old tread and, if necessary, part of the underlying material, after which the exposed fabric is buffed and polished and a layer

of unvulcanized rubber woven with wire is applied, with eight wire terminals left exposed. The new tread is then fitted on, the tire inflated, and the rubber unit electrically vulcanized by means of the eight terminals.

3858

DISCONNECTING HANGER FOR STREET LAMPS

Disconnecting hangers for street lamps of either the filament or arc type, now being introduced widely,

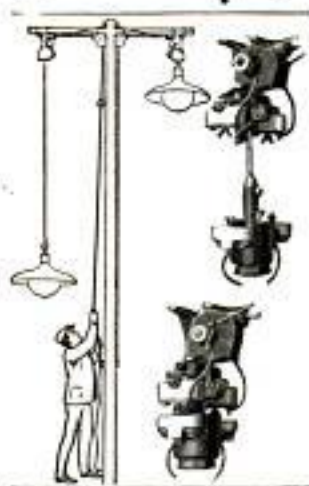

minimize the labor of keeping the lighting units clear because they make the lowering of the lamps an easy, safe matter. With these hangers also, all the wiring is reduced to straight lines. The lowering rope for these lamps passes

from a hook on the side of the pole, up through a pulley at the bracket and through an-

other pulley just above the hanger. It attaches to the lower of the two interlocking parts into which the hanger is divided. By properly jerking the rope the locking mechanism releases so that the lower half, with the lamp and reflector, can be let down. In lowering the lighting unit the forked electric contact, through which the current passes to the bulb or arc, is broken, but is connected again when the lamp is drawn up.

3514

REVERSIBLE WINDOW SASH CLEANED FROM WITHIN

A new window-operating device enables a double-sash window to be cleaned from the inside, thus doing



away with the dangers of the old system of outside window washing with which all housekeepers are familiar. It also has other novel features. By its use the window can be fully screened inside, making it fly and mosquito-proof, and can be

opened and closed without disturbing the screen, curtains, or shade. Each sash is suspended from the top in the window frame, and swings outward from the bottom by the operation of an inside transom shaft connected to a handle, or lever, near the point of suspension. To swing the sash inward for cleaning, it is only necessary to detach the transom from the handle, when the motion of the sash may be reversed and both sides of the window pane can be washed from the inside.

At least six of the former German ships, which were interned in the Philippines, are to be utilized in bringing to this country a quantity of hemp that has accumulated in the islands and is needed here for making binder twine.

Thompson Electric Co.,
5606 Euclid Av.,
Cleveland, O.

W. S. Odell
7422 So. Armande
St. Louis, Mo.



A Submarine Chase in a Display Window

By HARRY MARCELLE

DIPPING in the waves, now submerging, only to reappear and continue the pursuit of the giant liner tossing on a choppy sea, a daring submarine holds the attention of spectators before a novel window display, depicting "Somewhere off the Irish Coast." The endless water stretches out in the background, and the chase continues while the faithful electric motor keeps the "wheels going round." The rolling cardboard waves, and the pitching vessels on the ever-changing scene, produce the effect of a ship attempting desperately to elude its submarine enemy.

A painted background of a marine view, in water colors, or flat oil colors, is set up behind the display. The waves are painted on heavy cardboard, or better still, beaver or compo board, 18 in.

wide, and of a length to suit the size of the window. A strip, 2 in. by $\frac{3}{4}$ in., extends along the bottom of each wave, holding it in an upright position, and forming a base for the wave, when riding on the cams, as shown in detail. Five waves are shown in the illustration, Fig. 1. A stationary one is in the front of the window, to hide the mechanism, which is 2 ft. in width. The other four travel on the cams, mounted

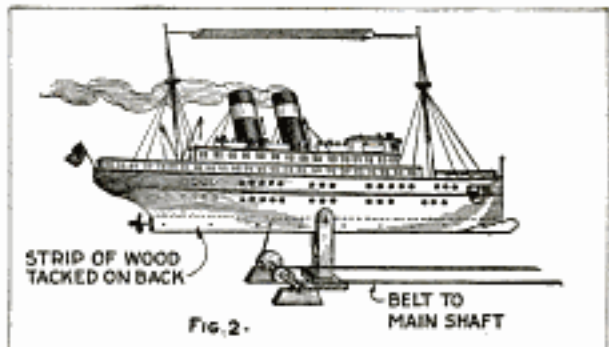

Fig. 2.

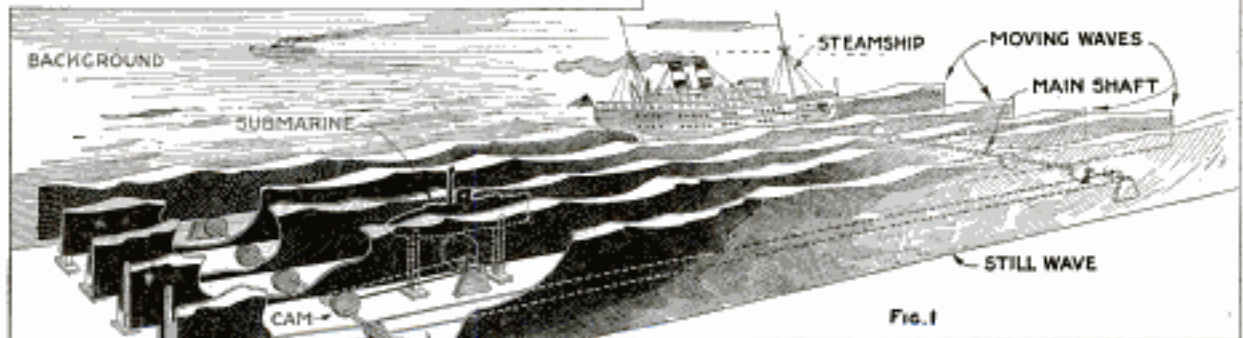

Fig. 1

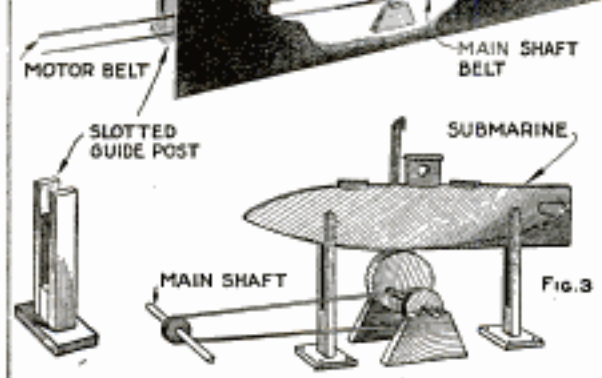

Fig. 3

"Somewhere off the Irish Coast:" The Ocean Liner Has a Pitching Motion, as if Battling the Waves, and the Enemy Submarine Submerges, Only to Continue the Pursuit

on shafts, as shown. The cams are set so that their high points are opposite those of the adjoining cams, to produce alternations in the wave motion. The ship is made of the same material as the waves, is 3 ft. long, and placed in front of the last wave. The ship also

has a strip tacked to the bottom to strengthen it. The submarine is built similarly, and is 24 in. in length.

The wood disks for the cams are cut

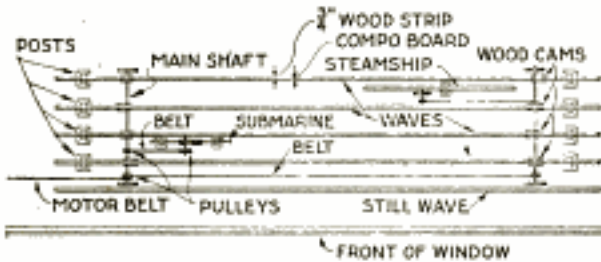

Plan View Showing Details of the Driving Mechanism, and the Relative Positions of the Waves, Boats, and Other Parts

8 in. in diameter, out of 1-in. lumber. Two shafts are provided, and in each disk a hole is drilled, 3 in. from the edge, to fit the shafts tightly, thus making cams of the disks. Seven grooved wooden pulleys, of proportionate sizes, as shown, are also placed on the shafts. Eight uprights, as detailed, are provided, in which the waves ride. One upright is used on the large ship, which is balanced on a nail shaft, placed in the end of the upright support, as

shown. A small countershaft, belted from the main shaft near the liner, oscillates the steamship, by means of a wire crank, as detailed in Fig. 2. The submarine rides on the cam only, and is not pivoted in the center, as shown in Fig. 3. It is also driven from a countershaft. This gives it the effect of being submerged, and slowly rising to the surface. The ship has a pitching motion, as if battling with the sea. A large cam is used on the submarine countershaft, and a small pulley belted from the main shaft, so that the action of the submarine is not as frequent as the tossing and pitching of the steamship. The submarine is placed to the left of the display, between the second and third waves. The display is operated by an ordinary electric-fan motor, and can be driven by various other kinds of power. Of course, much depends upon the artistic and mechanical ability of the maker in painting the background, waves, and boats, as well as in making the parts.

Automatic Hammer for Light Work

Electricians, tinsmiths, gas fitters, and others doing light riveting, chipping, and the like, will appreciate the advantages of this automatic hammer. It can be used in places inaccessible with a hand hammer, it will not split or smash a rivet, and all of them will be

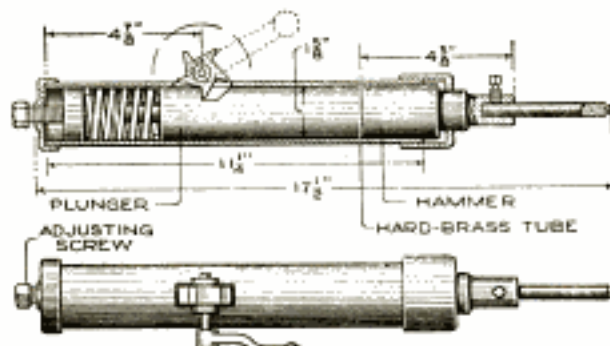

This Automatic Hammer Is Capable of Delivering 300 Strokes a Minute, with One Crank Turn a Second

hammered uniformly. By using form dies, the rivet head may be formed round, square, oval, star-shaped, or in

other designs. It has no valves to get out of order, and no joints to regrind, or glands to pack. As there is no pressure used, save that of a spring, very accurate fits are not essential in its construction, and only a few simple parts are required.

In use, the tool is held in one hand, and the riveting die is pressed against the rivet; then the crank is turned as indicated. The star wheel engages the plunger, and forces it back against the helical spring, compressing the latter. The tooth frees itself from the plunger, and the latter is driven forward by the spring, and strikes the hammer and tool holder, delivering the blow to the rivet. The force of the blow is regulated by tightening or loosening the adjusting screw; the length of stroke is not variable, being controlled by the size and number of teeth on the star wheel, and the depth of the recess in the plunger. On a short stroke a heavier plunger must be used, since the direct weight must be made up in the

weight of the plunger. The hammer is proportioned for work up to riveting $\frac{1}{4}$ -in. soft-brass rivets.—J. B. Murphy, Plainfield, N. J.

Inclines to Platform Scale Save Lifting

Many shops cannot afford a large built-in scale with a platform on a level with the floor. Such scales save much labor of lifting, since crates or barrels can be pushed or rolled directly onto the platform. An ordinary platform scale can be made to serve as a good substitute if inclines are built up to its side. These inclines, made from wood and well supported, should be portable, so that the scale may be used in various parts of the shop. Barrels, heavy crates, etc., can be moved to the platform with rollers, instead of the block-and-tackle arrangement otherwise required.—F. M. Ball, Kansas City, Mo.

Bell Signal Calls Automatic-Machine Operator

A signal bell is used in connection with an automatic machine which fills cans and deposits them in the trough, as shown. When the trough is

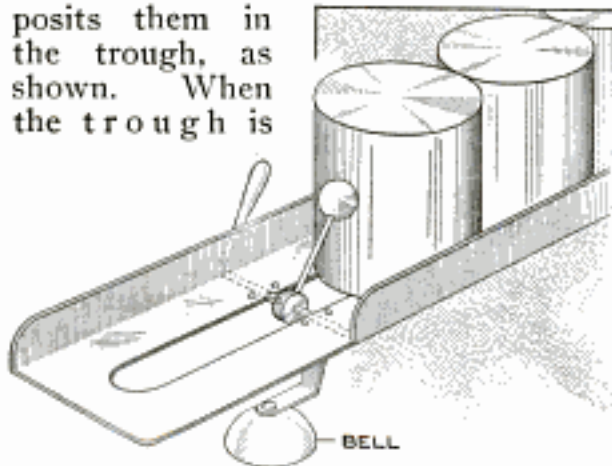

The Clapper is Automatically Tripped against the Bell, Warning the Operator

full, the front can actuates the clapper, which falls through the slot, striking the bell. This calls the attention of the operator, who removes the cans from the trough. The handle beside the trough is used to return the clapper into position for the next batch of cans.

Charcoal Forge Made of Washbasin and Concrete

While engaged in some experimental work at home, I made a small forge,

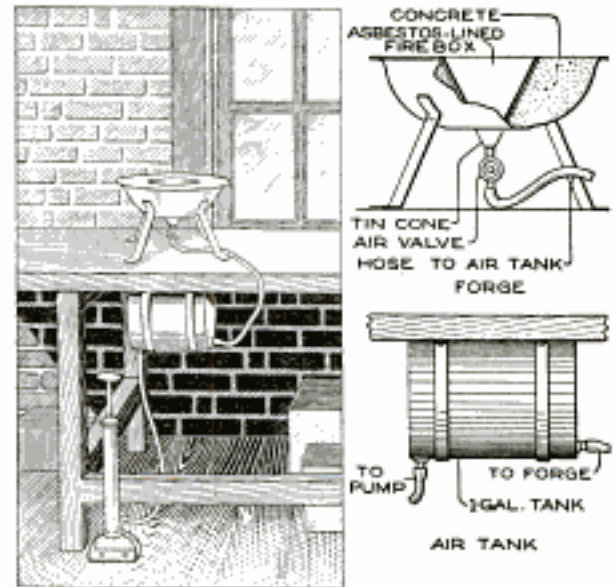

This Concrete and Asbestos-Lined Blast Forge, Made for Temporary Use, Became a Permanent Shop Fixture

and it worked so well that I pass the method on to others. Its construction is very simple. An old granite basin from the kitchen was filled with concrete, and a hole left for the fire box. While the concrete was still wet, a sheet of asbestos was laid around the inside. This keeps the cold concrete from the fire, and makes possible a greater heat. An old fixture from a discarded oil stove was connected to the tin funnel extending to the rubber tubing from the forge, to regulate the air flow. A gallon can, with the proper accessories, was used to regulate the otherwise uneven flow of air from the pump, and to store a pressure supply. The pump was an ordinary tire pump. Legs for the basin were made of strap iron and riveted to the basin, so that it may be more easily handled and the regulating valve underneath reached handily. Charcoal is used in the forge, homemade wood charcoal being prepared with little trouble. The forge melts most of the common metals in small crucibles, and the heat is localized so that it does not heat the room to any considerable extent.—Dale R. Van Horn, Milton, Wis.

A Handy Sheet-Metal Bench Dog

The carpenter's workbench is not complete without a bench dog and a bench stop.

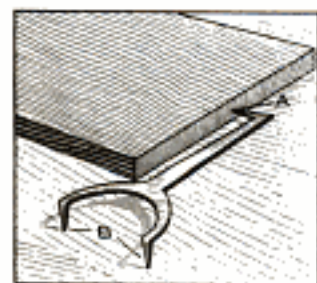

When cutting a mortise, or using a router plane, scraper, or sandpaper, it is often necessary to hold both ends of the board rigid. The bench dog shown is especially handy, being cut from a piece of sheet steel, $\frac{1}{8}$ in. thick. It is 6 in. long, and the points B are 2 in. apart. To use it, place the board on the bench with one end firm against the regular bench stop; then drive point A into the other end as far as necessary, being careful to hold points B close to the top of the bench. Next drive points B into the bench, holding the board perfectly.—John Countermine, Vinton, Iowa.

Can for Recovering Oil from Chips and Sweepings

Around lathes, tapping and milling machines, etc., considerable quantities of expensive oils are used, so that the borings and chips are coated with it. This oil is often wasted, and to save it, I devised this oil-recovering can,

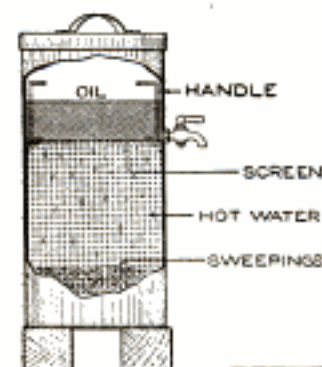

which soon paid for itself. To make the device, get a 5 or 10-gal. can, and provide a cover. Fit in the tray of screen wire, with two handles soldered on, as shown. On one side of the can fit a small drain cock. To use the reservoir take out the tray and fill the can with hot water up to a few inches of the tray. Throw the chips into the water. Put the tray back in place. The oil rises to the top of the water where it can be drawn off. The screen

tray is necessary only when wood or sawdust is mixed with the chips, the screen preventing them from rising in the oil.—M. S. Hay, Denver, Colo.

Whetstone and Strop Kept Handily in Bench Drawer

The disagreeable mess often caused by using a whetstone on a clean bench top can be avoided, and the stone made more quickly available, if the latter is placed in a specially constructed drawer in the bench.

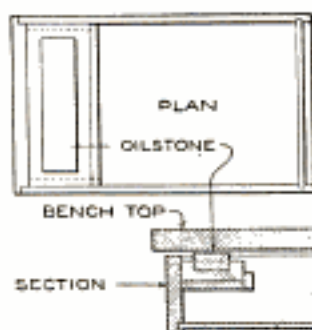

The drawer consists of a frame 2 in. deep, having a bottom and sliding on two strips in grooves. The oilstone is mounted in a wooden block fitted inside the drawer snugly, and resting on guide strips. It is arranged so that the top of the stone just clears the bench top and extends slightly above the edge of the drawer front. The stone and block may be removed from the drawer if desired, and sharpening accessories, strop, etc., are also kept in the drawer.

A Nonslipping Ladder End

A large steel mill adopted the non-slipping ladder end shown in the sketch, to reduce the number of accidents caused by the slipping of ladders.

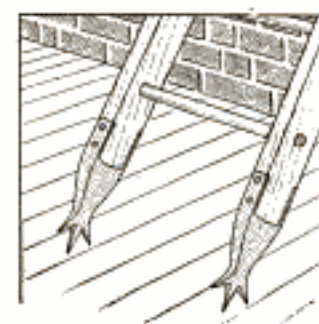

The feet are made of steel and fastened to the ladder ends with rivets. The teeth are filed sharp, and kept well pointed. This type of foot is superior to the common single-prong variety, because at various angles there is always a sharp prong squarely against the floor.—E. B. Hanson, Duluth, Minn.

Small Power-Plant Tractor Made of Engine and Mower

By LUTHER STROSNIDER

*Foot Bros. Gear & Machinery Co.,
213 N. Curtis, Chicago*

BY mounting a 1-hp. engine on a heavy plank, supported on driving wheels obtained from an old mower and steering wheels from a light farm machine, I get much more use out of the power plant than when it was set on a portable carrying frame, or on skids. The outfit is rigged so that it runs under its own power, climbing ordinary hills, and making it practically a small tractor, useful in many ways on the farm. It is guided by the lighter wheels, which are pivoted at the center of their axle, and controlled by the hand lever, as shown in Fig. 1. This outfit has been used for the corn sheller, grindstone, sausage mill, feed grinder, pump, washing machine, and wood saw, and I have used it a few times to draw a wagon, instead of going a considerable distance to get a team.

The old mower wheels and driving gear were set so that the pitman shaft is horizontal, as shown in Fig. 1. An 8-in. bevel gear was set on the end of the shaft, to engage a small pinion set on a second shaft which runs across under the plank, and is bracketed from



Fig. 1. This View Shows the Mower Pitman and the Gearing Connecting It with the Engine, and Also the Steering Lever, Gripped by the Driver

it with heavy strap iron, as shown from the opposite side, in Fig. 2. On this end of the second shaft, a clutch device is arranged, two pins fitting into holes in a pulley, which has a rim to prevent

the belt from slipping off when the clutch is released by means of the slanting rod.

The power is belted from the engine



Fig. 2. The Belting of the Power from the Engine Shaft to the Lower Shaft, Which Connects with the Pitman Shaft on the Opposite Side, and the Clutch-Control Rod are Shown in This View

shaft, where a wide pulley is set, to the flange pulley on the lower shaft, as shown in Fig. 2. The lower shaft and pitman shaft are engaged only when moving the power plant. When in use on a saw or other machine, a belt is fitted from the engine pulley to the pulley of the machine being driven. The tools and other equipment for the outfit are kept in the tool box, mounted on the plank.

Liquid Glass Used to Make Asbestos Packing Stick

In setting pipe covering on valves, tanks, and other similar surfaces, it is often difficult to make the covering stick. To overcome this, give the surface a coat of silicate of sodium, known as water glass, and apply dry asbestos by the handful while the surface is wet. The silicate sticks to the metal and retains sufficient asbestos to form a ground for the later coats, applied with a trowel. Wire mesh may also be wrapped around certain forms on which the asbestos will not stick readily, and provides a good foundation.

A Grade Indicator for Motor Vehicles

The construction of a grade indicator suitable for automobiles, for use on railways, etc., is shown in the sketch.

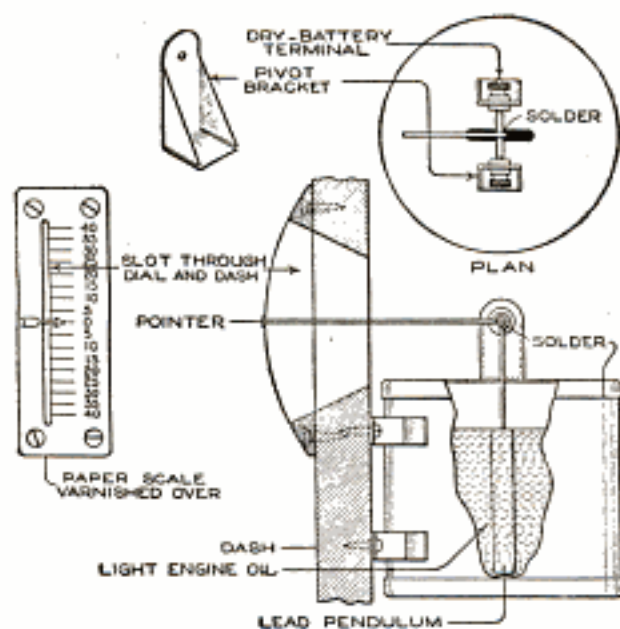

The Pointer Shifts Steadily as the Grade of the Road Changes, Indicating the Percentage

It was made of a baking-powder tin, partly filled with engine oil, in which is suspended a lead pendulum attached to a pivot. Dry-battery terminals form the bearings. The pendulum and pointer arms are of steel wire, soldered to the pivot. The paper scale is glued to a wooden back and is graduated in grade percentages, and not in degrees.

The lengths of the arms and dimensions of the parts are omitted as they may be varied. The spacing for the graduations is varied to suit the radius of the pointer. The arm that carries the pointer is of light material and the pendulum reasonably heavy. The liquid steadies the oscillations of the pointer. When attached to an automobile, the device indicates the proper time to change gears, as well as provides a measurement of gradients. An instrument similar in principle is used on aeroplanes to bring the craft on an even keel, when dropping bombs or other explosives.

The scale is determined by using the following degree indications in marking it, the figures being for grades of

0 to 40 per cent, inclusive, at intervals of five per cent: $2^{\circ} 52'$; $5^{\circ} 43'$; $8^{\circ} 32'$; $11^{\circ} 19'$; $14^{\circ} 3'$; $16^{\circ} 42'$; $19^{\circ} 18'$; $21^{\circ} 48'$. This range is satisfactory for all ordinary gradients that a motor vehicle can make.—G. A. Luers, Washington, D. C.

Steel-Roller Lathe Dog for Making Small Spindles

In turning and grinding small steel shafts it is usually necessary to grip the finished end with a copper dog so as not to mar the work. The steel-roller dog shown in the sketch is superior to this, and for quantity production the making of a set of these dogs was found economical. The dog grips the shaft automatically, and the gripping surface is of sufficient width so as not to mar smooth bearings. The dog is essentially a piece of steel, of the shape and dimensions shown, and having a hole bored through it, the size of the finished shaft on which it is to be used, plus .002 in. A small steel roller fits into an offset at the side of

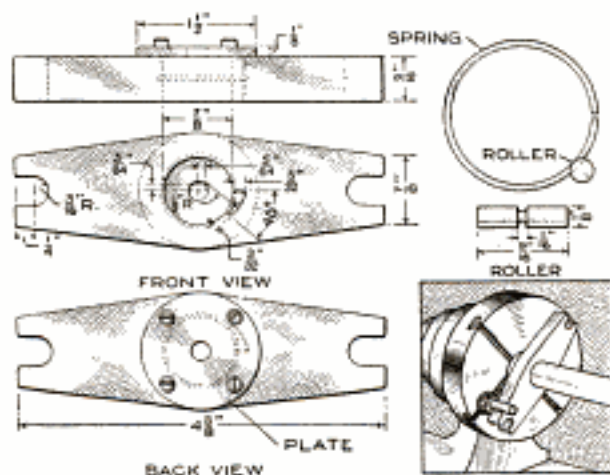

This Lathe Dog was Found Economical for Polishing Steel Shafts in Large Quantities

the hole, and is free to roll about one-eighth of the circumference. When the dog is placed on a shaft and revolved counterclockwise, the roller is forced against the shaft, gripping it firmly. The roller is held in place by a spring ring, fitted into a groove, as detailed. The dog is made of iron, casehardened, and the roller of tool steel, hardened.—Hubert Kann, Pittsburgh, Pa.

Counting Small Parts by Weighing Them

Purchases of small machine parts, screws, bolts, washers, etc., in large quantities, usually require that they be checked as to number, and counting them is tedious. An ordinary scale, with a scoop pan, was used in counting to great advantage. First the empty scoop was set on the platform, moving the hanging weight along the scale beam until it balanced the weight of the scoop. The parts were poured into the scoop, until a suitable, easily calculated weight, 10 lb. for example, was registered. The parts weighed were counted, and succeeding batches poured into the scoop until the unit weight was registered. Thus, the total number of parts was recorded in form for easy calculation. If especially accurate results are desired, several tests for the number of parts in a given weight may be made, and the number determined by an average.—C. M. Hall, St. Louis, Mo.

Eyeshade Carried Safely under Shoulder

Frequently it is desired to take an eyeshade from the place where it is ordinarily used, and those who have tried it know how easily the shade is damaged. By carrying the eyeshade under the shoulder, as shown in the illustration, the shade lies flat, fitting the curve of the body. It is entirely comfortable to the person carrying it and not likely to be broken.—H. Chait, New York, N. Y.



Sliding Gable-End Hay Doors Easily Operated

Hay doors hinged in the gables of barns are troublesome when the crop

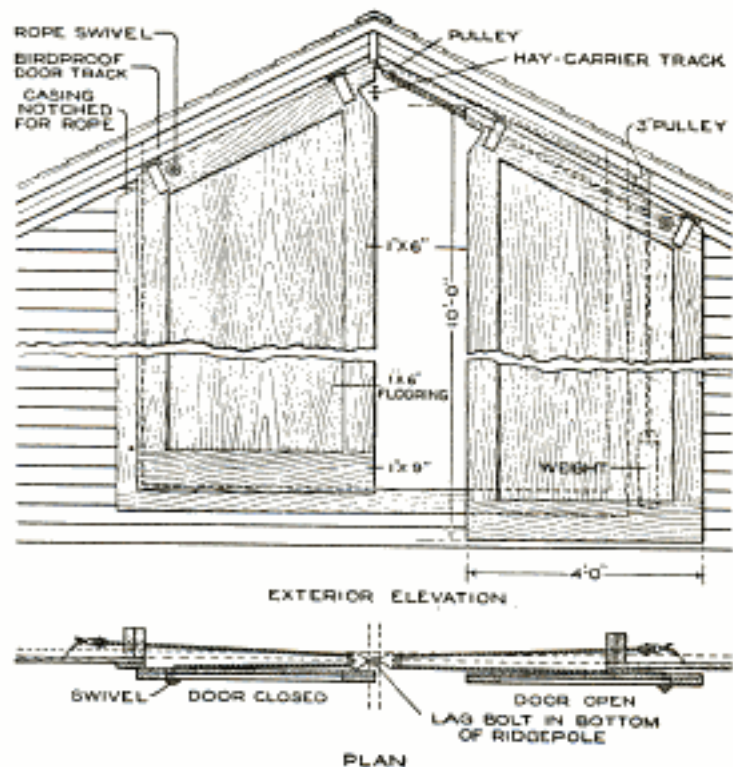

The Doors are Easily Slid into Position on the Inclined Tracks by Reason of the Counterweights

is being hoisted into the mow, and are a constant source of annoyance through damage from the wind or by the weakening of the hinged fastenings. By using sliding doors in the gable, these troubles are easily avoided. Sliding doors, as detailed in the illustration, can be installed easily to operate on the incline of the roof, under the eaves. Provision is made for the usual hay-carrier track, extending under the ridgepole. The doors are strongly framed and suspended on a bird-proof track, from roller hangers, and are counterbalanced by weights suspended on ropes, run over 3-in. pulleys, as shown. This makes it easy to slide the doors into place up the incline. The sectional plan shows the arrangement of the rope counterweight device, and the pulley rigging is also shown in the sketch. By extending the control ropes, the doors can be opened from the barn below.—W. E. Frudden, Charles City, Ia.

Hollow-Tile Wall Construction Using Metal Bonds

Hollow tile is a sanitary material for building purposes, especially adapted for residences. In the ordinary form of

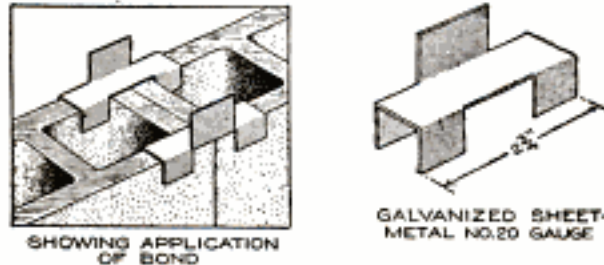
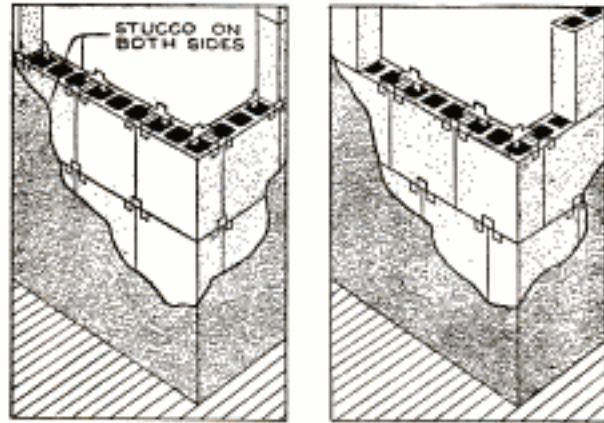

A House was Built of Tile at Much Less Expense and Time, by the Use of Metal Bonds, and Proved Substantial, Not a Crack Developing in Four Years

structure, the tile are laid up in mortar, and most building ordinances require them to be 6 to 8 in. thick. This new wall construction, using tile 4 in. thick, provides a very strong, rigid wall. A metal bond is used, and holds together the adjacent tiles, preventing not only lateral displacement at the joints, but deflection in the wall.

The bonds are made of No. 20 gauge galvanized sheet steel. They are 2 3/4 in. long, and of such size in cross section that the side wings will clasp the web of two abutting tile. The upper side of the bond has an upward projecting wing, to hold the next tile above. Two bonds are used at each joint, as shown.

The tile can be laid with matched or staggered joints. In a building constructed with the bonds four years ago, there is not a single crack. The building was laid up without mortar, and the stucco, or concrete, applied afterward. Partitions can be run from the walls,

the same bond being used. The bonds cost less than the mortar usually employed, and the cost of putting up the tile was less than half that under the usual method. The mortar or cement forced into the cracks between the tile assures a perfect seating of the tile. This bond without mortar assures perfect seating of the tile as they are laid in, and the stucco or concrete finish on both sides is not necessary to make a rigid wall.

Blueprint and Roll-Paper Box with Sheet Cutter

Frequently in drafting rooms the rolls of prepared paper, tracing cloth, etc., are kept in a cupboard or closet. A more convenient plan is to make a long narrow box, with a hinged top. A strip of heavy felt is glued along the top edge and a strip of heavy tin, or galvanized iron, is nailed on the under side of the cover. A small catch at each end keeps the cover against the felt. When paper is required, pull out as much as desired and tear it off against the metal edge. The box has two compartments with independent lids. A yardstick for measuring the

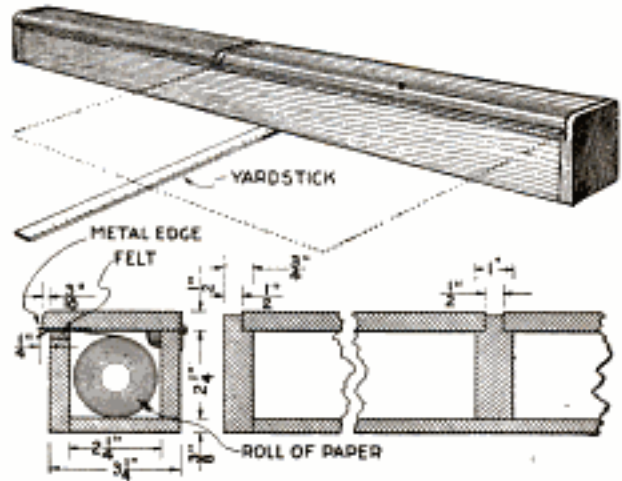

This Box Economizes Paper and Makes Cutting of Neat Sheets Convenient

sheets is pivoted underneath on a screw, and is swung out of sight when not in use.—John D. Adams, Phoenix, Arizona.

☞ In mixing plaster of Paris, sprinkle the plaster in the water to obtain a smooth mixture.

Pointers on the Use of Valves

An angle valve is generally more satisfactory than a globe or gate valve and an ell, when a valve is required near a right-angle turn in a pipe line. It demands fewer joints to be kept tight, and makes a better-looking job. Less friction is also caused by water or steam passing through the line. Brass or gun-metal valves should be used on pipe lines that convey superheated steam; never use rubber-disk valves for such duty. In taking down valves, especially those of brass, use a wrench that fits the nut portion closely, so that the corners will not be worn off by the slipping of the wrench.

Old Street-Car Gongs Used as Hardware Trays

An ingenious use of worn-out and cracked street-car gongs is made by a street-railway company in its shops. The old gongs are utilized in making convenient stands to hold small materials, such as washers, screws, nails, nuts, etc., in the storeroom and the shops. A gong weighted with babbitt is used as a base, and the other gongs, inverted, are fastened by pins on an upright, to form receptacles, as shown. Graduated holes in the pipe upright provides for adjusting the receptacles.—Ralph O. McGraw, Chicago, Illinois.



An Emergency Hack-Saw Frame

On a hurry-up bench job in a machine shop, the only available hack-saw frame broke, and it became necessary to provide a substitute or abandon the job. A satisfactory frame, that has

proved useful as a regular tool, was made in a few minutes, as detailed in the sketch. The main portion of the

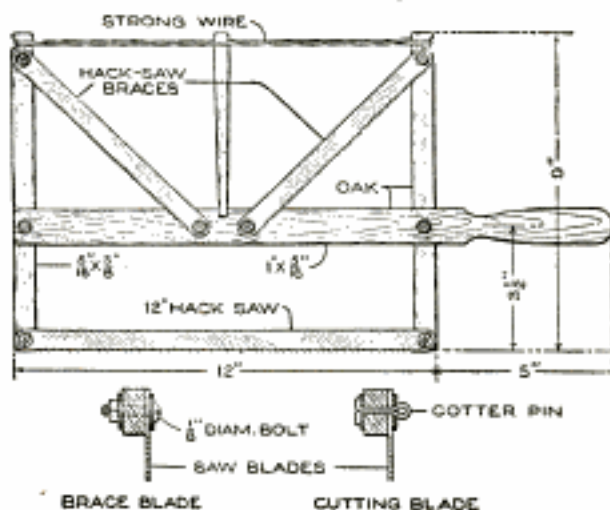

This Emergency Tool Proved so Useful That It was Kept as a Regular Part of the Shop Equipment

frame was made of $\frac{5}{16}$ -in. wood and a handle was cut on the crossbar. The saw blade was fitted into place, as shown in the detail, and braces were made of saw blades. A strong wire, tightened with a tourniquet, braced the frame at the top, and made the cutting blade rigid.—J. C. Marsh, Boston, Massachusetts.

Device for Undercutting Mica on Commutators

The mica insulation between the commutator segments of copper, on

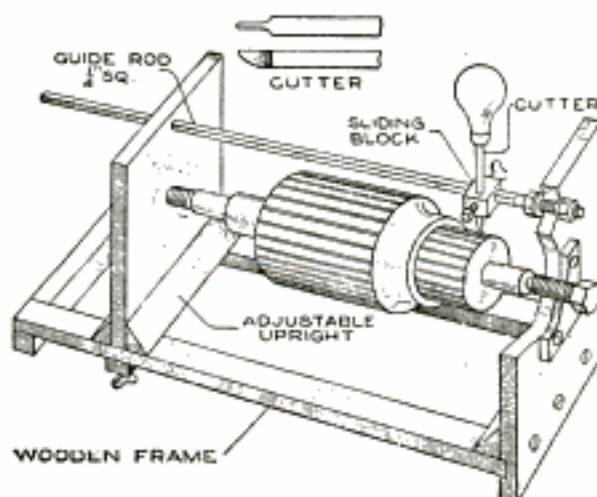

The Mica Insulation between the Commutator Segments is Reduced Uniformly by Means of This Arrangement

motors or similar machines, should be kept below the surface of the seg-

ments. Where a number of small motors are to be cared for, a frame for holding the armature conveniently, and a device for cutting the mica are timesavers. In the arrangement shown, the armature is mounted between pointed machine screws set in metal plates, fastened to the ends of the frame. The latter is adjustable, and the cutting device is made of a piece of drill rod suitably ground and handled, for clamping in a sliding block, set on a guide rod.—R. L. Hervey, Baltimore, Md.

Jig for Piercings on Dies and Machine Parts

A fixture, or jig, for locating piercings can be used to good advantage on follow dies, or dies that blank and

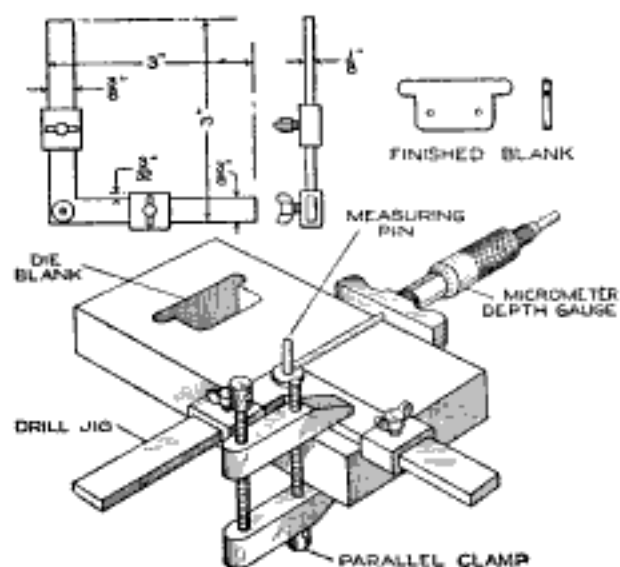

The Piercings on Dies are Located Quickly and Accurately by Means of This Jig

pierce the stock in one revolution of the punch press, in which the die is held. That shown in the illustration consists of a 3-in. right-angle square, made of $\frac{1}{8}$ -in. flat, cold-rolled steel, or ground stock. Two adjustable sliding stops of machine steel are fastened with thumbscrews. The bushing at the corner of the square is of hardened tool steel and set with a drive fit. The center hole in the bushing can be of various desired sizes. A number of different-sized bushings are convenient. A small pin fits the bushing, and is used

as a measuring point, as shown. The fixture is placed on the die to be drilled, and set so that the center of the bushing is in about the position in which the piercing is to be drilled. The stops are then set, and the fixture is clamped to the die. With a micrometer depth gauge, the fixture is set precisely in position.—William E. Jewett, Jersey City, N. J.

Economy by Use of Government-Size Letter Paper

While trying to stow away in my files an $8\frac{1}{2}$ by 11-in. sheet of 20-lb. folio bond paper, now selling around 40 cents a pound, I wondered why more persons do not save paper by using the 8 by $10\frac{1}{2}$ -in. size, weighing one-fourth less in folio weight, and nine per cent less because of its size. A typical sheet of this size is equivalent in weight to 16-lb. folio stock—17 by 22 in.—but in cutting four sheets out of a paper 16 by 21 in., I get nine per cent more sheets, by weight, for the same money. This size sheet is satisfactory for letters and manuscripts, and often saves postage. The government has used it for years, and many of the government sheets are only half this size.—J. Cecil Alter, Cheyenne, Wyo.

Grinder as Winch for Hoisting Countershaft

Supporting a piece of machinery against a ceiling while bolting it in place is often a trying and difficult job. Two boys had such a job in the shape of a countershaft and shifter for an emery-wheel grinder, the part being too heavy for them to handle. Two block pulleys were attached to the ceiling timbers. Two pieces of rope were tied to the lower parts of the countershaft, the other ends being attached to the grinder shaft, which was turned by a wrench, making a crude winch. The grinder was bolted to the floor. The countershaft was safely raised, and held in position, while the lag screws were tightened.—E. H. Post, Pittsburgh, Pa.

A Homemade Hydraulic Ram

By B. FRANCIS DASHIELL

THE hydraulic ram is used where considerable flow of water with a moderate fall is available, to raise a small portion of the flow to an elevation. The principle upon which it operates is as follows: An outflow of water falls through a pipe; when the lower end is suddenly closed, the movement is arrested, and the momentum of the current in the pipe forces a small portion of the water, through a check valve, into an air chamber, and out into the delivery pipe. When the momentum is down to normal pressure the outflow valve drops open of its own weight, and the delivery check valve closes, as shown in Fig. 1. The cycle repeats itself about 40 times a minute. Thus, the water is elevated by a succession of impulses.

A hydraulic ram, as detailed in Fig. 2, is easily built. The diagram, Fig. 1, shows the operation of the ram, the water being drawn from a reservoir, or spring, through the inclined drive pipe A to the ram. It overflows through the vertical check valve B. When the velocity of the water through the pipe reaches a certain pressure, the valve is closed. The extreme pressure in the pipe at this moment is great enough to force open the check valve C, and drive some water into the air chamber D, and thence out of the delivery pipe E.

In Fig. 2 the parts are shown assembled. The ram should be set in a

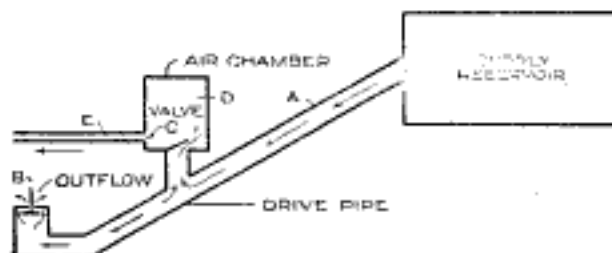

Fig. 1. Diagram Showing Operation of the Hydraulic Ram

vertical position. The supply pipe should be 1 in. inside diameter, and the delivery pipe $\frac{1}{2}$ in. Set the ram

about 5 ft. below the level of the supply dam, or reservoir, and not over 60 ft. away. The supply should have at least 8 gal. a minute to give good re-

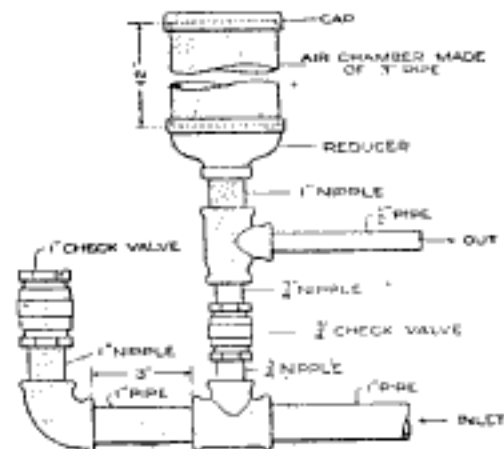

Fig. 2. Assembly Drawing of the Pipes and Fittings of Which the Ram is Made

sults from the delivery. It will lift water over 20 ft. above the ram, and 200 ft. away, but, of course, the farther away the water is to be delivered, the less will be obtained, owing to the considerable resistance of $\frac{1}{2}$ -in. pipe. Fix a strainer over the drive-pipe intake to keep dirt from getting into the ram, and preventing the valves from seating properly.

Engine Nut Recovered with Pill Box on Stick

I removed a castle nut from my motorboat engine pump, and it dropped from my greasy fingers through several openings to the engine bed. None of the openings near it were large enough to permit inserting pliers or similar devices. Here I was, 50 miles from a good machine shop or other source for obtaining a like nut. I finally used soap, as burglars sometimes do. I tacked a small pill box on a stick, and filled it with soap. I inserted the stick into the engine pit, and there was the castle nut imbedded in the soap.—Egbert A. Clark, Washington, D. C.

Stove Lid Used to Repair Forge

The bottom of a portable forge burned out and a thoroughly satisfactory repair was made by bolting an old 7-in. stove lid into the bottom of the fire pit. Holes were drilled for the free passage of the air blast, and similar holes for the fastening bolts, and the lid was bolted into the forge.—Oscar Dzois, Tilbury, Canada.

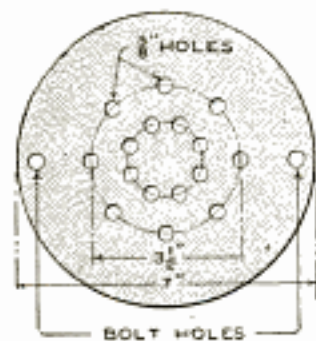

Cutting a Glass Tube or Bottle

To break a bottle, or similar glass receptacle, smoothly around it, wet two strips of paper and wrap them about the bottle, as shown, a narrow margin intervening. Nick the glass carefully with a file and

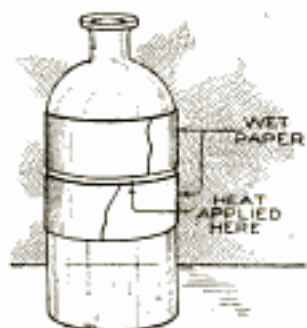

apply a hot flame on this line, while turning the bottle.

Brass Guide Strip for T-Square

Draftsmen know what an annoyance it is to have the working edge of a drawing board warp, or wear, so that the head of the T-square does not fit snugly against it. I have overcome this difficulty by fixing a metal edge on the board. I fastened a strip of aluminum—brass will serve— $\frac{3}{32}$ by 1 in., to the working edge of the board with small screws, rabbeting it in flush with the top. The metal projects $\frac{3}{16}$ in., and fits into

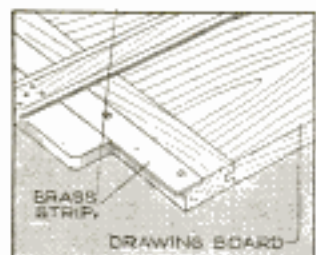

the groove in the head of the T-square, holding it firmly in place, yet permitting it to slide freely.—Guy E. Waite, Ottawa, Ill.

A Homemade Rabbet Plane

In making skis it was necessary to groove them, and I made a rabbet plane for the purpose. Two pieces of 1 by 4-in. board were cut, 12 and 14 in. long. Two bored holes, and a few cuts with a key-hole saw effected a handle on the

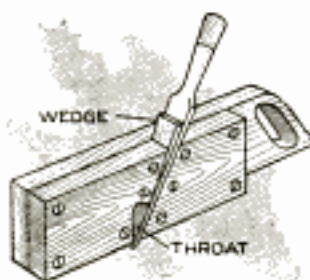

longer piece. The short piece was cut in two, at an angle, and the pieces fixed to the longer piece with screws, leaving a slot for a $\frac{1}{4}$ -in. chisel, and a wedge. A throat was cut, as shown, for the shavings. A slight tap on the chisel at each complete stroke permitted the cutting of the groove to the desired depth.—Victor Pare, Gladstone, Mich.

Pencil Sharpener with V-Groove Made from Files

An efficient pencil sharpener may be made from two files and a block of wood, 2 by 3 by 5 in. long. In the top surface cut a 45° groove, as shown. Break the files to two 5-in. lengths, fit them in the groove, and glue them in position.

The rough surface of the files holds the glue nicely. The block is held in the left hand, and the pencil point rubbed, with a twisting motion, in the file-lined groove, with the right hand, sharpening the pencil in a few moments. By holding the pencil at different angles, various degrees of fineness of point are obtained.



Revolving File Cabinet on Double Desk Saves Time

A revolving file cabinet, mounted at the center of a large double desk, solved the problem of making the files readily available to two clerks in an office where space was valuable. A cabinet was provided, with short filing drawers, and compactly and lightly built. It was fixed to the center of the desk top by means of an iron pedestal, provided with a center shaft, around which the cabinet turns.

Shop Ladder Made of Pipe and Fittings

In a railroad repair shop where ordinary ladders were found bulky when made strongly enough, ladders built up of pipe and fittings, reinforced, were made and used with satisfaction. They were built of $1\frac{1}{2}$ -in. pipe joined with tees, and bolts were passed through the tees and rungs for further strengthening. The ladders being 28 in. wide,

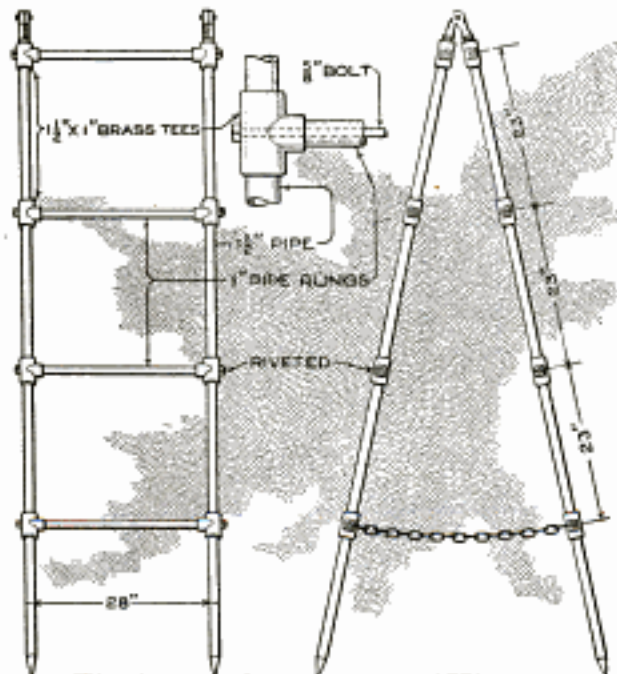

This Strong Ladder was Designed for Use in a Railroad Shop

it is possible to pass planks at any of the rung levels. The ends were pointed to give a secure footing.—Joseph K. Long, Renovo, Pa.

Reinforcing a Blown-Down Iron Smokestack

One of the guy wires running to the top section of a 60-ft. iron smokestack broke during a high wind, and the

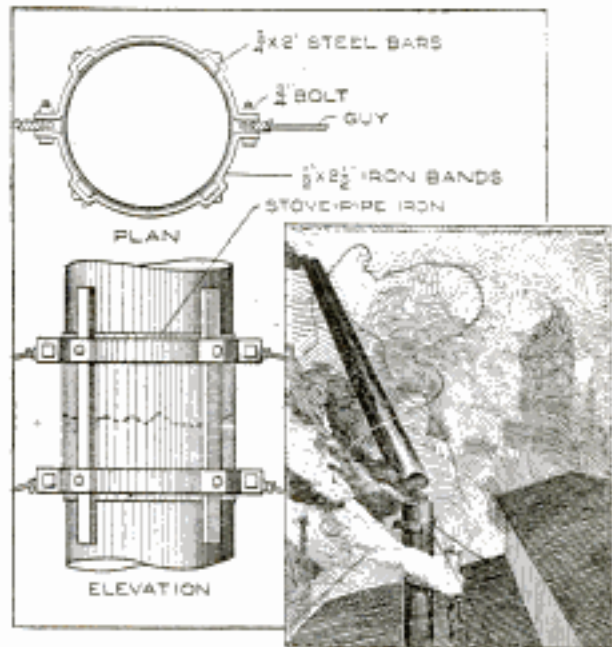

A High Wind Blew Down the Smokestack, and It was Quickly Repaired at Little Expense

stack broke off just above the ring to which the lower guys were fastened. The loss of time to get a new stack would have been great, and the old one was, therefore, patched up and proved satisfactory for continued use. The broken-off section, which remained intact, was hoisted back in place, and kept in line by guys and a set of clamps and bars made for the purpose, as shown in the detail sketch. Guys were run from the clamps on each side of the break, and the stack was made rigid. Around the break, two thicknesses of stovepipe iron were wrapped, before the clamps were put on, to stop leakage.—Donald A. Hampson, Middletown, N. Y.

Wire Mesh for Rough-Surfacing Concrete Walk

Concrete walks can be made with a rough surface, when a regular rough-surfacing roller is not at hand, by applying wire mesh, pressing it firmly on the surface, while the concrete is slightly soft.—H. K. Capps, Stahl, Mo.

A Shear of Angle Iron for the Vise

A useful piece of apparatus for the workshop is a vise shear, easily made out of two sections of $1\frac{1}{2}$ by $1\frac{1}{2}$ -in.

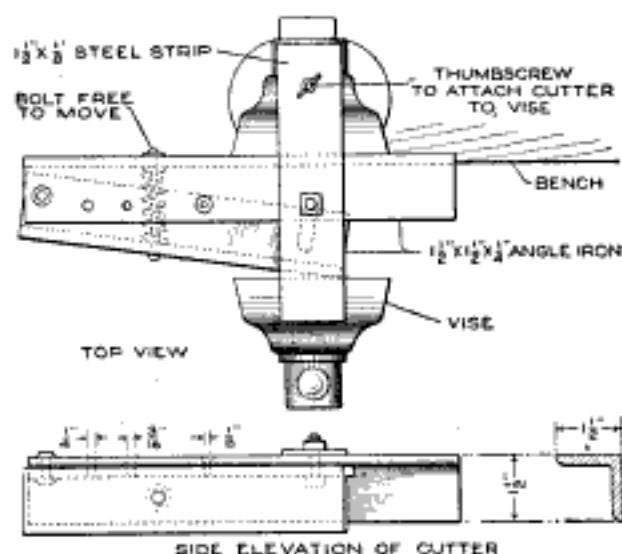

Rivets, Lengths of Small Rod, and Similar Stock can be Cut Quickly with This Homemade Vise Shear

angle iron, riveted together as detailed, and fitted with a stiff spring, on a bolt, which opens the cutter when the vise is released. Holes, the size of the rivets or rods to be cut, are drilled through both pieces of angle iron, when they are in position, as shown in the top view. Both pieces are casehardened around the holes. A metal strap is fastened to the stationary angle iron by bolts, to hold the shears in the vise. A hole is drilled and tapped in the vise to take a thumbscrew, which steadies the shears. The stock to be cut is placed in the hole of the same size diameter, and the vise is tightened to shear the stock. When one requires a number of rivets of a particular length, this device cuts them quickly. By using a slotted plate to hold the rivets, which are fed into the shear steadily, quicker work can be done.—B. E. Dobrée, Battleford, Sask., Canada.

ⒸEspecial care must be taken in protecting oak from various kinds of oil used on machinery, as this wood is easily spotted black by the combination of the tannin and products from crude oil.

Pointers on the Care of Auto Tires

Every autoist has his share of tire troubles, which usually start with punctures, and then casing troubles. Half the joys of automobiling can be destroyed if the tires are not properly looked after; so the following hints may be the means of avoiding difficulties and displeasure.

The first rule to be observed is to keep the tires properly pumped up to the pressure specified by the tire manufacturer. A good rule is to make it a point to try the pressure in the tires once a week; a pressure gauge is necessary and should always be carried in the car. Jack up the axle once a week and turn the wheels round and look for cuts, nails, stones, etc., that are likely to injure the casing without causing a puncture. Tacks and nails that have penetrated only the outer rubber may be removed to prevent blow-outs on the road. When a small cut has been made in the casing, it should be vulcanized before dampness or sand has time to work in. Dampness soon rots the fabric, and sand will work in between the fabric and rubber, causing them to separate, and make a boil. Then, undue wear on the rubber is caused and very quick destruction of the tire follows.

There are many gums and fillers sold for filling up cuts in the casings, but vulcanizing is probably the best remedy. Efficient vulcanizers are inexpensive, and convenient for home repairing. If the tire has a bad gash or blow-out, it is best to take it to a vulcanizing shop. The best method to make a temporary repair for a cut or blow-out that has gone through the fabric, is to put an inside blow-out patch inside the casing, being careful to get the edges pinched under the beads of the tire so that the patch will hold in position when the tire is inflated.

Sometimes the fabric of the tire is broken without cutting the rubber. This will cause a blow-out in time, and the only safe way is to take it to the shop and get it repaired; for

a blow-out patch inserted will not last long as the continued friction caused at the break in the casing will crack the patch open. Inner linings help a badly worn casing, but they are a poor substitute for a good vulcanizing job.

The only satisfactory way to repair inner tubes is to vulcanize them, and this may be done in the home garage. Cold patches are desirable in emergencies, but when driving for any length of time on macadam, asphalt, or concrete roads, the tires get very warm, and these patches are likely to loosen up, causing a leak. Vulcanizing all punctures at the first opportunity is the best practice in the long run.

When the hole is larger than an ordinary nail hole, the following method of repairing is good: Cut out a regular-shaped hole in the tube, and scrape the inside of the tube, all around the hole, for $\frac{3}{4}$ in. on each side. Cut a piece of old inner tube, large enough to allow a margin of $\frac{3}{4}$ in. around the hole. Apply cement to this on one side, previously cleaned, and also on the inside of the tube. When both are tacky slip the patch into the tube, and see that it adheres well all around the inside of the cut. After preparing the outside in the usual way, the patch may be vulcanized. The patch inside will form a good backing for the soft vulcanizing, and when it is clamped up a perfect weld is made.

If there is a slow leak in a tire, before taking the casings off, test out the air valve by holding a drop of water over it; if air bubbles come out, replace the valve. Dirt is blown into the valve seat, causing a slow leak and much trouble; frequently this is the cause of leakage attributed to a supposed puncture. Summing up, the automobile equipment is not complete without a vulcanizer and material for it, an air-pressure gauge, a blow-out patch, extra air valves, and extra tubes.—F. S. Korb, Detroit, Mich.

ⒸA section cut from a cotter pin is useful for replacing buckle tongues.

Apple-Packing Table Mounted on Wheels

A table for sorting apples to be packed for shipment was made of odd ends of lumber, and mounted on discarded wheels, as shown, making it



The Table is Moved as Required, and the Culls Placed in the Chute

readily portable. The handiest feature of the rig is a chute from the top, on which the apples are sorted, for culls, leaves, etc., which might get into the barrels. The slats of the table extend lengthwise, and the chute opening is across the top. When the chute opening is wanted wider or narrower, the slats around it are moved.—M. Glen Kirkpatrick, Des Moines, Iowa.

Fitting a Handle to a Pick

A quick and thorough method of fixing handles in the heads of picks is as follows: Put the head on the handle, as shown, and pound the butt on a solid foundation, until the edge of the pick eye cuts its way nearly to the end. Reverse the handle and pound the other end to loosen the pick. Cut off the slivers, insert the handle in the proper way, and pound the butt on the iron or base to a solid fit. If carefully done, the handles will not loosen even in great changes of weather.—James M. Sherman, Columbia, Mo.



Charcoal Heating Stove Made of Flowerpots

A small stove that was made originally for taking a chill from winter

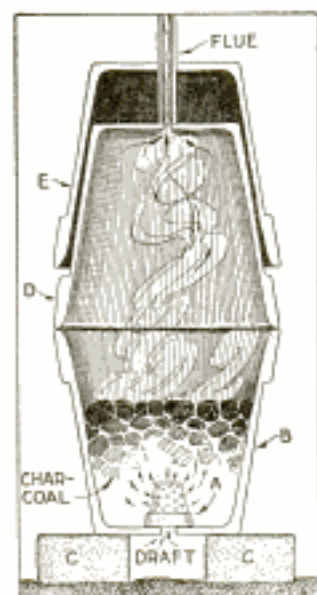

hotbeds, and which can be used for various purposes throughout the year, was made from several clay flowerpots. A small pot, A, was drilled with small holes, as indicated. A 12-in. flowerpot, B, was set on bricks, C, with the small flowerpot inverted over the hole at the bottom. The charcoal fire is made in the flowerpot B, which is covered with a similar pot, D, and over this is another pot, E, which retains the heat. A flue, made of a piece of 1-in. pipe, carries off the smoke and gas. Soft coke may also be used, and the pots will hold heat and fire about 24 hours if pot B is filled three-fourths full.—R. S. Matzen, Fort Collins, Colo.

Device for Holding Screws While Threading Them

It is often desired to rethread screws which have become burred, and in the tool room many odd sizes of screws are required. It is difficult to hold a screw in a vise while threading it, and the device

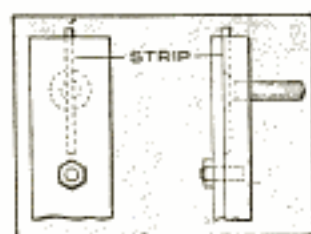

shown in the sketch was made to overcome this. The screw is inserted in the hole and the small strip of steel in the slot prevents it from turning. A small bolt holds the two pieces of the device together, so that it may be clamped in a vise.

Gauge Determines Diametral Pitch of Gears

The simplicity of this gear-pitch kink, that I have worked out, will appeal to a large number of mechanics, and others who have occasion to send a helper to get the pitch of a gear, in a position where it cannot readily be measured or taken down. Obtain a piece of sheet metal, about .008 in. thick, $\frac{1}{2}$ in. wide, and 3.1416 in. long, and bend it to the circumference of the gear on the pitch line. The teeth between these two points will be the diametral pitch. The explanation is that the diametral pitch is the number of teeth to each inch of the diameter of the gear; therefore, if a gear has, for example, four teeth for an inch of diameter, those four teeth cover a space on the pitch line of 1 in. multiplied by 3.1416, and that is the length of the gauge.—Robert D. McElvany, Norfolk, Virginia.

Rheostat Made from Old Arc-Lamp Carbons

A simple rheostat was made from discarded arc-lamp carbons, as shown in the sketch. A wooden box, 12 in. high and 6 by 6 in. inside,

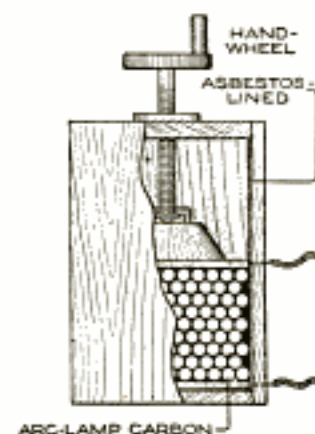

was used as a container, and lined with asbestos, to guard against overheating. A metal plate was fastened to the bottom of the box, and several dozen arc-lamp carbons laid in. The more carbons used, the greater the range of resistance. A second plate was placed on top of the carbon pile. By employing a hand-screw device the pressure on the carbons between the two plates may be varied. When electrical connection is made to the two plates, the resistance varies inversely with the pressure.

An Inexpensive Color-Changing Sign

Color-changing signs are effective as advertising devices, and the box sign shown is so simple in construction and operation that it has a wide use. An angle-iron frame is made up to the desired size. The four corner uprights are riveted to the bottom. The top is fastened to the uprights with screws, to permit its being removed for the insertion of the mechanism and glass sides. The front and two sides are of glass, with the desired advertisement painted on one side of each, and the inner side frosted, to obscure the mechanism. The back, top, and bottom are cut from one piece of galvanized sheet iron, A, with a circular opening cut near one end, and a circle of holes near the other. It is then bent to shape and fastened in place.

The inner mechanism consists of a cylinder of celluloid, B, fastened to a revolving air vane, C, which is made of thin metal, preferably aluminum, with the blades bent at an angle of about 25°. This cylinder is large enough to revolve freely around an upright electric-light bulb. A cylinder of sheet metal, D, is next made, slightly larger in diameter than the celluloid one, and serves as the upper part of the air shaft. A strip of metal is fastened across the inside, and supports the revolving member. The bearing is a glass-head pin inserted in the center of the vane and fastened to the cross strip.

The lower air shaft E is made $\frac{1}{2}$ in. smaller at one end than the celluloid cylinder, and extends 1 in. up into the same. The other end flares out to inclose the air holes in the bottom of the sign. The upper and lower air shafts are then fastened in position, at the galvanized sheet iron which forms the top, bottom, and back. A weather-proof electric-light receptacle is mounted within the lower air shaft, so that the electric bulb will be in the center of the sign. The wires, protected, are led from the socket through a hole in the bottom of the sign, and properly insulated in tubing. A hood,

riveted over the circular opening in the top, keeps out the rain. The celluloid cylinder can be painted in broad, vertical stripes with transparent col-

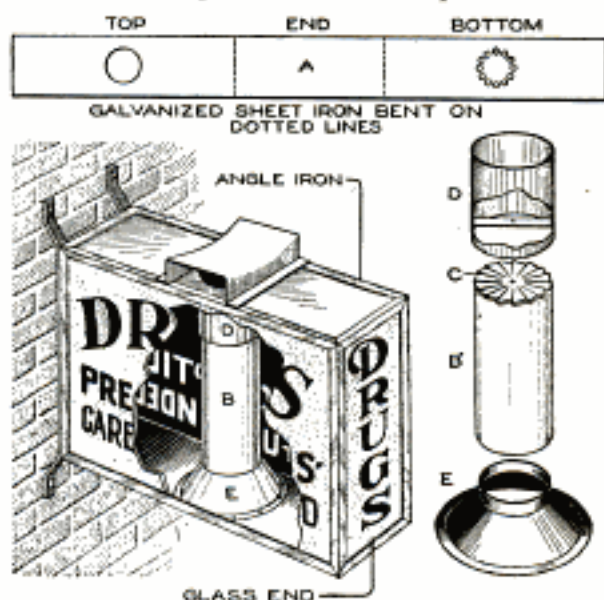

The Draft through the Cylinder Operates the Fan. Various Novel Effects can be Devised Readily for This Homemade Sign

ors. The angle-iron frame is given an oxidized-copper finish by sandpapering in spots, and applying a solution of copper sulphate. This will give only a light deposit, and can be protected with a heavy coat of lacquer or shellac.

The expense in operating this sign is for the electricity consumed only, as the motive power is furnished by a draft of air formed through the air shafts.—George Niederhoff, St. Louis, Missouri.

Speed Indicator Counts Turns on Wire Coil

Desiring to rewind a field coil on a form, an electrician placed the form on an arbor and fastened the arbor in the

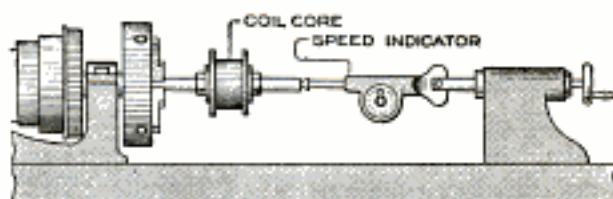

The Number of Turns of Wire Wound on a Coil Core was Recorded by the Use of a Speed Indicator

chuck on a lathe. In order to record the number of turns wound on the form, a speed indicator was rigged up as shown. A taper arbor fitting into

the tailstock was notched out to receive the handle of the indicator, and a small pin put through to hold it in place. The tailstock was then run up until the rubber tip of the indicator fitted into the center in the arbor. The number of turns was recorded accurately, and when the wire became crossed, and the form had to be backed up, the indicator automatically subtracted the number of turns unwound.—Earl Pagett, Coffeyville, Kans.

Rigging for Reboring Engine Cylinder by Hand

A high-pressure cylinder on a steam engine was to be bored out, the casting being of such shape and size as to re-

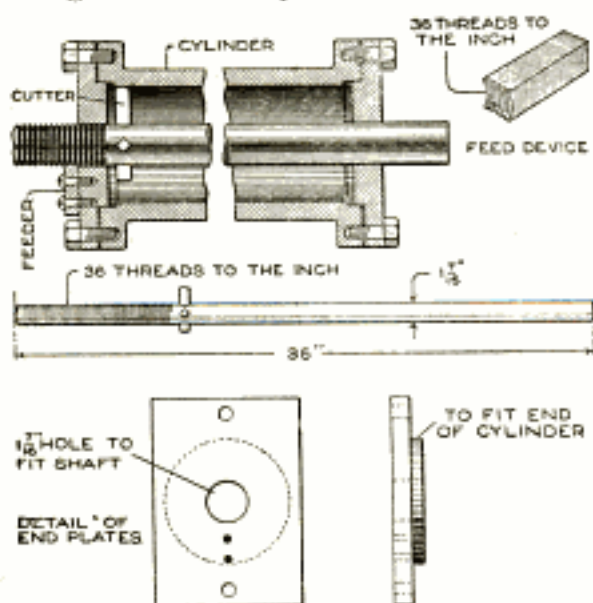

The Engine Cylinder was Bored Out Accurately and Smoothly by Hand

quire much rigging to fasten it in a lathe. I bored the cylinder by hand with the arrangement shown, getting a satisfactory job. The boring bar is a shaft of cold-rolled steel, $1\frac{1}{16}$ in. in diameter, threaded as indicated, and fitted with a $\frac{3}{8}$ -in. high-speed steel cutter ground like a finishing tool. A $\frac{1}{2}$ -in. square, cold-rolled steel, threaded feed device, on the end of the cylinder, engages the boring bar, causing it to move in or out when turned. Plates of steel, as detailed, provide bearings for the shaft, which is fed in by a crank made of a wrench.—Hermann G. Kroeger, Louisville, Ky.

Large Wheelbarrow Saves Time in Cleaning Wood Shop

After watching a man cleaning up shavings and hauling them out in an ordinary wheelbarrow that enabled him to take only about one-third as much material at a trip as he should, I had a large hopper made for his barrow, to permit the hauling of a good load each trip. The hopper was supported by a frame of round iron, 36 in. square at the bottom and widening toward the top. The frame was covered with heavy canvas, and the hopper was lifted from the barrow like a basket when emptying it.—M. C. Webster, St. Louis, Mo.

Wafer Razor-Blade Device for Scraping Paper from Glass

Show windows are often stuck up with posters, playbills, etc., the corners of which are frequently securely pasted to the glass, and removed with difficulty. A tool with which to scrape these off can be made of a wafer razor blade, fastened to a wooden handle. The blade is held by screws, through the holes in the blade, or under the lugs at the end. Kept near the window, this scraper will be found a handy tool.—L. B. Robbins, Attleboro, Mass.

Device Prevents Loosening of Eyeglass Screws

A defect in many eyeglass frames is that the wings which hold the lenses, and through which screws pass, are so thin that the screw soon strips the threads, loosening the lens. A thin, flat piece of suitable metal, three-pointed, as shown, provides a remedy. It is placed beneath the wing, and after the screw is driven home, the points are turned over, one of them in the slot in the screw head, preventing the screw from turning. In tightening

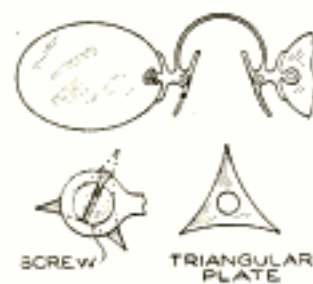

the screw, the point is raised. This device on a pair of glasses has prevented the slightest turn of the screw for over a year.—J. S. Zerbe, Coytesville, N. J.

Double-Drive Countershaft Arrangement

On a rush order, floor space was at a premium, and a milling machine had to be set beside a lathe, in constant use. To get the miller going in good time, and with little expense, I put up a double-drive arrangement. After figuring the pulley diameters, for the required speeds, two 14-in. pulleys, one 9 in. and the other 4½ in. wide, with set collars, were mounted on the countershaft. Both of these pulleys are loose on the shaft, and held in position by the collars. The drive belt from the line shaft runs on the 4½-in. pulley when the miller is not running, and is shifted over on the 9-in. pulley when

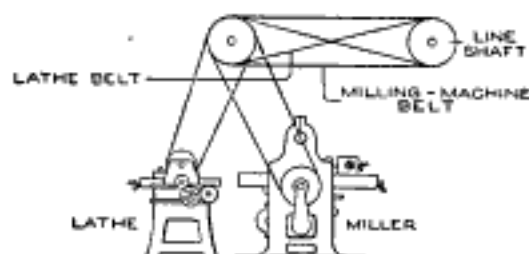
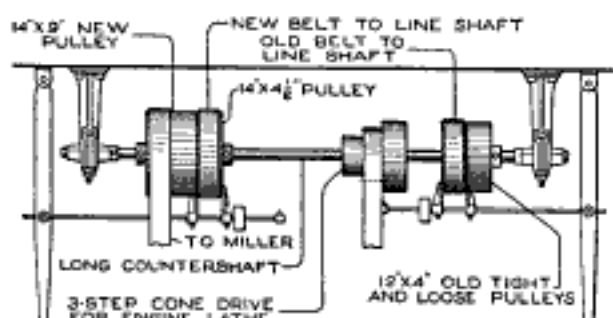

An Old Lathe and the Newly Installed Miller were Driven from the Same Countershaft

the machine is started. This drive has given no trouble, and does not interfere with the running of the lathe.—Joe V. Romig, Allentown, Pa.

ⒸCircular areas of crosshatching, scratched into triangles near their corners, prevent them from slipping too easily on the drafting board.

Washing Rack for Blueprints

In using this blueprint-washing rack the prints are spread over the galvanized-iron surface, which is first

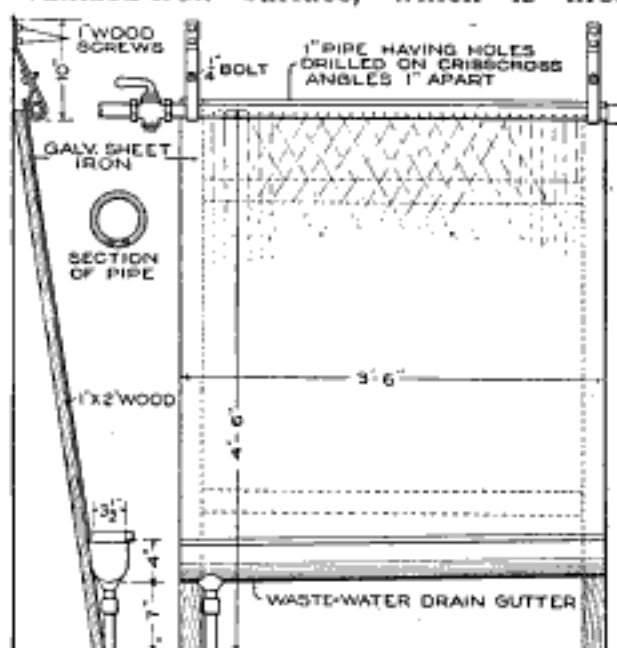

The Blueprints are Spread on the Moistened Surface and Washed Until Developed

sprayed with water, causing the paper to adhere. The water is then turned on as desired, and the paper sprayed until it is thoroughly developed. The water is turned off, the paper is removed, and placed on the drying line. The water-supply pipe is supported by strap-iron brackets, and the washing surface is built over a wooden frame, as indicated. A galvanized-iron drain gutter carries away the excess water.—J. M. Morse, Brooklyn, N. Y.

Clip Holds Door of Terminal Boxes during Tests

A kink that I have found very handy while working in electrical-terminal and test boxes is the use of a clip for holding the door open, especially in a breeze. It is extremely annoying to have a door of a test box blow shut unexpectedly. This simple holder, which is made somewhat like a large clothespin, slips over the upper or lower edge of the terminal box near the hinge edge of the door, and is set in front of the door, holding it open.—A. Gemmill, Ansonia, Conn.

Size of Objects Photographed Indicated by Background

When making photographs of small objects for catalogs and similar pur-



The Sizes of These Patterns can be Estimated by Comparison with the Two-Inch Squares in the Background

poses, divide the background into squares of equal dimensions, and the size of the objects photographed can be estimated readily in the picture. In the photograph of some small patterns, the copy board was divided into 2-in. squares, by means of black strings stretched tightly from brads driven at intervals on the edge of the board.—R. D. Stevens, Lawrence, Mass.

Raising Shop Desk Increases Its Usefulness

The man in the shop office usually does not care to sit down to write an occasional order or note, and a desk with a chest-high writing surface saves his time. The photograph reproduced shows a raised desk used by a shipping clerk. The arrangement also enables him to get paper, tags, etc., from any of the drawers without undue stooping.



Suggestions on Automobile-Tire Economy

In extremely hot weather it is better to start out with automobile tires a trifle slack rather than pumped up too hard. The heat of running will increase the air pressure several pounds. Never run a tire which shows any pronounced "give" when the car is rocked by hand. The moment the car shows an unusual tendency to swerve, or steers hard, stop and make sure that a puncture is not the cause.

High, Portable Lamp Standard for Shop Lighting

Unless the illumination of a shop is unusually well planned, it will be necessary to employ local lighting at night, and on dark days. The use of the portable lamp standard, shown in the illustration, has been adopted in a large shop. It consists of a gas-pipe standard, 12 ft. long, screwed into a heavy cast-iron base. A high-candlepower, nitrogen-filled lamp is used, providing plenty of light for accurate shop work. The lamp is moved to the work, rather than the work to the light, and suitable electrical connections made.—C. M. Hall, St. Louis, Missouri.



Preventing Typewriter Platens from Becoming Grooved

By using the variable line spacer frequently on a typewriter, or moving the platen slightly from its previous position, the entire surface of the platen is written over, thus preventing its becoming deeply grooved, as occurs when line after line is written, day after day, over the same point on the platen.—John M. Bonbright, Philadelphia, Pa.

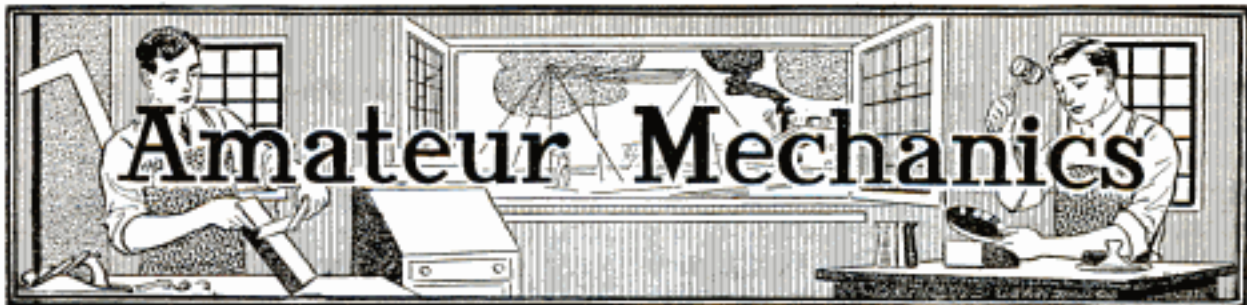

A Twisting Thriller Merry-Go-Round

By R. E. EDWARDS

STEP right up; three twisting thrillers for a penny—a tenth of a dime!" was the familiar invitation which attracted customers to the delights of a homemade merry-go-round of novel design. The patrons were not disappointed, but came back for more. The power for the whirling thriller is produced by the heavy, twisted rope, suspended from the limb of a tree, or other suitable support. The rope is cranked up by means of the notched disk A, grasped at the handle B, the car being lifted off. The thriller is stopped when the brakeplate I rests on the weighted box L.

Manila rope, $\frac{3}{4}$ in. or more in diameter, is used for the support, and is rigged with a spreader, about 2 ft. long, at the top, as shown. The disk is built up of wood, as detailed, and notches, C, provided for the ropes. The rope is wound up and the car is suspended from it by the hook, which should be strong, and deep enough so that it cannot slip out, as indicated at H.

The car is made of a section of 2 by 4-in. stuff, D, 10 ft. long, to which braces, E, of 1 by 4-in. stuff are fastened with nails or screws. The upper ends of the pieces E are blocked up with the center piece F, nailed securely, and the wire link G is fastened through the joint.

The seats J are suspended at the ends of the 2 by 4-in. bar, with their inner ends lower, as shown, to give a better seating when the thriller is in action. The seats are

supported by rope or strap-iron brackets, K, set 15 in. apart. The box should be high enough so that the seats do not strike the ground.

Kinks for the Talking Machine

When short of fiber needles or when the jewel needle has broken, file down the tooth of a bone comb to the required point, and it will serve well. If the needle arm becomes loosened from the diaphragm, and no wax is handy,

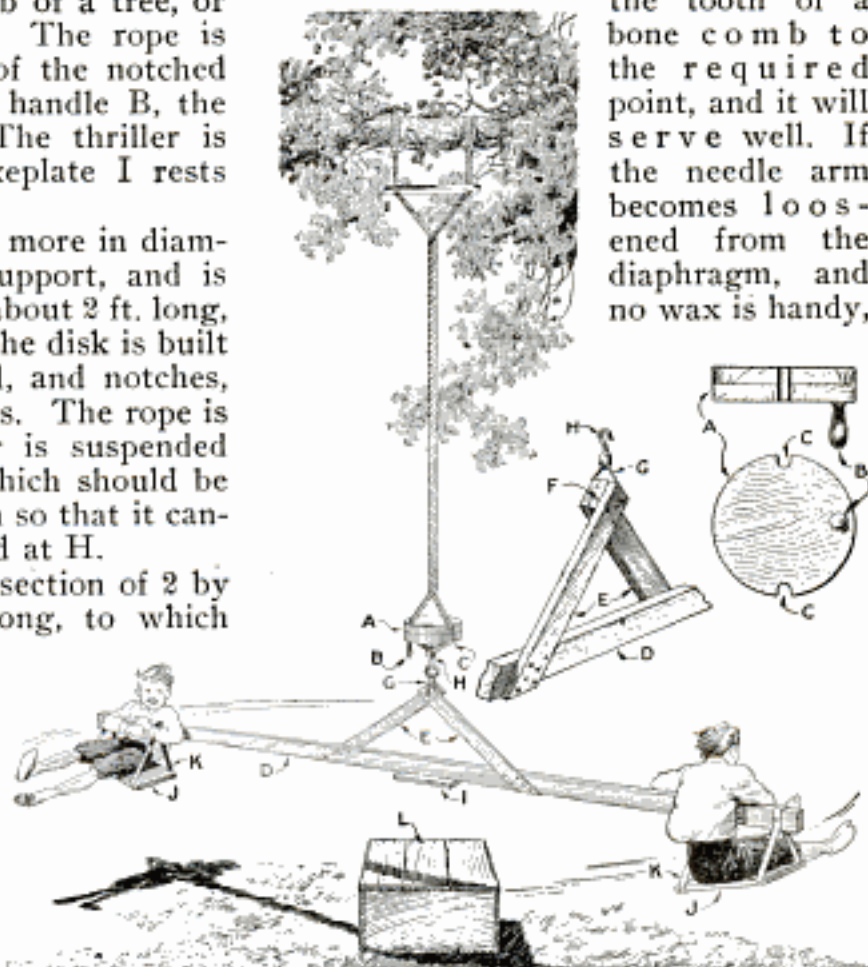

The Supporting Ropes are Wound Up at the Disk A, the Car is Hooked into Place, and the Passengers Take Their Seats for a Thrilling Ride, Until the Brakeplate I Rests on the Box

a bit of soft chewing gum makes an excellent temporary repair. Use a

magnet to pick up steel needles from the receptacles on the machine, to save time and avoid punctured fingers. If the machine is too loud for the room, placing a piece of loose cotton in the tone arm, directly behind the reproducer, is more effective than muffling the sound at the horn end.—L. B. Robbins, Attleboro, Mass.

A Wire-Walking Toy

A daring wire-walking performer who, unmindful of the fact that a misstep may mean destruction, keeps on going, back and forth, so long as the motor runs, or the crank is turned, is a toy

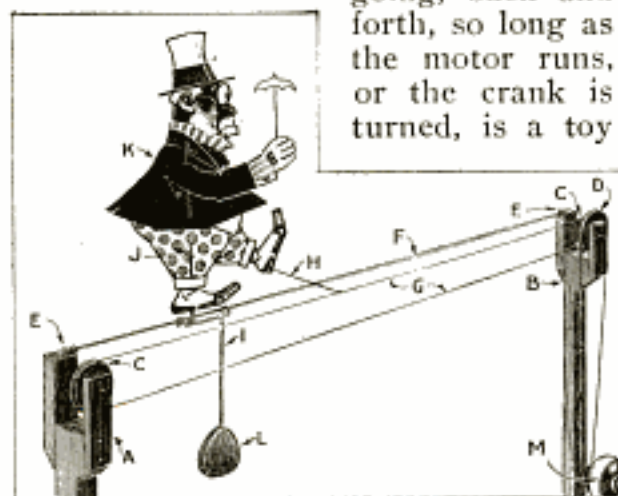

Adapted to Window Displays, This Amusing Toy Has an Advertising Value

that boys can make easily. The wire is stretched, not across Broadway, but between two 1 by 1-in. standards, held upright by guy cords, or fixed to a baseboard. They are fitted with forked tops, at A and B, and pulley wheels, C and D. A wire, F, is fastened to two of the prongs, at E, and a black thread, G, runs over the pulley wheels. A carriage, I, is formed from a 12-in. length of stiff wire, and weighted, at L, to balance upon the tight wire. The figure K is cut from stiff paper, and made to turn upon the carriage upright J, and braced with thread, at H. Thus the figure is always drawn forward, revolving on the support J at the end of each trip. Power to turn the thread is transmitted from a hand crank or motor, M, by means of the double pulley wheel at D.—Edward R. Smith, Walla Walla, Washington.

Double Roofs Provide Ideal Shade for Poultry Coops

Having no native shade in our city chicken yard, we noticed one summer that the hens, especially those in the low brooder coops, became droopy and exhausted from the excessive heat. We studied the construction of the U. S. Weather Bureau thermometer shelter, which usually stands out in the sun, and is no larger than our brooder coops. It has a double roof with free air-circulation space between the roofs, hence the inclosed thermometers are exposed to a true-shade temperature. We then placed an extra roof on each of the brooder coops, leaving a 6-in. open air space between, the top roof being supported at the corners only. The arrangement proved so effective that the hens sought the coops, against the heat of unventilated inclosures on quiet, hot days.—J. Cecil Alter, Cheyenne, Wyo.

An Illuminated Indicating Target Box

The joys of target practice are often hampered by the delays in the settlement of hits. It takes time and is annoying to be constantly advancing to the target to examine it. To do away with this, an illuminated target was constructed that enables the shooter to locate every hit without leaving his post. To make the device, a square wooden box of convenient size is obtained. In one side of this, cut a round hole as large as the largest ring on the targets used. The side opposite this is

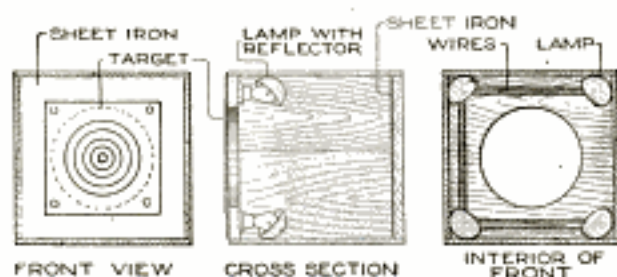

The Location of Hits is Recorded by a Beam of Light Streaming through the Hole Shot in the Paper Target

fitted with a piece of sheet iron to stop the bullets. Paint this iron and the interior white. Inside the box, arrange

four electric lights so their rays will be thrown on the hole, as shown. Candles may be used, if necessary. The lamps must be out of range of the bullets, that hit the target, and protected by an iron plate. The targets, painted on thin paper, are fastened over the front of the hole, and the lights are on, while shooting. Each shot punctures the paper, and the light streaming through the hole will show the location of the hit.—Thomas W. Benson, Philadelphia, Pa.

Kinks in Washing Photographic Negatives and Prints

Photographic defects, spots, stains, etc., are often due to inadequate washing. In the common method of washing negatives or prints under the tap, in a dish, the water is not changed quickly enough. If the negatives are placed film downward and supported at the edges, the washing is quicker and more thorough. Films as well as glass negatives are in the same class in the matter of washing. Films should not stick together, and the sharp edges must not be permitted to cause scratches.

Bird House Made of an Old Straw Hat

A bird house of an old straw hat is a practical and easily contrived affair. Cut a hole in the crown of the hat. Then nail the hat against a board of proper size. To protect the hat against the rain, put a roof over it, as shown. A perch is also provided. Such a bird house can be hung against the trunk of a tree, or nailed against a wall. Leaving the hat in its natural straw color, and painting the rest a dark brown, produces a satisfactory effect.—C. L. Meller, Fargo, N. D.



Camp Shelter Affords Protection from Mosquitoes

When it is undesirable to stay in a camping tent, on warm nights or during the day when a siesta is taken,



Lite Branches Cut in the Woods are Used for the Framework, Which is Covered with Mosquito Netting

a mosquito shelter can be made of materials readily available at most camping places. The arrangement, as shown, is made as follows: Procure a number of pliable switches, about $\frac{3}{4}$ in. in diameter, and 8 or 10 ft. long, willow or similar growths. Sharpen the butts, and force them into the ground in two rows, $3\frac{1}{2}$ ft. apart. Bend the tops together, and tie them in arches of the same height, as indicated. Next, tie a ridge binder the entire length. Cover the frame with mosquito netting, providing an entrance at one end. The shelter shown is for one person, but may easily be made larger. The fly, supported on a rope between posts or trees, affords shade.—J. T. Trammell, Milwaukee, Wis.

☞The annoyance of a chair rocking on a bare floor, especially a child's rocking chair, may be overcome by tacking sections of garden hose along the curved rockers. If properly done this also adds to the comfort of the chair.

A Miniature Fighting Tank

That Hurdles Trenches

By EDWARD R. SMITH

AMONG the engines of war in action on land, probably none has created greater interest than the now famous "fighting tank," which, according to reports, pours out missiles of destruction on the enemy from armored turrets, and crawls over trenches, shell craters, and similar obstructions, like a fabled giant creature of prehistoric ages. The tank described in this article, while not as deadly as those on the battle fields of Europe, performs remarkable feats of hurdling trenches, and crawling over obstructions, large in proportion to its size. The model, as shown in the heading sketches, is full-armored, and has a striking resemblance to these war monsters. The turret is mounted with a magazine gun, which fires 20 projectiles automatically, as the tank makes its way over the rough ground. The motive power for the tractor bands is furnished by linked rubber bands, stretched by a winding drum and ratchet device, on the rear axle, as shown in Fig. 1. When the ratchet is released, the rear axle drives the fluted wheels on it, and they in turn drive the tractor bands, as shown in the side elevation, Fig. 6. The wire-wrapped flywheel conserves the initial power of the rubber-band motor, and makes its action more nearly uniform.

The tank will run upward of 10 ft. on the rubber-motor power, depending on the size and number of the bands used. The gun is fired by a spring hammer, actuated by a rubber band. The trigger device is shown in Fig. 1. The pulley A is belted, with cord, to the front axle. Four pins on its inner

side successively engage the wire trigger, drawing it out of the gun breech B, and permitting another shell to drop into place. As the pulley revolves, the trigger is released, firing the projectile. This process goes on until the motor runs down, or the supply of shells is exhausted.

The tank is guided by the pilot wheel, shown in Fig. 1. The sheet-metal armor, with its turret, is fitted over the mechanism, and can be removed quickly. It bears on angles bent up, as detailed in Fig. 2, to fit on the ends of the wooden center cross-piece of the main frame, and is held by removable pins at the ends of this frame. While the rubber motor is easy to make and install, the range of the tank can be increased by using a strong spring motor, the construction otherwise being similar.

The construction is best begun by making the wooden frame which supports the armor. The perspective sketch, Fig. 1, used in connection with the working and detailed drawings, will aid in making the latter clear. Make the frame C, as detailed in Figs. 5 and 6, $\frac{3}{8}$ by $1\frac{3}{4}$ by 11 in. long, with an opening cut in the center, 1 in. wide, 1 in. from the rear, and $1\frac{1}{4}$ in. from the front end. Make the cross-piece D $\frac{3}{8}$ by $1\frac{3}{4}$ by $5\frac{7}{8}$ in. long; the gun support E, as detailed in Fig. 4, $\frac{3}{8}$ by $1\frac{5}{16}$ by $6\frac{1}{4}$ in. long. Shape the support E as shown. Fasten the frame C and the cross-piece D with screws, setting the piece D $5\frac{3}{4}$ in. from the front, and its left end 3 in. from the side of the frame, as shown in Fig. 5. This is important, as the fitting of the

made also. Cut the stock for the front support J, for the rubber motor, $4\frac{1}{8}$ by $3\frac{3}{4}$ in. long, and shape it as shown in the detail, Fig. 6. Make the support K from a piece of sheet metal, in general shape similar to that used for support H, the dimensions being made as required, and no spring arrangement being provided. Drill these metal fittings, as indicated, for the points of fastening, and mark the places for the holes in which shafts or axles run very carefully.

The driving mechanism can then be made, as shown in Fig. 1, and detailed in Figs. 5 and 6. The driving shafts and their parts, as well as the pulleys, can be turned in a lathe, or made from spools, round rods, etc. Make the front axle L, and wheels, joined solidly, $5\frac{3}{4}$ in. over all, the grooved wheels being $\frac{3}{4}$ in. thick, and $1\frac{7}{16}$ in. in diameter. Wires are used as bearings for shafts for the driving axles. If the rear axle is turned in a lathe, it is cut down to the shape indicated, thinner at the middle, to provide a place for the cord connected to the rubber motor. The grooved pulley and the fluted drive wheel at the winding-key end, shown in Fig. 5, are then cut loose; the drive wheel on the other end is cut loose, forming three sections, mounted on the wire axle, one end of which is the winding key. Ratchet wheels, M, are fitted between the ends of the center section and the adjoining pieces, the ratchet wheels being nailed to the center section and soldered to the wire axle. Pawls, U, are fitted to the inside of the two end sections, as indicated in Fig. 1 and in Fig. 5. When the rubber motor is wound up on the drum, the tractor bands are gripped until it is desired to start the tank on its trip. Then the power is communicated from the drum, or center section of the axle, to the drive wheels by means of the ratchet wheels, acting on the pawls.

Mount the hangers F on the center crosspiece D, fitting the axles of the drive wheels into place. Make the weighted flywheel, and mount it on its shaft, as shown, lining it up with the pulley on the rear drive shaft. Fit the

supports J and K into place, setting spools for the rubber-motor cord in place, on wire axles. Arrange the belt from the flywheel to the drive shaft, and connect the rubber bands for the rubber motor as shown. Fasten one end in the hook of support J, and pass the winding cord through the spools, and fix it to the drive shaft. The device can then be operated with the fluted drive wheels, bearing on strips of wood for tracks.

The tractor bands N are fitted over the drive wheels, as shown in Fig. 6. They are built up of canvas strips, on which wooden shoes are glued and sewed, as detailed in Fig. 5. The stitches which reinforce the gluing are taken in the order indicated by the numerals. The pilot wheel is 2 in. in diameter, and sharpened at its circumference. Make a metal shell, O, for it, as detailed in Fig. 6. Solder the shell to the double wire, which supports the wheel and gives it a spring tension to take obstructions nicely. The wire is fastened to the crosspiece D, as shown in Fig. 5.

The gun and its mechanism can be made handily before the support E is fixed into place at the front of the crosspiece D. Shape the magazine P from sheet metal, making it $2\frac{5}{8}$ in. high, as detailed in Fig. 4. Make the gun Q from a piece of sheet metal, as detailed, cutting the metal to the exact dimensions indicated. Mount the magazine and the gun, and arrange the wire hammer R, and the rubber band that holds it. Fit the pulley A into place on its axle, supported by a small block of wood. Belt it to the front drive-wheel axle, as shown in Fig. 5, after the gun support is fastened into place with screws. Make the projectiles of wood, as shown, and the fighting tank is ready to be tested before putting on the armor.

The armor is made of one deck piece, S, Fig. 3, into which the covered turret is set, and two side pieces T, as detailed in Fig. 2. Make one left and one right sidepiece, allowing for the flanges all around, to be bent over and used for riveting or soldering the

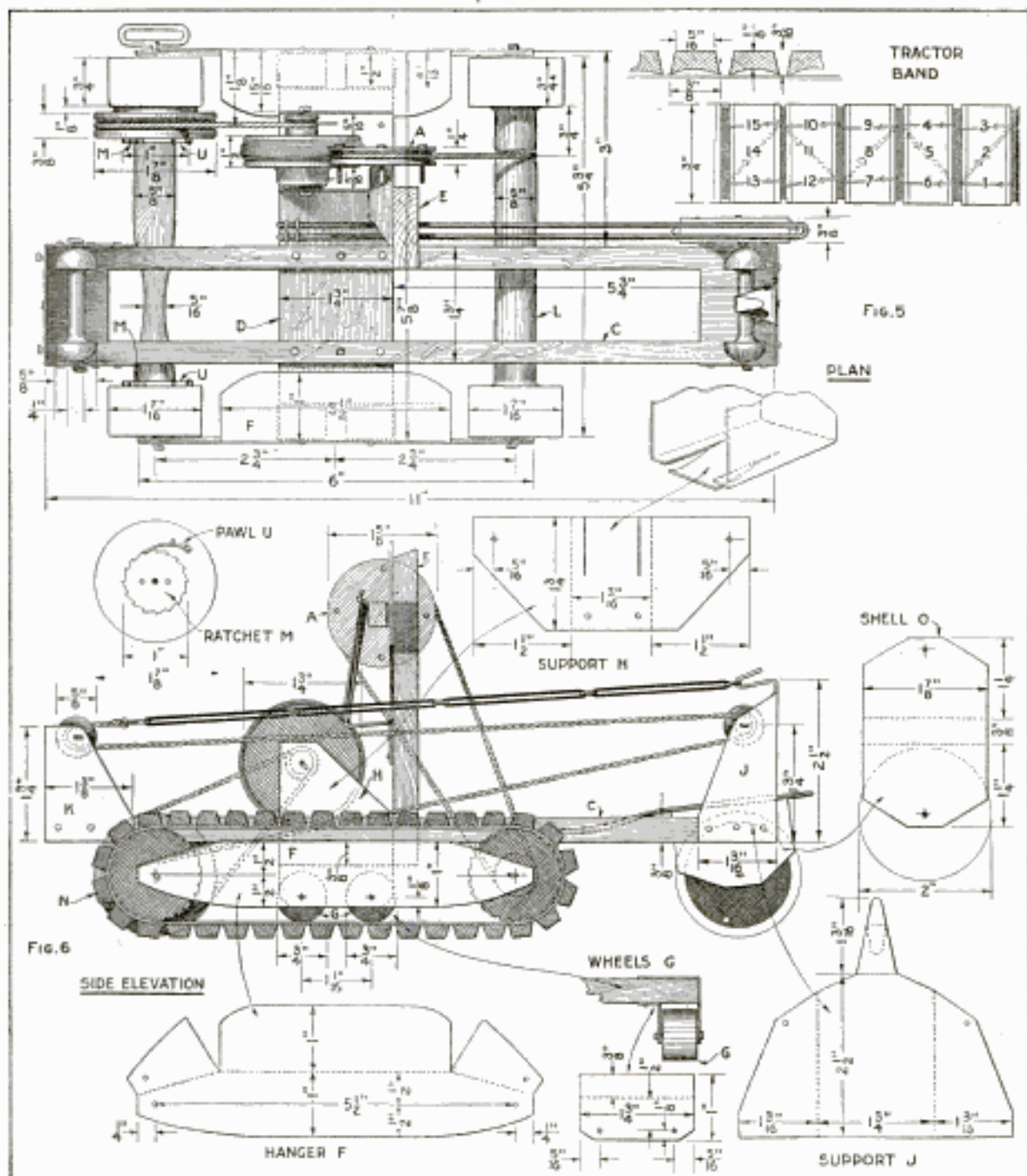

Plan and Side Elevation of the Interior Mechanism, with the Armor Removed, and Details of the Metal Fittings, the Ratchets, and the Tractor Bands

armor together. The bottom extension on the sidepieces is bent double to form an angle, on which the armor is supported, where it rests on the top of the hangers F. The turret is fitted to the deck by cutting notches along its lower edge, the resulting strips being alternately turned in and out along the point of joining, as shown in Fig. 3. When the armor is completed, it is fitted over the main frame, the gun

projecting from the turret. Small pins hold the ends of the armor solid against the ends of the main frame C, so that the armor can be lifted off readily. The various parts of the fighting tank can be painted as desired, care being taken not to injure the points of bearing, on the axles and pulleys, which should be oiled. Silver bronze is a good finish for the exterior of the armor, which may be decorated with a coat of arms.

Plier Drives Nails in Backing Picture Frame

The fastening of a picture into a frame by the use of brads, or tacks, driven into the frame behind the backing is often done carelessly, because it is difficult to do a neat job with an ordinary hammer. A much better way of driving in these nails is to use a plier, as shown. Protect the edge of the frame with a layer or two of cardboard, and start the nail carefully, forcing it in by steady pressure on the plier handles.

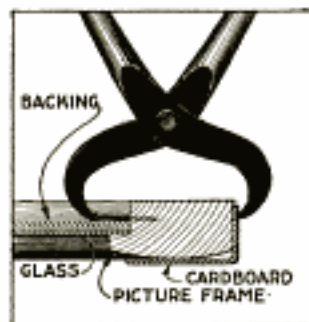

Clip Holds Flash Lamp on Handlebar as Headlight

An ordinary pocket flash light makes a satisfactory headlight for a bicycle if fitted to the handlebar with a suitable clip. The arrangement shown makes it possible to remove the light quickly for use in the usual manner. The clip, as detailed, is of spring brass and is clamped over the post of the handlebar.—P. P. Avery, Garfield, N. J.

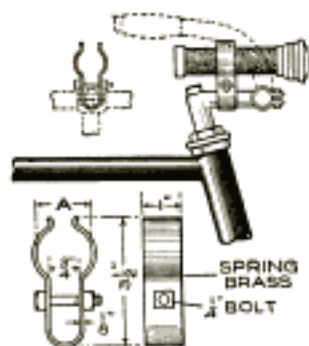

A Backwoodsman's Nutcracker

Most persons know what a difficult job it is to crack hickory nuts, unless provided with a suitable hammer, or other tool, for the purpose. When nut hunting, such tools are usually not at hand, and a method used by an old backwoodsman will be of interest.

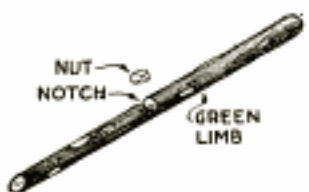

First he cut a hickory limb, about 2 in. thick and 3 ft. long. In the center of the limb, he cut a square notch, about halfway through, and just large enough to admit a nut. Then placing one end of the limb on the ground, the other end held in the left hand, he placed a nut in the notch, and bent the limb slightly. This brought the edges of the notch closer together, and cracked the nut neatly.—C. M. Vaiden, Portland, Ore.

Handy Tool for Tightening Wire Spokes in Wheels

The wire spokes in bicycle and similar wheels often become loose, and a small pocket device for tightening them on the road is handy. A satisfactory one can be made quickly from a washer, 2 in. in diameter, cut as shown. A tapering slot is cut to the center of the washer to engage the nipples of various-sized spokes. The outer circumference of the washer is filed with a triangular file to provide a good finger grip.—H. E. Randell, Boston, Mass.

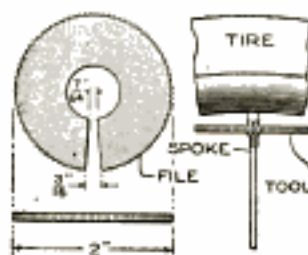

Bottle Economizes Spray Liquid in Atomizer

Atomizers are sometimes provided with delivery tubes the lower ends of which are $\frac{1}{4}$ in. or more above the bottom of the reservoir, thus rendering useless considerable of the spraying liquid. To overcome this waste, in the case of expensive sprays, a small homeopathic vial was filled with the liquid from the bottom of the reservoir, and lowered into the bottle, as shown. The delivery tube of the atomizer was



set into the vial, and the cap screwed on. By this means almost every drop of the spraying fluid was utilized.—Carl L. Hartshorn, West Haven, Conn.

A Small Rotary Pump Easily Made

This small power pump is made from a block of wood, a piece of rubber hose, and a 5-arm rotor of brass, with small spools attached to it. The base of the casing is 6 in. square, and of $\frac{7}{8}$ -in. wood. A $\frac{3}{4}$ -in. triangular block is set at each corner, and a $\frac{1}{8}$ -in. cover of wood, fastened at the four corners with screws. A large nail is used as a shaft for the rotor, which is cut from brass, $\frac{1}{32}$ to $\frac{1}{16}$ in. thick. Small spools are mounted on the arms of the rotor, and the small pulley wheel is fixed on the end of the axle. The action is simple: As the rollers on the arms revolve against the hose, the force of the stream at the discharge end is increased, the

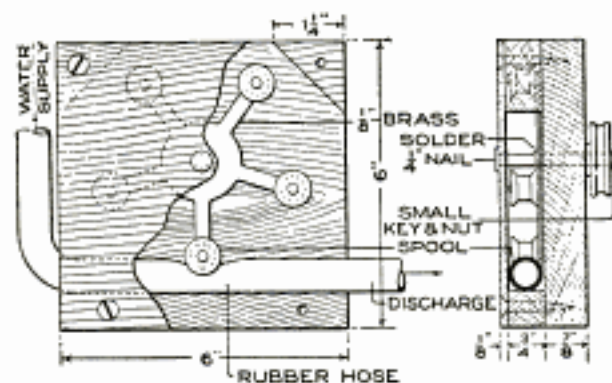

The Rotating Spools Press against the Water Hose and Force the Water from It at Increased Pressure

device acting as a pump. Such an arrangement was used for moving targets in a rifle range, and can be built on a larger scale if desired. A small water, or electric, motor is used to drive the pump.—S. A. Hardy, St. Paul, Minn.

Cleaning Type Cases with Bicycle Pump

Type cases can be cleaned easily by using a bicycle pump, which will blow the dust out. Typewriters and other small machinery can also be cleaned this way. A long hose used with a foot pump is often preferable to the hand pump.

Weighted Rope Holds Flag Upright

A householder devised a simple and effective method of keeping the flag upright when displayed from a nearly

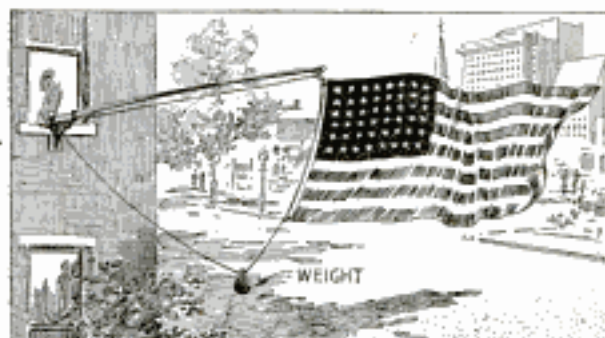

This Weighted Rope Permits the Flag to Fly in Its Natural Position

horizontal flagstaff. The cord which held the flag was run through pulleys, as indicated, and weighted with a pulley weight.—M. T. Kanary, Chicago, Illinois.

Homemade Gate Sign with Metal Letters

Needing a permanent sign to be mounted on an iron gate, I made one of metal, which is more durable and better-looking than most wooden or other common signs that the home mechanic can make. I used sheet metal and marked out the letters to cut them from the smallest possible strip, by reversing some of them. They were cut out with snips and chisels, and the edges filed smooth. The letters were then soldered to heavy wires, which



The Metal Letters were Quickly Made and Are Durable as Well as Neat

were bolted to the gate by means of sheet-metal straps and bolts, as shown. The letters should be polished from time to time, especially if made from brass or copper.—Hugo Kretschmar, Brooklyn, N. Y.

Lighted Whirling Fan Used as Radiator Ornament

An ornament for the automobile-radiator cap that attracted a great deal of attention at night was made by

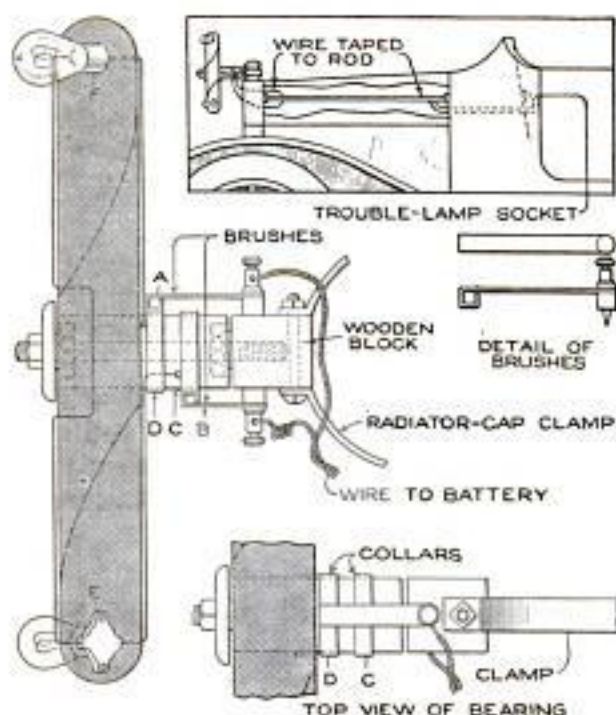

Homemade Ornament for an Automobile Radiator Revolves with the Bulbs Lighted, Attracting Attention

attaching two incandescent lamps to the blades of a small propeller, which is whirled around by the wind. By using the shaft on which the wheels of a roller skate revolve, ball bearings were provided. One end of this shaft is held rigid in a block of wood.

The wires which lead from the propeller are run under the hood, and attached to the socket for the trouble lamp. They are taped to the rod that braces the radiator, to avoid a short circuit, and then out from under the hood at the radiator cap, and connected to the brushes A and B. The incandescent electric-light bulbs are attached to the ends of the propeller blades and connected in series. The wire is run from one side of the socket E to the collar C, and soldered to the latter. The wire from the other side of the socket is connected to the other lamp F. The other wire from this lamp socket at F is soldered to the other col-

lar D. The brushes are made by bending a strip of copper into the shape shown in the detail, and fastening it to the wooden block by means of screw binding posts, soldered to the strips.—F. Lloyd Adams, Jersey City, N. J.

A Fifty-Cent Electric Stove

Few persons realize what an intense heat may be developed when the globe of an ordinary incandescent lamp is tightly inclosed, largely eliminating the loss of heat. When the lamp is inclosed, the temperature will increase until the rate of radiation is equal to that at which the heat is generated. A good reflector is a poor radiator, hence, when the metal wall surrounding the lamp is bright and shiny, both inside and out, the heat is reflected inward.

To make a small stove that will keep liquids warm, melt paraffin, dissolve glue, etc., procure an ordinary 16-cp. carbon lamp, a porcelain receptacle, and a bright, clean tin can, about 4 in. in diameter and 7 in. long. Thoroughly blacken the bottom on the inside, and then solder on four small brackets, cut from sheet brass or copper, so that the can may be held down firmly, when inverted on the base. The latter should preferably be made of hard wood, with the upper edges beveled, as shown. Next bore the hole for the wire or flexi-

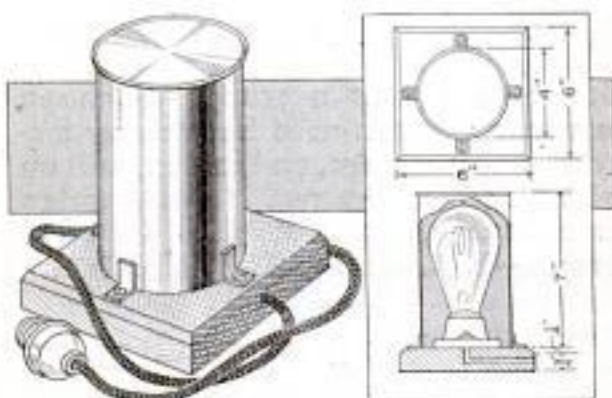

A Handy Electric Stove can be Made at an Outlay of 50 Cents

ble cord. Fasten down the porcelain receptacle, connect the wiring, screw in the globe, and screw down the tin can; the stove is then ready for operation.—John D. Adams, Phoenix, Ariz.

A Soldier's or Traveler's Kit for Sundries and Toilet Articles

A soldier's kit approved by a colonel of the national guard because of its compactness, can be made easily of a band of khaki cloth. The kit, including the "housewife," requires cloth, 27 in. wide. Cut 12 in. from one end for the housewife, which is 12 by 5 in. wide. To make the housewife, fold under the edges $\frac{1}{4}$ in., and fold one end over $2\frac{1}{2}$ in. and the other $1\frac{1}{2}$ in. for pockets. In the larger center pocket can be placed court plaster, adhesive tape, photographs, letters, etc. Bind the edges $\frac{1}{4}$ in., and form other pockets, as shown. The entire kit weighs $1\frac{1}{4}$ lb. and can be carried by the soldier in his army blanket. The housewife, if necessary, can be removed and taken

to the firing line. Handy articles to be fitted in the kit are mirror that can be hung up, comb, box of talcum powder, cold cream, tooth paste, pencil, wash cloth, soaps, shaving brush, toothbrush, and scissors. Three safety pins

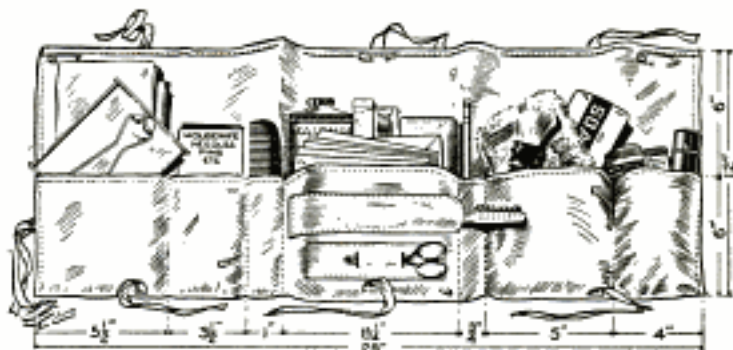

The Soldier Appreciates a Handy Folding Kit, Especially If the Girl He Left Behind Made It

at the top of the bag enable it to be hung up in the tent. Strong binding tapes are sewed to the bag, and it can be folded handily in three sections.—Kate Thomen, Topeka, Kans.

Cooling Foodstuffs with a Moist Rag and a Draft

It is not always necessary to keep milk and butter, or other foodstuffs, in refrigerator temperature to preserve them, for 50 or 60° will often serve quite as well where the articles are to be consumed within a short time. To accomplish this slight degree of cooling, wrap a moist linen cloth, single thickness, snugly about the dish or package, and place it in a shallow pan of water, in an open window, out of the sun. The brick of butter should be placed on a support to hold it out of the water. The cooling is due to evaporation from the moist cloth. Not infrequently on a warm summer day, a thermometer with a bulb, wetted as suggested, will be 20° cooler in a breeze, than a dry-bulb thermometer.

CA table of decimal equivalents, or other information can be mounted in shellac, at an angle to be easily read, at the head of a T-square, and is quite convenient.

Device Quarters and Cores Apples and Other Fruit

To provide a simple homemade device for cutting apples and other fruit into quarters and at the same time removing the core, the arrangement shown in the sketch was made. The circular frame is built up around a ring, $\frac{3}{4}$ in. in diameter, and the ribs and handles are soldered to it. A strip of galvanized iron, $\frac{1}{2}$ in. wide, was used for the cutting portion, and the lower edge was filed sharp, and then finished with a small oil stone. In use, the cutter is set over the fruit, as shown, and by pressure on the handles, it is cut neatly.—L. N. Brown, Baltimore, Md.

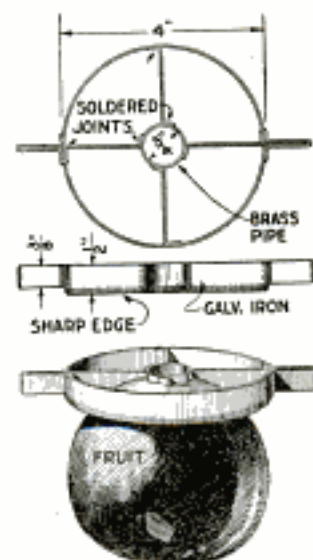

Detachable Motor-Driven Tire Pump Made of Foot Pump

To make this motor-driven pump, which I use with considerable success,

I fitted a bicycle foot pump to a stand, arranging it to be detached quickly. A 4-in. wooden disk was cut in two, and one-half bolted to the stirrup of the pump. A wheel, 14 in. in diameter and 2 in. thick, was

mounted on a 2 by 6-in. support, as shown. A crankpin at the outer edge of the large wheel was connected to the plunger of the pump. The latter may be run with an electric motor, belted as indicated, or with other power. I use a small homemade water motor described in "Shop Notes," with excellent results.—R. S. Matzen, Fort Collins, Colo.

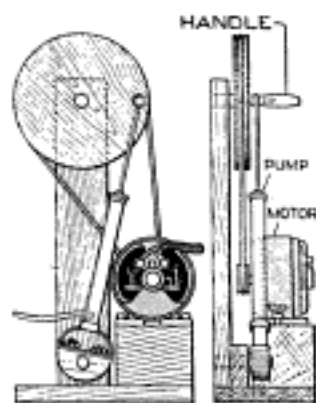

Fisherman's Pail with Wire-Mesh Cage

Oftentimes the fisherman takes a pail along on a fishing excursion so that

he may bring back his catch alive, to put it in a water tank, or to keep the fish fresh. The water in an ordinary pail soon becomes stale, and the fish may die before he reaches home. They should be kept in

the water of the lake or stream until the fisherman goes home. A good means of caring for them, superior to the common string, is to make a wire-mesh container, to fit inside the water pail, as shown. The mesh form can be lifted out, carrying with it all of the fish in the pail, and be set in the fresh water.—Dale R. Van Horn, Milton, Wisconsin.

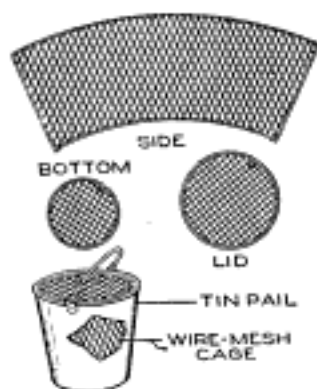

Reinforcing a Strained Auto-Truck Frame

The side member of an automobile-truck frame was overstrained, and started to sag. To replace it with a new channel piece was out of the question, so it was decided to repair the trouble. A piece of $\frac{3}{16}$ -in. plate steel was cut to the proper length, in a truss-shape, wider at the middle than at the ends, to carry the load properly. It was riveted to the strained member by means of $\frac{5}{16}$ -in. round-head rivets, and prevented further sagging.

Drying Rack for Shoes and Rubbers

Footgear is injured when not properly dried out after use in water

or in rough weather, and to care for the shoes, rubbers, etc., I made a rack fitted behind a stove on which they are dried out quickly and thoroughly. The rack consists of a row of brackets

made of strap iron, bent as shown in the sketch, and the shoes are slipped on them. The brackets are mounted on a strip of wood, which is fastened to the wall with screws. A thin piece of board or sheet metal protects the wall.

—Edgar Morgan, Robbinsdale, Minn.

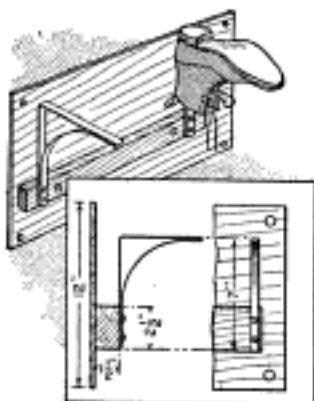

Keeping Scissors Blades Apart Lengthens Their Service

Scissors will wear better and keep their cutting edges longer, if they are kept hanging up with the blades apart when not in use. The better-grade scissors, especially the longer pairs, are made with each blade slightly bowed, so that in cutting, the edges cross at an angle near the cutting point. Keeping them closed tends to weaken the springiness of the blades, and the points are worn by contact under tension.—John M. Bonbright, Philadelphia, Pa.

Making Lead Soldiers and Similar Small Castings

By E. R. GARFIELD

THE boy who likes to play games in which the lead soldier and other features of imitation warfare have a part, can make his own lead soldiers, and other castings, by the use of a plaster-of-Paris mold. If he cannot undertake this work alone, the process is interesting for his older brother, or even for "daddy." A mold of plaster of Paris, as shown in the illustration, is used for the casting box. The hollow impression of the soldier is filled with the molten lead, which is poured in through the sprue hole at the top. When the lead cools, the mold is opened, the casting removed, and the process repeated. An entire army can thus be made with a single mold.

First obtain a small lead soldier, and coat it with shellac. Make a box somewhat larger than the pattern for the soldier, as shown in the sketch. Make it about $1\frac{1}{2}$ in. deep, and set bolts near the corners, as shown, pouring the plaster around them. Fill the box half full of plaster of Paris. While still soft, press the pattern into the center of the plaster so that half its thickness is imbedded. Permit the under mold to dry, and remove the pattern. Shellac the surface of the plaster and the impression. Wrap a layer of oiled paper around the bolts. Replace the pattern in the impression and fill the remaining half of the box with plaster, and permit it to dry.

Also make a small wooden plug, and set it in the center, its point touching

the pattern, and pour the plaster around it. When the mold is dry remove this plug, thus forming the sprue hole, through which the molten lead is poured into the mold.

When the second part of the mold is dry, lift it carefully from the under mold, and remove the pattern. Shellac the surface of the top mold, cleaning away any small bits of plaster around the edges. Trim down the box so that the top mold projects over it about $\frac{3}{8}$ in., making it easy to drop the top mold into place over the bolts. To use the

mold, make certain that it is clean inside and set the top into place. Fasten down the wing nuts at the washers. Be very careful that the mold is dry, as hot metal poured on a wet surface may cause a dangerous splash. Repeat this process, and if care is taken, about 300 castings can be made with one mold. The soldiers can be painted suitably and even sold in sets. The process can be adapted to

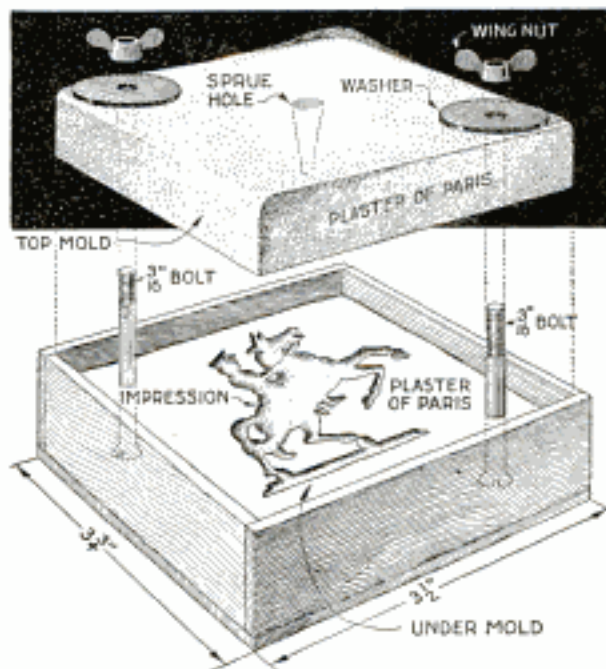

Lead Soldiers, and Many Other Small Castings, can be Made by the Use of This Plaster-of-Paris Mold

many forms of other small castings, using other suitable metals, or wax, where the casting is to be molded into shape further.

A Trap Nest for the Poultry House

Poultry raisers find a trap nest useful, and one can be made quickly by fitting an old packing box with a suitable sliding gate. In the arrangement shown, the gate is raised slightly as the hen enters the nest box, releasing the spring and causing the gate to drop.

The gate and spring can be adjusted to various-sized breeds of poultry. The two grooved uprights can be cut

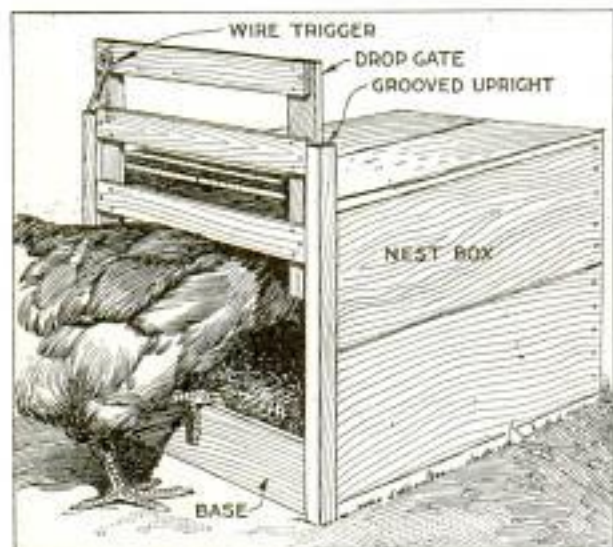

The Trap Nest Automatically Closes as the Hen Enters the Nest Box, Releasing the Trigger

from flooring and the other wooden parts made from laths or wooden strips. The trigger is made of wire.—A. J. Call, Hartsville, Mass.

A Simple Wireless Detector

A cheap and serviceable wireless detector was made from odds and ends such as any amateur can obtain. The base was made of wood, saturated in paraffin. The mineral cup is a brass cap from a cartridge fuse. The upright was

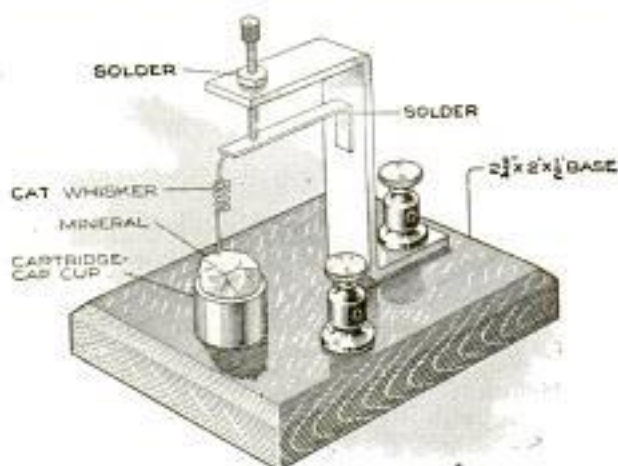

This Neat Wireless Detector was Made of Materials Easily Gathered in the Boy's Workshop

made of a piece of copper, $\frac{1}{2}$ by $4\frac{1}{2}$ in. long, and is fastened to the base by an old-battery binding post. The spring which supports the cat whisker is made

of a strip of copper, $\frac{1}{32}$ in. by $\frac{3}{16}$ in. wide. The cat whisker is soldered to the spring, and the spring is bolted to the upright. The setscrew, which regulates the pressure of the cat whisker upon the mineral, works in a nut, soldered over a hole in the top of the upright. The cat whisker is made of No. 22 gauge bare copper wire. The connection between the cup and the battery binding post, at the front edge, is made on the under side of the base.—Charles Brinkmann, Chicago, Ill.

A Wire-Screen Pincushion

Pins placed in a pincushion like that shown automatically arrange themselves vertically, head up, so that they may be removed handily when needed. The pincushion is durable, and a useful device for the desk. It is made by binding two layers of ordinary screen wire between wooden frames, mounted on a wooden base, $\frac{1}{4}$ in. thick, $2\frac{1}{2}$ in. wide,

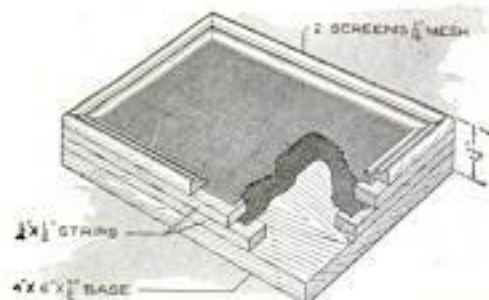

Pins Placed in This Durable Desk Pincushion Arrange Themselves in Vertical Position, Head Up

and $3\frac{1}{2}$ in. long. The frame can be finished neatly, and made of hard wood to match other desk fittings.—D. J. McKean, San Francisco, Calif.

Straightening Sheets of Paper

When a sheet of paper, a drawing, or a blueprint becomes curved or warped, it is annoying to use the sheet unless it is straightened. An easy method of doing this is to lay the sheet flat on the edge of a drawing board or table and draw it down over the edge, the hand pressing down on the paper, stretching it out. This, repeated several times, will soon smooth a much-curved sheet.

A Reversible Photographic Developing Tank

By LAWRENCE F. CAMPBELL

ONE of the chief difficulties in developing plates in a nonreversible developing tank is that irregular development takes place, because the developer tends to settle more or less, depending on the time necessary for complete development. The construction of a reversible tank is a simple matter, and the cost is slight. The tank described is $3\frac{1}{4}$ by $4\frac{1}{4}$ in. in size, but the dimensions can be varied for other sizes of plates. The tank is a box having grooves in opposite ends for the plates. By placing the latter back to back, 12 can be developed at a time. Sheet rubber is fitted between the cover and the body of the tank, and the cover, upon being screwed down, makes a water-tight compartment of the box. The asphaltum paint used is not affected by the developer, and preserves the wood. Fixing and developing may both be done in the one tank, but it is preferable to use the tank for developing only.

and extending the length of the piece, which is $\frac{1}{2}$ by $2\frac{1}{2}$ by $4\frac{1}{2}$ in. long. The grooves can be made either on a

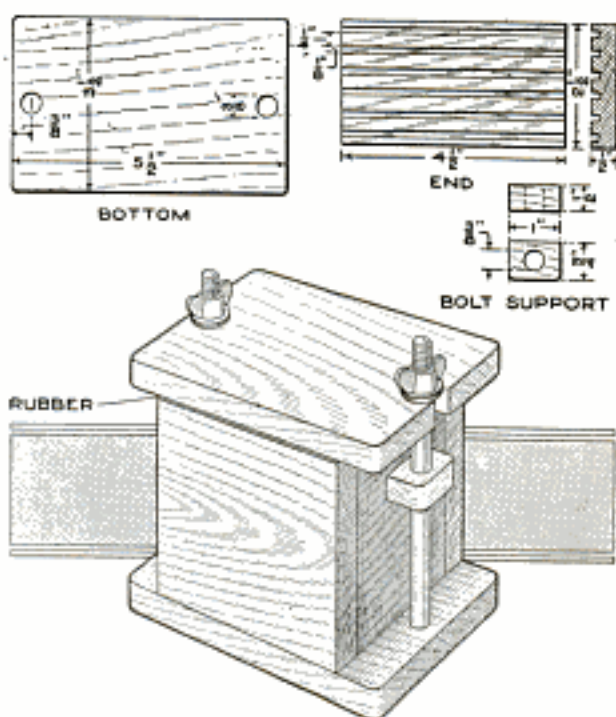

The Finished Tank, and Details of the Bottom, Ends, and Bolt Supports

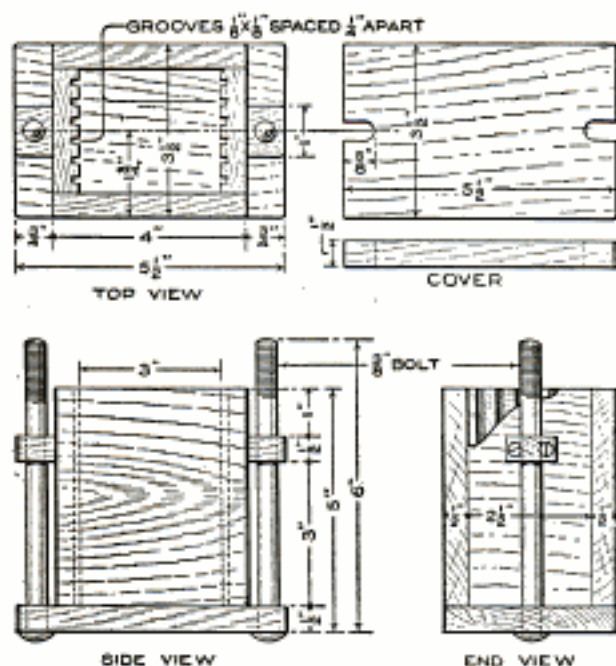

Assembly Views, Showing the General Construction and Detail of the Cover

The two sides are plain pieces, $\frac{1}{2}$ by 4 by $4\frac{1}{2}$ in. in size. The end pieces have $\frac{1}{8}$ by $\frac{1}{8}$ -in. grooves, $\frac{1}{4}$ in. apart

power saw, or by chiseling them out by hand. The bottom piece is $\frac{1}{2}$ by $3\frac{1}{2}$ by $5\frac{1}{2}$ in. in size, with two $\frac{3}{8}$ -in. holes bored to receive the bolts. The two bolt supports are $\frac{1}{2}$ by $\frac{3}{4}$ by 1 in., and are also bored $\frac{3}{8}$ in. to receive the bolts, and are nailed to the end pieces. The cover is $\frac{1}{2}$ by $3\frac{1}{2}$ by $5\frac{1}{2}$ in. long, with a slot in each end for the bolts, which are $\frac{3}{8}$ by 6-in. carriage bolts.

The parts are assembled with screws, and the tank is given two coats of asphaltum paint. Care should be taken, before assembling the parts, to insure that the plates fit the grooves.

Turned Cane with Snakes Inlaid

The making of a cane is a favorite job for the home craftsman, especially the veteran who finds himself in need of such a support and has the leisure to make it. A novelty in constructions of this kind is a turned cane built up of

dark and light-colored woods with snakes inlaid. That shown in the illustration was made of black walnut and birch, with a walnut knob. It is made as follows: Glue up a piece of walnut

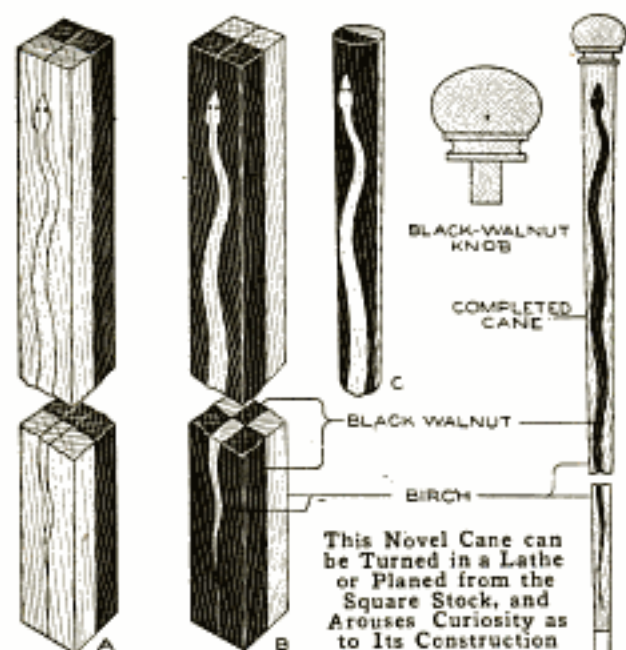

and a piece of birch, $\frac{7}{8}$ by $1\frac{3}{4}$ by 3 ft. long, as shown at A. Mark out the snake on the birch surface, and cut it out very carefully on the band saw, or with a fine hand turning saw. The snake portion will drop out and is then separated into a walnut and a birch strip, making two similar snakes. Bore holes for the eyes and plug them with the opposite kind of wood. Replace the snakes in opposite positions, the one of birch in the walnut side, and the walnut one in the birch side. Glue them carefully into place, removing a small portion of the wood at the ends of the sawed pieces to make a close fit.

The stock then appears as at B, and is ready for turning in the lathe. If desired, circles may be laid out on the ends of the stock, and the piece planed down to the rounded and tapered form of a cane. This is a more tedious job, but if carefully done with sharp tools will give good results.

Turn down the shaft to the desired thickness, as shown at C, the upper end being about 1 in. and the lower end $\frac{1}{2}$ in. in diameter. Turn a knob of walnut as suggested, and after sandpapering the work carefully, finish it with

shellac. Tip the bottom of the cane with a suitable ferrule.—E. K. Wehry, Cedar Rapids, Ia.

An Inexpensive Dry-Plate Kit

Wishing to use some $2\frac{1}{4}$ by $3\frac{1}{4}$ -in. plates in a $6\frac{1}{2}$ by $8\frac{1}{2}$ -in. camera, I made kits that proved satisfactory, as follows, the method being adaptable also to other sizes: A piece of cardboard the size of the camera plate was procured. A rectangle, as at A, was cut in the center, $\frac{1}{16}$ in. larger each way than the plate. Paste, over the back of the cut-out rectangle, a sheet of tough, thin paper, B, and glue two small pieces of cardboard, as at C. Cut cardboard pieces D, E, F, and G, proportioned as at H, and glue them into position, G being over the others, the piece E sliding. If a dry plate is placed in the rectangle and E is slid toward the plate, it will hold the latter in position. The plate holder is loaded with the kit, and to prevent warping, a couple of pins are driven into the plate holder, as at H. Figures J and K indicate the open and closed positions. The

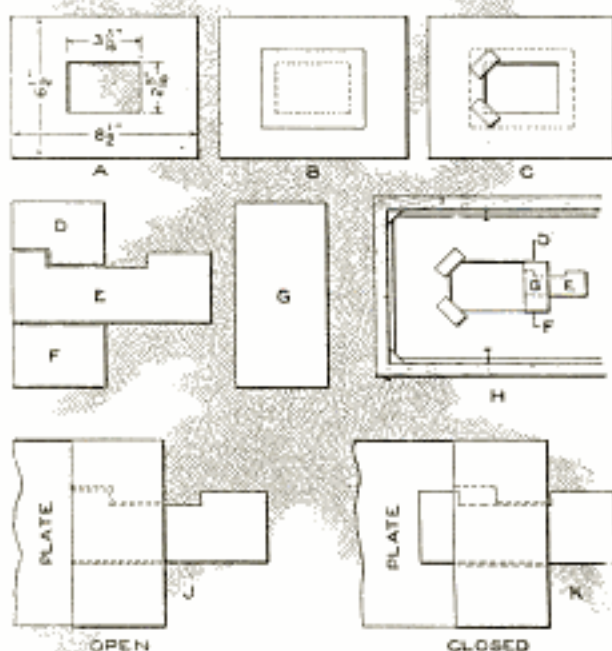

This Dry-Plate Kit is Made of Cardboard and Serves the Purpose Admirably if Carefully Fitted

ground glass is marked to correspond with the rectangle, so that one can tell where to focus the image.—L. L. Llewellyn, Piedmont, Calif.

Emergency Tension Weight Used on Typewriter

If the band that draws the typewriter carriage should break, the operator can continue to write until proper repairs are made by a temporary substitute for the spring tension. Tie a string to the carriage, where it will not become entangled in the mechanism, and attach a weight, about equal to the pull of the spring, to the string. Let the weight hang over the edge of the desk, to the left of the machine. It will pull the carriage along, as does the usual tension device.

Improved Penholder Made with Pencil and Clip

An ordinary pencil clip can be used to make a practical penholder by sliding it to the end of the pencil, as shown, and inserting the pen under it. The tension of the clip holds the pen firmly, and provides a serviceable holder, for emergency use, or even for permanent use, where a pen and pencil combined are desired.—Raymond B. Rogers, Portland, Ore.



Generator Attachment Provides Current for Bicycle Lamp

Rigging up a small dynamo on the bicycle is a simple job, the dynamo being belted from a friction pulley, making connections with the rubber tire of the rear wheel, as shown. Fig. 1 shows the make-up of the head lamp. It is composed of a tin cylinder, grooved at one end to hold the lens; at the other end of the cylinder is fastened a 3/4-in. wooden disk, to which the lamp socket is fixed. Clamp straps hold the lamp on the fork frame. The small lamp, inserted in the socket, holds the reflector in place.

The dynamo-driving arrangement is shown in Fig. 2, and detailed in Fig. 3. A leather belt fits in the groove side of

the wooden pulley. The swinging pulley arm supports and clamps the driving arrangement. A spring holds the friction wheel against the tire, and to

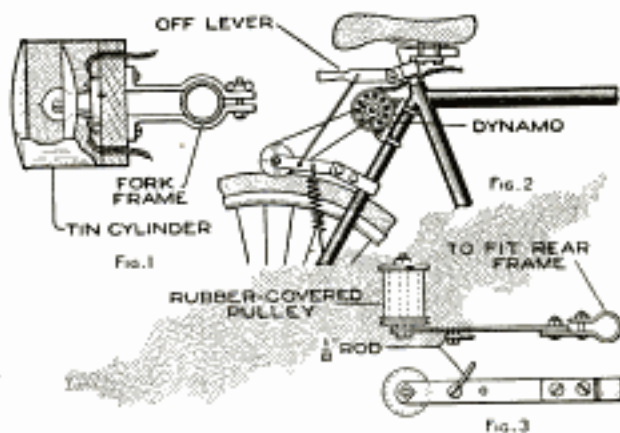

The Dynamo is Operated by a Belt Arrangement Connected to the Rear Wheel, and Supplies Light, and, if Desired, Operates a Horn

release it, the "off" lever is used. A small direct-current dynamo serves well, and may also be used to operate the horn and whistle.—G. F. Thompson, Pittsburgh, Pa.

Eccentric Drawbolt Stops Rattling of Door

A simple method of preventing a bolted door from rattling, by forcing it against the doorstop, or a weather strip, by means of an eccentric filed on the socket end of the bolt, is shown in the sketch. The bolt is fitted closely to the door and casing, and, when the

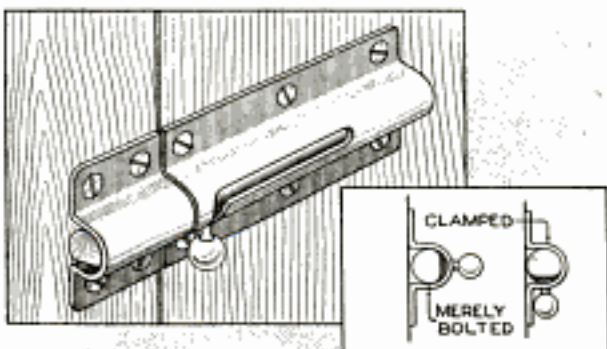

The Eccentric End on the Drawbolt Holds the Door Firmly, Preventing Rattling

bolt is turned so that the eccentric end is in action, the door is forced firmly against the doorstop.—C. H. Chambers, Schenectady, N. Y.

Manhattan Electrical Supply Co.
 114 W. 14th St. N.Y.C.
 General Electric Co. Schenectady
 Dynamo. Price. about \$10.00

Water 4473. - Prentice P. Avery, M. E.
38 Midland Av.

POWER AND PUMPING HOUSE FOR COUNTRY HOME

Garfield N. J.



at
Arcola, N. J.

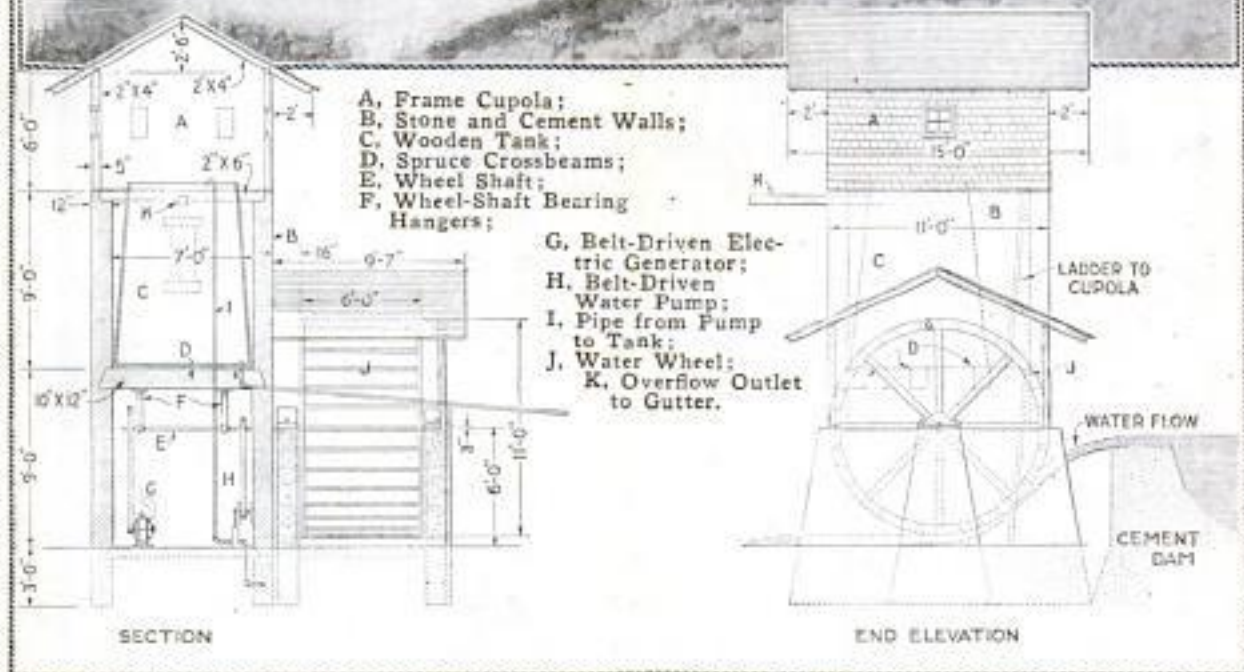

THOSE who desire to utilize the water power available at their country places, may receive a helpful suggestion from an artistic little structure not far from Paterson, N. J., that houses pumping and generating equipment for an adjacent residential establishment. It stands at one end of a concrete dam crossing a branch of Saddle River, and was erected and outfitted at a cost of about \$700. The photograph reproduced at the top of the page amply illustrates the exterior appearance of the building, while the drawings explain many of the details of its construction and the arrangement of its simple equipment. As is made clear diagrammatically, the water wheel drives a pump and electric generator; the one lifting water to an elevated tank that supplies the house piping, and the other developing current for lighting purposes. It will be understood that storage batteries are provided to take up what surplus energy is produced, and reinforce the system when emergencies arise. Obviously, modifications would adapt this type of plant to varied local conditions.

IN accordance with the editorial policy of this magazine never to accept compensation in any form for what appears in our reading pages, and also to avoid all appearance of doing so, we are obliged to omit the name of the maker or the seller of any article described. This information, however, is kept on file and will be furnished free, by addressing Bureau of Information, Popular Mechanics Magazine, Chicago. [Editor.]

\$756 for this 6-Room ALADDIN



Your Own Home—Build It This Year

HERE is your opportunity to own a home and dodge high building prices. You can do it even though building prices are going up! THE ALADDIN READI-CUT SYSTEM of building stands between you and present high prices. It offers you this ideal home or one hundred other attractive homes at substantial savings in price. Think of the home pictured above containing large living room and dining room, large kitchen, three large bedrooms, bathroom and porch for \$756 for complete material, readi-cut. This is only one of a hundred homes with prices from \$200 to \$8000 shown in the handsome book. Let us send you a copy of this book entitled "Aladdin Homes." Send stamps today for your copy.

Why Pay \$900 for a Home That You Can Buy for \$600?

Why hand over three hundred dollars of your savings to a contractor when you can keep that money by having any carpenter put up your Aladdin Read-Cut Home? Your staunch, beautiful Aladdin Home comes all ready for building—complete to the last lock screw in the front door. It saves you money because the lumber is cut by machinery—the materials bought at wholesale. The daily capacity of our mills is 40 Aladdin Homes—we get 18% more out of our lumber than any builder. This great saving becomes YOURS.

What You Get Aladdin price includes all lumber, millwork, flooring, outside and inside finish, doors, windows, shingles, lath and plaster, hardware, locks, nails, paint, varnishes. Your home is shipped in a sealed box car, complete, Read-Cut, ready to erect. Safe arrival of the complete material description of the house shown above will be found in the Aladdin Book of Homes. Send stamps today for the book, "Aladdin Homes," No. 180.

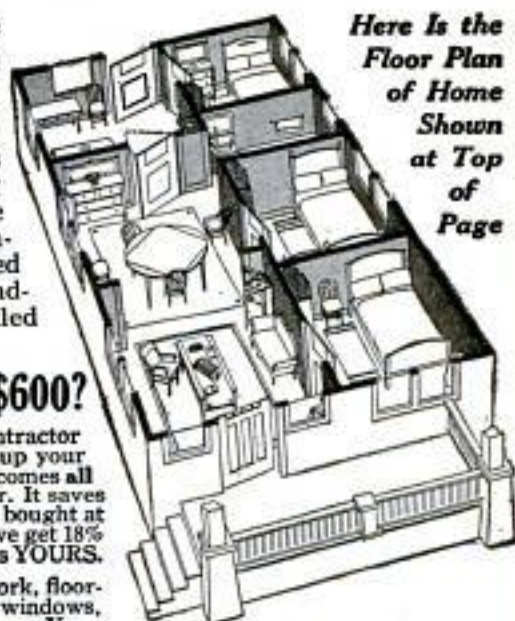

*Here Is the
Floor Plan
of Home
Shown
at Top
of
Page*

The Aladdin Company

Homebuilders to the Nation
Canadian Branch, C. P. R. Bldg., TORONTO, ONT.

1464 Aladdin Ave., Bay City, Mich.





DODGE BROTHERS ROADSTER

All the qualities which you look for
in roadster design and construction

There is generous room for the passengers. The seats are tipped at the most comfortable angle. The luggage space is extra large. The car is steady on the road at all speeds.

Roadster or Touring Car, \$835. In Canada, \$1185.
Coupe or Sedan, \$1265. In Canada, \$1800.
All prices f. o. b. Detroit.

DODGE BROTHERS, DETROIT

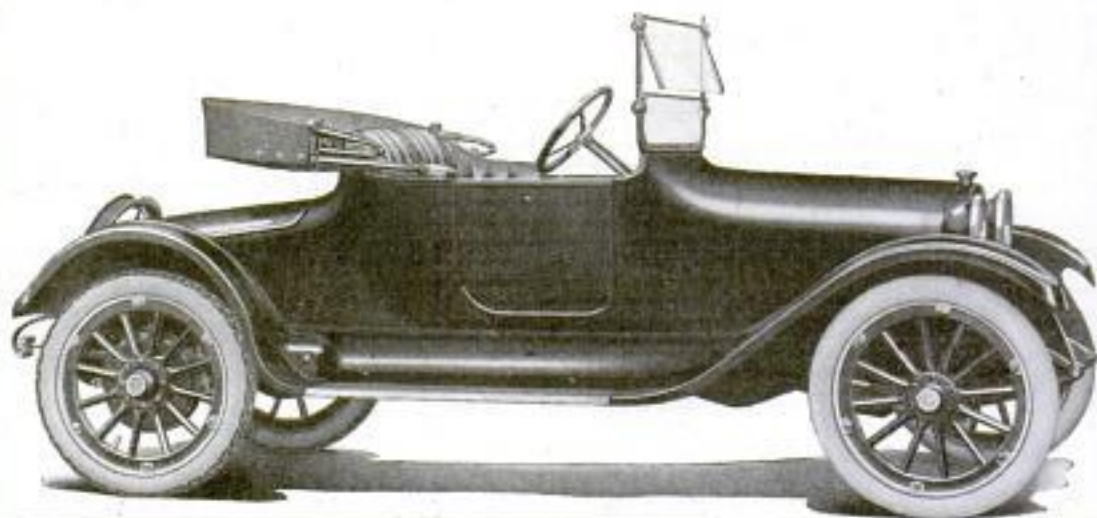

Please Mention Popular Mechanics

TRADE MARK REG. U. S. PAT. OFF.

BLUE STREAKS



When the Government puts a stop to food speculation, the public is pleased but the speculators are not.



When Goodyear began giving better bicycle tires cheaper, not all dealers were pleased but the bicycle rider was.

It Took Nerve to Reduce the Dealer's Profit

It does not cost as much to make a good bicycle tire as some dealers' prices would lead you to believe. It is the needless profits consumed between the factory and the rider which have been to blame for the high prices of bicycle tires in the past.

The Goodyear plan of making and selling Blue Streak Bicycle Tires has finally changed this condition for the rider. You may now buy really good quality tires for as little as \$3.25 each.

You have a right to know how most bicycle tires are sold. The dealer does not buy directly from the factory. Several profits are made before the dealer receives his tires. Then, too, most manufacturers make a great many brands of tires. That means their cost is much higher than necessary. And in the past the dealer has fixed his own prices and determined his own profits. The rider has paid what the dealer asked.

Goodyear decided to save the rider these wastes and needless profits on bicycle tires. The Goodyear dealer makes a fair profit on Blue Streaks. He buys direct from Goodyear. Goodyear makes only one tire—a standard quality. Goodyear advertises the price of that tire to you.

Some dealers do not handle Goodyear Blue Streaks. They prefer to sell a tire on which they make more profit. So it took nerve to reduce the dealer's profit. But the dealer who believes in giving the rider a square deal prefers to sell Goodyear Blue Streaks. He sells more tires in the long run at a smaller profit. *And each tire makes a friend.*

That is because Goodyear Blue Streak Bicycle Tires have built in them such wonderful values. They are rugged and durable. So they help you save money.

They are light and active. That helps you pedal. The non-skid tread absolutely prevents side-slipping.

Moreover, Goodyear Blue Streaks are handsome in appearance. Look for the bright blue streak around the side. Your friends will admire these tires wherever you ride.

Boys everywhere are wearing Goodyear Bicycle Caps. Ask your dealer. They're especially popular with Bicycle Clubs—name of club printed on the cap.

See your Goodyear Dealer or write The Goodyear Tire & Rubber Co., Akron, Ohio, for his address.

GOODYEAR

AKRON

Please Mention Popular Mechanics

Road
Construction
 and
Maintenance



Prepared by
 E. I. DU PONT DE NEMOURS PULVER CO.
 WILMINGTON, DELAWARE

Save

Road Building
 Labor *and* Time

Good roads are imperative — vital. They deal with your personal welfare and the progress — the stability — the safety of the Nation. Road construction requires labor. Labor is scarce. Something must be done. This book tells how.

It covers in a complete and practical way all of the latest road building methods. It explains the use of all up-to-date road building machinery. It tells how to speed up road work, economize in time, and cut down manual labor. It covers every phase of road building from choice of location down to the finished road.

It is written in a plainly understandable style, is profusely illustrated, and is now being used as a text book in many colleges and universities.

GET THIS BIG BOOK FREE

Send today for your copy of

Good Roads Book No. 386

E. I. DU PONT DE NEMOURS & CO.
 WILMINGTON, DELAWARE



"Hurry up, Jimmy— it's my turn next"

Let your boy in on this contest—let him
earn a "Sharpshooter" Medal

We are offering Gold "Sharpshooter" Medals and Silver "Marksman" Medals for skill with a Winchester .22 caliber rifle and Winchester ammunition.

The Gold "Sharpshooter" Medal goes to the boy or girl under sixteen who makes the first grade score. The Silver "Marksman" Medal goes to the boy or girl who makes the second grade score.

No limit is set to the number of trials a contestant may make for these medals; he may shoot as many practice targets as he wants to.

Get your boy a Winchester, and start him in on this contest. Your dealer can tell you all about the details.

Remember that a boy's natural interest in a gun is going to make him get his hands on one sooner or later, and the sooner you teach him the correct use of a gun, the better. Remember it is just as important for every boy to know how to handle a gun safely as it is that he should know how to swim. The Win-

chester prize contest will teach your boy how to handle a gun correctly from the start.

There is a place near you, either in the open or at a club, where you can shoot. If you do not know where to shoot, write to us, and we will tell you where you can, or we will help you to organize a club.

What the name "Winchester" means

The Winchester Company makes a gun that cannot be duplicated by any other manufacturer.

Every gun or rifle that bears the name "Winchester" is fired over 50 times with excess loads for strength, smooth action and accuracy.

This care in manufacturing explains why Winchesters are used by experts everywhere.

Let the boy enter the contest now

Don't delay any longer getting your boy started on the Winchester contest. Get him a Winchester and let him start now.

You will be surprised to find what a fine gun you can get for a low price. Your dealer will be glad to show you his stock of Winchesters, and give you our catalog and booklet on the proper use of a gun. If your dealer cannot supply you, write us direct.



BOYS AND GIRLS Winchester Medals for Skill with the Rifle

Go to your dealer today; he will give you a sample target and booklet explaining the full conditions of the contest. This booklet also tells you how to get the best results from your Winchester. The dealer will also supply you with targets.

If your dealer cannot supply you, write to the Winchester Repeating Arms Co., Dept. 14, New Haven, Conn.

Model 88. Take-down Repeating .22 caliber rifle, 20-inch round barrel. Shoots three sizes of ammunition. The most popular .22 caliber repeater ever placed on the market.



Model 90. Take-down Repeating .22 caliber rifle, 24-inch octagon barrel. The standard target pattern rifle for 25 years.

Model 91. Automatic hammerless, take-down rifle. Handles only its own .22 automatic cartridges. Shoots ten shots as fast as the trigger can be pulled.

Model 64. Take-down .22 caliber single shot rifle. A low priced hammerless, light weight gun made in the States.

WINCHESTER

World Standard Guns and Ammunition

Please Mention Popular Mechanics



Champion Toledo

Dependable
Spark
Plugs



Champion Regular
Price 32

Perform the Most Important Function in a Car

No matter how fine and costly your car is, it is unable to budge an inch until the spark plugs give it the life that sends it into action.

Unerringly and with mighty vigor, Champion Spark Plugs explode the gas mixture in the cylinders—forcing down the piston—turning the crankshaft—delivering the propelling power back to turn the rear wheels.

Avoid substitution by looking for the name "Champion" on the porcelain of every plug you buy.

There is a special Champion Spark Plug designed for every type of motor car, motorcycle, marine and stationary engine.

You can get Champions everywhere.

Champion Spark Plug Company

419 Upton Avenue

Toledo, Ohio

Canadian Office: Champion Spark Plug Company of Canada, Ltd.,
Windsor, Ontario

SAXON ROADSTER

A CAR COMPLETELY EQUIPPED WITH EVERY MODERN FEATURE

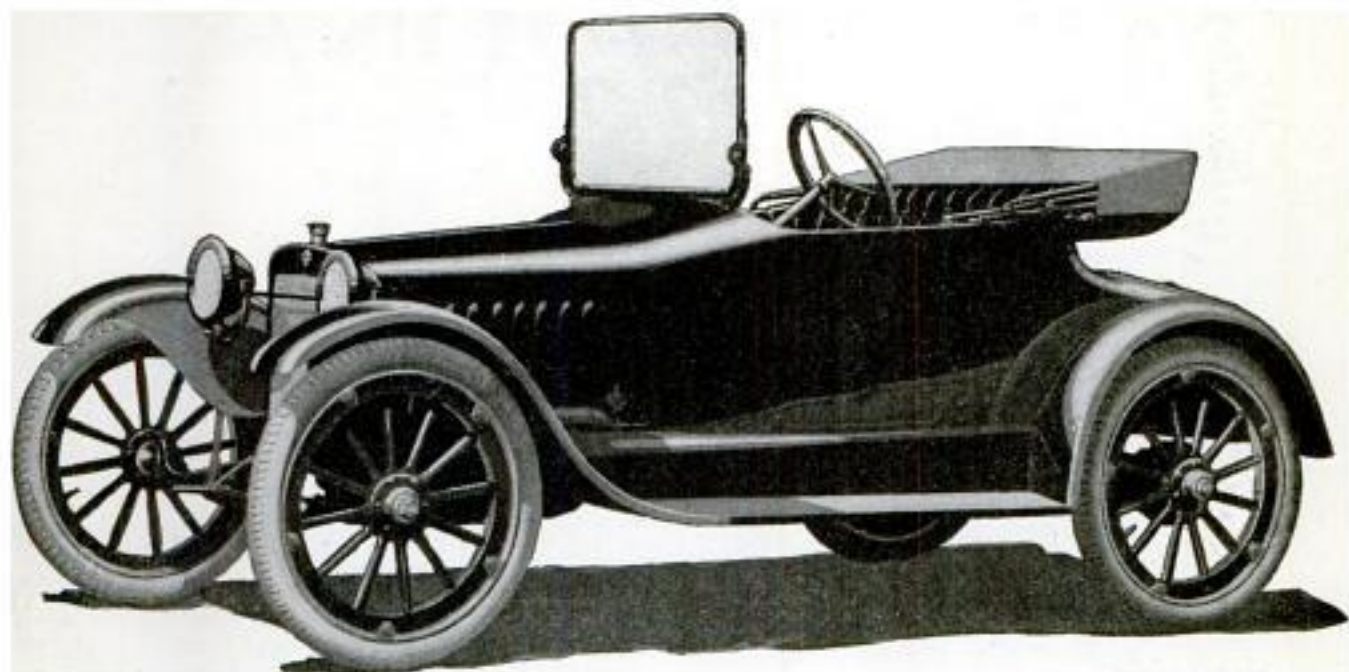

Speaking of Economy

**Saxon Roadster gives 30 miles
to the gallon of gasoline**

Thirty miles of satisfactory travel to each gallon of gasoline. Isn't this record a factor to consider in your motor car selection? Especially if those 30 miles are as easy and comfortable as automobile construction permits.

Saxon Roadster has definitely established itself with those who are seeking the most miles of satisfactory travel for the least money. With this car it isn't a question of "Can I afford it?" It is a question of "Can I afford to be without it?"

Take out your pencil and figure the time you can save in today's work

with Saxon Roadster. Then multiply this by 365 and realize the time you are wasting during the year. And time is the most valuable asset we have today.

Isn't Saxon Roadster, which can be operated day in and day out for the present cost of your car fare, a decided factor in productive economy?

This car fully equipped with Wagner 2-unit starting and lighting system, three-speed transmission, Continental motor, Atwater-Kent ignition, Fedders radiator, demountable rims and Hyatt bearings is \$495 f. o. b. Detroit.

(161)

SAXON MOTOR CAR CORPORATION, DETROIT

CORONA

The Personal Writing Machine



THE BOOK which met instant favor with his publishers and charmed his reading public, seemed clearly to reflect the quiet of the great woods, where with his handy Corona he typed out his best work undisturbed.

YOU can stretch your vacation this summer—away from the heat and noise of the city—by handling essentials yourself, at home. You can add many an

hour of golf or tennis, of boating or motoring, through the long afternoons, by taking work home and cleaning it up in the cool of the evening.

And you'll work all the better for it next day.

It's Corona that makes this possible. For Corona is truly the *personal* writing machine, as useful at home as in the office, and so readily portable that you can carry it with you wherever you go. Corona weighs but six pounds, and travels *folded*. Never in the way, but always ready to handle your correspondence, your records, your reports, your stories or scenarios—and to put them all into legible and permanent form, with carbons for future reference.

Simple to operate, too—anyone can use Corona without special instruction. Corona and case, complete, cost \$50. Send for our Booklet No. 13, and learn the way to increase your usefulness and your playtime.

CORONA TYPEWRITER CO., GROTON, N. Y.
NEW YORK CHICAGO SAN FRANCISCO
AGENCIES IN ALL PRINCIPAL CITIES

Please Mention Popular Mechanics

Williams'

PAT EN TED Holder Top Shaving Stick



IS your beard the wiry kind that grows forty ways for Sunday? Is your skin the tender kind that looks upon a razor as its deadly enemy?

Then try Williams' Holder Top Shaving Stick and see what its rich, soothing, softening lather will do for you. Ask for it by its full name—Williams' Holder Top Shaving Stick—then you will get the firm, dry, metal grip for your fingers; a convenience you will appreciate more and more as the stick grows less.

Send 12c in stamps for trial sizes of the Stick, Powder, Cream, Liquid, and then decide which you prefer. Or send 4c in stamps for any one.

The J. B. Williams Co.
Dept. A.
Glastonbury, Conn.

Add the finishing touch to your shave with Williams' luxurious Toilet Powder.

Liquid

Powder

Cream

Three other forms
of
Williams' Shaving Soap

Please Mention Popular Mechanics



WAR-TIME WATCHWORDS

—Economy
—Efficiency

Accuracy, definite knowledge, saving of time and speeding up of energy are of utmost importance today.

The American Adding and Listing Machine meets these exacting requirements. It combines efficiency and economy for every business no matter how large or how small.



The American Adder
Adds and Lists
Up to One
Million Dollars . . . **\$88**

In operation, the American is simplicity itself. Seven keys do the work of 81 or more. And they are all within the span of one hand.

Machine-Made Totals and Calculations In Your Own Business

Do you have them? They mean unvarying accuracy—they mean definite knowledge—they mean saving of time—and they mean security from loss of money through mistakes.

Crowd mechanical adding and calculations into every possible department of your business. Where efficiency is, mechanical adding and calculating must be.

Money Cannot Buy Better Material

Every part of the American Adding and Listing Machine, excepting the moulded base, is made of selected steel—the same special stock that is used in all expensive adders, typewriters, etc.

"Mail Order" Coupon—Clip and Send Today

AMERICAN CAN CO., Dept. 304
Adding Machine Division, Chicago

Express one American Adder on terms as indicated by cross in square.

Will pay \$4.00 herewith—\$7.00 per month, for 12 months.

Will pay cash in 30 days, less 3 per cent.

Order cancellable in 15 days after delivery, with return of any money paid without argument if machine is not entirely satisfactory.

Name.....

Address.....

Please Mention Popular Mechanics

2 SPARKS TWIN FIRE



The only spark plug of its kind on the market. Fires two separate, distinct sparks at same time—each independently of the other. Double intense sparks on same current as ordinary plug consumes.

Fires two-series sparks. Saves gasoline, reduces carbon and laughs at soot and oil. If one point clogs, the other continues to fire—hot explosions soon clean fouled point. Go to your dealer today. Twin Fire plugs only cost \$1.00. If he cannot supply you, send direct to

Twin Fire Spark Plug Company
660 Woodward Ave., DETROIT, MICH.



Ordinary plug dead when even one point clogs.

DEALERS:
Thousands of motorists are buying Twin Fire Plugs. They're easy to sell. Write or wire for proposition.



Twin Fire always fires—one point cleans the other.

For Small Power

The wash machine, cream separator or any other machine that a strong man can drive with a crank.

This is the very latest small engine development and a great advance over other types for the purpose. It has no exposed moving parts, is automatically governed, cooled and lubricated. It is even furnished with a combination countershaft and starter. Any woman or child can operate it on gas or gasoline in the house with no inconvenience or danger.

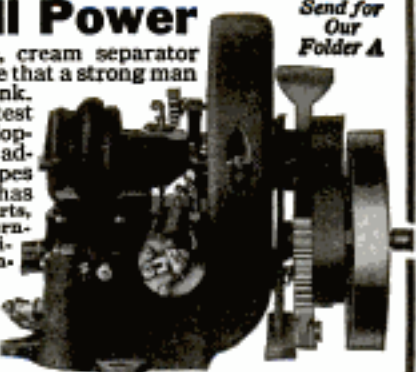

Send for
Our
Folder A

THE ELGIN GAS MOTOR CO.
149 Brook Street ELGIN, ILLINOIS

Teach ^{your} Family to Shoot



They need it in these troublous times. No racket—no disturbance—no sore shoulders. Boys—girls can learn quietly in no time. Big folks too. It's great fun. Make yours a silent rifle for practice or outdoor sport with a

MAXIM SILENCER

Jolly booklet telling of sportsmen and the Maxim Silencer—free. Write today. **FREE BOOK**
The Maxim Silencer Co. 93 Homestead Ave. HARTFORD, CONN.



FREE TRIAL

Keep It
for \$3.00 per Month

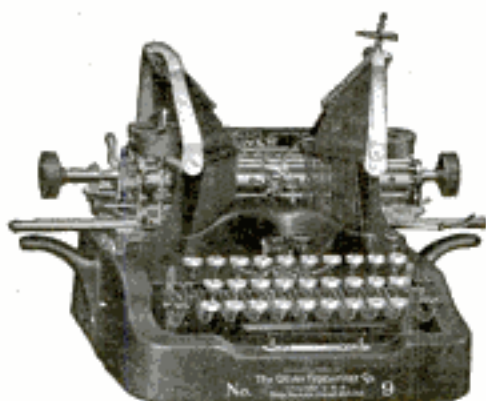

Or Return It
At Our Expense

The Oliver Typewriter—Was \$100—Now \$49

A \$2,000,000 Guarantee that it is the Identical Model

Be your own salesman and earn \$51. It used to be that 15,000 salesmen and agents, office rents in 50 cities and other expenses demanded 50 per cent of the price. But all that is ended. You get the identical typewriter formerly priced \$100—not a cent's alteration in value. The finest, the most expensive, the latest Oliver Model. Old methods were wasteful. Our new plan is way in advance. It is in keeping with new economic tendencies. It does away with waste. Inflated prices are doomed forever.

Brand New—Never Used

Do not confuse this with offers of earlier models or second-hand. Note the signature of this advertisement. This is a \$2,000,000 concern.

We offer new Olivers at half price because we have put typewriter selling on an efficient, scientific basis.

You now deal direct—sell to yourself, with no one to influence you. This puts the Oliver on a merit test. No middle men—no useless tolls.

You Save \$51

This is the first time in history that a new standard \$100 typewriter has been offered for \$49. Remember, we do not offer a substitute model, cheaper nor different. But the same splendid Oliver used by the big concerns. Over 600,000 Olivers have been sold.

We ship direct from the factory to you. No money down—no C. O. D.—no red tape. Try the Oliver Nine at our expense. If you decide to keep it, send us \$3.00 per month. If you return it, we even refund the shipping charges. You are not placed under the slightest obligation. That's our whole plan. We rely on your judgment. We know you don't want to pay double. And who wants a

lesser typewriter? You may have an Oliver for free trial by checking the coupon below. Or you may ask for further information.

An Amazing Book

All the secrets of the typewriter world are revealed in our startling book entitled "The High Cost of Typewriters—The Reason and the Remedy"—sent free if you mail the coupon now. Also our catalog. Order your free trial Oliver—or ask for further information at once.

THE OLIVER TYPEWRITER CO.
109-B, Oliver Typewriter Bldg., Chicago

NOTE CAREFULLY—This coupon will bring you either the Oliver Nine for free trial or further information. Check carefully which you wish.

Mail
This Coupon
Now!

THE OLIVER TYPEWRITER CO.
109-B, Oliver Typewriter Bldg., Chicago, Ill.

Ship me a new Oliver Nine for five days' free inspection. If I keep it, I will pay \$49 at the rate of \$3 per month. The title to remain in you until fully paid for.

My shipping point is.....

This does not place me under any obligation to buy. If I choose to return the Oliver, I will ship it back at your expense at the end of five days.

Do not send a machine until I order it. Mail me your book—"The High Cost of Typewriters—The Reason and the Remedy," your deluxe catalogs and further information.

Name.....

Street Address.....

City..... State.....

Oxy-Acetylene Welding and Cutting

The Nation's Scrap Pile is Conservation's Worst Enemy

IN ordinary times scrap pile waste costs American business millions of dollars annually.

Today, conservation is a matter of national necessity. It is imperative that you help to stop this waste.

Analyze your scrap pile. You'll probably find conditions such as our research men are finding in many industries—months' supplies of valuable materials easily available for use by oxy-acetylene welding.

There are thousands of instances where oxy-acetylene welding has made wonderful savings from discarded parts and materials.

Prest-O-Lite engineers have been among the pioneers in welding research. For years they have studied and investigated the uses of the oxy-acetylene process in American industry. All the fruits of this work are yours for the asking. Let us help analyze your scrap pile.

Stop this waste in your business

Get a list of the broken and worn parts in your scrap pile today. Let us tell you where welding by the Prest-O-Lite Process will enable you to take certain discarded parts out of scrap and reclaim them at trifling cost.

Our illustrated literature describes hundreds of possible savings—many of them directly applicable to your own problems. Write for it.

Solving problems in production

Oxy-acetylene welding as a production process is manufacturing war munitions, railway supplies, boilers, ships, agricultural implements, delicate surgical instruments—

In fact, wherever two pieces of metal are to be joined, this simple portable process is saving time and materials—giving increased

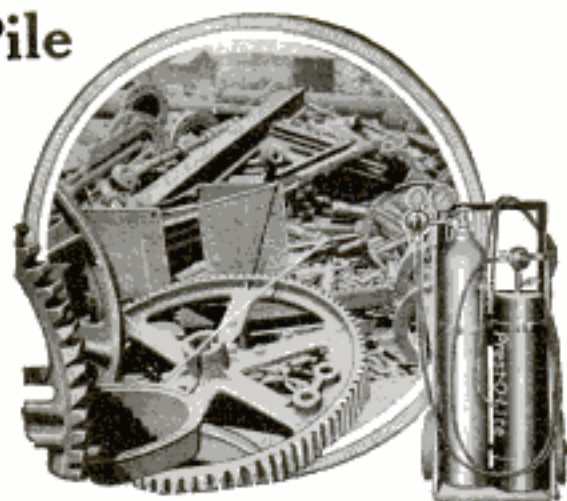

strength, simplicity and neatness to the product. It is rapidly displacing the bolt, rivet and threaded joint.

Prest-O-Lite PROCESS

High-grade welding apparatus costs but \$75 (Canada \$100); acetylene service at additional cost. Adaptable for oxy-acetylene cutting by the addition of special cutting blow-pipe. Thorough instructions furnished free to every user of Prest-O-Lite—any average workman who understands metals can learn the Prest-O-Lite Process quickly and easily.

Good profits in job welding

Repair shops and service garages are making big profits and saving money for customers by using oxy-acetylene welding to make broken or worn parts good as new.

Job welding offers an unusual opportunity for enterprising mechanics to get in business for themselves. The cost of necessary equipment is low. The big growing demand for job welding insures continuous profits. Write today and get full details.

The Prest-O-Lite Co., Inc.

U. S. Main Offices and Factory
516 SPEEDWAY, INDIANAPOLIS

Canadian General Office
Dept. U TORONTO, ONT.

59 Branches and Charging Plants



World's Largest Makers of Dissolved Acetylene

The Dominant One-Ton Truck Unit



\$350 and Up
F.O.B. Chicago

will convert a Ford or other car into a One or Two-Ton Dearborn Truck that has the Quality, Stability and Carrying Capacity of a Standard Truck costing \$1500 to \$2500 or more.

Dearborn Universal One or Two-Ton Units

are now made to fit ALL makes of Cars—the same sturdy, extra heavy construction throughout that characterizes ALL Dearborn Truck Units, the same care and attention to detail, material and workmanship forces recognition of their superiority in daily service in nearly every line of business—cheaper to operate than a team and wagon.

\$350 and up **DEARBORN** **\$350** and up
One or Two-Ton
Truck Unit

All Dearborn Truck Units are designed so that 90% of the load is carried on their heavy Dearborn Rear Axles, Heavy Springs and Heavy Pruden artillery type Rear Wheels, with guaranteed hickory spokes and felloes. Bock Heavy Duty Roller Bearings, Baldwin Roller Chains, Baldwin Steel Sprockets, Jack-Shaft Hangers and Back-Rod Hangers HOT riveted to frame—not merely bolted.

We Want an Exclusive Dealer in Every Locality

Dearborn Truck Units are built in our own factory under our own supervision by expert auto mechanics and are guaranteed. It is the Biggest Seller in the truck field today and our Dealers are making Big Money. Territory is being rapidly taken under our liberal, exclusive agency plan. It will pay you to write TODAY for particulars and territory desired.

Dearborn Truck Co., Manufacturers
1244-1264 So. Campbell Ave.
CHICAGO

A MONEY MAKER FOR ALERT DEALERS.

Please Mention Popular Mechanics

EXCEPTIONAL-MEN WANTED

Tire Repairing Revolutionized!! Motorists To Save Millions in Tire Expense

A new scientific method of Tire Repairing has been originated—the only Scientific Tire Repair Service known. It strikes a new chord in tire economy. It is done on a standard of efficiency. It saves tires—increases mileage. It lasts. It has required years of experience to develop it. Practical tests have proven it. Its excellence and superiority is acknowledged—accepted by those who know, as a **Triumph**.

30 Million Tires to Repair!

Haywood Stations are to be established at once throughout the country. We want capable, energetic, ambitious men in charge of each—men who are dependable—competent. **You can have this opportunity**—share in the Haywood success—become a link in a mammoth chain of a country-wide, thoroughly efficient Tire Repair Service.

Make \$3,000 a Year or Better!

You Own Your Own Business! Keep Your Own Profits!

Haywood equipment is sold outright. We teach you Haywood Scientific Tire Repairing in our Laboratory especially equipped for this purpose. Here you learn all about tires—the inner mechanism of construction—how to repair **scientifically** every tire injury. This training is thorough—practical and equips you to give Haywood Service of the standard we advertise nationally and are so careful to maintain—the Service that saves motorists millions of dollars in tire up-keep.

A Wonderful Opportunity!

The coupon below—your name and address, brings full particulars. How to start. How to tie up with the Haywood Service. We'll give inside facts and figures about costs and profits. Explains in detail our co-operative plans which mean your Success. Write today without fail. Learn how you can start at once.

Haywood Tire & Equipment Co.
646 N. Capitol Ave.
Indianapolis, Indiana

Mail
This
Coupon
Today

OPPORTUNITY COUPON

Haywood Tire & Equipment Co.
646 N. Capitol Avenue
Indianapolis, Ind.

Gentlemen: Please send full particulars of your Scientific Tire Repair Service and details of your co-operative plans.

Name _____

Address _____



This
Man
Makes

Big Money
Repairing
Tires

Scientifically

Please Mention Popular Mechanics

"Bristol" Steel Fishing Rods Meek and Blue Grass Reels

More people, especially expert fishermen, are buying "Bristol" Rods this year than ever before. Nearly twice as many people are buying Meek and Blue Grass Reels as ever bought them in the past. "Bristol" has won national and international fame by a constantly increasing volume of victories under everyday fishing conditions. There is a model for every kind of fishing. Meek and Blue Grass Reels mean the most perfect reels that have ever been produced—most perfect in material, in design, in workmanship and in operation.

Write for FREE "Bristol" and MEEK Catalogues

THE HORTON MFG. CO. 196 Horton Street, BRISTOL, CONN.

BUILD THIS CAR OR BUY IT COMPLETE Lowest Priced Car in the World



Very fast. Economical. Seats 2 full grown persons. Not a toy. Complete Detailed Drawings, 35c. Catalog 10c. Cycle Car and Light Car parts at low prices. Discount to Agents.

Tribune Engineering Co., Dept. P, Owego, Tioga Co., N. Y.

World's Best Shoe Value \$3.95

Ruthstein's Scientific Shoe for Men made of selected Gun Metal Calf, leather sole; Goodyear Welt finish; comfortable, roomy last; Blucher Lace style; D to EE widths. Money back if examination proves otherwise.

200 OTHER SHOE BARGAINS FOR MEN, WOMEN, BOYS AND GIRLS

Big, New, 1917 Scientific Footwear Catalog shows how to save 20 to 50 per cent on shoes—FREE.

RUTHSTEIN SCIENTIFIC SHOE CO. We Retail at Less Than Wholesale Shoe Prices Dept. 640 RACINE, WIS.

\$3.95

A Baseball Jersey



Be the First in Your Club

School, City or Town, to wear this pure, all wool sweater, double collar and cuffs. Your choice in colors. This jersey was selected by 10,000 of my customers for last season. Your chum will recommend it. Send for my big illustrated catalogue. Write me and learn my offer for your club's order. Popular Prices. Best Grade Sporting Goods—Baseball, Basketball, Tennis, Golf, Football, etc.

WRITE ME NOW.

JACK SHANNON CO., Dept. 46, 54 E. Monroe St., Chicago

Russel Internal Gear Drive Axle



The most serviceable and economical motor truck axle made. Write for convincing reasons why your truck should be equipped with the Russel Axle.

RUSSEL MOTOR AXLE COMPANY, Central Ave., North Detroit

ERECTOR THE TOY LIKE STRUCTURAL STEEL

BOYS: Write for facts about the Big Prize Contest and get Erector Tips, the boys' magazine, FREE. THE A. C. GILBERT COMPANY, 104 Fox St., New Haven, Conn.

UNI-LECTRIC Light and Power for the farm and summer home. Operates on same principle as city electric plant. 110 volt, direct current. No belts—no batteries. Uses standard lamps and fixtures. CATALOG ON REQUEST.

Waterman Motor Co., 182 Mt. Elliott Ave., Detroit, Mich.



Engine User-Agents Wanted

Men wanted in every county to USE, demonstrate and sell "BIG BEN"—wonderful new 4-cylinder engine for every work. Big demand. Liberal profits. Free details and introductory offer. C. Bensinger & Sons, Department 611, Hamilton, Ohio.

Prest-O-Lite for Motorcycles



Photo by Kadel

& Herbert, N. Y.

Photo shows motorcycle squad of first Armored Motor Battery N.G.N.Y. engaged in sham battle.

Under Fire!

Here's a motorcycle machine gun squad of the New York National Guard in action. Note that the machines are equipped with Prest-O-Lite—the only practical light for motorcycles.

U. S. Government has chosen Prest-O-Lite for motorcycle squads simply because it is the most efficient, reliable and economical light.

Prest-O-Lite makes night riding safe. It gives the rider perfect vision of the road ahead—shows up "chucks" and stones clearly. Prest-O-Lite never fails in an emergency—gives safe, sure, penetrating light **under all conditions**.

The choice of Uncle Sam should be your choice.

Equip Your Motorcycle with Prest-O-Lite

and get the greatest lighting service and satisfaction at lower cost.

No matter what make of machine you have or buy, you can have it equipped with Prest-O-Lite. See your dealer. He can supply you with "A Prest-O-Lite, a good lamp and horn" at an attractive price.

Get real information on motorcycle lighting now. Our special booklet gladly sent you on request.

The Prest-O-Lite Co., Inc.

U. S. Main Office & Factory, 265 Speedway, Indianapolis.
Canadian General Office, Dept. N8, Toronto, Ont.

Prest-O-Lite Exchange Agencies Everywhere

The World's Largest Makers of Dissolved Acetylene

Please Mention Popular Mechanics



Do You Like to Draw?

Whether your ambition is to become a second Bud Fisher or whether you draw merely for your own amusement—you will find lots of inspiration in

CARTOONS MAGAZINE

It contains each month the cream of caricature, and cartoon art the world over. The foremost American cartoonists are represented, together with the most famous of the Parisian artists and cartoonists of Berlin, London, Petrograd, and Rome.

Either as an art student or a student of current events you will enjoy seeing how cartoonists are portraying world history in the making. "Cartoons" is a monthly review, but doesn't take itself too seriously.

There are pictures by Ethel Plummer, stories by Helena Smith-Dayton, comics by King, Webster, and others, and Parisian sketches by the artists of Fantasio and La Baionnette. It also tells what the big fellows in the cartoon world are doing.

A two-bit piece together with the following blank filled out, will bring you post haste a sample copy.

CARTOONS MAGAZINE,
6 North Michigan Avenue, CHICAGO

Enclosed find 25 cents for which send me a sample copy of your magazine.

Name.....

Street and No.....

City..... State.....



The Western Front at a Glance

Just off the press, this new war map is designed to satisfy those who desire a complete, large-scale map of the Western Front; scale 10 miles to one inch; size 28x36 inches. Shows forests, fortifications, altitudes, aircraft depots, wireless stations, etc. It contains upwards of 5,000 place names which can be readily located by means of the complete index which accompanies the map.

Paper, \$1 (money refunded if dissatisfied); Cloth, \$2 postpaid
POPULAR MECHANICS BOOK DEPT.
6 N. Michigan Ave., CHICAGO

YOU WILL NEED

Our New 1917 Handy Reference

Catalog of the Latest and Best Books

on Mechanical, Electrical
and Industrial Subjects

128 Pages. More than 400 good books described.
Free upon request. Write for your copy today.

Popular Mechanics Book Dept.
6 N. Michigan Ave., Chicago

The New York Metropolitan Museum of Art had 295,904 visitors in 1916 as against 707,890 in 1915. The falling off is attributed to the lack of notable special exhibitions during the year.

LITHOGRAPHIC MODELS IN COLORS

show and name every part of the following: Mallet Compound Locomotive—Atlantic Type Locomotive—Automobile—Steamship—Steam Engine—Steam Turbine—Dynamo—Gas Engine—Wireless Telegraph. Size 10x14 in.
PRICE 50c EACH. Set of Nine Models \$4.00 Postpaid
POPULAR MECHANICS BOOK DEPT., 6 North Michigan Ave., CHICAGO

Stop Eating Poison! Wrong food combinations are poisonous and destroy health—right combinations build health. Eugene Christian's 24 lessons in Correct Eating tell how to eat for health, strength and efficiency. Send for Free Trial No Money in Advance offer. Write today. **Corrective Eating Co., Dept. 50, 443 Fourth Ave., New York City**

Encyclopaedia Britannica "HANDY VOLUME" ISSUE Printed on India Paper

FREE Beautiful Book About Taxidermy

Learn at home by mail to mount birds, animals, tax skins. Be a taxidermist. Delightful art easily learned by men and women. Decorate home and den. Make big profits. Wonderful new art. Intensely interesting. Investigate. Write Today For This Wonderful Free Book, and our attractive offer. Send TODAY. N. W. School of Taxidermy, 4119 Elwood Bldg., Omaha, Neb.



POP-CORN FRITTERS MAKE BIG MONEY



Perrine, Cal., says: "One day's sales \$380.00." Start in safe, easy, profitable, fascinating business. Everybody likes fritters—everybody buys. Think of fortunes made in 5-cent pieces. Get full particulars—reports from others. HURRY. WRITE A CARD NOW.

1350 High St. W. Z. LONG CO. SPRINGFIELD, OHIO



The Legend of Charlemagne's Table Cloth

tells how the Emperor of the West astounded his warrior guests by flinging into the fire the cloth from the table, later withdrawing it unburned. What passed for black magic then is today almost a commonplace. The one-time costly curio of kings is now the servant of mankind. You know it as

JOHNS-MANVILLE Asbestos

Resistant to heat,

water, wear and weather

—the natural paradox which neither alchemy of old nor modern science has duplicated. Where wood burns, Asbestos is unchanged; stone crumbles—Asbestos defies erosion; steel rusts—Asbestos is immune. Fire, time, nor all the ele-

COVERS
THE CONTINENT

ments seem to affect its structure. Johns-Manville has called into play these marvelous properties—has taken this rock and fashioned it into a long list of J-M Products. This is Johns-Manville's contribution to progress—Asbestos in useful form.

H. W. JOHNS-MANVILLE COMPANY
New York City
Branches in 54 Large Cities

Asbestos Fabrics, Packings, Roofings, Shingles, Brake Linings, Building Materials, Electrical Devices, Heat Insulations, Refractory Cements, Waterproofing.

The Motor Car



The Farm



The Home



Industry



Power Plants



Transportation



Roofings



When you think of Asbestos you think of
Johns-Manville

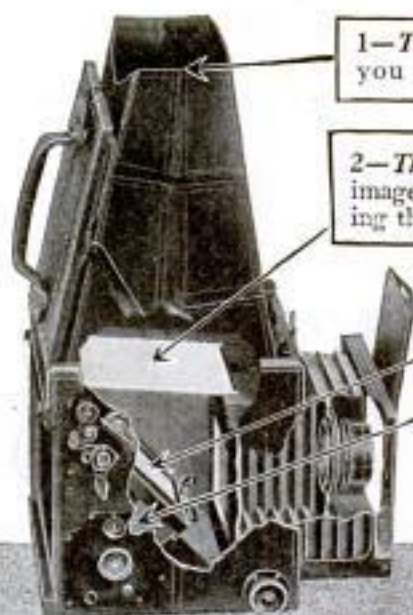

1—The *Focusing Hood* into which you look to see the picture.

2—The *Ground Glass Screen* where you watch the image full negative-size—focusing it exactly, adjusting the composition up to the instant of exposure.

3—The *Swinging Mirror* which reflects image in full negative-size onto the ground glass screen.

4—The *Focal Plane Shutter* gives not only a wide range of speeds but also FULL-timed, uniform exposure of the entire plate.

GRAFLEX Camera



HOW the GRAFLEX shows the object *actual negative-size, in focus up to the instant you snap the shutter*—how it makes the *most of lens-power and exposure-time*—and why you can be certain of **GOOD** pictures even on a rainy day is told on pages 3 to 5 of the 64-page GRAFLEX Catalog. Get a copy from us or your dealer.

**FOLMER & SCHWING
DEPARTMENT**

Eastman Kodak Company
Rochester, N. Y.



Please Mention Popular Mechanics

Have You Got the Bug Yet?

It's not too late yet to fill in the attached coupon and get the beautiful green-gold stick-pin pictured here. Write today.

Meanwhile, call at your nearest dealer and ask him to show you the twelve famous

*United States
Bicycle Tires—*

the Good tires and *Your* tires.

United States Tire Company
1791 Broadway NEW YORK



FILL OUT—TEAR OUT—MAIL TODAY

United States Tire Company, 1791 Broadway, New York

Gentlemen:

Please tell me how to get one of your beautiful green-gold bicycle bugs free.

Full Name.....

Address.....

Name of Nearest Dealer.....

Address of Nearest Dealer.....

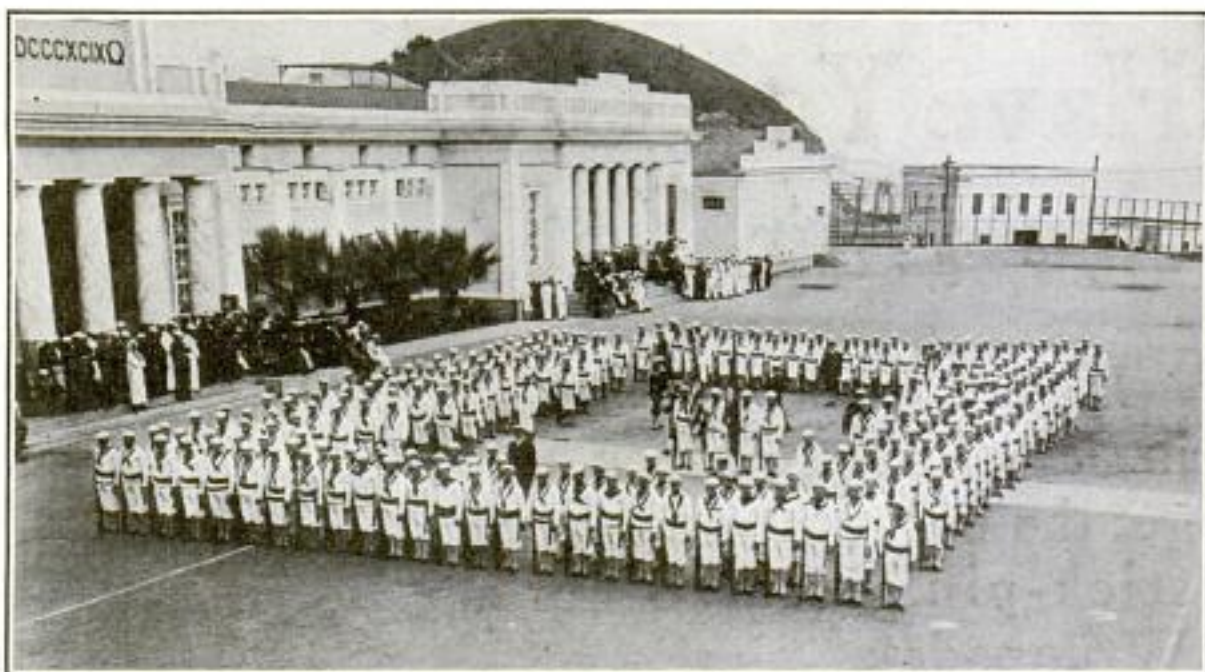

Young Man Your Navy Needs You!

*The first duty of every American
now is to his country and his flag*

The NAVY is the First Line of Defense and offers you an opportunity to see active service. NOW is the time to enlist in order to complete your preliminary training at the earliest practicable date.

Are YOU doing your duty by the country which has protected you and given you the inestimable benefits of American citizenship? If you are not doing your full duty decide to do it **NOW**.

Young men between 17 and 25 years old may enlist for training, and if possessing a Navy trade may enlist if under 35.

The Navy will pay you well for your services. Congress has recently granted liberal increases in the Navy's pay table for war service. You will be given valuable instruction. You will have exceptional opportunities for advancement and a chance to fight for your country!

The many inducements offered young men in the Navy are fully explained in a handsome illustrated booklet which will be sent **FREE** upon request. It tells all about the instruction at the training stations, the courses at the NAVY trade schools, the different rates of pay, the chances for advancement, the daily routine on board ship, the drills and sports—in fact everything you want to know about the **BEST NAVY ON EARTH**. Send for this booklet, mentioning your age, trade, or experience. Men of mechanical ability especially needed.

Address: Recruiting Division

BUREAU OF NAVIGATION
NAVY DEPARTMENT WASHINGTON, D. C.

Scientific study coupled with practical manufacturing methods — this is the basis of the MAZDA Service that helps lamp-makers produce better lamps.

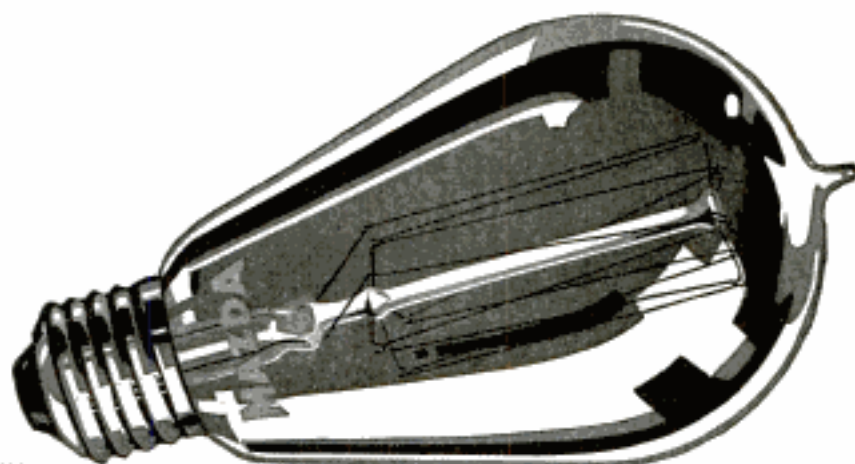

MAZDA

"Not the name of a thing, but the mark of a service"

The Meaning of MAZDA

MAZDA is the trademark of a world-wide service to certain lamp manufacturers. Its purpose is to collect and select scientific and practical information concerning progress and developments in the art of incandescent lamp manufacturing and to distribute this information to the companies entitled to receive this Service.

MAZDA Service is centered in the Research Laboratories of the General Electric Company at Schenectady, New York. The mark MAZDA can appear only on lamps which meet the standards of MAZDA Service. It is thus an assurance of quality. This trademark is the property of the General Electric Company.



RESEARCH LABORATORIES OF GENERAL ELECTRIC COMPANY

4638

Please Mention Popular Mechanics

The Santa Fe SHATTERS WATCH PRICES

SEE THIS WATCH FIRST

Don't Send a Penny Examine Watch Free

21 JEWEL \$3.50 A MONTH
"Santa Fe Special"

—the one standard railroad watch "That's Guaranteed for Life," thin model, all sizes, adjusted to positions, adjusted to isochronism, adjusted to temperature, adjusted to the second.

Write for **FREE Watch Book Today** — shows newest watch case designs in 4 colors. Read the so-called Secrets of watch-making. Read how you can save from One-Third to One-Half of your money—Buy "Direct," out out the Wholesale Jeweler's profit.

EASY PAYMENTS TO SUIT YOU — Write Today

Our "Direct-to-You," easy payment plan is explained fully in the Santa Fe Special catalog. Payments are so small you will not miss the money, only \$2.38 a month and you wear the watch right from the start. Sent on Approval Without One Cent Down.

NEW CASE DESIGNS

The new watch book shows all the very latest designs of the world's most talented engravers, each case illustrated in beautiful color combinations, showing three color inlay monograms, engraved monograms, fraternal emblems, French art and special designs.

A postal brings the new watch book

Address Dept. 86
SANTA FE WATCH CO.
Topeka, Kan.

300 Candle Power of Light at a Cost of 1-8c Per Hour Burns Kerosene or Gasoline

This lamp generates and burns its own gas from ordinary kerosene. "QUICKLIT" gasoline lamps can be lit with an ordinary match like city gas.

Write today for illustrated catalog of our complete line of kerosene and gasoline lamps, lanterns and lighting systems. **Agents Wanted**

The Nagel-Chase Mfg. Co.
258 to 270 East Erie St., Chicago

ACORN UNI-LITE

Turns night into day. 300 candle power. Carry as a lantern: use anywhere as a lamp. Weather proof. For house, barn, garage, camp and around the farm. Write for big, free offer. Special opportunity to farmers, Stockmen and motorists. Agents make big money.

FREE OFFER

WRITE TONIGHT for new 1916-1917 offer.
ACORN BRASS MFG. CO., 522 Uni-Lite Bldg., Chicago

Do You Need More Money?

To help your husband—to help your children—to help yourself? We can show you an easy way that is dignified, honorable and profitable

The happy, contented women shown above are all free from worry and with money coming in. Each of them has founded, with our help, a growing and prosperous business and every year sees each of them making more money. And these cases are by no means exceptional, for

In More Than 13,000 Cases We Have Helped ambitious, deserving women. You can do the same as they have done. Sell World's Star Hosiery and Knit Underwear in your home town. No previous experience is necessary—we show you how to make money in an easy, congenial and profitable way. We sell direct from the mill to the home through our local representatives, and our lines of hosiery and underwear for men, women and children are famous the world over.

Write today for our free catalog. It tells the whole story

WORLD'S STAR KNITTING CO.
DEPT. 146 BAY CITY, MICH.

We have been in business here for more than 22 years

THIS BUNGALOW \$900 CAN BE BUILT FOR

This and many others in my new book, Building Plans for Modern Homes, will save you hundreds of dollars. One of the most complete and comprehensive books of plans ever published by any architect. Fifth edition just off the press. Two hundred and fifty floor plans and photographs of bungalows, etc., costing from \$200 up; gives sizes and cost to build. Sent postpaid for \$1.00

FREDERICK H. GOWING ARCHITECT
18 Tremont St., BOSTON, MASS.

The Thor

Send for the big Thor Book which describes the Thor Electric Washing Machine and shows how a good sized washing can be done at a cost of only 2 cents.

HURLEY MACHINE CO., Dept. C119, CHICAGO

BUY PLUMBING and HEATING SUPPLIES at WHOLESALE Will Save You 30%

Don't pay retail prices. Full stock on hand for prompt shipment. Send for free catalog.

B. P. KAROL, 800-802 South Kedzie Ave., CHICAGO

When You Build

please bear in mind that there is still plenty of

WHITE PINE

Send for our free booklet, "WHITE PINE IN HOME-BUILDING"

WHITE PINE BUREAU
1626 Merchants' Bank Bldg. ST. PAUL, MINN.

The Prophylactic is the **ONE Tooth Brush in universal use today—everywhere**

Highest Grade UNDERWOOD FOR

With Back Spacer—Two-Color Ribbon and Tabulator



You Try It
10 Days
Free

Guaranteed
for Five
Years

Think What
You Can Get
Now for \$39.96

A genuine No. 4 Underwood—the standard visible typewriter, with back spacer, two-color ribbon and tabulator—*complete* with waterproof cover, new ribbon and special touch typewriting instruction book—the machine that is

today the leading typewriter of the world! *Guaranteed* to be delivered in perfect condition! Fully guaranteed for five years.

You May
RENT APPLYING RENT ON PURCHASE PRICE
OR
BUY FOR CASH OR ON EASY PAYMENTS

'Way Under 1/2 Manufacturer's Price

Read This Letter And Then Write Us for NEW Offer

Grand Rapids, Mich.,
March 5, 1917

The Underwood No. 4 Typewriter you sent me, was received promptly, and to say I was highly pleased with it is only putting it mildly. I have spent about five years in New York and other Eastern cities as stenographer, and have used nearly every type of modern machines. In view of the fact I think I can lay claim to be a reasonably accurate judge of a typewriter, and I want to say that the machine you sent me is first class in every respect. It has been thoroughly rebuilt and it works and looks like a brand new machine.

Very truly yours,
(Signed) R. H. Pousma

Moreover, you don't have to buy it to try it! We will send one to you on Ten Days' Trial. Write all you please on it for ten days and then if you are not *perfectly* satisfied, send it back at *our* expense. What's more, if you do not care to buy, you may rent it at our low monthly rates. If later you want to own it, we will apply *six months'* rental payments on the low purchase price. Any national bank in Chicago, or any Dun's or Bradstreet's Agency anywhere will tell you that we are responsible. Learn *all* the facts about this remarkable offer. Write us today—send us your name and address on the attached coupon—or a post card. Ask for Offer No. 52.

Write tonight—send your name and address on the coupon or a post card and learn all about Offer No. 52.

Write for our agency
proposition.

Typewriter Emporium, 34-36 W. Lake St., Chicago
Established for a Quarter of a Century

Send me immediately full facts about your Offer No. 52

Name _____
St. or R. R. No. _____
City _____
State _____

Please Mention Popular Mechanics

My Corn
Said
"This
Shoe"

-but
Fashion
Said
"This
One"



Touchy Corns and New Shoes

The comfort of *old* shoes may now be had with *new* shoes. Blue-jay makes it possible. No need to wince from new shoes nor frown. No need to undergo a period of pain.

Before getting a new pair of shoes be corn-free by using Blue-jay, gentle and certain. Then, should a new corn come later, Blue-jay will bring instant relief.

Most families have a package of Blue-jay Plasters at home, always ready. Relief is always handy, and instant.

Paring never cures. Harsh liquids are

harmful. Blue-jay removes the corns permanently, roots and all. The first application removes 91 per cent. More stubborn cases require a second or third treatment.

Wear new shoes—any shoes—with complete comfort. Forget your feet. Blue-jay points the way. Know tonight.

BAUER & BLACK
Chicago and New York
Makers of
Surgical Dressings, etc.

Blue-jay

Stops Pain—Ends Corns

Sold by All Druggists

Also Blue-jay Bunion
Plasters



I will send my 25 cent BOOK
STRONG ARMS
for 10c in stamps or coin

Illustrated with 20 full-page halftone cuts, showing exercises that will quickly develop, beautify, and gain great strength in your shoulders, arms, and hands, without any apparatus.

PROF. ANTHONY BARKER
Studio 647, 127 W. 42d Street, NEW YORK

**FIBRE LEGS
ARMS**
4-LB. FIBRE LEGS—ON EASY TERMS
Orthopedic braces for all deformities. Send for booklet.
MINNEAPOLIS ARTIFICIAL LIMB CO., 636 Deane Bldg., MINNEAPOLIS, MINN.



PRINT MY OWN
Cards, circulars, menus, book, paper, etc. Press \$5.
Larger \$15. Rotary \$50. Save money. Print for others,
big profit. All easy, rules sent. Write factory today
for illustrated catalog presses, TYPE, cards, samples.
THE PRESS CO. D-37. MERIDEN, CONNECTICUT.

DIAMONDS
ON CREDIT
20% DOWN 10% A MONTH
The most beautiful Diamonds are the Blue-white, especially if absolutely perfect. LYON DIAMONDS
are 1st Quality, Blue-white. A certificate furnished with every Diamond guaranteeing its value and providing for exchange at full purchase price. Goods sent prepaid for examination and approval. Write for Catalog No. 3. 10 per cent DISCOUNT FOR CASH.
J. M. LYON & CO. (Incorporated) 1 Maiden Lane, NEW YORK, U.S.A.



Swear Off Tobacco

Tobacco Habit Banished In 48 to 72 Hours

Immediate Results

Trying to quit the tobacco habit unaided is a losing fight against heavy odds, and means a serious shock to your nervous system. So don't try it! Make the tobacco habit quit you. It will quit you if you will just take **Tobacco Redeemer** according to directions.

It doesn't make a particle of difference whether you've been a user of tobacco for a single month or 50 years, or how much you use, or in what form you use it. Whether you smoke cigars, cigarettes, pipe, chew plug or fine cut or use snuff—**Tobacco Redeemer** will positively remove all craving for tobacco in any form in from 48 to 72 hours. Your tobacco craving will begin to decrease after the very first dose—there's no long waiting for results.

Tobacco Redeemer contains no habit-forming drugs of any kind and is the most marvelously quick, absolutely scientific and thoroughly reliable remedy for the tobacco habit.

Not a Substitute

Tobacco Redeemer is in no sense a substitute for tobacco, but is a radical, efficient treatment. After finishing the treatment you have absolutely no desire to use tobacco again or to continue the use of the remedy. It quiets the nerves, and will make you feel better in every way. If you really want to quit the tobacco habit—get rid of it so completely that when you see others using it, it will not awaken the slightest desire in you—you should at once begin a course of **Tobacco Redeemer** treatment for the habit.

Results Absolutely Guaranteed

A single trial will convince the most skeptical. Our legal, binding, money-back guarantee goes with each full treatment. If **Tobacco Redeemer** fails to banish the tobacco habit when taken according to the plain and easy directions, your money will be cheerfully refunded upon demand.

Let Us Send You Convincing Proof

If you're a slave of the tobacco habit and want to find a sure, quick way of quitting "for keeps" you owe it to yourself and to your family to mail the coupon below or send your name and address on a postal and receive our free booklet on the deadly effect of tobacco on the human system, and positive proof that **Tobacco Redeemer** will quickly free you from the habit.

Newell Pharmacal Company
Dept. 300 St. Louis, Mo.

Free Book Coupon

NEWELL PHARMACAL CO.,
Dept. 300 St. Louis, Mo.

Please send, without obligating me in any way, your free booklet regarding the tobacco habit and proof that **Tobacco Redeemer** will positively free me from the tobacco habit.

Name.....

Street and No.....

Town..... State.....

Please Mention Popular Mechanics

Copyrighted material.



ED.
H.
WITTE,
Pres.

My Special Model KEROSENE ENGINE

**CUTS
FUEL
COST
65 PER
CENT**

Not an experiment! Thousands in use! Better and more powerful than ever! Starts as easily as a gasoline engine! Will use any fuel that can be used in a kerosene engine! You get three times as much power for the money, at present fuel prices! Latest improvements! Your Own Terms! Cash, Deposit, Payments, or No Money Down! If you are in the market, write me today! I CAN MAKE YOU THE BEST PRICE—Sell You A BETTER Engine. Any style, 2 to 22 H-P.—Save you \$25 to \$100.

**Immediate
Shipment**

WITTE HIGH GRADE ENGINES

are made in the largest exclusive engine factory in the world, selling direct. You can see quality in every line and curve. Look at the long solid base affording absolutely solid footing. See how cleanly-built—no cumbersome overweight of cast iron—no cylinder hanging out behind—no interior packing—vertical valves—auto ignition—no cranking—and many other special features that make WITTE Engines high-grade, better and more desirable. **90 Days' Trial** will fully prove superior quality.

Write for latest Engine prices and Free Book.

Or, wire your order—I will handle it—save you time and money. Ed. H. Witte,

WITTE ENGINE WORKS

1747 Oakland Ave., Kansas City, Mo.

1747 Empire Bldg.,
Pittsburgh, Pa.

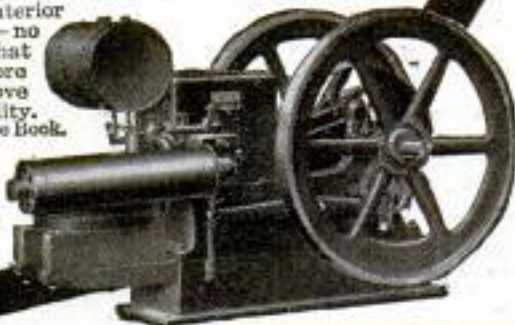

Here's Health and Power, Vim and Vigor



Do you want them? Strength that is more than mere muscular strength. The strength, health, power and vigor of youth is now within your reach through the White Cross Electric Vibrator. Be strong—be healthy—enjoy things the way you used to. Write—learn what vibration may do for you.

The White Cross Electric Vibrator

With this machine in your home you can give yourself the treatments for which specialists receive \$3.00 to \$5.00. Can be connected up as easily as an electric lamp. Or, if your home is not wired for electricity, it will run on its own batteries. See it—try it.

Write Today For Our Big FREE BOOK!

Just your name and address on a letter or post card is enough. We will send you, absolutely free and prepaid, our new book, "Health and Beauty." It tells you about vibration and about our special offer. Write today.

Lindstrom-Smith Co., Dept. C119, 1100 So. Wabash Ave., Chicago

Now \$250



Only \$2.50 down brings you the brand new Rex (with 10 years' guarantee) built because world's greatest merchandise houses wanted a better machine than any on market. Sent on trial. Typewriter prices smashed! Write today for our big free book and our startling offer. Our big illustrated book is an education in typewriters. Write for it now!

Rex Typewriter Co., Dept. C119, Steger Bldg., Chicago

Don't Wear a Truss



Brooks' Appliance, the modern scientific invention, the wonderful new discovery that relieves rupture will be sent on trial. No obnoxious springs or pads.

Brooks' Rupture Appliance

Has automatic Air Cushions. Binds and draws the broken parts together as you would a broken limb. No salves. No lies. Durable, cheap. Sent on trial to prove it. Protected by U. S. patents. Catalogue and measure blanks mailed free. Send name and address today.

C. E. BROOKS, 126 State St., Marshall, Mich.

1900 Motor Washer

Electric or
Water Power

on Free Trial to Readers of Popular Mechanics

Reduce household expenses by using this great laundry outfit. Cuts cost of washing to 2 cents per week. Write for Free Book, giving full details, to

1900 WASHER CO., 6338 Court St., Binghamton, N. Y.

Address Canadian 1900 Washer Co., 355 Yonge St., Toronto
if you live in Canada

**Don't
Tell**

**They'll
think it's
a
Diamond**

If You Can Tell a Lachnite from a Diamond, Send It Back

These exquisite man-made gems have the eternal fire of diamonds—and stand all diamond tests. We will send you one on 10 days' trial. If you can tell it from a diamond, send it back. If you keep it, pay as you wish. Terms as low as 3 1/4 cents a day.

Send for Booklet! Write today for booklet showing illustrations of the newest solid gold mountings.
Harold Lachman Co., Dept. C11912 N. Michigan Av., Chicago



Starrett Tools

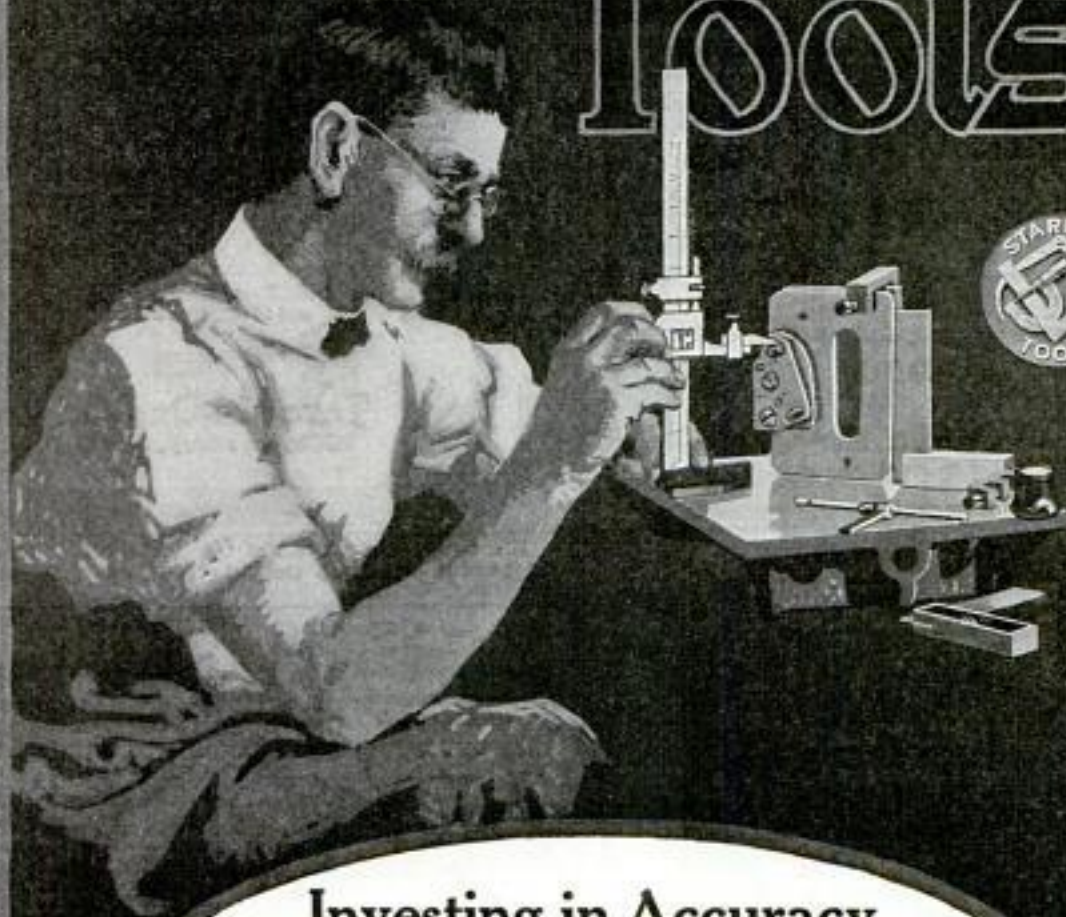

Investing in Accuracy

You are investing in accuracy when you buy a Vernier Height Gage, or a Micrometer, or any one of the fine precision instruments bearing the name Starrett. Think of your fine tools in this way, as the means to accuracy, and you will value them more.

Catalog No. 21 AP describing the 2100 styles and sizes of Starrett Tools will be sent on request.

THE L. S. STARRETT COMPANY

The World's Greatest Toolmakers

ATHOL, MASS.

(42-690)



Please Mention Popular Mechanics

Copyrighted material

Pipe, Nipple and Bolt Threading



Note the quick-action die-head

COMBINE your work of this type—handle it on one compact, speedy, efficient, one-man machine.

OSTER COMBINATION MACHINES

give you the widest range of usefulness concentrated in the smallest space. For full details and prices

SEND FOR CATALOG
List No. 30

The Oster Mfg. Co.
2100 E. 61st St., Cleveland, Ohio

OSTER 300A,
¼ to 2 in. pipe
and nipples,
7/16 to 1¼ in.
bolts. Belt or
motor drive.
Built in 3 other
sizes—1 to 4 in.,
1¼ to 6 in. and
2½ to 8 in.



SIMPLICITY
in construction, yet
embodying all necessary
features and backed
up by perfect workman-
ship, is what we offer in a
SEBASTIAN

13-14- and 15-inch Swing

The Sebastian Lathe Co. 107 Culvert Street
Cincinnati, O., U.S.A.



A complete line of appliances for the transmission of Power. Anything from a bolt to a complete mill or factory outfit. Send for catalogue. Largest Manufacturers of Pulleys in the country.
W.A. Jones Foundry & Machine Co. 4400 W. 12th Street
CHICAGO

Oils Everything

about house and office. 3-in-One has a hundred daily uses. You constantly need it to oil clocks, locks, casters, sewing machines, go-carts, velocipedes, roller skates, lawn mowers, guns and fishing reels; magnets and commutators.

3-in-One Oil also polishes automobile bodies; prevents rust on andirons, escutcheons, and tools; puts an edge on a razor; keeps nickel-ed faucets, etc., bright.

3-in-One

has been the standard household oil for twenty years; nothing can take its place.

At all stores: In bottles, 10c, 25c, 50c.
In Handy Oil Cans, 25c.

FREE—A generous sample and Dictionary of Uses.

Three-in-One Oil Co.
165CNH, Broadway, New York City

The belief that stars are visible in the daytime from the bottom of a deep well has been tested by scientists and found untrue.



ORDER TODAY
DON'T DELAY

Cash with order buys this small
\$3 BENCH LATHE

Swing 3 in. 8 in. C. to C. Shipping Wt. 10 lbs.
PETER AUSTIN, 910 W. First St., NUNCIE, IND.



South Bend Lathes
For the Machine and Repair Shop

How to Run a Lathe
A 50 cent book for 10 cents.
Postpaid, stamps accepted.

Straight or Gap Beds. Send for free catalog giving prices on entire line.
SOUTH BEND LATHE WORKS
423 Madison St., South Bend, Ind.



LATHES

9 to 18-inch Swing

List price \$75 and up according to size. When ready to buy send for Lathe Catalog and prices.

W. F. & John Barnes Co.
100 Ruby Street, ROCKFORD, ILL.

Drilling Wells is a Year Round Business



Drilling Water Wells is a profitable, healthful, year-round business. There are wells all around you to be drilled. Don't you want to get into a money-making business for yourself? Write for particulars.

STAR DRILLING MACHINE CO.
664 Washington St. AKRON, OHIO



WHERE DEPENDABILITY COUNTS

Where quick action may mean the difference between life and death, and adjustments must be made in seconds rather than minutes, the Crescent Wrench is daily proving its superiority.

Whether it's keeping a hard worked battery in order, keeping a truck train moving under fire, or making a lightning adjustment three thousand feet in the air, you'll find a Crescent the favorite Wrench with men who know.

Crescent construction means easy, quick, positive adjustment. Crescent materials insure unfailing strength in every emergency.

CRESCENT TOOL CO.
JAMESTOWN, N. Y.



"Why Do I Always Insist On The B & S Trade Mark?"



Because then I'm *always* sure of accurate, dependable tools — and good work.

My First Kit Was Brown & Sharpe Tools

and the man who sold it to me said that to him the B & S Trade Mark meant 'Best Service.' My first morning in the shop one of the older men said to me, 'My boy, I see you've started right, with a B & S Kit.' Now I buy them for my own shop — the best is none too good for my work."

You, too, whether toolmaker, machinist or apprentice, will find the same aid and protection by using tools from this world-endorsed line.

1000 Varieties—One Quality

Does your tool kit contain a copy of our Catalog 27? It should. We will supply you with one

FREE ON REQUEST

Brown & Sharpe Mfg. Co.
Providence, R. I., U. S. A.



CRANE FITTINGS

Established 1855



CRESCENT

Wood Working Machinery will save labor and then help you keep up your regular standard of efficiency when short handed. Ask today for your Crescent catalog telling about our splendid line of hand saws, jointers, saw tables, planers, planers and matchers, disk grinders, swing cutoff saws, shapers, hollow chisel mortisers, variety wood workers, universal wood workers.

THE CRESCENT MACHINE CO.
93 Columbia St. LEETONIA, OHIO



A Constant Water Supply For Your Farm Home

Don't depend on a windmill or the back-breaking hand pump to fill your water tank. It's more reliable and economical to install a

RIFE RAM

and be sure of a constant supply of fresh water, without fuel or attention. The Rife Ram operates by the flow of any stream having a fall of 3 feet or more and a supply of 3 gallons or more per minute. Will maintain air pressure system. Simple to install. Over 11,000 in use. Satisfaction guaranteed.

Write today for catalog and free estimate

RIFE ENGINE CO.

Dept. F, 90 West St. NEW YORK



Stanley Tools

STANLEY Improved Leveling Stands

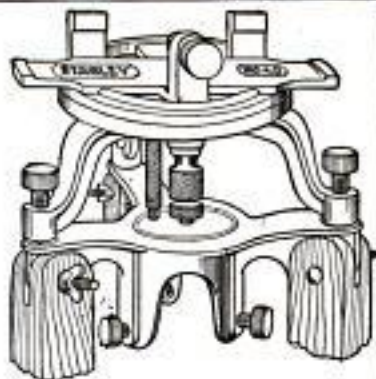

A Stanley Leveling Stand, used in connection with a wood or iron level and a pair of level sights, will be found in many cases a very satisfactory and inexpensive substitute for the more expensive surveyors' instruments.

By its use one can readily determine levels from a given point to one at a distance, such as locating or setting the profiles for foundation work, ascertaining the proper grades for drains, ditches, etc.

It can be placed on a stake or crow-bar and adjusted to a horizontal position, even though the stake or crow-bar may not be exactly perpendicular.

A Thoroughly Practical Tool

Price of Stand with a 12-in. metal level and a pair of level sights **\$4.50** | Price of Stand only — adapted for either wood or metal level **\$2.00**

SEND FOR SPECIAL CIRCULAR

STANLEY RULE & LEVEL CO.
NEW BRITAIN, CONN. U.S.A.

SIMONDS

Workmanship

is what makes Simonds saws so good. It gives them that fine hang and balance, that fine appearance. Eighty-five years' experience has made us saw experts. It has made Simonds a password for good saws. Any man likes good tools and a Simonds saw is the best that science can produce.

Send for our booklet.

Simonds Manufacturing Co.
FITCHBURG, MASS.
5 Factories 11 Branches

*I tell you it's
A Great Saw*



Portable Cases

For Tool Makers and Machinists

Twelve styles, felt lined drawers, solid brass trimmings, best of material, beautiful finish, low prices, satisfaction guaranteed. Ask for booklet of cases built for service.

THE PILLIOD LUMBER CO.
SWANTON, OHIO



The Midget Slide Rule

will add, subtract, multiply, divide, solve problems involving even and uneven roots and powers. Also gives the Logarithms of numbers and the Sines, Tangents, Cosines and Cotangents of all angles. Its operation is very simple; quickly solves any mathematical problem. Made of wood and metal. Adapted for shop and office use. Fits the pocket, 3 1/4" in diameter.

Price, with instructions, **75c**

Your money back if you are not satisfied

GILSON SLIDE RULE CO., NILES, MICH.

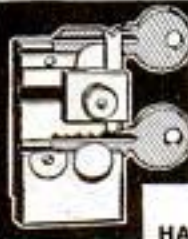

Duplicate Keys

for all Pin Tumbler Locks made in one minute with Harrison M.I.P. Key Filling Machine. No misfits. Thousands in use. \$9.50 net. Special diamond-shaped files for angular cut keys, 40c each; 3 for \$1.00. Harrison O.K. Key Clamp duplicates all common keys without a caliper. Price, \$1.10. Parcel post prepaid.

Money returned if not satisfactory.

HARRISON & CO., 81 New St., New York

THE AWL YOU WANT

See That Reel



Is the genuine MYERS \$1.00 "Lock Stitch" Sewing Awl with the exclusive feature. See thread reel in front of handle under the finger tip. Natural tension. Sews heavy or light material, diamond point, full grooved needles used to protect the thread when sewing. **C. A. MYERS COMPANY, 6339 University Ave., Chicago, Illinois**

The ONLY Rule that SLIDES! **Interlox** **The ONLY Interlocking Rule Made!**

Now you can take inside as well as outside measurements quickly and correctly. Use this handy rule — the best friend of the Mechanic, Engineer, Carpenter, Electrician and Student.

If not at dealer's, send his name and \$20 per foot (any length, 2 to 8 feet), and we'll send rule prepaid.

Fine Proposition to Live Agents and Dealers

DAHL MFG. CO., 841-43 E. 136th St., NEW YORK CITY

DISSTON SAWS AND TOOLS

"RED DEVIL" CIRCULAR GLASS CUTTER

A useful tool for cutting circles and curves from plain or plate glass. Cuts 2 to 20 in. diameter. Steel cutting wheel, adjustable rod. Style No. 033, sample postpaid for 50c.

Glass Cutter Booklet Free.

SMITH & HEMENWAY CO., Inc. 97 Coit Street IRVINGTON, N. J.



Cuts Auto Headlights, Etc.



YANKEE
TOOLS
*Make
Better
Mechanics*

The Right Feed for Any Job

Hard wood, soft wood; large holes, small holes — all look alike to this

"YANKEE" AUTOMATIC PUSH DRILL No. 44

Price \$2.15 — with 8 "Yankee" Drill Points 1/16" to 11/64" TENSIONS

A simple turning of the cap gives the *proper tension* for any boring operation—a strong push for rough holes in soft wood, or a light push for careful, clean-cut boring in hard or free-splitting wood. The Adjustable Tension minimizes drill breakage, permits free arm action, and enables faster and better work under all ordinary conditions. Drill points are carried *upright* in magazine—will not spill or become jumbled. **Your Dealer Can Supply You.**

"Yankee" Tool Book" of boring, drilling and screw-driving tools free for the asking

NORTH BROS. MFG. CO., PHILADELPHIA

The first device resembling a modern elevator is described by the Roman author Vitruvius, and its inventor was Archimedes, who lived in the second century before the Christian era.



ToolCases for Toolmakers and Machinists
Keep your tools orderly arranged in a Gerstler's Portable Tool Case. There's a place for every tool in one of the felt lined drawers. Every up-to-date mechanic needs one and you'll find our Cases the best built, toughest and most practical on the market. We guarantee to please or refund all money. Write for our free booklet!

Gerstler's Patent

Mfrs. of Mechanic's High Grade Tool Cases
808 Columbia St., DAYTON, OHIO

AGENTS—\$40 A WEEK

R. M. King Made \$45 in 6 Days



15 IN ONE

Forged steel. Patented. Low priced. Sells to auto owners, farmers, mechanics in the shops and the home. Not sold in stores. No competition. Sales easy. Big profits. Ten-inch sample to workers. Write at once.
THOMAS TOOL CO., 3248 East St., DAYTON, OHIO

**GOODELL
PRATT**

1500 GOOD TOOLS

PIPE-THREADING

5 big features *Plus* the Ratchet make the Bull-Dog Ratchet Die-Stock the handiest, easiest stock for shop, farm, trench, and factory. Every pipe-threading trade knows the 5 big Oster Features—(1) Self-locking dies, (2) Self-centering guides, (3) Dies open up after cut and reset automatically to size—no backing off, (4) No loose bushings, (5) No breakable parts.

Write for catalog of 47 hand and power threading tools—gladly mailed you on request.

**THE
OSTER
MFG.
CO.**

2100
East
61st St.

CLEVE-
LAND,
OHIO,
U.S.A.



In use
without
ratchet

Catalog,
please.

Name.....
Address.....
City.....State.....
Occupation.....(2100-8)

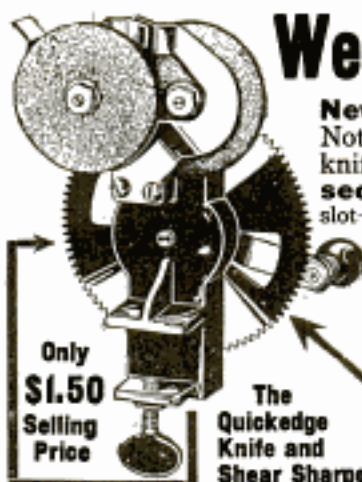

We Want Agents at \$30 to \$75 a Week

New Invention—Just out. Needed in every home every day. Patented. Nothing else like it. Low priced—**Sells on sight**. Sharpens any kitchen knife, paring knife, carving knife, bread knife, or shears and scissors in **ten seconds**. Mechanical masterpiece. A child can use it. Just put knife in slot—turn crank—sharpens both sides at once automatically. **We want representatives at once**—men and women hustlers. Get this position where **profits start first day**.

No Experience Necessary — 200% Profit

Make as much money next week as these men are making now. J. C. Lewis, of Kansas, says: "I have sold one hundred sharpeners in four days." Hobart Kerr, of Md., writes: "The women can hardly wait till they get them." Herbert Cain, of Ky., sold nine after supper. At the end of the first day, J. W. Gordon, of Pa., writes: "I sold two dozen and I sold to every one I saw." Wm. G. Hall, of N. J., says: "I think it is great. I sold six in about one-half hour. The machine is a mighty fine proposition. I am a mechanic and I know what I am talking about." You can make this easy. **WRITE TODAY. TERRITORY FREE. GET BUSY AT ONCE.**

QUICKEDGE SHARPENER CO., 687 Sharpener Bldg., 215 N. Desplaines St. CHICAGO, ILL.

Only
\$1.50
Selling
Price

The
Quickedge
Knife and
Shear Sharpener

PATENTS

IF YOU HAVE AN INVENTION which you wish to patent you can write fully and freely to Munn & Co. for advice in regard to the best way of obtaining protection. Please send sketches or a model of your invention and a description of the device, explaining its operation.

All communications are strictly confidential. Our vast practice, extending over a period of seventy years, enables us in many cases to advise in regard to patentability without any expense to the client. Our Hand-Book on Patents is sent free on request. This explains our methods, terms, etc., in regard to *Patents, Trade Marks, Foreign Patents, etc.*

All patents secured through us are described without cost to the patentee in the *SCIENTIFIC AMERICAN*.

MUNN & CO.

SOLICITORS OF PATENTS

672 WOOLWORTH BLDG., NEW YORK
and 625 F STREET, WASHINGTON, D. C.

Relief to Ruptured People

Any appliance is a truss. Ruptured people must wear a support. Our New Spongy Rubber Pad (pat'd) is velvety, soft to the skin, pliable, **cannot slip**, extremely comfortable, adapts itself to ruptured parts with less pressure, is sanitary, long lived, Massage and strengthens muscles, allows blood circulation and **produces many cures**.

Scrotal Pad Needs No Leg Strap
Our New Akron Spongy Rubber Scrotal Pad (pat'd) holds 8 out of 19 cases of scrotal hernia perfectly without strap between the legs.

Cures Man of 86
The Akron Truss Co. Gentlemen: I am 86 years and 6 months old and have had a rupture for 23 years. I am an active man, tend to a large garden, saw and split the wood and do the household chores. I bought an Akron Truss and wore it one year and am as sound as a dollar.
Respectfully yours, S. W. Glaze, Illinois.

Cured Double Hernia
The Akron Truss Co. Gentlemen: I have worn one of your trusses for some time. All this time have carried two heavy spongy cases; notwithstanding this handicap, your truss has cured me of a double hernia.
Yours truly, O. E. Jones, Indiana.

Girl Baby Cured
The Akron Truss Co. Gentlemen: The infant's truss was a perfect success. The child wore it about one year, and the rupture healed so that a person cannot see she was ruptured. Yours truly, J. Mayunga, Illinois.

Free Sample Pad A Sample Akron Spongy Rubber Truss Pad will be sent absolutely FREE upon request, also booklet "Relief to Truss Users." It's full of help. Ask your dealer, or write us.
THE AKRON TRUSS CO., 60 TRUSS BLDG., Akron, Ohio

ASBESTOS

We are miners and shippers of Crude Asbestos in any quantity. We produce all grades at our world-famous Bell Asbestos Mines, in Canada. We also card fibres, spin yarns, weave cloths, and make all sorts of Asbestos products.

For anything you want in Asbestos, turn to
KEASBEY & MATTISON COMPANY
Dept. S-3, AMBLER, PENNA., U.S.A.
Owners of the world's largest Asbestos Mines



"Bow Legs and Knock-Knees"

Unightly Send for booklet showing photos of men with and without

The PERFECT LEG FORMS

Perfect Sales Co., 140 N. Mayfield Ave., Dept. 3
Austin Station, CHICAGO, ILL.

LE PAGE'S
CHINA
CEMENT
STANDS HOT AND COLD WATER 10¢

Hand
Forged
Razor Steel
Blades, No. 57



A Genuine
\$2 Knife for **88c**

Direct at Factory Prices

This \$2 KNIFE 88c Postpaid
Hand Forged Razor Steel Blades

Handy shaped blade makes this knife best for mechanics, sportsmen and farmers; light but strong; re-sharpened easily. Stag handle, German silver finish; blades file tested, hand forged from razor steel and warranted.

Sample 88c. 3 for \$2.12 postpaid.
Send for our 100 page List and
"HOW TO USE A RAZOR" **FREE**

MAHER & GROSH CO., 106 A. St., Toledo, Ohio

Mr. Edison's Wonderful Phonograph

Only **\$1** After
Free Trial



Yes, you may keep this New Edison—Thomas A. Edison's great phonograph with the diamond stylus—and your choice of records, too, for only \$1. For the balance at rate of only a few cents a day. Try the New Edison in your own home before you decide to buy. Send no money down. Entertain your friends with your favorite records. Then return it if you wish.

Write Today For Our New Edison Book. Send your name and address for our new book and pictures of the New Edison phonograph. No obligations—write now while this offer lasts.

F. N. BABSON, Edison Phonograph Distributors
6119 Edison Block, Chicago, Illinois

DIVINE Red Devil Water Motor 4-inch size
6-inch size

A perfect small motor—made like the big turbines—wonderful power.

No muss—no fuss—no mechanical complications. Attach in cellar or at any faucet.

4-inch size for Polishing 6-inch size for Power

Only Motor to do This Work

For Mechanics, Tradesmen, Doctors, Dentists, Shop and Home



Anyone can install. We also supply pulley, emery and buffing wheel. Booklet and Prices Sent Free if you will write today and give us size of faucet, water pipe and water pressure and work to be done. You must furnish information to get booklet. **Divine Water Motor Co., Dept. P, Utica, N.Y.**

**TYPEWRITERS**

\$10 and Up. ALL MAKES SAVE \$25 TO \$50



on rebuilt at the factory by the well known "Young Process." Sold for low cash—installation or rented. Rental applies on purchase price. Write for full details and guarantee. Free trial. **YOUNG TYPEWRITER CO., Dept. 248, Chicago**

DIXON'S ELDORADO
"the master drawing pencil"

RUNS ON KEROSENE ALCOHOL, GASOLINE OR GAS
A MOST REMARKABLE INVENTION

No electricity, wires or springs. 1913 Improved patented Model. Burns 8 hours for a cent on kerosene. Quiet—convenient. Brings genuine comfort and satisfaction. Ideal for the cook. A proved success. The Wonder Fan. 2 Models. 3 Sizes.
A } 12-in. \$16.50, Alcohol or Gas only (Gas \$1.50 ex)
 } 16-in. \$18.50, Alcohol or Gas only (Gas \$1.50 ex)
B } 16-in. \$19.50, Any Burner (Gasoline \$2.50 ex)
 } 21-in. \$22.50, Any Burner (Gasoline \$2.50 ex)
F. O. B. Chicago. Cash with order only. **KEEP COOL.**



LAKE BREEZE MOTOR, 546 W. Monroe St. CHICAGO, ILL.

TYPEWRITERS SUMMER PRICES

Our entire stock of latest models is offered at special prices for the summer only.

Factory Rebuilt Typewriters
All trademarked, and guaranteed for one year. Buy now and save as much as \$75. Branch stores in leading cities.

Write for Catalog and Summer Price-List
American Writing Machine Co., Inc., 339 Broadway, N. Y.



The 21-Jewel Burlington
Adjusted to positions, isochronism and temperature. The newest gold strata cases.

\$2⁵⁰
a Month
Pays for the master watch. Send coupon.

Send This Coupon

BURLINGTON WATCH COMPANY—Dept. C919
19th Street and Marshall Boulevard, Chicago, Ill.
Please send me your free watch book and full particulars about your rock-bottom, direct offer on the Burlington Watch, either for cash or \$2.50 a month.

Name

Address



Write for These Books on Game Birds and Game Farming

They tell all about game farming—the profit and pleasure to be obtained from it. "Game Farming for Profit and Pleasure" is sent free on request. It treats of the subject as a whole, describes the many game birds, tells of their food and habits, etc. "American Pheasant Breeding and Shooting" is sent on receipt of 10c. in stamps. It is a complete manual on the subject.



HERCULES POWDER CO.
1025 Market Street
Wilmington Delaware



Use Your Railroad Tickets and Go Through by Boat

Your rail tickets are good for transportation on D & C Line steamers without extra charge.

Practically all classes of tickets, including reduced-rate, round-trip, delegate and tourist tickets, are honored on D & C steamers. Ask your ticket agent to route you via D & C Line.

Steamer Schedules

Daily service between Detroit and Buffalo; also between Detroit and Cleveland, and between Toledo and Put-in-Bay. Four trips weekly between Toledo, Detroit, Mackinac Island and Lake Huron way ports. Send 2c stamp for illustrated pamphlet and Great Lakes map. Address L. G. Lewis, G. P. A., 16 Third Street, Detroit, Mich.

Detroit & Cleveland Navigation Company

Philip H. McMillan, Pres.
A. A. Schantz, Vice-Pres. & Gen. Mgr.
L. G. Lewis, Gen. Pass. Agt.

Universal MARINE MOTOR

9-12 H.P. 4 Cycle 4-Cyl. inder. Speed range 300 to 1800 R.P.M. Adapted to boats from 14 to 30 feet. Write to

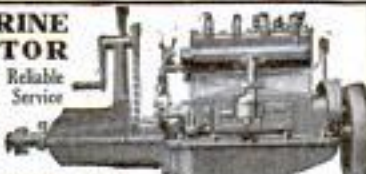

UNIVERSAL MOTOR CO.
OSHKOSH, WIS. Dept. P

For Bulletin No. 25 giving full description

Has The Motor Boat Bug Got You?



Health and happiness are assured with one of the new popular priced Gray motors in your boat. Select your boat from our 1917 Boat Builders Catalog showing products of 200 leading boat builders. Select your engine from our new complete Engine Catalog. Both books FREE. Send today.

GRAY MOTOR COMPANY
846 Oakland Ave., DETROIT, MICH.

Mullins Steel Boats Can't Sink

When you think of buying a boat, whether it be a 16-foot Runabout, a big 26-foot Auto Boat, or something in between—remember that Mullins Steel Boats are guaranteed for life. They cannot sink, leak, water-log, dry out or open at the

seams—never require caulking. Designed by America's foremost naval architects—built in the largest boat factory in the world. More than 65,000 in use. Big catalog of steel or wooden motor boats, row-boats or canoes, on request.

THE W. H. MULLINS CO., 52 Franklin Street, SALEM, OHIO

GET THIS CATALOG
FULL OF VALUABLE INFORMATION TO EVERY BOAT OWNER ON
RACING PROPELLER WHEELS, REVERSE GEARS AND MARINE ACCESSORIES
LARGE CATALOG FREE. SEND TODAY
MICHIGAN WHEEL CO.
1129 MONROE AVE., GRAND RAPIDS, MICH.

AGENTS—Make \$100 to \$300



per month easy selling our new Triplicate Sauce Pan. Cooking utensil for 3 different foods on one burner. 400 Specialties—all whirlwind sellers. Write quick for exclusive territory and large catalogue.

AMERICAN ALUMINUM MFG. CO.
Div. H-T LEMONT, ILL.



YOUR OWN BOSS

Easiest thing—right in your town. Small investment—sure profit with a Kingery Peanut and Popcorn Machine. Prices \$40 to \$400—easy to buy!

Ask for particulars and Catalog No. 50.

KINGERY MFG. CO. Pearl, East of Broadway, CINCINNATI, OHIO

ROWBOAT MOTOR FERRO

Pay for Yours by Selling Others

Make your rowboat or canoe into a motorboat, and make the motor pay for itself. Get our agency proposition 215. The Ferro Rowboat Motor is a sturdy and dependable power plant, with carburetor (not a mere mixing valve), Bosch magneto and complete equipment. Runs 4 hours on a gallon of gasoline; 2 to 3 miles an hour; easy to start, easy to run, practically trouble proof. Quiet, efficient, durable; thousands in satisfactory use—some near your home, perhaps. Write us,

\$90 with Bosch high-tension magneto.

\$70 with waterproof batteries.

The Ferro Machine & Foundry Company

843 Hubbard Avenue Cleveland, Ohio



DON'T GO ROWING - GO FERROWING



Big money for you

Think of the auto owners in your own locality who are eager to have their tires repaired! Open a repair shop with a Shaler Tire Repair Outfit. Earn \$250.00 per month. No experience necessary. We make it easy for you to start right away. You have your own business.

Free Book Tells How

Write for our wonderful book, "How to Open a Tire Repair Shop." It will open your eyes! Shows you how easy the work is. Shows you the big money that can be made. Write for this book today. A post card will do.

C. A. SHALER COMPANY

2007 Fourth Street

Waupun, Wis.



Mobiloils

A grade for each type of motor

More Miles From Gasoline—Guaranteed!

The Wilmo Manifold gives your car a flying start at the first few turns of the motor—increases gasoline mileage from 42 to 54 per cent by actual official A. A. tests—keeps the engine free from carbon—makes a smoother running motor at all speeds. Quickly and easily applied with a monkey-wrench. No holes to bore. Absolutely guaranteed. Made for various cars. Price \$7.50 up. Ask your dealer or garage man, or write.

THE WHITTIER CO., 808 First National Bank Building, CHICAGO

STANWELD Cold Drawn Seamless Steel TUBING

Lightest, smoothest, strongest Steel Tubing made. World's largest manufacturers of bicycles, motorcycles and automobiles use it exclusively. Send for Folder "A."

THE STANDARD WELDING COMPANY
Main Office and Factory CLEVELAND, OHIO

Firestone

Motorcycle Tires

Toughest, Safest, Most Attractive

Sent On Free Trial

YES, we will send you the Violin of your choice for one week's free trial. Play on it—test it in every way before you decide whether you wish to buy or not. Compare it with other instruments—then if you are not more than satisfied, Send it back at our expense. You do not pay us a penny for the use of the violin. Write for circular.

Your Choice of Instruments

Write today for our new Violin catalog and see handsome illustrations in full color of all the superb instruments that you have to choose from.

There you will find illustrated products of the leading violin makers of the world—Farny, Bader, Glier, Heberlein, Fiedler, Wurlitzer and many others. Violins of the highest grade, as well as those of moderate prices—all special values. Priced from \$2.70 to \$50.00, and from \$60.00 to \$250.00.

Rare Old Violins

Our collection of rare old violins is one of the largest in America. Write today for Special Art Catalog.



WURLITZER

200 years of instrument making

Get the benefit of our mammoth facilities for buying in large quantities. The house that supplies the United States Government now makes a startling money-saving offer direct to you. Write for circular.

Pay as You Wish

If you decide to keep the violin you have selected after you have tested it out for one full week, pay the rock-bottom price at the rate of only a few cents a day. No red tape. No collectors or mortgages. Your credit is good with the House of Wurlitzer.



10c a Day

now buys this superb Lyric Cornet. Exquisite triple silver-plated long model Lyric Cornet direct to you on a starting offer. One week free trial before you decide to buy. Liberal allowance for old instruments. Write today for 164-page Catalog—showing 5000 instruments that you have to choose from.

Send the Coupon

Put your name and address on the coupon now and indicate catalogue matter you wish us to send you. Absolutely no obligation in sending the coupon. Do it now. Find out about the startling money-saving offer we are making. Write today—send Coupon or a Letter or a Post-card.

The Rudolph Wurlitzer Co.

Dept. C119
East 4th Street,
Cincinnati, O.
So. Wabash
Avenue,
Chicago

The Rudolph Wurlitzer Co.
Dept. C119
S. Wabash Av., Chicago
4th St., Cincinnati

- Gentlemen:—Please send me without obligations, free and prepaid the catalog matter checked below
- The special violin circular.
 - Special low priced violins under \$15.00
 - Your 225 page illustrated catalog of musical instruments.
 - Catalog of music stands, cases and other stringed instrument accessories.
 - Art catalog of rare old violins.

Name _____

Address _____

Please Mention Popular Mechanics

Pulls you out of trouble

Carry this little Pull-U-Out in your tool box and you will be independent of road conditions. With it a boy can, unaided, pull a 5000 lb. car out of ditch or mud. Pays for itself on its first job. Besides pulling autos out of trouble it will do all kinds of lifting and pulling in the factory, garage, on the farm or construction job, etc.

Consists of a winding drum, lever crank, 40 feet of steel cable, two 7 ft. chains and 3 stakes. Weighs only 28 lbs. and goes in space 4x6x14 inches.

A pressure of only 30 lbs. on the handle will lift a ton



Cheaper and better than a chain block. Does jobs no other machine can do.

WRITE FOR BOOKLET—VERY INTERESTING
Tells how and why this marvelous little Pull-U-Out works.

Pull-U-Out Sales Co., 2035 Market Street, St. Louis, Mo.

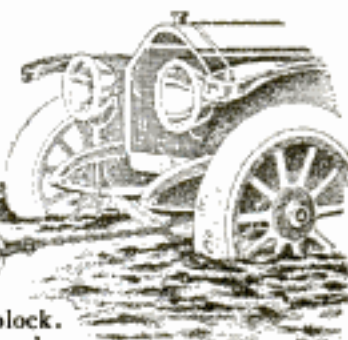

Get 5,000 more miles

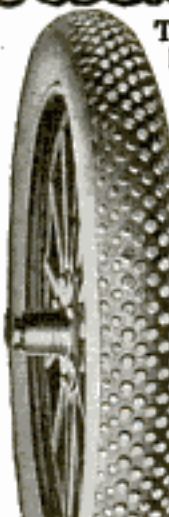

The worn tires that you have been throwing away can be made to give at least 5,000 miles more service. Durable Steel Studded Treads are a perfected product of the World War. Over half the cars in Europe are equipped and more than 50,000 American motorists have already profited by the saving and security which they have made possible.

5,000 Miles without puncture is guaranteed whether your tires are new or old.

We Deliver Free without a cent deposit, and prepay express. You can apply them in a few minutes in your own garage and judge for yourself.

Special Discount offered to motorists in new territory on first shipment direct from factory.

Mail the coupon today. You will hear from us within a week.

Guaranteed 5000 Miles Without Puncture

MAIL TODAY—SAVE THE DISCOUNT,
The Colorado Tire & Leather Co.

844 Tread Bldg., Denver, Colorado, H-44 Transportation Bldg., Chicago, Ill., 720-448 Woolworth Bldg., New York City

Send me without obligation or expense booklet, sample and written guarantee for 5,000 miles more service.

Name

Address

My Tire Sizes are

Tighten Stop the Creaking!

4 Wheels For \$1.00

Avoid Danger of Wheel Collapse

Don't neglect your loose wheels. They are dangerous! Thousands of accidents are caused every year by loose wheels. You can stop "body squeaks" with Spoktite. A proven success. If your dealer doesn't handle Spoktite, send us his name and \$1.00 for a good supply postpaid.

LIQUID WHEEL TIGHTENER CO.
Dept. L, Modesto, California
Sales Offices: Boston—New York



Go to your auto supply dealer at once and get a 4-wheel size can of Spoktite, the great wheel tightener. Apply it to the joints of the spokes and felloes, and the squeaking and creaking will stop. Spoktite is not a glue but a liquid compound that goes right into the wood, swells it to original size AND **KEEPS IT THERE.**

Boy's Junior Auto - 3 H. P. Motor Driven

SPEED, 20 Miles per hour

We furnish parts; build it yourself. Inexpensive. Send 21 cents for blue prints and price list of parts.



SYPPER MFG. CO.

146 Warren St., Toledo, Ohio

IVER JOHNSON

REVOLVERS SHOTGUNS BICYCLES MOTORCYCLES

Send for free books, "A"—Arms, "B"—Bicycles, "C"—Motorcycles.

Iver Johnson's Arms & Cycle Works
307 River Street FITCHBURG, MASS.



Convert Your Bicycle into a Motor-Cycle

Motor fits any wheel. BEST, MOST RELIABLE. Best hill climber. More STEFFEYS in use than all others. Stamp for circulars. STEFFEY MFG. CO., 5007 Brown Street, PHILA., PA.

MIAMI-MADE BICYCLES

Stand at the top of the bicycle world. RACYCLE, HUDSON, MIAMI, FLYING MERKEL. Write for our catalog. THE MIAMI CYCLE & MFG. CO., MIDDLETOWN, OHIO

Vitalic Bicycle Tires Deluxe

\$8 a pair, Brigadier \$6 a pair—made for endurance
Continental Rubber Works, 1964 Liberty St., Erie, Pa.

America's Tested Tires

GOODRICH

BLACK SAFETY TREADS

THE B.F. GOODRICH COMPANY, Akron, Ohio

The Harley-Davidson "Master 17"



It sets the pace for 1917. Has more power, more speed, greater flexibility, faster getaway. Equipped with hand-operated, auxiliary brake in addition to regular service brake. Finished in beautiful military drab. Write for 1917 catalog. HARLEY-DAVIDSON MOTOR COMPANY 509-B Street Milwaukee, Wis. Producers of High-Grade Motorcycles for More Than Fifteen Years

Please Mention Popular Mechanics

STOP USING A TRUSS

Do Away With Steel And Rubber Bands

FREE TRIAL



Inner surface is made adhesive to secure the PLAPAO-PAD firmly to the body, keeping the PLAPAO continually applied and the pad from slipping. No straps, buckles or springs attached. Soft as velvet—easy to apply.

It's the Non-Slipping, yet Non-Rigid Pad and What is Within It That Counts

PAT'D
APRIL 6
1909

FREE to 5,000 Truss Sufferers

To the extent of 5,000 sufferers who may apply I will send, ABSOLUTELY FREE, a sufficient quantity of the Plapao to positively convince them that this is the only logical, common-sense way of treating rupture. Plapao is a highly astringent medication placed within the Plapao-Pad and being absorbed through the skin, creates a wonderful feeling of relief and at the same time tends to strengthen the weakened muscles and thus permanently close the rupture opening. The process of recovery is natural, so you'll have no use for a truss—you can throw it away forever! Old and young have testified under oath that the Plapao-Pads cured their rupture—many of them long-standing, aggravated cases—without delay from work. Patent allowed in U. S. and foreign countries. Awarded Gold Medal at Rome and Grand Prix at Paris.

Send No Money—for a sufficient quantity of the Plapao is sent without charge to enable you to give it a thorough test; you pay nothing for this trial now or ever. Write for it and full information today. Address Plapao Laboratories, Block 1427 St. Louis, Mo.

The world's production of rubber has doubled in a little more than eight years, and rubber at 25 cents a pound is not regarded as a possibility of the future.

Lost—A valuable key. Dropped it in the dark. Burned my fingers several times with lighted matches. Could have found it instantly with an Eveready DAYLO—the light that says, "There it is!"

Driver Agents Wanted

Five-Place, 34.7 H. P. Drive and demonstrate the Bush Car. Pay for it out of your commissions on sales, my agents are making money. Shipments are prompt. Bush Cars guaranteed or money back. Write at once for my 48-page catalog and all particulars. Address J. H. Bush, Pres. Dept. 317

114-inch Wheelbase
Denco Ignition—Elect. Str. & Ltg.

BUSH MOTOR COMPANY, Bush Temple, Chicago, Ill.

FREE BOOK TELLS HOW TO MAKE \$150 TO \$1000 PER MONTH

Making celebrated Flavo Nature Flavored Flour in rural communities or small towns with

AMERICAN MARVEL Flour Mill

(Self-Contained)

You can quickly become a member of Community Marvel Millers. We start you. Help you. 30 days' free trial. Investment and terms easy to handle. Write for fully illustrated book.

ANGLO-AMERICAN MILL CO., Inc.
135-141 Trust Bldg. Owensboro, Ky.

Over 100,000 in Use
Mostly sold through recommendation. For PERSONAL DESK or GENERAL OFFICE. It checks mental calculations. Buy through your Stationer. Write for 10-day trial offer.

E. GANCHER, A. A. M. CO.
148 Duane Street, NEW YORK

AGENTS WANTED

Golden Gem
PORTABLE Adding Machine
\$10

Multiples - Subtracts

DIAMONDS ON CREDIT

LOFTIS SOLITAIRE DIAMOND CLUSTER RINGS

The Diamonds are Mounted So as to Look Like a Large Single Stone



92—\$50
Looks like a \$150 single stone.
\$10 Down.
\$5 a Month.

94—\$75
Looks like \$250 single stone. \$15 Down, \$7.50 a Month.

96—\$100
Looks like a \$300 single stone. \$20 Down, \$10 a Month.

98—\$125
Looks like a \$350 single stone. \$25 Down, \$12.50 a Month.

The Loftis Seven-Diamond Cluster was designed for those who desire a large showy ring for the least money, as it has the exact appearance of a Solitaire that would cost three or four times as much. The secret of the rare beauty of this ring lies in the perfectly matched stones; all the Diamonds are uniform in size, quality, brilliancy; set in platinum; 14k solid gold mounting.

SEND FOR FREE CATALOG There are over 2,000 illustrations of Diamonds, Watches, Jewelry, etc. Whatever you select will be sent, all shipping charges prepaid. You see and examine the article right in your own hands. If satisfied, pay one-fifth of purchase price and keep it. Balance divided into eight equal amounts, payable monthly. Our Catalog shows all the new watches—15, 17, 19, 21, 23 Jewels, adjusted. Guaranteed by the factory and further guaranteed by us. Watches that will pass railroad inspection as low as \$2.50 a month.

Gold Medal Highest Honors



World's Fair Universal Exposition

LOFTIS BROS. & CO., The National Credit Jewelers
Dept. C994 100 to 108 North State Street, Chicago, Illinois
(Established 1858) STORES IN LEADING CITIES

50c Trial Order for 10c

BEST KODAK FINISHING Any size roll developed 10c; six prints free with first roll. Or send six negatives, any size, and 10c for 6 prints. Beautiful 8x10 mounted enlargements 35 cents.

ROANOKE PHOTO FINISHING COMPANY
Formerly Roanoke Cycle Co. 208 BELL AVENUE, ROANOKE, VA.

MONEY IN MUSHROOMS

GROW AND SELL MUSHROOMS

An unexcelled occupation. Exceptional opportunities for live men and women. Raised at home. Only small space needed. Small expenditure will start you in a practical money-making enterprise. Big profits. Booklets telling all free. Write

Nat'l Spaw Co., Dept. 12, Boston, Mass.

MAKE YOUR BIKE A MOTORCYCLE

at a small cost, by using our attachable outfit. Fits any Bicycle. Easily attached. No special tools required.

"Used His Four Years"

Harry A. Hyatt, of Boreas River, New York, writes: "About four years ago I received my motor attachment, and wish to say that I am satisfied with it in every way, for it has certainly given me good service. Anyone wanting a motorcycle or attachment, I would recommend them to the Shaw Manufacturing Co."

FREE BOOK Write today for bargain list and free booklet, fully describing the SHAW Bicycle Motor Attachment. Motorcycles all makes, new and second-hand, \$35.00 up.

SHAW MANUFACTURING CO.
Dept. 6 GALESBURG, KANSAS



The Cleveland Lightweight



$\frac{1}{2}$ the Weight
 $\frac{1}{2}$ the Cost

One enthusiastic owner after riding 32,000 miles has figured that his *entire upkeep cost* has been *3-5 of a cent* per mile, and his machine, he says, is good for another 32,000 miles.

Do not judge the Cleveland Lightweight by *any motorcycle you ever saw or rode*—it is *entirely new and different*.

Write us for the facts.

\$170 f. o. b. Cleveland

to the gallon Cleveland Motorcycle Mfg. Company, Cleveland, O.



Save $\frac{1}{3}$ on This
Rowboat
Motor

This rowboat motor has a five year record for faithful performance in actual service.

The **Columbian** ONLY **\$60**

1917 model, only \$60—with high tension magneto built in fly wheel \$70. Greater manufacturing facilities enable us to keep the price down and save you \$20 to \$30. Send for literature—Boats, Canoes, Engines. Come in and visit our big Motor Boat Show—everything from a canoe to cruiser.

CULLEN MOTOR CO., Dept. 1
112 W. Lake Street Chicago, Ill.



Motor Perfection
is what you get in Watkins Class "B" all iron motors. Especially fine for canoes and light boats. Constant and efficient.

- 3 H. P. single cylinder . . . 45 lbs.
- 6 H. P. double cylinder . . . 85 lbs.
- 12 H. P. four cylinder . . . 155 lbs.

Are light, at the same time strong, accomplished by using semi-steel castings, high carbon steel shaft, bronze bearings, high class workmanship.

THE WATKINS MOTOR CO.
837-839 W. 6th Street Cincinnati, Ohio

DIAMONDS ON CREDIT

BEAUTIFUL DIAMONDS SENT ON APPROVAL

NO MONEY DOWN. Order any diamond from our catalogue; we will send it, all charges paid. After you have made a thorough examination and are satisfied as to the quality and value, pay 20 per cent of the price and only 10 per cent per month thereafter. If not satisfactory, return it at our expense. Don't pay a cent until you are satisfied. Certificate furnished guaranteeing the quality of every diamond. Your diamond purchased from us can be exchanged at a yearly increased value of 7 1/2 per cent on a larger purchase. Own a genuine Diamond. Send for our Catalogue De Luxe No. 69. It's free.

L. W. SWEET & CO., Inc., 2 and 4 Maiden Lane, New York City

A Likely Spot

Easy to pull anchor and find a likely spot if your rowboat is equipped with an

EVINRUDE

DETACHABLE ROWBOAT & CANOE MOTOR

Used by sportsmen the world over for hunting, fishing and camping. Equipment includes Evinrude Magneto—Built-In Flywheel Type—Automatic Reverse—new refinements for 1917. More speed and power. Catalog and dealer's name on request. Special folder describes rowboats, canoes, skiffs and accessories.

EVINRUDE MOTOR CO.,
568 Evinrude Bldg. Milwaukee, Wis.
Over 80,000 sold—Used by 25 Gov'ts.
Also manufacturers of 2 and 5 H. P. 2 cycle inboard motors for launches, canoes, dinghies, landers.

Distributors,
New York, Portland,
Boston, San Francisco



Evinruding—Is Rowboat Motoring

4 Weeks' Trial

Any Superb Wings Piano or Player Piano, choice of 23 styles, on 4 weeks' absolutely free trial. No money down, all at the rock-bottom direct price. Easy terms. **Valuable Book FREE**

Write today for "The Book of Complete Information About Pianos." Also free catalog.

Wing & Son (Est. 1865) 9th Ave. and 13th St., Dept. C119 New York

SMALL ENGINES

Perfect Gasoline Engines—4, 1 and 1 1/2 h. p.—for Farm and Shop use. Price \$15.00 and up. Also

WASHING MACHINES

We ship on trial. Send for Booklet and Special Offer.

SIEVERKROPP ENGINE CO.
1224 18th St. RACINE, WIS.

STARTER for FORD CARS

MEN WOMEN

Amazing Profits In Mushrooms

Anybody can add \$10 to \$40 per week to their income. In spare time, entire year growing mushrooms in cellars, sheds, barns, boxes, etc. I tell you where to sell, at highest prices. Free illustrated instruction Booklet

HIRAM BARTON
Desk 2, 329 W. 45th St., New York

14K \$75
420 \$50
428 \$100
\$50



EXCELSIOR KUSHION SPROCKET

*The Greatest Improvement Ever
Made in Motorcycle Construction*

Exclusively EXCELSIOR of Course
Equalizes the Pull without loss of Power. Conserves and Delivers to the Road Wheel Every Ounce of Power Developed by the Motor.

The Supremacy of the Big Twin motor in Power and Efficiency has been repeatedly proven in every test to which a motorcycle can be subjected. The one unpleasant feature has been the intermittent pull and the resultant jerky action of the machine.

By all ordinary methods of overcoming this, such as slipping clutches, compensating sprockets, etc.,

**By This Method EVERY OUNCE OF MOTOR POWER IS UTILIZED
and the JAR AND VIBRATION ENTIRELY ELIMINATED.**

The new Kushion Sprocket is now supplied as extra equipment on all Model 18-3 Excelsiors at an additional cost of \$5.00, and can be supplied for all series 15-16-17 and 18, EXCELSIOR Twins, complete and ready to install for \$5.00.

If Your Dealer Cannot Show You This New Sprocket, Write to Us for Details

EXCELSIOR MOTOR MFG. & SUPPLY CO. CHICAGO 3702 Cortland St.

**MAKE \$3,000⁰⁰
THIS YEAR**

You can do it in a Tire Repairing Business of your own. The one field where there is more work than men to handle it. Easy to learn—Small investment and big profits for you.

AKRON-WILLIAMS TIRE REPAIR EQUIPMENT

Used and endorsed by 90 per cent of the big tire factories and most successful tire repair shops.

Don't delay. Send for details of our plan to help you start on big-paying basis from the very first day.

The Williams Foundry & Machine Co.
80 Cherry Street AKRON, OHIO



BIGGEST VALUE

Ever Offered in a VIOLET RAY MACHINE

A triumph in mechanical construction! Pronounced most perfect by eminent mechanics. In convenience and efficiency of operation

THE VIOLETTA is without a peer. In price—the most economical. The greatest

money's worth ever offered. Send quick for Free Descriptive

Matter and source of testimonials from users who have received amazing health and beauty benefits—an astounding

cash-saving offer.

BLEADON-DUNN CO., Dept. C9 Chicago, Ill.
11 So. Desplaines St.



CARRY YOUR Claw Pipe Vise



to the job and attach it INSTANTLY.

Don't waste time carrying pipe back to a bench. Fits any post, round or square, iron or wood, door or window casing. Fastens absolutely rigid.

Pipe simply cannot slip in the 4 inch teeth. Reverse jaws instantly for small pipe. Weight about 25 lbs. Pays for itself in a few weeks.

Ask your dealer or write us.

COMMONWEALTH ENGINEERING CO., 216 High St., Boston, Mass.

SLEEP COZILY IN YOUR FORD WITH GENUINE HOME COMFORT



No leaky tent. No cumbersome trailer. No ants or snakes. No crowded hotels.

The New "PULLMAN" Reclining Seat

makes your car instantly a substantial,

full-width, mattress bed. Easily installed.

Handsome and durable. Saves its

costs in hotel bills. Price \$45. Write for

handsome descriptive folder and

special introductory proposition.

Reliable Owner-Agents Wtd.

FIELD MFG. CO., Owosso, MICHIGAN

GREEN
AUTOMATIC
MACHINE



ADD TO YOUR INCOME WITH LITTLE EFFORT
\$5 to \$10 A DAY MADE EASY WITH

The GREEN AUTOMATIC MACHINE

Sharpens, Honors and Strops all kinds of safety razor blades, in one operation, from four to six blades per minute. For both Quality and Quantity this machine is in a class by itself. There is nothing like it on the market. Let us send you our free booklet explaining everything, including the "AMERICAN" Key Cutter—cuts square, angular or round slots.

AMERICAN SHARPENING MACHINE CO. (Inc.), Dept. 8, 184 W. Washington St., CHICAGO



Take Pictures with—

The EXPO WATCH CAMERA



A camera that closely resembles a watch in size and appearance—takes pictures $\frac{1}{2} \times \frac{1}{4}$ inches as shown on margin. Easy to operate. It's a camera for both amateur and professional.

Surprise Your Friends

Take their picture in the act of doing some funny stunt. Next time you see them produce the print. You will have a lot of fun over their bewilderment and catching people in queer and awkward positions. Carry the EXPO about in your pocket—easily concealed in the palm of the hand—picture can be taken unobserved. Produces clear, sharp negatives, indoors or outdoors equal to any camera on the market.

One Cent a Picture

The EXPO loads in daylight with a 25 exposure film costing 25c. A whole day's outing picture taking can be had for the small sum of 1c a picture. Films are also made in 10 exposures for 15c. Photos may be enlarged to any size. We have Automatic Enlargers specially made for the purpose, that may be had any time.

\$2.50

For EXPO WATCH CAMERA, postage 10c extra. Films 25 Exposures 25c—10 Exposures 15c. Leather Pocket Carrying Case 35c.

JOHNSON SMITH & CO., Dept. 88, 7121 N. Clark St., CHICAGO

Quick as a Flash

The EXPO takes pictures through the stem, where the rapid fire lens is located. Equipped with a time and instantaneous shutter. Weighs but three ounces and is highly nickel-plated. Endorsed and in constant use by the police, newspaper reporters, detectives and general public. Important evidence can be secured with a camera of this kind. Sold under a positive guarantee. Delivered to any address in the world.

Johnson Smith & Co.

Dept. 88
7121 N. Clark St.
CHICAGO, ILL.

Please send me one EXPO WATCH CAMERA for which I enclose \$2.50 and 10c to cover postage.

Name _____

Street Address _____

City _____



BOYS! HAVE DAD GET STRUCTO

Structo—Mechanics in miniature—will turn the trick. With it you can build that bridge or derrick, and a hundred other models that really work. Write for Free illustrated book.

STRUCTO MFG. CO., Dept. 118, FREEPORT, ILL.

BOYS—Build and Fly a Model War Aeroplane



"Ideal" accurate Scale Drawings enable you to EASILY build 8 Ft. Flying Models of Aeroplanes now used in the European War. Students of Aeronautics, everyone with an inquiring turn of mind, should construct one of these fascinating Models.

Prices of 3 Ft. Scale Drawings

Curtiss Flying Boat 25c
Curtiss Military Tractor 25c
Hydroaeroplane 35c
Nieuport M's'plane 25c

Bleriot Monoplane 25c
Taube Monoplane 25c
Wright Biplane 25c
Cecil Peeli Racer 25c

Complete Set of Eight, \$1.75 postpaid

Get our 1917 Aeroplane Book, containing full information about models, parts, etc., 3c postpaid.

Ideal Aeroplane & Supply Co., 82-88 West Broadway, New York



Taube

A Yearly Income for You

Would you invest a moderate amount in small monthly or semi-annual installments, if you felt assured it would earn for you an income from \$1000.00 to \$5000.00 annually, according to your investment? A Dixie Estate near Tampa, Florida, planted to grapefruit, oranges and avocados, should do this for you. The proof is what you want. We have it and will gladly send it to you free. Write us today for details of this money making opportunity.

The Thomas Nurseries, Inc., Tower Bldg., Chicago

RECTIFIERS for garages. All sizes. Charge from alternating current 1 to 8 batteries. \$12.00 upwards.

AMERICAN BATTERY CO., 1137 Fulton St., Chicago. (Estab. 1888)

DUCK'S BIG 300-Page No. 11 CATALOG

Mailed on receipt of 8 cents in stamps or coin, which may be deducted on first dollar purchase. Great cost of catalog and low prices prohibit distribution otherwise. Catalog contains 260 pages of wireless apparatus and 140 pages of electrical supplies. No bigger or better values are obtainable elsewhere.

THE WILLIAM B. DUCK CO., 223-227 Superior Street, TOLEDO, OHIO

Ask Your Dealer



Red Seal Dry Batteries Are Guaranteed

to give absolute satisfaction for Automobiles, Motor Boats, Gas or Gasoline Engine Ignition, Medical Batteries, Telephone, Door Bells, Annunciators, Wireless Apparatus or any other open circuit work.

Our New Edition Pocket Catalog P28

Ready About Sept. 1st.

It will be pocket size, 8x4 1/2, and will contain 248 pages with over 1,000 illustrations, describing in plain, clear language all about Bells, Push Buttons, Batteries, Telephone and Telegraph Material, Electric Toys, Burglar and Fire Alarm Contrivances, Electric Call Bells, Electric Alarm Clocks, Medical Batteries, Motor Boat Horns, Electrically Heated Apparatus, Battery Connectors, Switches, Battery Gauges, etc.

There exist a thousand and one ways where electrical devices may be used, and to know what is best for your purpose you will need this catalog. It will be in fact a pocket encyclopedia of the most popular and up-to-date electrical appliances in general use, and will cost you nothing.



Send for a Copy Now

MANHATTAN ELECTRICAL SUPPLY COMPANY, Inc.

NEW YORK, 17 Park Place

CHICAGO, 114 So. 5th Ave.

ST. LOUIS, 1106 Pine St.

San Francisco, 604 Mission St.



Be a Caille Motor

OWNER AGENT

For Fishing Hunting Pleasure Business

Steers And Controls With Same Lever

Hundreds of Caille Owners have asked to become our agents,—they have seen how easy it is to sell Caille 5 Speed Master Motors. They wanted to represent us in their vicinity because everyone who saw the Caille perform wanted one. We are going to give everyone a chance to be an owner agent and sell the Caille 5 Speed outboard motor. No previous selling experience is necessary. No office or shop is needed. Anyone can easily understand and operate a Caille 5 Speed Outboard Motor. Be first in your neighborhood.

Special Owner Agent Offer

We will give a special "Owner Agents" discount to one in each community. Our best advertisement is the Caille in operation. Owner Agents sell from 1 to 12 Caille Motors a year easily among friends and acquaintances. Buy yours at discount and sell all you can. *We want a Caille Owner Agent in your vicinity.*

2 Speeds Forward—Standstill—2 Speeds Reverse Without Stopping Motor

The Caille 5 Speed Motor Starter operates with a quick, easy pull,—women and children operate it easily. There are two speeds forward—two reverse or standstill without stopping the motor. This makes the Caille so flexible that anyone can use it for hunting, fishing, pleasure in fresh or salt water. The Caille is simple in construction, made of best materials and is fully Guaranteed.

FREE Catalog, Special Owner Agents Discount, Booklet "Installation-Operation and Care of 2 Cycle Motors and Equipment," all absolutely **FREE**. Here's a chance to earn while you play.

Caille Perfection Motor Co., 28 Caille Bldg., Detroit, Mich., U. S. A.

*We make a complete line of Inboard Marine Engines from 2½ to 30 h. p.
If interested ask for catalog, giving dimensions of boat.*

GROW MUSHROOMS!



Start right, have a big paying business month in and month out, right at home. Costs little to start, grow fast. Mushrooms in big demand everywhere. Men, women and children can grow them, in sheds, cellars, boxes, etc., in spare time. Learn expert facts about successful growing, right spawn, etc., from America's great authority. Send for free illus. publication, "TRUTH ABOUT MUSHROOMS," today.

BUREAU OF MUSHROOM INDUSTRY
Dept. 395 1342 N. Clark St., CHICAGO

MILITARY MUSIC

The Dixie Music House, 105 W. Madison St., Chicago

Cut Your ICE BILL

Get a White Frost—30 days trial—we pay freight. Steel built, white enameled. **White Frost Refrigerator**

Write **WHITE FROST REFRIGERATOR CO.** Today 879 E. Michigan St., Jackson, Mich.

The
Wellington
THE UNIVERSAL PIPE

WEAR

Trade Mark Registered

B.V.D. U. S. Patent Office and Foreign Countries

UNDERWEAR

\$100 a week pays for the Black-Beauty-Bicycle



JUST THINK OF IT—here's the classiest bicycle ever built—and yours at the unusual terms of \$1 a week. What's more, we ship *freight prepaid*. **DIRECT FROM FACTORY—ON APPROVAL**. You take no risk, for if you don't like the Black Beauty, send it back at our expense—you're not out a penny. **5-Year Guarantee**—All sizes, all styles, and a tool kit free. Get color catalog now.

WRITE US TODAY

HAVERFORD CYCLE CO.
Est. 1896. Dept. F, Philadelphia, Pa.

Get this LA Engine Book



— it gives valuable information about motor boat engines. It also describes the full line of L-A motors and tells of the 30 days' free trial plan. Write for your copy today.

LOCKWOOD-ASH MOTOR CO.
1430 Horton Ave. Jackson, Mich. (22)

THOUSANDS ARE JOINING OUR THRIFT CLUB!

AN EASY WAY TO OWN A GENUINE DIAMOND

Terms As Low As \$1.00 A Month!

\$39.50 Regular \$50 Value. From Our Large Free Catalog you may select any 14-carat 2 1/2 ct. diamond from \$10 to \$50, but on our Special Club Plan This Month we are offering a popular \$50 engagement ring at only \$39.50

Get the Diamond NOW You Have Always Wanted.

HARRIS-GOAR JEWELRY CO., Dept. 138 KANSAS CITY, MO.

Sent on Approval—NO MONEY DOWN! ELGIN OR ANY WATCH YOU WANT—As \$10 Value—This Model. On Railroad Grades we save **FREE CATALOG** you a third.

Write for it. Gives full information about our Club Plan and how you can earn a Watch or Diamond.



A Scientific Solution of the Sanitary Drinking Water Question



Ice Cooled

Holds 75 lbs. of Ice.
Supplies 150 Men.

Fifteen and one-half circulating coils of pipe in the cork-jacketed ice tank insure an ice-cooled sanitary drink to every employee.

The quality of the ice is immaterial, as it does not come into contact with the water. This construction reduces the amount of ice and water required to a minimum.

Send for Our Complete Catalogue

showing our line of Wash Bowls, Metal Lockers, All Steel Stools and Chairs with Inset Wood Seats, Stock and Storage Racks, Metal Shelving, Metal Vault Fixtures, Improved Soda Kettles, 40 and 60 gallons, Water Heaters and Instantaneous Mixers, Bubbling Drinking Fountains, Work Benches and Bench Legs, Drawing Stands, full line of Plumbing Fixtures, etc.

Manufacturing Equipment and Engineering Co.
136 Federal Street Boston, Mass., U. S. A.
Works and Mail Address, Framingham, Mass.



Replace Your Heating Plant with a **ROUND OAK** Moistair Heating System

Only Heating System that Automatically Ventilates and HUMIDIFIES.— Keeps air moist, free from disease germs. Durable, dependable, easy to operate, a big fuel-saver. Send for FREE Book explaining all.

Made by Makers of Good Goods Only

The Beckwith Co. Round Oak Folks—Established 1871
100 Front St.—DOWAGIAC, MICH.

DIAMOND PRICES SHATTERED



GENUINE
PERFECT CUT
BLUE WHITE
DIAMOND \$2.50
A MONTH

LOOK! No Security—No Red
Tape—Buy "Direct"—Save from 1/3 to 1/2

SEE DIAMOND FIRST

Sent for Inspection Without One Penny Down
We trust you absolutely. Examine diamond at your leisure. Wear it 30 Days FREE. Send it back if not satisfactory. You're not out a penny.

FREE DIAMOND BOOK
Send for it today

READ the TRUTH about diamonds. READ how to judge a good diamond. Read about our splendid BUY BACK offer at full value. Read our EASY PAYMENT PLAN arranged to suit you.

EVERY DIAMOND GUARANTEED

Money put in a diamond is saved and forms one of the best investments on earth. Begin saving NOW. Write today for FREE booklet of diamonds and high grade diamond jewelry.

SANTA FE WATCH CO., TOPEKA, KAN.
Dept. 863

SARGENT

REG. U. S. PAT. OFF.

Automatic-Set Bench Planes

For working against the grain
on cross-grained
hard wood.

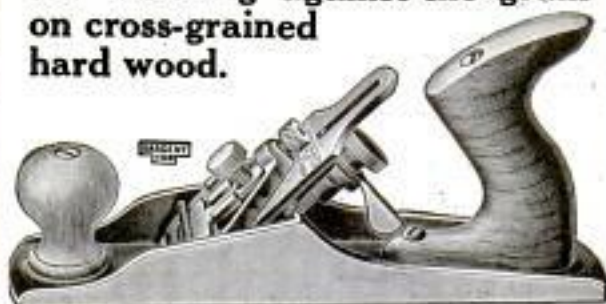

Mechanics who have used these Planes say they are the BEST. They have superior features and do work that no other Planes will do.

The automatic set is a great time saver; the rigidity insures good work; and the ease of adjustment is a great advantage.

These features are fully explained and the six sizes of these Planes described in the Sargent Plane Catalogue, a copy of which will be sent free on request.

SARGENT & COMPANY
49 Water St., New Haven, Conn.

5¢ Does a Big WASHING
That is the cost for power when you use the Larkin Electric Washer. Terms \$3 monthly. Ask today for special offer.
Larkin Co. Desk 817 BUFFALO, N. Y.

A Birthday Present

If you are racking your brains to think of a suitable birthday present—stop. Go to any dealer and ask to see Ingersoll watches. There are eleven kinds from a \$1 to \$3.

Be Sure It's "POROSKNIT"
GENUINE SUMMER UNDERWEAR
Cool, elastic, comfortable—GUARANTEED
Chalmers Knitting Co., 78 Washington St., Amsterdam, N. Y.

1917 Fall Suit Free **A WONDERFUL amazing OFFER**



If you are a live wide-awake man we want you to get one of our elegant Fall suits, made to YOUR measure, absolutely FREE. All we ask you to do is to wear it, show it to your friends and take a few orders for our high grade, Made-to-Measure Clothes.

**\$25 EXTRA A WEEK
AND YOUR OWN CLOTHES FREE**

Does it look good to you for a little more time? Write at once or simply send us your name on a postal and we will send details of this "STARTLING OFFER." We will also send you FREE a large assortment of cloth samples and dozens of fashion plates to choose from **NOTHING LIKE IT EVER OFFERED** by any other Tailoring House. We don't ask you to spend your cash profits for your clothes. Ours is a new and better plan. Write at once. Be the first in your town to get this FREE suit.
SPENCER MEAD COMPANY
Dept. 1478 CHICAGO

POWER



For Your Basement Workshop

Here is just the motor you have wished for many a time—little $\frac{1}{2}$ or 1 h. p. marvel that can be placed anywhere in your basement or tool house to run your grind-stone, emery wheel, drill, lathe, washing machine, ice cream freezer, etc. The

Maytag Multi-Motor

is the most remarkable motor of its size and weight. Easy to carry and quickly connected for use. Operates with gasoline or city or natural gas at no more cost than electric current. The cheapest power you can buy. Strong, simple and durable—only five actual moving parts—no gears, cams or valves to cause trouble.

Put this indispensable power utility in your home now while the price remains \$30 for the $\frac{1}{2}$ h. p. and \$37.50 for 1 h. p. We'll ship on condition that you must be satisfied. Write now.

THE MAYTAG CO.
Dept. 226 Newton, Ia.

Dealers—Write for Maytag proposition

76

QUEER FANCY OF CHINESE GARDENERS.—In Chinese gardens belonging to wealthy men one sometimes sees the oddest sort of plants, says the Christian Science Monitor. It is a fancy of Chinese gardeners to plant statuettes of tiny men firmly in pots, just like real plants, and then to train live evergreens to grow up over these statuettes. The vines thus form a kind of robe for the statuette men, their white faces and hands protruding out of the greenness.

Butler Home Canning Outfits

REDUCE the high cost of living. Help your country, help your family. Store all surplus food-stuffs. Write today and find out about the great, serviceable Butler Canning Outfits. Made for Home, Club or commercial use.

Simple—Economical—Practical

Butler Outfits cook better, quicker and with less trouble than old-fashioned methods. They will pay for themselves in one season and will last for years. Best and most practical outfit on the market. Don't delay. Write nearest factory today for free literature.

AGENTS and DEALERS MAKE MONEY SELLING THESE GREAT OUTFITS

Every housewife is a prospect.

BUTLER MFG. CO.
604 Butler Bldg., KANSAS CITY, MO.
899 6th Ave. S.E., MINNEAPOLIS, MINN.

Steel Tanks, Grain Bins,
Truck Bodies, etc.

ELIMINATE WASTE

\$2.85 and up

Never Mind How STRONG You are— What d'ye Know?



Today it's a battle of wits—and *brains* win. Muscle and brawn don't count so much as they used to.

The great question now is "What do you Know?" It draws the line between failure and success.

What do *you* know? Have you special ability in any one line? Could *you* "make good" in a big job right now?

For 25 years the International Correspondence Schools have been helping men to get ready for better work and bigger salaries. They can do the same for YOU. No matter where you live, what hours you work, or how little your education—the I. C. S. can train you for a more important and better-paying position.

Mark and mail the attached coupon—it won't obligate you in the least—it won't cost you anything to find out how you can get this salary-raising ability right in your own home, during your spare time.

MARK THE COUPON NOW

TEAR OUT HERE

INTERNATIONAL CORRESPONDENCE SCHOOLS

Box 5597, SCRANTON, PA.

Explain, without obligating me, how I can qualify for the position, or in the subject, before which I mark X.

- | | |
|---|--|
| <input type="checkbox"/> ELECTRICAL ENGINEER | <input type="checkbox"/> SALESMANSHIP |
| <input type="checkbox"/> Electric Lighting | <input type="checkbox"/> ADVERTISING MAN |
| <input type="checkbox"/> Electric Car Running | <input type="checkbox"/> Window Trimmer |
| <input type="checkbox"/> Electric Wiring | <input type="checkbox"/> Show Card Writer |
| <input type="checkbox"/> Telegraph Expert | <input type="checkbox"/> Outdoor Sign Painter |
| <input type="checkbox"/> Practical Telephony | <input type="checkbox"/> RAILROADER |
| <input type="checkbox"/> MECHANICAL ENGINEER | <input type="checkbox"/> ILLUSTRATOR |
| <input type="checkbox"/> Mechanical Draftsman | <input type="checkbox"/> DESIGNER |
| <input type="checkbox"/> Machine Shop Practice | <input type="checkbox"/> BOOKKEEPER |
| <input type="checkbox"/> Gas Engineer | <input type="checkbox"/> Stenographer and Typist |
| <input type="checkbox"/> CIVIL ENGINEER | <input type="checkbox"/> Cert. Public Accountant |
| <input type="checkbox"/> Surveying and Mapping | <input type="checkbox"/> Railway Accountant |
| <input type="checkbox"/> NINE FOREMAN OR ENGINEER | <input type="checkbox"/> Commercial Law |
| <input type="checkbox"/> Metallurgist or Prospector | <input type="checkbox"/> GOOD ENGLISH |
| <input type="checkbox"/> STATIONARY ENGINEER | <input type="checkbox"/> Teacher |
| <input type="checkbox"/> Marine Engineer | <input type="checkbox"/> Common School Subjects |
| <input type="checkbox"/> ARCHITECT | <input type="checkbox"/> CIVIL SERVICE |
| <input type="checkbox"/> Contractor and Builder | <input type="checkbox"/> Railway Mail Clerk |
| <input type="checkbox"/> Architectural Draftsman | <input type="checkbox"/> AGRICULTURE |
| <input type="checkbox"/> Concrete Builder | <input type="checkbox"/> Textile Overseer or Supt. |
| <input type="checkbox"/> Structural Engineer | <input type="checkbox"/> Navigator |
| <input type="checkbox"/> PLUMBING AND HEATING | <input type="checkbox"/> Poultry Raising |
| <input type="checkbox"/> Sheet Metal Worker | <input type="checkbox"/> AUTOMOBILES |
| <input type="checkbox"/> CHEMICAL ENGINEER | <input type="checkbox"/> Auto Repairing |
| | <input type="checkbox"/> Spanish |
| | <input type="checkbox"/> German |
| | <input type="checkbox"/> French |
| | <input type="checkbox"/> Italian |

Name _____

Occupation & Employer _____

Street and No. _____

City _____ State _____

If name of Course you want is not in this list, write it below.

Please Mention Popular Mechanics

**MUSCLES
and VEINS are
NOT
RESTRICTED
by the**



E.Z. GARTER

"The One That Won't Bind"

MADE WIDE for comfort and free circulation. Wide elastic webbing — cool, washable. No straps, buckles, hooks, or adjustments. Can't sag or unfasten.

25c for lisle, 50c for silk. If not at dealer's, send his name and price. THE THOS. P. TAYLOR CO., Dept. P, Bridgeport, Conn.

Dealers: Ask your jobber or order sample dozens from us without obligation.

Acetylene Blow Torch

Prest-O-Torch

Quicker and cheaper than a gasoline blow-torch for brazing and soldering

For factories, repair shops, linemen, dentists, jewelers, the Prest-O-Torch saves time and money. Used with Prest-O-Lite Tanks—ready-made gas. Intense, concentrated flame instantly lighted. No depreciation, safe and convenient. Style "A", price, 75c (Canada, 85c) will braze up to 3/8 inch round rod. Style "C" for heavier work, \$2.25 (Canada, \$2.75). Special styles for dentists. Write for literature or send order now. Money refunded if not satisfied.

The Prest-O-Lite Co., Inc. 835 Speedway Indianapolis, Ind.
Canadian General Office, Dept. A4, Toronto, Ont.

3 YEARS TO PAY

Meister Piano 30 days' free trial in your own home

\$1 A WEEK or \$5 A MONTH Price \$210.00

No cash payment down. No interest — no extras. Piano stool and scarf free.

ROTHSCHILD & COMPANY
Dept. F16 CHICAGO, ILL.

DIAMONDS AT LESS THAN CASH RETAIL PRICE WEAR AS YOU PAY WATCHES

50 cents Down and 50 cents a Week. No Interest Charged

Guaranteed perfect cut and brilliant color. Latest 14K Gold Mounting For Ladies or Gentlemen. PRICE \$25.00

Sent on First Payment Anywhere in U. S. A. Why Pay Cash? We can Save You Money. Send for Catalog.

LENOX JEWELRY Co. 373 Washington Street Boston, Mass.
20 Years of Honest Dealing

Waltham, Elgin, Hamilton, Illinois and Rockford. A d. - Justed in 20-year Gold Case. PRICE \$10.75 to \$28.50

Super-Sensitive Microphone ^{Only} \$7.50



This instrument is offered at an extremely low price. It is excellent for building your own amplifier. Can also be used in many experiments where a sensitive microphone is required.

Detectograph, \$15

This detecting instrument of marvelous sensitivity can be used for detecting secret conversations. Outfit consists of Sensitive Transmitter, 25-ft. Black Cord, Receiver, Headband, Case and Battery.

Send for One Today and Compare Yourself



Detectograph, \$15

THE \$15 MICROPHO DEAF-PHONE



is a super-sensitive instrument which has been developed to meet the demands for a practical and efficient hearing device at an extremely low price. It is equal to any \$35 instrument made and superior to most of them. The outfit consists of One Super-Sensitive Transmitter with cord connector; One Super-Sensitive Ear Piece with small black cord; One Black Single Headband; Black Case and Two Batteries. Write today for free booklet.

MICROPHO-DETECTOR COMPANY

Gaston Boissonault, President

25 DEY STREET

NEW YORK

Makers of Super-Sensitive Microphone Apparatus

ARE you reading the double-page Westinghouse more-than-advertisements in The Saturday Evening Post, Literary Digest, Collier's, Leslie's, National Geographic, Popular Mechanics and other publications?



Made-to-Measure Express Prepaid \$3.25

Pants cut in the latest style. Made-to-your individual measure. Fit, workmanship and wear guaranteed.

NO EXTRA CHARGE

for peg tops, no matter how extreme you order them.

Agents A good live hustler in every town to take orders for our **Wanted** celebrated made-to-measure clothes. Samples of all latest materials **Free**.

WE PAY BIG MONEY

to our agents everywhere. Turn your spare time into cash by taking orders for our stylish clothes. Write today for beautiful **FREE** outfit. THE PROGRESS TAILORING CO., Dept. 775, CHICAGO, ILL.



Bell Telephone highways make you the near neighbor of your farthest-away fellow-citizen.

AMERICAN TELEPHONE & TELEGRAPH Co.
AND ASSOCIATED COMPANIES

One Policy One System Universal Service

5¢ A DAY BUYS A GIBSON

Terms as low as \$1.00 down and \$1.50 per month. Mandolin or Guitar sent on approval. Get our new FREE BOOK—100 pages, 30 illustrations. Valuable information for player and teacher. Explains wonderful new violin construction with carved and graduated Top and Back and Stradivarius Arching. Also FREE treatise on "How to practice".

TEACH AND SELL THE GIBSON—BIG MONEY

Become a teacher. Splendid opportunities for Mandolin and Guitar teachers—either sex, in every locality, private and class instruction, and sale of Gibsons. The Gibson has "made" many a teacher professionally and financially. C. A. Templeton, Sioux City, Iowa, writes, "If it were not for the Gibson I would not be in the teaching business". Wm. Price, Jr., Providence, R. I., Star Solist for Victor, uses and endorses the Gibson.

Write Today. If a teacher, become our agent. Instruments furnished. We help sell. Agents' territory protected. You make the profits. We pay the advertising. You pay for goods when sold; return goods not sold. Try our "Still Hunt". Catalog and Thematic List Free.

GIBSON MANDOLIN GUITAR COMPANY
169 Harrison Court. Kalamazoo, Mich.

OPEN—Permissions teaching and business opportunity. Either sex. Write now. Other positions pending.

RABBITS



Tells all you want to know about Rabbits. Our book: "The Rabbit: How to Select, Breed, and Manage the Rabbit and Belgian Hare for Pleasure or Profit," by breeders of long experience with rabbits. Sixth edition, nicely illustrated, enlarged and much improved. Price 25 cents with sample copy of the *American Poultry Advocate* containing Belgian Hare Department.

POULTRY ADVOCATE, Dept. 257, Syracuse, N. Y.

RAISE GUINEA PIGS

for us. We need thousands and will buy all you raise. Big money-making opportunity. Pay better than poultry or squabs—easier to raise—cost less to house, feed, keep. Particulars, contract, booklet how to raise, FREE!

CAVIES DISTRIBUTING CO., 3102 Grand Ave., Kansas City, Mo.

Kohlhase Sold 30 in 3 Hours

Latest invention in self-heating flat-irons. Two point base or ironing surface. Irons either way. Housewives buying thousands of them. Extra generous agents' commissions given. Send for startling facts about

Acorn 2-Point Gasoline Iron

One agent in town of 1500 made \$62.50 one day. Another made \$37.25. Hundreds others making big money. Get in touch with us immediately. Open territories growing scarce.

Acorn Brass Mfg. Co., Dept. 15 Chicago, Ill.



BIG CHANCE FOR AGENTS



You can earn BIG MONEY

selling the most complete line of guaranteed transparent handle Knives and Razors with Photo, Name and Lodge Emblem—also full line of cutlery. Write today for catalogue and terms.

Golden Rule Cutlery Co., 212 N. Sheldon St., Dept. 360, Chicago, Ill.

NO MORE BALD HEADS



WHEN our VACUUM CAP is used a few minutes daily. We accept no pay until you have tried the Cap 60 days and are satisfied. The Vacuum Cap is an appliance that draws the blood to the Hair Roots and starts a new healthy crop of hair. It stops Dandruff, stops the hair from falling out.

Bought by Doctors and men who know that it is the only reasonable HAIR GROWER known to science. No Drugs Used. Write for application blank, testimonials, and booklet on "HAIR," sent sealed in plain envelope, FREE.

THE MODERN VACUUM CAP CO.

S. 559 BARCLAY, DENVER, COLO.

The Burlington



FREE BOOK

21
Jewels

\$250
a Month

Adjusted to
the second—
temperature—
isochronism—
positions.

Rock-Bottom
Prices Direct
on Quality.

Mail

Coupon

Burlington Watch Co., Dept. C119
19th St. & Marshall Blvd., Chicago

Please send me, without obligation, your free book of newest watch designs; also full explanation of your rock-bottom, direct shipment offer (cash or \$2.50 a month).

Name

Address

Please Mention Popular Mechanics

Roofing Book FREE



Get Our Freight Paid Roofing Prices

Don't buy Roofing of any kind until you get our big Free Roofing Book, describing full line of Edwards Famous "Tightcote" Galvanized Roofings, Sidings and Ceilings, and our lowest freight-paid prices. Then see for yourself how much we save you by selling direct and saving you all in-between dealers' profits.

EDWARDS "REO" Metal Shingles

Absolutely rust proof. By our patented "Tightcote" process, edges as well as sides of metal sheets are heavily coated with zinc—not a space the size of a pin point exposed to weather. Fire and lightning proof. Outlasts three ordinary roofs. Forever wind and weather proof. Need no repairs—end all roofing expense. Patent WATERLOCKING DEVICE makes water tight seams—all nail heads covered—no chance for rust or leaks.



EDWARDS Galvanizing Test

Edwards "Tightcote" Galvanized Roofing can be bent, twisted or struck by lightning, and the galvanizing will not crack or flake. Bend it or hammer it—you can't loosen or scale the galvanizing. No other galvanized roofing can withstand this test.

Garage \$69.00. 50 styles, all

styles of Portable Fireproof, Metal Garages, \$69.00 and up. Lowest prices ever made. Postal brings Big Garage Catalog free.

Write Today for free samples and proof that we can save you a lot of money on any kind of roofing siding or ceiling you may need. Ask for Roofing Book No. 569.

THE EDWARDS MFG. CO.,
800-850 Pike St., Cincinnati, O.

FREE
Samples &
Roofing Book

Now \$2.50

Only \$2.50 down brings brand new Rex (10 years' guarantee) built because world's greatest merchandise house wanted a better machine. Sent on trial. Typewriter prices smashed! Write today for big free book and startling offer.

REX TYPEWRITER COMPANY, Dept. C919, Steger Bldg., CHICAGO, ILL.



How to Cut Coal Bills $\frac{1}{2}$ to $\frac{2}{3}$

Free Book "From Overfed to UNDERFEED" tells how—guaranteed. Tells how to burn cheaper grades of coal cleanly and effectively. No clinkers. No partly burned coal. Ashes few, clean and white. No sifting. A boy can tend the Williamson UNDERFEED Furnace or Boiler with expert results. Coal fed from below. Hot, clean fire always on top. Write for free book today. NOW.

THE WILLIAMSON HEATER COMPANY
65 Fifth Avenue Cincinnati, Ohio

SAVE 25% to 60%

On GRAFLEX—KODAKS—ANSCO, REXO AND PREMO CAMERAS

10-DAY FREE TRIAL GUARANTEE
If unsatisfactory, money will be refunded in full. Complete Line of Motion Picture Cameras.

Write at Once for Our Free BARGAIN BOOK and CATALOG listing hundreds of slightly used and new cameras, also supplies of every description. No matter what camera you want, we can save you money. Compare our prices with others on slightly used and new cameras and we know you will be another one of our satisfied customers. Our prompt and fair dealing will please you. Established in the Photographic Business over 16 years. (5)

Central Camera Co., 124 S. Wabash Ave.
Dept. 130-Y, CHICAGO, ILL.



Lift Corns out with Fingers



A few drops of Freezone applied directly upon a tender, aching corn stops the soreness at once and soon the entire corn or callus loosens and can be lifted off with the fingers without even a twinge of pain.

Freezone

Removes hard corns, soft corns, also corns between the toes and hardened calluses. Does not irritate or inflame the surrounding skin or tissue. You feel no pain when applying it or afterward.

Women! Keep a small bottle of Freezone on your dresser and never let a corn ache twice.

Small bottles can be had at any drug store in the U.S. or Canada

THE EDWARD WESLEY CO. CINCINNATI, OHIO



AETNA-IZE Protect yourself and your family in case of sickness or accident. \$50 a week, and as high as \$15,000 for death. Write for particulars.

Drawer 1341 DEPT. PM. 8-17 Hartford, Conn.

SAVE American Metal Shoes SHOE BILLS save from \$10 to \$30 shoe bills every year. Outwear many all-leather pairs. FREE SHOE BOOK tells all. Write Am. Metal Shoe Co., 10-12th St., Racine, Wis.

Erickson Artificial Limb Co., 38 Wash. Av. N., Minneapolis, Minn.



We are Under Govt. Bond



Deafness Is Misery

I know because I was Deaf and had Head Noises for over 30 years. My invisible Anti-septic Ear Drums restored my hearing and stopped Head Noises, and will do it for you. They are Tiny Megaphones. Cannot be seen when worn. Easy to put in, easy to take out. Are "Unseen Comforts." Inexpensive. Write for Booklet and my sworn statement of how I recovered my hearing.

A. O. Leonard, Suite 226, 150 5th Ave., N. Y. City

Write today for our 168-page FREE Book on

Deafness

and learn how Perfect Hearing is now being restored in every condition of deafness or defective hearing. Our "Little Wireless Phones for the Ears" require no medicine, but effectively replace what is lacking or defective in the natural ear drums. They are simple devices, which the wearer easily fits into the ears where they are invisible. Soft, safe and comfortable.

WILSON EAR DRUM CO., Incorporated
940 Inter-Southern Bldg. LOUISVILLE, KY.

Please Mention Popular Mechanics

Wanted—Ideas

Inventors! Send for these Remarkable FREE BOOKS, Today



"Inventions Needed"

This book lays before you a description of the active and profitable field of invention. It tells you the inventions the world needs today, the devices manufacturers are seeking for their business, the ideas for which the public will pay big money.

"How to Get Your Patent"

This book is a guide to the inventor. If you have invented something and desire to learn what it will cost you to get your patent and what you must do to find your market, read this book.

"Special Bulletin of Patent Buyers"

This bulletin contains letters from men who are seeking to purchase patents. We act as intermediary without one cent of charge, between the man who invents and the man who invests.

Send Model or Sketch and description of your invention for Free Opinion as to patentability

*Rejected and Difficult
Cases are Our
Specialty*

RANDOLPH & CO.

600 F St., N.W., Washington, D.C.

RANDOLPH & CO.
600 F St., N. W., Washington, D. C.

Gentlemen: Please send me without obligation on my part, the books indicated on margin of this coupon. (Write on margin of coupon, names of books desired.)

NAME

STREET

CITY.....STATE.....



Inventions Wanted!

Manufacturers constantly writing us for patents. List of inventions actually requested and book "How to Obtain a Patent" sent free. Send rough sketch for free report regarding patentability. Special assistance given our clients in selling patents. Write for details of interest to every inventor.

CHANDLEE & CHANDLEE, Patent Attorneys
Est. 21 Years 1011 F Street, WASHINGTON, D. C.



GEARS ALL KINDS SMALL

The most accurate made and prices reasonable. We carry a complete line of gears in stock for immediate shipment. Can also quote on special gears of all kinds. Send us your inquiries. WRITE FOR CATALOGUE.

CHICAGO STOCK GEAR WORKS
16 S. Fifth Av. CHICAGO

PATENTS SECURED OR ALL FEES RETURNED

Wonderful 190-page GUIDE BOOK FREE! Greatest book published in 20 years, containing many helpful chapters: "Patents Sold Free—Our Patent Sales Department;" Our "All Fees Returned" System; "Preparedness;" INVENT something for the Army or Navy; "U. S. Government Buys Inventions," etc.

Mail postal today for this 190-page book — FREE! Mr. Inventor, don't miss this book.

Send Data at Once for Actual Free Search and Report

FOREIGN PATENTS GUARANTEED
BEST REFERENCES. PROOF GIVEN!

E. E. VROOMAN & CO., 871 F St., WASHINGTON, D. C.
(Old-Established Firm, and Practitioners Before Supreme Court.)

PATENTS SECURED OR FEE RETURNED

Compare My SERVICE and TERMS with Those of Any First Class Attorney

Send Sketch, Photograph, or Model of your invention for an ACTUAL SEARCH of the Records of the Patent Office and report as to patentability — FREE. I give every detail of every case my closest personal attention and do not entrust your interests to assistants. Impartial advice on your ideas. I help you sell your patent. Terms moderate. My 90-page book (1917 edition) tells what inventors should know before they apply for a patent.

GEORGE P. KIMMEL, Patent Lawyer
200 Barrister Bldg. Washington, D. C.

Latest and Most Complete Patent Book Ever Published for Free Distribution

WRITE FOR IT

PATENTS TRADE-MARKS AND COPYRIGHTS

LARGEST PATENT FIRM
IN THE WORLD

SPECIAL OFFER

Free Opinion as to Patentability

Before sending your invention to any attorney or manufacturer or disclosing your invention, write for our free blank form **PROOF OF CONCEPTION** in order to protect your invention and secure your rights. This should be signed and witnessed and returned to us, together with a model or sketch and description of your invention, and we will give a **FREE OPINION** as to the patentability of the invention. If we report the invention patentable we will furnish a Certificate of Patentability.

VICTOR J. EVANS

This Certificate of Patentability, together with our blank form Proof of Conception will protect the inventor and serve as proof of the invention until the case can be filed in the U. S. Patent Office.

Obtaining Assistance for Inventors—Our certificate is of great assistance to inventors who require financial aid to obtain patents.

OUR FIVE BOOKS MAILED FREE

(See Coupon Below)

to any address. Send for these books—the finest publications ever issued for free distribution.

How to Obtain a Patent

Our illustrated eighty-page Guide Book is a book of reference for inventors and contains 100 mechanical movements, illustrated and described. Tells how to invent for profit.

What to Invent

Contains a valuable list of inventions wanted and suggestions concerning profitable fields of inventions; also information regarding prizes offered for inventions amounting to

One Million Dollars

Millions in Trade-Marks

Shows the value of Trade-Marks and information regarding unfair competition.

We Advertise Our Clients' Inventions Free in a list of Sunday newspapers, in manufacturers' journals and in *World's Progress*. Sample Copy Free. We save you time and money in securing patents. After the patent is granted we assist you to **sell your patent**.

WANTED NEW IDEAS

Prepare Now to meet the Demands of Industry in All Fields for New Ideas and New Inventions. We are constantly receiving requests from manufacturers who consult us when purchasing patents for inventions in all lines. We invite manufacturers and promoters to address our Sales Department regarding the purchase or leasing of a number of meritorious patents secured by us.

List of Patent Buyers

Contains requests from manufacturers, mail order houses and promoters for patents secured by us and suggestions as to **New Ideas** they wish to purchase. We place our clients in touch with capital free of charge. We have recently received over 300 requests from manufacturers.

Foreign Patents

We have direct agencies in all the principal foreign countries and secure foreign patents in the shortest possible time and at the lowest cost. Write for our illustrated Guide Book on Foreign Patents, sent free to any address.

VICTOR BUILDING



FREE COUPON!

VICTOR J. EVANS & CO.

New York Offices:
1007 Woolworth Bldg.

PATENT ATTORNEYS

Pittsburg Offices: 514 Empire Bldg.

Philadelphia Offices:

1429 Chestnut St.

Main Offices: 765 Ninth St., N. W., WASHINGTON, D. C.

Name..... Address.....

Please Mention Popular Mechanics

WANTED IDEAS

Inquiries from Manufacturers and Other Buyers of Patents
Who Are Looking for Good Ideas

Protected by Owen Patents

Are constantly being received. Hundreds of ideas are wanted—a market exists for them to-day. **YOURS** may be one of them. Send for my free books and see for yourself—read the requests for inventions protected by me. Many are simple. You can help supply this demand.

As soon as my clients' rights are protected I aid in every practicable way, **without charge**, to sell. Their applications are advertised free—their patents are called to the attention of the proper prospective buyers—every necessary thing is done. Get my booklets and see.

THESE ARE FREE

You will incur no obligation by writing me. A simple request will bring them to you—the finest, most reliable and instructive patent books published. A postal will do.

"Successful Patents"—a 72 page guide book, tells how to proceed; describes my advantageous business methods; gives references, testimonials, etc.

"Stepping Stones"—gives hundreds of hints of inventions wanted; articles from interviews of noted authorities; tells the truth about prizes for inventions.

"Patent Promotion"—tells you how to sell; why some inventors fail; discusses the value of your idea; how I aid my clients; manufacturing aids furnished you; recent successful patents, etc.

"Patent Buyers"—Publishes letters, and abstracts of letters, from over 400 of the many manufacturers, and other patent buyers, who wish to buy, or obtain on royalty, **Owen Patents** on innumerable inventions of interest to them.

You will also be sent from time to time, as new inventions are wanted, full information concerning them. Only in this way can you keep up to date.

WRITE FOR THESE TO-DAY—Advice costs nothing. All communications confidential. Your work will receive my personal supervision—but my fees are no higher than others.

Results Speak Loudest—But Here Are Some References

Columbia National Bank, Washington, D.C.	Antholene Mfg. Co., Hutchinson, Kan.
National Lockfile Co., Washington, D.C.	National Rack Co., 61 Hanover St., Boston, Mass.
The Carnahan Press, Washington, D.C.	The C. J. Loftus Co., 13 Spring Common, Youngstown, Ohio.
Lightning Gun & Cycle Works, Oklahoma City, Okla.	Whitehead Hosiery Mills, Burlington, N. C.
	Dickinson Mfg. Co., Des Moines, Iowa.

A LARGE NUMBER OF OTHERS IN MY BOOKLETS.

RICHARD B. OWEN 9-303 OWEN BLDG.
WASHINGTON, D. C.
NEW YORK OFFICE: 22nd Floor Woolworth Building

Inventors submitting their inventions to me are protected in a tangible manner until their applications are filed.

Nuts for You to Crack

Invent something for which a demand exists—for which there is a waiting market. Here are abstracts from a few recent requests—**hundreds** are published in full in my literature. Can you invent any of these? Watch this list each month.

A large middle Western manufacturer states "we are interested in any novelty that has merit and can be manufactured at an attractive profit. We would prefer something selling to the shoe trade; however, will consider any good novelty. We would rather favor the royalty proposition."

An unusual request has just come in, an investor desiring to purchase a patent covering different kinds of Guitar Zithers "such as base and treble attachments."

Can you make even a slight improvement in your suspenders? If so I can refer you to a manufacturer who has just inquired for anything new in this line.

Another unusual request has just come from a man who desires patents "in the line of playthings or dolls made of a new kind of papier-mache composition to be pressed in moulds or cast in same."

SPECIAL FREE REPORT

Send sketch or model of your invention for free report on patentability, practicability, etc.

PATENTS THAT PROTECT and PAY

Send for FREE BOOKS.

Advice free. Terms reasonable. Highest references. Best results.

Send sketch or model for FREE examination and opinion.

BONDED and recommended Patent Lawyer in the Rand-McNally Directory of Bankers and Attorneys, Published by Rand-McNally & Co., Chicago, Ill. Recommended Patent Attorney in the Bankers Register and special list of selected lawyers published by the Credit Company, Pontiac Building, Chicago, Sharp & Alleman's Directory of Lawyers and Bankers, published at Philadelphia, and Martindale's American Legal Directory of New York City.

ALL BUSINESS GIVEN PROMPT AND PROPER ATTENTION

A large list of strong recommendations furnished free

WATSON E. COLEMAN, Patent Lawyer, 624 F St., Washington, D. C.

HIGH-VALUE PATENTS

—the ONLY kind Wanted and BOUGHT by Manufacturers.
Send 10c. postage for new book of Extraordinary Invention to Inventors.
R. S. & A. B. LACEY, 51 Barrister Building, Washington, D. C.

Send for FREE BOOK { WHAT TO INVENT
WHAT NOT TO INVENT
HOW TO SELL YOUR PATENT

Nearest Patents and report in each case to be filed—no charge
H. L. WOODWARD, 9th and G Sts., WASHINGTON, D. C.

R. MORGAN ELLIOTT & Co.
PATENT ATTORNEYS

MECHANICAL, ELECTRICAL & CHEMICAL EXPERTS

713-721 WOODWARD BUILDING
WASHINGTON, D. C.



PATENTS

Send Sketch or Model of Your Invention for
Free Opinion as to Patentability

Our Certificate of Patentability is Evidence of Conception of your invention and may prove valuable to you. Our Credit System enables you to file your application for Patent and proceed without delay. Every case receives personal attention of one or both members of the firm. Patents we secure advertised at our expense in Popular Mechanics Magazine.

Write today for Free copy of 104-page book,
"How to Obtain a Patent and What to Invent"

Talbert & Parker, Patent Lawyers
4683 Talbert Bldg. WASHINGTON, D. C.



EVERY INVENTOR



should have this book, "Patents and Patent Possibilities." It is chock-full of ideas and practical advice, telling what to invent and where to sell. Write for your copy today. It is FREE. I have requests for patents upon sound inventions of all kinds. Can you help supply the demand? My service is individual, prompt and efficient. (14 years' experience.) Every expedient is employed to secure patents at least possible cost.

H. S. HILL, 802 McLachlen Bldg., WASHINGTON, D. C.

PATENTS PROMPTLY SECURED

I assist you to market your invention. Send sketch or model for my honest advice. Prompt personal service. BOOKLET FREE.

J. R. KELLY 743 Woodward Bldg.
WASHINGTON, D. C.

Reliable, prompt service by a Competent Attorney. Inquiries invited.

Norman T. Whitaker

Attorney-at-Law and Mechanical Engineer
Former Examining Official of the U. S. Patent Office
27 Legal Building - - Washington, D. C.

PATENTS C. L. PARKER

Formerly Member Examining Corps, U. S. Patent Office
PATENT LAWYER
MCGILL BLDG.
WASHINGTON, D. C.

Patents, Trade Marks, Copyrights, Patent Litigation

Handbook for Inventors, "Protecting, Exploiting and Selling Inventions," sent free upon request.

Protective Patents

Procured Promptly. No fee refund, no guarantee certificate, no so-called prize or free search schemes used in our business. Investors 104 page Blue Book sent on request.

Robb & Robb, 211-215A Southern Bldg., Washington, D. C.

Patents on Easy Payments

Send model or sketch for Free Search and opinion as to patentability. Write today for our free book of Inventions Wanted and How to Obtain Patent on Easy Fee Payments. We furnish our clients with list of patent buyers and assist inventors to sell patents.

C. C. HINES & CO., 591A Loan & Trust Bldg., Wash., D. C.

PATENTS AND TRADE MARKS

LANCASTER & ALLWINE



204 OURAY BLDG., WASHINGTON, D. C.

BOOK "Inventions—Patenting & Promoting" FREE

Our co-operation with an inventor is, FIRST, to help him establish his rights before he discloses the idea to ANY attorney; SECOND, to give a frank opinion whether it will pay to patent his idea, based upon our extensive knowledge of manufacturers' wants and facilities; THIRD, to obtain for him a patent which is in reality a valuable monopoly; FOURTH, to advise and assist him in the profiting by outright sale, territorial grants, obtaining royalty, or independent manufacturing of the invention; and FIFTH, aiding him to so profit by conferring with manufacturers, investors or distributors of machinery. Before sending a sketch to anyone, sign, witness and deposit in our fireproof vault our document,

EVIDENCE OF CONCEPTION

AND ESTABLISH YOUR RIGHTS

Models and Gears

Experimenters—Inventors

Developing inventions and making working models our specialty. Well equipped shop and staff of experts at your service. Carry complete stock of gears. Shipments same day order received. ESTABLISHED 1882.

UNION MODEL WORKS, 121 S. Clark St., CHICAGO

HAVE YOU A REALLY GOOD IDEA

Or INVENTION or ARTICLE that you feel would be valuable if properly developed? We are in the position to handle this right. Small, conveniently handled article preferred—Bank references. **PETTINGILL & CO., Box 2685, BOSTON, MASS.**



MECHANICAL SUPPLIES AND MATERIAL of all kinds. EXPERIMENTAL AND LIGHT MACHINE WORK to order. **132 MILK STREET, BOSTON**

Steger & Sons Pianos, Player Pianos and Talking Machines

Embody artistic and musical excellence. Catalog sent free on request.

STEGER & SONS PIANO MANUFACTURING COMPANY

Established 1879 Dept. 24 Steger Building N. W. Cor. Wabash Ave. and Jackson Blvd., Chicago, Illinois

Dealers Wanted

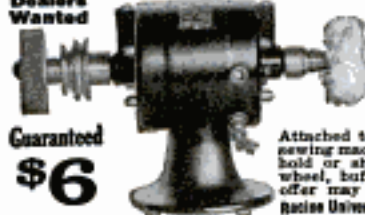

Grind Your Own Tools — Sharpen Your Own Cutlery — Polish Your Own Silver — and save money with a **UNIVERSAL MOTOR**

Guaranteed \$6

Attached to any socket will run electric fan, sewing machine and perform many other household or shop duties. Complete with switch, wheel, buffer, cord and plug for \$4.00. This offer may never be repeated. Write today. **Radius Universal Motor Co., 53 W. Jackson Blvd., Chicago**

Makers of Fans, Vacuum Cleaners, Motor Appliances of All Kinds

Delivered TO YOU FREE

Your choice of 44 styles, colors and sizes in the famous line of "RANGER" bicycles, shown in full color in the big new Free Catalog. We pay all the freight charges from Chicago to your town.

30 Days Free Trial allowed on the bicycle you select, actual riding test in your own town for a full month. Do not buy until you get our great new trial offer and low Factory-Direct-To-Rider terms and prices.

TIRES, LAMPS, HORNS, pedals, single wheels and repair parts for all makes of bicycles at half usual prices. No one else can offer you such values and such terms.

SEND NO MONEY but write today for the big new Catalog. It's free.

MEAD CYCLE COMPANY Dept. F108 Chicago

INDOOR CHEMICAL CLOSET

No smell, no germs, sanitary. Use in any room. Needs no plumbing, sewerage or running water. Chemicals in closet kill germs. Fine for the sick and old folks.

DESTROY OUTDOOR CLOSET

Put in a warm, Indoor Sanitary Closet. Empty twice monthly, only attention necessary. Satisfied users and Boards of Health endorse it. Fully Guaranteed. **30 Days Free Trial.** Write for FREE Literature. Agents wanted. **SANITARY CLOSET CO., 28 Colton Bldg., Toledo, O.**



ANY WATCH YOU WANT on CREDIT



1917 Models

WALTHAM HAMILTON ELGIN, MILLER Illinois, Howard

Sent on **30 Days Free Trial**

No Money Down

Express Prepaid in Advance by Me

You take no chances with me. I am "Square Deal" Miller and I trust the people. That is why I am doing the greatest Credit Watch, Diamond and Jewelry business in the country. Suppose you want any one of the country's best makes of watches? Name any one, I have it for you. No money Down, Express Prepaid. A full month to carry it in your pocket and the easiest of Long Time Payments. That's the test that tells. All these watches **GUARANTEED 25 YEARS**

I Smash the Terms

No References Demanded

My terms are made to suit you. You get unlimited credit, with no red tape, notes or collectors. All unnecessary detail left out.

An "Open Charge" Account

the same kind of credit you get from your grocer. No matter where you live or what your income is, you can now own the finest watch, a beautiful diamond or any rare jewelry and never miss the money.

Costly Catalog FREE

Send me your name and address so I can mail you, Free and postpaid, the most beautiful catalog of its kind ever printed. I want you to have this book. It's a gem. It illustrates all makes of valuable Watches, Elegant Genuine Diamonds, and a vast assortment of Beautiful Jewelry, all on the easiest and most liberal terms

Square Deal MILLER PRES.

890 Miller Bldg., Detroit, Mich.



BE THRIFTY BUY A DIAMOND PAY MONTHLY

MONEY REFUNDED IF YOU CAN BUY CHEAPER FOR CASH.



Fine Diamonds

SQUARE DEAL MILLER PRES.

Fine Diamonds

Our diamonds are all perfect cut beautiful stones, white in color and lots of fire.

You cannot buy by mail better diamonds at any price than we are selling on credit.

FREE CATALOG COUPON

SQUARE DEAL MILLER, Pres. 890 Miller Bldg., Detroit, Mich.

Please send me your 1917 Catalog and explain fully your 30 Day Trial Plan and Easy Terms

Name.....

Address.....



The Perfect Garage Door Hanger Quickly Installed—Easily Operated

Garage doors are a mean proposition if they don't work right—cause all sorts of trouble and often damage car going in or out.

The Topping garage Set *does* end your troubles

Moderate in cost—easy to install—no small parts to get out of order—built to stand wear and tear—yet a child can operate.

The result of years of concentrated effort to solve Garage Door Hanger trouble.

Ask your hardware dealer—or write us direct for unusually low price. Do this today—you'll be amazed at Topping performance.

Dealers—No Hanger so satisfactory as the Topping. There's a big demand and a big profit in it. Architects—The one important detail in your plans that satisfy if you specify "Topping Hanger." Write for terms.

Safety Door Hanger Co., 108 Topping Bldg., Ashland, Ohio

Modern Work-Bench for Garage or Work-Shop



6 ft. long, 20 in. wide, 3 ft. high. Small bins 6 in. wide, 18 in. long. Drawer 16x16 in., 6 in. deep. Shelves 12 in. wide full length. Tool rack furnished complete with spring clips for tools. Strongly built. Painted two coats. Your

tools always before you. Convenient, serviceable, economical. You cannot buy the lumber, bolts, screws, steel clips, and build this bench for the price. Our making them in large quantities enables us to offer you this bench at this very low figure of \$9.75; Visa, \$1.75 extra. Price 4-foot bench, \$8.25. We manufacture work benches for any kind of work. Write us for information regarding them. Garage Equipment Co., 2831-33 Cottage Grove Ave., Chicago, Ill.

Write for FREE Book on Vibratory Massage

Explains this new scientific way of gaining health and strength with the Arnold Vibrator. Gives the low price with special 10 day trial offer. Write today for this valuable book.

ARNOLD ELECTRIC CO., 1467 12th St., Racine, Wis.

Garnes Artificial Arm

is the best substitute ever invented for the natural arm. Full finger motion hand, turning and bending wrist and bending elbow. Endorsed by surgeons. Write today for big, illustrated catalog B25 and recommendations from many satisfied wearers of this wonderful invention.

CARNES ARTIFICIAL LIMB COMPANY

31 Carnes Bldg., 904 E. 12th St., KANSAS CITY, MO.

Towns in the Canary Islands are to be provided with a long-distance telephone service.

MEN

For \$15.00 we hand tailor to your measure and deliver express charges prepaid, a \$25.00 all wool suit or overcoat, absolutely guaranteed to fit and delight you or you don't pay us one cent. Our new Fall-Winter Style book and about 50 samples mailed free on request.

THE RUBY TAILORS, Dept. 41, CHICAGO, ILL.

1917 Indian Motorcycles

With New Power-Plus Motor and Cradle Springframe. Write for catalog.

HENDEE MFG. CO., 710 State Street, SPRINGFIELD, MASS.

Big Profits Charging Auto Storage Batteries HB Chargers are bringing users from \$40.00 to \$60.00 clear profit each month. No special skill or knowledge required. Charging cost per battery 13c. You get from 75c to \$1.50 from outlet. Charges from one to seven batteries at once. This money-maker sent complete, ready to operate, for \$15 cash, balance in ten monthly payments of \$10. Money-back satisfaction guarantee. Mail this ad with your name for full particulars. Hebert Bros, Co., Box 58, Troy, Ohio



The Electrical Experimenter



BOYS!

Here is THE electrical magazine for you. For the Dabbler and the "How-to-make-it" fiend. Chuck full of experiments and the latest electrical doings. Non-technical—in plain English. One of the foremost authorities on WIRELESS in U. S. 200 Illustrations, 90 big pages, over 100 articles.

One copy will convince you
At All News Stands, 15c
\$1.50 a year (Foreign \$2.00).
Send 25c for 3 numbers.

THE ELECTRICAL
EXPERIMENTER
234 Fulton St., New York



100 Edwin's GENUINE Havana Seconds \$ 2.40

FROM FACTORY DIRECT TO YOU BY EX. OR PARCEL POST
Made of Imported Havana Picadura, from our own plantations in Cuba—leaves that are too short to roll into our 15c cigars. They're not pretty, no bands or decorations, but you don't smoke looks. Customers call them "Diamonds in the Rough." All 4 1/2 inches long. Only 100 at this "Get Acquainted" price. Money refunded if you don't receive at least double value. When ordering specify mild, medium or strong. Your check accepted. Our references, Dun or Bradstreet's or any Bank. To each purchaser of 100 Edwin's Genuine Havana Seconds, we will extend the privilege of ordering, for 60c additional, one of Edwin's "SAMPLE CASES" containing one sample cigar each of our 12 Best Sellers—all Bargain Values—priced up to \$12.00 per 100. Include this in your order—it's the biggest sample value ever offered.

Largest Mail Order Cigar House in the World
EDWIN CIGAR CO. Dept. N. 16 Get Acquainted 2338-2342 THIRD AVE., NEW YORK
When in New York SAVE MONEY by Patronizing any of the 100 EDWIN Retail Stores

Tobacco Habit Banished in a few days

The GUSTAFSON Method will drive the poisonous nicotine out of your system. Thus you can rid yourself of all kinds of tobacco habits, cigars, cigarettes, pipe, chewing or snuff, in the scientific way without the dangers of injury encountered by suddenly stopping by will-power.

This Great Discovery is Positively Guaranteed

The GUSTAFSON method is absolutely guaranteed to be pure in all respects, contains no drugs or dope. Easy to take and a stimulant to the nerves. Brings results very quickly, easily and marvelously. The craving starts to leave after the very first dose. Your nervous system will be toned up and your general health will be greatly improved.

Why continue poisoning your system by using tobacco and seriously injure your health in many ways? Tobacco causes disorders of the entire system. Many eminent physicians attribute nervous breakdown, weakened intellects and even insanity to the tobacco poisons. Why not stop the suicidal habits and live happy and contented?

We make this positive announcement and guarantee that all craving for tobacco in its various forms is gone for keeps and for all time when you have used the course of this method according to directions or we will cheerfully refund your money. Our legally binding guarantee is enclosed in every full treatment package.

FREE

We have prepared a book giving valuable information and telling all about the Gustafson Method and will mail you a copy FREE, Postpaid. Write today for your copy and proofs of the effectiveness of the Gustafson Method, which has banished all desire or craving for tobacco in any form for thousands who suffered possibly more than you do. Just drop us a post card today, without any obligation to you.



Get Gustafson's Free Book telling what eminent Physicians have discovered about injurious tobacco poisons to humanity

GUSTAFSON MFG. CO., 1324 Hall Avenue, Cleveland, O.

"I Would Not Part with it for \$10,000"

writes an enthusiastic, grateful customer. "Worth more than a farm," says another. So testify over 100,000 Men and Women who have worn it.

The Natural Body Brace

Develops erect, graceful figure. Brings comfort, health, strength and pep.

Makes You Feel Good and Look Good

Replaces and supports misplaced internal organs; reduces enlarged abdomen; straightens shoulders; relieves backache, curvatures, nervousness, ruptures, etc., in both sexes. Fine after operations. Write today for illustrated booklet, measurement blank and our very liberal free trial proposition.

HOWARD C. RASH, President

Natural Body Brace Co., 223 Rash Building., Salina, Kans.



Rider Agents Wanted

in each town to ride and show a new 1917 model "RANGER" bicycle. Write for our liberal terms. DELIVERED FREE on approval and 30 days' trial. Send for big free catalog and particulars of most marvelous offer ever made on a bicycle. You will be astonished at our low prices and remarkable terms. FACTORY CLEARING SALE—a limited number of old models of various makes, \$7 to \$12. A few good second-hand wheels \$3 to \$8. Write if you want a bargain. Tires, lamps, wheels, sundries, parts, motorcycle supplies of all kinds at half usual prices. Write us before buying. MEAD CYCLE CO., DEPT. F108, CHICAGO



NEVERLEAK TIRE FLUID

Heals punctures automatically "on the run."

Cures porous tires—preserves new tires. No more delays, no more hard, wearisome pump, pump, pump.

**25c Tube Gives \$2.50
Extra Tire Mileage**

Saves paying big repair bills and continually buying new tires. Neverleak prevents these troubles and "doubles life of your tires."

GET A TUBE TODAY

Sold by repairmen and bicycle dealers everywhere.

BUFFALO SPECIALTY CO.

BUFFALO,

N. Y.



DIAMONDS, WATCHES ON CREDIT

YOU SHOULD HAVE THE JAMES BERGMAN 160 PAGE JEWELRY BOOK IN YOUR HOME. 4,000 Photos, Diamonds, Watches, Jewelry, Toilet Articles, etc. Anything selected sent on approval, all charges prepaid. If satisfactory, Pay 20 per cent Down—10 per cent Monthly. Write Today for our Free Catalog No. 9. It tells all about our confidential relations, binding Guarantees and Liberal Exchange Offer. 10 per cent off for cash.

James Bergman Estd. 1880 NEW YORK CITY



NEW BOOK ON ROPE SPLICING

Useful Knots, Hitches, Splices, etc.

How Different Knots Are Made and What They Are Used For
INDISPENSABLE TO EVERY MECHANIC AND RIGGER

PRICE
25c



A most practical handbook giving complete and simple direction for making all the most useful knots, hitches, rigging, splices, etc. Over 100 illustrations. All about wire rope attachments, lashing, blocks, tackles, etc. 37 Heraldic Knots illustrated. Of great value to mechanics, riggers, campers, boatmen. Price 25 cents postpaid.



LUMINOUS PAINT

Make Your Watches, Clocks, Etc., Visible by Night

The very latest discovery in the scientific world. Hitherto, practically unobtainable except at an exorbitant price, we have at last succeeded in producing this remarkable LUMINOUS PAINT, which, applied to the surface of any article, emits rays of white light, rendering it perfectly visible in the dark. THE DARKER THE NIGHT, THE MORE BRILLIANT IT SHINES. Quite simple to use. Anyone—you can do it. A little applied to the dial of your watch or clock will enable you to tell the time by night. You can coat the push buttons or switch plates of your electric lights, match boxes, and innumerable other articles, make your own Luminous Candles, Luminous Hourglasses, etc. Bottle containing sufficient to coat several small articles, Price 25c. Larger sizes 50c and \$1.00 postpaid.



INVISIBLE INK

The most confidential message can be written with this ink for the writing MAKES NO MARK. Cannot be seen unless you know the secret. Invaluable for many reasons. Keep your postals and other private memoranda away from prying eyes. Great fun for playing practical jokes. Only 15c Bottle



VANISHING INK

Writing written with this remarkable ink vanishes entirely in a few weeks sooner if desired, leaving the paper QUITE BLANK. 15c p.p.d.



LUMINOUS INK writing can be READ ONLY IN A DARK ROOM; writings shine like fire. Quite invisible like fire. Very remarkable. 15c

SILK FLAG PINS

4 for 10c



Wear the colors and show your patriotism. The flags are made in bow shape of silk ribbon, with pin for sticking into coat or dress. 4 for 10c, 12 for 25c

AMERICAN FLAG GUM STICKERS



These Flags are about same size as a postage stamp. Glued on the reverse side ready for use. Use them on your envelopes, stationery, etc., and let every one know you are an American. Put up in sheets, each containing 100 flags. Tear them apart like stamps. PRICE 10c per sheet, 3 sheets for 25c.

All the Latest Surprising and Joke Novelties

- | | | | |
|---|-----|--|-----------|
| Pharo's Serpents Eggs, box . . . | 10c | X Ray Novelty | 10c |
| Miniature Water Pistol | 10c | Trick Pencil | 10c |
| Cleopatra's Snake (very lifelike) . . . | 15c | Rubber Tacks (a good joke) | 10c |
| False Mustache (fool your friends) . . | 6c | Memorized Poetry (dodges the law of gravitation) | 20c |
| Big Roll Stage Money | 10c | Charles' Shooting Powder | 10c |
| Ford Auto Puzzle (latest) | 15c | Mysterious Tumbler and Vanishing Coin Trick | 25c |
| Magic Figs (anyone can play) | 10c | Enchanted Bottle (won't lay down) . . | 6c |
| Rubber Razor (very formidable) | 10c | Magic Plate Lifter | 20c |
| Rubber Dagger (sensational) | 20c | Isolation Gold Teeth | 3 for 10c |
| Window Smashers (great joke) | 20c | Great Rollup Puzzle | 10c |
| Pocket Detective (see behind you) . . . | 15c | Wire Puzzles, 10c. 22 different, \$1.25 | |
| Great Mind Reading Mystery Cds. . . . | 10c | | |
| Topper's Mystery Trick Cds. | 10c | | |
| Fighting Roosters, pair | 10c | | |
| Cover the Spot Trick, a seldom-seen . . | 10c | | |

JOHNSON SMITH & COMPANY, Dept. 88, 7121 North Clark Street, CHICAGO

You Are Sick and Do Not Know It!

I can prove to you that you are only half as alive as you must be to realize the joys and benefits of living in full. I can show you how, without drugs or medicines or dieting, without excessive exercise, without giving up any of the pleasures of life, you can revitalize, re-energize, re-educate every cell, tissue and organ of the body and become a Giant in health and mind. The secret of wealth, health and happiness is fully explained in Swoboda's new book, "Conscious Evolution." In it, hundreds of pupils tell what this great discovery has meant to them in increased earnings, increased ability to live the well-rounded, wholly successful life. This great book will be sent free to all who are interested in greater health and mental power. Write today—now—before you forget. ALOIS P. SWOBODA, 2052 Acollan Hall, New York City



Please Mention Popular Mechanics

Automatic Repeating Rifle

Fires
20 Shots in
One Loading



This is a regular size automatic revolver. Shoots B. B. shots obtainable anywhere, same as other rifles and guns. Repeats 20 times with one loading. Very handsomely finished.

Only
25c
Postpd

No caps or load necessary, as it works with a spring and shoots with rapidity and accuracy. Simply load with 20 B. B. shot, then press the trigger. Nothing to explode—absolutely harmless and safe. Remember, it is not a mere toy, but the same size and shape as a REGULAR AUTOMATIC. Sent complete with a round of shot for ONLY 25c postpaid.

GREATEST TOY SENSATION OF THE DAY! FIGHTING DREADNAUGHT

SENSATIONALLY REALISTIC!!!

Exact Model of a Modern Warship

The Fighting Dreadnaught is an exact model of Uncle Sam's latest fighting monster. It carries eight big guns, each of which flashes, at correct intervals, from twelve to twenty times. Extra ammunition always obtainable. Absolutely harmless. Can be operated indoors or out. Now, boys! Here's your chance to see a battleship in action, and the best of it is you can OWN the ship and command the firing yourself! By having two or more Battleships, you can arrange EXCITING NAVAL BATTLES in your own home. Price of Warship and Ammunition, 15c, three for 40c, or a fleet of 12 ships for \$1.50 postpaid. Extra Ammunition, 5 cents per pkg.



PIANO
PLAYING
MADE
EASY

New Vamping Card

NO TEACHER NEEDED—SURPRISINGLY SIMPLE SYSTEM

Persons having neglected their Musical Education need not despair, for with the aid of our new VAMPING CARD (placing the card upright over the piano keys, you can at once Vamp away to thousands of Songs, Ballads, Waltzes, Rag Time, etc., etc.) equal to a Professional Musician. No knowledge of music is required. After using it a few times, you will be able to dispense with the aid of the Vamping Card entirely. The price of this very clever invention is only 15 cts. postpaid.

WEBER Throttle-Governed VALVE-IN-HEAD KEROSENE ENGINES

WILL SAVE YOU HALF IN FUEL COST. All 1917 Weber Engines are equipped with that great engine improvement, the "Weberator." Makes kerosene as convenient to use as gasoline. Saves 50% cost. Write today for full details and 60 day trial offer. Sold direct to user at factory prices. WEBER ENGINE CO., Dept. 1775 KANSAS CITY, MO.



Learn Aviation

Learn the science of aviation at home! The U. S. will spend hundreds of millions of dollars on aviation. Right now we need not only flying men. There is even greater need for Airplane Designers; Builders; Salesmen; Assemblers; Repairmen; Inspectors; Instructors; Mechanics. This course gives you all the basic training for these positions and the groundwork for successful flying. Write Today! Get our Special Offer. Learn how you can get free a flying model and all materials to build your own model. Don't fail to write us today! National Aero Institute, Dept. C101 Morton Bldg., CHICAGO

200 Homes Wholesale

**\$300 Up—
Save \$200
To \$500!**



Gordon-Van Tine Home No. 1164—The most popular 5 room cottage in America. Craftsmen slash grain for finish. All lumber, millwork, hardware and paint at wholesale. Also blue print and specifications..... **\$979**

Ready-Cut or Not Ready-Cut

We are the only firm pricing houses both ways. But either way you prefer. All standard grades—highest quality. No extras. Wholesale prices. Cost guaranteed no matter where you live. Prompt delivery. Shipped anywhere.

Send for Big FREE Plan Book

Shows plans, photos, color-schemes, "fill-to-order" prices. Not mere estimations! Built everywhere—near you! Local references among our 100,000 customers. Send a postal for FREE book today—NOW!

Gordon-Van Tine Co.

Satisfaction Guaranteed or Money Back

6413 Case Street DAVENPORT, IOWA.
Established Half a Century 2181



30 Days Free Trial

and freight prepaid on a new 1917 "RANGER" bicycle. Write at once for our big catalog and special offers. Take your choice from 41 styles, colors and sizes in the famous "RANGER" line.

Marvelous improvements. Extraordinary values in our 1917 price offers. You cannot afford to buy without getting our latest propositions and Factory-to-Rider prices.

Boys, be a "Rider Agent" and make big money taking orders for bicycles and supplies. Get our liberal terms on a sample to introduce the new "RANGER."

TIRES equipment, sundries and everything in the bicycle line at half usual prices. Write today. A post card will do.

MEAD CYCLE COMPANY
Dept. F108 Chicago

THE "ELECTRO" TELEGRAPH

is not a toy, but a practical, honestly built telegraph outfit, which not only sounds but works like the big commercial instruments. By studying the code for 30 days you can become a first-class telegraph operator. Such operators are in big demand now. Outfit consists of TWO complete telegraph instruments, each measuring 1 1/2 x 2 1/2 x 2 1/2. All metal parts are highly nickel plated, including key lever. Note hard rubber knob. Telegraph Code Chart, telegraph blanks and connecting wire come with set, but no batteries. Outfit works on two dry cells (one cell for each instrument). The "Electro" is the ONLY outfit that works both ways; each station can call; no switches, no extras. Nothing to get out of order. Guaranteed to please you or money back. Price complete as illustrated.

AT ALL GOOD DEALERS AND DEPARTMENT STORES

If your dealer cannot supply you send us \$1.00 for outfit and add mailing charges for two pounds, otherwise we ship express collect. Goods shown here are only a fraction of our wonderful assortment illustrated and described in our great 328-page Electrical Cyclopaedia (contains more information than most electrical works). Also contains twenty coupons for free Wireless Course.

Electro Importing Co., 245 Fulton Street, New York City



\$1

Cyclopaedia Sent FREE on receipt of 4c to cover postage. Send for your copy today

Buy Genuine DIAMONDS

Direct from
**BARNARD, the
Diamond Headquarters**



14K Engagement Solitaire \$8 and Upwards



14K Mounting Men's Diamond Rings, \$10 up

BlueWhite
\$88
Per Carat



Ignatius Barnard President

I eliminate all middlemen—all waste—in the selling of diamonds. Direct buying from the European cutters, then reselling direct to you saves 35% of dealer's prices. Tremendous sales-volume permits smallest profits and makes my price actually less than wholesale!

Send No Money

Merely send for my beautiful Diamond Book—select the diamond and mounting of your choice, and I'll ship it for your inspection—at my expense and without obligating you to buy. As we get all our business in this way our success proves our prices lowest by comparison.

Bankable Money Back Guarantee

The only bankable Money Back Guarantee in the diamond business. You can take it to any bank and cash in your diamond investment. The only guarantee without red-tape, delays or evasions. Allows you to exchange at full value at any time.

\$100 Liberty Bonds Accepted At \$102

Lend to your country and keep the wheels of commerce running at the same time. To encourage both, I will accept \$100 Liberty Bonds at \$102 for entire or part payment of my diamonds.

1917 DeLuxe Book of Diamonds FREE!

Illustrated in colors. Contains thousands of the greatest bargains in diamonds ever shown. Tells facts you've wanted to know in order to buy diamonds intelligently. Tells about diamond qualities, colors, imperfections. A bound volume that you'll be glad to give a permanent place in your library. Free for the asking. Send postal or coupon.

BARNARD & CO. Dept. 3088C
N. W. Cor. State & Monroe Sts.
Chicago, U. S. A.

FREE BOOK COUPON
BARNARD & CO., Dept. 3088C
N. W. Cor. State & Monroe, CHICAGO
Without expense to me or the slightest obligation, please mail 1917 DeLuxe Book of Diamonds as offered in Popular Mechanics

Please Mention Popular Mechanics

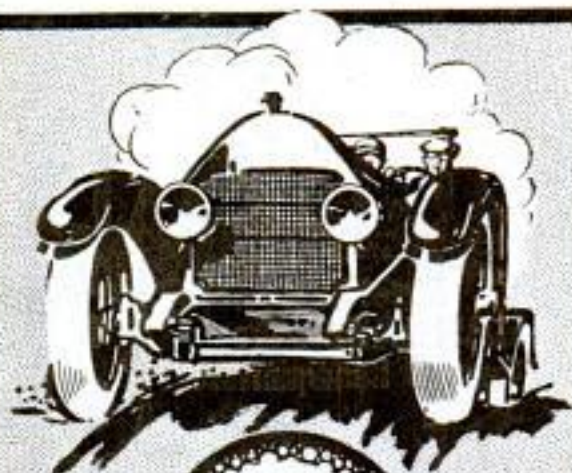

**OVER THE
HIGH PLACES
IN A HURRY**

Reduce hill-climbing hindrances to "mole-hill" motoring ease. Spin up the hard high places with that on the level certainty and snug satisfaction of *getting there*.

THE NEW Stromberg Carburetor

holds—with a wide margin of security—the record climb to the top of Pikes Peak. Its winning *first* place in the most grueling hill climbing test to which a car was ever subjected is ample proof of Stromberg superiority. While its every day — *demonstrated* — reliability in mounting steepest inclines on all kinds of cars is convincing evidence that it will provide the power to carry your car "over the High Places in a Hurry."

Send name, model and year of your car, for FREE information.

**Stromberg Motor
Devices Co.**

Dept. 814
64 E. 25th St.
Chicago, Ill.

**New STROMBERG Does It!
CARBURETOR**

BUY DIRECT FROM THE DIAMOND CUTTERS

BY MAIL TO YOU

**GENUINE
DIAMONDS**

Pure
White
GENUINE
DIAMONDS
\$70
Per Carat
ALL SIZES
14 to 10
Carats

The best proof in the world that we undersell all others is the fact that we give you a **Legal Money-back Guarantee Bond**, which enables you to return your diamond any time within one year and get back every penny you paid.

Shaded
Perfect
GENUINE
DIAMONDS
\$125
Per Carat
ALL SIZES
10 to 14
Carats

1-3 Carat \$7.25	1-2 Carat \$36.87	1-8 Carat \$10.98	3-8 Carat \$41.75
2-16 Carat 12.15	5-8 Carat 45.75	2-16 Carat 18.98	1-2 Carat 63.67
1-4 Carat 18.75	3-4 Carat 54.75	1-4 Carat 24.75	5-8 Carat 77.62
2-5 Carat 28.35	7-8 Carat 63.28	1-3 Carat 29.95	3-4 Carat 95.00

BUY THROUGH YOUR BANK

You send us no money—simply the name of your bank or express and we will send you a selection of diamond rings, enabling you to see our offerings **FIRST** before you pay a penny. Our values will prove a revelation to you and demonstrate that it pays to buy from the diamond cutters direct.

Our Big FREE Catalog gives you the inside rock-bottom diamond cutters' prices and shows you the way to big savings. It's an education on diamonds; contains much valuable information. **Write Today—It's FREE.**

J. PRESS & SONS
IMPORTERS AND CUTTERS OF DIAMONDS
WHOLESALE JEWELERS
888 CHESTNUT ST.
PHILADELPHIA, PA.

Build Your Own Super-Ford \$6

With life size, sure-fit "Red-Kut" patterns, simple instructions and a few dollars worth of material from the hardware store you can make your Ford into this classy, speedy car. It's low, rides wonderfully easy and absolutely quiet. Bullet shape rear fenders by pressed metal flange gives free. Central disk wheel patterns included. Specify for older new radiator. Life size patterns complete, three two-dollar bills. **Send today.**



KUEMPEL COMPANY, Design Dept. 29, DUBUQUE, IOWA

PAN-GERMAN—literally, All-German. In the European war the term is applied to Germany and her allies as a whole.

PAN-GERMANISM—in international politics, the theory or dream long entertained in Germany of world domination in the interest of German commerce. It includes the idea of a great East and West empire, running from the North Sea across Europe into Asia by way of Constantinople, that could be maintained under German control independent of British sea power, if the latter could not be broken.

Several books on the subject appeared just before the war, by both English and German writers.

PHONOGRAPH PARTS

SEND FOR CATALOGUE

ELECTRO MECHANICAL PARTS CO., 57 E. Jackson Blvd., CHICAGO
See our ad on page 181, June issue, Popular Mechanics Magazine.

AGENTS—NEW INVENTION

Ventilated chemical indoor closet, for country, village and suburban homes; no plumbing, no waterworks, no cesspool; absolutely odorless; 30 days' free trial guarantee; every village and farm home a customer; an order at every house; one agent made \$112 commission in 8 hours. Agent's outfit free. Exclusive territory contract. Write today for full particulars of this biggest winner ever offered to salesmen. Address

SHAFER MFG. CO., 482 Colton Bldg., Toledo, O.

G T D Gages-Taps-Dies

Greenfield Tap and Die Corporation, Greenfield, Mass.

Extra money for you now

You need more money this summer—and here's a dignified, easy way to get it. Take orders for the

Wisconsin Detachable Motor Row Boat

Equip your boat with a guaranteed Wisconsin—enjoy yourself while demonstrating and making money. Thousands in use. Everyone interested. Has many exclusive features including self-locking tiller and patented top adjustment, which make the Wisconsin the best row boat or canoe motor to use, and the easiest to sell. Ask for our agents' plan. Ask for catalog Q.

WISCONSIN MACHINERY & MANUFACTURING COMPANY
Minor Street, Milwaukee, Wisconsin
Highest Award Panama-Pacific Exposition.
Purchased by U. S. Government.



Sharpens Safety Blades Perfectly

At last, the perfect sharpener—the **Stag Sharpener**. The only sharpener that both hones and stropps all makes of safety blades. Keeps blades in perfect sharpening condition. Makes old blades better than new. Surprisingly simple. Roller in holder

automatically sets blade always at correct honing and stropping angle. Our **New Patented Feature** makes inserting and removing blades easy. Just press rollers together. Heavily nicked holder, barber's hone and stropp in neat box, complete, postpaid, \$1.00. Try it 10 days; money back if not satisfactory. Dealers Write for Special Introductory Offer.

STAG CO., 329 Plymouth Court
Dept. 5292, Chicago



Red or Black "Vulcan" Ink Pencils

The ONLY perfect, non-leakable ink pencils at moderate prices.

Two

Sizes—

4 1/4 and 5 1/2 inches.

Extra Size—8 inches

(black only) \$1.25.

Your name in gold inlay 35c.

FREE—liberal supply of ink with

retail orders. Agents Wanted. Big Profits.

J. G. ULLRICH & CO., 27 Thames St., New York

Order today \$1

Red or Black "Vulcan" Ink Pencils

The ONLY perfect, non-leakable ink pencils at moderate prices.

Two

Sizes—

4 1/4 and 5 1/2 inches.

Extra Size—8 inches

(black only) \$1.25.

Your name in gold inlay 35c.

FREE—liberal supply of ink with

retail orders. Agents Wanted. Big Profits.

J. G. ULLRICH & CO., 27 Thames St., New York

Order today \$1

Red or Black "Vulcan" Ink Pencils

The ONLY perfect, non-leakable ink pencils at moderate prices.

Two

Sizes—

4 1/4 and 5 1/2 inches.

Extra Size—8 inches

(black only) \$1.25.

Your name in gold inlay 35c.

FREE—liberal supply of ink with

retail orders. Agents Wanted. Big Profits.

J. G. ULLRICH & CO., 27 Thames St., New York

Order today \$1

Red or Black "Vulcan" Ink Pencils

The ONLY perfect, non-leakable ink pencils at moderate prices.

Two

Sizes—

4 1/4 and 5 1/2 inches.

Extra Size—8 inches

(black only) \$1.25.

Your name in gold inlay 35c.

FREE—liberal supply of ink with

retail orders. Agents Wanted. Big Profits.

J. G. ULLRICH & CO., 27 Thames St., New York

Order today \$1

Red or Black "Vulcan" Ink Pencils

The ONLY perfect, non-leakable ink pencils at moderate prices.

Two

Sizes—

4 1/4 and 5 1/2 inches.

Extra Size—8 inches

(black only) \$1.25.

Your name in gold inlay 35c.

FREE—liberal supply of ink with

AGENTS \$60 WEEKLY



Robinson Folding Bath Tub. Big seller. Costs little, no plumbing, little water. Weight 15 pounds. Fits into small tub. Full length bath, far better than tin tubs. Guaranteed 10 years. \$19 a day easily made. Write for free tub offer.

ROBINSON CABINET MFG. CO. 4722 Factoris Bldg., Toledo, Ohio

Abdominal MASSAGE

with the wonderful, new **KOLON MOTOR** brings health, strength and energy. Banishes chronic constipation. Write for interesting booklet—"Colon Cleanliness"—mailed free. Send a postal.

MARTIN'S METHOD, Inc., Dept. 80, 105 E. 30th St., NEW YORK

Comfort Indoor Closet

Odorless, Sanitary, Germ-proof. Can be placed anywhere in home. A guarantee of healthy, sanitary conditions. 80 days' Free Trial.

SWAT FLY BREEDING CLOSET

Have city conveniences. Germ-life killed instantly by chemicals. Emptied once a month. Needs no other attention. Boards of Health endorse. Write for literature.

Agents wanted—exclusive territory

COMFORT CHEMICAL CLOSET CO. 388 Factoris Bldg., TOLEDO, OHIO

COMFORT CHEMICAL CLOSET CO. 388 Factoris Bldg., TOLEDO, OHIO

COMFORT CHEMICAL CLOSET CO. 388 Factoris Bldg., TOLEDO, OHIO

COMFORT CHEMICAL CLOSET CO. 388 Factoris Bldg., TOLEDO, OHIO

COMFORT CHEMICAL CLOSET CO. 388 Factoris Bldg., TOLEDO, OHIO

COMFORT CHEMICAL CLOSET CO. 388 Factoris Bldg., TOLEDO, OHIO

COMFORT CHEMICAL CLOSET CO. 388 Factoris Bldg., TOLEDO, OHIO

COMFORT CHEMICAL CLOSET CO. 388 Factoris Bldg., TOLEDO, OHIO

COMFORT CHEMICAL CLOSET CO. 388 Factoris Bldg., TOLEDO, OHIO

COMFORT CHEMICAL CLOSET CO. 388 Factoris Bldg., TOLEDO, OHIO

COMFORT CHEMICAL CLOSET CO. 388 Factoris Bldg., TOLEDO, OHIO

COMFORT CHEMICAL CLOSET CO. 388 Factoris Bldg., TOLEDO, OHIO

COMFORT CHEMICAL CLOSET CO. 388 Factoris Bldg., TOLEDO, OHIO

COMFORT CHEMICAL CLOSET CO. 388 Factoris Bldg., TOLEDO, OHIO

COMFORT CHEMICAL CLOSET CO. 388 Factoris Bldg., TOLEDO, OHIO

COMFORT CHEMICAL CLOSET CO. 388 Factoris Bldg., TOLEDO, OHIO

COMFORT CHEMICAL CLOSET CO. 388 Factoris Bldg., TOLEDO, OHIO

COMFORT CHEMICAL CLOSET CO. 388 Factoris Bldg., TOLEDO, OHIO

COMFORT CHEMICAL CLOSET CO. 388 Factoris Bldg., TOLEDO, OHIO

COMFORT CHEMICAL CLOSET CO. 388 Factoris Bldg., TOLEDO, OHIO

COMFORT CHEMICAL CLOSET CO. 388 Factoris Bldg., TOLEDO, OHIO

COMFORT CHEMICAL CLOSET CO. 388 Factoris Bldg., TOLEDO, OHIO

No Money In Advance

This Marvelous CAMERA On FREE Trial!

Only 10,000 of these marvelous, instantaneous picture-taking and making cameras to be sent out absolutely on approval without a penny in advance just to prove that it is the most wonderful invention—the camera sensation of the age. So you must send for it quick! Just think of it—the new Mandel-ette



**TAKES
AND
MAKES
Finished
Pictures
Instantly!**

You press the button, drop card in developer and in one minute take out a perfect, finished post card photo, 2 1/2 x 3 1/2 inches in size. Camera, itself, is about 4 1/2 x 5 x 7 inches. Loads in daylight 16 to 50 post cards at one time.

No Films—No Plates—No Dark Room

Not a bit of the fuss and bother of the ordinary kodak or camera. It is instantaneous photography. Universal focus lens produces sharp pictures at all distances. Pictures develop and print automatically. Can't overdevelop; results simply amazing.

We Trust You

No difference who you are, where you live or what your age, we will send you the complete "Mandel-ette" outfit absolutely on approval and give you 10 days to test it. If not satisfactory return it. But when you see what elegant pictures it takes—so quick, so easy, with no trouble at all—if you wish to keep it you simply send us \$1.00 per month until our special price of only \$5.00 is paid.

EASY PAYMENTS—NO REFERENCES

No red tape of any kind. Monthly payments so small you'll not notice them. Lots of fun and big profits.

NO EXPERIENCE REQUIRED

Plain instructions and everything complete with outfit so you can begin taking pictures the moment it arrives. We guarantee that even a child can operate it. Mail coupon right now. No risk or obligation to keep camera.

The Chicago Ferrottype Co.,

Desk 516 Ferrottype Bldg., Chicago, Ill.

Send me at once one complete model Mandel-ette Camera outfit including supply of post cards and instructions. I agree to examine and test it thoroughly and if satisfied keep it and pay you \$1 a month until your special price of \$5 is paid. Otherwise I will return it at the end of 10 days.

Name.....
St. and No.....
Town.....State.....

Please Mention Popular Mechanics



\$500 REWARD

We will pay \$500.00 reward to anyone who can permanently dim the brilliancy of the RAJAH Im. diamond without destroying the stone.

RAJAH Im. Diamonds

They stand all diamond tests—dra, acid, file, and glass cutting. Their brilliancy is eternal. Guaranteed for a lifetime. Set in solid gold, and sent to you on 30 Days' Free Trial. If you can tell it from a real diamond return it. Send today for our beautiful, FREE illustrated jewelry catalog in colors. Write now.

KRAUTH & REED, 159 N. State St., Dept. P2 CHICAGO, ILL.

A YEAR
TO PAY

Here's Your Camera Opportunity

Buy just the outfit you want direct from our big money-saving catalog. Save \$35 on a 1-A Graflex—\$40 on a 3-A Graflex—\$4.75 on a 3-A Autographic Kodak—\$1.75 on the latest model vest pocket autographic Kodak. Save money on any camera, Kodak, lens, motion picture outfit or photo accessories. Eastman Film, Ansco Speedex Film, and Rexo Speed Film at cut prices.

FILMS Developed
Nine Cents per Roll
Finest developing and
printing plant in the
country. Quality work.

Send for price list.



Ansco Vest-Pocket No. 2
Equipped with
Modico Anastigmat
Lens, F 7.5. Our
price \$15. With
Ansco Anastigmat
Lens, F 6.3 and extra
speed Bionic shutter—our price \$24.

10 Days' FREE Trial

Money-back guarantee
backs every article we
sell. Get our catalog.
Convince yourself.

**David Stern
Company**

In Business Since 1885

712 Davisco Bldg.

1027-29 Madison Street
CHICAGO, ILL.



3A Kodak with
special autographic
back, the ideal hand
camera. Our price
\$17.75. Hundreds of
other money-saving
camera offers.

Get our
prices

Write Now
for Your
Copy



Please Mention Popular Mechanics

**Saves Money
Speeds Work
Raises Efficiency**

The remarkable Temco Portable Electric Drill is the most used tool in thousands of machinshops, garages, automobile factories, ship yards, public buildings, etc.

Many executives, superintendents and foremen have proved its efficiency and quality and their requisitions for new tools always specify TEMCO.

Five sizes—9 to 19 pounds. Capacities to 3/4" drilling in steel.

Also Temco Drills, Grinders, Buffers, etc., of larger capacity.

At leading Dealers and Jobbers Everywhere.
Write for our catalog.

The Temco Electric Motor Company
141 Sugar Street LEIPSIC, OHIO

Makers also of TEMCO-Alfa Shock Absorbers and TEMCO Shock Absorbers. Master Vibrators and Lock Switches for Fords.

Drills by electricity anywhere—direct or alternating current

TEMCO

THE TOOL OF MANY USES

Mammoth Jubilee Book Free

Picturing 5152 Home Things
Make your own Credit Terms—1 to 3 years' time.
SPIEGEL, MAY, STERN CO., 1409 W. 35th St., Chicago



THE PLEASING AND POSITIVE SIGNAL

The Buell Explosion Whistle is sweet toned. It cuts the air—"carries" great distances—still doesn't "grate on the ear." Announces your approach—but doesn't annoy. New style whistle. Vastly superior. Screws in place of printing cap. Blown by direct explosion. No upkeep cost. Positive in operation. Now standard equipment on many cars. Write for interesting FREE circular.

THE BUELL CO., 1610 Michigan Ave. CHICAGO

INDOOR CLOSET

More Comfortable, Healthful
and Convenient than the Out-Door Closet

Eliminates the out-door closet and open vault. They are breeding places for germs. Have a warm, sanitary, odorless toilet right in your house. No going out in cold weather. A boon to invalids. Endorsed by State Boards of Health.

W. M. Davis writes: "Your indoor closet is giving absolute satisfaction. It is certainly the thing for a home without sewerage."

**Absolutely Odorless
Put It Anywhere in the House**



The germs are killed by a chemical process in water in the container, which you empty once a month. **Absolutely no odor.** No more trouble to empty than dishwasher. Closet absolutely guaranteed. Write for full description and price.

Agents Wanted—Big Profits Wonderful opportunities in every town, village and in the country. Best season just at hand. Every home is a good prospect. Sell eight out of every ten you call on. Ernest Riddell writes: "Have ten orders." G. A. Dismann says: "Ship at once twenty closets and fifteen washstands. Sold them all in one community." Sell itself. Everybody takes the outdoor closet. Everybody wants a Ro-San Indoor Closet. Write quick for territory and full particulars. We are prepared to ship promptly any quantity of closets—no waiting.

ROWE SANITARY MFG. CO., 805 Sixth St., Detroit, Mich.
Ask about the Ro-San Washstand—Hot and Cold
Running Water Without Plumbing

COMBINATION 2 IN 1



BOYS—Here's the very latest thing in Coasters. It's two in one—Roadster and Coaster, and you can change it from one to the other in a second, simply by drawing the sides of the wagon upward.

The AUTO-WHEEL Convertible Roadster

is made with the same wonderful features as the famous Auto-Wheel Coaster. Has ball-bearing wheels, dust-proof hub-caps. Constructed of steel, ash and maple. Fastest on hills, easiest to pull.

Don't take a substitute—look for same Auto-Wheel. Fast Permanent and Booklet for names of 3 Coaster Wagon Dealers. Tell which handles Auto-Wheel.

THE BUFFALO SLED CO.

In Canada, Preston, Ont. 137 Schenck St., N. TONAWANDA, N. Y.

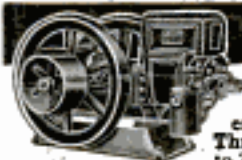

KEROSENE ENGINES

OTTAWA LATEST DESIGN

Durable, powerful, reliable, massive, built to last; to do hard, heavy work. Uses cheapest fuel, pulls $\frac{1}{4}$ to $\frac{1}{2}$ H. P. more than rated. **Three Months' Trial, Easy Terms.** Sizes $1\frac{1}{2}$ to 22 H. P. Easy to start. No cranking. No batteries. Ten Year Guarantee. Most practical engine ever built.

ENGINE BOOK FREE. A POSTAL BRINGS IT.

OTTAWA MANUFACTURING CO., 531 King St., OTTAWA, KANSAS

SHOOTING-PERMIT BOOKS FOR HUNTERS—A vest-pocket-size booklet, containing 10 forms for shooting permits given by owners of land to individual hunters, has been recently published by a powder company, and should be a welcome convenience to every hunter.

Attractive *Columbia* Bicycles
Catalog Free
WESTFIELD MFG. CO. Department 15
WESTFIELD, MASS.

Make Big Money Selling a Fridger a day is making money at the rate of \$25,000 a year. We want more dealers. Investigate our proposition. See our ad, page 58 June issue Popular Mechanics.

THE SILK MAT ICEMAN
FRIDGER WELLS STREET BRIDGE BUILDING CHICAGO

Bausch and Lomb BALOPTICON

THE PERFECT STEREOPTICON

Bausch & Lomb Optical Co., 576 St. Paul St., Rochester, N. Y.

Effecto FINISHES

MAKE OLD AUTOS NEW

Hartman Will Trust You

Rock Bottom Prices

Furniture, Carpets, Rugs, Etc.

Easiest Terms Hartman's credit terms easiest, most liberal ever offered. No security—no notes—no mortgages. Free from all objections.

At the end of a month you may return anything unsatisfactory.

Hartman refunds your money including freight.

FREE—Big Bargain Book Over 5,000 bargains. Write today for FREE copy.

HARTMAN FURNITURE AND CARPET CO.

3945-47 Wentworth Av., Chicago



Please Mention Popular Mechanics



ZEPPLINS!

THE TERROR OF THE OLD WORLD—THE POSSIBLE DESTRUCTION OF THE NEW
Learn New Aeronautical Ideas:
Defend Fort Totten

Five foot complete model of German War Balloon. Equipped with COMPLETE parachute and bomb dropping apparatus. SILK parachute and an entire inflating arrangement. Will positively drop parachute from height of 1,000 feet and will fly one mile. Is easily retrieved and is practically indestructible.

May be flown in only slight wind attached to cord or be allowed to take its own course and return to earth on expiration of gas. When in the air appears to be a giant German War Balloon.

Airship is cylindrical in shape with both ends tapering, and the equipment of the above includes complete wood and fibre car, inflating device, silk, circular parachute of large size, parachute and bomb dropping apparatus, and is guaranteed to fly one mile and give satisfaction when assembled, for which are also supplied diagrams and directions.

Mailed to any address in the world for \$1.00 and warranted to give more satisfaction than any article heretofore offered in the aerial field. Absolutely new ideas involved.

Large FRENCH WAR KITE, cloth planes complete. Large reel of strong twine, silk parachute and dropping device post-paid for \$1.50.

This kite will carry aloft cameras, parachute and bombs at the same flight and will drop them safely and with remarkable precision. Is an exact model of man-carrying kites in use at the front today.

Both of the above will be immediately sent by parcel post on receipt of \$2.25. Returnable if displeased.

MANUFACTURED BY

THE AERO COMPANY, Dept. 8, Binghamton, N. Y.

KEROSENE Gas Lamps

BURNS KEROSENE or GASOLINE

one just as well as the other; or the two mixed. Make their own gas. 300 to 600 C. P. at 40 an hour. Family or Business use.

WRITE FOR COMPLETE ILLUSTRATIONS
BRILLIANT GAS LAMP CO.
1000X So. Wabash Ave., CHICAGO, ILL.

THE CORBIN DUPLEX COASTER BRAKE

is the standard brake equipment assuring absolute control. Equip it now. Send for catalog.

THE CORBIN SCREW CORP. The American Hardware Corporation, Successor
NEW BRITAIN, CONN. BRANCHES: New York, Chicago, Philadelphia



Oh, You Skinny!

Why stay thin as a rail? You don't have to! And you don't have to go through life with a chest that the tailor gives you; with arms of childish strength; with legs you can hardly stand on. And what about that stomach that flinches every time you try a square meal? Are you a full feeder?

Do you expect Health and Strength in tabloid form—through pills, potions and other exploited piffle?

You can't do it; it can't be done.

The only way to be well is to build up your body—all of it—through nature's methods—not by pampering the stomach. It is not fate that is making you a failure; it's that poor, emaciated body of yours; your half-sickness shows plain in your face and the world loves healthy people. So be healthy—strong—vital. That's living. Don't think too long; send 4 cents in stamps to cover mailing of my book, "INTELLIGENCE IN PHYSICAL AND HEALTH CULTURE," written by the strongest physical culture instructor in the world.

LIONEL STRONGFORT

PHYSICAL CULTURE EXPERT

No. 203 Park Bldg. Newark, N. J.

BERNARD-HEWITT & CO.,
Desk F28, 424-434 So. Green St.,
CHICAGO, ILL.

Please send me your new Fall and Winter style book with 70 samples free — also full details of your special lining offer.

Name

Address

MAIL COUPON

For Fall and Winter
STYLE BOOK

70 SAMPLES
FREE



High Grade Blue Serge Suit Made to Measure only \$15

GUARANTEED ALL WOOL

A SPECIAL proposition to introduce the wonderful values offered by our system of tailoring. We have no agents — no dealers — no traveling salesmen — our values make their own customers — and once a Bernard-Hewitt customer always a Bernard-Hewitt customer. That's why, to secure your first order, we are willing to make to your individual measure, a handsome, all pure wool worsted blue serge suit (usual \$25 value) for only \$15 and line it with a

\$4 SATIN LINING FREE

Remember, this suit is strictly hand tailored to your individual measure from the very finest all wool blue, light blue, black or gray serge, in the latest approved Chicago style, and by the very best tailors in this whole city.

But perhaps you don't care for a serge suit. Well, our big book which we will send you free contains generous samples of the latest fabrics; plain and fancy mixtures, the up-to-the-minute offering of leading woolen mills.

The \$4.00 Satin Lining free offer goes, no matter what fabric you select — and we pay all shipping charges. We take all the risk — you none — for this is

OUR GUARANTEE Complete Satisfaction
or Refund of Money

You must be pleased in every particular — in fit — in style — in workmanship and in materials, or we don't want your money. Could anything be fairer? Write today — wear real tailor-made clothes — dress better and save money.

Take Your Own Measure — Save \$10

Write for Your Copy of Our Big Book Today

Our big new Fall and Winter book is ready for you — contains 70 samples latest woolens — also lowest prices on men's hats, shoes and furnishings. It is your guide to correct and economical clothes buying. Mail coupon above or send post card for your copy. Please mention POPULAR MECHANICS so that we can identify this special offer.

BERNARD-HEWITT & COMPANY

424-434 So. Green St.

Desk F28

CHICAGO, ILLINOIS



WE PAY
SHIPPING
CHARGES

JAPANESE ROSE BUSHES

The Wonder of the World

Japanese Rose Bushes bloom all the year round. Just think of it. Six weeks after planting the seed, the plants will be in full bloom. It may not seem possible, but we positively guarantee it to be so. They will bloom every ten weeks, Summer or Winter, and when three years old the bush will be a mass of roses, bearing from five hundred to a thousand roses on each bush. The flowers are in three shades—white, pink, and crimson. The plants will do well both in and out doors. We guarantee at least three bushes to grow from each packet of seed. Price, 10c packet, 3 pkts. for 25c postpaid.



10
cts.

Chinese Fragrant Tree Fern

Just introduced; noted for its rapid growth. An exceptionally pretty ornamental plant. Foliage rich dark green. Forms grand pyramidal bushes about 6 feet high. Branches very desirable for decorative purposes, wreaths, etc. Seeds 15c pkt., 3 for 40c.



Weather Plant

NATURE'S WEATHER PROPHECY By mysterious changes that take place, this remarkable plant accurately forecasts the weather many hours in advance. Will grow anywhere all the year around. An interesting house plant. Bears large, fragrant, pink, butterfly shape flowers. Seeds, 15c packet, 3 for 40c, postpaid



Wanted— Men Who Know the Science of Aviation!

The fact that the United States government plans to send 30,000 flying men to Europe and spend possibly a billion dollars in aviation means something more than a big demand for flying men.

It Means the Sudden Building Up of a Vast New Industry!

There will be urgent need for thousands of men who thoroughly understand the science of aviation—men who can serve as airplane designers, builders, engineers, assemblers, salesmen, repairmen, mechanics, contractors, inspectors, instructors.

Learn at Home!

Start now to master the science of aviation. Help to meet this tremendous demand for trained men. You can learn at home, in your leisure time, without giving up your employment—and you do not need a college education.

The National Aero Institute offers you a mail course of 53 lessons in the principles of aviation. Your training will be under the supervision of aeronautical experts—men like Walter L. Brock, the famous aviator who won the great London to Paris race. While you cannot, of course, learn to fly by mail, this great home course gives you all the ground work which is so necessary to successful flying—and all the basic training needed to fit you for any of the positions mentioned above.

When you have completed the course you will need only actual working experience to make you an aviation expert. Aviation experts command big salaries.

Authorities agree that after the war aviation is bound to become a vast means of transportation—passenger—freight—mail. Orville Wright says, "There is no means of transportation that is so safe." Be a pioneer in this great new industry. Pioneers have the best chance of being leaders. The sudden rise of the automobile industry turned poor men into millionaires. YOU may be the future "Henry Ford" of aviation!

This Course Gives You

all the basic training needed to fill such positions as:
Airplane Designer;
Builder; Salesman;
Assembler; Contractor;
Repairman; Inspector; Mechanic

Write at Once

For Special Offer

Send for our special limited offer. Just now we are offering this Complete Mail Course in the Principles of Aviation at a greatly reduced price. We also furnish free, to every student who enrolls now, a complete flying model and all materials for a radio model. Tear out the coupon and mail it at once—before this offer is withdrawn. Do it right away—NOW.

NATIONAL
Aero Institute
Dept. C319
Morton Bldg.,
CHICAGO

National Aero Institute

Dept. C319 — Morton
Building Chicago, Ill.

Gentlemen:—Please send me, free and prepaid, full particulars of your mail course in the principles of aviation, and details of your special limited offer.

Name

Address

GROUND ALMONDS

Amazingly Prolific—Easily Grown From Seed The Ground Almond has a flavor that is MOST EXCELLENT, resembling the coconut. The meat is snow white, covered with a shell or skin of brown color. It grows close to the surface and anything from 200 to 300 Almonds may be expected from a single nut. There is no trouble whatever in growing anywhere and in any kind of soil. May be planted any time, and in eight or ten weeks from time of planting you will have an ENORMOUS CROP of the MOST DELICIOUS ALMONDS YOU EVER TASTED. Seeds 15c Pkt.



Perfume Plant

Blooms only at night, giving forth the most delightful scented fragrance for quite a distance. Causes much comment. For house or garden. Also valuable because of rare perfume made from it. SEEDS, 10c pkt., 3 for 25c.



Calabash or Pipe Gourds A luxuriant and rapid growing climber; everywhere where. Produces the ornamental gourds from which the calabash pipes are made. Grow down interesting vines and make your own. Seeds, with instructions, 15c pkt., 3 for 40c.

SENSITIVE PLANT

Marvel of the Philippines. Leaves curl, heads drop when touched. Apparently resents interference. A handsome shrub for house or garden; very curious and interesting. Seeds, 15c pkt., 3 for 40c.



Japanese Nest Egg Gourd

Very curious. Produces fruit same size, shape and color of nest eggs. Matured fruit does not crack. Will serve for years as a nest egg, stocking darrer, ornament, purposes, etc. Seeds 15c pkt., 3 pkts. for 40c.



Mammoth Peanuts

Peanuts can be easily cultivated. Their culture is very simple and exceedingly interesting. Mammoth Peanuts grow to an astonishing size. It is a good producer, very prolific, and the giant nuts have a thick, heavily ribbed protecting shell. The plant is very attractive, the leaves being of odd shape and a handsome green shade, tinted through the center with white. You will derive much pleasure cultivating this interesting species. Seeds 15c pkt., 3 pkts. for 40c.



Shoo Fly Plant

A very remarkable botanical curiosity you should have. Though quite odorless, flies will not remain in a room where it is grown. Bears very pretty blossoms; blooms summer and winter. Grows rapidly from seed. SEEDS 15c packet, 3 for 40c, postpaid.



Japanese Climbing Cucumber

Unusually strong and vigorous growing vine. Attains twice the size of ordinary varieties. Grows readily on fences, poles, trellises, etc. One hill will keep an entire family supplied all summer. Seeds 15c, 3 pkts. for 40c.



HERE ARE A FEW OTHER SEED NOVELTIES YOU SHOULD CULTIVATE: Price 15c packet

Japanese Kudzu Vine
(Jack and Bonnets)
Chinese Bellflower
Purple Feather Grass (Ornamental)
Curious Ferns (Grows from seed)
Bird of Paradise Flower
Japanese Hop Vine

Caster Oil Plant
Ornamental Cotton
Job's Tears (Great curiosity)
Cathedral Bells
"Tiger" Flower
Snake Cucumber
Emerald Isle Kale

Famous Passion Flower Vine
Fuchsias
Ornamental Gourds
Bougainvillea, or Red Cluster
Pepper
Salvia, or Oyster Plant
White Velvet Okra



NITTO'S PLANT & FLOWER FOOD

NITTO'S PLANT FOOD is clean, odorless, and highly concentrated. It is used in liquid form on all kinds of plants, shrubs, roses, ferns, bulbs, berries, lawns, fruit, flower and vegetable gardens. It changes the roughest plants into LUXURIOUS BEAUTIES, producing masses of blooms that will equal any. Causes plants to bloom early and ahead of others. Your friends will marvel at your success. Makes no difference how healthy or how delicate your plants may be. Nitto's Plant Food will bring out New Foliage and Flowers, and cause a Marvelous Transformation. 15c, 3 for 40c

Johnson Smith & Co., Dept. 88, 7121 N. Clark St., Chicago

Please Mention Popular Mechanics

BLUE STREAKS

TRADE MARK REG. U. S. PAT. OFF.



Service Station Sign of the Goodyear Dealer in Blue Streak Black Tread Motorcycle Tires and Goodyear Tubes. It will pay you to know him.

HERE are construction advantages that reach a new, high mark in motorcycle tire manufacture. You may point to them proudly in Goodyear's new Black Tread Blue Streaks—and *only* in these tires.

Wider breaker strip than ever before. This prevents tread separation and absorbs shocks. Treads that are tougher, thicker, and longer wearing. These mean extra mileage and an easier riding tire.

Thicker side walls. Carcass of extra high grade fabric—four-ply and *skim-coated* on one side. Skim-coated fabric combats fabric separation, which weakens the carcass and causes blow-outs.

Altogether a record-value tire with greater inbuilt mileage than you will

find in any other tire.

No wonder Goodyear Blue Streaks are standard original equipment for 1917 on all motorcycles made. And no wonder that Goodyear and the Goodyear Dealer are proud of them.

You, too, will be proud of them.

Buy Goodyear Black Tread Blue Streaks from the Goodyear Dealer in your town. And get Goodyear Tubes, too.

The Goodyear Tire & Rubber Co.
Akron, Ohio

GOODYEAR
AKRON

Please Mention Popular Mechanics

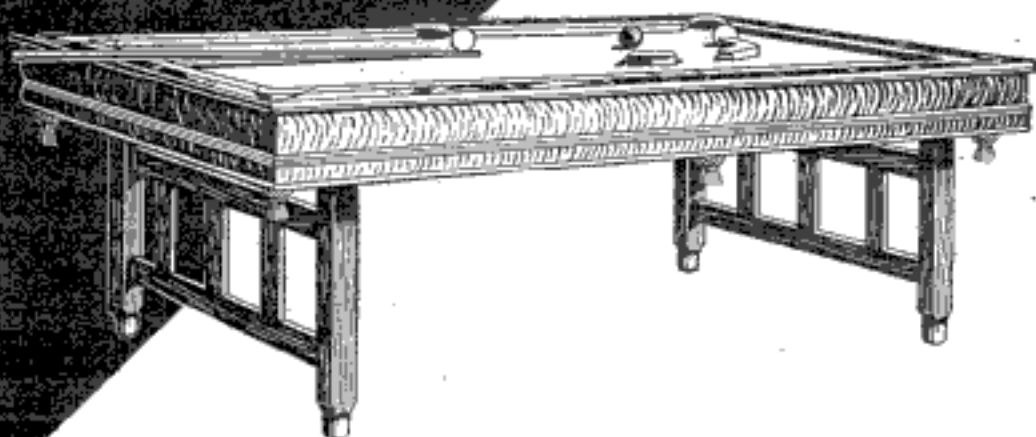

A Father Writes:

"No Home Complete Without One"

And he is but one of thousands who feel the same way. We receive hundreds of letters each month telling of the joys of billiards played on a Brunswick Table.

Young and old alike find pleasure in the spirited combat around the billiard table. A skillful shot, a clever bank brings forth shouts of joy from father or mother as well as brother or sister.

BRUNSWICK HOME BILLIARD TABLES

Used by Experts

Professionals endorse the Brunswick. Accurate angles, fast ever level beds and quick acting Monarch cushions give them expert playing qualities.

In design and cabinet work these tables are superb. Cues, Balls, Markers, etc.—complete playing outfit included *free*.

**The Brunswick-Balke-Collender
Company**

Dept. 50X, 623-633 S. Wabash Ave., Chicago

Write for Catalog

Low prices, easy terms and home trial offer all fully explained in our handsome illustrated catalog. Full of interesting information, color pictures, letters from owners, etc., etc. Write for it today, it's free.

**Write
for Catalog
Today**

The Brunswick-Balke-Collender Company
Dept. 50X, 623-633 S. Wabash Ave., Chicago

Without obligation, I should like to receive your color catalog, "Billiards—The Home Magnet," and details of your free trial offer.

Name

Address



INSTALL Your Own PLUMBING

or Heating our New Hardin Easy Way. Save high cost of skilled labor. Save on unnecessary material our new cut-to-fit way. Buy plumbing and heating goods at wholesale direct from us and save $\frac{1}{2}$. Our new big Handy-Man book actually shows and tells you how to properly install any plumbing or heating system, make repairs, etc., with wholesale prices on everything in plumbing and heating supplies exclusively. Any handy man with a few ordinary tools can install our goods with the aid of our FREE SERVICE DEPT.

Our New Hardin Easy Way

Every home owner, contractor, farmer, institution and factory needs this big valuable book. It clearly explains our new Hardin Easy Method. Shows you how easily you can install any kind of plumbing outfit or heating plant our new, original, practical cut-to-fit way. This 236-page book shows over 10,000 different kinds of guaranteed plumbing and heating fixtures, supplies, parts and repairs, fitted throughout with our easy installing features, perfected by us through 40 years of scientific and practical experience in this same business.

Send us a rough sketch of what you have in mind. Our Service Dept. will show you the easiest, cheapest and most economical way to install a complete plumbing or cut-to-fit steam, hot water, or air heating system. Write today. To avoid sending this large valuable Handy-Man book broadcast to non-interested parties, we request a temporary deposit of 25c, which will be refunded on first order, or, if you are not satisfied with book, return same and we will gladly refund your money.

New Pipeless Heating System Order from this page and save 10%. Satisfaction Guaranteed.

Our modern all cast furnace heats and ventilates entire home automatically. No cold corners. It supplies pure humidified warm air, free from dust, gas and smoke. Has longest interrupted staggered fire travel; deep fire pot; extra large overhanging combustion circulating chamber. Makes most heat on smallest amount fuel. Easy to operate. Smooth, heavy, tight-fitting castings. Highest Quality with Lasting Durability. Ease of Installation, Convenience, Comfort and Economy built thru and thru.

No.	FIRE POT	SIZE REG.	CAP. CUB. FT.	PRICE
320	20 in.	22 x 24	13,000	\$ 67.75
322	22 in.	22 x 27	16,000	79.50
324	24 in.	30 x 30	23,000	96.50
326	26 in.	30 x 36	35,000	110.50

Money-Back Guarantee

Our "Money-Back Guarantee Label" is on every fixture. It protects you, and assures you that all Hardin-Lavin fixtures are Highest Quality, Grade A, Guaranteed. Our aim is to furnish plumbing and heating plants with new, original, easy installing features, combining highest quality, lasting durability, and complete satisfaction.

The Hardin-Lavin Co.

40 Years at
4540-50X Cottage Grove Ave.
CHICAGO



P. N.
AUG. '17
"Handy-Man"
BOOK COUPON

The Hardin-Lavin Co.
4540-50X Cottage Grove
Ave., Chicago

Enclosed find 25c. for which send me complete Handy-Man Book. This 25c is to be refunded on my first order, or if I am not satisfied with the book, I will return same and you are to refund my money at once.

Name

Address

SIGN, TEAR OFF AND MAIL



*At the end of the rainbow,
I've been told
Thar's a fairy pot
Full of fairy gold,
But I never went thar to see.*

*I'd ruther sit still,
In my easy chair,
For thar's gold enough
In you chil'en's hair
To make a rich man of me.*

*An' thar ain't no gold
In that fairy hoard
As bright as the sunshine
The ole sun stored
In Velvet to make it ripe.*

*An' no gold that ever
I heard about
Is as good as the mellowness
Nature brings out
In the Velvet in my ole pipe.*

Velvet Joe

W. F. HALL PRINTING COMPANY, CHICAGO

Copyrighted material

COLGATE'S "HANDY GRIP"

The *NEW* SHAVING STICK

Colgate's "Handy Grip" combines economy, convenience, speed, and comfort better than any other shaving preparation.

We couldn't improve the soap, so we improved the economy and convenience of the box.

Colgate & Co., New York

It Screws in —
You can use all the Soap



1. Stick it on the new stick



2. Refills



3. The box locks

News

1. How to use the last of it.
2. How to buy a new one at less cost than the complete Grip.
3. How to prevent coming apart in your traveling bag.