

April

See Page 487

15 Cents

# POPULAR MECHANICS MAGAZINE

WRITTEN SO YOU CAN UNDERSTAND IT

REG. U.S. PAT. OFF.



Copyrighted material

©





# \$641 Buys the Material to Build this Home!

## NO MONEY IN ADVANCE!

When you "Build-To-Stay—The Harris Way," you secure the *utmost possible* in Quality, Economy and Service. Why? Simply because you profit directly—*immediately*—by our 24 years' experience. You get the benefit of our practical knowledge as the *originators* of the "Direct-to-You" Home Building Industry. We were the *first* to sell Lumber and Material direct to Home Builders at one small profit. We were the *first* to reduce this vitally important industry to a *perfect system* and extend the benefits uniformly to the people of the nation. *The splendid Harris Home above has 5 rooms, bath, pantry and reception hall in an excellent arrangement. The size is 22 ft. x 26 ft.*



### "THE HARRIS WAY"

has exclusive merits—special advantages for the shrewd and careful Home Builder—possessed by no other plan or method. It is the best, safest and most sensible way to build your ideal home *right* without sacrifice of quality—or the waste of a *single penny!* Thousands have built "THE HARRIS WAY" with profit and satisfaction.

### SEND LUMBER BILLS

Our ten million dollar buying power gives Harris customers an overwhelming price advantage. We can—and do—undersell all others. The *proof?* Easy! Just send us your lumber bills—for any kind of building you may be planning and get *our* prices. Compare them item for item, and let the *test* be the *proof.* Write us today!

### BUY YOUR HOME SENSIBLY CUT-TO-FIT—SHIPPED ALL COMPLETE IN ONE CAR

The material used in building all Harris Homes is prepared by us, complete for your use in a way that is instantly—and easily understood. It is sensibly cut-to-fit with *absolute accuracy* and *positive elimination of all waste.* You pay for nothing you do not get—you pay our *bed rock low, one-small-profit bargain price* *only* for what is needed to do the work *right*—"THE HARRIS WAY."

Our mammoth material stations, in the heart of the finest lumber tracts are always filled to overflowing with brand new, quality material. These stations are centrally located for quick and economical deliveries, "DIRECT-TO-YOU," no matter where you live, at the *lowest possible freight charge.*

### Free Beautiful New \$10,000 Book of Over 100 Harris Homes

Be sure to mail free coupon for the latest edition of the famous \$10,000 HARRIS HOME PLAN BOOK, now ready. A golden guide to Quality, Service and Economy in Home Building. Explains—fully and freely—everything about building economy. Contains 100 modern Harris Home Designs, with descriptions, material, specifications, prices, etc., and explains how we save you \$50 to \$75 on our Special Free Architect's Plans. Think twice before you pass this opportunity.

Harris Bros. Co.  
Dept. FH-7, CHICAGO

Please send me free—without the slightest obligation—the Harris Home Book of Plans, and show me how to save big money in building my home.

Name .....

Address .....

Harris Brothers Co. Dept. FH-7 35th & Iron Streets Chicago



Photo  
WhiteOscar  
Saenger

The Victor Company  
announces  
a complete course  
in vocal training  
by **Oscar Saenger**  
in twenty lessons  
on ten Victor Records  
**\$ 25**

Soprano; Mezzo-Soprano; Tenor; Baritone; or Bass

Every student of vocal music, every aspiring young singer, every one who has a voice, even though it be untrained, can now develop his or her talents under the direction of Oscar Saenger—America's greatest and most successful vocal teacher.

No matter where they may live, all those who wish to sing may now learn to do so under the direction of a master who is credited with having entered more pupils upon successful operatic, oratorio or concert careers than has any other teacher in the United States.

The Oscar Saenger Course in Vocal Training consists of ten double-faced Victor Records, which provide twenty lessons in vocalization.

There is a separate set of records for each of the following five voices: Soprano, Mezzo-Soprano, Tenor, Baritone, and Bass.

For each set of lessons, perfect examples of tone production have been secured through Oscar Saenger's personal choice of the artists best qualified to serve as exemplars.

The Oscar Saenger Course in Vocal Training for any of the voices mentioned above, may be procured from any Victor dealer at \$25—the cost of a *one-hour* lesson at the Saenger Studio in New York.

**Write for an illustrated booklet**

giving full information about the series of Victor Records of the Oscar Saenger Course in vocalization. We will gladly send a copy upon receipt of your request.

**Important Notice:** All Victor Talking Machines are patented and are only licensed, and with right of use with Victor Records only. All Victor Records are patented and are only licensed, and with right of use on Victor Talking Machines only. Victor Records and Victor Machines are scientifically coordinated and synchronized by our special processes of manufacture; and their use, except with each other, is not only unauthorized, but damaging and unsatisfactory.

# Victrola

"Victrola" is the Registered Trade-mark of the Victor Talking Machine Company designating the products of this Company only.

**Warning:** The use of the word **Victrola** upon or in the promotion or sale of any other Talking Machine or Phonograph products is misleading and illegal.

Victor Talking Machine Co., Camden, N. J.  
Berliner Gramophone Co., Montreal, Canadian Distributors



This One



DX8G-UN6-5PZZ lighted material

Please Mention Popular Mechanics



## IMPORTANT NOTICE to LUMBER USERS:

THE SOUTHERN CYPRESS MANUFACTURERS' ASSOCIATION HEREBY INFORMS YOU THAT ALL CYPRESS NOW AND HEREAFTER SHIPPED BY MILLS WHICH ARE MEMBERS OF THE ASSOCIATION WILL BE

**IDENTIFIED  
BY THIS MARK**



TRADE MARK REG. U.S. PAT. OFFICE

This registered trade-mark will be, henceforth,

*YOUR INSURANCE POLICY OF QUALITY.*

It will appear stamped (mechanically and ineradicably) on one end, or both ends, of EVERY board and timber of

# CYPRESS "THE WOOD ETERNAL."

CYPRESS FLOORING, SIDING, MOULDING AND SHINGLES, which come in bundles, will bear the same mark on EVERY BUNDLE.

The legal right to apply this epoch-making symbol of strict RESPONSIBILITY IN LUMBER MAKING AND SELLING

is, of course, restricted to those Cypress mills which, by their membership in the Southern Cypress Manufacturers' Association, attest their devotion to its Principles of SERVICE to the CONSUMER and their foresighted appreciation of its open and progressive educational methods.

Only mills cutting "Tide-water" Cypress are eligible for membership. (Cypress which grows too far inland is not equally noted for the "Eternal," or decay-resisting, quality.)

Only mills which subscribe to the Association's standard of scrupulous care in methods of MANUFACTURE, INTEGRITY OF GRADING and ACCURACY OF COUNT can belong to the Association. These responsible "A-1" mills the Association now licenses to

**CERTIFY THEIR CYPRESS** by applying the registered trade-mark with their identifying number inserted.



TRADE MARK REG. U.S. PAT. OFFICE

BY THIS MARK YOU KNOW THAT IT'S CYPRESS, "THE WOOD ETERNAL," AND WORTHY OF YOUR FAITH. IT IS WELL TO INSIST ON SEEING THIS TRADE-MARK ON EVERY BOARD OFFERED AS "CYPRESS."



TRADE MARK REG. U.S. PAT. OFFICE

Let our ALL-ROUND HELPS DEPARTMENT help YOU MORE. Our entire resources are at your service with Reliable Counsel.

### Southern Cypress Manufacturers' Association

1219 HIBERNIA BANK BLDG., NEW ORLEANS, LA., or 1219 HEARD NATIONAL BANK BLDG., JACKSONVILLE, FLA.

INSIST ON TRADE-MARKED CYPRESS AT YOUR LOCAL LUMBER DEALER'S. IF HE HASN'T IT, LET US KNOW.



# Popular Mechanics Magazine

6 N. Michigan Avenue, Chicago, U. S. A.

EDITED BY H. H. WINDSOR

England: The International News Co.,  
5 Beams Bldg., Chancery Lane, London, E. C.

Australia:  
The Australian News Co.

ISSUED MONTHLY

SUBSCRIPTION:

SINGLE COPY, 15 CENTS

In United States, and its possessions, Cuba and Mexico, per year, postpaid	\$1.50
To Canada	1.75
To all other countries in the Postal Union	2.50

All subscriptions are discontinued at expiration. Please examine the date printed on your wrapper.

Entered as Second Class Matter Sept. 15, 1933, at the Post Office at Chicago, Illinois, under Act of March 3rd, 1879.

Entered as Second Class Matter at the Post Office Department, Canada.

Published monthly by POPULAR MECHANICS CO.

Copyright, 1917, by H. H. WINDSOR.

Copyright, in France.

## Contents for April, 1917

Aerial Cable Saves Long Haul from Gravel Bed	558
Aerial Transit—Rapid Transit in Mid-Air, by J. E. Murphy	453
Aeroplanes, American, Sixteen Cylinder Engine for	490
Ambulance, Animal, Has Labor Saving Devices	572
Anchors, Apparatus for Testing Strength of	577
Automobile Driving Taught by Novel Method	511
Automobile Has Military and Marine Adornments	565
Automobile Hood, Chauffeur's Odd Method of Keeping Warm on	528
Automobile Tested by Hurdle Jump	537
Automobile, Tiny, Is Dog's Seat on Auto Running Board	558
Aviation—Flying School, Big Army, Started in East	573
Aviation Station, Army, at Mineola, N. Y.	500
Bag, Shell and Game, for Sportsmen	497
Ball, Eight Foot Lighted, on Toledo Skyscraper	517
Balls, Steel, Moving Heavy Loads on	543
Bathing Beaches, Eastern, Protected from Sharks	568
Bayonets, Army, to Lose Their Luster	536
Bear That Killed Man Blown to Pieces	581
Bed, Disappearing, Hidden in Ceiling of Room	525
Bees, Hives of in Bank Window Teach Thrift	509
Belt, Self-Adjusting, for Machinery	592
Benches, Garden, in Shaded Retreats	556
Boat—Excavate Ancient Vessel Remarkably Preserved	508
Boat Hull, Old, Supplies Salt Water for Bath Pool	583
Boat, Lake, Lengthened Forty Feet	530
Boat, Roomy Air Driven, for Texas Streams	531
Book, Huge, to Contain "Deutschland" Stories	498
Bowl, Fish, Acts as Lens and Sets Bed Afire	560
Bridge, Great Columbia River, is Completed	516
Bridge, Great Hell Gate, Nears Completion	533
Building—Hollow Concrete Sphere Is Dance Hall	579
Bulb—Prize White Dahlia Given to California City	513
Burglar Alarm, Automatic, Phones for Help	481
Burner Top of New Type, Outside Trusses Support	512
Camera Clamp to be Used Instead of Tripod	573
Camping Bed Outfit, Auto, for Family	552
Canal Project, Nicaraguan, No Longer Menaces Panama	570
Canoes, Ribless Seamless, of Three Ply Veneer	511
Carnival—St. Paul Folks Again Frolic in Snow	529

Cash Register, Automatic Bookkeeping by	561
Cattle, Hundreds of, Make Quarter Mile Swim	534
Caves, Famous Tennessee, Being Developed	486
Cells, Long-Lived Dry, of New Type	503
Children, Toys and Novelties That Appeal to	600
Climbing Test, Many Applicants Fail in	495
Ciup, Paramaribo's Hospitality Extended at	559
Colors, Standard Set to Designate	510
Compasses of Liquid Type, Soldiers Given	513
Concrete Work of a Railroad, Centralizing	586
Crib—American Adapts African Carrier to Baby's Needs	592
Crib, Folding Washable, and Nursery Table	552
Dance Announcer is Used in Large Country Club	546
Display Case, Adjustable, for Advertising Matter	691
Dog, Lap, Hand Bag Shields from Cold	526
Dog, Wounded War, Fitted with Wooden Leg	528
Doors, Garage, Holders for Safeguard Motor Car	579
Drawing, Isometric, Combination Tool for	602
Drinking Cup, Public, Good Points Embodied in	585
Electric Bulb Lock Fits Any Socket	602
Electric Heating Units for Workmen	590
Electric Lamp, Miner's, of Improved Form	579
Electric Lights, Finger Tip, for Theater Ushers	525
Electric Logs for Fireplaces	568
Electric Motor, Gearless, Operates Phonograph	524
Elephant Enjoys Being Vacuum Cleaned	483
Engine, Heavy Donkey, Carried by Truck	584
Entryway, New Screened, Is Trap for Flies	594
Fiber Vessels Replacing Glass Milk Bottles	593
Fire Ruins, Pictorial, of Department Store	509
Fireplace is Unharmed When Building Burns Down	502
Fish Packing Trade, Labor Saving Machines in	578
Fish—Sturgeon, Big, Nets Large Sum to Fisherman	538
Food Control—War Menus Limit English Dinner Courses	512
Fountain, Bubble, for Ordinary Faucet	488
Frost Coated Window, Realistic Landscape Seen on	518
Fuel in Ashes, Dutch Find New Way to Recover	540
Furniture, Reed, for Warm Weather	588
Gauge, Condition of Steam Trap Indicated by	555
Germany, Preparing for eventualities after Break with	515
Glass, Spun, as Insulation for Steam Pipes	513
Gas Ball Marker Prints Owner's Full Name	538
Golf Clubs—Where Springtime Draws Denver Golfers	597
Gun, Machine, Improved Magazine for	542

(Continued on Page 6)

Popular Mechanics offers no premiums; does not join in "clubbing offers," and employs no solicitors to secure subscriptions. It is for sale by nearly every newsdealer in the United States and Canada.



## [Contents—Continued]

Hair Drier, Convenient, for Women's Use.....	482
Hall, Lecture, with Novel Convenience.....	544
Horse Collar and Hames, Adjustable.....	582
House Boat, Speed, Built on Hydroplane Lines..	582
House Built of Quartz Rich in Minerals.....	547
House, Old, Moved across Bridge over Railway	543
Houses, Railroad Derrick Used to Move.....	496
Ice Sawing Outfit with Motor on Sled.....	531
Insurance—German Concern Founded to Insure	
Unsafe Risks.....	587
Iron Foundry Ladles, Salt Treatment for.....	532
Kitchen Cars, Large, Built for Troop Trains....	503
Land—Vast Tracts Opened Up for Stock Raisers	532
Lawn Mower Sharpener of Novel Kind.....	580
Lawn Sprinkler, Sledlike Base for.....	511
Lawn Sprinkler Works on Novel Plan.....	573
Leather, Scrap, Used in England to Make Soles	548
Life Belt Equipped with Flash Lights.....	507
Lighting System, Flood, Aids Airmen at Night..	552
Lighting System, Overhead, in Movie Studio..	530
Locomotive Pulls Church to New Site.....	438
Locomotive, Squatty Mine, Works in Low Drifts	498
Lunch Counters Designed in Novel Style.....	438
Machine Transported on Its Own Belt Wheel..	577
Magneto of Circular Type for Gas Engines.....	520
Magnetic Pole, Local, in Alaska.....	534
Man, Helpless, How to Lift from Burning Build-	
ing.....	576
Mercury, Magnet Used to Overcome Vibration of	530
Mining, Open Pit Iron, Leaves Land Tillable..	530
Motor Bus Has Open and Closed Compartments	546
Motor Cars, Boys', Adults at Palm Beach Race	517
in.....	
Motor Truck Supersedes Sleds in Alaska Mail	490
Service.....	
Motor Trucks, Wide Tired, Make Own Logging	
Roads.....	555
Motorboat, Stern Extension Makes Skim Water	535
Motorcycle Seat, Low Leather Back for.....	588
Motorcycles, Four, Modern Ben Hur Drawn by	524
Moving Pictures—Vast Audience Shown Film on	
Four Screens Simultaneously.....	506
Moving Pictures, Why Cause Eyestrain.....	438
Musical Instruments, Many, Combined in Movie	
Organ.....	571
Novel Accessories for the Home and Its Members	506
Oil Bath for Lumber Heated Electrically.....	538
Oil from Fruit Stones, Germans Obtain.....	502
Oil Waste Burned after Pumping It into Ditch	586
Oilcan, New, Minimizes Waste of Oil.....	603
Organ, Pipe, in High School Auditorium.....	554
Organ, Pipe, in Store Serves Two Floors.....	480
Packages, Revolving Cone Aids in Sorting....	589
Paint, Always Luminous, for Light Switches...	486
Paper Box, Folding, Made in One Piece.....	592
Paper, Old, Made into New by Cheap Process..	585
Parks, National, Spain to Establish.....	542
Patent Office, Increasing Business of.....	522
Pedals, Adjustable, for the Motorist.....	520
Periscope Reveals Goods in Store Basement...	406
Pictures, Remarkable, in Fish Stall.....	510
Pier, New, for Handling Canal Freight.....	592
Pipes, Bursted, Clamps for Mending.....	602
Police, Mounted—World's Longest Man Hunt,	
by Francis J. Dickie.....	549
Railroad, Alaska, To Build with Canal Equipment	576
Railroad Box Car Carries Autos in Tiers.....	502
Railroad Train and Load Immersed in Tie Treat-	
ing Fluid.....	553
Railroad Trains, Anticollision Buffers and	
Fenders.....	547
Railroad Trains Carry Official Storm Signals...	591
Railroads, Cold Weather Brings Big Problems to	482
Railroad's Right of Way, Farmers Till.....	560
Rails, Used, Bring Same Price as When New..	512
Registry Booth, Rustic, in National Forest...	569
Road, Motor Toll, To Build in Kansas.....	552
Rowing Machine of Small Size and Weight....	536
Ruler, Safety, Prevents Inky Fingers.....	593
Sacks, Device for Sampling Contents of.....	595
Sausage Skin, New Surgical Use for.....	593
Screw Extractor Works Like Corkscrew.....	595
Screwdriver, Pocket, Has Three Bits and Reamer	602
Seeds, Peach and Apricot, Used as Fuel.....	604
Ship—Flagship, Farragut's, with Canvas Spread	487
Ship Knees, Wooden, Made from Fir Stumps..	538
Ship—Lake Steamer Used as Hotel for Work-	
men.....	540
Ship, New, Able to Carry Ammunition or Sup-	
plies.....	488
Ships in Fog, New Eyes are Contrived for....	508
Ships, Sunken, Magnetic Device Fastens Cables	
to.....	583
Shipwreck—Grounded Army Transport Breaks	
in Two.....	535
Shoes Left by Departing Soldiers, Many Obtain	538
Shovels, Foot Rest or Guard for Use on.....	532
Signs, Death's-Head and Humor Make Effective	620
Silo, Special Roof Increases Capacity of.....	570
Silos, Fourteen Sided, Made of Two-by-Fours..	544
Skirt with Leggings for Outdoor Women.....	528
Sled, Air Propeller Pushes at Speedy Clip....	616
Snakes, Den of Discovered by Motorcyclists...	508
Snakes, Harmless, Campaign Against Killing of	505
Solarium, Oscillating, for Taking Sun Baths...	544
Soldiers' Sensations in Battle, by Lewis R. Free-	
man.....	491
Speed Indicator, Novel, for Stationary Racers..	530
Sprinkling and Fertilizing Device, Combination	540
Statue, Striking, Eastern Football Trophy.....	482
Steam Shovel Lifts Its Own Wheels.....	582
Stereoscopic Views Show Stars in Perspective..	586
Sterilizer, Operates Quickly and at Low Cost..	591
Store Entrance Replaced by Show Window at	
Night.....	554
Stove Lid Made Like Iris Diaphragm.....	505
Stump Puller, Rotary, Saves Shavings.....	542
Sugar Process, New, may Increase Production..	504
Tap That Cuts Metal in New Way.....	578
Teeth Filed by Filipinos for Beauty's Sake....	548
Telephone Stands, Costly, in Summer Home...	504
Telescope, World's Greatest, at Mount Wilson..	503
Tent, Sportsman's Bath, Rolls Up Compactly...	509
Thoracimeter—Contour of Girl Students Re-	
corded by Machine.....	507
Tin from Old Cans, Simple Machine Recovers...	522
Toothbrush, New U-Shaped Bristles Used in...	593
Toy Industry in America Grows Rapidly.....	616
Tractor, Army Recruiting Officers Use in Cam-	
paign for Enlistments at Chicago.....	514
Tray, Fruit Picker's, Saves User's Time.....	486
Trees, Dying, Linseed Oil Treatment for.....	580
Trick Performer—Self Liberator Performs Hang-	
ing Head Downward.....	534
Turtles, Catching with Hooked Steel Rod.....	503
Typewriters, Shock and Sound Absorber for...	530
Vagrancy, Turning to Account, by Louis J.	
Hennessey.....	574
Vegetable Ivory Waste as Stock Food.....	632
Vehicle—Ricksha, One Wheeled, Used on	
African Trails.....	489
Vial, Convenient, for Keeping Serum.....	576
Voices of Great Singers Visualized for Study..	513
War, European:	
Ship—Transport, Grim Moments Follow Sink-	
ing of.....	519
War, Europe's, Human Interest Phases of...	520
War Pictures, Unusual, Passed by Censor...	522
War's Progress, Striking Pictures Telling...	523
Watches, Electricians', Rubber Sheaths Safeg-	
uard.....	508
Water Supply of Canal Zone Closely Computed	436
Watering Trough Designed to Prevent Freezing	599
Wharves, Florida, Have Novel Bulkhead.....	518
Windmills, Small, Used by Herring Fisher....	532
Wireless Station, Powerful, for Use of Navy...	537

## SHOP NOTES

Armature Section, Short Circuited, Repairing..	604
Ash Can, Garden Hose on Rim Makes Noiseless	622
Automobile, Double Hood Roadster.....	617
Automobile Speeds, Formula for Calculating....	619
Automobile Steering Connections, Care of.....	606
Blowtorch, Raising Level of Gasoline in.....	611
Box, Shop Order, Saves Time of Workmen.....	619
Brush Preserver and Carrier, Painter's.....	612
Castings, Irregular, Stand for Stacking.....	618
Chuck, Universal, Repairing Damaged.....	616
Concrete Pipes, Lowering into Well.....	622
Concrete Tile Machine, Homemade.....	615
Curtain, Weather, for Converted Sleeping Room	615
Drum in Table Top for Listing Merchandise Sale	621
Electric Drier Used in Drafting Room.....	620

[Contents Continued on Page 8]



**MAIL COUPON**For Spring and Summer  
**STYLE BOOK****70 SAMPLES  
FREE****BERNARD-HEWITT & CO.,**Desk F24, 424-434 So. Green St.,  
**CHICAGO, ILL.**Please send me your new Spring style  
book with 70 samples free — also full  
details of your special lining offer.

Name .....

Address .....

**Handsome \$25 Blue Serge  
Suit Made to Measure only \$15**

**A** SPECIAL proposition to introduce the wonderful values offered by our system of tailoring. We have no agents — no dealers — no traveling salesmen — our values make their own customers — and once a Bernard-Hewitt customer always a Bernard-Hewitt customer. That's why, to secure your first order, we are willing to make to your individual measure, a handsome, all pure wool worsted blue serge suit (usual \$25 value) for only \$15 and line it with a

**\$4 SATIN  
LINING FREE**

Remember this suit is made to your individual measure from the very finest all wool blue, light blue, black or gray serge, in the latest approved Chicago style, and by the very best tailors in this whole city.

But perhaps you don't care for a serge suit. Well, our big book which we will send you free contains generous samples of the latest fabrics; plain and fancy mixtures, the up-to-the-minute offering of leading woolen mills.

The \$4.00 Satin Lining free offer goes no matter what selection you make — and we pay all shipping charges. We take all the risk — you none — for this is

**OUR GUARANTEE** You Don't Pay  
Us One Cent

Unless you are more than pleased in every particular in fit — in style — in workmanship and in materials. Could anything be fairer? Write today — wear real tailor-made clothes — dress better and save money.

**Take Your Own  
Measure — Save \$10****Write for Your Copy of Our Big Book Today**

Our big new Spring and Summer book is ready for you — contains 70 samples latest woollens — also lowest prices on men's hats, shoes and furnishings. It is your guide to correct and economical clothes buying. Mail coupon above or send post card for your copy. Please mention POPULAR MECHANICS so that we can identify this special offer.

**BERNARD-HEWITT & COMPANY**

424-434 So. Green St.

Desk F24

CHICAGO, ILLINOIS

**WE PAY  
SHIPPING  
CHARGES**



## The Automobile Business is Growing

More help needed and big pay. No other business offers such opportunities. It's easy to learn. An Auto Repairman is not a machinist—his work consists of adjustments and re-fitting worn parts, "knowing the principle," that's the thing. One of our students writes: "Before I started with your course I was a clerk at \$50 per month. After finishing I followed your instructions, started a repair shop and cleared \$122 the first month—pretty good for the first month." Let us show you this and many other letters.

## LEARN THE Automobile Business during your spare time

WE CAN HELP YOU IN 3 WAYS:

- 1st We can teach you quickly and thoroughly.
- 2nd After we teach you, we have a plan to assist you in getting started in the actual practical line of work and assist you in getting actual driving experience.
- 3rd While we are teaching you we show you how to make money right on the start.

## THE DYKE WORKING METHOD

of teaching by mail is a new invention—a new idea—we use real 4 and 6 cylinder engine models—11x11 1/2 inches—on which you can actually see all parts moving—it is the only system of its kind in the world.

This is one of the 7 real models used in addition to 50 simplified instructions with hundreds of illustrations, charts and manikin.

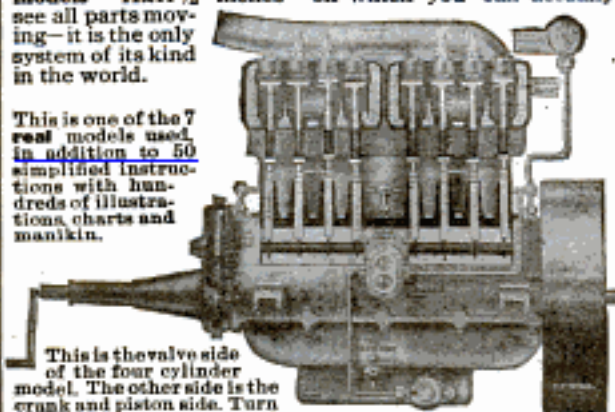

This is the valve side of the four cylinder model. The other side is the crank and piston side. Turn the crank and all of the real metal parts actually operate. The six cylinder engine model is similar.

This system is endorsed by Barney Oldfield, Elwood Haynes, Chas. Duryea and other motor authorities.

Mr. Dyke has been identified as a pioneer inventor, supply man, etc., with the auto industry since its beginning. He originated the first auto supply Co. and manufactured and marketed the first float type carburetor in America. No other man with such experience is today teaching others.

If we prove to you that we have started hundreds of others into the repair business and as chauffeurs—who had no previous experience and who knew no more about an auto than you do right now—you must admit we can do the same for you. Write me TODAY—NOW—and LET ME PROVE IT.

## Write for DYKE'S FREE BOOKLET

It is interesting and instructive in itself. Fully illustrated. Learn how you can get all this training for only \$15. Fill out below or write a postal—but do it NOW.

Send me your free 32-page booklet about your new Idea Working Model Course and testimonials and proofs. It is understood I am under no obligations in sending for this.

It is understood I am under no obligations in sending for this.

Name.....

Address.....



Deal with the originators. Beware of imitators. This school is a department of the firm of A. L. Dyke, Pub. and Importer, Box 188, Roe Bldg., St. Louis, Mo.

## (Contents—Continued from Page 6)

Engine, Adhesion and Impulse.....	614
Eyeglasses, Broken, Improved Frame for.....	618
Faucet Tap for Large Cans.....	606
File Cabinet, Drawing, Protective Flap for Drawers of.....	618
Flag, Illuminated, Remains Unfurled.....	620
Garage, Ridding of Automobile Exhaust Gas....	611
Gold Leaf, Manipulation of.....	616
Headlight as Emergency Lamp for Operating Room.....	611
Hose Coupling, Positive Grip.....	620
Insulation of Splices, Proper.....	603
Insulators, Porcelain, Cutting.....	612
Key, Drawer, Adjusting to Insure Privacy.....	617
Ladder, Folding Bracket for.....	618
Lettering, Line Guide for.....	622
Light, Shop, Radial Pivoted Arm for.....	604
Motorboat—Building a Fast 19-Foot Runabout	607
Oil Cups Remodeled to Adjustable Feed.....	619
Pipes, Long, Handling in Small Shop.....	612
Plaster, Preventing Breaking of by Door Knobs	613
Pump Plunger, Loose, Babbitt Collar Overcomes	622
Safety Pins, Small Cutters or Dies Kept on....	613
Sawhorse, General Utility.....	613
Shelter House, Rustic Four Square.....	603
Sink for Washing Blueprints.....	611
Soapsuds Reduces Carbon Deposit in Compressor	614
Spring, Safety, for Variety Wood Molding Machine.....	604
Stones, Slip, Holder for.....	612
Storage Battery, Carrying in Tool Box.....	620
Thread, Loose Wooden, Making Fit Tightly.....	616
Tire Fabric, Device for Cutting on Bias.....	612
Tool Rack, Trolley, for Shop or Laboratory....	613
Trees, Large, Transplanting.....	605
Washers, Cupped Leather Piston, Making.....	610
Water Gauge, Electrical.....	621
Wrench Adapted Easily for Many Uses.....	606

## AMATEUR MECHANICS

Bird Basin, Simple Metal.....	632
Box, Automatic Lock, for Milk Bottles.....	628
Button Clasps, Old, Practical Uses for.....	632
Cabinet, Sportsmen's, for Guns, Equipment and Books.....	624
Camera for Bird Photography.....	626
Camp Kitchen Cabinet and Table, Combination.	623
Cane Made of Tubing Contains Cigars.....	630
Cane, Patching Canvas Bottom of.....	630
Cart for Carrying Huge Drum in Parade.....	625
Chair Arm, Detachable.....	620
Chest Expander, Comic, for Play or Stage Use.	629
Chest, Homemade, Linoleum Panels for.....	625
Closet, Rigging Economizes Space in.....	633
Door Screen, Device at, Frightens Flies.....	625
Drawing Board, Tool Sockets for Edge of.....	635
Electric Fan Aid to Heating Room.....	626
Electric Light Fixture, Homemade Inverted....	635
Fencing, Portable Sectional Poultry.....	639
Fuel Box in Seat Filled from Floor Trapdoor..	638
Golf Tee Made of Shotgun Shell.....	630
Headrest, Removable, for Chair.....	632
Hinge, Double Swing, Plain Butts Used as....	636
Key Ring Used as Cover Fastener.....	630
Lamp, Bark Covered Porch, and Plant Shelf....	632
Lamp, Small Desk, Supported by Paper Weight..	624
Life Buoy, Homemade.....	623
Lock, Effective Combination, Easily Made....	631
Milk Pail, Knee Rest Holder for.....	634
Pencils and Penholders, Handy Tray for.....	630
Phonograph Needles, Worn, Uses for.....	639
Photo Print Washing Device, Automatic.....	639
Photographic Negative Filing System.....	634
Register, Hot Air, Catch All Screen Inside....	632
Relay, Homemade, of Inexpensive Materials....	638
Scarecrow, Cat and Bells.....	626
Scoop Made of Box End.....	633
Sheath, Locking, for Hunter's Knife.....	628
Skylight, Portable, for Home Portraiture.....	636
Spring, Couch, Removing Sag from.....	630
Spring, Discarded Buggy, for Diving Board..	629
Suitcase Holder for Running Board of Automobile.....	639
Swing, Porch, Made from Automobile Seat....	625
Table, Folding, with Split Bamboo Tray for Top	624
Toothbrush, Old, Uses for.....	628
Toy Pigeon, Mechanical, Made of Wood.....	633
Turbine, Small Hydraulic.....	627
Water Wheel Turns Spit over Camp Fire.....	629
Wheelbarrow for Large Cans.....	636



# Learn Piano Twice Faster By *Scientific* "Short Cut"

Wonderful Invention now saves you months of time and effort—  
Leaves nothing out, but gets you there sooner—Cuts cost in half, too.

You learn more *thoroughly*—play more artistically, more individually—thousands who have tried it say so. Old-fashioned, round-about methods *must yield to scientific, direct methods*. It's the Law of Life.

## A Momentous Discovery

After twenty-five years of painstaking, technical research, Dr. Quinn discovered the great Law of Nature that the "vibration waves" of twelve tones in music (Key of E) *exactly coincide* with the "vibration waves" of twelve tones in color. This simple Law of Nature, like all such laws, opened out whole worlds of PRACTICAL BENEFITS—and led to Dr. Quinn's inventing the COLOROTONE.

## Easy to Understand—For Beginners or Experts

The COLOROTONE, like all great inventions, is simplicity itself. Children master it as easily as grown people. It brings the same amazing results to experts that it does to beginners. Investigate without cost, by writing today for 64-page free book explaining all about it.

## Sweeps Away Century-Old Stumbling Blocks

The important musical subject of Transposition—usually a "night-mare" to students—becomes easy and fascinating by the use of the COLOROTONE. The COLOROTONE enables you to master, from the very beginning of your study the great Liszt System, by which you play every piece in *every key with exactly the same fingering*. Formerly this great time-saver could be taught only to *advance students*. By using the scientific COLOROTONE you start the Liszt System in your *third lesson*—a tremendous advantage. And the COLOROTONE has scores of other equally important advantages. Write for free book.

## Nothing Else Like It—No Special Music Necessary

There is nothing else even remotely like the COLOROTONE. It stands on the keyboard before you and instantaneously solves, by correct, scientific methods, all kinds of troublesome playing problems. After the first dozen lessons you discontinue using the COLOROTONE. Almost miraculously it has taught you; and you thereafter play without using it. No special music is necessary. You play by note from *any* music.

## Surprising Results of Learning By a Scientific System

It's amazing to see how quickly you gain skill at either the piano or organ, and how expressively and feelingly you can play. Men and women who have failed by all other methods have quickly and easily attained success when using Dr. Quinn's COLOROTONE, and his famous WRITTEN METHOD. Dr. Quinn's WRITTEN METHOD (now including the COLOROTONE) is a complete COURSE IN PIANO OR ORGAN for home study. Each of the clearly-written lessons leads you logically, correctly, and systematically to playing skill. The COURSE is fully illustrated with diagrams and drawings showing every position and movement of the fingers, hands, and arms. Thus you rely not on your memory of verbal instructions, which must sometimes be incorrect, but on detailed illustrations and explanations *always before you*. Nothing is, nor can be forgotten. You practise in spare time, at your convenience, in the privacy of your own home. Progress as rapidly or slowly as you wish. All necessary music is included *Free*. Diploma of recognized value is granted.

## Endorsed by Distinguished Musicians

Among our graduates are thousands of accomplished amateur players, as well as prominent professional players, successful music teachers and leading composers. The COURSE is endorsed by many distinguished musicians and educators in whose opinion you have the utmost confidence.

## Investigate Without Cost—Special Offer

Write *today*, using post card, letter or free book coupon, for our new 64-page book explaining everything you want to know about how to study music and learn to play piano or organ in less than half the time usually required. The book gives full particulars of our COURSE and wonderful COLOROTONE and is a possession *worth having*. Special reduced terms this month on account of our Twenty-Fifth Anniversary offer. Investigate without cost or obligation *now*.

**Marcus Lucius Quinn Conservatory of Music**  
Social Union Bldg., Studio K. P., Boston, Mass.

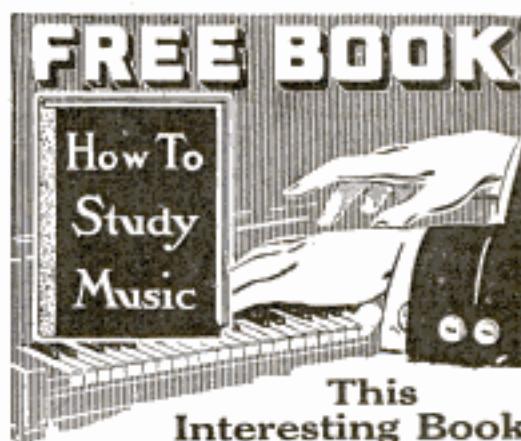

contains 64 pages of vital information about how to study music and learn to play the piano or organ. It explains the great pleasures and social advantages of skill at the piano or organ and tells how you can acquire this skill at half the usual cost and effort by a method of home study which is scientific. It tells how you can become a music teacher and earn \$25 to \$100 weekly. It tells how you can become a professional player at a liberal salary—and how the world's greatest pianists, organists and composers earned their way to Fame, Honor and Wealth. It fully explains everything about Dr. Quinn's wonderful COLOROTONE and his famous WRITTEN METHOD. Send for this remarkable free book at once. No cost or obligation.

**Free Book Coupon**

Quinn Conservatory  
Social Union Bldg.,  
Studio K. P., BOSTON, MASS.

You may send me without obligation or expense your 64-page Free Book "How To Study Music," explaining Dr. Quinn's COLOROTONE, his WRITTEN METHOD, your Twenty-Fifth Anniversary offer, and other interesting information about how to learn piano or organ.



Write

Now

NAME .....

ADDRESS .....



# Grow Younger as You Grow Older

**Younger in Body, Younger in Spirit, Younger in Ambition, Younger in Every Characteristic that Gives Greater Earning and Living Power, Greater Thought Power, Greater Pleasure Obtaining Power and Greater Health Promoting Power.**

**T**HE number of years a man has lived does not tell how old or young he is. A man is as old or as young as his energy, his vitality, his capacity for work and play, his resisting power against disease and fatigue.

A man is only as old or as young as his memory power, will power, sustained-thought power, personality power, concentration power and brain power. He is only as old or as young as his digestive power, his heart power, his lung power, his kidney power, his liver power. *Age is measured by the age of our cells, tissues and organs, and not by the calendar!*

## Cultivate the Cells

Everybody knows that the body and brain are made up of millions of tiny cells. We can be no younger than those cells are young.

We can be no more efficient in any way than those cells are efficient. We can be no more energetic than the combined energy of those cells.

By conscious cultivation of those cells, it is as natural as the law of gravity that we become more efficient, more alive, more energetic, more ambitious, more enthusiastic, more youthful. By consciously developing the cells in our stomachs we must improve our digestion. By consciously developing the cells in the heart, we must increase its strength in exact proportion. By consciously developing the brain cells, the

result can only be multiplied brain power—and so with every organ in the body.

What we are and what we are capable of accomplishing depends entirely and absolutely on the degree of development of our cells. They are the sole controlling factors in us. We are only as young and as great and as powerful as they are.

## There Is No Fraud Like Self-Deception

You may think you are young, strong, brainy, energetic, happy, yet when compared with other men or women, you are old, weak, dull, listless, and unhappy. You do not know what you are capable of accomplishing because you have not begun to develop the real vital powers within you. The truth is you are only a dwarf in health and mind when you can easily become a giant through conscious development of every cell, tissue and organ in your body and brain. By accelerating the development of the powers within you, you can actually become younger, as you grow older—yes, younger in every way that will contribute to your health, happiness and prosperity.

## Conscious Evolution —the Secret

*Swoboda proves that Conscious Evolution gives energy and vitality to spare, digestive power to spare, self-reliance to spare, and gives many other desirable characteristics to spare. He proves that Conscious Evolution makes people disease-proof, fatigue-proof. He maintains that to possess sufficient vitality and energy and to keep the body in normal health under the most favorable conditions is no more health prosperity than to have only enough money from day to day to meet current expenses. Great reserve health, great reserve energy is what we must acquire if we are to successfully nullify the ravages of time, and to easily overcome every adverse condition and thus enjoy the benefit of our resources, the benefit of our health power and the advantage of our energy.*

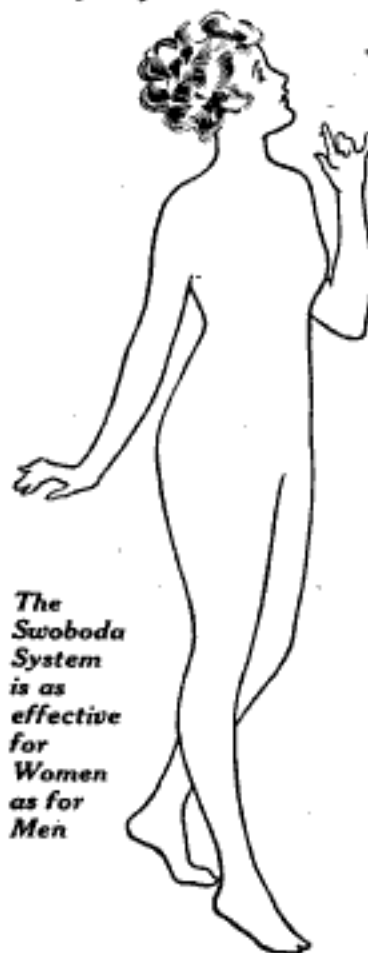

*The Swoboda System is as effective for Women as for Men*



### Beware of Health Poverty

As Swoboda says, "there are individuals who seek work only when their last cent is gone. Likewise, individuals live from minute to minute and from day to day, seeking health and energy only as they need them badly."

Conscious Evolution is for them — for everyone. It is a simple, scientific and practical system by means of which every part of the brain and body is energized, strengthened, awakened, so that we become possessed of a super health and mentality — the Swoboda kind of health and mentality. Conscious Evolution makes for good fortune by developing the resources and the ability and power of personality.

Strange as it may seem, this revolutionary method of consciously awakening and developing weakened and lifeless cells requires no drugs, medicines or apparatus of any kind. It does not require dieting, deep breathing, excessive exercising, cold baths, electricity or massage. It takes only a few minutes a day, yet so startling is the effect of Swoboda's system that you begin to feel younger, renewed, revitalized, re-energized after the very first day.

### An Amazing Book for You

Swoboda has published for distribution a remarkable book which explains his system of Conscious Evolution and what it has already done. Write for this book — not because Conscious Evolution has meant so much to 200,000 other men and women, not because there is scarcely a prominent family in the country that hasn't at least one member a pupil of Swoboda, including Chas. E. Hughes, Woodrow Wilson, Rockefeller, the Vanderbilts, the Goulds, the Huntingtons, the Armours, the Cudahys, the Swifts — but write for the book because it means so much to you in multiplied living power, earning power and resisting power. It is a big book filled from cover to cover with the vital facts about yourself and how you can acquire the degree of perfection in body and mind that you so much desire. It exposes the dangers of excessive deep breathing, excessive exercise, and excessive muscular development.

Regardless of how young you may feel, of how efficient you may think you are — regardless of how active, energetic and alert you may consider yourself — regardless of how happy, how contented you may pride yourself on being — regardless of how healthy, wealthy or successful you may be, you cannot afford, in justice to yourself, to miss the interesting and instructive secrets explained for the first time in this startling new book.

A mere reading of "Conscious Evolution" will so fill you with enthusiasm and ambition that you will not rest until you have yourself acquired the Swoboda kind of health and energy by cultivating and revitalizing intensively every cell, tissue and organ in your own system. Tear out the coupon on this page, write your name and address on it or write a letter or a postal card and mail it today. Even if you gain but one suggestion out of the 60 pages you will have been repaid a thousand fold for having read it. I urge you by all means not to delay, not to say, "I'll do it later," but to send now, while the matter is on your mind. Remember, the book is absolutely free for you to keep — there is no charge or obligation now or later. Write now. Address

**ALOIS P. SWOBODA** 2032 Aeolian Building  
NEW YORK CITY

Beware of individuals pretending to be my agents or representatives. All such are impostors and frauds. — Swoboda.

CREATOR OF CONSCIOUS EVOLUTION



*Swoboda*

A Remarkable Personality

Swoboda, himself, is perhaps the most perfect example of what Conscious Evolution can accomplish. As Swoboda gains in years, he is growing younger in enthusiasm, younger in vitality, younger in health; he is becoming stronger, more energetic, more confident, more dominant, more alive, by capitalizing his creative powers through Conscious Evolution. What Swoboda is accomplishing for himself you can accomplish — every individual can accomplish, for every individual is governed by the same laws and principles, and every individual can make use of the same laws and principles. His mind and body are so ALERT AND ACTIVE that in his presence one feels completely overpowered. His personality dominates everything with which it comes in contact; yet Swoboda is REAL — there is absolutely nothing MYSTERIOUS about him. He knows not what fatigue is — he is a TIRELESS WORKER. He delights in making sick people well and weak people strong. He loves his work because he is of benefit to humanity — making a BETTER, more VITAL, more POTENT race of men and women.



**ALOIS P. SWOBODA**  
2032 Aeolian Building  
NEW YORK CITY

Please send me your free copyrighted book, "Conscious Evolution."

Name.....

Address.....

City..... State.....



# These books will help you to greater

# Electr

## PARTIAL CONTENTS OF THE 10 GUIDES

**No. 1.** Contains 240 pages, 246 illustrations. Electrical signs and symbols—static and current electricity—primary cells—conductors and insulators—resistance and conductivity—magnetism—induction coils—dynamo principles—classes of dynamo, etc.

**No. 2.** Contains 218 pages, 256 illustrations. Armatures—windings—commutation—brushes—motor principles—armature reaction—motor starting—calculations—brake horsepower—selection and installation of dynamos and motors, etc.

**No. 3.** Contains 276 pages, 280 illustrations. Galvanometers—standard cells—current measurement—resistance measurements—voltmeters—wattmeters—watt hour meters—operation of dynamos—operation of motors, etc.

**No. 4.** Contains 308 pages, 423 illustrations. Distribution systems—wires and wire calculations—inside, outside, and underground wiring—sign flashers—lightning protection—rectifiers—storage battery systems, etc.

**No. 5.** Contains 278 pages, 379 illustrations. Alternating current principles—alternating current diagrams—the power factor—alternator principles—alternator construction—windings, etc.

**No. 6.** Contains 272 pages, 538 illustrations. A. C. motors—synchronous and induction motor principles—A. C. commutator motors—induction motors—transformers—losses, construction, connections, tests—converters—rectifiers, etc.

**No. 7.** Contains 320 pages, 460 illustrations. Alternating current systems—switching devices—circuit breakers—relays—lightning protector apparatus—regulating devices—synchronous condensers—inducting devices—meters—power factor indicators.

**No. 8.** Contains 288 pages, 330 illustrations. Wave form measurement—switch boards—alternating current wiring—power stations—turbines—management, selection, location, erection, testing, running, care and repair.

**No. 9.** Contains 576 pages, 849 illustrations. Telephones—telegraph—wireless—electric bells—electric lighting—photometry—electric railways—electric locomotives—car lighting—trolley car operation, etc.

**No. 10.** Contains 704 pages, 730 illustrations. Miscellaneous applications—motion pictures—gas engine ignition—automobile self-starters and lighting systems—electric vehicles—elevators—cranes—pumps—air compressors—electric heating—electric welding—soldering and brazing—industrial electrolysis—electro-plating—electro-therapeutics—X-rays, etc.

Also a complete ready reference index of the complete library.

The work of the world today is done by electricity. Electricity runs our machines; transports our goods; lights our homes, shops and factories; heats our buildings—is indispensable in hundreds of ways. Opportunities in electricity are greater than ever before. Exact electrical knowledge means more money and greater success for you.

## HAWKINS ELECTRICAL GUIDES

give you ALL the electrical information you want, in the shortest, most concise form—namely, by means of questions and answers and unlimited illustrations. No matter how great or how little your previous knowledge of the subject at hand, you "get the point" at once in Hawkins Guides. They are absolutely complete—brought right up-to-date—the last volumes are just off the press.

### FLEXIBLE POCKET-SIZE TEXTS Arranged for Home Study and Reference

They are the handiest books to read and to use, ever produced. In flexible, black covers, leather binding—just the right size—5x6½ inches—to fit in your pocket, so that you can carry each single volume about with you until you have mastered its contents. The whole set fits easily in the hollow of your arm, and still there are actually 3,500 pages and 4,700 illustrations.

**10 Practical Volumes. 3500 Pages. 4700 Illustrations**  
**\$1 Per Volume—Payable \$1 Per Month**



# success through

# electricity

## WHAT USERS SAY

"Every Electrician, Operating Engineer or Student who wants to advance himself in the Electrical field should have a set of these books."

JOHN KELLEY, 116 Union St., Newark, Ohio.

"For the man not getting a college training, and even in that case, I can sincerely say I do not believe there is a better set of books on the market today."

LLOYD D. HUFFMAN, Dayton, Ohio.

"We consider Hawkins Electrical Guides the most compact and complete set of electrical references in the market."

NOGOLA ELECTRIC WORKS, Monterey, Cal.

"Hawkins surely knows the art of condensing information."

ELDRIDGE F. BALL, Buckland, Conn.

"I think they should be in the hands of everyone who has anything to do with Electricity."

T. B. MURPHY, Orange, Va.

"For the practical electrician, they are the best books published—worth many times their price."

L. C. WAGNER, Wyoming, Ill.

"I have gained valuable information from them which has helped me directly in my line of work."

HERMAN NODENBERG, Hoboken, N. J.

"They are wonderful value. Everything is so clear and concise. Even one who had no knowledge of Electricity would have no difficulty in grasping the facts."

F. L. TAYLOR, Amesbury, Mass.

"It is the best work an apprentice can study if he wants to get ahead in his trade. As a reference for the experienced worker HAWKINS ELECTRICAL GUIDES are unexcelled."

I. McCLELLAN, Chillicothe, Mo.



**THE ENTIRE SET of  
10 VOLUMES**

**SHIPPED TO YOU FREE**

Send no money. Examine the books first. Use them for seven days in connection with your work, and decide for yourself that they are the most complete, the most helpful and the clearest written electrical books ever published. This unusual offer is a sign of our confidence in the Guides.

**EASY PAYMENTS** Accept the offer now—mail the coupon today. If you decide to keep the books you can make settlement at only \$1 per month until paid for.

**THEO. AUDEL & CO.**  
72 Fifth Avenue  
NEW YORK N.Y.

**THEO.  
AUDEL & CO.,**  
72 Fifth Avenue, N. Y.

Please submit me for examination Hawkins Electrical Guides (Price \$1 each). Ship at once, prepaid, the 10 numbers. If satisfactory I agree to send you \$1 within seven days and to further mail you \$1 each month until paid.

Signature.....

Occupation.....

Business Address.....

Residence.....

Since we have not yet had the pleasure of business relations with you, we shall appreciate your giving us name of reference on line below

Reference.....

P. M. Apr. 17

Please Mention Popular Mechanics

Copyrighted material



# The Way to go Back to the

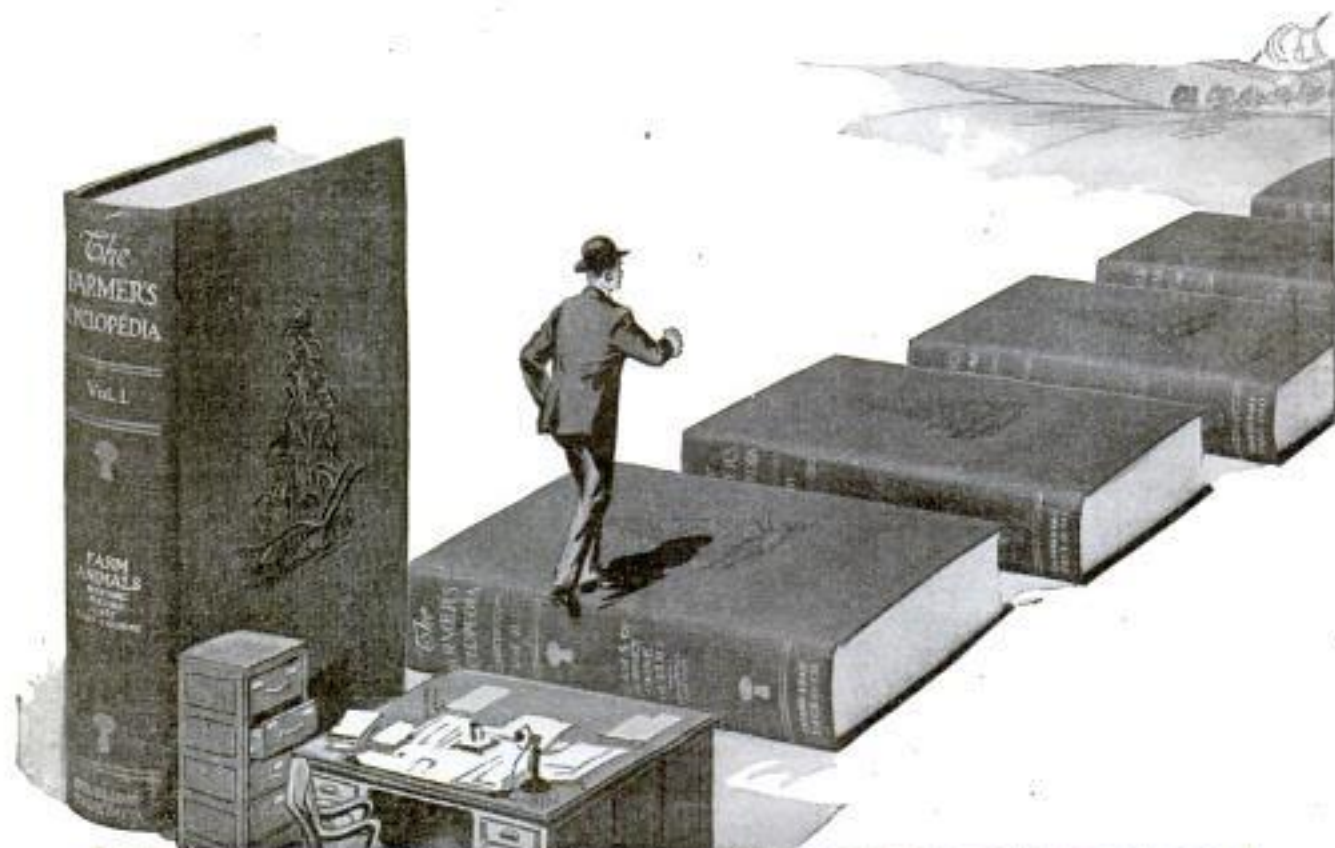

**The Lure of the Farm**— that is in every man's heart, the thrill of the soil, the craving to create, to see things grow and to grow himself, to plant and harvest, to feed and be fed, to build up physical strength and financial independence, to reap the full reward of his own efforts, to breathe deep of clean country air, to watch his family learning lessons from the birds and flowers, to rest his eyes and his mind with distant views of field and stream, to become gloriously tired, ravenously hungry and to fall asleep with the restful noises of the rural night murmuring to him, to walk upon his own land, to rest upon his own front porch, to make sure the comfort and independence of his future — this is the lure of the country home — the joy of the farm.

## The Farmer's

FOR the man who wants to go back to the farm and for the man on the farm who wants to increase his earnings — here is your guide to success.



# Farm—and make Money

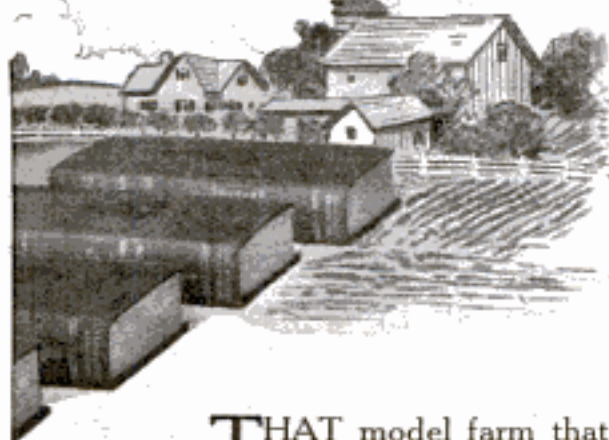

**T**HAT model farm that is going to take you away from the crowded city and make you independent is right here within the pages of the Farmer's Cyclopedic.

It cost Uncle Sam \$4,000,000 to put this farm on paper for you. It took the U. S. Dept. of Agriculture ten full years to gather the whole truth about this ideal American farm. Yet we will sell it all to you for a few cents a day. (Read the coupon.)

The Farmer's Cyclopedic covers the whole subject of farming; from buildings to care of the soil, from farm management to marketing the crops. It takes seven big books to hold the results of all these government tests and investigations, but we will sell them all to you for a few cents a day.

This Cyclopedic is the greatest farm implement ever produced. It will teach farming to a man who has never seen a farm; and will help the most experienced farmer in every branch of his work. It's the whole farm, and every kind of a farm, put on paper by experts. No matter

where you want to farm, North, East, South or West—no matter what kind of a farm you have or want, the Farmer's Cyclopedic will tell you how to run it.

Among its thousands of facts, it will tell you all about the following subjects:

- Farm Buildings**—how to plan and build on the farm.
- Farm Management**—U. S. Government Tests.
- Farm Machinery**—how to run it, care for it, use it.
- All about Poultry**—covers the entire subject.
- Feed and Care of Dairy Cows**—this alone worth the price.
- Dry Farming**—full details of this great movement.
- Intensive Farming**—the way to double your profits.
- Domestic Science**—how to keep house easily, economically, attractively.
- Fruit**—how to raise it, protect it, get larger yield.
- Crops**—Government experts tell all about all kinds of crops.
- Irrigation**—how deserts were turned into gardens.
- And all those special undertakings that are now making small farms so profitable.

The Hon. F. D. Coburn, the world's master farmer, says:

"Today, farms are run less by hand-power and more by brain-power.... That is why farm life says to the city man: 'Come out to the land and share in this prosperity. ... That is why I stand back of these books, this great FARMER'S CYCLOPEDIA.... These volumes cover every important phase of farming, from the planting and the growing, to the home life and the home."

**FREE**—We give Coburn's Manual, the wonderful book in which he analyzes and explains the big service rendered by the cyclopedic, to every purchaser of the FARMER'S CYCLOPEDIA. (Don't forget the coupon.)

Just think what you get for some easy monthly payments: 7 great volumes, strongly bound; 5,000 pages of proven farming facts; 3,000,000 words of the most valuable farm helps; pictures, charts and diagrams by the hundred, \$1 down and \$3 per month until \$29.50 have been paid—that's all it costs you to own these \$4,000,000 worth of farming facts. (Now cut out and fill in the coupon.)

Do you want to make more money out of your truck garden, your chickens and eggs, your dairy, your hogs, grain-fields, orchards; do you want to know how to plant, cultivate and harvest some special crop; do you want to know how to sell at the best market prices?—then mail that coupon now.

**YOU RUN NO RISK**—If the books do not please you after ten days' reading, send them back and we will at once return your dollar. Here is a great opportunity. No other books are like them. They will tell you how to make more money—with less work—from any farm. So mail the coupon.

Doubleday,  
Page & Co.,  
Department 304,  
Garden City, N. Y.

I want to see that Farmer's Cyclopedic, all of the 7 volumes and the (free) Coburn Manual. Here's my dollar. If I like the books I will send \$3 each month until \$29.50 has been paid. If I don't like them I'll send them back in ten days and you are to return my dollar.

Name .....

Address .....

**SPECIAL** For one extra payment we will send you The New Country Life for a whole year. If you want this great magazine, write "yes" below.

# Cyclopedic

**Coupon — mail it quick**



# LEARN AUTOS

*Where Autos are Made*

Detroit is a city of motors. Eighty-five per cent of the motor cars in the United States are said to be made here. Here are located 40 or more auto factories, hundreds of parts makers. Detroit *makes* automobiles, *sees* automobiles, *thinks* automobiles day and night. Detroit is the *place* to learn the auto industry, and the Detroit Y. M. C. A. Auto School is the *school* at which to learn it.

## Backed by Automobile Factories

The automobile men of Detroit endorse our work without hesitation. The Studebaker, Buick, Hupp, Ford, Packard, Gray Motor, Disco, Zenith, Chalmers, and many others have contributed to our equipment their latest models and designs. Can you ask stronger proof of a school's standing than the fact that the *men who know* give freely their time and money to co-operate with it and aid in its growth.

## Not Operated for Profit

The Y. M. C. A. Auto School is not run for profit. Our purpose is to give our students the training necessary to get and hold good paying positions in the rapidly growing automobile industry. Tuition goes to procuring the highest class of instructors and the best of equipment. The automobile business is crying for trained men,—testers, chauffeurs, inspectors, salesmen, assemblers, repair men, bearing scrapers, motor mechanics of every description. Factories, dealers and garages join in the call. We fit you for these positions. Will you take advantage of this opportunity.

## Tuition Includes Membership in the "Y"

Tuition at the Y. M. C. A. Auto School is low — and *includes a year's membership in the "Y."* Our big Club House is at your disposal during time off. Reading rooms, lounging rooms, gymnasium, swimming pool, billiard and pool tables, bowling alleys, with five floors of dormitories and restaurant at low rates. You are assured of not only thorough and competent instruction, but good companionship and clean living conditions with the comforts of home and club life combined.

## Don't Visit Detroit Without Seeing Us

You want to consider everything carefully before you enroll for any course of instruction. Come and look us over, whatever purpose brings you to Detroit. Get all the particulars of this school, get the records of our instructors, hear what auto factories and automobile men have to say about us, see for yourself our comfortable quarters and big equipment. We will be glad to see you and show you around whether you enroll or not. Day and night classes. Start at any time. The average time required is 6 weeks for day course, and 12 weeks for night course.

WRITE TODAY FOR FULL PARTICULARS. Address

Educational Director, Box 305, Y. M. C. A., Detroit, Mich.



Main Building Y. M. C. A.  
Detroit



Students Working on Axle  
and Transmission



Block Testing and Motor  
Department



"Y" Auto School Repair Shop



Lecture and Demonstration  
of Chassis







# Aviation

## Learn Practical Aeronautics By Mail

**F**OR the first time in the History of Aviation, a Practical and Efficient Correspondence Course is waiting for you under the direction of Qualified Aviators and Aeroplane Builders, and a **Special Offer of Great Importance** is yours, if you will send the coupon at once.

Aviation is in its infancy. It stands today where the automobile and moving picture business did ten years ago. And the big men, the money kings in these colossal enterprises were ten years ago obscure mechanics with less opportunity than you have today with this wonderful Course in Practical Aeronautics. Now is the time to rise with the tide that means to you both fame and fortune.

## Earn \$50 to \$500 a Week!

Today there is a great demand for men in all branches of Aviation. Experts in Aeronautics command tremendous salaries. Government Branches, Aero Societies, Aeroplane Builders, Repair Shops and others are clamoring for trained men.

We prepare you by mail to train for flying—at home—in spare time to fill any of these positions:

**Aeroplane Mechanic**  
**Aeroplane Builder**    **Aeronautical Engineer**  
**Aeroplane Salesman**  
**Aeroplane Assembler**    **Aeroplane Repairman**  
**Aeronautical Contractor**  
**Aeronautical Instructor**    **Aeroplane Inspector**

No matter what your present business may be, equip yourself NOW to take up the new profession of Practical Aeronautics. Send the Coupon today for full particulars of our Course and the Special Offer we are now making. This is your opportunity.

## Highest Endorsement By Aviation Authorities

This wonderful Course is highly endorsed by leaders in Aviation and Flying Organizations. It has their unqualified approval as a quick and reliable basic training for the business of Aviation. Under the personal direction of Mr. Bud Morris, well known Aviator and Instructor, assisted by a distinguished Staff of Aviators, Aeroplane Manufacturers, and Aeronautical Engineers, you learn all about this fascinating, profitable profession. Every Lesson, every Lecture, every Blue Print and Bulletin self-explanatory, in plain terms, for quick understanding. Your training is thorough and complete. A common school education is all that is necessary to thoroughly understand the Course. Get the facts today. Send the Free Coupon.

## Special Limited Offer-- Write Now

Send the coupon at once for full particulars of our remarkable special offer open to you now. Find out all about the marvelous

opportunities that are opening in the Aviation game. This offer is the greatest stepping stone to bigger opportunities ever known. Write today for complete literature, all free and prepaid. You are not obligated in any way. Do not waste time in thinking about it. Act! Send the coupon or a letter or a post card will do.

WRITE AT ONCE.

**AMERICAN SCHOOL OF AVIATION**  
 431 So. Dearborn St., Dept. 2624 Chicago, Ill.



**AEROPLANE BUILDER**



**AEROPLANE REPAIRMAN**



**AEROPLANE INSPECTOR**



**EXHIBITION FLYING**



**AERONAUTICAL ENGINEER**

**American School of Aviation**  
 431 So. Dearborn St.  
 Dept. 2624  
 Chicago, Ill.

Gentlemen: Please send me free and without obligation, full particulars of your Course in Practical Aeronautics and your Special Offer to those who write at once.

Name .....

Address .....

Please Mention Popular Mechanics





## ALL ABOUT CARPENTRY

Here, in ten volumes, is explained in simple, easily understood English, everything in carpentry and building from the first rough sketch of the architect to the acceptance of the finished structure. Includes wood, stone, steel and reinforced concrete construction, estimating and contracting, interior finishing and decorating, modern house lighting and sanitation. No one interested in the building profession can afford to be without these books—they increase incomes. Valuable alike to the handyman, the experienced carpenter, and the contractor and builder. And—we will send you the entire set of books without a penny down, so you can see them for yourself.

### Partial Table of Contents

Mechanical, Freehand, Perspective and Architectural Drawing, Lettering, Pen and Ink Rendering, The Orders, Superintendence, Strength of Materials, Masonry, Reinforced Concrete, Carpentry, Steel Square, Stair-Building, Hardware, Steel Construction, Roof Trusses, Practical Problems, Estimating, Contracts, Specifications, Building Law, Sanitation, Steel Metal Work, Electric Wiring and Lighting.

Fletcher Cunningham, Shreveport, La., writes: "After receiving the books I decided that with their help I could go into the contracting business for myself. I have just closed a contract on which I expect to clear about \$112.00 for two weeks' work."

### Shipped FREE!

Yes, we send the entire ten volumes prepaid right to your own home. This offer is open to every resident of the U. S. and Canada. Read—examine them—put them to every test for seven full days and then decide whether or not you can afford to get along without them. If you do not want to keep them, send them back at our expense.

### Free Consulting Service

In addition to the books, you get free of charge a year's Consulting Membership in the American Technical Society. Our corps of experts will answer any of your questions for a whole year. The regular price of this service is \$12.00, but you get it free with the set of books.

### 50 Cents a Week

Yes, send only \$2.00 after the seven days' trial and then \$2.00 a month (50 cents a week) until the total price of \$24.80 has been paid. The regular price on these books is \$50.00, but you get them at the special price of \$24.80, a saving of practically one half. The set consists of ten volumes bound in half black morocco, stamped in gold. 4,760 pages (7x10 inches); 4,000 illustrations, full page plates, building plans, diagrams, etc. See it for yourself before you decide to buy.

### Send the Coupon

American Technical Society  
Dept. R 1194, Chicago, Illinois

Please send the Cyclopaedia of Architecture, Carpentry and Building for seven days' examination. If I decide to keep it I will send \$2.00 after seven days and \$2.00 a month until \$24.80 has been paid. Then you will send me a receipt showing that the \$50 set of books and Consulting Membership are mine and fully paid for. Otherwise I will return at your expense.

Name.....

Address.....

Reference.....

Don't send us a single penny. Just put your name and address in the coupon and send it to us. We will send you the books for seven days' free trial. Don't decide to buy until you have seen them and examined them carefully for seven full days. Send the coupon now.

American  
Technical  
Society  
Dept. R 1194  
CHICAGO  
U. S. A.

Please Mention Popular Mechanics

## "A Train Load of Books"

### What Clarkson is Doing for the Book Buyer



IN several hundred thousand libraries, in the homes of people in every walk of life—from the day laborer to the college professor and high government official, from the persons who buy a few books of popular fiction to the persons who pride themselves on having the complete works of all the standard authors in De Luxe Sets artistically printed and bound, almost every book was bought from me. WHY? Because I have no agents and sell you just the book you want—all new—many at a saving of from 50 to 90 per cent. You examine the books in your own home for five days before paying for them. If not satisfied, return them at my expense—and owe me nothing.

### Sample Prices:

When a Man is a Man, Publisher's price, \$1.25. My price, 90c.  
Eyes of the World. My price, 99c.  
Famous Pictures. \$8.00—\$1.45.  
Encyclopedia of Quotations. Pub. price, \$1.50. My price, 99c.  
What All Married People Should Know. \$1.00—75c.  
Buffalo Bill's Own Story of His Life and Deeds. \$1.50—85c.  
Famous Orators. \$2.50—95c.  
Law Without Lawyers. Pub. price, \$2.50. My price, 45c.  
Shakespeare, 24 vols. \$200. Limp Leather. \$2.50.  
When a Man Comes to Himself—Woodrow Wilson. 50c.  
Jiu-Jitsu, or Art of Self-Defense. \$1.25—85c.

Key to the Bible. \$3.75—95c.  
Library of Wit & Humor. \$1.50—62c.  
Huckleberry Finn and Other Mark Twain Books. \$1.75—\$1.25.  
Brann: The Iconoclast. 2 vols. \$2.25.  
History of the World. 3 vols. \$12.00—\$2.50.  
Memory: How to Develop. 88c.  
Century Book of Health. Pub. price, \$2.50. My price, \$1.50.  
New Americanized Encyclopedia, 15 vols., 3-4 Leather. Pub. price, \$75.00. My price, \$14.75.  
Century Dictionary and Cyclopaedia, 15 vols., 3-4 Leather. Pub. price, \$150.00. My price, \$35.50.  
New American Encyclopaedic Dictionary, 5 vols., 3-4 Leather. Pub. price, \$21.00. My price, \$4.75.

Here are De Luxe Sets, Morocco bound, complete works, many of them at less than 25 cents on the dollar. Hugo, Kipling, Poe, Eliot, Dickens, Thackeray, Stevenson and scores of others.

### Get My Big, New Catalogue

My new catalogue, sent free for the asking, tells you how to save 50 to 90 per cent on thousands of books. It is a course in literature, giving nationalities, date of birth and death of authors, the author's life and standing in literature, etc. Hundreds of sets and thousands of single volumes listed. I sell more books direct to the booklover—the individual reader—the rich man who insists upon his dollar's worth—the man who watches his pennies—and sell them for less money—than any other man in America. Every book new and fresh, and guaranteed to please you—you to be the judge. I do not gamble, and would rather have a book or set of books returned at my expense than to have a dissatisfied customer.

DAVID B. CLARKSON, The Book Broker,  
416 Clarkson Building, Chicago, Illinois



### SEND 2 CENTS

in United States stamps to pay postage and we will send you FREE a SAMPLE COLLAR of our New Style "Copley." State size wanted.  
REVERSIBLE COLLAR CO., Dept. U, BOSTON, MASS.

### Encyclopaedia Britannica

"HANDY VOLUME" ISSUE  
Printed on India Paper

### Learn Watchwork, Jewelrywork and Engraving.

A fine trade commanding a good salary, and your services are always in demand. Address HOROLOGICAL, Dept. P, Bradley Institute, Peoria, Ill., for our latest catalog.

WIRE UP YOUR OWN HOUSE

This BOOK Tells How!

.55c  
a copy

Do the job yourself  
—and save money

CONTENTS  
Planning the Wiring, Completing the Installation, Installing the Lights, Other Methods of Wiring, Materials and Notes, Conduit and Protected Wiring, Digest of Nat'l Underwriters Rules, 1915 Edition.  
Gives Latest Methods and Newest Fittings  
Cloth, 128 pages, 45 illustrations, 9 plates

SPON & CHAMBERLAIN  
123 P. M. Liberty St. NEW YORK



**EARN  
\$25  
TO  
\$50  
PER  
WEEK**

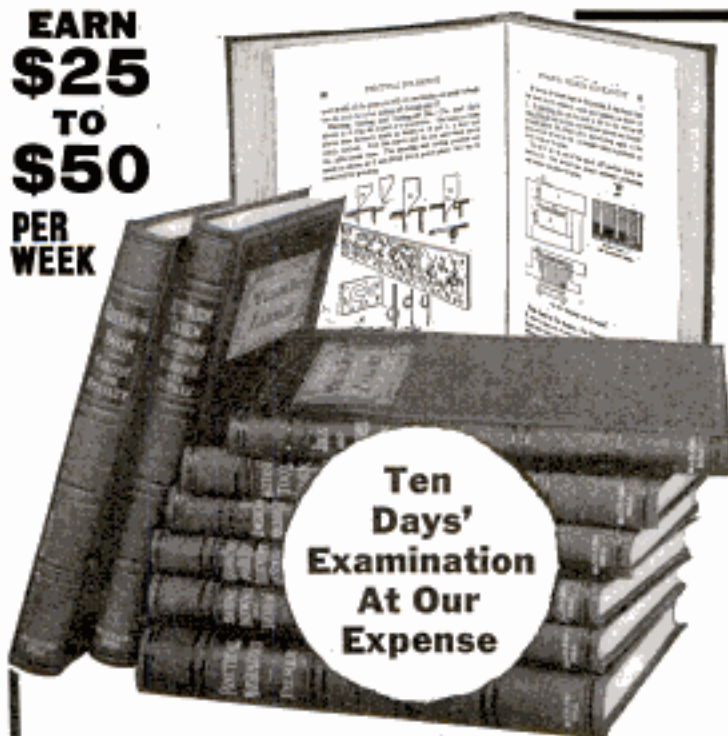

**Ten  
Days'  
Examination  
At Our  
Expense**

## Small Monthly Payments

Use these nine volumes ten days at our expense. Pay nothing in advance or at any time unless you decide that the books will give you all the information you require to earn \$25 to \$50 per week and more.

The Machine Shop Library teaches you as in practice. It is written clearly. It is understandable even to the beginner. It is free from theory and higher mathematics. The illustrations were drawn specially for these books. Over 200 shop experts assisted in making it perfect. It commences with the simplest principles and advances by easy steps. It is as valuable to the apprentice as to the \$50 per week expert. It tells everything you want to know about machine shop practice. These books tell you in three thousand pages and by three thousand illustrations that which it has taken the authors many years to learn.

## The Coupon Brings the 9 Vols.

Fill out the attached coupon now. Start perfecting your knowledge of machine shop practice right away. There is no time to be lost. It is a trade or profession in which the more you learn the more you can earn. Your services in this work are needed right now. There are not nearly enough trained men to fill the responsible positions, and there probably never will be. You can earn more than you ever dreamed of earning—and all you need do is return the coupon. That starts you right. The library weighs sixteen pounds, but we pay the charges going, and coming back if you are not pleased.

## Quality of Books

The books are bound in dark red morocco-grained cloth, the finest and toughest to be had. The lettering is in gold, and the paper super-calendered. The books are built to last a lifetime, and are an ornament to any home.

**McGraw-Hill Book Co., Inc.**

Publishers of Books for Machinists Since 1876  
239 W. 39th Street, NEW YORK

# Machine Shop Practice Complete

You can now be master of machine shop practice. You can now get the required knowledge from records of actual practice.

No other library will do what the Machine Shop Library will do—start you with the simplest principles of machine shop work and carry you safely and surely over every operation in the machine shop of today, no matter how difficult. There is no skimping. There is no mere mentioning of a subject—on the other hand, every topic taken up is treated at sufficient length for you to master it.

## Why the Machine Shop Library Is the Standard in America

The eight authors of the Machine Shop Library gained their knowledge of machine shop work with their sleeves rolled up. They are practical men. That is why the Machine Shop Library is accepted as the standard in America. You are supplied with genuine working data. No theories are advanced. You are not told what might be done—you are told what should be done, and how to do it, as taught by experience.

## All the Information You Need to Reach the High Position

From the Machine Shop Library you gain expert and accurate knowledge. You gain this knowledge quickly. It is knowledge that would cost you much time and money if procured from any other source. You save long years of hard work at low pay. You have before you for constant reference and study information that has

taken eight authors and over two hundred other machine shop experts years to gather. It is all the information you need to reach the high position in the machine shop field.

**McGRAW-HILL BOOK COMPANY, Inc.**  
239 W. 39th St.,  
NEW YORK

Gentlemen:—I am interested in your Machine Shop Library. You may send me the nine volumes, charges paid, for my inspection. If satisfactory I will send \$2 in ten days and \$2 per month until I have paid the price of the books, \$16. If the books are not what I want, I will write you for shipping instructions.

**NOT ONE CENT IN ADVANCE** **FILL OUT THIS COUPON TODAY**

Signature.....  
Your Address.....  
City and State.....  
Name of Employer.....  
His Address.....  
Your Position.....

P. M. Apr.



# FREE Complete \$15.00 Set of Drawing Instruments

**Y**ES, I will give you this complete set of drawing instruments absolutely free. They are regular working instruments—the kind I use myself and they do not cost you a cent.

And besides the instruments in an exquisite plush lined leather case, I will give you absolutely free a 20x25 inch drawing board, a 24 inch T square, a 12 inch rule, a supply of drawing paper, two triangles and a French curve, pencils, erasers, thumb tacks, etc., etc. A complete draftsman's working outfit. And I give it to the men who get my personal instruction absolutely free.

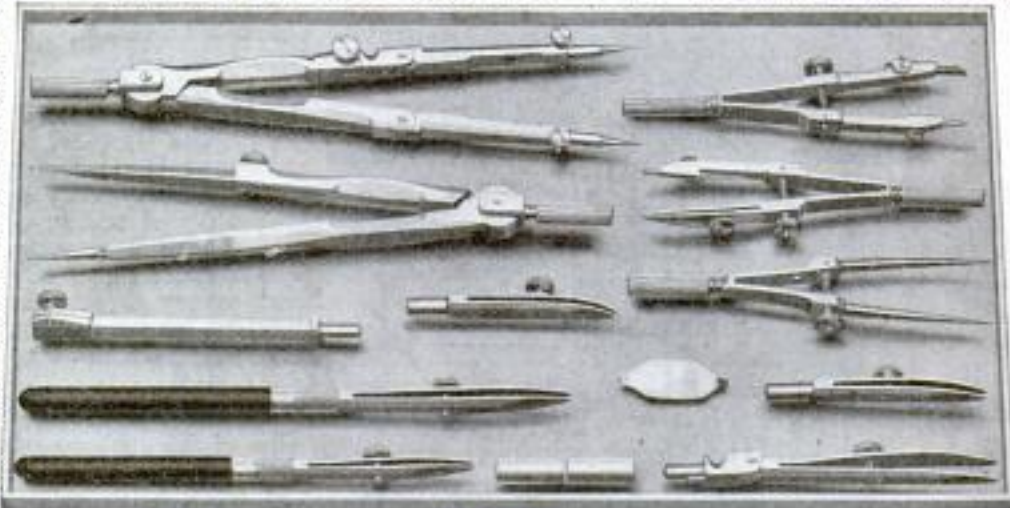

## Be a Draftsman!

**Draw \$125 to \$175 per month**

There is an urgent demand for skilled draftsmen. Companies are issuing calls every day for men to fill positions paying from \$125.00 to \$175.00 per month. Work is light, pleasant and profitable.

## Chief Draftsman Will Instruct You Personally

I am Chief Draftsman of a large and well known firm. I have been doing the highest paying expert drafting work for a quarter of a century and I know just the kind of training that is demanded from men who get the big salaries. I will give you personal instruction, deal individually with you and give you up-to-date, practical working plans just as your ability and advancement require. I train you by giving you actual work—practical work, the kind that you must be able to do in order to hold permanent, big paying positions. I give you my individual instruction. If your work is right, I will advance you rapidly. If it is wrong, I will show you where, and make you do it right, and do all I can to make you an expert draftsman and designer in a short time. **Write Today Without Fail**

**Pay as You Wish!** What I want is the RIGHT KIND of men. Don't bother about expense. I will give you the working outfit free if you get in at once. I charge a very small fee for training you to be an experienced draftsman. You can pay the small cost as suits you best. My object is to develop experienced draftsmen.



**Chief Draftsman Dobe**  
Engineer's Equipment Co.  
Div. 1194 Chicago, Ill.

Without any obligation on me whatsoever, please mail your book "Successful Draftsmanship" and full particulars of your liberal "Personal Instruction" offer to a few students. It is understood that I am obligated in no way whatever.

## Send the Coupon for My Big New Book

Put your name and address on the free coupon or a letter or a post card and send it to me today. I will send you absolutely free and postpaid my new book "Successful Draftsmanship," and the great special offer that I am now making on which you get the \$15.00 Draftsman's Working Outfit absolutely free. You assume no obligations of any kind in sending in the coupon. Get in line now for a big paying position. Getting the book and full particulars of the special offer is the first step. Write today—now.

**Chief Draftsman Dobe**  
Engineer's Equipment Co., Inc., Div. 1194 CHICAGO, ILL.

NAME.....

ADDRESS.....



# CLASSIFIED ADVERTISEMENTS

WORLD'S BEST WANT AD MEDIUM

We have records to prove that a classified ad in these columns will find a buyer for almost anything which can be sold. Doubtless you have some article of value to some one else which you no longer need. Why not turn it into money?

Advertisements in this section, 18 cents per word, each insertion, minimum 10 words, payable in advance. To insure ads being inserted under proper classified head in the May issue, copy must reach this office not later than March 31st.

Popular Mechanics Magazine, City.

Gentlemen: Enclosed please find money order for \$8.10 to cover the cost of January ad, and the cost of ad for next issue. From four issues of your magazine I received prospective orders close to \$3,000.00; the total advertising only cost me \$18.00 for the four months.

Chicago.

Yours sincerely,  
JULIUS SWANBERG.

## AUTOMOBILES

**PAINT Your Own Car with Autonamel;** you can do the work as perfectly as a skilled workman with common paint. Autonamel is not a paint. It is a new chemical discovery. It lays a smooth and lustrous with one coat as a shop-painted car with several coats. \$5 outfit paints car. Booklet "B" explains all. Write for it. Autonamel Company, Rochester, N. Y.

**AUTOMOBILES Overhauled and Repainted** at rock bottom prices. Write us for Special Bulletin. Eureka Auto Co., Rebuilders, Beavertown, Pa.

**AUTOMOBILE Mechanics—Your ideas** may be valuable. Protect them by patents. Fortunes have been made on patented improvements in automobiles and accessories. Send sketch for opinion as to patentability. Book, "How to Obtain a Patent and What to Invent" and list of patent buyers free. Automobile Specialist, Talbert & Parker, Patent Lawyers, 4638 Warder Building, Washington, D. C.

**SCORED Cylinders,** repaired by our new Nickel and Silver process; no heating required; same Pistons and Rings used; reshipped 24 hours. New Chemical Process Co., 8 West Ross Street, Wilkes-Barre, Pa.

**SLIDING gear Transmission \$35.** Four-cylinder Magneto \$12. "Hustler" delivery car \$65. W. Robb, Dover, Ohio.

**PAINT Your Car Yourself—Save \$25 to \$75** by doing the work at home with the Arsenal system. Our big free booklet "The Car Beautiful" tells how. Send for it today. Arsenal Varnish Co., Dept. P, Rock Island, Ill.

**AUTOMOBILE Questions and Answers—**A self-educator on automobiles without an equal. Covers over 2000 questions and their answers relating to the modern automobile. 450 pages, 350 illustrations. Cloth, \$1.50 postpaid. Complete description on request. Popular Mechanics Book Dept., 6 N. Michigan Ave., Chicago.

**CYLINDERS reground,** new pistons and rings fitted. Restores lost power. Write for prices, giving make and model. The Everts Machine Co., Hartford, Conn.

**PATENTS for Automobile Improvements** are in great demand. We have special Automobile Department in charge of experts who are in touch with demands of trade. Write for "What to Invent and List of Patent Buyers," sent Free. Victor J. Evans & Co., 158 Ninth, Washington, D. C.

**AUTOMOBILE Repairs—Automobile owners,** Garages and Repairmen should subscribe for the Automobile Dealer and Repairer; 150-page illustrated monthly devoted exclusively to the care and repair of the car. The only magazine in the world devoted to the practical side of motoring. The "Trouble Department" contains five pages of numbered questions each month from car owners and repairmen which are answered by experts on gasoline engine repairs. \$1 per year; 15c per copy. Canadian subscription, \$1.50. Postals not answered. Charles D. Sherman, 50 Windsor Road, Hartford, Conn.

**THE Modern Gasoline Automobile—Most** complete and up to the minute automobile book published. Recognized as the standard book on construction, operation, maintenance and repair, showing every recent improvement. Over 700 pages, 500 illustrations. Cloth. Price \$2.50 postpaid. Send for complete description of this and other reliable automobile books. Popular Mechanics Book Dept., 6 N. Michigan Ave., Chicago.

## AUTOMOBILE SUPPLIES

**STOP!** Does your motor skip or knock? Mail dollar bill to Motor Trouble Finders, Incorporated, Haverhill, Mass., for an instrument that will tell you why and how to stop it, warranted to do the business or money back.

**UNUSUAL Bargains in Automobile Repair Parts.** Axles, Bearings, Carburetors, Complete Engines, Cylinders, Differentials, Magnets, Pistons, Radiators, Springs, Valves, Wheels and other parts for Buick, Cadillac, Chalmers, Interstate, Maxwell, Mitchell, Moon, Overland, Packard, Peerless, Royal, Studebaker, Thomas and other cars at a fraction of factory cost. Maxwell Bros., 2331 Olive Street, St. Louis, Mo.

**WE wreck cars for parts.** Special prices on used motors, carburetors, coils, magnets, etc. All parts for all cars. Warshawsky & Co., 1921 South State St., Chicago, Ill.

**25% PROFIT** selling Jubilee Spark Intersifiers to automobile owners, garages. Sure cure for Spark Plug troubles. Sells like wildfire. Brand new. Exclusive territory. Write today. Jubilee Mfg. Co., Dept. N-2, Omaha, Nebraska.

**VULCANIZER for shop.** Bargain. Vanderpool's, Springfield, Ohio.

**SPARK Plug sizes,** for all cars 25c. Motor Specialist, Dept. A, 469 N. Halsted St., Chicago, Ill.

**"GIDZ,"** the Modern Auto Fuel, satisfies O. O. Nightingale, Crescent City, Illinois, writes: "I used 'Gidz' in my automobile; it sure does all you claim. I think it does something you don't know: In my home we use a gasoline pressure lighting system; always had trouble with the lights. One 'Gidz' tablet per gallon did away with all the trouble." "Gidz" removes carbon while you drive. Used by thousands past two years. One Dollar Can convinces. Dealers wanted. Quick repeater. "Gidz," Galesburg, Illinois.

**MITTEN Guster** for polishing brass and nickel parts. Postpaid 50c. Brinckerhoff, 23rd and Kearney, Portland, Ore.

**GET into the biggest money-making end** of the automobile business—replacing necessary equipment. Live, hustling, ambitious men wanted as special factory representatives in exclusive territory to take orders and attach tops, top coverings, seat covers, patent silkite windows. No experience necessary. No capital required. No competition on our copyrighted system. Write for free catalog, samples, and full details. Cincinnati Auto Specialty Co., Dept. MAS 47, Cincinnati, O.

**REPAINT your car at home** with a Presto Auto Paint Kit. Details free. American Accessories Co., Dept. P-3, Cincinnati.

**POWER increased;** carbon eliminated; results guaranteed. Write for folder. Automobile Accessories Co., Baltimore, Md.

**AEROFRAM Gasoline Saver** for automobiles, motorcycles, etc., \$1 at your dealers or by mail; guaranteed. Aerofram Company, Inc., 105 Mass. Ave., Boston.

**AUTOMOBILE owners** make money introducing Guaranteed 6,000 Mile made-to-order Tires at 3,500 Mile Prices. Customer's name on each tire. Dept. A, American Rubber Corporation, 1974 Broadway, New York.

**FOR Sale:** 1 Ford Engine in excellent condition. Complete equipment for Motor Boat Installation goes with this engine. Write for prices, etc. John Dietrich, Cadott, Wis.

**AUTOMOBILE Parts** for most all makes of cars: Buicks, 10, 17, 19, 27, 29 and 25; Maxwells, E. M. F., Flanders, Paige 25, Overlands, 37, 38, 42 and 59; Cadillacs '09 to 1913, Parry, Regals, '09 to 1913; Oakland 25, Jeffery, Mitchells, 1907 to 1913; Empire, Elmore, Chalmers, '09 to 1913; Auburn, Jackson 35, Interstate 30, Hudson '20", Hupp '20", Ohio, Staver, Marion and many others. Pistons, Connecting rods, Cam Shafts, Crank Shafts, Cylinders, Axles, Bearings and gears for most any make of car. Write us your needs. Satisfaction guaranteed. Auto Parts Company, 4116-18 Olive St., St. Louis, Mo.

**BUCKET seats** for racing cars. Prices low. American Accessories Co., Dept. P-4, Cincinnati.

**TIRES—Double Tread Guaranteed** for 3,500 miles. Absolutely Puncture-Proof. Big—Strong—Extra, heavy 30x3 tire, \$5.00; 30x3 1/2, \$6.00; 33x3, \$9.00; 34x3, \$9.25; 36x3 1/2, \$12.00; 37x3, \$15.00. Big saving on other sizes and tubes also. Trade in your old tires. Discount to dealers. 10% deposit required on C. O. D. orders. Send for list now! State size and bead of tire. Max Libon & Co., 295B West 48th Street, New York.

**AUTO top roof** for any model car \$6 to \$15 parcel post paid. Easy to apply, you save 1/2 price of new top. Samples and catalog free. S. & H. Top Co., 430 Hunt, Cincinnati, O.

**FOR Sale:** 4 Cylinder 30 H. P. Automobile engine complete with Magneto, etc., \$75. 4 1/2 H. P. Locomobile steam engine, \$19. 10 H. P. Mason steam engine, \$20. 1425 North Ave., Bridgeport, Conn.

**SPARK Plug or Tire Troubles?** Pronto Spark Gaps, either separate or Plug and Gap as one construction, eliminate all missing, new designs. Pronto Inner-tube Patches repair any puncture or blow-out instantly. Big profit and sellers. Real Salesmen write quick. Pronto Manufacturing Co., Omaha, Neb.

**INSYDE Tyres,** inner armor for Automobile tires, double mileage and prevent punctures and blowouts. Quickly applied. Cost little. Demand tremendous. Profits unlimited. Details free. American Automobile Accessories Co., Dept. P2, Cincinnati, O.

**L AND M Gasoline filters** separate water, dirt and all sediments. Saves 75 per cent motor troubles, fits gasoline tank, no tools required. Give name car. Sent prepaid for two dollars. The Hudson Sales Co., 7 East Jackson Blvd., Chicago.

**AUTOMOBILE Owners—A practical** simple Vulcanizer for tire casings and tubes. Write for circular. The L. H. R. Mfg. Company, Rock Island, Ill.

**TIRE Pressure Gauge—locks** like a watch. Built to stand hard knocks, accurate, reliable. Booklet, "Tire Economy," full of good ideas. Both for \$1.25. Money back if not satisfied. Home Specialty Co., Box 172, Cleveland, Ohio.

**EXPLOSION Whistle—Fits** priming cup. First whistle adopted as standard equipment on any automobile. See display ad, Page 167. Buell Co., 1610 Michigan Ave., Chicago.

**MAGNETOS:** 4-cyl. high-tension—Bosch—K. W.—other makes, \$10.00. Stimmus \$15.00. Dixie \$15.00. Remy & Spiltdorf \$5.00 each. All makes and sizes. Presto Tanks \$5.00. Head lamps \$2.00. French Ebony steering wheels \$2.50. Coils—Windshields—other parts, low price. Johnston, West End, Pittsburgh, Pa.



**PARTS** for Maxwells, Buick, Overland, Oakland, Chalmers, Cadillac, Everett, Emf, Interstate, Beh, Franklin, Reo, Mitchell, Jackson, Peerless, Thomas, Stevens, St. Dayton, Great Smith, Locomobile, Premier, Velle, Huppomobile, Parry, Brush, Kent Auto-Parts Co., Denver, Colo.

**MODEL 39 Buick Eng.** \$125. Studbaker 25 \$85. Flanders 20 \$69. Adams 30 \$75. B. C. H. \$75. Parts for 100 old model autos. No catalogue. Auto Salvage Co., 1436 Wabash Ave., Chicago, Ill.

**GEARS** for all purposes; transmission gears, bevel-drive gears, sprockets, axles. Special machine work. Must have old parts or drawing. Turley Gear Plant, 1595 N. 10th St., St. Louis, Mo.

**DOUBLE Service Tires.** Guaranteed 3,500 miles. Sizes 30x3 \$5.00, 30x3 1/2 \$6.00, 32x4 \$8.00, 34x4 \$9.00, 36x4 \$9.00, 36x4 1/2 \$10.00, 36x5 \$11.00, 37x5 \$11.00. Non-skid \$1.00 extra. 10% required on C. O. D. orders. State if Q. D. straight bead or clincher type. Special discount to dealers. I. Jaffess, 1319 H. Fifth Ave.; Branch, 241 W. 54th St., New York.

**JUST Out—Modern Starting, Lighting and Ignition Systems—A new book on automobile electricity without an equal. Nearly 400 Pages, 250 Engravings. Cloth. Price \$1.50 postpaid. Complete description sent on request. Popular Mechanics Book Dept., 6 N. Michigan Ave., Chicago.**

**AUTO Engines:** 4-cylinder water-cooled, \$35.00. Buick 10—Buick 17—Metz—Franklin 4—Pierce. All sizes—low price. Johnston, West End, Pittsburgh, Pa.

#### TO FORD OWNERS

**YOU can get the best Starter ever made for a Ford car, regardless of price, for \$6.00, from Symons Brothers Co., 2611 E. Railroad Ave., Evanston, Ill.**

**"STEER BELIEF"** corrects faulty steering in Fords. Gives safety and better service. Sample \$3.50. Pays agents. Chas. B. Post, New London, Ohio.

**FORD Car Owners—U-Auto Compound** cleanses the water circulating system of your engine without injury; thereby increasing power efficiency 100%. 50 cents prepaid in U. S. Money-back guarantee. Agency proposition. Seymour Specialty Company, Box 477N, Syracuse, N. Y.

**SYMONS Brothers Co., Evanston, Illinois,** can save you from 20% to 30% on your gasoline bills on Ford cars. It will pay you to make them prove it.

**SLEEP** in your Ford in McMillin Auto Bed, \$7.50. Free booklet on auto camping. Auto Bed Company, Bellingham, Wash., Box 0.

**BE** our agent. Buy the Safety Ford Starter for \$4.50. Retail for \$15.00. Try one; write for particulars. Safety Ford Starter Corporation, Columbia Theatre Bldg., New York.

#### FORD ACCESSORIES

**SLEEP** in Your Car. Auto-Sleeper only \$3.00! Auto-Sleeper Co., 917 L, Sacramento, Cal.

**FORD Coil Contact Points** 50c per set. Electric Service Co., Dallas, Texas.

**FORDS, Both Lights Doubled.** Low speeds, automatic, easily attached. Price, \$2.00. North American Instrument Co., 206 Michigan Ave., Grand Rapids, Mich.

#### CYCLE CARS AND MATERIAL

**SEE** our advertisement on page 186. The lowest priced car in the world. Tribune Engineering Co., Owego, N. Y.

#### MOTORCYCLES, BICYCLES & SUPPLIES

**MOTORCYCLES—\$25.** If you want a high grade New or Used Motorcycle and have \$25 Cash, write quick for Bulletin "K"; lowest prices, easiest terms. Peerless Motorcycle Co., Boston, Mass.

**BIG bargains** in good motorcycles we have taken in exchange on new ones. Send for special bargain list. Shaw Mfg. Co., Galesburg, Kansas.

**JEFFERSON,** turn, clutch, new tires, mile minute, \$99 takes it. Rosestone, Passaic, N. J.

**WILL** sell my Harley motorcycle. Photo. H. Sunderlin, Goldfield, Colorado.

**SEND** for our catalog. Hundreds of Used and Rebuilt Motorcycles \$25 up. Myerov Bros., 149 Berkeley St., Boston, Mass.

**OVERSTOCKED** with fine Milka Spark Plugs for Motorcycles, "Indian Size" thirty cents each "Prepaid." Send stamps. Henry Pardon, Indian Dealer, Owensboro, Ky.

**MOTORCYCLES** and small cars on easy payments. List and terms, 6c. Stroganoff & Company, Schenectady, N. Y.

**INDIAN Powerplus.** Nearly new, 1916 model; a bargain. Otis Gilliam, Mullinville, Kans.

**LARGE stock** of rebuilt motorcycles, new parts for all makes 25% discount; second-hand parts, good as new, 50% discount. Motorcycle Parts Mfg. Co., Chicago.

**TWIN Indian.** Sacrifice for \$65. Perfect condition. Bedford Moulden, Front Royal, Va.

**A REAL bargain** in second-hand motorcycles. We have an overstock of all makes, such as Indians, Harley-Davidsons, Excelsiors, Pops, Merks, and 4-cylinder Hendersons. All are in A-1 condition and fully equipped. If interested in buying a motorcycle write for our Bargain Bulletin No. 5 giving description and prices from \$35 up. Gotham Sporting Goods Co., 57 Warren St., New York City.

**1913 7 HORSEPOWER** chain drive Excelsior, clutch, magneto, fine shape, \$65. Samuel Myeroff, 9 Cooper St., Boston, Mass.

**MOTORCYCLES,** overhauled \$40 up. List free. C. C. Williams, Reed, Ky.

**MOTORCYCLES!** One Hundred machines sacrificed before moving! Sporting Goods, Fishing Tackle, accessories at your price. Write for Bargain Bulletin with cuts. Goods unsatisfactory exchanged, or money refunded. Largest Motorcycle Store West. W. E. Wandersee Company, 129 Gratiot Ave., Branches: 1361-1363 and 2096 Woodward Avenue, Detroit, Mich.

**1917 EAGLE** Motorcycle now ready. Get Circular M4, and agency proposition. Eagle Motorcycle Company, Brockton, Mass.

**AUTOMOBILE Mechanics—Your ideas** may be valuable. Protect them by patents. Fortunes have been made on patented improvements in automobiles and accessories. Send sketch for opinion as to patentability. Book, "How to Obtain a Patent and What to Invent" and list of patent buyers free. Automobile Specialist, Talbert & Parker, Patent Lawyers, 4657 Warder Building, Washington, D. C.

**SIDE Cars,** New, \$60. Others \$25 and up. Outlook Mfg. Works, 2445 Wabash Ave. (Rear), Chicago.

**1913 INDIAN** Twin, good condition, \$70. M. Weenstin, 45 Alden St., Malden, Mass.

**1913-1916 HARLEY'S** Twins for sale, both in good condition. Write Ed. Ries, Carroll, Ia.

**LET** us save you 15c on every dollar you spend for your motorcycle. Our prices are already the lowest quoted but we have 15% more to give you. New list, 25 splendid motorcycle bargains and special offer. Yours for the asking. Write today. Prices advance next month. Western Supplies Company, 128 Hayutin Bldg., Denver, Colo.

**BIG bargains** in second-hand motorcycles, \$25 up. Indians, Harleys, Thors, Excelsiors and Merks. Write for description. Howard A. French & Co., Baltimore, Md.

**SEND** for big list of slightly used motorcycles; from \$25 up. Buy on easy terms. Howard Cycle Co., Trenton, N. J.

**I SAVE** you half on parts and accessories for all makes. Jones, "The Parts Man," Box 691, Brockton, Mass.

**MOTORCYCLE Riders' Catalog** and Encyclopedia of Parts and Accessories. Thousands of articles. It's free. Sausley Supply Company, Gateway Station, Kansas City, Mo.

**BARGAINS** in Motorcycles. 1914 Harley-Davidson Twin, \$90, 1913 Harley-Davidson Twin \$75, 1912 Harley-Davidson Single \$35. Get our list. All machines equipped and guaranteed. S. N. Hennigar, Danvers, Mass.

**IYER** Johnson big four chain drive—1916. Run 500 miles, good as new, \$150. Ralph Miller, Hughesville, Pa.

**MOTORCYCLE** cylinders, reground, fitted with new piston and rings \$5.00. "Crosby's Cyclery," Aurora, Ill.

**BICYCLES** and tandems from five to fifty-five dollars. Strongest on the market. Biggest bargains in tires. Write for information. Park Cycle Co., 7117 North Clark Street, Chicago, Illinois.

**ELECTRIC Bicycle Light** Free. Ask for "Sycamo" Tire Bulletin and Catalog. A postal card will do. Give name of your dealer. Sausley Supply Company, Gateway Station, Kansas City, Mo.

**1914 2 SPEED** Yale, best mechanical condition \$70. M. Myers, 584 Eastern Ave., Malden, Mass.

**EASY Terms** on new and rebuilt motorcycles, side cars, tandems, and lighting outfit. Motorcycles Investment Company, 801 Centre St., Brockton, Mass.

**RIDE** in comfort. Very fast Light Cars at Motorcycle prices. See our advertisement page 186. Tribune Engineering Co., Owego, N. Y.

**SPRING Clearance Sale—350 Machines—Harleys, Excelsiors, Indians, Hendersons, Thors—\$35 and up.** Every machine guaranteed. Write now for April Bargain Bulletin. Haverford Cycle Company, Philadelphia, Pa.

**BARGAINS,** new motorcycles, F. Zimmermann, Jr., Oakland St., Shreveport, La.

**WANTED:** We pay cash for used motorcycles or take them in on exchange for new machines. Write with complete description. State condition of tires, frame, motor, make and model. Shaw Manufacturing Co., Dept. 137, Galesburg, Kans.

**DON'T** buy a Bicycle Motor Attachment until you get our catalogue and prices. Shaw Mfg. Co., Dept. 27, Galesburg, Kansas.

**WANTED:** Henderson or other 4-cylinder engines. High-tension magnetos, all sizes. Johnston, West End, Pittsburgh, Pa.

**BARGAINS** in used motorcycles—all machines guaranteed and in A-1 condition ready for use. Write for terms and new bulletin. Photos free. Harley-Davidson Sales Company, Birmingham, Alabama.

**WRITE** for list of bargains on used Motorcycles. Little Falls Motorcycle Co., Little Falls, N. Y.

**WILL** sacrifice entire stock of used and rebuilt motorcycles, all makes. Write for list. Will accept any reasonable offer. Seeber & Hofheins, Buffalo, N. Y.

**JUST Out—Send** for our revised list of genuine bargains in used motorcycles of all makes. Victor H. Ross, "The Cycle Man," 2701-03 Leavenworth St., Omaha, Nebr.

**MAKE** your bike a motorcycle by using our motor. Fits any wheel. Good hill climber. Price only \$32. Ashland Motor Works, Dept. B, Ashland, Ohio.

**MOTORCYCLE Bargains.** Single and Twins. Hendersons, Harleys, Indians, Excelsiors, Kulturs, Emblems, Thors, Pops. All makes guaranteed. A-1 shape, tuned up ready to ride. \$35 to \$100. Motorcycle tires, \$3. Lamps, \$5. Automobile tires, \$3. Bicycles \$5. Tandems, \$20. Bicycle tires, \$1. Bicycles and motorcycles at Factory prices. Old motorcycles taken in trade. Highest prices allowed for them. Swap in yours. Deninger, the Price Cutter, Rochester, N. Y. Send for Catalog. Free.

**WANT** to sell your motorcycle? I have a method which has sold many. Write me today for free information. F. W. Johnson, Room 990, 78 E. Madison St., Chicago.

#### WELDING

**OXYACETYLENE** Welding Equipments and Acetylene Generators. Hamilton Welding & Mfg. Co., Hamilton, Ohio.

**SOLDERING** Flux, half pound 50c prepaid. Box 85, Stockton, Calif.

**DAY'S** Welding Solder, for scored cylinders and all metals, apply with soldering-iron, sample bar 50c or \$1.50 per pound. Bellingham Solder Co., Bellingham, Wash.

**LEARN** to solder aluminum, brass steel and cast iron, write for particulars. Modern School of Soldering, 471 Fabre, Montreal, Canada.

**WELDING—Automobile** Welding with the Oxy-Acetylene Flame—Just Out—167 pages, fully illustrated. Price \$1.00 postpaid. Explains the actual welding of all automobile parts in a manner understandable by everyone. Popular Mechanics Book Dept., 6 N. Michigan Ave., Chicago.

**OXY-ACETYLENE** Welding and Cutting. Electric and Thermit Welding. Brand new book of practical instruction in this process. The workman will find all necessary information for handling any kind of welding. 215 pages, fully illus. Cloth, \$1.00; Leather, \$1.50 postpaid. Popular Mechanics Book Dept., 6 N. Michigan Ave., Chicago.

**SIMPLE** Soldering, both hard and soft—82-page book telling how to join metals. Do your own repairing. 52 illustrations. 25c postpaid. Popular Mechanics Book Dept., 6 N. Michigan Ave., Chicago.

**WELDING** Plants for All Purposes. Small Cash Payment. Balance to Suit. Beresky Mfg. & Engineering Co., Omaha, Neb.



## AERONAUTICS

**PROPELLERS**—I manufacture standard aeroplane propellers for professional and practice work. Laminated of best selected material, true to pitch, etc. Performance assured. Sizes up to 6 ft. diameter, \$15. \$5 for each additional foot length. These are professionals. The practice type run \$5 less account size. A thoroughly practical propeller, but not so highly finished. Copper sheathed for hydro work, \$5 extra. Hubs are plain. Bored if ordered. If interested write for information. The Crawford Motor & Aeroplane Mfg. Co., Pittsburgh, Pa.

**GET** into the aviation game and get into it right. We can and will help you. American School of Aviation, Dept. 8194, 431 South Dearborn Street, Chicago.

**DICTIONARY** of Aviation. 4276 words and phrases. Paper \$1, cloth \$1.50. Languages Company, 143 West 47th St., New York.

**GET** our latest Aeroplane Book containing full information about "Ideal" Model Aeroplanes, parts, plans, etc. 5c postpaid. Ideal Aeroplane Co., 82½ West Broadway, N. Y.

**FOR SALE**—Curtiss Type Biplane—Good condition, \$125. W. Banning, Lorain, Ohio.

**THE American School of Aviation** announces a new correspondence course in aero-construction and design. A thorough training in aeronautical engineering. American School of Aviation, Dept. 9194, 431 South Dearborn Street, Chicago.

**PATENTS**—Send Sketch. Free Opinion and Certificate of Patentability. Free Book, "How to Obtain a Patent and What to Invent." Patents secured through Credit System. Talbert & Parker, Patent Lawyers, 459 Warder Bldg., Washington, D. C.

**FOR SALE**, 69 H. P. De Luxe Aeroplane Motor. Absolutely guaranteed. J. Shumway, 4509 Montgall, Kansas City, Mo.

**"LEARN to Fly"** from men of long practical experience. Write Ecker School of Flying, Syracuse, N. Y.

**LEARN** principles of Aviation at home in spare time. Complete course in Aero engineering equips you to fill big paying positions in short time. Write for free particulars and limited offer. National Aero Institute, Dept. 2194 Morton Bldg., Chicago, Ill.

**CURTISS** type biplane all complete less motor, \$290. Finished looping tractor woodwork, \$80. Twin Indian motorcycle, sacrifice, \$90. All good condition. Henry Toncray, Troup, Texas.

**TANDEM** Monoplane Glider, full size, how to make—Our book "Amateur Mechanics No. 6" contains a complete detailed description of how to make one and also over a hundred other interesting articles. Price 25c postpaid. Popular Mechanics Book Dept., 6 N. Michigan Ave., Chicago.

**BI-PLANE** Glider, full size, how to make—Our book "Amateur Mechanics No. 7" contains a complete detailed description of how to make one and also over a hundred other interesting articles. Price 25c postpaid. Popular Mechanics Book Dept., 6 N. Michigan Ave., Chicago.

**AVIATION** Motors, all makes, up to 150 H.P., \$250 up. Complete aeroplanes, all types, \$500 up. State your needs. Aero Exchange, 28 Park Row, N. Y. C.

**SPECIAL** Light Weight gasoline engine, ½ H.P., 2½ pounds. Send stamp for catalog. Weiss Mfg. Co., Torrington, Conn.

**AEROPLANE** accessories, propellers, fittings, etc. Dependable parts at the right prices. Illustrated catalog eight cents postpaid. Chicago Aeronautical Supply Co., Chicago.

**TRACTOR** type biplane, complete, good condition. Cheap if taken at once. T. P. Hindman, 132 West 4th Street, Oklahoma City, Okla.

**HEATH** Aerial Products and Supplies. Why are they the best and cheapest? It's the old story—quantity production. Aeronautical supply catalogue, 6 red stamps; propeller catalogue, 3 red stamps. Heath Aeroplane Co., formerly Heath Aerial Vehicle Co., Chicago.

**PATENTS** Wanted in Aeronautics—U. S. Government spending millions in this class for Army and Navy. Our Aeronautic Department will give full information on this subject upon inquiry. Write for "What to Invent," sent Free. Victor J. Evans & Co., 169 Ninth, Washington, D. C.

**MODEL** Aeroplanes—materials, supplies. Motor-driven Scout Monoplane. Submarine diving boat. Send 5c for catalogue. Wading River Mfg. Co., 313 Sumpter St., Brooklyn, N. Y.

**BUILDING** and Flying an Aeroplane—160-page handbook covering the building of small models and full-sized gliders and machines. In both biplane and monoplane models the well-known Curtiss and Bleriot types are followed. Fully illustrated with detail drawings. Price, \$1 postpaid. Popular Mechanics Book Dept., 6 N. Michigan Ave., Chicago.

## BOOKS AND PERIODICALS

**FREE** Handbook for mechanics and contractors in any line. Shows how to make your work easy; do more and better work and save money. State your occupation and the book is yours Free. Van Expansion Bolt Company, 26H West Lake Street, Chicago.

**PERPETUAL** Motion. Old, honored mechanical problem. All about it. History, explanation, prophecy. Descriptive literature with beautiful cuts. Free. Enlightenment Specialty Co., 411 Olive St., St. Louis, Mo.

**SEND** ten cents for Correct English Magazine. Evanston, Illinois.

**DEVELOP** your Mental Powers for greater efficiency and success by reading "Your Mind and How to Use It," by William Walker Atkinson, 224 pages. One dollar postpaid. Inland Book Co., Ft. Wayne, Ind.

**WORLD** Romie System. Master-key to all languages. Three sample books, 36c. Languages Company, 143 West 47th St., New York.

**UNDERGROUND** Treasures. How and where to find them. Morton Bldg., Chicago, Ill.

**"RAILROADING** As a Vocation." Start right and reap promotions. Fifty cents, postpaid. Chas. Elliott, Fayetteville, N. C.

**REESE** Publishing House, Mt. Pleasant, Pa., can supply any book published. Catalogs free.

**ENCYCLOPAEDIAS**, New. Bargain. Terms, J. G., 3129 W. 84th Street, Cleveland, Ohio.

**"STENOGRAPHY** and Bookkeeping Simmered Down," 50c. Practical, easy self-teaches. Marr, B 285, Nashville, Tenn.

**FIND** Out for Yourself what to invent and how to procure and sell a patent for the same. My book, "Inventor's Universal Educator," covers the matter from A to Z. 140 pages, elegantly bound. Also contains 600 mechanical movements and 50 perpetual motions. Price \$1.00, postage free. F. G. Dieterich, 651 Ouray Bldg., Washington, D. C.

**USED** Books, Bargains, Catalog. Higen's, A-2441 Post, San Francisco. (Books Bought.)

**FOR SALE**—Second Hand Books, all kinds 25c, some cost new \$10; Catalog 4c; McCarthy, 1236 Arthur Ave., Chicago, Ill.

**ENGINEERS'** questions and answers for license by Hobson, for twenty-five cents, postpaid. Send stamps. Reilly's Book Store, Philadelphia, Pa.

**MOTORCYCLES**, Side Cars and Cycle-cars. Their Construction, Management and Repair—The only complete work published on this subject. The dealer mechanic and rider will find this an excellent treatise. 550 pages, cloth, 350 illus. Price \$1.50 postpaid. Complete description sent upon request. Popular Mechanics Book Dept., 6 N. Michigan Ave., Chicago.

**BINDER** for Popular Mechanics magazines. Best adjustable magazine binder on the market made especially to hold any number from one to six copies of this magazine with name "Popular Mechanics" in gold letters on front cover. No laces or cutting or perforating of pages necessary. Simple, unique adjustment; handsome, durable and neat. We buy in quantities and can offer our readers this regular \$1.50 binder for \$1.25, all shipping charges prepaid. Address Popular Mechanics Book Dept., 6 N. Michigan Avenue, Chicago.

## CARTOONS

**CHALK** Talk Series—Turnover, trick, applause-getting caricatures. Complete program with "talk" \$1.00. Copy "Drawing Made Easy" (fifty sets trick drawings) free with order. Chalk Talk Magazine, Elm-creek, Nebraska.

## EDUCATIONAL AND INSTRUCTION

**SHORTHAND**—The New Way. Boyd System. The Wonder of the Age. Learned in 30 Days in Spare Time. 100 to 150 words a minute. Writers hold World's Record. Send today for Special Offer, Catalog and Sample Lesson. Chicago Home Study Schools, 551 Hepler Block, Chicago, Illinois.

**ARTIFICIAL** Marble, sanitary flooring, complete instructions, \$1. Ornamental casting, concrete, plaster, papiermache, decorations, garden furniture, statuary, rubber moulds, electrometallurgy. Particulars, 200 illustrations free. Mahler, D-721 Woodland Ave., Woodhaven, L. I., New York.

**PERSONAL** Instruction — Cartooning, Comic Art, Lettering. Write Freeburn, Hicksville, Ohio.

**COMPLETE** I. C. S. course in Electrical Lighting. New, Scholarship Privilege. Best offer wins. F. Bahovec, 4117 W. 24th St., Chicago.

**BE** a Finger Print Expert—\$25 to \$50 a week in this new and fascinating profession. Write—find out how you can learn at home to supply the big demand for finger print experts in banks, big factories, detective agencies, etc. Special limited offer—write while it lasts. Evans University, Finger Print Dept., Room 1194, 1816 Wilson Ave., Chicago, Ill.

**I. C. S. BOOKKEEPING** and business forms course, very reasonable. 311 N. E. Boulevard, Philadelphia, Pa.

**STUDY** Law at Home by the Dwight Method. A strictly Practising Course. Bar Ex. Guarantee. Oldest and Best School. Approved by Bench and Bar. Write today for free catalog giving rules for Admission in the several states. Chicago Correspondence School of Law, 376 Hepler Block, Chicago, Illinois.

**BOOKKEEPING**, Expert Auditing, Rapid Arithmetic, 50c. Garfield Commercial School, 1616 Germantown Ave., Philadelphia.

**MOULDS**, 200 illustrations free, beautiful art casts, concrete, artificial marble, plaster. Complete instructions thoroughly pictured, (copyright). Beautiful homes, garden ornaments, garages, statuary taken from life, quick sale novelties. Make them yourself. (mail address today). Mahler, Woodhaven, N. Y.

**"HOW** to Make Show Cards," 134 pages. Fully illustrated \$1. Catalogue of Business Books free. The Spatula, Boston, Mass.

**SHORTHAND** in five lessons: Rapid, accurate: Author ten years official stenographer Harvard University. Sample lesson 10c. H. McKinley, 708 Buckingham, Chicago.

**LEARN** Ad Writing from practical ad writer; no school; profitable profession; send for particulars. John Allen, 25 Parkhurst St., Newark, N. J.

**MOULDS**, Simplified and inexpensive methods of reproducing works of art. Ornamental casting. Novelties, Statuary, Garden Fixtures, Italian Marble, etc. Illustrations and instructions—Fifty (50) cents. Beaux-Art-Moulds Co., 436 Broadway, Brooklyn, N. Y.

**ROPP'S** Calculator and Short-Cut Arithmetic—Shows the answer as quickly as a watch shows the time to all problems likely to occur in office, store, shop, bank, farm or factory. Over two million sold. Price, rent pocket size, 50 cents; leather, pocket size, \$1.00; large, desk size, \$1.25 postpaid. Complete description sent upon request. Popular Mechanics Book Dept., 6 N. Michigan Ave., Chicago.

**WRITE** 100 words a minute with Brief-hand. Uses Longhand letters. Simple. Practical. Home study. Complete manual \$1.00. Sample lesson free. Premier Brief-hand School, Washington, D. C.

**FINGER** Print Instructor—A text book for the guidance of finger print experts and an instructor for persons interested in the study of finger prints. Book based on the Henry System and prepared by an expert. Cloth, 155 pages, illus. rated. Price, \$2.00 postpaid. Popular Mechanics Book Dept., 6 N. Michigan Ave., Chicago.

**WAR** Atlas—Large 20-page (11x15 in.) Atlas of the War in Europe, containing large colored scale maps of the Battleground, showing Europe, Austria, Serbia, Germany, England, Belgium, France, Russia, Italy, Greece, the World, etc. Special data showing comparison of armies and navies involved, pictures of rulers, etc. Price 50 cents postpaid. Popular Mechanics Book Dept., 6 N. Michigan Ave., Chicago.



**WANTED—New Ideas.** Write for list of Patent Buyers and Inventions Wanted. \$1,000,000 in prizes offered for inventions. Our Four Books sent free upon request. Victor J. Evans & Co., 167 Ninth, Washington, D. C.

**LEARN Drafting—**One of the most practical subjects, and indispensable in many occupations. Individual study at home without an instructor may be successfully carried on with the aid of our book, "A Practical Course in Mechanical Drawing," 160 pages, 157 drawings. Cloth. Price 50 cents postpaid. Popular Mechanics Book Dept., 6 N. Michigan Ave., Chicago.

**IDEAL Atlas—**Just Published—Contains large scale maps, yet is a book of handy size. Has special maps of all war zones in addition to all regular maps found in a good atlas. Is self-revising, that is, contains a certificate entitling the purchaser to a supplement of new maps after the war is over. Genuine flexible leather binding. 512 pages, 256 pages of maps, 256 pages of text. Price \$1.65 postpaid. Popular Mechanics Book Dept., 6 N. Michigan Ave., Chicago.

#### TRADE SCHOOLS

**ELECTRICITY.** Plumbing, Bricklaying, Mechanical, Architectural and other Drafting Courses. Motion Picture Operating taught by practical work. Largest, best equipped practical trade school in America. Short time to learn. Small cost, easy payments. Write for big illustrated book; it's free. Coyne National Trade Schools, Dept. 8194, Chicago, Ill.

**WE Train Men** in all lines of mechanical engineering. Long established, reputable, practical school. Gas, Electrical, Automobile, Tractor, Mechanical Drawing Courses. Will make you competent. Send for free illustrated catalogue, Seattle Engineering School, Seattle, Washington.

**LEARN Sign Painting and Card Writing** by correspondence. Catalog Free. Dept. A, Sign Card School, 181 North Fifth Avenue, Chicago.

**HILES' Watchmaking and Engraving School,** the largest and best equipped school in the West. 117 Market Street, San Francisco, Cal.

#### TELEGRAPHY

**TELEGRAPHY—**Morse and Wireless—taught at home in half usual time and at trifling cost. Omniograph Automatic Transmitter will send, on Sounder or Buzzer, unlimited messages, any speed, just as expert operator would. Adopted by U. S. Govt. and used by leading Universities, Colleges, Technical and Telegraph Schools throughout U. S. Catalog free. Omniograph Mfg. Co., 41-G Cortlandt St., New York.

**TELEGRAPHY for Beginners—**Best textbook for students of telegraphy. The standard method. 64 pages, 19 illustrations, 25c postpaid. Popular Mechanics Book Dept., 6 N. Michigan Ave., Chicago.

**PRACTICAL Railroad Telegraph School.** Circular free. 1034 Arch St., Philadelphia, Pa.

**TELEGRAPHY—**Morse and Wireless—also Station Agency taught. Graduates assisted. Cheap expense—easily learned. Largest school—established 42 years. Correspondence courses also. Catalog Free. Dodge's Institute, 15th St., Valparaiso, Ind.

#### WIRELESS

**WIRELESS Set, How to Make—**96-page book telling how to construct at small cost an outfit suitable for transmitting four or five miles. Price, 50 cents, postpaid. Popular Mechanics Book Dept., 6 N. Michigan Ave., Chicago.

**MAKING Wireless Outfits—**Become a wireless constructor. This book tells how. 61 pages, 27 illustrations. 25c postpaid. Popular Mechanics Book Dept., 6 N. Michigan Ave., Chicago.

#### PICTURES, POSTCARDS, PENNANTS

**BIGGER** than ever, more names, stories, etc. 1,099 names to select each issue. Enrollment 8,000; rapidly growing. Trial 10c. Elite Postcard Exchange, R-15, 3684 Milwaukee Ave., Chicago.

**200 ILLUSTRATIONS** free, beautiful art statuary. Mahler, Woodhaven, L. I., New York.

**FREE.** 25 poster stamps; membership 10c. Sagebrush Postcard Exchange, Goldfield, Nevada.

**SEND 10c** for 10 Different Post Cards of Picturesque America, from Maine to Florida. No Comic or Trash. Views only. Standard Card Co., Haverhill, Mass. We have Post Cards from all over the world.

**EXCHANGE** postcards; large club. Membership 10c silver. Capital League, Box 1539-P, Washington, D. C.

**EXCEPTIONALLY** rare photos of shipwreck on Atlantic coast, showing captain landing in breeches buoy, 25c. Marine Views Co., Bishopville, Md.

**MAKE** new acquaintances, join our postcard club, membership, 10c. Worlds Postcard Club, 13 West 42nd, New York.

**MAKE** friends exchanging postcards. Membership 10c. Universal Exchange, 454 Palisade Av., Jersey City, N. J.

**"MOVIE Stars"** 25c. Postcard Photos 25c. Chas. Crane, Racine, Wis.

**JOIN** a featured card club—trial 10c. Monarch Exchange, 1364 Marquette Road, Cleveland, Ohio.

**IF** you really want to exchange postcards, try our splendid club. Lists circulate in many countries. Membership, 10c. Halcyon Club, Box 138, Erie, Pa.

**PRETTY** view cards from many cities, towns and countries. Membership and 6 pretty cards, 10c. Riverside Club, Knoxville, Md.

**RECEIVE** pretty postcards from everywhere. Join best card club. Membership 10c. Jolly Card Exchange, Decatur, Indiana.

**CROSS-SECTIONAL** view of ocean liner "Britannic," showing interior arrangement of ship in colors, size, 14x20 inches, on heavy plate paper for framing or hanging. Very interesting. Reproduced from front cover design of July, 1914, Popular Mechanics. Will be sent postpaid to any address in the world on receipt of 4 cents in stamps to cover packing and mailing. Popular Mechanics Magazine, 6 N. Michigan Ave., Chicago.

#### CAMERAS AND PHOTO SUPPLIES

**MAKE** Beautiful transparent photos on watch dials, cases, etc. Complete process and working instructions 25c. C. Johnson, 1319 N. Whipple St., Chicago.

**FILMS** developed 5c, any size. Prints 3c each, all sizes. Free enlargement with first \$1.00 order. Johnson's Studio, Oswego, N. Y. 3 months' instruction in Photography \$10.00 at studio.

**PRINTS,** any size, 3c each, first-class work only. Films developed 10c per roll. Prompt Service. Postage paid. Grant Co., 236 Brandeis Theater, Omaha, Nebr.

**SENSITIZE** your own gaslight papers, postcards. Make pictures on anything. Save 50%. Bottle silver emulsion \$1.00. W. Bailey, 314 Kearny, San Francisco.

**FILMS** Developed 10c. Prints Postcard size and less 5c. Enlargements. Price List. Established sixteen years. Deusing Studio, West Allis, Wis.

\$95.00 No. 1A GRAFLEX Camera \$68.00, \$85.00 Auto Graflex 3 1/2x4 1/4 \$55.00. 100 other bargains in our Special Price List. J. L. Lewis, 522-8th Ave., New York, Dept. A.

**FILMS** Developed Free, perfect prints, modern up to the minute methods. We do the best work in this Photo City. Films developed absolutely free when we make the prints. No matter where you live send us your films. We return all work promptly by parcels post. Bryans Drug House, Rochester, N. Y.

**SPECIAL Sale—**3A Autographic Kodak f:7.7 Anastigmat Lens, \$19.75. 3x7 Velostigmat f:6.3 Lens, Optimo Shutter, \$28.75. 3A Graflex Autographic \$52.50. Eastman Vest Pocket Kodak \$3.25. Hundreds of slightly used bargains. Send for Free Bargain Book. Save 25 to 60%. Money back if unsatisfactory. Kodaks, Lenses, bought or exchanged, Central Camera Co., 124-E So. Wabash Av., Chicago, Ill.

**WE** furnish kodak films free. Send 2 negatives for sample prints, price-list and Free Film Offer. If you include 50c we will make one 10x12 (regular 85c) Sepia enlargement. Homer Howry Co., Los Angeles, Cal.

**HARVEY** Exposure Meter gives correct Exposures for all kinds of Cameras, Exteriors, Interiors, Night work or Color Plates. Ask your dealer, or write G. L. Harvey, 105 S. Dearborn St., Chicago. Price \$1.40.

**MAKE** prints and pictures have old appearance. Send 25c for instructions. Box 431, Montosano, Wash.

**PATENTS—**Send Sketch. Free Opinion and Certificate of Patentability. Free Book, "How to Obtain a Patent and What to Invent." Patents secured through Credit System. Talbert & Parker, Patent Lawyers, 4661 Warder Bldg., Washington, D. C.

**8x10 ENLARGEMENTS** made from negatives. Hand colored, mounted 45c prepaid. J. Gonder, Tremont Ave., East Orange, New Jersey.

**KODAK** films developed, 7 cents each, any size. Prints, three cents each, all sizes. 8 by 10 enlargements 25 cents. C. C. Smith, Tarrytown, N. Y.

**ROLL** Films developed 10c. Prints on best grades of paper at moderate prices. All work guaranteed. Schnyder's, 3858 Humphrey St., St. Louis, Mo.

**FILM** developed, 10c roll. Packs 20c; Prints, Brownies, 2c; 1a, 3x4, 3x5 and Post Cards, 3c. Returned next day. Prepaid. Kodak Film Finishing Co., 112 Merchants Station, St. Louis.

**SPRINGTIME** is Camera time, \$20 3A Kodak, our price \$11. Brownies, Motion Picture Cameras and everything photographic, at remarkable money-saving prices. Ten days' trial, money-back guarantee backs every item we sell. Our new catalog No. 82 just off the press. Send for your copy today. See our display advertisement on page 177. David Stern Company, Everything in Cameras. In business since 1885. 1047 Madison Street, Chicago, Ill.

**ANY** roll film developed 5c. Prints 3 1/2x 5 1/2 and smaller 3c. 24-Hour service. National Photo Company, Omaha, Nebr.

**INVENTIONS** Wanted in Motion Pictures and Photography. Special department for these classes of invention. Advice, What to Invent and List of Patent Buyers sent free. Victor J. Evans & Co., 159 Ninth, Washington, D. C.

**KODAK** Finishing that is different. Write for valuable information and how to get free enlargement. Salsbery Studio, Cherokee, Iowa.

**PHOTOGRAPHIC** Enlargements equal to contact Prints. To prove quality send Film or Negative and 20c for trial Print. Artistically Mounted. Myland, 2125 N. Front, Philadelphia.

**FILMS** Developed, 10c all sizes. Prints 2 1/2x3 1/4, 3c; 3 1/2x4 1/4, 4c. We give Profit sharing Coupons. 24 hour service, work guaranteed. Send negatives for samples. Girard's Com'l Photo Shop, Holyoke, Mass.

**EQUIP** your camera or Kodak with a Wollensak lens and shutter and obtain the best possible results. Beautiful descriptive catalogue "B" sent on request gratis. Wollensak Optical Co., Rochester, N. Y.

**BIG** Money Saved on Photographic Lenses and Apparatus—goods exchanged; repairing done. Ralph J. Golsen, 230 Kenmore Ave., Chicago, Department P.

#### MOTION PICTURES

**MOVING** Pictures for sale; most any character or subject; \$3.00 per reel. Davis Film Service, Wilkes-Barre, Pa.

**ELECTRIC** Arc Generator makes your own current for half. Your engine operates. Easy terms. Hobarts, Box MF, Troy, Ohio.

**MOTION** Picture Machines bought and sold. Bargain lists free. National Equipment Company, Duluth, Minn.

**MAKE** money writing Photo-plays; details free to beginners. No correspondence course. Producers League, 230 Wainwright, St. Louis.

**WRITE** Moving Picture Plays; constant demand; big prices paid; past experience or literary ability unnecessary; details free. Gliese Co., 302 Whiteman St., Cincinnati, Ohio.

**NEW** Edison Kinetoscope \$75.00. Lecturer's outfits with Prest-O-Lite attachment. "Royal" moving picture machines easy terms. Write for description. F. E. Russell, Batavia, N. Y.

**FILMETTES:** Send us your moving picture film, positive or negative; will make photographs to your order, any size. Filmettes, 5643 Santa Monica Blvd., Los Angeles, Calif.

**MOTION** picture machines slightly used at low figures. Hommel's, 947 Penn Ave., Pittsburgh, Pa.

**POWER'S** Moving Picture machine, cost \$185; take \$50. 208 South Market, Canton, Ohio.



WRITE for free copy "Hints to Writers of Photoplays, Short Stories, Poems." Also catalog of best books for writers. Atlas Publishing Co., 71, Cincinnati.

**MAKE Big Money** in moving-picture business. We start you and furnish guaranteed outfit on easy payment plan. Easy to accomplish. Catalog free. Monarch Film Service, 228 Union Ave., Dept. P, Memphis, Tenn.

**BIG Profit Nightly**—Moving Picture Business—small capital starts you, easily accomplished. Teach you—furnish everything. Ralph J. Golsen, 5123 Kenmore Ave., Chicago, Dept. M.

**ARE You a Movie Type?** Many of the greatest stars were discovered by accident. You want to know if you have the natural qualifications that bring \$50,000 salaries. The book Motion Picture Acting tells you this, also 191 screen favorites show you how they register 499 human emotions. Use of cosmetics, costume requirements and color schemes also treated. Price leather \$1.19, cloth 75 cents postpaid. Popular Mechanics Book Dept., 6 N. Michigan Ave., Chicago.

**MOTION Picture Operation, Stage Electric and Illusions**—The only practical handbook and guide published for motion picture operators, theater electricians and managers. A thoroughly practical and useful book, covering the subject comprehensively. Pocket size, leather, 393 pages, fully illustrated. Price \$2.00 postpaid. Popular Mechanics Book Dept., 6 N. Michigan Ave., Chicago.

### BUSINESS OPPORTUNITIES

**YOUNG men**, we build our big jewelry organization from the ranks. No experience necessary. Must learn watch and jewelry repairing. We train you thoroughly and furnish everything necessary to commence with. Affords life-time business; big income. We are establishing branches everywhere. We start you right. \$1500 to \$5000 yearly in home town or elsewhere. No capital needed, though possession of \$300 to \$500 gives better start. Write today; full particulars free. Rogers Thurman & Co., 55 East Madison St., Chicago.

**INCREASE your wages** by learning how to file; complete course in book form, \$1.00; published by world's leading office equipment manufacturers; money back in 10 days if unsatisfactory. Yawman & Erbe Mfg. Co., Dept. L, Rochester, N. Y.

**GET Into a Business of Your Own** cleaning wallpaper window shades, and kalsomine. Big demand everywhere. Selling and doing the work with Swanson's Lightning Cleaner. Particulars free. New Plan. Write quick. G. Swanson and Sons, Mankato, Minn.

**BECOME a "green-back getter"**: Read "Tips," the Money-Maker's Friend. Three months' trial for quarter. Single copy, dime. Greb, Pub'r, Kenil, N. J.

**START Original Mail Order Business.** Honest, legitimate, highly profitable, exclusive. Write Clement Moore, Box 98, New Egypt, N. J.

**MAKE, sell—"Spyder" Cardboard Fly traps**, a good proposition for the summer, four styles 30 cents. For particulars write, Harry Green, 1316 Larimer St., Denver, Colo.

**DOLLARS yearly in your backyard.** No Ginseng, mushroom dope. New ideas. Investigate. Particulars free. C. Metz, 313 East 89, New York.

**\$300 TO \$500 per month** easily earned in the Real Estate Business. "The Real Estate Educator" tells you how. Teaches management, salesmanship, insurance, brokerage, advertising, renting, agency, forms, etc. Exceeds \$25.00 correspondence course. 256 pages, artistic silk cloth \$1.00 prepaid. Money back if dissatisfied. Circular free. F. E. MacMichael, Dept. 49, Victor, N. Y.

**PATENTS**—Send Sketch. Free Opinion and Certificate of Patentability. Free Book, "How to Obtain a Patent and What to Invent." Patent secured through Credit System. Talbert & Parker, Patent Lawyers, 4671 Warder Bldg., Washington, D. C.

**MONEY makers for the man with little or no capital.** Send 50c for book of plans and formulas. A. Weaver, Buena Vista, Ga.

**NEW way to paint signs**—Our patterns do the work. Complete outfit \$5.00. Butts Advertising Co., Gumbel Bldg., Kansas City, Mo.

**ADVERTISE**—20 words in 50 weeklies, \$1; 100 monthlies, \$1; 10 Sunday papers, \$2; all, \$3.50. Cope Agency, St. Louis.

**MAKE Music Rolls** for profit and pleasure, with simple perforator. Splendid opportunity. Particulars free. The Leabarian Mfg. Co., Hamilton, Ohio.

**MAIL Order Business** is your opportunity. Start as side line, the Brenner way, gradually earn good income. Business like dealings, common sense, honest help, exclusive plan to every client; proved successes. Send 25c for information worth a dollar; no free circulars. Brenner, 302 A, Walnut, Philadelphia. Send \$1 and receive all the above, also a big collection of other mail order books.

**LUMINOUS Paint.** Shines in the dark. Make and sell your own Luminous articles; watches, clocks, electric switch plates, crucifixes, etc. Latest discovery. Only 25c bottle. (Agents wanted.) Luminous Paint Co., Douglas Park Sta., (B-7) Chicago.

**NEW \$2.50 Automatic Adder**, sells quick from demonstration. Big profits, no competition. Every business man buys. Bassett, 5921F Indiana Ave., Chicago.

**\$50 TO \$100 a day** can be earned with a Long Crispette Machine in any town. Machine a wonder. Makes Crispettes—a new, delicious popcorn confection. Sells at 5c a package—almost 4c net profit. Everybody buys at sight—nickels roll in. All you need is one machine and good location. No experience necessary. Investment small, returns large. Write at once for free book "Dollars & Sense"—a valuable guide to wealth and independence—a start to the ownership of a store of your own. Don't wait. Send postal today. Address, W. Z. Long Co., 1329 High St., Springfield, Ohio.

**MAIL Order Dealers.** Let the 4 in 1 coupon plan increase your profits. Sell valuable instruction systems by cut price coupon under money back guarantee. Big margin. Small selling expense. Complete plan, sample coupons and bargain bulletin sent on request. Mail Dealers' Coupon System, 519 So. Dearborn St., Chicago.

**MANUFACTURERS, Promoters and Patent Buyers** are invited to write us stating the line of invention in which they are interested, as we can supply their wants in any class of patents. Victor J. Evans & Co., 142 Ninth St., Washington, D. C.

**Big money in promoting inventions.** Write Adam Fisher Mfg. Co., 2061D Railway Exchange, St. Louis, Mo.

**NEW invention—Curtain Protector.** Retail \$1.00. Agents wanted. Address, O. Jones, 4540 Bryant Ave. South, Minneapolis, Minn.

**500 FORMULAS**, including Resilvering Mirrors—Renewing Dry Batteries, Luminous Paint, Luminous Ink, 25c. Ideal Book Shop, 3315-C4, Belleplaine Ave., Chicago.

**SAFE Experts** make \$15 to \$25 per day. You can be an expert too. Learn how to open and repair safes and make big money. I will teach you. R. G. Herrmann, 504 Gibbs, Ave., Waukegan, Ohio.

**RELIABLE man** to open office handling best automobile specialty on market; new; good for \$5,000 annually. Small capital required. Wood, 325 Title Guaranty, St. Louis.

**GOOD monthly income** easy in spare time manufacturing letters for signs. Free particulars, J. F. McPherson, 677 Brown Avenue, Butler, Pa.

**LUMINOUS Paint**—5 formulas—different colors, 25c. C. Johnson, 4319 N. Whipple St., Chicago.

**ENTER the Rubber Manufacturing Business.** Guaranteed Rubber Formulas, for the manufacturing of Dipped rubber goods, balloons, nipples, gloves, etc. Equipment not expensive. Write to-day. Department E, 34 Central Office Bldg., Akron, O.

**ENTER a new business.** Earn \$8,000 to \$8,000 yearly in professional fees making and fitting a foot specialty, openings everywhere, with all the trade you can attend to; easily learned by anyone at home in a few weeks, at small expense; no further capital required, no goods to buy, job hunting, soliciting or agency. Address Stephen Laboratory, 11 Back Bay, Boston, Mass.

**WE start you in business** furnishing everything; men and women make handsome income weekly operating our "New System Specialty Candy Factories" home or small room anywhere; no canvassing. Opportunity lifetime; booklet free. W. Rapsdale Co., East Orange, N. J.

**INVENTORS:** We develop and perfect inventions, make models, dies, tools. Metal stamping and special manufacturing. Gerding Bros., Lion Bldg., Cincinnati, O.

**ADVERTISERS, Mail Dealers.** Our New Rate Book lists 2,009 Principal Publications, rates, circulation. Includes 30 Mail-Order Plans. Free. Dearborn Advertising Agency, 219 Franklin Bldg., Chicago.

**PLASTOGRAPHY:** Nothing so engaging and profitable; "Plastography" instructions \$2. A model or mould of President Wilson or Lincoln sent free with your order. P. B. Spahr, York, Pa.

**LEARN the real estate business;** our enlarged instruction book teaches listing, appraising, management, salesmanship, insurance, brokerage, advertising, renting, agency, estates, titles, rights, forms, etc.; revised edition; 246 indexed subjects; exceeds \$25 correspondence course; buckeye cover, \$1; silk cloth, \$1.25, postpaid. Realty Book Co., Dept. No. 29, Cleveland, Ohio.

**LEARN the "Practical" Advertising Business** and become independent. I teach you how to establish yourself without capital, and furnish you original plans and methods to work upon; rare opportunities; booklet free. Dawson, Avenue 3, Stockton, California.

**LEARN to collect money.** Good income; quick results. Send for free booklet. "Skillful Collecting." Collectors' Association, Long Street, Newark, Ohio.

**25-WORD Advertisement** in 100 monthly magazines, 3 months, \$1. Quadri Co., 425 E. 149th St., N. Y.

**FORTUNES in Food Products;** Product now selling in 35 States; \$25 invested now may yield big returns. Particulars free. Home Securities, First National Building, Oakland, Cal.

**SILVERING Mirrors**—My exclusive French Tartaric Method opens enormously profitable business. Booklet free. H. Barstow, 514 23rd St., Oakland, Calif.

**CRAYON Portrait Finishing;** easy; profitable home employment. Walton, L-29, Prairie City, Ill.

**CONDUCT a profitable Candy Kitchen;** very small capital required; booklet free. Kennon School, 509 Wells St., Dept. A, Chicago.

**COMPETENT Chemical Advice Reduces Costs,** improves products, bridges difficulties. Analyses are inexpensive. Let us study your requirements. Formulas developed. Chemist N, Industrial Laboratories, New Orleans.

**INDEPENDENCE and fortune** quickly attained in the Manufacturing Mail Order business. I furnish Formulas, Manufacturing Processes and Trade Secrets in all lines. Sold under positive guarantee; 18 years' practical experience. Revision and improvement of Formulas and Processes—reduction of manufacturing cost—utilization of waste materials, etc., a specialty. Booklet, Formula List, and Valuable Information Free. W. L. Cummings, Ph. D., 127 Standard St., Syracuse, N. Y.

**PATENTABLE Ideas Wanted**—Send for 3 free books. R. B. Owen, 30 Owen Bldg., Washington, D. C.

**GOOD money** easily earned at home, sparetime, silvering mirrors; No capital. Free instructive book tells how. Patterson & Co., Brooksville, Ky.

**HUGE Opportunity** to make money, new simple ways. Blue Ribbon Scheme Book. Particulars free. Sheridan Company, 417 E 151st St., New York.

### MAIL-ORDER SUPPLIES

**INCREASE your sales.** Place your proposition before the readers of "Cartoons Magazine," 20,000 copies guaranteed every month. Classified rate 5c per word. Mail in a trial ad today. Cartoons Classified Dept., 78 E. Madison St., Chicago.

### FOR ADVERTISERS

**NEED Agents?** Our system used by largest concerns with great success. Write Moore's Expert Service, New Egypt, N. J.

**25 WORDS** in 100 monthlies, \$1; 100 weeklies, \$2.50; 40 Sunday papers, \$10. Cone Agency, St. Louis.

**ADVERTISERS**—Here's your opportunity. Your proposition placed before the readers of "Cartoons Magazine" for only 5c per word. Circulation 20,000 copies guaranteed. Send a trial ad for our next issue. Cartoons Classified Dept., 6 N. Michigan Ave., Chicago, Ill.

**YOUR Thirty-Word Ad** in our big post-card magazine, 25c. Inch display, 50c. Elite Exchange, 2694 Milwaukee Ave., Chicago.



## TO MANUFACTURERS

WANTED manufacturer to manufacture good toy, Raymond Weikel, 21 Penn St., Milton, Pa.

THE locating of a manufacturing enterprise in DeGraff is desired by the DeGraff (Ohio) Commercial Club.

PATENTS—Send Sketch, Free Opinion and Certificate of Patentability. Free Book, "How to Obtain a Patent and What to Invent." Patents secured through Credit System, Talbert & Parker, Patent Lawyers, 4662 Warder Bldg., Washington, D. C.

## ART AND ADVERTISING SERVICE

FACING a sales or advertising problem? Consult Harry A. Stern, Specialist, 1660 Gaylord, Denver.

## BUSINESS SERVICE

WE will get you anything that is manufactured in Chicago and save you money. Tell us your needs. R. & G. Austin, Manufacturers' Agents, 3224 Polk St., Chicago, Ill.

INCORPORATE. Our lawyers do the work, saving you time, annoyance and money in incorporating under the most liberal laws of Arizona. Laws and forms free. Southwestern Securities & Investment Co., Box D488, Phoenix, Ariz.

## COLLECTIONS

EIGHT Good Will Collection Letters, 25c. For small and mercantile accounts. If dissatisfied, return immediately and money will be refunded. Letter Service Co., Hartford, Conn.

## AGENTS WANTED

\$1,000 PER Man per county. Strange invention starts world—agents amazed. Ten inexperienced men divide \$40,000. Kurstad, a farmer, did \$2,200 in 14 days. Schleicher, a minister, \$195 in first 12 hours. \$1,200 cold cash made, paid, banked by Stoneham in 30 days; \$15,000 to date. A hot or cold running water bath equipment for any home at only \$6.50. Self-heating. No plumbing or waterworks required. Investigate. Exclusive sale. Credit given. Send no money. Write letter or postal today. Allen Mfg. Co., 311 Allen Bldg., Toledo, Ohio.

MEN and Women—You make startling profits selling the original Delbare's Naptha Washing Tablets. Washes clothes dazzlingly white without rubbing—positively guaranteed—non-injurious to the finest fabrics—an amazing repeater. Factory-to-you prices—protected territory. Free circulars—prompt shipments—overwhelming evidence—a big reliable corporation. Write for our money-making proposition. Naptha Washing Tablet Co., 123 So. Dearborn St., Chicago.

AGENTS: You can make big money taking orders for our fine made-to-measure clothes, so write quick for 60 beautiful cloth samples, 32 smart styles in rich colors, wholesale and retail price lists, lowest prices and best offer to agents, \$5.00 to \$10.00 a day easy. Big outfit, over 250 samples free to live wires. No experience needed—no capital. We furnish everything free—pay postage or express charges—back you, boost you, show you how and clearly explain everything. Costs nothing to try. Let us make you a stylish suit to measure to prove our fine quality and style. Send postal or letter today. Paragon Tailoring Co., Dept. 414, Chicago.

AGENTS Wanted—Tolliver Puncture-Proof Inner Tubes sell easily—our agents make \$5.00 to \$50.00 a day net profit—no competition. If you wish to establish a business of your own with unlimited possibilities for profit write us for complete details. Tolliver Tube and Tire Co., 523-C Foster Bldg., Denver, Colorado.

AGENTS—Steady income. Large manufacturer of Handkerchiefs and Dress Goods, etc., wishes representative in each locality. Factory to consumer. Big profits, honest goods. Whole or spare time. Credit given. Send for particulars. Preport Mfg. Co., 59 Main St., Brooklyn, N. Y.

AGENTS Wanted Everywhere—To sell our attractive theatre Brass Poster Frames, Changeable Signs, Building Directories, Brass Signs, Brass Railings, Bank Fixtures, Adjustable Electric Light Brackets. Big demand; easy sales. Established 1882. Newman Manufacturing Company, Cincinnati, Ohio.

EASY, pleasant work for Mechanics, Shop Men, Clerks, during spare hours, will add many dollars to their salaries. Also want persons who can give full time. Big wages assured. Novelty Cutlery Co., 67 Bar St., Canton, Ohio.

AGENTS. Make Big Money; fast office seller; particulars and samples free. One Dip Pen Co., Dept. 2, Baltimore, Md.

AGENTS—\$5 daily selling our Handy Tool, 12 articles in one. Lightning seller. Sample free. Thomas Mfg. Company, 762 North St., Dayton, Ohio.

\$5 TO \$15 profit a day selling most complete line Sanitary Household Brushes for every purpose. Our own make. Your territory awaits you. Write for attractive proposition. Puritan Sales Co., Dept. M, 1966 Broadway, New York.

GARRETT sold Twenty-Nine Spray Pump Auto Washers in Three days. Profits, two dollars each. A Square Deal. Rusler Co., Johnstown, O.

NEWLY invented article for agents. Everyone you approach needs it. 100% profit. Paul Cochran, Windsor, Mo.

AGENTS, either sex, make big money, 100% profit. Send 10c in stamps for sample; particulars. J. C. Mendenhall, Evansville, Indiana.

AUTO Owners—We want a few live motorists who drive their own cars to introduce International Half-Sole Tires in their territory. Greatest Tire Cost reducer ever offered to the motoring public. Practically sells on sight. Our sales jumped 400% in ninety days. For details write the International Rubber Company, 41 W. Tennessee, Denver, Colo.

BLAXIT Safely While Hot; new stove polish; works without soiling hands. Huge profits for agents. M. Ross Mfg. Co., New London, Conn.

QUICK selling article to Garages—Mechanics—Farmers. Geo. S. Long, De Kalb, Ill.

RAINCOAT Agents. Write for the honest, live, guaranteed proposition. Biggest Commissions. Free Outfit. Consolidated Raincoat Co., Clerk B, Boston, Mass.

AGENTS, 500% Profit. Sign-Letters for office and store fronts. Samples and particulars free. Inter-States Letter, 2424 N. Halsted St., Chicago.

AGENTS—are you looking for something of merit? Welder Supply Co., Mineral City, O.

SELL Joker's Novelties! 16 samples, 10c. Chambers Works, Plainwell, Mich.

CAR owner Agents Wanted. Spring rush season now on for Funnel-Vac, guaranteed gas saver and carbon eliminator. Hundreds sold every week. Big profits. Write for details. The Funnel-Vac Mfg. Company, Box 651, Denver.

\$61.50 WEEKLY. Introducing and selling a new gas light burner for kerosene lamps. Beautiful light. No chimney. No mantle. Samples free. Luther Manufacturing Co., Dept. 298, Cincinnati, Ohio.

AGENTS—Make \$40 Weekly Selling Goodyear Raincoat. Sample coat free. Write for agency. Goodyear Mfg. Co., 400 Lillis Bldg., Kansas City, Mo.

100% PROFIT. Every good home in city a prospect. Inexpensive massage machine—not electric. Indorsed by physicians and thousands of users. Attractive territorial proposition to live men. Clifton Specialty Co., 703 Main St., Buffalo, N. Y.

AGENTS—Snappest household line on earth. Red hot sellers, steady repeaters—100% profit. 250 light weight, fast selling, popular priced necessities. Agent's outfit free. Get busy—quick. Write today, postal will do. American Products Co., 9439 3rd St., Cincinnati, O.

MEN and Women: \$1500 to \$3000 yearly taking orders for over 90 Household Articles. Outfit Free. Big Chance. Full Particulars. Duo Factories, Dept. B, 58, North Java, N. Y.

GENERAL Agents—Crew Managers—Capable of earning \$75 or more weekly. Sell new Guaranteed home specialty backed by \$200,000 corporation. Big Profit. Quick sales. Exclusive Territory. Sales Manager, Dept. H-8, 20 W. Lake St., Chicago, Ill.

AGENTS can double their money on a Three Dollar world beating patented specialty. Every man and most women are prospects. Apply immediately to Manufacturer, 967 Liberty Avenue, Pittsburgh, Pa.

BIG Money Selling Flower Seeds, List Free. John Weaner, Kinzers, Pa.

ONE Thousand Dollars Reward if this is not the greatest money-making-house-to-house proposition. N. R. G. Laundry Tablet washes clothes in 10 minutes, without rubbing. Contains no Lime, Lye, Paraffin Wax or other injurious chemical and cannot possibly injure the clothes or hands. Nothing like it on the market. Positively the wonder of the age—sells for 15c enough for 5 family washings. We supply free samples and guarantee the sale of every package you buy. Just leave the free sample with the housewife and when you call again, she is eagerly awaiting to become your steady customer. Secure territorial rights at once, or you will regret it. A 1c postal brings sample and full particulars. Farquhar-Moon Mfg. Co., Desk K-200—140 W. Van Buren St., Chicago.

25% PROFIT selling Jubilee Spark Intensifiers to automobile owners, garages. Sure cure for Spark Plug troubles. Sells like wildfire. Brand new. Exclusive territory. Write today. Jubilee Mfg. Co., Dept. M-5, Omaha, Nebraska.

A NEW, Novel, and Clever Invention; wonderfully attractive; a market in every home; good profits; big demand; particulars free. Shomescope Mfg. Co., 523 W. 13th St., Kansas City, Mo.

PORTRAIT Agents: Deal with artist direct. Good work at reasonable prices. Chas. A. Sweet, Artist, 520 New Era Bldg., Chicago, Ill.

SNYDER'S Toilet Preparations and household necessities are big values; big profit makers; sell themselves; start making money immediately. T. H. Snyder Co., Cincinnati, Ohio.

SELL superior laundry marvel, no rubbing. Sample 15 cents. Urquhart, 632 West 131 Street, New York.

AGENTS 200% profit selling Stransky's Automatic fuel vaporizer at \$2.00. Guaranteed to save 25 to 50% in gasoline. Greatest money maker on earth. Money back guarantee. Booklet free. J. A. Stransky, Pukwana, S. D.

BUILD up a profitable Manufacturing Business of your own making Marvello-Wizard Laundry Tablets—No Paraffin, lye or Potash—unequaled Washing Wonder. Zeero-Salt—New Egg Preserver—powdered form—beats cold storage. Fibro-Vac—Automatic Puncture plugger tire treatment—Carbo-Cide, the only satisfactory gasoline intensifier, decarbonizer. I supply guaranteed Formulas for making these and latest advertised specialties in all lines. Particulars, latest lists, Stamp, Miller, Analytical Chemist, Tampa, Florida.

AGENTS make \$5.00 to \$8.00 a day selling never fail Iron Rust and Stain Remover, and 125 other fast sellers. Exclusive territory. Credit given. Sample free. Sanford-Beal Co., Inc., Newark, New York. Dept. C.

\$70.00 TEN Days! Hedrik's Profit. Patented Curtain Rod. Over 2,000,000 sold. Sample 10c. Rodolph, 504 Northwestern Building, Chicago.

SHOES waterproofed with Gofco wear 3 times longer. Greatest Discovery and Seller. O. Fedler, 58 Whittier Ave., Providence, R. I.

INVENT something; your ideas may be worth wealth; our free book tells what to invent and how to obtain a patent, through our new credit system; write today. Waters & Co., 4663 Warder Bldg., Washington, D. C.

BE your own employer. 100% profit. Manufacturers, 264 Spring, New York.

AGENTS—Just out, New Dollar Winner. One-Hand Speed Wrench. Machinists, autoists, farmers, everybody buys at sight. 100% profit. Make \$30 to \$50 weekly. Toledo Speed Wrench Co., Toledo, Ohio.

AGENTS. I want 100 men to act as my agents and take orders for "Kantleak" Raincoats. I paid Eli Bridge \$88.95 for one week's spare time. Cooper \$314 last month. Wonderful values. A dandy coat for \$3.98. No money required. No delivering or collecting. Sample coat and complete outfit all free. Big season just starting. There's a thousand dollars in this for you if you grab it quick. Write now. Comer Mfg. Co., 127 Paige St., Dayton, Ohio.

AGENTS—Make a dollar an hour. Sell Mendets, a patent patch for instantly mending leaks in all utensils. Sample package free. Collette Mfg. Co., Dept. 404-B, Amsterdam, N. Y.

INSYDE Tyres, inner armor for Automobile tires, double mileage and prevent punctures and blowouts. Quickly applied. Cost little. Demand tremendous. Profits unlimited. Details free. American Automobile Accessories Co., Dept. P, Cincinnati, O.



**AGENTS Wanted.** To sell direct from factory to Dealer our new style regular razor with renewable blades. Regular or safety as you wish, made of Sheffield Steel and Gorman Silver. Good commission. Write Litt Cutlery Co., Spencer, Iowa. Incorporated at \$40,000.00. A. O. Bjornstad, Pres.; S. E. Carlsen, Sec., Mgr.

**AGENTS.** We have a good proposition for you. Write for particulars and samples. Chicago Agency Co., 838 Altgeld St., Chicago.

**SELL** guaranteed made-to-measure raincoats. Agents' price, \$2.50 delivered. Material, workmanship incomparable. Outfit free. Standard Raincoat Co., 395 Broadway, New York.

**AGENTS—Sell your own brands;** we furnish bulk goods and formulas and all supplies. Goldberg Laboratory, 45 Clinton St., Newark, New Jersey.

**TELL** us what you would like to have made in tablet form. German Chemical Agency, Cleveland.

**500 WEEKLY** and up selling Mexican Diamonds. Exactly resemble genuine; Same Rainbow Fire; stand tests; sell at sight; repeat orders. Write quick for Sample Case offer free. Mexican Diamond Importing Co., S. W. Las Cruces, New Mexico.

**25 CENTS** saves \$5.00—Hercules Fireless Solder. This wonderful solder requires no heat, tools or skill to use. Squeezed from a tube and air hardens. Mends all metals, water and gas pipes, automobile radiators, water jackets, gasoline tanks, steam radiators, etc. Price 25c. Agents wanted. Hercules Supply Co., 726 President St., Brooklyn, N. Y.

**NEW "4 in 1"** changeable letter sign, original. Four signs in one. Working quickly changed with 4th machine cut characters. Salesman's profit 100%. New England Sign Co., New Haven, Conn.

**LADIES** and Gentlemen of refinement to sell new patented article in homes and offices. Sells at sight. Big profits. Sample 15 cents. E. A. Lueck, 602 Caswell Block, Milwaukee, Wis.

**AGENTS:** Big Hit; Our 5-Piece Aluminum Set is all the rage. Cheaper than Enamel Ware. Sells like wildfire. Guaranteed 20 years. Retail value \$5.00. You sell to housewives for only \$1.83. Biggest seller of the age. 9 sure sales out of every 10 shown. Others cleaning up \$10.00 to \$20.00 a day. Answer this quick to secure your territory. Div. GG5, American Aluminum Mfg. Co., Lemont, Ill.

**SPECIALTY** Salesman Magazine—100 pages monthly, chock full of inspirational selling talks; where to buy, how to sell; every issue is a course in salesmanship; vicariously and fearlessly exposes fraudulent advertisers; salesman's true friend and champion. Yearly \$1.00; three months trial subscription 20c (stamp accepted). Specialty Salesman Magazine, 508C So. Dearborn St., Chicago.

**PROFIT** 152 per cent to agents. Why pay \$28.00 to \$35.00 for check protectors? Our vest pocket machine perforates and inks, protects amounts, names, signatures, complies with the law; send \$1.00 for sample. Bear Check Protector Co., Box 194, Cincinnati, Ohio.

**SEVEN** out of ten automobile owners buy on sight, Campbell's Self-Vulcanizing Fabric Patch Tire and Tube Repair Outfit. 100% profit. Send 50c for sample \$1.00 outfit. Blowouts repaired in three minutes without heat. One Illinois agent averaged \$28.00 day profit last week. Campbell Tire Company, Kansas City, Mo.

**A MOUSE** a minute can be caught with a "Gravity" trap, send dime for one, quarter for three, agents wanted. Phil H. Kohl, Morris, Illinois.

**CLEANING** Preparations—Rust Remover, Laundry Tablets, etc. Agents, 100% profit. P. S. Lawrence, Bowling Green, Ohio.

**SELL** Vulcurel auto inner tube repair material and Kutite rubber dough for tire casings. Good profits. American Accessories Co., Dept. P-6, Cincinnati.

**AGENTS** sell Reliable Custom-Made Raincoats and Gabardines. Big commission. Complete sample line free. Temple Raincoat Company, Templeton, Mass.

**AGENTS** to sell Handy Dish Washer. Write for particulars. Charles Pursell, 179 Broad St., Newark, New Jersey.

**"GOLDINE"** Sign Letters—1,000% profit. Particulars free. Johnston Co., Quincy, Ill.

**\$10 DAILY** refinishing chandeliers, brass beds, automobiles by new method, producing amazing results; no capital or experience necessary; particulars free. Gunmetal Co., Ave. H., Decatur, Ill.

**PHOTO** Pillow Tops, Portraits, Frames, Sheet Pictures, Photo Plates, Pennants. Rejects credited. Prompt shipments; samples and catalogues free to agents; 30-days' credit. Jas. C. Bailey Co., Desk G, Chicago.

**LUMINOUS** Paint! Shine like fire in the dark. Big seller to Hotels, Garages, etc. Make and sell your own Luminous articles, watches, clocks, electric switch plates, crucifixes, etc. Sample bottle only 25c. Particulars and special price list free. Luminous Paint Co., Douglas Park Station (B-6), Chicago, Ill.

**TAILORING** Agents Wanted—Big complete sample outfit and case, nearly 300 large cloth samples, 3 piece lists and everything needed for canvassing or use in store, free to live agents. \$25.00 to \$50.00 a week; may make more. Write us today for free elegant outfit to begin, cloth samples, wholesale prices, special offer on a suit for yourself and full information—see our wonderful values, beautiful fabrics and styles. Established 25 years. Every garment made to measure—everything guaranteed and express prepaid. Just send a postal. American Woolen Mills Co., Dept. 414, Chicago.

**WANTED.** General Agent to represent us in your locality. Exclusive territory. Big inducements. Chicago Agency Co., 840 Altgeld St., Chicago.

**AGENTS** Wanted—To advertise our goods by distributing free samples to consumer. 90 cents an hour. Write for full particulars. Thomas Mfg. Co., 562 North St., Dayton, O.

**MAKE** and sell your own goods. Formulas by Expert Chemists. Manufacturing Processes and Trade Secrets. Formula Catalog for Stamp. Blake Mystic Company, Washington, D. C.

**WANTED**—Mechanics every factory, sell Udel's Healing Oil. Wonderfully heals cuts, scratches, burns, minor wounds, instantly relieving pain. Profitable proposition. Particulars free. 25c sample 10c. Exclusive territory. Manager, 2942 Clifton St., Indianapolis.

**AGENTS, Signpainters.** New proposition. Samples free. Wadhams, 90 Broadway, Brooklyn.

**AGENTS**—Men and women. Make \$50 to \$50 weekly selling the New Improved Monitor Self-Heating Iron—the "World's Best." Over \$50,000 in use. Positively the easiest, fastest selling, lowest priced, best known iron made. Binding guaranteed. Big profit for all or part time. Evans, N. Car., sold two dozen on Saturday. Mrs. Nixon, Va., sold eight first half day. Liberal terms. Exclusive territory. Sample outfit free to workers. Write today. The Monitor Sad Iron Co., 836 Wayne St., Big Prairie, Ohio.

**AGENTS:** Big profits selling our New \$2.50 Automatic adding machine. Quick sales. Ten a day easy. No competition. Anyone having adding to do is positive customer. You'll be glad you wrote us. Bassett Company, 5921 Indiana Ave., Chicago.

**INSURANCE** Agent in every town. Sickness and Accident, easy selling, popular, successful, commission or salary. Superintendent Mullaney, 434 Westover Building, Kansas City, Missouri.

**AGENTS**—Salary or commission. Greatest seller yet. Every user pen and ink buys on sight. 200 to 500 per cent profit. One agent's sales \$620 in six days; another \$32 in two hours. Monroe Mfg. Co., X 6, La Crosse, Wis.

**SOFT** Drinks in Powder. Just add water—delicious, refreshing, healthful. Everyone buys—big profits. Enough for 17 glasses Orangeade and particulars 10c postpaid. Chas. S. Morrissey Co., 4417 Madison St., Chicago, Ill.

**AGENTS**—Sensation of last business exposition open to you. Act quickly. Get selling rights. A practical appliance, pocket size. Sells on sight. Profitable side line. M. Well, 138 Metropolitan Tower, New York.

**FORMULAS**—Trade Secrets and Manufacturing processes. Valuable collection of formulas and big catalog 10c. Ideal Book Shop, 3315-R4, Bellport Ave., Chicago.

**ONE** good man wanted in each small town to take orders for tailoring in spare time or as a regular business. Good profits. Get your own clothes at special inside wholesale prices. Perfect fit and satisfaction guaranteed or no pay. Wonderful opportunity, experience not needed. Beautiful sample book and fashion plates free. Banner Tailoring Co., Dept. 562, Chicago.

**CAN** Germany Win? Great war puzzle. Agent's sample ten cents. Phoenix Specialty Co., 351 Hoyt St., Buffalo, N. Y.

**AGENTS.** \$50 a week. Will show you how. Genuine Gold Leaf Window Letters. Chicago Agency Co., 842 Altgeld St., Chicago.

**"WASHWHITE"** makes easy sales. Big profit. Sure repeat business. Genuine Rogers Silverware free to your customers, and valuable Premiums for you. Free printed matter and Sales Course. Free samples with every order. Cleans clothes without rubbing, and without injury to the finest fabric. 7 big washings for 15 cents. Sales Guaranteed. Write for Our Offer. The Naema Co., Dept. H-7, 20 W. Lake St., Chicago.

**AGENTS**—Send for sample "Fretnot"—the wash day wonder. Be convinced you can do a whirlwind business. You can clear at least \$20 to \$100 weekly, according to spare or whole time. You don't have to talk; if she doesn't buy at sight, leave sample; she will be looking for you long before you are able to make the rounds again. Samples furnished free. Premiums granted to agents who can produce. Credit given. Don't call. P. M. Motter & Sons, 3213 Warren Ave., Chicago.

**FREE** sample with particulars. No splashing water strainers. Easy seller. Returns big. Experience unnecessary. Union Filters Co., New York.

**TAKE** orders for men's custom tailoring, part time or all time. We furnish samples and everything needed to make a success without experience. Low prices; fit guaranteed or money refunded. You make good money on every order. You can wear swell clothes for almost nothing. Write quick for samples and all information if you live in a town smaller than 5000 or on R. F. D. Knickerbocker Tailoring Co., Dept. 613, Chicago.

**AGENTS** make 500 per cent profit selling our Auto Monograms and Initials. Window Sign Letters, Changeable Signs, and Show Cards. 1,000 Varieties. Enormous Demand. Sullivan Co., 1123 Van Buren St., Chicago, Ill.

**AGENTS:** If you are earning less than \$200 a month our Sentinel Burglar Alarm proposition will interest you. Many agents earn \$15 daily. New invention. Exclusive territory. No competition. Sells on sight to homes, offices. Instantly attached any door knob. Impossible turn knob without ringing bell. No batteries, screws, nails. Handsomely nickel-plated. Provides cheap burglar insurance. It is a big money maker. Write today for liberal terms to agents. Marshall Dobbins & Co., Manufacturers, 1422 Marquette Building, Chicago.

**GET** into the biggest money-making end of the automobile business—replacing necessary equipment. Live, hustling, ambitious men wanted as special factory representatives in exclusive territory to take orders and attach tops, top coverings, seat covers, patent skylite windows. No experience necessary. No capital required. No competition on our copyrighted system. Write for free catalog, samples, and full details. Cincinnati Auto Specialty Co., Dept. MC 47, Cincinnati, O.

**FREE** sample with particulars. Nosplash Water Strainers. Easy seller. Returns big. Experience unnecessary. D. D. Union Filter Co., New York.

**DECALCOMANIA** Transfer Initials and Monograms: You apply them on automobile while they wait; cost 2c each; profit \$1.38 on \$1.50 job; free particulars. Auto Monogram Supply Co., Dept. 1, Niagara Bldg., Newark, N. J.

**A FEW** reliable men or women to handle my 1916 "Business Guide." Sells everywhere. Beginners clear \$7 per day. 60% commission. Outfit free. Prof. Nichols, Box P. M., Naperville, Ill.

**SELL** Presto Auto Paint Kits for repainting Fords, etc. Good profits. American Accessories Co., Dept. P-5, Cincinnati.

**AGENTS.** grab this 25c household specialty. Lightning seller. One agent sold 100 one day. 140% profit. Write today. G. L. Erwin & Co., Manufacturers, 2113 Harrison St., Chicago.

**AGENTS:** Introducing toilet necessity. Easy seller. Big profits. Orders repeat. Act quickly. Sample 15 cents. Particulars, Reddy Sales Company, 1416 Broadway, New York.

**500 FORMULAS.** Including Resilvering Mirrors—Renewing Dry Batteries, Luminous Paint, 25c. Ideal Book Shop, 3315-A4, Bellport Ave., Chicago.



**NEW invention.** \$10.00 per day to agents. Quickedge Knife and Shear sharpener for household use. Sharpens any kitchen, paring, carving knife or shears in ten seconds. A child can use it. Grinds both sides of blade at once, automatically. Guaranteed. A sale at every house. 200% profit gross lots. No charge for territory. Business furnishes capital, profits, start first day. Low priced. No experience necessary. Ray Carter of Massachusetts sold 36 in four hours—profit \$36.00. J. H. Stemple of West Virginia sold 45 first day. New proposition—just out. Complete particulars free. Write today giving name of your county. Address Quickedge Sharpener Co., 676 Sharpener Bldg., 215 N. Desplaines St., Chicago, Ill.

**AGENTS—Don't miss this unusual opportunity.** Valuable premiums get the orders. Particulars free. Sound Supply Co., Dept. D-8, Seattle, Wash.

**AGENTS** Coining Money Placing Hercules Tablets with motorists. Reduces gasoline consumption, increases power and mileage—removes carbon. Only 15c pkg. Cost agents less than 5c. Write quick. Irita Co., Dept. A, 116 Broad St., N. Y.

**BEST paying offer:** 15c Water Filter for 35c; 35c for 18c; 25c for 13c; 15c for 6c, etc. Sample, 5c. Catalogue free. Survio, 696 East 161st St., New York.

**HOW Men and Women can earn more money.** Start now with the newest line. Establish a permanent and profitable agency business selling the Yancoo Complexion brush, French Ivory combs, mirrors, brushes and other household articles. Big assortment, repeat sales, liberal commission. Write now for money-making plan and territory. Yancoo Ivory Company, Avenue P., Leominster, Mass.

**200 MORE salesmen wanted—also general agents and managers.** Make big money selling new Vacuum Compress Clothes Washers. With our new self-selling plan, washers positively sell themselves. L. Palmer put out 108 washers, 107 sold themselves, profit \$107.00. T. F. Speakman put out 36 first day; 36 stuck, profit \$36.00. Many make \$1,200 to \$3,600 year. Over 1,000,000 already sold. Washes tub of clothes in six minutes—no cranks to turn—no levers to push—works perfectly. Write for pictures and full details today. H. F. Wendell Co., 2050 Oak St., Leipsic, Ohio.

**AGENTS:** Make real money this year; not "paper money." Just think! Our Eradium (luminous) Articles Shine in the Dark. We manufacture a complete line so that every call can be turned into a sale. Everyone amazed at the wonderful possibilities of these goods. Our Eradium Bulb is easily attached to any light and "Locates Your Light in a Jiffy" in the darkest room. Our Eradium Crucifix showing the Christ figure in startling outline through the night sells to every Catholic. Our Eradium House Numbers (just out) are selling like Ford automobiles. Our Eradium Clock tells the time in the dark. Our Eradium Match Box sells like hot cakes everywhere. Garages, homes, etc. Our Eradium Switch Plate for hotels is a big seller. Write today for best proposition you ever heard of. Sole manufacturers, The Pioneer Corporation, 1259 West 63rd, Chicago.

**AGENTS, Make War-Time Profits, build permanent business with our Big line Perfumes, Creams, Extracts, Spices, Medicines.** Catalogue free. Western Laboratories, 109A Van Buren St., Chicago.

**SIGN Letter Agents and Painters:** 500% Profit Gold and Silver Sign Letters for Stores and Office Windows. Anyone can put on. Big demand. Free samples. Metallic Letter Co., 494 N. Clark St., Chicago.

**HUGE profits selling Nibco Sanitary Brushes, Auto Washers, Brown Beauty Adjustable Floor Mops, Dustless Dusters, and other specialties.** Big line. Fast sellers. Write today. Silver-Chamberlin Company, Department M. Clayton, New Jersey.

**WHO wants to make more money selling brushes that every household needs?** Special method of getting entrance to demonstrators. Fuller Sanitary Brushes are nationally advertised—largest output—best terms and prices—western distributing stations. Your territory is valuable. Write. Fuller Brush Company, Hartford, Conn.; Rock Island, Ill.

**AGENTS—Stamping names on Pocket Key Protectors;** sample Check with your name and address, 12c. Stamping Outfits, Emblem Checks, Check Fobs, Name Plates, Hart Mfg. Co., Desk 2, 303 Degraw St., Brooklyn, N. Y.

**NEW household necessity; not sold in stores;** quick seller; big repeater. Write Eberhart Co., 6530M, Eberhart Avenue, Chicago.

**BIG Profits for You! Manufacture Barley Crisp.** New Confection, 5c package costs you 1c. Machine instructions complete \$7.50 prepaid. Send 10c for samples. Barley Crisp Co., 1295 Broadway, San Francisco.

**EARN \$50 to \$100 monthly** distributing Parker Hosiery to repeat customers at mill prices. All or spare time. Protected territory. Credit. D. Parker Mills, 2733 No. 12th St. Philadelphia, Pa.

**YOU can be your own boss with our Key Check outfit.** Good for \$5 a day stamping names on pocket key checks, fobs, etc. Sample check with your name and address, 15 cents. Pease Die Works, Dept. M, Winchester N. H.

**PORTRAIT Agents:** Our goods will make you big profits, Delivery guaranteed. Rejects credited. Prompt shipments. Send for latest catalogue and prices. Adam J. Kroll & Co., 602 Blue Island Ave., Chicago, Ill.

**AGENTS, sell Feather Flowers, the All-Purpose Home Flower.** Sample 15 cents. De Witt Sisters, Route 10, Battle Creek, Mich.

**BUILD your own phonograph or manufacture them to sell.** Instructions, drawings, illustrations, parts-price-list 25c. Circular free. Associated Phonograph Co., Dept. P2, Cincinnati, O.

**THEY sell themselves Agents.** Wire Products, 1720 North Main, Scranton, Pa.

**AGENTS:** 50 calling cards 10c. F. Shepard, Rome, N. Y.

**RELIABLE People Wanted to Place Our Orangeade Powder in stores and appoint agents.** Makes the most delicious drink you ever tasted by just adding cold water and sugar. Enough for 17 glasses and particulars 10c postpaid. Chas. A. Morrissey Co., 4417 Madison St., Chicago, Ill.

**HANSON Making \$380 Monthly Selling Buckeye raincoats.** Largest 1917 samples ready. Free. Write at once. Become sole agent. Big season. Buckeye Manufacturing Company, B1 Union Square, N. Y.

**AMAZING, new invention.** Marvelous adding machine. Retail \$7.50. Adds, Subtracts, Multiplies. Does work of \$200 machine. Five-Year Guarantee. Offices, stores, factories buy from one to dozen. Enormous demand. Every demonstration sells. Write quick for trial offer and protected territory. Dept. PM, Calculator Corporation, Grand Rapids, Mich.

**MAN or Woman to travel for old-established firm.** No canvassing: \$1,170 first year, payable weekly, pursuant to Contract. Expenses advanced. G. E. Nichols, Philadelphia, Pa., Pepper Bldg.

**AGENTS:** Screen door check. Demonstrate and sale is made. Stops the bang and saves the door. Wonderful summer seller. Demonstrating sample free. Thomas Mfg. Co., 1382 North St., Dayton, Ohio.

**GET Davis' Latest Proposition.** \$15.00 daily a cinch. No matter how many times you have answered my ads in last 26 years, write again. E. M. Davis, Dept. 506, 940 Lake, Chicago.

**AGENTS—Sell rich-looking imported 36x48 rugs, \$1 each.** Carter, Tenn., sold 115 in 4 days. Profit, \$57. You can do same. Write for sample offer selling plan; exclusive territory. Sample rug by parcel post prepaid, 95c. E. H. Condon, Importer, Stonington, Maine.

**AGENTS wanted for "Air-Cure"** self-rubricating tire patch. Wild Mfg. Co., 1307 Nicollet, Minneapolis, Minn.

**AGENTS—Line up for big profits this year.** Hot string of brand-new exclusive sellers with the big "punch" just being brought out. Grab your territory now. You'll regret it if you delay. Adam Fisher Mfg. Co., Agency Dept., 2061 Railway Exchange, St. Louis, U. S. A.

**EXCLUSIVE selling rights given for our Wonderful Triplex Folding handbag and other sellers.** None sold in Stores. Write for terms and catalogue. Diamond Bros., 35 West 21st Street, New York.

**SELL something new.** Every merchant buys Ever-Ready Changeable signs. Make 95c on every \$1.50 sale. If you make less than \$2.00 an hour, write for proposition. Changeable Sign Co., 535 E. 102nd, Cleveland.

**MEDALLIONS—300% profits.** Make up your own goods and be independent. Catalogue free. Resag Co., 1205 Randolph St., Chicago.

**AGENTS—Our gold window letter proposition beats 'em all.** Stalbrite Co., Dept. P, 1115 Second Ave., N. Y. Established 1905.

**AGENTS Wanted: Sell Polishing Cloths, Rust Remover, Food Flavors, etc.** 130 household necessities, guaranteed line, big profits, quick repeater, permanent business. Stuart & Co., 16 Main St., Newark, N. Y.

**AGENTS make \$100 monthly** selling our 500 handy household articles. Catalogue free. Scheff Company, Desplaines, Ill.

**"1916's SENSATION!"** Eleven piece toilet article set selling like blazes at \$1.00 with \$1.00 carrying set Free! Enormous profits! Tremendous hit! Engle made \$51.00 first week. Write quick! Pierce Co., Dept. J, 996 Lake St., Chicago.

**WANTED—New Ideas.** Write for list of Patent Buyers and Inventions Wanted. \$1,900,000 in prizes offered for inventions. Our Four Books sent free upon request. Victor J. Evans & Co., 163 Ninth, Washington, D. C.

**LARGE Manufacturer wants representatives to sell shirts, underwear, hosiery, dresses, waists, skirts, direct to homes.** Write for free samples. Madison Mills, 536 Broadway, New York City.

**AGENTS, Either Sex, the greatest 35c proposition on earth.** Send six two-cent stamps for sample, particulars. Ideal Specialty Co., Duluth, Minn.

**AGENTS—"Exclusive features" are what make easy sales—I can gain attention, close the sale and collect the money on six customers with the exclusive features of my non-alcoholic flavoring extracts, while you are struggling with one customer on the old commonplace line of talk.** So can you! Prove it! Write today—big summer sellers—extra summer profit. J. M. Pitkin Co., 626 B. St., Newark, New York.

**LARGE Manufacturer wants agents to earn good pay selling high-grade custom-made raincoats.** Goods sell themselves. No experience nor capital necessary. Deliver to customer. Prices defy competition. Guarantee every sale. 1917 outfit free. Amer-Europ. Raincoat Co., 175 E. Broadway, N. Y., Desk P.

**A MARVELOUS Selling Article!** Used in every home. Silveron, the polish that actually rubs on Sterling Silver. Big profits. New selling plan. A good article to handle. Send 25c for sample outfit. F. Silveron, 157 Cedar, New York.

**AGENTS make 500% profit handling Auto Monograms and Initials, Changeable Signs, Novelty Signs, and Window Letters.** Catalog Free. Hinton Co., 6142 40th Court, Chicago, Ill.

**SELL California Rosebuds.** Swell line. Large profits. Send for catalogue today. Mission Seed Co., 2819PM, West Pico, Los Angeles, Calif.

**AGENTS—\$30 a week and expenses; free samples;** gold and silver letters for store fronts, office windows and glass signs; anyone can put them on; big demand everywhere; liberal offer to general agents. Metallic Letter Co., 407 N. Clark St., Chicago.

**AGENTS—Ho-Ro-Co.** Skin Soap and Toilet Goods plan beats everything for agents' profits. "Ho-Ro-Co." 112 Locust St., St. Louis, Mo.

#### SALESMEN WANTED

**WERE you ever offered a grocery store?** Our proposition is better. Let us tell you how you can handle Flour, Canned Goods, Provisions—an entire line of Groceries, as well as Paints, Roofing, Stock Foods, Automobile and Machinery Oils and Greases. No rent to pay, no investments in stock. Larger orders taken from samples. Goods of guaranteed and proven quality. Selling experience not necessary. Very profitable work for "workers." Address R. S. Hill, President, Hitchcock Hill Co., Chicago. Reference: Any bank or express company.

**LARGE Cleveland Million-Dollar Corporation** will pay you \$20 to \$30 weekly for your spare time, or as high as \$100 weekly if you prefer to devote your entire time to representing a widely known and nationally advertised product in your community. Furthermore we will furnish you absolutely free a full and complete course in salesmanship. You do not have to pay one penny—you do not have to invest a single cent in our products. This course is the equal of any \$30 course in the country. Only one course given to each community. We are particularly desirous of securing inquiries from small towns having electricity. Write at once for full particulars. The Frantz Premier Company, World's Largest Makers of Electric Cleaners, Dept. 129, Cleveland, O.



LIVE salesmen wanted to sell Guaranteed 6,000 Mile made-to-order Tires. Factory to User. Full commission on repeat orders. References in first letter. Real opportunity for hustlers. Sales Dept., American Rubber Corporation, 1971 Broadway, New York.

EXCLUSIVE county rights. Sell Tankol; modern auto fuel. Profitable. Tankol Chemical Co., Cleveland, Ohio.

SALESMEN—Experienced Painter, for local territory to sell Lifecote paints and varnishes. Write with references to the Union Products Co., Cleveland, O.

TRAVELING Salesmen selling heating trade to handle high grade specialty for side line. 1526 Lytton Building, Chicago.

EARN \$5,000 to \$20,000 yearly. New business territory. Retail \$5 to \$200. 100-200% profit. Purchaser satisfied or money refunded. No competition. Exclusive territory. Free samples. Sayers, 408 Wainwright, St. Louis.

WANTED—Large lumber company wants local representatives for ready-cut house business. Good profits. Company owns forests, logging camps, saw mills, planing mills, shingle mills, sash and door factories, lumber yards, etc. Splendid opportunity and permanent connection for live representative in your town. Write, National Home Building Co., Portland, Oregon.

SPECIALTY Salesman Magazine, 100 pages monthly. Chuck full of inspirational selling talks; where vigorously and fearlessly exposes fraudulent advertisers; salesman's true friend and champion. Yearly \$1.00; three months' trial subscription 20c. (Stamps accepted.) Specialty Salesman Magazine, 508D So. Dearborn St., Chicago.

OPENING for Salesman and District Manager: We have open territory for few men of ability—hustlers and men looking for big income and permanent position will do well to write, giving reference, Address Viker Co., Broadway and 4th St., Los Angeles.

SALESMEN with automobile to sell goods we make to dealers. The V. Air Valve & Mfg. Co., 1539 Blake St., Denver, Colo.

NEW \$2.50 Automatic Adder sells quick from demonstration. Big profits, no competition. Every business man buys. Bassett, 5921G, Indiana Ave., Chicago.

WANTED Representatives for typewriter specialty of proven merit. References required. Neufeed Company, Asheville, North Carolina.

SALESMEN—Wanted everywhere to sell Ajax Chemical Fire Engines. Liberal commission on every engine sold. An average of one or two machines a week would earn you \$2,000 to \$4,000 a year. Factories, Stores, Industrial Plants, Private Estates, etc., all use Ajax Engines. No capital required. Goods well advertised. Ajax Fire Engine Works, 95 W. Liberty St., New York.

SALESMEN—Sell beautiful 28x58 Artz-kraft felt rugs for \$13.50 per doz. Your profit \$2.50 per doz. Kelso, Battle Creek, Mich., sold 39 doz. last week, his profit \$75. Sample Rug prepaid \$1.50. E. H. Condon, Mgr., 12 Pearl St., Boston, Mass.

NEW Ford Runabout for \$100 and your spare time, distributing Stewart's "Off-On-On" Tire Tools. It's easy. Particulars free. Stewart, 139 Cass Ave., Detroit, Mich.

WANTED—Representatives everywhere. Exclusive territory. Gold sign letters for stores and office windows. Any one can put on. Write today for free sample. Metallic Letter Co., 403 N. Clark St., Chicago.

SALESMEN—Acquainted with grocery trade. Large demand; liberal commission; pocket sample. Wirth Salesbook Co., Dept. P, Chicago.

SALESMEN—Get our plan for Monogramming Automobiles and motorcycles by transfer methods. Very large profits. Motorists' Accessories Co., Mansfield, O.

#### HELP WANTED

WE need your application for position as general manager, superintendent, mechanical, civil, electrical engineers, architects, draftsmen; almost any position in the mechanical line; also accountants, bookkeepers, stenographers, office clerks. United States, South America, and Canada. Write us your qualifications and what you want. Send \$1.00 for application. Opportunities absolutely guaranteed. Business Men's Clearing House, Inc., Commerce Trust Bldg., Kansas City, Mo.

WANTED: Men-Women, 18 or over. \$75 month. Government Jobs. List positions free. Write immediately. Franklin Institute, Dept. A-21, Rochester, N. Y.

WANTED. Men and women to qualify for Government positions. Several thousand appointments to be made next few months. Full information about openings, how to prepare, etc., free. Write immediately for booklet UG-29, Earl Hopkins, Washington, D. C.

WANTED—Draftsmen and Designers, Cleveland Engineering Agency, Rose Building, Cleveland.

MEN—Become Government Railway Mail Clerks. \$75 to \$150 month. Every second week off with pay. Education unnecessary. Sample examination questions free. Write immediately. Franklin Institute, Dept. A-21, Rochester, N. Y.

WANTED: One honest man in each locality. Can't make you rich overnight, but steady income year round. Home work. All or part time. No selling. Everything furnished. Children and "Fakers" don't write. Particulars free. American Mirror Company, Johnstown, Penna.

BE a Mirror Expert. Good income; spare time home at first; no capital; we train, start you making and silvering mirrors; French method. Free prospectus. W. P. Derr, Pres., 579 Decatur Avenue, Brooklyn, N. Y.

DO You Want a sure job with big pay, easy hours and rapid advance? Write for my big Free book, DW-29, which tells you how you can get a good Government position. Earl Hopkins, Washington, D. C.

FOREMEN, Shopmen and Office-men Wanted to work spare time as special representative of large well-known mail-order house, selling Watches, Diamonds and Jewelry on Credit. Liberal commissions and exclusive sales rights granted. No investment or deposit required for outfit or samples. Write at once for details. Address S. D. Miller, Dept. 10, Agency Division, Miller Bldg., Detroit, Mich.

GOVERNMENT pays \$900 to \$1,800 yearly. Prepare for coming "exams" under former Civil Service Examiner. New Book Free. Write Patterson Civil Service School, Box 3020, Rochester, N. Y.

GET a Sure Job with big pay, steady work, short hours, regular vacations, rapid advance. Thousands of positions open with Uncle Sam. I will prepare you in a few weeks at small cost. Write immediately for big Free Book DW-29, with special offer. Earl Hopkins, Washington, D. C.

\$10 DAILY refinishing chandeliers, brass beds, automobiles by new method, producing amazing results; no capital or experience necessary; particulars free. Gunmetal Co., Ave. G, Decatur, Ill.

UNCLE Sam has thousands of jobs open this year. I will help you get one. Write for my big Free book, DX-29. Earl Hopkins, Washington, D. C.

RAILWAY Mail Clerks Wanted, \$75.00 month. Sample examination questions free. Franklin Institute, Dept. A-21, Rochester, N. Y.

CASH paid for butterflies, insects. Some \$1 to \$7 each. Easy work. Even two boys earned good money with mother's help and my pictures, descriptions, price list, and simple instructions on painless killing, etc. Send 2c stamp at once for prospectus. Sinclair, Box 244, D 8, Los Angeles, Cal.

CIVIL service examinations lead to good government positions. Railway mail pays up to \$1,500; postoffice clerk, carrier, \$1,200; customs, \$2,500; internal revenue, \$2,100; bookkeeper, \$2,500; stenographer, \$1,800; clerk, \$1,800; technical, \$4,000; rural carrier, \$1,200; women, \$1,800; guard, \$840 up. I can coach you by mail at small cost and give bond guaranteeing success or money refunded. Particulars free to American citizens over seventeen. Ask for booklet QE-29, naming position wanted. Earl Hopkins, Washington, D. C.

"UNCLE Sam" wants Men-Women, 18 or over, as Government Clerks, \$100.00 month. Write immediately for list positions now open. Franklin Institute, Dept. A-21, Rochester, N. Y.

NO Strike; 8-Hour Day. Men Everywhere. Firemen, Brakemen, Baggage-men, \$120. Colored Porters. Experience unnecessary. 810 Railway Bureau, E. St. Louis, Ill.

GOVERNMENT Employees Wanted—Big pay, sure work. I will prepare you in a short time at small cost. Must be American citizen. Write for my free book FC-29 today. Earl Hopkins, Washington, D. C.

WANTED—Cartoonists—\$25.00 to \$100.00 per week. Success guaranteed. Free particulars. Dept. J. The Dennon School of Cartooning, Harrison, New York.

MAKE money writing Photo-plays; details free to beginners. No correspondence course. Producers' League, 239 Wainwright, St. Louis.

A POSITION is open for you in the Government service after we have helped you qualify. My money back offer guarantees it. Write quick for big free book DA-29, Earl Hopkins, Washington, D. C.

PATENTS—Send Sketch. Free Opinions and Certificate of Patentability. Free Book, "How to Obtain a Patent and What To Invent." Patents secured through Credit System. Talbert & Parker, Patent Lawyers, 4102 Warder Bldg., Washington, D. C.

GOVERNMENT Positions are easy to get. My free booklet BY-29 tells how. Write today—Now, Earl Hopkins, Washington, D. C.

DO You Want a position for life, with big pay, short hours and sure advancement? Then work for Uncle Sam. My free illustrated book DK-29 tells how to get an appointment. Earl Hopkins, Washington, D. C.

CIVIL Service Examinations open the way to good Government positions. I can coach you by mail at small cost. Full particulars free to American citizens of eighteen or over. Write for Booklet CE-29, Earl Hopkins, Washington, D. C.

STATE Managers Wanted. If you have ability to manage a sales force you can make from \$3,000 to \$7,000 a year selling rope machines. 45,000 sold. New Era Rope Machine Co., Plymouth Bldg., Minneapolis, Minn.

BECOME Chauffeurs, \$25 week. Learn while earning. Sample lessons free. Franklin Institute, Dept. AS-02, Rochester, N. Y.

WORK for Uncle Sam. He is the best employer. Big pay, sure work, easy hours, long vacations, rapid advance. Thousands of jobs open this year. I will help you get one. Write for my big Free book, DY-29, today. Earl Hopkins, Washington, D. C.

STOP that daily grind; take some off grindstone; be no man's slave—punch nobody's time clock. Own your business. I start you silvering mirrors, plating tableware; home. Sure income—plans free. Clarence Sprinkle, Dept. 28, Marion, Ind.

EARN extra money every month. Any employed person can without interfering with regular work. No selling, no canvassing. Positively no investment. Unemployed need not apply. Address The Silver Mirror Co., Inc., 211 W. Randolph St., Chicago, Ill.

\$75 MONTH. Government Jobs. Men and women wanted. List of positions open free. Franklin Institute, Dept. A-21, Rochester, N. Y.

FREE Illustrated Book tells of about 500,000 protected positions in U. S. service. Thousands of vacancies every year. There is a big chance here for you, sure and generous pay, lifetime employment. Just ask for booklet CS-29. No obligation. Earl Hopkins, Washington, D. C.

LUMINOUS Paint. Shines in the Dark! Make your watches, clocks, electric switch plates, crucifixes, etc., visible at night. Latest discovery. Only 25c bottle. Circular free. Luminous Paint Co., Douglas Park Station (B-9), Chicago, Ill.

WANTED—An Idea! Who can think of some simple thing to patent? Protect your ideas; they may bring you wealth. Write for "Needed Inventions" and "How to Get Your Patent and Your Money." Randolph & Co., Patent Attorneys, Dept. 144, Washington, D. C.

SALESMAN—\$6,000 Accidental Death, \$30.00 Weekly Accident Benefit, \$25.00 Weekly Sick Benefit, \$10.50 yearly, half amount \$5.50, \$250,000 deposited Insurance Department. Become independent. Experience unnecessary. Guaranteed steady income from renewals. Registration. Dept. B, Newark, N. J.

GOVERNMENT Examinations. Most thorough preparation, \$5; returned if not appointed; particulars free. American Civil Service School, Washington, D. C.

#### PARTNERS WANTED

GARAGE partner wanted to take charge of shop in the largest, best equipped place in town. Gem City Garage, Los Gatos, Calif.

#### WANTED

22x34 STRAIGHT side casings, mention condition, make, spot cash price. Box 172, Cleveland, Ohio.

BRITANNICA Encyclopedia—Cambridge or handy volume edition. Also books, single or sets. Mention condition, binding, spot cash price. Box 172, Cleveland, Ohio.



## FOR SALE

WIRE for Sale at half price, thousand pounds each, No. 18 and 24 magnet wire. Silk and cotton covered German silver resistance wire No. 21 to 30. Ammeters and volt meters, D.C. arc lamps and motor-generator sets. Walsh's Sons & Co., 299 Passaic St., Newark, N. J.

POWERFUL marine day and night glasses with case, 25-mile adjustment, \$7.50. Satisfaction or money returned. Wells Curiosity Shop, 29 South Second St., Phila., Penna.

\$35 EDISON hand shaving machine for commercial records \$18. L. M. Durham, Cory, Pa.

TYPE and Printing Material at bargain prices. Now is the time to buy. All sizes rebuilt Job Presses very cheap. Catalogue free. Philadelphia Printers' Supply Co., 14 So. Fifth St., Philadelphia.

SURVEYOR'S Telescopes, Chronograph, Barometers, Phonographs, Bargains, Frances Farrar, Elmira, N. Y.

TOWN lot at South Hilliard, Fla. Some books for old coins, stamps or Indian relics. Robt. L. Stephens, 309 E. Fairchild St., Danville, Ill.

MOTORCYCLE, Typewriter, Shotgun for sale. Raymond Stewart, Spring Valley, Minn.

## SALE OR EXCHANGE

WANT to Swap? Send 50 cents for year's subscription to "The Market for Exchange," 141 Milk St., Boston, Mass. It gives bi-monthly long list of those who have things to trade or sell. Send list of things you have to trade or sell.

EXCHANGE New Smith Motor Wheel for house-lighting storage battery or generator. Bert Paul, Good Hope, Ill.

## GUNS, SPORTING GOODS, ETC.

"BEST Bait" Makes Fish bite. 25c per bottle, sample 10c. Richard Schwarz, Buchanan, Mich.

BUY, sell, exchange all sorts old-time and modern Firearms. Stephen Van Bunselaer, Antiques, 805 Madison Ave., New York.

## FLOUR &amp; FEED MILLING MACHINERY

SPECIAL bargains in second hand Attrition mills, burr mills, crushers, corn shellers, bran dusters, dust collectors, purifiers, reels, double, single, 2 and 3-pair high roller mills, sieve bolters, receiving separators, scourers, etc. Write for description and prices. Sprout, Waldron & Co., P. O. Box 429, Muncy, Pa.

## MACHINERY, TOOLS &amp; SUPPLIES

WIRE—all sizes— $\frac{3}{4}$  to No. 16. Coppered, tinned, galvanized and plain steel wire for sale. Cooley Mfg. Co., 533 W. Monroe St., Chicago, Ill.

WILL buy small used milling machine; must be in good condition, cheap. Guy Davis, Mulberry, Ind.

GRINDING machine, sharpens tools, cutlery, etc., without touching tools with hands. Mustin Mfg. Co., Newport, Kentucky.

\*HALF Cost. Practically new shop equipment. Screw cutting lathe, bench drill, grinder, motor, shafting, pulleys, belts and tools. All \$150. Consider good motorcycle. Lock Box 115, Midway, Pa.

PRINTING outfit, ten by fifteen Gordon press, twenty-six inch Oswego cutter, lots cases, type, etc. and stock. New, cheap. Mueller, 537 Winslow Ave., Buffalo, N. Y.

FOR Sale—One Power Machine ranging from  $\frac{1}{4}$  to 2 inches equipped with a Big-nall & Keeler head with dies; in first-class condition. Derheimer Bros., Ft. Wayne, Ind.

CONCRETE Block Machine, nearly new. Wizard. Rolston Cushman, Old Orchard, Maine.

SANDPAPERING now a treat. Our Patented sandpaper gripper resembles a plane; works and wears like one. Sandpapering done in one-tenth ordinary time. Hundred percent better. Paper does ten times more work. Small size fifty cents, large size seventy-five, both one dollar. Free. Always please. Illustrations free. L. H. Fowler & Son, Colony, Kas.

TO buy or sell a machine, write Interstate Machinery Co., Troy, N. Y.

PATENTS—Send Sketch. Free Opinion and Certificate of Patentability. Free Book. "How to Obtain a Patent and What to Invent." Patents secured through Credit System. Talbert & Parker, Patent Lawyers, 4670 Warder Bldg., Washington, D. C.

HAYWOOD Master Vulcanizer for shop—bargain. Harry Topmiller, address, Bowling Green, Ky.

PULLEYS, Gears, Sprockets, Shafting, Hangers, See page 145. W. A. Jones, Foundry & Machine Co., Chicago.

TOOLS—for shop, factory, garage and home—many high-class tools attractively priced in our "Odds and Ends" pamphlet—which is mailed free on request by Montgomery & Co., Inc., 195 Fulton St., New York City.

SMALL bench lathe for \$3. Peter Austin, Muncie, Ind.

## ENGINES, MOTORS AND DYNAMOS

FOR Sale—One (1) Vilter Corliss, single cylinder, high pressure, heavy duty engine. Size, 20x42, speed, 75 r. p. m. Size of fly-wheel, 14 ft. x 2 ft. 11 in. Engine just as good as new. Northern Paper Mills, Green Bay, Wisconsin.

SPECIAL Bargain—One horse engine nearly new, \$14.50. Herbert Paine, Hayward, California.

FOR Sale—30 H. P., four cylinder beaver engine, with carburetor, timer, pump, universal joint, automatic oiler, new coil, \$75.00. John Toomey, North Adams, Mass.

LIGHTING Arc and Battery Charging Generators sold on easy payments, Hobart, Box MF, Troy, Ohio.

MAHINE Motor; new Gray 6 H. P., all equipments, never uncrated, \$100. R. J. Mattingly, Zurich, Kans.

ALTERNATING and direct current, rebuilt guaranteed motor bargains. General Electric, Wagner, Westinghouse, Emerson, Peerless, Crocker-Wheeler, Sizes from 1/30 h.p. upwards. Money-worth or Money-back. Send for new illustrated wholesale catalog supplies and motors. Hyre Electric Co., 613 TM South Dearborn St., Chicago.

FOR Sale—Bradford D. C. Dynamo, 110 Volts, Amp. 8, K. W. 8, Revolutions 1750, Weight 125 lbs. L. D. Parkhurst, Danfelson, Conn.

A NEW  $\frac{1}{4}$  HP. R. & M. Motor, 110 V. S.P., AC, 1750 RPM—\$25. A  $\frac{1}{2}$  HP. One new make and description—\$35. One new Robbins & Myers charging outfit, 150-watt capacity, \$55. Tranter Mfg. Co., 105 Water Street, Pittsburgh, Pa.

PATENTS—Send Sketch. Free Opinion and Certificate of Patentability. Free Book. "How to Obtain a Patent and What to Invent." Patents secured through Credit System. Talbert & Parker, Patent Lawyers, 4670 Warder Bldg., Washington, D. C.

NEW A. C. 60-cycle, 110-volt motors, fully guaranteed.  $\frac{1}{4}$  H. P. \$15.00;  $\frac{1}{2}$  H. P. \$16.50;  $\frac{3}{4}$  H. P. \$20.00; 1 H. P. \$22.00. Also larger sizes A. C. & D. C. Aaron Electric Co., 15 So. Clinton St., Chicago, Ill.

CHARGING Dynamos—Several hundred small machines from Bankruptcy Stock. All voltages and sizes—guaranteed new, less than factory cost.  $\frac{1}{4}$  H. P. A. C. Motors \$15.00 each. Write for illustrated list. Johnston, West End, Pittsburgh, Pa.

REBUILT Engines—We have rebuilt "Buffalo" Engines, guaranteed, at greatly reduced prices. Write for bargain list. Buffalo Gasoline Motor Co., 1293-1303 Niagara Street, Buffalo, N. Y.

FOR Sale: A few new 5, 8 and 12 H. P. horizontal, water-cooled engines at cost. Northwestern Steel & Iron Works, Eau Claire, Wisconsin.

## ENGINE CASTINGS AND BLUE PRINTS

CASTINGS and Blueprints of  $\frac{1}{4}$  and  $\frac{1}{2}$  H.P. Steam Engines. Get Circular Latest American Model. Modern Model Engineering Co., 3091-N Central Park Ave., Chicago, Ill.

## FOR MECHANICS

FIFTY cents brings you new idea machinist's Gauge Dial. 13 complete shop tables. Handy; Efficient; Time and Labor Saver; Satisfaction Positively Guaranteed. Box 191, Kokomo, Ind.

CARPENTERS, machinists, and tool-makers. When buying a tool case get a Keystone Portable Tool Case. Send for catalog. Keystone Case Co., 215 N. Keystone Ave., Chicago, Ill.

## BOATS, LAUNCHES, ETC.

BUILD your own Steel boat from patterns. Material furnished, also finished boats. Catalogue free. Darrow Boat Co., Albion, Mich.

MOTORCRAFT Encyclopedia—A 150-page book that tells 1001 things every motor boatman should know. How to overcome engine troubles. Price \$1, postpaid. Popular Mechanics Book Dept., 6 N. Michigan Ave., Chicago.

## FOR THE SHOP

SHOP Notes for 1917—Just Published—524 Articles, 422 Illustrations, 224 Pages. Easy Ways to do the Hard Things in every trade and calling. Price 50 cents, postpaid. Also all previous numbers in Shop Notes series Volumes 1 to 12 inclusive at 50 cents each, postpaid. Send for description. Popular Mechanics Book Dept., 6 N. Michigan Ave., Chicago.

PATTERN Makers! A book devoted to the principles of pattern and core making and molding. Written by G. H. Willard, a practical pattern maker of years' experience. This book, just published, treats the subject in a much more simple, direct and effective manner than most books along this line. 224 pages, 312 illustrations. Price, \$1, postpaid. Popular Mechanics Book Dept., 6 N. Michigan Ave., Chicago.

## BLACKSMITHS

BLACKSMITHS, Listen! The Blacksmiths come first of all trades. He must make the tools for all, from the Surgeon to the Safe Blower. With Toy's Modern Methods doing hard jobs easy. Forging and making solid welds, hardening and tempering to a standard, with colored tempering charts. All for one dollar. Samples Free. W. M. Toy, Sidney, Ohio.

## ELECTRICAL

ILLUSTRATED catalog, wholesale prices, just issued. Electrical motors and supplies including sockets, switches, loom, wire, knobs, cleats, rosettes, cut-outs. Hyre Electric Co., 613 HW South Dearborn St., Chicago.

ELECTRICIANS: Sell and install Marg bell and toy transformers. Large profits. Special transformers built. Marg Electric Works, Racine, Wis.

PATENTS—Send Sketch. Free Opinion and Certificate of Patentability. Free Book. "How to Obtain a Patent and What to Invent." Patents secured through Credit System. Talbert & Parker, Patent Lawyers, 4670 Warder Bldg., Washington, D. C.

RENEW Your Old Dry Cells and Wet Batteries. Send for Booklet, 25c. "L" Development Co., 996 Thirtieth, Milwaukee.

STORAGE Batteries Simplified—A complete new treatise on action—maintenance—repair—use. Describes fully the Exide, Edison, Gould, Willard, U. S. L. and other forms. Only complete and up-to-date book on subject. 320 pages, fully illustrated. \$1.50 postpaid. Complete description sent upon request. Popular Mechanics Book Dept., 6 N. Michigan Ave., Chicago.

DRY Batteries and Their Construction for All Purposes. A practical handbook of 60 pages with 30 illustrations dealing with batteries for automobiles, gas engines, medical and coil work, electric bells, alarms, telephones, experiments, etc. Price 25 cents postpaid. Popular Mechanics Book Dept., 6 N. Michigan Ave., Chicago.

## STAMP COLLECTING

24 VARIETIES Cuban stamps, 10 cents. List of 6,000 low-priced stamps free. Chambers Stamp Co., 111 P. Nassau St., New York City.

STAMPS, 75, all different, free. Postage, 2c. Mention paper, Quaker Stamp Co., Toledo, Ohio.

FREE! Two stamps cataloging 30c to approval applicants enclosing postage. B. F. Gurnett, Elgin, Ill.

FREE—Packet from South American countries with request for Royal Approvals, with reference. Bargain list free. Belmont Stamp Co., 32 South 17th St., Philadelphia.

PACKET of 25 stamps; no two countries alike. 500 hinges. Set of \$1 and \$2 U. S. Rev., all for 5c. Mention paper. Miami Stamp Co., Toledo, Ohio.

25 DIFFERENT British Colonials to approval applicants. Postage 2c. Nickles, 122 Florida Ave., Washington, D. C.



**PREMIUMS** to approval applicants. Big Discount. Stamp Shop, Clearfield, Penna.

**FREE**—60 different stamps, including Newfoundland, China, Japan, Mexico, etc., to applicants for our high-grade approvals. Send 2c stamp for return postage. The Edgewood Stamp Company, Dept. H, Milford, Conn.

**900 STAMPS** from 30 different countries, 15c. Lufbery, Wallingford, Conn.

**15 DIFFERENT** Philippine stamps, catalogues 90 cents for 14 cents. R. Irlie, Honeoye Falls, N. Y.

**MAIL** 15c for 150 different stamps. Fine approvals, 60% discount. Send reference. Borsch and Potter, 409 Widener Building, Philadelphia.

**105 CHINA**, etc., stamp dictionary, list, 2c. Album (500 illustrations) 3c. Bullard, Sta. A., Boston.

**FREE** stamp collections. Choose one: 200 different international; 50 Asiatic; 10 Mexican revolutionary; 100 United States. Remit 25c, six months' subscription, McKele's Stamp Weekly, Beverly, Mass.

**FOREIGN** Stamps Free! A Grand Set of 8 Spain, 5c to 1 peseta. Send 4c postage, mention Gift Hill. Bright & Son, 104 Strand, London, England.

**AMERICAN** Packet Free—Old Issues, Commemorative, Jubilee, Dues, Revenues, etc., 2c postage. Midland Stamp Company, Midland, Ontario.

**STAMPS**—500 fine foreign incl. Mex. War, Salvador, incl. officials, Guatemala, China, etc., only 10c. Best App. Sheets 60 to 80% dis. We give valuable extra presents free! Big 120 pg. catal. free. We buy stamps. Hussman Stamp Co., St. Louis, Mo.

**SIX** different Newfoundlands free to approval applicants. Colman, 634 Keefer Place, Washington, D. C.

**20 UNUSED** stamps free. All different. Postage, 2c. Fisk Stamps, Toledo, Ohio.

**PACKET "A"** 100 varieties foreign stamps, 20c. F. J. Pope, Charlotte, Vermont.

**121 ALL** Different Foreign Stamps, including Guatemala, Honduras, Roumania, Costa Rica, Egypt, Chili, China, Mexico, Peru, Cuba, Russia, Japan, India, Victoria, Portugal, etc., 15c. 200 hinges free. Royal Stamp Co., 48 N. 51st Street, Philadelphia, Pa.

**STAMPS** on approval, 40% discount. Lang, 1433 B, 59th Ave., Cicero, Ill.

**FINE** Collection of 250 different stamps 25c. Joseph, Roxbury Crossing, Boston, Mass.

**STAMPS**—12 different from warring nations, 10c; 10 different foreign coins, 15c; 20 Belgian stamps, 10c. Lists free. Toledo Stamp Co., Toledo, Ohio.

**STAMPS** sent on approval at 70% discount. Reference required. Emory Renoll, Hanover, Pa.

#### RARE COINS

**10 OLD** Curious Coins. Catalogue, package of stamps, mail for two dimes. Vance Supply House, 2125 W. Van Buren St., Chicago, Ill.

**\$36.50 VILLA** Currency, 40c. \$16.00 Carrara 50c. Villa Silver dollar, \$1.50. Moore Coin Company, Commerce, Texas.

**50,000 COINS**, notes, newspapers, almanacs, guns, pistols, engravings, relics, Catalogue 4c. Collectors' Exchange, 1536C Willington, Philadelphia.

**SPECIAL:** Villa \$10.00 bills, 10c each. Border Tradepost Z-198. Albuquerque, New Mexico.

**WILL** pay \$10.00 to \$750.00 for certain \$5.00 gold without motto. We want and offer cash premiums for all rare dollars, halves, quarters, dimes, nickels, cents, paper money and stamps. Send 4c now. Get our Large Coin Circular. Numismatic Bank, Dept. H, Fort Worth, Texas.

**CALIFORNIA** gold. Quarter size 27c. 1/2 size 53c. Large cent before 1821. Columbian Nickel coin and price list, 10c. Norman Shultz, King City, Mo.

**OLD** Coins. Large Spring Coin Catalogue of Coins for Sale, free. Catalogue quoting prices paid for coins, ten cents. William Healdin, 101 Tremont St., Boston, Mass.

**88 PAID** for 1853 Quarters, \$100 for rare 1853 half dollars. From \$2 to \$600 paid for hundreds of old coins. Send 10 cts. for our coin Guide Book. Model Co., Morton Bldg., Chicago.

**\$4.25 EACH** Paid for U. S. Flying Eagle Cents dated 1856. We pay cash premiums on hundreds of Old Coins. Send ten cents at once for New Illustrated Coin Value Book 4x7. It may mean your fortune. Clarke & Co., Coin Dealers, Box 15, Le Roy, N. Y.

**12 CURIOUS** things from China, including Coins and Coin Book, 25 cts. Coin Exchange, New Rochelle, N. Y.

#### GAMES AND ENTERTAINMENTS

**"I WIN,"** Wonderful mathematical game. You can always win. 15c. Specialties Mfg. Co., Detroit, Mich.

**TRICKS, Puzzles, Jokes, Magical Apparatus, Plays, Stage Supplies, Mind-reading Acts, Sensational Escapes, and Illusions.** Free large illustrated 1917 catalog. Oaks Magical Co., Dept. 395, Oshkosh, Wis.

**1917 CATALOG** of Escapes, Illusions, Parlor and Stage Tricks, 10c. Hornman, Magic Manufacturer, 470 8th Ave., New York.

**BE** a Handcuff King. Escape from handcuffs, boxes, ropes, etc. Secrets of 20 Sensational Escapes \$1.09. Particulars free. Magcraft Co., Box 251, Detroit, Mich.

**APRIL** Fool Cigars 10c. April Fool Cigarettes 15c box. Sneezing Powder 10c. Itching Powder 10c. Stink Bombs 10c, and hundreds of others. Large catalogue 2c. D. De Luca, 889 Charles St., Marietta, R. I.

**NOVELTIES** just out. Chaplin miniature movie, 10c. Many others made by us; dealers supplied. Universal Mfg. Co., 519 Main, Cincinnati, Ohio.

**TRICKS, Stage Money, 150** Magic bargains in new catalog No. 32 just out. 2c. Twenty Buffalo Greenbacks, 10c. 100-35c; 1,000-\$1.50. Gilbert Magic Co., 11185 Irving, Chicago.

**WONDERFUL** Card Panel Trick (Not Sand Frame) 20c. Chas. Herr, 394 N. Ninth, Allentown, Pa.

**GOOD** card trick and large catalog 5c postpaid. Sales Co., Box 15, Howell, Indiana.

**PLAYS, Vaudeville Sketches, Monologues, Dialogues, Speakers, Minstrel Material, Jokes, Recitations, Tableaux, Drills, Musical Pieces, Entertainments** for all occasions. Make-Up Goods, Large Catalog Free! T. S. Denison & Co., Dept. 11, Chicago.

**A POSITIVE** Rafter. Done anywhere and detection impossible. All metal and lasts a life time. Complete apparatus and instructions prepaid 50 cents. G. Catlin, 52 Inkster, Winnipeg, Manitoba.

**67 TRICKS, 250** jokes, riddles, 75 toasts, 8 Fortune Telling secrets, 52 moneymaking secrets, 22 Funny readings and big catalog 10c. Ideal Novelty Shop, 3315-N-4, Belleplaine Ave., Chicago.

**SOMETHING** different in Novelty. Try them. 10c (Coin). Peerless, 1616 Cleveland Ave., Chicago, Ill.

**SEND** 10c for two Standard Puzzles. Receive Free, 2 Card, 2 Coin, 2 Joke Tricks, Apparatus and Catalogues. Chicago Puzzle Works, 3310 Herndon St., Chicago.

**MAGIC**—Tricks, Books and Supplies. For Amateurs as well as the Great Professionals. Any one can learn through our instructions. Feature Acts in Mind Reading, Spiritualism, Rope Ties, etc. Large illustrated Professional Catalogue, 10c. Chicago Magic Co., Dept. B, 72 West Adams St., Chicago, Illinois.

**MAGIC** Tricks for pocket, parlor and stage. Largest assortment in the world. Thurston's Book of Pocket Tricks 25c. Book of Card Tricks 25c. postpaid. Send 2c stamp for catalogue. (216 page professional catalogue 10c.) A. Felsman, 115 So. State, Chicago.

**SHOW** them what a wad you carry. Big bunch greenbacks 10c, 4, 25c. Howes, 3084 Milwaukee Ave., Chicago.

#### FOR BOYS

**"HOW to Pitch,"** 10c. 1917 Illustrated Catalogue free. Corson, 4720 N. Tripp Ave., Chicago.

**FIREWORKS!** How to make! Wonderful book, including 1,200 games, experiments, riddles, roll fake money, pocket foreign stamps, 25c. Name 3 companions. Boys' Amusement Exchange, Box 103, Oak Park, Ill.

**BOYS** to distribute circulars. Nothing to sell. John W. Burt, Coshocton, O.

**"SLIMMY** Slivers" Metallic Frame Kite. Big value for a dime. Thayer Mfg. Co., Jackson, Mich.

**JUST** Issued—Amateur Mechanics No. 8, How to make 132 different interesting things such as electric fountains, bird houses, model monoplane, porch swing, kites of various kinds, fishing rods, camp outfits, scarecrow, shocking machine, etc., 128 pages, 234 illus. Price 25 cents, postpaid. Also all preceding numbers in the series at same price. Popular Mechanics Book Dept., 6 N. Michigan Ave., Chicago.

#### FOR MEN

**CLEVER** Invention (Patented), 100 samples, 10c. DeLoof, 247 Harmon, Detroit.

**MR. Man!** Let us supply you with the style collar you like in any brand. Arrow, Lion, E. & W., \$1.75 per dozen postpaid. Money order or cash. All Collar Supply Co., 2008 South Street, Philadelphia, Pennsylvania.

#### RAZORS AND BLADES SHARPENED

**MARQUIS** Razor Strop Dressing restores worn strops; sharpens dull razors, 25 cents, postpaid. Agents wanted. Marquis, 5202 North Keystone, Indianapolis.

**RAZORS** ground, honed and set, \$0.40. Safety blades sharpened, \$0.02 each. Satisfaction guaranteed. Established 1907. Maspeh Grinding Co., 25 Linden St.; Maspeh, N. Y.

**SAFETY** razors sharpened; two cents each. Guaranteed. Blade box free. Electro Stropping Co., 134 Shelby St., Detroit, Mich.

#### FOR THE HOME

**IDEAL** Clinker Tong. Cleans fire; saves coal and work. Price, \$1.50. Kansas City Furnace Company, 2429 Independence Avenue, Kansas City, Missouri.

**"GAMBLING** and Gambling Devices" by John Philip Quinn. Instructs your son about the pitfalls, exposes the frauds of gambling machines, punch boards, etc. Cloth binding, gold title, 300 pages, 200 illustrations \$1.00 postpaid. Money back if not satisfied. Home Specialty Co., Box 172, Cleveland, Ohio.

**DELICIOUS** Chocolates and Bon Bons—Best you ever tasted. Pound box 85c, half pound 45c. Post-paid. Money back if not satisfied. Candy Crafters, 844 E. 93 St., Cleveland, Ohio.

**FURNACE** Regulators open drafts at any hour. Turn on electric lights, \$5.00. Will Haynes, 2429 Independence Ave., Kansas City, Missouri.

#### PERSONAL

**TOBACCO** Habit Cured. Prescription sent absolutely free by Mrs. J. Kay, Box 653—Sec. A, Oakland, Cal.

**FREE**—Stop using Tobacco. Free. We will give free information how to conquer the habit easily and permanently. Results Guaranteed. Anti-Tobacco League, 618 Paxton Block, Omaha, Nebr.

**BROTHER**—Discovered root cures tobacco habit. Gladly send particulars. F. Stokes, Mchawk, Florida.

#### ANTIQUES AND RELICS

**POMO** Indian Star Baskets. Prices free. Gilham, Highland Springs, Cal.

**FLINT** Lock Guns and Pistols. War and Indian relics. Many other antiques. List for 2c stamp. Davis Brothers, Kent, Ohio.

#### HONEY

**FINEST** Quality White Clover Honey, crop of 1916, thirty lb. can \$3.60, two or more cans \$3.45 each. Sample 10c. Satisfaction guaranteed. Price list free. M. V. Facey, Preston, Minn.

#### DIAMONDS, WATCHES AND JEWELRY

**SEND** your broken watch and I repair it for \$1.10; guaranteed one year. Frank Rose, Jeweler, 4 E. Third St., Dayton, Ohio.



## PHONOGRAPHS AND RECORDS

**VICTOR**, Columbia, Edison Disc and Cylinder Records bought and sold. Victor and Columbia 15 cents up. Edison Standard 9 cents. Blue Amberol 25 cents. Up to date music rolls 20 cents. Send for list of records or rolls. Weil's Curiosity Shop, 20 So. Second Street, Philadelphia, Pa.

**COLUMBIA** hornless disc talking machine and six Columbia double face ten-inch records \$12. Tone equal to any \$50 machine. Sent C. O. D. anywhere, subject to examination. Weil's Curiosity Shop, 20 S. Second St., Phila., Penna.

**BUILD Your Own Phonograph.** Any type. Big saving. Patents expired. Profits making and selling them. We furnish parts you can't make. Full instructions, dimension drawings, illustrations, parts—price-list only 25c. Circular Free. Associated Phonograph Co., Dept. P, Cincinnati, O.

## MUSIC

**IF** you really want good Sheet Music try our Century Edition. Price per copy, 10c. Write for Free Catalog. New Jersey Sales Co., Dept. C, Box 213, Passaic, N. J.

"LOVELY Hawaiian Moon" song, 15c. Dissatisfied, returns in 5 days; money refunded. F. Rempe, 2827 Myrtle St., Oakland, Calif.

**FAVORITE** Old Home Songs—No home in the land should be without this book of 209 of the familiar old songs everybody loves. Words and music complete in a substantial volume 9½x7 inches in size. Price 50 cents postpaid. Popular Mechanics Book Dept., 6 N. Michigan Ave., Chicago.

## FORMULAS AND TRADE SECRETS

**POLISHING** Cloths, Rust Remover, Silver Polish, Washing Compound, Perfumes, Tube Flavors, full line of Toilet Products, etc., under your own label cheaper than you could manufacture. Pitt Laboratories, 790 Newark, New York.

**1,000 FORMULAS**, 25c. 75 Manufacturing Secrets, 10c. Resilvering Mirrors—Renewing Dry Batteries—Gas Tonic—Mechanics Soap—Luminous Paint—20c each. Entire Collection, 50c. Satisfaction guaranteed. Big Catalog, 2c. Ideal Book Shop, 3315-F4 Bellepoint Ave., Chicago.

**GAS Tonic**, 3 valuable formulas, 25c. C. Johnson, 4319 N. Whipple St., Chicago.

**1,000-PAGE** volume of formulas and trade-secrets for all trades and professions, \$2. Eli Emm, 687 Ocean Ave., Jersey City, N. J.

**55 VALUABLE** Formulas, Trade Secrets, etc., in our magazine, Two issues 10c. Lefkas, Racine, Wis.

**GUARANTEED** formulas for everything. Highgrade only. Make and sell your own goods. Staff of former U. S. Government experts for analyses and consultation. United Chemical Laboratories, 13 H Street, Washington, D. C.

**FORMULAS** for two of the best face creams and hand lotions on the market, 2c each. Box 624, La Grande, Ore.

**10,000 FORMULAS**, \$1. Postpaid. Complete list 4c stamps. Edm Bromley, Watervliet, N. Y.

**GUARANTEED** Rubber Formulas. We have compounds for any line of Rubber, Auto Tires, Tubes, Repair Stocks, Cements, Toy Balloons, Gloves, etc. Write for our list. Rubber Compound Bureau, 34 Central Office Bldg., Akron, O.

**10,000 SELECTED** scientific, chemical, technological, and practical recipes and processes, including hundreds of so-called trade secrets for every business, alphabetically arranged in one large volume of 800 pages. Price \$3 postpaid. Large descriptive circular sent upon request. Popular Mechanics Book Dept., 6 N. Michigan Ave., Chicago.

## TYPEWRITERS AND SUPPLIES

**LARGEST** Stock of Typewriters in America. Underwoods, one-fourth to one-half manufacturer's prices; rented anywhere, applying rent on purchase price. Free trial. Installment payments if desired. Write for catalogue 70. Typewriter Emporium, estab. 1892, 34-36 W. Lake St., Chicago, Illinois.

**STARTLING** Values in Typewriters. \$10 to \$15 up. Factory rebuilt. All makes. Shipped on trial. Write for our special offer No. 128D. Whitehead Typewriter Co., 186 N. La Salle St., Chicago.

**TYPEWRITERS**—\$10 up—Guaranteed. Write for cash price list E. Bassett Typewriter Co., Chicago.

**TYPEWRITERS**, all makes factory rebuilt by famous "Young Process." As good as new, look like new, wear like new, guaranteed like new. Our big business permits lowest cash prices. \$10 and up. Also, machines rented—or sold on time. No matter what your needs are we can best serve you. See our display advertisement on page 153. Write and see now. Young Typewriter Co., Dept. 76, Chicago.

**FRESH** typewriters, ½ market price! Investigate free trials. Tell make wanted. Co-Operative Union, Covington, Kentucky.

**TYPEWRITERS**—Prices wrecked. All makes. Nearly New and Rebuilt, \$5.00 up. Coronas and other portable machines, \$10.00 up. Write for Catalogue 5067. Bureau Typewriter Co., 58 W. Washington St., Chicago.

**SEND** for list of Typewriter Bargains, new and rebuilt; cash, time or rent. 10 days' Free trial. American Typewriter Exchange, 14 N. Dearborn St., No. 4, Chicago.

**TYPEWRITER** Ribbons Re-linked, made new, 20 cts. each, \$1.50 per dozen. Monon Reinkers, 740 Monon Bldg., Chicago.

**GUARANTEED** Typewriter Ribbons 3 for \$1.00, any color, any machine. Non-Smear Carbon Paper, any size, any color. Featherweight or Standard, \$1.00 per box. Acme Co., 440 S. Dearborn, Chicago.

## DUPLICATORS AND DEVICES

**\$300 MULTIGRAPH** like new for \$100. Guaranteed. Russell Baum, Philadelphia Bourse, Philadelphia.

"**MODERN**" Duplicator—A Business Get-ter. Saves money, time, trouble. No glue or gelatin. Always ready. Easy to operate. 35,000 firms use it. 50 to 75 copies from pen, pencil, typewriter. Letter size complete, \$4.50. Satisfaction or money back. You need one. Write for free booklet now! J. E. Durkin & Reeves Company, Pittsburgh, Pa.

## OFFICE EQUIPMENT

**THE** Ray Adding Machine, complete for \$15, handsome desk stand free. Adds with speed and accuracy of highest priced machines—also actually subtracts. Saves time, money, labor. Convenient to have on desk or to carry wherever needed. Used by Hershey Chocolate Co., Barrett Manufacturing Co., etc. Send no money, but write for 20 days' free trial. Ray Company, 1401 Power Bldg., Richmond, Va.

**LARGE** Assortment Check Writers; Protectors; Montages, Elliott Addressing Machines; Addressographs; Adding Machines, Equipments, Dictating Machine, Shavers; Slightly Used. Spayd, 821-23 Walnut Street, Philadelphia, Pa.

## MAILING LISTS

**FOR** Sale, list of 5000 property owners with their correct addresses and rating. Price \$5.00; also list of Automobile owners. P. O. Box 598, Anniston, Ala.

**TRY** our mailing for results. Huggard Mailing Service, Goldfield, Nevada.

**1000 AGENTS** \$2.50, Lady Mail Order Buyers \$2.00. Modern Name Supply, Milwaukee, Wis.

**MAILING** List Dealers, Attention, What's the use of getting up mailing lists if you can't sell them? I've got a list of 1,000 prospective buyers, all classifications. Write for special price. Box 52-E, Mansfield, Ohio.

**1,000 PROSPEROUS** Buyers or Agents' names postpaid \$1.50. Liebau, Drawer 385, Erie, Pa.

## PRINTING, ENGRAVING AND MULTIGRAPHING

**QUALITY** Printing Prepaid. 500 either envelopes, noteheads, cards, statements, \$1.35; 1,000, \$2.25; 1,000 envelope slips, \$1.25; 1,000 6½ circulars, \$1.85; 500 linen-finish letterheads or envelopes, \$2.25; 1,000 \$3.50. Prepaid. Typewriter letters. Stamp brings samples. Model Company, Manchester, Iowa.

**BUSINESS** Stationery—500 No. 7½ Good bond envelopes with letterheads to match. The new Two-Fold size, \$4.25. Pomeroy Envelope Company, Menasha, Wis.

**BUSINESS** Courtesy Seals, 50 samples, 10 cents. Circular free. Helmers Company, Hoboken, N. J.

**PRINTING** Outfits—Presses, type, supplies, type novelties. Send stamp for catalogue. Model Press, York, Penna.

**200 LITHOGRAPH** Letterheads \$1.25—like lithographing; samples stamp. Higgs Press, Veary, Indiana.

**50 CARDS**, name and address neatly printed. Postpaid 12c. C. H. Turner, Galesburg, Ill.

**AT** Last! Beautiful Lithography for small users. 1,000 Letterheads, 1,000 Billheads and 1,000 Statements, \$9.90. Engraving Free. Kaylee Lithographing Co., 764 Teutonia, Milwaukee.

**100 BABY** Blotters 50c. Lincoln Novelty Co., Rochester, N. Y.

**SOMETHING** New: Patented business and calling cards in book-form; tear off smooth; 100 cards and elegant seal grain case 50c; agents wanted. Sample case 15c. Anderson Co., 8412 South Green St., Chicago.

**1,000 IMITATION** Typewritten letters, heading black, body purple, \$5.50; 1,000 envelope slips, \$1.00; 5,000, \$3.25. Samples. Good's Printery, Harrisonburg, Va.

**PRE-USED** Printing presses, Type, Supplies, cheap. List for stamp. Popular Bargains, Richmond, Pa.

**50 CLASSY** Calling Cards and patented card case, 25c. Extra grade, Linen, 35c. Samples. Retter, 304 Fourth, Tippecanoe City, Ohio.

**PRINTING** outfit complete with Paper Cutter \$175. G. Willis, Dover, Ohio.

**CARDS**, envelopes, bond noteheads, letterheads, statements, billheads, \$2.50 per thousand. Samples free. Gale Printing Co., Galeton, Pa.

**1,000 16-PAGE** colored booklets printed, \$15.00. Miller, 1952b Germantown Ave., Philadelphia.

**FORM** Letters, ribbon process. Neat work. Low prices. Quality printing, letterheads, circulars, booklets. Stox Press, Odell, Illinois.

**1,000 GOOD** letterheads, envelopes, billheads, statements, \$2.25; samples free. Weaver's Print Shop, 217 Columbia St., Michigan City, Ind.

**250 BOND** letterheads and 250 envelopes \$1.75 postpaid. 1,000 Typewriter letters \$1.75. Samples for stamp. Rose Company, Culberson, N. C.

**PRINTED** Gummed Labels our Specialty. Wetzell's Labels, Box 101-A, Madison Square, New York City.

**GUMMED** Labels 3,000, 75 cts. up. Send for catalog. Stickite Labels, 44 N. 4th St., Philadelphia, Pa.

**1,000 16-PAGE** 3½x6 colored booklets, \$12.50. Clapp, Franklin, N. H.

**CATALOG** 102 free illustrating gummed labels and advertising stickers. 3,000 75 cents upward—direct from manufacturer. Royal Label Co., 408 Cherry, Philadelphia.

**GOOD** Printing at low prices. 1,000 good letterheads, envelopes, cards, billheads, labels, circulars, \$2.50. Samples free. Catalogues, booklets and circulars our specialty. Ernest L. Fantus Co., 523 S. Dearborn St., Chicago.

**PERFECTION** Letter Company, Muncie, Indiana. Multigraphs 500 purple letters with black letter heads, \$2.15. Samples for stamp.

**LABEL** Catalog "A" free. Irvin Wolf, 3136 Jasper Street, Philadelphia.

**250 ENVELOPES** or Letterheads \$1.25. Meyer Supply House, Milton, Pa.

**GOOD** Printing, low prices, 1000 good Letterheads, Envelopes, Cards, Bill Heads, Statements, \$2.00 per 1000. Imitation Typewritten Letters \$2.40 per 1000. Acme Co., 440 S. Dearborn, Chicago.

**200 WHITE** Bond Letterheads, printed \$1.00. W. Kinnear, Box 236, Brooklyn.

**500 LINEN** Finish Letterheads \$1.75; printed 2 colors, \$2.50 postpaid. Samples. Starb Printing Co., Hamilton, Ohio.

"**THE** House of Quality" will print your envelopes for \$2.35 per 1,000. House of Quality, Bancroft, Iowa.

**LITHOGRAPH** letter heads 1,000 \$4.50. State your business and let us submit samples. We make rubber stamps to order. Nocco, Zion City, Ill.

**3000 GUMMED** stickers \$1.00. 100 letterheads and 100 envelopes, \$1.00. Walden Press, Boston, Mass.



## PATENT ATTORNEYS

**PATENT** Your Ideas—\$9,000 offered for certain inventions. Books, "How to Obtain a Patent," and "What to Invent," sent free. Send rough sketch for free report as to patentability. Manufacturers constantly writing us for patents we have obtained. We advertise your patent for sale at our expense. Established 20 years. Address Chandler & Chandler, patent attorneys, 1930 F. St., Washington, D. C.

**INVENTORS** Attention—Get particulars of my system before applying for patent through others. It saves you money, and keeps you in touch with, and in control of, your case at all times. W. N. Rowch, Jr., 959 McGill Bldg., Washington, D. C.

**PATENTS**—Send sketch for free search and report. Books on patents and book of reference letters sent free. John S. Duffie & Co., 410 F St., Washington, D. C.

**INVENTORS**: Write our Patent Dept. Adam Fisher Mfg. Co., 2061 C Railway Exchange, St. Louis, Mo.

**UNPATENTED** inventions and patents sold or no fee. Inventor's Advocate—1, Washington, D. C.

**PATENTS** Secured or Fee Returned. Actual search free. Send sketch or model. 1917 Edition, 90-page patent book free. My patent sales service gets full value for my clients. It should never require more than two days to report upon the patentability of your invention; nor longer than ten days to prepare your application for filing. Longer delay amounts to gross neglect and the jeopardizing of your rights. For prompt personal service write. George P. Kimmel, 212 Barrister Building, Washington, D. C.

**PATENTS** obtained through D. Swift being promptly sold to Manufacturers. Write to-day for free books of "Inventions Needed," and surprising references. D. Swift, 317 Seventh St., Washington, D. C.

**INVENTORS**. Let us sell your patent. Send for our liberal proposition. Atlantic Supply Co., Long Branch, N. J.

**PATENTS** on easy payments. Send Sketch or Model for Free Search and Certified Registration of Your Invention for your Protection. Free Book tells What to Invent and How to Secure a Patent on our Easy Payment Plan. C. C. Hines & Co., 591 Loan & Trust Bldg., Washington, D. C.

**PATENT** what you invent. It may be valuable. Write me. No attorney's fee until patent is allowed. Estab. 1882. "Inventor's Guide" Free. Franklin H. Hough, 522 Loan & Trust Bldg., Washington, D. C.

**PATENTS**—Send Sketch. Free Opinion and Certificate of Patentability. Free Book, "How to Obtain a Patent and What to Invent." Patents secured through Credit System. Talbert & Parker, Patent Lawyers, 4222 Warder Bldg., Washington, D. C.

**PATENTS** secured or all fees returned. Do not miss the generous offers in E. E. Vrooman & Company's display ad on page 160.

**DON'T** lose your rights to patent protection. Before proceeding further send for our blank form Evidence of Conception to be signed and witnessed. Book, suggestions and advice free. Lancaster & Allwine, 221 Ouray Bldg., Washington, D. C.

**PATENTS** Bring Riches; Protect Your Invention. Attorney's fee payable when patent allowed. Plain advice and "Patent Facts" free. Trade-marks registered. Jaynes & Jaynes, 653 Kellogg, Washington, D. C.

**ATTENTION**—Patents. You will like my easy Plan. Write for free booklet. C. L. Drew, 4 Victor Bldg., Wash., D. C.

**PROTECT** your invention. Honest advice. Personal service. Write for "The Truth About Patents." J. R. Kelly, 740A Woodward Bldg., Washington, D. C.

**PATENTS** procured on square deal fee plan with real service. We help sell the patent. Free booklet and advice. Milo B. Stevens & Co., 685 F St., Washington; 353 Monadnock Bldg., Chicago. Est. 1864.

**PATENTS**: Send model, sketch or drawing. Advice. 100 Mechanical Movements and 50 Perpetual Motions Free. Fred G. Dieterich & Co., 61 Ouray Bldg., Washington, D. C.

**C. L. PARKER**, Ex-member Examining Corps, Patent Office, Patent Attorney, McGill Bldg., Washington, D. C. Inventor's handbook, "Protecting, Exploiting and Selling Inventions," sent free upon request.

**PROTECTIVE** patents procured promptly. 204-page blue book on patents sent on request. Trade-marks registered. Robb & Robb, 211-215 Southern Bldg., Washington, D. C.

**HIGH-VALUE** Patents. See R. S. & A. B. Lacey's advertisement on page 159.

**H. L. WOODWARD**—Safe methods. Paying patents. Write today, 902 G St., Washington, D. C.

**PATENTS** that protect and pay. Advice and books free. Rates reasonable—highest references; best results. Watson E. Coleman, Patent Lawyer, 624 F St., N. W., Washington, D. C.

**PATENTS**—Herbert Jenner, patent attorney and mechanical expert, 606 F St., Washington, D. C. I report free of charge if a patent can be had and its exact cost. Send for circular.

**PATENTABLE** Ideas Wanted—Send for 3 free books. R. B. Owen, 30 Owen Bldg., Wash., D. C.

**THE** Patents is free. An education in obtaining patents. Established 1865, Anderson & Son, Attorneys, 707 7th St., Washington, D. C.

**PATENTS** Wanted. Write for list of Patent Buyers who wish to purchase patents and what to invent with List of Inventions Wanted. \$1,000,000 in prizes offered for inventions. Send Sketch for free opinion as to patentability. Write for our four Guide books sent free upon request. Patents advertised Free. We assist inventors to sell their inventions. Victor J. Evans & Co., 166 Ninth, Washington, D. C.

"**PATENTS** and Patent Possibilities" is a 72-page treatise which tells all about patents, what to invent and where to sell it. It gives honest advice to inventors and tells about the successes of some of my clients, also explaining what are frequent causes of failure. Manufacturers are constantly writing for protective patents upon all kinds of sound inventions. Can you help supply their wants? The book is free. Write for it today. H. S. Hill, 905 McLaughlin Building, Washington, D. C.

**PATENTS** without advance attorney's fees. Send sketch for free report. Books free. Frank Fuller, Washington, D. C.

**KEEP** up with progress. Promote your patent. Send \$1.00 for year's subscription to best inventor's magazine, "Invention and Manufacturing." United States Patent Corporation, Washington, D. C.

## FOR INVENTORS

**INVENTORS**: Invent for profit. Write for list of needed inventions. Sanders, 7 Webster Bldg., Chicago.

**FOR** \$3 I'll write you a powerful letter that will sell your patent. Harry A. Stern, Specialist, 1069 Gaylord, Denver.

**PATENTS** on easy payments. Send sketch or model for free search and Certified Registration of your invention for your protection. Free book tells what to invent and how to secure a patent on our easy payment plan. C. C. Hines & Co., 591 Loan & Trust Bldg., Washington, D. C.

**PATENTS**—Send Sketch. Free Opinion and Certificate of Patentability. Free Book, "How to Obtain a Patent and What to Invent." Patents secured through Credit System. Talbert & Parker, Patent Lawyers, 4222 Warder Bldg., Washington, D. C.

**NO** Attorney fees until patent allowed. Send sketch for free report. Books free. Frank Fuller, Washington, D. C.

**PATENTS**, Trade-Marks and Copyrights. Our handbook on patents will be sent free on request. All patents secured through us are described without cost to the patentee in the Scientific American. Munn & Co., Patent Attorneys, 672 Woodworth Bldg., N. Y. Washington, D. C. office, 625 F St.

**PATENTS** and unpatented inventions sold or no fee. Inventor's Advocate—2, Washington, D. C.

**PATENTS** secured or all fees returned. Do not miss the generous offers in E. E. Vrooman & Company's display ad on page 160.

**HIGH-VALUE** Patents. See R. S. & A. B. Lacey's advertisement on page 159.

**INVENTORS**—We specialize in manufacturing new patented articles—make models—dies—and do experimental work. Leo J. Gerding Mfg. Co., Dept. D, Opera Place, Cincinnati, O.

**HAVE** You An Idea? If so, you should protect it by a patent. Send us a model or sketch for free opinion as to patentability. Write for our Four Books sent free to any address. Victor J. Evans & Co., 157 Ninth St., Washington, D. C.

**HAVE** you a Patent to sell? You'll be interested in my proposition. Write now for free particulars. Don't call. F. W. Johnson, 6 N. Michigan Ave., Chicago.

**PATENTABLE** Ideas Wanted—Send for 3 free books. R. B. Owen, 30 Owen Bldg., Washington, D. C.

**WANTED**—An Idea! Who can think of some simple thing to patent? Protect your ideas; they may bring you wealth. Write for "Needed Inventions" and "How to Get Your Patent and Your Money." Randolph & Co., Patent Attorneys, 623 F. St., Washington, D. C.

**INVENTIONS**—Patenting and Promoting. A book containing practical advice and directions for inventors and manufacturers. Book, suggestions and advice free. Lancaster & Allwine, 221 Ouray Bldg., Washington, D. C.

**PATENTS** Wanted. Inventors write for Free Booklet. Tells how to get the cash value of your invention. F. E. Wooten, Sta. P., Philadelphia, Pa.

**INVENTIONS** commercialized on cash and royalty basis. Patents secured. Models, experimental work and contract manufacturing. Inventors should write at once. Adam Fisher Mfg. Co., 2061A Railway Exchange, St. Louis, Mo.

## PATENTS FOR SALE

**FOR** Sale—Outright or royalty; U. S. and Canadian patents covering Flewelling Gear Mechanism; pulley revolves in either desired direction regardless of direction of rotation of shaft; controlled by one lever; simple and substantial. Address: Robert Holmes, Eden, Idaho.

**REVERSIBLE** Handsaw Handle. Enables the user to saw at any angle and still have the handle in a position that is most convenient. Will sell or let on royalty. Herman Pause, Route 4, Oroville, Cal.

**"SWINGING** Faucet Connection," faucet swings to one side and prevents broken dishes. Eugene C. Bacon, 1156 Elm St., Medina, N. Y.

**PATENTS**, all kinds, for sale, satisfactory terms, Patent News, Washington, D. C.

**ATTENTION**—Patent Buyers interested in metal articles; a collapsible Clothes and Hat Tree or Stand; general demand. Will sell outright or royalty at a reasonable price. Address Tompkins, Masters Place, Beacon, N. Y.

**FOR** Sale or Royalty—Stone digging and loading apparatus, simple and substantial. Proven success. Iver Sewall, Lowry, Minn.

**AUTOMATIC** Throttle Control facilitates the shifting of transmission gears. Operated by clutch lever. Investigate this. Clarence Reppert, R. F. D. No. 1, Uffington, W. Va.

**ELECTRIC** Self-Surfacing Floor Machines. Old or new wood floor, terrazzo, mosaic and cement floors. Great demand machines. Jas Hampton, P. O. Box 64, Evanston, Ill.

**PATENT** Auto Horn for sale. Patterns and dies. Vance Supply House, 2125 W. Van Buren St., Chicago, Ill.

**LOOSE-LEAF** Manufacturers and Paper-Bulers: Creasing attachment on Buling Machines. Adjustment very simple. Joseph Hayes & Co., 45 Fulton St., New York.

**PATENT** Buyers are invited to address our sales department for information on any class of Patents they wish to purchase or lease on a royalty. We have secured a number of valuable patents in all lines of invention. Mail Order, Department Store and Household Novelties a specialty. Victor J. Evans & Co., 160 Ninth St., Washington, D. C.

**SANITARY**, never clog Salt Sifter. Simple, inexpensive; patent for sale. Wheeler, 2069 Third Ave., N. Y. City.

**A DIME** savings bank netted \$88,000. Have just patented nickel bank rated high by manufacturers who have made sample and given cost of manufacture. Would sell whole or half interest. F. J. Rupert, Salem, Oregon.

**PATENT** for Sale: Tool for separating and oiling spring leaves. Simple and positive in operation. A handy, low priced Auto accessory. Act quick. George Lewis, Alms, Mich.

**MAKE** me an offer, cash or royalty. Patent \$1,210,290 protects reinforced cord entering electric sockets, hand-lamps, fittings and fixtures. Herbert Feick, 296 S. Payson St., Baltimore, 56d.

**TELEPHONE** Directory; compact attachment for telephone; universal demand; cash or royalty. Clyde Maxey, Craig, Colorado.

**LATEST** Window Washing Device; patented; good. 2527 Cedar, Berkeley, California.



**SALE or Royalty**—Adjustable Electric Light Shade and Reflector capable of shading in any possible direction. R. F. Vass, Hyattsville, Md.

**FLEXIBLE** transparent window panel can be rolled up or down to open or close the entire window. Outright or royalty. J. R., 713½ Grove St., San Francisco, Cal.

**PATENT** on steam boiler for locomotive. Liquid fuel burning. Combined fuel and compressed air tank. Frank Sierka, Rogers, Nebr.

**PATENT**—For sale newly patented Ice-creper; make offer. Ruggiero's Co., 1233 Wharton St., Philadelphia, Pa.

**PATENT** Tractor Hitch for Headers or Pushhinders for Sale. Best offer accepted. E. A. Kirch, Rush Center, Kas.

**INVENTIONS.** Sell outright or royalty. Washing machine with extractor. Carburetor. Produces absolute mixture, manufactured cheaply. Agricultural Implement. Eliminates harrowing, simple, cheap, extensively advertised. Reflexed Co., 1928 Glendale, Peoria, Ill.

**FOR Sale** United States and Canadian rights on one man controlled power glider. Simple, safe, cheap and practical for sport, learning to fly, soaring, exhibition and commercial purposes. Patent allowed. Frank Summers, Memphis, Mo.

**PATENT** for sale. Boiler blow Recorder. Patent U. S. and Canada, Box 144, Stowe, Pa.

**PINLESS** Clothesline, greatest labor saving device ever invented. Recently patented. Wonderful money-maker. Nothing like it. Will sell to every user of clotheslines. Big demand everywhere. Good opportunity for profitable investment. Outright or royalty considered. John Nelson, Stamford, Nebraska.

**PATENTS**—Send Sketch. Free Opinion and Certificate of Patentability. Free Book. "How to Obtain a Patent and What to Invent." Patents secured through Credit System. Talbert & Parker, Patent Lawyers, 4668 Warder Bldg., Washington, D. C.

**U. S. AND Canadian Patent.** Nos. 1188162, 174728, on wonderful new boring brace for Mechanics, good hardware article. C. B. Duggan, 10610 Shale Ave., Cleveland, O.

**NEW** invention for sale or royalty, window screen, adjustable both ways, John Neuman, Amber, Ia.

**FOR Sale or Royalty.** Convertible camping chair. 12 in one. F. Goetz, Keyport, N. J.

**AUTOMATIC** Friction Clutch Pulley for gasoline engine. J. S. Owen, Repb-Grove, Va.

**PATENT** on Automatic Gate; opens and closes by wheel of vehicle; effective; ornamental; working model; nothing like it. F. W. Bourgois, patentee, 3939 Cook Ave., St. Louis, Mo.

**SUCCESSFUL** Raising and Lowering Wagon. Recently patented. Walter Swanson, 1605 Burr St., St. Paul, Minn.

**HANDY** bit-brace attachment. Gears hit up or down "2 to 1." Best offer takes patent. "Jeweler," Plum City, Wis.

**UNITED States and Canadian Patent** on the only simple, practical, inexpensive Curtain Stretcher made in either country. C. B. Riggs, Seattle, Washington.

**PATENT** on new trolley pole. Will not come off wire while car is in motion. Best offer takes it. Eugene Washington, 1234 Brushton Ave., Pittsburg, Pa.

**"PATENT** for Combination Table." Good article for Mail Order or Furniture Specialty business. Talbert & Parker, Patent Lawyers, 19027 Warder Bldg., Washington, D. C.

**OUTRIGHT or Royalty:** New signaling device for automobiles, etc. United States and Canadian patent-rights granted. United States No. 1,298,656. Canadian No. 171,796. Will sell jointly or separately. Thomas Richardson, 2916 Perdido Street, New Orleans, La.

**PATENTS and Inventions** for sale or on royalty. My clients have valuable inventions for market. No better investment for manufacturers or individuals. Full information without charge. Mention line of invention interesting you and data will be sent. Richard B. Owen, Patent Lawyer, Owen Building, Washington, D. C.

**PATENT** pending. Anti-Skidding Devices for Wheel Tires. Prevents skidding. 80% easier on tires than other makes. Cash or royalty. Write, Seth Weed, Cooksville, Illinois.

**FOR Sale.** Patent 1,188,864. Novel Dancing Doll, issued June 27, 1916. Box 182, Stoneham, Mass.

**PATENTS.** U. S. and foreign, on Means for operating and controlling machine guns from a distance. Will sell outright or on royalty basis. Also something new in ship indicator mechanism. A. B. Knotts, Ramos, La.

**IMPROVED** Loading Apparatus No. 1,215,077, will take and load hay or grain in one operation. Will shovel and load snow from streets; can be manufactured in large or small machine shops; bright future for someone. J. F. Collier, So. Aberdeen, Wash.

**FOR Sale**—U. S. and Canadian Patents on My Solid Tire Spring Base Auto Wheel. Will sell outright. For further information, address Philipp Wehner, 2022 Rear Market St., New Albany, Ind.

**THE** problem solved—just patented. First dish-washing device for family use. Wonderfully simple, cheap. Abramo, 151 W. 11 St., New York.

**"AMPLIFIER or Telephone Relay"** for sale or lease. Cash or royalty. No. 1213298. Other valuable patents for sale. Talbert & Parker, Patent Lawyers, 10172 Warder Bldg., Washington, D. C.

**FOR Sale** for cash or royalty. Patent on automatic feeding grease cup. Excellent proposition. Write F. C. Haeber, Fresno, Cal.

**ELECTRIC** Steering for autos and trucks. Patents owned by F. W. Austin, Cabool, Mo.

**PATENT** For Sale—A quick heating dinner pail cheap to make and to operate. James Shewan, The Allen, Niagara Falls, N. Y.

**AUTOMATIC** shears, just patented, great money-maker, used all over the world. J. Schutz, 424 S. Homan Ave., Chicago, Ill.

**WE** have some money-making inventions for placing on royalty; outright sale or trade. Write Adam Fisher Mfg. Co., 2961B Railway Exchange, St. Louis, Mo.

**THERE** has long been needed a good hemmer for sewing machine; here is one patented July 11, 1916. Miss O. M. Cartwright, 235 W. 13th Street, New York, N. Y.

#### MODELS AND MODEL SUPPLIES

**INVENTORS.** We make models, all sizes, of any device or patent. Inventions advertised and exploited. Send for estimates. Atlantic Supply Co., Long Branch, N. J.

**MODELS, Punches and Dies, Patents Perfected.** The Sachs-Lawler Co., Inc., Established 1881, 1543 Larimer St., Denver, Colo.

**PATENTS**—Send Sketch. Free Opinion and Certificate of Patentability. Free Book. "How to Obtain a Patent and What to Invent." Patents secured through Credit System. Talbert & Parker, Patent Lawyers, 4668 Warder Bldg., Washington, D. C.

**WANTED**—New Ideas. Write for list of Patent Buyers and Inventions Wanted. \$1,000,000 in prizes offered for inventions. Our Four Books sent free upon request. Victor J. Evans & Co., 165 Ninth, Washington, D. C.

**WE** make working models for inventors; also dies and stamping of specialties, and carry a complete stock of brass gears and model supplies. Send for catalogue. The Pierce Model Works, 3495 Pierce Ave., Chicago, Ill.

**PRODUCERS of Results:** Inventions developed. Models, Experimental work, anything special in metal to order, novelties, spinning, forging, castings in any material, electrical devices, patterns of all kinds, plating, general manufacturing, designing, special tools, punches and dies, stampings. Send drawing or sample. Expert information free. The John's Machine & Stamping Works Company, Dept. C, Cleveland, Ohio.

**PERFECT** models sell inventions. We make them. Write Adam Fisher Mfg. Co., 2961B Railway Exchange, St. Louis, Mo.

#### MANUFACTURING

**HARD** rubber and brass specialties developed and manufactured. Rubber, glass or metal models quickly and cheaply made. International Rubber & Brass Works, 1516 Foster Ave., Chicago.

**AUTOMOBILE** Accessories, Metal Specialties, electrical and mechanical devices; will manufacture on contract or royalty accurate die, tool, screw machine, brass finishing, drill and punch press, model and experimental work. Send models, drawings or blue prints for estimate. Berkmann Mfg. Co., 623 Jackson Blvd., Chicago.

**THAT** Special Machine can be designed, developed and built in any quantity on a contract basis in this modern factory covering 40,000 sq. ft.—by an organization backed by 41 years' experience in this line of work. You furnish the drawing—we'll build your special machinery. We promise you careful service and attention at reasonable terms. Send in your specifications. C. H. Cowdrey Machine Works, Fitchburg, Mass.

**WANTED,** to manufacture, special machinery, dies, tools, metal specialties. Screw machine work. Thompson & Bremer, 850 S. Canal St., Chicago.

**THE** Brooklyn Specialty and Manufacturing Company, Cleveland, Ohio, design or make special articles to order. Inventions developed. Tools, Models, Stampings, Castings.

**PATENTS**—Send Sketch. Free Opinion and Certificate of Patentability. Free Book. "How to Obtain a Patent and What to Invent." Patents secured through Credit System. Talbert & Parker, Patent Lawyers, 4668 Warder Bldg., Washington, D. C.

**PATENTED** Articles. Models. Brass Work, Dies made. Baum's Metal Specialties, Kansas City, Mo.

**WIRE** Goods, all kinds, made to order. Cooley Mfg. Co., 553 W. Monroe St., Chicago.

**LEATHER** specialties manufactured to order. LeRoy Mangans Mfg., Anderson, Ind.

**INVENTIONS** developed and marketed. Dies, models, stampings, electrical or mechanical manufacturing, and machine work. Gits Electrical Co., 1122 Washington Blvd., Chicago.

**INVENTIONS** manufactured under contract. Write Adam Fisher Mfg. Co., 2961B Railway Exchange, St. Louis, Mo.

#### REAL ESTATE AND FARM LANDS

**FREE** Book of Florida Facts. If interested in Florida, before visiting or settling in this wonderful state of fragrant flowers and sunshine, write Lake County Land Owners' Association, No. 93 Lloyd St., Fruitland Park, Florida, for free book of actual photographs and real conservative facts concerning this State. There is poor, good, better and best land in Florida. This book will teach you what is Best and Why. The members of the Association are not land agents; they simply wish to tell actual facts to those really interested in the State. They have no time to waste on curiosity seekers, children or people who expect to grow rich without effort, but to those of character, energy, some capital, with a desire to learn more of the opportunities in this most prosperous State we would be glad to give fullest information.

**FOR Sale** at a Bargain—¾-acre in Civic Center, Atascadero Colony, Cal., Ia. Paid \$1,000. To get needed money quickly, shall sell for \$600. Carl Stolar, Paso Robles, California.

**\$5.00 DOWN,** \$5.00 monthly; seven acres fruit, poultry, fur farm; river frontage; Ozarks; \$100.00; hunting, fishing, trapping. Harvey Hubbard, 1973 North Fifth, Kansas City, Kansas.

**FARM,** 90 acres, 3-acre bearing apple orchard, 9-room house, big new barn, silo, all equipment. \$4,500, \$2,000 down. A. B. Borgeson, Naugatuck, Conn.

**557 ACRES** best grazing land. Artesian water. Good markets. Rail and water transportation. For reasons, cheap. Owner, Box 1168, Sanford, Fla.

**A LITTLE** Farm Complete for \$350. With comfortable little bungalow, live stock, flock of chickens, poultry house and set of implements. Ready to move into and go to work. Only ten of these ready-made little farms available on Little Planters Colony at Richland Heights in the Shenandoah Valley of Virginia. Write quick for full description and easy terms of payment. F. H. LaBaume, A. & L. Art., N. & W. Ry., 250 Arcade Bldg., Roanoke, Va.

**NO** interest. No taxes. No interest charged. Taxes paid by seller. First payment for ten acres only \$10. Subsequent payments only \$9 month. Five acres one-half this. Land cost \$65 to \$115 acre. Four hours rail from San Francisco. Level San Joaquin Valley. Clear. Ready to plow. Photographs, maps, particulars, Free. Howard B. Hogan, Desk J, 785 Market Street, San Francisco.



**IMPROVED** fruit, dairy and stock farms, 20, 40, or more acres, in vicinity of Fresno, San Joaquin Valley, heart of winterless California, greatest raisin belt in world; now paying good profits; houses, barns, fences, live stock—everything ready; crops in many instances paying better than \$150 an acre. \$2,500 will buy a \$10,000 place, with long time on balance. Your farm income will take care of future payments. Only limited number of farms can be had on these terms, so write today. I will gladly put you in touch with those having farms for sale. C. L. Seagraves, Industrial Commissioner, AT&SF Ry., 1809 Ry. Exch., Chicago.

**FREE** U. S. Land, Oil and Mineral Claims. Northwest Arkansas, 200,000 acres opened. Descriptive literature with State, township, elevation map, three colors—25c, or 60c includes year's subscription to Arkansas' Development Magazine, Homestead Magazine, Harrison, Ark.

**TEXAS** school land for sale by the state at \$2 an acre; 5c per acre cash, and balance in 40 years at 3 per cent; send 6c postage for further information. Investor Pub. Co., Dept. 4, San Antonio, Texas.

**MONTANA** Public Land Auction. Investment; Values doubling. We represent you. Box 953, Helena.

**CALIFORNIA** land \$1 per acre cash. Balance purchase 90c month per acre. Immediate possession given. No taxes. No interest. Level San Joaquin Valley. Only four hours from San Francisco, 5 acres up. Clear; ready to plow; open ditch irrigation \$1 acre per annum. Particulars, maps, photographs, free. Steinson Colony, Desk D, 785 Market St., San Francisco.

**SELL** your property quickly for cash, no matter where located. Don't pay big commissions. Particulars free. Real Estate Salesman Co., Desk B, Lincoln, Neb.

**FOR** Sale. 2,640 acres hill land near Hattiesburg, Miss., at \$3.25 per acre. J. A. Hodge, Jackson, Miss.

**ENLARGED** Homesteads. Valuable information. Booklet dime. Joseph Clark, Sacramento, California.

**MONEY-MAKING** Farms, 15 states, \$10 to \$50 an acre; stock, tools and crops often included to settle quickly. Write for Big Illustrated Catalogue. E. A. Strout Farm Agency, Dept. 3043, New York.

**LANDS**—Northern Realty Company, Duluth, Minnesota, dealers in Northern Minnesota lands, timber; also iron lands.

**CALIFORNIA** little farms near Los Angeles for sale, easy payments. Write E. R. Walte, Shawnee, Oklahoma.

I HAVE a successful way of selling farms and farm lands. Write me for free particulars. No obligation whatever. Don't call. E. J. Zimmer, 925 Tower Bldg., Chicago.

#### DOGS, BIRDS, POULTRY AND PETS

**FLYING** Squirrels—for pets or show; odd, beautiful, intelligent, hardy; mated pair, \$2.50. Safe delivery guaranteed. Wildwoods Fur Farms, Colmesneil, Texas.

**COLLIE** Pups—Thoroughbred; beautifully marked. 3010 Reading Rd., Cincinnati, Ohio.

**HOUNDS** for any game. Three States Kennels, Somerset, Ky.

**BIG** Money in Pigeons and Squabs. Free book tells you all about it. Write today. Start profitable business of your own. Demand unlimited. Investment is small. Write today for Free Book. Indiana Squab Co., Dept. 1194, Terre Haute, Ind.

**SCOTCH** Collie Pups; beautiful; pure bred, 8 wk. old. Males \$10, Females, \$8. Bowbells Collie Kennels, Bowbells, N. D.

**AIRDALE** pups, bred from the leaders in style and quality. Dr. Hoffman, Detroit, Minnesota.

**SCOTCH** Collie Dogs. Write for lists and prices. J. H. Autrobus, Toluca, Okla.

**REGISTERED** Dachshund Puppies. Alendale Farm Kennels, Lake Villa, Illinois.

**AIRDALE** pups for sale, pedigree, Dr. Borree, Maple Ridge, Mich.

**"ALL** About Eggs." New Book about making better hatches and stronger chicks, making hens lay more and regularly; preserving eggs absolutely fresh for higher price market; packing, shipping, marketing, etc. Free on request. Lee Complete Poultry Library (5 books) postpaid for 5 cents in stamps. Write today. Geo. H. Lee Co., Box 506, Omaha, Nebraska.

**BREED** Canaries. Profitable Pastime. Particulars Free. Bird Farm, Woodside, N. Y.

**RAISE** Guinea Pigs for us. We buy all you raise. Pay better than poultry. Contract, particulars, booklet how to raise free. Cavies Distributing Co., 707 W. 14th St., Kansas City, Mo.

**RAISE** skunks in city or country. Odorless method. Illustrated circular P free. Skunk Development Bureau, Chicago.

**SQUABS** are raised in one month, they sell for fancy prices. Write at once for big free book telling how to make money breeding squabs. Plymouth Rock Squab Co., 654 Howard St., Melrose Highlands, Massachusetts.

**LEADING** varieties Poultry. Eggs for hatching, stock for sale, prices reasonable. Catalogue free. H. P. Roth, Souderton, Pa.

**RAISE** Belgian Hares for us. Big profits. We furnish stock and pay you \$2.00 each. Also Cavies, mink, skunk, fox, squabs, frogs, etc. Two booklets and contract for dime. None free. Address the Belgian Hare, 31 Main Street, Holmes Park, Mo.

#### SEEDS, PLANTS, NURSERY STOCK

**GROW** Your Own Fruit. 5 peach, 3 apple, 2 cherry trees, 15 Concord grape vines. Assortment and instructions complete \$1.50 prepaid. Sample peach tree and complete price lists 10c. Barnes' Nurseries, College Hill, Cincinnati, Ohio.

#### MISCELLANEOUS

**BOYS, Clubs and Secret Organizations** use Cryptography. Write letters that cannot be read without key. Cipher and cipher-key to 1,000 secret writings, 25 cents. Wakeley's Cryptography, 67 Burton, Waterbury, Connecticut.

**PEARLS, Baroque, Slugs**—Bought and sold. Designing, Mounting, Repairing Jewelry done. Laverne Mapes, Indiana Harbor, Ind.

**MINERAL** Specimens and collections bought and sold. Specimens from 5c up. Send for list. Globe Mineral Co., Box 299, Beverly, N. J.

**YOUR** name and address stamped on key ring (with chain), also grip check—both for 25c, postpaid. Home Specialty Co., Box 172, Cleveland, Ohio.

**LUMINOUS** Paint. Shines like fire in the dark! Make your watches, clocks, electric switch plates, crucifixes, etc., visible at night. Latest discovery. Only 25c bottle. Circular free. (Agents wanted.) Luminous Paint Co., Douglas Park Station (R-8), Chicago, Ill.

**NEW** \$2.50 Automatic Adding Machine. Circular free. Bassett, 5921-H, Indiana Ave., Chicago.

**CASH** paid for butterflies, insects. Some \$1 to \$7 each. Easy work. Even two boys earned good money with mother's help and my pictures, descriptions, price list, and simple instructions on painless killing, etc. Send 2c stamp at once for prospectus. Sinclair, Box 214, D6, Los Angeles, Cal.

**SILVER** Powder—Silver plates without a battery. Price 25c. Pfeiffer, 509 N. Robey St., Chicago.

**MARK-O** Acid marks signature on tools. Complete outfit 50c. Mark-o Co., Box 15, St. Paul, Minn.

**SKELETON** key; unlocks most door locks, 10c. American Mantle Co., Anderson, Ind.

**HOW** to clean your gold jewelry for 10c. Box 431, Montessano, Wash.

**ESCAPE** King's trick set of Three Keys will open most ordinary doors. 25c complete set. Padlock Opener, 10c. Chicago Novelty Works, 3510 Herndon St., Chicago.

**MAKE** your own Printing Cuts. "Art of Cut-Making" tells how. 20c. C. Johnson, 4319 N. Whipple St., Chicago.

**5000** ENLISTMENTS wanted for war on flies. Join, learn and earn. Address, A. E. Chapman, Redlands, Calif.

**TATTOOING** Supplies. Write at once for my Catalogue. Don't be fooled by amateur manufacturers and imitators. Only reliable machines and outfits manufactured. Prof. J. Barber, 70 1/2 Brush St., Detroit, Mich.

**CUTS** anybody can make. Simple, cheap process. Specimens, particulars for stamp, M. Day, Windfall, Ind.

**C. S. A. MONEY.** I guarantee what I handle are not Reprints of Confederate Money. Write for price list. Frank Shilling, Navarre, Ohio.

**RUBBER** stamps, seals, adjustable stencils, metal badges. Catalogue 10c. Pecan nuts. Samples 10c. Walter Karstaedt, Dayton, Ohio.

**GRANDFATHER'S** Clocks. Build your own Grandfather's Clock with our free blue prints. Works, Dial, etc., \$5 and up. Others with chimes at all prices. Write for free offer. Clock Co., 1671 Buffum St., Philadelphia, Pa.

**500** FORMULAS, including Reilvering Mirrors—Renewing Dry Batteries, Luminous Paint, Luminous Ink, 25c. Ideal Book Shop, 3315-M4, Belleplaine Ave., Chicago.

**EVERYBODY** wants a musical clothes-brush. 25c postpaid. Freepost Supply House, Box 367, Freeport, Ill.

#### TOO LATE TO CLASSIFY

**MUST** Sell—10 acres, "Kingswood Irrigated Farms"; original cost \$1,250, now \$500; terms. Full particulars, Owner, Box 95, Carrizo, Texas.

# GOV'T JOBS OPEN

Railway Mail Clerks, City Carriers, Rural Carriers  
City Postal Clerks, Clerks at Washington, D. C.

\$800 TO \$2000 A YEAR, FOR LIFE

Rapid advancement to higher Government Positions. No "lay-offs" because of STRIKES, FINANCIAL FLURRIES or the WHIMS OF SOME PETTY BOSS. THE POSITION IS YOURS FOR LIFE.

Country residents and city residents stand the same chance for immediate appointment. Common-sense education sufficient. Political influence NOT REQUIRED.

Write immediately for schedule showing the places and dates of the coming examinations. Don't delay. Every day you lose means the loss of just so much coaching before these rapidly approaching examinations.

FRANKLIN INSTITUTE Dept. A96, Rochester, N. Y.

FRANKLIN INSTITUTE  
The Pathway to Plenty  
Dept. A96, Rochester, N. Y.

This coupon, filled out as directed, entitles the sender to free sample questions; a free copy of our copyrighted book, "Government Positions and How to Get Them," a full list of positions now obtainable and to consideration for Free Coaching for examination here checked.

#### COUPON

.. Railway Mail Clerk [\$800 to \$1800] .. Customs Positions [\$800 to \$1500]  
.. Postoffice Clerk [\$800 to \$1200] .. Internal Revenue [\$700 to \$1800]  
.. Postoffice Carrier [\$800 to \$1200] .. Stenographer [\$800 to \$1500]  
.. Rural Mail Carrier [\$400 to \$1200] .. Clerk in the Departments  
.. Bookkeeper [\$800 to \$1800] at Washington [\$800 to \$1500]

Name.....

Address..... A96

Use this before you lose it.

Write plainly.



# Men Mechanically Inclined

Are Successful in the Automobile and Tractor Business

The Sweeney System Teaches You This Business  
By the *Only Practical Method*

We Tell You and Show You—*You Do the Work*



## FIRST DRIVING LESSONS—A PART OF MY CARS

"When you were a boy in school," you remember your teacher used to make you prove all your problems in Arithmetic, and you had to understand the reason why you did, this or that, to get a certain result.

I use the same general plan in teaching you this business. When you are through my school you have proved you know the business and will wonder how you learned it all in such a short time and so easily. There is no guess work in the Sweeney System of teaching. You put your overalls on; forget that books were ever printed and dig in with a capable instructor at your elbow to first tell you, then show you, but you do the work.

My course gives you a thorough training in Blacksmithing and Forging (you make your own tools), Oxy-Acetylene welding, Vulcanizing, Machine Shop work, such as Lathe work, Gear cutting and Cylinder boring, also Babbitting and Soldering, Valve grinding and Piston ring fitting.

I pay particular attention to teaching you thoroughly about Self-Starters and I have every make, Storage Batteries and Carburetors. These are the most important parts of an Automobile and always cause the most trouble.

The training you have received in going through these departments comes in mighty handy, when you hit the Block Motor room. Here you have to work on nineteen different makes of engines, learn to time valves, adjust Carburetors, make your Electrical connections, and make them run.

This is a very interesting department and the boys hate to leave it, but they have to learn the construction of cars from tail light to bumper, so we shoot them to our Trouble Department where we have almost every kind of Car in all conditions, and you have to set them up and make them run properly. For example: today you will be fixing up a Ford, then a Franklyn, etc. I have tried to get cars, each entirely different in principle and construction, so you will have the best possible experience. Now, naturally you think you are some automobile man, but for your own good I want you to prove it.

E. J. SWEENEY,  
President

**Sweeney Automobile School**

*Largest and Best Equipped in the World*

1220 E. 15th St.,  
KANSAS CITY, MO.

I have the biggest garage in Kansas City and the only one in the country run entirely by students and without employing outside help. I send you down there and give you just the same kind of work you would do if you were in your own garage or working for somebody. I have all kind of cars coming in and they sure hand me some cripples. This is the final proof, if you can do the work, and 86% of my students can, you can truthfully say you have learned the business.

The Tractor industry will soon rival the Automobile and on my Tractor farm and in my Factory (you know I make the Famous Sweeney Iron Horse) you get the experience needed to teach you this important business; you help me assemble machines and test them and besides I have nine of the most popular makes of Tractors on my farm. I will give you this training absolutely free for a short time.

In taking my course you are working in a big and completely equipped school, in fact I had the first eight cylinder car owned by any school; the first twelve cylinder, and I know I have the only Owen Magnetic (the car with a thousand speeds) owned by any school.

If you are mechanically inclined and enjoy working around machinery the Automobile and Tractor business offers you pleasanter work and bigger pay than any business in the world.

The reason my school is so large, is solely on account of the success of my students. 70% of my present Students come to my School on the recommendation of my former Students.

If you are ambitious and realize the possibilities of this business, drop me a postal card and I will send you my 72-page catalogue, explaining the Sweeney System and showing pictures of all Departments and equipment, and the Students at work.



# Free Test Lesson

**Wonderful  
Opportunity for Every Ambitious  
Man To Decide Whether or Not To—**

## Be A Draftsman!



Charles W. Morey  
Pres. of the College  
and Head of a Large  
Chicago Firm of Engi-  
neers and Contractors

Here is, without doubt, the most wonderful offer ever made by a Correspondence or Home Study Institution of any kind. Just think of it! We positively will send you a **Free Test Lesson in Draftsmanship** without any obligation on your part whatever. Just

the coupon brings you **Free Test Lesson**. We don't even ask you to pay postage. We do that.

We send you this **Free Test Lesson** at our expense simply because we want you to see for yourself that the Chicago "Tech" Course in Draftsmanship is the most practical, simplest and easiest to master of any course ever written on the subject. This **Free Test Lesson** also positively proves that our Course will fit you for a Draftsman's position in the shortest possible time. It will prove that our

Course will give you the practical knowledge necessary to make you an expert in any branch—Architectural, Structural, Machine Drafting or in the Building Line. It will prove to you that in Draftsmanship lies your future.

### Investigate

If you are wide awake to the possibilities of Draftsmanship as a profession—if you are ambitious—you will at once send coupon for this **Free Test Lesson** and investigate the great future for you in this Big Income Paying Profession.

At present, thousands of Draftsmen are needed in all branches. The demand is increasing every day. The wonderful boom in all businesses in this country has created positions for more trained Draftsmen than can be recruited from the ranks for years to come. Our Special Training is the short cut that brings you to the top quickly. If you start NOW—in a comparatively short time you will be qualified to step into these big paying positions and

## Free



Complete Drawing Outfit  
and Full Instructions  
In Mechanical Drawing  
Sent FREE  
on Enrollment

### See for Yourself

This Free Lesson is an absolute test, pure and simple. Send for it today. In the privacy of your home study it, then you will know for yourself whether you are proper material for a successful Draftsman. Other institutions will ask for your money first. You find out later at your own expense, whether you can adapt yourself to the work and succeed in this profession.

We do not charge you one cent for the Test Lesson, either now or later. It is absolutely FREE. Nor do we obligate you in any way whatever by writing for the Free Test Lesson, so send coupon or write postal request today. If you do nothing else but secure the **Free Test Lesson** you will gain such valuable knowledge as will be beneficial to you through life, for the Free Lesson gives the very fundamentals of draftsmanship which are helpful to every man.

## Earn \$25 to \$100 a Week and More

You can do it—with our help. We have successfully trained thousands of ambitious men—fitted them to qualify and hold the best positions in the business. Some of these men attended our school in Chicago—others learned at home—in spare time, evenings, through our simplified, new Correspondence Method. What we have done for these men we will do for you. No special advance training is necessary. The only qualifications you need possess are the ability to read and write. It will pay you to investigate. It means a big future—Independence, prosperity, happiness for you.

**CHICAGO TECHNICAL COLLEGE**  
1026 Lake View Building, Chicago, Ill.

### MAIL THIS COUPON

**CHICAGO TECHNICAL COLLEGE,**

1026 Lake View Building, Chicago

Without obligation to me, please send me your FREE Test Lesson in Draftsmanship and other interesting literature covering the subject indicated below.

Mark X opposite work in which you are specially interested.

Architectural Drafting.	Building Superintendence.
Builder's Course.	Structural Steel Drafting.
Estimating.	Sheet Metal Drafting.
Plan Reading.	Reinforced Concrete.
House Planning.	Machine Drafting.
General Contracting.	Surveying.

Name.....

Address.....

City.....State.....

Please Mention Popular Mechanics





## "You Get The Job"

"We've been watching you, young man, and we know you're made of the stuff that wins. The man that cares enough about his future to study an I. C. S. course in his spare time is the kind we want for responsible positions. You're getting your promotion on what you *know*, and I wish we had more like you."

The boss can't take chances. When he has a responsible job to fill, he picks a man *trained* to hold it. He's watching YOU right now, hoping you'll be ready when your opportunity comes.

Start today and train yourself to do some one thing better than others. You can do it in spare time through the International Correspondence Schools. Over 5,000 men reported advancement last year as a result of their I. C. S. training.

The first step those men took was to mark and mail this coupon. Make your start the same way—right now.

TEAR OUT HERE

## INTERNATIONAL CORRESPONDENCE SCHOOLS

Box 5568, Scranton, Pa.

Explain fully about your Course in the subject marked X:

- |   |   |                                       |
|---|---|---------------------------------------|
| <input type="checkbox"/> Civil Engineering      | <input type="checkbox"/> ADVERTISING      | <input type="checkbox"/> CHEMISTRY    |
| <input type="checkbox"/> Electrical             | <input type="checkbox"/> Salesmanship     | <input type="checkbox"/> Illustrating |
| <input type="checkbox"/> Steam                  | <input type="checkbox"/> Commercial Law   | <input type="checkbox"/> Farming      |
| <input type="checkbox"/> Mining                 | <input type="checkbox"/> Bookkeeping      | <input type="checkbox"/> Poultry      |
| <input type="checkbox"/> Mechanical             | <input type="checkbox"/> Stenography      | <input type="checkbox"/> French       |
| <input type="checkbox"/> Mechanical Drafting    | <input type="checkbox"/> Civil Service    | <input type="checkbox"/> German       |
| <input type="checkbox"/> Architectural Drafting | <input type="checkbox"/> Ry. Mail Service | <input type="checkbox"/> Italian      |
| <input type="checkbox"/> ARCHITECTURE           | <input type="checkbox"/> AUTOMOBILES      | <input type="checkbox"/> SPANISH      |

Name \_\_\_\_\_

Address \_\_\_\_\_

Mr. A. E. Patterson, whose advertisement appears below, was for eight years a Civil Service Secretary-Examiner, and is well qualified to help YOU secure a Government Position.

## FREE BOOK OF GOV'T POSITIONS

Earn \$75 to \$150 a Month



WRITE TODAY

Be a Railway Mail Clerk, Post Office Clerk or Carrier, Rural Mail Carrier, Internal Revenue Officer, Clerk at Washington, D. C., or Panama Canal, or accept any other good Civil Service position with Uncle Sam, world's greatest and best employer.

Good Pay, Easy Work, Vacations, Position for Life

Earn \$75 to \$150 a month from the start. Rapid advancement. Work 8 hours or less a day. 15 to 30 days vacation with full pay. No Sirikes, no "lay-offs," no "straw bosses." No politics, no "pull" needed. Ordinary education sufficient. American citizens 18 or over WANTED.

PATTERSON PREPARES YOU

Only school offering help of former Civil Service Sec'y-Examiner. Quick appointment certain. Sure position or no pay. Send coupon or postal NOW for book free.

**FREE!** Tells what positions are open. How to prepare easily and quickly for job you like best. Don't be satisfied with small pay, uncertain job. Write for book of Uncle Sam's positions and get on easy street. Mail coupon or postal NOW. Address \_\_\_\_\_

\*\*\*\*\*COUPON\*\*\*\*\*  
Send me Free Book of Government Positions.

Name \_\_\_\_\_

Address \_\_\_\_\_

PATTERSON CIVIL SERVICE SCHOOL  
84 News Bldg., Rochester, New York

## Are You Interested In

### Automobiles-Driving? Motoring-Repairing?

THIS ROSE GOLD FINISHED FOB



Do you drive and take care of your own car? Are you an expert Auto Mechanic? Are you going to buy a car soon? Are you in the repair business? No matter what interest you have in Automobiles, **THE AMERICAN CHAUFFEUR**, "America's Greatest Monthly Auto Paper," gives pointers and information each month that will

### Save Several \$100 Yearly

in operation, upkeep and repairs. It's the clearing house for money-making and money-saving ideas not published elsewhere. It is written in common-sense language, explains clearly how to adjust valves, magnets, carburetors, etc., tells how to have repairs made at a saving. Technical knowledge told so you can understand.

### FREE FOB Special OFFER

Originally designed Auto Watch Fob, real rose gold finish with seal Grain-Leather Strap (like illustration, 5 inches long.)

**ACT QUICKLY, NOW.** Send 25 cents in stamps or coin for 3 month's subscription to the **American Chauffeur** and we will send you the above fob absolutely Free. Your money back if you are not satisfied.

The American Chauffeur Pub. Co.  
84 Butler Bldg., Cincinnati, Ohio

## ELECTRICAL ENGINEERING

men with training are always in demand. Having trained over 2000 young men in the past 23 years in the fundamentals of Applied Electricity, **The Miles Electrical School**, with its well-equipped shops and laboratories, is peculiarly well qualified to give a condensed course in Electrical



including Mathematics, Steam and Gas Engines, Mechanical Drawing, Shop Work, and Theoretical and Practical Electricity, in all branches. Students actually construct dynamos, install wiring and test efficiency of electrical machinery. Course, with diploma, complete

## IN ONE YEAR

For practical young men with limited time. 25th year opens Sept. 25th. Catalogue on request, 104 Takoma Ave., Washington, D. C.

## \$50 FOR ONE DRAWING PAID

Illustrators—Cartoonists—Commercial Artists make big money. Learn NOW at home in spare time by our new instruction method. Handsome free booklet explains everything. Write for it today. Get our Special Free Offer. **WASHINGTON SCHOOL OF ART** 1005 H St., N. W. WASHINGTON, D. C.



## Cornet Free!

We guarantee to teach you to play by mail, and will give you a Beautiful Cornet or any brass Band Instrument absolutely FREE. You pay weekly as lessons are taken. Instrument is sent with first lesson. Graduates in every state. Hundreds of enthusiastic testimonials. Write to-day for our booklet and wonderful tuition offer.



INTERNATIONAL CORNET SCHOOL, 637 Music Hall, BOSTON, MASS.

## Be an Artist

Comics, Cartoons, Commercial-Newsprint and Magazine Illustrating. Pastel and Crayon Portraits. Earn \$25 to \$200 a week. By our simple method your talent is quickly developed without interfering with present work. **By Mail or Local Classes.** Small sums you now fritter away pay your tuition. Write for terms, list of successful pupils and instruction method FREE. **ASSOCIATED ART STUDIOS, 2203 Flatiron Building, New York**

## SPEAK A FOREIGN LANGUAGE!!!

The War has created unlimited opportunities for those who know Spanish, French, German or Italian. Better your position or increase your business. You can learn quickly and easily, at home, during spare moments, by the

### LANGUAGE-PHONE METHOD

And Rosenthal's Practical Linguistry (Highest Award Panama-Pacific Exposition, 1915)

You listen to the living voice of a native professor pronounce the foreign language, over and over, until you know it. Our records do all talking machine. Write for booklet, particulars of Free Trial. The Language-Phone Method, 951 Putnam Bldg., 2 W. 45th St., N.Y.



Please Mention Popular Mechanics



# Don't Envy Successful Men Be One!



## BE AN EXPERT ACCOUNTANT

500,000 Firms Need Them—Only 2,000 in America

Today, in America alone, there are over 500,000 large firms that need annual or semi-annual audits. In every large city there are hundreds of openings for trained accountants. As there are only about 2,000 certified public accountants in America, the demand far exceeds the supply. For this reason the incomes and salaries paid are good. Just as soon as you complete the LaSalle Course, your chances for obtaining immediate employment will be excellent—no weeks or months hunting for a job—the position will seek you. If you complete the course with satisfactory grades you will be fully qualified for one of these positions.

**We Will Train and Coach You In Your Home—By Mail—In Your Spare Time**

Hold your present position. Earn while you learn. Study when you feel most like it. Advance as rapidly or as slowly as you desire. Study a little every day in your leisure time—part of which is now wasted. You can complete our entire course, become a master accountant—in less time than any other because our system will teach you the "working-knacks" and "short-cuts" employed by experts. In this our course differs from all others.

**Quit—The "Shirt Sleeve" Class** Why "grind" along, day after day, with the other untrained "help" waiting for a raise that may not come—and will be small even if it does? Determine to get out of the "shirt-sleeve" class. Resolve to bid goodby forever to hard work, long hours, and low wages. Decide to become a trained accountant—to direct others—and to draw a "man's" salary.

**Choose Your Future Today**—The first thing to do is to mail the coupon. If you don't do it today the chances are you never will. Quit dreaming—act. Write your name and address on Coupon. Mail it. We will send you by return mail the **Free Booklet**: "Ten Years' Promotion in One," also complete information concerning the course and 112 page catalog which explains state examinations, salaries, etc.

### La Salle Special Guarantee

We give the student a written agreement signed by our Treasurer, that if the student completes the course with satisfactory grades, and fails to pass the Certified Public Accountants examination held in any state, we will give him special instructions and help—without additional charge—until he does pass.

**La Salle Extension University, Dept. 464-H, Chicago**  
"The World's Greatest Extension University"

**Under Personal Supervision of William Arthur Chase, C. P. A.**

You will receive your training under the direct personal supervision of William Arthur Chase, an accountant of National prominence, who is Ex-Secretary of Illinois State Board of Examiners in Accountancy.

**The Course** was prepared by some of the world's most noted accountancy experts. It fully covers the field—Theory of Accounts—Practical Accounting—Cost Accounting—Auditing—Business Law, etc. It will prepare you for the C. P. A. Examination in any state.

**The WAGES**  
Of Bookkeepers, Clerks and other untrained help is from \$12 to \$20 a Week

As long as you neglect to obtain special training you will belong to this class. You will be one of the "help." You must keep your nose on the grindstone. You can't demand a raise because hundreds of men are waiting to take your job—and for less money. No matter how honest or how faithful you are—or how hard you work—the wages will be not more than \$20 a week. That is the limit—you can take it or leave it. If you want more salary you must obtain special training—there is no other way. Why work hard for wages of from \$12 to \$20 a week when you can become a **Trained Accountant** and draw a real salary instead of mere living expenses.

**The SALARY**  
Of Many Trained Accountants is from \$3,000 to \$10,000 a Year and up.

Trained accountants get large salaries because there are only a few hundred of them—while thousands of firms need them. For this reason an expert can demand and get his pay. Then why don't you become a trained accountant? It is not very difficult, after all. The La Salle System will make it easy for you. Our course is written in a clear and simple manner. Everything is fully explained. You cannot help but learn. Under the personal supervision of our instructors—and the coaching of our experts—you will soon be qualified to earn a good salary. With our help—if you have average intelligence, and are determined—failure is impossible.

**La Salle Extension University**  
Dept. 464-H Chicago, Ill.

Send at once your free Book "Ten Years' Promotion in One" and Catalog of your Course in Higher Accountancy and C. P. A. training. I am obligated in no way.

Name.....

Street No.....

City..... State.....

Please Mention Popular Mechanics



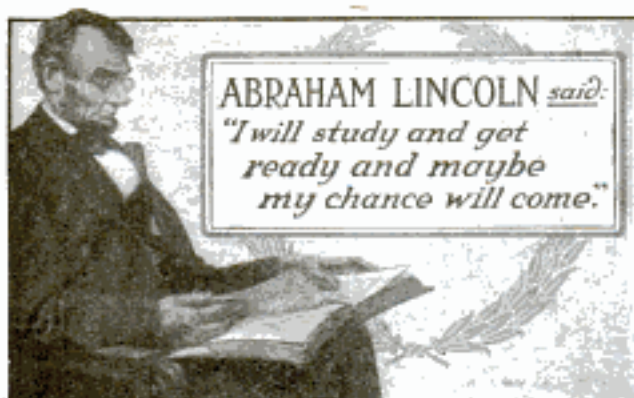

ABRAHAM LINCOLN *said*:  
*"I will study and get  
 ready and maybe  
 my chance will come."*

## YOUR Chance Will Come

Born in a log cabin, Abraham Lincoln had little chance to acquire an education. But he was determined to succeed. "Some day," he said, "my chance *will* come." So he studied and got ready. And his chance *DID* come.

Your chance will come. Some day you'll be considered for promotion or for a good job in some other line of work. If you are ready, you'll go up.

And you *CAN* get ready. No matter if your schooling was limited—if you do have to work long hours. If you really want a better job, the International Correspondence Schools can train you for it at home during your spare time.

Every month more than 400 I. C. S. Students voluntarily report promotions or salary increases due to I. C. S. help. What the I. C. S. have done for these men they can do for YOU. Mark and mail the coupon NOW.

INTERNATIONAL CORRESPONDENCE SCHOOLS, Box 5565, Scranton, Pa.

TEAR OUT HERE

### INTERNATIONAL CORRESPONDENCE SCHOOLS BOX 5565, SCRANTON, PA.

Explain, without obligating me, how I can qualify for the position, or in the subject, before which I mark X.

- |  |   |
|--|---|
| <input type="checkbox"/> ADVERTISING MAN             | <input type="checkbox"/> ELECTRICAL ENGINEER        |
| <input type="checkbox"/> Salesmanship                | <input type="checkbox"/> Electric Lighting          |
| <input type="checkbox"/> Commercial Law              | <input type="checkbox"/> Electric Car Running       |
| <input type="checkbox"/> BUSINESS (Complete)         | <input type="checkbox"/> Electric Wiring            |
| <input type="checkbox"/> Certified Public Accountant | <input type="checkbox"/> Telegraph Expert           |
| <input type="checkbox"/> Higher Accounting           | <input type="checkbox"/> Practical Telephony        |
| <input type="checkbox"/> Bookkeeper                  | <input type="checkbox"/> Railroad                   |
| <input type="checkbox"/> Stenographer and Typist     | <input type="checkbox"/> Mine Foreman or Engineer   |
| <input type="checkbox"/> Railway Accountant          | <input type="checkbox"/> Metallurgist or Prospector |
| <input type="checkbox"/> WINDOW TRIMMER              | <input type="checkbox"/> ARCHITECT                  |
| <input type="checkbox"/> Show Card Writer            | <input type="checkbox"/> Contractor and Builder     |
| <input type="checkbox"/> Outdoor Sign Painter        | <input type="checkbox"/> Architectural Draftsman    |
| <input type="checkbox"/> Common School Subjects      | <input type="checkbox"/> Concrete Builder           |
| <input type="checkbox"/> Good English                | <input type="checkbox"/> Structural Engineer        |
| <input type="checkbox"/> Teacher                     | <input type="checkbox"/> Plumbing and Heating       |
| <input type="checkbox"/> Civil Service               | <input type="checkbox"/> Sheet Metal Worker         |
| <input type="checkbox"/> Railway Mail Clerk          | <input type="checkbox"/> CHEMICAL ENGINEER          |
| <input type="checkbox"/> CIVIL ENGINEER              | <input type="checkbox"/> Illustrator                |
| <input type="checkbox"/> Surveying and Mapping       | <input type="checkbox"/> Designer                   |
| <input type="checkbox"/> MECHANICAL ENGINEER         | <input type="checkbox"/> Textile Overseer or Supt.  |
| <input type="checkbox"/> Mechanical Draftsman        | <input type="checkbox"/> AGRICULTURE                |
| <input type="checkbox"/> Machine Shop Practice       | <input type="checkbox"/> Navigator                  |
| <input type="checkbox"/> Stationary Engineer         | <input type="checkbox"/> Poultry Raising            |
| <input type="checkbox"/> Gas Engineer                | <input type="checkbox"/> AUTOMOBILES                |

Name \_\_\_\_\_  
 Present Occupation \_\_\_\_\_  
 Street and No. \_\_\_\_\_  
 City \_\_\_\_\_ State \_\_\_\_\_

If name of Course you want is not in this list, write it below.

Please Mention Popular Mechanics

# Be a Commercial Engineer

Unparalleled Opportunities for Big-Paying Positions  
in a Field That is Crying for Trained Men—

## LEARN WHILE YOU EARN

Commercial Engineering is a profession that is demanding ambitious young men with combined *technical* and *commercial* training. To meet this demand, leading electrical and engineering concerns have induced us to offer a 2-year Course in Commercial Engineering to students who have credits in algebra and plane geometry, or a 2½-year course to students with a common-school education. Large Milwaukee concerns will give *part-time employment* to students at good wages while acquiring this technical training, and provide *permanent positions* to all *duly qualified graduates*. Enter at Any Time.

WRITE FOR FURTHER INFORMATION

SCHOOL OF ENGINEERING of MILWAUKEE, 312 Stroh Building, Milwaukee, Wis.



THIS JOB PAYS  
\$25-\$50 Weekly

## IN 10 WEEKS' SPARE TIME

We can teach you the entire subject at your own home and help you to get a good position. ONE MILLION AUTOMOBILES will be built this year. The demand for trained help next spring will be tremendous. Sample Lessons Free — Write for Them Today (Owners—we supply competent men.)

Franklin Auto Institute, Dept. A802, Rochester, N. Y.

## STUDY LAW 30 Days FREE

Let us prove to your entire satisfaction, at our expense, that the Hamilton College of Law is the only recognized resident law school in U. S., Conferring Degree of Bachelor of Laws—LL. B.—by correspondence. Only law school in U. S. conducting standard resident school and giving same instruction, by mail. Over 500 class-room lectures. Faculty of over 30 prominent lawyers. Guarantee to prepare graduates to pass bar examination. Only law school giving Complete Course in Oratory and Public Speaking. School highly endorsed and recommended by Gov. Officials, Business Men, Noted Lawyers and Students. Send today for Large Handsomely Illustrated Prospectus and Special 30-Day Free Trial.

HAMILTON COLLEGE OF LAW, 1255 Advertising Bldg., Chicago, Ill.

## Be a Finger Print Expert



Police departments, factories and industries everywhere are adopting this system of identification. Experts needed at once. You can train yourself in spare time at home. Write for details.

Free Book—Write Valuable and interesting book on finger prints sent absolutely free and prepaid. Also details of special limited offer. Write at once, while this offer lasts.

EVANS UNIVERSITY, FINGER PRINT DEPT.  
Desk 9194, 1810 Wilson Avenue, CHICAGO



## This Man Specialized in Electrical Meter Engineering!

Now he is superintendent of instruments and meters for a large Electric Light and Power Co. and has 25 men under him. The training he got from our easily mastered, home study course enabled him to step into this big job after only a few months study. What he has done YOU CAN DO!

Write Today for Free Literature with this man's own story of his success. Find out about the exceptional opportunities in this interesting, fascinating, profitable profession. Your name and address is enough. The book is free. No obligations. Write today—NOW. You can have a job like this.

Fort Wayne Correspondence School, Dept. 1194, Fort Wayne, Ind.



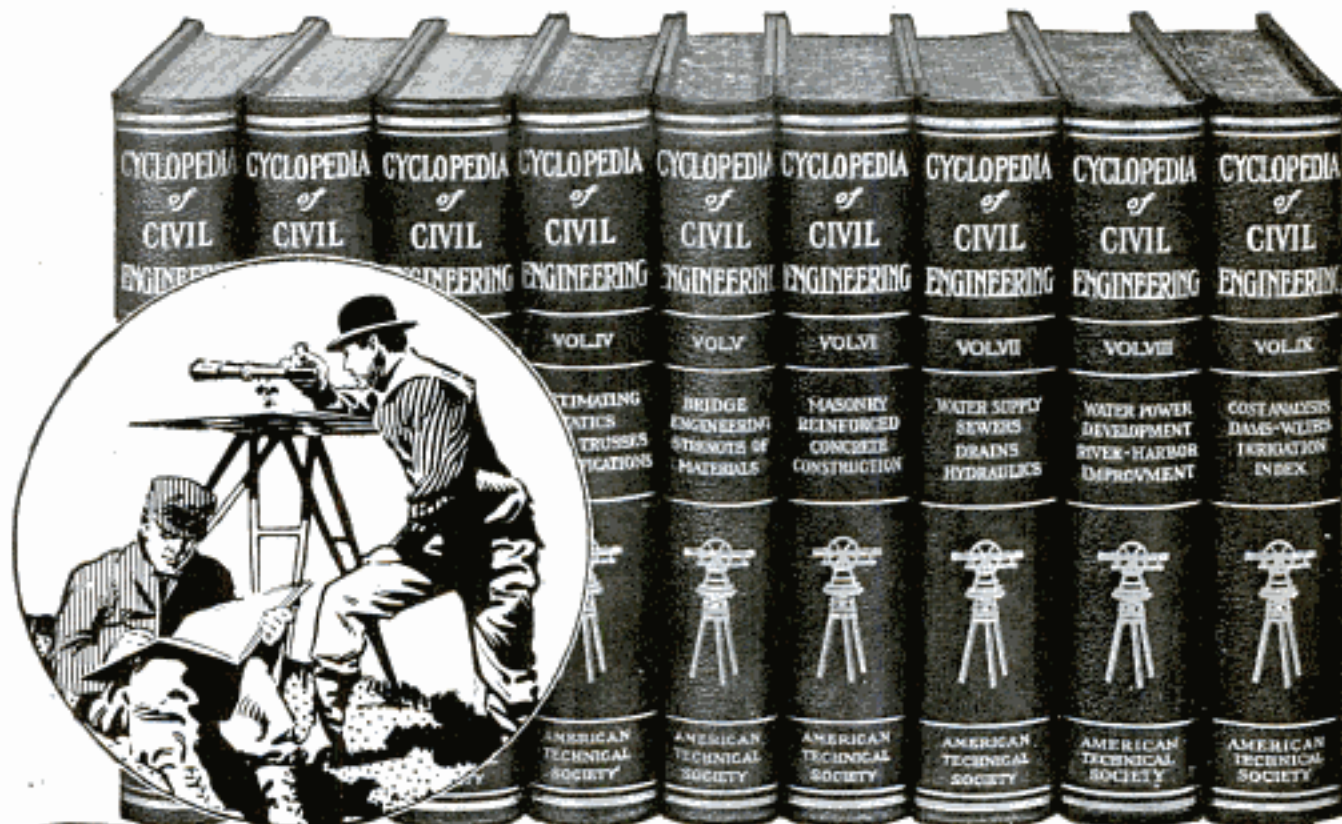

# Civil Engineers Earn \$1500 to \$5000 a Year!

**D**ON'T take our word for it that these books will fit you to earn \$1500 to \$5000 a year as a Civil Engineer. Get them into your home—free of all charges—and determine their value for yourself. The books themselves, not what we say, must convince you that you need them. Send the coupon now for your free-for-examination set of the brand-new Cyclopedia of Civil Engineering. The demand for Civil Engineers was never greater than today. The enormous development of reinforced concrete construction insures steady employment at big pay to thousands of trained men. The nine thick volumes illustrated above will give you the knowledge you need to qualify for one of these jobs. Send for them today.

**50c a Week** This trivial sum—less than most of us pay for tobacco—will soon pay the low introductory price of the Cyclopedia of Civil Engineering. But you must act now! This liberal offer can't be continued indefinitely, so mail the coupon while you can buy this valuable set at a great reduction—and on the easiest of easy-payment plans.

## Use Them 7 Days!

The entire nine volumes will be sent to you by prepaid express for seven days' free examination. Don't send a penny—just the coupon! The books are handsomely bound in half red morocco leather, gold stamped, and contain 3900 7 x 10-inch pages and 3000 illustrations, plates, maps, diagrams, etc.

These big, thick volumes contain everything you need to know to become a successful Civil Engineer. They cover surveying, highway construction, railway engineering, earthwork, specifications, estimating, contracts, bridge engineering, masonry, reinforced concrete, water supply, sewers and drains, water power equipment, river and harbor improvements, irrigation engineering, etc., etc. Every line is written in plain, simple English. Every technical point is made perfectly clear.

## Don't Send a Penny—Just the Coupon!

All you need to do to get the Cyclopedia of Civil Engineering is fill in and mail the coupon. Then the entire nine-volume set will come to you by prepaid express for a full week's examination. If you keep it, send only \$2.00 within seven days, and then \$2.00 a month—50c a week—until the introductory price of \$29.80 has been paid. This is \$15.30 less than the regular price of \$45. If you don't want the books, send them back at our expense and you won't be out a penny.

This is a remarkable opportunity to prepare yourself—in your spare time—for the fascinating, highly-paid work of a Civil Engineer. If you live within the borders of the United States and Canada, fill in and mail the coupon today—now!

**American Technical Society, Dept. C1194, Chicago, U. S. A.**

## Free Consulting Service

With each set of this new Cyclopedia we give without charge a year's Consulting Membership in the American Technical Society. This entitles you to the privilege of submitting your perplexing problems to our corps of Civil Engineers. Such a membership regularly costs \$12.00, but in connection with this special offer you don't pay a cent for it. Remember, this service is absolutely unlimited. Ask as many questions as you wish for an entire year. Send the coupon now—see for yourself what this opportunity means to you.

**American Technical Society  
Dept. C1194, Chicago, U. S. A.**

Please send me the nine volume set of Cyclopedia of Civil Engineering for seven days' free examination. If I decide to buy, I will send \$2.00 within seven days and the balance at \$2.00 a month until \$29.80 has been paid. Then you send me a receipt showing that the set of books and the \$12.00 consulting membership are mine and fully paid for. If I think that I can get along without the books after the seven days' trial I will return them at your expense.

Name.....

Address.....

Reference.....







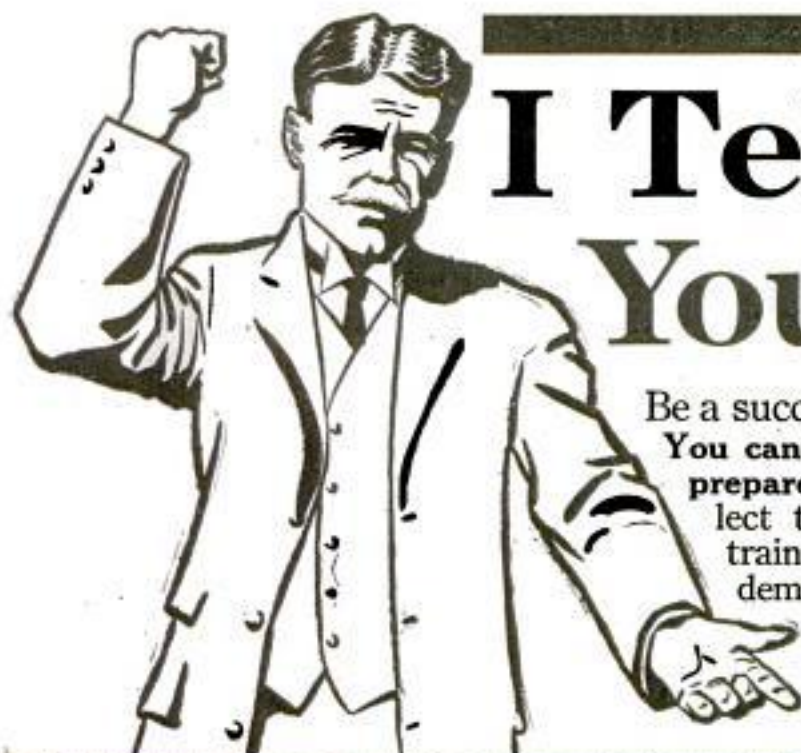

# I Tell You You Can!

Be a success and command big pay. You can easily do it if you will **only prepare yourself!** Why will men neglect to prepare themselves, when trained **electricians** are always in demand at big pay? When employers are **searching** for \$3,000 and \$10,000 men, while this country is crowded with poorly-paid men who could easily qualify for these positions!

## \$50 to \$200 a Week

As a Trained

# ELECTRICIAN

If you have a common school education **you can** easily qualify **at home** by my new Course in Electricity, no matter if you know nothing at all about electricity now. My Course, while complete and absolutely scientific, explains everything so clearly that any one can understand it and do the work. But this Course is designed to give you a **real** electrical education, to help men become **bigger, better men**—men who can command big pay.

And remember, I give every student a **GUARANTEE BOND** which insures you satisfaction or every dollar of your money refunded. **We can make** such a guarantee because we know our Course and what it does for our students. Send for free illustrated book telling all about it. **PART OF YOUR SPARE TIME** devoted to this interesting work is all that is needed. You will find it most fascinating, and in a short time your earning power will be greatly increased.

## \$17<sup>00</sup> Electrical Outfit Free:

Every student who enrolls with me now gets a \$17.00 outfit of electrical equipment, instruments and material—**FREE**; also my Quick Money-Making Electrical Course **FREE** as soon as enrolled, so you can earn while learning; you also get **FREE** Employment Service; **FREE** \$100 Scholarship opportunity; **FREE** 5-year Advisory Service. And besides all this I have a pleasant and **truly valuable surprise, FREE**, for every student who answers this ad. Send in the coupon now.

**You have one life to live**—and time is passing. Make the most of it. Prepare for success. Aim high; you can hit the mark if you will only **try**. **Do it! Tear off the coupon now!**

### CHIEF ENGINEER

Chicago Engineering Works  
439 Cass St., Dept. 14, CHICAGO, ILL.

Dept.  
14  
CHIEF  
ENGINEER  
Chicago Engineering Works  
439 Cass St.  
Chicago, Illinois

Without obligation on my part kindly send at once, fully prepaid, particulars of your complete Practical Home Study Course in Electricity.

**USE THIS FREE "OUTFIT" COUPON**

Name .....

Address .....

Town .....

State .....



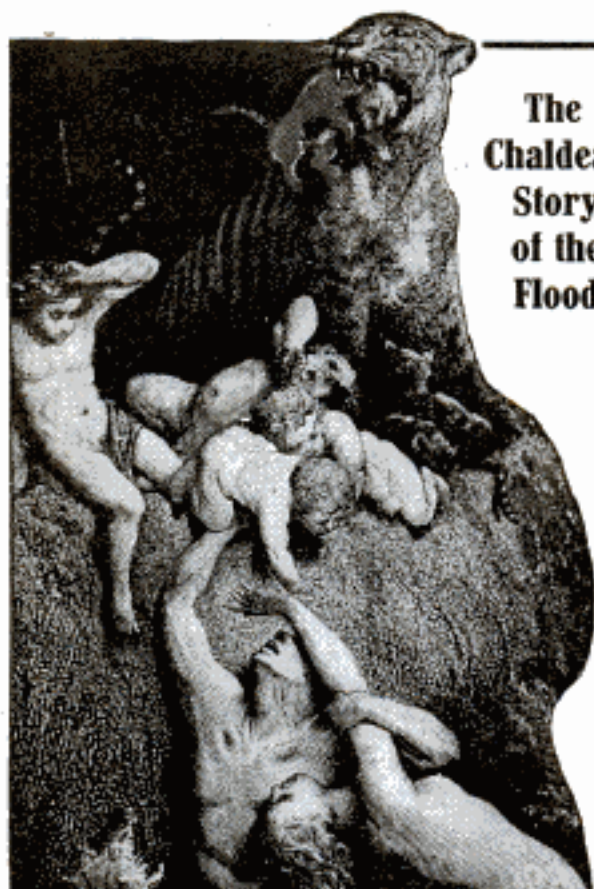

## The Chaldean Story of the Flood

### Dug Up from the Ruins of Ancient Chaldea

**DO YOU KNOW** that there has been dug up from the ruins of old Chaldea a complete story of the Flood—the same in every detail as Moses' account in Genesis—and that it was written thousands of years before his version appeared? Hardly one in a million has ever had an opportunity of seeing this startling story—**HAVE YOU?** But it is one of the many thousand curiously interesting accounts in

## The Library of Original Sources

now for the first time available to the general public. By purchasing the entire unsold edition from the publishers we secured it at an **absolutely unheard of reduction**. We offer a few sets to Popular Mechanics readers at a

**GREAT BARGAIN** Send us the attached coupon **AT ONCE**, and we will tell you how to get the Library on **EASY MONTHLY PAYMENTS**, and mail you **FREE** a book of rare documents showing curious inscriptions of the Ancients. Act quickly. Mail the coupon **NOW**. The book is **FREE**.

**OVER 100 RESEARCH SPECIALISTS** spent 10 years gathering the contents of this great work. Ancient and remote civilizations in all parts of the globe, age-buried hieroglyphics on monuments, tablets and sun-baked bricks yielded their secrets; untiring workers ransacked the hidden literature of every age to find these "original documents." Nothing like it has ever been attempted or thought of before. You'll be amazed at the wealth of information this unique library contains.

**MAIL THIS COUPON FOR FREE BOOK**

**UNIVERSITY RESEARCH, Dept. G, P. M. 4-17 Milwaukee, Wis.**

Send me the **FREE** book of rare documents showing inscriptions of the Ancients and tell me of your easy payment offer. I assume no obligation; the book and all you send me is to be **free**, and no salesman is to call.

Name .....

Address .....

## The 1917 Book

### ABOUT MOTOR CARS

This very latest authoritative book gives ALL the information in 16 easy lessons.

### The Automobile Instructor

By Clyde H. Pratt, B. Sc., M. E., Member Nat'l Society of Auto Engineers. 166 pages, 210 illustrations, cloth bound. Shipping wt., 22 oz.

**New 1917 edition out Jan. 3.** The standard work for home-study, class-room and reference, for amateur and expert. A complete course for all who desire to master this profitable profession.

### LEARN AT HOME HOW TO DRIVE AND REPAIR ALL CARS

Invaluable pointers for every car owner, driver, garage man and repair man. **Adopted by Cleveland and other Auto Schools and by Boards of Education as their standard text-book.** The author will answer your auto inquiries. **FREE.** This book is guaranteed to be just what you want or your money back. (Auto schools, write for quantity prices.)

Price, postpaid . . . . . \$1.50

**Shrewesbury Publishing Co. CHICAGO, U. S. A.**

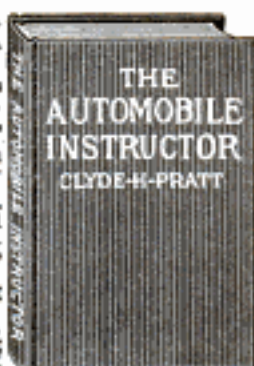

**Motor Craft Encyclopedia Illustrated.** Tells how to build and operate Motor Boats. Best book on boats. Price, \$1.00.

**5525 South Boulevard CHICAGO, U. S. A.**

## A CLEAR TRACK TO

**SUCCESS**

## FOR THE TRAFFIC INSPECTOR

Learn this new profession in 3 to 4 months with our complete course. Prepare for big pay—promotion—**success**. Railroads everywhere are watching for good traffic inspectors. The training obtained in this work leads to sure opportunities for advancement.

### Get Ready for the Success that Awaits You

Earn big pay with short hours. Travel at no expense. Our Employment Bureau helps successful graduates obtain positions. Write now for Booklet G2, giving full information.

**FRONTIER PREP. SCHOOL, BUFFALO, N. Y.**

## LEARN RAG TIME

Let me teach you Rag-Time Piano Playing by Mail. You learn easily—in just a few lessons, at home. My system is so simple you'll play a real ragtime piece at your 5th lesson. Whether you can play now, or not, I'll teach you to play anything in happy ragtime. "**Money Back Guarantee.**" Write at once for special low terms and testimonials.

**AXEL CHRISTENSEN, "Czar of Ragtime,"**  
20 E. Jackson Blvd., Dept. D10, CHICAGO, ILL.



## Learn Mechanics of Aviation

Write today. See how you can learn the principles of Aeronautical Construction and Engineering in your spare time at home. Save all the time and expense of laborious field training. Big opportunities now for trained Aviation Experts in different branches of the service. \$50.00 to \$250.00 a week.

**Write At Once!** Big tuition reduction offer now open. Write for details while this offer lasts. No obligations.  
**American School of Aviation, Dept. 1794 431 S. Dearborn St., Chicago, Ill.**



## Learn How to WRESTLE

In Your Own Home  
By Mail

Yes, learn to become an expert wrestler, her right in your own home, by mail, from the greatest wrestler the world has ever known. Be an athlete, be strong, be healthy. Learn how to throw and handle big men with ease. Learn to defend yourself. All taught in our course of lessons, and illustrated with hundreds of charts and actual photographs by

### Farmer Burns and Frank Gotch

Farmer Burns, "the grand old man of the mat," taught Frank Gotch, the present World's Champion, all he knows about wrestling, so Gotch says. He will now teach you Scientific Wrestling—Physical Culture—Jiu-Jitsu—Self Defense. Every man and boy in America, no difference what age, needs this wonderful course of lessons. Write today—your name, age and address on a postcard or letter brings you our free book absolutely free—no obligations of any kind. A splendid book on wrestling and physical culture. Write today stating your age.

**Farmer Burns School of Wrestling, 1194 Range Bldg., Omaha**





# Twenty Famous Lessons

(PROF. THERON Q. DUMONT'S COMPLETE COURSE)

# In Concentration Sent

# FREE

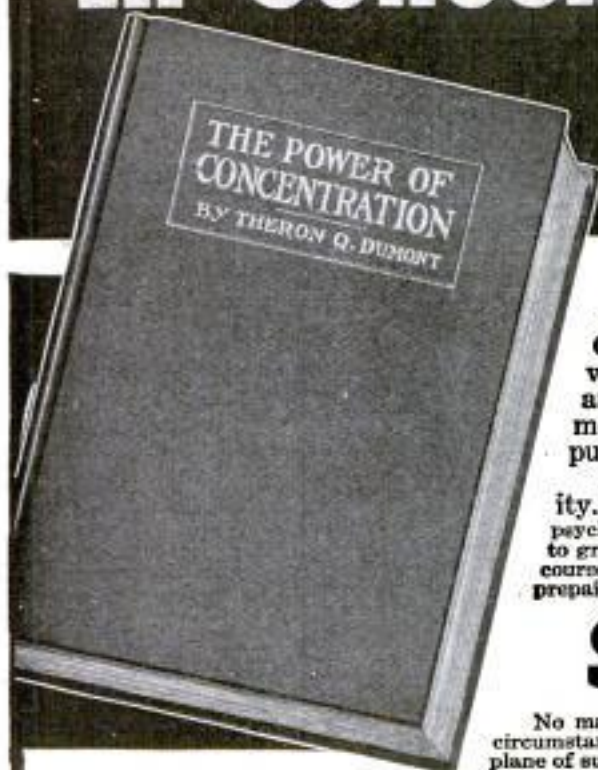

A startling offer. Professor Dumont's famous course on success building through Concentration. Now put in handy book form and sent without a penny required in advance. Information and principles for developing the greatest, most vital mental faculty—never before presented to the general public—yours on this wonderful offer if you act at once. Read below and grasp the meaning of this opportunity. Learn how by special arrangement with this noted psychologist we can place in your hands his crowning triumph—the key to greater influence, greater power, greater prosperity. This complete course in Concentration, first prepared only for his private pupils, sent prepaid for the coupon—yours to examine free at your leisure.

## Success Yours

No matter what may be your position, you can rise, you can command circumstances, you can easily overcome difficulties, you can reach a higher plane of success, through the help you will get from this great work.

## POWER OF CONCENTRATION

### A Few of the Topics Opportunities Made Through Concentration

(Shows the Plain Road to the Top.)

#### Self Mastery

(How to Centralize Attention.)

#### Training the Will

(A Mighty Force at Your Disposal.)

#### Mental Poise

(How to Command Conditions.)

#### Business Success

(How to Co-ordinate Forces by Concentration)

#### Attaining Wealth

(How to Attract Money Bringing Factors.)

#### How Courage Is Gained

(Use of Concentration to Drive Out Fear.)

#### Memory by Concentration

(A Very Valuable Lesson.)

#### Practical Exercises

(Never published before. The actual application of the principles of Concentration.) Etc., etc., etc.

In these twenty lessons, this famous savant gives you in simple, concrete form the results of his lifetime investigations. He shows you how to acquire that mental quality of concentration which has made world-known leaders like Napoleon, Edison, Morgan, Roosevelt. He shows you how to focus your ideas, to get away from mind wandering, to eliminate day dreams—how to use your mind like an ever-ready tool and to accomplish in hours what the man without this ability does only in weeks or months—or never. He tells you clearly why some men lead while others with equal intelligence remain in the ranks. He shows the clear way to make the utmost out of your mentality. No man is your master if you have this wonderful gift of concentration. No degree of success within reason is beyond your grasp. You stand superior to your fellows because you have mental powers beyond theirs. You command circumstances. You attract success. No longer need you wonder why others have risen above you though no better informed than you. You will know why some men seemingly ordinary have gone upward and onward. Professor Dumont shows why. He tells you the secret of their success. Read the principles laid down so clearly by Professor Dumont. Practice the exercises which he has so carefully worked out. This training is all you need. Simply learn to use your brains—learn to focus, to concentrate and the highway to bigger success is open to you.

## Send Coupon

(WITHOUT MONEY)

Sign and mail the coupon. We will send you this complete course in book form free for 5 days examination. If you find it all we say—if you see that it will help you to greater achievement—send us \$3 and keep it.

Name.....

Address.....

City..... State.....

### Advanced Thought Pub. Co.

Dept. 29

168 N. Michigan Ave., Chicago

Send me Prof. Dumont's Complete Course in Concentration (in handy book form). I am to have 5 days to examine it. If then I decide to keep it I will send you the special price of \$2.00. Otherwise I will tell you that I will not keep it and you will tell me where to send it.

Otherwise tell us you will not keep the book and we will tell you where to send it. You run no risk. You can lose nothing. The decision is in your hands. Mail the coupon now while this special offer is good.

**ADVANCED THOUGHT PUBLISHING CO.**  
Dept. 29 168 N. Michigan Ave. Chicago

Please Mention Popular Mechanics



# Ignition Starting and Lighting

## Just Out

The 1917 edition of **Automobile Ignition, Starting and Lighting (with Questions and Answers)**, by Charles B. Hayward, is just off the press. It contains 750 pages, 480 wiring diagrams and illustrations, and is flexibly bound in genuine morocco leather, gold stamped.

The new edition describes the electrical equipment of all standard makes of automobiles. It is written in easily-understood language, and all difficult points are made perfectly clear. No matter what electrical equipment your car may have, this handy volume will help you to locate troubles and show you how to overcome them. Used in many automobile schools as an instruction book, and by thousands of experienced repairmen.

### PRINCIPAL SUBJECTS COVERED

The Electric Circuit—Magnetism—Induction Principles in Generators and Motors—Ignition Principles—Sources of Current—Ignition Systems (Dual, Duplex, Double Spark, Ford Magneto)—Spark Timing—Modern Battery Ignition Systems—Testing—Adjustment and Maintenance—Lighting Equipment—Analysis of Types with Wiring Diagrams, including Auto-Lite, Bijor, Bosch-Kushmore, Delco, Disco, Dyneto, Gray & Davis, Leico-Neville, Remy, Simms-Huff, Splitdorf, U. S. L., Warner, Westinghouse, etc.—Installing Ford Starters—Starting and Lighting Storage Batteries—Summary of Instructions, with Questions and Answers.

## Sold at All Bookstores

All progressive bookstores stock this handbook. If your dealer can't supply you, send us \$2.50 and we'll send you a copy by mail. Examine it carefully—use it at your work for five days. If it fails to meet with your expectations, return it and get your money back.

Send for a copy of our 48-page catalog, which describes our series of 88 handy handbooks. It's free.

**American Technical Society, Chicago, U.S.A.**

**American Technical Society, Chicago, U.S.A.**

Enclosed is \$2.50. Please send me a copy of **Automobile Ignition, Starting and Lighting**, with the understanding that if it is not suited to my needs I may return it within five days and get my money back. Pop. Mech. 4-17

Name.....

Address.....

Please Mention Popular Mechanics

## LEARN PIANO TUNING



Making Trials of True Tone by Tune-a-Phone

## Capitalize YOUR Ability THE WORLD PAYS FOR SKILL

We teach piano tuning and its allied branches by correspondence. Our patented teaching device, the **Tune-a-Phone** and other mechanical aids, make it easy and sure.

Write today for **FREE** illustrated booklet describing the school and its methods.

**NILES BRYANT SCHOOL OF PIANO TUNING**  
28 Fine Arts Inst., BATTLE CREEK, MICH.

## LEARN MUSIC AT HOME!

Lessons Free **New Method—Learn To Play By Note—Piano, Organ, Violin, Banjo, Mandolin, Cornet, Harp, Cello, Guitar, Piccolo, Clarinet, Trombone, Flute, or to sing. Special Limited Offer of free weekly lessons. You pay only for music and postage, which is small. No extras. Money back guarantee. Beginners or advanced pupils. Everything illustrated, plain, simple, systematic. Free lectures each course, 16 years' success. Start at once. Write for Free Booklet Today—Now.**  
**U. S. SCHOOL OF MUSIC, Box 4-A**  
225 Fifth Avenue, New York City

## NATIONAL TRADE DENTAL SCHOOL

506 S. Wabash Ave., CHICAGO, ILL.

### LEARN MECHANICAL DENTISTRY—DEMAND UNLIMITED

Earn \$1200 to \$4000 yearly in mechanical dentistry. A big and growing demand everywhere for mechanical dentists—like a gold mine, unexplored. Attend this school any time of the day or evening; be taught individually and learn by actual practice, without book study. Our System, the most complete in the world, is used exclusively in this school. We are constantly called upon to fill high-salaried positions. Why not qualify for one? Be fair to yourself; find out more about exceptional opportunity we offer. Visit the school or write for booklet B.

## LEARN TO WRITE EARN \$25 to \$100 ADVERTISEMENTS A WEEK

We can positively show you by mail how to increase your salary. **BOOK MAILED FREE.**  
PAGE-DAYIS CO., 112 Page Building Chicago, Ill., or 159 Nassau St., New York

## LAW UNIVERSITY EXTENSION LAW SCHOOL ESTABLISHED 1897

Our Simple Experience Method of Home Training in Law prepares you for the Bar or Business Law. A complete Standard Law Library Free to every student. **Low tuition costs. Free consultation privilege. Law prepares you for bar examination in any state. Our business course will qualify you to act as legal adviser for corporations and firms. Pay in monthly installments. Money refunded if dissatisfied. Write today for catalogue.**

**UNIVERSITY EXTENSION LAW SCHOOL**  
Dept. A-1, 206 S. Wabash Ave. CHICAGO, ILL.

## RIDE A RANGER

bicycle and know you have the best. Buy a machine you can prove before accepting. Select from the 44 styles, colors and sizes in the famous new "Ranger" line of bicycles.

**DELIVERED FREE on approval and 30 days' trial. NO EXPENSE to you if, after trial you decide you do not wish to keep it.**

**LOW FACTORY COST, great improvements and values never before equalled.**

**WRITE TODAY for our big catalog showing our complete line of 1917 bicycles, TIRES, sundries and parts, and learn our wonderful new offers and liberal terms. Do not buy until you know what we can do for you. A postal brings everything. Write for it now.**

**MEAD CYCLE COMPANY**  
Dept. B108, Chicago



Ranger Electric Lighted Motorbike



# HELP WANTED

## \$65 to \$150 Month—Life Jobs

Men 18 or over become United States Government Railway Mail Clerks, City Mail Carriers, Postoffice Clerks, Customs Clerks, Internal Revenue Clerks, Clerks at Panama Canal and at Washington, D. C.

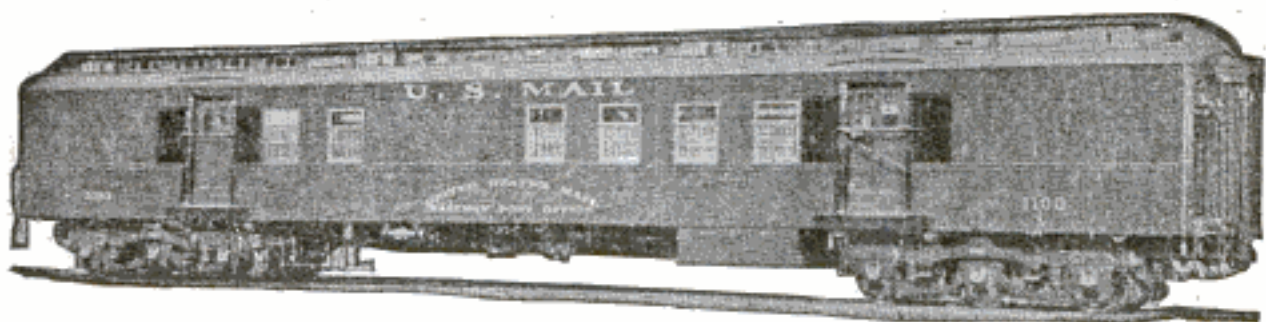

## Railway Mail Clerks Have Pleasant Work— Travelling Continually

All Government positions have Summer vacations with full pay. The work is easy and interesting. The pay is sure. The position is not affected by strikes, wars or the whims of some petty boss.

Country residents and city residents stand the same chance for appointment—common education is sufficient—Pull is not required.

Write us today for schedules showing dates and places of the Spring examinations in your locality.

**Don't Delay** Every day you delay lessens your chance of immediate appointment.

**WE COACH FREE CANDIDATES**

FRANKLIN INSTITUTE  
Dept. A 105  
Rochester, N. Y.

Kindly send me, without any obligation whatever on my part, and entirely free of charge, (1) a full description of the position checked below; (2) Sample examination questions; (3) Free copy of copyrighted book, "Government Positions and How to Get Them"; (4) A list of U. S. Government Jobs now easily obtainable; (5) Directions telling me how to get free coaching for the position checked; (6) Schedules showing dates and places of the Spring examinations in my locality.

..... Railway Mail Clerk	..... (\$900 to \$1800)
..... Postoffice Clerk	..... (\$800 to \$1200)
..... Postoffice Carrier	..... (\$800 to \$1200)
..... Rural Mail Carrier	..... (\$500 to \$1200)
..... Bookkeeper	..... (\$800 to \$1800)
..... Customs Positions	..... (\$800 to \$1500)
..... Internal Revenue	..... (\$700 to \$1800)
..... Stenographer	..... (\$800 to \$1500)
..... Clerk in the Departments at Washington, D. C., or at Panama Canal	..... (\$800 to \$1800)

Name .....

Address .....

Use This Coupon Before You Mislay It—WRITE PLAINLY—A 105



## Mr. Webb Says—

DEAR MR. HILL:

I have just received a promotion and I feel it would be very selfish in me to pat myself on the back and say "Old boy you are some goer". I want to give you and your associate instructors full credit for the great service you have rendered me through your course in



D. B. WEBB,  
Chicago

## Advertising & Salesmanship

When I took up your course I was working as a pressman for a large printing concern. After a month's study of your course I wrote a letter in answer to an advertisement that brought me a special delivery reply and secured me a position for which there were 115 other applicants.

Just the other day I called on one of the largest and oldest concerns of its kind in the country and I was given a little folder to figure on. The job would have amounted to about \$50.00 I took the copy, rewrote it, changed the layout and submitted a dummy and sketch and sold the job for \$250.00. Since then, this firm seeks my advice on all its printing. I never would have enjoyed this splendid success without the help of your course.

D. B. WEBB,

3116 Ainslee Street, Chicago.

## Success Ten Years Sooner

Mr. Webb is not the only man we have helped. We have started hundreds of others on the road to success. We can shorten this road for you by at least ten years, because our instructors are practical men—not "professional" teachers. Each of them has won success in the field of advertising and salesmanship. You get the full benefit of all that they have learned from years of practical experience. The course is nine-tenths practice and only one-tenth theory. You "learn by doing."

## Free Personal Analysis

You can succeed in ADVERTISING AND SALESMANSHIP—if we accept you. Send coupon for personal analysis chart and be analyzed free by a well known Vocational Director. He will tell you if you are qualified to succeed as a sales or advertising manager. Only those so qualified are accepted.

**BRYANT & STRATTON COLLEGE**  
1029 Bryant & Stratton Bldg., Chicago, U. S. A.

**SIGN, CLIP AND MAIL THIS COUPON**

Bryant & Stratton College (Pop. Mech. April, '17.)  
1029 Bryant & Stratton Bldg., Chicago  
Gentlemen: Send free personal Analysis Chart, Booklet, "Poverty to \$10,000 a Year," and full particulars of your Home Study course in Advertising and Salesmanship.  
Name and Address Below

## You May Now Use

this valuable art. Others are using Lichtentag Paragon as a daily convenience. Executives and business men find it very useful. Because of its remarkable simplicity you can learn the entire

**LICHTENTAG PARAGON**

## SHORTHAND

in your own home, during the evenings of one week. **Speed comes with use or practice.** Wonderfully easy to read. Paragon Writers are stenographers in service of U. S. Gov. and officers of corporations, also in court reporting. System already adopted by number of cities for high schools. Write for full pamphlet.

**7 DAYS**

### What Others Say

"The study of Paragon is a fascinating pastime."

"I was able to use it in making my private memoranda through slowly, even before the end of the week."

"So simple and legible that in a week I could read all the shorthand matter, even before starting speed practice."

By practice I have already developed a speed of 175 words a minute."

"The highest I was able to reach on a four minutes dictation of new matter, was 200 words per minute."

THE PARAGON INSTITUTE  
300 Calumet St. New Orleans, La.

## BE AN ARTIST

We can teach you **DRAWING** in your own home during spare time.

Our 18 years of successful teaching prove our ability. 10 Courses in Commercial and Illustrative Drawing.

**Endorsed by high art authorities.**

Students trained by members of our Faculty are filling high-salaried positions. Artist's Outfit FREE to Enrolled Students. Fully equipped Residence School. Write today for Art Year Book.

OUR HANDSOME ART YEAR BOOK "FREE TO YOU"

**SCHOOL OF APPLIED ART**  
APPLIED ART BLDG. NO. 2 BATTLE CREEK MICH.

## "The Language Of Shapes"

A NEW and FASCINATING STUDY  
For Brainy Men and Women!

YOU CAN NOW learn to make good Drawings and Sketches just as surely as you have learned to write good English!

**KNOWLEDGE! TECHNIQUE! SUCCESS!**

The "L-O-S-BOOK" will convince you... Intensely interesting... Illustrated with 24 original Drawings and 3 Pencil Portraits. Size 9" x 8"....

MAILED, with 5 Original-drawing Problems, for **20c**

THE SCHOOL OF ORIGINAL DRAWING, E. End Trust Bldg., Pittsburgh, Pa.

**60 BOOKS** Bound in \$100 After The world's Leather Trial greatest literature now shipped to you FREE on approval, not a penny in advance. The masterpieces of Kipling, De Maupassant, Stevenson, G. Bernard Shaw, Victor Hugo and dozens of others. Each book bound in genuine limp leather, pocket size. Write postal now for offer.  
**LITTLE LEATHER LIBRARY, 193 Newcastle Bldg., 23rd St., New York**

## LAW STUDY AT HOME

Complete Resident University Course by mail. Also Lawyers' Law Course, LL.B. Degree conferred. Endorsed by Bench and Bar. Strong Faculty of Distinguished Jurists and Lawyers. Catalog Free

Oklahoma City University, 106 Concord Building, Oklahoma City, Okla

## A GOOD POSITION

with **UNCLE SAM** is most desirable. Life positions, pleasant surroundings, good pay, steady work, short hours, promotions on merit. Both sexes. No political pull. Thousands of appointments yearly. Most thorough preparation \$5. Returned if not appointed. Full information and questions used by the Civil Service Commission free.

**AMERICAN CIVIL SERVICE SCHOOL**

WASHINGTON, D. C.



# 414 PAGES 145 ILLUSTRATIONS

I.C.S.

ELECTRICAL ENGINEER'S  
HANDBOOK

50¢

## ELECTRICITY!

HERE'S just the book on Electricity that you need to answer your many questions—to solve your knotty problems, to teach you new kinks, to be your memory for tables, rules, formulas and other Electrical and Mechanical facts that some people try to carry in their heads—and fail.

With this "Little Giant" I. C. S. Electrical Engineer's Handbook in your pocket, tool chest, on your work bench, drawing table or desk, an hour or a day need not be lost "digging up" some forgotten rule, some unfamiliar fact; you'll just turn to the very complete index and get it "in a jiffy." Just a few of the subjects treated are:

Electricity and Magnetism; Electrical Symbols; Batteries; Circuits; Magnets; Direct and Alternating Currents; Dynamos and Motors; Belts; Shafting; Electroplating; Electrical Measurements; Meters; Arc and Incandescent Lamps; Mercury Arc Rectifiers; Transformers; Insulation; Electric Cars; Single and Multiple-Unit Control; Transmission; Rail Welding; Tables of Wires—Sizes, Capacities, etc.—Mathematical Rules, Formulas, Symbols; Tables of Constants, Equivalents, Roots, Powers, Reciprocals, Areas, Weights and Measures; Chemistry; Properties of Metals; Principles of Mechanics; First Aid, etc.

The Electrical Engineer's Handbook is one of 22 I. C. S. Handbooks covering 22 Technical, Scientific and Commercial subjects, all crowded with value. They have the contents of a full-size book condensed into pocket-size ready to go with you anywhere and be at your instant command. They are substantially bound in cloth, red edges, goldleaf stamping, printed from new, clear, readable type on good quality book paper. There is an illustration at every point where a picture will help. Hundreds of thousands have been sold on a money-back guarantee of satisfaction.

The regular price is \$1.25, but for a LIMITED TIME you can buy the ones you want, postpaid, delivery guaranteed, for only 50 cents each.

You Run No Risk! Money Back if Desired!

International Correspondence Schools

Box 5566, Scranton, Pa.

### INTERNATIONAL CORRESPONDENCE SCHOOLS

Box 5566, SCRANTON, PA.

I enclose \$\_\_\_\_\_ for which send me postpaid the Handbooks marked X, at 50c. each. I may return any or all and get my money back within ten days from receipt:

- |  |   |
|--|---|
| <input type="checkbox"/> Electrical Engineer's         | <input type="checkbox"/> Advertiser's               |
| <input type="checkbox"/> Teleph. and Teleg. Engineer's | <input type="checkbox"/> Business Man's             |
| <input type="checkbox"/> Mechanic's                    | <input type="checkbox"/> Bookkeeper's               |
| <input type="checkbox"/> Steam Engineer's              | <input type="checkbox"/> Steno. and Correspondent's |
| <input type="checkbox"/> Westinghouse Air Brake        | <input type="checkbox"/> Salesman's                 |
| <input type="checkbox"/> Civil Engineer's              | <input type="checkbox"/> Window Trimmer's           |
| <input type="checkbox"/> Coal Miner's                  | <input type="checkbox"/> Cotton Textile Worker's    |
| <input type="checkbox"/> Concrete Engineer's           | <input type="checkbox"/> Farmer's                   |
| <input type="checkbox"/> Building Trades               | <input type="checkbox"/> Poultryman's               |
| <input type="checkbox"/> Plumber's and Fitter's        | <input type="checkbox"/> Mariner's                  |
| <input type="checkbox"/> Chemist's                     | <input type="checkbox"/> Automobile                 |

Name \_\_\_\_\_

Street and No. \_\_\_\_\_

City \_\_\_\_\_ State \_\_\_\_\_

Never Mind How STRONG  
You are—

## What d'ye Know?



Today it's a battle of wits—and brains win. Muscle and brawn don't count so much as they used to.

The great question now is "What do you Know?" It draws the line between failure and success.

What do you know? Have you special ability in any one line? Could you "make good" in a big job right now?

For 25 years the International Correspondence Schools have been helping men to get ready for better work and bigger salaries. They can do the same for YOU. No matter where you live, what hours you work, or how little your education—the I. C. S. can train you for a more important and better-paying position.

Mark and mail the attached coupon—it won't obligate you in the least—it won't cost you anything to find out how you can get this salary-raising ability right in your own home, during your spare time.

MARK THE COUPON NOW

### INTERNATIONAL CORRESPONDENCE SCHOOLS

Box 5564, SCRANTON, PA.

Explain, without obligating me, how I can qualify for the position, or in the subject, before which I mark X.

- |   |  |
|---|--|
| <input type="checkbox"/> ELECTRICAL ENGINEER        | <input type="checkbox"/> SALESMANSHIP              |
| <input type="checkbox"/> Electric Lighting          | <input type="checkbox"/> ADVERTISING MAN           |
| <input type="checkbox"/> Electric Car Running       | <input type="checkbox"/> Window Trimmer            |
| <input type="checkbox"/> Electric Wiring            | <input type="checkbox"/> Show Card Writer          |
| <input type="checkbox"/> Telegraph Expert           | <input type="checkbox"/> Outdoor Sign Painter      |
| <input type="checkbox"/> Practical Telephony        | <input type="checkbox"/> RAILROADER                |
| <input type="checkbox"/> MECHANICAL ENGINEER        | <input type="checkbox"/> ILLUSTRATOR               |
| <input type="checkbox"/> Mechanical Draftsman       | <input type="checkbox"/> DESIGNER                  |
| <input type="checkbox"/> Machine Shop Practice      | <input type="checkbox"/> BOOKKEEPER                |
| <input type="checkbox"/> Gas Engineer               | <input type="checkbox"/> Stenographer and Typist   |
| <input type="checkbox"/> CIVIL ENGINEER             | <input type="checkbox"/> Cert. Public Accountant   |
| <input type="checkbox"/> Surveying and Mapping      | <input type="checkbox"/> Railway Accountant        |
| <input type="checkbox"/> MINE FOREMAN OR ENGINEER   | <input type="checkbox"/> Commercial Law            |
| <input type="checkbox"/> Metallurgist or Prospector | <input type="checkbox"/> GOOD ENGLISH              |
| <input type="checkbox"/> STATIONARY ENGINEER        | <input type="checkbox"/> Teacher                   |
| <input type="checkbox"/> Marine Engineer            | <input type="checkbox"/> Common School Subjects    |
| <input type="checkbox"/> ARCHITECT                  | <input type="checkbox"/> CIVIL SERVICE             |
| <input type="checkbox"/> Contractor and Builder     | <input type="checkbox"/> Railway Mail Clerk        |
| <input type="checkbox"/> Architectural Draftsman    | <input type="checkbox"/> AGRICULTURE               |
| <input type="checkbox"/> Concrete Builder           | <input type="checkbox"/> Textile Overseer or Supt. |
| <input type="checkbox"/> Structural Engineer        | <input type="checkbox"/> Navigator                 |
| <input type="checkbox"/> PLUMBING AND HEATING       | <input type="checkbox"/> Poultry Raising           |
| <input type="checkbox"/> Sheet Metal Worker         | <input type="checkbox"/> AUTOMOBILES               |
| <input type="checkbox"/> CHEMICAL ENGINEER          | <input type="checkbox"/> Auto Repairing            |
|   | <input type="checkbox"/> Spanish                   |
|   | <input type="checkbox"/> German                    |
|   | <input type="checkbox"/> French                    |
|   | <input type="checkbox"/> Italian                   |

Name \_\_\_\_\_

Occupation & Employer \_\_\_\_\_

Street and No. \_\_\_\_\_

City \_\_\_\_\_ State \_\_\_\_\_

If name of Course you want is not in this list, write it below.

Please Mention Popular Mechanics



# WANTED! MEN FOR NEW JOBS!

Short hours. Easy work. No strikes, no hard times, no layoffs. No petty bosses. No politics—no pull. Ordinary education sufficient. 15 and 30 day vacations each year with full pay. Sickleave with full pay. Positions for life with

## Bigger Pay

steady income, rapid advancement. Earn \$75 to \$150 a month to start. Earn up to \$2000, \$3000 or more later. These are but a few of the many attractive features of working for the U. S. Government in the Railway Mail Service, Post Office Service, Custom House Service, Internal Revenue Service, Panama Canal Service, R. F. D. Service and other divisions.

## Write Now!

If you are an American Citizen 18 or over, send in your name for all facts about Government Positions and how to get one. Send no money—this book is free. Tells how A. B. Patterson has successfully prepared thousands for government service, how you can prepare for coming examinations at home in spare time. Mr. Patterson was U. S. Civil Service Secretary-Examiner for 8 years and has students and graduates in practically every State in the Union in all branches of Government Service. Not one cent if you do not secure a position. Don't be satisfied with uncertain job and small pay when you can so easily secure a permanent position with Uncle Sam. Mail Postal NOW for Free Book and special 20-Day Offer! Address

**PATTERSON CIVIL SERVICE SCHOOL**  
384 News Building Rochester, N. Y.



## Ridpath's History of the World At a Bargain



On account of the great increase in cost of paper and leather it is necessary to soon increase the price to cover increased cost of manufacture. We will name our present low price and easy terms only in direct letters to those mailing us the Coupon below. Tear off Coupon, write name and address plainly, and mail now before you forget it. The 46 Free Sample Pages will give you some idea of the splendid illustrations and wonderfully beautiful style in which the work is written. Thousands have already availed themselves of our offer and every purchaser is more than satisfied. MAIL COUPON NOW.

### FREE COUPON

WESTERN NEWSPAPER ASSOCIATION 4-17  
140 So. Dearborn St., Chicago, Ill.  
Please mail your 46-page free sample booklet of Ridpath's History of the World, containing photogravures of Napoleon, Socrates, Caesar and other great characters in history, Map of European War Zone, and write me full particulars of your special offer to Popular Mechanics readers.

NAME.....  
ADDRESS.....

Please Mention Popular Mechanics

## New Automobile Books

### For OWNERS, DRIVERS and REPAIR MEN

The new equipment makes the old books obsolete. We will send any or all of the following books prepaid upon receipt of price.

#### BROOKES' AUTOMOBILE HANDBOOK

Revised by H. P. MANLY

715 pages, of which 400 pages are devoted to practical information on new equipment. 335 illustrations and diagrams. Special articles on carburetors, ignition starting and lighting, and every new device used.

Pocket size, leather, round corners, red edges, gold stamping. Price, postpaid....\$2.00

#### AUTOMOBILE STARTING and LIGHTING

By HAROLD F. MANLY

Every starting and lighting device in the market is covered in this work in a practical manner, for the owner, operator and repair man. The principal subjects treated are as follows: Electric Lighting and Engine Starting



Equipment; Lighting Dynamos and Starting Motors; Storage Batteries; Lamps and Wiring; Control Parts; Dynamo and Motor Drives; Current Measuring and Indicating Devices; Starting and Lighting troubles.

200 pages. Illustrated. Pocket size. Cloth, postpaid.....\$1.00  
Full Leather, red edges, gold stamping, postpaid.....\$1.50

#### AUTOMOBILE CATECHISM and REPAIR MANUAL

By C. F. SWINGLE and H. A. TARANTOUB

Part I comprises questions and answers. Part II is devoted entirely to automobile repairs. It gives complete instructions for locating troubles and making adjustments and repairs of all kinds. Motor knocks, carburetion, ignition, valve troubles, fitting piston rings, and tires.

Pocket size. Leather, stamped in gold. Red edges. 165 pages. Fully Illustrated. Price, postpaid.....\$1.25

Send for our catalogue of practical mechanical books for Electricians, Engineers, Telephone Men, Machinists, Railroad Men, Automobileists, Carpenters, Plumbers, Sign and Card Writers, Scene Painters, etc. It is FREE  
FREDERICK J. DRAKE & CO., 1008 Michigan Ave., Chicago

## LEARN TO DANCE!

Fox-Trot, One-Step, Waltz, Two-Step, and latest dances taught by mail.  
Wonderful, New Diagram Method. No music needed; everything made easy; thousands taught successfully. Learn at home in spare time; same way I teach society leaders. WRITE FOR SPECIAL TERMS. Send today for free information and surprisingly low offer.  
PROF. W. C. PEAK, Graduate of Castle House Room 19, 821 Crescent Place, CHICAGO, ILLINOIS

## DRAWING

Learn by Mail in YOUR OWN HOME  
Newspaper, Magazine and Commercial Illustrating, Cartooning, Water Color and Oil Painting. Learn drawing or painting for profit and pleasure. We can develop your talent. This school has taught thousands. Free Scholarship Award—special limited offer. Your name and address brings you full explanation and our handsome illustrated Art Annual by return mail. Don't delay, write to-day.  
Fine Arts Institute, Studio 564, Omaha, Neb.

## CIVIL SERVICE

positions are in all parts of the country. Good pay, steady work, life positions, congenial surroundings, promotions on merit, short hours, annual vacation and sick leave with pay. Many thousands appointed yearly. Both sexes. No political pull. Nearly 300,000 classified positions. Common school education sufficient. Full information and questions used by the Civil Service Commission free.  
COLUMBIAN CORRESP. COLLEGE, WASHINGTON, D.C.

## I Will Buy Your Old Drawing Instruments

If you are not using your old instruments, turn them into money. I pay cash. Tell me what you have. Give full description and condition and I'll send my price bulletin. Write today.  
JOSEPH H. INDIG, Lytton Building, Chicago, Ill.



# Stop Forgetting!

Make  
Yourself  
Master  
of  
Every  
Situation



## Perfect Your Memory —and Command What Salary You Will

Your earning power—your position in life—depend upon your memory. The ability to recall needed facts and figures—to concentrate on matters on hand—to grasp the details of a proposition instantly—to be able to make decisions quickly and safely—means everything to the achievement of success.

### Men of Power Are Men of Trained Memories

Roosevelt, Wilson, Edison—America's men of power are uniformly men of trained memories. Train your memory the *Dickson way*, and you endow your personality with that "divine spark" that enables you to make your mind "forget-proof"—to overcome self-consciousness and bashfulness—that gives complete mastery over every situation—that will make you a power to be reckoned with in social, business or public life.

### I Will Give You a "Steel Trap" Memory

A tenacious memory cannot rightfully be called a "gift." My experience with 50,000 students—men with exceptionally poor memories who have developed them to amazing perfection—men with remarkably good memories who have made them even better—has proven the value of systematic training of the Memory. What Dickson training has done for these men, it will do for you—will teach you to think and talk connectively—will increase your earning power.

### Special Offer! "How to Speak in Public" — FREE

If you enroll at once for this course in memory training you'll receive—absolutely FREE—this valuable book, "How to Speak in Public," Deluxe edition, handsomely bound. Teaches you to express yourself clearly and convincingly whether talking to one person or a thousand. Full particulars of this offer, together with my remarkable booklet, "How to Remember," and a copy of my unique copyrighted "Memory Test," are yours free—simply fill in the coupon, tear off, and mail.

### Dickson Memory Training Endorsed by Noted Men

**Elbert Hubbard:** "Good memory is essential to all achievement. The Dickson System of Memory Training—if I understand it—and I do understand it—is very simple. If you want to enlarge your arm to increase the power and strength of your muscle, you exercise it. The same with your mind."

**Carl F. Schader, California:** "I have been improved physically and mentally beyond my own expectations by the continued studying of your course. I unhesitatingly recommend it to those who desire to increase their Power of Personality."

**Wm. H. Weeks, New York Attorney:** "After a thorough trial of your method of mental and memory training, I find it to be not only first class—simply wonderful I can truthfully say that I would not be again without the benefits I have received from your study for \$10,000."

For FREE Book—  
"How to Remember"  
Mail the Coupon

Stop forgetting

PROF. HENRY DICKSON,  
Principal, Dickson School of Memory,  
1705 Hearst Building, Chicago

Please send me free of charge and without obligation your booklet, "How to Remember," and a copy of your copyrighted "Memory Test." Give me facts on your special offer of a free copy of "How to Speak in Public."

Name \_\_\_\_\_

Address \_\_\_\_\_





33,000 sq. ft. of  
Additional  
Floor  
Space

# Come to Detroit The Automobile Center and LEARN THE AUTOMOBILE BUSINESS

DETROIT trained men get preference and get jobs quickly. No other city can give what Detroit offers. Think what it means to learn in the Michigan State Auto School. Factories endorse our school, glad to employ our graduates or offer them territory in which to sell cars and start garages. Unlimited opportunities. 71% of Automobiles are made in Detroit. You're right in the Heart of the Auto Industry. Men are needed everywhere as testers, repairmen, chauffeurs, garage men, and salesmen. Hundreds of our graduates start in business for themselves.

## Get Better Job—or—Go in Business

We teach you to handle any auto proposition. You graduate in from ten to twelve weeks. Our equipment is new, up-to-the-minute, and complete. No old, obsolete motors, chassis or electrical equipment used. Students actually build cars from start to finish, getting factory training in assembling, block-testing, road-testing, everything. Special complete course in Oxy-Acetylene brazing, welding and cutting, separate from regular course. Learn to time motors, rebore cylinders, adjust carburetors, magnetos, valves and bearings quickly and accurately. Six-cylinder Lozier,

Chalmers "6," Detroit "6," Overland, and 8-cylinder King are used for road instruction. We have a new Chalmers "6-30" chassis with 3400-r. p. m. motor, the latest thing out,

Willys-Knight 1917 chassis  
Studebaker "6" 1917 chassis  
Hudson Super-Six 1917 chassis  
Cole "8" 1917 chassis  
Detroit Electric 1917 chassis

Saxon "6" 1917 chassis  
Maxwell 1917 chassis  
Oldsmobile "8" 1917 chassis  
Briscoe 1917 chassis  
Winton "6" chassis

All completely equipped for students to work on. We have more than 25 motors in our block test department—2 cyl., 4 cyl., 6 cyl., 8 cyl., and 12 cyl. Our electrical department is complete, having every standard starting, lighting, and ignition system, including Delco System as used in Buick, Hudson, and Packard Twin "6,"

## Detroit Is the Place to Learn—Start Any Time

There are 44 auto factories in Detroit and 140 accessories and parts factories. Our students have the privilege of going through any or all of them. We operate Starting, Lighting, Ignition Service Station. This has added thousands of dollars' worth of equipment and makes our electrical department unequalled. Students get actual experience in handling all kinds of electrical auto equipment and taking care of trouble. We have just installed a Sprague Electric Dynamometer for block-testing purposes for students' use. Ours is the only Auto

school having this equipment. Auto factories need Dynamometer men constantly. Factories and garages are paying big salaries to men who know how to handle electrical equipment quickly and properly. Detroit is the automobile center. You get practical instruction. School open all the year. Enter classes any time, any day. Three classes daily: morning, afternoon, evening. All instructors are members of the Society of Automobile Engineers (S.A.E.) There is a great demand for Michigan State Auto School students. Auto factories write and phone for men constantly.

## Follow the Crowd to the Michigan State Auto School. Come to Detroit

### Money-Back Guarantee

We guarantee to qualify you in a short time for a position as chauffeur, repair man, tester, demonstrator, garage man, or automobile dealer, paying from \$75 to \$100 monthly or refund your money. We have constantly more requests for Detroit trained men at GOOD salaries than we can supply.



THIS IS ONE OF THE JANUARY 1916 CLASSES

### Additional Building and Equipment

Thousands of dollars' worth of new equipment, plenty of room for students to work, at 687-89-91 Woodward Ave. in addition to our building at 11-19 Selden Ave. Our school has grown by leaps and bounds, students come from all over the world. We are constantly adding new equipment. Our electrical department is thorough and complete.

### Factory Co-Operation

We have completed arrangements to put them in touch with men who intend going into business for themselves. Men who know the auto business from A to Z are in biggest demand. Remember, the price of course is based on giving full value. Graduates in the complete auto course are competent to handle farm tractors.

### Auto Factories Endorse Our School

The Leading Automobile factories in Detroit, as well as in other cities, endorse our school. They have been watching our school and graduates for years and are satisfied. They are putting their latest model, complete chassis in our school for students to work on. They are employing our graduates in their factories and service stations and assisting them in opening garages and salesrooms. They allow our students to go through their factories. They need trained, competent men and are asking for more of our graduates constantly. The Michigan State Auto School in Detroit, the heart of the Auto Industry, is endorsed by the Leading Auto Factories, is receiving their hearty co-operation. What better endorsement could you ask?

## SEND THIS COUPON TODAY

### MICHIGAN STATE AUTO SCHOOL

304 Auto Bldg., 687-89-91 Woodward Ave.  
DETROIT, MICHIGAN, U. S. A.

Gentlemen: Send me absolutely FREE "Auto School News" and New Catalog, or better still, you can expect

me about.....

Name.....

Street.....

Town..... State.....

## Act Quickly—NOW!

Fill in the coupon; get full particulars, "Auto School News" and New 128-Page Illustrated Catalog. All absolutely free. Or better still, jump on the train, as hundreds have done, and come to the "Heart of the Automobile Industry," and learn right. We have no branches. Write or come direct to this school.

## Michigan State Auto School

The Old Reliable School A. G. ZELLER, Pres.

304 Auto Building  
687-89-91 Woodward Avenue  
DETROIT, MICHIGAN, U. S. A.

## DETROIT THE HEART OF THE AUTO INDUSTRY





**EARN \$75. TO \$300. A MONTH**

With the New Building and Thousands of Dollars Worth of New Equipment, Our's is the Largest Exclusive Auto School in the Country



We teach the newest and best way to re-bore cylinders as a part of the complete Auto Course. No need to have big, heavy, expensive machines. This is very important instruction.



These men are getting final instructions after they have taken down and rebuilt a new up-to-date 6 cyl. motor.



This is a partial view of our Chassis room showing eight up-to-date chassis for students' use.



A new 12 cyl. motor connected to our Sprague Electric Dynamometer in Block Test Dept. for students' use.



DECEMBER 1916 CLASS IN MECHANICAL LECTURE ROOM

This is the first work a student receives. A 6 cyl. 1917 Saxon "Cut-open" chassis is used to make perfectly clear and practical the first instructions. There were 350 men set for this picture. The Electrical Lecture room is the same size. The classes are divided so that more intense work can be done on each subject. Every man is given personal help and his progress through the school is watched carefully.



This is a section of the Brazing, Welding and Cutting Department. Each man handles the torches and works with an individual outfit.



View showing about 18 motors in the Block Test Department. Sprague Electric Dynamometer shown in center background.

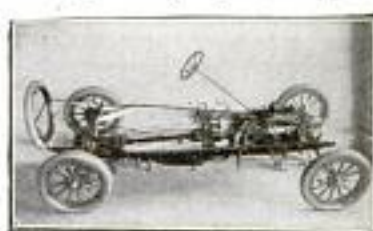

A close view of Saxon "Cut-open" chassis. Used in Mechanical Lecture room. Hidden parts are cut open and electric lighted.



Students getting personal instructions on Willys-Knight 1917 chassis.



Students making final test on Maxwell 1917 unit power plant motor.



Complete working Delco System as used in Buick, Hudson, and Packard Twin "6."



Battery Charging room, showing lighted switchboard and distilled water rack.

These cuts were all made from actual photographs taken in our school. **Use the Coupon - DO IT NOW Don't Even Hesitate**



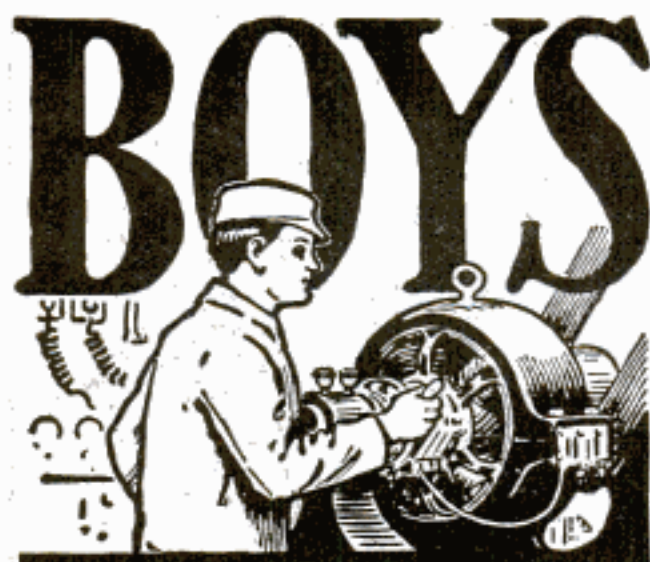

## Big Money in Electricity

The Electrical industries offer wonderful opportunities to boys with a liking for Electricity. The salaries paid to trained men are large, promotion comes rapidly and, best of all, the work is fascinating.

The discovery and development of new lines (such as wireless telegraphy and telephony), from time to time, promise attractive and paying fields to those who wish to specialize. The *will to do* and *Special Training* will bring success to you.

The International Correspondence Schools can help you to become an expert in electrical work, no matter what branch you like best. Thousands of young men have already won success through I. C. S. help. You can do as well as anybody, *if you try*. Everything is made so clear that you can learn in your spare time, regardless of where you live or what your work. No books to buy.

There's big money in Electricity. Get after it by marking and mailing the Coupon today. *Finding out costs you nothing.*

### INTERNATIONAL CORRESPONDENCE SCHOOLS

Box 5563, SCRANTON, PA.

Explain, without obligating me, how I can train for the position before which I mark X.

- |  |  |
|--|--|
| <input type="checkbox"/> ELECTRICAL ENGINEER       | <input type="checkbox"/> ARCHITECT               |
| <input type="checkbox"/> Electrician               | <input type="checkbox"/> Architectural Draftsman |
| <input type="checkbox"/> Electric Wiring           | <input type="checkbox"/> Mine Foreman or Supt.   |
| <input type="checkbox"/> Electric Lighting         | <input type="checkbox"/> Business (Complete)     |
| <input type="checkbox"/> Electric Car Running      | <input type="checkbox"/> Bookkeeper              |
| <input type="checkbox"/> Electric Machine Designer | <input type="checkbox"/> Stenographer            |
| <input type="checkbox"/> Telegraph Engineer        | <input type="checkbox"/> Advertising Man         |
| <input type="checkbox"/> MECHANICAL ENGINEER       | <input type="checkbox"/> Salesmanship            |
| <input type="checkbox"/> Mechanical Draftsman      | <input type="checkbox"/> Window Trimmer          |
| <input type="checkbox"/> STEAM ENGINEER            | <input type="checkbox"/> Civil Service           |
| <input type="checkbox"/> GAS ENGINEER              | <input type="checkbox"/> AGRICULTURE             |
| <input type="checkbox"/> CIVIL ENGINEER            | <input type="checkbox"/> Poultry Raising         |
| <input type="checkbox"/> Structural Engineer       | <input type="checkbox"/> AUTOMOBILES             |
| <input type="checkbox"/> CHEMICAL ENGINEER.        | <input type="checkbox"/> Auto Repairing          |

Name \_\_\_\_\_

Present Occupation and Employer \_\_\_\_\_

Street and No. \_\_\_\_\_

City \_\_\_\_\_ State \_\_\_\_\_

If name of Course you want is not in this list, write it below.

Please Mention Popular Mechanics

## SHORTHAND IN 30 DAYS

We absolutely guarantee to teach shorthand complete in only thirty days. You can learn in spare time in your own home, no matter where you live. No need to spend months as with old systems. Boyd's Syllabic System is easy to learn—easy to write—easy to read. Simple. Practical. Speedy. Sure. No ruled lines—no positions—no shading as in other systems. No long lists of word signs to confuse. Only nine characters to learn and you have the entire English language at your absolute command. The best system for stenographers, private secretaries, newspaper reporters and railroad men. Lawyers, ministers, teachers, physicians, literary folk and business men and women may now learn shorthand for their own use. Does not take continual daily practice as with other systems. Our graduates hold high grade positions everywhere. Send today for booklets, testimonials, etc.

Chicago Correspondence Schools  
969 Unity Bldg., CHICAGO, ILL.

## A High School Course In Two Years

Learn in your own home. Here is a thorough, complete, and simplified high school course that you can finish in two years. Meets all college entrance requirements. Prepared by leading members of the faculties of universities and academies.

Write for booklet. Send your name and address for our booklet and full particulars. No obligations whatever. Write today—now. American School of Correspondence, Dept. P1194, Chicago, U. S. A.

## Be a Finger Print Expert



Police departments, factories and industries everywhere are adopting this system of identification. Experts needed at once. You can train yourself in spare time at home. Write for details.

**Free Book—Write** Valuable and interesting book on finger prints sent absolutely free and prepaid. Also details of special limited offer. Write at once, while this offer lasts.

EVANS UNIVERSITY, FINGER PRINT DEPT.  
Desk 9194, 1810 Wilson Avenue, CHICAGO

## LAW High-Grade Instruction by CORRESPONDENCE

Prepares You for the Bar—Est. 1892

Four Courses: College, Post-Graduate, Business Law and Bar Ex. Review. Classes begin each month. Approved by Bench and Bar. University Methods. Unabridged Text-Books, Cases, Course in Oatery, Public Speaking and Moot Court FREE with regular course. Graduates now practicing in every State. Write today for Catalog and Rules for Admission to the Bar. CHICAGO CORRESPONDENCE SCHOOL OF LAW, 520 Reaper Block, CHICAGO



## The Student Illustrator



a practical art magazine publishes lessons and articles on every phase of cartooning, designing, lettering, newspaper, magazine and commercial illustrating. It is an art education in itself. The latest and most up-to-date methods in the big paying field of commercial art thoroughly explained by experts. Amateur work published and criticized. Satisfaction guaranteed or money refunded. \$1.00 per year. Three months' trial 25 cents. Del. S. Schwartz Bldg., Washington, D. C.



LEARNED BY ALMOST ANYONE AT HOME SMALL COST

Send today 2c stamp for particulars and proof. O. A. SMITH, Room D 149, 823 Bigelow St., PEORIA, ILL.

## LEARN WATCH REPAIRING



You can learn by our modern and original system of instruction every part of the Watch Repairing Trade at home as good or better than at a shop. You can earn money while learning and secure a well paying position or start in business after completing our course of instruction. Good watch repairs are always in demand and earn from \$20 to \$35 per week. For particulars apply to the Wisconsin School of Watchmaking, 518th Bldg., Milwaukee, Wis.



# Let This Man Train You For A Big Traffic Position



**NORMAN D. CHAPIN**

## FACULTY and LECTURE WRITERS (Partial List)

**N. D. Chapin**  
Formerly Chief of Tariff Bureau  
of the New York Central and  
West Shore Railroad.

**Ann Colton**  
Instructor in Interstate Commerce;  
Sometime of Freight Department  
of the South Brooklyn  
Railway Company.

**R. E. Riley**  
Formerly Instructor in Railway  
Transportation at Y. M. C. A.,  
New York City; formerly with  
the I. C., N. Y. C., B. P., C. N.  
& T. C., Atlantic Steamship,  
C. H. & D., and E. & O. S. W.  
Railroad.

**G. F. Falley**  
Formerly General Freight and  
Passenger Agent of the  
B. & N. W. Railway.

**John P. Curran, LL.B.**  
Central Freight Association; formerly  
with South Western Tariff  
Committee, St. Louis.

**F. R. Garrison**  
Chief Clerk, Central Freight Association;  
formerly with L. E. &  
W., C. H. & D., and G. K. & I.  
Railways.

**C. R. Lincoln**  
Formerly with C. R. L. & P. and  
C. H. & D. Railroads, and Traffic  
Department, Marshall Field & Co.

**L. E. O'Brien, Ph. B.**  
Formerly Industrial Traffic Mgr.

## Text and Lecture Writers (Partial List)

**E. R. Dewarup, A. B., A. M.**  
Professor of Railway Administration,  
The University of Illinois;  
Author of Freight Classification.

**A. R. Smith**  
Vice-Pres., Louisville & Nashville  
Railroad; Author of Freight  
Rates in Southern Territory.

**W. H. Chandler**  
Transportation Manager, Boston  
Chamber of Commerce; Author  
of The Express Service and Rates.

**B. Olney Hough**  
Editor, American Exporter; Author  
of Ocean Traffic and Trade.

**I. L. Sharfman, A. B., LL.B.**  
Professor of Railway Economics,  
The University of Michigan;  
Author of Railway Regulation.

**James Peabody**  
Late Statistician, A. T. & B. F.  
Railway; Author of Railway  
Organization and Service.

**J. F. Morton**  
Asst. Traffic Director, Chicago  
Association of Commerce; Author  
of Boosting Freight Shipments.

**C. L. Lingo**  
Traffic Manager, Inland Steel Co.

The complete LaSalle organization consists of more than 300 business experts, professional men, text writers, instructors and assistants, including recognized authorities in all departments.

## Over 25,000

ambitious men in all lines of railroad and industrial traffic work, throughout the United States, have benefited through membership in our Department of Interstate Commerce and Railway Traffic. More than

**\$150,000**

has been expended by our institution in organizing and perfecting the training and service rendered members of this department, which is now under the direct, personal supervision of

### MR. N. D. CHAPIN

Formerly Chief of Tariff Bureau, N. Y. C. Lines  
Mr Chapin has been engaged to devote his entire time to this work, and is assisted by a selected corps of railroad and industrial traffic experts, together with an organization of more than 300 people.

## LaSalle Training Fully Recognized

The LaSalle Course in Interstate Commerce and Railway Traffic is now fully recognized by the country's greatest traffic authorities as the highest type of traffic training now available. It has been adopted as representing the highest standard of technical training, information and practice, in the matter of Interstate Commerce, railway and industrial management, in important traffic centers and is approved by many trunk railroads, such as the following:

**Baltimore & Ohio R. R., Louisville & Nashville R. R.,  
Cumberland Valley R. R., Erie R. R.,  
Pennsylvania Lines West**

The course is a complete, up-to-date, and thoroughly practical system of training, covering all phases of modern traffic operations. It is a "100 man power" course, conducted by thoroughly qualified traffic experts who have risen from the ranks. No other course compares with it. Should not be confused with so-called traffic clubs or traffic associations. Hundreds of men are now holding big positions and drawing greatly increased salaries as a direct result of LaSalle training and service.

A few of the many LaSalle Students Now Industrial Traffic Managers: M. Epply, Traffic Manager, Hammermill Paper Co., Erie, Pa.; T. J. Bennett, Traffic Mgr., American Steel Foundries, Chicago; P. D. Seward, Traffic Mgr., The Garland Corp., Pittsburg; R. R. Muller, Traffic Mgr., U. S. Light and Heating Co., Niagara Falls, N. Y.; J. D. Quinn, Traffic Mgr., Franklin Steel Works, Franklin, Pa.; Theo. S. Barry, Traffic Mgr. for the City of Pawtucket, R. I.; Seth Tate, Traffic Mgr., Higginbotham, Bally-Logan Co., Dallas, Texas; K. L. Crikman, Traffic Mgr., Great Western Smelting & Refining Co., St. Louis; R. Denholm, Traffic Mgr., Lockwood Engineering Co., Cleveland; O. R. H. Culbertson, Traffic Mgr., Seattle Construction & Dry Dock Co., Seattle, Wash.

## Send Coupon For FREE Traffic Book

Send now for big illustrated traffic book giving full particulars regarding our course of instruction by mail, opportunities open, salaries paid, etc. There is no obligation on your part, book and all information sent free. Act promptly. Special reduced rate scholarships and small monthly payment plan open to those enrolling now. Write today.

### LaSALLE EXTENSION UNIVERSITY

"The World's Greatest Extension University"  
Dept. 464-C Chicago, Ill.

## Read This Letter From A Well Known Traffic Official

"If the information in the enclosed clipping (referring to Mr. Chapin's appointment as head of the department of traffic and transportation) from 'The Pittsburgh Dispatch' today is correct, I wish to extend sincere congratulations to yourself and the University in the selection of Mr. N. D. Chapin for the position mentioned. I consider Mr. Chapin not only one of the best-informed rate and tariff men in the country, but also possessed of all the necessary personal qualifications to engage successfully in the good work of your University.

F. S. DAVIS,  
Gen'l Western Freight and  
Passenger Agent,  
N. Y., N. H. & H. R. R.

## Other Prominent Railroad Men Endorse LaSalle Training

"Your enterprise has my entire approval."

E. P. RIPLEY, Pres.,  
Santa Fe Ry.

"I unhesitatingly recommend your course to anyone."  
H. J. STEEPLE, Gen'l Agt.,  
Erie Railroad.

"I recommend your course to anyone as a means of improving his knowledge and efficiency in traffic work."

HAMILTON BAXTER,  
Div. Freight Agt.,  
Southern Ry.

Among others who endorse our course are: E. T. Campbell, Gen'l Traffic Mgr., Erie Railroad; James Webster, Asst. Freight Traffic Manager, N. Y. C. Lines; R. H. Drake, Division Freight Agent, American Can Co.; etc., etc.

## Mail Coupon NOW

LaSalle Extension University  
Dept. 464-C Chicago, Ill.

Please send FREE proof about opportunities now open to TRAFFIC EXPERTS with LaSalle training.

Name.....

Occupation.....

Address.....

City..... State.....

Please Mention Popular Mechanics



# LEARN ELECTRICITY AT HOME



## FREE! 20 COMPLETE LESSONS



Write me at once—**TODAY!** Just send the coupon or a postal. I will give you 20 complete lessons in practical electricity **FREE!** Think of it! My personal and individual instruction for 20 lessons without a cent of cost to you if you act quick. No charge to you for these 20 lessons now or later. I make this sensational offer to secure a few more live students—to show, too, how quickly I can make you a Trained Electrician no matter where you live, or what you do. But you must act at once! This offer closes in 23 days! Remember these free lessons are not merely sample lessons, but are a regular part of my full and complete course in electricity. Send the coupon without delay—**TODAY!**

### Earn \$2,500 to \$4,000 a Year

You can now qualify at home during your spare time, and without giving up your present position or occupation, for that most wonderful of all fields open to the ambitious man—the great and growing field of Electricity! Yes, no matter if you don't know a thing about electricity or never had a bit of electrical experience, I will take you in hand and make you a Trained Electrician so that you should easily earn \$2,500 to \$4,000 a year and more. And I'll do it so quickly and with so little effort on your part, that you'll wonder how it was possible. No books or tools to buy.

### Men Wanted

Wherever you go there's always urgent demand for Expert Electricians and at big pay. That's because the watchword of the age is, "DO IT ELECTRICALLY." The field of electricity is broadening so fast that there's a big shortage of competent electricians. And the demand is increasing every day.

### I Train You By Mail!

I will instruct you personally—make the whole matter so simple for you that you can't help but learn. When you have finished my instructions you are a Trained Electrician—ready to take a big paying job or start in for yourself. I show you not only how to do practical electrical work, but how to estimate on jobs so that you can take contracts at big profits. That's what it means to be trained by a man of my practical experience.

### Mail Coupon Today

**A. W. WICKS, E. E., Director, Wicks Electrical Institute**  
81 W. Randolph St. Dept. 291 Chicago, Ill.

Without any obligation to me whatever, please send me full description of your personal instructions in Electricity and particulars of your special offer of 20 of your lessons free.

Name.....

Street and No.....

City..... State.....

### You Must Act Quick

Mail coupon today. I want to hear from you immediately. Don't miss my offer of 20 personal lessons free. Remember this offer is strictly limited to 23 days. Write for all particulars at once. Here's your chance! No obligation to you. **Send coupon or postal NOW!**

**A. W. WICKS, E. E., Director**  
**Wicks Electrical Institute**  
81 W. Randolph St., Dept. 291, Chicago, Ill.

Please Mention Popular Mechanics



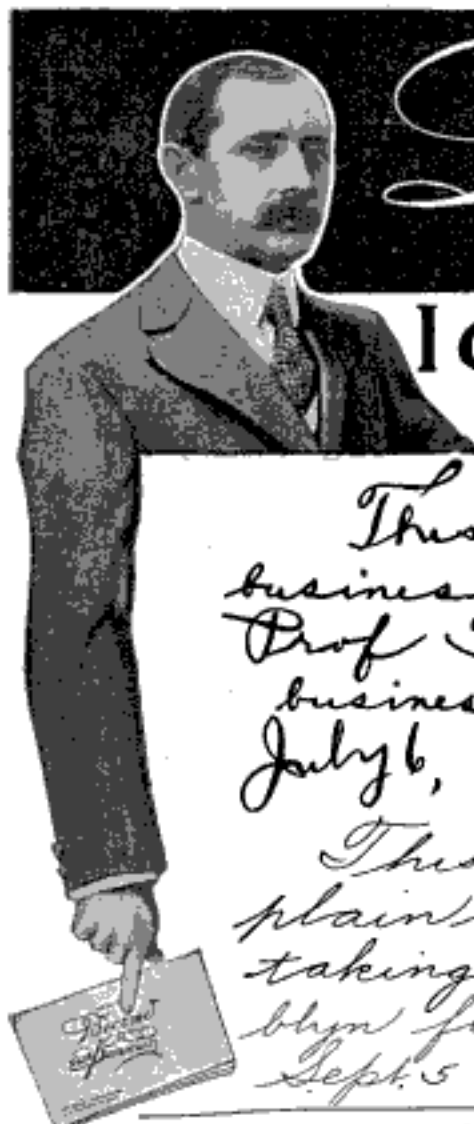

TO  
*Learn to Write*

**I CAN TEACH YOU AT HOME**  
During Spare time

*This is a specimen of my business writing before taking Prof Tamblin's course in business writing July 6, Clarence P. Weber.*

*This is a specimen of my plain business writing after taking lessons from F. W. Tamblin for 2 months Sept. 5 Clarence P. Weber.*

**FREE BOOK**

My 32-Page book "How to Become a Good Penman" is FREE to anyone who wants to write better. Contains copies and information that will help you, and beautiful specimens that will make your eyes twinkle with delight.

**WRITE FOR IT**—use the coupon below—or a postal will do—but

**Send at Once!**

*If you enclose a stamp, I will write your name on a card with white ink, making one of the prettiest specimens of penmanship you ever saw*

**F. W. TAMBLYN**

418 Ridge Bldg., KANSAS CITY, MO., U.S.A.

**"A Wonderful Bargain"** "It is now about two months since I began your course, and while I am not quite half through with Business Writing, I am delighted with my improvement, which is quite marked as you will see by comparing my present writing with the specimen written when I began. My parents objected to my taking it up, but now see I'm getting a wonderful bargain."

— CLARENCE P. WEBER, Middletown, Del.

### Good Writing Is the Very Foundation of Business Success

I can make a good penman of you at your own home, in your spare time, no matter where you live or how poorly you now write. Ever fail to secure a good position because of poor penmanship? Ever know of better positions you could have stepped into if you only wrote a good hand? If not, you're an exception. The advantage of good penmanship is seen all around us.

I have been teaching penmanship by mail over 20 years. I know that any ambitious person can master penmanship just as quickly and thoroughly by my system at home as if in a schoolroom under the personal instruction of the teacher.

**BEGIN NOW** to learn good handwriting and be ready for the next better position that comes your way. Learn right at home—in your own room, outside of working hours. Your spare time is all I ask.

I teach *Spelling and Letter Writing* also.

#### This Brings FREE BOOK

F. W. TAMBLYN, 418 Ridge Bldg., KANSAS CITY, MO.

I am interested in improving my penmanship. Send me your Free Book, "How to Become a Good Penman," postpaid.

Name.....

Address.....

Mr. Weber's wonderful improvement shows in the specimens above was made in 2 months. Hundreds and hundreds of others in all parts of the country are doing the same.

**YOU CAN DO AS WELL**



# Salesmen Get the Big Pay

Highest salaries are paid Salesmen—because the Salesman is a direct producer of profits. He it is who brings in the orders—dividends depend on his success. The Trained Salesman never lacks a position—thousands of concerns are willing to pay well for his services.

## Why Not Be A Salesman?

Surely you can make good in this uncrowded, well-paying field—providing you get the proper training. Read above the letter of Mr. J. E. Wood—Mr. Wood was formerly a carpenter. Then read how Mr. J. L. Debonis—formerly a clerk—is now earning as high as \$100 a day as a Salesman. These letters are not unusual—in our files we have the originals of thousands of such letters from N. S. T. A. Students who have made good—letters from men who have graduated from work that was drudgery to work that brought the opportunity to travel on the finest trains—to live at best hotels—easy hours—financial independence.

## Study By Mail

Salesmanship can be mastered through home study as testified to by our record of thousands of successful students covering a period of Ten Years. Our Course of Instruction in Scientific Salesmanship, planned by Master Salesmen—gives you just the training necessary to qualify for a big paying position. It covers the entire field of Salesmanship. Among the many subjects taught are the following—how to prepare a "Selling Talk"—how to approach the prospect—how to manage the interview—how and when to close—how to handle sales correspondence—how to be a good mixer.

## Free Employment Bureau Service

Employers everywhere recognize the value of N. S. T. A. Training. We have constantly on file more requests for salesmen than we can possibly fill. The service offered by our Free Employment Bureau is a most valuable one. We put you in touch with good positions while you are still a student—and help you to make good.

## FREE This Book

Our Free Book, "A Knight of the Grip" contains testimonials from members now earning from \$100 to \$1000 monthly. It will be accompanied by a Special List of the many lines of businesses in which good positions are now open for Salesmen paying from \$2500 to \$10,000 yearly. A position as Salesman is ready for you—prepare yourself now—mail the coupon below—delay may mean opportunity lost. Address Dept. 507H.

## National Salesmen's Training Association

Chicago New York San Francisco

## Mail This Coupon NOW

National Salesmen's Training Association, Dept. 507H.  
CHICAGO NEW YORK SAN FRANCISCO

(Send your request to the office nearest your home)  
With no obligation on my part, please send me your Big FREE Illustrated Book  
"A Knight of the Grip."

Name \_\_\_\_\_

Street \_\_\_\_\_

City \_\_\_\_\_



## I am in the \$2500 to \$10,000 Class

"I was a carpenter, am now a Salesman, and can proudly say I am in the \$2500 to \$10,000 a year class. Wish I could invest more dollars that would bring me the big returns those invested in your Course did."—J. E. WOOD, Rooms 202-14 Pacific Bldg., San Francisco, California.

## Our Students Make Good

### I Now Earn As High as \$100 A Day

"I took your Course two years ago. Was earning \$15 a week clerking. Am now selling many of the largest firms in the U. S. I have earned more than \$100 a day. You secured me my position. Our Sales Manager is a graduate of yours."—J. L. DEBONIS, 1850 So. Harding Avenue, Chicago, Illinois.

### I Earned \$6500 This Year

"Last year I only earned \$600.00 as a clerk. This year I have earned \$6500.00 and have been promoted to Sales Manager, and done it by studying your Course during spare time. Your Employment Bureau offers me many good positions."—C. W. BIRMINGHAM, 128 Bank St., Dayton, Ohio.

### Your Course Makes Success Easy

"More than two years ago I joined the N. S. T. A. You secured me a good position with one of the best firms in their line. Am making fine wages. Former experience is unnecessary—your Course makes success easy."—Wm. H. Kessler, 199 N. 15th St., E. Orange, N. J.



## Stronger, Clearer Voice—for You!

A SINGING voice, a speaking voice. All weakness, all huskiness, all harshness banished. Special attention to stammering and lisping. A voice with clear, strong tones and increased range. This yours if you will just go through a system of silent, simple exercises under our direction. The famous Feuchtinger Method at last available in this country, is the easy way to build the voice. No strain on vocal organs. Strength given by a natural process (a home method). Permanent results.

**Write Today** Learn about this wonderful new method now. Recommended by physicians and greatest singers and speakers in Europe. Send for our literature today. Absolutely free and prepaid. It explains everything. Write.

### Perfect Voice Institute

Studio 1194, 1810 Wilson Avenue, Chicago

## A High School Course In Two Years

Learn in your own home. Here is a thorough, complete, and simplified high school course that you can finish in two years. Meets all college entrance requirements. Prepared by leading members of the faculties of universities and academies.

Write for booklet. Send your name and address for our booklet and full particulars. No obligations whatever. Write today—now, American School of Correspondence, Dept. P1194, Chicago, U. S. A.

## Be a Finger Print Expert



Police departments, factories and industries everywhere are adopting this system of identification. Experts needed at once. You can train yourself in spare time at home. Write for details.

**Free Book—Write** Valuable and interesting book on finger prints sent absolutely free and prepaid. Also details of special limited offer. Write at once, while this offer lasts.

EVANS UNIVERSITY, FINGER PRINT DEPT. Desk 9194, 1810 Wilson Avenue, CHICAGO

## LEARN WATCHMAKING

and become independent. Good-paying positions secured. Easy to learn. Send for FREE CATALOG.

ST. LOUIS WATCHMAKING SCHOOL, Dept. 5, ST. LOUIS, MO.

## STAMMERER

Attend no school until you read my book "How To Stop Stammering." A practical, modern Method that kills the fear of stammering.

The Hatfield Institute, 109 North Dearborn St., Chicago, Ill.

Learn to PAINT SIGNS and SHOW CARDS

I teach you personally, by mail, in a short time. Oldest and largest School. Big field, work interesting. You can EARN \$18 TO \$45 A WEEK

Writener, Minn., wrote: "Did job after first lesson, got \$10, profit \$7.00." Crawford, S. C., says: "Earned \$200.00 while taking course." Got literature, samples, guarantees—all FREE.

DETROIT SCHOOL OF LETTERING  
Established 1899. 204 D. S. of L. Bldg. DETROIT, MICHIGAN

Please Mention Popular Mechanics



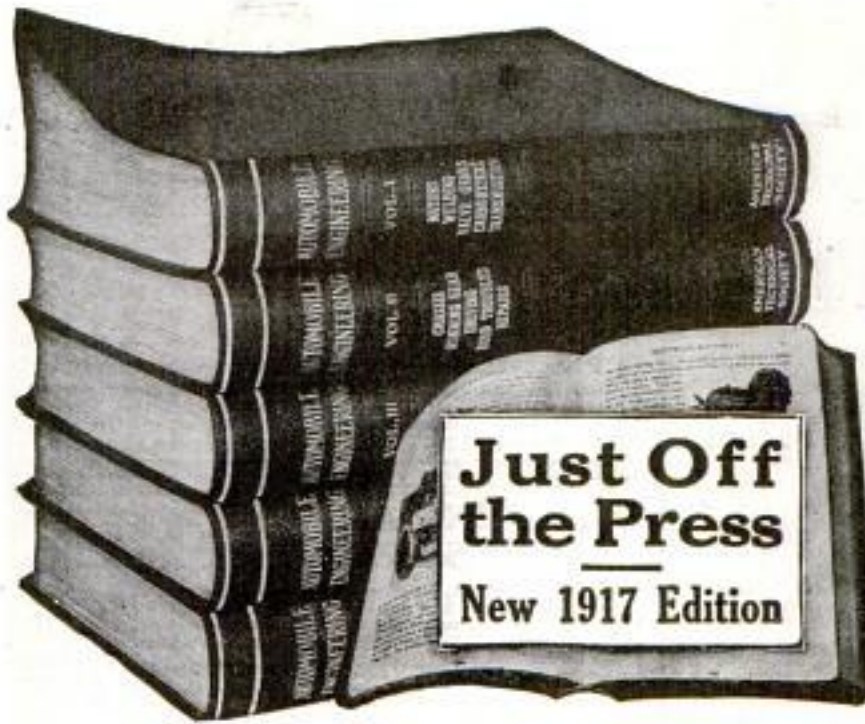

# 20c brings these books!

## Automobile Engineering

**A TWO-CENT STAMP** is all that it will cost you to get the five-volume library of Automobile Engineering delivered, prepaid, to your door—for seven days' free examination. The new 1917 edition is just off the press, and explains every practical repair method in simple, easily-understood English.

Hundreds of pages describe all the up-to-date systems of ignition, starting and lighting. Welding, vulcanizing, and commercial garage equipment and operation is thoroughly covered. Carefully cross-indexed, so that the information you want can be referred to instantly. Handsomely bound in flexible morocco leather, gold stamped, these five volumes should be owned by every man interested in automobiles. They contain the combined knowledge of the greatest experts in the business. 2,200 pages (5½x8 in.) and 2,000 illustrations, tables and explanatory diagrams.

And now a great introductory offer is open to those who will send the coupon at once. The regular price of this brand-new edition will be \$25.00, but you can get the complete library for only \$14.50—payable at the rate of 50c A WEEK!

# Shipped Free

## On 7 Days' Trial

To those who send the coupon immediately we will send the complete five volumes without a penny deposit—express prepaid. Then you can use the books for seven full days—see what they are going to mean to you. After the trial—if you think you can get along without them—send them back to us at our expense. The trial doesn't cost you a penny. But if you decide to buy—send only \$2.00 and then \$2.00 a month—50c a week—until the specially reduced price of \$14.50 has been paid.

### Partial List of Subjects:

Explosion Motors, Welding, Motor Construction and Repair, Carburetors and Settings, Valves, Cooling, Lubrication, Fire Wheels, Clutch, Transmission, Final Drive, Steering, Frames, Tires, Vulcanizing, Ignition, Starting and Lighting Systems, Wires, Diagrams, Shop Kinks, Commercial Garage Design and Equipment, Electricity, Storage Batteries, Cars and Buses, Motorcycles, Commercial Trucks, Glossary.

## FREE Consulting Service!

With each set we give you, absolutely free, a year's Consulting Membership in the American Technical Society. The regular price is \$12.00, but you get it free with this set. Put your perplexing problems up to a staff of experts. Ask them any other question you wish. The solution of one problem might easily be worth more than you pay for the books. Ask as many questions as you wish for an entire year.

## Send the Coupon!

Your name and address on the coupon brings the five books to you, express prepaid, for seven days' free trial. This offer is open to every person within the boundaries of the United States and Canada. Act quick—while offer lasts. Send coupon today—NOW!

**American Technical Society** Dept. A-1194  
Chicago, U.S.A.

**American Technical Society**  
Dept. A-1194 Chicago, U.S.A.

Please send me the 5 volume Automobile Engineering for 7 days' free examination. If I decide to buy, I will send \$2.00 within 7 days and the balance of \$2.00 a month until \$14.50 has been paid. When you send me a receipt showing that the \$25 set of books and the \$12.00 consulting membership are mine and fully paid for. If I think that I can get along without the books after the seven days' trial I will return them at your expense.

Name.....

Address.....

Reference.....

Please Mention Popular Mechanics



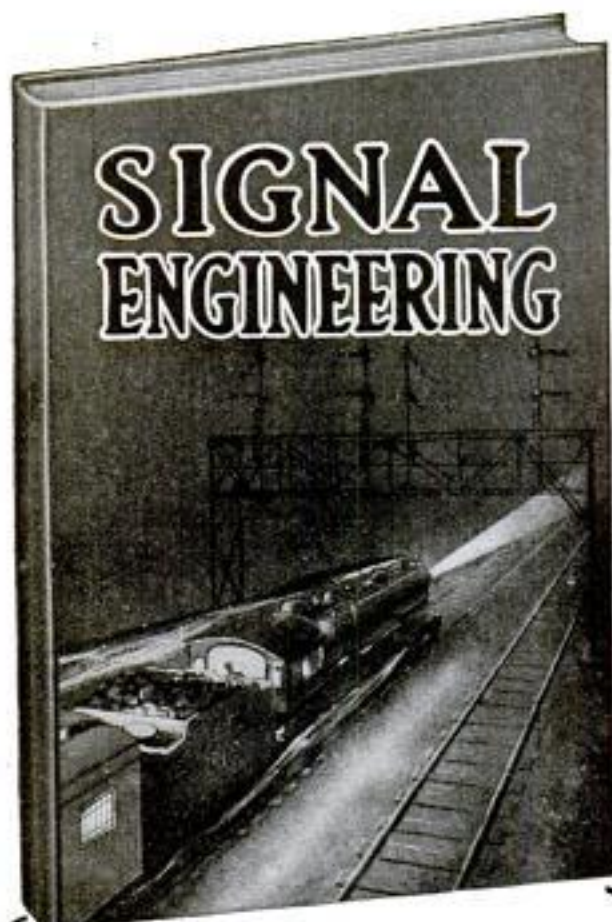

# SIGNAL ENGINEERING

## Free Book On Signal Engineering

THERE are thousands of miles of railroad that must be equipped with block signal systems. To superintend these installations and to maintain the systems now in use thousands of men are necessary. Golden opportunities are offered. Every ambitious man in America should write for the free book on Signal Engineering. It will be sent to you prepaid—without obligation.

### Men Are Needed to Accept High Salaried Positions

When you stop to consider that, at the present time, less than one-fourth of the passenger lines in this country are equipped with automatic block signal systems—and when you read that the day is fast coming when the law will compel railroads to install them, you will realize what remarkable opportunities are offered to ambitious men in the profession of Signal Engineering. The work is big—broad—high salaries are paid. \$20.00 a month is an ordinary salary for a Signal Engineer.

#### Department of Signaling

Dept. 1194, 1810 Wilson Ave.  
Ravenswood Station Chicago

GENTLEMEN:—Please send me absolutely free and prepaid your big new book on Signal Engineering. Also full particulars about your great special free outfit offer. It is distinctly understood that I assume no obligations of any kind.

Name.....

Address.....

Age..... Occupation.....

### Send the Coupon

Put your name and address in the coupon, or a letter or post card Now and get the free book about Signal Engineering. Too, we will tell you how you can get the training that you need in order to become a Signal Engineer. You will be under no obligation by writing for this free book. Do it Now.

Department  
of Signaling  
Dept. 1194  
1810 Wilson Ave.  
Ravenswood Sta.  
Chicago



### Learn a Paying Profession

that assures you a good income and position for life. For twenty-two years we have successfully taught

## PHOTOGRAPHY

Photo-Engraving and Three-Color Work

Our graduates earn \$20 to \$30 a week. We assist them to secure these positions. Learn how you can become successful. Terms easy—living inexpensive. Write for catalogue—NOW!

ILLINOIS COLLEGE OF PHOTOGRAPHY, 999 Wabash Avenue, Effingham, Ill.

### "FORGING AHEAD IN BUSINESS" FREE

This 128 page book, which we will send you free, tells of the wonderful help which the Modern Business Course and Service is to every man in business from manager to clerk; tells how it helps; tells who are back of this great institution, who are enrolled, and what they say about it. Send for this Free Book today

ALEXANDER HAMILTON INSTITUTE  
616 Astor Place, New York



### The University of Chicago

HOME STUDY in addition to resident work, offers also instruction by correspondence.

For detailed information address  
25th Year U. of C. (Div. V) Chicago, Ill.



Eschell Tower

## ENGINEERING MECHANICAL ELECTRICAL

One Year Practical Courses. Day and Evening classes. Splendid equipment and instruction. Low tuition. For particulars address

DETROIT TECHNICAL INSTITUTE  
Box 308, Y. M. C. A. Building, DETROIT, MICH.

### EARN TELEGRAPH

Morse and Wireless—R. R. Accounting (Station Agency) taught. Splendid opportunities. Positions secured. Marconi Co. contracts to employ graduates. We own and exclusively occupy two large modern buildings equipped with R. R. and Western Union wires and complete 2 K. W. Marconi Wireless Station. Largest school—established 42 years. Investment \$25,000. Endorsed by Railroad, Marconi and Western Union Officials. Expert practical teachers. Low living expenses easily earned if desired. Tuition low—Easy payments. Correspondence courses also. Catalogs Free.

Dodge's Telegraph, Ry. & Wireless Institute  
8th Street, Valparaiso, Ind.

## BE A BANKER

Prepare by mail for this high profession, in which there are great opportunities. Six months' term. Diploma awarded. Send for free book, "How to Become a Banker," EDGAR G. ALCOHN, Pres. AMERICAN SCHOOL OF BANKING  
419 East State Street, COLUMBUS, OHIO



### Men Wanted To Learn Automobile Business

EARN BIG MONEY—\$75 to \$300 Per Month

Only a few weeks required to train you. In six weeks I teach you to run and repair properly any automobile made. Learn to be repairman, demonstrator, garage manager and salesman. I teach thoroughly, practically and personally on real automobiles in everyday use. No books used. Tools furnished free. Actual practice on big, powerful cars brought here for inspection and repair.

SEND FOR BOOKLET, "Making You Master of the Auto." Free upon request.

WM. H. ANHELGES Milwaukee Motor School, 217-21 Seventh St., Milwaukee, Wis.

Please Mention Popular Mechanics





# Learn Electricity

in the Great Shops of

# COYNE!

Practical training is the golden road to quick success. No mere books or theory can fit you to hold the big paying jobs. Here in our great shops you learn Electricity from the bottom up—under actual working conditions—as every great electrical expert must learn to completely master it. Here you handle actual equipment! Here you actually do the work that pays

## \$125 to \$300 a Month

Think of the difference! No correspondence! No books and papers! No long hours of tedious grind. The work at Coyne is vibrating with life—charged with electricity. Experts show you everything. They work with you—show you how. You imitate these masters! You learn by doing. It's amazing how quickly you progress. From the simplest door bell to the mighty motors—dynamos—electrical locomotives—everything is mastered with remarkable ease. Hundreds of successful graduates prove this fact. Many finish in 4 to 5 months.

## Day or Evening Courses

LOW COST—EASY TERMS

Come to the great Shops of Coyne. Enter day or evening courses! Nothing bars you! Our tuition is so low it will astound you. You don't have to pay cash! We arrange acceptable easy payments if necessary. All tools and equipment are furnished free. Think of it! Your opportunity to thoroughly learn Electricity, Drafting, Plumbing, Motion Picture Operating, Bricklaying is right before you.

## FREE Employment Bureau!

Don't let *anything* stop you! We maintain a Free employment bureau. We help worthy—serious young men get work while studying. We also help place graduates in big jobs.

BENNETT WELLINGTON COOKE, *Director*

## COYNE NAT'L TRADE SCHOOLS

Dept. 1194, 39-51 E. Illinois St., CHICAGO

### Drafting

Mechanical,  
Architectural,  
Builders' Course

Most thorough and complete Practical Courses in America. No correspondence. No mere copy work. Experts show you every more in our big shops. Check coupon for FREE Book.

## MAIL COUPON FOR FREE BOOK

Get this book of Opportunity! From cover to cover it tingles with interest. Tells about our great shops! Covers many jobs open for Coyne trained men! Tells of great successes of Coyne graduates. Get this book by all means! It's free. Merely fill in the coupon, stating which trade you are interested in, and mail it **now—at once!**



B. W. COOKE, Director, COYNE NAT'L TRADE SCHOOLS  
Dept. 1194, 39-51 E. Illinois St., CHICAGO

Please send at once your big Free Book of Opportunity. I am interested in—  
 Electricity  Drafting  Plumbing  Bricklaying  Motion Picture Operating

Name.....  
Address.....  
Town.....  
State.....



# TRAFFIC MEN earn \$3,500 to \$10,000 Yearly



TRAFFIC MANAGER



R. R. TRAFFIC MEN

No other field or profession offers such advantages as are open to trained Traffic Men. Railroads, Factories, Jobbers, Commerce Clubs are taking all the trained men they can find. They are paying from \$3,500 to \$10,000 and more yearly for competent men. There are now more than 95,000 Traffic positions open in all parts of the country. We are training men in a short time to fill these positions. Only spare time is needed. The work is easy to understand; you begin to earn more after your first few lessons. The course is thoroughly practical. Anyone who understands common every day language will succeed. Positions are permanent.

## Learn from Practical Traffic Men

Our instructors are practical, experienced, successful traffic men. Been in the work for years, and are teaching men successful methods. Students get personal attention of our faculty. One man wrote: "I saved my firm \$4,000 from August 1st to December 1st." It was his first traffic position and he made good. Instructors help graduates for two years after graduation. We have over 100,000 tariffs on file. Rates, routing and classifications can be quoted from any two points in the U. S., Canada and Mexico. This immense tariff file, together with our practical instructors, gives an advantage found in no other school.

**Post Graduate Course Free** Our Students and Graduates have the privilege of coming to our School for Post Graduate Work. They may stay as long as they like. They get actual experience in rates, routing, classification and packing. This work is absolutely free. It is not essential, but is very helpful. This privilege is not found in any other school.



TRAFFIC BUREAU



COMMERCE CLUB TRAFFIC SEC'Y

## Why Traffic Men Are Needed

Factories, Auto Manufacturers and Wholesale Houses are extending territory. Every extension means new rates, routing, classification or changed packing methods. The Interstate Commerce Commission and the Railroads are constantly changing rates and classifications. It takes a trained Traffic man to handle problems like these. Only men who have been in the Traffic business for years, men who have grown up in this high-salaried business, are competent to train men. There will always be a demand for trained, competent Traffic Men.

**FREE** Our Booklet "TRAFFIC," catalog and full information, all **ABSOLUTELY FREE**. Make up your mind **Now** to get started. Get our literature at once.

<b>Traffic Men</b>	Salaries range from \$3,500 to \$10,000 yearly.
<b>Traffic Bureaus</b>	Bureaus make \$2,500 to \$10,000 yearly.
<b>R. R. Traffic Men</b>	Salaries vary from \$1,500 to \$12,000 yearly.
<b>Commerce Club Traffic Secretaries</b>	\$2,500, \$3,000, \$4,000, \$5,000, \$10,000 and up.

## MEN WITH VISIONS

**James J. Hill** was a man with a vision. He saw the possibilities of a railroad through the northwest; he accomplished his vision. **Cecil Rhodes** envisioned an immense railroad in South Africa. He lived to see his vision come thoroughly. **Thomas Jefferson** saw a vision of the U. S. reaching from ocean to ocean. He accomplished this. **Abraham Lincoln** saw great visions in the law practice and by hard knocks reached his goal. The vision of these great men made it possible for them to stand the hard knocks and overcome every obstacle. They were pioneers and it took a lifetime for them to win out. No one avoided them or told them how. Think of the possibilities for you in the traffic field. Think how quickly you can reach the big salary. Make up your mind to be a traffic man. Get started and don't let anything change your vision. Let our seasoned practical Traffic instructors train you for a big traffic position. It's a vision worth while. Graduates of the Interstate Traffic School are competent to handle any traffic position.

**INTERSTATE TRAFFIC SCHOOL, 24 Traffic Building, FORT WAYNE, IND., U. S. A.**

**Earn \$125 to \$250 a Month**

in the Steam Engineering field. Prepare in your spare time for a Stationary or Marine Engineer's License, or position as Locomotive Engineer. These great books, written by 27 experts, contain all the information necessary for you to take up this fascinating, high-salaried work. We send them free!

## Steam Engineering

7 volumes; 3300 pages, 7x10 inches; 2500 illustrations, full page plates, diagrams, etc.; hundreds of valuable tables and formulas. Handsomely bound in half red morocco, gold stamped. Covers the construction and operation of stationary, locomotive and marine engines and boilers; the use of gas and gasoline engines for power and locomotion; the transformation of steam and gas power into electricity, and the application of steam and gas power to refrigeration, compressed air, etc.

### Send FREE—Just Mail the Coupon

The entire seven volumes will be sent, express prepaid, to any resident of the U. S. or Canada, on receipt of the coupon below. Look these books over for a whole week free. Then decide whether or not you want them. If you do, send us \$2.00 within seven days and \$2.00 a month until the special price of \$19.50 has been paid. Otherwise we'll take them back at our expense. In addition to this liberal discount from the regular price of \$35.00, we include with each set a \$12.00 Consulting Membership. This entitles you to the advice of a staff of experts for a whole year free.

**American Technical Society, Dept. 51194 Chicago, U. S. A.**

Please send Encyclopedia of Steam Engineering for 7 days' free examination. I will send \$2.00 within 7 days and \$2.00 a month until I have paid \$19.50; thereafter I will notify you and hold the books subject to your order. Title not to pass until fully paid.

NAME.....  
ADDRESS.....  
REFERENCE.....

**IF YOU STAMMER**

attend no stammering school till you get my large FREE book and special rate. Largest and best school in the world curing by natural method. Write today.

**Lee Wells Millard, Pres., North-Western School, Inc.**  
2317 Grand Avenue Milwaukee, Wis.

**LEARN WATCH REPAIRING**

Be a watchmaker—you can learn this profitable trade by correspondence in a few weeks in your own home by the DeSelms Chart System. After you complete the course you will know a watch from A to Z. You will know just what the matter is and how to repair one. When you graduate you will be a practical watchmaker and repairer and competent to fill any position. Positions for our graduates.

Ask for our Free Book. It explains our system and terms.

**THE DeSELMS WATCH SCHOOL**  
23 Perry Street ATTICA, INDIANA

**STUDENTS ART MAGAZINE**

Publishes cash art assignments, lessons and articles on Cartooning, Designing, Illustrating, Lettering, and Chalk-Talking. Criticizes amateurs' work. Full of interesting and helpful information for artists and art students. Satisfactory or money refunded. 10 cents a copy, \$1 a year.

Send \$1 NOW, stamps or bill, to the Editor  
**G. H. LOCKWOOD, Dept. 237, Eshmun, Mich.**

**Learn to Play Piano Well**

**LEARN TO PLAY BY NOTE**

— in your own home. We'll teach you to play before company after a few lessons at small cost. Our method is that of the great masters of Europe. Write for present special low terms.

**APOLLO INSTITUTE OF MUSIC**  
368 Milwaukee St., MILWAUKEE, WIS.



# The Training For YOU!



**H. J. RAHE**  
President

This twin-six motor is block mounted.

Then there are the Eight and many other motors for my

students special training and experience. These motors are in the practice room. All Types of lighting and self-starting devices—full equipment, so that you learn all easily. Tire vulcanizing, Oxy-Acetylene welding—training and experience in all branches of the automobile business. My students do practical work. They handle welding torches under the guidance of master-welders. Don't bother with any training that gives you only a little—come here and I'll hand you a kit of tools—not printed books.



All types of motors—Block-mounted. Easy to get around.



17 Complete Welding Outfits. Big Demand for Expert Welders.

## Tractor Engineering

I want to enroll the full capacity of my school a month earlier this year, and to all students enrolling now I am giving a free scholarship for complete instruction in **Tractor Engineering, Power Farming, Gas and Stationary Engineering.** The development of the farm tractor and its growing popularity is second only to the automobile itself. Come and see my large tractor practice field and complete tractor and farm equipment. With this added knowledge you can reap new profits in an entirely new field. Remember—it's FREE when you enroll for my automobile course.



Both types of Tractors, Kerosene and Gasoline, Gang Plows, Big Practice Field

## Come to the School of Complete Equipment

—and let me train you to earn big money in the Automobile and Tractor Business. The supply of men to fill the many open positions and waiting opportunities is far short of the demand. Now is the time to start. I'll help you—I'll train you **right**. My success in training thousands of ambitious men is known throughout the country. I have been right here in Kansas City for a number of years and I rightly claim more successful graduates than any similar institution in the world. I am always ahead with complete equipment—with plenty of floor space and more expert instructors. My graduates earn from

# \$75 to \$350 a Month

**YOU CAN DO THE SAME** if you have ambition and determination to learn. **Rahe's Original Practical Method of Automobile Training and Experience** is everywhere recognized as the most efficient method of training ever devised. Remember—it's not theory—there are **no books or printed lessons**. My training is unique and distinctive—it's the **actual doing**—getting into overalls and starting at the bottom under the guidance of expert instructors.

## Only a Few Weeks Required

That's all—just a few weeks and you will have a thorough understanding of the basic principles of this wonderful business. You will then be ready for a position, paying good money right from the start—with a world of opportunity before you. My original practical method is all simple and easy. You get the full instruction in easy stages and you have the wonderful advantages of complete equipment—Automobiles, Tractors, Welding Plants, Big Drill Presses, Power Lathes, Forges, etc. Two big garages and repair shops. Cars of all kinds for my students' practical use. Every type of motor is represented in my equipment—block mounted so they are easy to get around, easy to take apart. It's the Rahe method—

**Practical—Efficient—Complete**

## Get My 80-Page Catalog

Use the coupon below or post card, but send now for my new catalog. Filled with Copper Engravings of men at work in the various departments—views of equipment—three big buildings and big tractor farm. Let me start you. **Let me help you to be the success you can be**—if you have backbone and ambition. Send for the book at once and read letters from men like yourself—who came to me without previous experience and are now earning big money.

**H. J. RAHE, President**  
**Rahe's Automobile Training School**

(World's Greatest Auto Training School)

1028 Locust St. Kansas City, Mo.

## OPPORTUNITY COUPON

**H. J. RAHE, Pres.,**  
**Rahe's Automobile Training School,**  
**1028 Locust St., Kansas City, Mo.**

Send me your new 80-page catalog, fully illustrated, telling of your Practical Training and big money opportunities in the Automobile and Tractor Business.

Name.....

Town.....

Street or R. F. D..... State.....



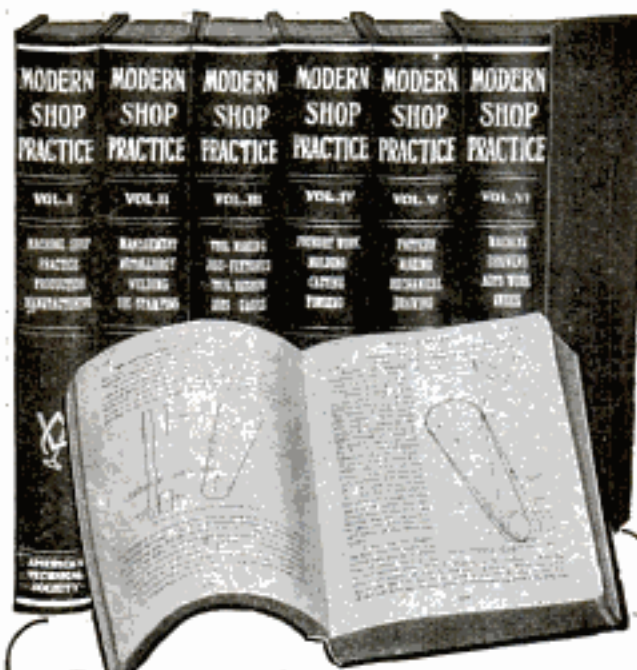

## Special Sale

**New Shop Books at Reduced Price**

**THIS** magnificent six-volume set of Modern Shop Practice that regularly sells for \$30.00 is now offered for only \$17.80. And this rock bottom price may be paid at the rate of \$2.00 a month. Think of it! Here are the latest shop books, complete in every detail and offered at a startling low price. Here is a tremendous offer. Here you can get all the knowledge that gives the boss his job—and more. The results of experiments and methods worked out by actual experience are placed before you. Profit by what others have learned through hard knocks.

## Everything About the Shop

In these six volumes, bound in genuine Bagdad leather, limp covers, 5½ x 8½ inches, 2300 pages, 2300 illustrations, is all that experts know about the shop and shop methods. All the latest inventions and methods explained in detail. Tabulated and cross-indexed so that everything is right at your finger tips ready for instant reference.

## 50 Cents a Week

Yes, this small sum pays for this superb set. Pay only \$2.00 after seven days' free examination and then \$2.00 a month (50¢ a week). We send these books upon your written request and you have 7 full days in which to decide if you want them. This offer is open to every man within the boundaries of the United States and Canada.

## Consulting Service Free

With each set is included a free consulting membership (regular value \$12.00) in the American Technical Society for one year. This gives you the right to ask our experts any question regarding shop practice for an entire year. There is no limit to this service. Ask as many questions as you like.

### Treats These Subjects in Every Detail:

Machine Shop Work — Machine Shop Measurement — Tool Making — Foundry Work — Pattern Making — Machine Drawing — etc.

## Send Coupon!

Just send the coupon — no money — and we will send, prepaid, to your own home, a complete set of Modern Shop Practice. Look it over for seven full days. Use it as if it were your own. Then, if you decide that you do not need it, return it at our expense. If you want to keep it, send us \$2 and \$2 a month thereafter until special price of \$17.80 has been paid. Send coupon.

**American Technical Society**  
Dept. M1194  
Chicago  
U. S. A.

Name .....

Address .....

Reference .....



*Dr. Charles P. Steinmetz says —*  
"There is an enormous field for the electrical worker," but the big opportunities are for the expert, not for the dabbler in electricity.

## The Only Way to Learn Electricity

You cannot become an expert in any field by simply reading a book. You must "learn by doing." That's the way electricity is taught at the New York Electrical School. Our concentrated-work with actual apparatus under actual conditions will put you abreast of men with from 5 to 10 years' experience in the electrical field. 4000 of our students have gone forth into electrical success.

### Learn by Doing

This method makes you an expert, able to command a high salary. All instruction is individual. You go ahead as fast as you can learn. Good students complete the course in seven months. Send today for FREE 64 page book. Tear out this advertisement and mail it with your name and address.

**NEW YORK ELECTRICAL SCHOOL**  
44 West 17th St. NEW YORK, N. Y.

## A High School Course In Two Years

Learn in your own home. Herein thorough, complete, and simplified high school course that you can finish in two years. Meets all college entrance requirements. Prepared by leading members of the faculties of universities and academies.

Write for booklet. Send your name and address for our booklet and full particulars. No obligations whatever. Write today—now.

American School of Correspondence, Dept. P1194, Chicago, U. S. A.



## Do You Like to Draw? Cartoonists Are Well Paid

We will not give you any grand prize if you answer this ad. Nor will we claim to make you rich in a week. But if you are anxious to develop your talent with a successful cartoonist, so you can make money, send a copy of this picture, with 6¢ in stamps for portfolio of cartoons and sample lesson plate, and let us explain.

The W. L. Evans School of Cartooning  
821 Leader Bldg., Cleveland, O.

## MUSIC TAUGHT FREE

**IN YOUR OWN HOME**  
You can read Music like this quickly

Piano, Organ, Violin, Mandolin, Guitar, Banjo, etc. Beginners or advanced players. One lesson weekly. Illustrations make everything plain. Only expense about 2¢ per day to cover cost of postage and music used. Write for FREE booklet which explains everything in full.

AMERICAN SCHOOL OF MUSIC, 51 Lakeside Building, CHICAGO

## Be a Finger Print Expert

Police departments, factories and industries everywhere are adopting this system of identification. Experts needed at once. You can train yourself in spare time at home. Write for details.

**Free Book—Write** Valuable and interesting book on finger prints sent absolutely free and prepaid. Also details of special limited offer. Write at once, while this offer lasts.

EVANS UNIVERSITY, FINGER PRINT DEPT.  
Desk 9194, 1810 Wilson Avenue, CHICAGO

## FREE BOOK ON BANKING

Tells of the great opportunities in this wonderful profession, and how you can learn by mail. Six months' term. Diploma awarded. EDGAR G. ALCOORN Pres., AMERICAN SCHOOL OF BANKING  
490 East State St., Columbus, Ohio

## JEWELRY ENGRAVING

We teach you, by our new and original method of instruction, this clean, fascinating and profitable business right at your home, and furnish you all tools needed absolutely free. Write for free book to the WISCONSIN SCHOOL OF ENGRAVING, Sirsh Bldg., MILWAUKEE, WIS.



# Ambition

## -take a Lesson from Life

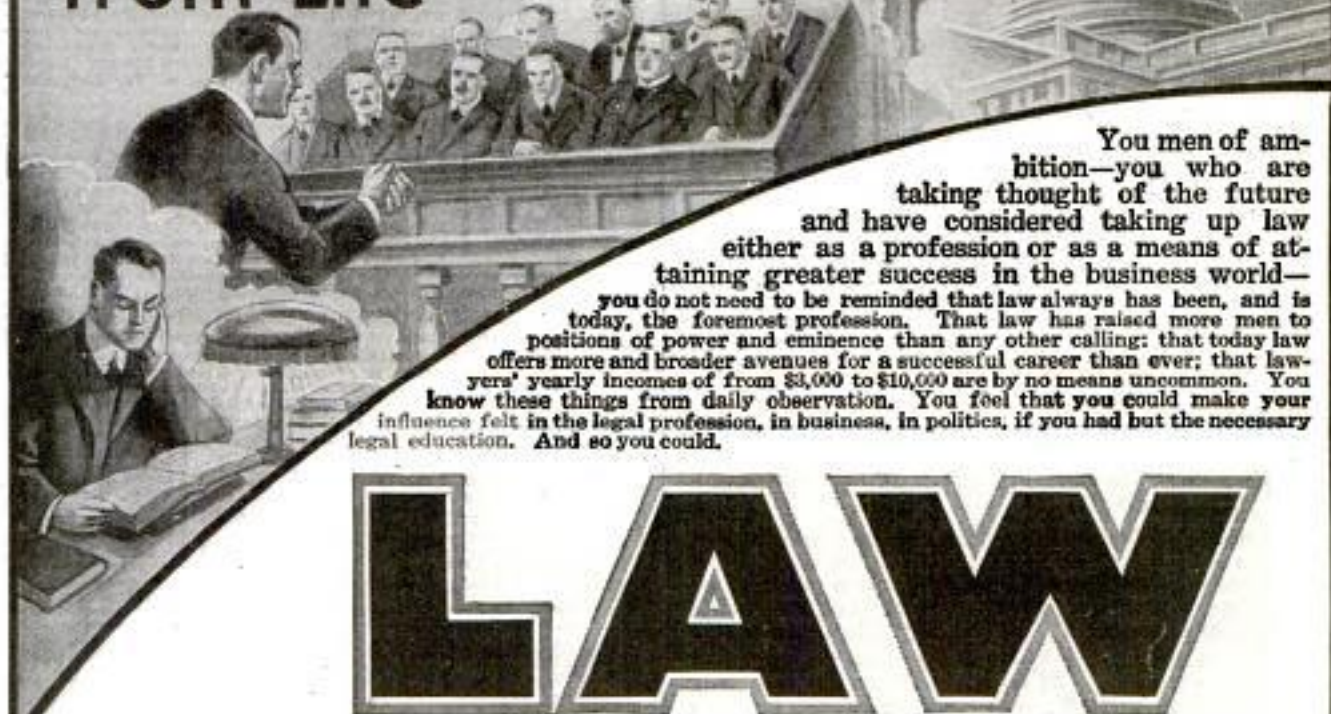

You men of ambition—you who are taking thought of the future and have considered taking up law either as a profession or as a means of attaining greater success in the business world—you do not need to be reminded that law always has been, and is today, the foremost profession. That law has raised more men to positions of power and eminence than any other calling; that today law offers more and broader avenues for a successful career than ever; that lawyers' yearly incomes of from \$3,000 to \$10,000 are by no means uncommon. You know these things from daily observation. You feel that you could make your influence felt in the legal profession, in business, in politics, if you had but the necessary legal education. And so you could.

# LAW

## At \$3,000 to \$10,000 a Year Is Your Opportunity

Right now you may be debating the question as to where you can best learn law. Let us help you answer that question. Let us tell you how, through our simplified Home Study Course, we have revolutionized the study of law. Let us explain fully, just how easily this great law course can be mastered right in your own home, during spare time; how we have taken the hard, grinding work out of the study of law and have made it as fascinating and absorbing as a work of fiction.

There are many things about this really remarkable home study law course which you should know. For instance—

### Do You Realize—

That the LaSalle Home Study Text and Course are prepared by some of the ablest law professors, jurists and legal experts in the country? The list includes such men as James Parker Hall, Dean of University of Chicago Law School; James DeWitt Andrews, former member faculty Northwestern University, and other famous legal authorities, and professors in such colleges as Harvard, Leland Stanford, University of California, Michigan, Wisconsin, Etc.

That it is the only home study law course in existence that is of university grade and that gives you the same kind of legal instruction and training—the same kind of individual lessons, class talks, quizzes and examinations—that you would receive at the most famous resident law schools in America?

That, under the laws of the State of Illinois, we are authorized to confer the degree of LL. B. on our graduates?

That LaSalle graduates taking bar examinations in states where the requirements are most rigid, and in competition with graduates of the best known resident law schools of the country, are among those who have passed with highest honors?

That, should a student fail to pass the bar examination in any state, we guarantee to give him additional instruction and coach him free of charge until he does pass?

That we further give a legal binding guarantee to refund the entire amount of tuition paid, if the student is dissatisfied with course?

That there are, in practically every state in the Union, LaSalle Law graduates who are today highly successful practicing lawyers?

**LaSALLE EXTENSION UNIVERSITY, Dept. 464-F Chicago, Ill.**  
The World's Greatest Extension University

That, as a part of the course, and immediately upon enrolling, we furnish a magnificent law library consisting of 14 massive volumes bound in X sheep—the preparation of which cost us over \$50,000?

Do you grasp the full significance of what it means to you to be able to obtain this thorough, practical course of university grade on terms so easy that you would scarcely miss the money? And the total cost is so surprisingly small you will wonder how it is possible.

### FREE Complete Course in Public Speaking

Every lawyer—every successful man—should be a forceful speaker. Mail coupon at once for full particulars of how, by your acting promptly, we will give you, absolutely free, a complete course in public speaking that will quickly train you in the fine art of persuasive speech. Course prepared by Frederick B. Robinson, A. B., A. M., Ph. D., Professor Public Speaking at College of City of New York.

### You Owe It To Yourself—To Your Future—To Get All the Facts

They are interestingly told in our remarkable book which is yours, free for the mailing of the coupon. It imposes not the slightest obligation upon you—and the book, together with our book, "Evidence" and letters from hundreds of successful graduates which we will send you, also free—will give you a clearer insight of the wonderful work of this great institution and of the high educational ideals it has set and is maintaining.

ACT! Take your first step toward greater success today. Mail coupon.

**MAIL NOW!**  
COUPON

LaSalle Extension University  
Dept. 464-F - Chicago, Ill.

Without obligation on my part, send me by return mail, information concerning your Course in law together with the free books: "Evidence" and Valuable Law Guide —also your offer of FREE Course in Public Speaking.

Name.....  
Street and No.....  
City..... State.....





**There's the only man who controls your future**  
 Nobody else can push you ahead. Nobody else  
 can hold you back. Money, position, power—  
 the things you want—it's up to you to win them.  
 And you can do it.

If you want a better job than the one you have, there's  
 just one thing to do—get ready for it. Don't worry about  
 opportunities. Employers everywhere are looking for  
 men who can do things. Learn to do some one thing better  
 than others, and there'll be plenty of them looking for you.

And you can get ready—for any work you choose—  
 through the International Correspondence Schools. You  
 can do it at home, in spare time, without losing a day or a  
 dollar in your present occupation.

Your future depends on yourself. Start to build it today  
 and let the I. C. S. help you. Here's all we ask: mark and  
 mail this coupon.

TEAR OUT HERE

### INTERNATIONAL CORRESPONDENCE SCHOOLS

Box 5567, SCRANTON, PA.

Explain, without obligating me, how I can qualify for the position, or in the subject, before which I mark X.

- |   |  |
|---|--|
| <input type="checkbox"/> ELECTRICAL ENGINEER        | <input type="checkbox"/> SALESMANSHIP              |
| <input type="checkbox"/> Electric Lighting          | <input type="checkbox"/> ADVERTISING MAN           |
| <input type="checkbox"/> Electric Car Running       | <input type="checkbox"/> Window Trimmer            |
| <input type="checkbox"/> Electric Wiring            | <input type="checkbox"/> Show Card Writer          |
| <input type="checkbox"/> Telegraph Expert           | <input type="checkbox"/> Outdoor Sign Painter      |
| <input type="checkbox"/> Practical Telephony        | <input type="checkbox"/> RAILROADER                |
| <input type="checkbox"/> MECHANICAL ENGINEER        | <input type="checkbox"/> ILLUSTRATOR               |
| <input type="checkbox"/> Mechanical Draftsman       | <input type="checkbox"/> DESIGNER                  |
| <input type="checkbox"/> Machine Shop Practice      | <input type="checkbox"/> BOOKKEEPER                |
| <input type="checkbox"/> Gas Engineer               | <input type="checkbox"/> Stenographer and Typist   |
| <input type="checkbox"/> CIVIL ENGINEER             | <input type="checkbox"/> Cert. Public Accountant   |
| <input type="checkbox"/> Surveying and Mapping      | <input type="checkbox"/> Railway Accountant        |
| <input type="checkbox"/> MINE FOREMAN OR ENGINEER   | <input type="checkbox"/> Commercial Law            |
| <input type="checkbox"/> Metallurgist or Prospector | <input type="checkbox"/> Traffic Management        |
| <input type="checkbox"/> STATIONARY ENGINEER        | <input type="checkbox"/> GOOD ENGLISH              |
| <input type="checkbox"/> Marine Engineer            | <input type="checkbox"/> Teacher                   |
| <input type="checkbox"/> ARCHITECT                  | <input type="checkbox"/> Common School Subjects    |
| <input type="checkbox"/> Contractor and Builder     | <input type="checkbox"/> CIVIL SERVICE             |
| <input type="checkbox"/> Architectural Draftsman    | <input type="checkbox"/> Railway Mail Clerk        |
| <input type="checkbox"/> Concrete Builder           | <input type="checkbox"/> Textile Overseer or Supt. |
| <input type="checkbox"/> Structural Engineer        | <input type="checkbox"/> Navigator                 |
| <input type="checkbox"/> PLUMBING AND HEATING       | <input type="checkbox"/> AGRICULTURE               |
| <input type="checkbox"/> Sheet Metal Worker         | <input type="checkbox"/> Spanish                   |
| <input type="checkbox"/> CHEMICAL ENGINEER          | <input type="checkbox"/> German                    |
|   | <input type="checkbox"/> French                    |
|   | <input type="checkbox"/> Italian                   |

Name \_\_\_\_\_  
 Occupation \_\_\_\_\_  
 & Employer \_\_\_\_\_  
 Street \_\_\_\_\_  
 and No. \_\_\_\_\_  
 City \_\_\_\_\_ State \_\_\_\_\_

If name of Course you Want is not in this list, write it below.

## Garages Earn \$3,000 to \$10,000 Yearly Auto Mechanics \$80 to \$200 Monthly



I will make you a competent Auto Mechanic, Classifier, Tractor Operator, Farm Lighting Expert, Salesman or Garage Owner in a short time, the I. M. I. way, in spare time at home.

Harry L. Wells, Pres.

Get into Auto Business where success is sure. Competent Auto Mechanics needed constantly. Factories and garages advertising for competent men. Garages and Sales companies paying big salaries to men who know autos thoroughly. Farmers need Tractor Operators. The demand is for trained men. 1,250,000 cars will go into use in six months; 3,500,000 now in use. Think of men in Auto Business making fortunes. More cars mean more garages, more auto mechanics. Knowledge means money. Opportunities all about you. I. M. I. Course easy to understand, has complete detailed diagrams of everything. No previous education or auto experience needed. Earn while you learn. Start doing work in spare time, after first few lessons. Extra money will more than pay tuition. Pay for course in small monthly payments.

### Learn Electrical Equipments

We teach how to handle every electrical equipment. You learn to locate trouble quickly. Starting, lighting and ignition troubles can stump you. 80% of auto troubles are electrical. Electrical Auto Men get big pay, have steady jobs. Garages giving best electrical service get business easily and hold it. You learn how to adjust carburetors, time valves, care for electrical troubles. Complete course as quickly as you like. No matter what business you are in, you can succeed if you take I. M. I. Course.

### CAR OWNERS—AUTO MECHANICS—GARAGES

One I. M. I. graduate saved price of course in three months fixing his own car. Hundreds of car owners taking I. M. I. Course so they can save repair bills. I. M. I. graduates in demand everywhere because they make good. More garages needed everywhere. I. M. I. graduates are competent to open them. We teach men how to build, rebuild, repair and operate every make of auto including Packard Twin-6, Cadillac-8, Hudson Super-6, Owen Magnetic.

### 25 LESSONS ABSOLUTELY FREE

This remarkable offer is made to 1000 men—One man in each community. I will meet them half way, by giving half the course (25 lessons) free. I want men of quick decision and foresight. Send for special enrollment blank, free offer, testimonials, literature, all free. A post card will do.

### Iron Clad Money-Back Guarantee

I guarantee to return to any student all his money if he writes me within 10 days after completing last lesson that he is not satisfied.

Harry L. Wells, Pres.

International Motor Institute

24 Kessler Bldg.  
 CHICAGO, ILL.

## BOYD SHORTHAND IN 30 DAYS

Shorthand simplified. Learned at home in 30 DAYS. Boyd Syllabic System, based on Syllables. No shading—no positions. Writers hold World's Record. Two of the largest Mail Order Houses have installed the Boyd System. 100 to 150 words a minute guaranteed. Write today for Special Offer, Free Catalog and Sample Lesson. Chicago Home Study Schools, 504 Reaper Bldg., Chicago, Ill.

## STAMMERERS

Our course of private lessons will correct your impediments.  
**BOSTON STAMMERERS' INSTITUTE**  
 Founded 1867, Samuel D. Robbins, Principal,  
 246 Huntington Ave. BOSTON, MASS.

### LEARN WATCHMAKING AND ENGRAVING



Earn while learning. Most practical watch school. Individual instructions. Graduates in great demand. Book free. Chicago School of Watchmaking, 63 E. Van Buren St., Chicago

## AT HOME Learn TO SING

Send 2-cent Stamp for Helpful Booklet, "The Voice Made Beautiful."  
 HARVEY SUTHERLAND, 1832P 49th St., BROOKLYN, N. Y.

## LEARN LANGUAGES BY LISTENING ON YOUR OWN PHONOGRAPH



at home with Disc Cortinaophone Language Records. Write to us for FREE booklet today; easy payment plan.

Endorsed by leading universities  
**CORTINA ACADEMY OF LANGUAGES,**  
 Suite 2196, 12 East 46th St., New York

Spanish-French-English-Italian-German

Please Mention Popular Mechanics





## Do You Like to Draw?

Whether your ambition is to become a second Bud Fisher or whether you draw merely for your own amusement—you will find lots of inspiration in

# CARTOONS MAGAZINE

It contains each month the cream of caricature, and cartoon art the world over. The foremost American cartoonists are represented, together with the most famous of the Parisian artists and cartoonists of Berlin, London, Petrograd, and Rome.

Either as an art student or a student of current events you will enjoy seeing how cartoonists are portraying world history in the making. "Cartoons" is a monthly review, but doesn't take itself too seriously.

There are pictures by Ethel Plummer, stories by Helena Smith-Dayton, comics by King, Webster, and others, and Parisian sketches by the artists of Fantasio and La Baionnette. It also tells what the big fellows in the cartoon world are doing.

A two-bit piece together with the following blank filled out, will bring you post haste a sample copy.

CARTOONS MAGAZINE,  
6 North Michigan Avenue, CHICAGO

Enclosed find 25 cents for which send me a sample copy of your magazine.

Name.....

Street and No.....

City..... State.....

All sizes  
for both men  
and women

The newest  
ideas in gold  
strata cases



## The 21 Jewel Burlington is a Rare Bargain

The *Burlington* smashes all watch competition. This superb new model surpasses anything of the past. 21 jewels, adjusted to positions, temperature and isochronism. Runs almost two days on one winding. New thin model—all the newest ideas in gold strata cases to choose from.

### \$2<sup>50</sup> a Month

And all of this for \$2.50—a great reduction in watch prices—direct to you—positively the exact prices the wholesale dealer would have to pay. Think of the high-grade, guaranteed watch we offer here at such a remarkable price. And, if you wish, pay this rock-bottom price at the rate of \$2.50 a month. Write now.

**See It First!** Don't pay a cent to anybody until you see the watch. Then look at the works! There you will see the masterpiece of watch makers' skill. A timepiece adjusted to positions, temperature and isochronism. Write!

*Every Fighting Vessel in the U.S. Navy has the Burlington Watch aboard. This includes Every Torpedo Boat—Every Submarine as well as the Big Dreadnaughts.*

## New Watch Book

### FREE!

Get the Burlington Watch Book by sending coupon. You will know more about watch buying after you read it—and it will be sent to you free and prepaid. Send the coupon today for watch book and our special offer.

**Burlington Watch Co.**  
Dept. 9194  
16th St. and Marshall Blvd.  
Chicago, Ill.

**Burlington Watch Co.**  
19th St. and Marshall Boulevard

Dept. 9194, Chicago, Ill.

Please send me without obligation (and prepaid), your free book on watches, with full explanation of your cash or \$2.50 a month offer on the Burlington Watch.

Name.....

Address.....



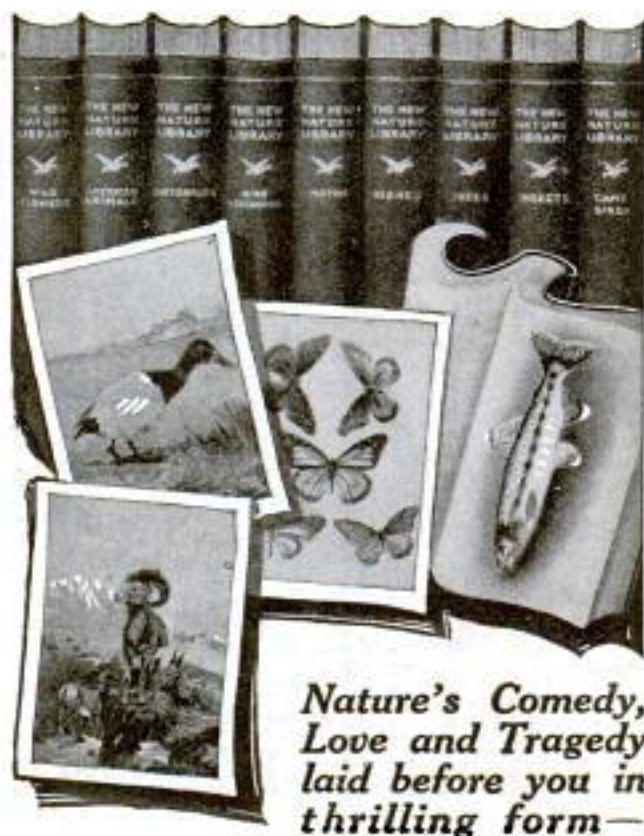

*Nature's Comedy,  
Love and Tragedy  
laid before you in  
thrilling form—*

THE quarrels among the trees, love affairs of the birds, the intrigues of the flowers, the warring of the wild beasts—all this is thrillingly told in the greatest Nature set ever written.

## The New Nature Library

Lays before you all the secrets of forest, field and stream. Now yours on special terms if you act quickly. Gives a new delight to all outdoors. Brings nature into your home. Children love the fascinating stories and many pictures, and it will give you the most wonderful romances you ever read.

Greatest experts in the country have contributed to these books—Dr. David Starr Jordan of Leland Stanford University, Dr. Howard of U.S. Department of Agriculture, Dr. Evermann of U. S. Fish Commission, Dr. Holland of Carnegie Museum, and Neltje Blanchan.

Size of volumes, 7 1/4 inches x 9 3/4 inches. Hundreds of illustrations. Thousands of pages of fascinating text matter. Bound in durable green cloth, or a flexible black leather. Gilt tops, silk headbands, decorated end papers. Order while the edition lasts.

### Splendid Pictures!

A vast collection of wonderful color plates made direct from Nature. Shows you just how the birds, animals, fish, trees and flowers look in their native haunts.

**Special Offer** The edition is limited. It will soon run out. The next edition will undoubtedly cost more. Do not postpone sending.

**Send This Coupon**

Doubleday,  
Page & Co.,  
Dept. 304,  
Garden City, N.Y.

Send me the big 9-volume Nature Library. I am enclosing \$1 with order and agree to send \$3 per month until a total of \$24.50 has been paid. If I keep the books, otherwise I will return them in seven days and you are to refund my dollar.

Note: If you want the rich, limp leather edition \$1 down and \$4 per month, total price \$44.50, write "yes" here.

Name.....

Address.....

Reference.....

We ship the books at once. You pay only \$1.00 with the order and \$3.00 a month until \$34.50 is paid if you choose the cloth, or \$4.00 a month until \$44.50 is paid if you prefer the leather. If you are not perfectly satisfied with the books we will refund your dollar—but you must act at once. Remember, the edition is small. Act now.

**Doubleday, Page &  
Company**  
GARDEN CITY  
NEW YORK

**\$80 to \$250  
and  
more per Month**

— is being made by our graduates as Expert Auto Engineers, Chauffeurs, Race Drivers, Shop Foremen, Testers, etc.; others make \$12,000 to \$20,000 yearly in salary and profits—because our training is thorough and practical.

Opportunities now are better than ever; we have constant calls for more and more men. To get the best positions you must have the right training and the place to get it is the

## CLEVELAND AUTOMOBILE SCHOOL

14 Years of Success—Over 4000 Graduates

Our school has the latest equipment including Knight type and 12 and 8 cylinder motors; latest starting and lighting equipment; Akron-Williams tire repair equipment, etc., etc.

### JOIN US NOW!

Up-to-date training in 4 weeks, tuition reasonable, board \$5 to \$6 a week. New classes forming. Come now.

**Cleveland Automobile School**  
2338 Euclid Ave., Dept. 4, Cleveland, O.



## DON'T TAKE A COURSE IN MACHINE DRAFTING

til you've read my proposition. Practical, experienced Draftsman, regularly employed in large modern works, will teach a few men by mail. Best way to become a well-paid Draftsman. Special courses in Mathematics also. Instruments furnished. Rates very reasonable. Pay a part after in position. Draftsman, 252 S. Corona St., Denver, Colo.



## FINLAY Engineering College

KANSAS CITY, MISSOURI  
ONLY SCHOOL OF THE KIND IN THE WEST

Specialties: Electricity, Steam, Gas. Six weeks, three months, year, and two year courses. Auto-Tractor, Armature Winding, Conduit Work, Lathe Work, Oxy-Acetylene Welding, Corlies Valve Setting, Operation of Steam, Gas, Electric Machinery. Anything you want, any time you want it, night or day, from a week to two years. Write for Catalog W.



## Marvelous Book Sent FREE

You can now learn Taxidermy, the wonderful art of mounting birds, animals, tanning skins, etc. Learn at home, by mail. The free book tells how. Mount your own trophies. Decorate home and den. Hunters, trappers, nature lovers, you need taxidermy. Interesting, fascinating, big profits. Join our school, 65,000 students. Success guaranteed. Get our free book without delay. Send right now—today.

N. W. School of Taxidermy, 1194 Elwood Bldg., Omaha, Neb.

## RIDER AGENTS WANTED

Everywhere to ride and exhibit the new Ranger "Motorbike" completely equipped with electric light and horn, carrier, stand, tool tank, coaster-brake, mud guards and anti-skid tires. Choice of 44 other styles, colors and sizes in the famous "Ranger" line of bicycles, all at Factory-to-Rider prices.

DELIVERED FREE on approval and 30 DAYS TRIAL. Send for big free catalog and particulars of our Thirty Days Free Trial offer and marvelous offers and terms.

**TIRES** Lamps, Horns, Wheels, Sundries, and repair parts and supplies for all bicycles—at half usual prices.

SEND NO MONEY but tell us exactly what you need. Do not buy until you get our Factory-Direct-to-Rider price, terms and the big FREE catalog.

**MEAD CYCLE COMPANY**  
DEPT. 8 108 CHICAGO, U.S.A.



Please Mention Popular Mechanics



# This will Prove Your Ambition

**T**HIS little "X" has marked the way to success for thousands of ambitious men. It marked the day when they stopped *dreaming* and began *acting*. Merely dreaming about the job ahead won't help you get it. But marking "X" in the coupon proves your ambition—and shows that you are ready to put your dreams into *action* to earn success.

The job you dream about *can* be yours. Not through favor or pull or some lucky chance—but through *training*. Thousands are proving it every day.

And it is easy for you to get that training.

It isn't necessary to make a drudge of yourself. The first step is to mark *your* "X" before the job you want, and we will show you the way to success.

## Make Your Mark Now

Mark an "X" before the job you want, and mail the coupon to us now. We'll show you *your* way to success—more simple and easy than you have dreamed. You'll be under no obligation and for the sake of your ambition you should act today. Make your mark now.

Send the coupon.

**American School**  
 of Correspondence, Chicago, U.S.A.

Dept. G 1194

American School of Correspondence,

Dept. G 1194, Chicago, Ill.

Gentlemen: Please send me booklet and tell me how I can fit myself for the position marked X.

..... Electrical Engineer	..... Business Law
..... Elect. Light & Pwr. Sup.	..... Business Manager
..... Hydroelectric Engineer	..... Auditor
..... Telephone Engineer	..... Accountant
..... Architect	..... Certif'd Public Acc'tnt
..... Architect'l Draftsman	..... Stenographer
..... Building Contractor	..... Bookkeeper
..... Build'g Superintendent	..... Fire Ins. Inspector
..... Structural Engineer	..... Fire Ins. Adjuster
..... Structural Draftsman	..... Fire Ins. Expert
..... Mechanical Engineer	..... Sanitary Engineer
..... Mechanical Draftsman	..... Master Plumber
..... Civil Engineer	..... Plumb'g & Heat'g Est.
..... Steam Engineer	..... Heat'g & Vent. Engin'r
..... Shop Foreman	..... Reclamation Engin'r
..... Shop Superintendent	..... Automobile Engineer
..... Sheet Metal Draftsman	..... Automobile Repairer
..... Lawyer	..... High School Course

We also prepare for civil service examinations in all engineering subjects.

Name.....  
 Address.....

Please Mention Popular Mechanics



## YOUR OPPORTUNITY

- TO LEARN THE AUTOMOBILE BUSINESS
- TO SEE AND KNOW NEW YORK CITY
- TO MAKE FROM \$75 TO \$300 A MONTH
- TO GET INTO A BUSINESS FOR YOURSELF

Get out of that rut into a profitable business. The automobile field offers more opportunities for the **TRAINED MAN** than any industry today—and they are getting bigger every year. **THINK—SERIOUSLY—NOW**—if this isn't just the opportunity you've been seeking. Automobile men are combing the country for trained men for every branch of this mammoth business.



### —Learn in New York City—

Visit New York City—see the sky scrapers—the gigantic ocean liners—old Broadway—the Statue of Liberty—the world famous sky line—and the million and one things you have heard people talk about. Right now **YOU ARE** planning to go somewhere to train yourself for a well paying position or a business of your own. This **IS** your opportunity to become thoroughly acquainted with New York and at the same time **SETTLE THE QUESTION OF YOUR FUTURE PAY ENVELOPE.**

#### Make \$75 to \$300 a Month

This old world won't give you any more than you will walk up and take, but when you step up and say, "I'm after mine," and put "pep" into your action, the world hands it right over. A thorough training in the automobile business immediately puts more money in your pay envelope—and the more you know the bigger the pay envelope.

#### Our Course—Our Motto

Think of it—a full five weeks' practical course under the most competent instructors available, in the most complete and up-to-date school in the country—right off Broadway in the heart of New York City—Day and Night classes. We have lists of desirable places, conveniently located to school, for you to stay while learning. Our dealings with our students have been our mainstay and built for us the fine school we now have. Everybody gets a square deal and thorough personal instruction.

#### Be Independent—

#### Start a Business of Your Own

Once you are trained the **Stewart** way you need not work for the other fellow—you have sufficient knowledge to start a business yourself—in every city there is a great opportunity for the live fellow who will get out and hustle—and there's big money in it.

#### Don't Delay—Act Quickly— Write Today

Write at once for our catalog giving detailed information about our course—how we help our students. Start any time, but **don't wait** a minute to ask for our catalog which contains just the proposition you have been seeking.

## THE STEWART AUTOMOBILE SCHOOL

Department 1, 225 West 57th Street, at Broadway, NEW YORK CITY  
Established nine years—the old dependable school. Founded on honor—Prosperes on merit.



Watch  
will be  
Delivered  
on First  
Payment



# 10c DOWN and You keep the watch

New easiest watch selling plan. Send us only 10 cents and we will ship the watch direct to you on your credit—the highest grade watch—an Illinois watch—and at a lower price than you would ordinarily pay for spot cash. These are not big, clumsy 18 size watches. They are the latest and most up-to-date gentleman's thin model watches 16 or 12 size. A regular spot cash \$25 Illinois watch for only \$22.50.

### \$22.50 Only 10c Down

on the following remarkable terms: and a dime added to a dime each week. *This is the easy plan of payment:*

\$ .20 the 2nd week	\$ .90 the 9th week	\$1.60 the 16th week
\$ .30 the 3rd week	\$1.00 the 10th week	\$1.70 the 17th week
\$ .40 the 4th week	\$1.10 the 11th week	\$1.80 the 18th week
\$ .50 the 5th week	\$1.20 the 12th week	\$1.80 the 19th week
\$ .60 the 6th week	\$1.30 the 13th week	\$1.80 the 20th week
\$ .70 the 7th week	\$1.40 the 14th week	\$1.80 the 21st week
\$ .80 the 8th week	\$1.50 the 15th week	\$22.50—Total

This offer is open to every honest person of legal age in the U. S.

Ladies' high grade up-to-date bracelet watches \$18. Ladies' full-jeweled open-face Illinois watches \$16.50. Hunting case \$18. All sold on same easy plan. Send a dime today and get your watch on this easy plan. Put an X in coupon for the watch you want. Send today.

The Wholesale Jewelry Co., 5707 South Blvd., Dept. 5248, Chicago, Ill.

#### 10c COUPON

Wholesale Jewelry Co.

5707 South Blvd., Dept. 5248, Chicago, Ill.

Gentlemen: Enclosed is 10c; send me an Illinois watch: ( ) 16 size, ( ) 12 size, ( ) ladies' bracelet, ( ) ladies' open face, ( ) ladies' hunting case.

#### 17 JEWEL ILLINOIS

High Grade Movement, (Adjusted) Steel Escape Wheel fitted with Gold Filled Double Stock 20 Yr. Guarantee Case

Name.....

Address.....



# REACH OUT

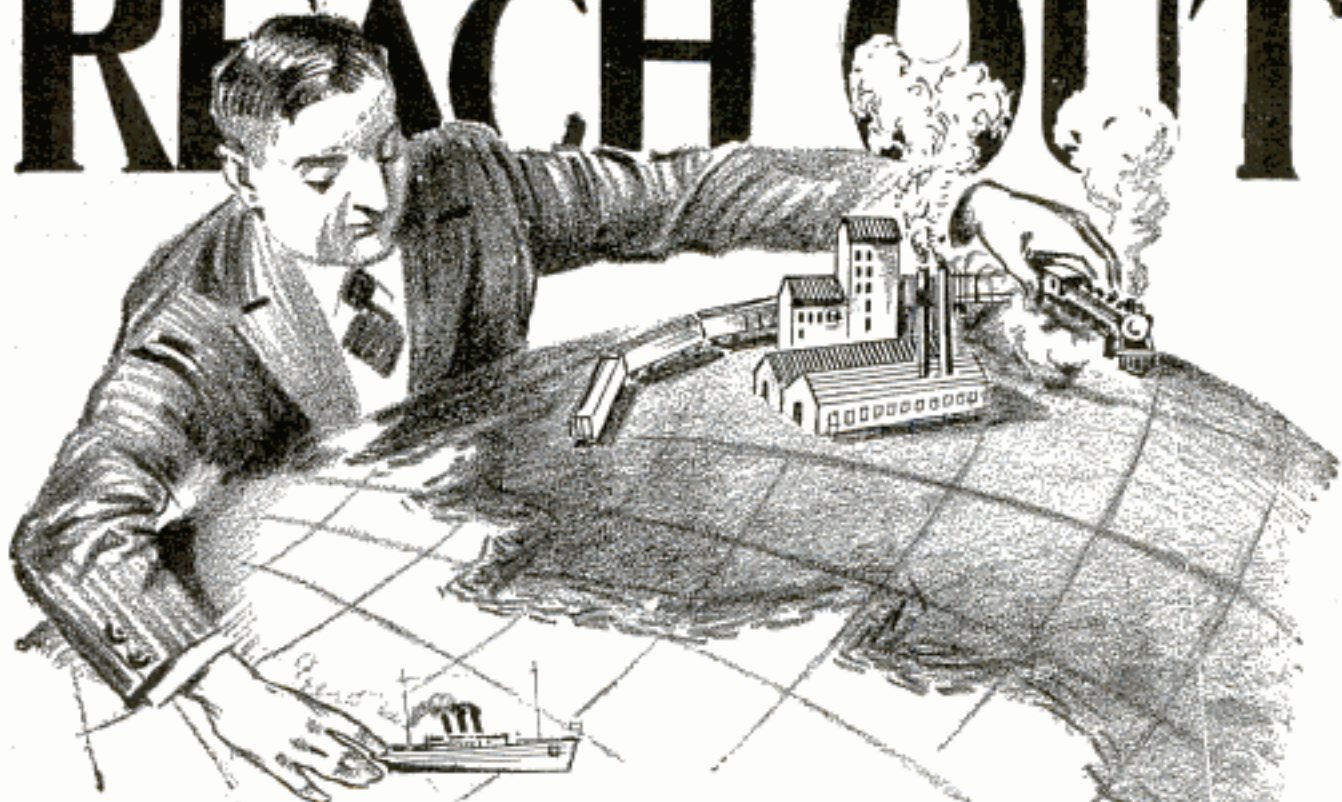

## Reach Out for Big Salary Become a **TRAFFIC MANAGER** —and a Member of This Association

### Digest of Traffic

The Association has compiled the only digest of traffic ever produced. This work required the co-operation of over three hundred traffic experts—took five years and over \$100,000 has been expended. This great reference and working library is for the exclusive use of its members.

The great European war has suspended the commerce of several of the great nations. America has profited thereby immensely. The U. S. has won the trade thus lost by the European nations and is now supplying the greater part of the world with food, supplies and manufactured articles. It is also furnishing the warring nations with vast quantities of munitions. **MEN** are **REQUIRED** who **KNOW** how to **SHIP** goods.

### Thousands of Positions Now Waiting

Never before have there been such a variety and number of splendid opportunities for young, and middle aged, men. This is especially true in manufacturing and in **SHIPPING**. Live men who **START NOW** are assured of **GOOD** salary.

### SALARY

The salary of trained traffic men is from \$2,500 to \$10,000 a year. The work is always interesting because it is not routine work. The traffic man is an executive—not a subordinate.

### Gorged — Shipments Tied Up

The shipments of food, supplies, manufactured articles, munitions of war, etc., for European and other foreign delivery, are so **LARGE** that the shipping departments of thousands of factories—railroads—warehouses—seaboard wharves—are **GORGED**. In addition our Interstate shipping is tied up. Shippers are crying for help.

### Trained Men, Only

These thousands of positions are for **TRAINED** men **ONLY**—men who understand **TRAFFIC**—shipping. Men are wanted who are fully informed—who know how to get **QUICK ACTION**—who know how to **SAVE** freight money.

**American Commerce Assn.**

### We Will Train — YOU

Our Association will instruct you—tell you **JUST WHAT** is required—and **JUST HOW** to do it. We give you individual "coaching" and **TRAIN YOU** by our "experience" method.

### Don't Delay — Apply NOW

Now is the time—today. It is not difficult to make good—if you don't it will be **YOUR OWN** fault. Send the **COUPON** now for complete instructions by **RETURN MAIL**.

(Dept. 48, ) 206 So. Wabash Ave., Chicago, Ill.

### American Commerce Association

Dept. 48, 206 So. Wabash Ave., CHICAGO, ILL.

Send me **FREE**—and without obligation—complete information concerning the Association and how I can train as a traffic man.

Name.....

Occupation.....

Address.....

City..... State.....

Please Mention Popular Mechanics





## Great Opportunities in Sanitary Engineering

**S**ANITARY ENGINEERING offers a remarkable opportunity for the trained man. Now by spending a few of your idle hours getting a technical and business training, you can put yourself high up in one of the most profitable businesses of the day. You can get this training *right in your own home*. Here is a course of training, investigated and endorsed by sanitary societies all over America, that will prepare you for the position of

**Sanitary Engineer  
Drafting and Estimating Manager  
Heating and Ventilating Engineer  
Plumbing or Sanitary Inspector**

## One Billion Dollars in New Buildings Last Year

In only 100 cities over one billion dollars was spent for new buildings last year. The experts in heating and sanitation received approximately 15% of this vast sum. Just think of what that means — think of the opportunities awaiting men who have the technical training that enables them to reach out and share this vast expenditure.

American School  
of Correspondence  
Dept. H 1194  
CHICAGO, U. S. A.

Gentlemen: Please send me free your new book describing the courses of training in Sanitary Engineering, Plumbing, Heating and Ventilating Engineering, Drafting and Estimating.

Name.....

Address.....

### Send the Coupon

For our new book that describes these four new courses of technical training. Read about the opportunities in these uncrowded professions. Read the vital inspiring facts that it gives you, and how you can get the training right in your own home. You will be under no obligations. The book is free. Send for it today. Mail the coupon now.

American School  
of Correspondence, Chicago, U.S.A.  
Dept. H 1194, Chicago, U.S.A.



## Typewrite the New Way

*Double Your Speed—Your Salary*

80 to 100 words a minute **guaranteed**. Salaries increased to \$25, \$30, \$35 and even \$40 weekly. Totally new system. It's all in the fingers — gymnastically trained *away from machine*. Brings amazing speed — perfect accuracy. Easy for anyone. Increases speed first day. Learn in spare time — no interference with regular work.

**FREE BOOK** illustrates and explains all. Contains letters *double and treble* since taking up this remarkable new method. A postal will bring it, but write today — **NOW**.

Tulloss School of Typewriting, 124 College Hill, Springfield, Ohio

## MEN WANTED

to represent our company. You can easily make from \$25 to even \$50 a week and be your own boss. Send for our agent's proposition and

### ILLUSTRATED BOOK AND FREE PHOTOGRAPH

Send ten cents to cover postage and packing costs and we will mail you our illustrated book showing 50 large halftone illustrations of our many genuine photographs and different poses, also a free picture of one of our most famous beauties.

**ART PHOTOGRAPH CO.**

Tower Bldg., Chicago, Ills.



Write Today

## A Yearly Income for You

Would you invest a moderate amount in small monthly or semi-annual installments, if you felt assured it would earn for you an income from \$1000.00 to \$5000.00 annually, according to your investment? A Dixie Estate near Tampa, Florida, planted to grapefruit, oranges and avocados, should do this for you. The proof is what you want. We have it and will gladly send it to you free. Write us today for details of this money making opportunity.

The Thomas Nurseries, Inc., Tower Bldg., Chicago

## "HEAVEN AND HELL"

The most startling of the profound writings of SWEDENBORG, the renowned theologian, philosopher and scientist.



Big 632-page book treating of the Life after Death, sent without further cost or obligation on receipt of 5c. **5c**

WRITE FOR COMPLETE LIST OF PUBLICATIONS.

THE AMERICAN SWEDENBORG PRINTING & PUBLISHING SOCIETY  
Room 9 3 West 29th Street, NEW YORK



## AGENTS \$60 WEEKLY

Robinson Folding Bath Tub, Big seller. Costs little, no plumbing, little water. Weight 35 pounds, folds into small roll. Full length baths, far better than tin tubs. Guaranteed 10 years. \$10 a day easily made. Write for free tub offer.

ROBINSON CABINET MFG. CO. 4640 Foster City Bldg., Toledo, Ohio

## John Wanamaker

for the book. Read it 5 days. Then remit \$3.50 if you want to keep it — otherwise return it. Address  
Frank E. Morrison, Publisher, Dept. 20, 4433 Broadway, New York

## Public Speaking

**Taught at Home** Write for our special offer. Become a powerful speaker in spare time by mail. Overcome

"stage fright", enlarge your vocabulary, train your memory, gain self-confidence. Learn how and when to use gestures; how to suit the speech to the occasion. Increase your earning power — become more popular. We have trained hundreds of successful speakers by mail at home.

**Write Now for Special Offer** Send quick for details of our special limited offer. No obligation. Write while this offer lasts.

Public Speaking Dept. American Correspondence School of Law, 1154 Manhattan Building, Chicago, Ill.





## Chas. Woodward, of Wyandotte, Mich.

Mr. Woodward answered the advertisement of Bush Motor Co., Sept. 20, 1916. He subscribed for the Course in Driving, Repairing, and Selling Automobiles, Sept. 29th, 1916. He completed this course on October 16, and received his Bush Car on November 10, 1916. Write Mr. Woodward and see what he has to say.

Also write Harvey C. Lyon, Pueblo, Colo.; John I. Briggs, Rochester, Mich.; Henry U. Teel, Rexford, Kans.; Henry H. Harris, Glens Falls, N. Y.; J. B. Holt, Sibley, Louisiana; Christner & Guest, McKeesport, Pa., and hundreds more if you want them.

# BUSH CAR

## A 5-Passenger Touring Car With Delco Ignition — Electric Lighting and Starting

The car of Comfort, Convenience, Speed and Power. Has 114-inch wheel base, Two Unit Starting and Lighting, Delco Ignition, Unit Power Plant, Full Floating Rear Axle, Full Streamline 5-Passenger Touring Body, One-Man Top, Rain Vision, Two-Piece Windshield, 32x3½ Tires, Stewart-Warner Vacuum Feed, Stewart-Warner Speedometer, Complete Dash Equipment, including Dash Light, Gas Tank holds 15 gallons, Lyconing

Motor, same motor used in cars selling up to \$900.00 and more—develops at 2500 revolutions, 34.7 H. P., Guaranteed Hill Climber.

The Bush Car was recently put under Instrument Tests by American Society of Mechanical Engineers, at Pueblo, Colorado, and Lookout Mountain, Colorado, which proves the Bush Car to be all and more in mechanical reliability and performance than is claimed by its builders.

## AGENTS ARE MAKING MONEY

All agents of cars are making money. Everybody has money and everybody wants cars. There have been only three and one-quarter million cars built, including Fords, since the start of the automobile industry. New York State has a population of eight millions. Think this over. Remember that there are one hundred million people in the United States today—they would all like to ride in automobiles. Over one billion dollars will be paid for automobiles, supplies, repairs, and men to drive them in the U. S. this year. No wonder agents for good cars are making fortunes. How would you like to have the agency for the Bush Car?

## Great Bush Auto Offer

You can get this magnificent Bush Car and the agency for your Territory if you act quickly. Ride in a Bush Car—pay for it out of your commissions. Qualify to make \$3,000 to \$5,000 a year and up in the Automobile Business. Coupon brings Big Catalog and full details of this Great Auto Offer to readers of Popular Mechanics. Write quick before your territory is taken. Use the coupon or address me like this:

**J. H. BUSH, President**

Dept. 417 **Bush Motor Co.** Bush Temple Chicago, Ill.

**BUSH**  
**J. H. BUSH, President**  
 Dept. 417, BUSH MOTOR CO., Bush Temple, Chicago, Ill.  
 Please rush Bush Catalog and Great Bush Auto Offer.

Name.....  
 Address.....



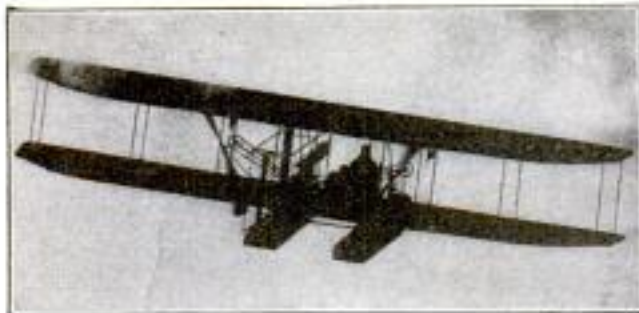

# Big Money in Aviation

**SEND** the coupon below at once. Find out about the big opportunities that are awaiting you in this newest industry. The day of aviation is here! It is no longer a spectacle or a stunt—it is a business! Fame, fortune is awaiting those who are the pioneers in this new field. Get in early. Become an aviation expert. Opportunity is awaiting you. \$50 to \$250 a week and independence with the rapid expansion of the industry.

Everywhere aviation experts are in demand. Government and private enterprises are taking up aviation seriously. They need men who know.

## Now— Learn at Home!

Yes, you may learn the science of aviation right in your own home and in your spare time. No longer need you sacrifice the time and money of years of practical experience on the flying field. Send the coupon and find out how we have condensed into a short course, all the knowledge which is necessary to equip you to take your place upon the field as a practical Aviation expert. We'll tell you just how you can save years of time and much money. We'll show you how you can gain this knowledge in your spare time, at home, without interfering with your regular work.

**A PARTIAL LIST**  
of subjects in our course:

- Elementary Principles;
- History; Nomenclature;
- Stream Line Shapes; Motor Development; Aerofluid Dynamics; Dynamics of the Air; Controls (Types & Operation); Balance; Inherent and Automatic Stability; Propeller and Wing Design; Structures; Principles of Construction; Performance Calculations; Materials.

**Famous Authority Teaches You Personally**  
Mr. Glenn Muffy, the famous aeronautical engineer, co-designer of the first rotary air plane engine now universally used, supervises the instruction of those who take this course. As a student you have the privilege of free consultation at all times with this famous authority.

## Send Coupon —Free Information

**National Aero Institute**

Dept. 1194, Morton Bldg., CHICAGO, ILL.

Gentlemen: Please send me, absolutely free and prepaid, full particulars of your course in aviation and details of your special limited offer.

No matter in what business you are now engaged, if you are mechanically inclined, or interested in aviation, you should at least find out, now, about this great course. Learn the opportunities that are opening every day for scientifically trained men and get particulars of this course which revolutionizes the training of aviation experts. We are making a special introductory offer now. Write for free information while this offer lasts.

**National Aero Institute**  
Dept. 1194  
Morton Building,  
CHICAGO, ILL.

Name.....

Address.....

Please Mention Popular Mechanics



## Vitality in Violet Rays

Marvelous, perfected Virayo. For home use. Virayo, the true Violet Ray instrument, endorsed by leading physicians. Soothing, delightful, nerve toning, health building Violet Rays. Send immediately for important book on health and beauty. FREE.

## VIRAYO

Virayo, the true Violet Ray instrument, recommended by physicians for personal use. Use it anywhere. Appliances for every form of treatment by Violet Rays. Special limited introductory offer.

### BOOK FREE.

You need this book on Violet Rays. It is free. A new book on health, beauty, vitality and vigor. Book sent free. Special introductory price for limited time; all particulars postpaid free to you with book.

Write today. WESTERN COIL CO., 130 N. Dearborn St., Dept. 5248, Chicago, U.S.A.



## My \$3 Exerciser \$100

I will also include  
A Complete

Body Building Course of  
24 Selected Exercises

and an extra handle to instantly convert the

Muscle Builder into a perfect

Chest and Lung Expander

Act now while opportunity lasts.



Reduced to  
Send me today \$1 for the complete

**Barker Muscle Builder Outfit**

It's just one-third the regular price. My Muscle Builder will meet the requirements of any person—man, woman or child—weak or strong. Can be used to exercise every muscle.

Prof. Anthony Barker, Studio 6 C, 110 W. 42d St., New York City

## Big Money for You In the Automobile Business

Every day offers greater opportunity for the trained man either to start a paying business of his own, or be a repair man, tester, timer, chauffeur, or salesman.

It's EASY to learn, and we make it EASY to pay your way. Write quickly—today—for catalog telling about our course and how we meet you "50-50."

**INDIANAPOLIS MOTOR SCHOOL** 204 Southeastern Ave. INDIANAPOLIS IND.

**Baker's Show Card Book \$3.00**  
EARN \$20 TO \$60 A WEEK  
LEARN TO MAKE SHOW CARDS (Salary or business of your own). My book teaches all the tricks of the trade. No single anyone can learn. Fully illustrated. Learn while learning. Send today. Money refunded if not satisfied.  
WM. J. BAKER, HENRY BUILDING, PORTLAND, ORE.

If you need a book on some mechanical subject and do not know where to find it, write  
**POPULAR MECHANICS BOOK DEPARTMENT**  
6 N. Michigan Ave., Chicago

## Publisher's Announcement

The date on which Popular Mechanics Magazine is due simultaneously on news stands in all parts of the country is the 20th of each month.

The traffic congestion on all railroads is simply unprecedented, and while the Publisher, the distributing News Companies and Railroad Officials are using every possible effort and sparing no expense, it is impossible to maintain our schedule of the 20th at all points every month. It is a condition which simply cannot be entirely avoided.

At such points as the magazine is a few days late, we ask the patience and forbearance of our readers.

Newsdealers are requested not to return unsold copies until the succeeding issue is received, and are reminded of our policy which puts no time limit whatever on returns.

**POPULAR MECHANICS MAGAZINE,**  
H. H. WINDSOR, President.

Chicago, March 3rd, 1917.



# Send For This Book Today

*Free To All Ambitious Men*



**Ten Years' Promotion In One**

There are hundreds of thousands of men with clear brains, good health and plenty of ambition who ought to succeed, but who are regularly "fired", "kicked out" or "held down". WHY? Read the answer in this book "Ten Years' Promotion In One"—a book that will open your eyes to some plain, common-sense success facts.

If a man feels that the chances are all against him; that it requires "pull" or "luck" or a combination of both to land the job higher up or to increase his income, this helpful, inspiring book will convince him otherwise. A prominent Chicago business man

recently said, "It would pay every ambitious person to read this book, even if he had to pay \$5 to get a copy." Let us send it to you FREE, with literature explaining how thousands of men have found the short cut to promotion through the training offered by

## La Salle Extension University

*"The World's Greatest Extension University"*

*More than 125,000 men of all ranks and positions, from office clerks to corporation officials, have benefited from LaSalle training and service. Over 20,000 new students annually now avail themselves of the home-study courses offered in the various departments of the University.*

The complete LaSalle organization and its associations consist of more than 800 people. It is backed by capital of \$1,000,000, with assets in excess of \$2,000,000. It has a staff of more than 300 prominent business experts, professional men, text and special lecture writers, contributors, instructors and assistants, including recognized authorities in all departments. Its students and graduates can be found throughout the entire English-speaking world.

Within the past two years the buying power of the American dollar has shrunk from 30 to 50 per cent. If your income is not more today than it was a year or two ago, your earning power too, has shrunk in proportion.

Today, big incomes are virtually begging for men to come and earn them. A recent editorial in the Saturday Evening Post on "Help Wanted at \$5000 a Year" referred to a business man who complained that "At \$10 a week he had three applications for every job; at \$15 a week, two jobs for every applicant." A want ad for a \$15 a week job in Chicago brought 171 written applicants. A \$5000 a year position advertised by the same concern at the same time in the same paper did not bring a single applicant—NOT ONE.

Big business is in need of capable executives, auditors, comptrollers, business and office managers, traffic managers, legally-trained men, bank officials, certified public accountants, cost accountants, sales managers, etc. Any one of these positions is within the reach of the wide-awake man who has intelligence and common-sense and will apply himself. No man need be content to do under-paid, disagreeable work, with the abundant opportunities trained men now have to pick positions with worth-while incomes.

Indicate in coupon the position for which you wish to qualify. We will send you a complete descriptive catalog, explaining fully how our training places the position of your choice within your grasp. Our plan enables you to use your spare time. You can carry on the work in your home or office, by mail, without interference with your present duties and you can pay for the course a little each month if you wish.

Your chance to get ahead is here before you—right now. Mark with an X the course in which you are interested. Send for your copy of "Ten Years' Promotion In One" today. You will never part with it except to loan it to a friend.

### FREE BOOK COUPON—MAIL IT TODAY

LASALLE EXTENSION UNIVERSITY, Dept. 464-R, Chicago

Send me free copy of book "Ten Years' Promotion In One"; also catalog and particulars regarding the training course and service in department marked with X.



- Business Administration:** Official, managerial and executive positions.
- Higher Accountancy:** Auditors, Comptrollers, Certified Public Accountants, Cost Accountants, etc.
- Business English:** Business Correspondents, Writers of Advertisements and Sales Literature.

- Interstate Commerce and Railway Traffic:** Railway and Industrial Traffic Managers, Traffic Experts, etc.
- Banking and Finance:** Officials, Tellers, Cashiers, Trust Officers, Financial Managers, etc.
- Law: Degree of L.L.B.** Executive-Business Positions Requiring Legally-Trained Men.

- Commercial Spanish:** Foreign Correspondent with Latin American Countries.
- Effective Public Speaking:** Training in the Art of Forceful, Effective Speech.
- Elements of Accounting:** Training for Expert Bookkeeping Positions.

Name..... Address.....

Please Mention Popular Mechanics



## 30 DAY COURSE IN TIRE REPAIRING **FREE**

Complete Tire Repair Outfit  
Less Than \$250.00

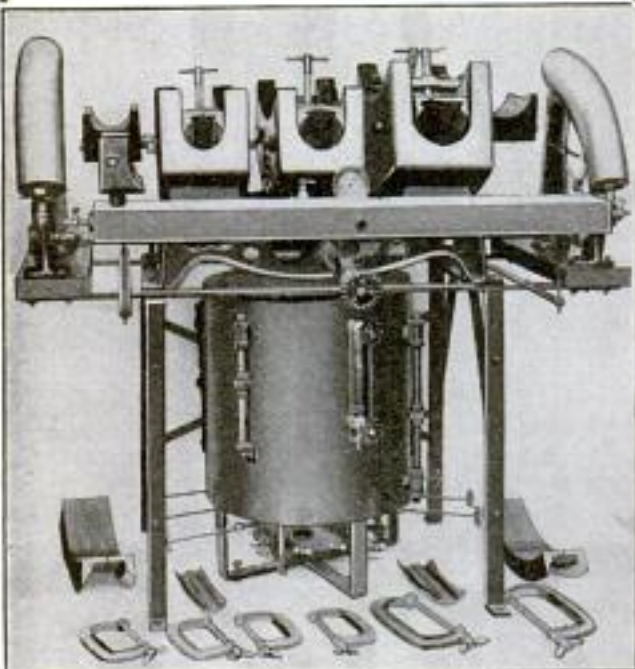

With this outfit and our course of free instruction, you can start up a good business.

## Learn to Repair Tires

Bigger opportunities than in any other branch of the Auto business. A broad claim, but easy to prove. Only stop and think!—you know it's true. Listen! Not one single Auto factory can build cars fast enough. Everybody is car crazy, and the craze is growing. 2,000,000 autos now in use. Four tires to each car. That means 8,000,000 tires to repair. Just think of it—8,000,000 tires! Each car wears out its cost in tires alone. Punctures and blowouts are common. Vulcanizing, patching, retreading, etc., must be done. Retreading alone—the new and better process—brings big money.

## Earn \$3000 to \$8000 a Year

Begin now. In almost every city, town, village, and cross corners, there is a fine chance to start. We know the places and put you next. Just a little money starts you in a business of your own. We guarantee to make an expert of you in 30 days free of charge. Write today for free catalog, or why not take a run over to Detroit and investigate personally? Don't let the chance slip by. Investigate now.

## Reliable Tire Repair School

401 Reliable Bldg., DETROIT, MICH.

FATHERS! This is a great opportunity for that boy of yours. Start him in the Tire Repair business. You'll always be glad. When in Detroit, look us up. We'll be glad to show you through.

### COUPON

#### RELIABLE TIRE REPAIR SCHOOL

Send me your free catalog and full particulars about the tire repair business.

Signed.....

Address.....

P. M.

Please Mention Popular Mechanics



## Detroit Wants You

We can teach you the Automobile Business in Detroit and, if you so desire it, our Self-Help Department can obtain work for you to cover your expenses while here. You can be fitted for all automobile work, including driver, demonstrator, repair man, tester, inspector, foreman, etc.

### Our Full Regular Course \$50

Our graduates are working in a number of Detroit factories and earning big money, what we have done for them we can do for you. Write us TODAY for full information and FREE illustrated booklet entitled "Detroit, The World's Automobile Capital."

### National Automobile School

734 Woodward Ave. Detroit, Mich.

## Mammoth Jubilee Book Free

Picturing 5152 Home Things  
Make your own Credit Terms—1 to 3 years' time.  
SPIEGEL, MAY, STERN CO., 1409 W. 35th St., Chicago

**Stop Smoking!** Prove at our risk this scientific discovery that destroys all craving for tobacco in any form. Used, praised and endorsed by all who have used it. Not an internal remedy. Write today for free particulars. Positive results.  
HUNTSMAN PHARMACAL COMPANY, Bozeman, Mont.

## 1900 Motor Washer

Electric or Water Power

on Free Trial to Readers of Popular Mechanics

Reduce household expenses by using this great laundry outfit. Cuts cost of washing to 2 cents per week. Write for Free Book, giving full details, to

1900 WASHER CO., 6334 Court St., Binghamton, N. Y.

Address Canadian 1900 Washer Co., 355 Yonge St., Toronto

If you live in Canada



## The Strength of a Hercules AND HOW TO OBTAIN IT

By the World's Champion Athlete

A book for all who wish to improve their Health by strengthening their bodily powers. Get it. Read it. It is for YOU! In this latest edition, Lionel Strongfort, the world's Champion Athlete, who has performed before the Kings and Queens of Europe and in all the leading theatres of the world, gives his experiences of over twenty years in Health and Strength Culture. YOU cannot afford to miss this book. It will show you the way to perfect Health and Strength and the VIGOR OF MANHOOD. FREE by sending only 4 cents to cover postage.

LIONEL STRONGFORT

Physical Culture Institute  
89 Park Building, NEWARK, N. J.



# These Are The Hours That Count



**M**OST of your time is mortgaged to work, meals and sleep. But the hours after supper are *yours*, and your whole future depends on how you spend them. You can fritter them away on profitless pleasure, or you can make those hours bring you position, money, *real success in life*.

Thousands of splendid, good-paying positions are waiting in every field of work for men *trained to fill them*. There's a big job waiting for *you*—in your present work, or any line you choose. Get ready for it! You can do it without losing a minute from work, or a wink of sleep, without hurrying a single meal, and with plenty of time left for recreation. You can do it in one hour after supper each night, right at home, through the International Correspondence Schools.

## Yes—You Can Win Success in an Hour a Day

Hundreds of thousands have proved it. The designer of the Packard "Twin-Six," and hundreds of other Engineers climbed to success through I. C. S. help. The builder of the great Equitable Building, and hundreds of Architects and Contractors won their way to the top through I. C. S. spare-time study. Many of this country's foremost Advertising and Sales Managers prepared for their present positions in spare hours under I. C. S. instruction.

For 25 years men in offices, stores, shops, factories, mines, railroads—in every line of technical and commercial work—have been winning promotion and increased salaries through the I. C. S. Over 130,000 men are getting ready *right now* in the I. C. S. way for the bigger jobs ahead.

### Your Chance Is Here!

No matter where you live, the I. C. S. will come to *you*. No matter what your handicaps, or how small your means, we have a plan to meet your circumstances. No matter how limited your previous education, the simply written, wonderfully illustrated I. C. S. textbooks make it easy to learn. No matter what career you may choose, some one of the 280 I. C. S. Courses will surely suit your needs.

### Make Your Start Now!

When everything has been made easy for you—when one hour a day spent with the I. C. S. in the quiet of your own home will bring you a bigger income, more comforts, more pleasures, all that success means—can you afford to let another single priceless hour of spare time go to waste? Make your start right now! This is all we ask: Without cost, without obligating yourself in any way, put it up to us to prove how we can help you. Just mark and mail this coupon.

## INTERNATIONAL CORRESPONDENCE SCHOOLS

Box 5562, SCRANTON, PA.

Explain, without obligating me, how I can qualify for the position, or in the subject, before which I mark X.

- |   |  |
|---|--|
| <input type="checkbox"/> ELECTRICAL ENGINEER        | <input type="checkbox"/> SALESMANSHIP              |
| <input type="checkbox"/> Electric Lighting          | <input type="checkbox"/> ADVERTISING MAN           |
| <input type="checkbox"/> Electric Car Running       | <input type="checkbox"/> Window Trimmer            |
| <input type="checkbox"/> Electric Wiring            | <input type="checkbox"/> Show Card Writer          |
| <input type="checkbox"/> Telegraph Expert           | <input type="checkbox"/> Outdoor Sign Painter      |
| <input type="checkbox"/> Practical Telephony        | <input type="checkbox"/> RAILROADER                |
| <input type="checkbox"/> MECHANICAL ENGINEER        | <input type="checkbox"/> ILLUSTRATOR               |
| <input type="checkbox"/> Mechanical Draftsman       | <input type="checkbox"/> DESIGNER                  |
| <input type="checkbox"/> Machine Shop Practice      | <input type="checkbox"/> BOOKKEEPER                |
| <input type="checkbox"/> Gas Engineer               | <input type="checkbox"/> Stenographer and Typist   |
| <input type="checkbox"/> CIVIL ENGINEER             | <input type="checkbox"/> Cert. Public Accountant   |
| <input type="checkbox"/> Surveying and Mapping      | <input type="checkbox"/> Railway Accountant        |
| <input type="checkbox"/> MINE FOREMAN OR ENGINEER   | <input type="checkbox"/> Commercial Law            |
| <input type="checkbox"/> Metallurgist or Prospector | <input type="checkbox"/> GOOD ENGLISH              |
| <input type="checkbox"/> STATIONARY ENGINEER        | <input type="checkbox"/> Teacher                   |
| <input type="checkbox"/> Marine Engineer            | <input type="checkbox"/> Common School Subjects    |
| <input type="checkbox"/> ARCHITECT                  | <input type="checkbox"/> CIVIL SERVICE             |
| <input type="checkbox"/> Contractor and Builder     | <input type="checkbox"/> Railway Mail Clerk        |
| <input type="checkbox"/> Architectural Draftsman    | <input type="checkbox"/> AGRICULTURE               |
| <input type="checkbox"/> Concrete Builder           | <input type="checkbox"/> Textile Overseer or Supt. |
| <input type="checkbox"/> Structural Engineer        | <input type="checkbox"/> Navigator                 |
| <input type="checkbox"/> PLUMBING AND HEATING       | <input type="checkbox"/> Poultry Raising           |
| <input type="checkbox"/> Sheet Metal Worker         | <input type="checkbox"/> AUTOMOBILES               |
| <input type="checkbox"/> CHEMICAL ENGINEER          | <input type="checkbox"/> Auto Repairing            |
|   | <input type="checkbox"/> Spanish                   |
|   | <input type="checkbox"/> German                    |
|   | <input type="checkbox"/> French                    |
|   | <input type="checkbox"/> Italian                   |

Name \_\_\_\_\_

Occupation & Employer \_\_\_\_\_

Street and No. \_\_\_\_\_

City \_\_\_\_\_ State \_\_\_\_\_

If name of Course you want is not in this list, write it below.

Please Mention Popular Mechanics



SHOP NOTES

**POPULAR MECHANICS SHOP NOTES**



**Vol. XIII 1917 50¢**  
EASY WAYS TO DO HARD THINGS  
POPULAR MECHANICS CHICAGO

**JUST OUT**

**Shop Notes for 1917**

This is Volume XIII of the series of Shop Notes books reprinted from Popular Mechanics Magazine and comprises

**524 Articles**  
**422 Illus.**  
**224 Pages**

**Price 50c**  
POSTPAID

The following partial list of contents gives some idea of the wealth of time and labor-saving kinks for all the trades found in this book:

(Size 6½ x 9½ x ½ in.)

Automobile, Turntable  
Band Saw, Care of  
Barn Construction, Modern  
Camp House  
Dynamo Troubles  
Electro-Pneumatic Signal  
Fence, Metal  
Garage, Private  
Hammock, Swinging-Chair  
Ice House, Hollow-Tile  
Lawn Cleaner and Sprinkler  
Milk House, Concrete-Block

Motorcycle Trailer and  
Camp Outfit  
Multiple Window Opener  
Oil Gauge  
Pressure Gauge  
Range Finder  
Road Roller  
Sandblast, Homemade  
Siphon, Automatic  
Tent House  
Tool-Chest Cart  
Workshop, Small-Farm

Shop Notes Series of 13 Volumes contain 6795 Articles, 2884 Pages, and 6373 Illustrations.

These books are a perfect gold mine of information for everyone who uses tools for pleasure or as an occupation. They tell easy ways to do hard things.

**Price 50 cents per Volume Postpaid**

**Popular Mechanics Book Department**  
6 N. Michigan Ave., CHICAGO

**1000 Interesting Things FOR BOYS TO DO**



are described in this greatest of all boys' books

**The Boy Mechanic**  
**VOL. II**

A sequel to, but containing nothing found in Volume I. It gives complete directions for making those things every boy likes to build and experiment with in electricity, mechanics, wood-working, model work, indoor and outdoor sports, magic, tricks, arts and crafts work, etc., such as

Bobsleds—Snowshoes—Ice Boats—Ice Gliders—Boats—Camps—Fishing Tackle—Houses of Poles—Kites—Aerial Gliders—Motion Picture Camera—Spot Light—Lantern—Mile-O-View Camera—Photographic Appliances—Games—Cyclemobile—Pushmobile—Flymobile—Roller Coaster—Ferris Wheel—Sunlight Flasher—Reed Furniture—Electrical Devices—Mechanical Contrivances and hundreds of equally interesting things.

**480 Pages. 995 Illustrations**  
**Handsomely Bound in Cloth**

**Price \$2.00 Prepaid to Any Address**

**Popular Mechanics Book Dept.**  
6 N. Michigan Ave., CHICAGO

## Home Builder's Guide

By WM. ARTHUR



EVERY one who is interested in building a house, either for a home or commercially, should read this new book, for it aims to give those who are not professional builders or contractors a thorough understanding of the value of good construction. It is written in Mr. Arthur's simple and direct style, so that the veriest

novice may understand the why and wherefore of every operation.

Starting with the site, the author has given pointers from his experience on the proper selection of a plot from the standpoint of health and economy. He then explains the planning of a house so that it will have the best light and be conveniently arranged. All types of construction are then taken up so that the reader may get an unbiased professional opinion of the best for many purposes.

### CONTENTS

The "Lay" of the Land; The Planning of the Home; The Big Four; A Firm Foundation; The Framework; Covering and Adorning the Frame; The Bungalow; Brickwork; Cement Stone—and Mere Stone; Lath and Plaster; Sheet Metal Work; The Interior Finish; Plumbing and Gasfitting; Ventilation; Heating and Lighting; Painting; Finish Hardware; An Analysis of an Ideal Plan; Tornado Construction; Wind Bracing.

186 Pages, 5x8 Inches. 40 Figures, Cloth

**Price \$1.10 Postpaid**

**POPULAR MECHANICS BOOK DEPT.**  
6 North Michigan Ave., CHICAGO

**1000 Interesting Things FOR BOYS TO DO**

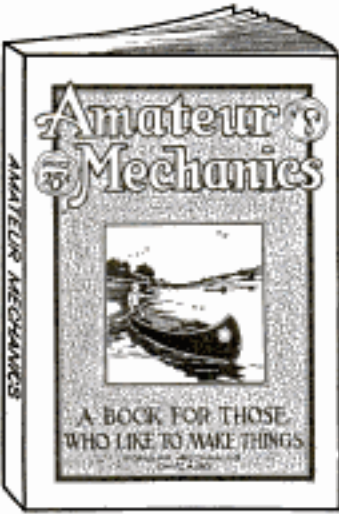

**JUST OUT**

**Amateur Mechanics No. 8**

An interesting new book for all those who like to make things.

**SHOWS HOW TO BUILD**

- Arc Light
- Bird Houses
- Bookrack
- Camping Outfits
- Cement Plant
- Dish Washer
- Electric Fountain
- Fish Lure
- Fishing Rods
- Grape Arbor
- Hammocks
- Illuminating Gas Plant
- Kites of Various Kinds
- Lawn Sprinklers
- Monoplane, Model
- Motorboat Whistle
- Mystery Coin Box
- Parlor Table
- Porch Swing
- Reed Furniture
- Scarecrow
- Shocking Machine
- Swing, Circular
- T-Squares
- Table Box for Campers
- Toy Bank
- Tuberculosis Cottage
- Wall Shelves
- Window Closer
- Woven-Top Stool

and scores of other useful articles

**128 Pages — 132 Articles — 234 Illustrations**

**Price 25 Cents, Postpaid**

**Popular Mechanics Book Dept.**  
6 North Michigan Ave., CHICAGO





# Music Lessons Sent FREE!

You, too, can now quickly and easily satisfy your musical ambitions. Learn to sing or to play your favorite instrument, whether for pleasure, social prestige or to teach music, by our wonderful home study lessons under great American and European teachers. These lessons are a marvel of simplicity and completeness, endorsed by Paderewski and other great authorities. Right in your own home you can have the instruction of these masters (see names below). This is made possible by the remarkable Siegel-Myers System—the only University Extension Conservatory of Music in existence. Send for full information and get 6 free lessons while the offer holds good. Read our offer—then write us a letter and get all this.

## Any Instrument or Voice

The Siegel-Myers System will be a revelation to you. You will wonder how you ever had the patience to study in the slow, tedious, ordinary way when you find how easily you learn by this method. Complete Courses in PIANO (students' or teachers' courses) by the great Wm. H. Sherwood; HARMONY by Dr. Protheroe and Rosenbecker; VOICE COURSE (with aid of phonograph) by Crampton; PUBLIC SCHOOL MUSIC by Frances E. Clark; VIOLIN, CORNET, MANDOLIN, GUITAR (including Hawaiian system of play-

ing), BANJO, REED ORGAN, CHORAL CONDUCTING, HISTORY OF MUSIC and ADVANCED COMPOSITION, by equally eminent and accomplished teachers.

No matter where or with whom you have studied or whether you have studied at all—even if you have tried unsuccessfully—if you love music and want to succeed as a musician or as a teacher of music, write. We have some very interesting information for you. You should send for it now—at once—while this special offer lasts.

## This Offer Is FREE—Write Today!

We do not ask you to pay one cent for the six lessons. This is our way of proving to you what splendid instruction we give. SEEING IS BELIEVING. Yes, you get the whole six lessons free. Isn't it worth a few minutes time to write for them? To send us a letter accepting this offer may be the turning point in your musical career.

Tell us frankly just what you have done in music, how long you have studied, or whether you have ever studied at all. Also tell us your age and just what your musical ambitions are. You will find our faculty ready to give you sug-

gestions toward making a career, or, anyway, for getting the most out of your natural ability for singing or playing.

This splendid system of ours has enabled thousands to see their hopes realized. You too can do more with music if you have scientific, practical instruction. Write us fully. Then we will tell you just what we can do for you. We will gladly explain the famous Siegel-Myers System.

A few Special Introductory Scholarships are now being awarded by our faculty. Full particulars about this will be sent with the free lessons. Write today.

**SIEGEL-MYERS SCHOOL OF MUSIC, CLARENCE EDDY, Dean, 2156 Siegel-Myers Bldg., Chicago, Ill.**

Please Mention Popular Mechanics



## NOW YOU NEED A GOOD ATLAS

Never before in the World's History has an atlas been so constantly necessary to an intelligent understanding of the World's News.

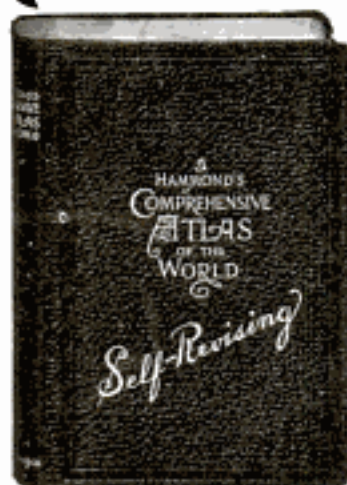

### Here is the IDEAL ATLAS

Hammond's Comprehensive Atlas is a compact octavo volume, bound in flexible leather. It solves the problem of

### Large Scale Maps in a Book of Handy Size

Contains 512 pages, 256 pages of large scale maps of all States, Canadian Provinces, Countries of the World, etc., also 256 pages of text, index, compilations, gazetteer, statistics of population, etc.

### Self-Revising After the War

Each copy contains a certificate entitling the purchaser to a supplement of maps showing the new boundaries after the war is over, making this atlas self-revising.

Size  $9\frac{1}{2} \times 6\frac{3}{4} \times 1\frac{1}{4}$  Inches

### Special New Maps Show the Several War Zones

Get your atlas now. Use it during the great war when you need it most and rest assured it will be up-to-date after the war is over. Price \$2.50 Postpaid.

**Return Privilege** Any purchaser who is not more than satisfied with this atlas may return same and have his money promptly refunded.

**POPULAR MECHANICS BOOK DEPT.**  
6 N. Michigan Ave., CHICAGO

JUST OUT

## Modern Starting, Lighting and Ignition Systems

By VICTOR W. PAGE, M. E.



Nearly 400 ( $5\frac{1}{2} \times 8$ ) Pages  
250 Engravings  
Folding Plates  
Price \$1.50 Postpaid

Indispensable to all needing a practical working knowledge of automobile electricity. A

self-educator on electrical systems without an equal. A comprehensive review of Modern Starting and Ignition System Practice. Includes a complete exposition of Storage Battery Construction, Care and Repair. Explains all types of starting motors—Generators—Magnets and all ignition or lighting system units. Considers the systems of cars already in use as well as those that are to come in 1916. All the leading systems of Starting, Lighting and Ignition have been described and illustrated with the co-operation of the experts employed by the manufacturers. Wiring diagrams are shown in both technical and non-technical forms.

Complete Description and Synopsis of Contents will be sent upon request.

Popular Mechanics Book Dept., 6 N. Michigan Ave., Chicago

JUST OUT

## OXY-ACETYLENE WELDING AND CUTTING

ELECTRIC AND THERMIT WELDING

By H. P. MANLY

Chief Engineer  
American Bureau of Engineering

215 pages, Fully Illustrated.  
Cloth, Price \$1.00; Leather, stamped in gold, red edges, Price \$1.50 (each postpaid).

The extensive use of the oxy-acetylene flame in welding and cutting has created an active demand for a practical book explaining this process. In addition to the oxy-acetylene welding are included electric and thermit welding, also a chapter

on hand forging and welding. In order to make a complete book on welding, the following subjects have been included: annealing, tempering, hardening, heat treatment, and the restoration of steel.

Much practical information is given on the uses and characteristics of the various metals. Thus, in this book the manufacturer and the workman will find all necessary information and data required in handling any kind of welding.

Sent postpaid upon receipt of price by

**POPULAR MECHANICS BOOK DEPT.**  
6 N. Michigan Ave., CHICAGO

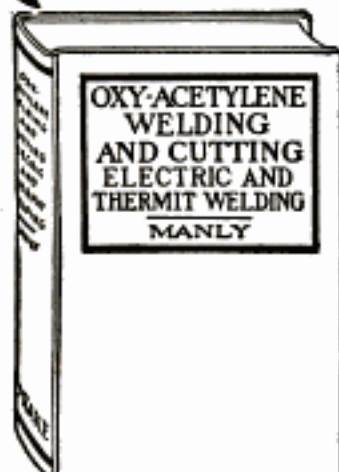

JUST PUBLISHED

## AUTOMOBILE WELDING

With the Oxy-Acetylene Flame

167 Pages Price \$1 Fully Illustrated  
POSTPAID



Explains in a simple manner apparatus to be used, its care, and how to construct necessary shop equipment. Proceeds then to the actual welding of all automobile parts, in a manner understandable by everyone. Aluminum, cast iron, steel, copper, brass, bronze and malleable iron are fully treated, as well as a clear explanation of the proper manner to burn the carbon out of the combustion head.

**POPULAR MECHANICS BOOK DEPT.**  
6 North Michigan Avenue, CHICAGO

## Mathematics Made Easy by ROPP'S CALCULATOR AND SHORT-CUT ARITHMETIC

Shows the Answer as Quickly as a Watch shows the Time to all Problems likely to occur in the Office, Store, Shop, Bank, Farm, or Factory.



Over 2,000,000 Sold

Explains and simplifies every principle in Arithmetic, Mechanics, and Mensuration.

PRICES, POSTPAID

Desk Size.....\$1.25

Leather, Pocket

Size.....\$1.00

Leather, Vest Pocket

Size.....\$0.50

Pocket Size.....\$0.50

Send for 4-page description of this work

Popular Mechanics Book Dept., 6 North Michigan Avenue, Chicago



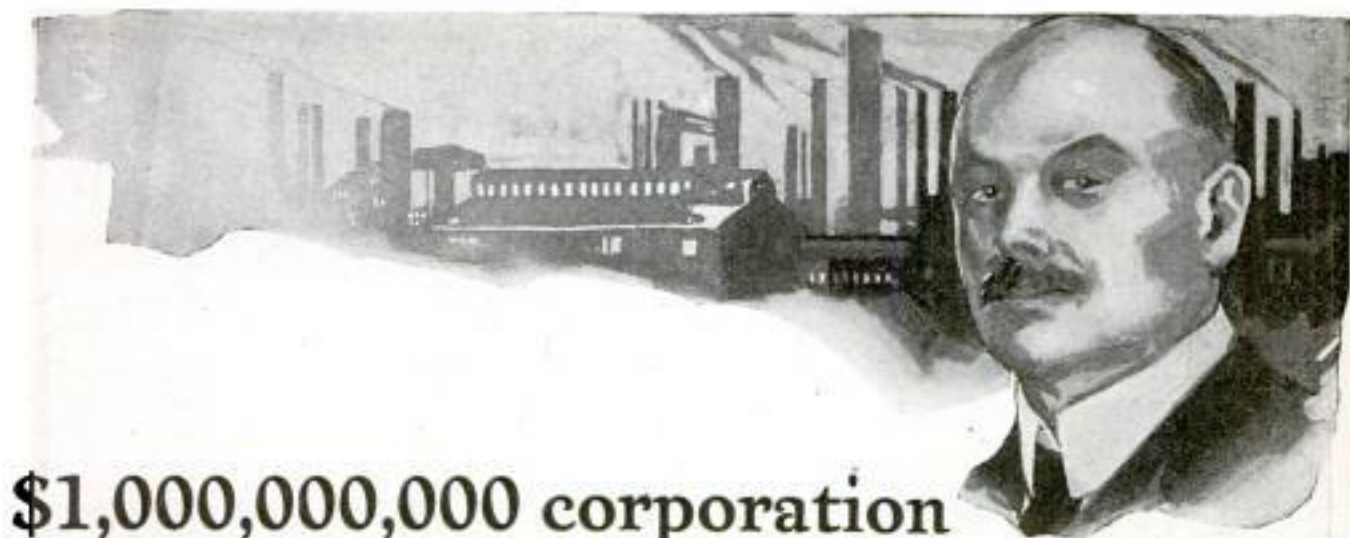

## \$1,000,000,000 corporation selects lawyer as president

*Law training wins high place in big business*

The biggest corporation in the world wanted a new president. After long study and deliberation the directors chose not a steel expert, nor a banker, nor a financier. They selected a lawyer.

His law training qualified him for this high industrial position. His legal mind grasped facts quickly, analyzed them logically, and acted on them with good judgment. His knowledge of the law enabled him to cope with big business problems, for law underlies all business.

The wisdom of the directors' choice has been confirmed by the prosperity and growth of the corporation under the lawyer's guidance. Not only is it the biggest corporation in the world, but it is one of the best managed as well.

### A growing demand for law trained men

Every day more and more big businesses are realizing the importance of having law trained men at their head.

James Stillman, Chairman of the Board of Directors of the National City Bank of New York, predicts that "in the next ten years every executive in a bank, and most business executives will have to have a law training."

### The demand for law trained men grows daily stronger

Law is the most powerful weapon in the hands of the business man. It enables him to protect his business interests and to analyze big and intricate problems.

To the man of real ambition and determination it is never too late to begin the study of law. Many men, well on in years, have left their business affairs to study law.

### We bring the law to you

You, however, do not have to give up your business to study law. You can master our Course in your spare time—in the odds and ends of your time, which added together make for an education. You do not

lose a day's work nor a dollar of income from your regular employment.

The Modern American Law Course and Service of the Blackstone Institute has been carefully prepared by eighty eminent legal authorities. It is written in simple, understandable language. This Course gives you a thorough, practical grounding in the fundamental principles of law, under the personal guidance of experienced and able lawyers and law trained business men.

The Blackstone Institute with its affiliations is the oldest and leading non-resident law school in America.

Among the 30,000 men and women who have been trained in law by the Blackstone Institute are members of Congress, a Governor of a State, City, County and State officials, judges, lawyers and thousands of successful business men.

Today our country is facing a crisis which will demand big leaders. As in all critical periods of our nation's development, these leaders will be chosen from the group of broad-gauged thinkers—the law trained men. They will bear the big responsibilities and reap the big rewards.

### "The Law Trained Man"

Our new 168-page booklet, "The Law Trained Man," has a vital message for every ambitious man. It will be sent you free. It tells you how a law training will help you to become more successful in business or in public life. Send for your copy today. Simply mail the coupon below with your name and address plainly written or typed. The booklet will be sent by return post.

**BLACKSTONE INSTITUTE**  
Dept. 54, 608 So. Dearborn Street Chicago, Ill.

Send me "The Law Trained Man"—168-page book—FREE

Name .....

Business Position .....

Address .....

State .....

Indicate with X whether you want to study Law  
For use in Business .....  
For admission to the Bar .....



Blackstone Institute, Dept. 54, 608 So. Dearborn St., Chicago, Ill.



# You Can Take Hills on High Without A Knock

If you will keep your motor free from carbon. That knocking in your engine—the difficulty you have climbing hills—poor pick-up—lack of power—noisy motor—pre-ignition—in fact 80% of engine trouble is caused by carbon. Clean it out with

## JOHNSON'S CARBON REMOVER

and your engine will run like it did the first 500 miles—quietly and full of "pep". And your gasoline consumption will drop from 12% to 25%.

### *You Can Do It Yourself*

For 25c—five minutes time—and with no labor you, yourself, can remove all carbon deposits. Simply pour an ounce of Johnson's Guaranteed Carbon Remover into each cylinder—allow it to remain from two to twelve hours and then drive your car 10 or 15 miles. You will be surprised at the wonderful improvement.

### *Use It Every 1,000 Miles*

If you will use Johnson's Carbon Remover at regular intervals giving carbon no chance to accumulate, you will automatically eliminate most valve trouble and your engine will always be at its highest efficiency.

If your dealer cannot supply you with Johnson's Carbon Remover use attached coupon

**\$1.00 Special Offer \$1.00**

S. C. JOHNSON & SON, Dept. PA4 Racine, Wis.  
I enclose \$1.00 for which please send me by prepaid express enough Johnson's Guaranteed Carbon Remover to thoroughly clean an ordinary four-cylinder motor four times.

NAME .....  
ADDRESS .....  
CITY & STATE .....  
MY DEALER IS .....

Made and Guaranteed by  
**S.C. JOHNSON & SON**  
Racine, Wisconsin, U.S.A.

Please Mention Popular Mechanics

Copyrighted material



# Popular Mechanics Magazine

REGISTERED IN U. S. PATENT OFFICE

WRITTEN SO YOU CAN UNDERSTAND IT

Vol. 27

APRIL, 1917

No. 4

3883

## Automatic Burglar Alarm Phones for Help

HEREAFTER armed robbers that enter a bank and "cover" the cashiers with revolvers, preparatory to gathering up the money, may find that they are not as secure from attack as the submissive men in front of them would indicate, for the bank may be protected with a recently devised secret signal system that automatically telephones for help in such an emergency. To operate this alarm one has only to press a hidden electric button with his foot or knee—an act that would be unnoticed by the plunderers. All the apparatus, save the button, is located in another room, or in a cabinet, out of hearing of the bandits. Pressing the button causes a lifting device to raise the receiver hook of a telephone, by means of a cord, thus making connection with central. Simultaneously, a small-size phono-

graph, situated in front of the telephone transmitter, begins to operate, repeating again and again some such message as this: "Help! Robbers! Send police to Third National Bank!" The tele-

phone girl, on hearing this appeal, will immediately notify the police. An obvious advantage of this system is that the robbers are wholly unaware that any alarm has been turned in and so their capture is much more probable. Another type of this protective device is provided with a buzzer, in the place of a phonograph, which sounds into the telephone. The apparatus can be connected so that if a bank is entered after closing hours, the signal will operate without



A Burglar Alarm That Talks: The Button near the Cashier's Knee Enables Him Secretly to Set the Phonographic Alarm to Operating in an Adjoining Room

the pressing of any button. A similar mechanism has been devised which automatically notifies central in case of fire in a building.

LEE & COLLINS  
426 So. 4th St., LOUISVILLE, Ky.  
(Cont. & Inv.)

481

Copyrighted material



1208327 Dec 12-1916 (Not in directory)  
Albertina Keegan  
Chicago.

P. G. V. 233 p 583

CONVENIENT HAIR DRIER

3574 FOR WOMEN'S USE

Women often experience difficulty in drying their hair after washing it, especially in the winter time, when the



This New and Convenient Hair-Drying Device, Invented by a Woman, Seems to Solve One of Woman's Minor Problems, Especially in Winter

sunny back porch and other summer facilities are not available. This difficulty is overcome by the recent invention of a Chicago woman. This consists of a tubular elbow of sheet metal, resembling stovepipe, which can be placed on the top of any range, over a lighted burner, and will direct heat as desired from the burner to the loose hair of a person seated near the range. The elbow forms a right angle, with one side longer than the other, to suit persons of different heights. It has a flange at each end, for fastening it to the range and directing the heat, also a convenient handle.

3600

(2.) COLD WEATHER BRINGS BIG PROBLEMS TO RAILROADS

Something of the magnitude of the problems that arise in railroad operation because of low winter temperatures is revealed in a bulletin issued by the New York Central Lines to its chief engineers, superintendents, etc. The pamphlet shows that the temperatures and precipitation for each month in the various important stations on its lines are carefully tabulated. A scien-

tific study of these records, covering several years, enables the road to issue general forecasts which are a material aid in preparing the track and the equipment for approaching cold weather. The bulletin referred to shows that the abnormally cold winter of 1911-12 caused the greatest number of broken rails in the history of the transportation company and also that an unusual number of wheels gave out. While such extreme cold does not occur frequently, it was deemed advisable to make improvements so that when the severe test does come, it could be met without serious interruption of traffic. Consequently the New York Central Lines laid no less than 900,000 tons of basic open-hearth steel rails, in the place of those among which were so many defectives, and a vast number of old wheels were replaced by solid steel wheels.

3776

EASTERN FOOTBALL TROPHY A STRIKING STATUE

Intense vigor is depicted in every line of the statue which is to be awarded



COPYRIGHT, UNDERWOOD & UNDERWOOD

to the football team that wins the eastern-university championship in 1917. The figure is that of a football player dressed in all his gridiron "togs," and shows him the instant after he has delivered a powerful kick to the ball. In por-

traying this difficult posture the sculptor has produced a work of art which is suggestive of the highest football development

Over 80,000 lb. of aluminum has been recovered in Ontario for munition making by substituting copper wire for aluminum wire on the main transmission lines of the Ontario hydroelectric commission.



# RAPID TRANSIT IN MID-AIR

3411

By J. E. MURPHY

**T**HAT aerial rapid transit connecting the roofs of the skyscrapers in cities like Chicago and New York will be the next transportation problem to demand solution was freely predicted at a recent convention of owners and managers representing the bulk of the big building interests of the United States. Congestion on the streets and on the elevated and surface lines, while important in itself, is not the only consideration leading to this conclusion. Time and convenience are the essential things. What is needed is a system of transportation that will make it unnecessary for a business man to take an elevator at an upper floor of a skyscraper, descend to ground level, and, after encountering the crowds on the streets, take an elevator in another skyscraper to reach perhaps the same level that he started from.

Plans for connecting adjacent sky-

*409 - Box 617 Duquesne Square, Ill.  
Bonnie Brae St., Los Angeles*

scrapers by means of aerial tramcars running on cables and operated by haulage cables, such as are now in use for reaching several peaks of the Alps, have already been definitely proposed. The requirements of city transportation, however, make such a system wholly inadequate. The only plan that will prove satisfactory is one that

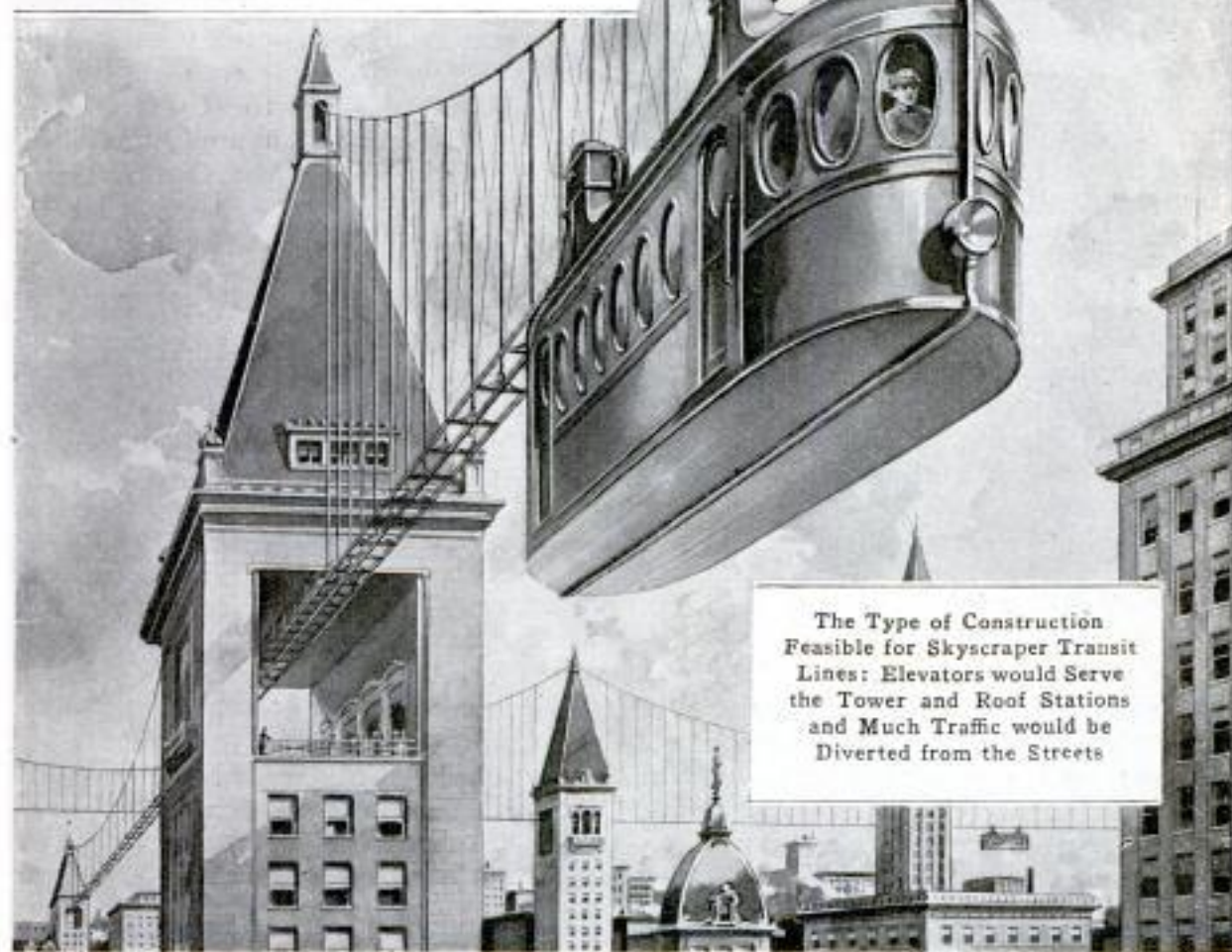

The Type of Construction Feasible for Skyscraper Transit Lines: Elevators would Serve the Tower and Roof Stations and Much Traffic would be Diverted from the Streets



provides a complete and dependable aerial rapid-transit system serving the entire skyscraper district. In Chicago, for example, if it is to be a practical success, such a system must virtually duplicate the surface lines of the loop district, in addition to providing a number of diagonal lines for giving quick access to the railway stations.

Novel as this proposition may seem, it is simply a problem in finance and engineering design. There is little doubt that a satisfactory solution of the engineering problem can be found if certain restrictions and requirements are observed. Cars suspended from sagging cables, like those of the Alps, would be clearly out of the question, for where there is a sag in the cable there is a sharp summit to be passed at each support. To make fast running safe, or even possible, it will be necessary to provide a supporting structure so rigid that there will be no appreciable sag under the weight of a loaded car. On the other hand, any type of trussed bridge construction such as is used for railways will impose too great a load on the buildings, and it is the buildings themselves that must furnish the support for the aerial structure. The same consideration evidently makes it necessary to suspend the cars from the running rails, as any plan for operating the cars above the rails will require a heavy floor system made of steel girders and floor beams. In addition to these requirements, the cars must be self-propelled, just as are surface-line cars, and must operate on double-track lines.

While it is impossible to say in advance of actual design just what the form of the aerial structure will be, there is at least one construction that meets all these requirements. This is a simplified suspension-bridge span. With this type of construction all the members of the span will be in tension and the span need have only a fraction of the weight that is necessary when compression members are used. A 2-in. cable made of the best steel, for example, will resist a pull of more

than a hundred tons, but the same cable placed under compression will buckle with the application of a few hundred pounds. The spans for each track might be made either single or double, as either construction would furnish satisfactory support.

Assuming that the single span, because of its simplicity, is the one to be adopted, the next question would be that of attaching the running rails. This could be done by means of brackets having roughly the form of an inverted "T" and suspended from the lower chord of the span, one rail being supported on each of the projecting arms of this bracket. Since the brackets would be located between the rails, an individual axle, acting as a revolving cantilever beam, would be required for each of the wheels. Here, again, the problem would simply be one of engineering design. A long bearing would be required and it would be necessary to make the axles of somewhat greater diameter than if each pair of wheels were mounted in the usual way on a single axle. Each axle would be mounted in a bracket extending upward from the framing of the car, and within this bracket would be housed the motor for propelling the wheel. Arranging the power or "third" rail is the easiest feature of the construction, as this could be attached to the lower side of the inverted "T" bracket, in convenient position for the contact shoe.

Steel towers springing from the roofs of the buildings would furnish support for the aerial spans. These towers might be rectangular in section to a point well above the running rails, and above this level would probably taper practically to a point. The cars would pass through openings in the towers.

Under the building ordinance of Chicago the height limit is now 200 ft. Prior to 1911 the limit was 260 ft., and a great many of the buildings of the loop district are built to this level. Grades might be put in in places, but the aerial lines would as a rule be built to correspond to the high level. The difference of 60 ft. would therefore be



the determining factor in the height of most of the towers and stations erected on the lower buildings. The station could be installed directly on the roof of a high building, and one or more of the elevators already in service in the building could be arranged to run to a cabin on the roof. With the lower buildings it would be necessary to support the station platforms on steel trestles, with elevators for reaching the platforms.

In New York there are a number of buildings, such as the Singer Building with its 41 stories, and the Woolworth Building with its 55 stories, that it would be practically impossible to reach the top of with an aerial line. In such cases the line could be run through the building at the twentieth

or thirtieth-floor level. In Chicago the situation is more favorable, there being a surprising regularity in the sky lines of the principal streets of the loop district. In few cases would spans of more than 200 ft. be required. In a steel span of this length the expansion or contraction due to heat and cold would amount to about  $1\frac{1}{2}$  in. for a change of  $100^{\circ}$ . No serious difficulty would be caused by twice this variation in length of span. There would be no necessity for "grade" crossings. North and south and east and west lines would undoubtedly be built at different levels, while the diagonal lines could be built at a third level. All could be served by the same stations, with the same elevators running to the three platform levels.

### 3599 LUNCH COUNTERS DESIGNED IN NOVEL STYLE

By an ingenious arrangement of his lunch counters a Chicago restaurant man has effected a saving of about 18 per cent of the space required to feed a given number of patrons, besides giving each customer plenty of elbow room and enabling the girl waiters to do their work in greater comfort. The space usually occupied by long straight

counters is broken up into sections, each forming three sides of a rectangle, with three pivoted stools to a side, leaving a clear space in the middle of the rectangle for the waiter, who thus has nine persons to serve when the seats are filled. Each stool has a comfortable low back, and the new arrangement, which accommodates over



Novel Arrangement of Seats in a Chicago Lunch Room: Each Waitress Has Nine Customers to Serve and a Clear Space to Work between Them. The Plan was Designed by the Proprietor

*Brown & McKimmon*  
*21 E. Adams, Chgo.*



Dec 19-1916 P. 2V.23,3 P

Chancey L. Sell + Lewis H. Page  
Cathlamet, Wash.

POPULAR MECHANICS

90 customers at a time, is said to work well, especially during the rush incident to the noon and supper hours in one of the busiest streets of Chicago's retail district.

367° **FRUIT PICKER'S TRAY SAVES USER'S TIME**

Rapid picking of berries or other fruit is made possible by using a recently patented tray which is held in



Fruit Picker's Curved Tray Having Raised Edges and Held in Place by Shoulder Straps so That Both Hands can be Used in Picking

front of the wearer by straps extending around the waist and over the shoulders. It is curved to conform to the shape of the body and has raised edges that prevent the baskets set on it from sliding off. The device permits the use of both hands, and its capacity is such that time is not lost in frequently stopping work to renew one's supply of empty containers.

3919 (2) **ALWAYS LUMINOUS PAINT**

**FOR LIGHT SWITCHES**

A compound which is continuously self-luminous is to be used by a large firm in the manufacture of electric-light switches, and the like, so that they may be easily found in the dark. This "radium paint," as it has been called, should not be confused with substances now on the market which are luminous only after being exposed to the light for several hours. The new preparation contains a small quantity of radium bromide which, in the dark, gives the paint about the brightness of a rubbed sulphur match. On aeroplane compasses a luminous compound is used that shines quite brilliantly, but it contains such a large percentage of radium that it rapidly disintegrates the zinc sulphide contained in it so that it lasts only about a year, whereas this preparation for switches will last for 10 to 15 years, it is said. For switches already installed it is proposed to supply luminous-head screws which would reveal the position of a switch in the dark.

3932

**FAMOUS TENNESSEE CAVES BEING DEVELOPED**

The development of two historic caverns in Tennessee, known as Arch Cave and Bone Cave, in Van Buren County, is now in progress. During the Civil War Confederate recruits are said to have been secretly mustered into service in Arch Cave, while Federal troops scoured the territory overhead. One room in this vast underground area is known as the "Muster Ground." It has a level floor, is 60 ft. wide and 300 ft. long, and is surmounted by a symmetrical oval dome. On at least one occasion, southern soldiers took refuge in these subterranean passages when hard pressed by the northern army. Until the Civil War broke out, the caves were inhabited by vast numbers of bats, and it is estimated that thousands of tons of bat guano, rich in potash and ammonia, have accumulated there.

12/22/16  
Electrical Review  
Town from Electrical World 1917 11/16 p 137  
General Electric Co.  
N.Y.



and which will render their location visible in the dark. "radium" paint will be used, similar to that already recently employed on luminous dial watches, compasses, etc. This paint is continuously self-luminous, and, it should be noted, is to be distinguished from the luminous paints and ball-chain balls which have been on the market for some years, which require exposure to strong light to make them luminous in the dark for a period of several hours.

The base, zinc sulphide, is the same for the new self-luminous paint as for the older phosphorescent paint which absorbs light and then gives it out again, shining with a greenish or bluish glow in the dark. The new paint, however, contains a small quantity of radium bromide, the alpha-particles of which, continuously bombarding the crystals of the sulphide, render it luminous in the dark with a pale greenish glow of about the intensity of a rubbed phosphorous match. By increasing the quantity of radium compound included in the paint the more brilliant can this phosphorescent glow be made. On aeroplane compasses used by the European armies, the luminous compound employed is of such intrinsic brilliancy that its glow can be seen even in contrast with twilight. Such a high mixture of radium compound, however, rapidly disintegrates the zinc sulphide, so that the life of the paint may be barely twelve months. In the intensity to be used on the new switches, which has been found most practical for average use on watch dials, etc., the figures are readily visible in a darkened room, and such paints have an assured luminous life of ten to fifteen years, if not longer.

It is proposed to tip the switch push buttons with this luminous compound, so that when entering a darkened room the user can quickly find the button, press it, and secure electric light.

In order that ordinary flush switches already installed may be made luminous, the electrical manufacturer referred to has devised the ingenious expedient of luminous-tipped screws which can be used to replace the present screws, giving visible points of luminosity by which the switch can be located in a darkened room.

The cost of the making and applying the self-luminous paint is, at present market prices of materials, about \$1 per square inch. At this rate it is expected that the extra cost of equipping an ordinary electric light switch will be from 20 cents to 30 cents.



has removed its New York office, in charge of William A. Daunt, from the Country Life Permanent Exposition Grand Central Terminal, to 31-33 East Twenty-seventh Street.

**Brass Mills Cause Delay in Flashlight Deliveries.**—The French Battery & Carbon Company has announced that owing to the failure of brass mills to make contract deliveries of sheet brass, cigarette type cases will not be ready for delivery until Nov. 1, 1916, and number 33 lighting batteries will not be ready for delivery until Feb. 1.

**New Buffalo Location for Western Electric Company.**—The Western Electric Company has moved its offices and showrooms in Buffalo from 98 Terrace to 709-11 Erie Street. The new location, with two large show windows fronting on two streets, affords splendid display facilities. J. W. Tabb is the manager.

**Fixture Manufacturer Increases Factory Space.**—The Mohrlite Company of Urbana, Ohio, manufacturer of direct, indirect and portable electric fixtures, is moving into a new 60 x 100-ft. factory. In its new home this concern will occupy three times the floor space of its present quarters. This company moved its factory from the Pacific Coast to Urbana last January, and since has outgrown the space taken at that time. A part of the increased business is attributed to orders received from the following foreign countries: Sicily, Norway, Australia, Japan, Hawaii, England and France.

**General Vehicle Company Moves Chicago Office to New Quarters.**—The Chicago sales office of the General Vehicle Company has been removed from the Otis Building to quarters on Automobile Row at 1621 Michigan Avenue. Here the company will have an office and showroom 43 ft. by 105 ft. in which truck chassis will be exhibited, and a room back of this 400 ft. by 43 ft. where a large stock of parts will be maintained. There is also sufficient space for a service station which the company may install at a later date. The Chicago manager of the General Vehicle Company is C. W. Squires, Jr.

**Shortage of Freight Cars.**—Conditions which are steadily becoming more acute have recently prompted the Interstate Commerce Commission again to call attention to the threatened shortage of freight cars and to urge the adoption of all possible steps to alleviate conditions. The commission urges upon both carriers and shippers the necessity for close supervision of the methods of loading, unloading and moving of cars to secure the fullest possible use of available equipment. The commission emphasizes the responsibility of shippers securing the prompt and full load of cars, and of consignees exercising the same degree of promptness in their unloading and release. It is urged that individual shippers and their associations and the carriers co-operate in this matter in order to avoid, so far as possible, the delays consequent upon a general car shortage.



3157

## FARRAGUT'S FLAGSHIP WITH CANVAS SPREAD



"OLD Salamander" was the popular title that David Farragut, the first admiral of the United States Navy, won as commander of the "Western Gulf Blockading Squadron" in the days of the secession. His flagship, the "Hartford," that fought its way up the Mississippi with dash and boldness, is the trim little vessel shown under way in the picture above. The boat now serves as a receiving ship and is stationed at the Charleston Navy Yard.

COPYRIGHT, E. MULLER, JR.

114 Fulton St N.Y.C.

487



488  
3898

POPULAR MECHANICS

3930

ELEPHANT ENJOYS BEING

VACUUM-CLEANED

A New York show elephant that thoroughly enjoys the sensation of being cleaned, has that part of her

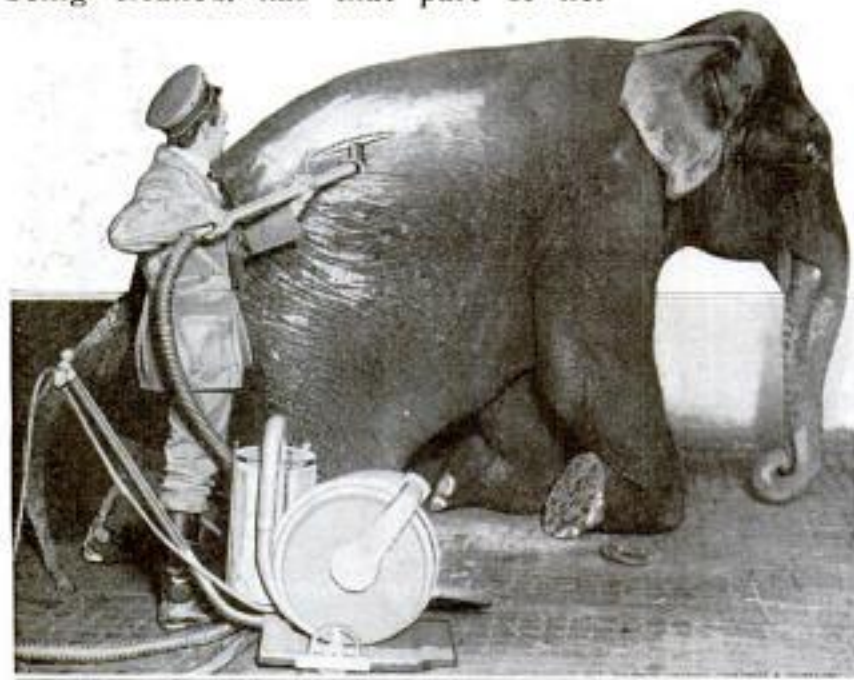

Cleaning a Show Elephant by the Vacuum Process: The Huge Animal Willingly Kneels to be Cleaned in This Way and Prefers It to a Scrubbing

toilet attended to in a novel manner. Contrary to the popular notion, "Lena," as she is named, does not care for rolling in dirt, but wails and annoys her keepers unless she is kept clean. An ordinary scrubbing fails to satisfy her, but when her vacuum cleaner appears she plainly manifests her delight and sinks to her knees that the work may be done conveniently. She is ready for the process at any time, and her deportment is especially good on days when the cleaner is regularly used.

3936

NEW SHIP ABLE TO CARRY AMMUNITION OR SUPPLIES

*Marine Journal 1-6-17*

An ammunition ship of a new type is to be built for the navy which will have a displacement of 10,000 tons and will be provided with refrigeration space so that it can be transformed into a supply ship with little alteration. The vessel will be equipped to burn either coal or oil fuel and will be armed with four 5-in. rapid-fire guns and two 3-in. anti-aircraft guns.

WHY MOTION PICTURES

CAUSE EYESTRAIN

*Sc. am. 1-27-17*

There are more factors involved in the proper presentation of motion pictures than the average person realizes, and if any one of these is not as it should be, it may result in injury to the eyes of those who view the "movies" frequently. This fact has been brought out recently by the acting secretary of the National Committee for the Prevention of Blindness. He has declared that either defective photography, improper illumination, poorly developed films, or inaccurate projection, may subject the eyes to overstrain. Furthermore, constant attendance at motion-picture shows in many cases reveals some weakness of the optics that was unknown before. Favorable conditions for the eyes can be obtained by having the theater as light as possible, by sitting directly in front of the screen, and by selecting a seat as far back as possible.

3720

BUBBLE FOUNTAIN FOR AN ORDINARY FAUCET

Any ordinary faucet can be readily converted into a drinking fountain of the bubble type by means of an ingenious attachment recently devised by a Denver woman. Even when attached, it does not interfere with the customary use of the faucet, as it can be instantly swung to one side when pulled down slightly from the water outlet, with which it has a pressure contact.



Winifred Edwards  
1817 Glenarm St.  
Denver, Colo.  
Copyrighted material



# Wm W. Warner, 310 W. Division St.  
So Bend.

Christian Science Church, So. Bend, Ind.

POPULAR MECHANICS

489



Two Views of an Old Church in South Bend, Indiana,  
being Drawn Five Blocks to a New  
Site by a Freight Engine

3758

### LOCOMOTIVE PULLS CHURCH TO NEW SITE

Among the many unusual methods employed to move buildings, few have been as novel as that used in South Bend, Ind., to transport an old church to a new site where it was to be remodeled into a theater. The structure, after being properly blocked up, was moved over to a railroad track and coupled to a freight engine. Then the locomotive slowly drew the bulky load a distance of five blocks, to a point not far from the new location. Because of unexpected delays nine hours were consumed in making the transfer.

3549

### ONE-WHEELED RICKSHA USED ON AFRICAN TRAILS

The one-wheeled ricksha of Africa, like its two-wheeled ancestor, the jinrikisha of Japan, was the invention of a missionary, the designer of the African vehicle being a Swede engaged in mission work on the Congo. An early form of the ricksha is shown in the illustration. Later models of somewhat different construction are made in England and are called "bush cars." The vehicle consists of a framework of bicycle tubing, supporting a cushioned chair seat over a single, low, rubber-tired wheel. The handles in front form



a continuous loop, and the rear handles resemble those of a wheelbarrow. Two native boys can easily transport a passenger in the ricksha, and it is the only vehicle practicable for many of the narrow and crooked foot trails which are still the only roads in the greater part of Africa.



Missionary's Wife Seated in a Ricksha for Transportation along Narrow Foot Trails in Angola, Africa

# Herbert C. Wichey,  
323 N. Curtis Av.,  
Alhambra Calif.



### TRUCK SUPERSEDES SLEDS IN ALASKA MAIL SERVICE

The automobile truck has found its way as far north as Alaska. Last

November, after the close of navigation, the government employed a machine with a four-wheel drive in place of dog teams, to distribute the mail in the vicinity of Nome. Before the holidays the loads weighed as much as two tons and sometimes a dog sled was used as a trailer. The longest trip made was from Nome to a point 22 miles distant. Instead of following a regular road, the sandy beach was traversed, and in spite of many patches of quicksand and bitter arctic weather, the powerful truck got through to its destination. At the end of the outbound trip the mail was transferred to sleds and carried on to more distant points.



Four-Wheel-Drive Truck Employed in Nome and Vicinity in the Place of Dog Teams to Transport United States Mail. The Dog Sled at the Rear was Used as a Trailer Shortly before the Holiday Season, When the Mail Was Very Heavy

3795

### SIXTEEN - CYLINDER ENGINE FOR AMERICAN AEROPLANES

America's gradually increasing concern in aviation matters is beginning to bear fruit, for inventors and manufacturers are concentrating more and more attention upon the development of engines that will free us from dependency upon those of European fabrication. It is therefore interesting to know of a new rotary motor with 16 cylinders that has been developed by a Rochester, N. Y., engineer. Freedom from vibration, obtained by balance and eight light explosions to each revolution; compactness of design, which keeps the head resistance of the unit down to that of a 25-in. circle; simplicity of arrangement, permitting a reduction of the usual number of working parts, and lightness, are among its outstanding features. The motor is rated at 150 hp. and weighs only 325 lb. Instead of using connecting rods, two pistons are built in one piece with a yoke in the center which has a

sliding bearing. The intake manifold is cast integral with the crank case. It will be understood that the motor revolves about the crank shaft, which remains stationary and serves as a part of the manifold, the carburetor being attached at one end of it just below the magneto.

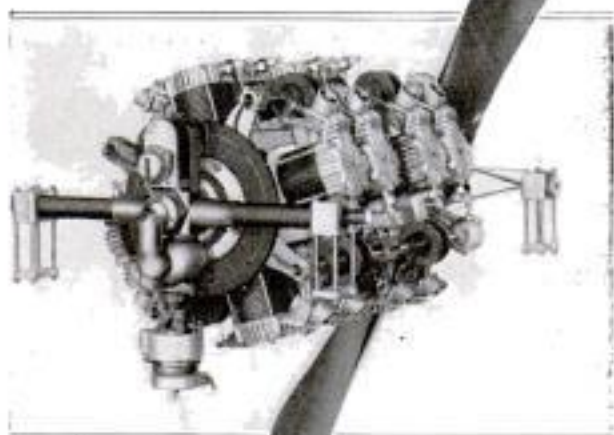

This New 16-Cylinder Developed by an Several Interesting Drawn through the the Main Manifold and Reaches the Cylinders through Valves in the Piston Heads

Aeroplane Engine Lately Eastern Engineer Has Features. The Gas is End of the Shaft into the Cylinders through Valves in the Piston Heads

H. L. F. TREBERT ENGINE WORKS,  
495 ST. PAUL ST., ROCHESTER, N. Y.



# 'Soldiers' Sensations in Battle

by Lewis R. Freeman

*Pasadena Calif.*



*"A German shell penetrating deep into the soft earth before exploding had driven him, unscathed by the explosion itself, straight through a barbed-wire entanglement. . . . He brought up like a snared partridge in a tangle of the wire, and they had to cut this away before he could be taken out."*

IT was recently my privilege to see, in a single period of 36 hours, all the stages through which a wounded soldier of the British army passes from the time he is brought back to the most advanced dressing station on the Somme until he is put aboard the hospital steamer for England or sent to a convalescent depot to recuperate his strength in France. During this short time I saw several thousand wounded men—with injuries all the way from two hours' old to as many weeks—and the one thing that impressed me most (aside, of course, from their magnificent courage and fortitude) was the apparent absence among them of poignant physical suffering. It was the exception rather than the rule to hear a groan; and this was especially true of those whose wounds had received their first careful attention and who (either through rest or sedatives) were over the first shock of injury. In a visit to all parts of a hospital ship about to leave for England with many hundreds of stretcher cases whose wounds had all been received within a day or two, while many—not unnaturally—looked extremely depressed and uncomfort-

able, I do not recall hearing a single exclamation of agony or even impatience.

This is all very largely due to the promptitude and skill with which wounds are usually dressed on the western front; but it is also true that the present-day bullet rarely inflicts an extremely painful wound. Indeed, one talks with men dreadfully mangled by shrapnel bullets and shell fragments, who stoutly maintain—though their eyes may be big with horror at the sight of their shattered bodies—that the physical pain is not extreme. I have an especially clear recollection of a young Scotchman, with his lower jaw so shot away that he could not articulate a single coherent word, who still shook his head in vigorous negative when I asked him if the pain was very great. The one class of wounds which are invariably excruciatingly painful are those in the vicinity of the diaphragm, while shots through the lungs or abdomen, though not always imposing great agony, are usually very uncomfortable.

One of the most painfully wounded men I saw was also one of the most



slightly wounded. A German shell penetrating deep into the soft earth before exploding had driven him, unscathed by the explosion itself, straight through a barbed-wire entanglement. Faring better in one respect than the man who jumped into the bramble bush in the nursery rhyme, he did not "scratch out both his eyes." Protected, as they were, by a rather beetling brow, these escaped injury; and they were about the only part of his unfortunate anatomy that did escape. While there was not a cut on him over half-an-inch deep, neither were there more than a few inches of cuticle at any place on his body that had been spared by the cruel barbs. Some of the furrows on his back and legs were over two feet long.

"He brought up like a snared partridge," said one of the doctors who at-

tended him, "in a tangle of the wire, and they had to cut this away before he could be taken out. Although the cuts were not deep, the germ-laden earth of the Somme was so thoroughly rubbed into them that only repeated injections of antitoxin saved him from blood poisoning. I have never known a human body to 'neutralize' so much antitoxin. During the first two weeks he was here he was constantly in greater pain than any one of the many hundreds of far worse wounded men that passed through our hands in that time. He's out of agony and on the way to sure recovery now, but we had a hard fight to save him."

It was nearly a month after he had been injured that I talked with this man, but the memory of the experience was still enough to make his eyes contract with horror when he spoke of it. He had been wounded twice before, he said, but this was the first time he had experienced great pain. "How did it feel?" I asked. "Like being curried"—he had been a groom and the expressive simile was doubtless the first that came into his head—"with a red-hot currycomb," he replied instantly. "It didn't stop smarting for two weeks, and the worst of it was that there wasn't any place left to lie down on, I was that scratched. There's one consolation, though," he added with a smile, lifting the edge of a bandage to show where the scars

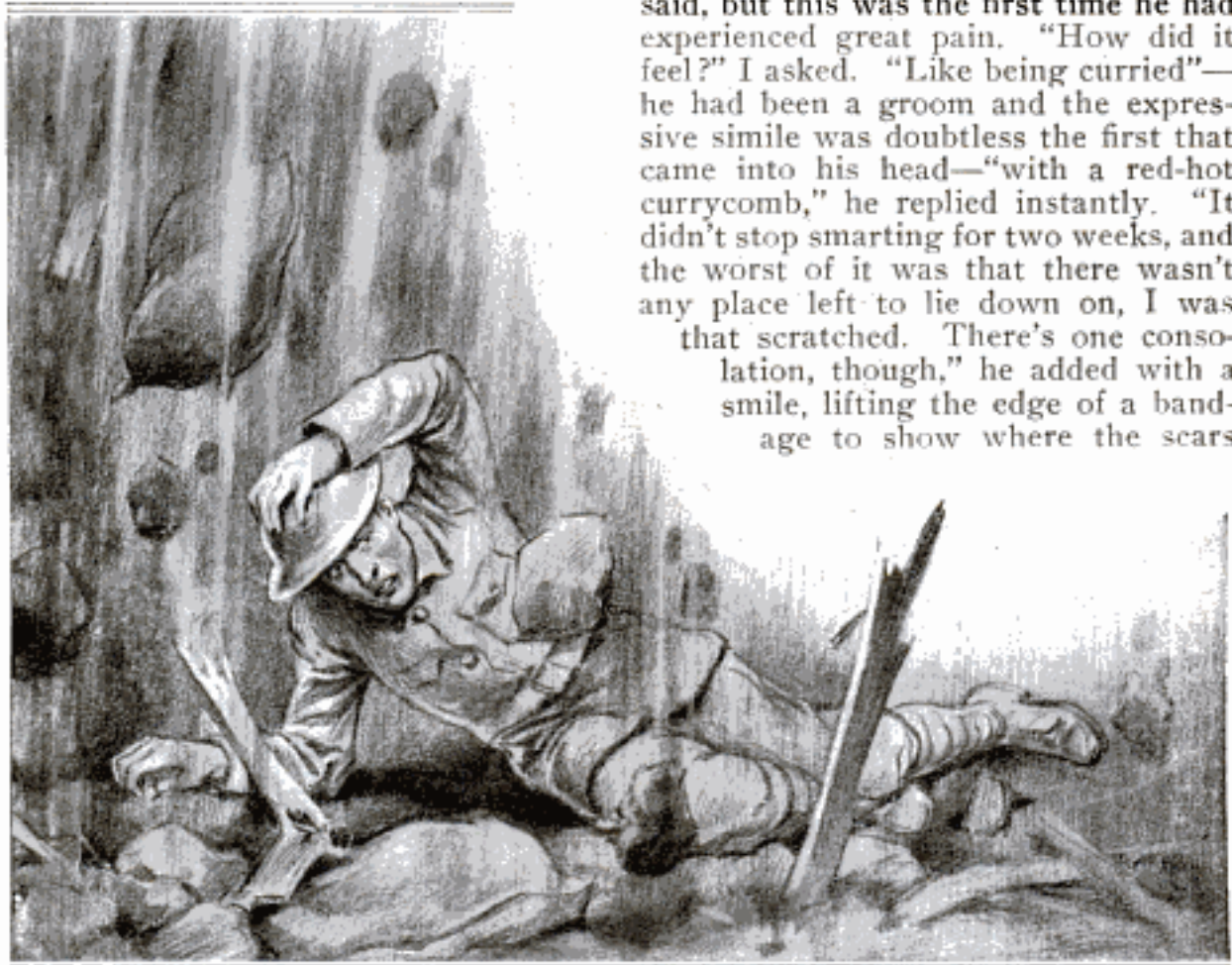

*"I was about 40 or 50 yards from the mine when it exploded. . . . The earth rocked; it billowed in waves like the surface of the sea, and I was thrown to the ground. . . . Then the things that had been thrown up high in the air began to fall, the heavier stuff first, the lighter later and more gently. . . . I struggled clear of the encompassing mass three or four times before my strength and senses gave way together and I fainted."*



were healing in alternate welts of red and white; "if they send me to prison some day, they'll only have to stamp the broad arrow on my back. There won't be any need of a suit of stripes."

As a consequence of the unprecedented artillery bombardments of Verdun and the Somme, and the incessant mining and countermining, the proportion of men buried in earth and rubbish in these areas has been a hundred times greater than in any operations of wars of the past. Those within the direct swath of the explosions are, of course, usually badly mangled or killed instantly. There is, however, a very large number of unwounded, or but slightly wounded, buried by great shell and mine explosions, and it is astonishing how large a proportion of these are rescued little the worse for the experience.

This is largely due to the soft porous earth all along the western front, which comes down on a man, as I heard a Tommy who had been through the mill put it, "as light as a feather bed." A heavy shell striking within a few yards of a trench will, unless there is a lot of "chicken wire" or wattle built into the sides, usually cave it in. Bags of earth become hard after a day or two, tending to retain their shape even when upset. If a man is buried under a great many of them life may well be crushed out of him; but if the covering is not too heavy, enough air will usually get in between the bags to prevent his suffocation. I

talked with one man who said that his worst discomfort during the ten hours he was buried under six feet of sandbags was from fleabites which, because his arms were pinioned, he could not scratch. Another, who was buried and stunned under a heavy layer of bags, was located and rescued the sooner through the whining of the company's pet dog that was covered up near him.

Mining and countermining have been responsible for some remarkable exploits and sensations. One of the most thrilling recitals I ever listened to was that of a sapper who was in command of a party trying to countermine a tardily discovered tunnel which the Germans had driven up almost under a very important British position on the Somme. "Before we located the tunnel," he said, "the Germans had driven it very nearly to a point at which the ex-



"Up flew me and the sandbag together, and the first thing I knew was a 'ell of a crack across the 'ips, and there I was 'anging in the blooming tree like last week's wash."

plosion of a large mine might have had very serious consequences for us. Our game, therefore, was to frighten them away, or, failing that, at least to hustle them so that they would place and fire their mine as far away as possible from the point at which they aimed. Accordingly, in driving our counter-cut, we made as much noise as we could in digging in order to give them the impression that we were much nearer them than we really were. This did not stop them, and, as they appeared determined to push on to their original objective, the only thing left for us



to do was to drive as near them as we dared and rush up the explosive for a small mine in the hope of caving in their tunnel by the shock, or, if luck were with us, even of setting off any explosive they might be getting in place.

"The ticklish part was in deciding how long to hang on, how long to wait before starting our little diversion. If we fired too soon we might be so far away from them that their cut wouldn't be affected, and then all our work would be lost and there would be left no means of checkmating them. If we waited too long they might push to a point so near that their end would be accomplished. Not a dirt-grimed mole among us—nor probably among the Germans either—but, consciously or unconsciously, was trying to pierce that earthen barrier with his mind as well as his tools and know the mind of the men on the other side. Perhaps it was because German psychology—here as in diplomacy—was faulty; perhaps it was only sheer luck. At any rate—I can't describe the sensation, but it was just as though something suddenly seemed to say to me, 'Now's the time!'—I fired such stuff as I had on hand first, and at what was probably about the right moment. The 'heading' of the German tunnel was even nearer us than I had anticipated and—although I was never sure that we detonated any of their explosive—their cut was so shattered and shaken that they did not attempt to use it again."

An officer of a London regiment who was introduced to me as "a man who had carried out to the letter the work he had been sent on, after having been buried for over an hour by the explosion of a German mine," in trying to explain to me "what it felt like," led me to a little eminence from which, standing on the ruins of a village church, we had an unobstructed view of a sector of the German trenches, a half mile away, that was under a concentrated bombardment of the British "heavies" in preparation for an imminent attack. "You see the way the earth flies up with a rush and falls

almost gently back," he said, pointing to the geyser of dust and débris and smoke that followed the explosion of a 15-in. shell. "Well, that is a mine on a small scale. Anything or anybody right over it is torn to pieces; and serious injury is usually inflicted upon anyone struck by the more solid of the falling fragments. But—in this region at least—most of the stuff that goes up and comes down is soft earth, and the chances of a man's getting out of that (if only he isn't buried too deep) are ten to one in his favor.

"It would hardly be proper for me to tell just why I happened to be where I was at the time. Suffice to say that I was about 40 or 50 yards from the mine in question when it exploded. Even at that distance the earth rocked—indeed it more than rocked; it billowed in waves like the surface of the sea—from the force of the explosion, and I was thrown to the ground by the sudden shock. A fragment of heavy timber flew by me. Some heavy lumps of earth struck me, but nothing more solid. These were driven straight out by the force of the explosion. Then the things that had been shot up high in the air began to fall; the heavier stuff first, with solid impact, the lighter later and more gently. Stones, fragments of timber, and bits of other trench materials arched over in even trajectory like the water of a fountain jet. After them came the clods and other stuff of medium weight. Then, out of the mushrooming cloud of smoke and dust which was swirling and spreading two or three hundred feet above, the lighter stuff—the finely disseminated earth, and leaves and pieces of bark—began to settle down.

"By great good luck, none of the heavy stuff struck me; and yet, for half a minute or more, the rain of clods was so heavy as practically to stun me. Although these fell to a depth of six or eight feet, I have always felt that, if I had not been more or less dazed by the shock, I could have fought my way upward fast enough to keep my head 'above water' all the time. Even as it was, I struggled clear of the en-



compassing mass three or four times before my strength and senses gave way together and I fainted. My last clear recollection was of having struggled free of the heaviest of the clods, and of the rather pleasant sensation—almost like the touch of falling snow—occasioned by the gently settling dust. It was probably this latter stuff—by cutting down my supply of oxygen—that caused me to faint. Fortunately, I had had the presence of mind to pull a corner of my tunic up across my face, so that, as there was plenty of air all through the fallen dirt, I would probably not have suffocated even if I had been covered up for several hours. As it was, I was so little upset in mind and body after being pulled out that, after a spell of coughing, a drink of water and a few minutes' rest, I was still able to go ahead with what I had been sent to do."

One cannot talk long with a Tommy on the Somme without hearing some weird tale or another of what he has seen happen to one of his comrades as a result of shell explosions in the trenches. For obvious reasons these tales are almost invariably told about some one else; in fact, the one first-hand recital of such an incident that I heard was a far less illuminative account of what happened than might well have been told by one of the chief

actor's comrades. I talked with the man in a hospital where he had been for a month recovering from crushed pelvic bones and internal injuries caused by impact with the limb, 20 ft. from the ground, of a tree against which he had been thrown by a German shell exploding in his trench.

"I was sitting on a sandbag," he said, "when the blighter that done the business plumped right into the bottom of the trench and buried itself deep in the mud before exploding. Up flew me and sandbag together, and the first thing I knew was a 'ell of a crack across the 'ips, and there I was 'anging in the blooming tree like last week's wash. Didn't 'ave to 'ang on at all. It just plastered me round the lim' like a piece of soft meat. I couldn't climb down, and, as they 'ad no ladders, there was nothing to do but for one of the boys to shin up and let the remains of me down at the end of a line. Course it 'urt like 'ell, getting me down; but I'm sure I didn't go off in a faint at that stage of the show, cause I can remember cursing, with the little breath I 'ad left, some bloke 'oo 'ad mooched along and was tryin' to snap me with a bit of a cam'y 'e'd smuggled up to the trenches. Camrys in the trenches are strictly forbid, and you can jolly well believe I told 'im wot I thought of 'im for 'aving it."

3780 *Journal*

### MANY APPLICANTS FAIL IN CLIMBING TEST

Some indication of the physical endowments of the average young man in this country may be found in the results of a test recently given to applicants seeking positions in the fire department of Portland, Ore. Each man was asked to climb five rungs of a ladder in hand-over-hand fashion. Of the 150 who made the attempt 74 were able to climb the required number, while only 10 exceeded the minimum. The results of the trials are especially interesting in view of the prevalent discussion of the need of more systematic physical training for the young.



An Applicant for a Position in the Portland, Oregon, Fire Department Undergoing a Climbing-by-Hand Test



Crane Co.

#B.Z. Kirkpatrick  
Bureau of Yards - Service  
Navy Dept  
Wash. D.C.  
Bureau

496 3872

# POPULAR MECHANICS

## PERISCOPE REVEALS GOODS IN STORE BASEMENT

By the novel use of a periscope installed in a show window on Michigan Avenue, Chicago, an exhibit of goods in the basement, which would otherwise be completely out of sight, is revealed to the gaze of interested passers-by. The idea originated in the establishment itself, and so far as is known, this is the first case of commercial use of the instrument in this way. The eyepiece is fixed close to the window pane, at a convenient height to be used by persons on the sidewalk outside, and a small sign says, "Look! See the Exhibit in the Basement." On peering into the eyepiece, one can plainly see the goods displayed on the floor below, the shaft of the periscope passing through the floor of the show window, below which an arrangement

of mirrors set at the proper angle brings the display of basement goods into view.

3811

## WATER SUPPLY OF CANAL ZONE CLOSELY COMPUTED

It is interesting to note that the estimates that were made by French and American meteorologists before the Panama Canal was built regarding the available water supply in that region were substantially correct, as is shown by the careful check which has been kept since the canal has been in operation. Rainfall and evaporation stations have been established over the Gatun Lake watershed, which comprises a large area, and an account is kept of the gain or loss of water due to lockages, spillway waste, hydroelectric-power generation, leakage, municipal needs, rainfall, evaporation, and increased or decreased storage water. In checking up it has been found that the estimates came within from 2 to 10 per cent of the actual totals, which is considered reasonably accurate in view of many changes in the Canal Zone in recent years.

3885 (8)

## RAILROAD DERRICK USED TO MOVE HOUSES

In removing houses that obstructed its right of way, a western railroad recently tackled the job with a large derrick—part of its wrecking equipment—and saved much time thereby. The method included the passing of



Viewing a Basement Exhibit of Plumbing Goods by Means of a Periscope on the Sidewalk Level: Note the Arrangement of Mirrors beneath the Floor, by Which the Goods are Made Visible from the Outside and Brought to the Attention of Passers-By

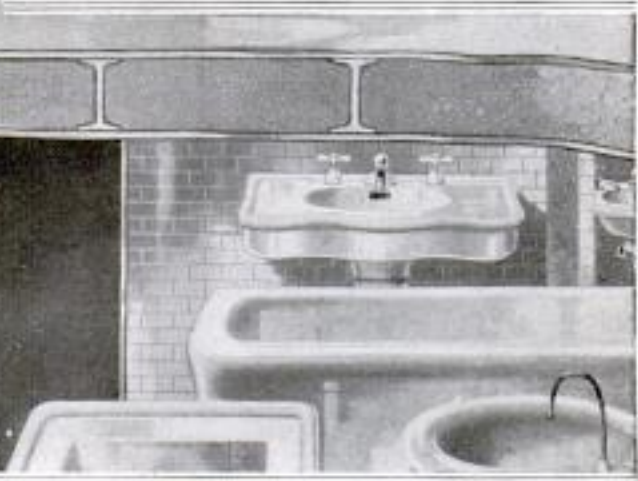





Moving a House with a Railroad Derrick: The Building was Supported on Steel Rails, Attached by Chains to the Arms of the Derrick. The Man at the Window and Other Residents were Undisturbed

four chains around the house to be moved, connecting them to steel rails on either side beneath the building, on which the weight rested, and then lifting the whole bodily into the air by means of the derrick to a new position beside the right of way. The houses being situated close to the track made the use of the derrick feasible, and the removal was accomplished without disturbing the residents or damaging the buildings, except where the roofs overhung.

3806

### SHELL AND GAME BAG FOR SPORTSMEN

Both hunters and fishermen may be served by a combined shell and game bag recently placed on the market in California. This bag is provided with means for circulation of air over fish or game carried inside, has four pockets for shells or tackle, and is so hung and

adjusted that the contents of the pockets can be readily reached and the weight is distributed evenly. It is



Front and Side Views of Combined Shell and Game Bag Adapted to Carry Fish and Tackle

made of standard khaki duck and may be worn either with or without a coat. It hangs from the shoulders by broad straps, and buckles in front.

Summers Mfg Co., Los Angeles



**HUGE VOLUME TO CONTAIN  
 "DEUTSCHLAND" STORIES**

In commemoration of the historic first voyage of the merchant submarine "Deutschland" to America, a commit-

tee, organized in this country, is preparing a huge book which will contain every available reference to the submarine's trip which has appeared in American publications. The tome when finished will measure 6 ft. long and 2 ft. thick and will be presented to the Royal Library in Berlin. The names of those contributing in any way to this memorial will be engrossed on the pages of the book. The unique volume will be bound in solid silver, embellished with corners and clasps of wrought gold. It will rest on four gold eagles, two typifying Germany and two emblematic of the United States. This is the first instance on record, it is claimed, in which practically all that has been printed in a whole country concerning a historic achievement is to be gathered into one book.

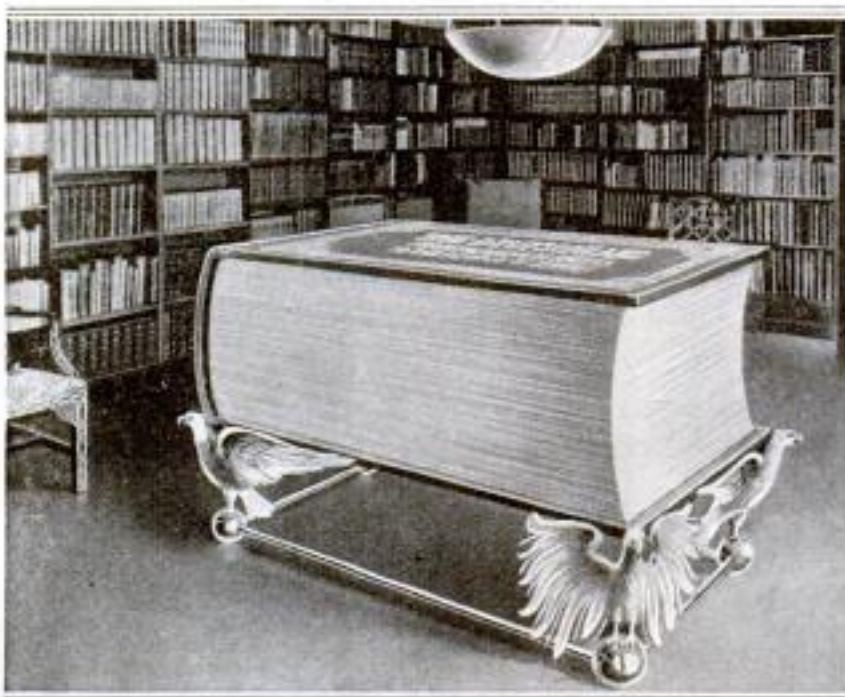

First Design of Mammoth Scrapbook, Handsomely Bound, Which is to Contain All Available Clippings from American Publications Regarding the First Voyage of the "Deutschland." It will be Presented to the Royal Library in Berlin

3797

**SQUATTY MINE LOCOMOTIVE  
 WORKS IN LOW DRIFTS**

To meet conditions in a certain coal mine whose galleries are very low, a special electric locomotive which extends only 26 in. above the rails has



This Locomotive Weighs Two and a Half Tons, Is 26 Inches High, and Pulls a 50-Ton Load Easily. It was Built Especially for Use in a Coal Mine Whose Galleries Are Exceptionally Low

been built. It is fitted with two trolley poles, one on each side, and a 300-ft. reel of cable that is employed in passages too low to permit overhead conductors to be strung safely. The free end of this insulated line is supplied with a hook which the operator slips over the trolley wire in one of the main levels when he is about to enter a small side drift. As the locomotive proceeds the reel unwinds. When the direction is reversed and the distance retraced, the reel winds automatically, recoiling the cable rapidly so that it does not slacken enough to cause interference.

*Jeffrey Mfg Co.  
 Columbus, O.*



### PIPE ORGAN IN A STORE SERVES TWO FLOORS

Some novel features of pipe-organ construction and service are embodied in a \$10,000 instrument recently installed in a progressive department store in Los Angeles. The organ and its



Above is the Auditorium of a Los Angeles Department Store, Showing at the Left the Keyboard of a \$10,000 Pipe Organ the Music of Which is Conveyed to the Café Below, by Means of the "Musical Radiator" Seen in the Ceiling in the Lower Picture

keyboard are placed in a large auditorium on the fifth floor, open to customers for rest and entertainment. Directly below, on the fourth floor, is the café of the store, to which the music of the organ is conveyed by means of a "musical radiator," 20 ft. long and 12 ft. wide, built of ornamental wood in the ceiling of the café and communicating directly with the pipe room above. This radiator is provided



with heavy wooden shutters padded with felt, which serve to exclude the music at will. They are controlled from the organ keyboard, or from the café by means of a small stop which is

operated by air pressure. The keyboard is said to be equipped with 20 more stops than have ever been built into any other organ. Motive power for the pumps is supplied by electricity, or by a water-power motor if required. As the organ serves two floors, its cost is expected to be soon covered by the elimination of the café orchestra. It was built and installed by California mechanics.

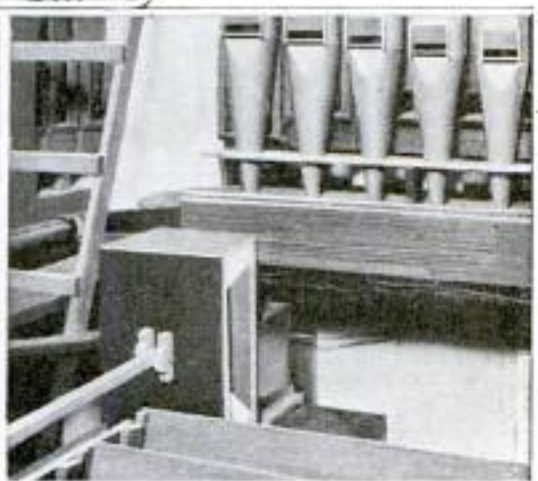

Pipe Room of the Organ, Situated on the Auditorium Floor of the Store: The Bellows are Seen Just below the Pipe Ends in the Picture at the Right. Also a Glimpse of the Shutters of the "Musical Radiator"



## PREPARING AERIAL FIGHTERS AT MINEOLA



By Some of Their Recent Squadron Flights the Mineola Airmen, Who Are Students and Instructors at the New Aviation Station Established at Mineola, New York, have Come into Notice. The Work That is Being Carried On at This Field Is Such as to Encourage the Advocates of Aerial Preparedness. The Picture Presented Above Shows a Group Studying the Details of a Model Monoplane Constructed by One of the Privates



The Service Uniform Worn by the Army Fliers Is of a Pattern That Differs Little, if Any, from the Togs of Most Civilian Airmen. The Cost of the Outfit Shown Above Is About \$75

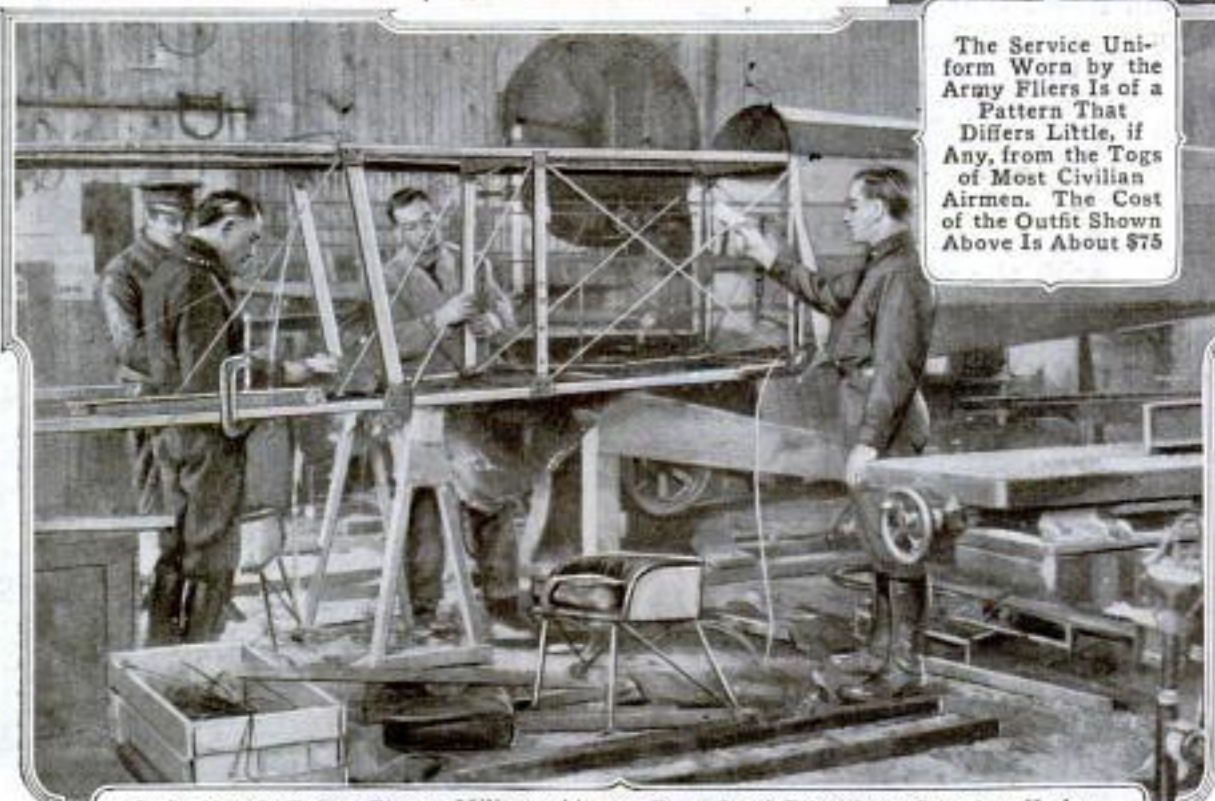

It Is Not Sufficient That a Military Airman Be a Good Pilot, for a Complete Understanding of the Craft and the Knowledge of How to Set Up as Well as Repair It When Breaks Occur Are Imperative. Therefore the Student Fliers are Taught How to Assemble a Machine and Construct Minor Parts Which Might Sometime Require Renewal. This Picture Shows Them Hard at It in a Workshop at Mineola



# FOR ARMY'S EMBRYONIC AVIATION SECTION

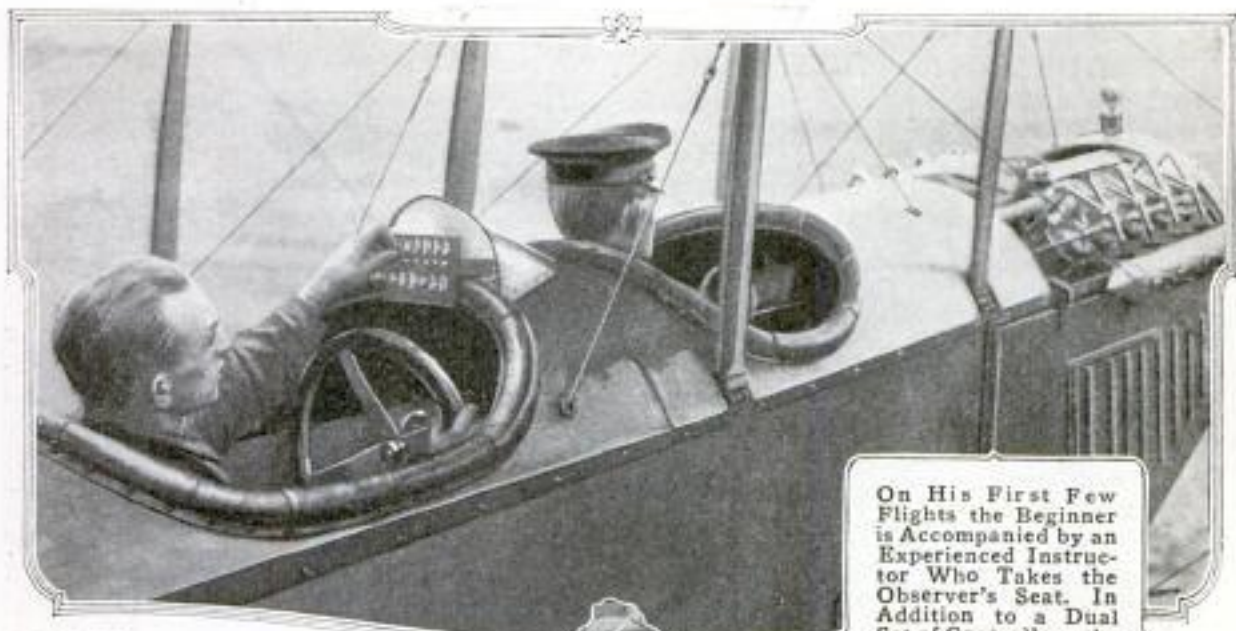

On His First Few Flights the Beginner is Accompanied by an Experienced Instructor Who Takes the Observer's Seat. In Addition to a Dual Set of Controllers, the Machine is Equipped with a Signaling System Which Enables the Tutor to Direct a Student by Pressing Different Push Buttons



This Battery of Searchlights is an Important Part of the Equipment at Mineola. When Flights are being Made at Night the Small Flood Lights are Used to Guide the Airmen and Help Them in Making Safe Landings



Lookout Tower on Top of a Hangar. An Observer with Binoculars is Stationed Here Whenever Flights are Made. He Summons the Ambulance in Case There is an Accident, and Dispatches a Mechanician When Motor Trouble Occurs



Motorcycles with Sidecars Attached are Used for Carrying Mechanicians Quickly to Different Parts of the Field When an Aeroplane Comes Down on Account of Mechanical Trouble. Machines Like This have been Used on the Mexican Border for Similar Purposes



### SPECIAL BOX CAR CARRIES AUTOS IN TIERS

In a new freight car special provisions have been made, enabling four ordinary autos to be loaded at once, or



In This New Freight Car for Autos the Windlasses Seen at the Right and Left are Used to Hoist the Upper Auto onto Its Platform of Channel Irons

five if they are not over 13 ft. long. The length of the car is 40 ft., height 10 ft., and width 9 ft. At each end there is a windlass-and-chain arrangement by which one automobile can be raised on a platform of channel irons and securely fastened in place so that another can be loaded beneath it. Thus two autos can be placed at each end, one over the other, by means of the special hoisting, locking, and safety devices, while a fifth can be put in the center of the car, if desired, and braced by the old method, namely by wood and nails. It is claimed that a great deal of time can be saved in loading and unloading motor cars by the use of the special box car, and that there is also a saving of freight.

Steps are being taken to establish a plant in Columbia, S. C., which will manufacture starch from sweet potatoes.

### GERMANS OBTAIN OIL FROM FRUIT STONES

*Knowledge Nov 1916*

An organization of German women has undertaken the collection of plum and cherry stones, according to a report, from which it is proposed to extract oil by a new process. This work is undertaken in an effort to overcome the shortage of oil in Germany. The cracked stones are treated with a solution of calcium chloride of such specific gravity that the shells fall to the bottom, while the kernels rise to the surface. These are skimmed off, washed and dried, and the oil is pressed from them. Oil prepared from plum stones in this way is described as having the odor and taste of bitter almonds. However, by treating it with steam or by heating it the odor can be largely removed. Exposure to the air for several days will effect the same change.

3849

### BUILDING BURNS DOWN BUT FIREPLACE IS UNHARMED

It is not altogether uncommon to find a chimney standing after the structure built around it has been burned, but an unusual feature was added to such an occurrence in Waco, Tex., recently, in that a handsome fireplace as well as its chimney passed through a destructive conflagration practically unharmed. The structure destroyed was a fine clubhouse, and the fireplace, which was the gift of one of the members, was built of white limestone. Although the building was burned to the ground, the smoke flue, together with the handsomely embellished hearth, remained uninjured.



*Huaco Club,  
Waco, Tex.*

*Dr. K. Alfano*





Meals for Several Hundred Soldiers are Prepared at One Time in This Kitchen Car, Which is Carried with Troop Trains Operated on One of the Canadian Railways

3846 Army  
**LARGE KITCHEN CARS BUILT FOR TROOP TRAINS.**

Kitchen cars that are individually of sufficient capacity to meet the needs of a fair-sized hotel are being carried with the long troop trains operated on one of the Canadian railways between military training camps and the seaboard. They have been constructed to facilitate the dining service so that meals can be prepared for several hundred men and served without confusion or delay. Each of these mobile kitchens occupies an entire car, is equipped with a 10-ft. range, steam-cooking apparatus, a spacious refrigerator, and other necessary paraphernalia. This is all installed on one side and inclosed by a long table extending the full length of the car. A passageway is provided between this counter and the unobstructed wall, so that waiters can enter and leave the kitchen without disorganizing the work of the eight cooks and helpers. A noncommissioned officer orders certain of the

soldiers in each car to act as waiters. At the appointed time a group of the latter from the first and the last cars walk to the kitchen, which is carried in the middle of the train, and get the big trays of food arranged for them on the serving counter. As soon as they have returned to their comrades, squads of waiters from the next two cars repeat the routine. In this way all of the soldiers are attended to within a short time and without difficulty.

3869  
**CATCHING TURTLES WITH A HOOKED STEEL ROD**

Turtle catching is an invigorating occupation now followed with profit by hunters in various parts of the country, who ship their quarry to city restaurants where the creatures are made into savory soup. Turtles are particularly easy to catch in the late fall and winter when they are hibernating in the mud of a pool or near the bank of a stream. It is a common practice for

by E. W. Smith  
 Dining + Parlour Car Service  
 Second Trunk Ry.  
 Toronto, Ont.

J. S. Bassler



hunters to pitch camp in a well-stocked region and then systematically search along the shores of every body of water within a radius of eight or ten miles.



Expert Turtle Catcher Photographed Just After He had Captured Several Creatures with His Hooked Spear

On such expeditions a man often carries a hooked steel rod with which the sleeping creatures are jabbed and drawn from the water. The aggregate weight of turtles caught in a single hole will sometimes be as high as 500 pounds.

3728 —

**NEW SUGAR PROCESS MAY INCREASE PRODUCTION**

A gain of at least three and one-half per cent, it is predicted, can be made in the commercial sugar crop of the Hawaiian Islands, and other regions as well, because of a new process, discovered by a resident of Hawaii, which recovers sugar from the so-called "final molasses." The new method takes from the final molasses nearly one-half of the eight per cent of sugar that heretofore has been considered a total loss. The inventor declares that his

*Inv: J. N. S. Williams*

*Field Engineer, Theo. H. Davis & Co.*

process will involve practically no additional cost in production, and that the cost of additional machinery needed is not large. In his experiments he has worked on the theory that it is not the glucose gums or ash, but solely the water in the molasses, that has prevented the sucrose therein from crystallizing. After removing practically all the water by boiling, a centrifugal of very high speed is used.

3880 —

*J. W. Williams*

**COSTLY TELEPHONE STANDS IN SUMMER HOME**

Ornamental standards, gold-finished and said to cost \$200 apiece, are among the special features of the telephone system recently installed in the summer home of a Chicago manufacturer at Ipswich, Mass. The system is of the automatic type, making intercommunication easy between any of the rooms of the large house and also with the indoor and outdoor departments of service, the casino, tennis court, Italian and rose gardens, swimming pool, farmhouse, dairy, and power plant. A directory card is conveniently mounted on each of the telephone standards. The European type of hand receiver-

*Robert Williams*



Telephone Stand in a Millionaire's Summer Home. It is Gold-Finished and Has the European Style of Instrument

transmitter is used, this combined instrument hanging from a contact-lever hook on the heavily gilt standard.



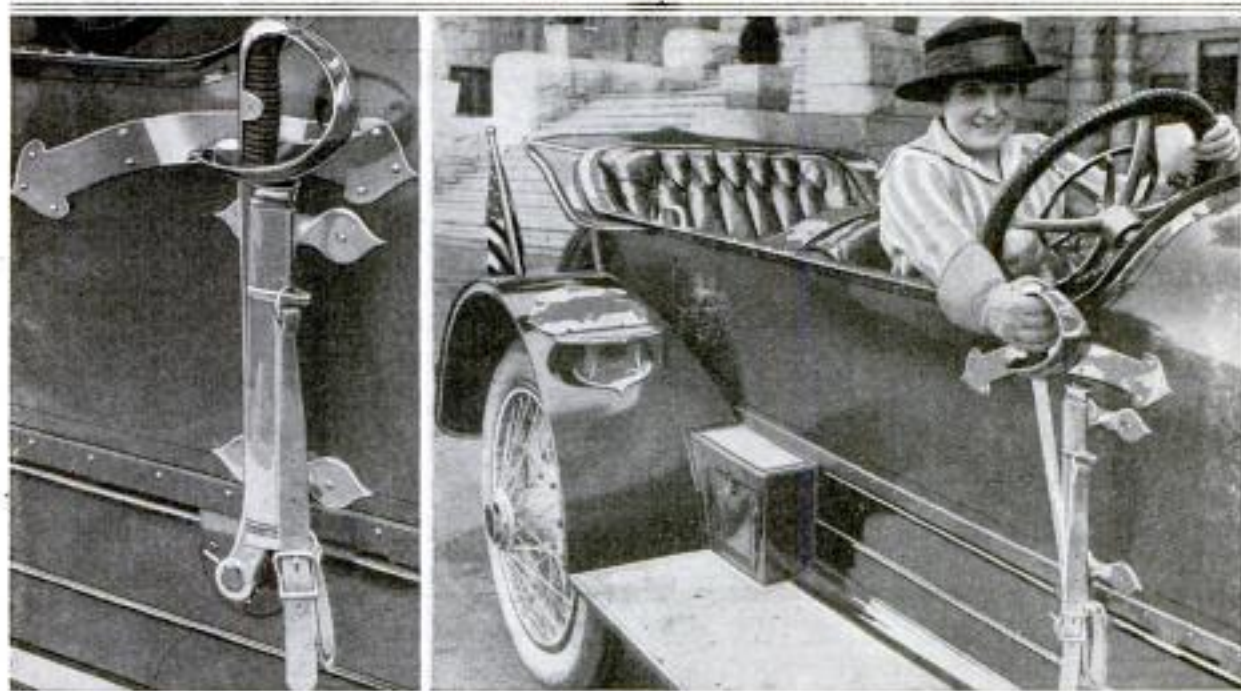

A Distinctive Automobile Having, Instead of Doors, Nickeled Steps by Which One Mounts over the Side. A German Saber Serves as an Emergency-Brake Handle. A Launch Whistle Gives Warning Signals, and a Yacht Flag, Held Slantingly, Adorns the Rear

3784

### AUTO HAS MILITARY AND MARINE ADORNMENTS

The fact that a German saber has been used for an emergency-brake handle is perhaps the first of several novel features to be noted about the body of the car shown herewith. The end of the saber has been cut off and the weapon welded to the brake lever, while a slit has been made in the side of the scabbard so that it serves as a sheath. The car has no doors and access to it is gained by steps of nickeled brass, inlaid with rubber treads. A nickeled angle iron forms a finished edge around the top of the body. On the front is a launch whistle operated by air from the air-starter tank, while at the rear a flag is held in place by a yacht flag socket. The windshield, not shown, has a frame of double sheets of brass, nickeled on the front and dull green on the reverse.

¶The president has forbidden the sale or transfer of any American-registered vessel to a foreign registry or flag, without consent of the new shipping board. Over 100 vessels were sold to foreign registry in the seven months preceding this order.

### CAMPAIGN AGAINST KILLING OF HARMLESS SNAKES

3454

A natural-history society of southern California is trying to prevent the killing of harmless snakes, and is conducting a campaign of education to inform the public that the only harmful and dangerous snake in that state is the rattlesnake. All other snakes in California are classified as public benefactors, because they destroy the rodent pests that convey diseases and damage crops. The doctrines of the society are being spread broadcast by means of placards and signs along the highways, trout streams, and mountain trails, and in the forests of the state, also through the press, the public schools, and the Boy Scouts.



*Los Angeles Natural History Club  
of California*



3904

Famous Players Film Service  
230 So. State, Chicago v.

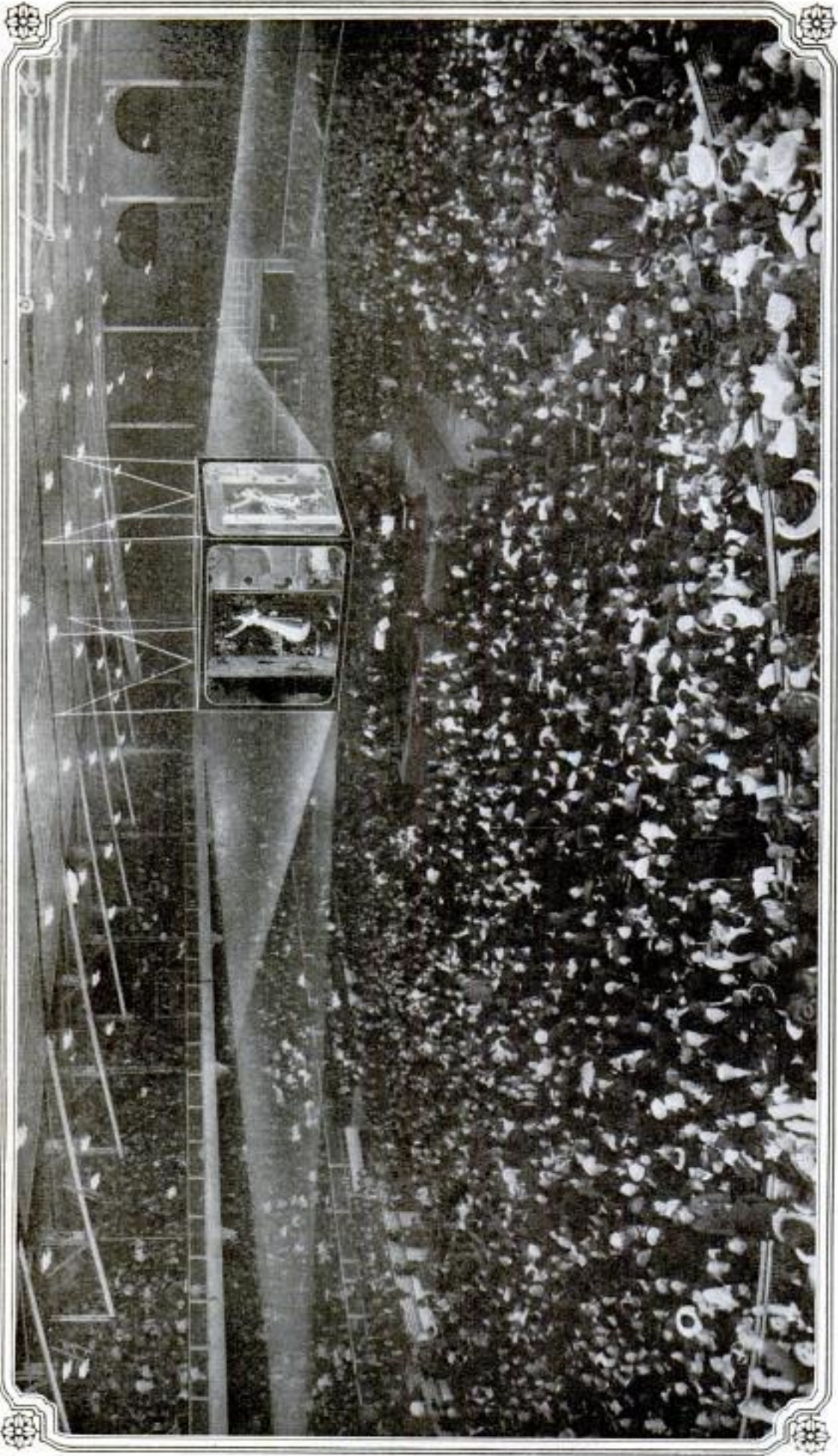

VAST AUDIENCE SHOWN FILM ON FOUR SCREENS SIMULTANEOUSLY

FOUR separate exhibitions of a popular photoplay were given simultaneously in Convention Hall at Kansas City recently before some of the largest moving-picture audiences on record. The entertainment was a free one given for advertising purposes by a local newspaper. There were five performances and at each of them nearly 14,000 persons crowded the auditorium. Four screens were arranged in the form of a square and suspended in the middle of the big room, while projectors were installed opposite each. This made it possible for practically every spectator to see the screen. By means of a signaling system, the films were run almost in synchronism.

71st St. Picture Screen



Inv: A. W. McGIFF  
337 W. 20th, N.Y.C.

3608 POPULAR MECHANICS

507

### LIFE BELT EQUIPPED WITH FLASH LIGHTS

In the darkness of a storm at sea, many a shipwrecked person, clinging to a life preserver, has finally despaired and gone down for lack of means by which he or she could signal to rescuers. This fact has recently prompted the invention of a luminous life belt, by a resident of New York City. It is made in either circular or folding form, and firmly strapped to it are two electric flash lights, thoroughly insulated against contact with the water and operated by a conveniently located button. The two lights are placed some distance apart so that if one is submerged the other probably will project above the water. The flashing signal of such a life belt would many times attract attention when a person clinging to an ordinary pre-



Life Belt Equipped with Flash Lights with Which the Wearer could Signal in the Dark to Rescuers and so Indicate His Whereabouts

server would be undiscovered in the darkness.

3823

### CONTOUR OF GIRL STUDENTS RECORDED BY MACHINE

In sizing up the girl students for physical-culture work at Wellesley College, accurate outlines of the chest and back are obtained and measured by means of an apparatus called a thoracimeter, specially designed for the college gymnasium. It comprises a platform and a standard supporting two outlining and recording arms and a wide strip of paper mounted on rollers. The student stands on the platform between the metal arms, the outer ends of which are then passed down the middle lines of the back and chest, respectively, from neck to waist. The outlines traversed are recorded automatically upon the paper strip by crayons at the inner ends of the arms. Thus when

the student steps off the platform she sees before her a graphic outline of her body above the waist. From this the instructors decide what exercises the girl needs to develop the lines of health and beauty, and subsequent outlines

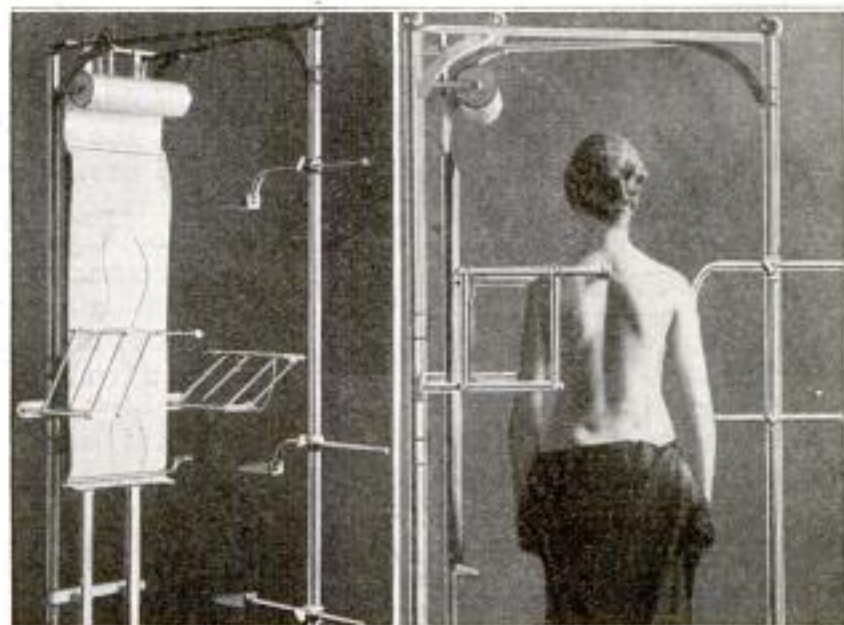

Recording the Outlines of the Chest and Back by Means of the Thoracimeter, as Used at Wellesley College: Details of the Apparatus at the Left

show the development from time to time.

Inv: - Henry H. Austin, Supt.



## DEN OF SNAKES DISCOVERED BY MOTORCYCLISTS

Two students of the University of Arizona, who were making a motor-



Two Arizona Motorcyclists Almost Stepped into This Den of Large Snakes When They Stopped to Shoot at a Rabbit near the Road

cycle trip to Phoenix recently, stopped by the wayside to shoot at a rabbit and found themselves close to a den of snakes of surprising size and number. They had the presence of mind—and the nerve—to make a snapshot of the extraordinary scene, showing the tangled family of snakes arousing at their approach. When the young men returned to relate their exciting experience, the photograph told its own story.

3934 —

## ELECTRIC LOGS FOR FIREPLACES

Sci. Am., 1-20-1917

Electrical fire logs are now being manufactured in various styles for houses and apartments which are similar to those which have been in use for stage purposes for several years. A translucent material and asbestos, reinforced with metal, are used in their construction. The bark and ends are fashioned and hand-painted to resemble natural wood. Inside the logs, which are hollow, are placed electric lights that give the fixtures the appearance of burning.

Wm. H. Hoops Co.  
531 S. Wabash St.  
Chgo.

## LONG-LIVED DRY CELLS OF NEW TYPE

A patent has been granted to two Orange, N. J., inventors recently, pertaining to a type of dry cell intended to overcome the defects of an ordinary cell due to the drying out of the electrolyte and the deterioration of the electrode even when on open circuit. In this new cell a gelatinous electrolyte of caustic soda and starch is used, and by this ingenious combination the ordinary cause of trouble has been largely eliminated, it is claimed. When zinc and oxide-of-copper electrodes, for example, are employed it is said that the efficiency of

the cell is greatly increased, being even greater than a wet battery employing similar electrodes and an alkaline electrolyte.

2638

## RUBBER SHEATHS SAFEGUARD ELECTRICIANS' WATCHES

Rubber cases are being made to protect the watches of electrical workers and others from being injured when carried into highly charged electromagnetic fields. Such a covering envelops all but the face of a watch and thoroughly insulates its metal parts. When applied it also lessens the chance of an instrument slipping from a workman's pocket. A protector of similar character is provided for those who desire to safeguard their timepieces from dust and water. This type of covering does not extend over the stem and ring, as does the other, but seals the seams.



Allyr Watch  
Protector Co.,  
Oakland, Calif. Registered material



1201481

V. 231

4. In a galvanic battery, a colloidal gelatinous electrolyte containing in combination, sodium hydroxid, an organic material, and a silicate to increase the capacity and conductance thereof, substantially as described.

5. In a galvanic battery, a colloidal gelatinous electrolyte containing in combination, a plurality of alkaline materials and another inorganic material which acts to increase the capacity and conductance thereof, substantially as described.

[Claims 6 to 13 not printed in the Gazette.]

~~Under abnormal heat from said bearing.~~

[Claims 6 to 10 not printed in the Gazette.]

1,201,479. PRIMARY BATTERY. EDWARD MCGALL, Orange, N. J., assignor to New Jersey Patent Company, West Orange, N. J., a Corporation of New Jersey. Filed July 27, 1914. Serial No. 853,279. (Cl. 204—38.)

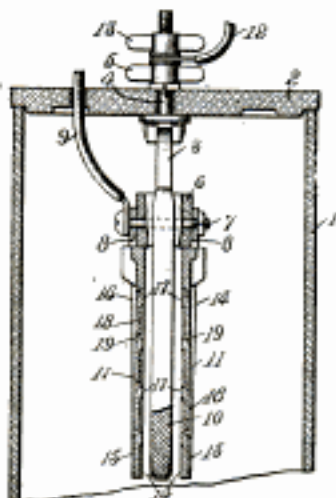

1. In a primary battery, the combination of a negative element and a slitted positive element adjacent thereto and insulated therefrom, said positive element being provided with flanges or ribs adjacent and substantially parallel to the slits respectively, substantially as described.

2. In a voltaic battery, the combination of a negative plate, and a positive plate adjacent thereto and insulated therefrom, one of said plates being provided with one or more horizontally extending slits and with horizontally extending flanges or ribs just below said slits respectively, substantially as described.

3. In a voltaic battery, the combination of a negative plate, and a positive plate adjacent thereto and insulated therefrom, said positive plate being provided with one or more slits inclined downwardly toward the side farthest from the negative plate, substantially as described.

4. In a voltaic battery, the combination of a negative plate, and a positive plate adjacent thereto and insulated therefrom, said positive plate being provided with one or more horizontally extending slits, said slits inclining toward the side farthest away from the negative plate, substantially as described.

5. In a voltaic battery, the combination of a negative plate, and a positive plate adjacent thereto and insulated therefrom, said positive plate having one or more horizontally extending slits and on one side thereof flanges or ribs respectively disposed below said slits, substantially as described.

[Claims 6 to 17 not printed in the Gazette.]

1,201,480. PRIMARY BATTERY. EDWARD MCGALL, Orange, N. J., assignor to New Jersey Patent Company, West Orange, N. J., a Corporation of New Jersey. Filed Sept. 14, 1915. Serial No. 50,625. (Cl. 204—38.)

1. A voltaic battery element having a metallic coating, said coating comprising finely divided compact metallic particles adjacent to and overlapping one another and forming a substantially homogeneous surface layer, substantially as described.

2. An electrode element for voltaic batteries having a metallic coating, said coating comprising finely divided

metallic particles applied to the element adjacent to each other, said particles being more or less flatter and overlapping and adhering to one another, forming a substantially homogeneous surface layer, substantially as described.

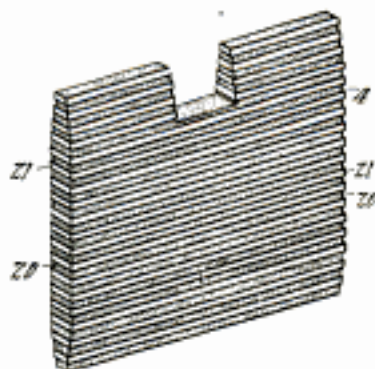

3. An oxid of copper element for voltaic batteries having a plurality of spaced metallic surface portions, each of said surface portions comprising finely divided compact metallic particles adjacent to and overlapping one another, forming a substantially homogeneous layer, substantially as described.

4. An electrode element for voltaic batteries having a plurality of spaced thin metallic bands or strips on the exterior thereof, each of said bands or strips comprising finely divided compact metallic particles united by impact to each other and to said element to form an integral part thereof, substantially as described.

5. An electrode element for voltaic batteries having a plurality of spaced metallic surface portions, each of said surface portions comprising finely divided metallic particles applied to the element adjacent to each other, said particles being more or less flattened and overlapping and adhering to each other, forming a substantially homogeneous layer, substantially as described.

1,201,481. GALVANIC BATTERY. EDWARD MCGALL, Orange, and MALCOLM D. MALCOMSON, West Orange, N. J., assignors to New Jersey Patent Company, West Orange, N. J., a Corporation of New Jersey. Filed Aug. 12, 1914. Serial No. 856,331. (Cl. 204—38.)

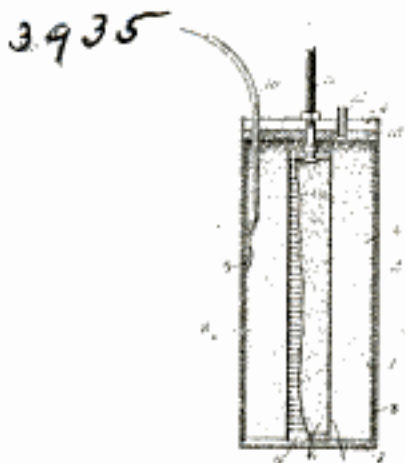

1. In a galvanic battery, a colloidal gelatinous electrolyte containing in combination, alkaline and organic materials, and another inorganic material which acts to increase the capacity and conductance thereof, substantially as described.

2. In a galvanic battery, a colloidal gelatinous electrolyte containing in combination, caustic alkaline and organic materials, and another inorganic material which acts to increase the capacity and conductance thereof, substantially as described.

3. In a galvanic battery, a colloidal gelatinous electrolyte containing in combination, sodium hydroxid, an organic material, and another inorganic material which acts to increase the capacity and conductance thereof, substantially as described. 54-74-201



3. In a husking machine, the combination of a horizontally rotatable frame having a series of peripheral pockets and a pair of oppositely acting rotatable husking rolls in each of said (separate and distinct) pockets.

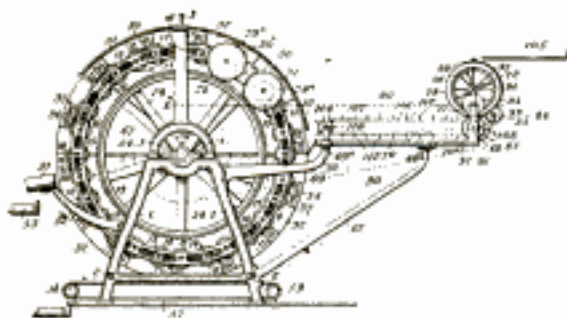

4. In a husking machine, the combination of a rotatable frame mounted on a horizontal axis having an annular series of rotary husking rolls projecting between the sides, and partition members projecting between the sides and overlying the sides of the rolls whereby to form exterior pockets.

5. In a husking machine, the combination of a rotatable frame having an annular series of husking rolls arranged in pairs, and a peripheral pocket on the frame for each pair of rolls and a stationary curved guide adapted to overlie the material when in engagement with the rolls and said pocket.

[Claims 6 to 31 not printed in the Gazette.]

201,477. MAIL-BAG CATCHER. HENRY G. LINDERWELL, Portage, Wis. Filed Feb. 5, 1916. Serial No. 76,464. (Cl. 258-20.)

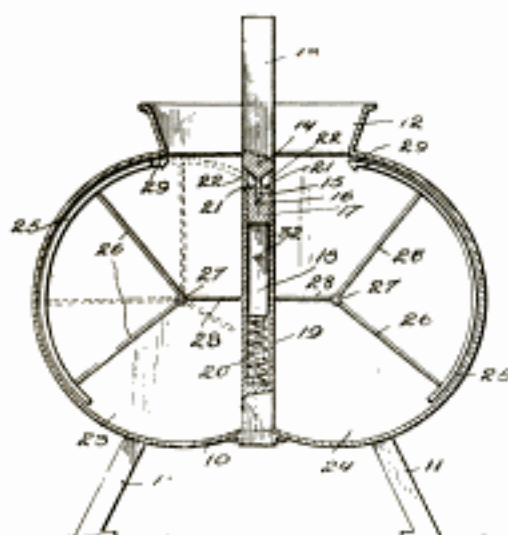

1. A mail catcher comprising a receptacle having an open inlet, a hollow standard in said receptacle, an abutment carried by said standard, said standard being provided with a side opening, a plunger slidably mounted in said hollow standard and yieldably held in a raised position and provided at its upper end with a latching head, a closure pivotally mounted in said receptacle for moving across the inlet and provided with a latching finger for passing through the opening of said standard into engagement with the latching head of said plunger, a trigger for said closure positioned for engagement with an article dropped into the closure, engagement of said trigger by the article moving the closure to a closed position in engagement with the latching plunger, and means whereby said latching plunger may be moved to an inoperative position.

2. A mail catcher comprising a receptacle, a standard in said receptacle, an abutment carried by said standard and extending through the inlet opening of said receptacle, latching means carried by said standard and yieldably held in an operative position, closures movably mounted in said receptacle upon opposite sides of said standard, triggers for said closures extending beneath the inlet

opening of said closure, said triggers when moved by an article placed in said receptacle bringing said closures to a closed position in engagement with said latching means, and means whereby said latching means may be moved to an inoperative position to release said closure.

3. A mail catcher comprising a receptacle provided with an inlet, an abutment extending across the inlet of said receptacle, latching means in said receptacle, closures movably mounted in said receptacle upon opposite sides of said latching means and provided with means for engagement by said latching means to releasably hold the closure in a closed position, and triggers for moving said closures to a closed position.

4. A mail catcher comprising a receptacle provided with an inlet, an abutment extending across the inlet of said receptacle, latch means in said receptacle, shafts extending through said receptacle, closures connected with said shafts and having their upper end portions provided with means for engagement by said latch means to releasably hold the closures in a closed position, and trigger plates extending from said shafts beneath the inlet of said receptacle when said closures are in an open position.

5. A mail catcher comprising a receptacle provided with an inlet, an abutment extending across said inlet, latch means mounted in said receptacle, a closure movably mounted in said receptacle, and a trigger for said closure positioned beneath the inlet when the closure is open, engagement of said trigger by an article entering said receptacle moving the closure into engagement with said latch means.

1,201,478. LUBRICATION OF BEARINGS. ERNEST W. LINK, Granite City, Ill. Filed Aug. 31, 1915. Serial No. 48,164. (Cl. 64-24.)

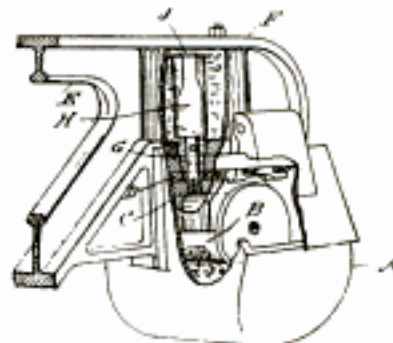

1. An emergency lubrication for a bearing, comprising a primary lubricant chamber and a secondary lubricant chamber, both chambers communicating with said bearing by a common outlet passage,—and a seal for said passage adapted to be opened by abnormal heat from said bearing.

2. An emergency lubrication for a bearing, comprising a primary lubricant chamber and a secondary lubricant chamber, a pipe from said bearing to the primary lubricant chamber and having a hole in the side thereof communicating with said secondary chamber, and a seal closing said hole and the end of said pipe adjacent to said bearing and adapted to be opened by abnormal heat from said bearing.

3. An emergency lubrication for a bearing, comprising a primary chamber to contain a liquid lubricant and a secondary chamber to contain a high-melting lubricant, a passage leading from said bearing to both of said chambers, and a fusible seal for said passage located adjacent to said bearing and adapted to be melted by abnormal heat from said bearing, and thereby effect a flushing lubrication of said bearing by the liquid lubricant and a supplemental lubrication by the other lubricant.

4. An emergency lubrication for a bearing, comprising a double chamber for a liquid lubricant and a slow-melting lubricant, respectively, a passage leading from said bearing to both said lubricants, a heat conductor extending from said bearing to said double chamber, and a fusible seal, located in said passage and also in contact with said heat conductor, whereby the opening of said seal will release the liquid lubricant at once and the continued



Frank & Seiler  
Smithfield St.

3894

POPULAR MECHANICS

509

3894 *Pittsburgh, Pa.*  
PICTURESQUE FIRE RUINS  
OF DEPARTMENT STORE

3927  
HIVES OF BEES IN BANK  
WINDOW TEACH THRIFT

Intense cold prevailed during a fire, that gutted a large Pittsburgh department store recently, and a picturesque scene resulted from the effects of the frost. Even while the blaze was still unsubdued and the firemen were di-

Two beehives, each containing several thousand bees, were the principal

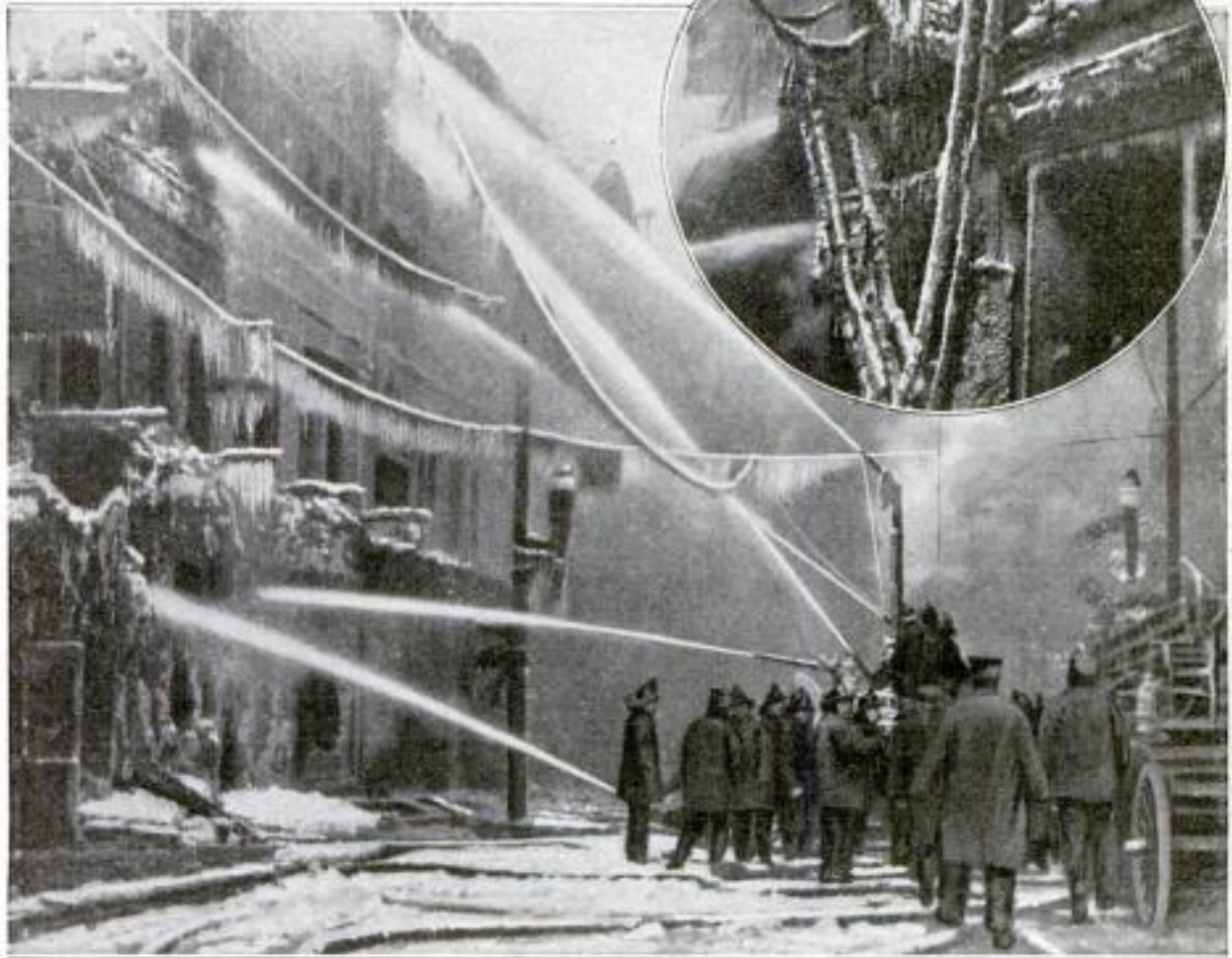

COPYRIGHT, INTERNATIONAL FILM SERVICE, INC.

Scene on Fifth Avenue, Pittsburgh, during a Recent Department-Store Fire: Note the Curious Effects of Water and Frost on the Trolley Wires in the Foreground. The Smaller Picture Shows Part of the Ruins on the Smithfield Street Front

recting many streams of water into the doomed building with all their latest apparatus, the store fronts on Fifth Avenue and Smithfield Street assumed the appearance of icy grottoes, each ruined story being heavily outlined in ice, with fringes of icicles pendent from every overhanging ledge. Adjacent trolley wires too were thickly coated with ice, and bore glistening fringes of a natural beauty that stood out in marked contrast to the smoky huddle of destruction behind the walls.

feature of an attractive display intended to teach thrift, which was installed in a window of a large Chicago bank not long ago. A painted farm scene furnished the setting for the hives, and in the foreground were grass matting, earth, and bark, which gave the display a realistic touch. Savings banks were strewn in the path that led from the hives to the painted fields. At intervals there were signposts bearing legends telling of the value of the habit of saving.

Greenbaum & Sons  
Bank & Trust Co.,  
9 S. La  
Copyrighted material  
Chgo.



REMARKABLE PAINTINGS

IN A FISH STALL

# GAWALTON

Artistic genius sometimes crops out in strange places. The walls of a sea-side fish stall are almost the last place

*C/o The Post, Boston*

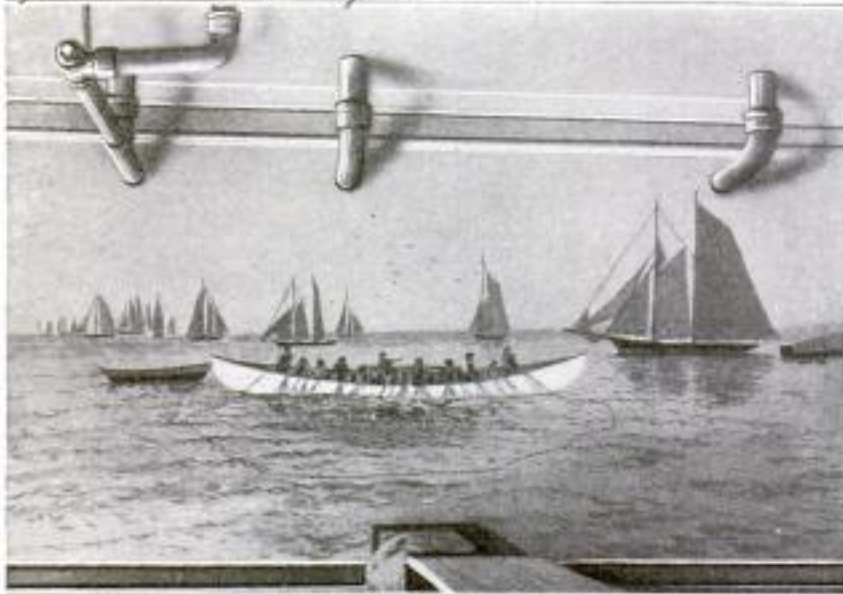

This Wall Painting of a Fishing Crew Hauling a Seine on the Banks Adorns the Interior of a Boston Fish Stall and is the Work of an Amateur Artist Who Handles Fish and Never Took an Art Lesson

where one would expect to find mural paintings of artistic merit; but two pictures that deserve this description may be seen in a fish stall on a wharf in South Boston, where they were painted by one of the fish handlers as decorations to cover up the bare walls. It is said the man never took an art

lesson, and artists have declared his work wonderful. One of the paintings represents a seining scene on the Banks, with the crew of a large dory hauling the seine in the foreground and a fleet of fishing schooners in the background. The other picture shows the final struggle of an infuriated swordfish that has been hooked by two men in a small dory, one of whom is about to give the final thrust with a long gaff. Among other merits, the paintings are remarkable for their faithfulness to detail.

3931

STANDARD SET OF WORDS TO DESIGNATE COLORS

The limited number of English words by which various shades of color can be accurately designated is being supplemented by means of a color card issued by the Textile Color Card Association. A movement is on foot to introduce this standard generally among selling agents, millmen, and any others who are especially interested in the question of colors. There are 132 different hues on this card and each is given a name. Up to the present time every season has witnessed the introduction of some new color term used to designate a particular shade which is being featured by a certain manufacturer of fabric, millinery, or other lines of goods. This inevitably causes much inconvenience and misunderstanding. If the standard card referred to becomes widely

*354 Fourth St., New York*



Another Mural Painting by the Artistic Fish Handler, Depicting the Last Struggle of a Swordfish About to be "Gaffed" by One of the Men in the Dory

*# upholsterer Jan'y '17*



known it doubtless will be of great assistance in expressing color thought. Already 140 firms have adopted its nomenclature.

3851—

### RIBLESS, SEAMLESS CANOES OF THREE-PLY VENEER

Canoes without ribs, made of three-ply veneer which is molded into shape in metal forms under hydraulic pressure, are about to be placed on the market by a Ludington, Mich., manufacturer. The veneer for the craft possessing these distinctive features is made with the aid of waterproof glue. The boats are described as strong, very light, difficult to puncture, and not subject to weather-checking when laid up for the winter. Since each one is made of a single sheet of material there are no seams, except at the ex-

*H L Haskell*

*Ludington Mich*



*Send inquiries to  
Haskellite Mfg. Corp  
Grand Rapids Mich*

Ribless Canoes of Three-Ply Veneer, Molded under Hydraulic Pressure: Strength, Durability, and Lightness, It is Claimed, are Possessed by This New Type of Craft

treme ends. The use of veneer makes possible very beautiful grain effects. The seats are made of the same material as the body.

3634—

### AUTO DRIVING TAUGHT BY NOVEL METHOD

A practical method of teaching novices to drive an automobile without leaving the store has been devised by the manager of a Los Angeles agency. The car used for the purpose is blocked up so that the wheels are off the floor, and the exhaust is connected to a pipe that leads outside the showroom. Thus, with the motor in operation, a

*Harold L Arnold auto agency*

*Los Angeles*

beginner seated in the car can learn to throw the clutch in and out, shift gears, accelerate or slow down the engine,



Teaching a New Owner How to Drive Her Car: Note the Series of Small Levers near the Instructor's Left Hand, Which Raise Signals at the Other End of the Table for the Pupil's Guidance

apply the brakes, and so forth, just as though the car were actually running on the street. By a system of special signals, like those used in traffic regulation by the police, the instructor tells the novice what to do, then sees that it is properly done.

2939—

### SLEDLIKE BASE FOR LAWN SPRINKLER

A simple device which lessens the inconvenience of moving a lawn sprinkler, consists of a sledlike base of galvanized iron, about 20 inches long, to which the sprinkler is securely attached. The



Galvanized-Iron Base for a Lawn Sprinkler: With This Sledlike Support the Sprinkler can be Drawn from Place to Place While the Water is Running

rounded bottom of the support permits it to slide along over the grass with either end foremost. To transfer the sprinkler to a new location it is only necessary to pull it along with the hose, without stopping to turn off the water and then turn it on again.



**OUTSIDE TRUSSES SUPPORT  
BURNER TOP OF NEW TYPE**

Like a portion of a Zeppelin's framework, standing on end, rises the new type of burner top which is now manu-

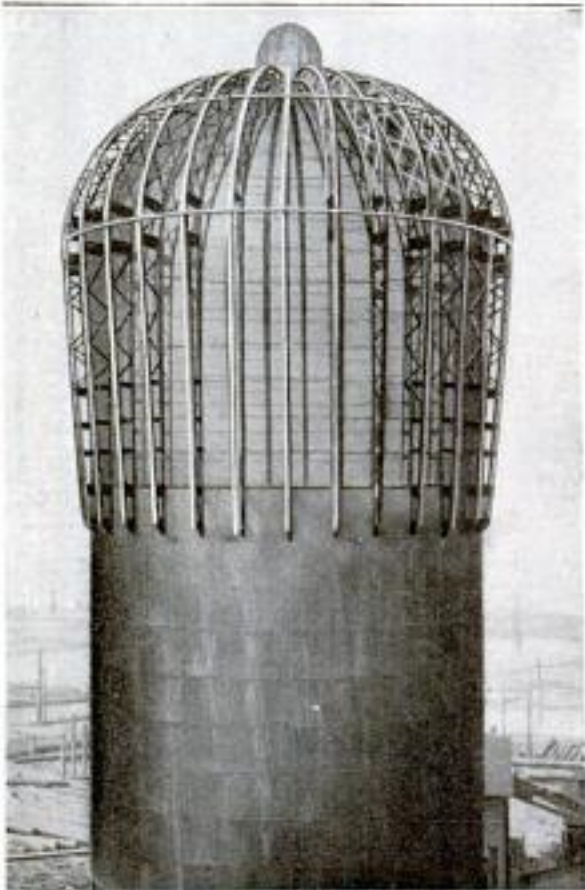

**New Type of Refuse Burner for Sawmills, Having a Screen Top Held in Place by an Outside Framework Composed of Curved Trusses**

factured in Everett, Wash., for sawmill burners. This cap is intended to catch the sparks from the bark and slabs that are consumed in the bottom of the big cylindrical furnaces. It is composed of heavy wire screening, held in place by overhanging trusswork. This steel frame is made up of numerous curved ribs fastened to the upper end of the sheet-steel cylinder, on the outside. These converge and form a domelike top, inside of which is the wire screening. In this form of burner top there are no interior obstructions to hold the heat, and no walk is required around it on which sawdust and fragments can accumulate and later, in burning, injure the burner. Repairs can be easily made from scaffolding between the truss beams.

**WAR MENUS LIMIT ENGLISH  
DINNER COURSES**

*Sphere 12/23-1916*  
Since the new antiextravagance laws of food control went into effect in England on Christmas Day, 1916, the number of courses which public restaurants are permitted to serve has been limited to three for dinner and two for luncheon. Meat, fish, and pudding or sweets are each counted as one course; soup, side dishes, and dessert of raw and dried fruit only, each as a half course. But the side dishes must contain no fish, meat, poultry, or game; otherwise each counts as a full course. For officers a maximum charge has been fixed, amounting to the equivalent of \$1.35 for dinner and 85c for lunch. Bread, butter, cheese, and biscuits (crackers) do not count at all, so that the regulations are not likely to prevent anyone from getting a satisfying meal.

**USED RAILS BRING SAME  
PRICE AS WHEN NEW**

The high price of steel may be said to have wiped out the depreciation which resulted from 26 years' use of the rails in an electric car line, running out from Tacoma, Wash. This fact was brought out a few months after the company began to improve four miles of its track with new and heavier rails. The old 40-lb. rails were torn up and stored in the yard of the company. Since the war began some 260 tons have been sold to logging companies for \$7,800, which is \$30 per ton, or just what they cost when they were laid 26 years ago. Even the steel which formed the track at the curves, and ordinarily would be regarded as worth little, sold for half its original cost.

ⓄThe Philadelphia mint is preparing to store a total of \$1,000,000,000 in gold bricks, it is said. Already \$470,000,000 is deposited there and the rest of the billion is to be brought from the New York subtresury, which is overflowing with gold coming from Europe.

*Steilacoom Electric Car Line  
Tacoma, Wash.*



### SPUN GLASS AS INSULATION FOR STEAM PIPES

*Refrigerating Assoc. Jan. 1917*  
Spun glass has been successfully used in Germany recently as an insulating material to cover steam pipes. The method of installation is to wind the spun glass loosely around the pipes, between rings of asbestos placed at intervals, the insulation being then inclosed in asbestos braid and sailcloth and painted over with oil paint, or tar. The spun glass, consisting of fine glass threads, makes a loose, light, and porous wadding, which adds little to the weight of the pipes and makes a good insulating material because of the presence of air between its threads. It is not affected by vibration of the pipes, by high temperatures, steam, water, or acids, and retains its insulating power indefinitely.

### 3839 VOICES OF GREAT SINGERS VISUALIZED FOR STUDY

Sound vibrations produced by the voices of some of the world's foremost singers were visualized through the medium of an ingeniously arranged projection apparatus and shown on a stereopticon screen recently for the study of delegates attending a convention of scientists. The device that was employed for this purpose was fitted with a delicate gauze diaphragm through which the sound waves passed, causing it to vibrate. The image of the oscillating diaphragm was cast onto a revolving triangular mirror by a series of intermediate reflectors, and in turn projected upon a screen where it was shown magnified 40,000 times.

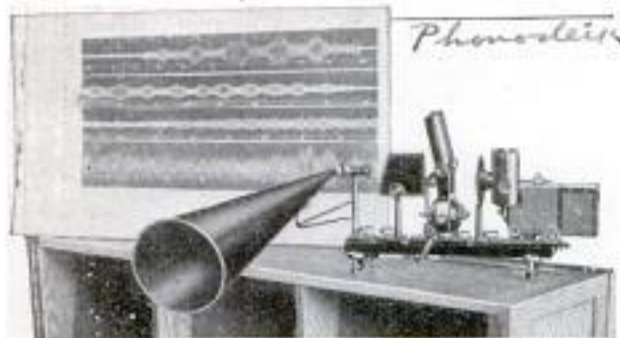

Records Showing the Vibrations of Different Singers' Voices Appear on the Chart Back of the Projecting Machine

### 3969 PRIZE WHITE DAHLIA GIVEN TO CALIFORNIA CITY

As a token of the affection he holds for the city, Luther Burbank, the plant wizard of the Pacific coast, recently



Bulb of the Champion White Dahlia being Presented by Its Creator, Luther Burbank, to the Chairman of the Oakland, California, Chamber of Commerce

presented to the people of Oakland, Calif., the bulb of the largest white dahlia that, so far as is known, has ever been produced. Picturesquely enough, the planting of the flower is to be made a gala event that will probably be observed on May Day. According to plans, a holiday will be proclaimed and the school children of the city marshaled together to welcome the naturalist. It is thought that the dahlia will be placed in City Hall Plaza, a public park which it is proposed to make symbolic of the city. Some of the other towns throughout the United States bearing the name of Oakland have made known their desire of contributing oak trees to this municipal garden. It has been suggested in Oakland that bulbs of the city's official flower, the new white dahlia, be presented to the sister towns in return as a mark of appreciation for their friendly gifts.

⌈The construction of another government wireless station connecting the United States with its insular possessions, has been completed at Tutuila, placing the Samoan Islands in direct communication with Honolulu.



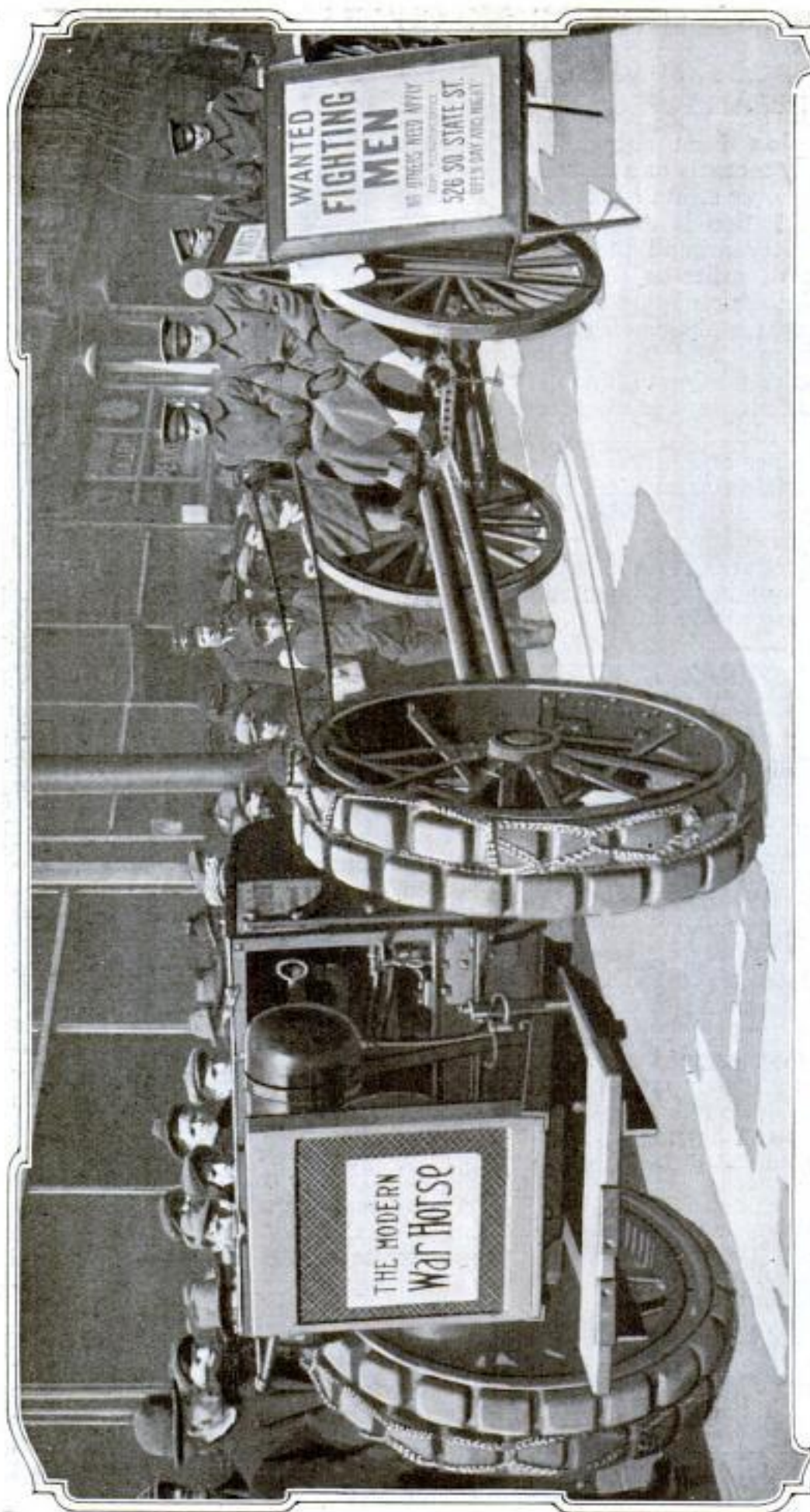

**ARMY RECRUITING OFFICERS USE SPECTACULAR METHOD IN CAMPAIGNING FOR ENLISTMENTS AT CHICAGO**

**DRIVING** a mechanical horse through the streets of Chicago to attract "fighting men" to the army recruiting stations: The powerful tractor, to which a field gun and caisson were hitched, was controlled entirely by two reins in the hands of a driver. It was taken through the congested "loop-district" thoroughfares with perfect ease. The plan was employed daily for a fortnight and apparently netted good results, for during the period large numbers of volunteers filed into the recruiting places. Although still little known, the machine is not a new type. Primarily it is intended for agricultural purposes and as a farm tractor has previously been described in this magazine. It is sufficiently striking in appearance and operation, however, to prick the curiosity of the street crowds, and in this capacity it performed valuable work for the army.



## PREPARING FOR EVENTUALITIES AFTER BREAK



COPYRIGHT, UNDERWOOD & UNDERWOOD

In Many of Our Large Cities the Patriotic Spirit Shown by Women of Late has Amounted to More than Idle Conversation, as is Incompletely Indicated by the Picture Above, Which Shows Members of the Women's Reserve Drilling on the Roof of a New York Hotel

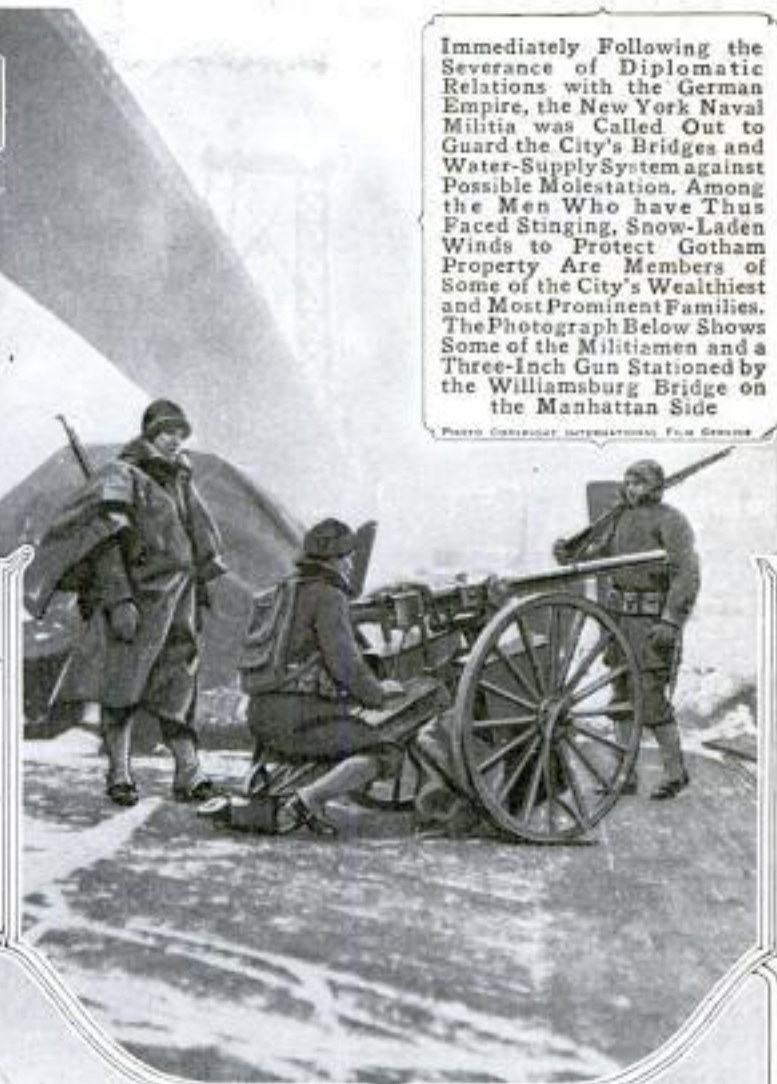

Immediately Following the Severance of Diplomatic Relations with the German Empire, the New York Naval Militia was Called Out to Guard the City's Bridges and Water-Supply System against Possible Molestation. Among the Men Who have Thus Faced Stinging, Snow-Laden Winds to Protect Gotham Property are Members of Some of the City's Wealthiest and Most Prominent Families. The Photograph Below Shows Some of the Militiamen and a Three-Inch Gun Stationed by the Williamsburg Bridge on the Manhattan Side

PHOTO COURTESY INTERNATIONAL FILM SERVICE

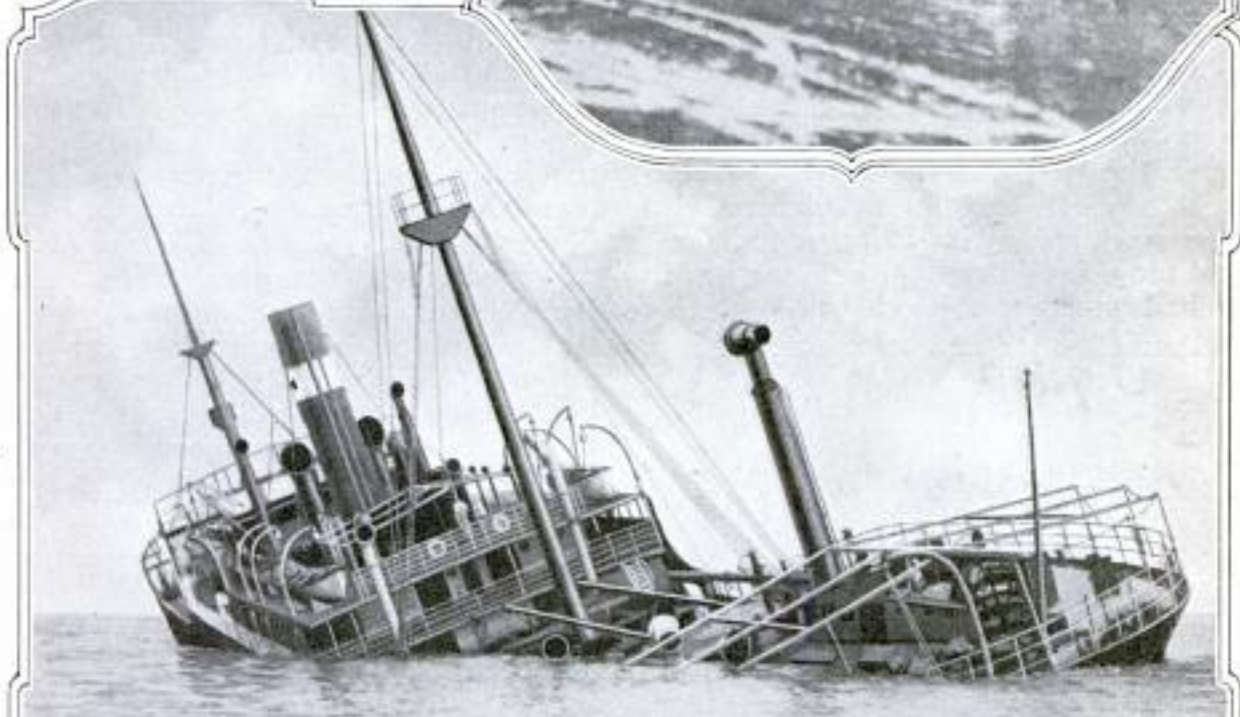
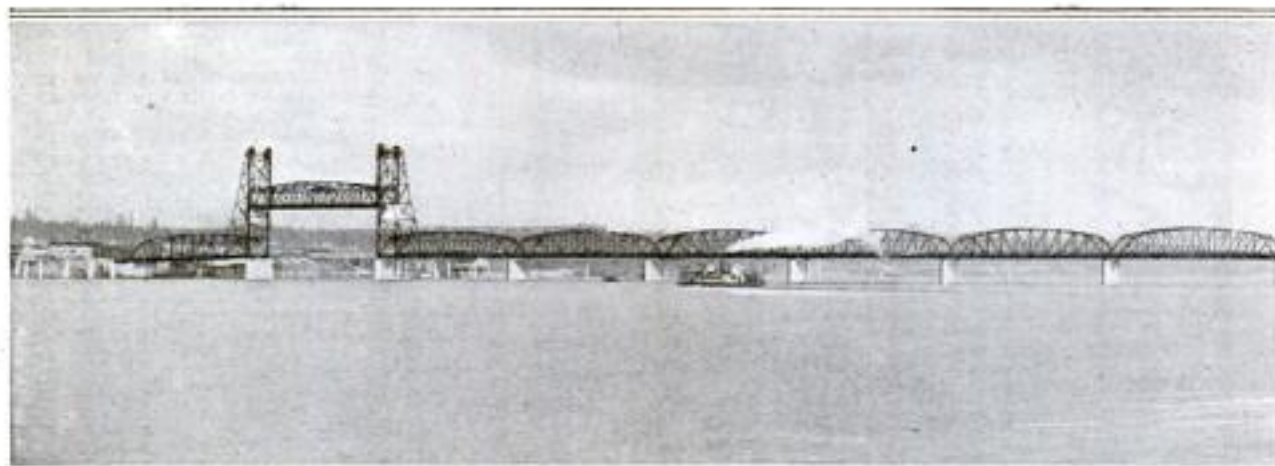

PHOTO COURTESY INTERNATIONAL FILM SERVICE

The German Steamer "Liebenfels" Awash in Charleston Harbor: The Sinking of the Vessel, Which had been Held in Port since the Outbreak of European Hostilities, Occurred When It Became Self-Evident That Washington would Break Off Relations with Berlin. There Seems to Be Little Doubt That the Boat was Scuttled by the Captain in Compliance with Orders Issued by the German Admiralty. The Engines of Several German Vessels at New York and Other Ports were Disabled by Their Crews





Motor Cars and Other Vehicles can Now Proceed from Portland, Oregon, across the Columbia River Planning, an Interstate Bridge has been Erected to Span the Waterway That Separates the Two States.

### AIR PROPELLER PUSHES ICE CAR AT SPEEDY CLIP

3967  
 Twenty-five miles an hour is easily attained with a motor-driven ice car that is used by a New Jersey devotee of winter sports. The vehicle is a stanch, simply designed sled carried on three runners, one of which is situated at the front and controlled by a steering wheel mounted under the streamline hood that partly shields the driver from the wind. A two-cylinder motor-cycle engine, mounted at the rear, turns an aerial propeller. On the smooth surface of a frozen lake or river, the sled is in its element. Well-beaten snow-covered roads are also open to it, but, as is obvious, the fastest and most invigorating "bobbing" is to be had on the ice.



Few Winter Sports, Aside from Good Coasting, Offer More Really Enjoyable or Invigorating Recreation than Motor Sledding with Some Vehicle Like This

### TOY INDUSTRY IN AMERICA

#### 3973 GROWS RAPIDLY

*Commerce Dept. 2/10/17*  
 12693  
 Recent official statistics show that the growth of the toymaking industry in the United States since the grandfathers of the present generation were children has been remarkable. While the population has grown but 219 per cent since 1859, the per-capita expenditure for toys has increased by 1,165 per cent. The toy factories have increased in number from only 12 in 1859 to 290 in 1914—the year of the latest returns—and the annual output has increased in value from \$184,000 to \$13,757,000. In 1859 nearly twice as many toys were imported as those of domestic make; 20 years later we were making twice as many as we imported. In 1914 the output of American toys was 1.6 times greater than the toy imports, and since the European war began the proportion of domestic toys in the market has steadily increased.

### 3966 GREAT COLUMBIA RIVER BRIDGE IS COMPLETED

Within recent weeks the long-needed interstate bridge, spanning the Columbia River and connecting Washington and Oregon, has been opened. Erected at a cost of about \$1,750,000, it replaces a legendary natural bridge of Indian lore and establishes the first artery, other than a ferry system, for general vehicular traffic between Vancouver and Portland. The bridge proper is





to Vancouver, Washington, without Making a Long Detour or Employing a Ferryboat. After Years of and Has of Late been Opened. It Is the Only Structure in the Vicinity That Accommodates General Traffic

3,530 ft. long, but including the approaches it has a length of nearly four and a half miles. Bridging the main channel of the stream there is a 275-ft. lift span that provides a clearance of 150 ft. above ordinary high water.

3956 *Auto*  
**ADULTS AT PALM BEACH RACE  
 IN BOYS' MOTOR CARS**

Almost every adult possesses a fondness for toys and playthings of a mechanical nature and if given an opportunity will operate them as enthusiastically as any boy—a fact which one of the present season's fads at Palm Beach has quite thoroughly demonstrated. A country club at this famous Florida resort has been the scene of

most amusing motor-car races, the "racers" used being the same as described on the children's page of Popular Mechanics Magazine recently. These little cars, which are built for boys and girls, are each propelled by a motor wheel attached to the rear. The contests were held on the seashore, and the drivers, who included some of the best-known men and women in Palm Beach's social set, were able to make quite surprising speed records.

*Jan 1917  
 7120*

ⒸTo a dealer in New York was consigned not long since what has been pronounced the largest single shipment of Russian caviar forwarded to the United States in many years. It consisted of 183 boxes and 66 kegs.



COPYRIGHT, INTERNATIONAL FILM SERVICE, INC.  
**Men Racing in Cars Built for Juveniles. One of the Latest Fads at Palm Beach: These Tiny Vehicles have been Nicknamed "Red Bugs." Each is Propelled by a Motor Wheel Attached to the Rear**

*A. O. Smith Co.  
 Motor Wheel Div 127  
 Milwaukee*



## REALISTIC LANDSCAPE SEEN ON FROST-COATED WINDOW

Quite an interesting example of the strange and even weird patterns in which frost occasionally forms on



Only Slight Imagination is Required to See in This Photograph of a Frost-Painted Window a Truly Beautiful Picture of a Fern-Filled Ravine

panes of glass during freezing weather is afforded by a formation that occurred on a store window in a western town not long ago. It bore a striking likeness to a foliage-screened ravine in some tropical jungle. A remarkable aspect of this particular design was that it presented a complete picture with high lights and shadows, unusual perspective, and atmosphere.

3980

## SOLDIERS GIVEN COMPASSES OF LIQUID TYPE

*Knowledge Dec 1916*

During the European war large numbers of liquid compasses have been manufactured as pocket instruments for army officers. Although the type has long been a common one, its adaptation to this form is in a certain degree interesting. As might be expected, the reason for using the liquid compass, in preference to the sort in which the card is held solely on a pivot, is that the dial ceases its oscillations and comes to rest more quickly than in the latter instrument.

## FLORIDA WHARVES HAVE NOVEL BULKHEAD

The new wharves at Commodore Point, Jacksonville, Fla., work on which was begun more than a year ago, are provided with a concrete and steel bulkhead wall of a type which has been little used heretofore. This bulkhead is part of a terminal situated at a bend in the St. John's River, and extends out some distance from shore. By filling in behind it the terminal's area is enlarged by several acres. The wall, which is a mile or more in length, is provided with steel I-beams driven at intervals of 3 ft. to a depth of 34 ft. or more below low tide, in most instances penetrating rock. Fastened

back of these supports is a continuous interlocked row of steel sheet piling. Concrete is filled in between the I-beams, so that all the steel except the outer edge of the I-shaped posts is protected from the salt water. The concrete facing, while designed primarily as a protection, naturally adds strength to the wall. Extending between the I-beams, and also incased in the concrete, are wales connected by tie-rods to piles several feet to the rear. Just back of the wall also is a relieving platform, supported by piles, which was installed before the filling was completed. This big new terminal is privately owned and is only a short distance from the city's shipping center.

¶ There are scarcely enough houses to go around in some Scandinavian cities at present because the shortage of building material has halted construction work, and the population has been greatly increased by foreigners seeking refuge in neutral territory.

*Wernlinger Steel Piling Co.  
44 Whitehall St., N.Y.C.*



## GRIM MOMENTS FOLLOW SINKING OF TRANSPORT



British Soldiers aboard the Sinking Transport "Ivernia." Laughing and Jesting While Posing for Their Pictures in the Face of Death: The Vessel Sank in the Mediterranean a Few Minutes after being Struck by a Torpedo, and with It were Lost the Lives of 153 Men. The Photograph Reproduced Below Shows What the Nervy, Smiling Fellows Knew Was Probably in Store for Some of Them. The Overloaded Lifeboat is Shipping Water and Slowly Sinking with Its Human Burden into a Rolling Sea Spotted with the Struggling Forms of Doomed Soldiers. The "Ivernia" Was a Cunard Liner of 14,000 Tons and was Destroyed Early in January

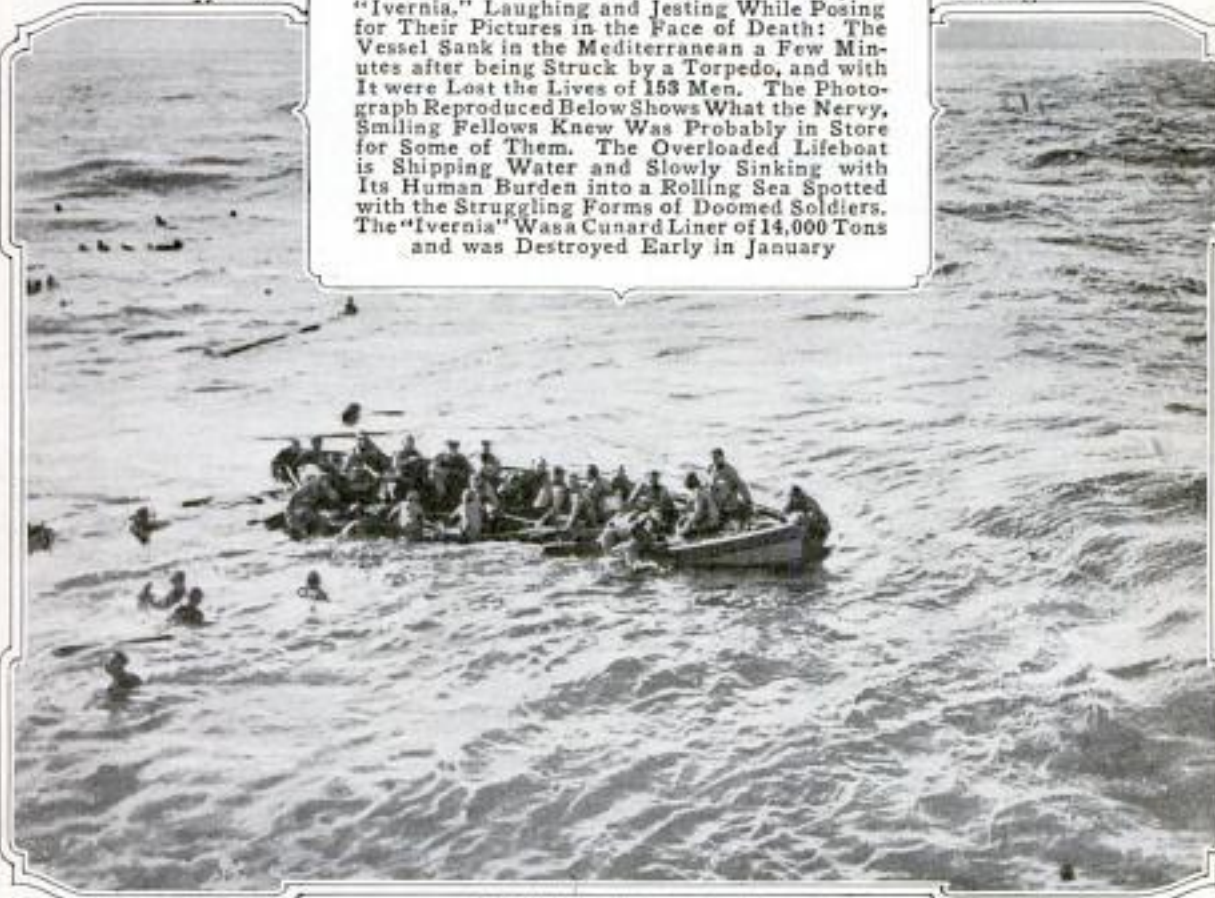

PHOTO COPYRIGHT, UNDERWOOD & UNDERWOOD



## SPECTACULAR AND HUMAN-INTEREST PHASES



One Corner in a Sun-Flooded Day Nursery That has been Established at a Large Munition Plant in France: Hundreds of Women Workers are Engaged in Making Shells, and Many of Them Are Mothers. They Carry Their Babies to the Plant Daily When They Report for Duty and Leave Them in Charge of Competent Nursery Attendants during the Working Hours. In This Way the Children are Properly Cared For and the Mothers Kept at Ease Mentally



PHOTO COPYRIGHT INTERNATIONAL FILM SERVICE



On Some of the Battle Fronts the Past Winter Proved to Be the Most Rigorous Experienced during the Great War. The Picture Above Shows the Flooded Condition of a Russian Second-Line Camp Somewhere along the French Front. Heavy Snowfalls, Thaws Followed by Freezing Temperatures and Bitter Winds, Then More Snow and Another Thaw; These have Been the Climatic Changes That have Caused Much Suffering



## OF EUROPE'S GREAT WAR TOLD PICTORIALLY



PHOTO COPYRIGHT UNDERWOOD & UNDERWOOD

Despite Size and Appearance, This Is Not a Picture of the Crater of an Inactive Volcano. Instead It Is a Hole Nearly 300 Feet Long and 180 Feet Wide Torn in the Ground by the Terrific Explosion of a French Mine Planted beneath the German Trenches on the Somme Front North of Comblès. Four Wounded Men Were the Sole Survivors of Two Companies—or 500 Soldiers—of Prussian Infantry, and of These Two Died the Following Day



Kneeling in the Sand over a String of Sacred Beads, a Moslem Soldier Offering His Prayers to the Great Prophet. He is Turned toward the East and Apparently Is Oblivious of the Christians about Him



Whether He Is Successful, or Unfortunate, the Lot of a Spy Is a Hard and Unappreciated One. A False Move Often Means Death, as It Did for These Two Fellows Who Failed to Escape the Suspicion of the Russians and were Captured. The Last Rites are being Performed by a Priest While Members of the Firing Squad Await Their Unpleasant, but Necessary, Task



PHOTO COPYRIGHT UNDERWOOD & UNDERWOOD

The End of a Dramatic, but Common, Story: The Execution. The Two Spies have been Tied to Posts by the Soldier Who is to be Seen Running Out of the Range of Fire. The Rifles are Cracking. This Is a Picture Which might have been Taken Hundreds of Times, for Many Men have Died under Similar Conditions during the Present Conflict



## UNUSUAL WAR PICTURES PASSED BY CENSOR



COPYRIGHT,  
INTERNATIONAL FILM SERVICE  
Débris of a Large French  
Munition Plant near  
Massy, One of the Suburbs  
of Paris, Which was De-  
molished by an Explosion  
That Occurred a Short  
Time Past. The Blast  
Fortunately Came on  
Sunday When only a Small  
Number of People Were  
on the Premises, and for  
This Reason only Two  
Persons were Killed

At the Right is Pictured  
a German Motor Car  
Equipped with Spring  
Wheels. It is Under-  
stood That These are  
becoming Widely Used  
Because of the Serious  
Shortage of Rubber,  
Which has Made the  
Manufacture of Tires a  
Difficult Problem. In-  
formation Explaining  
the Precise Situation has  
Not Passed the Censor

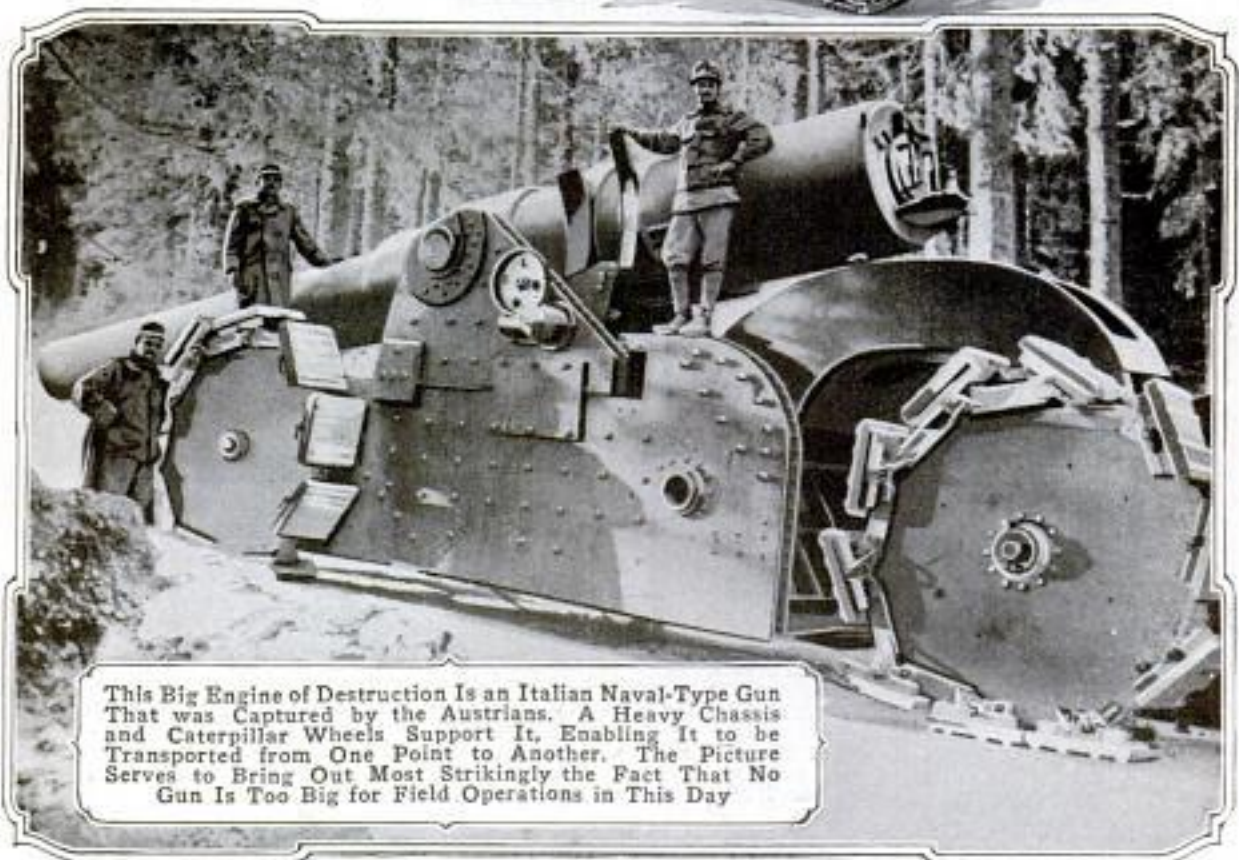

This Big Engine of Destruction Is an Italian Naval-Type Gun  
That was Captured by the Austrians. A Heavy Chassis  
and Caterpillar Wheels Support It, Enabling It to be  
Transported from One Point to Another. The Picture  
Serves to Bring Out Most Strikingly the Fact That No  
Gun Is Too Big for Field Operations in This Day



## STRIKING PICTURES TELLING WAR'S PROGRESS



Since Germany's Campaign of Ruthless Warfare has become effective, Halifax has been designated an obligatory port of call for neutral transatlantic shipping. The picture above furnishes a glimpse of the harbor, which is protected from submarines by a steel net made fast to the pontoons that are visible in the foreground.



PHOTO COPYRIGHT, TOPICAL PRESS AGENCY.

In a French town occupied at present by the German forces, shields of the sort shown here render the street lamps less noticeable to allied airmen.

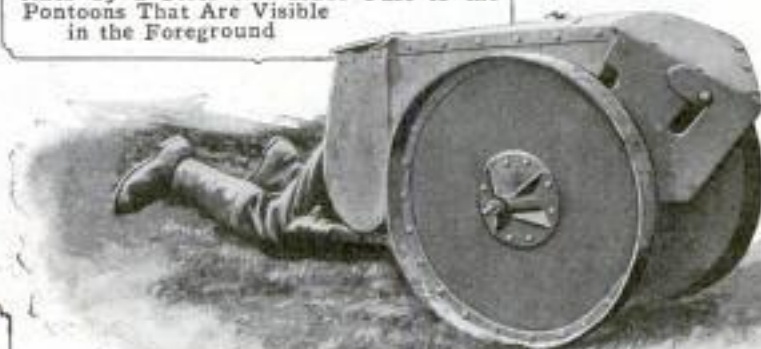

Mobile shield that enables French soldiers to advance in the face of machine-gun fire and cut wire entanglements protecting the enemy's trenches: before this device was put into use the wire cutter's job was a tragically brief one. Although it does not cover a man's entire body, it improves his chances manifoldly.



PHOTO COPYRIGHT, AMERICAN PRESS ASSN.

King George and his retinue visiting one of Britain's largest munition plants while work is in full swing: the almost innumerable long rows of shells, and the endless line of overhead conveyors steadily and ceaselessly moving their burdens along, give one a faint idea of the enormous quantity of ammunition produced in the factory daily.



### GEARLESS ELECTRIC MOTOR OPERATES PHONOGRAPH

In a new slow-running electric motor that has been designed for operating phonographs, the armature

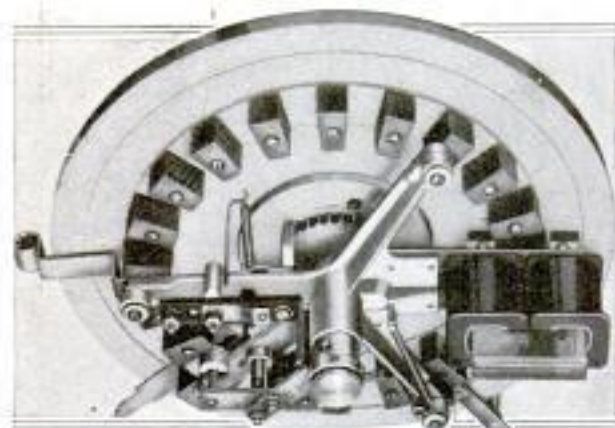

This Illustrates the Combined Turntable and Armature, an Arrangement That Permits Smooth Motion and Obviates Gearing

is a part of the turntable. This arrangement permits the latter to be of much heavier construction than is customary and also obviates the need of gears. Power is applied magnetically, and the turntable is driven with the smooth, steady motion that is characteristic of a flywheel. A constant speed is maintained, irrespective of loads and voltages, by means of an electric governor that is used in place

of the ordinary friction-brake governor. Because the motor consumes only a small amount of current it may be driven satisfactorily by a five-cell battery which under ordinary conditions will permit the playing of 1,500 or more records, it is said. The motor is so built that it is practically interchangeable with a spring motor of any standard make.

3814

### MODERN "BEN HUR" DRAWN BY FOUR MOTORCYCLES

Clad in a Roman toga and swinging a long-lashed whip, an impersonator of Ben Hur was drawn through the streets of Pasadena recently in a chariot of Roman design, but four motorcycles with riders, instead of fleet horses, drew the conveyance. The novel conception proved one of the hits of the rose tournament of which it was a part. The chariot and motorcycles were artistically decorated with flowers and greenery, and above the head of each costumed rider of the two-wheel power vehicles extended an arch of green. In spite of the slow pace of the procession—two miles an hour—the machines kept their place without difficulty.



Unique Float in the Recent Pasadena Tournament of Roses in Which "Ben Hur" and His Roman Chariot were Drawn by Four Decorated Motorcycles with Costumed Riders

L.H. Collins, 122 S. Michigan Ave., Chicago, Ill.



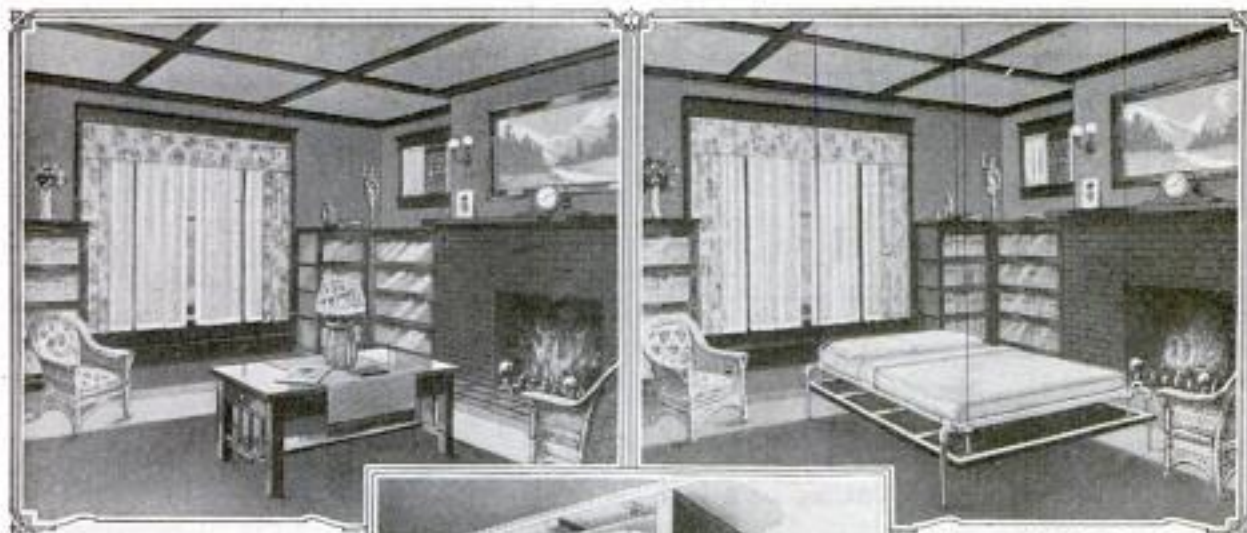

The Ceiling Bed can be installed in Any Room, Sun Parlor, or Sleeping Porch and be Entirely Concealed from View at All Times Except When It is Lowered for Use

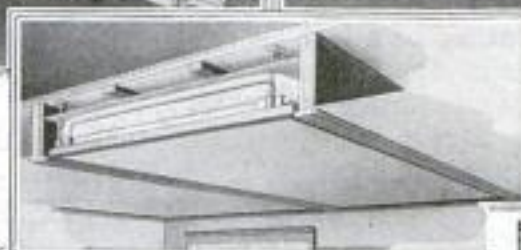

When the Bed is Lowered, as Shown Herewith, the Space It Occupies in the Ceiling is Covered by a False Panel Which Drops into Place Automatically

3939

### DISAPPEARING BED HIDDEN IN CEILING OF ROOM

For those who own small bungalows or cottages which lack guest rooms, some form of disappearing bed usually is convenient when emergencies arise. Certain advantages are apparently to be found in one which is hidden in the ceiling of a room when it is not in actual use. This arrangement does not usurp wall, closet, or floor space. Two false panels are employed, so that the place of concealment is always covered. When the bed is lowered to the floor one of these panels descends and seals the opening. The other one, which is held below the bed, fits into place when the latter is raised. The bed is held in a box installed between the ceiling and the floor above. Cables attached to its four corners pass around pulleys mounted in the retaining box, extend through channels cut in the joists, and are made fast to a winding drum fitted in one of the side walls. Access to this is given by a small, neat door and by turning a crank the bed is raised or lowered into position. Either of these operations requires but a moment's time and can be accomplished without any material physical exertion.

The Illustration Above Shows How the Bed Fits into a Receiving Box Fitted in the Ceiling. While Diagram at Right Explains the Arrangement of the Cables and the Location of the Winding Drum

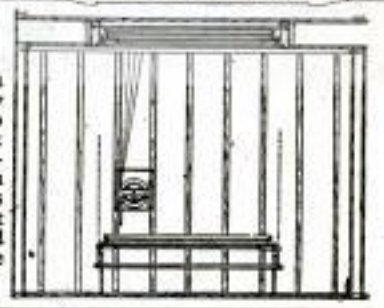

3722

### FINGER-TIP LIGHTS FOR THEATER USHERS

Phila. Record 1/27-1916

With a small electric battery and connections to light bulbs worn on the finger tips, an usher in a darkened theater or hall may now signal to a doorkeeper the number of empty seats available, so that the proper number of persons may be admitted to fill them. This device, recently patented, saves walking to and from the door to carry the message and conduct the persons admitted to the distant seats. It also saves considerable time in seating an audience.



No info

Sorlien Ceiling Bed Co.  
 406 6th Ave. S.,  
 Minneapolis, Minn.



3955  
**HAND BAG SHELTERS LAP  
 DOG FROM COLD**



Hand bags for lap dogs are among the very latest accessories devised for the amusement of society folk and the comfort of their pets. The extremely cold winter weather of a few weeks ago even chilled Florida air for a time, and forced the Palm Beach colony to don garments not altogether summerlike. At the same time some went so far as to shelter their pugnosed little lap dogs in spacious hand bags.

COPYRIGHT,  
 UNDERWOOD &  
 UNDERWOOD

3986

**INCREASING BUSINESS OF  
 THE PATENT OFFICE**

The business of the Patent Office during the year 1916 was greater than in any previous calendar year of its existence. From the report of the Commissioner of Patents, recently submitted to Congress, it appears that the total number of patents issued during the year ended December 31, including designs and reissues, was 45,927. The cash receipts from all sources amounted to \$2,343,540.94 and the expenditures to \$2,115,367.91, leaving a surplus for the year of \$228,173.03, which was deposited in the U. S. Treasury and increased the total net earnings of the Patent Office since the year 1836 to \$8,013,679.51. There were 71,033 applications for patents filed during 1916, and 23,296 patents expired. The applications allowed num-

bered 19,835, and 11,174 were forfeited for nonpayment of final fees. The grand total of patents granted since 1836, when the present series of patent numbers began, was 1,166,419; design patents 48,358, and reissues 14,040. The patents granted to residents of foreign countries in 1916 numbered 3,767, of which Great Britain and her colonies were credited with 1,882, Germany with 847, France with 309, Switzerland with 132, and Sweden with 114. The average time that applications upon which patents are granted remain in the Patent Office before final action is 21 months. A total of 117,298 applications were in the office December 31, pending action.

3815  
**SKIRT WITH LEGGINGS FOR  
 OUTDOOR WOMEN**



COPYRIGHT,  
 UNDERWOOD &  
 UNDERWOOD

A one-piece combination of skirt and leggings is now available for women who are fond of hiking, or any form of outdoor sport in which freedom of movement is desired. The new garment is both modest and attractive. The leggings have gaiter straps and button on the outside almost to the knee. For riding, driving, golf, tennis, and other active

sports, the combination is pronounced just the thing.

Tramways, lake barges, and caterpillar tractors were employed in turn in transporting cement to two remote dam sites in the Sierra Nevada Mountains recently, bringing the cost of the material up to \$7.50 per barrel.



3979

## WHERE SPRINGTIME DRAWS DENVER GOLFERS



In the Attractive Home Above, the Denver Country Club, Which is Actively Affiliated with the United States Golf Association, Is Host the Year Around in Gay Affairs. The 18-Hole Course, One of the Best in the West, Has an Exceptionally Baffling Hazard before the Fourteenth Green. As is Shown at the Left, the Famous Cherry Creek, with Menacing Trees on Either Bank, must be Crossed Obliquely



The Hospitable Atmosphere of Real Country Life is to be Found at the Lakewood Country Club, Where Many of Denver's Devotees of Golf Spend Delightful Hours on the Course and about the Clubhouse. There Are Spacious Verandas and Inviting Lounging Rooms with Cheery Big Fireplaces That Glow with Fellowship When the Air Is Crisp. On the Links, before the Seventh Hole, a Sporty Hazard is Met. The Green cannot be Seen from the Tee, for It is on the Opposite High Bank of the Stream Pictured to the Right





### WOUNDED WAR DOG FITTED WITH WOODEN LEG

Within recent weeks a crippled survivor of the battle of the Aisne has reached America. He is a war dog and



The Dog Limpes When He Walks or Runs, but is Not Seriously Hampered in His Movements

wears an artificial limb. The animal was used in the French army and wounded by shrapnel while carrying a dispatch to the first-line trench during the opening hours of the great onslaught. With his left foreleg torn away, the dog struggled ahead and carried out his orders. At about the same time the animal's master was wounded. Subsequently, however, he got possession of the dog and had an artificial limb made for him at Paris. A silver cap was used to incase and protect the stump, and this in turn was fitted into the aluminum-lined socket in the top of the peg leg. A strap attached to the limb and fastened about the animal's body keeps the wooden member in place.

*Monometer Mfg Co  
Aston, Birmingham  
England*

### SIMPLE MACHINE RECOVERS TIN FROM OLD CANS

In view of the prevailing high cost of tin, some importance is attributed to an apparatus developed in England for recovering this metal and solder from used cans. It is composed of an inclined cylinder that revolves in a brick-lined one and is heated by a series of oil or gas burners. These are arranged so that from the upper to the lower ends of the drum the temperature gradually increases. The machine is continuous in operation, cans being fed by a hopper into the high end of the cylinder and discharged at the opposite extremity through a chute. The molten tin and solder flow through channels that carry them out of the chamber.

### CHAUFFEUR'S ODD METHOD OF KEEPING WARM

There are queer ways of doing everything, and among them is the way an Iowa physician's chauffeur keeps himself warm during zero weather while the doctor calls upon rural patients. No mention has been made of the inhospitality of Iowa farmers, but for some reason this particular driver has the habit of throwing a fur robe over his body and curling up on the rounded top of the motor-car hood, there to absorb the heat radiated by the engine. There is no reason for doubting that he keeps fairly warm, but there possibly is cause to question his comfort.



During Cold Weather This Chauffeur Rests on the Warm Hood of the Motor Car When Long Stops are Made

*Wm. I. H. Hall*





ST. PAUL FOLKS AGAIN FROLIC IN THE SNOW

LIKE New Orleans' Mardi Gras, St. Paul's winter carnival is becoming a picturesque and rejuvenating festival. Singularly these two gala events are held respectively at the headwaters and the mouth of the Mississippi. The photograph reproduced herewith was taken a few weeks past when St. Paul's gayeties were at their height. It shows a throng of several thousand devotees of the outdoors costumed and passing in review before the king of the carnival.

3807

### MAGNETO OF CIRCULAR TYPE FOR GAS ENGINES

In a stationary gas engine of recent design the magneto used is of a new circular type, applied directly to the crankshaft, inside of the flywheel. There are no special gears, brackets, or other fixtures, as with the ordinary horseshoe magneto, and being of the high-tension type it requires only one cable to the spark plug. The timing of the spark is accomplished by rotating the magneto, which, being entirely inclosed, is claimed to be oil-proof, dust-proof, and rain-proof, while its location on the engine protects it against accidental knocks or breakage. The engine, it

is said, starts readily on this magneto, which the designers assert is both positive and durable, giving a good hot spark that can be depended upon. While no battery or spark coil is required, the new magneto can be used

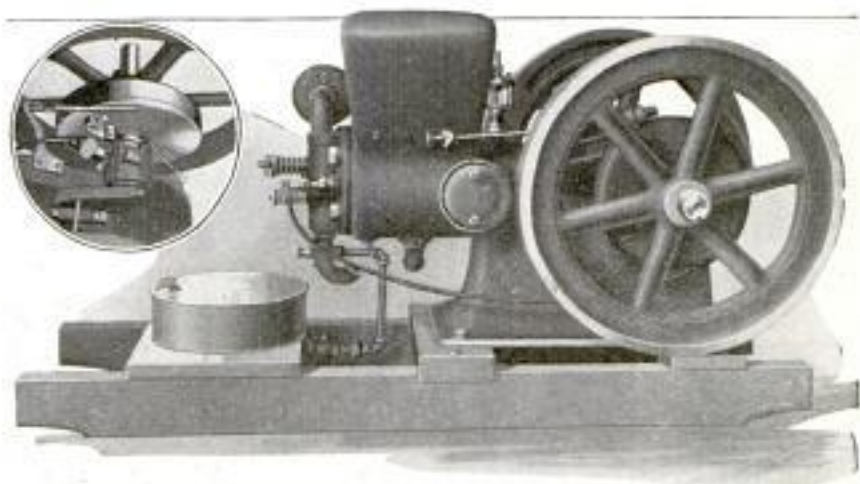

Gas Engine with New Circular Type of Magneto, Which may be Seen Mounted on the Crankshaft Inside of the Flywheel

with batteries in a dual system of ignition.

*Evinsville, Motor Co.  
564 ... in ... place  
Milwaukee*



### DEATH'S-HEAD AND HUMOR MAKE SIGNS EFFECTIVE

Originality and grim humor have been displayed by a county-road engineer in designing signs for a link of

### MAGNET USED TO OVERCOME VIBRATION OF MERCURY

Frequently it is highly important that the mercury contained in certain scientific instruments such, for in-

stance, as a barometer, be restrained from vibrating when subjected to some disturbing force. If the support of the vessel shakes slightly, small ripples occur on the surface of the liquid and often cause trouble when accurate observations are required. A physicist connected with the Bureau of Standards at Washington has found that such disturbances, as well as greater ones involving the whole of the mercury, can be largely, or entirely, overcome by subjecting the element to a strong magnetic field. The direction of the latter, it has been found, should be at about right angles to that of the motion of the quicksilver. The movement of the liquid across the magnetic lines of force has a ten-

dency to develop an electric current, and the resulting reaction has the effect of stopping the motion of the mercury. This method may be used when it is wished to obtain accurate adjustments of mercury surfaces at sea and elsewhere.



Two Signs on a Section of the Southern National Highway near Asheville, North Carolina, Which Strikingly Set Forth the Rules and Dangers of the Road

the Southern National Highway, not far from Asheville, N. C. At one curve in the fine asphalt-concrete thoroughfare is a boldly lettered notice which reads, "One Half of the Road Is Yours. The Other Half Mine." At another point in the same vicinity, near a sharp curve, is a board bearing a death's-head, below which are these words, "Just around Curve."

Because of the shortage of technically trained men for service in Russian munitions plants, 47 Russian women, formerly technical students, have been granted the degree of engineer and will serve in place of men.

### NOVEL SPEED INDICATOR FOR STATIONARY RACERS

Exciting races, the participants in which sit on stationary bicycles, are held in the gymnasium of the Grand Rapids, Mich., Y. M. C. A., with the aid of a novel speed indicator. Two bicycles are each installed on a set of rollers which are connected by means

Chas. H. Neal  
Asheville, N. C.

1764



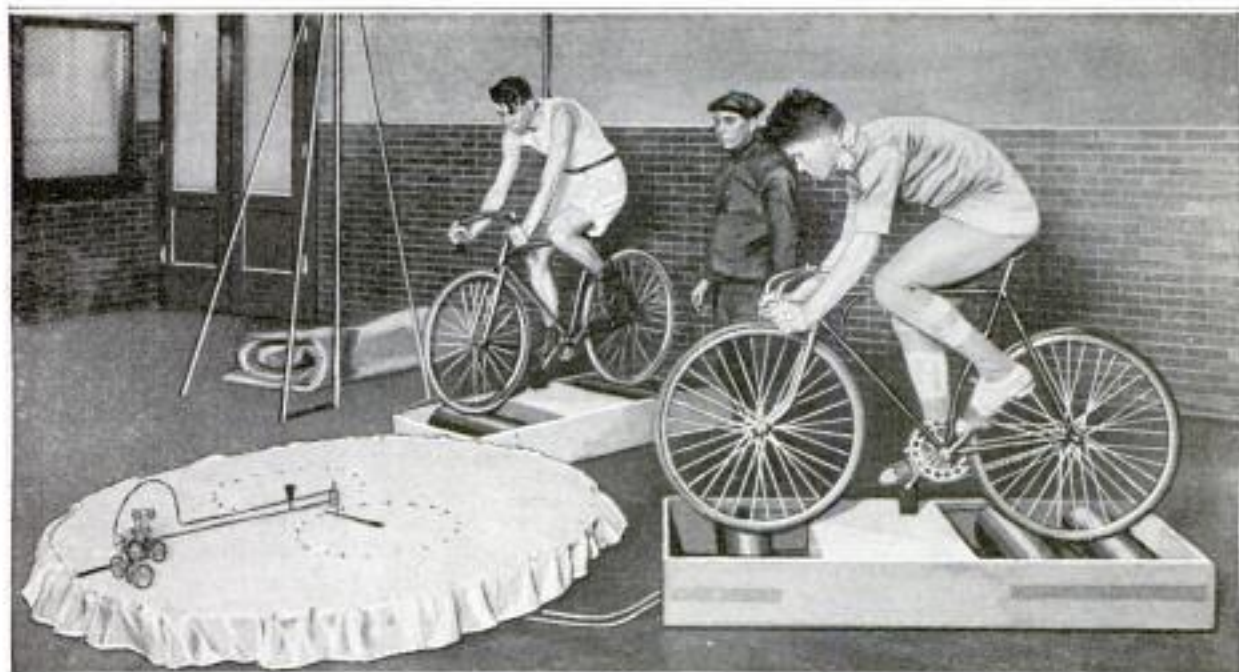

A Speed Indicator Which Makes Possible Exciting Races on Stationary Bicycles: The Two Toys Travel around Their "Half-Mile" Track Proportionately as Fast as the Contestants Operate Their Bicycles

of speedometer devices with a miniature race track set in full view of the riders. Two toy bicycles, with riders, are mounted on this track and are connected with the speedometer attachments in such a way that the large bicycles drive them round the track. One trip of the toys around the course represents half a mile of bicycle riding. The fact that the speed of each tiny bicycle is governed by the rate at which the corresponding large bicycle is driven, gives all the zest of an outdoor race to the contests.

3472  
**ROOMY AIR-DRIVEN BOAT  
 FOR TEXAS STREAMS**

The problem of navigating a good-sized boat in the shallow streams of Texas timber lands has been solved by a river boatman of Deweyville, Tex. He has applied the aeroplane method of propulsion to a handy craft, 36 ft. long and 9 ft. beam, that draws only 8 in. of water and attains a speed of about 15 miles an hour under favorable conditions. An 8-ft. air propeller is mounted at the stern and driven by a



This Boat Draws Only Eight Inches and Makes a Speed of Fifteen Miles an Hour in the Shallow Streams of Texas, with the Aeroplane Propeller Seen at the Stern. The Builder is Standing on the Forward Deck

Builder-Capt. David G Price, Deweyville, Tex.  
 for J. B. Smith, Beaumont, Tex.



6-cyl. gasoline motor in the canopied cockpit. There is a comfortable cabin and wheelhouse, and a gangway all around the deck. The boat was built for the use of a southern lumberman in visiting his camps along the streams, where a launch of greater draft could not be navigated.

3203

### SMALL WINDMILLS USED BY HERRING FISHER

In fishing for herring on the California coast small hooks are baited with bits of bright-colored yarn, which



This Small Windmill is Used by the Fisherman to Keep Herring Bait Spinning in the Water, and He has Made Some Record Catches by Its Aid

must be kept moving in the water to attract the fish. An Ocean Park man grew tired of constantly jigging his lines by hand and now uses small wooden windmills, which answer the same purpose. There is usually a breeze at the piers where he fishes, and when connected to a fishline the mill spins merrily, keeping the baited hooks in motion until a fish is securely hooked, when its efforts to escape stop the mill, and the inventive fisherman does the rest. Nibbles have little or no effect on the windmill, so that there are few false alarms, and other fishermen are adopting the labor-saving system.

### VEGETABLE-IVORY WASTE AS A STOCK FOOD

The feeding of sawdust to stock in the place of grain, which has often been the theme of jokers and comic supplements, may prove to be a practical proposition after all. But the sawdust to be employed as food will be of a particular kind, namely from vegetable-ivory nuts. This country imports about 10,000 tons of these nuts annually for use in making buttons. Now it is proposed to utilize the considerable waste, in the form of sawdust, chips, and turnings, that results from the making of buttons, by mixing it with grain for cattle. Experimenters for the Massachusetts Agricultural Experiment Station have found properly prepared vegetable ivory apparently quite suitable for such purposes, and stock fed on it seem to be benefited thereby.

3757

### SALT TREATMENT FOR IRON FOUNDRY LADLES

By melting a small quantity of common salt in iron or steel ladles and spreading it over the inner surface, a Birmingham, Ala., inventor claims that the metal ladles can be used for melting copper or bronze, which usually requires expensive crucibles of graphite or some other material that will withstand intense heat. It is said that copper can be melted in a few minutes in an iron or steel crucible so treated with salt, whereas in common practice from one and a half to two hours are required. The salted metal crucibles can also be used for pouring the molten copper, as they are not affected by the fusing temperatures. The process has been patented.

CA seaplane, attached to the aviation station at Pensacola, Fla., ascended to a height of 10,500 ft. recently, establishing a new altitude record for craft of that type. A flight to a height of 11,000 ft., made some months ago, was not officially acknowledged as a record.



3744

## GREAT HELL GATE BRIDGE NEARS COMPLETION



Hell Gate Bridge across East River at New York, Which Is Now in the Final Stages of Construction. It Is a Part of the New York Connecting Railway, a 10-Mile Line That is Carried for Nearly Half of Its Distance on Bridges and Viaducts

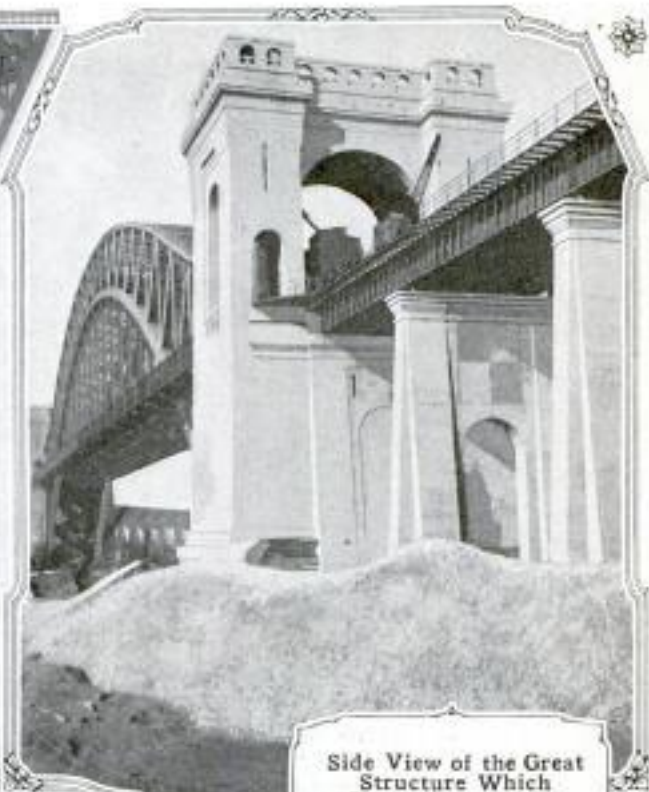

Side View of the Great Structure Which Shows Some of Its Imposing Architectural Features. The Bridge will Give New England Express Trains Routed to the South and West a Direct Path through New York City and will Also Allow Freight to be Shipped from South Brooklyn to New Jersey without being Carried through Manhattan



Including Its Approaches, the Bridge Is About 3,000 Feet in Length. This Picture Shows the Four-Track Roadway on One of the Long Viaducts. Work on the Connecting Road was Begun in 1912 and has Proved a Most Interesting Example of Modern Railway Engineering

U+U. 417 5th Av NYC 533



### SELF-LIBERATOR PERFORMS HANGING HEAD DOWNWARD

Not content with liberating himself from a strait-jacket in the way that tricksters ordinarily do, a vaudeville performer in Cincinnati not long ago performed this feat while hanging, head downward, from the side of a skyscraper. Clad in one of the garments used to restrain violent prisoners and with his feet tied to a heavy rope, he was swung out over the street far above several thousand spectators. After three minutes of effort, the gymnast had freed himself from the strait-jacket, despite the handicap of hanging by his feet at a nerve-racking elevation.



After three minutes of effort, the gymnast had freed himself from the strait-jacket, despite the handicap of hanging by his feet at a nerve-racking elevation.

3805

### HUNDREDS OF CATTLE MAKE QUARTER-MILE SWIM

When there is a chance to take advantage of a short cut and thereby

on a Montana range, near Grayling, where 2,000 head of cattle were made

to swim a quarter of a mile across a neck of water in order to save a 13-mile trip around the shore line of Lake Hebgen. The animals reached the opposite shore easily.



Making the Start across the Quarter-Mile Stretch of Water

eliminate a tedious ride of several miles, a cow puncher rarely overlooks it. An instance of this, which may be interesting to the tenderfoot at least, occurred not long ago



The Cattle Milled Until a Few Head were Rounded Up on the Opposite Bank. Then the Cowboys Started the Herd by Swimming Their Horses Alongside

### LOCAL MAGNETIC POLE IN ALASKA

*Along - Sci Press 12/23/16*

In common with a few other places on the face of the earth, Treadwell Point, Alaska, claims distinction in that it is a local magnetic pole. It is one of those localities in which scientists have found that a dipping needle stands in an almost vertical position. The phenomenon is due to some local condition, such as a deposit of ore possessing strong magnetic properties. It is said that when observations were made at Treadwell Point, in 1900 and again in 1907, the dipping needle stood practically straight up and down, the north pole pointing toward the earth. When a compass was moved about in a circle of very small radius surrounding a certain spot, it was found that it reversed its direction. The compasses on ships in the channel, a mile distant, are said to be deflected about  $11^\circ$  by this area, which possesses exceptional magnetic properties. Treadwell Point is not far from Juneau.



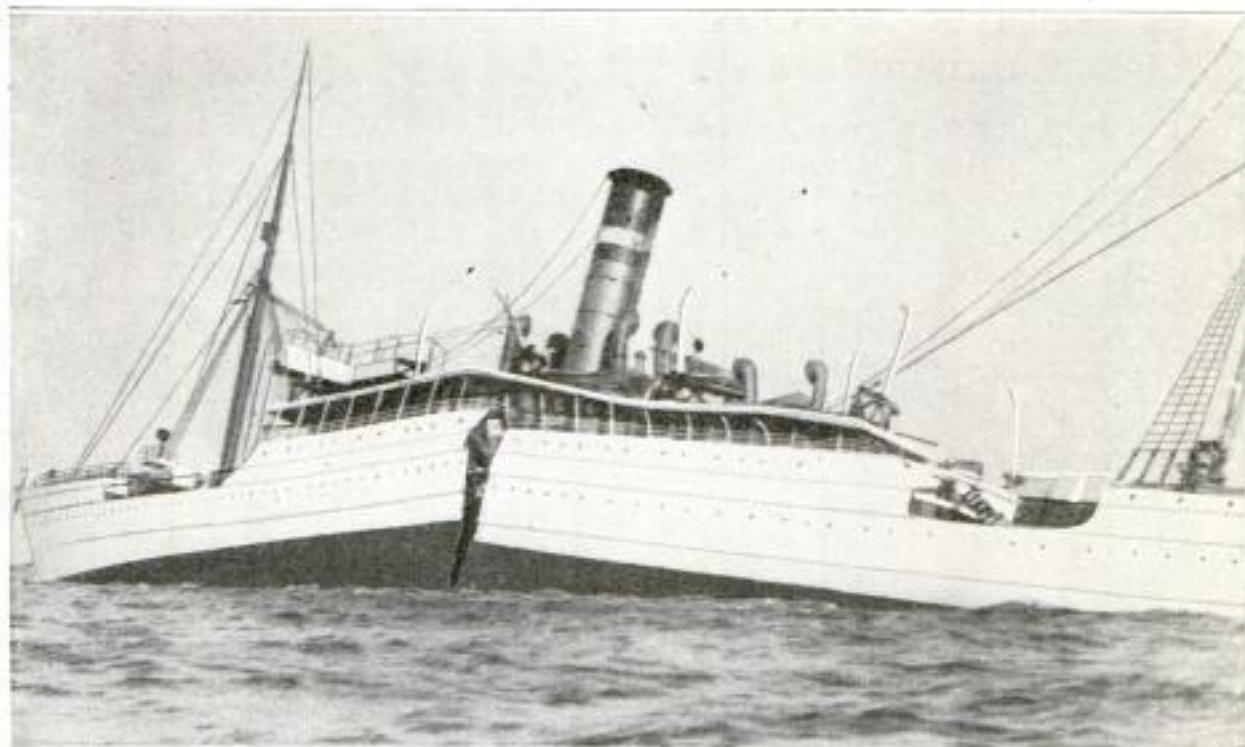

COPYRIGHT, UNDERWOOD & UNDERWOOD

United States Army Transport "Sumner" Aground on a Shoal off the New Jersey Coast, Broken in Two by the Winter Waves, and Abandoned by the Government as a Total Wreck

3897

## GROUNDED ARMY TRANSPORT BREAKS IN TWO

When the army transport "Sumner" went aground on a shoal off Barnegat Light, N. J., early in the winter, hopes were entertained of saving it. The pounding of the winter storms, however, proved too much for it and it finally broke in two amidships. The machinery and much of the equipment being ruined, it was given up by the government as practically a total loss, further salvage operations being abandoned to the wrecking companies.

3800 Hull

## WOODEN SHIP KNEES MADE FROM FIR STUMPS

Recent activity in building of wooden ships has revived an industry in the timbered regions of the West, in the furnishing of ship knees, the angular braces which are an important part of a hull. They are obtained from the stumps of large trees, at the angle where the trunk and the root meet. Douglas-fir stumps are said to yield the

finest and largest ship knees in the world, and as from 200 to 300 knees may be used in a single hull, there is a large demand for them among ship-builders when their yards are busy. Most of the knees are required to have



Left: Finishing a Right-Angled Ship Knee by Planing: These Knees were Obtained from Douglas-Fir Stumps and are Finished to the Shapes Seen in the Upper Picture

an angle of  $90^\circ$ , and are sawn from stumps grown in level ground, then finished by planing.



Michael T. Bradley  
Spokane,  
Wash.

Lloyds' Ironstone Co. Ltd.  
Corby near Kettering,  
England.

536  
3689

**POPULAR MECHANICS**

3754

**FOOT REST OR GUARD FOR  
USE ON SHOVELS**

Can. Pat. Re. No. 26,1916

The labor of using a spade, or shovel, may be lightened considerably by the use of a foot rest, or guard, which a resident of Spokane, Wash., has designed to fit over the upper edge of a shovel blade on either side of the handle. There is a broad guard surface on which the pressure of the foot is exerted and a resilient front portion to hold the guard in place on the shovel. It is a device that will be appreciated by amateur gardeners in the springtime.



172047-6 yr

3810

**ROWING MACHINE OF SMALL  
SIZE AND WEIGHT**

An exercising device which affords many of the benefits of rowing a boat and is convenient in size and weight for use in the home has been invented by a resident of Marion, Ind. The user's seat slides on a supporting track, while a lever pulled by handles is regulated by an automatic and noiseless friction clutch.

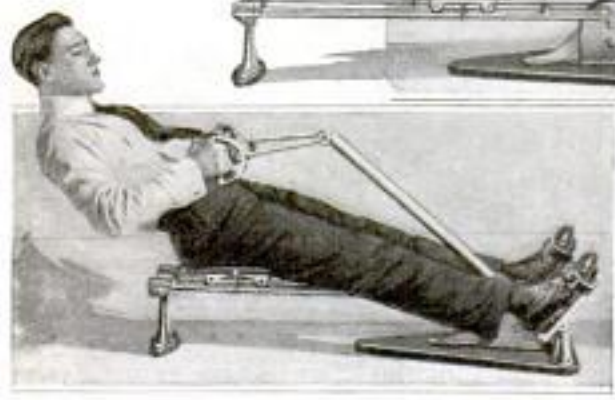

New Rowing Machine That Takes Up Little Space and is Intended for Use in the Home

#1 205426-Nov-21-1916 -  
P. S. V. 232 fr 723

(Inv.) Edward B. Barnhill,  
Marion, Ind.

**OPEN-PIT IRON MINING  
LEAVES LAND TILLABLE**

That open-pit mining, even in iron-bearing regions, need not convert the land into a desolate waste but can be so carried on as to leave the soil ready for the farmer, is demonstrated by the operations of an English company. Instead of leaving the earth in irregular barren heaps such as so often mark American open-pit digging, this concern replaced the dirt as fast as the ore was removed, and leveled off the top. The surface dirt was dug out to a depth of about 20 feet by a shovel which rested on the top of the vein. Immediately behind the shovel were workmen removing the ore, while in the bottom of the pit was a conveyor, within reach of the shovel, which received the surface dirt and carried it to the far side of the pit. Both machines moved forward in the same direction on tracks that were laid in front of them as fast as the digging progressed. The replaced earth was smoothed off ready for the planting so that in a short time it again became productive farm land.

3926  
**ARMY BAYONETS TO LOSE  
THEIR LUSTER**

The comment has often been made that the great European conflict has destroyed all the glamour of war and now it may be added, speaking more literally, that modern war methods are removing all the luster and glitter from war equipment. Just as the gaudy uniforms have given way to those of dull color, so now the luster of bayonets is to be destroyed. The authorities of the United States Army have decided that a company of marching soldiers with shining steel blades on their rifles would be too easy a target for hostile airmen and long-range artillery. Consequently, all bayonets, including those of the militia, are to be "blued" by a special process.

Quadrant Dept



Elgin Motor Corp'n  
2427 Mich. Av., Chgo.

3862

**MOTOR CAR TESTED BY A  
HURDLE JUMP**

An unusual test of an automobile was made recently in Grant Park, Chicago, when a skillful driver sent his car full tilt down the speedway at a 14-in. sloping hurdle which caused it to jump a distance of slightly over 36 feet through the air. The feat was repeated three times without apparent injury to the car, which was powered with a 6-cyl. engine and weighed about 2,150 pounds. When the car hit the hurdle it was traveling at a speed of

50 miles an hour and the crash as it landed on the ground after each leap fairly terrified the spectators, who feared serious injury to both the car and its daring driver.

*Burr Savin*



Automobile in Mid-Air, Making a 36-Foot Jump While Traveling 50 Miles an Hour: Both Car and Driver Came Through Safely

3901

**POWERFUL RADIO STATION FOR USE OF NAVY**

The largest wireless-telegraph station in the western hemisphere placed in commission at Chollas Heights, near San Diego, Calif., a few weeks ago, when formal greetings were exchanged with the Navy Department at Washington, for whose use it is intended. The plant is capable of flashing messages to a distance of 12,000 miles. Immediately after the

opening, the operators talked with points in Alaska, the southern Pacific, and Australia, while messages were overheard from the British high-seas fleet in the North Sea, the high-powered German plant

at Nauen, near Berlin, and American ships along the Atlantic coast from Portland to Key West. The aerial equipment includes three 600-ft. towers, containing 500

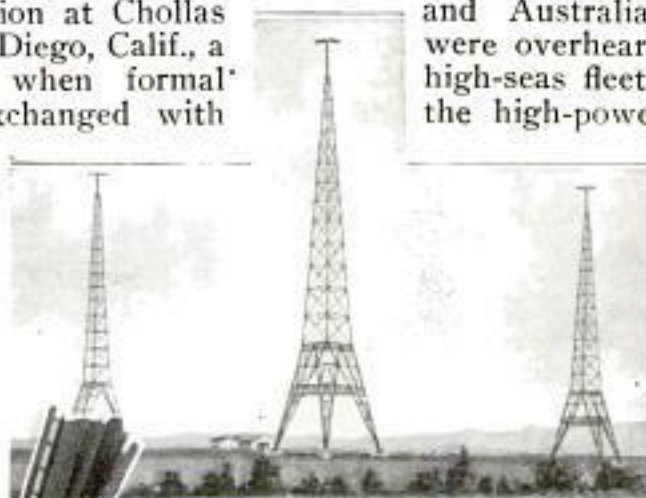

Top: Distant View of New Naval Radio Plant at San Diego, California, Showing the Huge Towers. Left: Concrete Base of One of the Towers; Insulation Plates of Porcelain Are Visible below the Steel. Right: The Building on the Right Houses the Engine and Generator, While the One on the Left Contains the Transmitting and Receiving Instruments



tons of fabricated steel. They are placed 1,100 ft. apart in the form of a triangle and are triangular in section, 150 ft. at the base and 8 ft. at the apex. Huge porcelain insulators imbedded in concrete form the base of each leg. The aerial wires, or antennæ, weigh 16 tons and sag 100 ft. between the towers; the generator weighs 60 tons, and the tuning coil is 14 ft. in diameter and 11 ft. in height. A government reservation of 72½ acres surrounds the station, with six commodious concrete buildings to house the power plant, operators, commanding officer, and guard.

3782 —

### BIG STURGEON NETS LARGE SUM TO FISHERMEN

That the catching of big fish in Lake Erie is not entirely a thing of the past is proven by the fact that not long ago a crew of fishermen captured a huge sturgeon about a mile from the harbor of Port Bruce, Ont. The fish measured 7 ft. 6 in. and weighed 249 lb. Dressed, the meat sold for 30 cents per pound, or \$42 in all, while the 40 lb. of caviar brought the fortunate fishermen \$110. Some 20 or 30 years ago, when sturgeons of this size were not uncommon,



Two Views of a Sturgeon Caught Not Long Ago in Lake Erie, Which Weighed 249 Pounds, Was Seven and One-Half Feet Long, and Sold for \$152

*Lang Fish Co.  
Port Bruce, Ont.*

a catch of this sort would have brought only a small fraction of the sum these men received. 3886 *any*

### MANY OBTAIN SHOES LEFT BY DEPARTING SOLDIERS

Trade in secondhand shoes has been a thriving business in the vicinity of the army camps on the Mexican border since the return of our troops to their homes began. Many of the soldiers, on breaking up of camp, threw away extra pairs of shoes which they did not wish to be burdened with or had no adequate means of carrying. This attracted "shoe pickers" who came in great numbers, some of them in automobiles, and carried away hundreds of pairs of footwear. In many cases the shoes needed half-soleing, others needed stitching, while not a few were in excellent condition. These shoes retail for from \$1.50 to \$2, and consequently the collectors realized neat sums for their pains.

3917 —

### OIL BATH FOR LUMBER HEATED ELECTRICALLY

*Electrical World* 1-13-17  
An unusual use for electrical heating units is found in the equipment of a Chicago concern that employs them to heat oil in a tank in which lumber is treated. The container has a capacity of 100 gal. of oil and is heated by six 4,800-watt immersion heaters placed at the bottom of the reservoir. Any desired temperature can be maintained by means of an automatic temperature control. Heat economy is made possible by reason of an auxiliary tank placed above the main tank so that it absorbs the radiation. The outfit will permit the treatment of 15 timbers simultaneously.



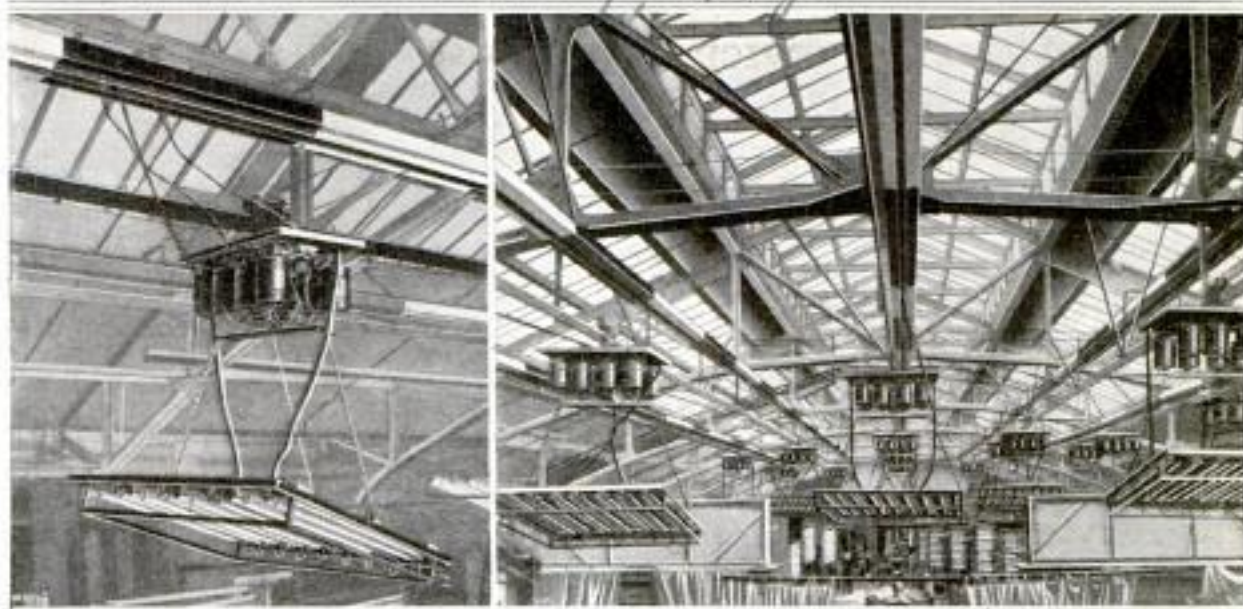

Costly Overhead Lighting System of a New York Moving-Picture Studio: The Stage to be Lighted Below Is 170 Feet Long and 70 Feet Wide. The Groups of Mercury-Vapor Lamps are Moved on the Tracks Seen in the Photograph and Give Results Better than Daylight

3889  
**OVERHEAD LIGHTING SYSTEM  
 IN MOVIE STUDIO**

A lighting system recently installed at an expense of \$50,000 in a large moving-picture studio in New York is said to be the most elaborate used in motion photography in the East. It comprises 25 overhead banks, or units, of mercury-vapor lights, each bank weighing 400 lb. They are movable on five tracks, each track having eleven contact spaces indicated by white paint. By shifting the lights a short distance either way, light is obtained for the deepest sets of scenery used in the studio. Contact is made by means of trolley arms. The entire weight of each bank of lights is supported by an overhead steel track, these tracks being 9 ft. apart and 170 ft. long. Each mercury-vapor unit consists of eight tubes, 56 in. long, and the weight being sustained by the hanger rail, there is no tension on the feed wires. The overhead lights are supplemented by a battery of similar units on the floor of the studio, which is also of remarkable size and power, so that when all the lights are in use a sort of superdaylight is produced, with fine results in photography. The actual taking of scenes is all done at night with these lights.

3812  
**SHOCK AND SOUND ABSORBER  
 FOR TYPEWRITERS**

Sixty per cent of the noise made by typewriters can be eliminated, it is claimed, by the use of a device recently placed on the market. This is intended not only to absorb shock and sound, but also to provide an automatic means for attaching and detaching a typewriter to and from a desk. It includes a front and a rear absorber, the former being adjusted by lugs to the side plates of the typewriter, while the latter is furnished with cups in which the rubber feet at the rear of the machine rest. The absorbers then form a resilient bed for the machine, thus taking up the shocks of operation and decreasing the sound made. Provision is made for fastening them to the desk, so that the typewriter is securely held in one spot and "creeping" is prevented.



Shock Absorbers Installed beneath a Typewriter to Lessen Its Noise

350

University of Shore  
 43 Cantor St. Newark, N.J.  
 Absorber Co. of N.Y.



Kirke Chemical Co., Inc.  
245 Robinson St.

540 3768 POPULAR MECHANICS

COMBINATION FERTILIZING  
AND SPRINKLING DEVICE

A garden-hose attachment now on the market provides a simple means for fertilizing or disinfecting flowers,



An Attachment for Garden Hose in Which is Inserted a Cartridge of Concentrated Fertilizer or Disinfectant That Slowly Dissolves in the Water. Tablets of Plant Food are Also Prepared for Use in a Sprinkling Can, as Shown in the Inset

shrubs, etc., that entirely does away with the task of pumping prepared liquids on plants to be protected or distributing bulky fertilizer by hand. The invention consists of a metal cylinder which attaches to the hose, either just behind the nozzle or next to the faucet. In this container is placed a cartridge composed of the material to be spread on the plants, in highly concentrated form. The flowing water gradually dissolves this compound and it is distributed with the spray. Fertilizer, nicotine insecticide, and other preparations, can be obtained in a form especially adapted for use in this attachment. Plant food can also be obtained in tablets designed to be dis-

solved in a sprinkling can, thus affording a simple means of fertilizing piazza plants and the like. The tablets can be inserted in the outer end of the spout if it has a screw top.

3726—

DUTCH FIND NEW WAY TO  
RECOVER FUEL IN ASHES

*Commercial Dept 11/21-1916*  
In seeking ways to overcome the fuel shortage in Holland due to the war, a process has been devised in that country by which the combustible remnants left in furnace refuse can be recovered easily. It is said that this valuable waste often constitutes 20 per cent of the ashes and sometimes as high as 75 per cent. By the new method the refuse is ground up and then put through sieves of four different sizes. Each part is put into a separate basin containing liquid somewhat heavier than water, and the whole is stirred thoroughly. This causes the lighter particles, which are coke and unconsumed coal, to rise to the surface. When they have been scooped out and dried they make excellent fuel, while the heavier particles can be used, it is said, in making a fine grade of concrete. The liquid employed in the separating process is said to be inexpensive and a refuse product of factories.

3848—

LAKE STEAMER USED AS A  
HOTEL FOR WORKMEN

When a shipbuilding concern of Manitowoc, Wis., found that many of its workmen were unable to obtain accommodations in the overcrowded hotels and rooming houses of the city, an old sidewheel passenger steamer was purchased by the company in Chicago and transformed into a hotel for their use. Being run ashore and rebuilt, it now furnishes comfortable sleeping quarters for 110 of the workmen, while hundreds more are daily sheltered, fed, and entertained between its roomy decks in the noon hour. The length of the boat is 205 ft., and its beam 30 ft. It was formerly in passenger service on Lake Michigan and

*Manitowoc Shipbuilding*



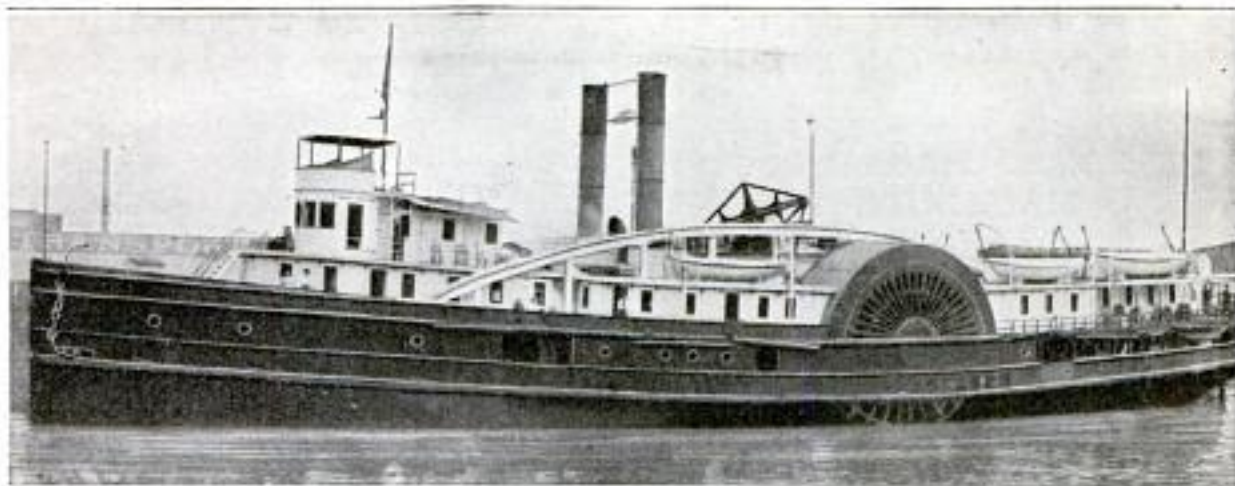

This Veteran Passenger Steamer of Lake Michigan is Now Doing Duty as a Hotel, and Accommodates Hundreds of Employees of a Shipbuilding Concern, as Regular Roomers and Noonday Guests

is well supplied with staterooms for the regular roomers, who have their own dining room on the upper deck, also shower baths, pool tables, and other means of recreation. On the main deck there is a large dining and smoking room for workmen who do

not sleep aboard, also a lunch room for those who bring their own dinners. Hot noonday lunches, soup, and coffee may be purchased on board. A special dining room is provided for the foremen and office employes of the company.

3871 Machinery

### ICE-SAWING OUTFIT WITH MOTOR ON A SLED

Harvesting ice is always a man's-size job, but it has become a comparatively easy task for a resident of Waterford, Me., since he designed and built an ice-sawing outfit with a motor-driven saw. On a substantial sled, capable of being pushed by hand, he mounted a light gasoline engine and a

circular saw, the latter being carried in front of the sled on a movable arm.

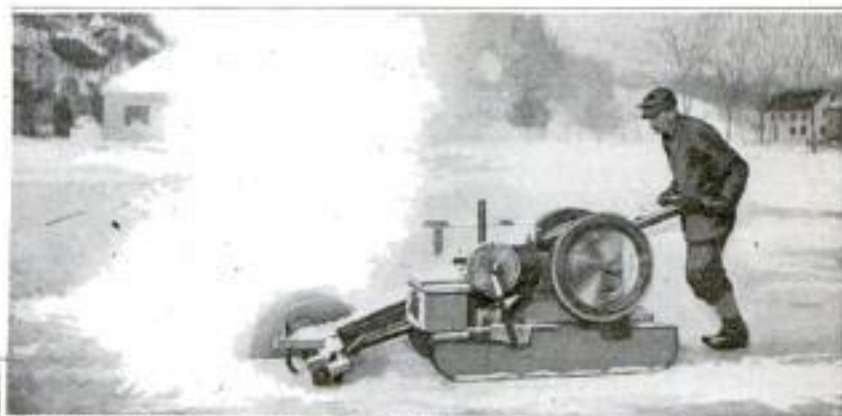

Cutting Ice with the Motor-Driven Saw: The Outfit is Easily Propelled by Hand and Raises a Cloud of Ice-Dust when at Work

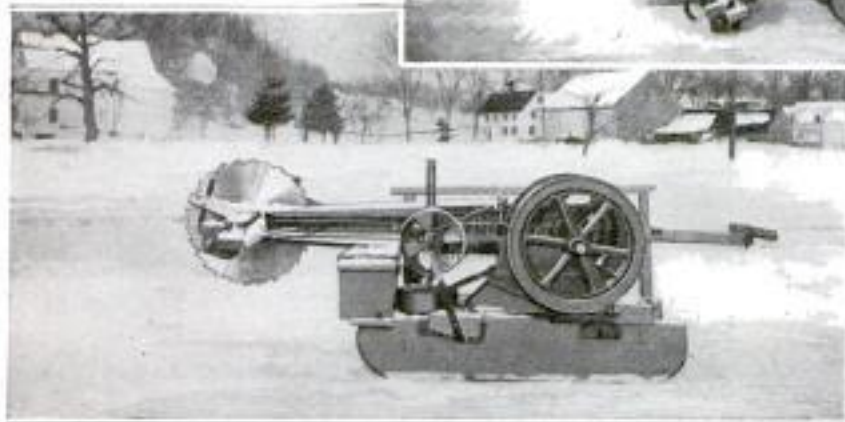

With This Circular Saw and Motor Mounted on a Sled a Maine Man and One Helper Cut from 10 to 15 Tons of Ice an Hour

Edgar L. Stone (Invs.)  
Waterford, Me.

This arm can be raised or lowered without disturbing the tension of a driving belt running from the engine pulley to the shaft of the saw; and the arm is extended at the rear to terminate in a push bar



by which the outfit is propelled. The depth of the cut is regulated by an adjustable gauge.

3725

### IMPROVED MAGAZINE FOR MACHINE GUN

A private of a Pennsylvania regiment stationed at El Paso, Tex., has invented a magazine attachment for a ma-



Operating a Machine Gun with New Continuous-Feed Magazine: Above, the Assistant is Seen Feeding Cartridges into the Hopper; Should the Assistant be Wounded, One Man can Operate the Gun, as in the Lower Photograph

chine gun, by the use of which the gun may be fired continuously. At present the cartridges are fed to the gun by an assistant operator, in strip magazines holding 47 cartridges each. With the new device, it is claimed, the delay caused by adjusting new magazines is avoided, and if necessary one operator can both load and fire the gun. The continuous-feed magazine is a steel hopper, 9 in. high, placed above the firing chamber of the gun. Loose cartridges are dumped into this hopper, just as they come from the ammunition cases, and are fed automatically into the firing chamber, the empty shells being ejected as at present.

### SPAIN TO ESTABLISH NATIONAL PARKS

*Commerce Dept. vs P 211*

Spain has profited by the example of the United States and has recently enacted a law providing for the creation of national parks. At the time the proposal was under discussion, reference was made officially to the policy of our country in this matter, and the beauties of our national playgrounds were cited. This conservation movement was instituted by the king himself, who was much concerned because of the rapid disappearance of the national fauna, especially in the beautiful Sierra de Gredos. In fact he personally assumed protection of the central portion of that mountainous region, giving it his name and providing for its care. A commission was established which will seek to interest travelers by preserving picturesque and historic spots, and to assist the general public in becoming more familiar with their location and events connected with them.

3237

### ROTARY STUMP PULLER SAVES SHAVINGS

When a rotary stump puller recently tested in the South finishes its work upon a refractory stump, there is nothing left but a clean hole and a few sacks of shavings—sacked by the machine automatically while the stump is disappearing. The device is a huge machine which travels and operates under its own kerosene power and grinds the stump to shavings by a powerful steel-knived auger, taking from one to five minutes according to the size of the stump. It cuts down 18 in. below the surface, or 8 in. lower than is considered necessary for plowing, and the hole which it leaves is readily filled with surrounding earth. On the machine used for demonstration on cut-over lands in Louisiana the cutter head is 42 in. in diameter, built into a 40,000-lb. tractor. There are two sets of knives, one set shaving the outside of the stump at an angle of 52 degrees, the other set shaving out the inside at the point of the auger proper as it bores

MOORE ROTARY STUMP PULLER Co. NEW ORLEANS, LA.

AUGUST 1915  
P 887  
Summ



down the center. The capacity of the machine is rated at two acres a day, or even more. But its chief merit, aside from clearing the land so that it may be sold for farming, lies in the claim that it saves practically every pound of



This Machine Removes Stumps with Neatness and Dispatch Leaving a Smooth Cylindrical Hole Which is Easily Filled In. Its Mode of Operation is Seen Above. It Cuts the Stump Down to 18 Inches below the Surface, Leaving the Ground Fit for Plowing. Besides Removing the Obstruction, It Draws Up the Shavings and Packs Them in Sacks



View of Stump Partly Cut Away by Rotary Stump "Puller," the Cutting Tool of Which is a Huge Steel-Knived Auger That Speedily Reduces the Stump to Shavings

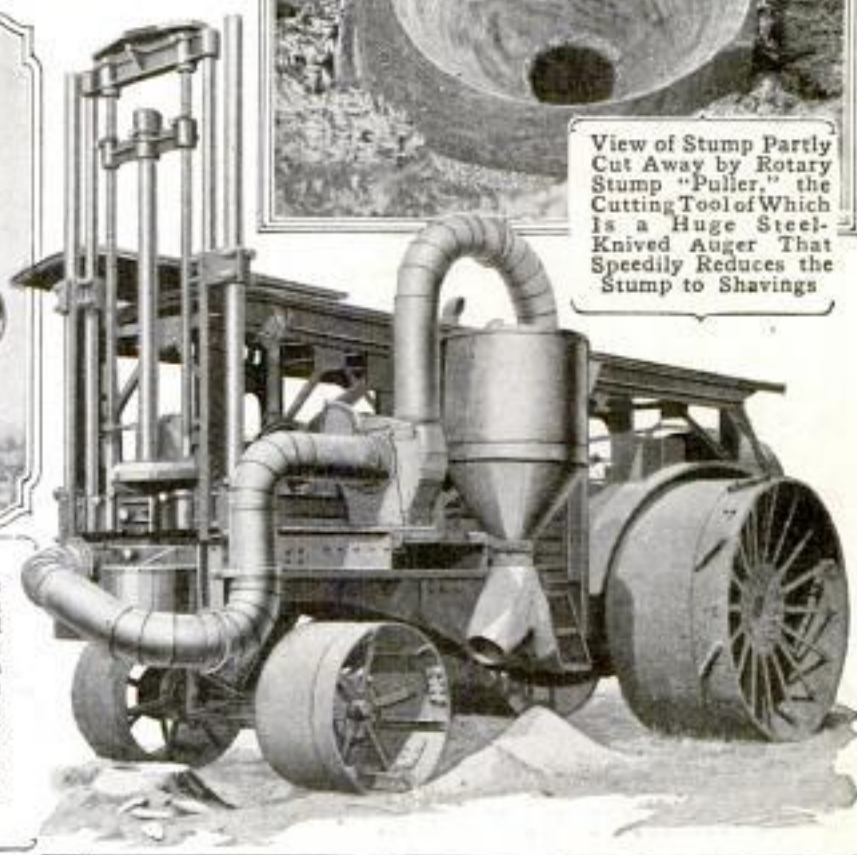

the stump in shredded shavings for the turpentine still and the wood-pulp mill.

3308—

### MOVING HEAVY LOADS ON STEEL BALLS

An ingenious method was used in a foundry recently to move two huge cast-iron bins filled with sheet iron to the door of an annealing furnace. The bins when filled weigh several thousand pounds. Two shallow grooves, parallel and about three feet apart, were made in the concrete floor, alined with the furnace door, and connected with similar runways on the floor of the oven. Then each groove was filled with hard steel balls, 6 in. in diameter. A steel plate, 5 ft. wide and 10 ft. long, made with runways to match those on the floor, rests upon the balls. The

heavy cast-iron bins are then placed on this platform, and when the material to be heated is deposited in them, the heavy load can be rolled in either

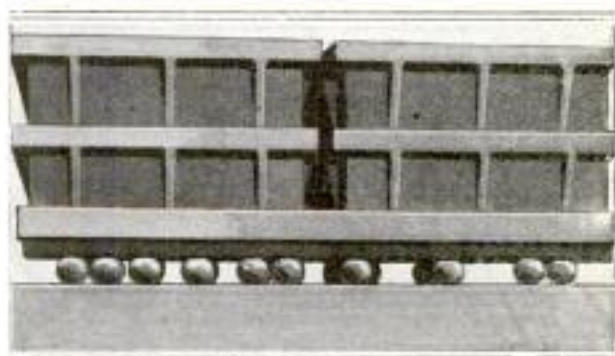

Moving Heavy Cast-Iron Bins Filled with Sheet Iron, by Means of Large Steel Balls Placed beneath Them on the Floor

direction on the ball bearings with surprisingly little effort on the part of the workmen.

H. M. Coggeshall, 24 S. E. in Ar.,  
Webster Groves, Mo.



Mr. Miller  
Mayetta Kan.

### FOURTEEN-SIDED SILOS MADE OF TWO-BY-FOURS

Two silos on a large stock farm near Mayetta, Kan., are of special interest because of their shape and the fact that

they are made entirely of 2 by 4-in. beams in the same manner that grain bins are sometimes built, that is, by laying the scantlings on their sides and spiking them together. These big fodder containers are 14-sided, 26 ft. in diameter, and 44 ft. high, and have a combined capacity of over a thousand tons. They are supported by concrete foundations and are so heavy and so substantially built that no guy wires are required to steady them. The lumber, which is dovetailed at the corners, was all cut before the work of building was begun. The structures cost \$800 each. They have been standing two years and are pronounced very satisfactory.

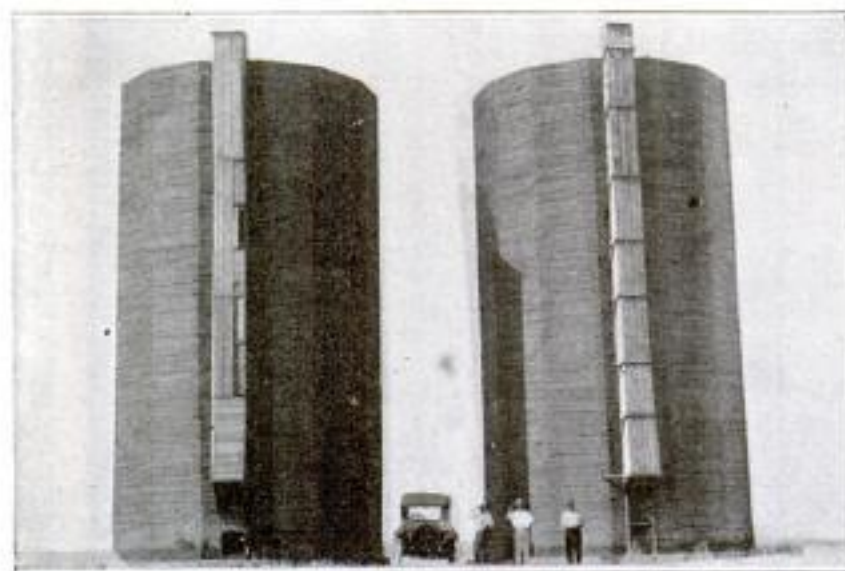

Two Big Silos on a Kansas Farm, Each Having 14 Sides, Made Entirely of Two-by-Fours Laid on Their Sides and Spiked Together. They Have a Combined Capacity of 1,020 Tons

3140

### OSCILLATING SOLARIUM FOR TAKING SUN BATHS

An oscillating solarium has been built in southern California in which patients are given sun baths. This novel structure is 16 ft. long, 12 ft. wide, and is mounted on wheels which run on a circular track. By means of a lever it can be made to swing back and forth through an arc of 270° so as to face the sun all day long. The roof and the sunward side are composed chiefly of glass and the interior is divided into two rooms in each of which is a cabinet, 6 ft. long, in which the patients recline directly in the sun's rays. Shades are provided to modify the glare, if desired. After

proper exposure the patient is given a shower bath in warm water drawn from a solar heater situated on the roof. This device consists of a glass-covered case containing four tubes, 8 in. in diameter and 4 ft. long. In these



Solarium Mounted on a Circular Track so That It can be Made to Face the Sun All Day Long. In It Patients are Given Sun Baths Followed by Shower Baths in Sun-Heated Water

water will get so warm that it will steam when drawn off.

Owned by Dr. E. H. Grove,  
144 Carr St., Los Angeles.





Tracks and Turntable Used for Wheeling Demonstration Tables into the Lecture Rooms

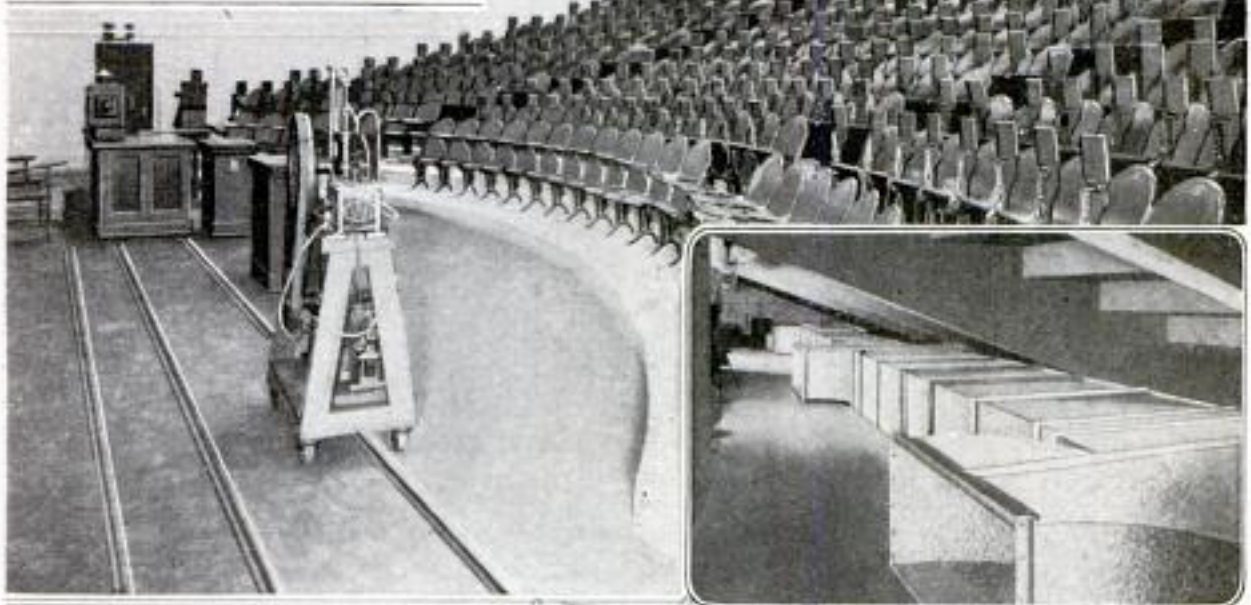

PHOTOS COPYRIGHT BOSTON PHOTO NEWS CO.

*114 State St. Boston*

New Lecture Room, Massachusetts Institute of Technology: This Hall Seats 700 Students. At the Left Are Tracks for Bringing In Apparatus. The Insert Shows the Ventilating Chamber

*3588*

**LECTURE ROOM WITH NOVEL CONVENIENCES**

A hall for lectures, demonstrations, and meetings of all kinds, recently completed at the Massachusetts Institute of Technology, is supplied with unusual conveniences for both lecturers and students. It is built and finished in concrete and has a seating capacity of 700. The seats are of the folding type, with hat holders beneath them and notebook rests which swing up out of the way when not in use. On the rear wall is a service board which controls electric current, direct and alternating, in different voltages, and illuminating gas, with other supplies, like compressed air; while a water system is at hand for chemical work. A set of rails in the floor in front of the seats is used to bring in and remove table trucks on which apparatus and materials for demonstrations in chemistry, physics, or elec-

tricity may follow, one after another, for different classes. The tracks run out into preparation rooms, where the apparatus is made ready for use, and there is a turntable outside the hall by which the trucks may be switched as desired. Ventilation of the hall is effected through a large hermetically sealed chamber beneath the rising tiers of seats, from which fresh air of the right temperature is conducted gently to the classroom through "mushrooms" placed under the seats.

*3373*

**OLD HOUSE MOVED ACROSS BRIDGE OVER RAILWAY**

The residents of Middleboro, Mass., recently had the unusual experience of seeing a large old-fashioned dwelling moved across a bridge which spans a railroad right of way in that town. The structure, which was 75 years old, was to be moved to a new site and the only available route was over this

*#Geo. H. Davis, Jr  
15 Park Street, Boston*



bridge. The house was too wide to be transferred all at one time and so it

the numerals from 1 to 20 distributed about its outer margin. In addition to

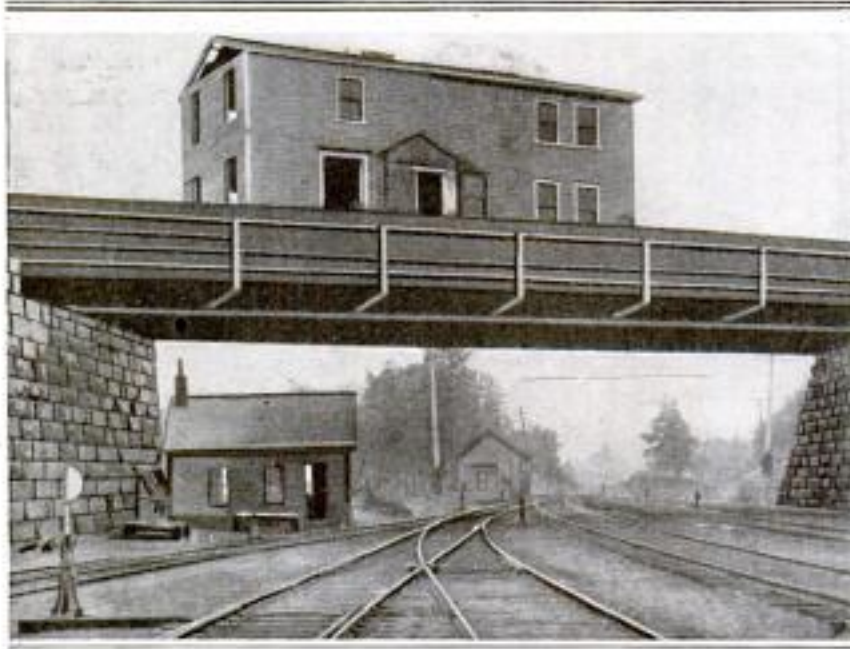

One of Three Sections of a 75-Year-Old Dwelling in Middleboro, Massachusetts, being Moved to a New Site

was cut into three sections, one of which is shown in the accompanying illustration. These sections were moved separately and reassembled at the new site.

3486

#### DANCE ANNOUNCER IS USED IN LARGE COUNTRY CLUB

For the convenience of its members and guests, the South Shore Country Club at Chicago has installed an electric annunciating system in connection with the ballroom so that the orchestra leader can flash signals to different parts of the clubhouse as new dance numbers are started. Seven indicators are distributed through the building and connected so that they are operated simultaneously with a push button. Each of these instruments is equipped with an 18-in. dial having

button is pressed. The advantage of the installation is easily appreciated.

3384

#### MOTOR BUS HAS OPEN AND CLOSED COMPARTMENTS

A motor bus has been built for year-round use in Los Angeles which has both an open and a closed compartment. The former is at the rear and has seats for eight persons. It is open at

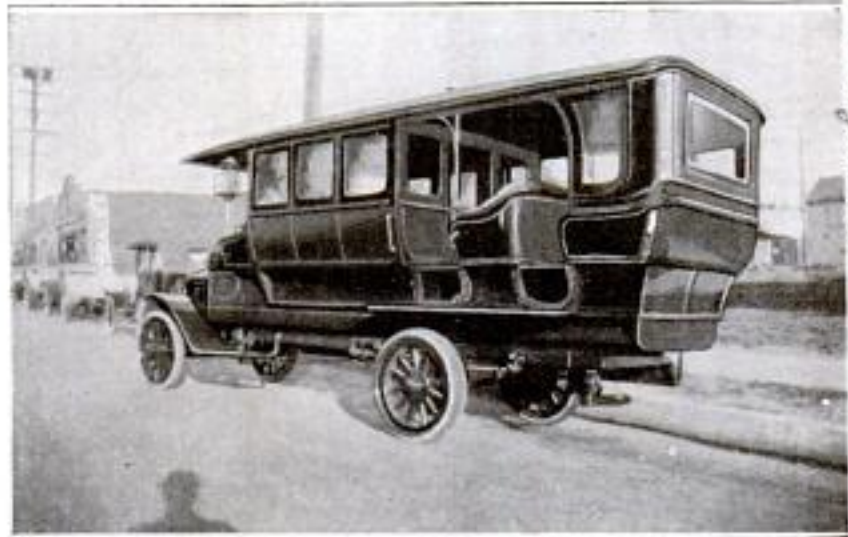

Motor Bus Built for Use in Los Angeles Having Eight Seats in the Open Compartment at the Rear and 10 Seats in the Closed Compartment

*Yaxley Mfg Co.  
Washington & Morgan  
Chicago*

*H. G. Penickell,  
1237 S. Figueroa,  
Los Angeles*



the sides only. The closed compartment is reached through double doors from the open division and has seats for 10. There are also seats for three persons beside the driver. The bus has a 25-hp. engine and is capable of 20 miles an hour. Baggage can be carried in racks on the top.

3447

**HOUSE BUILT OF QUARTZ  
— RICH IN MINERALS**

Probably the only house in existence that is built entirely of rich mineral-bearing quartz is situated at a spot known locally as Lovers' Roost, in the neighborhood of Butte, Mont. The rocks used in the structure are all honeycombed on the surface, showing where minerals have been washed out in the course of time, and experts



This House, Modeled after a Swiss Chalet, Contains a Large Quantity of the Precious Metals in the Quartz Rock of Its Walls and Foundation

estimate that there are still present in the rocks gold, silver, copper, zinc, and other metals to a value far more than double that of a similar house of ordinary building material.

1838 Equip

**ANTICOLLISION BUFFERS AND  
FENDERS FOR TRAINS**

Special buffers and fenders are being used on certain trains on an English railway to reduce the shock of violent collisions and at the same time prevent one car from mounting up over another. Two buffers are placed at each end of a car, having broad, flat iron heads, behind which are heavy coil springs. Each buffer is provided with a supplementary coil spring which is not brought into play until the principal coil has been fully compressed. If the strength of the impact exceeds

the combined resistance of the two springs the bolts holding them in place will give way. It is in such an emer-

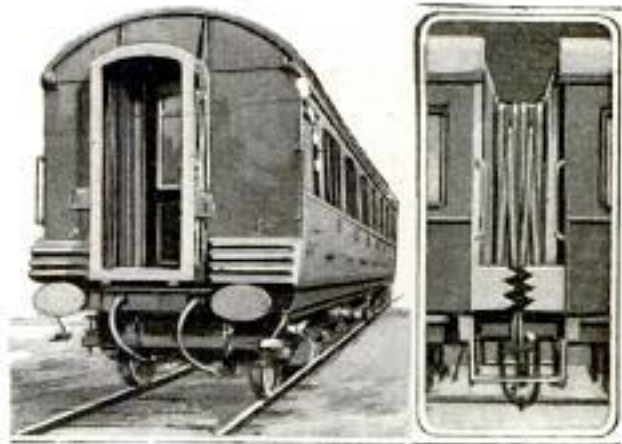

End and Side Views of Corrugated Fenders on English Train, Designed to Keep the Coaches in Alinement in Case of Collision, Thus Preventing Telescoping

gency that the fenders come into play. Each fender consists of a heavy metal guard, the face of which is marked by deep corrugations extending horizontally. One of these is placed above each buffer. When one coach crashes into another these corrugated fenders interlock and tend to keep the cars in alinement.

3775

**EIGHT-FOOT LIGHTED BALL  
ON TOLEDO SKYSCRAPER**

A huge metal globe, studded with 800 nitrogen lamps, has been erected above a 21-story building in Toledo,



and now serves as one of the most conspicuous landmarks in that city night and day. The sphere, 8 ft. in diameter, is mounted on an iron pole, steadied by several wire cables to help it withstand the fiercest gales. Current for the 50-watt lamps which cover it is controlled by a flasher that gives the ball the appearance of revolving on its axis. On a dark, clear night the sphere should be seen some 20 miles away.

Mr. J. Robinson  
Great Central Ry.,  
Gorton, Eng.

Geo. Beinke  
2nd Nat. Bldg. Pedg.  
Toledo, Copyrighted material

971 Tibbe Ar.,  
Indianapolis, Ind.



# Mrs. F. C. Coley  
5522 Dorchester Ave.  
Chicago

548 3709 POPULAR MECHANICS

**TEETH FILED BY FILIPINOS  
FOR BEAUTY'S SAKE**

Among the curious customs of the Philippine Islands one of the most peculiar is that of "beautifying" the

teeth by filing and blackening them, which prevails among the Bagobos of Mindanao. Both boys and girls of this tribe undergo the filing process before marriage, and this usually occurs while they are still very young.

The youth who is to be thus decorated sits on the ground beside the native dentist, gripping between his teeth a stick of wood to keep his mouth open. The dentist then files each tooth down to a stump or else he cuts or breaks each to a

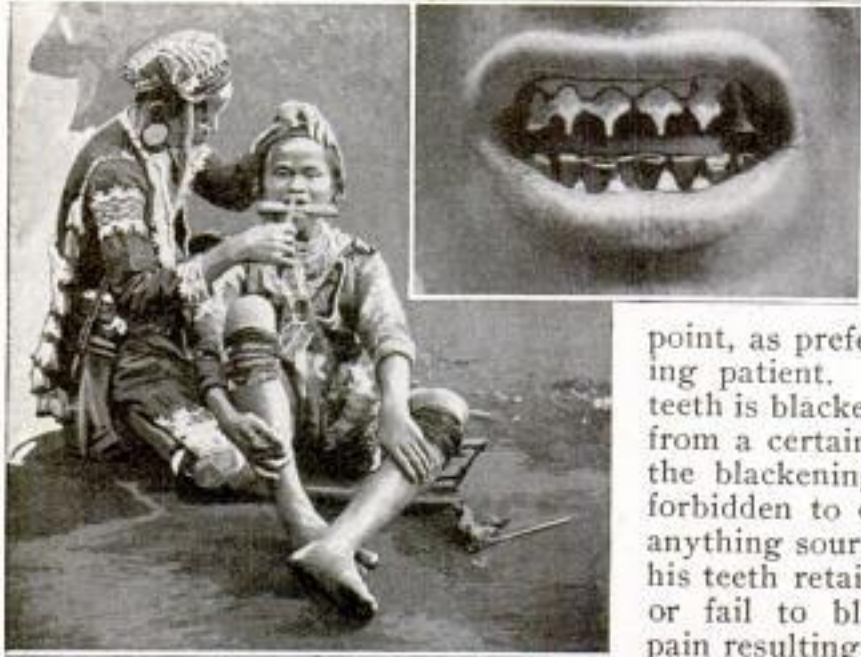

A Young Filipino having His Teeth Filed by a Bagobo Dentist, to Secure the "Beautiful" Effect Seen in the Photograph at the Right. The Patient's Mouth is Held Open by a Stick of Wood

point, as preferred by the beauty-seeking patient. All that is left of the teeth is blackened by a powder secured from a certain native tree, and during the blackening process the patient is forbidden to drink water, cook or eat anything sour, or attend a funeral, lest his teeth retain their "ugly" whiteness or fail to blacken beautifully. The pain resulting from such mutilations is partly relieved by the juice of the betel nut, of which the Bagobos are inveterate chewers.

3637

**GOLF-BALL MARKER PRINTS  
OWNER'S FULL NAME**

Many players have their golf balls plainly marked with their full name by a little machine which permanently

prints the name in waterproof ink without injury to the ball. This effectually prevents disputes as to ownership of balls during a game or when the links are crowded. In using the machine, an inked die bearing the full name of an individual is placed

*Fulname loc.*  
*4th Vine*  
*Cinti, O.*



in a slot provided for it, and the ball is locked between cup-shaped holders

by means of a lever at the side. The die is then adjusted on the ball by a handwheel, and a forward movement of the arm holding the die prints the name.

3914

**SCRAP LEATHER USED IN ENGLAND TO MAKE SOLES**

War prices for leather undoubtedly have been a factor in producing, in England, a patented method by which soles can be made from scrap leather. The new bottoms for shoes are described as nonslipping, waterproof, and costing less than the ordinary kind. One type of these soles is provided with rubber strips attached to a thin layer of canvas, and so arranged that the rubber fits in between the leather sections. This feature is said to lend pleasing resiliency to the sole. It is believed that the new process can be employed in heel building also.

*Commerce Rep. Oct 1/22/11*

# Garvey Anderson Co.  
(?) Cinti, O.





The First Mounted-Police Patrol That Went after the Murderers of Radford and Street were Caught in Open Boats While Crossing a Great Northern Lake and were Frozen In by a Sudden Drop of Temperature Peculiar to Northern Canada. They were Forced to Transship Everything Overland, and Even Cut Out the Boats. Here are Seen 13 of a Dog Team Drawing Boats and Contents of 6,000 Pounds

## THE WORLD'S LONGEST MAN HUNT

3664 miles, By FRANCIS J. DICKIE, *Parsonville-Apts., London, Ont.*

ON June 8, 1912, Harry V. Radford, noted arctic explorer of New York City, and his companion, Charles Street, were speared to death by a little band of Kilinomuit Eskimos in the lonely and desolate arctic region of northern Canada near to the shores of Bathurst Inlet, 60 miles from Point Barrow.

One year later a Chesterfield Inlet Eskimo, named Akulack, brought the story of the white men's murder to the Hudson's Bay Company's post at Chesterfield Inlet. Immediately upon receiving the news from the Eskimo, the factor, H. H. Hall, dispatched a messenger with all haste to the nearest mounted-police post at Nelson River. The story of the incident through which Radford and Street lost their lives is best summed up in his letter as supplied by the official mounted-police report of June 6, 1913. It is as follows:

"The Eskimo Akulack, who took the Radford party from Shultz Lake to Bathurst Inlet, reported to me on June 5th that both Mr. Radford and Mr. Street were murdered by Bathurst Inlet Eskimos. Cow-

muck, Mr. Ford's Indian trader at Shultz Lake, brought down the news shortly before this, but as I seldom take any stock in Indian yarns, I placed very little confidence in it until I heard the story from Akulack. Both Mr. Ford and myself questioned him twice today, and his version of the story was practically the same as the one given us earlier by Cowmuck. According to Akulack, he left Messrs. Radford and Street about June 5th last year near the shores of Bathurst Inlet, in company with a small tribe of Kilinomuit Eskimos. Everything seemed to be going fine then, and Radford was about to leave to connect with a whaling ship at Point Barrow.

Three days later Radford was about to make a start; in fact the Eskimo, supposed to go ahead, had started when the second Eskimo engaged for the trip backed out. Radford, to force obedience, struck him with the butt of his whip. A fight ensued and Radford was speared in the back. Mr. Street made a run for the sleigh, but by this time the rest of the members of the tribe, some thirty in number, had taken a hand, and he was also quickly speared to death. According to the story, as told to Akulack later by one of the natives, Nevelie, and by Akulack's father-in-law, Radford put up a game fight and had to be speared several times before he fell; and as life still lingered as he lay on the ground, he got the finishing touch from one of the women, who cut his throat with a seal knife. Akulack states the reason the Eskimo backed out from the trip was that his wife had suddenly taken sick, and he did not wish to leave her just then. Radford, not understanding the Eskimo language, must have taken a wrong meaning and then tried to enforce obedience as above mentioned. Akulack named the principal murderers as Am-me-ker-nic and Hull-lalark. There is one thing I can say, and that is Radford showed poor judgment when he tried to enforce obedience by striking an Eskimo when he was so outnumbered and far from civilization."

As quickly as boat and train could carry this report from the Nelson River



The Eskimo Talaruck and His Wife, Who Accompanied the Police Patrol. The Endurance and Fortitude of the Eskimo Women Equals That of the Men



post to headquarters at Regina, Saskatchewan, it came. And immediately upon its receipt, began preparations for sending a patrol of mounted police to capture and punish the murderers. That they might be anywhere in a vast loneliness, thousands of square miles in extent and icebound two-thirds of the year; that the trail was already more than 12 months old, and that not even a good description of the murderers was in their possession—all these things did not stop the mounted police. It is questionable if that phase of the situation was ever even thought of by them.

In the late summer of 1913 Inspector Beyts, Sergeant-Major Cochan, Corporal Conway, and two constables left the headquarters at Regina, to take up a man hunt that was to begin 3,000 miles away in one of the most hostile regions of the world. From Regina they traveled to Halifax, whence the steamer "Village Belle" was to carry them northeast into Hudson Bay.

The expedition was equipped with supplies for two years, and for 18 months the schooner was used as a base. From Halifax the "Village Belle" made a successful voyage until Cape Chitfield was reached. Here a gale was met with that buffeted the

boat for many days, carrying away her topmast. But the vessel rode out the storm and at last reached safety in Burwell Harbor on the extreme end of Labrador. From there on to Spearl Harbor, the stout little ship was many times in danger from ice floes and icebergs, barely escaping shipwreck on half a dozen occasions. The landing at Spearl Harbor was made late in September, 1914, too late to proceed farther inland. Here the expedition wintered and met Akulack, whose story has been already told.

As soon as conditions permitted, the party moved on to Chesterfield Inlet, which body of water extends far inland and, by means of several small rivers, permits easy access to an otherwise difficult and desolate interior by way of Baker and Shultz lakes, the territory in which the murderers of Radford and Street were somewhere wandering in that wilderness waste.

From Chesterfield the party pushed inland, in the spring of 1915, to Shultz Lake. Then the wilderness swallowed them up and the world heard no more of them until late in November, when word came out that they hoped soon to overtake the band after traveling over a thousand miles on the strength of the barest of clues furnished by friendly



The Mounted Police Patrol under Inspector Beyts Interviewing Friendly Natives near Shultz Lake as to the Whereabouts of Radford's Murderers in November, 1915





The Canadian Mounted Police: A Unique Photo Showing by the Variety of Costumes How Wide and Varied Is the Country and Weather This Remarkable Body of Men Cover. These Costumes Show Every Form of Uniform Worn from the American Boundary to the Country around the "End of the World," Far within the Arctic Region

Eskimos. Later again came another brief report to Regina, dated Thelon, February, 1916. At the eastern end of Baker Lake they had established a base post of this name. The immensity of the difficulties in this land can be glimpsed even in so brief and formal a thing as a mounted-police report.

According to this report a gasoline boat had been brought overland and by water to the lower end of Baker Lake. The work took up a great deal of time and it was not until late in the fall they were able to start across the lake in the launch, with three flatboats loaded to the gunwales being towed behind. The ice had already formed around the lake edges, but the outer water was still only thinly filmed, and through this the launch easily broke its way. But half-way across the lake the thermometer had dropped in the amazing manner of the country, and the film ice thickened so the launch could no longer proceed. The four boats were frozen in. Then

followed weeks of desperate labor, totting the provisions by dog train, and later the chopping clear and moving of the boats to Thelon.

However, though a diligent search covering all the spring and early summer of 1916 was carried on, success failed to attend their efforts. The murderers were still at large somewhere in that vast land. Certainly no chaser of the will-o'-the-wisp ever had any more difficult job than this sturdy band of mounted policemen.

Late in the summer, their time being up, they began the return trip to civilization; while, even as they moved back toward the land of soft beds and city things, another patrol of equal size under Inspector French was on its way to take their place and continue the search for these primitive lawbreakers. Although the hunt is moving on toward its fourth year, the mounted police still expect to make good their reputation for always "getting their man."



Kolb Specialty Co.  
4909 N. 11th., Phila.

552 3765 POPULAR MECHANICS

**FOLDING WASHABLE CRIB  
AND NURSERY TABLE**

A folding crib, having a body made of washable woven fabric and an enam-

31350



Two Views of a Portable Dressing Table for the Nursery: The Top is Made of Washable Leatherette

eled steel frame mounted on four rubber-tired wheels, is one of the new and attractive pieces of furniture for the nursery. When not in use it can be folded up much like a collapsible go-cart—a feature which renders it most convenient for traveling. An article

718

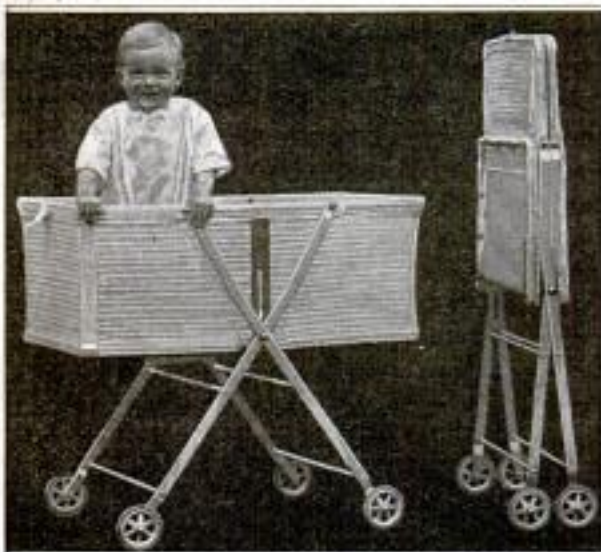

Portable Crib Folded and Open: The Woven Fabric of Which the Body is Made can be Removed for Washing

with a similar frame and wheels is a folding dressing table for a baby. In place of the crib body is a top measuring 19 by 32 in., made of washable leatherette.

3916

**FLOOD-LIGHTING SYSTEM**

**AIDS AIRMEN AT NIGHT**

*Army & Navy Journal* 1/20/17

The practice field, for use by the aviation section of the Signal Corps at Hempstead, N. Y., has been provided with 12 powerful flood-light projectors, which mark the area for those members of the section that are taking a course in night flying. The most conspicuous piece of equipment for this lighting system is a searchlight of 1,500,000 cp. which has an effective range of 8,000 yd. This powerful light is employed in "picking up" airmen as they fly over the field looking for a landing place. It also serves as a "lighthouse" for the "mariners of the sky." The great beacon was used for the first time last January.

3915

**TO BUILD MOTOR TOLL  
ROAD IN KANSAS**

An old post-road act, which has not been taken advantage of for more than a generation, furnished the legal basis for the incorporation recently of a Kansas concern which proposes to build a motor toll road between Fort Scott and Pittsburg, Kan., a distance of some 30 miles. This company intends to maintain a freight and passenger service between the two points and will derive additional revenue by collecting tolls from motorists using the highway. The concern has the same right of eminent domain that a railway has.

*Auto Traffic Co.,  
Fort Scott, Kan.*

3762

**AUTO-CAMPING BED OUTFIT  
FOR A FAMILY**

A complete camping outfit for family use, recently patented, can be carried on the running board of an automobile, without interfering with entrance to or exit from the car, as plenty of clearance is left for opening and closing the



*Mfr: Water Gas Carburetor Co  
Kansas City, Mo.*

*also J. H. Wetmann 1914  
150 + Grand Ar.  
K. C., Mo.*



The Camping Outfit is Inclosed in a Duffle Bag, Strapped to the Running Board of an Automobile

How the Full-Size Beds Look When Extended for the Night: They Are Light but Strong and do Not Sag Even under the Weight of This Load of Children and Grown-Ups

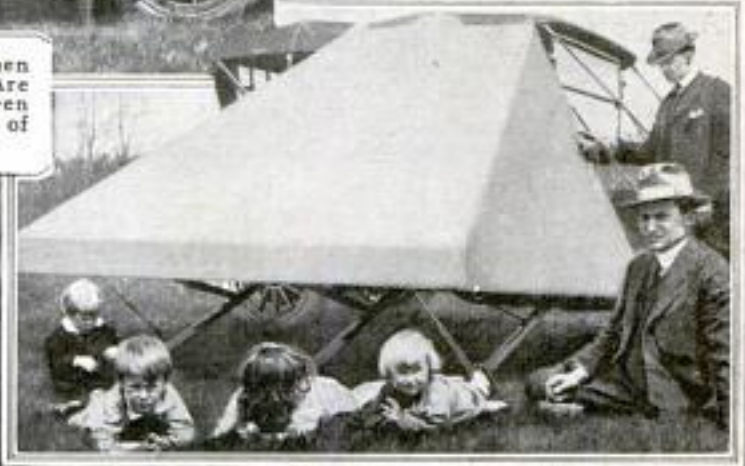

Beds and Two-Room Tent Erected, Showing the Method of Supporting the Tent from the Automobile Top

doors. This outfit includes two full-size beds, each 4 ft. 6 in. wide by 6 ft. 7 in. long, built side by side, and also a two-room tent with side-wall pockets; the whole being packed compactly in a water and dust-proof khaki duffel bag, 54 in. long and only 6 in. high. The bag is made of sufficient size to permit the adding of a sufficient quantity of blankets and other bedding to meet all usual requirements. When camping for the night, the tent and beds are erected at one side of the car, the tent being supported by the car top and the beds forming a floor for the two sleeping "rooms."

CA company has installed four flying boats at Palm Beach, Fla., to be used for fishing trips.

**TRAIN AND LOAD IMMERSSED IN TIE-TREATING FLUID**

A strange-looking train, composed of a narrow-gauge oil-burning engine and a number of very low flat cars of corresponding width, constitutes an interesting part of the equipment of a tie-treating plant recently opened at Riverton, Wyo., by the Chicago and Northwestern Railway. A string of these cars, loaded with about 500 ties, is backed into a strongly built steel cyl-

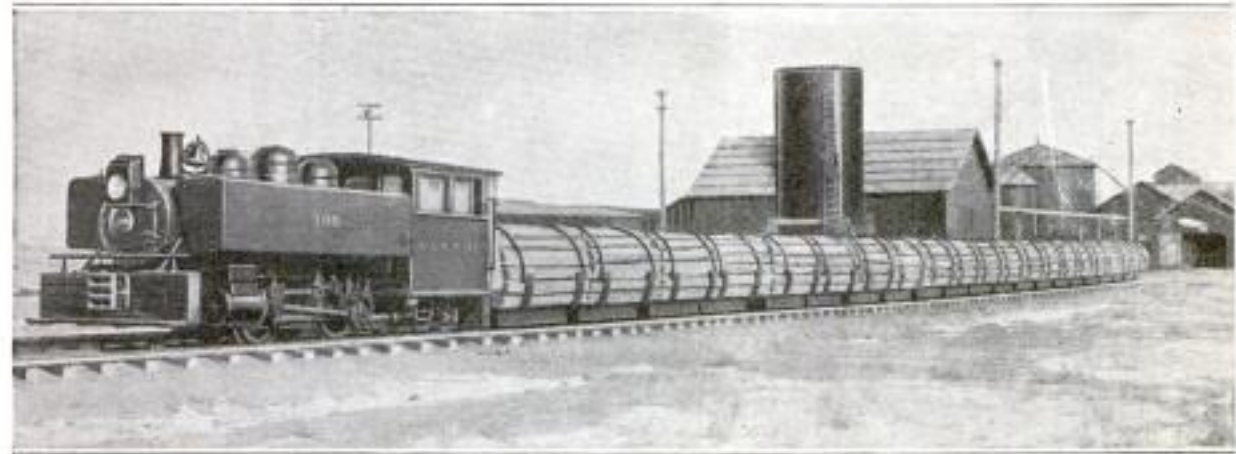

COURTESY OF ENGINEERING NEWS  
The Cars of This Novel Train are Loaded with Ties and are Designed Especially to be Backed into a Long Cylinder, in Which They and Their Load are Immersed in a Solution That Prolongs the Life of the Timbers

*L. J. Putnam Train, Asst. Engineer,  
C & N. W. Ry., Chicago.*



inder, 132 ft. long. The engine is then detached, the big circular door at the end of the retort is tightly closed, and a zinc-chloride solution is forced into the chamber by a vacuum process.

When the ties are completely immersed in the preserving liquid it is put under pressure to force it into the wood fiber. After six hours they are thoroughly saturated and are removed.

3453

**PIPE ORGAN IN HIGH-SCHOOL AUDITORIUM**

A pipe organ having 1,100 pipes is one of the features in the high-school

stage and the console is situated on the main floor in front of the platform. This is one of the few public schools in the country provided with a pipe organ. Both in connection with school theatricals and with the general assembly of the pupils the organ proves a valuable addition.

3653

**STORE ENTRANCE REPLACED BY SHOW WINDOW AT NIGHT**

One of the large window displays of a department store in Chicago, which is brilliantly lighted at night, disappears every morning as the hour approaches for opening the store, and a vestibuled entrance appears in its place. The show window is in reality an elevator cage, which is lowered each morning to the subbasement and raised again to the street level as soon as the store closes in the evening. As it rises it carries up with it the floor of the vestibule used by customers entering the store during the day. An adaptation of the same idea has been used in the East for some time.

*Boston Store, Chicago.*

*See June 1915*



Stage of Los Angeles High-School Auditorium with a Glimpse of the Organ Pipes above the Stage and the Console in Front of It

auditorium in Van Nuys, a suburb of Los Angeles. The manufacture of pipe organs is an important industry in this community, and it was natural that the local board of education should take pride in equipping the school with a fine instrument. The visible pipes are arranged above the



At the Right, a Chicago Window Display as It Appears at Night When the Store is Closed. At the Left, the Vestibuled Entrance in the Space Occupied during the Night by the Disappearing Show Window. Note the Floor, Which Rises with the Ascending Window Display in the Evening

*State St. - 2d entrance No. of Madison*



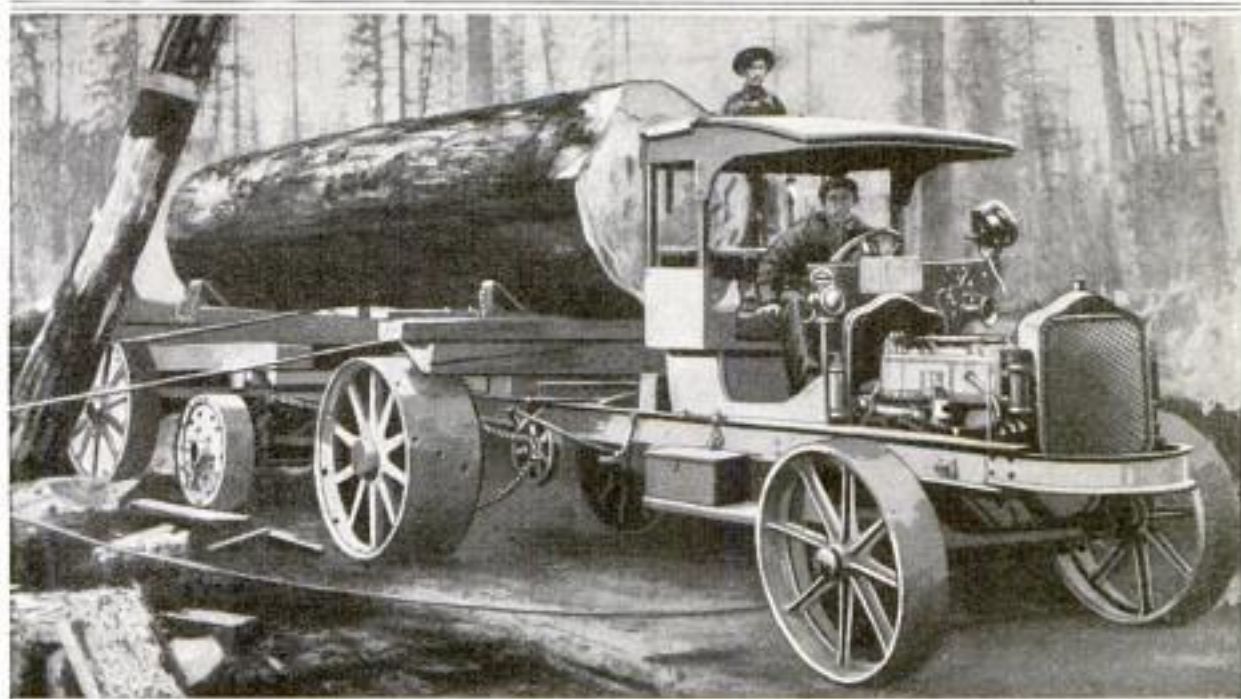

Wide-Tired Truck, with Trailer, Which Makes a Smooth, Hard Track as It Goes. The Outfit is Equipped with a Winch Which is Used in Loading the Logs and in Emergencies en Route

3294

**WIDE-TIRED TRUCKS MAKE OWN LOGGING ROADS**

Powerful wide-tired trucks are now being used in logging regions in Oregon and Washington, which virtually make their own roads as they go. One type of these cars has front tires 10 in. wide, and back tires, 20 in. wide. An experienced driver carefully selects his course as he goes over a route for the first time and the weight of his machine makes a road as it moves along. A few trips over the same line of travel serve to make a hard, smooth surface which will withstand considerable bad weather. Four-wheeled trailers are often used with these trucks, as shown in the accompanying illustration. Two-wheeled trailers are also used. Many of the machines are equipped with a winch and cable by which the logs are drawn up to the loading place and thence onto the truck. This outfit is also employed occasionally to pull the truck out of a mire. The big cars travel from six to eight miles an hour and draw as heavy a load as six or eight horses. The saving of time is an item of prime importance, especially where the hauls are long as is often the case in the western forests.

**CONDITION OF STEAM TRAP 2601 INDICATED BY GAUGE**

To help a stationary engineer determine quickly and certainly whether a steam trap is operating properly, a simple thermo gauge has been devised. Such a trap, it will be understood, is an appliance that permits the passage of water of condensation out of pipes, engine cylinders, radiators, and the like, without allowing steam to escape. The gauge is tubular in form, made of brass, supplied with a series of flanges, and fitted at the top with a "try" cock. When the trap to which it is applied is working as it should, the radiator disks about the gauge are fairly cool. In case the former is leaking, however, steam coming in contact with the gauge causes the flanges to become extremely hot. Thus by placing a finger on one of the radiators an engineer learns whether a trap valve is tight or leaking.



*Plant Engineering and Equipment Co.  
6 Church St., N.Y.C.*



2173



Just a Place to Pause for a Moment When the Sun Is Hot, or the Moon Shimmering: A Rustic Seat Built of Gnarled Branches and Bamboo Sticks around a Big, Friendly Palm



Here is a Bench That is Easily Constructed When Timber Is Available, but Also One That Usually Seems Out of Place Unless There Are Trees and Bushes Near at Hand. It Really Requires a Woodland Background



When in Its Proper Element amid Complementary Surroundings, the Classic Exedra Is Impressive. Interestingly, Too, It does Not Lose Its Conventionality When Modernized to the Extent of the One Pictured Above, Which Embellishes a Sun-Spotted Garden in California



When a Long, Solid Bench is Placed in an Alcove of a Garden Wall, an Atmosphere of Cloistered Privacy is Created; and if Palms, Vines, and a Rough Brick, or Flagstone, Walk Also Enter into the Setting, a Tinge of Romance Is Added. The Final Touch Developing the Laster Element in the Picture Above is Contributed by the Peephole That Gives a Glimpse Beyond





Not in Many Gardens does One Find a Place of Rest That Is so Pastoral in Its Suggestion as the One Sketched Above. It is Built of Rough Stones about an Inclined Tree and is Adorned with Ferns



Climbing Roses Cling to the Heavy Boulders and Entwine the Trelliswork of This Pergola, beneath Which, Back to Back, Are Two Benches. This Type of Outdoor Architecture Is Particularly Popular on the Pacific Coast

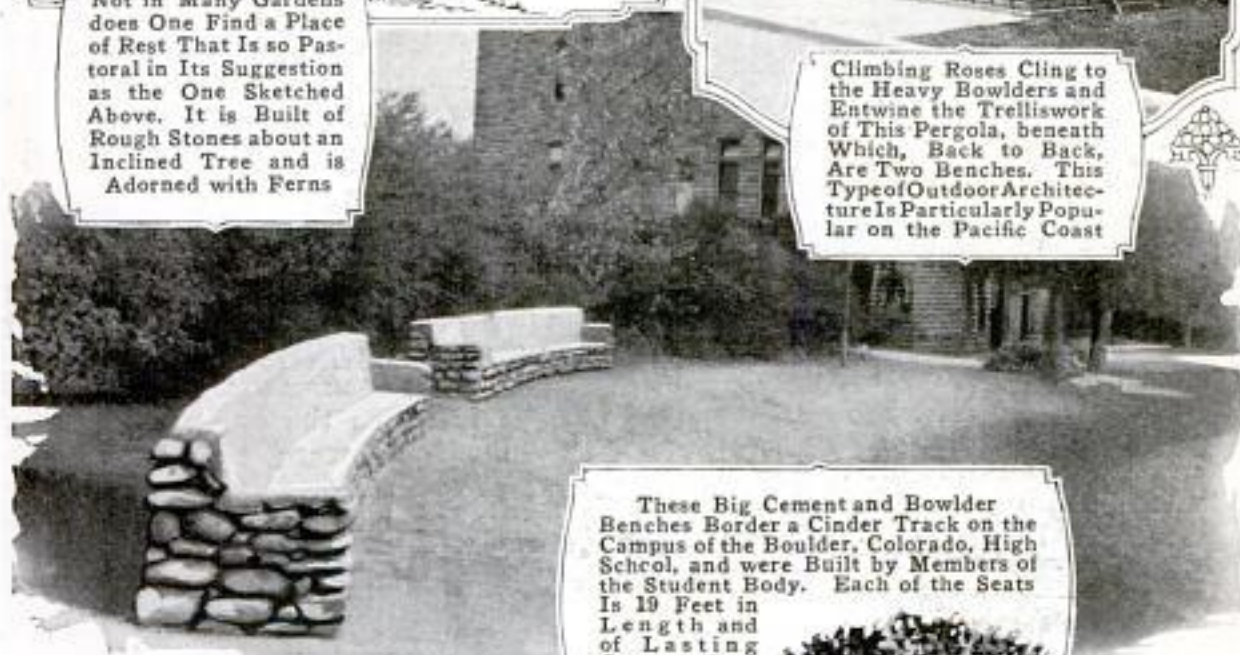

These Big Cement and Boulder Benches Border a Cinder Track on the Campus of the Boulder, Colorado, High School, and were Built by Members of the Student Body. Each of the Seats Is 19 Feet in Length and of Lasting Construction

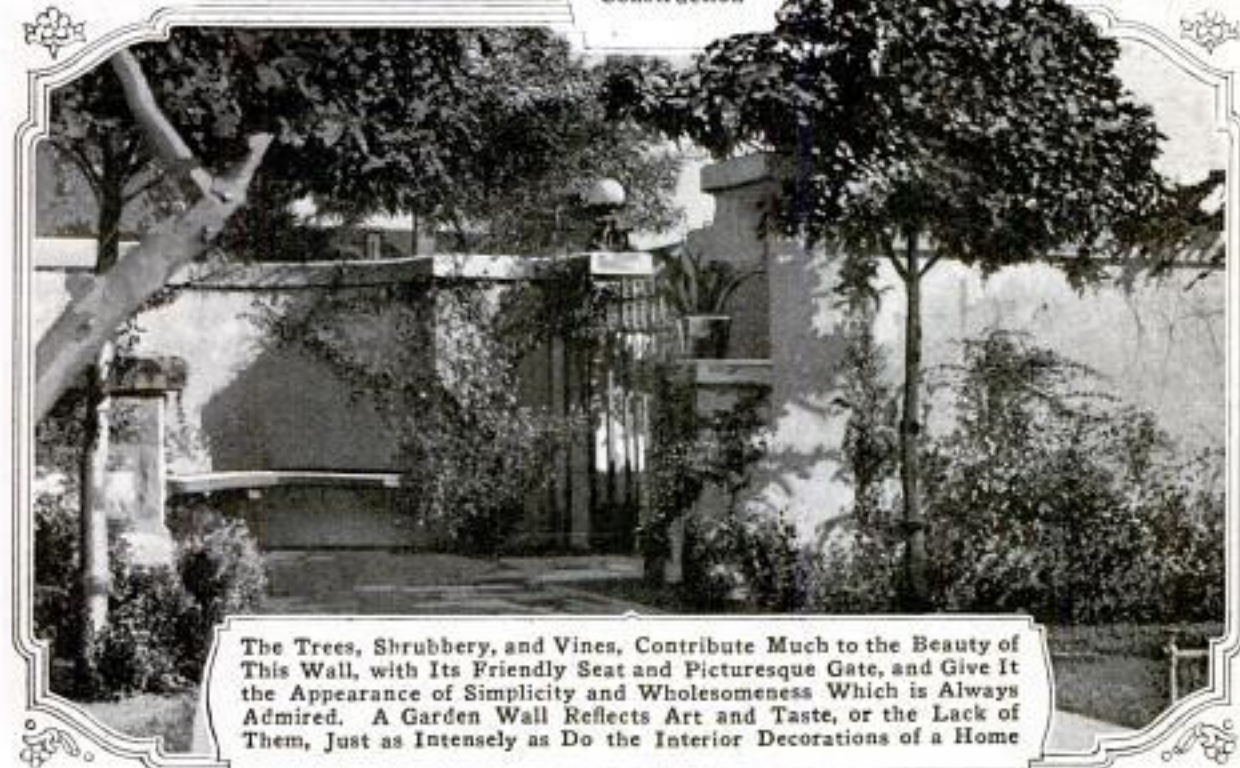

The Trees, Shrubbery, and Vines, Contribute Much to the Beauty of This Wall, with Its Friendly Seat and Picturesque Gate, and Give It the Appearance of Simplicity and Wholesomeness Which is Always Admired. A Garden Wall Reflects Art and Taste, or the Lack of Them, Just as Intensely as Do the Interior Decorations of a Home



3479  
**TINY CAR IS DOG'S SEAT ON  
 AUTO RUNNING BOARD**

A most unusual and elaborate seat for carrying a dog on the running

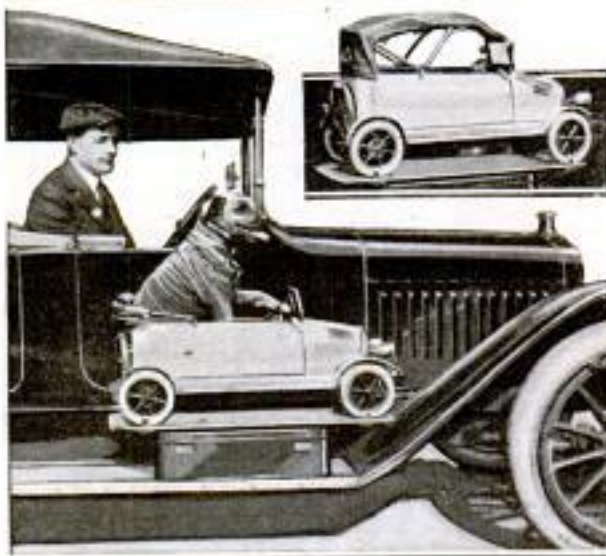

An Unusual Seat for a Motorist's Dog, Being a Miniature Reproduction of the Larger Car on Which It is Mounted

board of an automobile has been constructed with much ingenuity by a motorist in Los Angeles. It consists of



Aerial Tramway That Transports Gravel across the North River in Wyoming, Thereby Saving a Two-Mile Haul with Wagons. The Bucket, Shown Above Discharging Its Contents into the Hopper, Makes the Round Trip in About Two and One-Half Minutes

A. Leschen & Sons Rope Co.,  
 St. Louis, Mo.

a miniature car reproducing, in almost every detail, the large motor car on the running board of which it is fastened. It is equipped with an engine having a fan, starter, spark plugs, cylinders, etc. Many of these parts were constructed from old clockworks. The engine is driven by power from dry cells located in the big car, and through the isinglass window in the tiny hood one can watch the engine running. Other parts which have been provided are a differential gear, a movable steering wheel, a spot light, clock, tail light, and windshield.

3613  
**AERIAL CABLE SAVES LONG  
 HAUL FROM GRAVEL BED**

An example of a profitable aerial tramway is to be found in the equipment installed by a contracting company in Casper, Wyo. to transport gravel from the north bank of the North River to the opposite side. If the material were transported by wagon instead of by cable it would have to be hauled along the farther shore for at least a mile before reaching a crossing. The bucket used with this outfit makes a round trip in about two and one-half minutes. The container has a capacity of 1 cu. yd. and travels on a 1 1/8-in. wire cable. The crew which operates it consists of an engineer and a fireman.

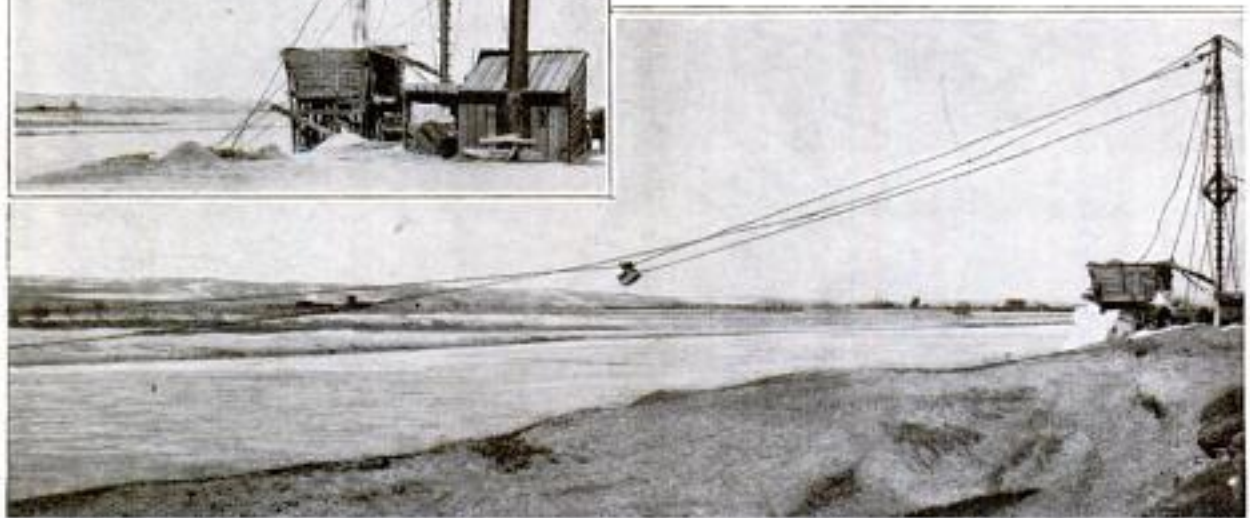





When the Stars and Stripes Float below the Dutch Flag at the Commercial Club, Yankee Travelers Know That a Boat from Home has Docked at the Wharves

2629  
**PARAMARIBO'S HOSPITALITY  
 EXTENDED AT CLUB**

Practically every one of any standing who arrives at Paramaribo, the capital of Dutch Guiana, is received at the Commercial Club and shown genuine hospitality. The institution is what its name implies, and more; it is the port's smartest resort. A large ball-room permits rather fashionable dances to be held twice weekly, while in other rooms globe trotters and international commercial representatives may meet, escape the heat of the afternoon sun, read the latest telegrams as they are posted, scan the New York market quotations, and practice with the cue. Architecturally the building, with its shuttered openings on all sides, is characteristic of the tropics, while its setting back of a well-trimmed hedge in the midst of a grove of palms is most inviting. It is constructed entirely of colonial hard woods.

CA naval officer, whose position enables him to know, has predicted that improvements now being made in radio direction finders will soon permit operators accurately to locate the position of a vessel sending a wireless message.

3718  
**REVOLVING CONE AIDS IN  
 SORTING PACKAGES**

Great facility in sorting addressed packages is obtained by means of revolving cones, two of which have been installed by an express company, one in New York and one in San Francisco. Bundles collected by the express drivers are delivered by a belt conveyor to the apex of this revolving distributor. As they fall upon its smooth sloping surface they quickly slip to its outer edge, whence each is transferred by one of a group of distributing clerks to the proper waybill and weighing employe, occupying one of the desks that encircle the device.



Revolving Cone Which Enables Express Clerks Rapidly to Distribute the Addressed Packages Dropped upon It, to the Proper Waybill Employes Seated at the Encircling Line of Desks

Wells, Fargo & Co.



**FISH BOWL ACTS AS LENS  
AND SETS BED AFIRE**

The fact that a goldfish bowl in a St. Louis home recently acted as a sunglass and started a fire has given



A Goldfish Bowl so Placed in the Window of a St. Louis Home That It Acted as a Sunglass and Set the Bed Afire

rise to considerable discussion in that city concerning the advisability of restricting the use of spherical aquariums. The transparent vessel was filled with water and stood in front of a window in the direct rays of the sun, which

were concentrated to a single point by the bowl. As the sun moved along its course this focal point fell upon the pillow of a bed, which stood near by, and set it afire. Fortunately the blaze was discovered before serious damage was done. The accident is not an unusual one.

3752  
**FARMERS TILL RAILROAD'S  
RIGHT OF WAY**

A very practical conservation movement has been undertaken by the Chicago, Burlington and Quincy Railroad by inducing farmers along its right of way to cultivate the railroad's land adjoining their farms. Over 600 country dwellers took advantage of this plan last year, paying the nominal fee of \$5, which entitles them to utilize the land adjoining theirs for an indefinite period. This soil, which is usually very rich because so long untilled, is planted to alfalfa and the yield has been as high as eight tons to the acre. The average amount of land which each man cultivates is three acres. The arrangement lessens the weed menace for the near-by fields and, since alfalfa remains green a long time, it lessens the danger of prairie fires. At the same time the road is saved the cost of mowing the right of way.



Utilizing the Railroad's Land: A View of a Newly Mown Alfalfa Crop Which Illustrates What Several Hundred Farmers, Whose Land Adjoins the Burlington Railroad's Right of Way, have Done under That Road's Direction

J. B. Lamson, Agriculturist, C. B. & Q. R. Co.  
Chicago



## BEAR THAT KILLED A MAN BLOWN TO PIECES

A bear that had severely mauled a government teamster in Yellowstone

National Park was blown to pieces by dynamite recently, while the teamster died from his injuries in the Military Hospital at Mammoth Hot Springs. The man was asleep under a supply wagon in the park when he was attacked by the bear. Two companions drove the animal away, after serious injuries had been inflicted on their mate, and when the latter had been removed to the hospital they prepared a warm reception for the bear, knowing it would return. Dynamite, connected with a small electric

battery, was placed under a bait of

army bacon a short distance from camp. When the bear came back under cover of darkness and nosed the bait, the mine was sprung and the dynamite did its work most effectively. Bruin



When a Bear Fatally Mauled a Teamster in Yellowstone Park, His Companions Set a Trap with Dynamite and Blew the Bear to Pieces

disappeared in sections, and the unlucky teamster was avenged.

3598

## AUTOMATIC BOOKKEEPING BY CASH REGISTER

A business appliance lately placed on the market in Kansas City, Mo., combines the functions of a credit register, an adding machine, and a cash register. It was designed for the use of retail merchants, but can be adapted to any business in which credit is extended. The keyboard comprises means for recording credit sales, cash sales, receipts and payments of money, invoices, and additional details of the day's business. Above the keyboard is a credit division, containing numerous trays with records of customers' accounts. These trays, as well as the cash drawer, are

locked, making it necessary for a clerk to identify himself by depressing his allotted initial, or number, key, before he can gain access to either. A permanent printed record of each transaction is made by the machine, as the

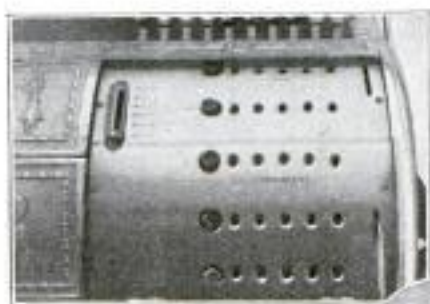

This Bookkeeping Register Keeps Credit Accounts Straight and Also Does Duty as a Cash Register and Adding Machine. Trays above Keyboard Contain Records of Accounts

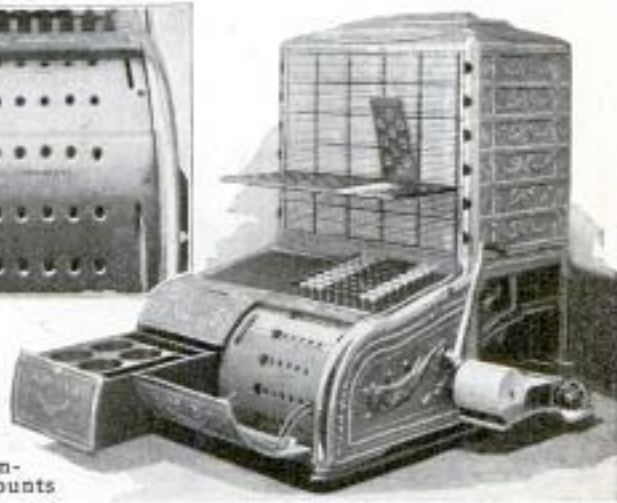

appropriate keys are depressed. In case of a credit sale, the original sales

*Automatic Bookkeeping Register Co.  
18th & Wyandotte Sts., Kansas City,  
Mo.*



ticket, including the amount of previous purchases brought forward, is filed in the credit tray containing the customer's account. Each of the removable sections holds 25 credit accounts. At the close of the day the machine records the totals for all the various kinds of transactions.

3162

### SPEED HOUSE BOAT IS BUILT ON HYDROPLANE LINES

Radical departure from conventional designing is found in a new 50-ft. speed house boat that was launched in the East before the close of the past season. The craft throughout is of very light construction and interesting arrangement, and has splendid accommodations. One of the surprising things about it is that it is built upon the expanded lines of a hydroplane. With a 12-ft. beam it carries enough freeboard to give a 6-ft. 3-in. clearance, and has a

regular ship's deck, which is roomy and comfortable. In all, the vessel has 45 separate windows which provide abundant light and ventilation below deck. A four-cylinder, 80-hp. engine drives a single propeller, and under way the vessel has a draft of only 27 in. The accommodations comprise a galley, cabin, three single staterooms, a toilet, and a large double stateroom at the stern. The galley is equipped with a four-burner alcohol range and a table 6 ft. 3 in. long, with shelves fitted beneath. In case of necessity this can be converted into a bunk. A large sink and refrigerator, the latter built so that it can be readily moved, are provided on the port side. Provisions and ice can be lowered through a hatch that also enables members of the crew to reach the galley without passing through the cabin. The craft has received much favorable comment from some of the enthusiasts who have seen it.

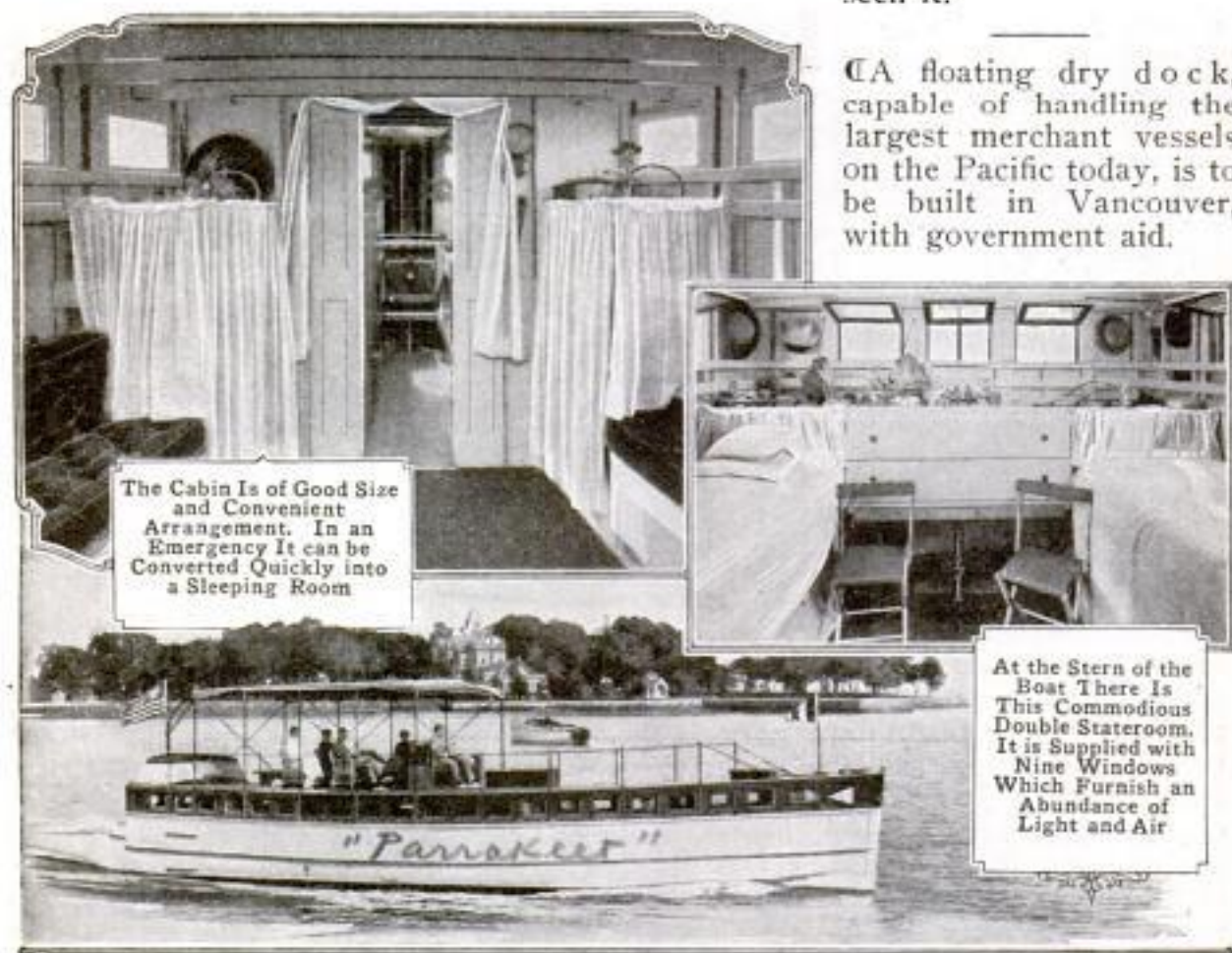

The Cabin Is of Good Size and Convenient Arrangement. In an Emergency It can be Converted Quickly into a Sleeping Room

A floating dry dock, capable of handling the largest merchant vessels on the Pacific today, is to be built in Vancouver, with government aid.

At the Stern of the Boat There Is This Commodious Double Stateroom. It is Supplied with Nine Windows Which Furnish an Abundance of Light and Air

The House Boat Has Surprising Accommodations and Embodies Refinements in Design and Construction  
Inventor: Which Make for Speed. Throughout, It Is Unusual and Interesting

Cipriano A. ... Jr., 116 Nassau, N.Y.C.



## WORLD'S GREATEST TELESCOPE

3257

## AT MOUNT WILSON

WORK on the 100-in. reflecting telescope at the Mount Wilson observatory, Pasadena, Calif., is approaching the final stage, and within a few months, possibly by July, will be completed. During the 10 years spent in designing and constructing it, much technical interest and popular misunderstanding have arisen. The instrument will be the largest stellar camera in existence and will collect twice as much light as any other telescope. From a scientific viewpoint it is an experiment in certain respects. But for the measurement of the heat radiation of stars and the spectroscopic study of the faintest objects it will yield results commensurate with its size, according to George Ellery Hale, director of the observatory. The instrument, contrary to the impression held by some, is not designed to settle the question regarding the canals of Mars. There is reason for hoping, however, that it will extend the visual boundaries of the universe by making possible the photographing of many millions of stars existing beyond the range of the most powerful telescopes in present use.

Primarily the new instrument will be employed in continuing astronomical investigations that have been undertaken with the 60-in. reflector at Mount Wilson. To be accomplished are the extension of studies now in progress on the structure of the universe and the evolution of the stars. The nature of nebulae and star clusters, the distances of stars and their motions in streams, the question whether light is scattered in its passage through space, and the matter of the dependency of a star's redness upon its physical condition, are, with innumerable other things, subjects which the power of the new reflector may help to determine and clarify.

Although its moving parts weigh about 100 tons, the big telescope is far more delicate than any watch ever made. Every part of its mechanism is as nearly perfect as human skill will

permit. The reflector, which is 101 in. in diameter, 13 in. thick, and  $4\frac{1}{2}$  tons in weight, has been ground from a block of glass cast at St. Gobain, France, in 1906. The disk was produced following several failures and accepted after being given a spherical surface and tested under various conditions of temperature and in different positions to determine the constancy of its surface. Subsequently the final grinding of the disk to a parabolic surface was undertaken and completed by the expert in charge of optics at Mount Wilson observatory. This work, requiring minute precision, made necessary the development of special grinding and polishing machinery and the originating of special processes. In addition to this major reflector, the telescope will be supplied with four smaller auxiliary mirrors.

The tube is about 12 ft. in diameter and 45 ft. long. This and other parts of the telescope's mounting and operating mechanism is being set up within a housing that is 100 ft. in diameter and 100 ft. high, the upper half of it being a dome. The latter is rotated by an electric motor on rails which have been ground so true that motion along them is smooth and perfect. This was imperative in order to avoid the possibility of vibrations being set up within a large fixed spectroscope occasionally to be employed with the telescope. The heavier parts of the instrument's mounting were built at an eastern shipyard, but all of the smaller parts, requiring great accuracy in fitting, were constructed in the instrument shop of the observatory by its own experts.

The dome and building housing the instrument are constructed so that no air can enter when the shutter opening is closed. This precaution and the use of refrigeration machinery are necessary to prevent changes in the shape of the mirror through temperature variations. The mirror is held in a steel housing which is insulated with felt and cork.





Dome Erected at Summit of Mount Wilson to House the World's Greatest Telescope, the 100-Inch Reflector That is Now Nearing Completion after Ten Years of Unceasing Work. The Dome, Strictly Speaking, is Only the Upper Half of the Structure and Revolves on a Track That has been Ground True to Insure Smooth Motion

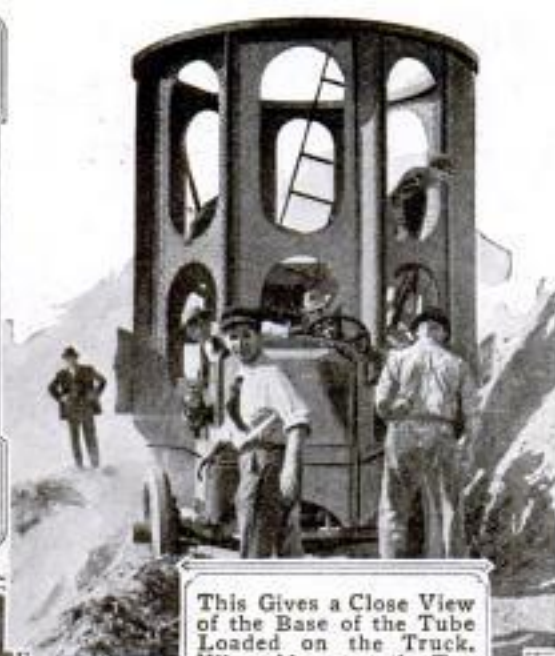

This Gives a Close View of the Base of the Tube Loaded on the Truck. When Almost at the Top of the Mountain, the Great Weight of the Machine and Its Burden Caused the Outer Edge of the Road to Crumble at a Curve. One Wheel Slipped over the Brink of a Precipice and the Truck Tilted to a Dangerous Degree, but did Not Tip Over. Had the Machine Rolled down the Mountain it would have Taken Many Months to Replace the Loss



Carrying the Massive Base of the Telescope Tube up the Steep, Hazardous Road That Winds for Nine Miles up Mount Wilson to the Summit, Overlooking Pasadena. This Section of the Steelwork Weighs 15,000 Pounds and, Like Certain Other Parts of the Instrument, Proved a Difficult Thing to Handle. It was Built at an Eastern Shipyard and Transported to California by Water. It was Then Placed on a Motor Truck and Hauled up a Road That Has a Grade Ranging from 10 to 18 Per Cent



Here is a Picture That Not Only Illustrates a Remarkable Motor-Truck Performance but Also Explains Some of the Difficulties Encountered in Carting the Telescope's Parts to the Mountain Top: It Shows a 10-Ton Girder being Carried around One of the Many Sharp Turns in the Steep Road Scaling Mount Wilson



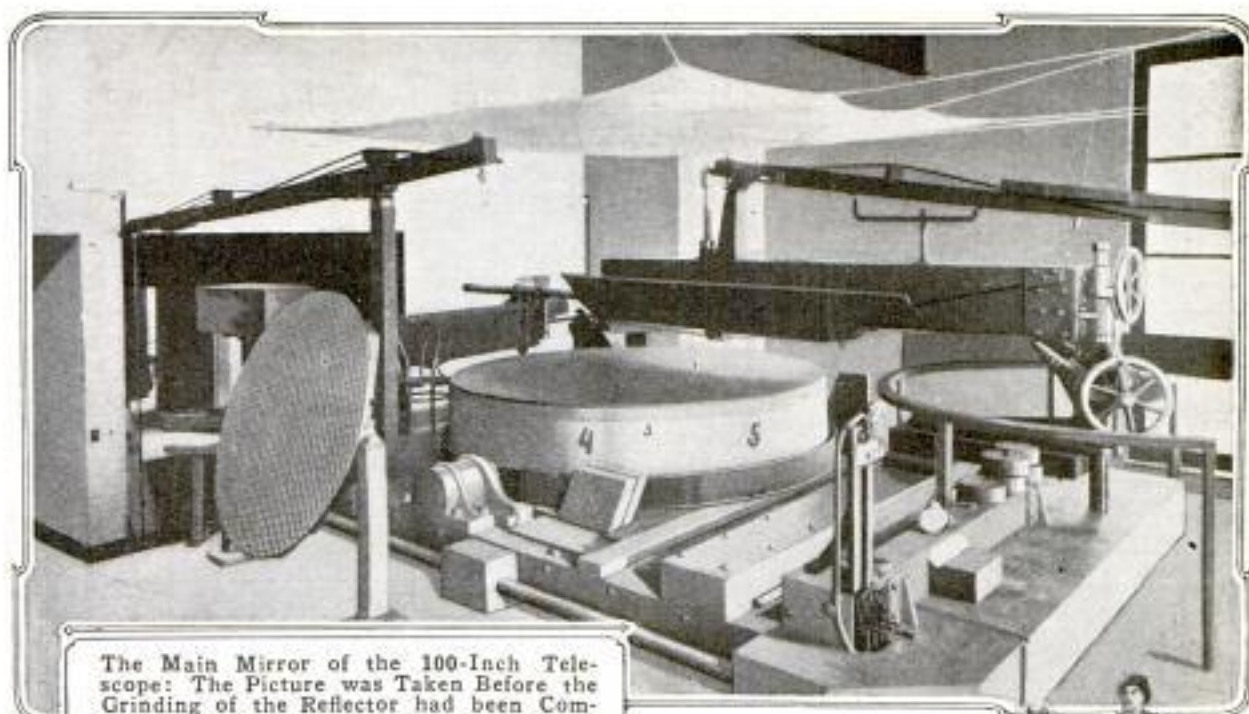

The Main Mirror of the 100-Inch Telescope: The Picture was Taken Before the Grinding of the Reflector had been Completed and Shows the Four-and-a-Half-Ton Cylinder of Glass on the Rotary Grinding Table in the Shops at Pasadena, Where the Work was Done by the Expert in Charge of Optics at the Mount Wilson Observatory. The Honeycomb Plate Seen at the Left is the Grinding Disk, Which, When in Use, was Held by the Big Arm That Extends over the Mirror

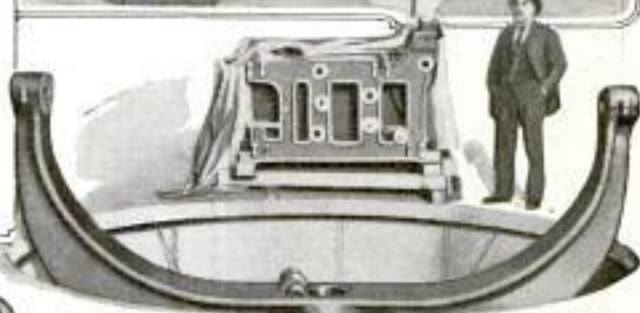

Elevator Installed beneath Telescope to Facilitate Removal of Reflector to Laboratory Below, Where the Periodical Resilvering of Its Surface will be Accomplished. Before Removal from the Instrument, the Mirror's Housing is Bolted to the Elevator's Uprturned Arms



Felt and Cork Insulate the Steel Housing of the Reflector at the Base of the Telescope Tube, While Water from a Large Tank, in Which the Temperature is Automatically Controlled, is Circulated in Coils around the Mirror

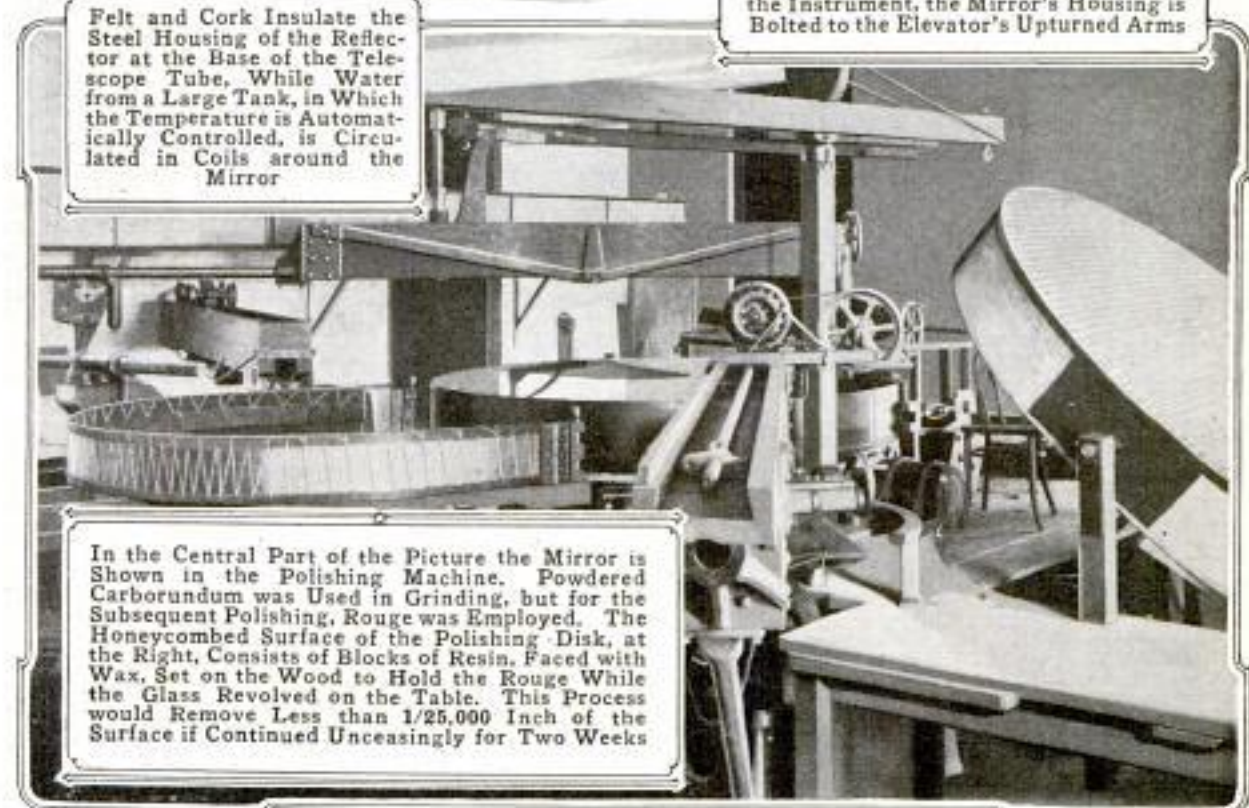

In the Central Part of the Picture the Mirror is Shown in the Polishing Machine. Powdered Carborundum was Used in Grinding, but for the Subsequent Polishing, Rouge was Employed. The Honeycombed Surface of the Polishing Disk, at the Right, Consists of Blocks of Resin, Faced with Wax, Set on the Wood to Hold the Rouge While the Glass Revolved on the Table. This Process would Remove Less than 1/25,000 Inch of the Surface if Continued Unceasingly for Two Weeks



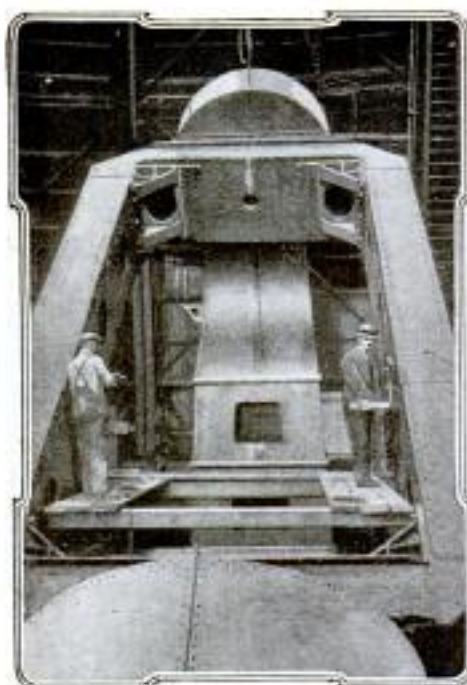

At the Left is Shown the Big Steel Yoke Which Serves as a Mounting for the Tube, While at the Right the First Section of the Latter Is in Place. The Floats on Which the Yoke is Rotated Are within the Cylindrical Members to be Seen at the Upper and Lower Ends. At the Bottom of the Right-Hand Picture may be Seen a Small Section of the Driving Worm Wheel, about the Circumference of Which Are 1,440 Teeth. The Cutting of the Latter Was an Extremely Delicate Piece of Work Requiring Great Skill

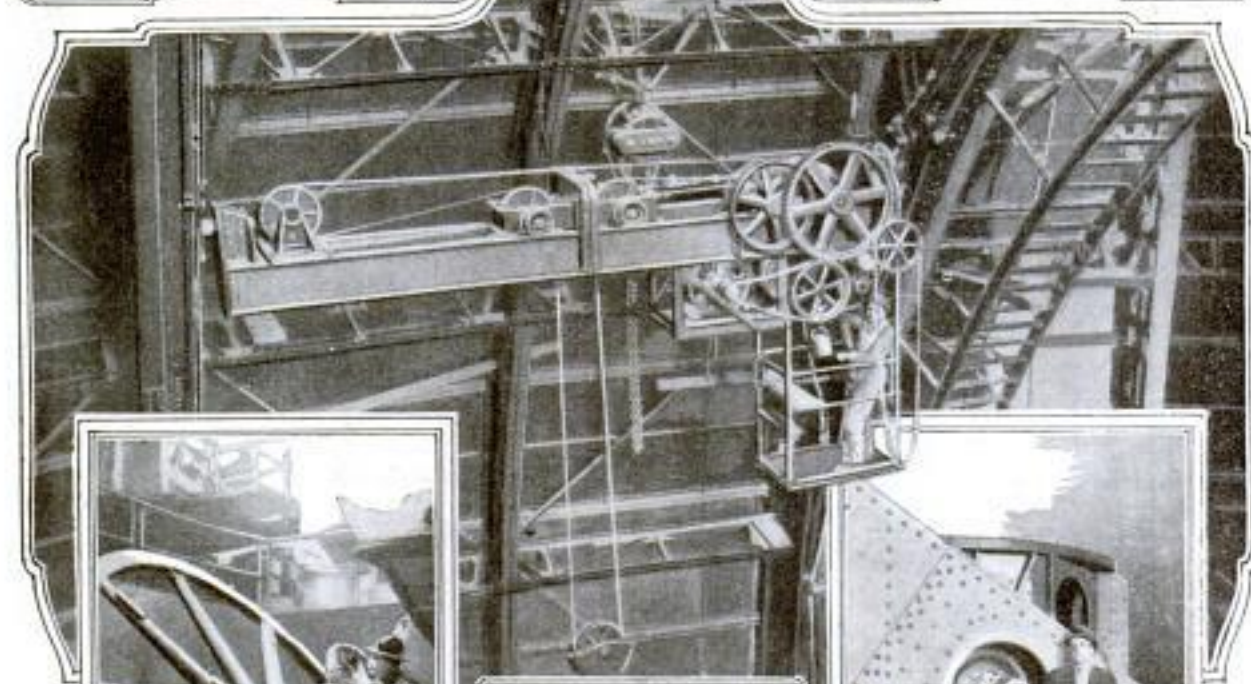
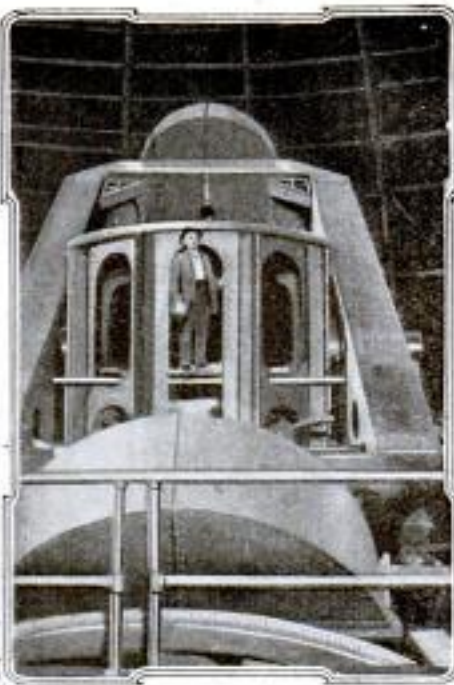

The Big Worm Gear Which Works in Conjunction with the Driving Clock That Keeps the Telescope Constantly Pointing at a Star Irrespective of the Earth's Movements. The Teeth about Its Circumference had to be Cut so That They would Not Vary More than  $1/10,000$  Inch

Above Is the Traveling Crane Used for Erecting the Telescope. It Also Provides a Means of Handling Heavy Parts of the Instrument at Times When Cleaning or Repairing has to be Done. The Apparatus Operates in a Grooved Track That Permits It to Crawl up and down One Side of the Massive Dome. The Picture was Taken by Flash Light While the Photographer was Lowered through the End of a Hoisting Crane, Nearly 90 Feet from the Floor

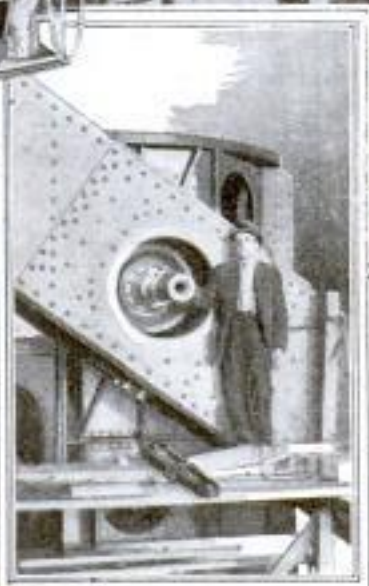

One End of the Axle on Which the Telescope Tube Swings in the Yoke. The Bearing Consists of Two Races of Balls and Two of Rollers, Which are Kept in Perfect Alinement by Means of a Special Mechanism Housed within the Walls of the Steel Framework



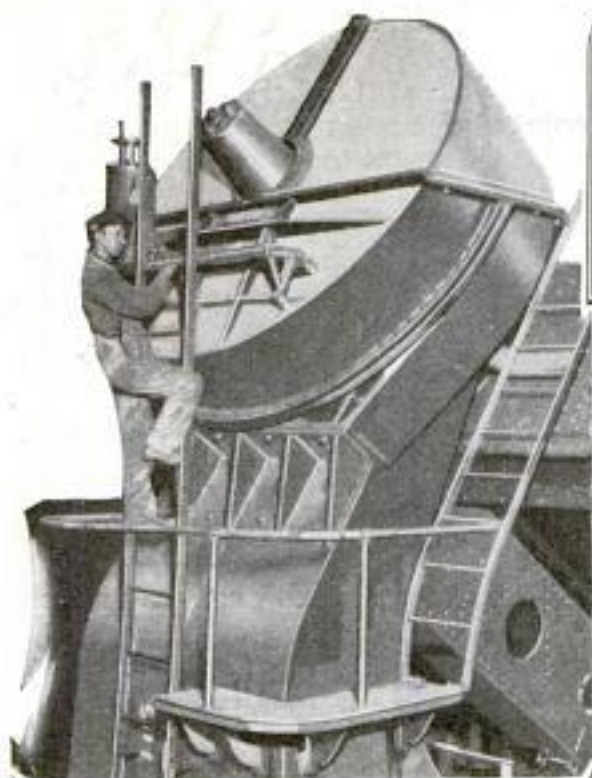

Above, and Also at the Right, are Presented Two Views of the Upper of the Two Big Bearings on Which the Yoke, Holding the Telescope Tube, Swings. These Bearings are Constructed as Accurately as Any Watch, the Permissible Error Being Only 1/10,000 Inch. Most of the Friction is Removed by Means of a Hollow Steel Float Lying in a Tank of Mercury. Auxiliary Instruments Weighing from a Few Ounces to a Ton or More, When Placed upon the Telescope, Necessitate Rebalancing It Each Time. For This Purpose Each Bearing Has a Gauge Which Controls the Level of the Quicksilver. In the Picture at the Right, the Small Cylindrical Object, That Appears to Be on a Platform near the Top of the Steel Ladder, is One of These Instruments

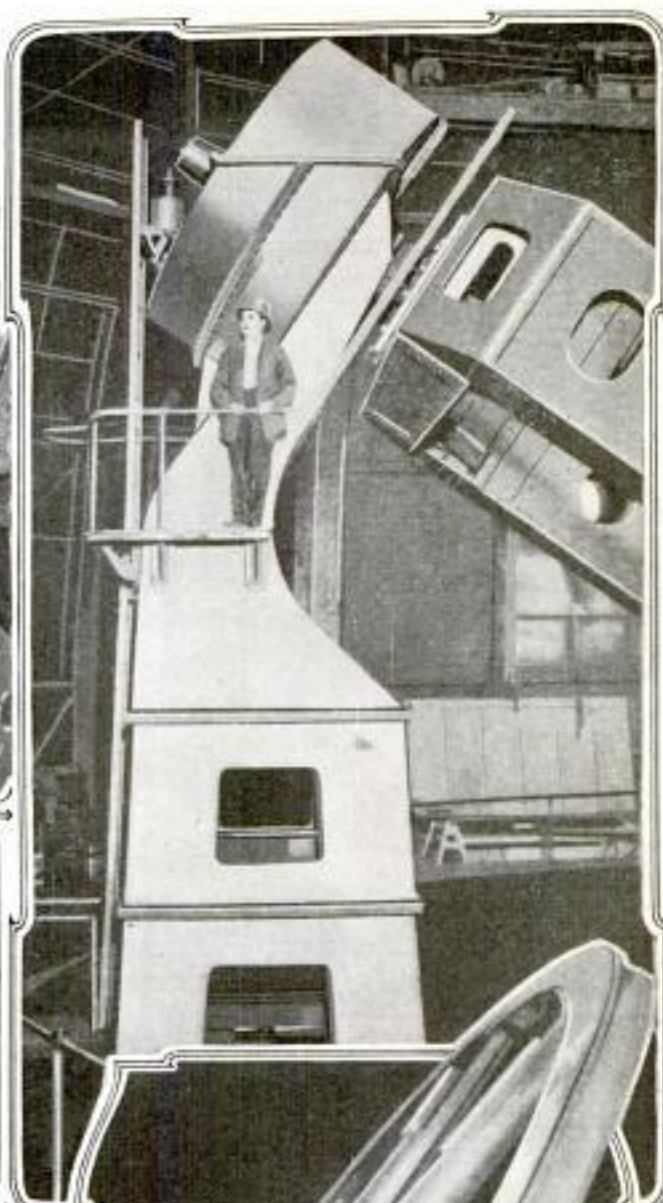

The Chief Instrument Maker of the Observatory and Two of His Skilled Mechanics Executed the Extremely Delicate Work of Cutting the Teeth of the Great Worm Gear, Which is Shown in Progress Here. After being Cut, the Teeth are Ground with Carborundum and Polished with Rouge. From Start to Finish, Accuracy has been the Paramount Requirement in Building the Telescope



This Shows the Gear Surface of the Big Cast-Iron Wheel Ready for the Painstaking Grinding and Polishing Work. The Danger of Damaging the Teeth While Transporting the Heavy Wheel to the Mountain Observatory, and the Need of Extreme Precision, Caused Those in Charge of the Work to Delay the Gear Cutting Until the Member had been Installed



**EXCAVATE ANCIENT VESSEL  
REMARKABLY PRESERVED**

Of late a most interesting memento of the Norsemen of old, a remarkably well preserved 70-ft. boat, believed to

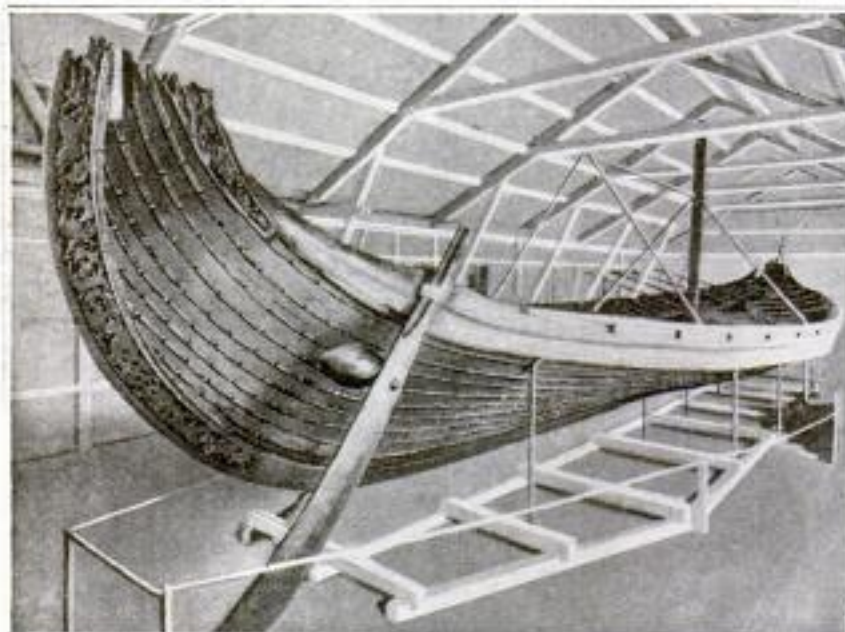

COURTESY MOTORSHIP AND MOTORBOAT

Although of considerable size, the shape of the boat shows that it was probably used in the narrow inlets, or fiords, of Norway, not on the open sea

have been used in the ninth century, has been brought to light. It was

excavated at Oseberg, Norway, at a point about two miles from the sea and at an elevation of some 50 feet. Structural details of the craft and the character of its decorations are considered to be unquestionable evidence that it was in use a hundred years or more before that intrepid viking, Eric the Red, discovered Greenland. As the boat was being uncovered, its pieces—which were not all intact—were numbered so that no difficulty was later encountered in the re-assembly at Christiania. The oak timbers were in such splendid condition that it was possible to steam them and give original shape to them and the boat. Except for one beam and a few pieces, only an inch or two in length, the vessel is composed entirely of its original timbers. The size of the boat makes it especially treasured.

its original timbers. The size of the boat makes it especially treasured.

3622  
**LOW LEATHER BACK FOR  
MOTORCYCLE SEAT**

A new attachment for a motorcycle, which affords considerable comfort for a rider, is a crescent-shaped leather back which attaches to the seat by means of the same bolts that hold the saddle in place. The article is so low

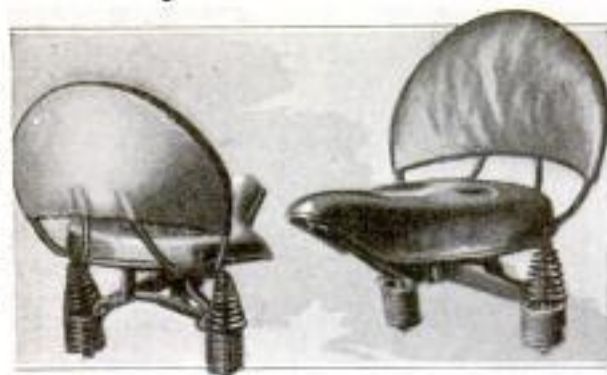

A Comfortable Back for a Motorcycle Seat That is Attached by Means of the Screws Which Hold the Saddle in Place

that it is not a serious inconvenience in mounting or dismounting. Particularly for those who take long rides and are troubled with backache as a consequence, the support will prove to be a rest-giving device.

2874

**EASTERN BATHING BEACHES  
PROTECTED FROM SHARKS**

Precautions have been taken at the Atlantic coast resorts to prevent sharks from reaching the bathing beaches, and there seems to be little likelihood that the tragedies of last season will be reenacted during the coming summer at such places. Heavy wire nets and chain barriers were erected at most of the popular bathing points after the New Jersey incidences which terrorized vacationists from New York to Savannah. It is under-

Chas A. Hoehn (Inv)  
Wilkinsburg, Pa.

1205541- Nov 21-1916 -  
P. S. V. 232-763



Central News Photo Service, 26-28 Beaver  
N.Y.C.



Anchored to the Bottom and Made Fast to Posts, a Chain Barrier 500 Feet in Length Fences One of New York's Most Popular Bathing Beaches. The Pictures Above were Taken When the Net was being Put in Place

stood that the "shark fences" will be renewed, wherever broken, so that surf bathers will be safeguarded should the "man-eaters" make a second appearance, which, however, is hardly expected.

3614

### RUSTIC REGISTRY BOOTH IN NATIONAL FOREST

Travelers' registers were used in the numerous national forests of this country for the first time during the recreation season of 1916. They were to be found at the principal entrances, at the ranger stations, and other frequented points. Each contained space for 2,000 names, and every person entering one of the reserved areas was invited to record his name. One purpose of the registers was to make it easier for the rangers to warn, or rescue, persons in

case of a forest fire, and to make more probable the delivery of telegrams or other important messages. In some instances, as in the Snoqualmie Forest, rustic booths were built to house the registers. In the one shown herewith the book is kept behind a hinged shelf, which when let down serves as a writing desk.



A Sign in Snoqualmie National Forest Inviting Travelers to Register Their Names, and an Artistic Booth Built to House the Register

H. A. G. Jackson, 418 Beach Bldg.,  
Portland, Oregon.



### SPECIAL ROOF INCREASES CAPACITY OF SILO

A sectional silo roof has been designed which can be opened in such a way that silage can be piled high above

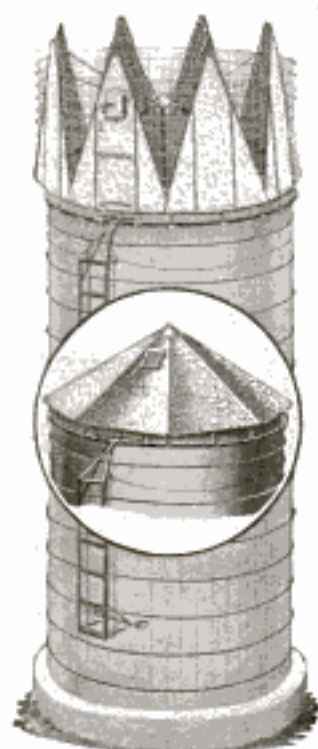

the permanent walls. In this way enough fodder can be put in storage at one time to fill the structure completely when settling has taken place. The ordinary silo is not only a dark, ill-ventilated place for the trampers to work in, but when the fodder has settled it leaves about one-fourth of the space vacant. This roof is pyramidal and is composed of triangular sections

supported by an iron framework. Hinges at the outer edges permit the sections to be set in an upright position while the silo is being filled, thereby letting in light and air. Inside the opened roof, a woven-wire cylinder is placed to keep the excess fodder from falling off. When no longer needed this guard can be removed. Access to the top of the silo is gained by a movable ladder suspended from a track that runs around under the eaves.

3832

### NICARAGUAN CANAL PROJECT NO LONGER MENACES PANAMA

In ratifying a treaty by which the United States agrees to pay the Nicaraguan government \$3,000,000 for the perpetual and exclusive right of cutting a canal across that republic's territory and thereby establishing a new passageway between the Atlantic and Pacific oceans, the government has made a significant, not to say impor-

tant, move. The agreement gives us the Great and Little Corn islands as well as the authority to establish in the Gulf of Fonseca—which is considered to be, strategically and otherwise, the best Pacific-coast harbor south of San Francisco—a naval station. The Corn islands and Tigre Island, the latter within the mouth of the gulf, are to be heavily fortified. As a protection for Panama Canal, the value of a naval station in Central America and fortified bases in the Caribbean is obvious. On the other hand the Nicaraguan canal rights are probably of equal, if not even greater, importance. In recent years the practicability of constructing the long-proposed waterway, which would make use of the natural advantages offered by Lake Nicaragua and its outlet, the San Juan River, cost less than half as much as did Panama Canal, and provide a route shorter than the existing one, has come to be realized by engineers. The military and commercial danger to Panama Canal would have been momentous had a foreign power undertaken the enterprise. And of late two great nations are understood to have discussed the project in secret. The purchase of the option by the United States has therefore been timely.

3696

### ADJUSTABLE PEDALS FOR THE MOTORIST

Among the auto accessories of recent invention are adjustable pedals, or

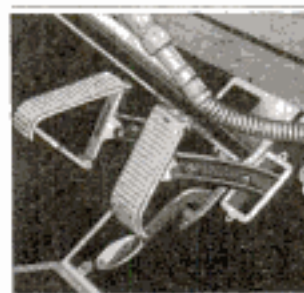

pedal attachments, made to suit all lengths of foot reach. When these are attached to the regular brake and clutch pedals, two or more

members of a family with varying reach can drive the same car in comfort. The attachments fit over the standard pedals, furnish a firm grip for the feet, and are readily adjusted at the required height by a locking bar.

Phila. Record  
1-7-1917

Fit-All Adjustable Pedal  
18 Charlotte St.  
Tiffin, O.



## MANY INSTRUMENTS COMBINED IN MOVIE ORGAN

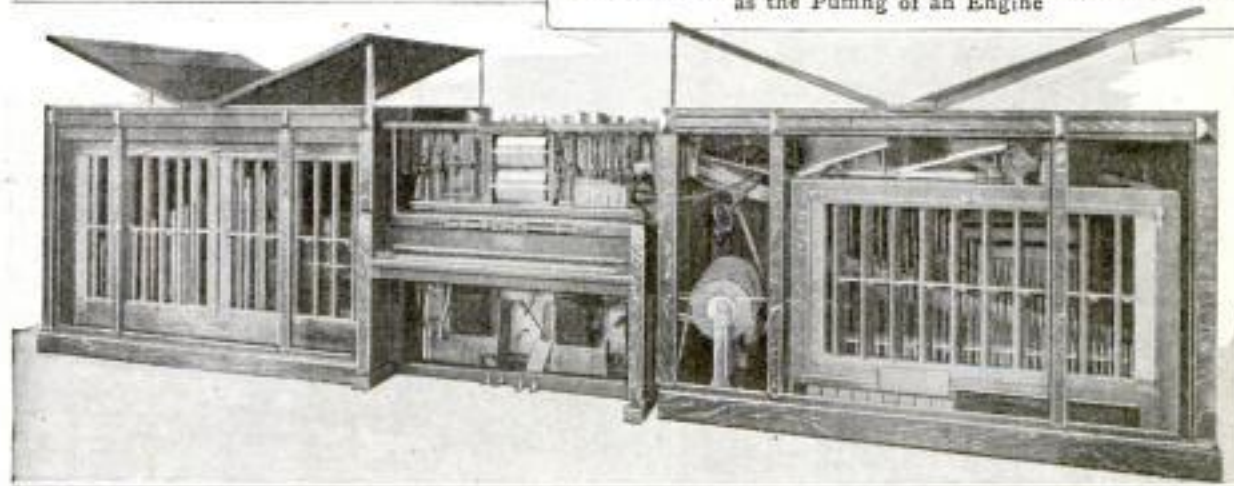
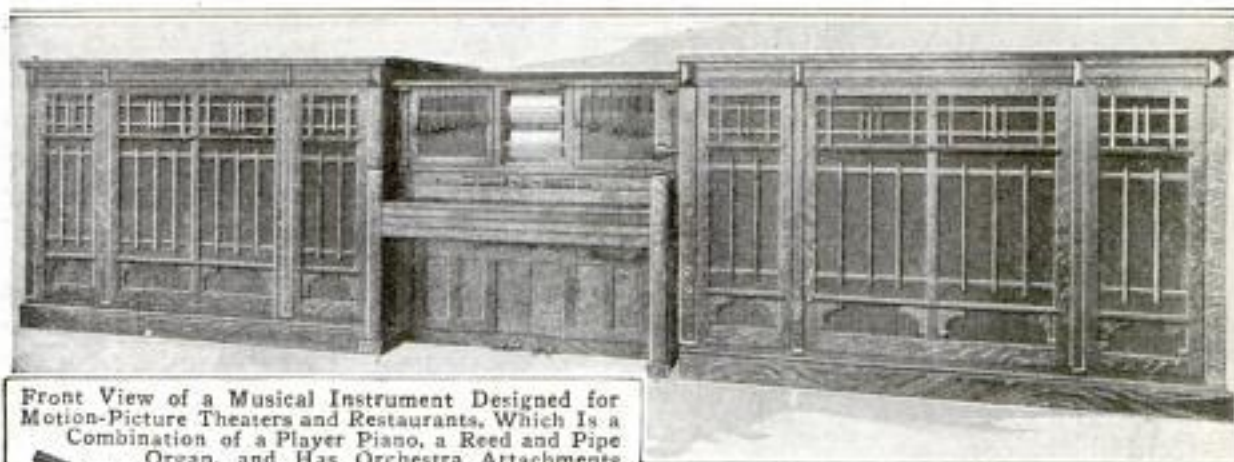

The special musical needs of the motion-picture theaters have been largely responsible for the development of an instrument, made in California, which, under the direction of a single

operator, can produce the soft tones of a piano or a symphony orchestra, or it can be changed instantly to give forth the crashing harmony of a brass band. Musicians in motion-picture theaters



are often required to change quickly from one selection to another, according to the scenes. The effect of a picture is heightened, also, if certain sounds, such as the warning of an automobile horn, are introduced at the proper moment. The instrument referred to is constructed to meet all these requirements. It is a combination of a player piano, a pressure reed organ, and pipes producing the effect of an orchestra, and has in addition a large number of special attachments. It is operated electrically, uses ordinary 88-note roll music, and is equipped with a patented device whereby the operator

can shift instantly from one music roll to another. If preferred, the piano or the organ can be played alone, manually or mechanically, or as many of the orchestral and band attachments can be introduced as desired. The largest size in which this instrument is made is 21 ft. long and 5 ft. 2 in. high. A skilled operator can produce music having no suggestion of mechanical playing and by pulling and releasing certain cords, which terminate above the keyboard, he can introduce at will such features as the sound of horses' hoofs, cow bells, an automobile horn, the whistle of a bird, and the like.

3628

### ANIMAL AMBULANCE HAS LABOR-SAVING DEVICES

An animal ambulance in which are embodied several special features, including labor-saving means for handling prostrate beasts, has recently been constructed for the Los Angeles Humane Animal Commission. The body of the car in which the creatures are carried is well padded and is hung low. It is provided with a rear and a side door and suitable means of approach. The side door is frequently

utilized in leading a horse from the car in preference to backing it out. Concealed just back of the driver's seat is a windlass operated by the engine. When a horse cannot be led into the car it is hobbled and thrown, if not already prostrate, after which it is rolled over onto a platform mounted on rollers. With the aid of the windlass and rope the platform and its burden are drawn into the automobile. The car is provided with a gas outfit with which an animal in a hopeless condition can be put out of misery without delay or additional suffering.



ⒸThe War Department's aviation board has under consideration a plan for the enrollment of women fliers in the Army Aviation Reserve Corps. In time of war these pilots would form an auxiliary defense force that would be used back of the battle front.

Left: Rolling a Hobbled Horse onto a Wheeled Platform with the Aid of the Rope and Windlass, the Latter Shown in the Inset. Right: Drawing the Wheeled Platform and Its Burden into the Car



### BIG ARMY FLYING SCHOOL STARTED IN EAST

The cause of aviation in this country has been given a decided advance by the recent purchase of 1,169 acres of land near Hampton, Va., where an army aviation school and experiment station will be established. It is stated that contracts will soon be awarded for buildings costing about \$1,500,000, and that eventually several millions will be expended. The contemplated equipment will include everything needed to test motors, aeroplane parts, materials used in the construction of aeroplanes and balloons, instruments used in the navigation of the air, and the testing of new inventions pertaining to flying.

3620 *Alschmitt*

### CAMERA CLAMP TO BE USED INSTEAD OF TRIPOD

Any hand camera can be fastened securely to a chair back, a small tree, fence rail, or post by means of a clamp recently placed on the market and designed to replace a tripod. It includes two stout wire hooks of different length, a locking lever, and a detachable chain which is needed only in fastening the clamp on objects exceeding 1 in. in diameter. The camera may be set in place either before or after the clamp is fastened to the object which is to serve as a support. If the latter is a post or a tree, or any other object up to 3 in. or 4 in. in diameter, one of the links of the chain is engaged in either hook of the lever. The clamp is especially useful in taking pictures with the camera downward.

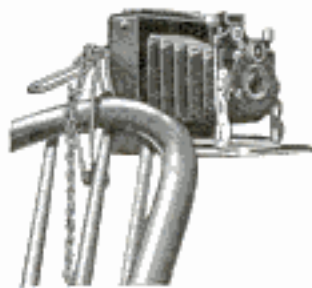

### LAWN SPRINKLER WORKS ON A NOVEL PLAN

In an efficient lawn sprinkler of novel design the pressure of water through a 1-in. hose drives a small tur-

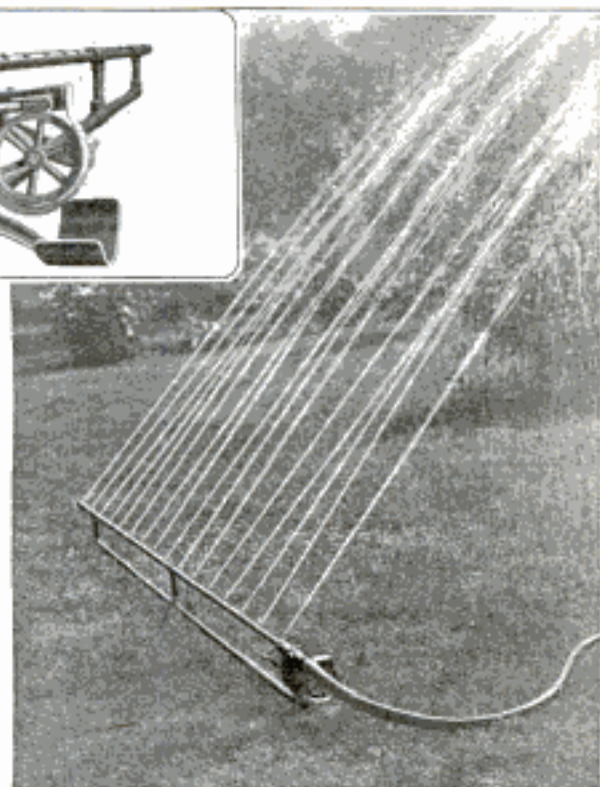

New Lawn Sprinkler in Operation: The Photograph at the Left Shows Details of Its Construction, Including the Turbine, Worm Shaft, and Wheel That Swings the Outlet Pipe in a Semicircle

bine, the shaft of which is provided with a worm that turns a wheel geared to a crank, thus moving a long outlet pipe in a semicircle of 15-ft. radius. The pipe into which the water passes through the turbine has 16 outlet holes, and the water is emitted in the form of parallel sprays with the effect of a gentle shower. Each revolution of the wheel causes the pipe to swing with a circular motion that sprinkles the water over a total width of 30 ft. of lawn. In operation the apparatus is said to make an ideal lawn sprinkler.

It has been demonstrated at the experimental paper works operated by the Bureau of Standards, that a good grade of paper stock can be made from used twine and cord that is usually wasted.

*International Photo Sales Corp'n*  
235 5th Av., N.Y.C.



## TURNING VAGRANCY TO ACCOUNT

3322 BY LOUIS J. HENNESSEY

WITH railroads stretching their steel tentacles to the four points of the compass, Houston, Tex., like many other large American cities, has felt the necessity of providing employment for hundreds of tramps, hobos and other vagrants, who use the freight cars of the railroads as a means of travel. Instead of providing steam-heated cells and every inducement to preserve the spirit of idleness, Houston offers a farm where all town prisoners spend their terms.

Intimate contact with the class of humanity usually brought before the magistrate, led the mayor of Houston to believe that the system of dealing with minor offenders was wrong. In his estimation, a sentence spent in a town jail did not inure to the good of either the prisoner or the community. So he devised ways and means of relieving the city of the burden of supporting nonproducers, and incidentally offered the prisoners an opportunity to learn the elements of successful farming.

The Houston city farm embraces 319 acres of land just beyond the outskirts of the city. It is not the very best land obtainable, but part of the mayor's scheme was to prove the fertility of lands not generally regarded highly for agricultural purposes. In this he has succeeded. In 10 months' time the city farm has raised crops of cotton, corn, potatoes, sorghum, and peanuts, valued at approximately \$10,000; this aside from the products used by the prisoners themselves.

An interesting feature of the Houston city farm is the large, well-ventilated "bunk house," used as sleeping quarters by the prisoners. Upon his arrival at the farm, the prisoner is led into the office of the bunk house, relieved of all his clothing, and introduced to a bath of cold, chemically treated water. The clothing worn by the prisoner is taken to a building apart from the bunk house, and thoroughly fumigated. Every vestige of vermin is removed. Garments worn

by the prisoner during his sojourn on the farm are furnished by the city.

In caring for the creature comforts of the farm's guests, the city of Houston has overlooked nothing. The beds used by the prisoners are double-decked affairs, running the length of the bunk house. Sanitary mattresses are used. Midway between the compartments used by the white and negro prisoners, a series of shower baths and stationary washstands are conveniently located. Fresh linen is always obtainable, and strange as it may seem, men who have not averaged one bath a month, soon become accustomed to taking two a day—morning and evening.

A canning factory, operated as an adjunct of the city farm, provides employment for the female prisoners. Sorghum and sweet potatoes are marketed, as well as green peas. Separate accommodations keep the men and women apart, and there is no social contact whatever.

Work begins at 5:30, when the prisoners awake to the notes of a bugle. Ten minutes are set aside for the regulation "setting-up" exercises, and then all hands enjoy a breakfast which invariably includes fresh milk, eggs, and vegetables raised on the farm. Work ceases at 5:30 p. m., and the prisoners spend the evening as they see fit. Ample supplies of reading matter are kept on hand, and the morals of the men are always improved after a 30 or 60-day visit to the farm.

The buildings on the city farm of Houston have been erected at a cost of \$15,153.50, and are designed with an idea of permanency. Other equipment, including farm implements, live stock, fencing, teams, etc., brings the total investment, exclusive of land, up to \$23,765.91. It is estimated that the average cost of prisoner per month is \$18.60, this including groceries, meats, feed for live stock, salaries of superintendent, assistants and matrons, and incidentals.

It is believed that the cost of caring





General View of the Buildings on the City Farm, Houston, Texas, Where the Municipal Authorities Provide Outdoor Work for Vagrants and Seek to Solve the Tramp Problem by Making "Weary Willies" Till the Soil.



Interior of the Men's Bunk House: The Double-Decked Beds are Furnished with Sanitary Mattresses and Prisoners are Compelled to Keep Themselves Clean. Shower Baths are Close at Hand and Bathing soon becomes a Daily Habit.



Women Prisoners at Work in the Canning Factory: White and Colored Prisoners are Separated except during Working Hours, and There is No Communication between Men and Women.

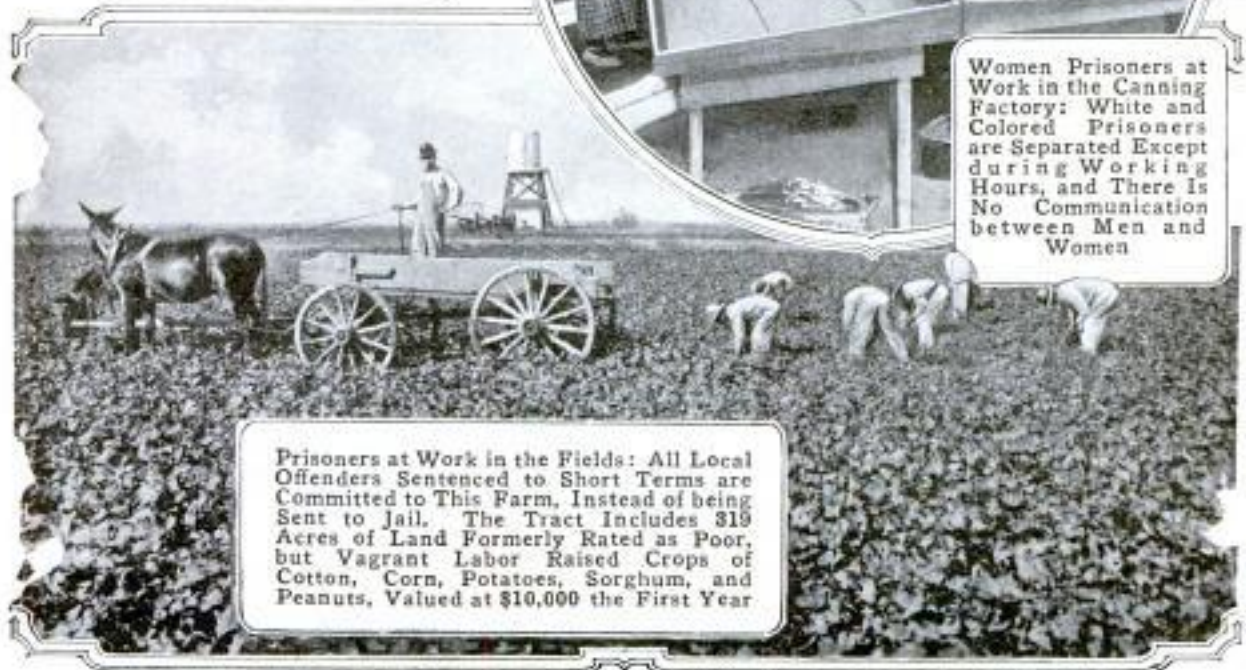

Prisoners at Work in the Fields: All Local Offenders Sentenced to Short Terms are Committed to This Farm, instead of being Sent to Jail. The Tract Includes 319 Acres of Land Formerly Rated as Poor, but Vagrant Labor Raised Crops of Cotton, Corn, Potatoes, Sorghum, and Peanuts, Valued at \$10,000 the First Year.



for the town prisoners on the farm can be reduced one-half after the farm has been in operation another year. Practically every article of food consumed will be produced on the farm, and it is the intention of the city officials to make the institution a model in every respect.

3446

### HOW TO LIFT HELPLESS MAN FROM BURNING BUILDING

So far as the mere mechanics of the acts involved are concerned, many things, such as rescuing a drowning



person from the water, overcoming an unexpected assailant, and removing prostrated victims from burning buildings, are often simple enough to perform providing resourcefulness rather than brute strength is used. There are many comparatively easy ways of accomplishing feats which might readily prove too much for an unthinking Hercules. Two methods of carrying a helpless person from a blazing building, when a ladder offers the only means of egress, were recently demonstrated. One of these makes use of the victim's coat, and the other provides for handling a disrobed person. In the first case, the coat is grasped by the collar, pulled down over the shoulders, and the tail wrapped so as to form a binding that holds the arms firmly above the elbows. The rescuer swings the victim onto his back and draws the twisted coat over his own head, thus leaving both arms free for negotiating the ladder. The other plan is to tie the victim's wrists together in front and carry out the rest of the procedure just recited, except that the man is lifted face forward instead of back to back.

J. C. Carson

### TO BUILD ALASKA ROAD WITH CANAL EQUIPMENT

*Canal Record 1-17-1917*  
The Alaskan Engineering Commission, which is in charge of building the government's railway in Alaska, is to make a considerable saving in expenditure by using much of the equipment employed in digging the Panama Canal. Already 47,000 lb. of copper wire have been sent from the isthmus northward. Among other items which are to see service in a frigid as well as in a tropical region, are 50 flat cars, 11 locomotives, two steam shovels, and five dump cars. Four of the engines weigh 11½ tons each and six are 42-in.-gauge engines with a weight of 33 tons each. All of the rolling stock except the narrow-gauge engines has been changed from the isthmian standard gauge of 5 ft. to the United States standard of 4 ft. 8½ inches.

3655

### CONVENIENT VIAL FOR KEEPING SERUM

*Lancet 12-16-16*  
Of special interest to the medical profession is a vial recently devised in France in which certain kinds of serum can be kept ready for use at any time. It consists of a small bottle having a rubber stopper, from the lower end of which hangs a little tube, for holding a gram of serum



in a dry state. The tube extends down into carbolyzed water that partly fills the bottle. When the serum is wanted the tube is removed and its contents emptied into the liquid, in which it quickly dissolves, and the solution is then ready for use.

☐ In 1915 the Wisconsin state hatcheries included in its distribution to the lakes and streams of the state 10,500,000 brook and lake-trout fry and 143,000,000 wall-eyed pike.



## APPARATUS FOR TESTING STRENGTH OF ANCHORS

When a ship is anchored in a storm the safety of the vessel depends quite as much on the strength of the anchor itself as upon the cables connected with it. Hence the test to which an anchor is subjected before it is put into service is an important one. The majority of the anchors used in the United States Navy and on merchant ships are of cast steel. They weigh from 200 to 20,000 lb. The parts of each are carefully tested before being assembled, by dropping them from certain heights and by hammering their surface to detect any flaws. No defects being found, the parts are put together and the anchor is placed in a machine such as is shown in the illustration. By

this means a pull, calculated according to the size of anchor, is exerted on the shank. The scales, which form a part of the testing machine, are set so that when the desired maximum of strain

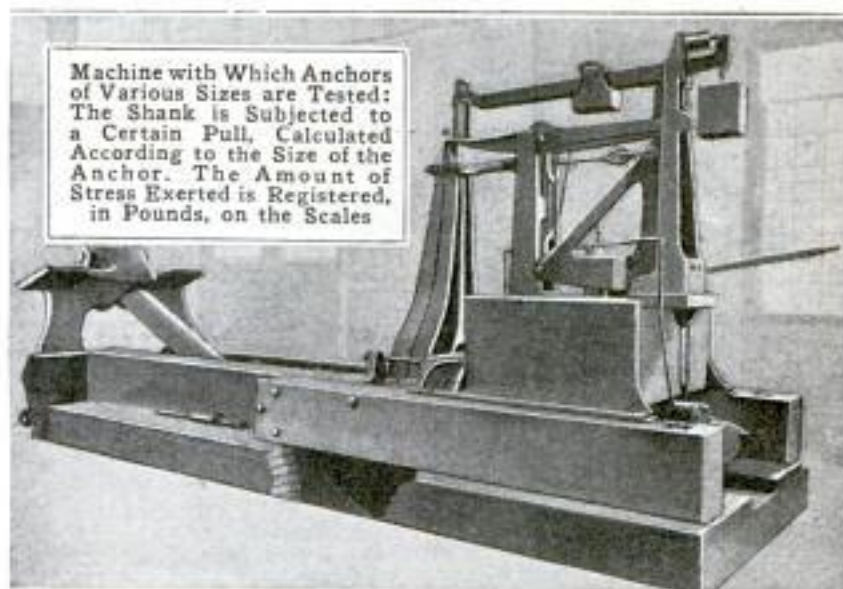

Machine with Which Anchors of Various Sizes are Tested: The Shank is Subjected to a Certain Pull, Calculated According to the Size of the Anchor. The Amount of Stress Exerted is Registered, in Pounds, on the Scales

has been reached, the beam rises and then the pull is relaxed. The anchor shown here weighs 20,000 lb. and is for one of the new United States dreadnaughts.

3190

## MACHINE TRANSPORTED ON ITS OWN BELT WHEEL

In South America the transporting of heavy machinery to its destination sometimes proves a more difficult task than the selling of it. The Brazil office of an American concern recently sold a large air compressor, which was to be delivered during the rainy season to a point in the mountains. The road was muddy and had many sharp turns and



A Heavy Air Compressor being Transported through a Mountainous Region in South America, Supported by Its Own Belt Wheel and a Heavy Cart

there was no wagon heavy enough to haul the big load. It was finally decided to assemble the machine partly and place one end on a wagon while the rest of the weight was borne on the big belt wheel which trailed at the rear. This member proved broad enough to prevent its sinking in the mud, and the arrangement made it easy to follow the abrupt turns in the road. When going downhill, a wedge was inserted between the wheel and the frame to serve as a brake. With 18 head of oxen, and nearly as many men, the machine was moved five miles a day.

¶The recently launched battleship "Mississippi," of 33,000 tons full-load displacement, is the third vessel to bear that name, the first having been the flagship of Commodore Perry at the time commerce was opened with Japan.



### TAP THAT CUTS METAL IN NEW WAY

A tap for cutting nuts, and for similar uses, has been manufactured

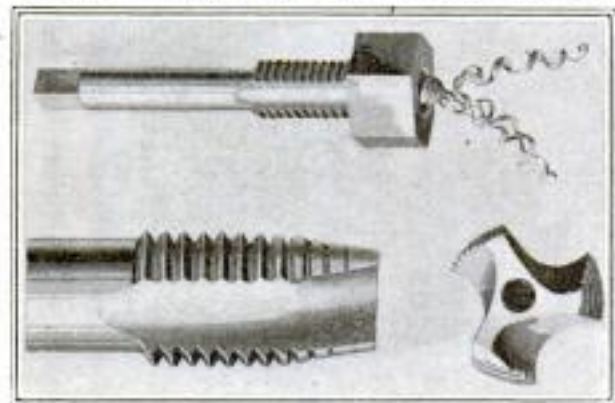

Views of New Tap Showing Flutes of Special Design Which Give the Tool Great Durability and Enable It to Operate with Less than Ordinary Pressure

by a Massachusetts concern, which is so designed that it shears out long curls of metal instead of cutting the material into fragments, as is commonly the case with ordinary taps. Each of these tools has three flutes which extend down its sides parallel

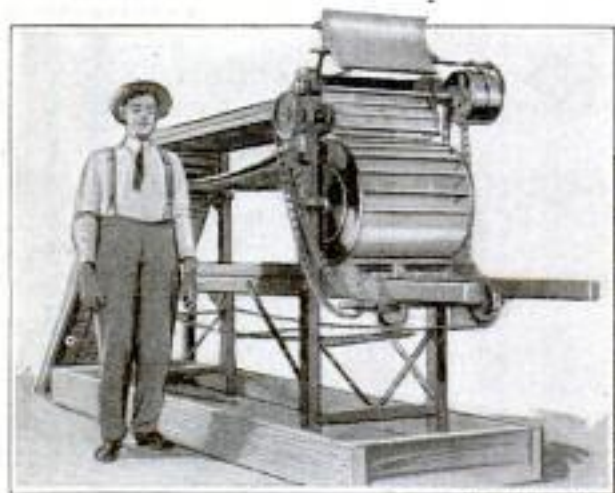

This Invention Dispenses with the Labor of a Large Number of Children Formerly Employed to Arrange Herring on Racks Preparatory to Sending the Fish to the Cooking Machines

with its axis until they reach a point a short distance from the cutting end. Here each flute is diverted to one side at a slight angle. The cutting edge of the flute forms an acute angle and the op-

posite edge an obtuse angle. As the tool revolves in the metal it shears out the chips, as already stated. The curls so cut are discharged from the hole as fast as they are made, whereas the fine chips cut by an ordinary tap often accumulate in the hole, and to remove them the tool has to be backed out. This tap operates with less pressure than is usually required. It also wears longer and seldom breaks. It cuts true to size in all kinds of materials.

2968

### LABOR-SAVING MACHINES IN FISH-PACKING TRADE

In the great changes which have come in the fish-packing industry in recent years, particularly on the Maine coast, two machines have played an important part. One of these has revolutionized the method of cooking sardines, cooking large quantities at one time. This cooker will hold 700 cans immersed in olive or cottonseed oil, which is heated to boiling by superheated steam. Each can is covered with a temporary perforated top which keeps the fish from floating out of the containers while being cooked. The machine discharges the cans at the rate of

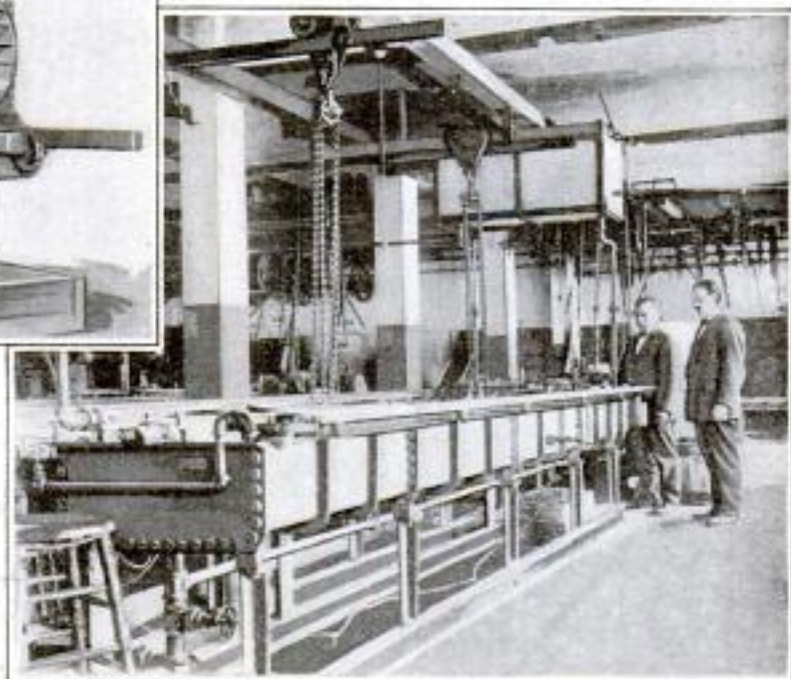

A Machine Which Cooks Sardines in Boiling Olive or Cottonseed Oil, Brought to the Required Temperature by Superheated Steam, and Discharges Them at the Rate of 65 Cans per Minute

E. M. Lawrence, Lubec, Me.



65 per minute, at the same time placing an air-tight cover on each, so that they are ready to be sealed. The other machine referred to does the work which, in the larger factories, formerly required 100 to 200 boys and girls. These children were employed to "flake" herring, that is to place them side by side on racks in which they were sent to the roasters or steam-cooking chests. Now this is done by a machine which carries the herring on an endless belt, consisting of trough-shaped units, to the racks where they are deposited in the position desired. Both of these machines were invented by a resident of Lubec, Maine.

3691

### MINER'S ELECTRIC LAMP OF IMPROVED FORM

An improved form of miner's lamp, recently approved by the United States Bureau of Mines, has a battery case of either sheet steel or aluminum connected by a 43-in. rubber-coated copper cable to the electric lamp on the miner's cap. The lamp is a steel shell with reflector and a  $\frac{1}{2}$ -cp. bulb having a



guaranteed life of 300 hours. The total weight of the outfit is approximately  $4\frac{1}{2}$  lb., the cap lamp itself weighing only 4 oz. No gas being generated by the battery, it is explosion-proof; all parts are also waterproof.

2839

### HOLDERS FOR GARAGE DOORS SAFEGUARD MOTOR CAR

Both convenience and accident insurance are offered by holders which prevent the wind from slamming the doors when a car is being driven into or out of a garage. The device is of simple, stanch construction and may be applied to curved-top doors as easily as to ordinary ones. It does not

interfere with casual opening or closing, but enables a pair of doors to be locked back in an open position so



When the Holders are Installed. There Is No Danger of the Wind Causing the Garage Doors to Slam against a Car as It is Entering or Leaving the Building

that the chance of their smashing against a car, breaking the lamps or denting the fenders, is obviated.

3192

### HOLLOW CONCRETE SPHERE IS A DANCE HALL

A building of reinforced concrete, recently erected as a dancing pavilion at an ocean resort in California, is constructed in the shape of a perfect hemisphere. The diameter of the sphere is 101 ft. and the building rests upon 16 concrete pillars, the spherical portion being raised 12 ft. from the floor. The walls are composed of reinforced concrete. Light is admitted through a skylight at the top, 40 ft. in diameter. As the building has no supports except the pillars around the circle, there is an uninterrupted area, 100 ft. in diameter, for dancing.



Hollow Hemisphere of Concrete Used as a Dance Hall at a California Ocean Resort

STANLEY WORKS,  
NEW BRITAIN, CONN.



INV: Raleigh L. Davidson  
328 Chamber of Commerce Bldg.,

580

POPULAR MECHANICS  
Portland, Ore.

LAWN-MOWER SHARPENER  
2822 OF NOVEL KIND

As the spiral blades of a rotary lawn mower revolve they are made to sharpen themselves by an ingenious

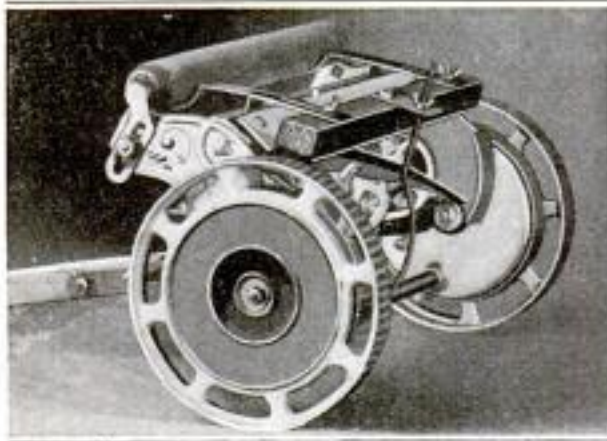

Lawn Mower with Sharpener Attached and Ready for Use: The Wooden Block Bearing a Strip of Corundum is Clamped to the Roller Which Normally Rests on the Ground, and Fastened to the Axle between the Wheels

device recently patented by a young man of Portland, Ore. The sharpener is made to clasp on any lawn mower and may be attached quickly and used by a novice. It sharpens the blades in a few minutes, as the mower is being run over the lawn, by their rotation against the grinding element of the attachment. This grinding element is a bar of corundum, which is attached to a block of wood. The rest of the device consists of the arrangement by which it is made fast to the mower in such a position that the blades or knives come into contact with the grinding surface as they rotate, while the corundum strip is held under slight tension so as to produce a square, even, and sharp bevel on the knives.

3740 —  
LINSEED-OIL TREATMENT  
FOR DYING TREES

*La Nature 11-11-16*  
A curious method of reviving languishing or dying trees was reported recently to the French Academy of Agriculture after being tested successfully in experimental gardens at Autun. The earth was first removed so as to lay bare the larger root branches, in which longitudinal slits were then cut

and kept open by wedges. These cuts were well rubbed with linseed oil and after awhile numerous small roots appeared, forming a sort of fur, and the trees so treated rapidly gained new life and vigor. The method was recommended for trial in the case of languishing fruit trees.

3759  
CENTRALIZING CONCRETE  
WORK OF A RAILROAD

An advance step in the manufacture of concrete products has been taken by a western railroad, which has established factories at Galesburg, Ill., Hannibal, Mo., and Havelock, Neb., for the execution of work for the entire system, instead of making their concrete products wherever they were needed, as has been the general practice heretofore. This plan makes it possible to standardize all products, mold them in sections ready to put together, and then ship them out over the line; complete concrete bridges, as well as watering troughs, fence posts, and cement curbing for the station platforms in small towns being turned out by the factories. Concrete bridges are made in sections all ready to be put together. Huge slabs of reinforced concrete are made in 14, 16, and 20-ft. lengths, and with a width of 7 ft. Two are fitted together sidewise, giving a width of 14 ft. to the single-track roadbed, while as many are placed end to end as are necessary for the length of the bridge. Even the piling for the bridges is made in standard lengths at the nearest plant and shipped out ready to be installed. Depot curbing is made in short sections, corners and all.

Several practical features characterize the plant at Havelock, Neb. Though but 60 ft. wide it is nearly five blocks long. To handle the huge concrete slabs, which weigh anywhere from 13 to 25 tons, a huge traveling crane has been installed which runs the entire length of the plant, and also serves to unload material. The concrete mixer runs on rails directly over a row of molds and is moved to any set of forms it is desired to fill.



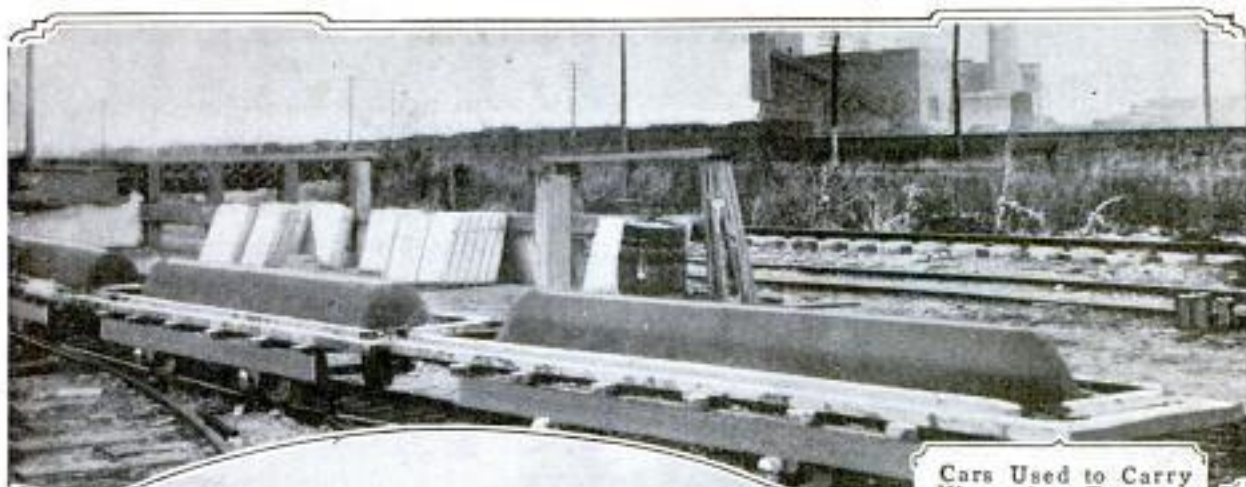

Cars Used to Carry Watering-Trough Molds: The Molds are Seen on the Cars. Whenever a Trough is Completed It is Run Out of the Building on These Little Cars. All Hand Labor is Done Away With. A Huge Crane Surmounting the Entire Plant is Used for Loading and Unloading the Products and Material

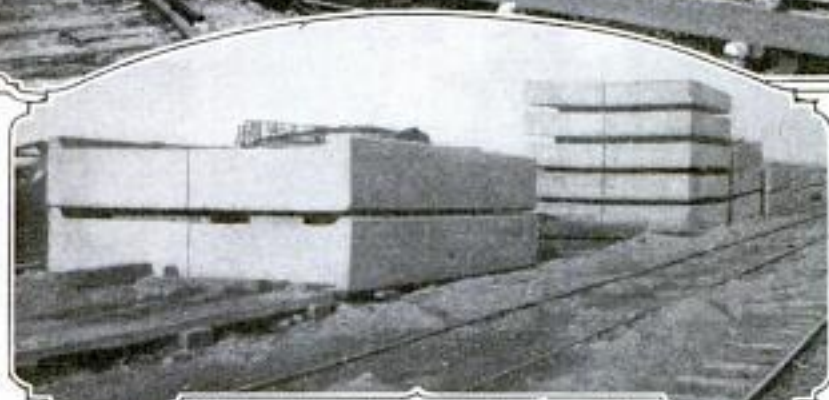

Bridge Slabs, All Ready to be Installed: Huge Slabs Such as These Form the Component Part of Bridges and can be Shipped Out to Any Point on the Line on a Moment's Notice. Under the Old Plan They would have been Made on the Spot



Piling for the Bridges is Also Manufactured in Standard Lengths and a Bridge All Ready to be Installed can be Shipped Out from One of the Plants. Toward the Left is Seen the Concrete Mixer for Outdoor Work. It Runs on Rails and can be Moved to Almost Any Part of the Yard



General View of One of the Three Factories Established by the Burlington Railroad for Standardizing Its Concrete Work: This Plant is Located at Havelock, Nebraska. Though but 60 Feet Wide, It Is Five Blocks Long. Some of the Watering Troughs are Seen in the Foreground



### STEAM SHOVEL LIFTS ITS OWN WHEELS

A steam-shovel engineer recently decided to hasten the slow operation

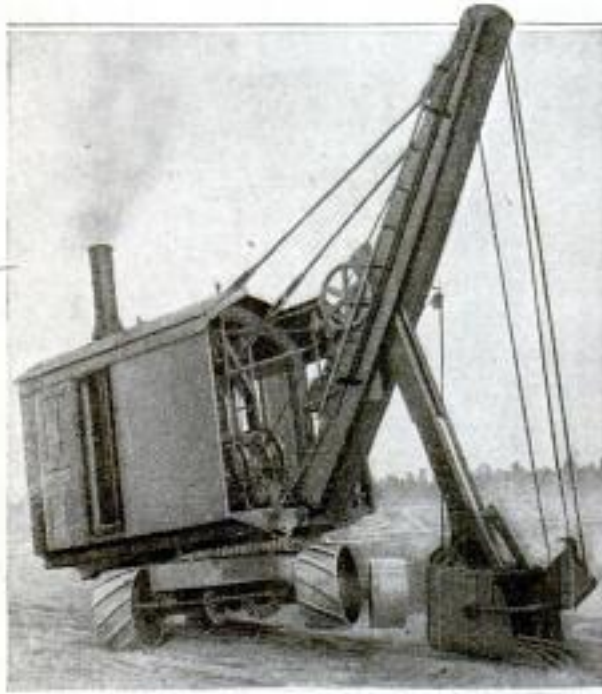

This Shows How a Steam Shovel was Raised from the Ground by Its Own Power, So That Planks could be Inserted under the Wheels. With the Bucket Lowered to the Ground, the Power was Turned On, Which Tilted the Whole Machine

of placing planks under the wheels of his ponderous machine in order to move it along. He made the shovel aid in lifting up the wheels. By lowering the steel bucket flat against the ground and then applying the power of the engine as though excavating, the entire apparatus was tilted until one wheel was a foot from the ground.

### 3840 VAST TRACTS OPENED UP FOR STOCK RAISERS

The signing by the president of what is known as the 640-acre stock-raising homestead law will result in the opening up to settlers of public lands in the West many million acres in extent. Under this law the land must be taken up for stock-raising homesteads, and for no other purpose. The total cost for filing on 640 acres, which is the maximum amount allowed per individual, is \$34. Improvements must be made and cattle raised at the outset. One object of this measure, which has

the approval of the Department of Agriculture, is to open up areas which are valuable only for grazing and raising forage crops, do not contain merchantable timber, and cannot be irrigated from any known water supply. The act is so worded that it will bring only bona-fide settlers into the regions opened up. Special precautions are being taken to prevent large corporations from gaining possession of territory by subterfuges. Colorado estimates that the opportunities offered will bring 100,000 persons to that state alone, within a year.

*Harness*

### ADJUSTABLE HORSE COLLAR 2896 AND HAMES

It is so important that the collar worn by a draft horse be properly fitted, if he is to do his full share of hauling, that the majority of owners of heavy teams exercise great care in getting collars for their horses that are the right size. A new collar has been placed on the market which can be adjusted 4 in. in width at the top, 3 in. at the bottom, and correspondingly as to length, so that it can be well fitted to an animal no matter what its condition of flesh. The article is really a combination of collar and hames and is made of pressed steel and leather, with a well-padded cushion. At the

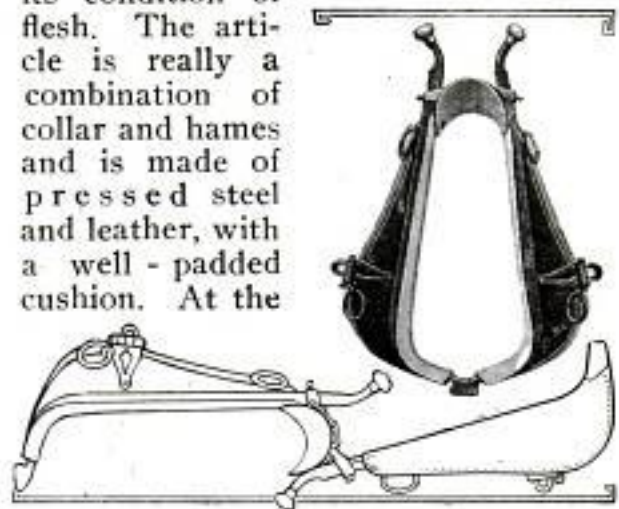

Combination Horse Collar and Hames Which can be Adjusted Both as to Length and Width at the Top and Bottom. It is Made of Pressed Steel and Leather

top is a swivel joint which hinges the halves together so that they are easy to handle in harnessing and unharnessing. The collar is equipped with a self-adjusting neck pad.

*Hahn Bros,  
Indianapolis, Ind.*



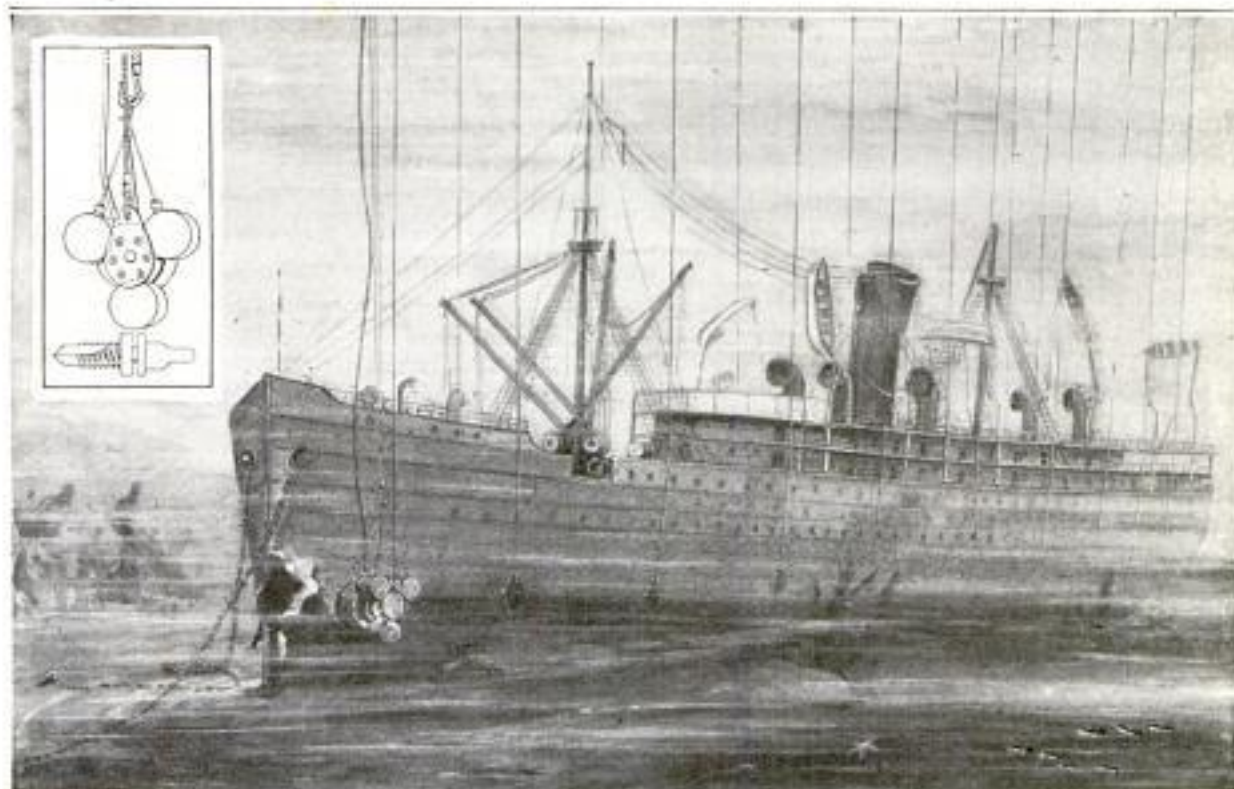

Near the Bow of the Sunken Vessel Is a Device, Held in Place by Magnets, Which Screws to the Hull a Plate Attached to the End of a Hoisting Cable. Other Cables are Shown Already Attached. A Diagram of the Mechanism Appears in the Insert, together with a Detail of a Combination Drill, Tap, and Bolt

3510 **MAGNETIC DEVICE FASTENS  
CABLES TO SUNKEN SHIPS**

A ship-salvaging device has been invented by a resident of Seattle, one of the interesting features of which is that it employs electromagnets to hold the apparatus to the side of the sunken vessel, thereby making it unnecessary to employ divers for such work. The apparatus has not yet been given a practical test, so far as is known, but the type of service which it is intended to perform by its unusual use of magnets suggests an enlarged field of application. It is provided with three electromagnets placed about a water-tight case containing an electric motor. When the apparatus is about to be used the case is filled with compressed air to withstand water pressure. The motor operates a set of boring instruments, each of which is a combination drill, tap, and bolt. A steel plate, in which are holes properly placed, is fitted over these drills and to the plate a hoisting cable is attached. The device is lowered to the desired point close beside the sunken ship and then the

magnets are energized so that they fasten themselves to the steel hull. This is indicated above water by the lighting of three bulbs. When the motor is started the drilling instruments begin boring into the hull. They are so made that at the proper time they break off, so that the mechanism can be raised to the surface, while the plate to which the hoisting cable is attached remains bolted to the hull. When enough cables have been attached in this way the raising of the vessel can begin.

2863 *Swimming*  
**OLD HULL SUPPLIES SALT  
WATER FOR BATH POOL**

A most ingenious means of profitably utilizing a wrecked and abandoned boat hull is that applied in the case of the "Seminole," which is now used as a floating tank to haul salt water for a public swimming pool in Oakland, Calif. The "Seminole" was one of two river boats which collided in San Francisco Bay and was so badly damaged that the hull was rescued with difficulty but never re-



turned to service. In Oakland is a salt-water swimming pool which had depreciated in value because of the difficulty of getting clean water. A shipyard owner, seeing an opportunity for a good investment, bought the hull at a low figure and also acquired control of the pool. He then laid a 4-in. pipe from the pool to a dock in the estuary two miles away, where he tied the hull. On the latter an 18-hp. pumping plant was installed. From time to time what once was the "Seminole" is towed out to Golden Gate and allowed to fill with 750,000 gal. of clean salt water. It is then brought back and its contents pumped through the pipe line to a reservoir serving the pool. The popularity of the baths has greatly increased now that the bathers are sure of salt water practically as clean as the open ocean.



Swimming Pool Now Supplied with Clean Sea Water by the "Seminole," Which Serves as a Water Barge



Above: View on the Deck of the Barge, Showing the 18-Horsepower Pumping Plant

Left: Hull of the "Seminole" at the Dock Where It Connects with a Two-Mile Pipe Line through Which the Water is Pumped

## PEACH AND APRICOT SEEDS USED AS FUEL

Hundreds of tons of peach and apricot seeds, which have been thrown away every season heretofore by the canning factories in the great fruit districts of California, are now sold as fuel and bring \$2.50 a ton retail. Formerly the seeds were considered too hard for fuel, but recently it was found that when heated in a stove burning hard coal they soon pop open and ignite, after which they burn with an intense glow like that of anthracite, and are practically smokeless, besides holding a fire well. This discovery at once gave the despised seeds a market value, and they have become a source of profit to the canners who formerly discarded them as worthless.

3220

## HEAVY DONKEY ENGINE CARRIED BY TRUCK

A motor truck was called upon to do extra-heavy duty in the big woods near Seattle recently, when it became necessary to move a 15-ton donkey engine to a new location. The feat was accomplished by setting up the engine on two big logs, laid side by side, making all firm by a wooden

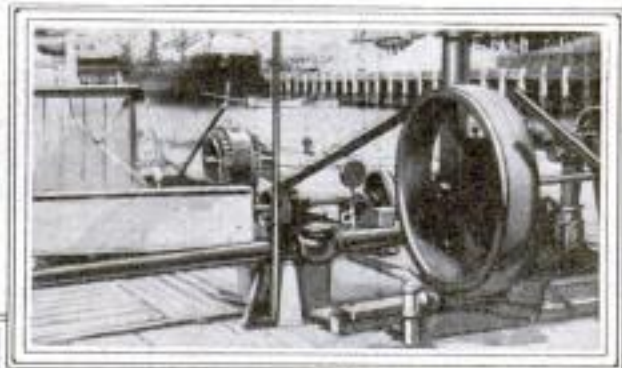



Kelly

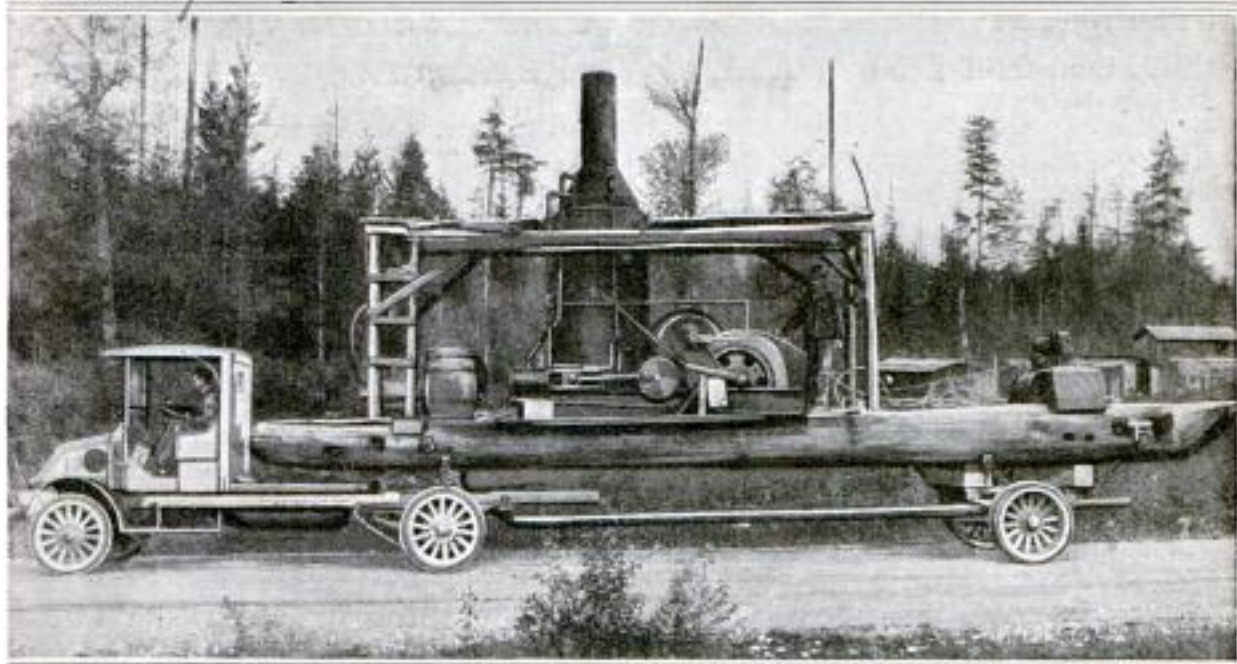

Carrying a 15-Ton Donkey Engine on a Motor Truck in the Washington Woods

2595

superstructure. The whole contrivance was then placed on a semitrailer, long enough to accommodate it, and attached to a 3½-ton motor truck. The truck responded gamely to the unusual load and carried it the required distance along a state road, thus demonstrating a new use for the motor truck in the lumber business.

3712

**OLD PAPER MADE INTO NEW BY CHEAP PROCESS**

C. S. Monahan

Some relief from the paper shortage, it is thought, may result from the discovery of a new process by which old newspapers can be used in producing fresh news-print paper. Experiments were made recently with three tons of old dailies and the new paper made from them is described as being whiter than the original. One of the objections to using old papers in the past has been that under the usual treatment the heat applied to the pulp caused it to turn a bright orange, thus making it unfit for use. The new method is essentially a cold process and involves a different chemical treatment so that a white product is possible. The cost of this process is said to be under \$5 per ton. Certain manufacturers are reported to be much interested in the new method.

**GOOD POINTS ARE EMBODIED IN PUBLIC DRINKING CUP**

Two objectionable features of the sanitary cup, such as is commonly employed with the so-called drinking fountains installed in public parks and elsewhere, have been overcome in the construction of a new article of this character. The depression of a thumb lever opens a valve and causes the water to fill a small chamber before flowing through openings in the rim of the bowl and forming a cone-shaped bubble. This arrangement dissipates the back pressure and prevents a shaft of water from spurting up as the valve is first opened. When fountains of this sort are used chiefly by children, it is quite a usual thing for some youngster to place one hand over the cup and squirt the water. When such a thing is attempted with the new device, the water is forced into tubes and carried into the drain pipe. Thus both spouting and squirting are obviated.



Inventor:

Dr. Thomas J. Pearson  
Keenah, W. V.

Oregon B. & C. Times

Not copyrighted material



# Stanley W. Todd  
327 The Bowing St.  
Brooklyn N.Y.

586

2717

POPULAR MECHANICS

3920

### STERN EXTENSION MAKES MOTORBOAT SKIM WATER

In order to get the hydroplane effect and increase the speed of his motorboat as much as possible, a racing

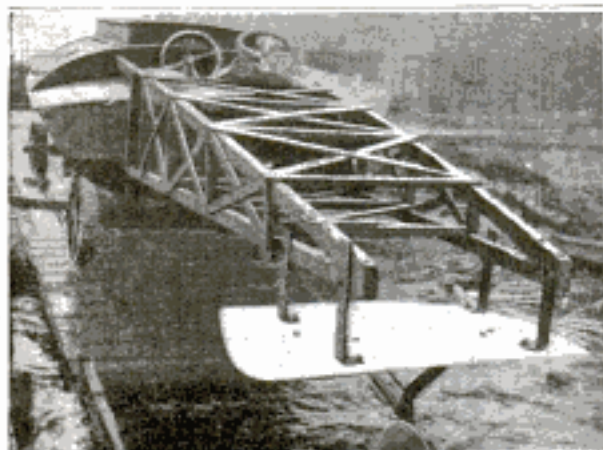

Rear View of Motorboat Extension, Showing the Metal Shield over the Propeller and the Construction of the False Stern

enthusiast of White Bear Lake, Minn., has equipped the boat with a framework ex-

tension at the stern, which supports the propeller at its outer end. To carry the additional outboard weight there is a metal shield with a slightly curved surface above the propeller. When the boat is running fast this glides along the surface, lifting the false stern clear into the air, while the bow is also lifted and the rest of the hull merely skims the water. The high-powered engine has automobile control.



Motorboat with Novel Stern Extension, Designed to Carry a Curved Shield along the Surface with a Lifting Effect at High Speed

### STEREOSCOPIC VIEWS SHOW STARS IN PERSPECTIVE

Sci. Am. 1-13-17

An American astronomer, borrowing the idea from Germany, has prepared stereoscopic views of the heavens, which have been found to portray celestial bodies in vivid perspective. These pictures are especially suited to popular use in the study of the stars. The illusion of perspective is obtained by allowing an interval, perhaps of several years, to elapse between the taking of the two pictures used at one time in the stereoscope. This differ-

ence of time generally permits the body photographed to move enough to present two slightly different aspects to the beholder. In one instance two exposures used were taken 14 years apart, and the resulting effect of depth in the heavens was pronounced very beautiful. This appearance of perspective the astronomer has found

hard to explain in certain cases, for sometimes there has been no observable motion in the object photographed. Furthermore, it was discovered that a pair of photographs from the same negative, showing the Milky Way in one of the constellations, conveyed this same sense of distance when viewed through the stereoscope. These experiments suggest a most interesting field for investigation.

Prof. Max Wolf

Heidelberg

2734

### OIL WASTE BURNED AFTER PUMPING IT INTO DITCH

When land adjoining San Francisco Bay was cleared preparatory to erecting the Panama-Pacific Exposition buildings, one of the difficult tasks which the workers faced was the disposal of two large oil tanks and quantities of oil waste which had accumulated while the tanks were in use. To pump the waste into the bay, half a

mile away, would have been to violate the law and seriously injure shipping, as well as harm the game birds which might alight in the oily scum. The tanks were disposed of by jacking them up and hauling them to another location. It was decided to burn the oil, but to do it in such a way that it would be kept well under control. A



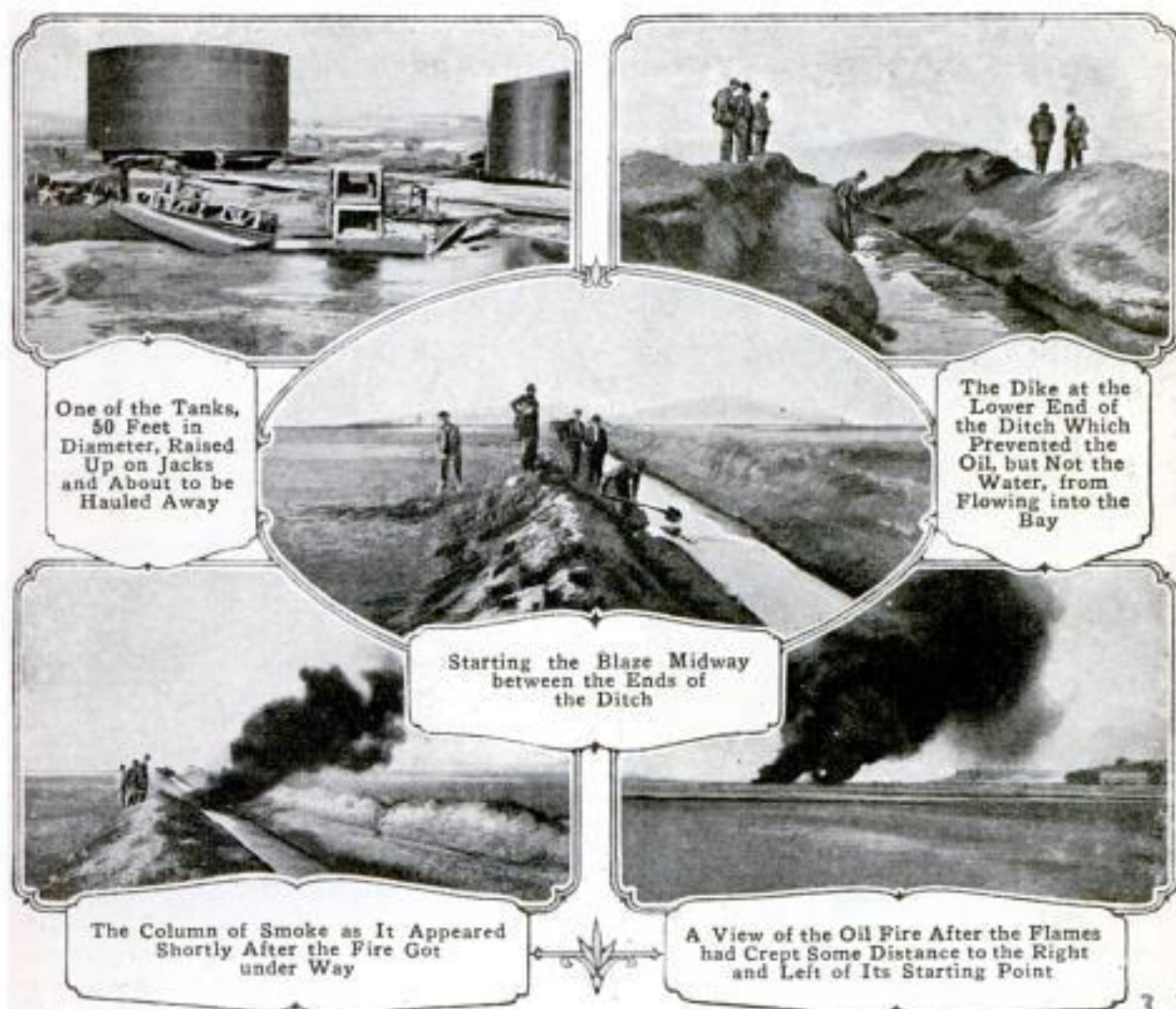

One of the Tanks, 50 Feet in Diameter, Raised Up on Jacks and About to be Hauled Away

The Dike at the Lower End of the Ditch Which Prevented the Oil, but Not the Water, from Flowing into the Bay

Starting the Blaze Midway between the Ends of the Ditch

The Column of Smoke as It Appeared Shortly After the Fire Got under Way

A View of the Oil Fire After the Flames had Crept Some Distance to the Right and Left of Its Starting Point

ditch 4 ft. deep was dug from the site of the tanks, sloping gradually down to the bay, and filled with water. A dike was constructed at the bay end to keep the water from flowing out except through a passageway under the barrier. The oil waste was then pumped into the ditch and, because it was lighter, spread out over the water from the tanks to the far end. After one or two unsuccessful attempts the oil was set on fire midway between the ends of the ditch. The flames traveled toward each end about as fast as a man would walk. A wind blowing toward the water hastened the blaze moving in that direction. All of the oil was consumed as the fire progressed and produced a vast double column of black smoke that drifted across the sky for many miles, and attracted considerable attention because of its peculiar formation.

### GERMAN CONCERN FOUNDED TO INSURE UNSAFE RISKS

*Stuttgart Insurance Ad. Co.*  
Persons in Germany who are unsafe life-insurance risks can now insure themselves, a company having been organized to issue policies to those to whom the standard concerns decline to give protection. The new movement is the result of a conference of the leading insurance companies in the empire who agreed that in these war times, particularly, all classes should be insured. Since about 10 per cent of the applications coming to German concerns are refused, it is evident that this new undertaking will fill a large gap. Rates and conditions upon which unsafe risks will be taken have been formulated. Some 18 companies have contributed money to the new corporation, which has a capital of about \$700,000 at the present time.



1-5 Peterson Art Furniture Co., Faribault, Minn.  
 2-7-10-12-13 R.L. Keryon Co., Wausau, Wis.  
 14-16

**SUGGESTIONS FOR WARM-WEATHER FURNISHINGS**

3778



1 Magazine Stand 30 Inches High with Serviceable Side Pockets for Newspapers



2 The Cushioned Chair Shown Here is Hinged to the Crescent-Shaped Desk, and When Not in Use can be Swung Forward Out of the Way

3 Stand with Ash Tray and Match Holder



*Chgo*

*Recreation Co. Mick Mr.*

*Chgo*



4 Hall Stand with Two Compartments for Umbrellas, One for Rubbers, and a Convenient Drawer



5 Hall Tree Provided with Many Hooks, Well Suited for Use with Stand Shown at Left



6 An Advantageous Feature of This Rather Quaint Tea Wagon Is Its Ample Shelf Space



10 Jardiniere and Stand Well Suited for Living Porch or Summer Cottage



7 The Broad Arm of This Oddly Shaped Chair is Designed to Hold a Telephone. The Pocket Below is for a Directory



8 A Most Inviting Chair with High Curved Back and Broad Arms. The Portable Reading Lamp Matches the Chair

9

*4-W + J. Sloane  
 15th St. at 47th N.Y.C.  
 San Francisco -  
 Wash. D.C.*



8-9-11 Heywood Bros & Washfield Co. Chicago.  
 1415 So. Michigan av. Chgo.  
 2 Wm. Washfield

SHOWING REED ARTICLES IN GREAT VARIETY

11

3778

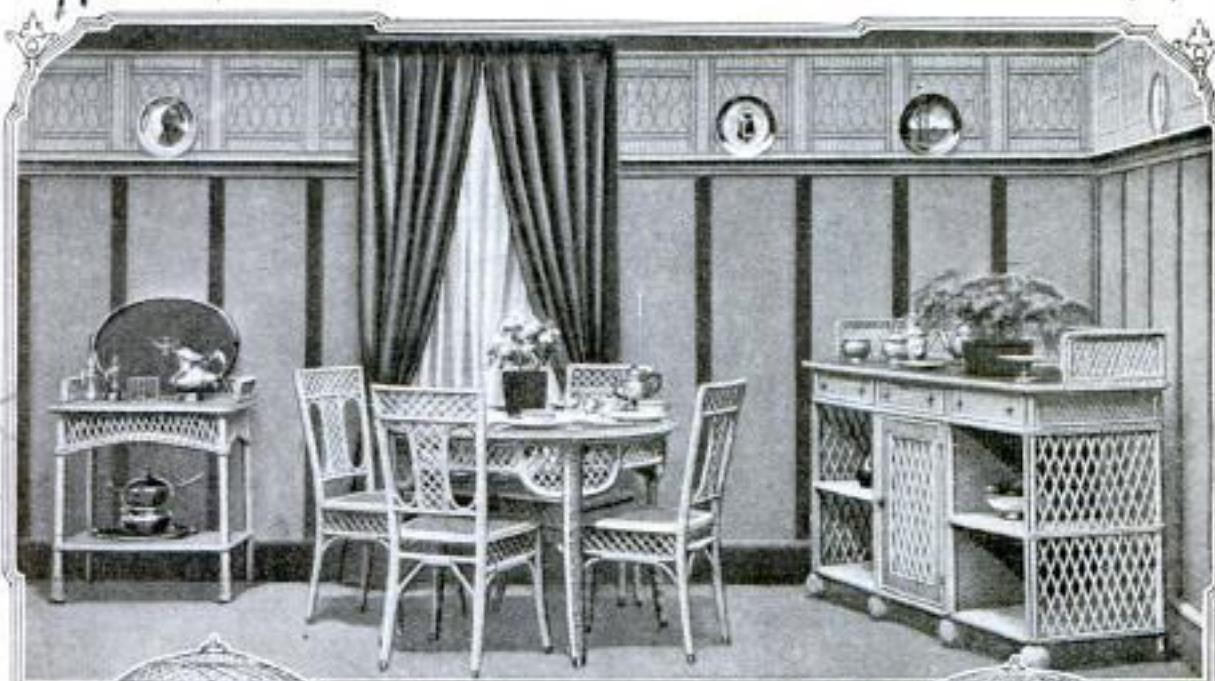

The Cool, Airy Effect Produced by Using Reed Furniture Exclusively, Makes an Apartment, as Shown in the Breakfast Room Above, Most Attractive. While Light, These Articles are Strongly Built and will Endure Steady Usage Well



12  
 The Bright-Hued Cretonne Lining in the Shade of This Hall Lamp Lends a Desirable Touch of Color to Any Room Furnished in Reed



14  
 The Openwork of This 28-Inch Indirect-Light Globe Produces an Artistic Illumination Effect



13  
 An Artistic Hall Lamp of Fine Weave but Substantially Made. Well Suited for Use the Year Around. It is Provided with Three Electric Bulbs

15  
 Another Example of Pleasing Latticework Effect. This Table is Designed to Stand in a Corner and can be Used as a Writing Desk



16  
 An Aquarium Stand, 31 Inches High, Provided at Either End with Boxes for Ferns or Flowers

*Ypsilanti Reed Furniture Co. Tonawanda, Mich.*



Wentler - Hammer Mfg. Co.  
Milwaukee

590 3700 POPULAR MECHANICS

### ELECTRIC HEATING UNITS FOR WORKMEN

Workmen who are more or less exposed to winter cold, like crane oper-

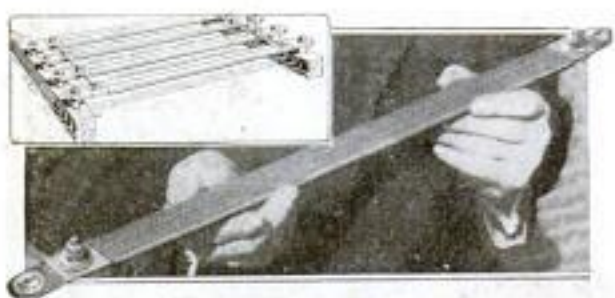

Electric Heating Unit, Which can be Used in Groups as a Stove for Workmen in Exposed Positions

ators, shearmen and tablemen in steel plants, can now be warmed in their

uncomfortable cabs by a type of electric heating units recently adapted for the purpose. The new heater is an inclosed steel-jacketed unit, resembling a flat ruler, 2 ft. long, 1 1/2 in. wide, and 3/16 in. deep. The steel jacket incloses a heating element and this is in turn inclosed in mica. Either direct or alternating current can be used, and the units can be installed either singly or in groups.

It is hoped that Federal aid can be secured for a proposed school of fisheries at the University of Washington in the state of the same name. Such an institution would be a great aid to all engaged in the fishing industry on the north Pacific coast.

### 2852 LAKE BOAT LENGTHENED FORTY FEET

By inserting a big section of steel hull in the center of the pleasure boat

of ship alteration took place a few months ago in Detroit. After the vessel had been dry-docked it was cut in two amidships. Ground ways were placed under the forward half, together with greased sliding bilge ways, packing and poppets, in the same way as launching is prepared for. Heavy tackle was then fastened to the bow and with the aid of a steam winch this half



Boat Cut in Two Amidships, Preparatory to Inserting a 40-Foot Section of New Hull

"City of Toledo" its owners increased the length of the craft from 212 to 252 ft. and its passenger capacity from 1,375 to 1,954, or more than 40 per cent. This interesting piece



Pleasure Boat the Passenger Capacity of Which was Increased from 1,375 to 1,954 by Lengthening It 40 Feet

White Star Line Detroit  
C. J. Billman, Sol. Agt. Copyrighted material



was drawn forward 40 ft. The section of the steel hull was then built to connect the halves. At a point about 30 ft. forward of the midship frame the width of the new section was increased 27 in. at the light water line and the body faired into the original lines forward and aft. This was done to increase the stability. The lengthening made it possible to construct a ballroom 50 ft. square on the promenade deck. A system of cantilever beams was used to support the upper deck. In this way few obstructing posts were required in the ballroom. The two original boilers, each having three furnaces, were displaced by five return-tube boilers, each having two furnaces. The new boat has two smokestacks instead of one. Another feature is space in the forward part of the vessel for motor cars, which form a large part of the cargo.

*3874*

### TRAINS CARRY OFFICIAL STORM SIGNALS

Whenever the weather bureau predicts a storm, a blizzard, or a cold wave the trains of a western Kansas railroad display the appropriate government weather flags as warning signals for trackmen, bridge gangs, and other employes of the road. Farmers and other residents along the line also get the benefit of the signals and appreciate them. The forecast of a storm, when received in the daily weather bulletin at the general offices of the road, is wired to all train conductors, who promptly place the signal flags, indicating the kind of weather expected, on special staffs mounted on the engines, at each side of the smokestack.

*301*

### NEW STERILIZER OPERATES QUICKLY AND AT LOW COST

A compact, almost instantaneous sterilizer is now being used by physicians, dentists, etc., which sterilizes instruments at atmospheric pressure with steam generated by electricity. It can be operated in full view of a

patient. The apparatus consists of a double-walled chamber with an opening in one end in which is inserted a tray that holds the instruments. Between the walls are electric heating wires. Above the cylinder is a cup



An Apparatus Which Sterilizes in 30 Seconds, with Steam Generated at Atmospheric Pressure by Electricity

from which water can be made to drop at any desired rate. The water drips through a tube and down between the walls, where it is converted into steam by the heated wires. The steam then passes through holes into the chamber and, together with the direct heat from the wires, will sterilize an instrument in 30 seconds.

*1669*

### ADJUSTABLE DISPLAY CASE FOR ADVERTISING MATTER

To permit advertising booklets, catalogues, and railway time-tables of different sizes and shapes to be advantageously displayed in offices and public places, a cabinet is being made which is so arranged that the vertical compartments in each tier can be adjusted to various widths. Metal spacers are fitted into a channel attached at the back of each row. When one of these members is moved to a

*National Ticket Co. Gen.*  
*840 W. 35th St.*  
*Chicago*  
Copyrighted material

*Antisepsis by Northern R.R.*



desired position and turned vertically, a slot in its upper edge engages a metal bar that extends across the front of the



The Compartments in Each Row can be Adjusted to Accommodate Booklets of Various Widths

row to prevent pamphlets from falling out. So long as the divider is in this upright position it is held firmly against movement. This scheme makes it possible to display a narrow timetable and wide descriptive booklet side by side.

3641 —

### AMERICAN ADAPTS AFRICAN CARRIER TO BABY'S NEEDS

Instead of being rocked to sleep in a regular cradle, the baby of a certain American missionary in Africa often takes its nap while being carried through the jungle in a crib, swung



A Modernized African "Machila" in Which the Baby of an American Missionary in Africa is Carried by Natives from Place to Place

from a pole that rests on the shoulders of two native bearers. The novel conveyance looks a little like a palanquin from India, but really is an adaptation of an African conveyance called a "machila." When the baby's parents are not on the road, the little one's bed is unslung from the pole and placed on a canvas cot, or swung between two trees like a hammock.

### SELF-ADJUSTING BELT FOR 3607 MACHINERY

A new nonslipping belt recently placed on the market by a South Dakota company is built of sections of leather, cut and punched by special machines and forced over lengths of coil springs, the number of springs depending on the width of the belt. In making a belt of any desired length, the ends of the springs are coupled and

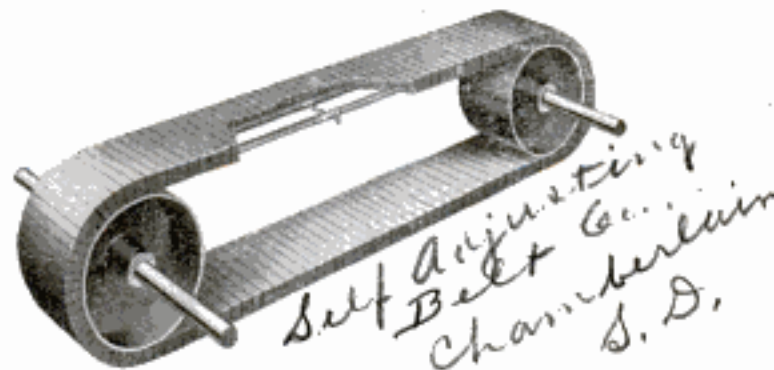

This Picture Shows Plainly the Construction of a New Nonslipping Belt, Made of Sections of Leather Forced over Coil Springs

hinged on a pin which passes crosswise through one section of leather and is clinched on the outer edges. The leather sections are set close together and edgewise, so that the wearing surface of the belt falls on the end grain of the leather, which gives the best wear. Being under constant pressure from the concealed springs, the belt is said to cling to a pulley with surprising tenacity. The springs are made of steel piano wire and will retain their original tension, it is claimed, under any working conditions. When placed upon the pulleys where it is to work, the belt is adjusted under a slight tension which keeps it constantly tight and prevents slipping.

# Herbert G. Withey,  
323 N. Curtis Av.,  
Humboldt,  
Calif.



Dr. Arnistead, L. Lerump,  
20 W. 50th, N.Y.C.

### NEW SURGICAL USE FOR SAUSAGE SKIN

In cases of stricture of the esophagus, which is the canal through which food passes to the stomach and which is situated behind the windpipe, it is very important to secure an early diagnosis. A New York hospital physician reports a new method which gives a clear outline of malignant strictures and is also a readily applied aid in the treatment of moderate cases. A small length of sausage skin, which is the fibrous coat of the intestine of the hog, is thoroughly washed and treated with formaldehyde and glycerin, then formed into a bag by tying one end with silk floss, the other end being slipped over a rubber tube and tied. The bag, which is now only a string, is then easily swallowed by the patient with the aid of a little water, and a thick bismuth mixture is allowed to flow into it, after which X-ray pictures show the outline of the stricture clearly.

### SAFETY RULER PREVENTS INKY FINGERS

3640

A ruling device that is claimed to be the only safety ruler known has been invented by an Ohio man. Its safety lies in the novel construction, which prevents inking the fingers and smudging the book or paper when ruling, as is common with ordinary rulers. The new ruler consists of two graduated boxwood strips, forming sidepieces and connected at the ends by T-bars of polished aluminum which support two parallel nickelplated wires, or bars, in the open space between the sidepieces. The ruling is done on these wires, which are always elevated above the surface to be ruled.



### NEW OILCAN MINIMIZES WASTE OF OIL

An oilcan with useful features has been designed by a young inventor of Smithton, Ill. The dome-shaped can is fitted with a false bottom in which are two leather valves, operated by pressure on the real bottom below, which is expanded and flexible. A spout with bent end runs down through the body of the can and is connected to the false bottom, so that oil can only pass into it from the pressure chamber formed by the false bottom, through one of the valves, thus preventing waste. The second valve admits the supply of oil to the pressure chamber, and there is a filling spout in the dome, with a filtering screen. In operation, when the bottom is pressed, oil flows through the first valve into the spout; when the pressure is released, a vacuum is created in the pressure chamber and new oil is drawn in from the can.



Dominic J. Reinhardt  
Smithton Ill.

### U-SHAPED BRISTLES USED IN NEW TOOTHBRUSH

Many dentists condemn the stiff-bristle toothbrush, especially when it causes continual laceration of tender gums. With this point in mind, a Pennsylvania inventor has sought to produce a less objectionable article by imbedding both ends of the bristles. Although it is possible that extra attention would be required if such a brush were to be kept sterile, it is easy to see that the looped bristles would not scratch so much as ordinary ones.



John E. Hamilton  
Smithton Pa.

Walter's Safety Ruler Co.  
Chambersburg, Pa.



### NEW SCREENED ENTRYWAY IS TRAP FOR FLIES

For capturing and exterminating house flies that invariably swarm around the doors of grocery stores,

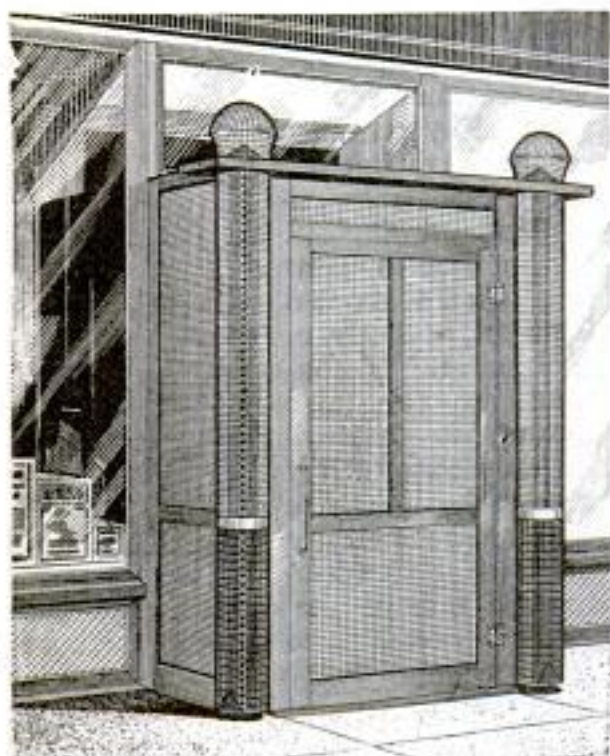

The Lower Part of the Screen Columns are Reinforced with Heavy Netting, While the Traps at the Top may be Removed and Cleaned from Time to Time

restaurants, and similar places, an Illinois man has devised a new type of trap. He makes use of a screened vestibule and at the corners of it, on either side of a swinging door, provides two vertical screen cylinders which extend from the sidewalk to the top of the inclosure. A metal channel piece, that has a row of perforations, is incorporated in each of the wire columns on the inside of the inclosure. Flies congregate within the screened vestibule in preference to the darker interior of the building, and in due course are supposed, in their quest for light, to enter the screened columns through the holes provided in the metal strips. Once inside, they climb upward and eventually pass through a cone trap at the top. In this compartment, from which escape is impossible, they reach poison bait and die. It is argued that the flies on the outside of the building

will, in seeking entry, gather at the sides of the vestibule nearest the store windows, instead of swarming in front of the screen door itself. In actual use the arrangement is said to have proved helpful.

### 2729 FIBER VESSELS REPLACING GLASS MILK BOTTLES

Air-tight, paraffined fiber containers for liquid and other food products are gradually being adopted by distributors and retailers, and accepted by consumers in certain localities as preferable to glass bottles, jugs, and other vessels. A receptacle that may be destroyed after being used once is of particular advantage in marketing dairy products, for the chipping of glass milk bottles, the possibility of contamination due to their improper sterilization, the loss through breakage, and the inconvenience alike to consumer and dealer occasioned by the necessity of their return, are all serious drawbacks. Therefore it is interesting to note that in several western cities milk, buttermilk, and cream are being delivered in sanitary, spruce-fiber containers that may be destroyed after they have once been used. Packages of the same character, provided with large openings,

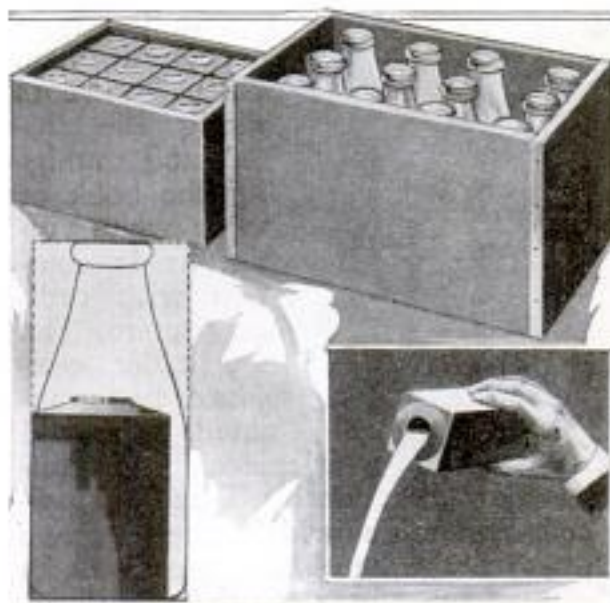

By Comparing the Two Cases Above, the Amount of Space Saved by Fiber Containers is Indicated. The Contrast between the Square Can and the Ordinary Milk Bottle is Even More Noticeable. Liquids can be Poured from the Receptacle Freely

Weis fibre container Corp  
Monroe Cop. Mfg. material



are also being made for grocery stores, so that bulk vinegar, oysters, olives, pickles, strained honey, cider, and similar commodities, may be handled conveniently and carried to customers in thoroughly sanitary, clean, and attractive packages. These containers are strong enough to withstand fairly rough handling without leaking, while their contents are not affected through contact with the paraffin coating, which is colorless, odorless, and tasteless. The packages are available in different sizes and when purchased in quantities are of reasonable price. They may be sealed as easily as ordinary milk bottles, and in a delivery wagon have the advantage of occupying much less space than glass bottles of similar capacity.

3535

## STOVE LID MADE LIKE

## AN IRIS DIAPHRAGM

IND-TID. NORDEN

A kitchen-range cover has recently been patented in Sweden which is so

constructed that an opening can be made in it of any size up to the limit of the device. It somewhat resembles an iris diaphragm of a camera or microscope and is a very convenient article in

that it enables a housewife to place dishes of various sizes, even down to a small cup, directly over the fire. The cover is opened and closed by means of a lever to which a knob is attached.

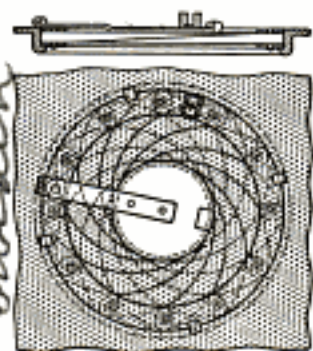

3761

DEVICE FOR SAMPLING  
CONTENTS OF SACKS

A simple tester has recently been devised by means of which a sample can be secured of the contents of a cotton, or burlap, grain bag without going to the trouble of opening the sack. It consists of a pointed brass tube, 13 in. long and  $\frac{3}{8}$  in. in diameter,

U. S. Bureau of Plant  
Industry

in the side of which are six oval openings. In the tube is a plunger provided with a convenient handle. To

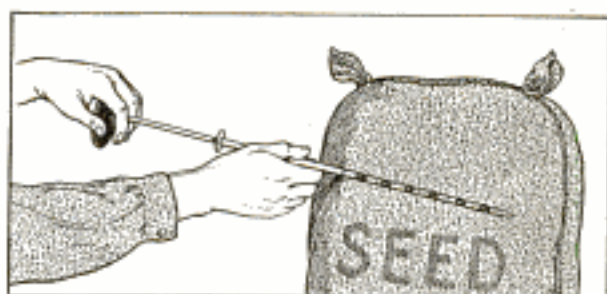

The Seed Sampler is Inserted through a Grain Sack. After Which the Plunger is Withdrawn, Allowing Seeds to Flow into the Tube through Holes in Its Side

obtain a sample the pointed end of the tester is inserted through the bag to the desired depth, after which the plunger is withdrawn. This allows the seeds to flow into the tube through the oval holes. After the tester has been removed, the samples which it contains can be emptied out through its open end.

— 3610

SCREW EXTRACTOR WORKS  
LIKE A CORKSCREW

A new tool lately placed on the market is designed to save the time and labor hitherto required for the removal of all kinds of broken screws, studs, and stay bolts, which has always been a long and troublesome job. This screw extractor is made of tough steel and operates on the principle of an ordinary corkscrew. When a setscrew, cap screw, or stud snaps off, the machinist equipped with this tool, it is claimed, need only drill a small hole in the broken part and insert the extractor, giving it a slight twist to the left to seat it firmly in the hole. On further twisting, it bites its way into the screw, secures a purchase, and backs the broken screw out on its own threads. When a wrench is brought into play the most stubborn screw comes out without damaging the threads of the hole.



Cleveland Twist Drill Co.  
E. 49th & Lakeside Av.,  
Cleveland, Ohio



# SOME NOVEL AND LITTLE-KNOWN ACCESSORIES

3777



Tea Set Consisting of Caddy and Kettle-Shaped Tea Ball with Stand. It is Packed in Satin-Lined Calfskin Case. Price \$18.75



Talcum Powder for the Nursery is being Packed in Containers Like These, Which may be Given to Children as Toys When Empty. Price, Postpaid, 25 Cents



Stove Lid Provided with Lip Which Allows a Flatiron Handle to be Used as a Lifter. Price, Three-Pound Size, 75 Cents at Factory



Paddles for Mixing Pastry Shortening. Ingredients Rubbed between the Disks until Properly Combined. Price 25 Cents



Breakage is Prevented if Toilet Preparations are Carried in "Armored" Flasks When One is Traveling. Three-Ounce Size, \$1



Many of the Little Things Needed in the Care of a Baby are Conveniently Arranged in This Dainty Toilet Screen, Which is Folded When Not in Use. Price, at Factory, \$25



Dusting Cloth That Gloves the Hand and Protects It Somewhat from Dirt. Price 25 Cents; Canada 35 Cents



This Glazed-Calfskin Desk Set is Available in Different Colors, and Has a Border Design of Gold Tooling. A Removable Silk Cover for the Blotter is Provided. The Price is \$47.50



For Carrying Parcels in the Motor Car, Robe-Rail Bags like These Are Available for \$5 and \$6



Compartments at the Ends of This Laundry Basket, a Recent Invention, Serve as Depositories for Clothespins



Sharpener That Remains on Pencil, Serving as a Grip for Fingers When Writing, and Protecting Point at Other Times. Price 10 Cents

In Addition to its Beveled End, This Funnel Has a Groove Which Allows the Air to Escape from a Small-Necked Container as the Inflowing Liquid Forces It Up



This New Dishwasher Uses the Water That Flows from a Hot-Water Faucet through a Soap Compartment to Actuate Revolving Sprays. Price, at Factory, \$25

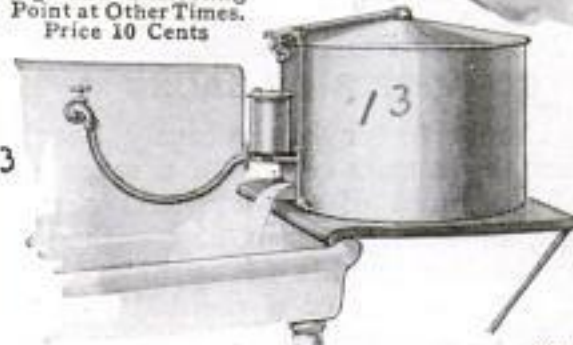



- 1 TEA SET--Mark Cross, N. Y. 404 5th Ave. 3777
- 2 TALCUM POWDER-- Toy Tale Co., 1336 Main St., Buffalo
- 3 STOVE LID-- J. T. Peet, Wellington, Mo.
- 4 PASTRY PADDLES-- Reliable Stamping Co., Tacoma, Wash. (11th + Oregon) <sup>Wash.</sup>
- 5 TRAVELING FLASK-- Holton & Adams, 29 E. 22nd. St., N. Y. <sup>see</sup>
- 6 DUSTING CLOTH-- Textile Utilities Corp., 110 W. 30th. St., N. Y. <sup>Klaarsen's E-Z Klean Cloth</sup>
- 7 DESK SET--Mark Cross, N. Y.
- 8 BEBETIERE SCREEN-- Beaver Board Co., Buffalo
- 9 ROBE-RAIL BAGS-- Lowe Motor Supply Co., 1727 Broadway, N. Y.
- 10 CLOTHES BASKET-- Invt. by M. L. Hagarty, Rear 412 Essex St., Lynn, Mass
- 11 FUNNEL-- Invt. by P. M. Church, 184 Franklin St., Buffalo, N. Y.
- 12 PENCIL SHARPENER-- S. Jensen & Co., 828 Santee St., Los Angeles
- 13 DISH WASHER-- Dietz Mfg. Co., 120 Opera Place, Cincinnati
- 14 POCKETBOOK-- Erpenbeck & Segessman, 412 N. Dearborn, Chicago
- 15 FLATIRON HOLDER-- Mrs. Dora Hartig, Invt., Essex County Parental School, Sussex Ave., Newark, N. J.
- 16 BABY'S TRAY-- Lisk Mfg. Co., Canandaigua, N. Y.
- 17 BOOK HOLDER--Harper's Bazaar
- 18 FLOWER BOX--Savo Manufacturing Co., 39 S. La Salle, Chicago
- 19 FLOWER POT-- A. L. RANDALL, Co., Wabash & Lake Sts., Chicago
- 20 ADJUSTO RACK-- Wayne Mfg. Co., 354 Mulberry St., Newark, N. J.
- 21 COFFEE MILL-- Hamilton-Beach Mfg. Co., Racine, Wis.
- 22 GARTER-- Thos. P. Taylor Co., Bridgeport, Conn.
- 23 AUTOMATIC COOKER-- R. E. Travis, Agent, 4950 St. Anthony Ct., Chicago <sup>"Thermo-Valve" Harter Co. Waukegan, Ill - see Pat. 2,111,747 p. 597</sup>
- 24 REGISTER SHIELD-- Hall Hardware Co., 137 W. Washington St., Indianapolis







1,087,943. CULINARY UTENSIL. NOAH S. HARTER, Waukegan, Ill., assignor to The Harter Company, Waukegan, Ill., a Corporation of Illinois. Filed Jan. 3, 1913. Serial No. 739,996. (Cl. 236-6.)

Feb 24, 1914

P. G. 194-964

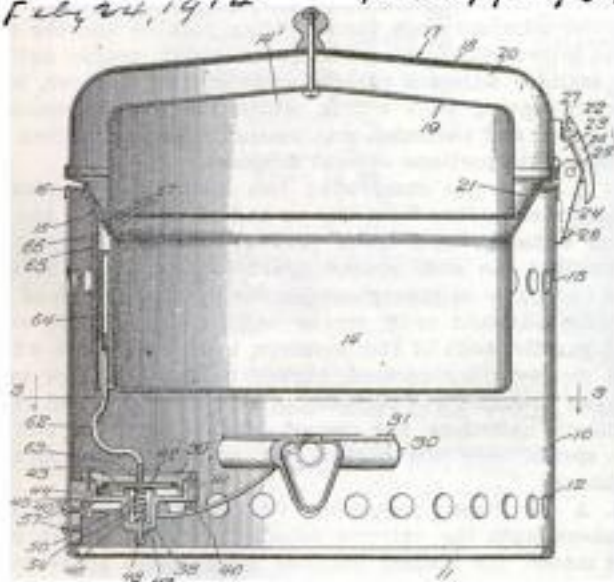

1. A device of the character described comprising a cooking vessel and a substantially tight fitting top therefor; controllable means for fuel for heating the contents of said vessel; a responsive means for controlling said fuel controllable means; a jacket opened at one end into said vessel and at its other end to the atmosphere, said jacket surrounding said heat responsive means whereby heated vapor escaping from said vessel must pass through said jacket, around said responsive means, when the vessel is closed, and a cooling blast of air will pass through said jacket when said vessel is open.

2. A device of the character described comprising a cooking vessel and a substantially tight fitting top therefor; a controllable means for fuel for heating the contents of said vessel; a heat responsive means for controlling said fuel controllable means; a vertically disposed jacket secured to said vessel, open at its upper end into said vessel and at its bottom end to the atmosphere, said jacket surrounding said heat responsive means, whereby heated vapor escaping from said vessel must pass down through said jacket around said responsive means, when the vessel is closed, and a cooling draft of air will pass upwardly through said jacket when said vessel is open.

3. A device of the character described comprising a cooking vessel and a substantially tight fitting top therefor; a jacket surrounding said vessel providing thereby a combustion chamber; a fuel burner supported by and in the lower part of said jacket for heating the contents of said vessel; a smaller jacket attached to the side wall of said cooking vessel, said jacket open at its upper end into said vessel and at its lower end into said combustion chamber; a fuel controlling means supported by said jacket and burner, and a heat responsive means for controlling said burner inclosed in said smaller jacket.

Are Black

Provided with water Pockets, Besides Protecting Walls and Draperies from Hot-Air Currents, It Supplies Moisture to Atmosphere. Small Size, \$1.25



Flower Box Made of Steel. Perforated Arches Distribute Water and Reach Roots. Box, 35 inches Long, \$3

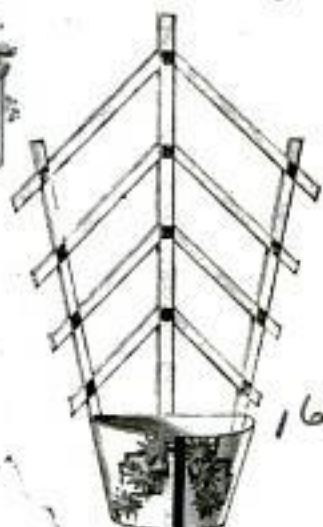

For Vines or Plants Needing Support, an Oddly Shaped Pot with Trellis Attached. Hand-Decorated



Loosely Woven Hose Supporter Made Unusually Wide to Give Muscular Freedom. In Silk, 50 Cents



Compact and Serviceable Electrically Driven Coffee Mill, Operating at the Touch of a Button. It may be Attached to a Wall and Connected with Lighting Circuit. Price \$16.50



Strap Permits Notebook to be Held in Palm of Hand, or Held Comfortably without Inconvenience. \$1 to \$5



Flatiron Holder Intended to be Clamped to One End of Pressing Board. There to Serve Its Purpose without Being in the Way. Retail at 85 Cents





### NEW EYES ARE CONTRIVED FOR SHIPS IN FOG

Inasmuch as one of the foremost electric companies has acquired the patent rights, there is considerable reason for the belief that a New York state inventor, who has developed a marine signaling system for the pre-

the fact that close to the surface of the water fog is invariably thin, while a few feet higher it may be impenetrable. As near as possible to the water line of a ship, projectors, equipped with shutters so their light may be flashed intermittently, are installed. An observer, whose post is likewise as near the water as is practicable, is supplied with

shuttered glasses connected electrically with the lamp shutters so as to operate in synchronism with them. Just before the projectors flash, the observer's glasses are screened, and an instant after the former are darkened the latter are opened. This arrangement protects the observer's eyes from the blinding glare of the light shafts emanating from his own vessel, but during the period of their ex-

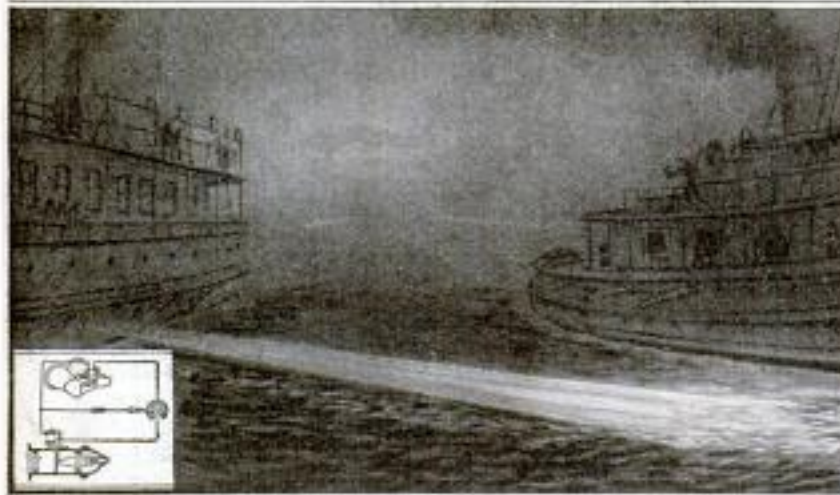

The Projectors are Mounted in Portholes near the Water Line of a Vessel, and Advantage is Taken of the Fact That Close to the Ocean's Surface Fog Is Usually Translucent

vention of collisions between fog-bound vessels, has worked out a meritorious idea. Advantage is taken of

extinction permits him to catch the gleams of signal flashes projected from a similarly equipped ship.

### FOLDING PAPER BOX MADE IN ONE PIECE

Folding paper boxes are now used for a great variety of purposes, especially for packing laundry, suits, shirt waists, and stationery, and the usual construction has been in two pieces. A Michigan concern has invented a one-

piece folding box that reduces the cost of manufacture by eliminating the necessity for expensive dies to stamp out the paper shapes or blanks. The new box is made in one simple operation, all the sides being cut on right angles. When folded, the corners are all reinforced, which prevents them from being crushed in shipment, and the cover flaps are interlocking. Boxes of all sizes can be made in this way.

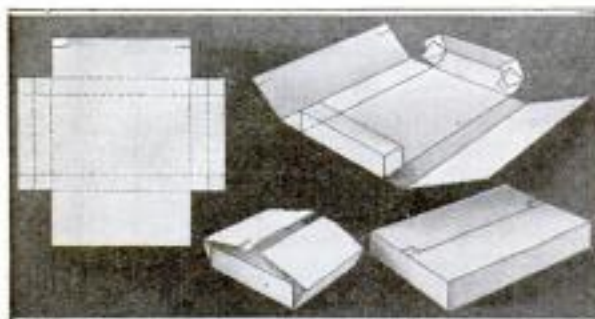

How the New One-Piece Folding Paper Box is Made: At the Left is a View of the Paper Blank, Then the Box is Seen in Process of Construction, and Finally the Box Completed and Locked

E. Z. WRAP PAPER BOX Co.,  
PONTIAC, MICH.

### NEW PIER FOR HANDLING CANAL FREIGHT

3738  
Engineering News 11/9/16  
Facilities for handling freight at the Atlantic terminal of the Panama Canal were largely increased this winter, when a new pier, 1,035 ft. long and 212 ft. wide, was put in service, although not quite completed. The pier is supported on 212 steel cylinders,



Invr:  
Bernard J. Gasser  
East Rockaway, L. I.

POPULAR MECHANICS 3671 599

6 ft. in diameter and 125 ft. long, having their tops at water level, which were sunk by open dredging and filled with concrete reinforced by steel rails. Girders composed of continuous steel stringers carry the 11-in. concrete slabs, forming the floor. Of the 237,000 sq. ft. of floor space, 155,000 sq. ft. are inclosed and roofed, the shed being of steel framework with concrete walls and cement-tile roof. A railroad track runs outside along the walls, for handling freight unloaded from ship cargoes. The cost of the pier was \$1,420,000.

3715

### WATERING TROUGH DESIGNED TO PREVENT FREEZING

An automatic watering device, invented by a resident of Zion City, Ill., is operated by the approach of an animal to the trough to drink. By keeping the trough empty when not in use, it is said to obviate the difficulty so often experienced in winter by stock farmers, liverymen, and others, through water freezing in the trough. A platform is provided in front of the trough and held in a slightly inclined position by stout springs beneath. When an animal steps upon this platform, the weight depresses it, and a concealed shaft is rotated, which opens an intake water valve and simultaneously closes an outlet valve, allow-

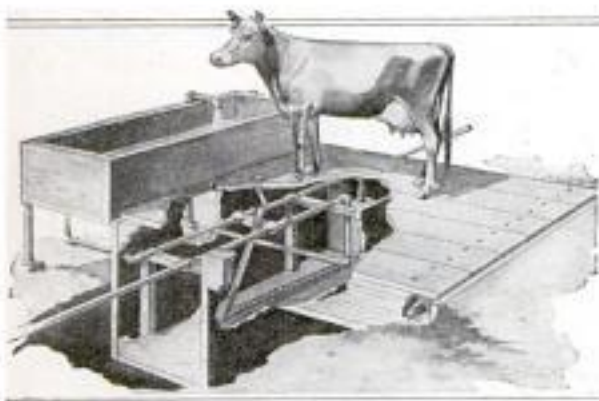

This Watering Trough is Filled Automatically When an Animal Steps on the Platform, and Emptied When It Steps Off. The Operating Valve Mechanism is under the Platform near the Trough

ing water to flow into and fill the trough. When the animal steps off the platform, the operation is reversed.

### SPORTSMAN'S BATH TENT ROLLS UP COMPACTLY

The many possible uses for a small bath tent, invented by a Long Island



A Tent Six Feet High and Three Feet Square. Made of a Single Strip of Canvas Which, Together with the Stakes, can be Rolled into a Bundle Three Feet Long and Seven Inches in Diameter

man, make it particularly attractive for canoeists and sportsmen. It can be employed as a bathhouse, stretcher, canoe sail, ground cloth for picnics, etc. The shelter is made of a single strip of canvas measuring 12 by 6 ft. Sewed across it, every 3 ft., are pocket seams through which bamboo stakes are inserted. When the tent is set up these form the four corners. The two ends of the canvas are fastened together by clasps. Each pole is made in two sections, one being doweled to fit into the end of the other half. Guy ropes are provided to keep the walls taut. Rolled up, the tent makes a bundle, 3 ft. long and 7 in. in diameter.

CA resident of Alaska is reported to have constructed an aerosled with which he made a trip of 1,100 miles from Nome to Valdez in 72 hours. The journey by dog team requires several days.

E. C. Miller  
3070 Excelsior St.  
Zion City, Ill.



~~Lincoln Construction Toy Co.~~  
 178 N. La Salle, Chicago

TOYS AND NOVELTIES IN NEW DESIGNS

3779

Pat.  
 A. F. Ramsey



A Little Log Cabin That Resembles President Lincoln's Birthplace: It is Made of 69 Pieces of Hard Wood. Any Child Who Likes Blocks will Enjoy Building This Dwelling or Making It Over into a Schoolhouse or Church. Fifty Cents is the Price of This Durable Set



125

3

Nursery-Rhyme Banks of Brightly Painted Wood: "Little Miss Muffet" is Shown Above and "Little Jack Horner" Below



125

3 - Ford & Taylor  
 387 1/2 W. 5th St.  
 N.Y.C.

Geo. J. Kennedy - Jan 4 1917  
 79 Irving St. N.Y.



Animal Toys with Detachable Parts so Made That Any Body can be Provided with Any Kind of Head or Legs, Thus Affording Endless Fun and Teaching Natural History Also

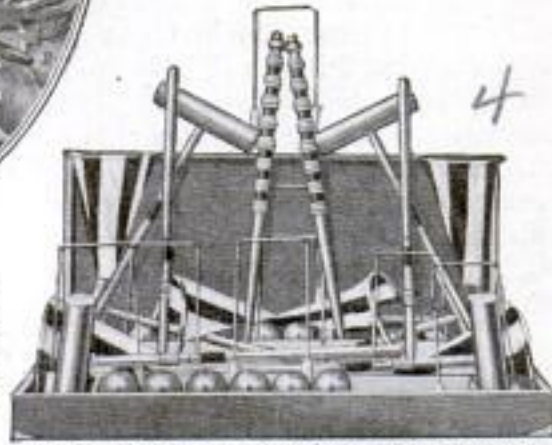

With This Croquet Set the Croquet Ground can be Changed into a Big Outdoor Pool "Table" on Which the Whole Family can Play. Six Striped Canvas Hoods Serve as Pockets at the Corners and Sides. There Are 15 Numbered Balls, and the Rules Are Similar to Those in Pool. These Combination Sets Cost from \$5 to \$12



After Its Hopper has been Filled with Sand This Sand Crane Works All by Itself: The Bucket Fills Up, Swings Around, Empties Itself and Swings Back. This is Repeated Many Times Until the Sand is All Gone. The Outfit, Which Costs \$1, is Well Made and Painted in Bright Colors

Maginor Wood Products Co.  
 Bayland, Mich.

5 - Wolverine Supply & Mfg Co  
 Western Av., Page & Pontcella Sts.,  
 Pittsburgh, Pa. Copyrighted material



6 - Louise Brigham  
17 Horatio St  
N.Y.C.

THAT APPEAL STRONGLY TO CHILDREN

3779



1  
Here Is an Outfit That Has All the Garden Things Any Boy or Girl would Want and a Strong Chest to Hold Them. The Spade, Rake, Watering Pot, Trowels, and So on, are All Painted in Bright Colors, and Some of the Sets Even Have Seeds and Blueprint Garden Plans. The Outfits Cost from \$8.50 to \$15

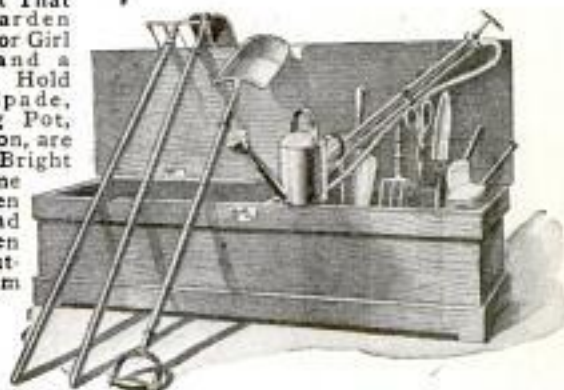

6  
There Is Truly "a Place for Everything" in This Handy Corner Rack, Built to Hold All a Boy's Equipment for Outdoor Sport. It can be Purchased Knocked Down for \$2.80 to \$5, and Is Easy to Put Together



8  
Just the Thing for the Child That Draws, and That Means Nearly Every Boy and Girl: A Light Drawing Outfit of Wood and Fiber Board Which Folds Up like a Screen. It Has Big Handy Pockets and a Blackboard That Isn't Black but Green, so as to Be Easy on the Eyes. The Cost Is \$8 at the Factory



9  
A Most Inviting Little Home for Birds, Made of Willow. This One Is Intended Especially for Some Mr. and Mrs. Chickadee, and Sells for \$1.75 or \$2, According to Finish



10  
A New Adding Game for Little Folks and Grown-Ups: When the Ball Rolls to the Lower End of the Alley It Drops through One of Five Holes and Tilts Up a Corresponding Number Which must be Added to the Score. The Lower Alley Returns the Ball. The Outfit is to be Sold for \$1

7 - The Woodcraft Shop  
73 market st  
Princeton N.Y.  
8 - Beaver Board Co.  
Buffalo N.Y.

7 - Whip - 0 - Hill  
352 Adams av.  
Scranton, Pa.

10 - 1198531 - Sept 19 - 1916

Chas. W. Fowler 2119 Fremont Chgo.

Copyrighted material



Goodell-Pratt Co.  
Greenfield, Mass.

**POCKET SCREWDRIVER HAS THREE BITS AND A REAMER**

The compactness of a pocket screwdriver now on the market makes it very convenient for light work, especially as it is equipped with three bits of different sizes, and a reamer. When not in use these parts are carried inside the handle, which is hollow. The adjustable threaded ring by which a bit is held securely in position for use can be removed from the end of the handle and placed in the storage chamber together with the other parts. When the tool is assembled in this compact manner it is only 3 1/4 in. long.

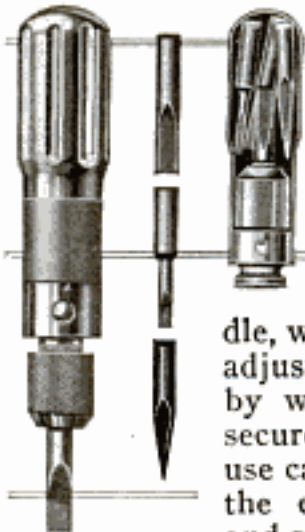

3 3 **ELECTRIC-BULB LOCK FITS ANY SOCKET**

A new lock, which prevents the theft, or temporary removal, of an electric-light bulb from its socket, is of special merit in that it is simple and can be used with any standard socket or bulb. It consists of a thin brass ring of the same diameter as a standard socket, inside of which lies a flat steel spring. A short shank, attached to the ring, is inserted between the socket and end of the bulb when the latter is screwed into place. The flat spring is so placed that a bulb screws in without difficulty, but in trying to turn it in the opposite direction, the spring tends to spread out



and acts as a lock. When a light is burned out it must be broken to be removed. The locks can be used repeatedly and are very serviceable in hotels and various public places.

3410 **CLAMPS FOR MENDING BURSTED PIPES**

Convenient clamps for quickly and effectively mending bursted water, gas, or steam pipes, are now being introduced among hardware stores and plumbing establishments. The clamps are used in pairs and each consists of a semicylindrical piece of metal having lugs on its longitudinal edges, through which bolts may be inserted. A pair of clamps is placed about the defective portion of the pipes to be mended, with packing of rubber or asbestos underneath, after which the two parts are drawn tightly about the pipe by means of nuts and bolts. In case the break is long, two or more pairs can be placed end to end, with the packing so arranged as to form a continuous tight covering.



3225 **COMBINATION TOOL FOR ISOMETRIC DRAWING**

A combination drawing instrument has been devised which is particularly convenient in laying out hexagonal and other forms according to the isometric system. In it are cut 10 ellipses, and seven hexagons of various sizes, and two right-angle triangles. The instrument itself is a trapezoid having two right angles and measuring 6 1/2 in. long and 5 in. wide. With the curves and angles which it supplies a suprisingly large variety of figures can be drawn at a great saving of time.



*Donath Hotel, Electric City, N.C.  
9304 Milwaukee Ave. Chicago  
Two Rivers Drawing Tools Co.,  
Box 412, Two Rivers, Wis.*

*Automatic Lamp Co.,  
304-717 Market St.  
Cincinnati, Ohio*





## A Rustic Four-Square Shelter House

By H. A. HOOPER

**C**HIEF among the advantages of the type of square summer house, or shelter, divided by diagonal partitions is the increased seating capacity. Shelter is afforded from the sun and elements under varying conditions in one or more of the sections. Each of the four sides affords entrance to a shelter, and has relative privacy from the adjoining sections. Several houses of this kind were built on a golf course and proved useful and popular.

This construction may be used for houses of various sizes, that shown in the illustration being 16 ft. square, about 30 in. from the ground to the floor, and with 8-ft. corner posts. The height from the lower edge of the roof to the peak is 4 ft., and the eaves have an overhang of 2 ft., giving added protection. Rustic timbers and smaller limbs were used for the structural portions of the house. The supports for the seats and the latticework under the floor were made similarly, of lighter stock. The partitions extend

to the height of the eaves, and are supported at their junction by a post. Standard mill stock may, of course, be used throughout the structure, if desired.

### Proper Insulation of Splices

A properly insulated splice should last as long as any portion of the insulation. Apply the tape while the splice is still hot from soldering. Rubber tape should be put on first, to a thickness according to the voltage which is to be carried. Then apply friction tape as firmly as possible, and heavy enough to withstand wear.

The tape should extend on the actual insulation at either side of the plug, otherwise there is a tendency for the wire to break at these points. On small work it is advisable to tear the tape into strips of not more than  $\frac{1}{2}$  in., for the best finish. A "whipping," made by winding twine tightly and evenly around the splice for the full



This Shelter House Has a Relatively Large Seating Capacity and Affords Added Protection by Reason of the Partitions



length of the tape, is desirable to produce a high-class finish. Insulation varnish, or shellac, should be applied, but not while the work is at all damp.—W. B. Baruch, Charlestown, Massachusetts.

### Radial Pivoted Arm for Shop Light

I recently installed a swinging light which reaches nearly all parts of the shop. It was made by supporting a long rod,  $\frac{7}{8}$  by 3 in. at the thickest portion and tapering toward

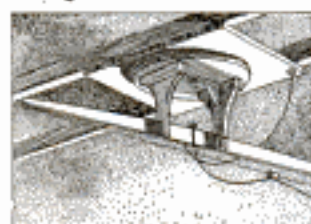

The Radial Arm is Swung Easily to Various Parts of the Shop and the Light Adjusted on the Wire

the ends, as shown. The arm was set in two brackets suspended from a circular turntable, pivoted at the middle on a bolt. The latter was fixed through a square plate which was fastened to the ceiling joists with screws. The cord for the electric light was carried on insulators which slide along a wire fixed to the lower edge of the radial arm.—R. E. Brown, Portland, Ore.



### Safety Spring for the Variety Wood-Molding Machine

The spring shown in the sketch is a safety device, and also satisfactory in preventing vibration, and in holding

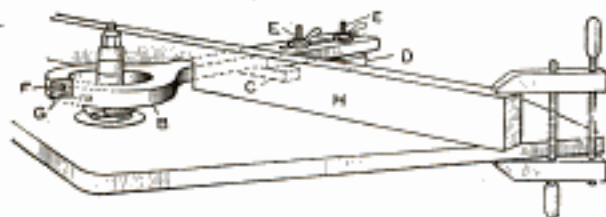

This Safety Spring Reduces Vibration and Is Adjustable to a Variety of Work

the face of the work closely against the table top. It is adjustable to various

thicknesses. The block C should be about  $\frac{1}{8}$  in. thicker than the piece to be fed into the machine, while the piece D should be enough thicker to insure that the under side of the head of the spring is practically parallel with the table top when the knives are cutting. The wing nuts E hold the spring firmly in contact with the blocks. The adjusting screws, at E, are threaded into the table.

The spring B should be made of from  $1\frac{1}{8}$  to  $1\frac{3}{8}$ -in. hard wood. The diameter of the circular opening is slightly larger than the extreme diameter of the knives. The neck of the spring should be from 2 to 4 in. wide, and must give a firm pressure. End adjustments are made by the slot, at E, extending to the end. A spline, F, is glued into the rim of the spring, as shown in the section, at G, to strengthen the short grain of the wood. The lower side, at G, is rounded to permit the work to enter easily; the inner edge is flat, and the under side of the head is waxed to make feeding easier. For heavy work, the piece H extends from edge to edge of the table, and is clamped at both ends. The groove in H fits the neck closely, but with sufficient play to permit the spring to move vertically without undue friction.—Charles A. King, East Kingston, N. H.

### Repairing a Short-Circuited Armature Section

To locate a short-circuited armature section, pass a current from a dry cell, or storage battery, through the armature, using the brushes of the machine. Using a low-reading voltmeter—a millivoltmeter if possible—touch its lead wires to one pair after another of adjacent commutator bars. A zero deflection of the voltmeter indicates a short-circuited section.

It will be noticed, at periodic intervals in passing around the commutator, that the voltmeter deflection reverses, and that just before this transition point the deflection is less than normal. This merely indicates a passage from one pole to another on the



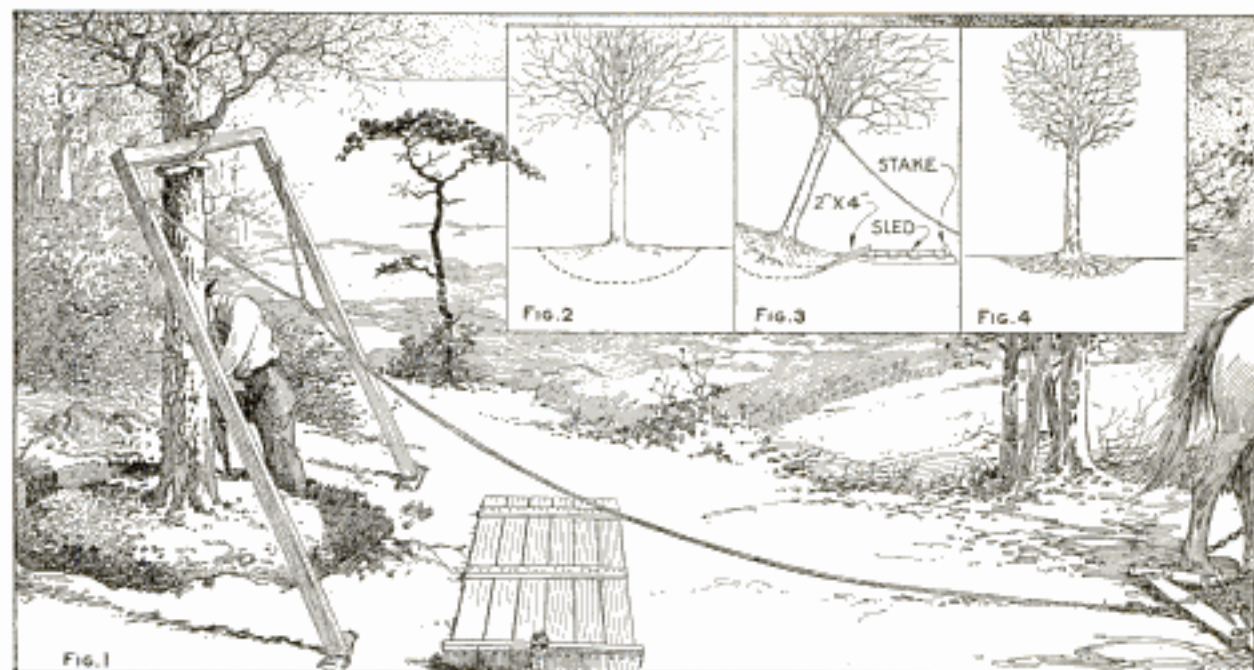

The Use of This Frame Enables One Man with a Team of Horses to Transplant Trees of Considerable Size

winding. On a four-pole armature, for instance, there will be four such reversals of the meter deflection. Switching of lead wires is all that is necessary to make the meter read in the right direction.

If a short circuit is found, clean out the spaces between commutator bars, to be certain no small bits of metal or copper dust are responsible. Failing thus to locate the trouble, carefully lift out the coil connected to the bars to which the short was traced, and repair any breaks in the insulation. Shellac and silk ribbon are the best materials for this work. Apply the ribbon smoothly, coating it thoroughly.

A broken circuit in the winding itself may be located by connecting a battery through an ammeter to two metal strips, held apart by a piece of wood, at such a distance that they will touch adjacent commutator bars. Holding this device against the commutator, turn the armature slowly by hand. A reduced deflection of the ammeter indicates a broken or open-circuited winding. The only resort, in case of open circuit, is to lift out the damaged coil, solder the ends together, reinsulate, and replace the wire in the slots.—K. M. Coggeshall, Webster Groves, Mo.

### Transplanting Large Trees

Trees of considerable size may be transplanted for shade, or decorative, purposes by one man with a team of horses, by the use of the frame shown in the illustration. It is made of 4 by 4-in. timbers, spiked together. A trench is dug around the tree, and the roots cut free, taking plenty of earth with them, as shown in Fig. 2. To get at the lower roots it is desirable to haul the tree to the position shown in Fig. 3, by means of a guy rope hitched to the team. If the tree is too large to be lifted clear of the ground by means of the frame, it may be skidded to a stoneboat, as indicated in Fig. 3. The frame is lashed to the trunk of the tree, and its lower ends set on blocks. A rope is fixed to it near the top, and the tree may be raised to drop on the stoneboat, by driving the team slowly forward. The frame may be used to set the tree into a pit at its new location, by using the frame in the reverse direction. The tree should be guyed to make it plumb, and the earth filled firmly around it, as shown in Fig. 4.—J. G. Allshouse, Avonmore, Pa.

☞Chalk sandpaper on the back to prevent it from slipping in the hand.



### Wrench Adapted Easily for Many Uses

The ordinary monkey wrench, with a few alterations and additions, may be made to serve many purposes other

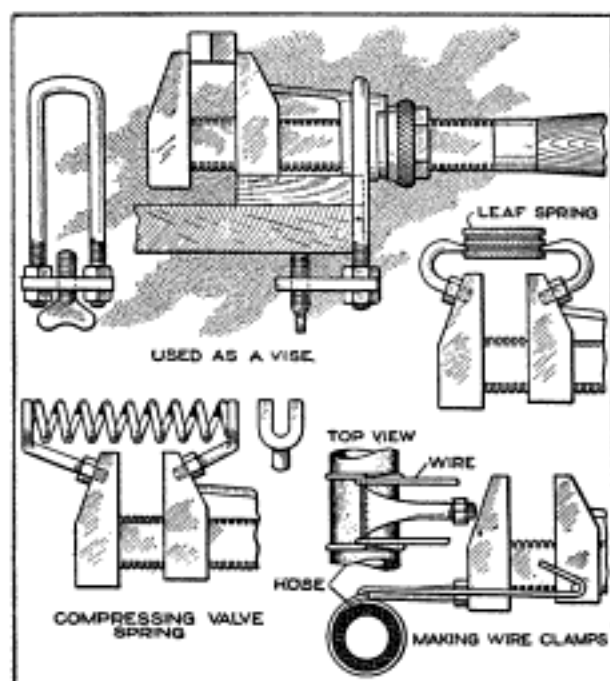

By the Addition of a Few Simple Attachments the Wrench Is Available for Several New Duties

than that of a wrench and hammer, by utilizing the adjusting feature as a tension screw. It is particularly desirable for automobile purposes, saving both weight and expense. The sketches show a few of the possibilities by providing threaded holes and attachments. If the jaws of the wrench are hardened, it is necessary to anneal them. If the knurled sleeve is not already hexagonal, it is advisable to flatten the sides so as to obtain gripping surface.

An attachment which converts the wrench into a small vise was made as shown. The detachable bracket is provided with a thumbscrew for securing it to the running board of an automobile or other projecting edge. An attachment of  $\frac{7}{16}$ -in. rod for converting the wrench into a valve-spring compressor is shown at the left. Attachments used in separating the leaves of an automobile spring to insert lubricants are shown at the right.

An attachment for the making of wire bands or clamps for radiator hose,

bands about buckets, garden-hose connections, etc., is also shown. The sliding jaw has a  $\frac{3}{16}$ -in. hole drilled through it and a pin inserted, which projects about  $\frac{1}{4}$  in. on either side. The chisel-shaped attachment is grooved for holding the wire. A strong tension by means of the knurled sleeve, before finally drawing up the loop, is desirable.—George A. Luers, Washington, D. C.

### Care of Automobile Steering Connections

The leather boots necessary to protect the steering joints of an automobile from mud and water should be given careful attention. Old grease should be removed from the joints when necessary, and the boot cleaned. The joints should be greased thoroughly, and a strip of linen, 3 in. wide, used as an inner covering to retain the grease. The boot is placed over this cloth covering, thus keeping it clean for lacing. The inner covering may be discarded when the joint is again greased.—Alexander Bollerer, New Britain, Conn.

### Faucet Tap for Large Cans

Oil cans shipped to an undeveloped region were not provided with a suitable tap, and it was found inconvenient to run off the oil from a plugged hole. The faucet tap shown in the sketch was devised, and proved convenient. A tapered screw was fitted to the faucet, and inserted through the end of the can by driving in the point and then turning the faucet until it was set tightly. A leather washer was provided to make a close joint. When the can is emptied, the faucet is quickly removed by unscrewing the threaded point, and may be used repeatedly.—Gus Hansen, Peachland, Can.

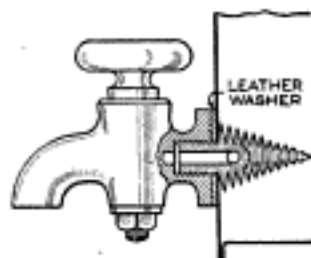



# Building A Fast Nineteen-Foot Runabout

By B. FRANCIS DASHIELL

**S**EA WORTHINESS in rough water, simplicity and strength of construction, and fair speed with comparatively low power, are features of the small runabout motorboat, shown in the illustrations and detailed in the working drawings. It is of the V-bottom type, and the high, flaring bow enables it to cut the water with slight pounding or spray. A light-weight motor of 4 hp. is satisfactory, and for greater speed one of not over 8 hp. may be installed with a proper margin of safety, and freedom from excessive vibration. The deck plan is shown in Fig. 7 of the page plate; the structural framework in Fig. 6 in plan, and in a vertical section from bow to stern, in Fig. 8.

Before beginning the work of construction Figs. 6, 7, and 8 should be understood, and then full-size paper patterns are made for the frames A to I, as shown in Fig. 1. The diagram for the transom frame A is shown complete, those for the other frames being given in half section only. Make the frames, other than the transom, of 1 by 3-in. straight-grained oak. The two parts of each side section are bolted

together with a 1-in. piece, 5 in. wide, called a knee, and the two side sections are joined at the keel by means of bolts and a heel, 1½ in. thick, as shown in Figs. 3 and 5. The fastenings are made with ¾-in. bolts, fitted with washers and nuts. Inspect the frames to make certain that they are not twisted, and mark them A, B, etc., as indicated.

The stern frame, or transom, shown in Fig. 2, as viewed in section at J-K, Figs. 7 and 8, is made of oak, cypress, or pine, preferably in one piece, and 1½ in. thick. Two boards for it may be doweled, as shown in Fig. 1. Paint the pins and joined edges with marine glue, and clamp the pieces together to dry. Then shape the transom as shown, and fasten 1 by 2-in. oak battens across it, fastening them with screws, as shown in Fig. 2. Fasten 1 by 2-in. oak battens around and ½ in. in from the edges, to provide a suitable nailing strip for the planking.

The keel is a straight-grained piece of oak, or yellow pine, 3 by 4 in. by 18 ft., as shown in Figs. 6 and 8. Lay it out on a suitable level area for the fitting and assembling of the frames. They are notched over it, as shown in

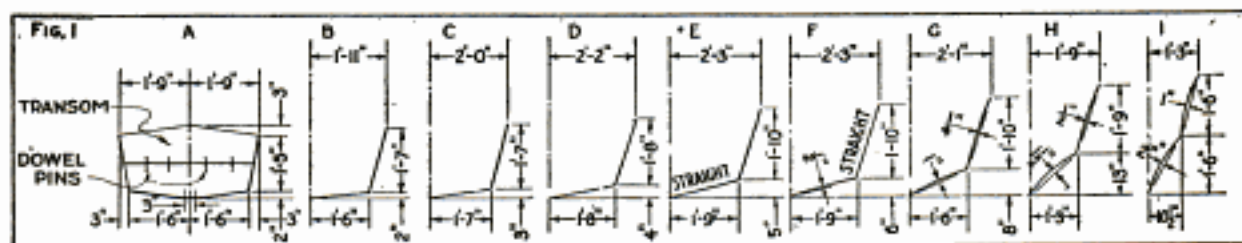

Sectional Diagrams of the Transom and Frames: To be Laid Out Full Size on Paper Patterns, to Which the Pieces are Fitted Accurately



detail in Fig. 5, and bolted into place through the heel. Countersink the bolt heads. Line the frames up perfectly or trouble will be experienced in producing the desired contour and balance in the craft. Where the propeller shaft extends through or near the keel, it is necessary to fix the frames with two bolts straddling the shaft, as detailed in Fig. 3.

The shape and construction of the stem post, the stem and stern knees, and the method of fastening them into place are shown in Fig. 8, and in detail in Figs. 2 and 9. These parts may often be supplied to the best advantage by dealers in boat stock, in the natural crook, which is most desirable. They may also be built up as shown. To prevent the water from working into the seams of these parts at the joints of the stem and knee, stopwaters are used, as indicated in Fig. 8, and detailed in Fig. 9. They are plugs or dowels of white pine, dipped in marine glue. The stem and knees are bolted to the keel with  $\frac{1}{2}$ -in. bolts, after painting the joints with glue.

Cut a rabbet, or planking groove, into the stem and stem knee, to provide a suitable nailing support for the planking, as indicated by the dotted line in Fig. 8, and in the stem detail, Fig. 9. Make the rabbet  $\frac{1}{2}$  in. deep, to bring the surface of the rabbeted parts flush with that of the planking. The upper corners of the keel are beveled to fit against the garboard, or lower plank, as shown in Fig. 5.

Brace the assembled frame temporarily, and strongly enough to withstand twisting strains. Turn the frame over so that the keel is uppermost, and level it carefully, for the nailing of the planking. The system of planking used is shown in Figs. 2 to 5, and in detail in Fig. 9. The best size for the planks is in lengths of 20 ft. 6 in., so as to give a minimum of end joints. Where short lengths are used, the joints should be supported on blocks on the inside, and the planks butted together. The planking, dressed on both sides, is  $\frac{1}{2}$  by  $2\frac{1}{2}$  in., though the width may vary slightly, preferably

less than this width. Put on the garboard, next to the keel, first, and fit it to the bevel on the keel, as shown in Figs. 4 and 5. Fit the ends of each plank to the transom and into the rabbet at the stem post. The planks are fitted alternately on opposite sides of the hull. Their edges are beveled slightly to form a close fit on the inside, and to provide a space for calking the seams. Nail the garboards into place against the keel by means of wire finishing nails, sunk edgewise through the plank, as shown in Figs. 5 and 9. Fasten the planks to the transom and the stem post with nails or screws, galvanized, or of brass. Fit the planks carefully to the frame. At the chine strake, as indicated in Fig. 4, it may be necessary to trim the sharp corner slightly to produce a good fit for the planks, as shown in the chine detail in Fig. 9. After all of the planks have been put on, plane the top plank, or sheer strake, flush with the upper ends of the frames. Then turn the hull over on its keel, supporting it with braces. The woodwork of the upper portion may now be installed in part.

Notch the frames to receive a 1 by 3-in. filler piece of oak or pine behind the coaming, as shown in Fig. 3 and in the coaming detail, Fig. 9. Make the coaming of  $\frac{1}{2}$  by 6-in. oak, fitting the pieces for it into place only temporarily at first. The position of the coaming at the ends of the cockpit is shown in Fig. 8. The side decking is of  $\frac{1}{2}$ -in. oak, or cypress, fastened with brass screws. Fill in the corners with quarter-round molding, as shown in Fig. 9. The forward and rear decks are of the same material, and are supported on deck beams fixed across the hull, as shown in Fig. 8.

The shaft log and engine bed should then be located. The position of the engine is about 7 ft. aft of the bow. Its exact location will vary with different types and sizes of engines, and should be determined carefully to give the proper stability. The engine is mounted on bed timbers bolted to the frame and keel. The engine shaft is carried in a wooden shaft log, fixed on the inside



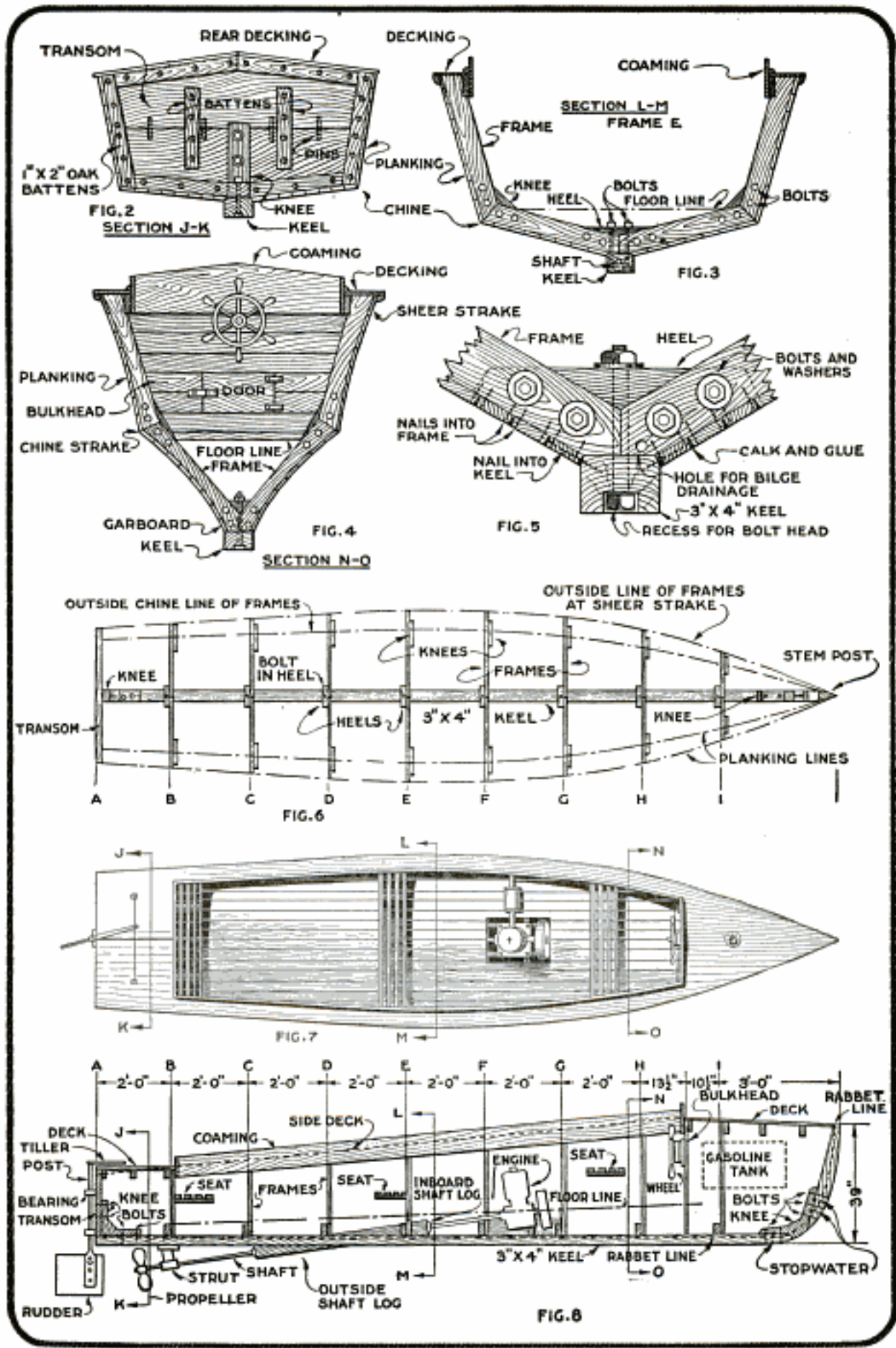

This Motorboat Runabout was Designed as a Light Craft of Fair Speed with Low Power. The Construction of the Framework and Other Details is Comparatively Simple, and Feasible for the Home Mechanic. The General Arrangement of the Framework and Main Working Parts is Shown in Figs. 6 and 8, and the Deck Plan in Fig. 7



and the outside of the keel, as shown in Fig. 8. If desired, the hole through the shaft log may be bored at a mill which may have furnished the keel and other special wooden parts. Metal stuffing boxes are fitted to the ends of

slightly. The glue does not become very hard, and when set, the hull should be scraped, removing excess glue. The outside should be given two coats of oil primer, and two of finishing paint. Paint the interior parts

also, creosote or asphaltum paint being preferable for this purpose. The cockpit should be painted first with an oil primer and then with a finishing coat. The coaming and decks may be finished with paint or several coats of spar varnish.

The general arrangement of the fittings is shown in Figs. 7 and 8. The metal fittings may best be purchased, but some of them may be made if desired. The location of the gasoline tank in the bow, the seats of wooden strips, the steering wheel, propeller and connections, and the method of fixing

the rudder into place, are shown in Fig. 8. A detail of the rudder and its supports is shown in Fig. 9. The rudder is controlled from the wheel by means of wire-reinforced rope extending from a cross arm at the top of the rudder shaft, around the coaming, and through pulleys to the wheel drum.

### Making Cupped Leather Piston Washers

Leather washers, cupped to fit the piston of a pump, were required to make a repair, and were made quickly as follows: The pump barrel was  $1\frac{1}{2}$  in. in diameter, and the disks were cut  $\frac{3}{4}$  in. larger in diameter. A spool of a diameter two thicknesses of the leather less than  $1\frac{1}{2}$  in. was used to form the wash-

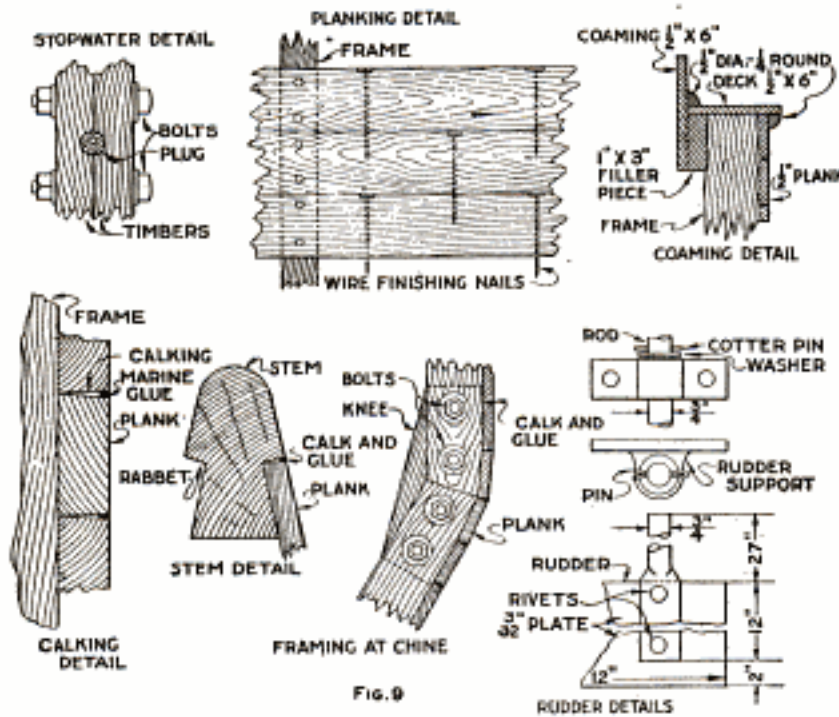

Fig. 9  
Details for the Rudder, Coaming, Stopwater Plug, and Other Constructional Features

the shaft log, and the joint of the shaft log and keel is made water-tight with marine glue or white lead, and bolted, as shown in Fig. 3.

The cockpit is finished with flooring and siding, and bulkheads are built at the stern and the bow. The stern bulkhead is made by paneling the frame B, and the forward bulkhead, by building in a partition, as shown in Fig. 8, and in detail in Fig. 4. The siding for the cockpit is nailed to the frames, and the flooring to 1 by 3-in. floor beams. The seams of the decking are calked with marine glue.

The calking of the hull must be done thoroughly to insure that the craft will be seaworthy. Twisted calking cotton is tamped into the seams, as shown in the calking detail, Fig. 9, by means of a calking iron. The calking is covered with a  $\frac{1}{8}$ -in. layer of black marine glue. Soften the glue by heating it in a water-jacket container, and force it well into the seams, overfilling them



ers, as shown in the sketch. The washer is moistened and tied over the spool, centered with a pencil in putting on the strings, and then placed on the same or another spool with a metal ring or strong cord to hold it, as shown at the right, and permitted to dry into shape.—Herbert Consterdine, Hammond, La.

### Ridding a Garage of Automobile Exhaust Gas

The exhaust gas from an automobile proved offensive in a closed garage and the difficulty was remedied by installing a pipe with a hose connection to the exhaust pipe of the car, and connecting it to the chimney. This method can be applied to garages having no chimney by the installation of a suitable flue, or outlet.—J. M. Straughan, Sprague, Wash.

### Sink for Washing Blueprints

The blueprint sink detailed in the sketch is simple in construction and practical in use.

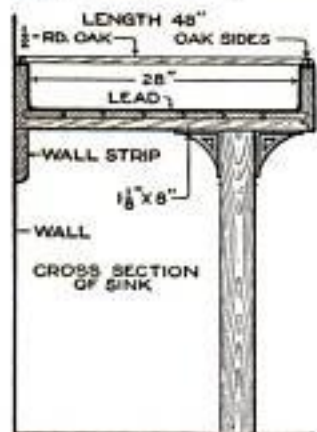

Four pieces, preferably oak, are made for the sides and ends. A groove is planed near the lower edge so that the tongue-and-groove bottom will fit in all the way around. This groove supports the bottom, and provides for shrinkage and expansion, avoiding buckling of the lead lining. Two cross strips are screwed to the under side, and a leg is fastened to each by means of brackets. The lead lining is fitted, and the upper edges turned over, and tacked down. Half-round strips are nailed over the lead, and the woodwork finished as desired.

CA spool cut at the middle provides two useful knobs.

### Headlight as Emergency Lamp for Operating Room

A surgeon found it necessary to perform an operation after dark, in a

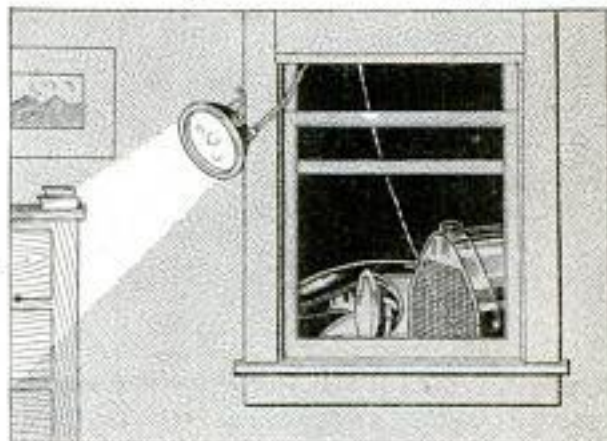

An Emergency Surgical Operation was Performed by the Aid of an Automobile Light

town where commercial electric light current was unavailable. As an open light should not be used in a room where an anesthetic is administered, the electric headlight of an automobile was made to serve. The car was run up to the window of the room; the reflector and bulb from one of the headlights were removed, and after hanging the reflector over the operating table, the wires were run through the window and connections made. To assure proper results, the system was tested carefully, and it was made certain that the storage battery was fully charged. An extra bulb was provided, in case the one in use should burn out. The light proved quite satisfactory, the reflector shading the eyes of the operators, and concentrating the light on a small area, as desired.—Harry M. Kennard, Charles City, Ia.

### Raising Level of Gasoline in a Blowtorch

When the gasoline level is low in a blowtorch the pressure causes an excess of air in the burner supply pipe, blowing out the flame. In an emergency, a little water poured into the gasoline will cause the latter to float to a high enough level to operate the torch satisfactorily.



### Handling Long Pipes in a Small Shop

Pipes, long rods, and similar pieces, are difficult to handle in a small shop.

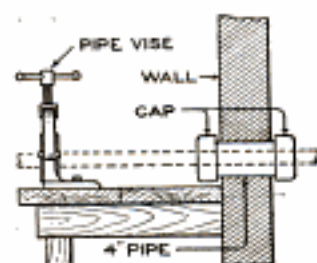

A 4-in. pipe, fitted through the wall of a small plumber's shop, made it possible to thread pipes of considerable length without bringing them into the shop. The pipes were drawn through the opening in the wall and clamped at one end, as shown. To thread the opposite end it was necessary only to reverse the pipe. When the opening was not in use, its ends were covered with pipe caps.—W. P. Langreich, New York, N. Y.

### Holder for Slip Stones

Slip stones of good quality are fairly expensive, and easily broken if left to lie about the bench or machine. They may be kept safely and conveniently in a block like that shown. The grooves of several sizes are chiseled into the block, which is as long as the longest stone to be fitted into it. The ends are guarded with strips of wood.—Henry Wedde, Chicago, Ill.

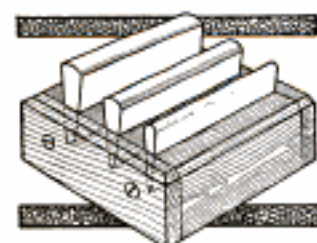

### Cutting Porcelain Insulators

Considerable difficulty was experienced in cutting round porcelain insulators used in electrical work. The job was satisfactorily accomplished as follows: A piece of flat, cold-rolled steel, twice as wide as the diameter of the insulators and of the same thickness as the smaller insulators desired, was procured. A small hole, A, was drilled through it,

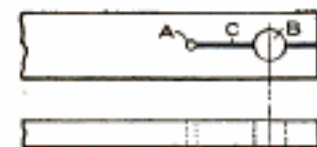

and a slot C cut from the end to the hole, with a hacksaw. The hole B was drilled the same size as the insulators. The latter were then clamped in the hole B, in a vise. With a blow of a hammer on a cold chisel, set on the upper surface of the steel strip, the insulators were cut neatly, and to the proper height, the same as the thickness of the strip. In half an hour, 500 insulators were cut, with only eight damaged ones. Carrying on this method of cutting under water, produced better edges on the insulators.—George N. Garrison, East Orange, N. J.

### Device for Cutting Tire Fabric on Bias

A wet knife instead of shears is used in cutting tire fabric on the bias in a large plant. A straightedge of hard wood, to which two 45° guide blocks are fastened, reaches across the table, as shown, and is used as a guide in cutting. The straightedge is held at the proper angle by keeping the guide blocks against the edges of the table.



### Painter's Brush Preserver and Carrier

A wood finisher and painter constructed the receptacle shown in the sketch to keep his paintbrushes in good condition, and also for use in carrying them to and from his work. The container is 12 by 6 by 6 in. in size. It is fitted with a raised cover, 4 in. deep, hinged to one side. The cover is built to fit inside the container somewhat like the cover of a dinner pail. Two hooks hold it in place, when being carried by means of a handle. A small hole is bored in the

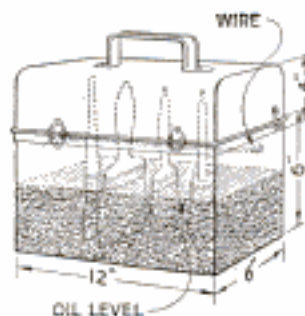



middle of each end, about 1 in. from the top edge. A stiff wire is passed through the two holes, leaving a little to spare at each end. Holes are bored through the handles of the brushes and the latter strung upon the wire. Sufficient oil or turpentine is poured in to immerse the bristles completely.—L. B. Robbins, Harwich, Mass.

### General-Utility Sawhorse

A sawhorse which will serve the purposes that two ordinary sawhorses serve in many instances is shown in the sketch. It may be built quickly of stock timber, and of a size suited to particular needs, the dimensions indicated being suitable for work of average size in carpentry. If desired, the construction may be made more permanent by fastening the pieces together with screws, making housed joints where the legs are fixed to the main piece, and bracing them securely below. A convenient height for the sawhorse is 22 in., and a length of about 8 ft. is satisfactory. The work is supported on this device at three points when ripping, making the frequent shifting of the board to get a solid backing unnecessary. The center board is made shorter than the end pieces, so that it will not interfere in ripping, yet

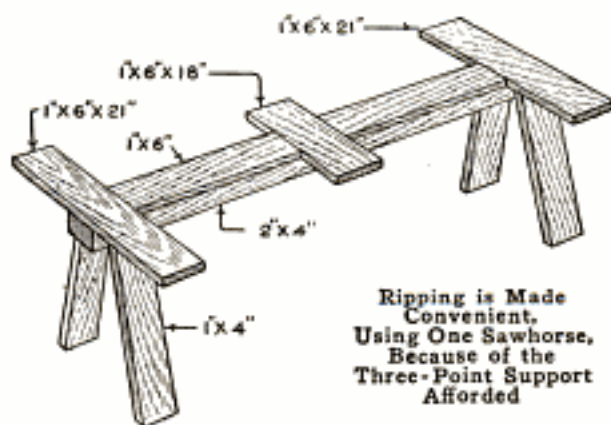

give a support at the middle. This is especially handy in ripping long narrow strips.—Harry Simon, Laguna Beach, Calif.

☞Oiling of bearings by an occasional flood of oil is wasteful and inefficient.

### Trolley Tool Rack for Shop or Laboratory

A trolley tool rack made up of a tray suspended from a two-wheeled

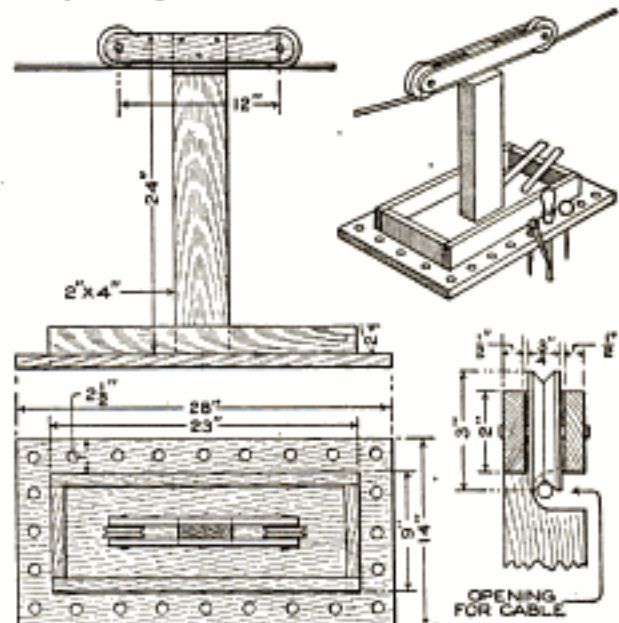

The Tool Rack and Tray is Moved to the Point Where the Tools are Needed by Shifting It on the Cable

hanger on a rod or stiff wire is convenient in bringing tools to the point where the work in hand is being done. The device may be placed above a long bench or adjacent to a row of machines, and has other uses even in such work as electrical installations. The rack proper consists of a board,  $\frac{7}{8}$  by 14 by 28 in., around the edge of which holes of various sizes are bored for the tools. A frame, 2 in. high, provides a tray. A piece of 2 by 4-in. stuff supports the tray from the hanger.—R. E. Edward, Seattle, Wash.

### Preventing Breaking of Plaster by Door Knobs

A 6-in. square of sheet cork, or composition, of the same thickness as the plaster, may be used, at the point of contact, to prevent the breaking of plastered walls by door knobs when no stops are provided at the floor. This method was used with success in a repair job and the patches of composition board were painted over the same color as the wall.—E. L. Thomas, Pittsburgh, Pa.



### An Adhesion and Impulse Engine

The rotary-fan type of power mechanism shown in the illustration was

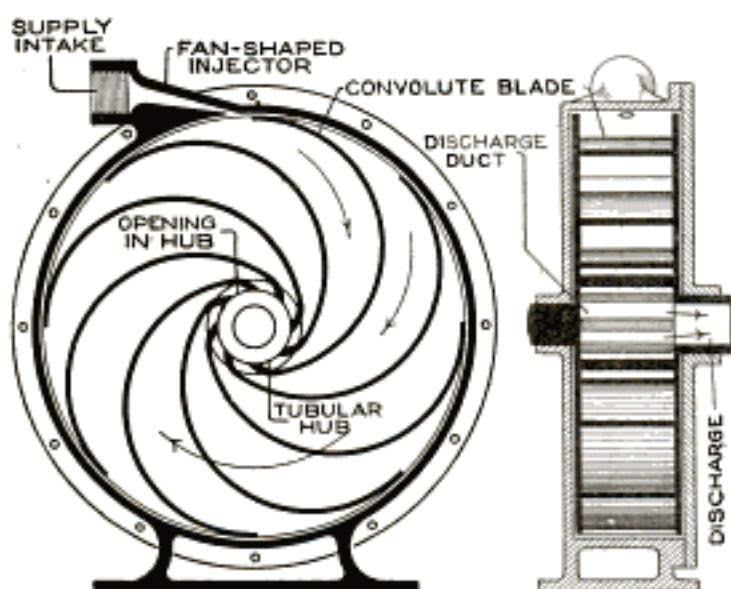

Steam is Forced from the Injector at High Pressure, and, by Adhesion as Well as Impulse on the Convolute Blades, Relatively High Power is Developed

designed and built to apply a moving jet of steam economically to a set of blades, making use of the impulsive force as well as the adhesion of the gas in contact with the peculiarly shaped blades. A jet of steam is forced at high pressure into the chamber from the fan-shaped injector connected to the supply intake. The steam comes into contact with the convolute blades and is carried toward the center of the chamber where the blades converge, passing out into the discharge tube. The curve of the blades is such that the maximum rotary propulsive force is obtained from the steam pressing against them. The device develops a relatively high power on the shaft, the openings through which the steam escapes being designed so that the gas is held in the chamber under sufficient pressure to produce the maximum power, without retaining it long enough to permit condensation.

The chamber is built up of a metal shell, having a circular plate riveted to its open side, and bearings cast as part of the shell and cover, as shown in the sectional view at the right. The injector is fitted in the top of the chamber and is fan-shaped, the width of the

chamber. The revolving wheel, housed in the chamber, is of sheet metal and fitted with a solid shaft on the left side, as shown in the sectional view, and a hollow hub, for the discharge of the steam, on the right. Eight convolute blades are fitted between the side plates of the wheel, and openings are provided between them to permit the steam to escape into the hub discharge tube.

The steam enters the chamber under pressure and is forced against the outer edge of the convolute blades, reacting against the curve and being carried toward the hub. I have obtained very high speeds with the device, and this seeming disadvantage was readily overcome by increasing the proportionate size of the wheel. It has given satisfactory results as a water motor, and when the wheel is well under way, and the chamber is filled with water in revolution, the power derived has been found to be large in proportion to the water pressure. This is caused by the centrifugal action of the water, the resulting power being applied largely upon the curved blades rather than upon the inner surface of the chamber.—J. S. Zerbe.

*Hotel Emlicott, N. Y. C.*

### Soapsuds Reduces Carbon Deposit in Compressor

Trouble was experienced with an air compressor, due to the accumulation of carbon in the cylinders, and after several methods for removing it had been tried unsuccessfully the feeding of soapsuds into the cylinders from an oil cup was suggested. While it did not prevent completely the formation of the carbon, the compressor could be run much longer without cleaning, and when it was shut down the deposit was found to be soft and easily removed. The soapsuds were introduced into the cylinder for about one-half hour once a day, and the feed from the oil cups was increased at this time.—T. S. Burns, Elmira, N. Y.



### A Homemade Concrete-Tile Machine

I built this tile machine for a farmer who made concrete drain tile in his spare time. The machine may be of various sizes, this one being for tile of 6-in. diameter, 1-in. wall, and 12 in. long. Heavy galvanized sheet iron, 12 by 26 in., was bent to a circular shape, and an internal diameter of 6 in., for the form A. The ends, at J, overlap 2 in. Make two straps, B,  $\frac{1}{8}$  by 1 by 8 in., and bend eyes for the rod D, of  $\frac{3}{8}$ -in. iron. Make two 4-in. pieces, E, similarly, and rivet both sets to the form A, as shown. Bend the  $\frac{3}{8}$ -in. iron rod D into shape and fasten it to the bands B and E. Make a hopper for the top, completing the outer form A.

Sheet metal, 14 by 12 in., is used for the inner form F, which is 4 in. in outside diameter. Rivet on, as shown, four straps of iron, C, provided with eyes, for the rod H. This rod is arranged so that, when the end H is set as shown, the outside diameter of the core is 4 in., and when released, becomes less. Make a cap, G, used only while filling the mold.

To use the machine, the form A is set on a suitable board, and the core F centered. The latter is then expanded, and the cap and hopper are put on. The concrete mixture is tamped in, the

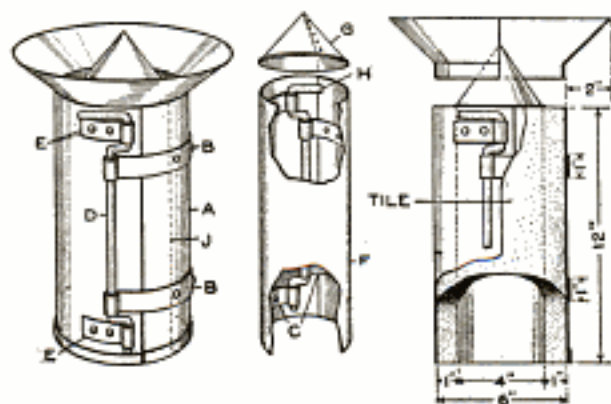

A Farmer Made Concrete Tile for His Land in Spare Time by Means of This Simple Machine

core is released by the handle H, and removed. The form A is taken off by releasing the rod D, leaving the tile on the board to cure.—R. S. Matzen, Fort Collins, Colo.

### Weather Curtain for Converted Sleeping Room

The arrangement shown in the sketch served to convert an ordinary bedchamber into an out-of-door sleep-

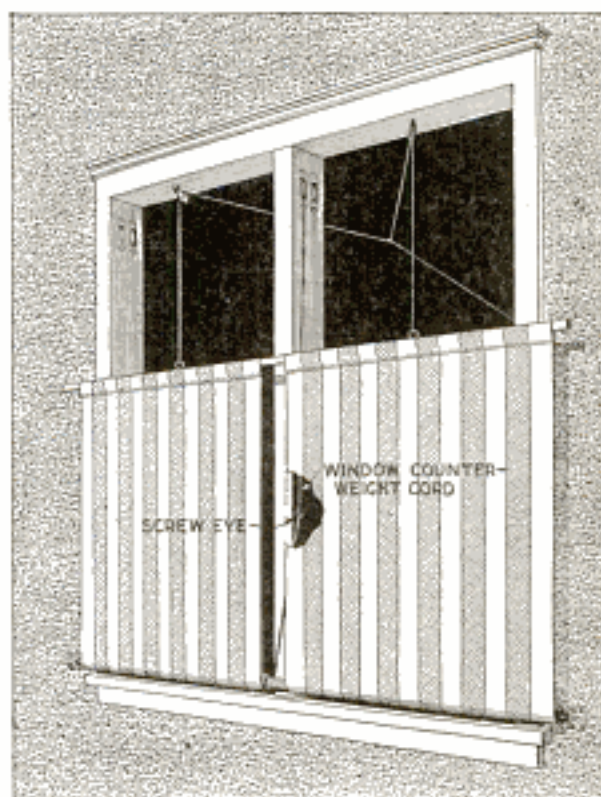

The Curtains are Held Taut and Rolled by the Center Cord Fixed to a Sash Weight

ing porch. The windows were removed from their frames to give plenty of fresh air. An awning was necessary to protect the room from the weather and to screen it properly. The awning cloth, pulleys, cord, and bearings for the rod were obtained at an awning store. A curtain pole served to wind the canvas; brass hinge pins, slipped through standard awning sockets and made fast in the ends of the pole, provided excellent bearings for the pole to revolve upon. The problem was to find some means of rerolling the awning automatically and keeping it stretched taut in the wind. To do this, one of the counterweight cords in the window sash was extended, wound around the awning pole in a direction opposite to that of the canvas, and made fast. The awning proved effective and strong.—Jack Bechdolt, Seattle, Wash.



### Repairing a Damaged Universal Chuck

A universal lathe chuck was broken, as at A in the illustration, two of the jaws being ineffective. It was thrown

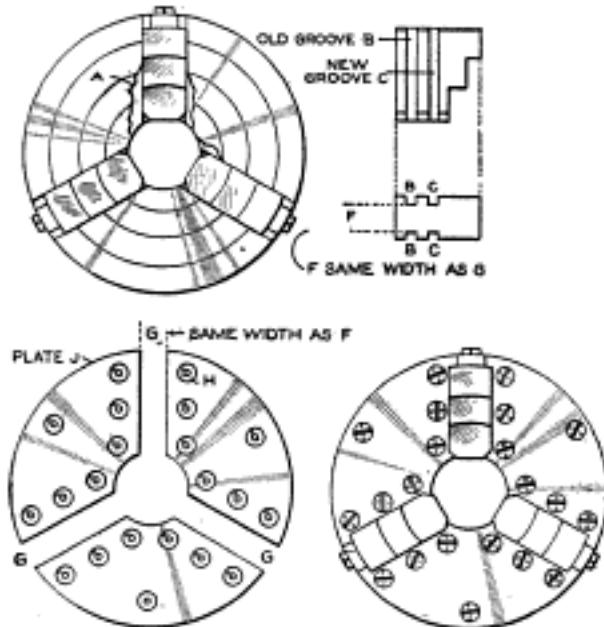

New Grooves were Cut in the Jaws to Fit Plates Fixed to the Face

into the scrap heap, and I repaired it as follows: New grooves, C, were cut on the sides of the jaws of the same size as the old grooves B, the jaws being annealed. A plate of soft steel, to fit groove C, was made of the same diameter as the face of the chuck, and a center hole cut in it. It was drilled, tapped, and counterbored, as at H, at the left, and fastened with screws. Three slots, G, were milled in the plate to correspond with the old guides for the jaws, thus forming the plate J. The jaws were fitted in the grooves G, and the chuck gave good service.—Richard H. Jehlicka, Worcester, Mass.

### Making a Loose Wooden Thread Fit Tightly

A loose handle, which was threaded into a mop, was tightened by driving a row of nails around the worn threads so that the fit was snug. The handle could be removed easily, just as if the threads were their original size. Nails with small or rounded heads are best for this purpose.—Charles L. DeCou, Los Angeles, Calif.

### The Manipulation of Gold Leaf

An old Pittsburgh sign painter told me how he used to sit on the bows of the river boats and gild the figure-heads, with much of his gold leaf blowing away. Finally he thought out this method: After removing the first leaf of gold, and thus exposing the next one, he turned over the paper leaf separating the gold, exposing as much of the gold leaf as he required for use, and, running his forefinger nail along the creased paper, cut the gold, after which he lifted it up on the tip. This is the method used generally today by sign painters, and many others who use gold leaf.

In gilding on glass, it is necessary to size the surface with water size, flowing plenty on until it runs off in quite a stream; onto this the expert swings his leaf, and it lands somewhere on the outlines of the lettering—he is not particular just how accurately, so that the letter is covered; and when he has all the letter spaces covered, with perhaps a great deal of space not included within the letters, he permits it to become dry. The leaf settles down flat on the glass.

There are several brands of gold leaf, grading according to amount of pure gold contained and the intended use. One variety is made expressly for gilding on glass, another for gilding on wood. The difference is mainly in the degree of thinness. One layer of leaf makes a good job on wood, while on glass two layers make a better job than one. For exterior gilding the medium shade of gold leaf does best; the pale-colored leaf contains silver, hence tarnishes from gas or smoke.

Water gilding is that in which the leaf is laid on a size composed of isinglass, or glue and water; oil gilding is done on a size composed of oxidized linseed oil. Water size is for gilding on glass, and oil size for gilding on wood. Oil size may also be used on certain textiles, and other surfaces, just as water sizes are sometimes used in decorative work. Water-size gilding is burnished as soon as the size and



leaf are dry, by rubbing with a wad of raw cotton; the same with oil-size gilding. One book of gold leaf will gild  $1\frac{1}{2}$  sq. ft. of surface.

Varnish impairs the luster and color of gold leaf. If varnish must be applied, first coat it with pale shellac.

Gold leaf is injured by dampness and cold. If gilded work is varnished before it is perfectly dry it will show scratches. To avoid this, apply a thin coat of white shellac, which will soon dry, and upon this the coat of varnish may be laid. To remove gold leaf from any part where not desired, as in letter gilding, or lining, use a dampened chamois skin.

In oil-size gilding, if the size is too fresh it will drown the gilding or injure its luster. Better have the size too dry than too wet. If too dry, breathe upon it, which will give sufficient "tack" to the size to hold the leaf.

Where two pieces of leaf overlap they will often cause a joint to show, and this may be removed by gently stippling it with the tips of a bristle brush. To prevent laps showing on very smooth surfaces, have the size quite tacky. When gilding becomes dull from gases and smoke, its color may be restored by a weak solution of sulphuric acid.

To gild carved wooden letters, dip them into a thin priming paint, made from white lead and raw linseed oil, with a little drying japan. Then hang them up to dry. When dry, sandpaper smooth, using steel wool for getting into the curves. Next apply a coat of paint thinned out with turpentine and containing a little varnish. When dry, sandpaper lightly to smooth the surfaces and apply another coat of flat paint. When this is dry, apply a coat of shellac, to insure a perfect surface. Use a slow oil size. Then gild, when of the right "tack."

To prevent gold leaf from adhering where not wanted, as when letters of gold are to be made on a painted, or other, surface, a raw potato cut in two, and rubbed over the parts that are to resist the leaf, may be used.—A. Ashmun Kelly, Malvern, Pa.

### A Double-Hood Roadster Automobile

A novel automobile which proved very convenient in "trouble shooting" at a garage, and which was also used



This Car was Dubbed "Automobile Janus" by Reason of Its Two "Faces"

for local advertising purposes, was made by rebuilding a car to have two hoods, seats, and steering columns, as shown in the photograph reproduced. The extra fittings were bought at small cost, and this arrangement provided for the gasoline tank under the rear hood and gave plenty of space for tools, etc. The entire body was painted and striped in orange and black. In towing disabled cars one man faces the car being towed, and can readily inform the driver, if need be.—A. P. Swaidmark, Concord, N. H.

### Adjusting Drawer Key to Insure Privacy

Where the locks in a cupboard or similar place are alike, and it is desired to make one of them private, a simple and efficient device is to saw off a piece of the key, about  $\frac{1}{16}$  in. long. Force this washerlike ring down tight over the post of the lock in the keyhole, as shown. This key will unlock the lock, but when another is tried it will not go far enough into the lock to turn.—Oliver Higgins, Napoleon, Ohio.

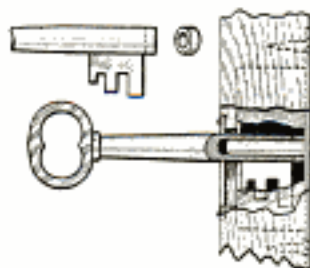



### Improved Frame for Broken Eyeglasses

In an emergency, when a pair of glasses was broken, and it was found difficult to get along without them, a pair of old lenses, broken at the fastenings only, was fitted into a frame made of cardboard. The frame was made of the proper size so that the lenses were centered over the eyes, and the lenses were glued to it. Bows were made of wire and fastened in holes at the ends of the cardboard. This improvised frame gave reasonable satisfaction, in spite of its peculiar appearance.—A. B. Wegener, Madison, N. J.

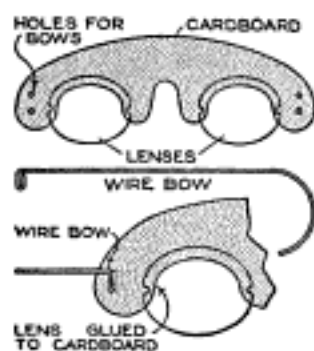

### Folding Bracket for a Ladder

Pails, brushes, or other tools and materials used in working from a ladder, may be supported conveniently on folding brackets like those shown in the sketch. They are hooked to adjoining rungs and a board is fastened across them. When not in use they are folded out of the way, or removed from the ladder. They are made by forming a hinge joint in two strips of iron, as at C. The upper end A and the lower end B are curved to fit the rung without slipping off easily. The upper strip D is drilled to provide a fastening for the shelf.—James E. Noble, Portsmouth, Canada.

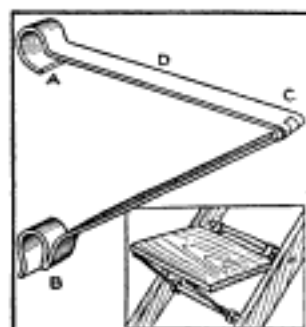

ⒸA washer placed around the neck of a bottle containing poison marks it effectively.

### Small Cutters or Dies Kept on Safety Pins

In the tool-dressing department of a machine shop there are usually many small parts, such as dies and cutters, to be ground. In order to keep the sets together, it was found convenient to place them on large safety pins made of spring-brass wire.—J. R. Minter, Washington, Ind.

### Protective Flap for Drawers of Drawing-File Cabinet

Drawings, tracings, etc., are wrinkled when the drawers of the file cabinet become so filled that the contents catch on the bottom of the next drawer above. The sketch shows how to avoid this by attaching a flap of flexible cardboard, or canvas, as indicated. Bind the front edge with a  $\frac{1}{2}$  by  $\frac{3}{4}$ -in. strip and provide handholes along it. Metal corner plates prevent the flap corners from lifting when they are tucked in. When selecting a drawing from the drawer, hang the flap on the knob of an upper drawer.



### Stand for Stacking Irregular Castings

A stand which prevents breakage of irregular-shaped castings and economizes space is shown in the sketch. It may be made of a size suitable to the castings to be stacked upon it. The base is a plate of cast iron and into it is threaded an iron pipe. A number of pipes may also be arranged on one base.—E. A. Binney, St. Louis, Mo.

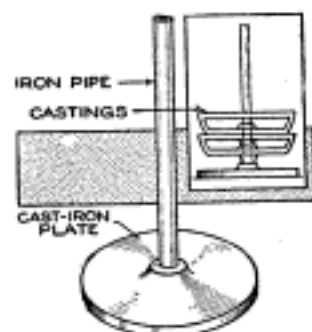



### Formula for Calculating Automobile Speeds

It is often desired to calculate the speed of an automobile, the engine speed, gear ratio, etc., being known. The formulas ordinarily used are long and involved, with considerable possibility of error. The following formula will make the calculation easier. The abbreviations used are: S, speed of car in miles per hour; s, speed of motor, in revolutions per minute; R, gear ratio; T, diameter of tires on rear wheels, in inches; K, a constant, 336, by which the process is shortened.

Tracing the power from the engine through a known gear ratio, R, the speed of the rear axle will be  $R \times s$  revolutions per minute. Each wheel has a circumference of 3.14 multiplied by the diameter, or  $3.14 \times T$  in., which is  $3.14 \times T \div 12$ , if reduced to feet.

The car will be propelled a distance equal to the circumference of the wheels, with each revolution of the rear axle. Thus, to find the distance in feet traveled in a minute, multiply the speed of the rear axle— $R \times s$  revolutions per minute—by the circumference of the wheels— $3.14 \times T \div 12$ . To change this rate to miles per hour, before dividing by 12, multiply the result by 60, and also multiply the 12 by 5,280. Reducing this result, it is found that the process may be simplified so that T multiplied by R, multiplied by s, and the result divided by 336, gives the speed in miles per hour. Thus 336 is established as the constant K, for use in shortening the calculation. The formulas, carried through the above process are:

$$S = \frac{60 \times 3.14 \times T \times R \times s}{12 \times 5,280} = \frac{T \times R \times s}{336}$$

$$\text{or} = \frac{T \times R \times s}{K}$$

as outlined in the detailed process above. — Claude Schuder, Takoma Park, D. C.

☞ A bundle of short strings, or cords, bound together can be used as a brush or swab.

### Shop-Order Box Saves Time of Workmen

To facilitate the work in a large railroad roundhouse, the jobs for the

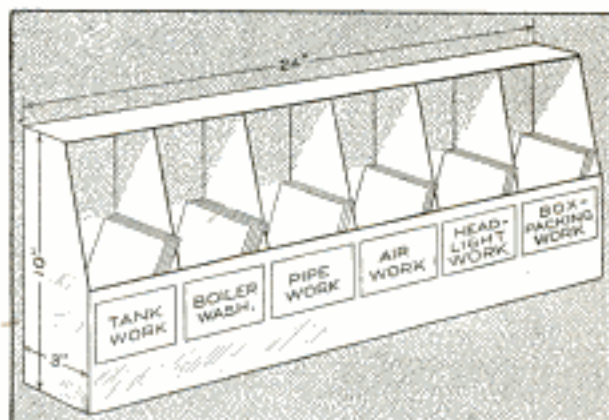

The Workmen Take Their Orders from the Box Instead of Having the Foreman Deliver the Cards to Them

various workmen were assigned by means of a card system. By placing the cards in an order box, subdivided for the various kinds of work, much time was saved, since the workmen removed the cards from their department files when passing the box, which was situated in a convenient place.

### Oil Cups Remodeled to Adjustable Feed

A number of plain oil cups were changed to a satisfactory self-feeding type at little expense as follows: The hinged cap of the oil cup was tapped for a  $\frac{5}{16}$ -in. cone-pointed setscrew, and a locknut applied to prevent the screw from jarring loose. This screw acted as a needle valve, seating on the edge of the small hole in the bottom. A hole for filling the cup was drilled through the cover, and the latter was then sweated fast. A feed as slow as one drop in ten minutes was obtained, and when once set for its particular purpose, the valve needed no further attention.—D. A. Hampson, Middletown, N. Y.

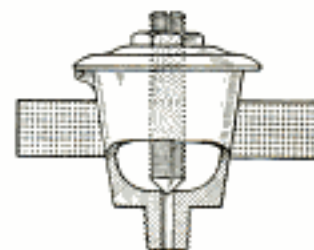



### Illuminated Flag Remains Unfurled

On days when there is only a slight wind blowing it is difficult to make a large flag remain unfurled unless it is

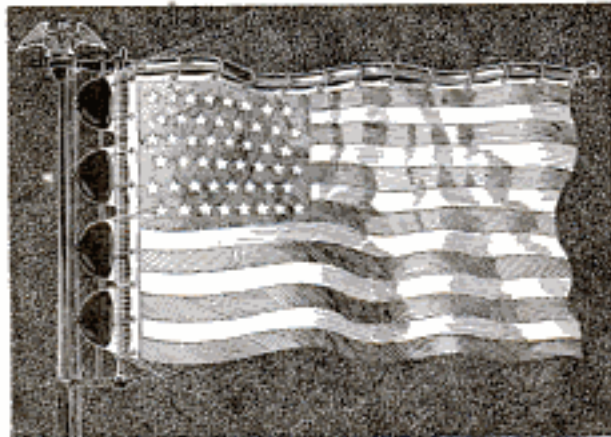

The Flag Remains Unfurled Even in a Light Breeze and is Illuminated at Night

supported. The device shown in the illustration, which is a permanent fixture of the staff, combines this feature with the illumination of the flag. A frame made of a piece of pipe, curved to cause the flag to have the appearance of being blown in a breeze, is supported at the top from the flagstaff. A vertical section is fixed to this and attached to the staff at its lower end by a short piece of pipe. The flag is suspended from the pipe by rings. Shaded lights are arranged along the staff to move with the flag in a change of wind.—L. E. Crane, Hastings, Minn.

### Carrying Storage Battery in Tool Box

Motorists are often cautioned against carrying a storage battery in a tool box

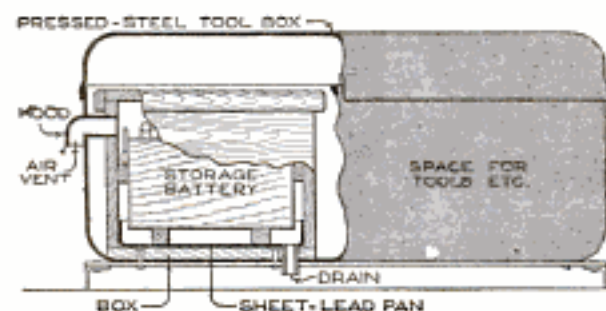

Space was Economized by Incasing the Battery in the Tool Box, without Injury to the Tools

because of its injurious effect on tools, clothes, etc. Sometimes the tool box

is most convenient for housing the starting and lighting battery, and this problem was solved as shown in the illustration. A wooden box was made, to hold the battery, having a tight-fitting cover, and painted inside with asphaltum acid-resisting paint. A sheet-lead pan was made to fit the bottom of the box, and provided with a drain pipe of lead, discharging to the ground. A lead-pipe vent passed through the side of the steel case to allow the gases to escape. The wires passed out through rubber packings in the front of the battery box.—Victor W. Pagé, Bristol, Conn.

### Positive-Grip Hose Coupling

In order to splice, or mend, various kinds of rubber, or fabric, hose I made

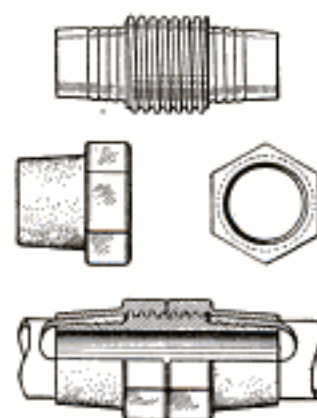

the coupling shown in the illustration. The central section is a brass union having corrugations at the end and a threaded portion at the middle. The ends of the hose to be joined are held in place by two caps having a

hexagonal nut at one end, the latter threaded to fit the center portion of the union. The caps are slipped over the ends of the hose, which are fitted snugly on the corrugation. By drawing up the cap, a close joint is secured.—E. E. Burnham, Amite City, La.

### Electric Drier Used in Drafting Room

A portable combination heater and fan, such as is ordinarily used by barbers, was employed successfully for the drying of ink on tracings and drawings, and for drying prints and mounted sheets in a drafting room. This kink saved considerable time in inking drawings, as it was not necessary to wait long for the ink to dry.



### Drum in Table Top for Listing Merchandise Sales

A clerk in charge of daily-sales reports found that much time was used in sorting over the twelve forms required, even though cards of different colors were provided. Heavy stock was necessary for the cards because of the wear on them. By the installation of a homemade revolving drum, set in the top of a table as shown, the work was done in one-half the time formerly required, and the cards were discarded in favor of forms printed on thinner paper.

The device was made as follows: Two flat-rimmed wheels were used as the foundation for a drum built up of laths. The drum was mounted on an axle and this in turn supported at its ends in lugs bolted to the framework of the table. The upper portion of the drum was exposed through an opening in the table top, and the blank forms were inserted on the drum, which was covered with several layers of wrapping paper. The drum was revolved easily to get at the various forms to

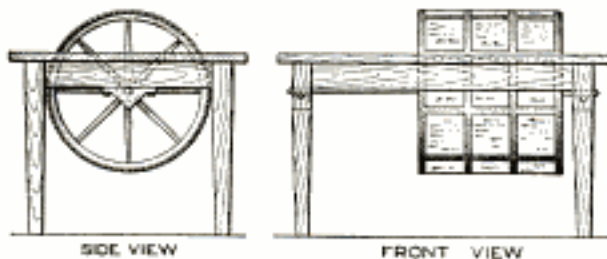

Economy of Time and Blank Forms was Effected by the Use of This Drum, in Listing Sales

which reference was made hundreds of times each day in keeping check on the quantity of stock disposed of.—John P. Lyons, Chicago, Ill.

### An Electrical Water Gauge

The house water-supply tank on the twelfth floor of an office building was a source of trouble to the engine crew in the basement, because of its small size, and the variable rate at which the water was used. An electrical indicating device was constructed, as shown, in which the consecutive lighting of 5-cp. lamps, located in the en-

gine room, denoted the water level in the tank in units of 1 ft. The tank was tapped close to the bottom and a piece of 1-in. pipe inserted with locknuts

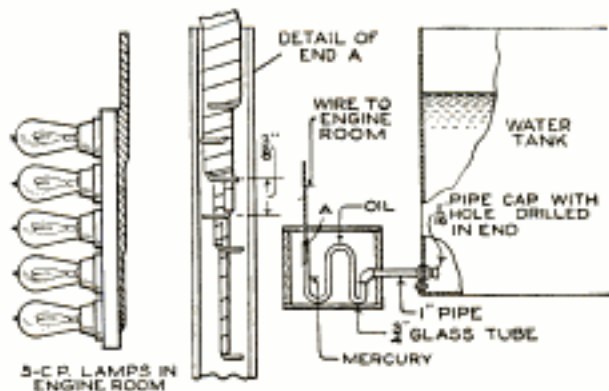

Engineers in the Basement were Enabled to Note the Height of Water in a Tank on the Twelfth Floor by Means of This Device

and rubber washers; an ell and a nipple were placed on the end of the pipe. One end of an S-shaped glass tube was made water-tight in the nipple by means of plaster of Paris. Six wires, taped together, having  $\frac{1}{2}$  in. of the insulation removed from the end of each, and bent at right angles, were taped to the other end of the tube. Mercury was then placed in the first bend of the tube, and oil in the second bend. When the device was connected to the tank the resulting water pressure forced the oil into contact with the mercury, balancing a column of mercury against a column of water. The oil provided an insulation between the mercury and the tank, and maintained its position because it is lighter than mercury or water, and mixes with neither.

The contacts for the various lamps were made through the longer wire, which was submerged in the mercury. As the water level became higher in the tank, the mercury was forced to a correspondingly higher position, making contact for the lamps in order. The distance between the wires is  $\frac{3}{8}$  in. A pipe cap, drilled with a  $\frac{1}{16}$ -in. hole, was placed on the end of the pipe in the tank, to prevent the surge of the water from disturbing the mercury. The glass tube was supported by felt pads in a hinged-cover box.—E. E. Stevenson, Los Angeles, Calif.



### Lowering Concrete Pipes into Well

In replacing a wooden well casing with concrete pipes, 30 in. in diameter, and weighing over 700 lb., the device shown in the sketch was used. The pipes were lowered from a windlass stationed over the well. A piece of 2 by 4-in. stuff, A, was cut slightly longer than the inside diameter of the pipe. A heavy rope was fixed to one end of it, and a lighter rope to the other. A cover, B, was fitted to the pipe and a hole bored at its middle, and the heavy rope passed through it. The smaller rope was passed through a hole adjoining. The board A was wedged into place in the pipe, at the top of the well. The cover B was set into position, with the ropes as shown. The heavy rope was fixed to the windlass. The pipe E was lowered into place, on the pipe F, and the rope D drawn up, releasing the piece A and the cover, which were drawn up for the next pipe.—Arthur E. Shaw, Columbia, S. C.

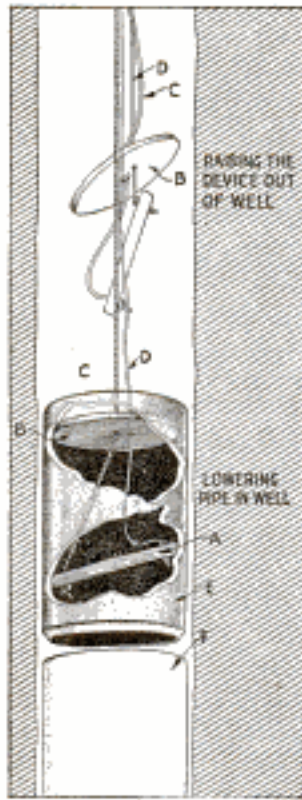

it. The smaller rope was passed through a hole adjoining. The board A was wedged into place in the pipe, at the top of the well. The cover B was set into position, with the ropes as shown. The heavy rope was fixed to the windlass. The pipe E was lowered into place, on the pipe F, and the rope D drawn up, releasing the piece A and the cover, which were drawn up for the next pipe.—Arthur E. Shaw, Columbia, S. C.

### Line Guide for Lettering

A guide for lettering on tracings, that will aid in making the letters uniform both as to height and slant, can be made easily by ruling a strip of tracing cloth as shown in the sketch. It is inserted under the tracing to be lettered and shifted to various positions

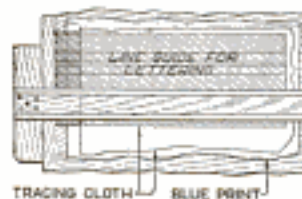

is inserted under the tracing to be lettered and shifted to various positions

as required. An advantage in using a strip of tracing cloth rather than a piece of paper is that the former may be set in relation to a drawing being traced, without obscuring it.—Samuel Kaufman, Philadelphia, Pa.

### Garden Hose on Rim Makes Ash Can Noiseless

Tenants in an apartment house were annoyed by the removal of metal ash cans in the early morning hours. The janitor took lengths of old garden hose and bolted them around the rims at the bottom of the cans, providing a noiseless pad. When the hose became worn it was replaced.—M. J. Schramm, Ridgewood, N. Y.

### Babbitt Collar Overcomes Loose Pump Plunger

In a heating system a vacuum pump was used to return the condensation to the boiler room. It did not give satisfaction, and on inspection it was found that the water had corroded the follower, as at A, to such an extent that the packing had pulled through and worked into the valve seat. Not having a lathe, some other means of repairing the plunger was required, and the following method proved successful: The follower was trued up on an emery wheel and the edge ground concave, as at B. A mold of wood, C, was made the same size as the pump cylinder and of the same thickness as the follower plate. The latter was centered in the mold, babbitt was poured around it, and after fitting slightly it has given complete satisfaction.—A. P. Sitton, Fort Stanton, N. M.

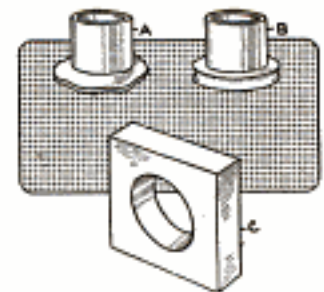

The follower was trued up on an emery wheel and the edge ground concave, as at B. A mold of wood, C, was made the same size as the pump cylinder and of the same thickness as the follower plate. The latter was centered in the mold, babbitt was poured around it, and after fitting slightly it has given complete satisfaction.—A. P. Sitton, Fort Stanton, N. M.

ⒸThe surface of metal to be electroplated should be free from scratches or imperfections, since the plating will not hide them.





## Combination Camp-Kitchen Cabinet and Table

By J. D. BOYLAN

**T**HE combination camp-kitchen cabinet and table is the result of not being able to take the members of my family on an outing unless they could have some home conveniences on the trip, and perhaps the sketch and description may help solve the same problem for others. The table will accommodate four persons comfortably, and extra compartments may be added if desired. The cabinet, when closed, is strong and compact, and if well made with a snug-fitting cover, is bug-proof, and the contents will not be injured greatly, even though drenched by rain or a mishap in a craft.

For coffee, tea, sugar, salt, etc., I used small screw-top glass jars. They are set in pocket shelves at both ends. When closed, one can sit on the box or even walk on it if necessary when in the boat, and if an armful or two of coarse marsh grass is spread over it, the contents will keep quite cool, even when out in the hot sun. When open for use, the metal table top *F* is supported on metal straps, *E*, which also act as braces and supports for the table

leaf, *G*, on each side of the box. This affords plenty of table surface and one can easily get at the contents of the cabinet while cooking or eating. The legs, *D*, are stored inside of the box when closed for traveling. They are held in place under metal straps when in use, and held at their upper ends by the metal plate and blocks, *B* and *C*. The bent metal pieces, *A*, on the ends of the top, spring over the blocks at *B* and *C*, and form the handles.



This Outfit Provides Accommodations for Four Persons, and Folds Compactly

### A Homemade Life Buoy

A serviceable circular life buoy may be made by sewing together rings of canvas, filling the resulting form with ground cork, and waterproofing the covering. Cut two disks of canvas about 30 in. in diameter, and cut out a circular portion from the center of each, about 12 in. in diameter. Sew the pieces together at their edges, leaving a small opening at a point on the outer edge. Fill the cover with cork used in packing grapes, and sew up the opening. Paint the buoy thoroughly, with white lead, and attach hand grips of rope.



### A Folding Table with Split-Bamboo Tray for Top

A folding table frame, designed as a support for a circular split-bamboo tray, is shown in the photographs re-

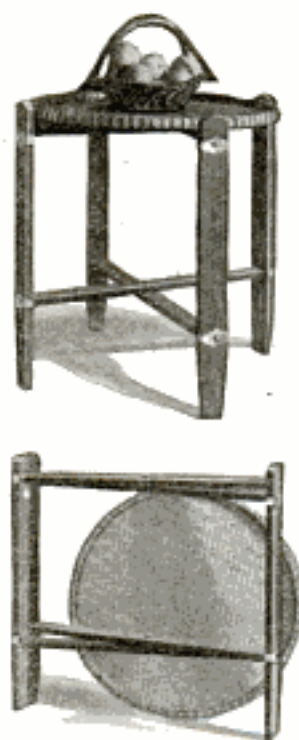

produced and detailed in the working drawing. It is a serviceable and inexpensive piece of furniture, and can be constructed readily by the home mechanic. As the trays vary in size, the frame must be made to correspond, those from 24 to 28 in. in diameter being satisfactory. The tray may be made by the ambitious craftsman or purchased at stores dealing in Oriental goods. A wooden top may, of course, be substituted. The frame is made

crosspieces, 1 by 2 by 25 in. Mortise the legs to the ends of the crosspieces, one set of mortises being  $\frac{7}{8}$  in. below the other. Assemble the parts and fasten the joints with glue and 2-in. flat-head screws, countersunk.

Adjust the crosspieces of each set so that their centers match, and fasten them in this position with screws, from the under side. The two parts of the frame revolve on them when the table is "knocked down." On the ends of the lower crosspieces of each set, fasten blocks to level the support for the tray. Finish the frame to harmonize with the furniture of the room. Conceal the screw heads under bands of hammered or oxidized copper, fastened with copper or brass pins. A second tray may be placed on the lower crosspieces.—F. E. Tuck, Nevada City, Calif.

Adjust the crosspieces of each set so that their centers match, and fasten them in this position with screws, from the under side. The two parts of the frame revolve on them when the table is "knocked down." On the ends of the lower crosspieces of each set, fasten blocks to level the support for the tray. Finish the frame to harmonize with the furniture of the room. Conceal the screw heads under bands of hammered or oxidized copper, fastened with copper or brass pins. A second tray may be placed on the lower crosspieces.—F. E. Tuck, Nevada City, Calif.

### Small Desk Lamp Supported by Paper Weight

Those who wish a small desk light that may be pushed back out of the way in the daytime, will find the accompanying sketch of interest. When in use on a roll-top desk, the lamp is placed on top near the edge, so that the bulb overhangs. A 25-watt lamp will light the bed of the desk, and the small metal shade is so placed that no part of the bulb is visible to the eye of the worker. By providing a suitable base, the lamp may be adapted to other uses.

A stock paper weight, about 2 in. in diameter and covered with green felt, was used as a base. An ordinary drop-cord socket is provided, and to one side of the top cap a strip of brass,  $\frac{1}{16}$  by  $\frac{1}{2}$  in., is soldered. A hole is drilled near the end of this strip so that the screw which holds the knob will also hold the socket. Connect the flexible cord in the usual manner.

The shade is made of sheet metal,

This Tray Table Is Readily Portable, and Useful in the House and on the Porch or Lawn

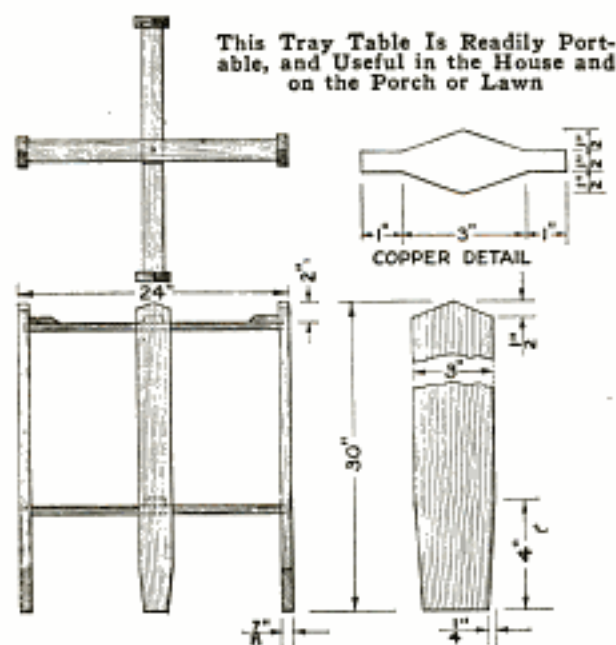

preferably of soft wood. The following finished pieces are required for a 24-in. tray: 4 legs,  $\frac{7}{8}$  by 3 by 30 in.; 4

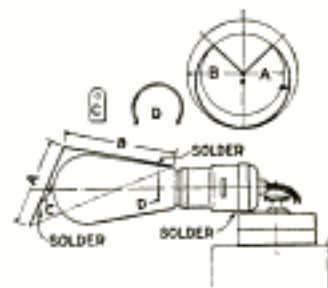



bent in the form of a cone, having the front shorter than the opposite edge. Make a sketch of the bulb, and determine the lengths of the two sides A and B, and then draw two concentric circles of corresponding radii on paper, as indicated in the small diagram. The proper curve for the shade will then lie between these two circles. Cut a paper pattern, and form it into a cone. After the proper shape is determined, mark it on the metal, cut it to shape, and solder it. A small spring clip, C, engages the tip of the bulb; the back of the shade is held by a piece of spring wire, D. It is easy to spring the shade off in replacing the bulb. The outside of the shade should be enameled an olive-green.—John D. Adams, Phoenix, Arizona.

#### Device Frightens Flies at Screen Door

An effective means of frightening flies away from a screen door may be made from a spring curtain rod and cotton duck. Scallop-shaped pieces of 8-oz. duck, 6 in. long, are fastened to the pole, on opposite sides, as shown. The ratchet on the end of the pole is arranged so as not to catch. A small cord is wound

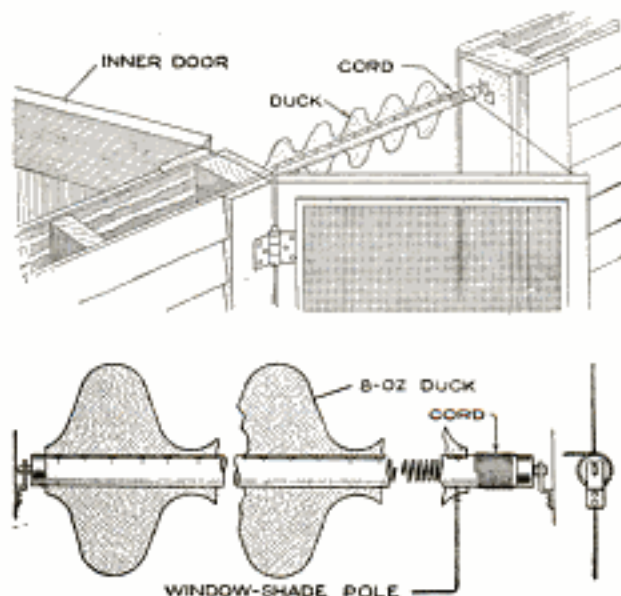

The Scalloped Roller is Revolved Rapidly When the Door is Opened, Frightening Flies

around the pole and fastened to the screen door. The rod supports are fixed near the top of the door frame.—Josef H. Noyes, Paris, Tex.

#### Porch Swing Made from Automobile Seat

When an obsolete type of automobile was converted into a truck for



The Seat Discarded from a Rebuilt Car was Put to Good Use

marketing purposes, a leather-upholstered seat, discarded, was utilized as an attractive and comfortable porch swing. Hooks were secured to the front corners of the seat and to the upper edge of the back, for the chains attached to suitable supports.—George L. Ayers, Washington, D. C.

#### Linoleum Panels for a Homemade Chest

A strong packing box was converted into a useful and not unsightly chest by covering it with panels of linoleum left over from a job of covering a floor. Strips,  $\frac{1}{2}$  by 2 in. wide, were nailed around the corners of the box to form a panel on the top, sides, and ends. The wood and the linoleum were shellacked, and made a good appearance.

ⒸThe lower corner of an envelope may be used as a small funnel.



### Camera for Bird Photography

A reasonably large image must be obtained in photographing bird life, or the details of plumage and identifica-



Bird Images Large Enough to Show Identification Markings are Obtained with This Camera

tion are lost, reducing the value of the pictures. The "gun camera" shown in the photograph was devised for this purpose, and with it exposures may be made more quickly than with the telephoto type of camera, a feature of great value in this class of photography. The device consists of an ordinary reflecting-type camera, mounted on a carriage for ready portability and quick adjustment. The bellows is supplemented with a tube, permitting the use of lenses of upward of 30-in. extreme focus. This gives a larger image without loss in speed. A  $\frac{1}{4}$ -in. image of a bird was obtained with a  $7\frac{1}{2}$ -in. extreme-focus lens, as against a 2-in. image with one of 30-in. focus, from the same position. The lens is set near the rear end of the tube, giv-

ing a deep hood for shading the sunlight. Lenses of an old type, known as "Long Toms," were used. They are inexpensive compared with newer types with iris diaphragms, and give good results even at  $\frac{1}{1,000}$  exposures.—Arthur Farland, New Orleans, La.

### Electric Fan an Aid to Heating Room

The electric fan is useful not only for cooling the air in summer, but also for distributing the warm air to advantage in the winter. An efficient way of warming a room fairly uniformly is to place an electric fan near a radiator, so that its breeze passes through the heating coils, or near another source of heat. The heat is circulated around the room, instead of being kept in a limited area.—Peter J. M. Clute, Schenectady, N. Y.

### Cat-and-Bells Scarecrow

A scarecrow resembling a living animal is often more effective than other devices, and the cat-and-bells arrangement shown in the sketch was found especially so. The hide of a cat was stretched over a hollow frame and suspended by a cord from a large weather vane. Several bells were attached to the cord, and when the vane shifts in the wind, the movement of the hide and the rattling of the bells combine to frighten the birds.—F. H. Sweet, Waynesboro, Va.



A coating of five parts of coal tar, one part gasoline, and one part japan drier will make canvas nearly watertight.



# A Small Hydraulic Turbine

By FRANK D. BELL

CONSIDERABLE power and speed can be developed under ordinary water-supply pressure by the turbine, or water motor, shown in the sketch and detailed in the working drawings. The parts are of simple construction, and the machine may be assembled or taken down easily. It is useful for either belt or direct connection to electrical generators, small machines, etc., the direct connection being preferable for a generator. The wheel is built up of sheet metal and provided with curved buckets set in the saw-tooth edge. The water is admitted through an opening in the lower part of the housing and passes out at the opposite end into a suitable drain pipe. The housing is made of two sections, the main casting and a cover plate. Bearings for the shaft are cast into the housing, which is reinforced on the back by ribs radiating from the center.

Wooden patterns are made for the housing, the main casting and the cover plate being cast separately. The pattern for the cover plate should provide for the bearing lug, as shown in the sectional detail, and for the angle forming a support at the bottom. Special attention should be given to allowance for proper draft in making the pattern for the main casting; that is, the edges

of the reinforcing ribs, and the sides of the shell should be tapered slightly to make removal from the sand convenient. The advice of a patternmaker

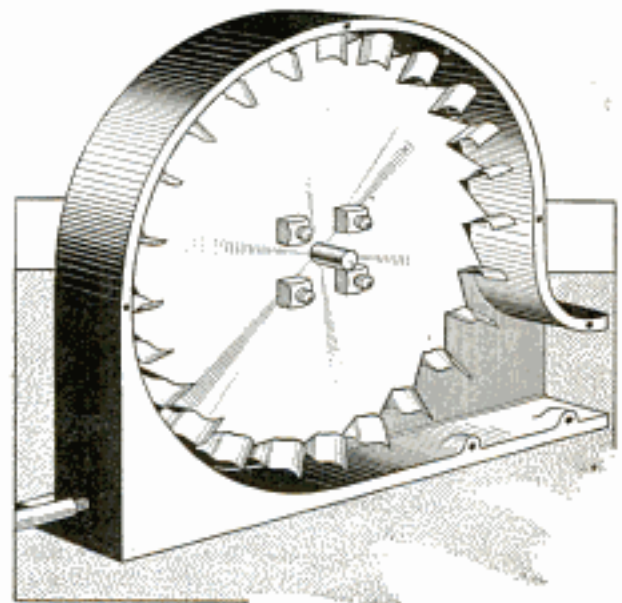

View of the Water Turbine with the Cover Plate Removed, Showing Inlet and Drain

will be helpful to one inexperienced in this work, although many machine metalworkers are familiar with the process.

The finishing and machining of the parts and their assembling should be undertaken as follows: Clean the castings and file off rough parts. Smooth the cover plate and the shell to a close

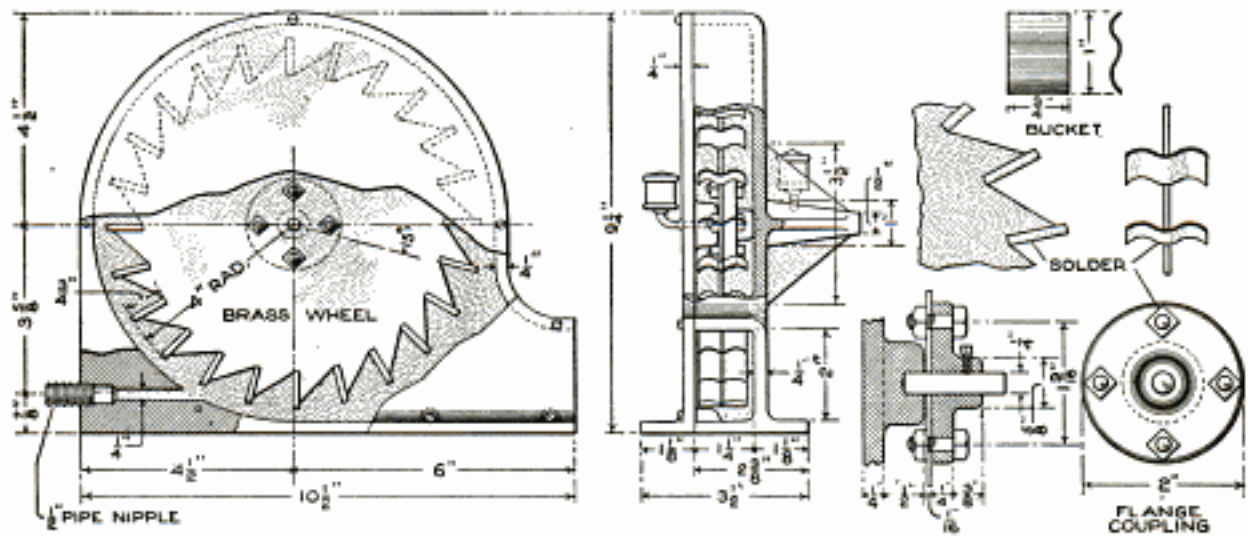

Details of a Water Turbine That will Give Considerable Power and Speed for Driving a Generator or Small Machine



fit, and drill and tap the fastening holes for 8-32 machine screws. Drill  $\frac{1}{4}$ -in. holes for the bearings, through the bearing arm and  $\frac{1}{4}$  in. into the lug on the cover plate. Drill and tap the two grease-cup holes for  $\frac{1}{8}$ -in. pipe thread. Drill the nozzle hole  $\frac{1}{4}$  in., and drill and tap it for a  $\frac{1}{2}$ -in. pipe nipple.

Lay out the wheel of  $\frac{1}{16}$ -in. brass, making 24 notches in its edge. Fasten the wheel to the  $\frac{1}{4}$ -in. shaft with a flanged coupling, fixing it with a set-screw. Bolt the flange to the wheel with 8-32 steel bolts. Make the buckets of  $\frac{1}{32}$ -in. sheet brass, curved as detailed, and round off the edges. Solder

them into place, using plenty of solder and making certain that the curve is set properly. Place drops of solder on the flange nuts to secure them. Place the ends of the shaft on two knife-edges, and balance the wheel by adding drops of solder to the lighter side. This is very important, as undue vibration from lack of balance will wear the bearings quickly.

Assemble the machine, using shellac between the cover plate and shell. Make connection to the water supply with a  $\frac{1}{2}$ -in. pipe. Bolt the machine down, and do not let it run at full speed without load.

### Automatic Lock Box for Milk Bottles

A mousetrap spring, provided with a suitable catch, was fitted into a box for

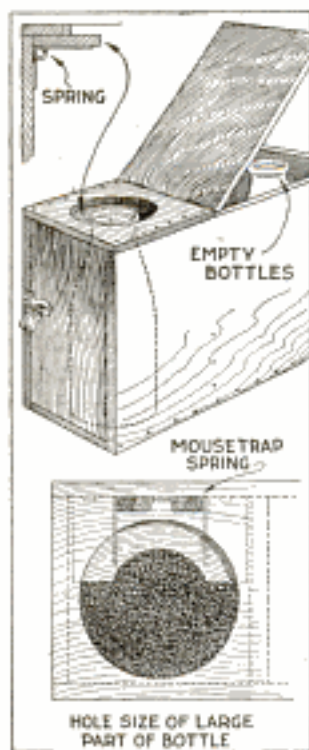

milk bottles, and served to protect the milk bottle against theft by prowlers. The box was made large enough to hold several bottles, the empty ones in one portion and the filled bottles in another. The bottle is dropped through an opening in the locked end of the box and the spring forces up the catch. While this device may be tampered with, it guards

effectively against the theft of bottles of milk, since most of those stolen are taken because they are easily accessible.—L. F. Head, Seattle, Wash.

¶The oxyacetylene flame may be used in cutting or welding steel cables, but such welds will not sustain the original safe load of the cable.

### Uses for an Old Toothbrush

A discarded toothbrush, properly cleaned so as not to be insanitary, may be used in one or possibly more of the following ways: to raise the nap of white buckskin shoes, after polishing them; in reaching corners with shoe polish, or in cleaning out eyelets and corners; cleaning typewriter keys with benzine; polishing small parts of metalwork.—Joseph A. Cunningham, Philadelphia, Pa.

### A Locking Sheath for Hunter's Knife

Having made a hunting knife and desiring a suitable sheath for it, I devised that shown in the sketch, which has the special feature that the guard on the knife handle locks in slots cut through the sheath. Two pieces of leather were used, one for the back section and the other for the shorter front piece. The sewing at the edges of the two sections extends from the level of the slots around the lower end of the sheath. Two slots were cut vertically through the upper portion of the sheath, which is fastened to the belt of the wearer, as indicated.—George H. Flint, Harrison, Me.





### Discarded Buggy Springs for Diving Board

Old leaf springs obtained from a buggy were used to give the necessary spring to a diving board. One of the springs was set at each side of the board about  $2\frac{1}{2}$  ft. from the fixed end, and they were joined by a cross support of 2 by 4-in. wood, on which the spring board rested. Straps to check the strain on the springs from the rebound were provided.

### Water Wheel Turns Spit over Campfire

When a camp fire is placed near a stream, water power may be utilized to turn the spit in roasting meat over the fire. The rod, on which the roast is suspended, should be extended, and supported at one end, over the water. A small paddle wheel may then be rigged up easily on the rod.

### A Detachable Chair Arm

The children in the home as well as others can make good use of a chair arm which may be attached quickly to an ordinary chair. The wide arm is clamped to the back of the chair by means of a strip of metal fitted with a thumbscrew, and the upright is fixed to the arm by a hinge, making it con-

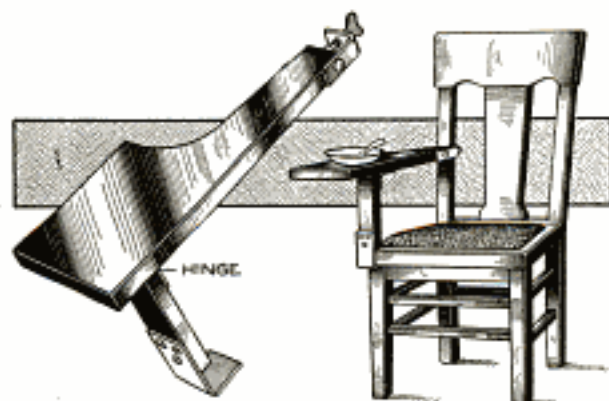

This Folding and Detachable Chair Arm Is Useful in the Home

venient to store the device. The lower end of the upright is fitted with a metal angle which fits on the corner of the chair.—J. F. Long, Springfield, Mo.

### Comic Chest Expander for Play or Stage Use

A device used in an amateur vaudeville sketch with good effect, and

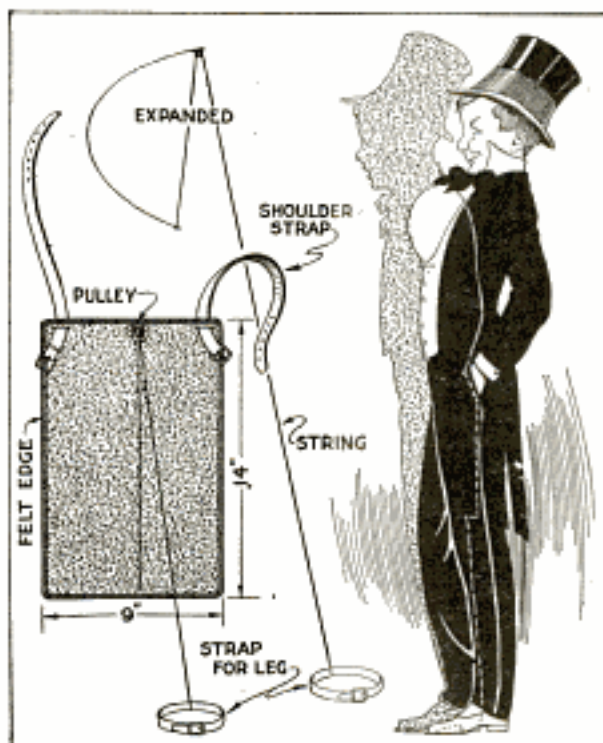

The Performer's Chest "Swells with Pride" When He Draws on the String by Shifting His Position

which is interesting for play purposes, was made of a  $\frac{1}{32}$  by 9 by 14-in. piece of sheet spring brass, rigged as shown. In the center, near the upper edge, a small pulley was soldered, and at the center of the bottom edge a small hole was drilled. In it was fastened one end of a 4-ft. string which ran up through the pulley. The other end was fastened to a strap to fit around the leg just above the knee. At the two upper corners of the brass sheet two slots were cut to accommodate similar straps, as fastenings. When the wearer stands in a normal position the chest is as usual, but by straightening the body and slightly moving the strapped leg back, the brass sheet is bowed outward, giving the appearance indicated.—Arthur L. Kaser, South Bend, Ind.

☞ Square cardboard disks fastened to the ends of a spool with thumb tacks will prevent it from rolling.



**Cane Made of Tubing Contains Cigars**

As a novelty in canes, a steel tube was provided with a suitable handle and used as a container for cigars and matches. The tube was fitted with a metal cap at its junction with the handle and the cigars are inserted or removed at this point. The end

of the handle was bored out and also provided with a cover, as a match safe. The tube was enameled and varnished to resemble wood.—James E. Noble, Toronto, Canada.

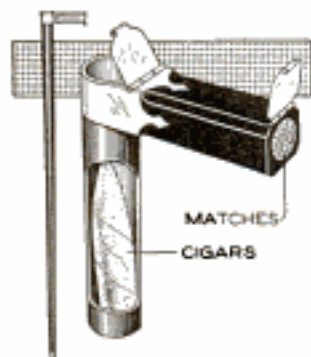
**Key Ring Used as a Cover Fastener**

The usual box-cover fastener in the form of a staple and hasp can be fastened quite securely, and much better than with the use of a wood pin, by applying a key ring to the staple. This is to take the place temporarily in case the lock is lost or discarded.—James M. Kane, Doylestown, Pa.

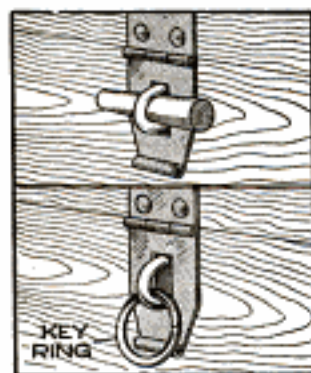
**Golf Tee Made of a Shotgun Shell**

Instead of making golf tees in the usual manner I used the brass end of a shotgun shell, weighted with a small iron ball attached to a string. The device was made as an experiment and proved so useful and convenient to carry that I continued to use it.—Edward Beasley, Texarkana, Ark.

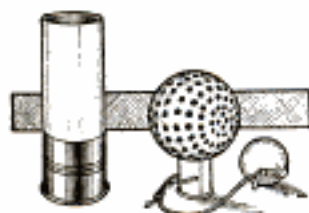
**Patching Canvas Bottom of a Canoe**

A patch of silk, properly applied, makes a good repair for a hole worn through the canvas bottom of a canoe. Loosen the canvas for about 2 in. around the hole and apply thick shellac. Insert a piece of silk in the hole to lap under the edges of the canvas. Permit the shellac to dry slightly and smooth down the patch. Protect the joint further with white lead, smoothing over the patch and painting it when dry.

**Handy Tray for Pencils and Penholders**

A piece of light cardboard, or sheet metal, may be folded into a neat and useful holder for pens, pencils, etc., on the desk or drafting table. In the latter case a piece of stiff drawing paper, folded into V-grooves and tacked to the board, is convenient. For use on a finished surface the folded piece should be pasted on cardboard or otherwise fastened down.—William Robert, Springfield, Mass.

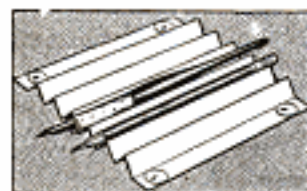
**Removing Sag from Couch Spring**

A couch spring of the type shown in the sketch sagged considerably, making it ineffective. The sag was taken up by bending the sections of wire with a monkey wrench, so that the entire spring was stiffened almost as satisfactorily as when new. Care must be taken that the wires are bent uniformly so that the strain is evenly distributed.

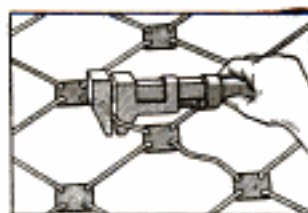

ⒸAn eggshell may be balanced on the edge of a knife if the egg is "blown," and then partly filled with sand.



## An Effective Combination Lock Easily Made

By E. F. STRONG

THE combination lock described has been used for years on lockers and letter boxes in a large public building. The details of a lock with three disks are given, and in Fig. 4 the use of two disks is suggested. The lock is made as follows: From a piece of  $\frac{3}{16}$  or  $\frac{1}{4}$ -in. hard wood, saw out three disks, A, Fig. 1, from 1 to 4 in. in diameter, according to the size of lock desired. For one with 2-in. disks, as shown, cut slots, B,  $\frac{1}{2}$  in. wide and deep, in the edge of the disks. For axles use  $\frac{3}{8}$  by 2-in. hardwood dowels, C, with a six-penny headless wire nail in one end, leaving about  $\frac{1}{4}$  in. of it exposed.

The case of the lock is shown in Fig. 1. It is made large enough to mount the disks, as shown. Around the edges of the inside surface of the lid fasten strips a trifle thicker than the disks. Place the disks in the positions shown, drilling small holes in the baseboard for the nail axles. The bolts, D, and the piece, E, are made of hard wood, fastened with a lap joint. On each side of the bar, D, fasten cleats, F, to hold it in position. The handle, H, moves in a slot in the lid, and is fixed to the bar, E.

The door, or lid, on which the lock is to be used, is provided with openings, J, as shown in Fig. 3. The axles C, project through openings, as bearings. When the windows J, through which the combinations are read, are made, place the ends of the bolts in the slots of the disks and screw the lock in position. Mark on each disk the point exactly in the center of the window, enabling one to work the combination temporarily. To lock the device, push the handle to the left and turn the axles. To unlock it, turn the axles until the pencil marks appear in the middle of the windows, and throw the bolts.

Next make paper dials, K, of a diameter as shown in Fig. 2. Divide the circumference into from 50 to 100

equal parts, according to the size of the dial, and draw radii, as shown.

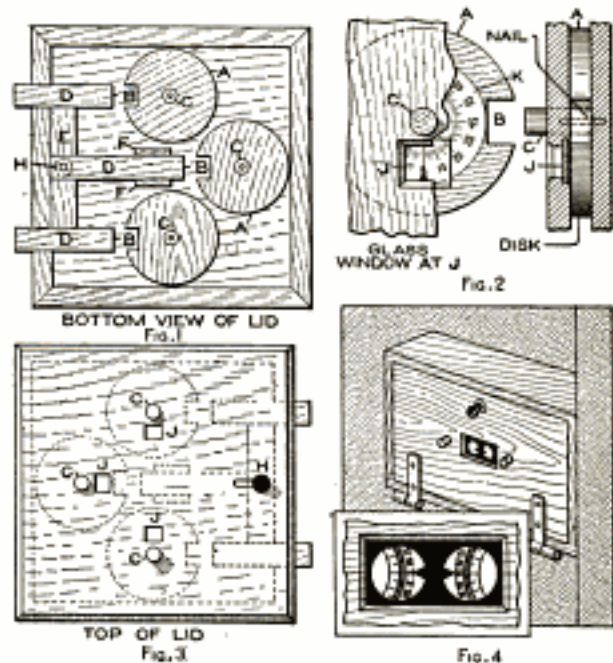

This Wooden Combination Lock Gives Good Service and is Easily Made

Number at least every fifth point. To the face of each disk, A, with small thumb tacks, fasten one of the dials, placing the combination numbers selected exactly over the pencil marks made in setting the temporary combination. Verify the combination before locking it. Unless the slots in the disks are a little wider than the ends of the bolts, the combination must be very closely adjusted. An aid in setting the combination is a line on the glass or a point of black paper, as shown in Fig. 2. The combination may be changed by setting the dials in new positions. The large number of combinations possible makes it very difficult to obtain the combination. For most purposes, two disks are sufficient in a lock of this kind.

CA convenient method of supporting a garden-hose nozzle is to tie a loose knot in the end of the hose, arranging the nozzle to spray as desired.



### A Simple Metal Bird Basin

A bird basin can be made an attractive feature of a home garden, and that shown in the illustration was

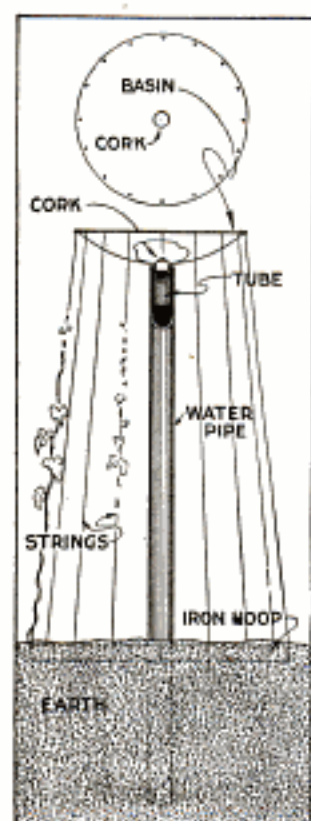

shown in the illustration was made easily of a metal basin and a section of iron pipe. The pipe was sunk in the ground to a depth of 30 in. and loose rock placed around the end of it. A shallow pan, hammered out of a flat piece of sheet metal and provided with a cork stopper, was fixed to the upper end of the pipe. Holes were made in the edge of the pan and strings to support morning-glories were attached from them to a hoop, set in the ground around the pipe. When it is desired to change the water in the pan it is drained off by releasing the cork.—Mrs. F. D. Reynolds, Stevens Point, Wis.

### Catch-All Screen inside Hot-Air Register

In order to recover small articles dropped through the floor-register grating of a hot-air heating system without the necessity of removing a section of the pipe, mesh gratings like

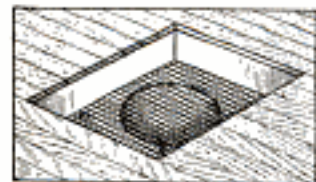

that shown were fitted into place. Number six gauge wire mesh was used in pieces just large enough to fit into the metal box below the register. Access to the screen may be had by removing the grating.—F. M. Ball, St. Louis, Mo.

### Practical Uses for Old Button Clasps

Leather and metal-button clasps from suspenders are useful in repairing heavy gloves, large leather cases, and other articles on which the clasps have been lost or worn out. They may be sewed or riveted into place. Attached to straps, they are useful means of making a fastening, and may be applied to leggings, and other parts of outing clothes.

### Bark-Covered Porch Light and Plant Shelf

A combination flowerpot holder and reading lamp was made from two pieces of wood, bark, and a lamp socket, and proved to be a good shaded reading light.

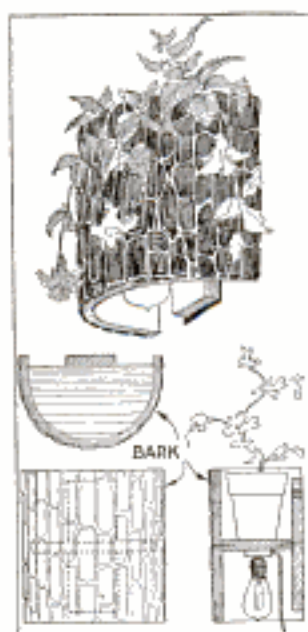

With a plant in the flowerpot, the fixture was made quite attractive by day. Maple bark, well dried out, was used. A piece of board,  $\frac{3}{4}$  in. thick, was cut to fit the curve of the bark, and fastened to it. The former was then nailed to another board,  $\frac{1}{2}$  by 5 by 14 in., which formed the support for the fixture. A lamp socket was attached and a suitable current source provided.

### Removable Headrest for Chair

A convenient attachment for the back of a chair is an extension padded to form a comfortable headrest. This may be made by fixing a padded piece of wood, 6 in. wide and 20 in. long, to the chair back by means of suitable wooden braces, notched to fit the top of the chair.



### Rigging Economizes Space in Closet

It was necessary to store a considerable quantity of clothing in a small clothes closet, and the rigging detailed in the illustration was devised, and provided unusual accommodations. Wooden rods, 1½ in. in diameter, were set across the closet at each side of the door and supported on notched blocks, as shown in the detail at the left. The clothes used frequently were supported on these rods by means of hangers. For clothes out of season, or used only occasionally, a special rigging was arranged in the space above the door. A 1½-in. rod was fitted between the walls to slide in a groove at its ends. Strips nailed to the wall formed the groove. Cords, attached to the rod, as shown, and carried to the ceiling, where pulleys were fixed, made it convenient to raise or lower the rod. A

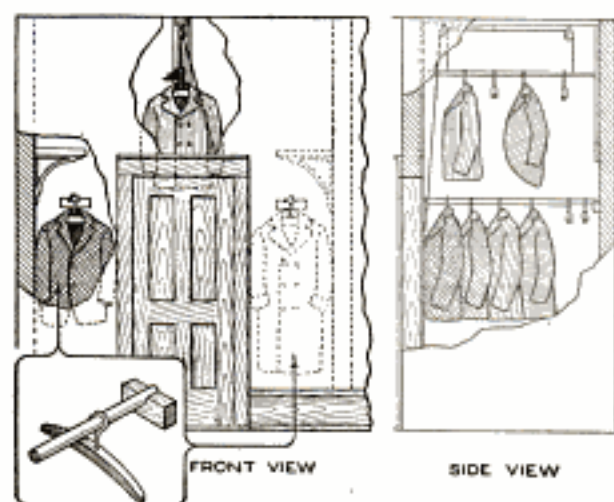

This Simple Rigging Gave Accommodation for a Large Quantity of Clothing in a Small Closet

sheet was spread over the clothes to protect them.—A. K. Hay, Ottawa, Canada.

### Scoop Made of Box End

A scoop that is serviceable for handling various kinds of lighter bulk material may be made by cutting the end from a cardboard box of suitable size and trimming it into shape. A handle may be provided by making a loop of cloth, or flexible cardboard, and fastening it with a paper fastener.

### Mechanical Toy Pigeon Made of Wood

When the head of the mechanical pigeon is lowered the tail rises, and

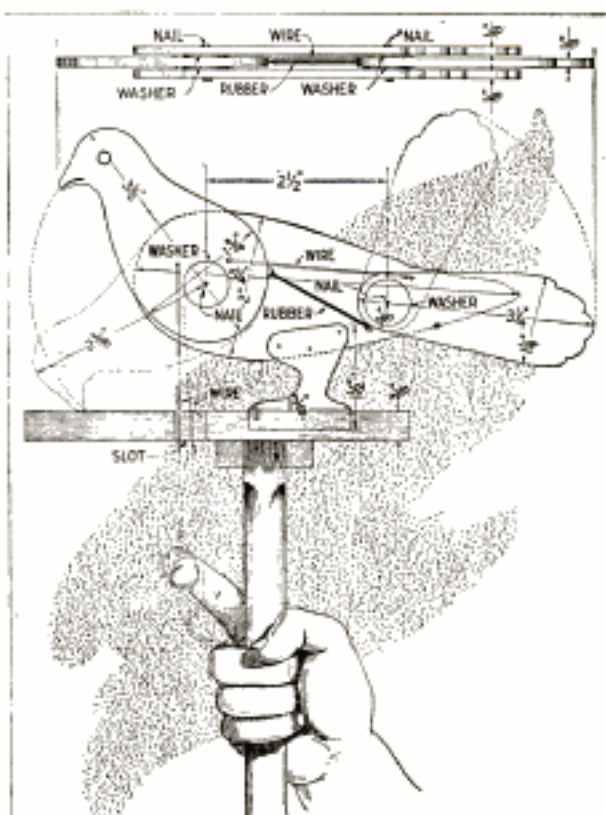

Draw on the Wire and the Head and Tail Bob Up and Down

the reverse. It is constructed as follows: Make paper patterns for the parts, which consist of two body pieces, a head, a tail, and the foot piece. The shape of the parts is shown in the sketch, the front body piece being removed to show the connections of the rubber and wire controlling the movements. The view above shows the fastening of the parts with nails. The main sizes of the parts, which are made of 1/8 to 1/4-in. soft wood, are: head, 1¾ by 3½ in.; body, 2 by 5¼ in.; tail, 1¼ by 3¼ in.; foot piece, 1¾ by 1½ in. Mark the shapes on the wood, cut them out, and mount them, with a rubber band connecting the head and tail, as shown. Nail the foot piece between the body pieces, and pivot the head and tail on nails. Connect the head with a wire, having a loop on one end. Make the holder, and cut a slot into it for the draw wire, operated with the finger.—C. C. Wagner, Los Angeles, Calif.



### Sportsman's Cabinet for Guns, Equipment, and Books

The books, magazines, guns, fishing tackle, camera, etc., of the out-of-door man are often kept or laid aside in various places.



To provide a good place for such equipment, I made the case shown. What apparently is a neat bookcase when closed, the top shelf used as a magazine rack, accommodates numerous other articles. After the "bookcase" has been examined superficially I open the door, swing the shelves out, and display back of them my guns, hunting togs and outfit. Two small drawers, covered by the upper rail of the door when closed, hold various small articles; and a blind drawer under the door holds shoes and the larger articles. I constructed this combination cabinet as follows:

The lumber used was  $\frac{7}{8}$ -in. chestnut. The dimensions of the cabinet are 60 by 30 by 14 in. For the back of the bookshelf and cabinet I used matched ceiling. The door casings are 4 in. wide; the sidepieces of the door are 3 in. wide, the top, 4 in., and bottom piece, 6 in. wide. This cabinet cost me less than \$3 and does the service of a gun cabinet valued at \$30.—F. E. Brimmer, Dalton, N. Y.

### A Photographic-Negative Filing System

In order to preserve photographic negatives and to make them easily available, the following homemade system was devised: The negatives are kept in envelopes having a print from the negative therein mounted on the face. A trial, or an inferior, print is used, and shows what negative it contains. Extra prints and enlargements are kept in the same envelope for each negative. On the face, or back, of the envelope is written data, such as name or title of subject, place and date taken, stop and shutter speed used, most suitable printing paper, developer, etc. This data may be kept in the negative envelope on a sheet of paper. This leaves the photograph album free from data that is of no interest to persons viewing the pictures. The envelopes are kept in their original boxes, classified as "Animals," "Birds," "Live Stock," "Landscapes," "My 1914 Vacation Trip," and so forth.

### Knee-Rest Holder for Milking Pail

Becoming tired of holding the milk pail between my knees while milking,



I made a contrivance of strap iron to overcome this. It is arranged so that the milk pail will just fit inside, the curved straps supporting the weight of the pail on the knees. The holder may be made of wood, with the possible exception of the

curved arms, which should be made of pieces of iron,  $\frac{1}{8}$  in. thick and about 2 in. wide. The circular frame can be made adjustable to various pails by bolts set in holes in the bands.—J. C. Whitescarver, Miami, Okla.



### Tool Sockets in Edge of Drawing Board

Drawing tools, pencils, etc., were kept out of the way on a drawing board by inserting them in pockets drilled in the upper edge of the drawing board. A small brass plate, pivoted on the center, was used to cover each set of two pockets, and the latter were numbered on the upper surface of the board.—Elmer O. Tetzlaff, De Pere, Wis.

### Cart for Carrying Huge Drum in Parade

The inalienable right of the small boy to carry the drum in a parade was disregarded when the cart shown in the sketch was made for a large drum. Two rubber-tired wheels were mounted on an axle bent to fit the drum, and curved handles, forming a supporting frame, were fixed to it. The frame was made of hickory, steamed

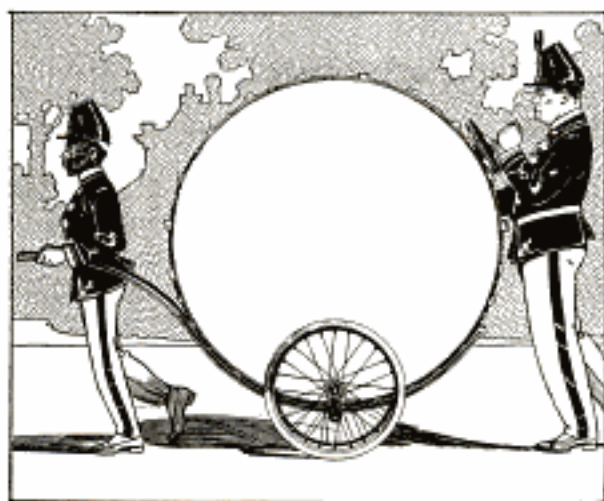

This Rubber-Tired Cart was Built Specially for a Large Drum Used in Parades

and bent into shape, and the drum was arranged to be quickly dismantled.—W. C. K., Mason City, Iowa.

### A Homemade Inverted Electric-Light Fixture

An attractive and serviceable inverted-light fixture for a den and study was made at an outlay of about 30 cents, the details of construction being shown in the illustration. The light is

distributed thoroughly, and with a 40-watt lamp is ideal for work at a desk. The lower portion A is a tin wash-basin, costing 10 cents, and the part

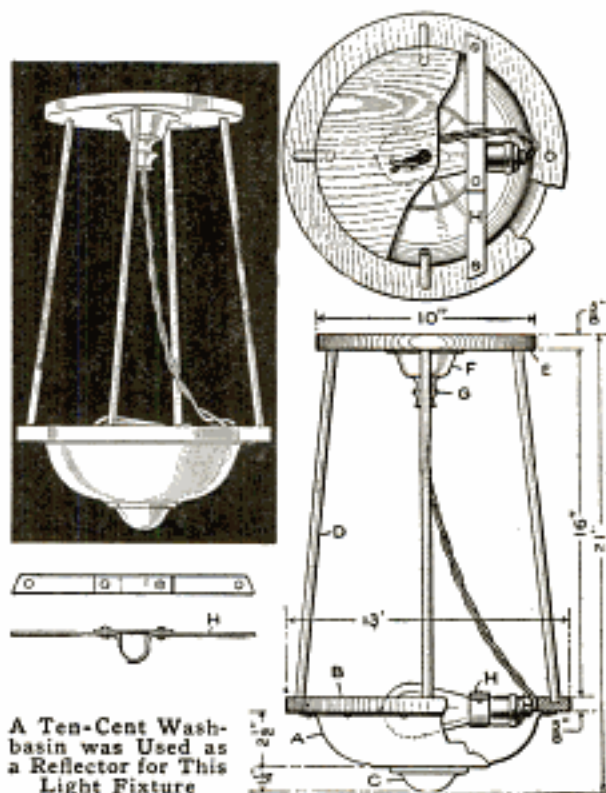

A Ten-Cent Wash-basin was Used as a Reflector for This Light Fixture

C is a cup-cake pan, costing 5 cents. The rim B is made of  $\frac{5}{8}$ -in. wood, 13 in. in diameter, and the disk E, 10 in. wide, is the round block cut from the center of the rim B. The uprights D are made of  $\frac{3}{8}$ -in. dowel rods and of a length suitable to the height of the room. They are glued and toenailed to the rim and disk. F is a cup-cake pan, and G is a drawer knob, fastened to the pan F. These parts can be omitted if desired. They are fastened to the top with wood screws.

The light socket is supported in a metal strap, H, having a rounded offset to match a bolted clamping strip. The inside of the basin, being tinned, acts as an excellent reflector. All parts except the inside of the pan are enameled white. The fixture is fastened to the ceiling with screws through the disk.—A. F. Krueger, Champaign, Ill.

ⓄThe gummed portions of unsealed envelopes are often useful when a gummed strip is desired.



### Wheelbarrow for Large Cans

Large cans for milk are awkward to handle and transport in the dairy or barn, and the cart shown in the sketch



Milk Cans were Handled Easily by Means of This Homemade Cart

was made from an old wheelbarrow and sections of pipe, to make this work easy. The pipes were bent to the shape shown and strongly braced with iron rods. A board bottom was provided, and the barrow wheel was

mounted between the forked ends of the frame. The cart may be used for numerous other purposes, and is especially convenient in that the load need only be lifted slightly.—Monroe Woolley, San Francisco, Calif.

### Plain Butts Used as Double-Swing Hinge

By placing two ordinary plain butt hinges so that two of their wings overlap completely, they may be made to serve as a double-swing hinge. If the holes do not correspond in the adjoining wings, drill new ones, disposing them to give the best hold in the wood. Allowance must be made in applying the hinge, for the double thickness of the center portion.

CA rubber finger tip is convenient in counting sheets in that the paper is not soiled, since moistening of the finger is unnecessary.

### Portable Skylight for Home Portraiture

By W. W. IRVINE

Photographers who wish to construct a part of their equipment may be interested in a portable skylight, which I made and use with thorough satisfaction, for home portraiture. Covered with imitation leather, it is quite presentable in carrying it about. Figure 9 shows the case closed, with stand, flash lamp, box of flash powder, and a white-cloth reflector inside. The apparatus set up for work is shown in Fig. 5, and the details of construction in the other sketches.

First make the frames for the top and bottom of the case, A, of  $\frac{3}{8}$  by  $2\frac{1}{2}$ -in. wood, and B, of  $\frac{3}{8}$  by  $1\frac{1}{4}$ -in. stock, lengths and construction as shown in Fig. 3. Cut from extra-heavy mount board, two 21 by 28-in. pieces, C, and tack one to one side of each of the frames. Cut a similar piece, E, 15 by  $26\frac{1}{2}$  in., and hinge it with strong cloth, or thin leather, to the inner side of the thicker frame, to

form the roof E, Fig. 5. Hinge the two frames with three butt hinges.

The frame is then ready for covering, and for this purpose imitation leather is economical and practical. Two yards of 36-in. material is needed. Use hot glue, first on the bottom half of the case, applying it smoothly, and press the fabric into place. Then cover the sides, the upper half, and the roof. The covering must be in one piece to prevent the smoke from escaping at the joints. Glue down the edges inside of the case, and set it aside for 24 hours to dry.

While waiting for the case to dry, the work on the bag can be done. Two yards of close-woven white muslin, or one yard of 60-in. sheeting, is required for the front. For the sides, close-woven black material should be used. Figures 1 and 2 show the dimensions, the white portions representing patterns, and the shaded portions mate-



material for hems and seams. The material is folded over the pattern, basted down, and hemmed at the dotted lines,

in Figs. 5 and 6. Mine was made for cartridges, but by attaching a pan of heavy tin, I use it for flash powder.

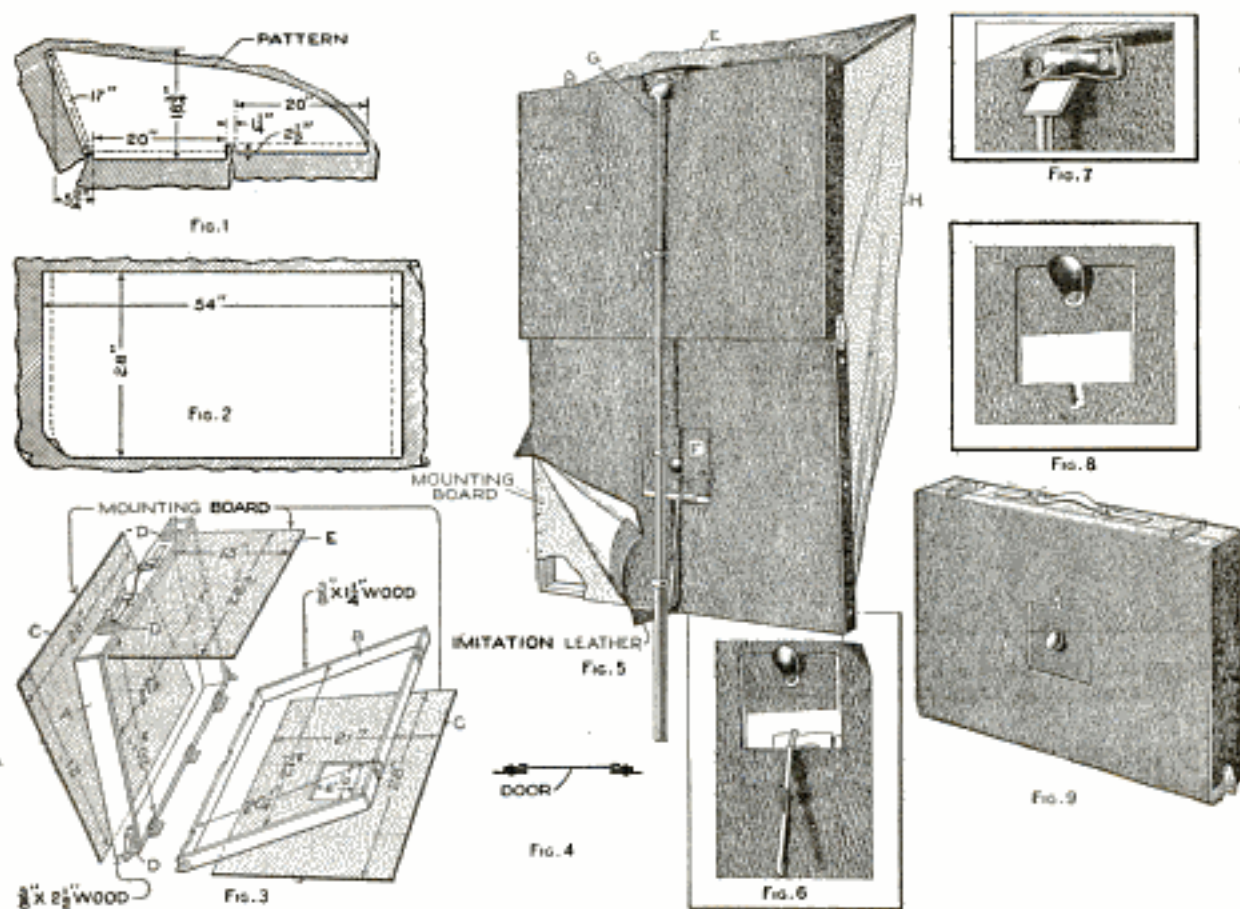

This Homemade Skylight was Made at a Cost of \$3, Gives Satisfactory Service, and Is Not Unsightly

1½ in. from the edge. Sew the front to the curved sides. Allowance for shrinkage, when the bag is washed and fireproofed, has been made in these sizes.

For fireproofing the bag, the following formula is good: water, 60 oz., ammonium phosphate, 4 oz., ammonium chloride, 8 oz. Soak the fabric half an hour, wring it out slightly, and hang it up to dry.

Cut a hole, 6 in. square, in the lower half of the case for the door F, Fig. 5. The door is of galvanized sheet iron, 7 in. square, covered on one side with imitation leather and provided with a leather handle. The door slides in guides of mount board, or metal, as shown in Fig. 4. Figure 8 shows the notch below the door to allow play for the spring of the flash lamp, in place

The leather socket, into which the top of the holder G, is slipped, is shown in detail in Fig. 7. Suitcase catches, D, lock the apparatus in open or closed position. The roof E, is supported by two folding desk slides.

To fasten the bag in place, slip a cheap yardstick, or strip, cut to the proper length, in each of the hems at the edges, and set them snugly inside and against the sides of the open case and under the edge of the roof. Fasten them with screws, as shown at the edges in Fig. 5. The bag is easily removed by withdrawing the screws and the strips, for washing and fireproofing it again. The front must hang away from the lamp before the charge is fired, or the bag may be burned. After firing the flash, the skylight is carried out and the smoke expelled.



### Fuel Box in Seat Filled from Floor Trapdoor

A fuel box for the fireplace may be easily arranged so that it is unneces-

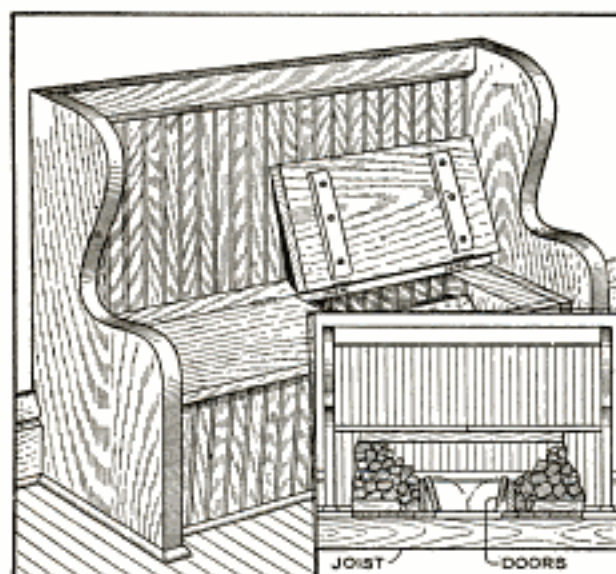

The Fuel is Placed in the Box by Passing It Up through the Trapdoors in the Floor

sary to carry the fuel through the living rooms, thus avoiding soiling floors and rugs. It may be installed, as shown, for a summer cottage, or even in the living room of a home. The fuel box is built under the seat of a comfortable settle, and the wood, coal, etc., are placed in the fuel compartment by passing it up through trapdoors in the floor at the center of the box. The fuel is piled at each side of the trapdoor behind a low partition, and the trapdoors are closed when not in use. The seat of the fuel box is divided at the middle and hinged to swing back. Suitable cushions should be provided for the seat.—M. P. Norton, Chicago.

### Homemade Relay of Inexpensive Materials

A practical relay was made of odds and ends gathered in the workshop. The base is of wood,  $\frac{3}{4}$  by 3 by 6 in. The magnets A are made of two wire nails driven into the base, the heads projecting  $1\frac{1}{2}$  in. They are wound with six layers of fine insulated No. 25 gauge wire, as shown in the small

sketch. The ends of these magnet wires are carried to the two binding posts B and C, taken from dry-cell carbons.

The armature D is a piece of soft iron,  $\frac{1}{2}$  by  $2\frac{1}{2}$  in., screwed to the armature lever E, which is a  $\frac{1}{2}$  by  $4\frac{1}{2}$ -in. piece of wood. A piece of tin is tacked to the opposite end F, and a  $\frac{1}{8}$ -in. hole is bored through the lever,  $2\frac{1}{2}$  in. from the front end. Nail a wooden block, G, to the base, slotted to accommodate the lever, so that when the latter is pivoted in the slot, the armature will lie directly over the magnet heads. Fit a wooden stop, H, under the end of the lever, so that the armature is held  $\frac{1}{8}$  in. above the magnets, by a brass spring, J, connected to the tin, F, and the binding post, K, with copper wire. Arrange the brass hook, L, so it comes in contact with F when the armature bears down upon the magnets. Connect this hook to the binding post, M. When current flows through the magnets, the armature is pulled down and the contact of the

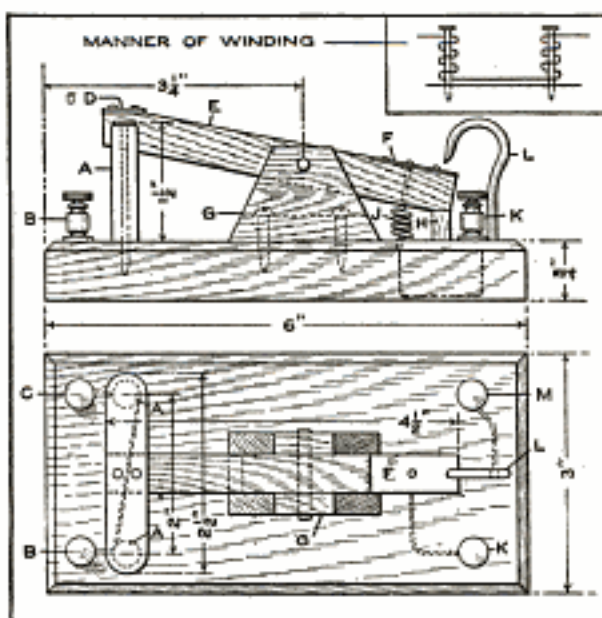

Nails, a Screw Hook, and Similar Common Materials, were Used in Making This Relay

hook, L, with the tin, F, completes a secondary circuit.—L. R. Hardins, Harwich, Mass.

ⒸA nutcracker may be used as a substitute for a pipe wrench or pliers, and its toothed handles grip round objects quite firmly.



### Uses for Worn Talking-Machine Needles

Among the uses made of discarded steel talking-machine needles are the following: as glazier's tacks; as brads, where a headless nail or an inconspicuous one is desired; as pins for fastening papers together; and for the tacking in of the backs on picture frames.—William A. Martin, Jersey City, N. J.

### Automatic Photo-Print Washing Device

A photographers' automatic print-washing device may

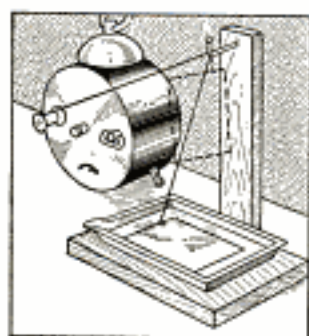

readily be made with the aid of an alarm clock, and a spool to which a piece of thread is attached as shown. The spool is fixed to the alarm-clock winder. An upright support, having a nail driven into the top and bent over to form a hook, carries the thread, to which the print is attached by a small clip. The alarm-clock mechanism is then set, and when released draws the print from the dish, the bell warning the operator.—George H. Holden, Chesterfield, England.

### Portable Sectional Poultry Fencing

Sectional poultry fencing has several advantages over stationary fencing: It can be easily moved, the poultry yard being made larger, smaller, or shifted; an area may be planted to a crop and gradually included in the yard, furnishing greens for the poultry. Also, the tenant who does not care to put down permanent equipment, will find sectional fencing desirable.

Sections are practical to about 18 ft. long, and should be 7 ft. high for the lighter breeds of poultry. If the fencing is to be used for grown stock only,

the fine-mesh wire below may be omitted, and 2-in. mesh used. Some sections should be fitted with gates, and the top batten should be set down

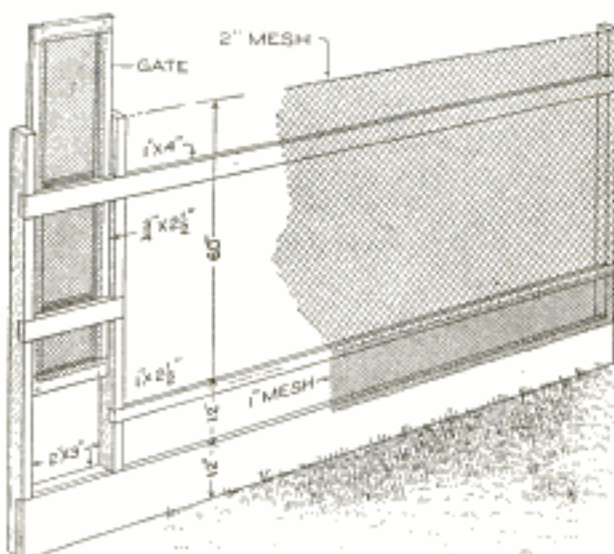

Poultry Fencing Made in Portable Sections Has Several Advantages over a Stationary Barrier

about 1 ft., so as not to afford footing for the poultry. The sections are lashed together with wire, and supported by an occasional post, or guyed to buildings or supports.

### Suitcase Holder for Running Board of Automobile

Two metal strips,  $\frac{3}{16}$  by  $1\frac{1}{2}$  by 20 in., were used to make a strong and adjustable holder for suitcases carried on the running board of an automobile. One-inch slots were cut near the top of the strips, which were bent to form angles having an upright portion 12 in.

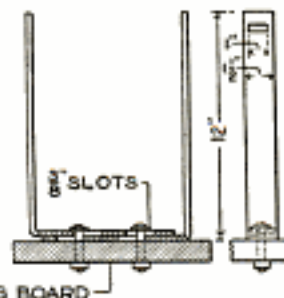

These Homemade Supports Are Adjustable to Suitcases of Varying Widths

long. The angles are adjusted at the bolts, as shown, and the suitcase is held in place by straps.—Lucien G. Baer, Los Angeles, Calif.



## TWO INEXPENSIVE PUBLIC BUILDINGS WORTH NOTICE

2789



Above is Shown the Schoolhouse and Below the Post Office at Estes Park, Colorado: These Buildings Are Worth Studying, for Neither of Them Cost the Village a Fortune and Both of Them Are Vastly More Attractive than Hundreds of Public Structures of Many Times Their Valuation



**N**OW and then one finds a small town blessed with public buildings that are a credit to the intelligence and taste of the community. That is, buildings whose cost is commensurate with the financial rating of the village, whose architecture is sufficiently divorced from monotony to be attractive, and whose capacity is adequate for present and near-future needs. Two structures of this sort, one a schoolhouse and the other a post office, are to be seen at Estes Park, a resort place in the Colorado mountains, 75 miles or so from Denver. Both of the buildings are constructed of native bowlders and stucco, and while neither is the least original architecturally, the effect in each case is kind to the eyes. Conditions in Estes Park are different from those in most small towns. The year-around population, for instance, is not more than 400, while some 8,000 or 10,000 persons reside in the vicinity during the summer months. In winter the school is attended by about 50 pupils of various ages, but in summer it serves as a kindergarten for tourists' children. Likewise the post office handles a sack or two of mail winter days and 30 or more of them later on. The spacious porch affords a resting place in summer for persons waiting for mail to be sorted. This building was erected by the villagers, 46 men and women contributing the money and labor that entered into its construction.

**I**N accordance with the editorial policy of this magazine never to accept compensation in any form for what appears in our reading pages, and also to avoid all appearance of doing so, we are obliged to omit the name of the maker or the seller of any article described. This information, however, is kept on file and will be furnished free, by addressing Bureau of Information, Popular Mechanics Magazine, Chicago. [Editor.]



# HOW I EARNED \$200,000 IN THREE YEARS

*The amazing and inspiring story of a young man who jumped from failure to fortune; did not speculate; says no man need beg for success. —As Told by Himself.*

SOME people say it takes money to make money—others complain that they never made money because they never had any luck. When one is up against the stern reality of making both ends meet, it is natural to feel that if they only had a little money, or a little luck, they wouldn't have to worry about their bread and butter, and rent, and clothes.

Three short years ago I too felt that way. I was \$5,000 "in the hole"—and earning \$30 a week. Figure out how long it would take me to pay what I owed! I had a wife and two children to support, and I used to worry myself sick about their future. What would become of her? What would become of them? Would we always have to skimp and scrape? Would we ever be able to pay what I owed?—to say nothing of saving something for the "rainy day."

Today—it seems like a dream—all my troubles are over. I am worth \$175,000—enough to keep me and my family in comfort for the rest of our lives. I own two automobiles. My children go to private schools. I have just purchased, for cash, a \$25,000 home. I go hunting, fishing, motoring, traveling, whenever I care to.

Let me say in all sincerity that I believe what I have done, you—*anyone*—can do. I am only an average man—not "brilliant"—have never gone to college—my education is limited. I know at least a hundred men who know more than I, who are better educated and better informed,—yet not one of them has made as much money as I have and their earnings probably average less than \$50 weekly, while my income is over \$1,000 weekly. I mention this to show that earning capacity is not governed by the extent of a man's education—to encourage those who have not had the advantage of a comprehensive education.

What then, is the secret of my success? Let me tell you how it came about.

One day, about three years ago, something happened that woke me up to what was wrong with me. It was necessary for me to make a decision on a matter which was of no great consequence. I knew in my heart what was the right thing to do, but something held me back. I said one thing, then another; I decided one way, then another. I couldn't for the life of me make the decision I knew was right.

I lay awake most of that night thinking about the matter—not because it was of any great importance in itself, but because I was beginning to discover *what was wrong with me!* Along towards dawn I resolved to experiment. I decided to cultivate my will power, believing that if I did this I would not hesitate about making decisions—that when I had an idea I would have sufficient confidence in myself to "put it over"—that I would not be afraid of myself or of things or of others. I felt that if I could smash my ideas across I would soon make my presence felt. I knew that heretofore I had always begged for success—had always stood, hat in hand, depending on others to give me the things I desired. In short, I was controlled by the will of others. Henceforth; I determined to have a strong will of my own—to demand and command what I wanted.

With this new purpose in mind I applied myself to finding out something more about will power. I was sure that other men must have studied the subject, and the results of their experience would doubtless be of great value to me in understanding the workings of my own will. So, with a directness of purpose that I had scarcely known before, I began my search.

The results at first were discouraging. While a good deal had been written about



the memory and other faculties of the brain, I could find nothing that offered any help to me in acquiring the new power that I had hoped might be possible.

But a while later in my investigation I encountered the works of Prof. Frank Channing Haddock. To my amazement and delight I discovered that this eminent scientist, whose name ranks with James, Bergson, and Royce, had just completed the most thorough and constructive study of will power ever made. I was astonished to read his statement, "The will is just as susceptible of development as the muscles of the body"! My question was answered! Eagerly I read further—how Dr. Haddock had devoted twenty years to this study—how he had so completely mastered it that he was actually able to set down the very exercises by which anyone could develop the will, making it a bigger, stronger force each day, simply through an easy, progressive course of Training.

It is almost needless to say that I at once began to practice the exercises formulated by Dr. Haddock. And I need not recount the extraordinary results that I obtained almost from the first day. I have already indicated the success that my developed power of will has made for me.

But it may be thought that my case is exceptional. Let me again assure you that I am but an average man, with no super-developed powers, save that of my own will. And to further prove my contention let me say that since Prof. Haddock's lessons, rules, and exercises have been published in book form, I have come across hundreds of other cases where strengthened will power has brought success and fortune to people who were failures, has enabled thousands to overcome drink and other vices almost overnight—has helped overcome sickness and nervousness, has transformed unhappy, envious, discontented people into dominating personalities filled with the joy of living.

I have been authorized by the publishers to say that any reader who cares to examine this startling book may do so without sending any money in advance. In other words, if after a week's reading you do not feel that "Power of Will" is worth \$3, the sum asked, return it and you will owe nothing. When you receive your copy for examination I suggest that you first read the articles on; the law of great thinking; how to develop analytical power; how to guard against errors in thought; how to drive from the mind unwelcome thoughts; how to develop fearlessness; how to use the mind in sickness; how to acquire a dominating personality.

Some few doubters will scoff at the idea of will power being the fountainhead of wealth, position, and everything we are striving for, and some may say that no mere book can teach the development of the will. But the great mass of intelligent men and women will at least investigate for themselves by sending for the book at the publisher's risk. I am sure that any book that has done for me—and for thousands of others—what "Power of Will" has done, is well worth investigating. It is interesting to note that among the 150,000 owners who have read, used, and praised "Power of Will" are such prominent men as Judge Ben B. Lindsey; Supreme Court Justice Parker; Wu Ting Fang, ex-U. S. Chinese Ambassador; Lieut.-Gov. McKelvie of Nebraska; Assistant Postmaster-General Britt; General Manager Christeson, of Wells-Fargo Express Co.; E. St. Elmo Lewis; Governor Arthur Capper of Kansas, and thousands of others.

As a first step in will training, I would suggest immediate action in this matter before you. It is not even necessary to write a letter. Use the blank form below, if you prefer, addressing it to the Pelton Publishing Company, 13-H Wilcox Block, Meriden, Conn., and the book will come by return mail. This one act may mean the turning point of your life, as it has meant to me and to so many others.

---

## PELTON PUBLISHING COMPANY

13-H Wilcox Block, Meriden, Conn.

I will examine a copy of "Power of Will" at your risk. I agree to remit \$3 or return the book in 5 days.

Name .....

Address .....

Please Mention Popular Mechanics



# Why the Average American Dies at Forty-three

*"He Feeds His Stomach with Tasty Junk"*  
says E. E. Rittenhouse of Equitable Life

By R. W. LOCKWOOD

President of the Corrective Eating Society

THE presidents of life insurance companies with perhaps twenty billion dollars insurance on the lives of Americans, recently met in convention at the Hotel Astor in New York, and in their discussion brought out some of the reasons why the average American dies at about forty-three years of age.

According to the press reports, Mr. E. E. Rittenhouse, Commissioner of Public Service and Conservation of the Equitable Life Assurance Society, said: "The average American would not think of mixing bricks or scrap iron or gravel with the fuel for his furnace, yet he feeds his stomach with all sorts of tasty junk, much of which cannot be fully digested . . . he is seriously over-straining his heart, arteries, kidneys, nerves and digestion, as the rapidly increasing death rate shows."

This statement from such an authoritative source—from a man who makes it his business to study both vital statistics and the causes behind them—sounds a warning which should be heeded by every man and woman.

Indeed, there is no longer a doubt among intelligent people that many of the foods and combinations of foods which we are most accustomed to eat are the direct cause of much sickness.

Yet how few of us heed the early warnings of illness, such as acid-stomach, fermentation, or constipation. I venture to say that nine out of ten persons suffer to a greater or lesser extent from one or more of these three symptoms, which are in many cases the forerunners of more serious sickness.

Stomach medicines and laxatives are plentiful, but of what avail are they? The only thing that a stomach medicine can do is to

temporarily neutralize the extra amount of acid in the stomach, because it is *stronger* than the acid. And this injures the stomach, usually bringing the acid back worse than it was before. A laxative is just as bad, if not a little worse; not only is its effect temporary, but all laxatives are habit-forming and are required in ever-increasing doses.

If neglected, a simple case of acid-stomach may lead in a short time to fermentation, with gas, and constipation. The fermenting food forms poisons which are absorbed into the blood, causing auto-intoxication, nervousness, mental depression, and a host of other unpleasant symptoms.

Is it any wonder that the officers of large insurance companies sound a warning against the evils of wrong eating?

\* \* \* \* \*

But just as wrong eating is the cause of 90 per cent. of common illnesses, so will correct eating create and maintain both bodily vigor and mental energy. And by right eating I do not mean freak foods—I mean just good everyday foods properly combined. In fact, to eat correctly, or follow a course of Corrective Eating it is not at all necessary to upset your table.

Eugene Christian, the well-known food specialist, has proved the efficacy of Corrective Eating in thousands of cases. Entirely without the use of drugs or medicines, men and women suffering from almost every conceivable non-organic ailment have been returned to health and vigor by following his simple directions in regard to their eating.

\* \* \* \* \*

In a recent talk with Eugene Christian he told me of several interesting cases which had

Please Mention Popular Mechanics



recently come under his care. One was that of a woman prominent in Woman Suffrage work in New York City. She had come to him with stomach and intestinal fermentation and gas, auto-intoxication, mental depression and anemia, vertigo, and threatened heart failure. She was very much overweight when she commenced, but reduced her weight thirty-seven pounds during the treatment. He showed me a letter she had written him afterward, in which she said:

"I am sure you will be gratified to hear that I continue to improve—it seems sometimes that I must have been made over, and it is difficult to remember that less than eight months ago I was a feeble old woman depending upon daily doses of strychnia for what little strength I had. When I came under your treatment, I weighed one hundred and ninety-seven pounds, was hardly able to walk, and was subject to most serious heart attacks upon the slightest exertion. And now I am so well, so strong, that my family and friends maintain that it is a miracle which has restored me to strength and vigor of life—certainly in my case the cure is most remarkable because of my sixty-seven years."

Another was a well-known minister who had been out of his pulpit for twenty-two months, unable to preach or conduct the simplest service. He was about twenty-five pounds under-weight, anemic, nervous, had superacidity, and could not assimilate his food; and his heart action was very irregular. He had gradually declined for two years although treated by one of New York's leading physicians. Three months after he placed himself under Eugene Christian's care, he preached the first sermon he had been able to preach in nearly two years. This was over three years ago.

He has gained about twenty-five pounds in weight and since has not missed a day from his arduous clerical work. He has steadily gained in strength and vitality and is to-day healthy and athletic.

\* \* \* \* \*

But Eugene Christian's own case is perhaps the most interesting of all, for it shows how he discovered the beginnings of the methods which he has since pursued so successfully with others—methods of selecting and proportioning one's meals so as to overcome conditions brought about by wrong eating.

*Merely clip out and mail the following form instead of writing a letter, as this is a copy of the official blank adopted by the society and will be honored at once.*

**CORRECTIVE EATING SOCIETY, Inc., Dept. 54, 450 Fourth Ave., NEW YORK CITY**

You may mail me the "Lessons in Corrective Eating" for examination. Five days after I receive them, I will either send you \$3 (full payment) or remail them to you.

Name..... Local Address.....

City..... State.....

Please Mention Popular Mechanics

Twenty years ago he was at death's door; for several years previous he had suffered all the agonies of acute stomach and intestinal troubles, until his doctors—among them some of the most noted specialists in the country—gave him up to die. As a last resort, he commenced to study the food question himself. As a result of what he learned, he succeeded in literally *eating his way back to health* without drugs or medicines of any kind and in a remarkably short space of time.

Eugene Christian is to-day nearly sixty years old—or shall I say young? For he has more vitality, more ginger, more physical endurance than most youngsters in their teens. During the past fifteen years he has not had even so much as a cold.

\* \* \* \* \*

Since the remarkable success of Eugene Christian has become known, people have sought his advice in such rapidly increasing numbers that he has found it necessary to put his methods in printed form. He has written a series of 24 Little Lessons which tell you exactly what to eat for health, strength and efficiency.

These lessons contain actual menus for breakfast, luncheon, and dinner, including corrective menus for almost every condition of health and sickness from infancy to old age, for all occupations, climates, and seasons.

With these lessons at hand it is just as though you were in personal contact with this great food specialist, because every point is so thoroughly covered and so clearly explained that you can scarcely think of a question which isn't answered. You can start eating the very things that will help to produce the increased physical and mental energy which you are seeking the day you receive the lessons. And you are quite likely to feel some results after your very first balanced meal.

If you would like to examine these "24 Little Lessons in Corrective Eating," simply write the Corrective Eating Society, Inc., Dept. 54, 450 Fourth Avenue, New York City. It is not necessary to enclose any money with your request. Merely ask to have the lessons mailed for five days' trial with the understanding that you will either send the small price asked, \$3, or remail the books.



# ALADDIN Bungalow Home Complete \$817

Quick Shipment



## 6 Rooms—Large Porch—Large Closets

Contains Large Living Room, Large Dining Room, Two Good Bedrooms with Large Closets, Spacious Kitchen, Bathroom

## Build This Year at Last Year's Costs



Don't delay your building plans. Decide to start building now. Building prices are going up. Labor prices will advance. The *Aladdin Read-Cut System* enables you to build your new home, garage, barn or farm building at a substantial saving in cost. Thousands of Aladdin customers—some near you—will tell you how much they have saved building the Aladdin way. The big book "Aladdin Homes" will show you plans and pictures of over 100 homes. It will also demonstrate the saving you can make by building NOW. Send stamps for your copy today.

## Aladdin Houses Save Waste of Lumber

Ordinary building methods waste on an average of 18% of the lumber you pay for. Think of it! \$18 out of every \$100 goes to the waste pile and is burned up for kindling wood. Of course, the lumber that is wasted costs just as much as the lumber that is used. Are you willing to pay \$180 on every \$1000 worth of lumber for waste? This is an important item to consider, especially when lumber prices are advancing. The Aladdin system saves you this unnecessary expense—puts the \$18 from every \$100 into your pocket. Aladdin Read-Cut Houses are cut-to-fit in our mills. You pay for the material used in your house—no more.

### Aladdin Customers Save \$200 to \$800

Each day in the year we receive letters from many Aladdin owners in every part of the United States saying: "Just finished my home. Find I saved \$200." "You have saved us enough to install a furnace and complete plumbing system." "We saved \$500." "SAVED" is the answer in one word. From the builder of the small three room home to the owners of homes averaging \$5000 to \$8000 it is the same story, "Aladdin saved us money."

### Bungalows, Dwellings, Summer Cottages

Buy direct from the forest—from Aladdin—and make four savings. You make a substantial saving on the lumber, on the millwork, on the hardware and on the labor. The big Aladdin catalog tells all the facts you want to know, gives photographs, floor plans, prices and descriptions of a hundred modern homes, bungalows, dwellings, summer cottages and garages. Send for it today.

**The Aladdin Co.** 1460 Aladdin Ave.  
BAY CITY, MICH.

Canadian Branch: Canadian Aladdin Co., C. P. R. Bldg. for Canada

### Price Includes All Material

Aladdin Houses are **complete**. You get material as follows: Sills, Joists, Studding, Building Paper; Sub-Floor, Rafters, Roof Sheathing, Siding, Outside Finish, Flooring, Lath and Plaster or Plaster Board; Inside Finish, Doors, Casings, Base Board, Windows, Sash, Glass, Nails of all sizes, Locks, Hinges, Tin Flashing, Paints, Oils, Varnishes, Stains, Putty and Shellac with completed drawings, illustrations and instructions for erection—**The Complete House**. Send for Catalog 180 today.

**The Aladdin Co., 1460 Aladdin Ave., Bay City, Mich.**  
Enclosed find stamps. Send me your Catalog No. 180.

Name ..... Street ..... City ..... State .....





# The New Oliver Nine

## How We Will Save American Business Millions of Dollars

### The New Plans of The Oliver Typewriter Company

**This is a proposal to sell new Oliver Typewriters for half what they used to cost. New machines of our latest model—Oliver Nine. That without altering the value one penny. All by ending a monstrous selling cost. If that interests you, we claim a few minutes' attention.**

**T**HE Oliver Typewriter Company is at the height of its success. With its huge financial resources it has determined to place the typewriter industry on a different basis. This, you admit, is in harmony with the economic trend of the times.

This is the time when American industry must prepare for the end of the war. New economic adjustments are inevitable.

Henceforth there will be no expensive sales force of 15,000 salesmen and agents. No high office rents in 50 cities. No idle stocks.

#### PRICES CUT IN TWO

By eliminating these terrific and mounting expenses, we will reduce the price of the Oliver Nine from the standard level of \$100 to \$49.

This means that you will save \$51 per machine. This plan, were it to become universal, would save all who buy typewriters over \$100,000,000 a year.

This is not philanthropy on our part. While our plan saves *you* much, it also saves for *us*.

On each Oliver typewriter for which the user paid \$100, more than half has been spent for salaries, traveling expenses, and commissions to an army of salesmen and agents.

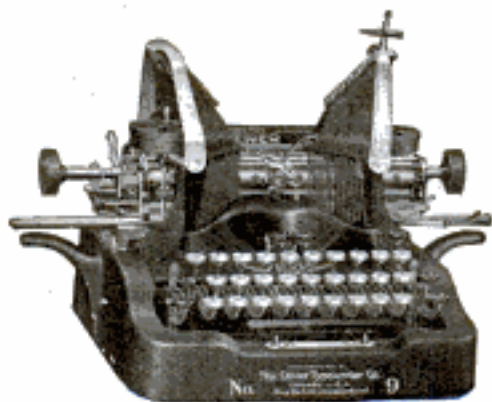

**Over 600,000 Sold**

Thousands of dollars have been spent in maintaining expensive branch houses and show rooms in many cities.

Our new plan now saves all this useless waste and brings the typewriter business down to a rock-bottom basis.

Thousands will welcome this announcement. It heralds a standard typewriter at a price never before possible.

Now note this fact carefully. We offer the very same Oliver Nine—the latest model—brand new—full standard equipment—for \$49, the exact one which was \$100 until this advertisement. Every Oliver Typewriter is fully guaranteed.

You may have one of these Oliver Nines for inspection without paying a cent. You decide in the privacy of your office or your home. There will be no forceful salesman—working for a commission—to influence you.

#### WHO CAN RESIST?

Now we ask you, is the old sales plan necessary? Must we turn over to salesmen more than half of what you pay? Or would you rather have us save \$51 and give the whole saving to you?

Read all of the details on the opposite page. Then order an Oliver Nine for free trial or send for our startling book, entitled "The High Cost of Typewriters—The Reason and The Remedy." Mail the coupon.

### Oliver Features—Many Exclusive

One-third lighter touch because type bars drop downward. Speed 50 per cent faster than human hands; every machine is tested at 800 strokes per minute. Permanent alignment insured by arch-shaped type bars. Built for hardest usage. Famed for dependability. Printtype—if you prefer—the clear, readable type that writes like print. Interchangeable carriages—make several machines in one. The clearness, readability and number of Oliver carbons is beyond comparison. Double color ribbon. In-built tabulator. Ruler—horizontal and vertical. Simplified construction—2000 fewer parts. Bronze bearings. No hair springs nor flimsy wires. Built of fine tool steel.



# Was \$100—Now \$49



## A \$2,000,000 Guarantee That This \$49 Typewriter Was \$100

### The Sales Policy Alone Is Changed—Not the Machine

The Oliver Nine—the latest and best model—will be sent direct from the factory to you upon approval. Five days' free trial. No money down—no C. O. D. No salesmen to influence you. Be your own salesman and save \$51. Over a year to pay. Mail the coupon now.

**T**HIS Oliver Nine is a twenty-year development. It is the finest, the costliest, the most successful model that we have ever built.

For \$49, whether you buy *one* Oliver Nine or one *hundred*, you receive the exact machine which was \$100, fully guaranteed.

It is the same commercial machine purchased by the United States Steel Corporation, the Standard Oil Company, the National City Bank of New York, Montgomery Ward & Co., the National Biscuit Company, the Pennsylvania Railroad and other leading businesses. Over 600,000 are in *daily* use.

#### SIMPLIFIED SELLING

Our new plan is extremely simple.

It makes it possible for the consumer to deal direct with the producer.

You may order from this advertisement by using the coupon below.

We don't ask a penny down on deposit—no C. O. D.

When the typewriter arrives, put it to every test—use it as you would your own. If you decide to keep it, you have more than a year to pay for it. Our terms are \$3.00 per month, the equivalent of 10 cents a day.

### To the Big User

This announcement is of particular value to you. Big users will save hundreds and thousands of dollars. An absolutely new Model 9 Oliver Typewriter, fully guaranteed, at a list price of \$49, presents a typewriter opportunity unparalleled in the history of the industry. To save 50 per cent is certainly interesting to any business man, especially when the value remains unaltered. You know the Oliver. This present Model 9 is operated by any stenographer or typist, including touch operators.

We suggest to purchasing agents or buyers whose concerns use typewriters in quantity to get in touch with us immediately. Write today for further particulars relating to large users.

Or if you wish additional information, write us or send us your address on this coupon for our proposition in detail. We immediately mail you our de luxe catalog and all information which you would otherwise obtain from a typewriter salesman.

#### WHY PAY \$100?

Why now pay the extra tax of \$51 when you may obtain a brand new Oliver Nine—a world favorite—for \$49?

Cut out the frills and order direct from this advertisement.

Or send for our remarkable book entitled, "The High Cost of Typewriters—The Reason and The Remedy." You will not be placed under the slightest obligation.

The Oliver Typewriter Company

1094 Oliver Typewriter Bldg. Chicago, Ill.

**NOTE CAREFULLY**—This coupon will bring you either the Oliver Nine for free trial or further information. Check carefully which you wish.

THE OLIVER TYPEWRITER CO.

1094 Oliver Typewriter Bldg., Chicago, Ill.

Ship me a new Oliver Nine for five days' free inspection. If I keep it, I will pay \$49 at the rate of \$3 per month. The title to remain in you until fully paid for.

My shipping point is.....

This does not place me under any obligation to buy. If I choose to return the Oliver, I will ship it back at your expense at the end of five days.

Do not send a machine until I order it. Mail me your book—"The High Cost of Typewriters—The Reason and The Remedy," your de luxe catalogs and further information.

Name.....

Street Address.....

City.....State.....



# For the Home Mechanic

To make close joints in moldings, railings, and such ornamental woodwork, an accurate Mitre Box is an absolute necessity. The Goodell-Pratt All-Steel Mitre Box is fully up to the standard of the tools on which the maker's reputation for high quality is based. Made entirely of steel, framed like a bridge truss, it is unbreakable and remains absolutely accurate after years of daily use.

This box is furnished with Disston Saws in five sizes. All sizes have a capacity of  $10\frac{1}{2}$  inches at right angles and  $7\frac{1}{4}$  inches at mitre. The saw can be set and locked at any angle as indicated on the graduated arc.

*For further details send  
for complete catalog*

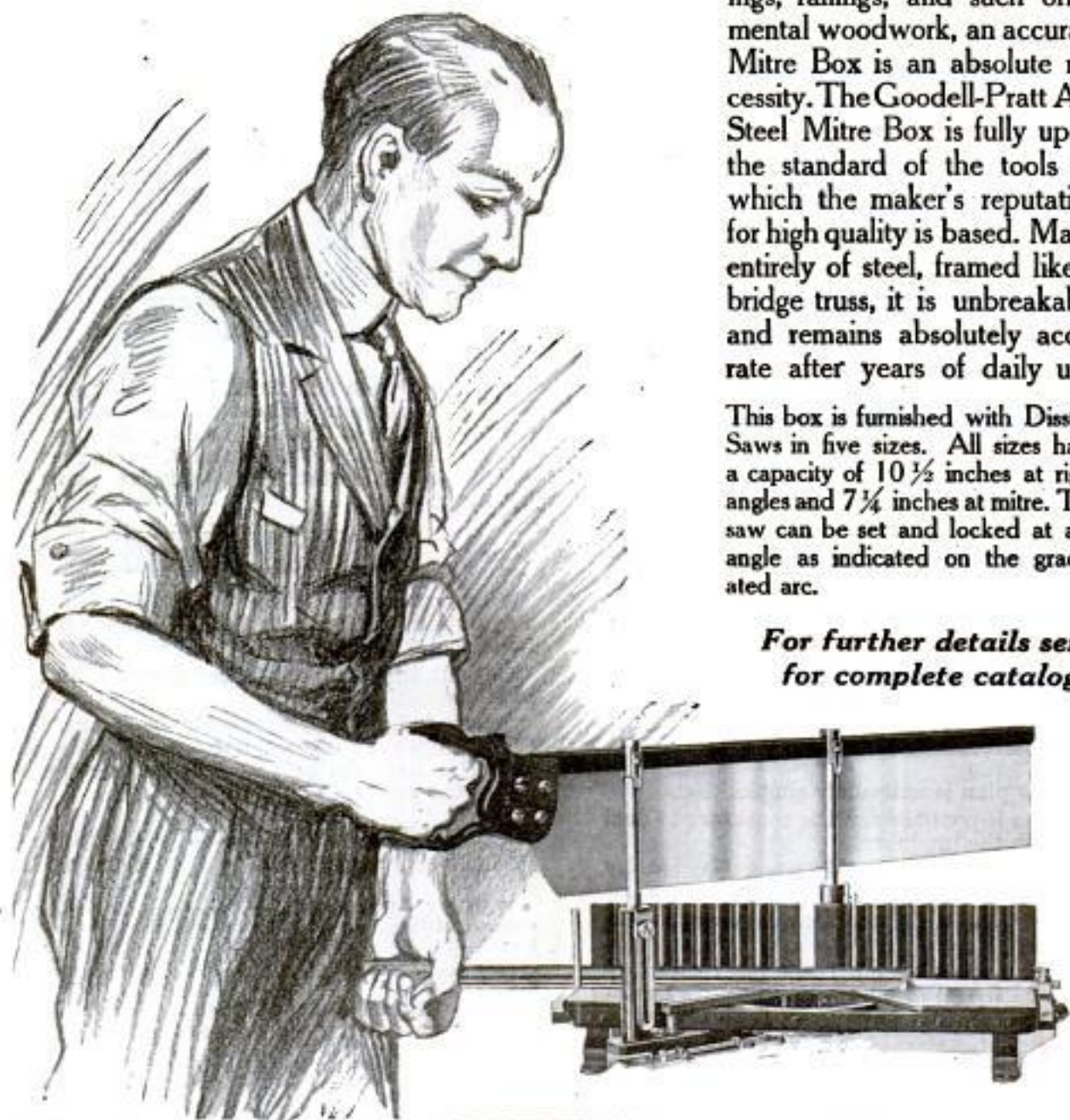

# GOODELL

1 5 0 0



# For the Home Mechanic

It's easy enough to cut glass with a good cutter like this Goodell-Pratt turret head cutter. Just run the cutter alongside a ruler lightly—not bearing on too hard—and the sharp little wheel makes a clean scratch across the glass. Glass is so brittle it readily breaks at the scratch. The six cutter wheels in the turret head insure a sharp cutter for a lifetime at an outlay of 30c.

The machinists' handy set consists of fifteen tool-steel chisels and punches in a convenient case. For metal working, ornamental or practical (as on an automobile), these tools are invaluable, and they cost only \$2.00.

**Goodell-Pratt Company** *Toolsmiths*  
Greenfield, Mass.

## Partial List of Goodell-Pratt Tools

Hacksaws	Drills
Gauges	Levels
Punches	Lathes
Micrometers	Calipers
Bit Braces	Squares
Vises	Grinders
Screw Drivers	

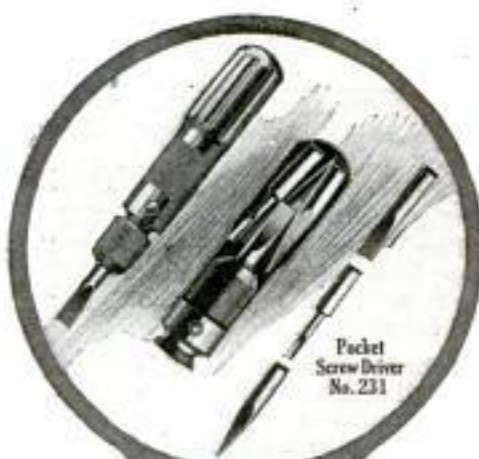

# PRATT

## GOOD TOOLS

A TOOL to carry in your pocket, in the house, in the car, in the motor boat, on camping or fishing trips—that's what this pocket screw driver is. It really will go in the pocket—it's only 3 1/4 inches long when closed—but it's strong enough for every ordinary use, and has three different-sized blades, all for 65c. Try it and see.



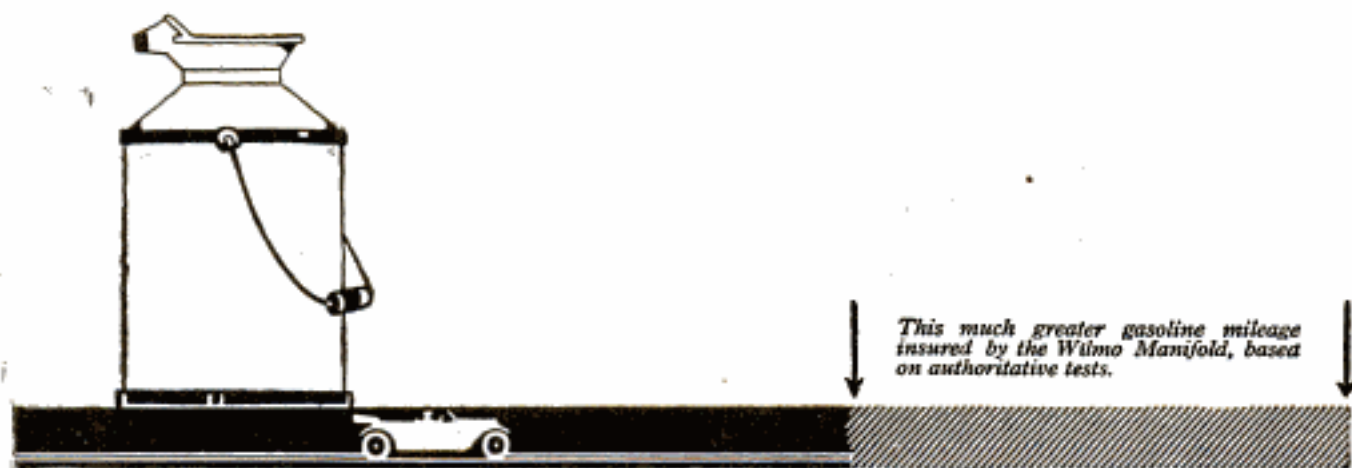

# More Miles From Gasoline

## Guaranteed With the Wilmo Manifold



The Wilmo Manifold is a one-piece casting combining the function of both intake and exhaust manifolds.

Exhaust gases heat dividing wall which in turn superheats and completely vaporizes gasoline at intake ports.

Insures a smoother running motor at all speeds. Gives virtually same increased efficiency from lower grades of gasoline.

#### Present Sizes and Prices

Ford—T	\$ 7.50
Maxwell—25	8.50
Overland—59-69-79	10.00
Studebaker—17-4	10.00
Saxon—6	10.00
Overland—81-83-85	10.00
Overland—80	12.50
Oakland—6-32	12.50
Buick—6-D44-45	15.00
Studebaker—17-6	15.00

Manifolds for other makes of cars will be added from time to time.

We also have another decarbonizing and gasoline economizing device for all other automobiles and trucks not listed above.

Don't blame the gasoline or carburetor when you're "short" on mileage and "long" on carbon. You haven't given them a fair show, that's all.

Let the Wilmo Manifold vaporize every drop of gasoline so that it enters the cylinders full of pep, every atom available in the form of clean, full bodied power that gets your car off instantly with all cylinders a'hitting, and that gives you up to 59% more mileage for the same gasoline money.

And, with all this, carbon troubles practically eliminated.

Official tests sanctioned by the American Automobile Association show an increased mileage of from 42% to 54% as a direct result of Wilmo Manifold efficiency. Other official tests show up to 59% mileage increase. Letters from users show even more—but we're content to abide by the official figures.

Sizes and prices are shown to the left. The Wilmo Manifold can be attached in thirty minutes with an ordinary monkey-wrench. No holes to bore.

Sold by garages, hardware and auto supply dealers everywhere. If unable to secure one near-by order direct. Give your dealer's name, and we will deliver through him.

### The Whittier Company

First National Bank Building

Chicago, Illinois

**DEALERS:** Write for interesting and profitable sales plan.

# Wilmo Manifold

Please Mention Popular Mechanics



*Plato Spring,  
French Lick,  
Indiana.*

## Do Your Tires Suit You?

Perhaps you are satisfied with the service being given you by the tires you use. If you are, that is well, and the limit of any tire's accomplishment.

But perhaps you feel as does another portion of the motoring public, that your tire money should buy a little more, in miles and untroubled travel, than it does now.

As much more, say, as the highest type of materials and method could give.

If you feel this way, we suggest that you swing with the general trend, and try Goodyear Tires.

They are the preferred tires of this hemisphere—more of them are bought by the motorists of America than of any other brand.

A quality of materials and a type of method less than the highest could not sustain this tremendous popularity.

A tire less than immensely superior could not increase it—as Goodyears are doing.

*Goodyear Tires, Heavy Tourist Tubes and "Tire Saver" Accessories are easy to get from Goodyear Service Station Dealers everywhere.*

The Goodyear Tire & Rubber Company  
Akron, Ohio



**GOODYEAR**  
AKRON

*Please Mention Popular Mechanics*



# A Lightning Edge on Safety Blades



A keener edge than you ever felt. An edge that will flash through the stiffest, wiriest hair. Only a few strokes works marvels on any safety blade. You can't fail to get a lightning edge. You can't misuse a Stag Sharpener. A child can sharpen blades on a Stag as well as an expert. Makes old blades better than new. Makes new blades better.

Complete \$1 postpaid to you on this special offer

# \$1

Stag Sharpener

with barber's hone and strop complete, on our money back guarantee

## Protect Yourself

A dull razor is dangerous to health and life itself. The Stag Sharpener is a health protection as well as a positive luxury in shaving. The truest, simplest, quickest, easiest safety blade sharpener on earth.

## Sharpen Any Blade



A Stag Sharpener is the only safety blade sharpener ever awarded the grand prize at an international Exposition.

Positively gives new blades a better shaving edge. Puts the oldest, dullest blades in lightning edge condition. Gives new blades a better edge than when they come from the factory. You can never know the delights of shaving with a positively perfect razor edge, until you sharpen your own blades with the Stag Sharpener. The quickest way. The truest way. The surest way. The safest way. The easiest way. The wheels of the sharpener guide the angle. Nothing to adjust. Nothing to get out of order. Practically lasts a lifetime. Our new patented feature makes the Stag more desirable than ever. Stag Sharpeners are used around the world. The new patented simplified sharpener is more popular than ever. Complete outfit includes

heavily nickeled sharpener, barber's hone and strop, in neat box, suitable for traveler's kit. Complete, postpaid to you only \$1. Send now.

## Sent on FREE TRIAL

Try a Stag Sharpener at our risk and at our expense. Use it ten days free. Use it at our risk and at our expense. Then if you are not delighted, send it back and get your money back in full. We gladly assume the risk and welcome your order on this liberal, free trial, money back guarantee. Send only \$1 today.

**Hone and Strop Free** With every Stag Sharpener we send a barber's hone and strop free. It is a part of the Stag outfit. The new patented, simplified improvements in the perfected Stag Sharpener and a new broad-width barber's hone and strop in attractive kit-box, all complete only \$1. Two minutes after you open the box, you can enjoy the first soft, smooth, silent shave with a lightning Stag edge. You will wonder how you ever got along without a Stag. It is the most suitable and welcome gift for any man for birthdays, weddings, or any occasion.



STAG sharpens all safety blades and welcome gift for any man for birthdays, weddings, or any occasion. **SEND \$1 TODAY.**

## Special \$1 Coupon

Hone and Strop Free

**THE STAG COMPANY**  
38 So. State St., Dept. 5248, Chicago

GENTLEMEN: Wishing to take advantage of your 10 days' free trial and money-back guarantee, you may send a Stag Sharpener, hone and strop complete. I am sending here-with \$1.

Name .....

Address .....

**Send Today** Enclose only \$1.00, money order, draft, dollar bill, or check. Send today and make a comfortable shave for yourself. You need a Stag Sharpener. Clip coupon, put in \$1 and get it by return mail.

**The Stag Company**  
Dept. 5248  
38 So. State St., Chicago

## Dealers

Write to us for special terms to dealers. The Stag is the quickest and best seller on earth. Get the benefit of this advertising and our Dealer Service.



# CHALMERS UNDERWEAR



This Label on Every Garment

*Chalmers Porosknit*  
*"Lets the Body Breathe"*

ALL STYLES

Men's Union Suits, Each	\$1.25
Boys' " " " "	85c
Men's Short and Drawers, Each	90c
Boys' " " " "	30c

Also makers of Chalmers  
 Spring Needle Ribbed Underwear  
 for Winter

## You Can't Move Too Fast for Chalmers "Porosknit"

No matter how fast you walk or run, or how strenuously you exercise, Chalmers "Porosknit" Underwear moves *with* you—and keeps you cool.

Its little "holes" let the heat of your body escape and allow the fresh, cooling air to get to your skin, stimulating rapid evaporation.

Its fabric instantly absorbs perspiration, keeping you comfortable on the stickiest day.

Give this genuine "Porosknit" a severe test.

Wear it when you are "playing your game"—it will produce a zone of coolness next your skin.

You cannot but be delighted with "Porosknit" Union Suits with the elastic Closed Crotch that cannot cut. Made of the best materials, well tailored to fit without tightness or bagginess.

Seams are reinforced; buttons well sewed on. Thorough washing is so easy that laundry wear and tear is much reduced.

Ask your dealer to show you  
 Chalmers "Porosknit" Underwear

Chalmers Knitting Co., Amsterdam, N. Y.

Chalmers "Porosknit" Underwear  
 is guaranteed in every respect

Please Mention Popular Mechanics



## When You're a One Man Business —

You've got to adopt *methods* that save your *minutes*. Corona saves your time by freeing you from dependence on other people's convenience.

# CORONA

*The Personal Writing Machine*

allows you to finish a swarm of small writing jobs, when you'd otherwise waste time waiting for a stenographer to get through with more important work.

No writing is too important for Corona to do, and there is no better writing than Corona does. Yet—Corona doesn't replace a stenographer but supplements her.

A chief convenience of your office is afforded you at all times and places, by the fact that Corona weighs but six pounds and is *portable*.

**Corona Costs \$50, Including Case**  
Special "Likly" luggage is made to accommodate Corona and your traveling kit.

**Corona Typewriter Co., Inc.**  
GROTON, N. Y.

NEW YORK CHICAGO SAN FRANCISCO

*Agencies in all principal cities*

*Booklet 13 tells all about  
Corona and Coronatyping*



Please Mention Popular Mechanics





## Turn them over

**W**HEN you buy a pair of shoes, turn them over and see what kind of soles they have. If the soles are Rinex, have the salesman wrap them up—you've got your money's worth.

Rinex is the wonderful, new shoe-sole material. It is neither leather nor rubber, but a material which combines the advantages of both.

It is more durable and uniform than leather and as light in weight; it is as flexible as rubber—and waterproof.

Rinex was invented and perfected in the great laboratories of the world's largest rubber company. Unlike leather, it comes in just one quality—the highest possible.

So, whether you pay \$4 for shoes or \$8, the word "Rinex" on the sole guarantees that you are getting the best sole-material ever devised by man.

Rinex Soles are also being put on by the best shoe-repairmen. Ask for them when you need new soles and see how much longer they last than leather and how much more comfortable they are.

## United States Rubber Company

*Sole and Heel Department*

1790 Broadway, New York

60 High Street, Boston



# Rinex Soles

*Please Mention Popular Mechanics*



# SAXON ROADSTER

A CAR COMPLETELY EQUIPPED WITH EVERY MODERN FEATURE

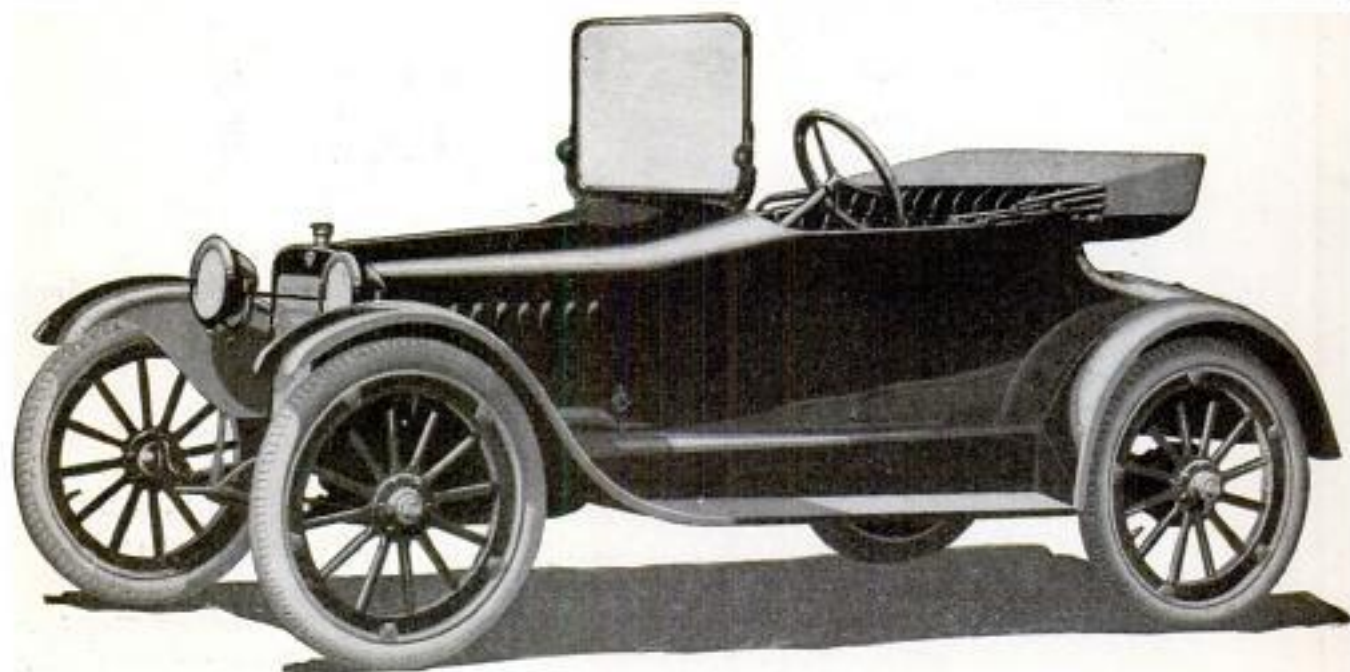

## The Lowest-Priced Completely Equipped Car On the Motor Car Market

This car—this new series Saxon Roadster—is the only motor car at less than \$500 that is completely equipped to the last detail.

In keeping with the pace set by the expensive cars, Saxon Roadster now has a fine 2-unit electric starting and lighting system.

It is a system built by Wagner that any car might envy—but no car surpass.

Simply press a button placed conveniently for your heel and your motor is started.

Can you picture yourself buying any car that must be cranked by hand when you can have such a car as Saxon Roadster for less than \$500?

Outwardly its beauty has been heightened by a new style body design. Inwardly its comfort has been increased through the larger size of the body, the greater roomi-

ness, and added seat space and leg room.

Demountable rims are now part of the equipment. So in event of tire mishap a change is readily made without trouble.

There are also 30-inch by 3-inch tires. And among other attractions are the 3-speed transmission; high-speed Saxon-Continental motor; Reichenbach carburetor; Hyatt Quiet bearings; honeycomb radiator; Atwater-Kent ignition; extra long cantilever springs; new style top with Grecian rear bow; 40-inch wide seat; electric horn; speedometer; extra tire carrier; ventilating windshield; adjustable pedals; and twenty further refinements.

The Saxon Roadster is \$495; Saxon "Six" Touring Car, \$865; Six Sedan, \$1250, f. o. b. Detroit. Canadian Prices—Six Cylinder Touring Car, \$1175; Touring Sedan, \$1675; Four-Cylinder Roadster, \$665. Price of special export models, "Six," \$915; Four, \$495; f. o. b. Detroit.

(1952)

SAXON MOTOR CAR CORPORATION, DETROIT



## Here is the Key

to robustness. Locks the door against weakness, anæmia and under-nourishment. Opens the door to strength, health and a sound digestion.

ANHEUSER-BUSCH'S  
*Malt-Nutrine*  
REG. U.S. PAT. OFF. TRADE MARK  
Liquid-Food-Tonic

A key whose repeated use has made it shine bright in the esteem of the medical profession and in the affections of the millions who have benefited by its fine tonic properties.

← *The key to the situation*

All Druggists—Most Grocers

Malt-Nutrine declared by U. S. Internal Revenue Department to be a pure malt product—not an alcoholic beverage. Contains 14.50 per cent malt solids—1.9 per cent alcohol.

Interesting booklet on request.

ANHEUSER-BUSCH  
St. Louis,  
U. S. A.



*The key that is used grows bright.*

—Old Proverb.

Please Mention Popular Mechanics



# MOISTAIR

*The Last Word  
in Home Heating Efficiency*

NO matter how cold and windy it is *outside* or how warm and comfortable it is *inside*, you can always rest secure in the knowledge that your home is properly *ventilated* and *humidified* when down in the basement there's a trusty *Round Oak* on the job.

For the best all-around heating service, in building, or replacing your old heating plant, insist on having a

## ROUND OAK Moistair Heating System

*The Only Heating System that AUTOMATICALLY  
Ventilates and HUMIDIFIES*



Makers of Good  
Goods Only

Regardless of weather, the Round Oak floods the home with a constant ever-changing stream of warm, *clean* air—air not only fresh and pure, but *moist* as well. An exclusive Round Oak feature!

Cleaner and easier to operate—requires less care and attention—installed by authorized dealer, it ends your heating troubles for life.

### Saves Fuel by the Ton

Warmth and comfort—with *moist* air requires less fuel than when the air is *dry*. Add to this, the savings effected by *features* noted at right, and you have a fuel-saving of *one ton in every nine*. Think of it!

More than 60,000 Round Oak Moistair Heating Systems now we know giving *unqualified satisfaction*. Backed by 46 years of experience and made by the makers of the *Genuine Round Oak Stove*. Investigate!

### Valuable BOOK and Heating Plan FREE

We will mail you a handsome book explaining advantages of Round Oak System. With book goes name of authorized dealer, also a *blank* which filled out and returned, brings you *without obligation* a Complete Heating Plan and Estimate, drawn up to meet your exact needs.

Many dealers sell on easy terms. To get the *Genuine* insist upon the Trade-mark showing the Round Oak Indian.

### The Beckwith Co.

Round Oak Folks. Established 1871  
72 Front St. Dowagiac, Mich.

### 5 Star Points of Supremacy

\***Health** Only Heating System that automatically ventilates and HUMIDIFIES.

\***Comfort** Delivers pure, warm ever-changing moist air, free from dust, gas, smoke—fitted with gas-tight doors and dampers.

\***Economy** Longest fire travel all inside casing; improved hot blast *Kouq*; extra deep fire pot; extra large combustion chamber affords perfect combustion; most heat on minimum of fuel.

\***Convenience** Simple regulator controls entire system. Self-cleaning. Ash pit dust-proof—seamless; fitted with sprinkler. Non-leak door frame cast on—not bolted. Easy to operate.

\***Durability** Materials used stand highest physical tests. All hinge pieces drilled, not cast. Never a bolt where a rivet will do! Tight fittings guaranteed. Good for generation of service.



Please Mention Popular Mechanics



PERFECT  
FITTING

MUNSING  
WEAR

UNION  
SUITS

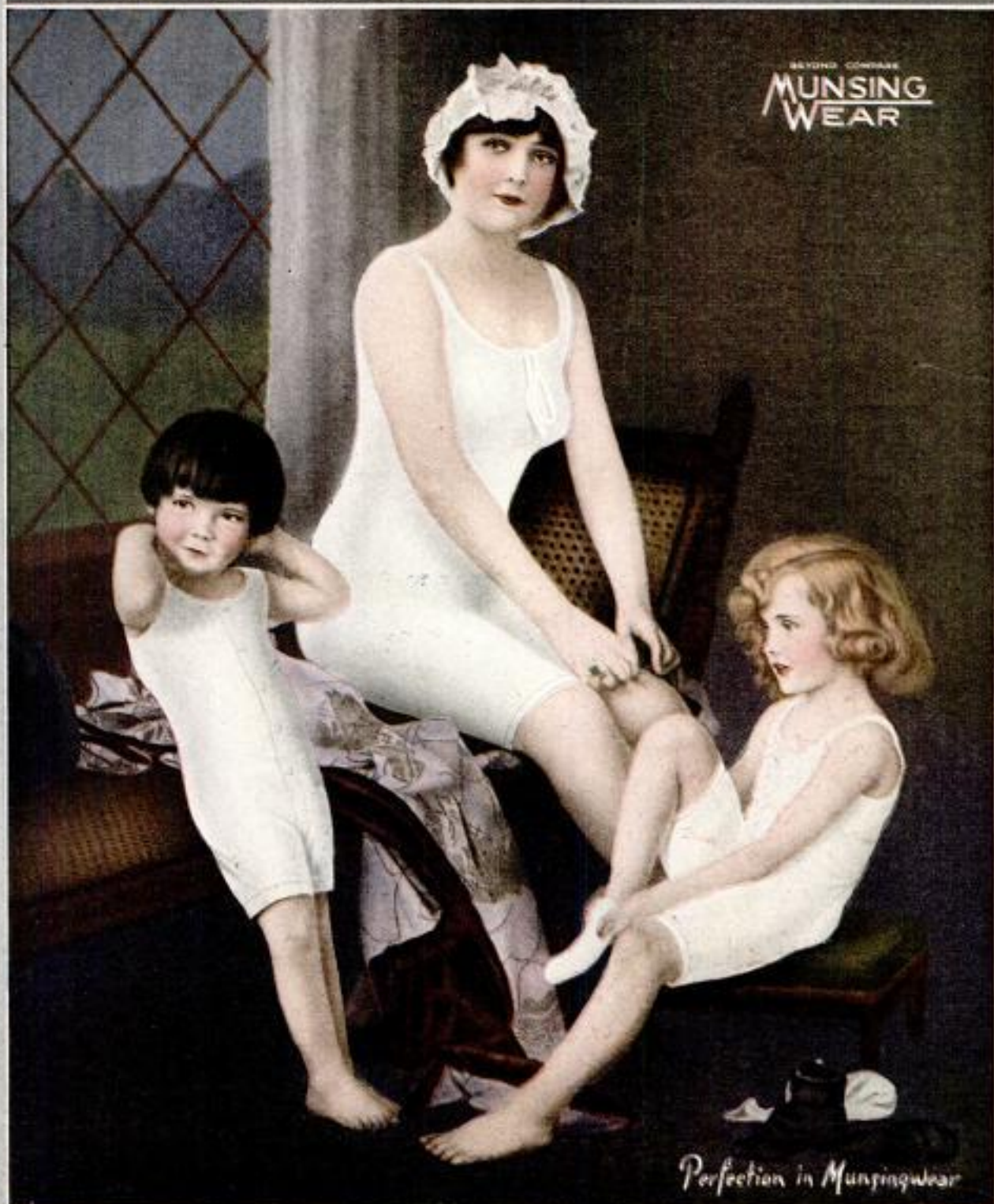

*Perfection in Munsingwear*

Munsing Union Suits in Summer Styles for Men, Women, Children  
Fine in quality - non-irritating - long wearing - always perfect fitting. The most in demand  
because the most satisfactory. For name of the Munsingwear dealers in your town address  
**THE NORTHWESTERN KNITTING COMPANY, Minneapolis, Minnesota**

*Please Mention Popular Mechanics*







# Make Your Own Movies

**\$29<sup>75</sup>**

Equal in performance  
to the best professional  
machine costing  
\$1000.00 or more.



Actual size  
of Movette  
Camera:  
7" long;  
5" high;  
2½" wide.



Every  
Dealer  
Sells It—  
You Can  
Buy It  
Everywhere!

## Guarantee to Purchasers

We absolutely guarantee that the Movette Camera will make perfect moving pictures. We will refund your money direct to you without question or equivocation if it does not do so.

MOVETTE CAMERA CORPORATION - ROCHESTER, N.Y.

The wonderful  
Movette home  
projector  
\$55.00



## The Greatest Home Entertainer In the World



For all the Family — Wonderful pictures because YOU took them. Your dear children romping magically upon the screen there in the parlor — or your friends, or the scenes you saw and captured in the city or on your trip—oh, there are hundreds of marvelous surprises this great invention gives to every lucky owner.

It will be miracle upon miracle. Always something different. The novelty of it gets more intense because the Movette reproduces "Life," "Motion." Pictures that captivate you with their strange power of living over and over again because YOU DID IT and YOU WISH IT and with a



and the equally remarkable Movette Projector you own an outfit that gives you pictures just as good as those taken with a thousand dollar professional camera and thrown upon the screen with the expensive projector used in the Movie Theatre.

The Movette Projector costs little but it performs marvels. It throws a clear, sharp picture, any size from 18 inches wide up to 9 feet, depending upon the size of your living room. Place the Movette Projector 15 feet from the screen and it throws a picture 4 feet wide with amazing clearness.

Like the Movette Camera it is so simple a child can use it. You merely attach the plug to any Electric Lamp Bracket and you're ready. Picture after picture. An evening's joy for you, the wife, the kiddies, the friends or neighbors. It's too wonderful to describe. You have to DO it yourself. And think! You can get 50 feet of Movette film for \$1.50. What entertainment! What education!

Ask your dealer to supply you with a Movette Motion Picture Camera and a Projector — or, fill out the coupon and we'll tell you more and more about Movette-ing — the scientific miracle of this age.

## Movette Camera Corporation

Largest Makers  
of Moving Pic-  
ture Cameras  
in the World

1173 University Ave.  
Rochester, N. Y.

## Investigation Coupon

Movette Camera Corporation Pop. Mech. 4-17  
Rochester, N. Y.

Gentlemen: I am interested in Movette. Will you kindly send me further details regarding the fascinating Movette Moving Picture Camera outfit and your interesting new book, "The Scientific Wonder of It" — FREE.

My dealer's name is .....

His address is .....

My name is .....

Address .....

City..... State.....

Please Mention Popular Mechanics





## It's Economy to Take Care of Fine Clothes

The old-fashioned washboard method is hard on the clothes, hard on the help and slows up the housework.

The new way cleans the clothes by gently rocking them through hot suds. For "Clothes Insurance" get a

# *Western Electric* Washer and Wringer

Here is an economical purchase at even an apparently large investment. But one hundred dollars is not a lot of money when figured as a business man does—on a *dividend* basis. Your "dividends" will be clothes and linens that wear longer and look better, and labor saved.

The Western Electric Washer cleans thoroughly and without damage. It turns wash-day and iron-day into one "laundry day," whether you yourself, your maid, or a laundress employed by the day does the work. At the existing high cost of domestic labor a Western Electric Washer will soon pay for itself.

There is a plan by which you can have a demonstration right in your own home. Write for details and a copy of Booklet No. 99-AW.

## WESTERN ELECTRIC COMPANY

INCORPORATED

New York  
Buffalo  
Philadelphia  
Newark

Atlanta  
Boston  
Richmond  
Savannah

Pittsburgh  
Birmingham  
New Orleans  
Cleveland

Chicago  
Cincinnati  
Detroit  
Milwaukee

Kansas City  
Indianapolis  
Minneapolis  
St. Louis

Denver  
Dallas  
Houston  
St. Paul

Salt Lake City  
Omaha  
Oklahoma City  
Oakland

San Francisco  
Los Angeles  
Seattle  
Portland

EQUIPMENT FOR EVERY ELECTRICAL NEED

Please Mention Popular Mechanics



# 3 Wonderful Bargains

From the Great UNIVERSAL Catalog  
— Each Sent Direct Only

# 50¢



## Sensational Sale on Refrigerators

No. U120. A remarkable value in Universal Sanitary White Enamel Lined Refrigerator. Lift lid design. Made of genuine ash, rich golden finish, solid brass trimmings. Has two nickel wire shelves. Ice rack of galvanized steel bars welded together. Ice compartment 50 lbs. capacity. Stands 42 in. high, 23 $\frac{3}{4}$  in. wide and 15 $\frac{1}{2}$  in. deep. Provision compartment measures 19 $\frac{1}{2}$ x14 $\frac{1}{2}$ x11 $\frac{1}{2}$  inch. Has syphon drip cup. Special handle allows for padlock. Order by No. U120. Price \$12.68. 50c with order; Balance \$1.25 per month.

## Collapsible Go-Cart



Here is a splendid value in a high wood side, full collapsible Go-Cart. Body made of 3-ply veneers, securely held by tinned ferrules; neatly enameled and trimmed with gold stripes. Has full tubular pushers, nickel trimmed handle, sensitive spring, positive foot brake, padded seat, 3-position back, adjustable 3-bow hood, nickel hub caps and many other features found only on higher priced Go-Carts. Has 10 inch wheels,  $\frac{1}{2}$  inch solid rubber tires, 16x28 in. frame, back 11 $\frac{1}{2}$  x 15 inches, seat 10x13 inches.

Merely mail the coupon and 50c and Go-Cart will be sent immediately. If, after 30 days use, you decide that you do not wish to keep it, return it at our expense and your money will be refunded.

Order by No. U133. Price only \$10.65. Terms: 50c with order; Balance \$1.05 per month.

## Remarkable Sale of Dishes

### 48-Piece Floral Design Dinner Set. Complete for Family of Six.

Beautiful Complete 48-Piece Dining Set, made of good quality pure white Porcelain, exquisitely decorated with latest rose floral pattern in many natural colors and gold. Six dinner plates, 9 $\frac{1}{4}$  in.; 6 breakfast plates, 7 $\frac{1}{4}$  in.; 6 cups, 6 saucers, 6 fruit dishes, 6 $\frac{1}{2}$  in.; 6 new style deep soup coupes, 6 butter plates, 1 deep open vegetable dish, 9 $\frac{1}{4}$  in.; 1 meat platter, 11 $\frac{1}{4}$  in.; 1 meat platter, 9 $\frac{1}{4}$  in.; 1 sugar bowl and cover (2 pieces); 1 cream pitcher. Every piece guaranteed full size for family use.

This 48-Piece Set is a wonderful value at our low price and easy terms.

Order by No. U127. Price only \$3.69. Terms: 50c with order; Balance 50c per month.

## Order One of These Special Bargains

Here is a plan for beautifying the home that marks the most advanced step ever taken in the history of merchandising. For only 50c we will send you any of the remarkable bargains shown on this page. If more than one is wanted send 50c for each item. You may use what you order for 30 days at our risk. If you then decide to keep it, pay the balance in small monthly payments. If you decide not to keep it return it at our expense and we will return your 50c—the 30 days use of the goods costs you nothing.

This small 50c deposit does not obligate you in any way, but is merely asked as an indication of good faith and to protect ourselves against irresponsible people ordering at random. You run absolutely no risk in sending in your order. Ours is a big, successful firm that is reputable, responsible and trustworthy in every way. And every article you order from us is backed by our legal binding guarantee which insures your absolute satisfaction. Send us your order today—only 50c and coupon for each article desired.

## SPECIAL BARGAIN BOOK FREE!

Send for Special Bargain Book picturing and describing everything for the home—at rock-bottom prices—and on the most wonderfully liberal terms imaginable. We will trust you for anything you want on our liberal, easy-to-pay, credit plan.

## UNIVERSAL MAIL ORDER CO.

145-53 W. 39th St.  
Dept. 297  
Chicago



If only catalog is wanted put an X in this square, fill in name and address on lines below and mail coupon.

### Universal Mail Order Co.

145-153 W. 39th St., Dept. 297 Chicago

Gentlemen: Enclosed find 50c for each item marked below. If satisfactory after 30 days examination I agree to pay the balance as per prices and terms printed in this advertisement. If not satisfactory I will return goods to you.

U120—Refrigerator.  
U133—Collapsible Go-Cart.  
U127—48-Piece Dinner Set.

Name.....

Address.....

City..... State.....

NOTE—Put line like this — in front of items wanted.

Please Mention Popular Mechanics



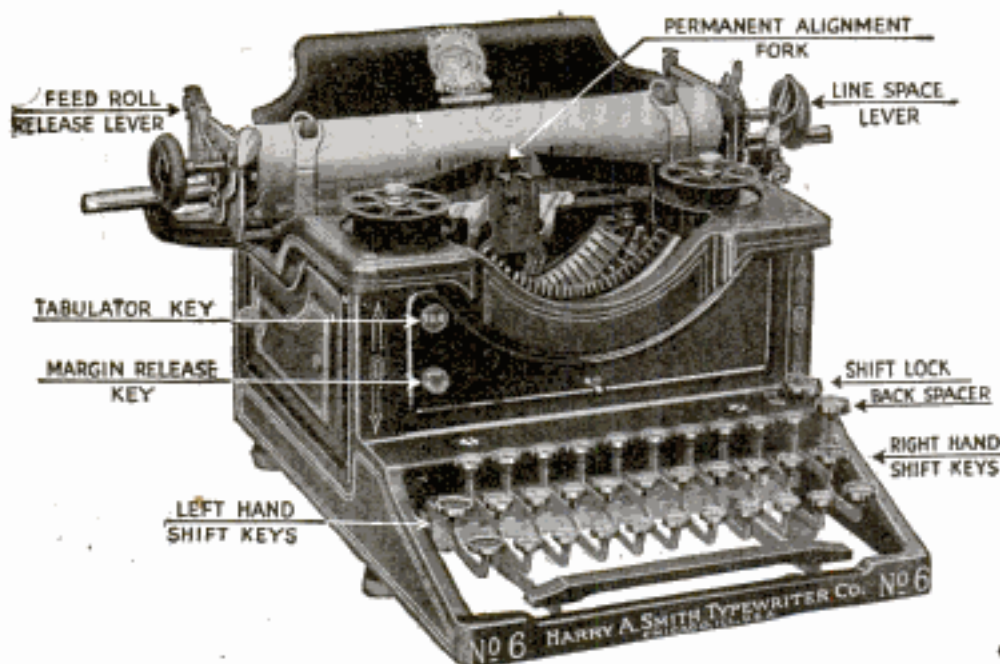

I want, through this advertisement, to establish as friendly business relations with you as I possibly can. I want you to realize also that it is my earnest effort and intention to give you full honest value for every dollar that you spend with me. This is the only way I can succeed. My advertisement has appeared in this magazine continuously for more than four years.

I am building up my business on the foundation of good value and square dealings. I am saving thousands of satisfied customers thousands of dollars, by supplying perfect—late style—visible writing—typewriters, at remarkably low prices.

All my transactions are handled throughout by personal correspondence. I assure you every courtesy and consideration in your dealings with me. Your order will have my prompt, careful, personal attention. I will be glad to do business with you.

*Harry A. Smith*

# TYPEWRITER SENSATION

## Free TRIAL—Use As You Pay

Send me only \$2.00 a month until the low total price of \$34.15 is paid, and the machine is yours

This is absolutely the most generous typewriter offer ever made. Do not rent a machine when you can pay \$2.00 a month and own one. Think of it—Buying a \$100.00 machine for \$34.15. Cash price, \$32.30. Never before has anything like this been attempted.

## Standard Visible SMITH Model No. 6

Perfect machines, Standard Size, Keyboard of Standard Universal arrangement, writing 84 characters—universally used in teaching the touch system. The entire line of writing completely visible at all times, has the tabulator, the back spacer; in fact, every late style feature and modern operating convenience. Comes to you with everything complete, tools, cover, operating book and instructions, ribbon, practice paper—nothing extra to buy. You cannot imagine the perfection of this beautiful typewriter until you have seen it. I have a thousand of these perfect latest style Model No. 6 typewriters at this bargain price, and each purchaser fortunate enough to secure one of these beautiful machines must try it out in home or office for five days before deciding to buy. I will send it to you F. O. B. Chicago for five days' free trial. It will sell itself, but if you are not satisfied that this is the greatest typewriter bargain you ever saw, you can return it at my expense. You won't want to return it after you try it—you cannot equal this wonderful value anywhere.

**H. A. SMITH**  
Room 510-231 N. Fifth Ave.  
CHICAGO, ILL.

Ship me a No. 6 Smith F. O. B. Chicago, as described in this advertisement. I will pay you the \$28.00 balance of the SPECIAL \$34.15 purchase price, at the rate of \$2.00 per month. The title to remain in you until fully paid for. It is understood that I have five days in which to examine and try the typewriter. If I choose not to keep it I will carefully repack it and return it to the express agent. It is understood that you give the standard guarantee for one year.

## You Take No Risk—Put In Your Order Now

When the typewriter arrives deposit with the express agent \$6.15 and take the machine for five days' trial. If you are convinced that it is the best typewriter you ever saw, keep it and send me \$2.00 a month until my bargain price of \$34.15 is paid. If you don't want it, return it to the express agent, receive your \$6.15 and return the machine to me. I will pay the return express charges. This machine is guaranteed just as if you paid \$100.00 for it. It is standard. Thousands and thousands of people own and use these typewriters and find them the best ever manufactured.

The supply at this price is very limited, the price will probably be raised when my next advertisement appears, so don't delay. Fill in the coupon today—mail to me—the typewriter will be shipped promptly. There is no red tape. I employ no solicitors—no collectors—no chattel mortgage. It is simply understood that I retain title to the machine until the full \$34.15 is paid. You cannot lose. It is the greatest typewriter opportunity you will ever have. Do not send me one cent. Get the coupon in the mails today—sure.

**HARRY A. SMITH, 510-231 N. Fifth Ave., Chicago**

Name .....

Address .....

Pop. Mech. Agr.

Please Mention Popular Mechanics





# Eleven Rooms Heated for \$35

Another Guaranteed  
Underfeed Saving

Just read the following letter. It tells its own eloquent story of *guaranteed* saving and comfort with a Williamson UNDERFEED. Then remember, there are over forty thousand other Williamson UNDERFEED users enjoying the same economy and heating efficiency. Here's the letter:

*"The UNDERFEED is built on the right principle for obtaining all of the heat from the coal. The cost of heating my residence, consisting of eleven rooms, three stories high, for the past three years has been only a trifle more than the ice bill of the summer, the average for that period being less than thirty-five dollars a season."* (Signed) Clay H. Alexander, Counsellor at Law, Kansas City, Mo.

And, what is more, the Williamson UNDERFEED means less work. No stooping. A few easy strokes of a lever from a standing position replenishes the fuel supply. Easy to operate when the man of the house is away.

## WILLIAMSON UNDERFEED Furnaces Boilers

Cut Coal Bills  $\frac{1}{2}$  to  $\frac{2}{3}$  Guaranteed



The UNDERFEED effects a first great saving by burning the cheaper grades of coal as effectively as others burn the costlier grades.

Because of the scientific principle of combustion, as explained to the right, there are no clinkers, no partly burned coals. Gas, smoke or soot—valuable heat elements—are consumed as they pass up through the fire. Ashes clean and white.

### Money-Saving Book Free

It is called "From Overfed to UNDERFEED" and pictures and describes the scientific UNDERFEED principle. Send for this book now, it will save you good money some time, whether you heat with warm air, hot water, steam or vapor—a saving of  $\frac{1}{2}$  to  $\frac{2}{3}$  in coal cost—guaranteed with the UNDERFEED. Send coupon NOW—no cost—no obligation.

**THE WILLIAMSON HEATER CO.**  
45 Fifth Avenue CINCINNATI, O.

*Cut-out view shows how the UNDERFEED burns coal on the candle principle. Fresh coal is fed from below. Clean, hot fire always on top in direct contact with most effective radiating surfaces. Fire never choked or smothered. All heat utilized instead of disappearing up the chimney in the form of smoke, gas and soot.*

**THE WILLIAMSON HEATER CO.**  
45 Fifth Ave., Cincinnati, O.

Tell me how to cut my coal bills from  $\frac{1}{2}$  to  $\frac{2}{3}$  with a Williamson Underfeed.

Warm Air.....Steam or Hot Water.....  
(Mark X after System interested in)

Name.....

Address.....

My Heating Contractor's Name is.....

Heating Contractors: Let us tell you about the Williamson UNDERFEED and our proposition. Both are winners.

36278 \$150.

36043 \$100.

36254 \$50.

36226 \$25.

36071 \$55.

36034 \$45.

## Beautiful Genuine DIAMONDS \$2.00 a month

ON CREDIT—NO MONEY DOWN—FREE EXAMINATION

YOU DON'T PAY A CENT until you see and examine the article. If perfectly satisfactory, pay 1-5 of purchase price and the balance in 5 equal monthly payments. If not entirely satisfactory, return at our expense. A guaranteed certificate as to quality with each diamond. Exchange at any time at an

**INCREASE OF 7 1-2 PER CENT. MORE THAN YOU PAID**

Send for free catalog DeLUXE No. 6 containing over 1000 illustrations of diamonds, watches, silver ware and other gift articles. Make a selection either for yourself, friend or loved one. We will send the article for your examination all fully prepaid. You assume no responsibility and are under no obligations. **Everything at rockbottom prices** direct to you. Send for catalog today. **It's Free.**

**L. W. SWEET & CO., Inc., Dept. 6**  
2-4 MAIDEN LANE, NEW YORK CITY  
THE WORLD'S GREATEST DIAMOND MERCHANTS

36030 \$25.

36184 \$100.

36055 \$300.

36211 \$90.

36080 \$100.

Please Mention Popular Mechanics





ED. H. WITTE

# I Can Make You The Best PRICE

## Save You \$25 to \$100

### Immediate Shipment

NO one has ever equaled WITTE Engine quality at WITTE Direct-From-Factory prices. No other exclusive manufacturer of engines, selling direct, has the equipment for making good engines that I have—no one will make you a better offer, or sell you a better engine at my prices, or on my favorable terms—Cash, Deposit, Payments, or No Money Down.

## WITTE ENGINES

Take Your Choice of 2 to 22 H.P.—Any Style—Kerosene or Gasoline

Years ahead in design and construction. Full-length bed makes absolutely solid footing, no cylinder hanging out behind; vertical valves require no lubrication, because no friction; semi-steel cylinders, full water cooled, no interior packing. Easy to operate, easy starting, and other exclusive features that make WITTE Engines high-grade. Hundreds and thousands used in every state. Get my prices for immediate shipment. Why wait 6 to 8 weeks for any engine, when I can ship you a better one NOW—Today! 90 Days Trial, Guaranteed 5 years. Write or wire me, I'll handle your order. ED. H. WITTE, Pres.

### WITTE ENGINE WORKS

1741 Oakland Ave.,  
Kansas City, Mo.

1741 Empire Bldg.,  
Pittsburgh, Pa.

# FREE



# POSTPAID

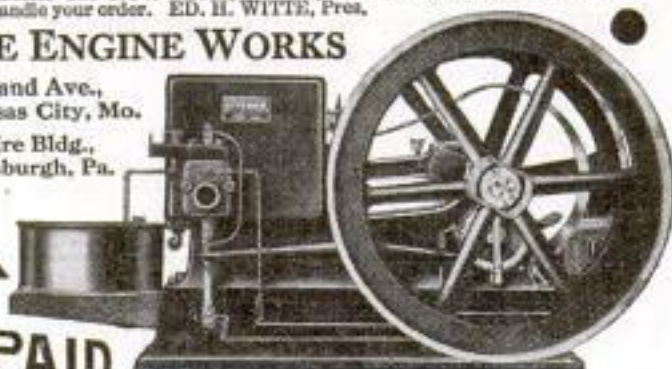

## Vitalize yourself with Violet Rays

Vigor, health and beauty in marvelous, delightful Violet Rays. Any good physician will tell you. Thousands are prescribing Violet Rays. Send for instruction book and learn what it will do for you.

### Sent on Free Trial

Violetta is the perfected instrument. Produces soothing, invigorating, curative Violet Rays. Used and endorsed for private use by physicians. Use it anywhere. Sent to you on Free trial. Special low price offer.

### Write for New Free Book

Send for the book on Violetta. Read what physicians say. Post card brings book and all particulars of special offer free. Write today.

**BLEADON-DUNN CO.**  
208 N. Fifth Ave., Dept. C5, CHICAGO



## BUILD YOUR OWN GRANDFATHER'S CLOCK WITH OUR HELP

We furnish blue prints, finishing material and instructions. Buy the works, dial, weights and pendulum from us at surprisingly low prices. You make a fine profit building artistic clocks for your friends.

Complete Works \$5.00. Others with Chimes at all prices. Ask for our attractive Free Offer  
CLOCK CO., 1673 Ruffner St., Philadelphia, Pa.



## "Best" Hand Lantern



A powerful portable lamp, giving a 300 candle power pure white light. Just what the farmer, dairyman, stockman, etc., needs. Safe—Reliable—Economical—Absolutely Rain, Storm and Bug proof. Burns either gasoline or kerosene. Light in weight. Agents wanted. Big Profits. Write for Catalog.

The Best Light Co., 324 E. 5th St., Canton, O.





## When the neighbor's house burns

and fire-brands fly in the wind—there are thousands who can congratulate themselves on fire-safe roofs—roofs in shingle form, made from

# JOHNS-MANVILLE Asbestos

Resistant to heat.

water, wear and weather



**N**OT only home roofs but big structures too enjoy its protection against time and fire. The farm silo and barn, the office building, the factory, the steel mill, all know Asbestos. Johns-Manville has developed Asbestos into hundreds of other

COVERS  
THE CONTINENT

useful forms; for the maintenance of industrial plants; as an ingredient of many manufactured products and household conveniences—wherever safety from fire and resistance to the elements and to chemical action are imperative.\*

H. W. JOHNS-MANVILLE COMPANY

New York City

Branches in 54 Large Cities

\* Asbestos Fabrics, Packings, Roofings, Shingles, Brake Linings, Building Materials, Electrical Devices, Heat Insulations, Refractory Cements, Waterproofing.

The Motor Car



The Farm



The Home



Industry



Power Plants



Transportation



Roofings



When you think of Asbestos you think of  
**Johns-Manville**

Please Mention Popular Mechanics



# READ THIS

## Before You Buy A Watch Anywhere

### World-Famous Watches at the Lowest Prices in the UNITED STATES!

Why pay retail prices for watches when you can buy the world's standard makes at practically the *wholesale* cost and save, in many instances, approximately 40%? For example, a 16 Size Hamilton No. 974—17 Jewel Adjusted Watch complete in 25 year gold filled case, sells at retail for \$21.00 to \$25.00—this very same watch can be bought direct from us at the *wholesale* cash price of only \$14.50! Think of that! Get our beautiful 226-page catalog just off the press, and you will be utterly amazed at the way we undersell all others in the United States. In this great book you will see all the world's most famous watches illustrated and described—Elgin, Waltham, Hamilton, Illinois, etc., etc. Page after page opens before you with such positively sensational values that there will be no question in your mind of our being the lowest-priced distributors in the country.

### FREE Examination See It Before You Pay for It!

So as to absolutely convince you that you are getting exactly what you order, and that the big value you get is true in every respect, we will gladly send you a selection at our expense, to any bank or express, and let you see it before you pay a penny. Write today for our 226-page catalog. It is the greatest authority on watches ever published. And it is free for the asking.

### Fill Out This Coupon for Big Free Catalog

I. PRESS & SONS  
833 Chestnut St., PHILADELPHIA, PA.

You may send me, free, postpaid, without obligation, your 226-page catalog.

Name .....

Address .....

Mail It  
Today

Choice of  
17 Jewel Waltham,  
Elgin, Hamilton or  
Illinois Movements  
In 25 Year Gold Filled  
Cases—Any Secret Order  
Emblem

**\$17<sup>35</sup>** \$25 Value

7 Jewel Elgin or  
Waltham  
20 Year Gold  
Filled Watches  
All Sizes

**\$6<sup>66</sup>** \$10 Value

Octagon, New  
Style 25 Year  
Gold Filled 12  
Size Watches

15 Jewel \$10<sup>50</sup>

17 Jewel \$12<sup>35</sup>

21 Jewel \$15<sup>00</sup>

Ladies' Watch

Brace-  
lets, 20

Yr. Gold

Filled or

Wal-  
tham

7 \$8<sup>98</sup>

15 \$11<sup>65</sup>

17 \$16<sup>98</sup>

Jewel

Jewel

Jewel

Jewel

Jewel

Jewel

Jewel

Jewel

Jewel

Jewel

Jewel

Jewel

Jewel

Jewel

Jewel

Jewel

Jewel

Jewel

Jewel

Jewel

Jewel

Jewel

Jewel

Jewel

Jewel

Jewel

Jewel

Hamilton Watches  
at lowest prices in the world

18-Size, No. 924—17 Jewel \$8<sup>98</sup>

16-Size, No. 974—17 Jewel \$14<sup>50</sup>

25 Year Gold Filled \$26<sup>80</sup>

16-Size, No. 992—21 Jewel \$26<sup>80</sup>

25 Year Gold Filled

25 Year Gold Filled

25 Year Gold Filled

25 Year Gold Filled

25 Year Gold Filled

25 Year Gold Filled

Gold Filled Ribbon  
Fob and  
 Charm  
to Match  
FREE



10  
Year  
Free  
Repair  
Guar-  
antee  
Bond  
Given  
With  
Every  
Watch

**I. PRESS & SONS**  
IMPORTERS AND CUTTERS OF DIAMONDS  
WHOLESALE JEWELERS  
833 CHESTNUT ST.  
PHILADELPHIA, PA.



# \$100 Model UNDERWOOD

WITH BACK SPACER—TWO  
COLOR RIBBON AND TABULATOR

# FOR

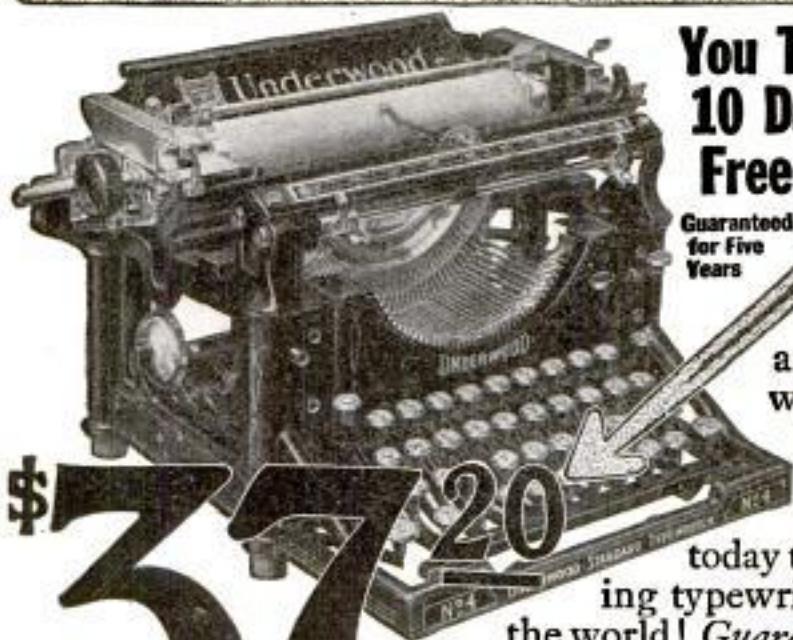

**You Try It  
10 Days  
Free**

Guaranteed  
for Five  
Years

**Think What  
You Can Get  
Now for \$37.20**

A genuine No. 4 Underwood—the standard visible typewriter, with back spacer, two-color ribbon and tabulator—*complete* with waterproof cover, new ribbon and special touch typewriting instruction book—the machine

**\$37.20**

that is today the leading typewriter of the world! *Guaranteed* to be delivered in perfect condition! Fully guaranteed for five years.

**You May**  
**RENT** APPLYING RENT  
ON  
PURCHASE PRICE  
**OR**  
**BUY** FOR CASH OR  
ON EASY  
PAYMENTS

## 'Way Under 1/2 Manufacturer's Price

Moreover, you don't have to buy it to try it! We will send one to you on Ten Days' Free Trial. Write all you please on it for ten days and then if you are not *perfectly* satisfied, send it back at *our expense*. What's more, if you do not care to buy, you may rent it at our low monthly rates. If later you want to own it, we will apply *six months'* rental payments on the low purchase price. Any national bank in Chicago, or any Dun's or Bradstreet's Agency anywhere will tell you that we are responsible. Learn *all* the facts about this remarkable offer. Write us today—send us your name and address on the attached coupon—or a post card. Ask for Offer No. 52

### Our Other Plan Brings You This Underwood

This is a new plan—Our Agency Plan. You are not asked to do any canvassing—no soliciting of orders. You simply co-operate with us. Become one of our nation-wide organization. You can easily get your Underwood *free* by this new plan. Write tonight—send your name and address on the coupon or a post card and learn all about Offer No. 52

# FREE

**Typewriter Emporium, 34-36 W. Lake St., Chicago**  
Established for a Quarter of a Century

**Typewriter Emporium, 34-36 W. Lake Street, Chicago, Illinois**  
Send me immediately full facts about your Offer No. 52

Name \_\_\_\_\_  
St. or R. P. No. \_\_\_\_\_  
City \_\_\_\_\_  
State \_\_\_\_\_



# The Skeptic About Corns



Some years ago a famous chemist invented the Blue-jay plaster.

In a bit of red wax he combined ingredients which no corn can resist.

Through us he offered to all people this sure ender of a corn.

But people said, "We've heard such claims before." They had used harsh, old-time methods which proved inefficient.

The same folks tried this Blue-jay, and each told others.

Since then this method has removed some 80 million corns.

Here is a way that's gentle, scientific, sure. It is applied in a jiffy. It costs but a few cents per corn.

It stops the pain instantly. It ends the corn in two days—that is, nine corns in ten. The stubborn ones need a second application.

It makes corns forever needless. Corn aches become unknown. For your own sake, prove this. Stop paring corns. Learn how easy it is to end them. Prove it tonight.

**BAUER & BLACK**  
Chicago and New York  
Makers of Surgical Dressings, etc.

## Blue=jay

Stops Pain — Ends Corns

15c and 25c at Druggists

Also Blue-jay Bunion  
Plasters



## Don't Wear a Truss

Brooks' Appliance, the modern scientific invention, the wonderful new discovery that relieves rupture will be sent on trial. No obnoxious springs or pads.

### Brooks' Rupture Appliance

Has automatic Air Cushions. Binds and draws the broken parts together as you would a broken limb. No salves. No lies. Durable, cheap. Sent on trial to prove it. Protected by U. S. patents. Catalogue and measure blanks mailed free. Send name and address today.

**C. E. BROOKS, 126 State St., Marshall, Mich.**

# Deafness



Perfect hearing is now being restored in every condition of deafness or defective hearing from causes such as

Relaxed or Sunken Drums. Roaring or Hissing Sounds. Perforated, Partially Destroyed Drums, etc.

### Wilson Common-Sense Ear Drums

"Little Wireless Phones for the Ears"—require no medicine but effectively replace what is lacking or defective in the natural drums. They are simple devices, which the wearer easily fits into the ears where they are invisible. Soft, safe and comfortable to wear at all times.

Write today for our 168 page FREE book on DEAFNESS, giving you full particulars and plenty of testimonials.

**WILSON EAR DRUM CO., Incorporated**  
686 Inter-Southern Building LOUISVILLE, KY.



# STOP USING A TRUSS

Do Away With Steel And Rubber Bands

## FREE TRIAL



Inner surface is made adhesive to secure the PLAPAO-PAD firmly to the body, keeping the PLAPAO continually applied and the pad from slipping. No straps, buckles or springs attached. Soft as velvet—easy to apply.

It's the Non-Slip- ping, yet Non-Rigid Pad and What is Within It That Counts

### FREE to 5,000 Truss Sufferers

To the extent of 5,000 sufferers who may apply I will send, ABSOLUTELY FREE, a sufficient quantity of the Plapao to positively convince them that this is the only logical, common-sense way of treating rupture. Plapao is a highly astringent medication placed within the Plapao-Pad and being absorbed through the skin, creates a wonderful feeling of relief and at the same time tends to strengthen the weakened muscles and thus permanently close the rupture opening. The process of recovery is natural, so you'll have no use for a truss—you can throw it away forever! Old and young have testified under oath that the Plapao-Pads cured their rupture—many of them long-standing, aggravated cases—without delay from work. Patent allowed in U. S. and foreign countries. Awarded Gold Medal at Rome and Grand Prix at Paris.

**Send No Money**—for a sufficient quantity of the Plapao is sent without charge to enable you to give it a thorough test; you pay nothing for this trial now or ever. Write for it and full information today. Address: Plapao Laboratories, Block 1427 St. Louis, Mo.

## Enormous Profits



### START GROWING MUSHROOMS

Learn the latest authoritative way to make still bigger profits than you ever thought possible or ever made growing mushrooms. Add \$10 to \$75 a week to your income. Anyone, men, women and children can do it in spare time in city or country. Grow in basements, cellars, sheds, boxes, etc. Start now. Demand larger than supply. Send for big free book of expert authority. "The Truth About Mushrooms." Write to

**BUREAU OF MUSHROOM INDUSTRY**  
Dept. 376 1342 N. Clark St. Chicago

## "A Friend of Mine Is a New Woman

in every way, since wearing your brace."

"Gives one a perfect form."—"I owe my life to you."—In like manner testify over 100,000 women who have worn it.

## The Natural Body Brace

Overcomes **WEAKNESS** and **ORGANIC AILMENTS** of **WOMEN AND MEN**. Develops erect, graceful figure. Brings restful relief, comfort, ability to do things, health and strength.

### Makes You Feel Good and Look Good

Does away with the strain and pain of standing and walking; replaces and supports misplaced internal organs; reduces enlarged abdomen; straightens and strengthens back; corrects stooping shoulders; develops lungs, chest and bust; relieves backache, curvatures, nervousness, ruptures. Easy to wear.

### Wear It 30 Days Free at Our Expense

Write today for illustrated booklet, measurement blank, etc., and read our very liberal proposition.

**HOWARD C. RASH, Pres. Natural Body Brace Co.**  
W306 Rash Building SALINA, KANSAS



For Children Also



## Compare It With a Diamond

*If You Can Tell the Difference  
—Send it Back at Our Expense*

**THESE** new, man-made gems will be a revelation to you. After centuries of research, science has at last produced a gem of dazzling brilliance that so closely resembles the diamond that you'll not be able to distinguish it. You may see it for yourself—without charge.

We will send you any of the Lachnite Gems that you may select for a ten days' free trial. We want you to put it to every diamond test. Make it cut glass—stand the diamond file, fire, acid—use every diamond test that you ever heard about. Then, if you can distinguish it from a diamond, send it back at our expense. Write for our new, free jewelry book.

## Pay As You Wish

If you wish to keep the remarkable new gem, you may pay the rock-bottom price at the rate of only a few cents a day. Terms as low as 3½ cents a day without interest. No notes, mortgages or red tape. You pay only the direct, rock-bottom price—a mere fraction of what a diamond costs.

## Set in Solid Gold

Lachnite Gems are never set in anything but solid gold. In our new jewelry book you will see scores of beautiful rings, La Vallieres, necklaces, stick pins, cuff links, etc., etc. from which you have to choose.

## Send Coupon For New Jewelry Book

Put your name and address in the coupon or on a letter or post card now and get our new jewelry book absolutely free. You will be under no obligations to buy anything—or to pay for anything. The jewelry book is free. Send your name and address now.

**Harold Lachman Co.**  
12 N. Michigan Ave.  
Dept. 1194  
Chicago, Illinois

**Harold Lachman Co.**  
12 N. Michigan Av.  
Dept. 1194 Chicago

Gentlemen: Please send me absolutely free and prepaid your new jewelry book and full particulars of your free trial, easy payment plan. I assume no obligations of any kind.

Name.....

Address.....





## The Dependable Pencil

Almost unconsciously, in drawing intricate plans, one bears stronger than necessary on the pencil. With an ordinary pencil the result is a broken lead, or an uneven line, or a scratched drawing.

With "the master drawing pencil" the pressure may be increased far out of proportion, and the lead will remain true.

## DIXON'S ELDORADO

*"the master drawing pencil"*

is made true to grade in 17 degrees.

It is the close friend of men who pride themselves on their work—who do difficult work, and who do good work.

Send fourteen cents in stamps for samples worth double the money.

**JOSEPH DIXON CRUCIBLE CO.**  
Dept. 10-J, Jersey City, New Jersey

DIXON'S BEST WHITE No 352  
*writes white on blueprints*

DIXON'S "ELDORADO"—the master drawing pencil—HB



## \$100 TO \$150 SAVED ON MEISTER PIANOS

Let us send this beautiful instrument to you on

**30 Days' Free Trial** Freight Prepaid

Eight beautiful styles to choose from. If it proves highly desirable to you, we will sell it to you on

Small monthly payments. No cash deposit down. No interest or extras. Stool and scarf FREE.

**THREE YEARS TO PAY!**

A binding guarantee of high-class material and workmanship. Write today for our beautiful 100-page illustrated catalog. **IT'S FREE.**

**Rothschild & Company Dept. 110 Chicago, Ill.**

## JENKINS BAND AND ORCHESTRA INSTRUMENTS

are world famous. Own a Cornet, Trombone, Clarinet, Drum, Saxophone, Violin, Guitar—any Band or Stringed Instrument. **PLAY WHILE YOU PAY** a little a day on the Jenkins Plan. **SAVE BIG MONEY. FREE Lesson Certificate** with each instrument.

**FREE** Complete Cornet and Violin parts from Jenkins' *Beginners' Band Book and Instructor* and Jenkins' *Beginners' Orchestra Book and Instructor*. All instructions to start and make a new band or orchestra. A big success. Easy to play pieces for a starter. Band instrument parts, each 25c; orchestra, 10c; piano, \$1.00. Jenkins' instruments and music stock the largest and best in the country. **CATALOG** Write for big Catalog of instruments and latest music lists. A test will prove us best. Address **JENKINS MUSIC CO., 90 JENKINS BLDG., KANSAS CITY, MO.**

## Mr. Edison's Wonderful Phonograph

Only **\$1.00**  
After  
**Free Trial**



Yes, you may keep this New Edison—Thomas A. Edison's great phonograph with the diamond stylus—and your choice of records, too, for only \$1. Pay the balance at rate of only a few cents a day. Try the New Edison in your own home before you decide to buy. Send no money down. Entertain your friends with your favorite records. Then return it if you wish.

**Write Today For Our New Edison Book.** Send your name and address for our new book and pictures of the new Edison phonograph. No obligation—write now while this offer lasts.

**F. K. BABSON, Edison Phonograph Distributors**  
1194 Edison Block, Chicago, Illinois

Please Mention Popular Mechanics



**Draughts  
Start Colds—  
LUDEN'S  
Stop Them**

Keep Luden's at home—at the office. Use at first sign of coughs, colds or "throat tickle." Often prevent serious illness.

*In the "Yellow Box"—5c*



# LUDEN'S

MENTHOL CANDY COUGH DROPS

*Luden's great popularity is due to its being more than an ordinary cough drop. You'll find many new uses.*

WM. H. LUDEN, Mfg. Confectioner, READING, PA.



Bell Telephone highways make you the near neighbor of your farthest-away fellow-citizen.

**AMERICAN TELEPHONE & TELEGRAPH CO.  
AND ASSOCIATED COMPANIES**

*One Policy One System Universal Service*

## TYPEWRITERS SAVE FROM \$25 to \$75

Up-to-date machines of standard makes—Remingtons, etc., thoroughly rebuilt, trademarked and guaranteed the same as new. We operate the largest rebuilt typewriter factories in the world. Efficient service through Branch Stores in leading cities insures satisfaction. Send for catalogue.

American Writing Machine Co., Inc., 339 Broadway, N. Y.



### Red or Black "Vulcan" Ink Pencils

The ONLY perfect, non-leakable ink pencils at moderate prices.

Order today \$1

Two Sizes—  
4 1/4 and 5 1/2 inches.  
Extra Size—8 inches  
(black only) \$1.25.

Your name in gold inlay 35c.  
**FREE**—liberal supply of ink with retail orders. Agents Wanted. Big Profits.  
J. C. ULLRICH & CO., 27 Thames St., New York



SUPERIOR SINCE 1904

### Over 100,000 in Use

Mostly sold through recommendation. For PERSONAL DESK or GENERAL OFFICE. It checks mental calculations. Buy through your Stationer. Write for 10-day trial offer.

E. GANCHER, A. A. M. CO.  
148 Duane Street, NEW YORK

**AGENTS WANTED**

### Golden Gem PORTABLE Adding Machine



Multiplies—Subtracts

21 Jewels  
Adjusted to  
the Second

Adjusted to  
Temperature,  
Positions and  
Isochronism

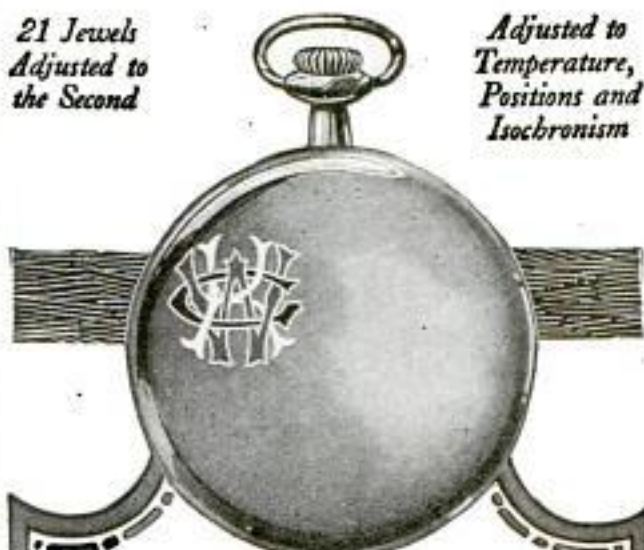

## Big Watch Value

The Burlington smashes all watch competition.

\$1 Ruby and Sapphire Jewels—  
Adjusted to positions—  
Adjusted to temperature—  
Adjusted to isochronism—  
25-year gold strata case—  
Genuine Montgomery Railroad Dial—  
New Ideas in Thin Cases.

# \$2<sup>50</sup> a Month

Yes, that's our astonishing offer—only \$2.50 per month—a great reduction in watch prices—direct to you—positively the exact prices that the wholesale dealer would have to pay. Think of the high-grade, guaranteed watch we offer here at such a remarkable price. And, if you wish, you may pay this price at the rate of \$2.50 a month. Write now!

**See It First!** Don't pay a cent to anybody until you see the watch. When it comes look at the works—and see why experts have called it the master timepiece. Look at the case—and see the newest product of the goldsmith's skill. Then decide if you are going to buy. The watch is sent to you—on approval.

*Every fighting vessel in the U. S. Navy has the Burlington Watch aboard. This includes every torpedo boat—every submarine as well as every big Dreadnaught.*

## Free Watch Book! Send the Coupon!

Learn the inside facts about watch prices, and the many superior points of the Burlington. See illustrations in full color of the newest cases that are yours to choose from. Just send coupon or letter or a postcard. Get this offer while it lasts.

**Burlington Watch Co.**  
19th St. and Marshall Blvd. — Dept. 1194  
Chicago, Ill.

**Burlington Watch Co.**  
19th St. and Marshall Blvd.  
Dept. 1194 Chicago, Illinois  
Please send me (without obligations and prepaid) your free book on watches with full explanation of your cash or \$2.50 a month offer on the Burlington Watch.

Name .....

Address .....

Please Mention Popular Mechanics





### Features of This Visible 5

Include—Ball bearing throughout. Typewriter segment shift. Rigid carriage. Automatic ribbon adjustment. Flexible paper feed. Lightening escapement. Elastic key touch. Inbuilt tabulator and biller. Marginal release key. Automatic paper fingers.

### Save \$36—Easy Payments—30 Days' Trial

You are the sole judge of the merits of this Model 5. Write on it 30 days. Return it at our expense if you are not convinced of its superiority. Small monthly payments and a saving of \$36. This we guarantee. You assume no obligation by sending this coupon now for our introductory offer.

### Larkin Co. Desk TYP-417, Buffalo, N. Y.

Please tell me about the Model 5 L. C. Smith Typewriter and quote the "special" Introductory Factory-to-Family price.

Name.....

Address.....

# From 100 to 5000

## Used by America's Great Institutions

Doesn't this tell a story of great superiority? Do you think for one moment that the United States Government would use 5000 Model 5 L. C. Smith Visible Typewriters unless they were the peer of many other Typewriters that could be bought for less money? Uncle Sam is looking for service rather than the immediate saving of a few dollars. Scores of this country's great institutions use this same Model 5. They demand a Typewriter that will give the longest maximum service for the smallest upkeep cost. Evidently the Model 5 demonstrates that it is such a Typewriter, otherwise would it be so widely used?

### 500 Visible 5's Used in Our Offices

We ourselves are well acquainted with the value of this Model 5 as a dependable business Typewriter, one that stands up under constant, everyday usage. On our batteries of Model 5's we write more than 5000 letters daily in serving our two million customers. We have used this Typewriter for years. Therefore we offer you a Typewriter which we know by long service test to be a machine that will not disappoint you.

### Get the Introductory Price On Model 5 L. C. Smith Typewriters

This Typewriter makes friends. One sold leads to others sold in the same community, for our offer on this genuine factory-rebuilt Model 5 is admittedly the surprise-Typewriter offer of the season. So we are naming a "special" Introductory Factory-to-Family price for the purpose of placing a great number of Model 5's into new communities. We depend on these Typewriters to spread the fame of this Typewriter and of the benefits gotten from Larkin Factory-to-Family dealing. You will do well to send the coupon now for the details.

### 100 New Model 5's Made Each Day

At times the manufacturers are hard pressed to meet the demand for new Model 5's although their output totals 100 or more of this model daily. We offer you therefore a Typewriter in great demand and not a discarded model. You'll be agreeably surprised the day you get the details of our liberal offer. The coupon awaits your name. Send it now.

**SPECIAL—Model 2's at \$45.30**



**MONEY IN MUSHROOMS**

**FREE BIG BOOKLET TELLING HOW TO GROW MUSHROOMS**

at home all the year. Big profits. Take advantage of this wonderful opportunity to become independent. Write Nat'l Spawn Co., Dept. 12, Boston, Mass.



**HERE YOU ARE, BOYS** A medallion pin of Foxy Grandpa. Everyone will notice it on the lapel of your coat and try to get a closer look at it. All you have to do is press the bulb.—Foxy Grandpa will finish the job by squirting a fine stream of water over the inquisitive one. Will squirt 20 feet. Greatest joke out. Order one today and fool your friends. Price 15c. Foxy Grandpa and Hooligan both for 25c. 5 for 50c or 1 doz. for \$1.00. A beautiful fountain pen free with every \$1.00 order.

**AMERICAN SUPPLY CO., ST. PAUL, MINN.**



### "Expanding Cuff Buttons"

Permit cuffs to be raised in a jiffy without unbuttoning. They spread two inches. Cuffs positively stay where you place them upon forearm. Lower cuffs, they close automatically. Neat—Durable and Guaranteed. Great shirt and laundry saver. Endorsed by 100,000 enthusiastic wearers. A real necessity that appeals to all. We want Live District Representatives and Sideline Salesmen everywhere.

Price 50c, \$1, \$1.50 per pair. Satisfaction Guaranteed.

FLEXY CUFF LINKS MFG. CO., Dept. P. N., Sheboygan, Wisconsin.

**Runs on Alcohol**

**Kerosene, Gasoline, or Gas**

No electricity, wires or springs. Convenient. Much cheaper to operate than other fans. Roller bearing. Reliable. Brings genuine comfort and satisfaction. Ideal for the sick room. Fourth season. A proved success. The Wonder Fan. Model A, 12" blades, \$16.50. Model B, 21" blades, \$22.50. Cash with order only. F. O. B. Chicago.

**Lake Breeze Motor, 548 W. Monroe St., Chicago**

**ETNA-IZE** Protect yourself and your family in case of sickness or accident. \$50 a week, and as high as \$15,000 for death. Write for particulars.

**ETNA LIFE INSURANCE COMPANY**

Drawer 1341 Dept. PM. 4-17 Hartford, Conn.

**Be the First in Your Club**

School, City or Town, to wear this pure, all wool sweater, double collar and cuffs. Your choice in colors. This jersey was selected by 10,000 of my customers for last season. Your chum will recommend it. Send for my big illustrated catalogue. Write me and learn my offer for your club's order. Popular Prices. Best Grade Sporting Goods—Baseball, Basketball, Tennis, Golf, Football, etc.

**WRITE ME NOW.**

**JACK SHANNON CO., Dept. 46, 54 E. Monroe St., Chicago**

**Hand Forged Razor Steel Blades. No. 57**

**This \$2 KNIFE 83¢**

**DIRECT AT FACTORY PRICE**

Handy shaped blade makes this knife best for mechanics, sportsmen and farmers; light but strong; resharpened easily. Stag handle, German silver finish; blades file tested, hand forged from razor steel and warrant. ed. Sample 83c, 3 for \$2 postpaid. (Checklist sent \$2 each.)

Send for our 80 Page List and "How to use a Razor" **FREE**

**MAHER & GROSH CO., 106 A. St., Toledo, Ohio.**



## One of the World's Greatest Inventions

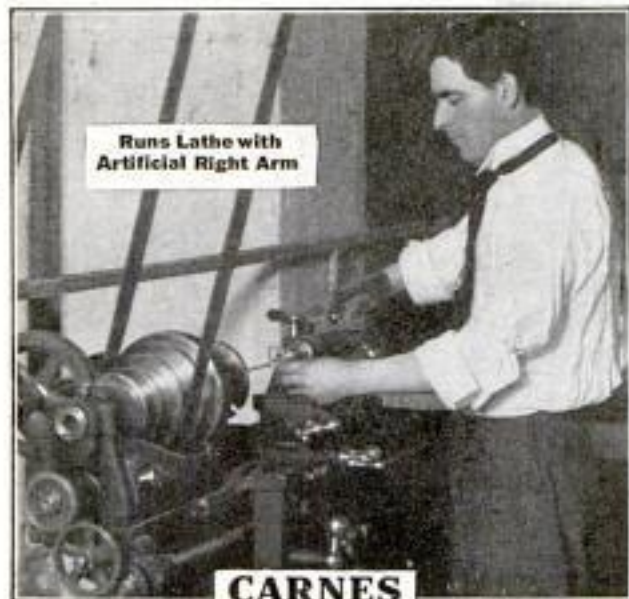

**CARNES**

## Artificial Arm

The only artificial arm and hand that you can really do so many things with and without assistance of natural hand. The only artificial arm with full finger motion hand, turning and bending wrist and bending elbow. Comfortable to wear, Easy to operate, Perfect fit guaranteed. Recommended by wearers the world over. Endorsed by surgeons. Awarded Gold Medal, San Francisco, San Diego, London, Eng. Write for illustrated catalog B. 25 of this wonderful invention.

**CARNES ARTIFICIAL LIMB CO.**

31 Carnes Bldg., 904-906 E. 12th St., Kansas City, Mo.

**NO MONEY DOWN** **2 CREDIT \$2 A MONTH**  
**ALL \$2 MONTH**  
 Buy a Genuine 15-17-19-21-Jewel  
 Elgin, Waltham, Howard, or any watch  
 you want, rock bottom prices, send for  
**FREE CATALOG**  
 95 pages of wonderful values, diamonds,  
 watches, rings, jewelry, up-to-date de-  
 signs. Buy the Ware Way, you will never  
 miss the money. Get posted, write today.  
**ALFRED WARE CO., Dept. 688, St. Louis, Mo.**

**FIBRE LEGS**  
**ARMS**  
**4-LB. FIBRE LEGS—ON EASY TERMS**  
 Orthopedic braces for all deformities. Send for booklet.  
**MINNEAPOLIS ARTIFICIAL LIMB CO., 636 Deen Bldg., MINNEAPOLIS, MINN.**

## NO MORE BALD HEADS



**W**HEN our VACUUM CAP is used a few minutes daily. We accept no pay until you have tried the Cap 60 days and are satisfied. The Vacuum Cap is an appliance that draws the blood to the Hair Roots and starts a new healthy crop of hair. It stops Dandruff, stops the hair from falling out.

Bought by Doctors and men who know that it is the only reasonable HAIR GROWER known to science. No Drugs Used. Write for application blank, testimonials, and booklet on "HAIR," sent sealed in plain envelope, FREE.

**THE MODERN VACUUM CAP CO.**

0. 559 BARCLAY, DENVER, COLO.

Please mention Popular Mechanics



## Here's Health

—vim, vigor, vitality! The keen, vivid relish of youth for work and pleasure! **Snap, ginger, punch in every thought and action!** The joy of glorious health, strength, power, life—**yours through vibration.**

Wake up that sluggish circulation! Send the rich, red blood leaping along through every vein and artery! Tune up those jangled nerves! Stir up those sluggish organs! Flood your whole body with **health!** Don't be satisfied with mere existence! **Begin to live!**

## Arnold Vibrator

Try this wonderful machine yourself. Test it on your own body. Notice the difference after the very first treatment. See how pleasant and easy it is to use—how marvelous the results. And don't forget that these results are permanent because vibration gets right at the cause of things—goes to the very root of the trouble. Aches and pains vanish like magic. You don't need to take anybody's word for these things—you can find out for yourself.

## 10 Days' Trial Free

Get the facts about our generous free trial offer. Learn how you may get these things yourself **at our risk,** and if you are familiar with the prices asked for ordinary vibrators you will be amazed to find how much less it costs to own the genuine guaranteed Arnold Vibrator. When there is so much at stake why risk buying an imitation unknown machine? Insist on the Arnold. Ask for it by name.



## 80-Page Book Free

Your name and address on the coupon or a postal or letter brings you valuable 80-page book on Vibration free and full particulars of our special offer.

**ARNOLD ELECTRIC CO., 1442 W. 12th St., Racine, Wis.**

## Mail Coupon For FREE Book

**ARNOLD ELECTRIC CO., 1442 W. 12th St., Racine, Wis.**

Please send me your big illustrated Book and 10 days' TRIAL REDUCED PRICE OFFER, all free.

Name .....

Street .....

City..... State.....





# Let Me Keep Your Ice for 30 Days

## I'll Save You 1/2 of It

Let me put a White Frost Refrigerator in your home on 30 days' trial. I'll pay the freight. Write and get my catalog. I sell the only round, white enameled refrigerator on earth. Made of zinc coated steel, soldered air-tight. Lasts a lifetime. Insulated with granulated cork. Noiseless doors and covers. Revolving shelves—nickel trimmings. Move-easy casters. Improved crystal glass water cooler with removable top. Write for catalog and factory-to-you price. Cash or easy payments. Yours truly, H. L. SMITH, Pres.

**White Frost Refrigerator**  
SANITARY

White Frost Refrigerator Co., 479 N. Mechanic St., Jackson, Mich.



## Dress Up!



Your socks fit like a glove when you wear the

# Boston Garter

It prevents unsightly wrinkles and keeps the ankles trim all day. Get the "Boston" and enjoy garter-luxury. It embodies the finest materials and workmanship—gives the most comfortable security—the longest service and costs no more.

At stores everywhere, 25c—35c—50c.  
GEORGE FROST COMPANY, MAKERS, BOSTON



Design No. 524  
By Jud Yoho.  
Estimated Cost \$2800.

## ALL ABOUT BUNGALOWS

### BUNGALOW BOOK, 1916 De Luxe Edition

Contains the cream of 1000 practical and distinctive bungalows actually built for \$400 to \$4000, suited to any climate, with photos of exterior and interior views, plans, size of rooms, cost, etc. Also valuable suggestions on bungalow building written by an expert. The largest exclusive Bungalow Book published. 112 pages. Price, \$1.00 Postpaid

Worth many times its cost to any prospective builder. A smaller edition of same, only 50 cents. Send check, money-order or stamps. Money back if not satisfactory.

JUD YOHO, The Bungalow Craftsman, 67 Bungalow Bldg., SEATTLE, WASH.

## THIS BUNGALOW \$900 CAN BE BUILT FOR



This and many others in my new book, Building Plans for Modern Homes, will save you hundreds of dollars. One of the most complete and comprehensive books of plans ever published by any architect. Fifth edition just off the press. Two hundred and fifty floor plans and photographs of bungalows, etc., costing from \$200 up; gives sizes and cost to build. Sent postpaid for \$1.00

FREDERICK H. GOWING  
ARCHITECT  
18 Tremont St., BOSTON, MASS.

## BUY PLUMBING and HEATING SUPPLIES



at WHOLESALE Will Save You 30%

Don't pay retail prices. Full stock on hand for prompt shipment. Send for free catalog.

B. P. KAROL, 800-802 South Kedzie Ave., CHICAGO

# Shingled Houses

are warmer in winter and cooler in summer than tiled, slated, clap-boarded, or gummed-paper houses. They cover the surface with three insulating layers and non-conducting air-spaces, and no other finish does this. They are also much more picturesque and attractive, and they admit of far more varied and beautiful coloring than any other finish.

# Cabot's Creosote Stains

color them in beautiful tones of moss-green, bark-brown, silver-gray, etc., and the creosote thoroughly preserves the wood and makes it less inflammable.

You can get Cabot's Stains all over the country. Send for stained wood samples and name of nearest agent.

SAMUEL CABOT, Inc., Masfg. Chemists, 18 Batterymarch St., Boston, Mass.  
24 West Kinzie Street, CHICAGO 523 Market Street, SAN FRANCISCO



Stained with Cabot's Creosote Stains  
C. M. Hart, Architect, Bay Shore, N. Y.



# South Bend

*The Watch with the Purple Ribbon*

## Accuracy

is the first thing I require of a watch; but, to be up to my standard, it must also be trim and stylish—a watch I may be proud to show.

That's why I bought a South Bend. And the Purple Ribbon Timepiece is certainly living up to its reputation. The model I am carrying is the new 19-jewel *Extra-Thin* watch at \$27.50. For, while I want accuracy, service and beauty, I don't want to pay fancy prices for them. My jeweler assured me that in no other watch could I have obtained such value for the price and my experience confirms his statement.

\* \* \*

Other models if you wish them at \$16 to \$125. See YOUR jeweler and send for our interesting booklet, "The Making of a Marvelous Mechanism."

**SOUTH BEND WATCH CO.**  
24 Studebaker St., South Bend, Ind.



Please Mention Popular Mechanics

Copyrighted material





**Answer  
the  
Call  
of the  
Open  
Road**

—Learn to know and enjoy the sights and sounds and scents of nature in all her moods. Put yourself in a position to go from where you are to where you want to be *any time*. This will be your privilege when you own a

## Harley-Davidson

for more than 15 years the "Master Motorcycle" and this year with its increased power, speed and flexibility, better than ever.

You will admire the new military olive drab finish of the "Master I7," you will be delighted with its quick "get-a-way," its smooth power on low speeds; its all

around performance efficiency. Decide now to join the enthusiastic throng of Harley-Davidson motorcyclists—the great brotherhood of the big outdoors.

*Let your Harley-Davidson dealer demonstrate.  
Write for Catalog.*

### Harley-Davidson Motor Company

488 "B" ST., MILWAUKEE, WIS.

Producers of High-Grade Motorcycles for  
More Than 15 Years

Also Manu-  
facturers of  
Harley-  
Davidson  
Bicycles

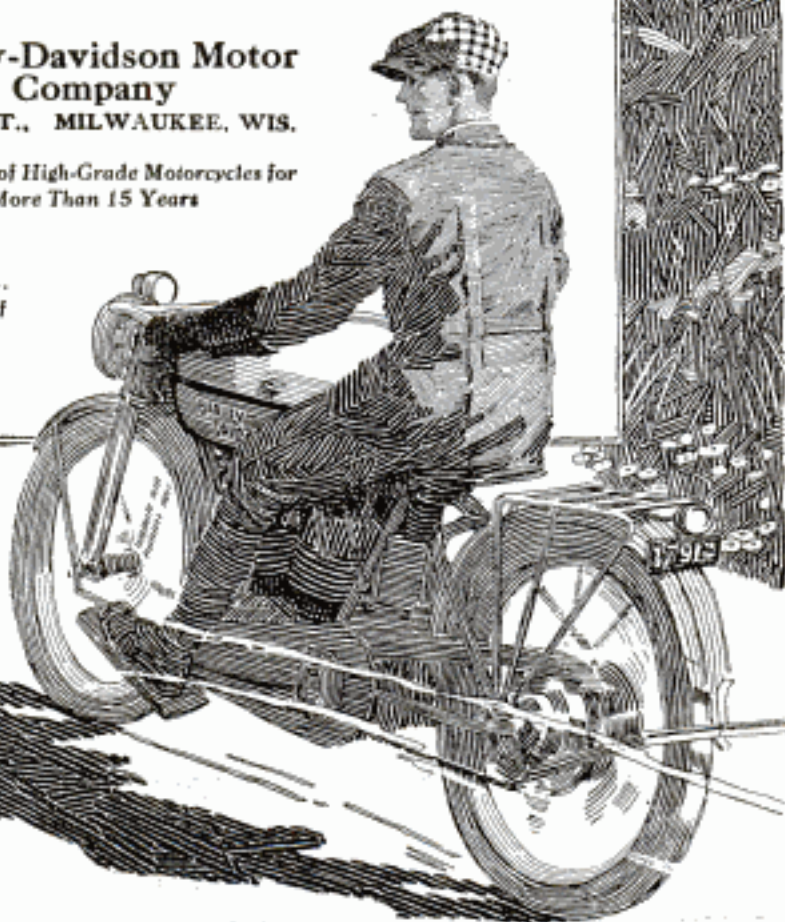

*Please Mention Popular Mechanics*

Copyrighted material



## DIAMOND PRICES SHATTERED

GENUINE  
PERFECT CUT  
BLUE WHITE  
DIAMOND \$2.50  
A MONTH

**LOOK!** No Security—No Red

Tape—Buy "Direct"—Save from  $\frac{1}{2}$  to  $\frac{3}{4}$

### SEE DIAMOND FIRST

Sent for Inspection Without One Penny Down  
Examine diamond at your leisure. Wear it 30 Days FREE.  
Send it back if not satisfactory. You're not out a penny.

### FREE DIAMOND BOOK

Send for it today

READ the TRUTH about diamonds. READ how to judge a fine diamond. READ about our splendid BUY BACK plan at full value and EASY PAYMENTS to suit you.

### EVERY DIAMOND GUARANTEED

You risk absolutely nothing. Our ironclad, money-back contract protects you in every respect. Simply write today for FREE DIAMOND BOOKLET, select the diamond you want and it will be sent to you, all charges prepaid. Examine the diamond, compare it, and if you do not find the diamond we send you to be the greatest value you have ever seen, simply return it at our expense.

### SAVE FROM 25 to 50%

Don't pay three or four dealer's profits. We sell "DIRECT FROM DIAMOND CUTTER TO YOU" at practically EUROPEAN PRICES.

Write today, your name on a postal brings the FREE DIAMOND BOOKLET

Santa Fe Watch Co., Dept. 463, Topeka, Kans.

# One Hour



Only 60 minutes!

That is all the time it takes to do a good-sized washing, Madam, if you have a Thor Electric Home

Washing Machine. All the rest of the day to yourself. Time to read—to make calls—to receive your friends—to go any

place you wish or do anything you want. Washday turned into play day by the Thor. No hand redness.

## Not a Rub!

No rubbing at all. You don't even have a wash board. Daintiest linens, finest laces, sheerest garments all made absolutely clean. No wear on even the most delicate fabric. The Thor washes and wrings better than a wash-woman and at a cost of only two cents an hour.

# The Thor

## Electric Washing Machine

The machine which washes your clothes just by touching a button. Wrings them, too. Makes them white as snow—makes them last six times as long. Find out about this wonder working machine and about the special offer we are making. You owe this to yourself. And, madam, this is something you should not put off. Your Thor dealer will sell to you on credit. And, if you have a Delco or other electric light system of your own we will furnish special motor to run the Thor.

### Mail the Coupon

Just mail this coupon and get our big 48-page book. And all about the special offer. We will make you this offer no matter where you live. Tells how you can positively and actually save yourself from the drudgery of washday. There is no doubt about it. Mail the coupon today—NOW.

### Hurley Machine Co.

Dept. 1194 - 29 So. Clinton St., Chicago  
147 W. 42nd St., NEW YORK  
413 Yonge Street, TORONTO

You may send me your big 48-page book. Also name of nearest Thor dealer.

### Hurley Machine Co.

Dept. 1194 - 29 So. Clinton St., Chicago  
147 W. 42nd St., NEW YORK - 413 Yonge Street, TORONTO

Also of Thor Electric Ironing Machines and Vacuum Cleaners.

Name.....

Address.....

Name of your Electric Dealer.....

Please Mention Popular Mechanics

**ELECTRIC HOME, FARM, PICTURE THEATRE, HOTEL & STORE LIGHT PLANTS.**  
Auto Starter Storage Batteries & Chargers. All Cars. Ask Price.  
Dynamo, Power Motors, Belts, Engines, Railways, Permanent & Traveling Motion Picture Machines.  
**OHIO ELECTRIC WORKS, CLEVELAND, O.**

### SMALL ENGINES

Perfect Gasoline Engines— $\frac{1}{2}$ , 1 and 1 $\frac{1}{2}$  h. p.—for Farm and Shop use. Price \$19.50 and up. Also

### WASHING MACHINES

We ship on trial. Send for Booklet and Special Offer.

SIEVERKROPP ENGINE CO.  
1224 19th St., RACINE, WIS.

### STARTER for FORD CARS

## Deafness Is Misery

I know because I was Deaf and had Head Noises for over 30 years. My invisible Anti-septic Ear Drums restored my hearing and stopped Head Noises, and will do it for you. They are Tiny Megaphones. Cannot be seen when worn. Easy to put in, easy to take out. Are "Unseen Comforts." Inexpensive. Write for Booklet and my sworn statement of how I recovered my hearing.

A. O. Leonard, Suite 226, 150 5th Ave., N. Y. City

## KEROSENE

\$30 a Week  
EASY

Men and Women Wanted to Sell  
**PERFECTO Kerosene Irons**

No experience necessary. Big profits selling this wonderful self-heating satisfaction guaranteed iron. Easy to operate and demonstrate. Sells itself. Use Kerosene (Coal Oil) or Gasoline with same satisfactory results. Absolutely safe, no smoke or odor. Get facts in detail and let us tell you how to obtain Free Sample and start you in a big paying business. Sample case FREE to Agents.

PERFECTO SAD IRON FACTORY  
Dept. P, 126 So. Clinton St., CHICAGO, ILL.





# Get This ALUMINUM SET FREE

OR  
CHOICE OF OTHER  
USEFUL PREMIUMS WITH YOUR  
1917 IMPERIAL RANGE

A special offer with every Imperial Range—elegant Pure Aluminum Cooking and Roasting Combination. Seamless and Sanitary—4 pieces. Makes 12 useful kitchen utensils, as illustrated.

**30 DAYS FREE HOME TEST  
PAY US NO MONEY IN ADVANCE**

We take all the risk. Choose any range you want from over a hundred styles. Try it, test it for 30 days before you decide to keep it. Send it back if not satisfied.

**FACTORY PRICES—WE PAY FREIGHT  
TO YOUR HOME TOWN**

Choose Your Own Terms if you decide to keep your Imperial—Cash or Credit. By dealing direct with our factory you pay manufacturer's prices only, and no freight. You easily

**SAVE \$10 TO \$20** By our new 20th Century methods. 100,000 Imperials now in use. Housewives delighted. IMPERIAL KNIVES are made of highest grade materials. 95% DAY'S GUARANTEE. Will not warp or crack. Have the marvelous even baking Old Dutch Oven modernized—a STONE OVEN BOTTOM—which holds heat like a Fireless Cooker. Great fuel-savers and new kind of PERFECT ODOOR HOOD. Test all these without risk in your home before buying any range. Write at once for

**BIG FREE CATALOG** with "No-Money-Risk" Trial offer. Also valuable Premiums and complete description of Imperial Ranges and their new 1917 improvements—You need this book to intelligently select a range. Write today. A letter or postal will do.

**THE IMPERIAL  
STEEL RANGE  
COMPANY**  
869 Detroit Ave.  
CLEVELAND, O.

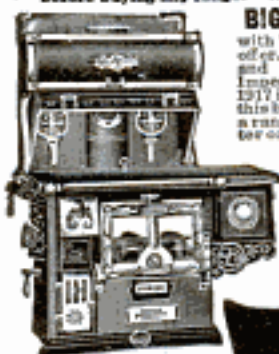

**300 Candle Power of Light  
at a Cost of 1-8c Per Hour  
Burns Kerosene or Gasoline**

This lamp generates and burns its own gas from ordinary kerosene. "QUICKLIT" gasoline lamps can be lit with an ordinary match like city gas.

Write today for illustrated catalog of our complete line of kerosene and gasoline lamps, lanterns. **Agents Wanted**

**The Nagel-Chase Mfg. Co.**  
176 East Erie St., Chicago



## Let Me Quote You a Special Price On My *Rapid* FIRELESS COOKER



Cook every meal on it. If you are not satisfied and delighted I will refund every cent. Get my

**Special Low Factory Price**

direct to you. Cooker is aluminum lined throughout. Full set of famous "Wear Ever" aluminum cooking utensils comes with it. Ask for free book of reliable recipes.

**WILLIAM CAMPBELL CO.**  
Dept. 64 DETROIT, MICH.



## The BEST LIGHT

Positively the cheapest and strongest light on earth. Used in every country on the globe. Makes and burns its own gas. Casts no shadows. Clean and odorless. Absolutely safe. Over 200 styles. 100 to 2000 Candle Power. Fully Guaranteed. Write for catalog. **AGENTS WANTED EVERYWHERE.**

**THE BEST LIGHT CO., 324 E. 5th St., CANTON, O.**

## BIG CHANCE FOR AGENTS



**You can earn BIG MONEY**

selling the most complete line of guaranteed transparent handle Knives and Razors with Photo, Name and Lodge Emblem—also full line of cutlery. Write today for catalogue and terms. **Golden Rule Cutlery Co., 212 N. Sheldon St., Dept. 358, Chicago, Ill.**

## EVEREADY

**SAFETY LIGHTS**

American Ever Ready Works  
of National Carbon Co.  
Long Island City, New York



## ACORN UNI-LITE

Turns night into day. 300 candle power. Carry as a lantern; use anywhere as a lamp. Weather proof. For house, barn, garage, camp and around the farm. Write for big, free offer. Special opportunity to farmers, stockmen and motorists. Agents make big money.

**WRITE TONIGHT for new 1916-1917 offer.**  
**ACORN BRASS MFG. CO., 823 Uni-Lite Bldg., Chicago**

# 1 Safety Razor Blade does the work of 4

When magnified, the cutting edge of a razor blade looks like a saw. After shaving, no matter how well you wipe the blade, moisture still clings between the microscopic teeth. As a consequence, very tiny particles of rust form and the blade becomes dull and "pulls". Put 3-in-One on your blade before and after shaving. Then rust can't possibly form. A little 3-in-One on your strop keeps it soft and makes the razor "cling" when stropping.

Try it and see. Your blades will last twice as long and shave cleaner. Send for our booklet "A Razor Saver" and **FREE** generous sample of 3-in-One Oil.

**Three-in-One Oil Co., 42CNR., Broadway, N. Y.**

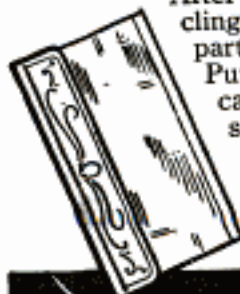



# TYPEWRITERS



\$10  
To  
\$50

All Makes Rebuilt by the  
Famous "Young Process"

Look Like New  
Good As New

Don't pay high, exorbitant Prices. Investigate. Our New Illustrated Catalog shows you what we have in all makes of Rebuilt Typewriters, with Prices marked in plain figures. It costs you nothing to look into this Saving Opportunity. If you are in the market for a Typewriter, it will surely mean an economical investment for you.

**SEND FOR CATALOG TODAY**

Our immense business and equipment enables us to sell one machine or a hundred for quick delivery. All Makes rented or sold at a sharp reduction; and rentals apply on purchase price. Prompt, courteous service. Address—

**YOUNG TYPEWRITER CO.**

Dept. 74 62 W. Madison St. CHICAGO



## Superb Idea

**In Setting.** Diamonds arranged to show their beauty to the utmost. The setting which has always been most admired. The diamonds are set so closely and skillfully that the facets shape up like one huge diamond. Now offered at net prices, direct to you. No jobbers—no retailers to pay. Send for our *Diamond Book*, listing exquisite

## Clusters

Pins and rings set in solid platinum. Every stone a brilliant of superb quality. Splendid opportunity now to buy these wonderful, extra brilliant cluster diamonds. Full information free. Send the coupon today for *Diamond Book*. Do it now.

## Diamonds

Rings in all styles of settings, Tiffany, Belcher, etc., LaVallieres, Brooches and other diamond jewelry. Every diamond a superb gem. Selected by a famous expert. Perfectly cut to give a maximum brilliancy. Richly mounted in solid gold and platinum settings.

**Free Examination** Not a cent down—before you accept it. We want you to compare these diamonds with others at twice their price. Write today.

**\$250 Monthly** Yes, only \$2.50 a month will make you the wearer of a beautiful diamond.

Other terms, \$3.50, \$4.50 and up— and middlemen's profits cut out.

# Write

For Net Price List and  
Diamond Book

Shows the different  
gems, styles of mount-  
ings and gives our  
best net prices with  
terms of payment.  
Do it now—today.

**BURLINGTON  
WATCH CO.**  
Dept. 1194  
Chicago, Ill.

**Burlington  
Watch Co.**  
Dept. 1194  
Chicago - Illinois

Without obligations  
send me your net price  
offer on diamonds; also  
send *Diamond Book*.

Name .....

Address .....

## Relief to Ruptured People

Any appliance is a truss. Ruptured people must wear a support. Our New Sponge Rubber Pad (pat'd) is velvety, soft to the skin, pliable, cannot slip, extremely comfortable, adapts itself to ruptured parts with less pressure, is sanitary, long lived. Massages and strengthens muscles, allows blood circulation and produces many cures.

**Scrotal Pad Needs No Leg Strap**

Our New Akron Sponge Rubber Scrotal Pad (pat'd) holds 8 out of 19 cases of scrotal hernia perfectly without strap between the legs.

**Free Sample Pad** A Sample Akron Sponge Rubber Truss Pad will be sent absolutely FREE upon request, also booklet "Relief to Truss Users." It's full of help. Ask your dealer, or write us.

**THE AKRON TRUSS CO.** 64 TRUSS BLDG. Akron, Ohio

39 STYLES OF TRUSSES  
23 DIFFERENT PADS

PAINTED MAR. 17 1904

## INDOOR CLOSET

More Comfortable, Healthful  
and Convenient than the Out-Door Closet

Eliminates the out-door closet and open vault. They are breeding places for germs. Have a warm, sanitary, odorless toilet right in your house. No going out in cold weather. A boon to invalids. Endorsed by State Boards of Health.

W. M. Davis writes: "Your indoor closet is giving absolute satisfaction. It is certainly the thing for a home without sewerage."

**Absolutely Odorless  
Put It Anywhere in the House**

The germs are killed by a chemical process in water in the container, which you empty once a month. **Absolutely no odor.** No more trouble to empty than dishwater. Closet absolutely gas-tight. Write for full descriptions and price.

**Agents Wanted—Big Profits** Wonderful opportunities in every town, village and in the country. Best season just at hand. Every home is a good prospect. Sell eight out of every ten you call on. Ernest Kidwell writes, "Have ten orders." G. A. Ozman says: "Ship at once twenty closets and fifteen washstands. Sold them all in one community." Sell (sell). Everybody hates the outside closet. Everybody wants a Ro-San Indoor Closet. Write quick for territory and full particulars.

**ROWE SANITARY MFG. CO.,** 405 Sixth St., Detroit, Mich.

Ask about the Ro-San Washstand—Hot and Cold  
Running Water Without Plumbing





## Meeting Every Requirement

For all practical measurements, no matter what the job, whether you are a machinist, carpenter, electrician or other mechanic, you will find that from the complete line of 2100 styles and sizes of

TRADE MARK  
**Starrett**  
REG. U.S. PAT. OFF.  
**Tools**

you can select exactly the right measuring instruments for your particular requirements. With these fine instruments, you can lay out, check up, and inspect work faster and more accurately.

## Starrett Calipers

We manufacture a complete line of inside, outside, and hermaphrodite calipers which have just the right shape and balance, the correct method of adjustment, hardness of contacts, and give long, satisfactory service.

Send for 342-page catalog No. 21AP which describes rules, squares, levels, calipers, micrometers, vernier calipers, gages, and hack saws. 42-641

**The L. S. Starrett Co.**  
The World's Greatest Tool Makers  
Athol, Mass.

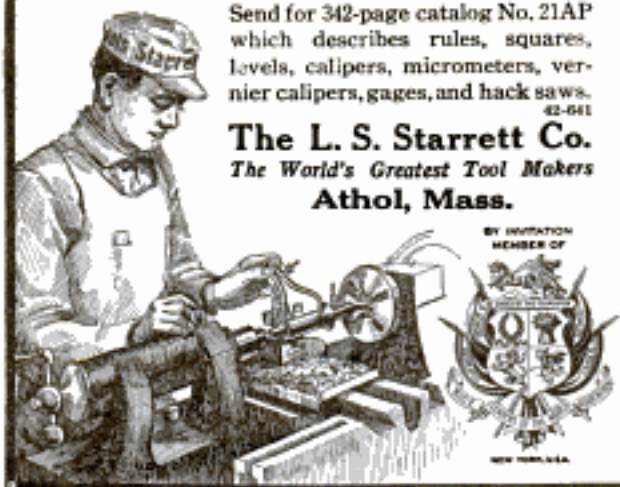

Please Mention Popular Mechanics

## "IDEAL" Lawn Mower Grinder

### Big Money-Maker

Many of our customers  
make \$300 in one season.  
YOU CAN DO AS WELL.

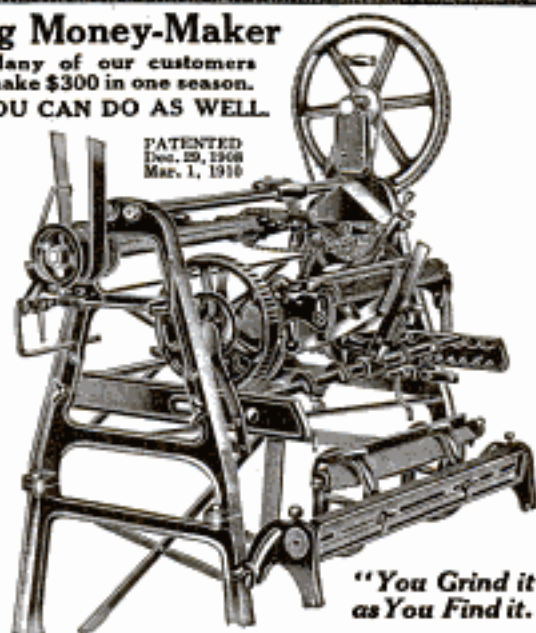

PATENTED  
Dec. 29, 1908  
Mar. 1, 1910

"You Grind it  
as You Find it."

Grinds all makes of Mowers perfectly in 15 minutes without removing wheels, ratchets or reel knife, BETTER, QUICKER and EASIER than it can be done by hand. Has perfect Skate Sharpener Attachment. Run by hand or power. Nearly 10,000 in use. Price, only \$50. Sold on easy-payment terms. Also makers of the "Peerless" Horse Mower Grinder.

WRITE TODAY for catalog and full information

THE ROOT-HEATH MFG. CO., Plymouth, Ohio

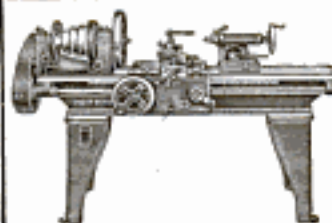

## South Bend Lathes

For the Machine and Repair Shop

How to Run a Lathe  
A 50-cent book for 10 cents.  
Postpaid, stamps accepted.

Straight or Gap Beds. Send for free  
catalog giving prices on entire line.  
SOUTH BEND LATHE WORKS  
423 Madison St., South Bend, Ind.

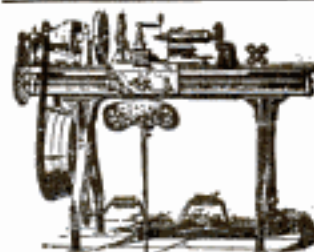

## LATHES

9 to 18-inch Swing

List price \$75 and up according  
to size. When ready to buy send  
for Lathe Catalog and prices.

**W. F. & John Barnes Co.**  
100 Ruby Street, ROCKFORD, ILL.



## A Constant Water Supply For Your Farm Home

Don't depend on a windmill or the  
back-breaking hand pump to fill your  
water tank. It's more reliable and eco-  
nomical to install a

## RIFE RAM

and be sure of a constant supply of fresh water,  
without fuel or attention. The Rife Ram operates  
by the flow of any stream having a fall  
of 3 feet or more and a supply of 3 gal-  
lons or more per minute. Will main-  
tain air pressure system. Simple to  
install. Over 11,000 in use. Satis-  
faction guaranteed.

Write today for catalog and free estimate

**RIFE ENGINE CO.**  
3131 Trinity Building NEW YORK





Do you know that  
there are more  
"Sebastian"  
Lathes used in Ga-  
rage and General  
Repair Shops than  
any other make?

The Sebastian Lathe Co. 107 Culvert Street  
Cincinnati, Ohio, U. S. A.

## Make Water Pressure Work and Save Your Back



The Divine Red Devil Water Motor built with bucket-wheels like big water wheels—easy to install, has nothing to get out of order and does work at very low cost.

**4 in. Motor Complete, \$3.** Including Emery, Buffing Wheel and Pulley for household use. With pulley for sewing-machine only \$2.50.

**6 in. Motor with Pulley, \$5.** For Mechanics, Tradesmen, Doctors and Dentists and the Home. Will run washing machine easy. Guaranteed to give satisfaction or money back. Order direct NOW or ask for descriptive Booklet FREE. Give size of pipe and water pressure, and work to be done.

DIVINE WATER MOTOR CO.  
Dept. P., Utica, N. Y.

## WATER SUPPLY

anywhere, in home, yard or barn. Install the Deming air pressure system—compact, dependable, simple—operated by hand, windmill, motor or gasoline engine. Complete, illustrated Bulletin No. M-3 FREE. Write

The DEMING Co., Salem, Ohio

## CRANE VALVES AND FITTINGS

The standard for 61 years

## AGENTS—Make \$100 to \$300



per month easy selling our new Triplicate Sauce Pan. Cooking utensil for 3 different foods on one burner. 400 Specialties—all Whirlwind sellers. Write quick for exclusive territory and large catalogue.

AMERICAN ALUMINUM MFG. CO.  
Div. H-T LEMONT, ILL.

## Portable Cases

For Tool Makers and Machinists

Twelve styles, felt lined drawers, solid brass trimmings, best of material, beautiful finish, low prices, satisfaction guaranteed. Ask for booklet of cases built for service.

THE PILLIOD LUMBER CO.  
SWANTON, OHIO

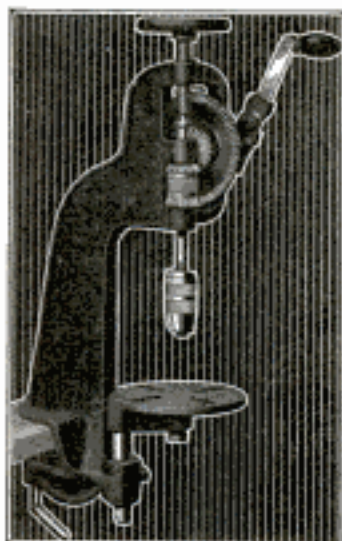

## If You Work in Metal

You can't afford to be without this handy, inexpensive bench drill. Saves you much time and hard labor.

### MILLERS FALLS BENCH DRILL PRESS No. 210

is a hand-feed machine at a moderate price that amply fills all ordinary requirements. Used in many small machine shops.

Speed instantly changeable. Three jaw chuck of Star pattern that centers accurately and will not get out of order.

Nine inch work capacity.

Mechanic's Handbook containing much valuable information never before printed and pocket catalog free on request.

### MILLERS FALLS CO.

"Toolmaker to the Master Mechanic"

MILLERS FALLS, MASS.

New York Office: 28 Warren Street

MILLERS FALLS  
TOOLS

Please Mention Popular Mechanics



## With Automatic Friction and Ratchet Feeds

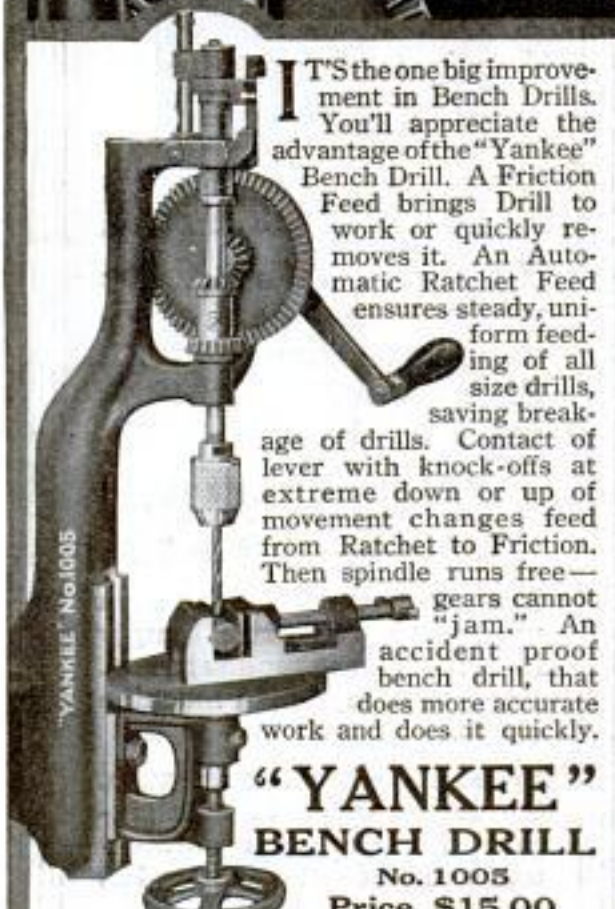

IT'S the one big improvement in Bench Drills. You'll appreciate the advantage of the "Yankee" Bench Drill. A Friction Feed brings Drill to work or quickly removes it. An Automatic Ratchet Feed ensures steady, uniform feeding of all size drills, saving breakage of drills. Contact of lever with knock-offs at extreme down or up of movement changes feed from Ratchet to Friction. Then spindle runs free—gears cannot "jam." An accident proof bench drill, that does more accurate work and does it quickly.

### "YANKEE" BENCH DRILL

No. 1003  
Price, \$15.00

Two Speeds, 3-jaw chuck. Holds drills up to  $\frac{1}{2}$  in., height, 28 inches.

"Yankee" Bench Drill No. 1003—Price, \$9.00. Holds drills up to  $\frac{1}{4}$  in., height 18 $\frac{1}{2}$  in.

"Yankee" Vise No. 990, to hold small work on "Yankee" Bench Drill. Price \$2.00. Used on sides, end or base. Swivel jaws to hold taper work. Jaws open 3 in.

Your dealer can supply you

Write for "The Yankee Tool Book" showing all "Yankee" wood- and metal-boring and screw-driving tools—it's FREE.

NORTH BROS. MFG. CO., Philadelphia

## "YANKEE" TOOLS

Make Better Mechanics



## Stanley "Bed Rock" Planes

These Planes may be adjusted for a wide or narrow throat opening as coarse or fine work is required, without removing the cutter or cap.

Other special and distinctive features are fully described in our "BED ROCK" Plane folder, a copy of which we would like to send you. A postal brings it.

ADDRESS

**STANLEY RULE & LEVEL CO.**  
NEW BRITAIN, CONN. U.S.A.

There was once a man in the financial district whose annual income was \$500,000. He lived at Irvington-on-the-Hudson and had his steam yacht, a palatial affair, on which he came to business daily. This man is now reduced to the necessity of borrowing \$5 now and again from former associates in the street. He prowls about Wall Street, wearing a long and shabby overcoat, much too large and evidently a gift from some former friend. He stole into a certain Wall Street man's office the other

Type \$6 A motor of universal application

### UNIVERSAL ELECTRIC MOTORS

Operating on A.C. or D.C.—110 to 130 Volts

THIS MOTOR 1/16 H.P.—6000 R.P.M. \$6

Being used successfully for grinding, polishing, driving small machinery, sewing machines, fans, spark gaps, electric fountain, check indicators, portable projectors, buzzsaws, electric hair clippers, valve graders, and numerous other appliances.

Complete with Pulley Emery Wheel Buffer "Chucks Cord & Plug"

Write for Catalogue Free

Chicago Electric Sales Co.  
53 W. Jackson Blvd. Chicago, Ill.

### Drilling Wells is a Year Round Business

Drilling Water Wells is a profitable, healthful, year-round business. There are wells all around you to be drilled. Don't you want to get into a money-making business for yourself? Write for particulars.

STAR DRILLING MACHINE CO.  
664 Washington St. AKRON, OHIO

### Crescent Wood Working Machinery

ALWAYS PLEASES

Send for catalogue today, describing hand saws, jointers, saw tables, planers, disk grinders, shapers, planers and matchers, borers, hollow chisel mortisers, variety wood workers, universal wood workers.

The Crescent Machine Co., 93 Columbia St., Leetonia, O.

Please Mention Popular Mechanics



# "Brown & Sharpe Tools Will Help You in Your Work"



## A MACHINE-SHOP TRADITION

There seems to be a tradition in most machine shops that the older man should acquaint his younger shopmates with the importance of Brown & Sharpe Tools in maintaining accuracy in their work. He speaks with experience—mature experience. That he is heeded is proven by the ever increasing demand for Brown & Sharpe Tools.

Send for Catalog 27 Today—It's FREE

**Brown & Sharpe Mfg. Co., Providence, R. I., U. S. A.**

day and sent in to this man a request for a loan of \$5. The money was given, and to prove to a visitor that the man was really the one the banker said he was, he asked for a receipt for the \$5. The name attached to the receipt was one made famous by the father of the borrower. We mention the incident merely as a true story of striking changes that come in the lives of men, who have inherited great names and lost all though one enemy—alcohol.

**"Interlox"** Just the **Rule** For Mechanics, Carpenters, Engineers, etc.  
**MASTER SLIDE RULE** Inexpensive and practical. Takes inside and outside measurements (doors, windows, walls, ceilings, etc.)  
 A strong, rigid rule, trimmed in brass. Made in all lengths from 2 to 8 feet. If dealer hasn't it, send 15c per linear foot (in U. S. A.) and get one by mail. Send for free descriptive circular.  
**Liberal Proposition to Dealers and Agents**  
**DAHL MFG. CO., 51A E. 42d St., NEW YORK**

## THE AWL YOU WANT



Is the genuine MYERS \$1.00 "Lock Stitch" Sewing Awl with the exclusive feature. See thread reel in front of handle under the finger tips. Natural tension. Sews heavy or light material, diamond point, full grooved needles used to protect the thread when sewing.  
**C. A. MYERS COMPANY, 6339 University Ave., Chicago, Illinois**

**Duplicate Keys**  
 For all Pin Tumbler Locks made in one minute with Harrison M.I.P. Key Filing Machine. No misfits. Thousands in use. \$3.50 net. Special diamond-shaped files for angular cut keys, 40c each; 3 for \$1.00. Harrison C.K. Key Clamp duplicates all common keys without a calliper. Price, \$1.00. Parcel post prepaid.  
 Money returned if not satisfactory.  
**HARRISON & CO., 81 New St., New York**



A complete line of appliances for the transmission of Power. Anything from a bolt to a complete mill or factory outfit. Send for catalogue, Largest Manufacturers of Pulleys in the country.  
**W.A. Jones Foundry & Machine Co. CHICAGO**

## Pattern Maker's Tool Chest



Style J—  
 Patternmakers' Special  
 Leatherette covered. Solid mahogany fronts. Extension drawer slides. Felt lined throughout. A real tool chest to meet your particular requirements. Guaranteed.  
 Fifteen other styles and sizes—quartered and plain oak and leatherette covered. Perfectly designed. Guaranteed.  
**Buy This "UNION" TOOL CHEST**  
 and stop the nuisance of lost tools. Has a place for every tool to keep it safe, clean, free from knocks and moisture—you know immediately if one is mislaid or borrowed. Write for our Catalog and Prices. If we have no dealer near you, get our special offer.  
**UNION TOOL CHEST WORKS 23 Railroad St. Rochester, N.Y.**



# Every Builder and Contractor Needs this Level

## 10 Days' Free Trial

We have been makers of transits and levels since 1883 and our instruments are the standard of the world. Prove the superior quality of the Aloe Convertible Level by giving it a 10 days free trial. Use it on your every-day work laying out buildings, leveling up foundations, walls and floors, aligning, shafting walls, piers, etc., for getting angles or levels anywhere.

### Easy Monthly Payments

If you decide to keep it, the instrument will earn its way while you make monthly payments so small that you hardly feel them. Costs no more than to pay all cash. No red tape about it, no embarrassing questions, everything confidential.

### Aloe Convertible Level

is the finest instrument ever offered at anywhere near its price. Permits taking of sights both above and below the horizontal. For taking vertical sights it is provided with a special convertible bracket rigidly and permanently attached to the cross bar. The telescope is fitted with permanent axis which rests in bracket bearings and is held by clasps easily and quickly released.

Aside from being a level, it is a modified transit that permits a much wider range of work than is possible with the ordinary architect's level. With it the man without technical training can obtain the same absolutely accurate results as the expert. Write today for descriptive circular.

**A. S. ALOE CO.,**  
620 OLIVE ST., ST. LOUIS, MO.



WEAR

Trade Mark  
Registered

**B.V.D.** U. S. Patent Office  
and Foreign Countries

UNDERWEAR



## TOOL CASES

For Up-to-Date TOOLMAKERS and MACHINISTS

We carry the finest and most complete line of mechanics' toolcases and tools in the country. We guarantee to please you or refund money. Write for free catalogue.

**J. M. WATERSTON**  
75 Woodward Ave., DETROIT, MICH.

**Lakeside**  
TRADE MARK REGISTERED

**Staple Puller and Wire Splicer**

6 TOOLS in one—staple-puller, double wire cutter, double hammer, wire splicer for any kind of wire, pinners and bolt wrench. Extra heavy and strong. Drop forged steel. Nickel plated. Worth \$1.25. Order by No. 8522230. Shipping wt., 2 1/2 lbs. Satisfaction guaranteed or money back.

85c

This is only one of 1000 wonderful tool bargains in our Tool Book, free. Write for it. Address house nearest you.

**Montgomery Ward & Co.** Dept. A. H. 133  
New York City Chicago Kansas City  
Fl. Worth Portland, Ore.

**SARGENT**

REG. U. S. PAT. OFF.

## All-Steel Block Planes

Light, Unbreakable, Indestructible



These Planes are light, unbreakable and indestructible; owing to their shape and size they may be readily carried in the pocket of a carpenter's apron; they are particularly desirable for use in work on scaffoldings, etc.

Mechanics will find them substantial, serviceable and handy; they are also particularly suitable for amateur work at home.

These Planes and other Planes are fully described in the Sargent Plane Catalogue, a copy of which will be sent free on request.

If your dealer cannot supply you, we will send prepaid, on receipt of the price.

No. 5206, 6-Inch Nickel Plated Plane, \$1.20

**SARGENT & COMPANY**  
49 Water St., New Haven, Conn.

The fisherman is educated by fishing to the best knowledge of nature. He is gentle, lovable, superintelligent and without ego; I am a fisherman myself.

He knows if you don't catch 'em, you don't have to clean 'em—and every loss can thus be thought a gain—because in fishing the great pleasure is the effort, not the result.

So only a true fisherman can enjoy losing money. A fisherman consoles himself by calling the littlest of the catch "just the right eating size," thus bunking

## SAMPLE 75c THE SPEEDY Stitcher



The greatest invention with which the unskilled man can repair leather goods or any heavy material. Needles and thread are inside the handle. FAST SELLER.

**Agents Wanted** Foreign trade solicited. Advertising circulars in different languages. Stewart-Skinner Co., 26 Burns St., Worcester, Mass., U. S. A.

**"RED DEVIL"**  
—That's All You Need to Know About Mechanics' Tools

You can accept that trade-mark with the utmost confidence of your skill that they will work more faithfully for you, stand harder wear and outlast other tools. Made by master mechanics with over 50 years' experience.

To be obtained from dealers, or if not, write us for tool literature.

**SMITH & HEMENWAY CO., Inc.**  
97 Chambers Street NEW YORK CITY

Please Mention Popular Mechanics





# OSTER

## Combination Threading Machines

Threading straight pipe, bent pipe, nipples and bolts, and requiring only a few square feet of floor space, an Oster pays big dividends in money saved over hand-threading. 3 days' work a month pays profit. Catalog free.

**THE OSTER MANUFACTURING CO.**  
 2100 East 61st St.  
 CLEVELAND, OHIO

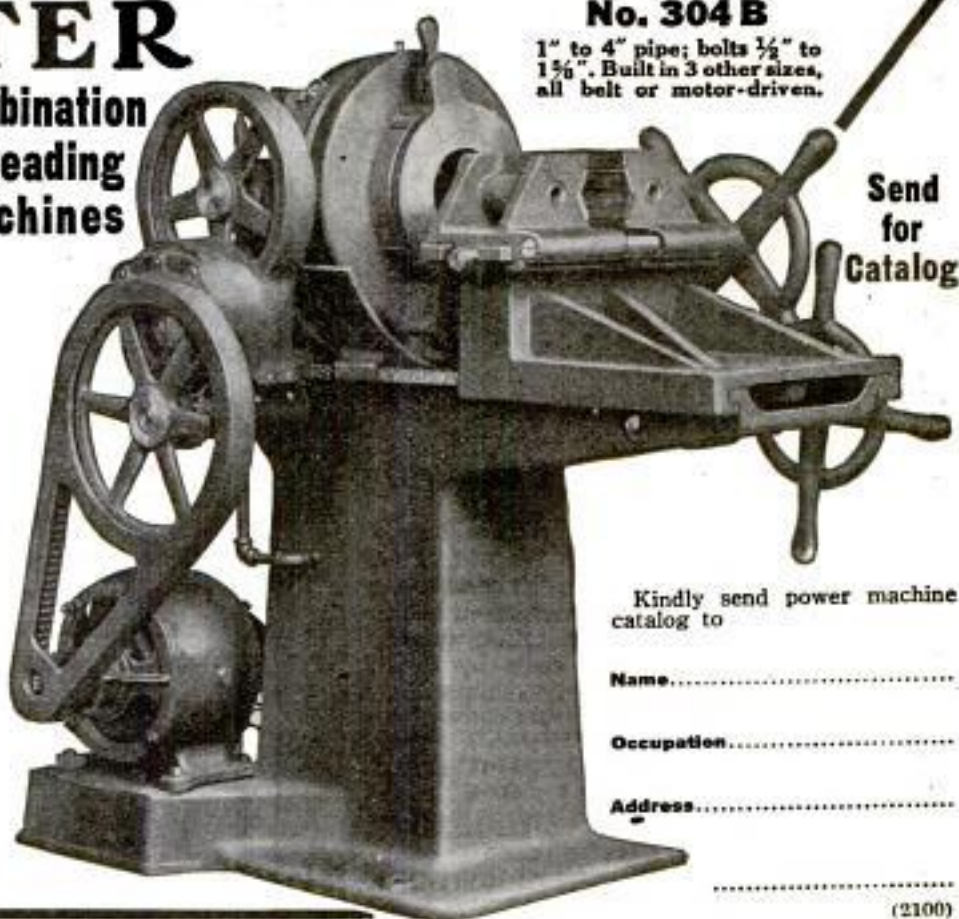

**No. 304 B**  
 1" to 4" pipe; bolts 1/2" to 1 1/2". Built in 3 other sizes, all belt or motor-driven.

Send for Catalog

Kindly send power machine catalog to

Name.....

Occupation.....

Address.....

(2100)

himself often and gladly. Realizing the business world is filled with bait, he bites freely and with a great regularity, hard though he may try to find out first which worm conceals a hook. He gets caught often, but frees himself with his hopes for the future. I am a fisherman myself.

**DON'T SCRAP ALUMINUM PARTS**

**SO-LUMINUM** repairs cracks, breaks or defects in aluminum in 1/2 the time and cost of acetylene welding. Parts so mended are stronger at welded joint than elsewhere. Gasoline torch, only thing necessary. No flux needed. Send 50 cents for sample bar. Money refunded if not satisfactory. Booklet on request.

**SO-LUMINUM MFG. & ENG. CO., Inc.**  
 Room 12, 1790 Broadway, NEW YORK CITY

**ToolCases for Toolmakers and Machinists**

Keep your tools orderly arranged in a Gerstner Portable Tool Case. There's a place for every tool in one of the felt lined drawers. Every up-to-date mechanic needs one and you'll find our Cases the best built, most practical on the market. We guarantee to please or refund all money. Write for our free booklet.

*Gerstner & Sons*  
 Mfrs. of Mechanics' High Grade Tool Cases  
 808 Columbia St., DAYTON, OHIO

**FREE BOOK TELLS HOW TO MAKE \$150 TO \$1000 PER MONTH**

Making celebrated Flavo Nature-Flavored Flour in rural communities or small towns with **AMERICAN MARVEL Flour Mill** (Self-Contained)

You can quickly become a member of Community Marvel Millers. We start you. Help you. 30 days' free trial. Investment and terms easy to handle. Write for fully illustrated book.

**ANGLO-AMERICAN MILL CO., Inc.**  
 135-141 Trust Bldg. Owensboro, Ky.

**Cleveland Grindstones**

take the lead for farm and shop use.

Provide yourself with the only GENUINE Berea and Huron grindstones obtainable. The grindstones that Agricultural Implement Manufacturers choose.

This Trademark identifies the **Genuine** Berea and Huron Stones.

**CLEVELAND GRINDSTONES**

**The Cleveland Stone Co.**  
 1111A Leader-News Bldg., Cleveland, Ohio

Please Mention Popular Mechanics



*The*  
**Rockland**  
SPECIAL  
**50¢**  
a week  
20 Year Case  
19 Jewels



Before you buy a watch find out about the best watch made in America—a watch of reputation, quality and appearance in a class by itself. Sold at prices that defy competition. We guarantee the Illinois Rockland and our catalog gives facts and figures that cannot be ignored.

**Cash or Liberal Payment Plan**  
SEND TODAY FOR CATALOG

**LENOX JEWELRY COMPANY**  
20 YEARS OF HONEST DEALING  
373 WASHINGTON STREET, BOSTON.

**LOOK FOR  
THIS NAME  
WHEN YOU BUY  
A WRENCH**

**CRESCENT**

*"Each genuine Crescent has  
the name on the handle."*

Crescent adjustable wrenches are famous for the very qualities you most desire in a wrench—strength; smooth, easy adjustment; positive, firm grip.

Every Crescent is sold under a positive guarantee of satisfaction or money back—the purchaser to be the judge.

**CRESCENT TOOL CO.**  
JAMESTOWN, N. Y.

## A Profitable Vocation

Learn to letter Price Tickets and Show Cards. It is easy to do rapid, clean-cut lettering with our improved Lettering Pens. Many persons make good money by lettering price tickets and show cards for the smaller merchant, outside of regular working hours. Practical lettering outfit consisting of 3 Marking and 3 Shading Pens, 2 colors of Lettering Ink, sample Show Card in colors, instructions, figures and alphabets, Prepaid \$1.00.

### Practical Compendium of Commercial Pen Lettering and Designs



TRADE MARK

100 pages, 8x11, containing 122 plates of Commercial Pen alphabets, finished Show Cards in colors, etc., also large list of crisp business Advertising Phrases—a complete instructor for the Marking and Shading Pen. Prepaid, \$1.00. Catalogue free. Address,

NEWTON AUTOMATIC LETTERING PEN CO., Dept. A, Pontiac, Mich., U. S. A.

## Learn Mechanics of Aviation

Write today. See how you can learn the principles of Aeronautical Construction and Engineering in your spare time at home. Save all the time and expense of laborious field training. Big opportunities now for trained Aviation Experts in different branches of the service. \$50.00 to \$250.00 a week.

**Write At Once!** Big tuition reduction offer now open. Write for details while this offer lasts. No obligations.  
American School of Aviation, Dept. 1784 431 S. Dearborn St., Chicago, Ill.

## Unusual Trial Offer for 10c

Best Kodak Finishing, any size roll developed 10c. Six prints free with first roll. OR, send 6 negatives, any size, and 10c (stamps) for 6 prints. 8x10 Enlargements, 25c.  
**ROANOKE CYCLE COMPANY, 54 Bell Avenue, ROANOKE, VA.**

**COVER WALLS WITH PICTURES**  
The handsomest homes are those where every room is filled with pretty wall decorations.

**Moore Push-Pins**  
for all light pictures, and Moore Push-less Hangers for heavy ones, have come away with destructive nails and tacks. Easy to use. Will not mar finest walls. Samples and illustrated booklet FREE.  
**Moore Push-Pins.** Made in 2 sizes } **10c pkts.**  
Glass Heads, Steel Points }  
**Moore Push-less Hangers,** 4 sizes } In Canada  
The Hanger with the Twist } 2 Pkts. for 25c.  
At Stationery, Hardware, Photo, Dept. Stores, or by mail.  
**MOORE PUSH-PIN CO., Dept. 30, Philadelphia, Pa.**

## "Bristol" Steel Fishing Rods and Meek and Blue Grass Reels

The No. 11 "Bristol" is the most popular rod for all-purpose fishing. Whether you have 2 rods or 50 rods, your outfit is incomplete without it. It is the "Old Standby"—the all around rod for most any kind of fishing.

**Prices \$4.50 to \$6.25**

The best reel for the No. 11 "Bristol" is the No. 5 "Meek" Blue Grass Reel. With the proper care this reel will last 50 years. **Price \$15.00**

**Both Catalogs Free** showing 59 rod and reel models. Send for them.

**THE HORTON MFG. CO.**  
196 Horton St. BRISTOL, CONN.

**KEROSENE  
Gas Lamps**



**BURNS KEROSENE  
or GASOLINE**  
one just as well as the other; or the two mixed. Make their own gas. 300 to 600 C. P. at 1/4c an hour. Family or Business use.  
WRITE FOR COMPLETE ILLUSTRATIONS  
**BRILLIANT GAS LAMP CO.**  
1909X So. Wabash Ave., CHICAGO, ILL.

Please Mention Popular Mechanics



# OTTAWA ENGINES Kerosene-Gasoline

With my Kerosene Engine you can get more power from a gallon of 6c Kerosene than you can from a gallon of 20 or 25 cent gasoline in any gasoline engine. No cranking, no batteries, easy to start, easy to operate.

**Valuable Free Book** Every farmer who owns an engine or expects to buy one should know how to figure exactly what an engine is worth—Why I use the valve in the head design, the off-set cylinder construction and larger valves.



**90 DAYS' TRIAL.**  
**10-YEAR GUARANTEE**  
Longest sold direct from factory to user. Before you buy any engine get my newest and finest book and money saving offer. Write today. **GEO. E. LONG,**  
**OTTAWA MFG. CO.**  
536 King St. Ottawa, Kans.

**4 H.P. Cushman Weighs Only 190 lbs.**  
**8 H.P. 2 Cylinder Only 320 lbs.**

Discussing light-weight motors recently, the Scientific American said: "Efficiency means light weight, reduced friction, and above everything else, lowered operating cost." Cushman Light-weight engines are today recognized as the leading American light-weight, high efficiency, all-purpose motors, challenging comparison in minimum weight per horsepower, reduced friction, quality of material and workmanship and cost of operation. Sizes 4 to 20 H. P. Throttle Governor. Scheller Carburetor. Forced Water Cooling System. Moving parts enclosed and run in bath of oil. Not cheap engines, but cheap in the long run. **ENGINE BOOK FREE.**

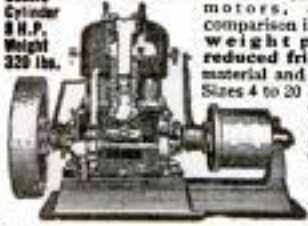
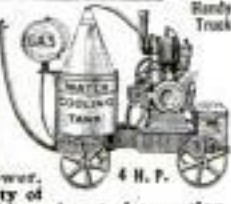

**Cushman Motor Works**  
582 N. 21st St., LINCOLN, NEB.

At a football match at New Cross in England recently, the Army and Navy Journal relates, a private of the Royal Irish Fusiliers, who had been rendered dumb by shell shock, suddenly recovered his power of speech through excitement.

## GALLOWAY MASTERPIECE ENGINES

Are powerful, durable, reliable. Designed and constructed by master engine builders for hard, continuous, heavy-duty service. Use any fuel. Develop way above rated h.p. Easy to start—no cranking. Heavy weight, large bore, long stroke, low speed, wide bearings. All sizes at wholesale prices. From 1 1/4 to 16 h.p. portable, stationary, saw rigs, etc. Send on five selling plans, cash or time.



**WM. GALLOWAY COMPANY** Box 965  
WATERLOO, IOWA

### GET THIS CATALOG

FULL OF VALUABLE INFORMATION TO EVERY BOAT OWNER ON

**RACING PROPELLER WHEELS,  
REVERSE GEARS AND  
MARINE ACCESSORIES**

LARGE CATALOG FREE. SEND TODAY  
**MICHIGAN WHEEL CO.**  
1139 MORRICE AVE., GRAND RAPIDS, MICH.



## POWER



The two horse-power Benninghofen Engine offers even economical power for every purpose. Many new, exclusive features, including "auto throttle governor" not hit and miss governed. Surprisingly low cost. Burns kerosene or gasoline. Runs machinery, pumps water, saws wood, runs separator, churns, etc. Catalogue and details free.

**C. BENNINGHOFEN & SONS**  
Dept. 125 A HAMILTON, OHIO

# 6 Months To Pay 6

## Tailor-Made To Order

This is the most sensational Tailor-Made Suit Offer ever made. You can now have any suit you want—cut and fit in the very latest style—to your individual measurements—and from your own choice of the seasons latest patterns, novelties, checks, stripes, etc.—and take Six Months To Pay for it, if, after trying it on, you decide to keep it. Furthermore, we will send you any suit you may want on receipt of



**Only \$100**

Send coupon for free book which explains this wonderful offer. No matter what price, style or pattern suit you may want we will make it to your order and send it to you on receipt of **Only \$1.00.** Even if you don't need or want a suit right away, don't fail to send for this wonderful book. It tells you how a Stanley-Rogers Suit is made up—of the best materials—highest grade interlining, body and sleeve linings, best buttons, etc., etc. Book also shows how to take your own measurements to insure a perfect fit—and proves that we actually

## Save You \$15 to \$25

on any Suit you may order. We buy all materials in enormous quantities, direct from the mills, at rock-bottom prices. We do our own designing, cutting and tailoring. And by making every suit in our mammoth establishment and selling direct to the man who wears the clothes, we eliminate all waste and save you the dealer's profit on each suit.

### BIG STYLE BOOK FREE and Cloth Samples



Send for this free book today. It shows latest styles in men's garments and a wonderful assortment of actual fabrics from the pick of foreign and domestic mills! Mail coupon or write us postal for Book and cloth samples today—sure! You will be surprised at the big saving offered and the remarkable easy credit terms.

### MAIL COUPON NOW

**Stanley-Rogers Co.,**  
1015 Jackson Blvd.,  
Dept. 544  
Chicago, Ill.

**Mail Coupon Now**

**STANLEY-ROGERS CO.,**  
1015 Jackson Blvd., Dept. 544 Chicago  
Please send me FREE, your new Spring and Summer Style Book showing latest Metropolitan Styles, also Cloth Samples and full particulars of your great \$1.00 down with 6-months-to-pay-offer.

Name.....

Address.....

Please Mention Popular Mechanics





## ROBERTS MOTORS FOR BOATS

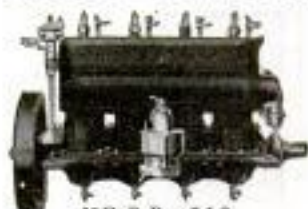

10 H. P. Bore 1-2  
Inch Stroke 4-inch  
Net Price \$240.00



8 H. P. Bore 1-2  
Inch Stroke 4-inch  
Net Price \$120.00



4 H. P. Bore 1-2  
Inch Stroke 4-inch  
Net Price \$60.00

**M**ORE power, more speed sums up the Roberts Motors for 1917. Three new engines have been brought out, characteristically Roberts in design, appearance and construction, with Roberts Dependability built right into them.

### Get Your Boatbuilder's Advice Before Getting That New Engine

Your Boatbuilder is the man that knows by experience just what a Roberts Motor will do for you, furthermore, his expert knowledge will enable him to advise you as to which size is best adapted to your boat and the necessary equipment required. He can tell you why Roberts Motors are so free from breakdowns, so absolutely dependable, yet full of power which means speed for your boat.

We have prepared a concise, clear description of the new Roberts Motors, write for this description today.

**ROBERTS MOTORS**  
1704 ROBERTS BLDG. SANDUSKY, OHIO

# KENNEBEC

## CANOES

### World Renowned

For seacoast, lake or stream. Best made. Reasonably priced. Free Catalog shows all models, gives details of construction and information that every prospective canoeist needs. Write for it before you buy canoe, rowboat or accessories. Satisfaction guaranteed.

**Kennebec Boat & Canoe Co.**  
49 R.R. Sq., Waterville, Maine.

# KENNEBEC

**ORIGIN OF THE EPITHETS "GRINGO" AND "YANKEE"**—If we are to accept the plausible theory, as many have done already, that the name "Gringos," which Mexicans give to the people of the United States, had its origin in the fact that our soldiers adopted as their marching song, "Green Grow the Rushes," placing emphasis on the first two words of the chorus, during the war of the '40s, says the Christian Science Monitor; then it will not be difficult to accept the theory that "Yankee" had its origin in the attempt of the Indians to pronounce the word "English" in the early days of

### Universal MARINE MOTOR

9-12 H.P. 4 Cycle 4-Cyl-inder. Speed range 300 to 1800 R.P.M. Adapted to boats from 14 to 30 feet. Write to

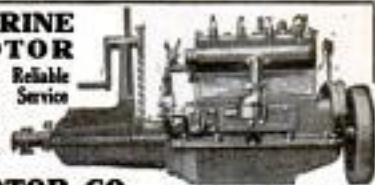

**UNIVERSAL MOTOR CO.**  
OSHKOSH, WIS. Dept. P

For Bulletin No. 25 giving full description

## Write for New L-A Engine Book

### Your Engine Makes or Mars Your Motoring Pleasure

So don't decide definitely on the engine for your boat until you have read the new L-A Engine Book—new—just off the press. It fairly bristles with valuable suggestions and interesting engine information. This new L-A Engine Book describes and depicts in detail the complete line of L-A inboard and outboard motors for launches, row-boats, work-boats, etc. It provides you with complete particulars covering our

### 30 DAYS' TRIAL PLAN

which allows you the privilege of proving the performance of L-A motors before making your final decision. Write for your copy to-day.

LOCKWOOD-ASH MOTOR COMPANY, 1430 Norton Avenue, Jackson, Mich.

(4)

AN L-A ENGINE FOR EVERY PURSE AND PURPOSE





## SIXTY-FIVE THOUSAND PEOPLE ENDORSE YOUR JUDGMENT

THAT is what happens when you buy a Mullins boat. There are 65,000 Mullins boats in use—everyone giving satisfaction. Whether you need a motor boat—or a rowboat or canoe, you can't go wrong when you buy a Mullins.

### MULLINS STEEL BOATS CAN'T SINK

Designed by America's leading naval architects, built in the world's largest boat factory, Mullins steel boats cannot leak, water log, dry out, warp or open at the seams—need no boat house and never require calking.

The motor boats are powered with 2 and 4-cycle engines, correctly installed and equipped with Silent Underwater Exhaust. They are light, graceful and speedy. Whether you wish to pole, row or motor in fresh or salt, deep or shallow water, you need a Mullins boat. Forty models now ready for delivery.

Write for big catalog of steel and wooden motor boats, rowboats and canoes—free.

### THE W. H. MULLINS COMPANY

52 Franklin St.  
SALEM, OHIO

World's Largest Manufacturers of Steel and Wooden Pleasure Boats, and Builders of the Celebrated Mullins Outboard Special 14-Foot Steel Boat.



"JOIN IN THE NATION'S MOST POPULAR SPORT—BOATING"



American settlement. The nearest the natives could come to it, it is said, was "Yengeese," and the transition from this to "Yankees" was easy.

The growing use of wireless telegraphy on small vessels and the need of a moderate power outfit for emergency uses on larger ones, have brought forth a  $\frac{1}{4}$ -kw. installation, in which the whole transmitting apparatus is mounted in a wooden box, which is only 27 in. high, 26 in. wide, and 17 in. deep.

### Motor Perfection



is what you get in Watkins Class "B" all iron motors. Especially fine for canoes and light boats. Constant and efficient.

3 H. P. single cylinder	45 lbs.
6 H. P. double cylinder	85 lbs.
12 H. P. four cylinder	155 lbs.

Are light, at the same time strong, accomplished by using semi-steel castings, high carbon steel shaft, bronze bearings, high class workmanship.

THE WATKINS MOTOR CO.

837-839 W. 6th Street

Cincinnati, Ohio

No advance in the price of the favorite—

# COLUMBIAN

Outboard MOTOR \$60

The price in this the fifth year is still \$60 (with high tension magneto built in fly wheel \$70). It has earned its reputation on faithful performances. Send for Free Boat and Engine Book.

CULLEN MOTOR COMPANY

Dept. 1 112 W. Lake St., Chicago, Illinois

Motor Boat Headquarters



## Runs 3 Years Without a Hitch



Does not shake the boat.

Three years without a single stop for engine trouble of any kind—is the remarkable record of performance reported by a delighted Koban owner from Lake Kegonsa, Stoughton, Wis.

The Great  
2-CYLINDER  
**KOBAN**  
ROWBOAT MOTOR

Simplicity is the secret of Koban dependability. Simplicity of design—simplicity of construction—simplicity of operation. No complicated parts to get out of commission. The Koban is a speed marvel. Opposed cylinders that fire simultaneously entirely remove vibration—the Koban can't shake the boat.

Send for catalog of 1917 Models. Agents wanted near every water point.

KOBAN MANUFACTURING CO., 291 South Water Street MILWAUKEE, WIS.

We also make a 3 H. P. Vibrationless Inboard Marine Engine which is ideal for small launches, canoes, etc. Write for Circular No. 80.



## FISHERMEN!

You can get to the fishing grounds early and feel fit for fishing when you get there, if you have an

### EVINRUDE

DETACHABLE ROWBOAT & CANOE MOTOR

Equipment includes Evinrude Magneto—Built-in Flywheel Type, Automatic Reverse—new refinements for 1917. More speed and power. Catalog and dealer's name on request. Special folder describes rowboats, skiffs, canoes and accessories.

#### EVINRUDE MOTOR COMPANY

564 Evinrude Bldg., Milwaukee, Wis.  
BRANCHES: New York, Boston, Portland, Ore., San Francisco

Over 80,000 Sold—Used by 25 Governments



Evinruding— is Rowboat Motoring

## Power Your Boat With a Caille Motor

Thousands of Caille motors have been tried out for you—a world-wide approval is your insurance of genuine satisfaction.

The Caille line of marine motors is complete up to 30 H. P. In each size and type—from the 5-speed rowboat motor to the "Aristocrat"—there is a distinct dominance.

Exclusive features, years of experience, and strict adherence to a fixed standard have won Caille success on practically every body of water where power-boats ply.

Send for Caille literature, naming the type of motor you are most interested in. We'll help you select the motor most adaptable to your work.

Caille Perfection Motor Company  
1523 Caille Street Detroit, Michigan

## CAILLE Perfection Motors

**DEALERS**—Caille motors are in bigger demand than ever. Our proposition earns handsome profits for you and we help you sell. Write for particulars today.

Please Mention Popular Mechanics



## Every Day a Happy Day

That's what an "Old Town Canoe" means. Invigorating, healthful exercise; pleasure trips out in the open, enjoying Nature—every leisure hour filled with good times in your

### "Old Town Canoe"

Light, strong, easy to manage. Swift, safe, graceful and beautiful—the most perfect canoe in the world. Don't worry about warping, leaking, cracking—anything. An "Old Town" lasts indefinitely and keeps "fit as a fiddle." "Old Town SPONSON Canoes" can't turn over. They're as safe and comfortable as an easy chair. Write for catalog. 4000 canoes ready to ship—\$34 up—from dealer or factory.

OLD TOWN CANOE CO.

1664 Middle St., Old Town, Maine, U. S. A.



## Racine Wis

### America's Finest Canoe

Speed, lightness and beautiful finish combined to the highest degree. Write for free catalog showing the many distinctive features of the Racine Wis.  
Racine Boat Company, Dept. O, Racine, Wis.

## AMERICA'S STANDARD FOUR-CYCLE ENGINE BOAT KERMATH MOTORS



\$225.00  
to  
\$395.00

4 Cylinder 4 Cycle  
10 to 25 H.P.

Used and recommended by all of the best boat builders. An engine which insures you the most pleasure and service. Extremely smooth operating, perfectly controlled and quiet. Catalog on request.  
KERMATH MFG. CO. 95 E. Fort St. Detroit Mich.





## Extra money for you now

You need more money this summer—and here's a dignified, easy way to get it. Take orders for the

### Wisconsin Detachable Motor Row Boat

Equip your boat with a guaranteed Wisconsin—enjoy yourself while demonstrating and making money. Thousands in use. Everyone interested. Has many exclusive features including self-locking tiller and patented top adjustment, which make the Wisconsin the best row boat or canoe motor to use, and the easiest to sell. Ask for our agents' plan. Ask for catalog Q.

WISCONSIN MACHINERY & MANUFACTURING COMPANY  
Misor Street, Milwaukee, Wisconsin

Highest Award Panama-Pacific Exposition. Purchased by U. S. Government, after competitive tests.

## ROWBOAT MOTOR FERRO

### Make Your Rowboat a Motorboat

For fishing—the Ferro gets you there quickly without tiring with oars. Runs quietly and slowly for trolling. For camping—takes you anywhere in a jiffy. For racing—has lots of speed. For general use—easy to carry, easy to run. 4 hours on a gallon of gasoline. 2 to 9 miles an hour. Bosch magneto, float-feed carburetor, roller, weed-proof propeller, noiseless muffler. Price includes everything. Agents wanted. You only need buy a motor for demonstrating. Ask for agency proposition 215.

\$90 with Bosch high-tension magneto.  
\$70 with waterproof battery.

The Ferro Machine & Foundry Company  
442 Hubbard Avenue Cleveland, Ohio



DON'T GO ROWING - GO FERROWING

## Hildebrandt Baits Hook and Land'Em

Use HILDEBRANDT BAITS and catch fish. Made in 300 sizes and kinds—three styles—six fishes, any size. Interchangeable three-reversable "Solo or Easy" blades suitable for any kind of fishing. Send for a FREE 1917 TACKLE CATALOGUE, shows our entire line in actual size and colors. A two-cent stamp brings it.

JOHN J. HILDEBRANDT CO., 1344 High St., Logansport, Ind.

## FREE! -3 Books on BOATS

1—Special Boats of 150 Leading Boat Builders.  
2—Gray 2 and 4 cycle Motor Engine Catalogue.  
3—Book of Boat Models for work, fishing, cruising.  
Ask for any (or all) of them if you are interested in boating for pleasure, or profit. Book 1 shows more boats than motor show.

Gray Motor Company  
446 Gray Motor Bldg.  
Detroit, Mich.

**"Bow Legs and Knock-Knees"**  
Unsightly Send for booklet showing photos of men with and without  
**The PERFECT LEG FORMS**  
Perfect Sales Co., 140 N. Mayfield Ave., Dept. 3  
Austin Station, CHICAGO, ILL.

GREEN AUTOMATIC MACHINE



## ADD TO YOUR INCOME

WITH LITTLE EFFORT  
\$5 to \$10 A DAY MADE  
EASY WITH

### The GREEN AUTOMATIC MACHINE

Sharpens, Honors, and Strips all kinds of safety razor blades, in one operation, from four to six blades per minute. For both Quality and Quantity this machine is in a class by itself. There is nothing like it on the market. Let us send you our free booklet explaining everything, including the "AMERICAN" Key Cutter—cuts square, angular or round slots.

AMERICAN SHARPENING MACHINE CO. (Inc.), Dept. 4, 184 W. Washington St., CHICAGO

Please Mention Popular Mechanics

## Say Good-bye to Laundry Bills



## CHALLENGE CLEANABLE COLLARS

Good looking, serviceable and offering a real economy. Stitched edge and dull linen effect. Better than merely "linen." Proof against the cracking velvet collar, rain, snow and perspiration.

*Instantly cleanable—on or off—with  
a bit of soap and a damp cloth.*

Every accepted style, half sizes, 25c each—  
at your dealers or by mail. State your style and size.  
Descriptive booklet on request.

THE ARLINGTON COMPANY  
725 Broadway NEW YORK



## Amazing Profits In Mushrooms

Anybody can add \$10 to \$40 per week to their income, in spare time, entire year growing mushrooms in cellars, sheds, barns, boxes, etc. I tell you where to sell, at highest prices.

Free Illustrated Instruction Booklet

**HIRAM BARTON**

Desk 2, 329 W. 48th St., New York

## Acetylene Blow Torch Prest-O-Torch

Quicker and cheaper than  
a gasoline blow-torch for  
brazing and soldering

For factories, repair shops, linemen, dentists, jewelers, the Prest-O-Torch saves time and money. Used with Prest-O-Lite Tanks—ready-made gas. Intense, concentrated flame instantly lighted. No depreciation, safe and convenient. Style "A", price, 75c (Canada, 85c) will braze up to 3/4 inch round rod. Style "C" for heavier work, \$2.25 (Canada, \$2.75). Special styles for dentists. Write for literature or send order now. Money refunded if not satisfied.

The Prest-O-Lite Co., Inc. 816 Speedway  
Indianapolis, Ind.  
Canadian Main Office and Factory, Merrittton, Ont.



"AMERICAN"  
Key Cutter





# WANTED IDEAS



Inquiries from Manufacturers and Other Buyers of Patents  
Who Are Looking for Good Ideas

## Protected by Owen Patents

Are constantly being received. Hundreds of ideas are wanted—a market exists for them to-day. YOURS may be one of them. Send for my free books and see for yourself—read the requests for inventions protected by me. Many are simple. You can help supply this demand.

As soon as my clients' rights are protected I aid in every practicable way, **without charge**, to sell. Their **applications** are advertised free—their patents are called to the attention of the proper prospective buyers—every necessary thing is done. Get my booklets and see.

## THESE ARE FREE

You will incur no obligation by writing me. A simple request will bring them to you—the finest, most reliable and instructive patent books published. A postal will do.

**"Successful Patents"**—a 72 page guide book, tells how to proceed; describes my advantageous business methods; gives references, testimonials, etc.

**"Stepping Stones"**—gives hundreds of hints of inventions wanted; articles from interviews of noted authorities; tells the truth about prizes for inventions.

**"Patent Promotion"**—tells you how to sell; why some inventors fail; discusses the value of your idea; how I aid my clients; manufacturing aids furnished you; recent successful patents, etc.

**"Patent Buyers"**—Publishes letters, and abstracts of letters, from over 400 of the many manufacturers, and other patent buyers, who wish to buy, or obtain on royalty, **Owen Patents** on innumerable inventions of interest to them.

You will also be sent from time to time, as new inventions are wanted, full information concerning them. Only in this way can you keep up to date.

**WRITE FOR THESE TO-DAY**—Advice costs nothing. All communications confidential. Your work will receive my personal supervision—but my fees are no higher than others.

### Results Speak Loudest—But Here Are Some References

Columbia National Bank,  
Washington, D.C.  
National Locktite Co.,  
Washington, D.C.  
The Carnahan Press,  
Washington, D.C.  
Lightning Gun & Cycle Works,  
Oklahoma City, Okla.

Antholene Mfg. Co., Hutchinson, Kan.  
National Rack Co.,  
61 Hanover St., Boston, Mass.  
The C. J. Loftus Co.,  
15 Spring Common, Youngstown, Ohio.  
Whitehead Hosiery Mills,  
Burlington, N. C.  
Dickinson Mfg. Co., Des Moines, Iowa.

A LARGE NUMBER OF OTHERS IN MY BOOKLETS.

**RICHARD B. OWEN** 9-303 OWEN BLDG.  
WASHINGTON, D. C.  
NEW YORK OFFICE: 22nd Floor Woolworth Building

Inventors submitting their inventions to me are protected in a tangible manner until their applications are filed.

### Nuts for You to Crack

Invent something for which a demand exists—for which there is a waiting market. Here are abstracts from a few recent requests—hundreds are published in full in my literature. Can you invent any of these? Watch this list each month.

An investor with money writes, "I am looking for a window burglar alarm or something small that will be a fairseller."

A large manufacturer wants patents upon "novelties, machines, etc., which could be retailed from one cent to fifty dollars."

A financier wants to purchase inventions—along the lines of toys, household and office novelties, and mechanical devices which could be handled by a mail order house."

Still another manufacturer wants to get in communication with any clients of mine "that have obtained patents on tricks, puzzles, or novelties." They also state "we are always interested in any new articles of this kind and are in a position to place anything of a practical nature on the market." There is a big field for the right article.

### SPECIAL FREE REPORT

Send sketch or model of your invention for free report on patentability, practicability, etc.



# PATENTS TRADE-MARKS AND COPYRIGHTS

LARGEST PATENT FIRM  
IN THE WORLD

## SPECIAL OFFER Free Opinion as to Patentability

Before sending your invention to any attorney or manufacturer or disclosing your invention, write for our free blank form **PROOF OF CONCEPTION** in order to protect your invention and secure your rights. This should be signed and witnessed and returned to us, together with a model or sketch and description of your invention, and we will give a **FREE OPINION** as to the patentability of the invention. If we report the invention patentable we will furnish a Certificate of Patentability.

**This Certificate of Patentability, together with our blank form Proof of Conception will protect the inventor and serve as proof of the invention until the case can be filed in the U. S. Patent Office.**

**Obtaining Assistance for Inventors**—Our certificate is of great assistance to inventors who require financial aid to obtain patents.

### OUR FIVE BOOKS MAILED FREE

(See Coupon Below)

to any address. Send for these books—the finest publications ever issued for free distribution.

#### How to Obtain a Patent

Our illustrated eighty-page Guide Book is a book of reference for inventors and contains 100 mechanical movements, illustrated and described. Tells how to invent for profit.

#### What to Invent

Contains a valuable list of inventions wanted and suggestions concerning profitable fields of inventions; also information regarding prizes offered for inventions amounting to

**One Million Dollars**

#### Millions in Trade-Marks

Shows the value of Trade-Marks and information regarding unfair competition.

**We Advertise Our Clients' Inventions Free** in a list of Sunday newspapers, in manufacturers' journals and in World's Progress. Sample Copy Free. We save you time and money in securing patents. After the patent is granted we assist you to **sell your patent**.

### WANTED NEW IDEAS

Prepare Now to meet the Demands of Industry in All Fields for New Ideas and New Inventions. We are constantly receiving requests from manufacturers who consult us when purchasing patents for inventions in all lines. We invite manufacturers and promoters to address our Sales Department regarding the purchase or leasing of a number of meritorious patents secured by us.

#### List of Patent Buyers

Contains requests from manufacturers, mail order houses and promoters for patents secured by us and suggestions as to **New Ideas** they wish to purchase. We place our clients in touch with capital free of charge. We have recently received over 300 requests from manufacturers.

#### Foreign Patents

We have direct agencies in all the principal foreign countries and secure foreign patents in the shortest possible time and at the lowest cost. Write for our illustrated Guide Book on Foreign Patents, sent free to any address.

VICTOR BUILDING



VICTOR J. EVANS



**FREE COUPON!**

## VICTOR J. EVANS & CO.

New York Offices:  
189-191 Broadway

PATENT ATTORNEYS

Philadelphia Offices:  
1429 Chestnut St.

Pittsburg Offices: 514 Empire Bldg.  
Main Offices: 765 Ninth St., N. W., WASHINGTON, D. C.

Name..... Address.....



# **PATENTS** THAT PROTECT and PAY

Send for FREE BOOKS.

**WATSON E. COLEMAN, Patent Lawyer, 624 F St., Washington, D. C.**

## **PATENTS SOLD**

All the service many of the Patent Attorneys render an inventor, is to procure his patent. They will not undertake to sell it for him, or aid him in obtaining some financial return for the money he has expended, or the reward of his genius.

Where an inventor takes out a patent through my office and wishes to sell it, I place same before leading manufacturers and submit all offers to the inventor.

I am frequently receiving letters from manufacturers and others who state they wish to purchase good patents on good inventions that they can place on the market, and the names and addresses of these persons are also furnished to my clients.

My commission for selling patents is ten per cent. of the net purchase price, and no charge is made unless the sale is made and you get your money.

---

I am a BONDED Patent Lawyer in the Rand-McNally Directory of Bankers and Attorneys, Published by Rand-McNally & Co., Chicago, Ill., the bond being issued by The American Surety Company of New York City. I am also a guaranteed and recommended Patent Attorney in the Bankers Register and special list of selected lawyers published by the Credit Company, Pontiac Building, Chicago, also recommended Patent Lawyer in Sharp & Alleman's Directory of Lawyers and Bankers, published at Philadelphia, Martindale's American Legal Directory of New York City, and the Con. P. Curran Directory of Bankers and Lawyers, published at St. Louis.

---

***Send Drawing or Model for Examination and Opinion as to Patentability.***

# **PATENTS** THAT PROTECT and PAY

Send for FREE BOOKS.

**ALL BUSINESS GIVEN PROMPT AND PROPER ATTENTION**

**A large list of strong recommendations furnished free**

**WATSON E. COLEMAN, Patent Lawyer, 624 F St., Washington, D. C.**



# Wanted—Ideas

Inventors! Send for these Remarkable FREE BOOKS, Today



## “Inventions Needed”

This book lays before you a description of the active and profitable field of invention. It tells you the inventions the world needs today, the devices manufacturers are seeking for their business, the ideas for which the public will pay big money.

## “How to Get Your Patent”

This book is a guide to the inventor. If you have invented something and desire to learn what it will cost you to get your patent and what you must do to find your market, read this book.

## “Special Bulletin of Patent Buyers”

This bulletin contains letters from men who are seeking to purchase patents. We act as intermediary without one cent of charge, between the man who invents and the man who invests.

Send Model or Sketch and description of your invention for Free Opinion as to patentability

*Rejected and Difficult Cases are Our Specialty*

**RANDOLPH & CO.**

600 F St., N.W., Washington, D.C.

**RANDOLPH & CO.**  
600 F St., N. W., Washington, D. C.

Gentlemen: Please send me without obligation on my part, the books indicated on margin of this coupon. (Write on margin of coupon, names of books desired.)

NAME.....  
STREET.....  
CITY.....STATE.....

Patents Secured by a Former Examining Official of the U. S. Patent Office

**Norman T. Whitaker**

Attorney-at-Law and Mechanical Engineer

Inquiries Invited

27 Legal Building - - Washington, D. C.

**PATENTS** C. L. PARKER  
Formerly Member Examining Corps, U. S. Patent Office  
PATENT LAWYER  
MCGILL BLDG.  
WASHINGTON, D. C.

Patents, Trade Marks, Copyrights, Patent Litigation

Handbook for Inventors, "Protecting, Exploiting and Selling Inventions," sent free upon request.

## Protective Patents

Procured Promptly. No fee refund, no guarantee certificate, no so-called prize or free search schemes used in our business. Inventors 104 page Blue Book sent on request.

Robb & Robb, 211-215A Southern Bldg., Washington, D. C.

**GEARS** ALL KINDS SMALL



The most accurate made and prices reasonable. We carry a complete line of gears in stock for immediate shipment. Can also quote on special gears of all kinds. Send us your inquiries. WRITE FOR CATALOGUE.  
**CHICAGO STOCK GEAR WORKS**  
16 S. Fifth Av. CHICAGO



## Four New Booklets for Inventors

Check full of ideas and practical advice.

Tell what to invent and where to sell it.

“Patents and Patent Possibilities,” and “Practical Suggestions for Inventors” are bristling with facts that every inventor should have. They explain how many of my clients have made money from patents procured by me. What I have done for them I can do for you, if you have **inventive genius** and the **will power** to use it. The “**Inventors Loose Leaf Record File**” will enable you systematically to preserve evidence to prove priority of invention on your part in the event of a controversy. These booklets are unlike anything ever issued for inventors, they were prepared with the idea of **Service**. If you are interested in inventions send for these books; they are free while they last. My service is individual, prompt, efficient and satisfactory. (16 years' experience). I am frank in my opinion on the value and patentability of inventions. Every expedient is employed to secure patents at the least possible cost.

**INTERNATIONAL**  
  
**PATENT SOLICITOR**

**H. S. HILL,**  
802 McLachlin Bldg., WASHINGTON, D. C.

Send all four of your booklets to

Name.....

Address.....

Please Mention Popular Mechanics



# Manufacturers Calling for Over Two Hundred Inventions

## Money Is Waiting to Back the Good Idea

(By a Washington Patent Attorney)

Never was there so good an opportunity for the inventor of something—*anything*—of merit as right now.

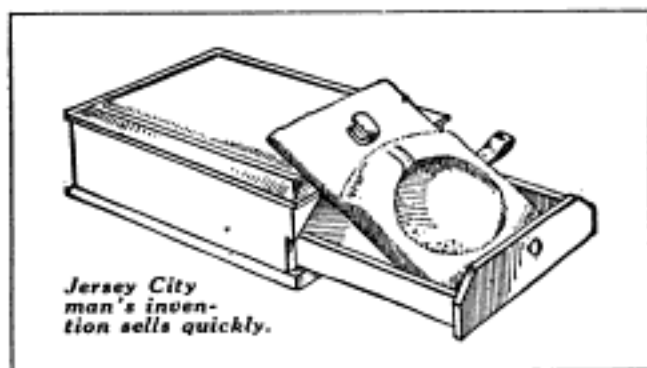

Jersey City man's invention sells quickly.

Manufacturers with money and facilities are asking for ideas—*calling* for them. The supply is not nearly equal to demand. Over 200 inventions are asked for in a list just given in a little book "What to Invent." The demand is not for anything extraordinary—just the common everyday things that make work easier or life more pleasant in the household, the shop or the field.

You might think the possibilities of the window screen had been exhausted, but I know of 28 concerns that are looking for a new screen, duly covered by patent, which they can manufacture. I know of 46 manufacturers and others who are ready to manufacture any good, patented household article such as can openers, baking pans, coffee pots, washing machines, carpet sweepers and other devices.

Within the last few weeks I have received forty special requests for a dishwasher and drainer; seventeen others request an improvement in scissors. Manufacturers know that everyone must have a pair of scissors in the house, and they realize that a novelty in them would always sell in place of the old kind, and hence the demand. Among my letters are sixteen requests for a device to turn sheet music on a music stand or piano, and seventeen people are interested in the purchase of a patent on a device for holding an electric light in any position. Besides these there are hundreds of manufacturers who do not specify any particular device but state that they would be interested in anything of merit.



Coupling hook adopted by Pennsylvania R. R.

A Chicago man says: "I want something that can be sold to farmers by mail. There is practically no limit to the investment my associates would make in a good proposition." A man in Woodhaven, N. Y., says he is in the market for a small household article, light in weight, which can be sold somewhere around ten cents.

A prominent manufacturing company is interested in something to sell to hardware stores, but would also be interested in other things promising to be money-makers.

A man in Revere, Mass., says: "I am looking for something that can be manufactured, plant equipped, etc., and marketed for an outlay of not over twenty-five thousand dollars."

A big textile machinery company says they are interested in newly patented devices that can be either bought outright or manufactured on royalty. They do not require machinery inventions alone, but anything of merit.

A company in Belvidere, Illinois, wants patents on small tools or metal novelties.

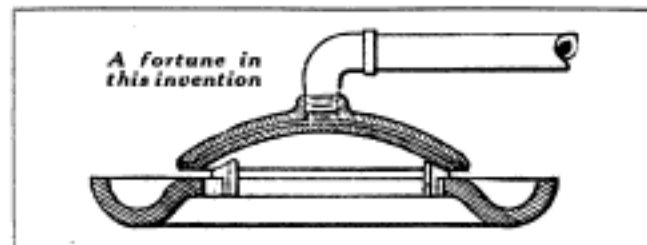

A fortune in this invention

A Dayton, Ohio, concern writes for some machine or device that would have a general sale throughout the land.

The names and addresses of these prospective purchasers are supplied absolutely without charge by Messrs. Chandlee & Chandlee to those who obtain patents through their firm. This firm has been in practice before the Patent Office for over twenty years, and its members are, consequently, familiar with every detail of patent work. They also issue a booklet entitled "How to Obtain a Patent," which tells in simple words just how to go about protecting an invention. The two books, "What to Invent" and "How to Obtain a Patent," are both free. Why don't you write for them and learn what manufacturers are looking for and how to protect your ideas? If you have an invention, send a sketch or model and description of it to Chandlee & Chandlee, 1011 F Street, Washington, D. C. They will give you a free opinion as to whether or not it can be patented.



# U.S. PATENTS FREE → BOOK & FORM EVERY INVENTOR SHOULD USE:



Without charge or obligation, we will give you our frank opinion on any questions you may put to us touching on patent, trade mark and copyright matters. You may ask, "Should I protect myself by a patent, or register under the trade mark or copyright laws? What kind of a patent should I obtain? What will it cost? Will it sell?" and many other questions that may occur to you. These are vital points to consider, and questions will be cheerfully answered. If you want suggestions on what to invent, in our *Bulletins of Improvements Wanted*, which are sent free to all on our mailing list, you will find the wants of progressive manufacturers and valuable information. All matters are held strictly confidential, and personal services are assured by our *Service Guarantee Contract*. References: 2nd National Bank, Washington, D. C.; John P. Roth Packing Co., Cincinnati, Ohio; Duskil Mop Co., Paducah, Kentucky; North Capitol Savings Bank, Washington, D. C. Listed in the Bankers' and Brokers' Directory.

## OUR CO-OPERATION

With an inventor is, **First**, to help him establish his rights before sending a sketch, drawing or model to any attorney; **Second**, to give a frank opinion whether it will pay to patent his idea, based upon our extensive knowledge of the patent laws, manufacturers' wants and facilities; **Third**, to obtain for him on reasonable terms, a patent that absolutely protects; and, **Fourth**, advise and assist him in making the invention a source of profit by outright sale, territorial grants, obtaining royalty, or the independent manufacture of the invention.

Before disclosing the invention to anyone, sign, witness and deposit in our fireproof safe, the form "Evidence of Conception" and establish your rights. A completed sample form in our book shows you clearly how to protect your invention. All are free. Just ask for them on a postcard or simply mail coupon below.

**LANCASTER & ALLWINE**  
245 Ouray Building Washington, D. C.

**DON'T  
LOSE  
YOUR  
RIGHTS**

### COUPON

LANCASTER & ALLWINE, 245 Ouray Bldg., Washington, D. C.  
Send me free book "Inventions—Patenting and Promoting," *Bulletins of Improvements Wanted* and blank form "Evidence of Conception."

Name.....

Address.....

Go into **MOVING PICTURE BUSINESS**  
**Small Capital Starts You**  
on our easy payment plan. Begin now and get your share. We sell everything. Write TODAY.  
**Atlas Moving Picture Co.**  
Dept. 22, 525 S. Dearborn St., Chicago

**GENUINE PERFECT CUT  
Diamonds \$97.50 PER CARAT**

Buy direct from Basch, the importer, and save 35%. Any diamond shipped for **Free examination**. Iron-clad **Money-Back Guarantee** with every purchase. Handsome 1917 Diamond Book mailed free upon receipt of name and address. Write now to  
**L. BASCH & CO.** Dept. M-3470  
State & Quincy Sts. CHICAGO, U. S. A.

3/8 c diamond \$8.25  
1/2 c diamond \$17.50  
3/4 c diamond \$31.25  
1 c diamond \$45.00  
1 1/4 c diamond \$67.50  
1 1/2 c diamond \$97.50

## "The Truth About PATENTS"

This booklet tells you the plain truth about patents and how to successfully procure and market them. Every inventor should read it before proceeding. Write to-day. It will be sent promptly upon request.

I personally report upon and prepare and prosecute every case submitted to me. Prompt service. Highest references. **Honest advice free.**

My clients receive my personal assistance in marketing their inventions. They receive real co-operation.

**J. R. KELLY, 743 Woodward Bldg., Washington, D. C.**

## HIGH-VALUE PATENTS

Get These Books now—read them—and if in your honest judgment they are not more interesting and worth more to you than all other patent books combined, we will refund the price in full.



- Talks by a Successful Inventor;
- How High Value Patents are Obtained;
- Facts about Prizes, Rewards and Offers for Certain Inventions; and
- The Patents Really Wanted by Manufacturers;
- Answers to All Questions of Greatest Interest to Inventors and Manufacturers concerning Patents and Trade-Marks; and
- Inside Information (contained in these books alone) of Utmost importance to Inexperienced Inventors—

That is a very general outline of what is contained in the 256 pages of these extraordinary books. Both will be mailed on receipt of 20 cents, coin or stamps, which is the regular price of the P. T. & S. Book alone. For Patent-Sense alone send 8 cents stamps.

**R. S. & A. B. LACEY**  
32 Barrister Building, Washington, D. C.



# PATENTS SECURED OR ALL FEES RETURNED!!

**THAT PAY** **Protect Your Idea!** **Don't Delay!** **We Issue a Contract with Each Favorable Report to Return ALL FEES!**

Send data at once by registered mail and we will promptly advise how our clients proceed to make fortunes.

Actual Search *FREE* of the Patent Office Records, and Report as to Patentability *Free!*

**PATENTS SOLD FREE:** Write Today For Our *FREE* "Patent Sales Department" Bulletin! **Proof Given.**

Watch this space next month:

**We Help Sell Only Our Clients' Patents FREE!**

Our client, A. D. LONG, just states: "You secured **BROAD** claims for me in my patent. I sold it for \$25,000.00."

**PATENT BUYERS** please write Our "Patent Sales Department" Today! Excellent Opportunities!



Patents advertised Free in Popular Mechanics, and further promoted if applied for thru us in 1917; write us at once and be one who secures this valuable free service!

We write manufacturers for you — We don't wait until they write us!

**WE LEAD — WE ARE LIVE WIRES!**

"Vrooman" Clients' Patents **SELL!** Over \$625,812.00 made by our clients.

**Foreign Patents Guaranteed** BRANCH OFFICES all over the world. Write for prices under guarantee.

**OUR OFFICES ACROSS STREET FROM PATENT OFFICE** CREDIT GIVEN Under Our CREDIT PLAN. **2 WONDERFUL PATENT BOOKS FREE** Don't miss these books! Mail postal today!

**E. E. Vrooman & Co., Patent Lawyers, 87 1/2 F St., Washington, D. C.**

(Old-Established Firm, and Practitioners Before Supreme Court of U. S.)

## PATENTS

Send Sketch or Model of Your Invention for **Free Search of Patent Office Records** Our Certificate of Patentability is Evidence of Conception of your invention and may prove valuable to you. Our Credit System enables you to file your application for Patent and proceed without delay. Every case receives personal attention of one or both members of the firm. Patents we secure advertised at our expense in Popular Mechanics Magazine. Write today for Free copy of 104-page book, "How to Obtain a Patent and What to Invent!"

**Talbert & Parker, Patent Lawyers**  
4683 Warder Bldg. WASHINGTON, D. C.

Send for **FREE BOOK** { **WHAT TO INVENT**  
**WHAT NOT TO INVENT**  
**HOW TO SELL YOUR PATENT**  
Copies of nearest Patents and report in every case without charge  
**H. L. WOODWARD, 9th and G Sts., WASHINGTON, D. C.**

## PATENTS

**MASON, FENWICK & LAWRENCE**, oldest U. S. firm having main office at Washington, D. C. Also New York and Chicago. Established 1861. Best References. **Trade-Marks Registered.** *BOOKLET and Information FREE.*



**MECHANICAL SUPPLIES AND MATERIAL** of all kinds. **EXPERIMENTAL AND LIGHT MACHINE WORK** to order.  
132 MILK STREET, BOSTON

**Models and Gears** **Experimenters — Inventors**  
Developing inventions and making working models our specialty. Well equipped shop and staff of experts at your service. Carry complete stock of gears. Shipments same day order received. **ESTABLISHED 1882.**  
**UNION MODEL WORKS, 121 S. Clark St., CHICAGO**

# PATENTS SECURED OR FEE RETURNED

Compare My **SERVICE** and **TERMS** with Those of Any First Class Attorney

Send Sketch, Photograph, or Model of your invention for an **ACTUAL SEARCH** of the Records of the Patent Office and report as to patentability — **FREE.** I give every detail of every case my closest personal attention and **do not** entrust your interests to assistants. Impartial advice on your ideas. I help you sell your patent. Terms moderate. My 90-page book (1917 edition) tells what inventors should know before they apply for a patent.

**GEORGE P. KIMMEL, Patent Lawyer**  
200 Barrister Bldg. **Washington, D. C.**

**Latest and Most Complete Patent Book Ever Published for Free Distribution**

**WRITE FOR IT**





# Tobacco Habit BANISHED

## in 48 to 72 Hours



### Immediate Results

Trying to quit the tobacco habit unaided is a losing fight against heavy odds, and means a serious shock to your nervous system. So don't try it! Make the tobacco habit quit you. It will quit you if you will just take Tobacco Redeemer according to directions.

It doesn't make a particle of difference whether you've been a user of tobacco for a single month or for 50 years, or how much you use, or in what form you use it. Whether you smoke cigars, cigarettes, pipe, chew plug or fine cut or use snuff Tobacco Redeemer will positively remove all craving for tobacco in any form in from 48 to 72 hours. Your tobacco craving will begin to decrease after the very first dose—there's no long waiting for results.

Tobacco Redeemer contains no habit-forming drugs of any kind and is the most marvelously quick, absolutely scientific and thoroughly reliable remedy for the tobacco habit.

### Not a Substitute

Tobacco Redeemer is in no sense a substitute for tobacco, but is a radical, efficient treatment. After finishing the treatment you have absolutely no desire to use tobacco again or to continue the use of the remedy. It quiets the nerves, and will make you feel better in every way. If you really want to quit the tobacco habit—get rid of it so completely that when you see others using it, it will not awaken the slightest desire in you—you should at once begin a course of Tobacco Redeemer treatment for the habit.

### Results Absolutely Guaranteed

A single trial will convince the most skeptical. Our legal, binding, money-back guarantee goes with each full treatment. If Tobacco Redeemer fails to banish the tobacco habit when taken according to the plain and easy directions, your money will be cheerfully refunded upon demand.

### Let Us Send You Convincing Proof

If you're a slave of the tobacco habit and want to find a sure, quick way of quitting "for keeps" you owe it to yourself and to your family to mail the coupon below or send your name and address on a postal and receive our free booklet on the deadly effect of tobacco on the human system, and positive proof that Tobacco Redeemer will quickly free you from the habit.

Newell Pharmacal Company  
Dept. 300, St. Louis, Mo.



**Mail Coupon NOW  
for FREE Booklet**

NEWELL PHARMACAL CO.,  
Dept. 300, St. Louis, Mo.

Please send, without obligating me in any way, your free booklet regarding the tobacco habit and proof that Tobacco Redeemer will positively free me from the tobacco habit.

Name .....

Street and No. ....

Town..... State.....

Please Mention Popular Mechanics





## Hello Boys! Here's the first ERECTOR EXPERT ENGINEER

Harold Heal, of Pittston, Pa., is the first boy to have the Second Degree title of "Gilbert Expert Engineer" conferred on him by the "Gilbert Institute of Erector Engineering."

# ERECTOR

The Toy Like Structural Steel

After winning the First Degree of "Gilbert Engineer," Harold lost no time in going after the Second, and is now the proud owner of the "Gilbert Expert Engineer" Diploma and the beautiful "E. E. E." button. He is now ready to go after the Third and Highest Degree with its great honors and valuable awards. Have you secured a membership in the "Gilbert Institute of Engineering?"

Win the handsome "Gilbert Engineer" Diploma by doing any one of the three following things:

Send me photograph or drawing of an acceptable Erector model—send the photograph or drawing of an acceptable motor model—or send me photograph showing you know how to put together a motor, the parts of which are included in the Gilbert Electrical Set.

Write today for a free copy of my beautiful book, "How to Become a Gilbert Master Engineer."

See Erector at your dealer's. Lots of fun building skyscrapers, flying machines, cranes, machinery, and hundreds of other models. Great fun operating them with the famous Erector motor. Performs wonders in weight lifting.

*Alfred C. Gilbert Pres.*

Send 10c postage for six months' subscription to my great magazine for boys, "Erector Tips."

**The A.C. Gilbert** 104 Fox St.  
New Haven, Conn.



## Charge Storage Batteries

from alternating current with

## The Blitzen Rectifier

Safe, Clean, Economical

\$2.50 and up

Bulletin for 2c stamps.  
2 catalogs of wireless  
telegraph and electrical  
apparatus sent for 6c  
stamps to cover postage.

**CLAPP-EASTHAM CO.**

147 Main Street Cambridge, Mass.



## DUCK'S <sup>BIG</sup> 300 <sup>PAGE</sup> No. 11 Electrical and Wireless Catalog

Mailed on receipt of 8c in stamps or coin which may be deducted on first dollar purchase. Great cost of catalog and low prices prohibit distribution otherwise.

**What This Big Catalog Contains:**

100 pp. Wireless Apparatus; 10 pp. Raw Material; 5 pp. Transformers; 8 pp. Storage Batteries; 15 pp. Telegraph Sets; 42 pp. Motors and Dynamos; 10 pp. Miniature Lamps; 8 pp. Flashlights; 5 pp. Message Vibrators; 10 pp. Miniature Railways; 5 pp. Lighting Plants; 10 pp. Ammeters and Voltmeters; 25 pp. Electrical and Mechanical Books; 12 pp. Telephone Equipment; 10 pp. Auto Accessories; 13 pp. Victrolas on Easy Payment Purchase Plan; 30 pp. General Electrical Supplies.

THE WILLIAM B. DUCK CO., 223-227 Superior St., TOLEDO, OHIO



## Dynamo \$6<sup>25</sup> Motor

For producing current for inductance coils, re-charging storage batteries, electroplating, and hundreds of other uses.

Well constructed throughout, exceptionally smooth running and highly efficient. A good, strong, durable dynamo.

At all live dealers. If your dealer cannot supply you, order direct from us. Send for FREE Illustrated Catalog.

**KNAPP ELECTRIC & NOVELTY CO.**  
519 W. 51 St., N. Y. City



## THORDARSON Wireless Transformer

Making new records for distance and distinctness. Perfected by C. H. Thordarson, whose high-tension transformers won the Gold Medal at the St. Louis and Panama-Pacific Expositions. Exclusive Variable Shunt and Ampere Scale. Comes completely assembled; no chance for mistakes or burnouts. Five sizes, 1/2 to 2 1/2 K. W.; 10,000-20,000 volts; any cycle desired.

WRITE FOR SPECIAL BULLETIN AND PRICES

**Thordarson Electric Mfg. Co.**  
518 So. Jefferson St., Chicago, Ill.



**RECTIFIERS** for garages. All sizes. Charge from alternating current 1 to 8 batteries. \$12.00 upwards.  
**AMERICAN BATTERY CO., 1137 Fulton St., Chicago. (Est. 1888)**

## BOYS! HAVE DAD GET STRUCTO

Structo—Mechanics in miniature—will turn the trick. With it you can build that bridge or derrick, and a hundred other models that really work. Write for Free Illustrated book.  
**STRUCTO MFG. CO., Dept. 118, FREEPORT, ILL.**

## Send 10c for Copy of Our New Wireless Manual P. 9

YOU GET YOUR MONEY BACK ON AN ORDER OF \$1.00

It contains 180 pages and tells how to erect and maintain wireless telegraph stations. Shows a number of diagrams. Has the Morse and Continental Telegraph Codes. Illustrates the best instruments to use; tells what they are for and how to use them. Has many new diagrams and other valuable information not contained in any other book. Do not wait. Send your request now. Get the best 10c value you will ever buy.

## Send for Our Pocket Catalog P28

It contains 248 pages, with over 1,000 illustrations, and describes in plain, clear language all about Bells, Push Buttons, Batteries, Telephone and Telegraph Material, Electric Toys, Burglar and Fire Alarm Contrivances, Electric Call Bells, Electric Alarm Clocks, Medical Batteries, Motor Boat Horns, Electrically Heated Apparatus, Battery Connectors, Switches, Battery Gauges, Wireless Telegraph Instruments, Ignition Supplies, Etc.

**MANHATTAN ELECTRICAL SUPPLY COMPANY, Inc.**

NEW YORK, 17 Park Place

CHICAGO, 114 So. 5th Ave.

ST. LOUIS, 1106 Pine St.

San Francisco, 604 Mission St.





## Wireless Receivers?

Get a **Murdock 2000-ohm** \$4 complete double set for and prove to your own satisfaction that there are no better 'phones obtainable at **DOUBLE** the prices. Fourteen days' trial allowed and money back without question if you are not sufficiently convinced of the remarkable value to keep them.

Our catalog is free. Ask for a copy.

**WM. J. MURDOCK CO.** 10 CARTER ST. Chelsea, Mass.

## MAKE THESE WIRELESS TESTS AT OUR RISK

Try a Brandes Wireless Head Set against any set of receivers for sensitiveness, clearness and range. If you don't like Brandes Receivers better, return within ten days and get your money back at once. Matched tone is the big reason for Brandes superiority. Catalog P, describing Brandes Matched Tone Receivers sent for 4c in stamps. C. Brandes, Inc., Wireless Receiver Specialists, Room 517, 32 Union Sq., New York, N. Y.

## BRANDES WIRELESS HEAD SETS

The Receivers with MATCHED TONE

## ELECTRICAL HANDY BOOK AND CATALOGUE FREE



### WORTH 25 CENTS TO ANYBODY

The **BIG BOOK** you need and want. Describing positively the fastest and most complete line of wireless, novelty, and experimental goods ever listed in any catalog and containing besides, innumerable tables, book-ups and treatises of incalculable value to the experimenter. Absolutely Free. Send No Postage.

**THE ELECTRO-SET COMPANY**  
Leader Bldg., Dept. P-11 Cleveland, Ohio

## THE AMERICAN MODEL BUILDER

WRITE FOR CATALOG

**The American Mechanical Toy Co.**  
304 E. First Street DAYTON, OHIO

## COIN RINGS 50 Cents POST PAID

Made of dimes, beautifully embossed. Big hit! Agents big discount. Send for circular, coin jewelry.

**WM. COMERFORD, 44 Seneca St., BUFFALO, N. Y.**

**CACHOO!** Make the whole family and all your friends "just sneeze their heads off" without knowing why, with **Cachos**, the new long distance harmless snuff. Sent anywhere for 10c. 3 for 25c. 1 doz. and special premium for 9c. **AMERICAN SUPPLY CO., St. Paul, Minn.**



## WATCHES

**21 JEWEL** Watches, 16 Size, that will pass Railroad inspection  
**CREDIT TERMS AS LOW AS**

**\$2.50** A Month



### Watch Prices "Down to Bed Rock"

Our prices on high-grade, standard Watches are always the lowest, while values are top-notch. Send for Watch and Diamond Catalog and get posted about Watches before you purchase. Our Catalog illustrates and describes all the new models—Elgin, Waltham, Illinois, Hampden, and others—15, 17, 19, 21, 23 Jewels, adjusted to temperature, isochronism and positions. You do not have to take any special make when you buy of us, for we have all the best for you to select from, and you judge for yourself after you see and examine the watch. Our watches are guaranteed by the factory and further guaranteed by us. We make any necessary repairs, barring accident, free of charge, for a period of three years from date of purchase.



## Diamonds On Credit

**Diamonds Win Hearts** SEND FOR CATALOG and see the splendid Diamond Rings we are selling on credit terms as low as \$2.50 a month; Diamond La Vallieres as low as \$1 a month; Diamond Ear Screws, Studs, Scarf Pins, at \$2 a month; all mountings solid gold or platinum. Wrist watches at \$1.50 a month. Anything you select will be sent prepaid by us. You examine the article right in your own hands. If satisfactory, pay one-fifth of the purchase price and keep it, balance divided into eight equal amounts, payable monthly. If not what you wish, return at our expense. You are under no obligation. Send for Catalog today.

**LOFTIS BROS. & CO., The National Credit Jewelers**  
Dept. M894, 100 to 108 N. State Street, Chicago, Illinois  
(Established 1858) Stores in: Chicago : Pittsburgh : St. Louis : Omaha



## WANTED—Railway Mail Clerks

Commence \$75 Month Increase to \$150 "

**Franklin Institute**  
Dept. A103, Rochester, N. Y.

Common Education Sufficient

Sure Pay. Life Job. Full Un-necessary.

Sirs: Send me, without charge, sample Railway Mail Clerk Examination questions; schedule showing dates and places of examinations; list of other government jobs now easily obtainable and free book describing them.

NAME.....

ADDRESS.....

## Unnecessary Indigestion

Indigestion, constipation and the ills they lead to are so *wholly unnecessary*—and cause so much *needless suffering*—that Dr. Kellogg, Chief Medical Director of the Battle Creek Sanitarium, has written a book, "Colon Hygiene", in which he tells you how such ills may be avoided. During his more than forty years' experience at the Sanitarium, Dr. Kellogg has prescribed for thousands of cases of indigestion, constipation and the more serious ills to which they lead. Therefore, what he tells you in his book, is the result of experience. He deals with facts—not theory. Dr. Kellogg recommends only natural methods—diet, exercise, rest and sleep. No drugs. Instructions given in

"Colon Hygiene" are so full, complete and plainly stated that you can easily follow them right in your own home. No tiresome regime. No exhaustive system. Only what your own common sense promptly tells you is rational and natural. Over 400 pages. Many illustrations. Price \$3. Write for the book today. You take no risk. For, after five days' examination, if you are not entirely satisfied, you may return the book for prompt refund of your money. Is this fair? We let you judge the value of this book for your own needs.

### USE THE COUPON

**GOOD HEALTH PUBLISHING CO.,**  
5304 Washington Ave., Battle Creek, Mich.  
I attach \$3 for "Colon Hygiene" which I will keep or return in five days for refund.  
(Write your name and address plainly in the margin.)





## Are You Sure?

ON the steep down grade or the elbow turn is your brake one that you can place absolute confidence in? An unreliable brake is worse than no brake at all. It gets you into trouble. There is one way of being sure, sure for once and all time. Equip your bicycle with the recognized standard brake equipment—the



### DUPLEX COASTER BRAKE

With this famous brake on your hub you can go where you please with absolute knowledge that it will control your speed no matter what demands you may make on it. Cyclists have tried it for years under all conditions and have found it never-failing.

Its action is powerful, smooth and flexible, enabling you to stop instantly or gradually. Its large ball bearings and sturdy construction make it everlastingly durable. This is the brake that has grown up with the bicycle—16 years of satisfactory service. It is 100% efficient. See that the Corbin Duplex is on your wheel. Equipped by all bicycle dealers everywhere.

**"Corbin Control Means Safety Assured"**

It doubles the comfort and pleasure of riding.

### The Corbin Screw Corporation

The American Hardware Corp., Successor  
200 High Street New Britain, Conn.  
Branches: New York Chicago Philadelphia  
Makers of Corbin-Brown Speedometers

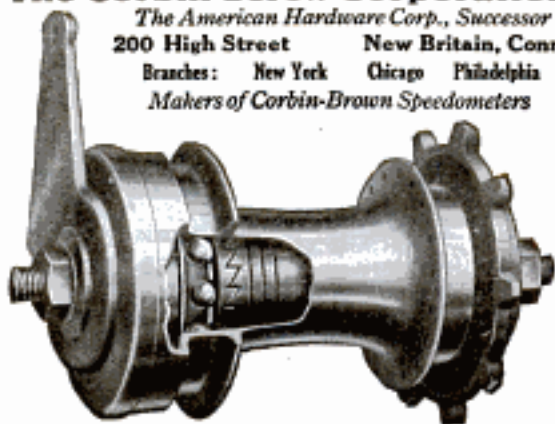

## Speedy, Sturdy, Bikes

Unquestionably worth one-third to one-half more. A swift, sturdy bicycle—sold on a basis of Satisfaction Guaranteed or Money Back. Carefully constructed of heavy gauge, seamless steel tubing—triple truss forks, arch crown design. Beautifully enameled and striped.

### The New Service \$19<sup>95</sup> Up

Equipped with genuine Majestic, heavily studded, anti-skid, puncture-proof tires—motorcycle type. Shipped from Chicago

### Get Our Beautiful Bicycle Book—FREE

Filled from cover to cover with wonderful illustrations in colors, of low-priced, high-grade bicycles. Address house nearest you.

**Montgomery Ward & Co.** Dept. G133

New York Chicago Kansas City Ft. Worth Portland, Ore.

### The Boy's Junior Power Driven Automobile

You can build it yourself or buy it complete already assembled. 1917 Model

Parts inexpensive. Send 20c for blue print and price list of parts.



SYMPHER  
MFG. CO.

146 Warren St., Toledo, Ohio

### BIG PROFITS in Charging Auto Storage Batteries

Hundreds of garage owners are clearing from \$20.00 to \$60.00 profit each month with the HB Charging Set. Current costs 12c per battery, and you get from 15c to \$1.50 for each battery charged. Figure your profits.

#### \$10 Places This Money Maker in Your Garage

The balance in monthly payments of \$10.00 each. Every HB outfit fully guaranteed. If you are looking for big profits, here is an opportunity. Tear out and mail this ad today with your name. We'll gladly tell you more.

HOBART BRON COMPANY, Box 54, TROY, OHIO



MAKE A  
MOTORCYCLE  
OUT OF YOUR  
BIKE

FITS EITHER  
SINGLE OR  
DOUBLE BAR  
BICYCLES

WITH OUR ATTACHMENT

#### 1917 MODEL NOW READY

No special tools required. Fits right in the frame of any single or double bar bicycle. Weighs only 15 pounds (including magnet). Runs 80 to 100 miles per gallon gasoline. Write now for FREE CATALOGUE and special offer for introducing first machine in your locality.

CYCLEMOTOR CORPORATION ROCHESTER NEW YORK

THE ONLY 2-STROKE HIGH-SPEED BIKE MOTOR

Please Mention Popular Mechanics



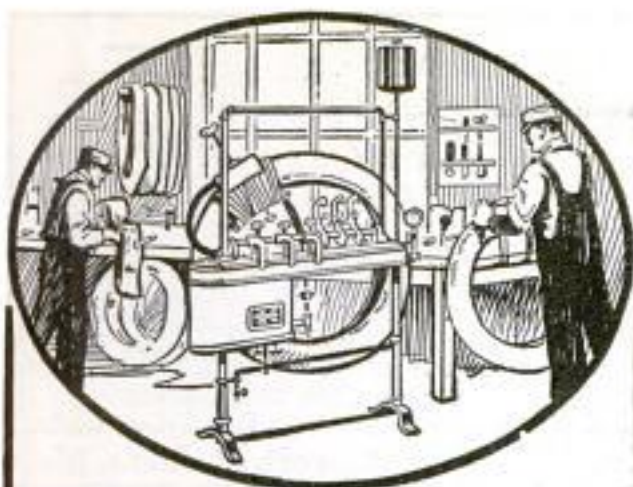

## Big money for you

Think of the auto owners in your own locality who are eager to have their tires repaired! Open a repair shop with a Shaler Tire Repair Outfit. Earn \$250.00 per month. No experience necessary. We make it easy for you to start right away. You have your own business.

## Free Book Tells How

Write for our wonderful book, "How to Open a Tire Repair Shop." It will open your eyes! Shows you how easy the work is. Shows you the big money that can be made. Write for this book today. A post card will do.

**C. A. SHALER COMPANY**

2003 Fourth Street

Waupun, Wis.

## STANWELD Cold Drawn Seamless Steel TUBING

Lightest, smoothest, strongest Steel Tubing made. World's largest manufacturers of bicycles, motorcycles and automobiles use it exclusively. Send for Folder "A."

**THE STANDARD WELDING COMPANY**  
Main Office and Factory CLEVELAND, OHIO

## EXTRAORDINARY BICYCLE VALUES

SEND FOR OUR MONEY SAVING BICYCLE CATALOG

YOU folks who are interested in the royal sport of bicycling will want a copy of our latest Catalog of Bicycles. Your copy is free on request. It describes and illustrates bicycles of high quality and quotes surprisingly low prices. That's why we say it is a book of "extraordinary bicycle values." Just mail us a postal card and ask for Bicycle Catalog No. 881P.

Sears, Roebuck and Co.,  
Chicago, Ill.



SEARS, ROEBUCK AND CO. CHICAGO



# Learn Mechanics of Aviation

**YES**, right in your own home, in your spare time, you can learn all the principles, the theory and the mechanics of Aviation. You can prepare yourself for flying, if you wish. Or you can gain all the practical knowledge to equip you to enter the big paying and fascinating business of aeroplane construction and as aero-mechanical engineer. Send the coupon at once! Find out how our wonderful course in Aviation will give you the knowledge necessary to enter this field. Everybody planning to enter the Aviation fields needs the knowledge which this course offers. This is the first time that anyone has had the opportunity to gain this instruction at home—and without great sacrifice of time and expense. Waste no time in sending coupon.

## Big Opportunities NOW!

### What Course Covers:

Aero History—Aero Physics—Aero Dynamics—Wing Designing and Construction—Aeroplane Assembling—Balloon Building and Operating—Aeronautical Wireless.

Now is the time for every man who has considered Aviation to get into the field. Each day presents new opportunities. The pioneers are going to reap the rich rewards. Automobile history, railroad history, motion picture history will repeat itself in Aviation. The men who get in early are the men who will amass the fortunes. Right now there are opportunities for men who are experts in the mechanics of Aviation that pay anywhere from \$50 to \$500 a week. In aeroplane factories, government branches, aero societies, repair shops. Only trained men will do. Heretofore this was obtainable only at a great sacrifice of time and expense by field training. Now you may secure this

same training at home—in much shorter time, a mere fraction of the expense, and without interfering with your regular work.

### Endorsed by Aviation Authorities!

Leading aviators and flying organizations have endorsed this course as a quick and reliable means of training for the business and practice of Aviation.

## Special Offer

### Send the Coupon

Those who write at once will still be able to take advantage of the special limited offer which is now in force by which they may secure a large tuition reduction. Write now while this offer lasts for full particulars. Send coupon—no obligation.

**American School of Aviation**  
431 S. Dearborn St.,  
Dept. 1184  
CHICAGO, ILL.

**American School of Aviation**  
431 So. Dearborn St.  
Dept. 1184, CHICAGO

Gentlemen:—Please send me, free and without obligation, full particulars of your course in Aeronautical Engineering and details of your special limited offer.

Name.....  
Address.....



## Pulls you out of trouble

Carry this little Pull-U-Out in your tool box and you will be independent of road conditions. With it a boy can, unaided, pull a 5000 lb. car out of ditch or mud. Pays for itself on its first job. Besides pulling autos out of trouble it will do all kinds of lifting and pulling in the factory, garage, on the farm or construction job, etc.

Consists of a winding drum, lever crank, 40 feet of steel cable, two 7 ft. chains and 3 stakes. Weighs only 28 lbs. and goes in space 4x6x14 inches.

A pressure of only 30 lbs. on the handle will lift a ton



Cheaper and better than a chain block.  
Does jobs no other machine can do.

WRITE FOR BOOKLET—VERY INTERESTING  
Tells how and why this marvelous little Pull-U-Out works.  
Pull-U-Out Sales Co., 2035 Market Street, St. Louis, Mo.

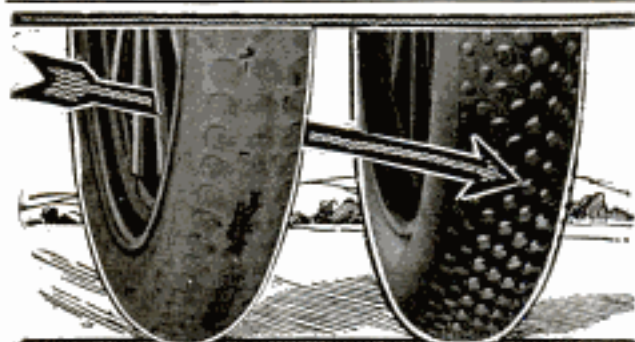
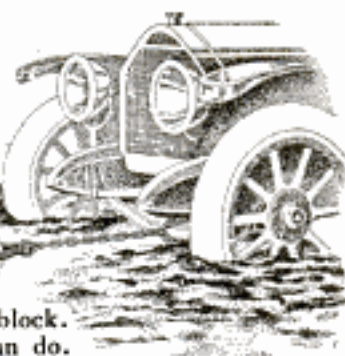

## Save Your Old Tires

Get 5,000 Miles More Service by "half-sooling" them with Steel Studded Treads the same as European Motorists have been doing for over three years. 20,000 American Motorists have done this in the last 8 months and are saving \$50.00 to \$200 a year in tire expense.

5,000 Miles Without Puncture is the signed guarantee you get with every Durable Steel Studded Tread.

We Deliver Free Special Discount without a cent deposit, prepay express and allow you to judge. offered to motorists in new territory on first shipment direct from the factory. Mail the coupon below for details. Be sure and put in your tire sizes.

MAIL TODAY—SAVE THE DISCOUNT

The Colorado Tire & Leather Co.

47 Tread Building, Denver, Colorado. D-2 Transportation Building, Chicago, Ill. 720-14 Woolworth Building, New York City.

Without obligation send me free catalog, copy of guarantee, sample and booklet "10,000 Miles on One Set of Tires."

Name .....

Address .....

My Tire Sizes are .....



The Guide That Knows All Trails—that shows you how to go—and come back in a straight line; that is never "all turned around."

The Only Guaranteed Jeweled Compass at \$1.00

Ask your dealer to show you the Taylor-made Line of Compasses—Leedawl, \$1.00; Libente, \$2.00; Meradial, \$2.50; Auropole, \$2.50; Centronie, \$3.00. If he cannot supply you or will not order for you, remit direct to us. Ask for Compass Folder or send 10c for Book, "The Compass, the Sign Post of the World."

Taylor Instrument Companies, Rochester, N. Y.

Makers of Scientific Instruments of Superiority

Please Mention Popular Mechanics



## STOP THOSE LEAKS!

Insure your new tires against punctures. Keep your old tires air tight. Treat all tires with

## Neverleak Tire Fluid

Makes tires last longer. The one reliable preparation. 25c a tube.

## The Cleveland Lightweight

The only light, low priced Motorcycle with straight line worm drive. Weighs 150 pounds. Highest quality through-

out. 75 miles to the gallon. 600 sold in one city last year. Price, \$160.00; with Kick Starter, \$170.00. Dealers wanted.

THE CLEVELAND MOTORCYCLE MFG. CO.  
7202 Platt Avenue, CLEVELAND, O.



## Mobiloils

A grade for each type of motor

## Edwards Steel Buildings



Everything from Garages to Factories

Erected easily and quickly. Taken down just as readily and moved to any desired new location. Weatherproof, fireproof, timeproof. Wonderfully durable. Whatever the need—garage, booth, bathhouse, office, storehouse, school, cottage, barn, hospital, or factory, there's an Edwards Steel Building for the purpose. Write today for descriptive literature and prices.

The Edwards Manufacturing Company  
1320-1370 Eggleston Avenue Cincinnati, Ohio



TRADE  
STEEL  
**BUTLER**  
PRODUCTS  
MARK

# Gas-Air System

THE Butler System will deliver either gasoline or air or both at the same time. It's a complete, attractive gasoline and air filling station with the work and danger eliminated. Simply turn the lever and gasoline or air is discharged.



**The Cabinet** is neat and attractive in appearance, beautifully finished in bright red. Built from heavy steel throughout. More substantial than cast iron, yet much lighter to ship and easier to handle.

**Equipment**—Accurate 100,000 gallon meter. Gravity filter. Overhead hose draining valve. Steel lined gasoline hose with nozzle. Pressure gauge for tank. Underground gasoline cut-off. With or without Electric Lighting System. Lower part of cabinet equipped with air pressure gauge, tire gauge, air hose and connections if desired.

**The Tank** is made from special heavy metal and painted with special Rust-Resisting Paint. All seams welded. Butler Tanks will stand many times the pressure required.

**Write Today** on your letterhead for attractive booklet giving full information and showing other styles of outfits.

**BUTLER MFG. CO.**

504 Butler Bldg., Kansas City, Mo.  
899 6th Ave. S.E., Minneapolis, Minn.  
Metal Garages, Truck Bodies, etc.



## Convert Your Bicycle into a

**Motor-Cycle** Motor fits any wheel. BEST, MOST RELIABLE. Best hill climber. More STEFFEYS in use than all others. Stamp for circulars. STEFFEY MFG. CO., 5007 Brawa Street, PHILA., PA.

## Used Motorcycle Bargains!



Get our wholesale prices on used and demonstration machines. Here's a sample—Indian, 7 H. P. TWIN, 1912 Model, \$35.00. Many others at prices you can't resist. All machines guaranteed to be in first class running condition, including tires. Our prices mean quick sales; don't run the risk of being disappointed, but write us today for prices and full particulars.

Olive Cycle & Motor Co., 1051 N. Grand Ave., St. Louis, Mo.



## Powerful and Positive

This whistle is not an exhaust signal. It screws in place of the priming cup and is blown by the explosion direct. Standard equipment on the following cars: "Little Giant," Sandow, Doan, Lamson, Hendrickson, Fargo, Pulmer, Nelson, and LeMoon. Could you wish further proof of the merits of the Buell? Write for interesting circular.

**THE BUELL CO.**

1610 Michigan Avenue CHICAGO



## Delivered TO YOU FREE

Your choice of 44 styles, colors and sizes in the famous line of "RANGER" bicycles, shown in full color in the big new Free Catalog. We pay all the freight charges from Chicago to your town.

**30 Days Free Trial** allowed on the bicycle you select, actual riding test in your own town for a full month. Do not buy until you get our great new trial offer and low Factory-Direct-To-Rider terms and prices.

**TIRES** LAMPS, HORNS, pedals, single wheels and repair parts for all makes of bicycles at half usual prices. No one else can offer you such values and such terms. **SEND NO MONEY** but write today for the big new Catalog. It's free.

**MEAD CYCLE COMPANY**  
Dept. B 108 Chicago

Rider  
Agents  
Wanted

# Put Kokomos On Your Bike This Spring

TRY any one of the seven splendid KOKOMO Bicycle Tires this spring, and you'll find out how good a bicycle tire really can be.

Seven different styles and prices in the KOKOMO line—with various treads and colors.

They are all good tires—every one of them the best tire we know how to build at its price.

The price of KOKOMO Tires has NOT been increased, and will not be if we can help it.

KOKOMO Tires will wear the way you've always wanted a tire to wear. When you buy a new bicycle, see that it has KOKOMO Tires. When buying tires, ask for KOKOMO.

LONG-LIFE  
**Kokomo**  
BICYCLE TIRES

Home for Lunch



2  
of  
the  
7

## CHOOSE:

EVERLASTER	each \$5.00
KOKOMO KORD	each 5.00
NO. 13 SPECIAL	each 4.25
STICK TIGHT	each 3.75
DEFENDER	each 3.25
OXFORD	each 2.50
PIONEER	each 2.25

**KOKOMO RUBBER CO., Kokomo, Ind.**

A leader for more than twenty years

Please Mention Popular Mechanics



REGULAR RIDING  
REGULAR GEAR

Be Sure That Bicycle is Up-to-Date  
with a  
**Sturmey-Archer 3-Speed  
Coaster Hub**

HILLS AND  
ROUGH ROADS  
LOW SPEED

Gives the rider three distinct gears which meets every road condition, also a perfectly free coaster and a powerful, smooth working brake. You can change instantly to any gear while pedaling, coasting or braking; can travel farther with less energy; light and very simple; over one hundred thousand in use.

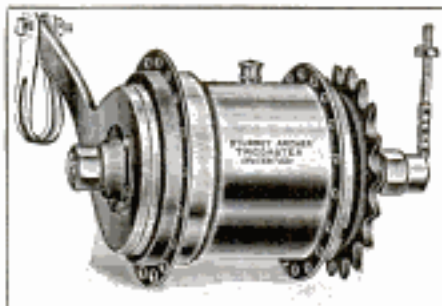

Adopted by the Allied Armies of Europe, where they get the severest use. All big bicycle makers are using them. Can be easily equipped to bicycles now in use. Costs only a trifle more than the old-fashioned coaster brakes, which gives one gear suitable for only one road condition.

GOOD  
ROADS &  
RACING  
HIGH SPEED

Why be satisfied to buy or own a bicycle with an old style coaster—a *Sturmey-Archer 3-Speed* brings it up to the minute—absolutely guaranteed—*See Your Dealer.*

Send for full information

**CYCLE MFG. & SUPPLY CO.**  
182 No. Dearborn St., CHICAGO

COASTING  
OR BRAKING  
ANY SPEED

SMALL SET BACK  
**Veeder Counters**  
(Ratchet or Revolution)

RESET TO ZERO BY A SINGLE TURN

These counters are just as high grade as our large counters, but are lower in price. Price \$5.

There are Veeder counters for practically every purpose. Our booklet describes these uses in detail and shows various instruments. It is interesting and free. Send for it.

The word Veeder stands for the best constructed and most accurate counting devices.

Cyclometers, Odometers, Tachometers. All kinds of counters. Fine Die Castings.

**VEEDER MFG. CO.**  
4 Sargeant St., Hartford, Conn.

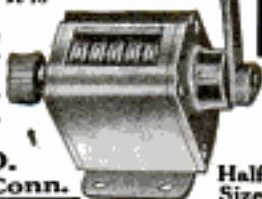
Half  
Size

Start a Big-Paying Business  
of your own with a  
**BADGER TIRE REPAIR OUTFIT**

The man who's equipped to supply the stupendous demand for auto tire repairs can make an assured income of \$100 to \$300 or more per month. The famous Badger Solid Pad System with its strong array of improved features

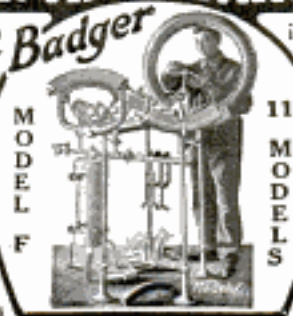

insures your customers quick, economical, high-grade repair jobs, the kind that build up steady trade. We teach you free and help you start the business. Write for copy of Catalog and details of complete money-making Free Aid Service. 601 Johnson Street APPLETON, WIS.

**TIRE REPAIR EQUIPMENT CO.**

The National Safety Council, Chicago, has a committee of 50 experts working out the maximum and minimum requirements in safeguarding. The findings of these experts are summed up in monthly Safe Practices Leaflets. These leaflets are distributed free to members.

GENUINE  
**"BULL"  
DURHAM  
TOBACCO**

High Grade **Hand Horn**

Look Out!

No Batteries Needed

For \$225

Long-life hardened steel mechanism.

**Riverside Hand Horn**

Satisfaction Guaranteed or Money Back. Send for FREE Auto Hook. Write house nearest you.

Montgomery Ward & Co. Dept. C133  
New York Chicago Kansas City  
Ft. Worth Portland, Ore.

Made of pressed steel and spun brass

Part of the Automobile Supplies





MODEL OU  
Open Express Body

## Real Delivery Bodies —Built by Engineers

Highland Utility Bodies are sturdy, durable and stylish. They carry the maximum of load with the minimum of strain on the chassis. We've been building them for 25 years, and we know how.

Yet Highland costs no more than a make-shift body, so why experiment? Special lines for the Ford chassis, for light duty, and for heavy duty trucks.

Write on business stationery for catalog, mentioning type of body you're interested in.

Highland Body Manufacturing Co.  
402 Elmwood Place Cincinnati, Ohio



Turn Your Motorcycle  
into a  
**LITTLE ROADSTER**  
by attaching the

**TRIPLEX SIDE SEATS—Price \$25**

Write today for booklet and agency offer

HAVERFORD CYCLE COMPANY, Philadelphia, Pa.

## The Mechanically Perfect Coaster-Wagon



Here is the substantial wagon. Built for wear. Fastest, smoothest coaster and easiest puller made. A favorite for play; a great help at chore time. Read these specifications: Steel axles; steel hubs; dust-proof hub caps; roller bearings (see cut below); steel tires; oval spokes; body, ash with maple bolsters (natural finish); braces where the strain falls.

**The Auto-Wheel Coaster**  
is built like a real wagon; and it will last longer.

**Boys** FREE Pennant for names of 3 wagon dealers. Mention those who carry the Auto-Wheel. **WRITE NOW.**

**BUFFALO SLED CO.**  
137 Schenck St., N. Tonawanda, N. Y.  
In Canada: Preston, Ont.



The 1917  
←ARROW→

Electric Light

# Great Bicycle Offer!

### Electric Light

Reinforced motorcycle frame—large, easy motorcycle saddle—long, rubber grip, motorcycle handlebars—New Departure coaster Brake—special motorcycle pedals—motorcycle mudguards, stand and luggage carrier—imported anti-friction chain—Fisk, Thorn Proof, Non-Skid Tires—beautiful enamel finish—other new features. Write now.

Send the coupon below today for free catalog of the new 1917 "Arrow" Bicycle. See our great offer below. Read the sensational improvements in the new 1917 model. **Motorcycle type.** Built like the very highest grade motorcycles. A positive wonder for speed, easy riding and comfort. The biggest bicycle value ever built. All sizes for boys, men and women. Send the coupon today for free catalog.

## Pay As You Ride

Find out about our special rock-bottom direct offer on this New 1917 Arrow. A special 30-day, reduced price offer. We ship the bicycle to you without a penny down. Start riding and enjoying the Arrow right away. And pay the special rock-bottom price—a small amount each month—while you ride. If you do not agree when you see the 1917 Arrow that it is the biggest bicycle bargain you ever saw, send it back at our expense. You be the judge. Send the coupon for free catalog.

**Pays for Itself:** The coupon brings our liberal rider-agent proposition. The easiest ever! Just ride your Arrow around. People will admire your handsome bicycle and ask about it. Just answer their questions. You can pay for your Arrow and get extra money besides. Just send the coupon for full particulars and New Catalog.

### Send the Coupon Now!

Don't delay. Learn about the sensational 1917 Arrow right away. Take advantage of our special, 30-day rock-bottom price offer. Get the free catalog and details of easy Rider-Agent offer. Send the coupon now while this offer lasts.

Arrow Cycle Co.  
Dept. 1194, 19th St.  
and California Ave.  
Chicago, Illinois

Please send me free catalog of the New 1917 Arrow and particulars of your 30-day rock-bottom "Pay-As-You-Ride" Offer and Rider-Agent Proposition.

Arrow Cycle Co.

Dept. 1194  
19th Street and  
California Ave.  
Chicago, Ill.

Name.....

Address.....

Please Mention Popular Mechanics



## GET THROUGH MUD UP TO THE HUB

A car equipped with a New Stromberg Carburetor generates power equal to the occasion. The increased pull necessary to ram through hard, heavy going comes into play instantly on demand—a forge ahead force that is mightier than the drag of the mud.

### The New Stromberg Carburetor

excels on all models of every make in creating power to answer every purpose—in mileage increase, fuel economy, acceleration and starting ease in coldest weather.

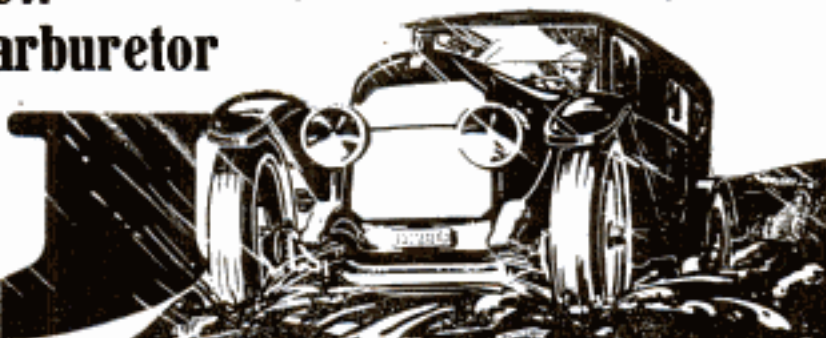

## Special New Stromberg For Fords

establishes official starting, speed and economy records—37 <sup>1</sup>/<sub>10</sub> miles on one gallon of gasoline—from standing start to 25 miles per hour in 11.4 seconds—then without touching carburetor car made 43 miles per hour. These tests made under ordinary conditions demonstrate Stromberg superiority and value to every Ford owner.

Write for World's records and free particulars—giving name, model and year of your car.

**Stromberg Motor Devices Co.**  
Dept. 414 64 E. 25th St., CHICAGO

# New STROMBERG Does it! CARBURETOR

## MIAMI-MADE BICYCLES

Stand at the top of the bicycle world.  
RACYCLE, HUDSON, MIAMI, FLYING MERKEL.  
Write for our catalog.  
THE MIAMI CYCLE & MFG. CO., MIDDLETOWN, OHIO



## 30 Days Free Trial

and freight prepaid on a new 1917 "RANGER" bicycle. Write at once for our big catalog and special offers. Take your choice from 44 styles, colors and sizes in the famous "RANGER" line. Marvelous improvements. Extraordinary values in our 1917 price offers. You cannot afford to buy without getting our latest propositions and Factory-to-Rider prices.

Boys, be a "Rider Agent" and make big money taking orders for bicycles and supplies. Get our liberal terms on a sample to introduce the new "RANGER."

TIRES equipment, sundries and everything in the bicycle line at 1/2 usual prices. Write today. A post card will do.

**MEAD CYCLE COMPANY**  
Dept. B 108 Chicago

Ranger Electric Lighted Motorbike

## DODGE BROTHERS MOTOR CAR



## Buy an Akron-Williams

Tire Repair Outfit. Get into this profitable business with the same equipment that is used and endorsed by 50 per cent of the big tire manufacturers and successful repair shops. Write for book giving full details.

The Williams Foundry & Machine Co.  
50 Cherry Street AKRON, OHIO

## It's the Brake I've Always Wanted

WIN THE RACES YOU ENTER—coast further than the rest of the bunch—be able to roll to a stop quicker and surer. You can if you equip your bike with an

## Atherton Coaster Brake

The Atherton Coaster is the real "Get-There-First" Brake. It's the Brake you can't help buying if you know the full facts about Brakes. It's the Brake that never gets out of order—because it has only six working parts.

Send for FREE Gold-Plated Stick-Pin Write us the names of three Bicycle Dealers in your town and we will send you the Stick-Pin absolutely FREE, together with interesting Booklets giving facts worth knowing about Brakes. Write Us Now

**Buffalo Metal Goods Co.** 221 Winchester Ave. BUFFALO, N. Y.

The **Atherton**  
It always works!





## MAKE BIG MONEY Concreting In Your Section

You can easily earn \$8 to \$20 a day with a Sheldon Batch Mixer. Our customers are doing it right now. The jobs go to the man with a Sheldon Mixer every time. Saves labor of 1 to 4 men, according to size of job. Or, if you buy machine for your own use, you can make many times its cost in a season by renting it to your neighbors.

**Build Your Own Walks, Floors, Foundations, Buildings, Silos, Tanks, Troughs, etc.**

out of concrete with a Sheldon Batch Mixer. The ideal machine for all small jobs. Will pay for itself on first small job. Beats hand mixing a mile. And it's a lot cheaper, too. Takes the backache out of concrete. Makes possible those many small improvements about the place; you wouldn't do without it. Improvements that save time, labor and money and add many dollars to the value of your property. Just the machine you need.

## Make Your Own Concrete Mixer.

At a cost so low you cannot afford to mix concrete by the shovel method.

Along with our iron parts we send **Free Plans** and permit for making your own machine. Or, we will sell you the complete machine. Two styles, hand or power. Will mix 2½ cu. ft. a minute. Keeps 1 to 6 men busy. Has chain drive, self-tilting dump, easily moved, and all parts guaranteed. Does work equal to \$400 machines, costs less than 1-10 as much. No other machine like it. Patented.

**Write for FREE Catalog and Special Offer**

Shows our full line. Sold direct to you on strong guarantee, backed by 90 days' trial. Ten men wanted in every county right now to accept our special offer, which will help you secure a machine at little or no cost. Write us today for catalog and particulars of offer.

**SHELDON MFG. CO.**  
Box 7578 NEHAWKA, NEB.

# FREE Plans



\$11<sup>50</sup> up

**Sheldon Batch Mixer**

## AGENTS—A Big Seller SCREEN DOOR CHECK



**Low Priced** Splendid summer seller. Stops the bang and saves the door. Easy sales. Big profits. Big demand. A sale in every home. Dozen can be carried in pocket. Demonstration sample free to workers.  
**THOMAS CHECK CO., 4448 East St., DAYTON, O.**

## Comfort Indoor Closet

Odorless, Sanitary, Germ-proof. Can be placed anywhere in home. A guarantee of healthy, sanitary conditions.

**SWAT FLY BREEDING CLOSET**

Have city conveniences. Germ-life killed instantly by chemicals. Emptied once a month. Needs no other attention. Boards of Health endorse. Write for literature.

Agents wanted—exclusive territory  
**COMFORT CHEMICAL CLOSET CO., 384 Parkside Bldg., TOLEDO, OHIO**



## Stop the scratch

Take the noisy scratch out of old, worn records, and restore the tone of your old favorites. Improve the tone and prolong the life of new records.

## The "Little One-der"

will do it. Instantly attached to any needle machine, Pathé or Victrola.

Postpaid for 75c. Order today. Money back if not satisfied.

**BROWN MUSIC CO.**

Dept. D, 3018-91st Street Chicago



## Your Choice For 10 Days' Wear FREE



**No. 2.** Ladies' Solid Gold Ring. Has a guaranteed genuine Tifnite Gem almost a carat in size. Price, \$12.50; only \$3 upon arrival. Balance \$5 per month.



**No. 3.** Men's Tooth Gold Ring. Six-prong tooth mounting. Guaranteed genuine Tifnite Gem almost a carat in size. Price \$12.50; only \$3 upon arrival. Balance \$5 per month.



**No. 1.** Men's Flat Back Ring. 8 claw mounting; flat wide band. Almost a carat, guaranteed genuine Tifnite Gem. Price, \$12.50; only \$3 upon arrival. Balance \$5 per month.

Here is the most amazing offer ever made on precious gems. To quickly introduce into every locality our beautiful TIFNITE GEMS—which in appearance and by every test are so much like a diamond that even an expert can hardly tell the difference—we will absolutely and positively send them out and on trial for 10 days' FREE wear.

## Only 10,000 On This Offer

Send coupon NOW! We'll send you your choice of these three magnificent rings at once. After you receive the beautiful, dazzling gem and the handsome solid gold mounting—should you then decide that you like it—pay us only \$3 upon arrival. If you believe you have a wonderful bargain and want to keep it, pay balance in small easy payments as stated under each item. If, however, for any reason you do not wish it, return it at our expense within 10 days; and any money paid will be refunded.

## Tifnite Gems Solid Gold Mountings

The nearest approach to a diamond ever discovered. Have the fine pure white color, fire, brilliancy, cut and polish. They stand every diamond test—fire, acid and diamond file. Will cut glass like a diamond, and guaranteed not to be made of glass. The mountings are guaranteed solid gold.

## Send No Money Send No References

Just send coupon. You do not obligate yourself in any way. Be sure to give correct number of ring and size wanted. To get the right size Ring, cut a strip of heavy paper so that the ends exactly meet when drawn snugly around the second joint of finger. Send the strip of paper to us with coupon.

Send it now and get a TIFNITE GEM on our liberal 10 days' free trial offer. Then decide whether you want to keep it or not. Send today—sure.

**THE TIFNITE GEM CO.,**  
Rand-McNally Bldg., Chicago, Ill.

## Free Trial Coupon

**THE TIFNITE GEM COMPANY,**  
Dept. 118  
Rand-McNally Bldg., Chicago, Ill.

Send me Ring No. .... on 10 days' approval.  
If satisfactory upon arrival I agree to pay \$3 on account and balance at rate of \$3.00 per month. If not satisfactory, I will return same within 10 days.

Name.....

Address.....

Please Mention Popular Mechanics



# JOIN THE ARMY

Of Peaceful, Contented Smokers Of The BREECHLOADER: The FIRST and ONLY DRY, "JUICELESS," "HEELLESS," "CLOGLESS," SWEET, SANITARY, SAFETY SMOKING PIPE Ever Devised. Anticipating Scepticism As To The Credibility of Said Statement, We Hereby GUARANTEE To Substantiate Each and Every Claim; MAKE GOOD, Or REFUND The Purchaser's Money Upon DEMAND. Columns of "Pipe-Talk" Could NOT Strengthen So EQUITABLE A Proposition, Positive Proof Of Which Is At YOUR Command. Study The Engravings; Note the Clog-Eliminating Aluminum Shield On Breech Plug, Then Decide To Send for the BEST PIPE You Ever Owned.



**THE BREECHLOADER** Is **EXTREMELY SIMPLE**, Most Substantial and Practical; Neat and Unique in Design; A Very Desirable Size; 5½ in. long With Graceful Curves; A Little on the "Chubby" order, Quarter Bent; Considerably Lighter, Holding about one fourth more Tobacco than the ordinary pipe of the same size. The Bowl and Breech Plug is made of **FIRST QUALITY, GENUINE FRENCH BRIAR**; Given a Rich, Natural, Friction Finish; Solid Rubber Stem; Sterling Silver Mounted; Price Including Nickel Plated Pipe Companion \$1.00 Postpaid. Or Write for Free Pamphlet.

**THE BREECHLOADER PIPE CO., Inc.**  
Suite One, 335 Broadway, New York, N. Y.



## Save Money Buy a Lewis-Built Home

Deal direct with the producer and get the inside price. Our plan gives you a selection from 100 modern houses, cottages and bungalows, cut without waste in our modern factory and shipped complete with all materials.

Big saving in cost of materials, time and labor. Forty per cent saved on carpenter work alone. Our 1917 prices based on 1916 costs. Our economy in cutting—our facilities for producing in quantities—the superior quality of our materials—is your gain.

Complete Catalog showing floor plans, actual photographs and rock-bottom prices on 100 modern houses costing \$300 and up, 4 cents postage. Home Furnishings Catalog also sent on request.



**LEWIS MANUFACTURING COMPANY**

Dept. 478 **LEWIS-BUILT HOMES** Bay City, Mich.



## Alco \$260

**LIGHTING SYSTEMS**  
Efficient—Reliable  
110 Volt Current

**THE AUTOMATIC LIGHT CO.**  
Port Clinton, Ohio, U. S. A.

## Save \$20 to \$50 on COAL BILL



Save \$20 to \$50 on winter coal bill with a New Scientific Down Draft Jahant Furnace. Lasts a lifetime. Heats every room evenly. Burns oxygen, saves coal. Burns coal to fine ash. Heats quickly in morning.

### WE PAY THE FREIGHT

We pay freight anywhere in U. S. or Canada. Price includes entire equipment cut to fit. Easily installed.

### Sold on Monthly Payments

Buy a Jahant now, a payment down, rest easy monthly payments. It will pay for itself in short time. Sold on 100 day Money-back, Legal Guarantee. Engineers' advice FREE.

**FREE!** Complete set of erecting tools Free with each Jahant. Get book, "WHAT USERS SAY," and literature, all free.

**JAHANT HEATING CO.**

24 Jahant Bldg., AKRON, OHIO, U.S.A.

## FREE TRIAL



Cut out this ad and mail it to us, with your name and address (no money); and we will send you our **FAMOUS KARNAK RAZOR** by return mail, postpaid. You may use the razor for 30 days **FREE**; then, if you like it, pay us \$1.85. If you don't like it return it. **SEND NO MONEY.** **MORE COMPANY, 355 More Bldg., St. Louis, Mo.**

## WE PAY CASH for Scrap and Old False Teeth PLATINUM

On rubber or metal plates. Highest cash price paid for old Gold, Silver, contact points, crowns, bridge work, mercury and broken jewelry. Send your package today by parcel post to **The Mutual Smelting and Refining Company** 116 North Front Street, Columbus, Ohio

## Get This CAR And the AGENCY For YOUR Territory



Drive a new 1917 Model Birch Motor Car. Pay for it out of your commissions and make big money on sales. Special offer now. Write quick for Big Free Book and full information. Address **Ralph Birchard, Pres.** Birch Motor Cars, Dept. 419, 81 E. Madison St., Chicago

## The Prophylactic Tooth Brush

Tooth Brush

The one with the popular reputation. Your dentist will tell why.



**DIAMONDS \$2 A MONTH**



OWN A DIAMOND NOW! OUR CATALOG TELLS HOW

## 21 Jewel ELGIN Only \$2.50 a Month

Sent on Approval with lowest price ever made on a genuine 21 Jewel Elgin. See Special Offer with our Free Catalog.

**Why Pay Cash? Our New Easy Payment Plan Helps Thousands and Will Help You—**

Our New Catalog teems with Watch Bargains. It shows the very watch you have always wanted at the **low price** and Easy Terms you can afford to pay. A Guaranteed \$10 Elgin as low as \$7; \$25 Thin Models at \$17.50; and on Railroad Watches, **we save you a third.**

**Free Catalog Write for it Today.** Postal will do. This New Book will post you. It tells you just what you want to know about Watches, Diamonds and Jewelry.

**HARRIS-GOAR CO., Dept. 54, Kansas City, Mo.**  
The House that sells more Elgin Watches than any other Firm in the World.

There is **Big Money** for you in **Automatic Card Printing**

Everybody—everywhere—wants cards—for Business, Social, Professional, and thousands of other uses. Our wonderful press feeds and prints automatically any card from smallest to post-card size—100 a minute—**Almost All Profit.** Investigate this clean **All-Year-Round**, good-paying business. Get our free booklet No. 11.

**S. B. FEUERSTEIN & CO.**  
Patentees and Manufacturers  
542 W. Jackson Boulevard CHICAGO



## "I Would Not Part With It for \$10,000"

So writes an enthusiastic, grateful customer. "Worth its weight in gold," says another. In like manner testify over 100,000 people who have worn it.

## The Natural Body Brace For MEN and WOMEN

Develops erect, graceful figure; overcomes **WEAKNESS** and **AILMENTS** of Women & Men.

Brings womanly beauty and manly strength, restful relief, ability to work and enjoy life.

### Makes You Feel Good and Look Good

Does away with the strain and pain of standing and walking; replaces and supports misplaced internal organs; reduces enlarged abdomen; straightens and strengthens the back; corrects stooping shoulders; develops lungs, chest and bust; relieves backache, curvatures, nervousness, ruptures. Easy to wear.

### Wear It 30 Days Free at Our Expense

Write today for illustrated booklet, measurement blank, etc., and read our very liberal proposition.

**HOWARD C. RASH, Pres. Natural Body Brace Co.**  
223 Rash Building SALINA, KANSAS



For Children Also

## Lowest Prices Ever Made on World's Best Roofing

Send at once for World's Greatest Roofing Book. We quote Rock-Bottom Prices and pay the freight on Roofing, Siding, Ceiling, etc. Everything the biggest values for the money ever offered.



"Reo" Metal Cluster Shingles

## Edwards Tightcote "Reo" Metal Shingles

outlasts three ordinary roofs. No painting, no repairs. Rot, fire, rust-proof. Guaranteed lightning-proof. Can be laid over old shingles if desired.

Edwards Galvanized Metal Shingles, Roofing, Siding, Ceiling, or finish is extra heavy galvanized by



"Spanish" Metal Tile



Edwards Patent "Grip Lock"

## Our Exclusive Tightcote Process

by which sides and edges are as heavily galvanized as body of sheet. No weak spots anywhere.

By means of our Patent Interlocking Device all nails are driven through under layer of metal only—no exposure—no leaks.



Corrugated



Brick Siding

## The Galvanizing Test

Take any other galvanized steel, bend it back and forth, hammer it down. Great scales of galvanizing will flake off. Apply this test to Edwards Metal Roofing—you'll find no flaking. Edwards products are **superior**—yet sell for less than other materials.

## FREE ROOFING BOOK

will prove to you that we make lowest freight paid prices. Send coupon for Roofing Samples. Ask for copy of FREE Book No. 450.

**The Edwards Mfg. Co.**  
400-450 Pike St.  
CINCINNATI, O.

## Book Coupon

Garage \$69.50 AND UP

Send for Garage Book showing styles and sizes of Portable, Fire-proof, Metal Garages, \$69.50 and up. Lowest prices ever made.

Send for book—today

Name .....

Address .....

**THE EDWARDS MFG. CO.**  
400-450 Pike St., CINCINNATI, O.  
Please send FREE samples, Freight Paid prices and World's Greatest Roofing Book No. 450.





## THE EXPO WATCH CAMERA

The most wonderful and ingenious Camera made

It is but little larger than a watch, which it closely resembles. You can carry the Expo about in your pocket and take pictures without any one being the wiser.

### One Cent a Picture

The Expo loads in daylight with 10 or 25 Exposure Films, costing 15c and 25c respectively, and then the picture taking part of a whole day's outing may be had for a very nominal sum — One cent a picture.

### Easy to Manipulate

It is simplicity itself to operate. Takes pictures through the stem, where the Rapid Fire Lens is located. The photos (2 1/2 x 7/8) may be enlarged to any size.

**QUICK AS A FLASH** Time and instantaneous shutters; weighs but 3 ounces; nickel plated. Endorsed by amateurs and professionals the world over. Thoroughly practical—printing and developing of films just the same as ordinary cameras—in daily use by the police, newspaper reporters, detectives, and the general public. Important heads have been secured with the Watch Camera by enterprising reporters. Produces clear, sharp negatives indoors or outdoors equal to any camera on the market, size or price notwithstanding. **Sold Under a Positive Guarantee.**

**Expo Watch Camera FILMS, 10 Exposures 15c, 25 Exposures, 25c postage 10c** **\$2.50** Leather Pocket Carrying Case, 35c  
MAILED TO ANY ADDRESS IN THE WORLD

JOHNSON SMITH & CO., 7157 North Clark Street, CHICAGO

## JAPANESE ROSE BUSHES

### The Wonder of the World

Japanese Rose Bushes bloom all the year round. Just think of it. Six weeks after planting the seed, the plants will be in full bloom. It may not seem possible, but we positively guarantee it to be so. They will bloom every ten weeks, Summer or Winter, and when three years old the bush will be a mass of roses, bearing from five hundred to a thousand roses on each bush. The flowers are in three shades—white, pink, and crimson. The plants will do well both in and out doors. We guarantee at least three bushes to grow from each packet of seed. **Price, 10c packet, 3 pkts. for 25c postpaid.**

10 Cts.

### Shoo Fly Plant

A very remarkable botanical curiosity you should have. Though quite odorless, flies will not remain in a room where it is grown. Bears very pretty blossoms; blooms summer and winter. Grows rapidly from seed.

SEEDS 15c, packet, 3 for 40c, postpaid.

### Weather Plant

**NAYNE'S WEATHER PROPHECY** By mysterious changes that take place, this remarkable plant accurately forecasts the weather many hours in advance. Will grow anywhere all the year round. An interesting house plant. Bears large, fragrant, pink, butterfly shaped flowers.

Seeds, 15c packet, 3 for 40c, postpaid

## GROUND ALMONDS

**Amazingly Prolific—Easily Grown From Seed**  
The Ground Almond has a flavor that is MOST EXCELLENT, resembling the coconut. The meat is snow white, covered with a shell or skin of brown color. It grows close to the surface and anything from 200 to 300 Almonds may be expected from a single nut. There is no feasible substitute in growing anywhere and in any kind of soil. May be planted any time, and in eight or ten weeks from time of planting you will have an ENORMOUS CROP of the MOST DELICIOUS ALMONDS YOU EVER TASTED. **Seeds 15c Pkt.**



### Perfume Plant

Blooms only at night, giving forth the most delightful scented fragrance for quite a distance. Causes much comment. For house or garden. Also valuable because of rare perfume made from it. **SEEDS, 10c pkt., 3 for 25c.**

much comment. For house or garden. Also valuable because of rare perfume made from it. **SEEDS, 10c pkt., 3 for 25c.**

### Musk Plant

Another charming floral novelty of the sweet scented variety. Equally suitable as house plant or garden. Makes the most delightful perfume. **SEEDS, 10c pkt., 3 for 25c.**

## The Wonderful Sensitive Plant

*The Marvel of the Philippine Islands.* Almost human in its nervous susceptibility. Leaves curl, and fronds droop when touched. Apparently resents interference; it shudders strong odors, and is painfully affected by artificial heat and electricity. Has graceful foliage and fluffy pink flowers. It is a handsome shrub for house or garden and very curious and interesting bloom all the year round. **SEEDS 15c pkt., 3 pkts. for 40c postpaid**



## NITTO'S PLANT & FLOWER FOOD

**NITTO'S PLANT FOOD** is clean, odorless, and highly concentrated. It is used in liquid form on all kinds of plants, shrubs, roses, ferns, bulbs, berries, lawns, fruit, flowers and vegetable gardens. It changes ill-nourished plants into LUXURANT BEAUTIES, producing masses of blooms that will equal any. Causes plants to bloom early and ahead of others. Your friends will marvel at your success. Makes no difference how healthy or how delicate your plants may be. Nitto's Plant Food will bring out New foliage and flowers, and cause a Marvelous Transformation. **3c for 40c**

**Johnson Smith & Co., 7157 N. Clark St., Chicago**  
Only Concern of its Kind in America

## Automatic Repeating Rifle

**Fires 20 Shots in One Loading**



This is a regular size automatic revolver. Shoots B. B. shots obtainable anywhere, same as other rifles and guns. Repeats 20 times with one loading. Hand-somely finished in gun metal. No caps or load necessary, as it works with a spring and shoots with rapidity and accuracy. Simply load with 20 B. B. shot, then press the trigger. Nothing to explode—absolutely harmless and safe. Remember, it is not a mere toy, but the same size and shape as a REGULAR AUTOMATIC. Sent complete with a round of shot for ONLY 25c postpaid. Extra shot, 10c a package.

Only **25c** Postpd

It is simplicity itself to operate. Takes pictures through the stem, where the Rapid Fire Lens is located. The photos (2 1/2 x 7/8) may be enlarged to any size.

## THE FIGHTING DREADNAUGHT

Sensationally Realistic! Exact Model of Modern Warship

The greatest toy sensation of the day. The Fighting Dreadnaught is an exact model of Uncle Sam's latest fighting monster. It carries eight big guns, each of which flashes, at correct intervals, from twelve to twenty times. Extra ammunition always obtainable. Absolutely harmless. Can be operated indoors or out. Now, boys! Here's your chance to see a battleship in action, and the best of it is you can OWN the ship and command the firing yourself! By having two or more Battleships, you can arrange EXCITING NAVAL BATTLES in your own home. **Price of Warship and Ammunition, 15c, three for 40c, or a fleet of 12 ships for \$1.50 postpaid. Extra Ammunition, 5 cents per pkg.**



## Nu-Face Masks

12 COMPLETE DISGUISES FOR 95 CENTS. Slip on and off in an instant. No end of fun. Puzzle your friends. ABSOLUTELY UNRECOGNIZABLE. They change the shape of your face beyond belief. Cool and comfortable. For Parties and Masquerades, Fairs, Car Rides, Mask Balls, Amateur Theatricals, they are simply immense. There are SIX MASKS FOR UPPER HALF OF FACE, AND SIX FOR LOWER, as follows: 101, Clown; 102, Sherlock Holmes; 103, Fox Grandee; 104, The Colonel; 105, The Flirt; 106, The Smiler; 201, Ze Count; 202, The Doctor; 203, The Sport; 204, The Duke; 205, Weary Willie; 206, Mr. Dookey. **Price, 10c each, or the complete set of 12 Masks for only 95c postpaid.**



**PIANO PLAYING MADE EASY**  
ING CARD (placing the card upright over the piano keys), you can at once Vamp away to thousands of Songs, Ballads, Waltzes, Rag Time, etc., etc., equal to a Professional Musician. No knowledge of music is required. After using it a few times, you will be able to dispense with the aid of the Vamping Card entirely. The price of this very clever invention is only 15 cents postpaid.

## New Vamping Card

Persons having neglected their Musical Education need not despair. For with the aid of our new VAMPING CARD (placing the card upright over the piano keys), you can at once Vamp away to thousands of Songs, Ballads, Waltzes, Rag Time, etc., etc., equal to a Professional Musician. No knowledge of music is required. After using it a few times, you will be able to dispense with the aid of the Vamping Card entirely. The price of this very clever invention is only 15 cents postpaid.

## All the Latest Surprising and Joke Novelties

- |  |   |
|--|---|
| Pharo's Serpents Eggs, box . . . . . 10c     | X Ray Novelty . . . . . 10c                                     |
| Miniature Water Pistol (4 shells) . . . 10c  | Trick Pencil . . . . . 10c                                      |
| Cleopatra's Nails (very realistic) . . . 15c | Rubber Tacks (a good joke) . . . 10c                            |
| False Mustache (fool your friends) . . 6c    | Mossmerized Penny (defies the law of gravitation) . . . . . 20c |
| Big Roll Stage Money . . . . . 10c           | Cachoo! Sneezing Powder . . . . . 10c                           |
| Ford Auto Puzzle (Latest) . . . . . 15c      | Mysterious Tumbler and Vanishing Coin Trick . . . . . 25c       |
| Magic Photo (anyone can play it) . . . 15c   | Enchanted Bottle (won't lay down) 6c                            |
| Rubber Razor (very formidable) . . . 25c     | Magic Pin Lifter . . . . . 20c                                  |
| Rubber Razor (sensational) . . . . . 25c     | Imitation Gold Teeth . . . . . 3 for 10c                        |
| Window Smashers (great joke) . . . . 25c     | Great Eclipse Puzzle . . . . . 10c                              |
| Pocket Detective (see behind you) . . 15c    | Wire Puzzle, 10c. 25 different, \$1.95                          |
| Great Mind Reading Mystery Cds. . . 10c      |   |
| Thurston's Mysterious Trick Cds. . . 10c     |   |
| Fighting Boosters, pair . . . . . 10c        |   |
| Cover the Spot Trick, a seven, nov. . . 10c  |   |

Large catalog of unique, novel and useful articles (unobtainable elsewhere) free with all orders, or mailed on receipt of five-cent stamp. Agents and dealers write for wholesale prices. Catalogs and circulars furnished at cost. Send 10 cents (credited for samples of each and perquisites of our proposition).

**Johnson Smith & Co., 7157 N. Clark St., Chicago**  
Read the next page, too





# LUMINOUS PAINT



## Make Your Watches, Clocks, Etc., Visible by Night

The very latest discovery in the scientific world. Hitherto practically unobtainable except at an exorbitant price, we have at last succeeded in producing this remarkable LUMINOUS PAINT, which, applied to the surface of any article, emits rays of white light, rendering it perfectly visible in the dark. **THE DARKER THE NIGHT, THE MORE BRILLIANT IT SHINES.** Quite simple to use. Anyone—you can do it. A little applied to the dial of your watch or clock will enable you to tell the time by night. You can coat the push buttons or switch plates of your electric lights, match boxes, house numbers and innumerable other articles; make your own Luminous Crucifixes, Luminous Rosaries, etc. All ready for use. Requires no preparation; contains no phosphorus. Luminous effect is positively permanent. Bottle containing sufficient to coat several small articles, **Price 25c.** Larger sizes **50c and \$1.00 Postpaid.**

Manufactured by

**JOHNSON SMITH & COMPANY, 7157 North Clark Street, CHICAGO**

### INVISIBLE INK

The most confidential messages can be written with this ink, for the writing **MAKES NO MARK.** Cannot be seen unless you know the secret. Invisible for many reasons. Keep your posts and other private communications away from prying eyes. Great fun for playing practical jokes. **Only 15c Bottle**



### VANISHING INK

Writing written with this remarkable ink vanishes entirely in a few weeks (sooner if desired), leaving the paper **QUITE BLANK.** **15c postd.**

**LUMINOUS INK** writing can be **READ ONLY IN A DARK ROOM**; writing shines like fire. Quite invisible at daytime. Very remarkable. **15c**



**DISSOLVING INK** A new kind of invisible and vanishing ink combined. Writing is quite invisible, but can be made to appear or disappear at will in a very simple yet mysterious manner. Same **PRICE, 15c postd.**

**PRICE 20c**

## Book on ROPE SPLICING

Useful Knots, Hitches, etc.

A most practical handbook giving complete and simple directions for making all the most useful knots, hitches, splices, rigging, etc. Over 100 illustrations. All about wire rope attachments, lashing, blocks, tackle, etc. 37 Heraldic Knots illustrated. Of great value to mechanics, riggers, campers, boatmen. **Price 20c postd.**



### Ink Erasing Fluid

Better and more effective than Rubber Erasers. Simply dip reverse end of penholder in fluid and apply to the blot or error. The fluid absorbs the ink, then dry off with blotting paper, and the thing is done, leaving no trace of the blot. Of special value for this paper. **Price, 15c bottle, 3 for 40c postpaid.**



### Magic Transfer

A process for transferring pictures, engravings, etc., in their original colors, from newspapers, books, etc., to album or elsewhere. Several copies may be made. Butterfly and moth wings can also be reproduced, and an instructive collection preserved in a scrap book. Process is very simple and highly interesting. **10c, 3 for 25c, postpaid.**



### Vest Pocket SECRETARY

**MARVELOUS COMBINATION.** Not a toy, but a really useful article you need every day. 12 articles in one—Pen, Pencil, Paper Knife, Ink Eraser, 4-inch Ruler divided into sixteenths, Compass can set for any size circle, Envelope Opener, Mechanical Marking, Pen, Pencil Sharpener, etc. Made entirely of steel, nickel-plated. Folds up into a small space occupying no more room than an ordinary pencil in the pocket. **Price 19c, 3 for 50c postpaid.**



### Thumb Brander

**NEW & NOVEL JOKE** to play on your friends. Fits on your thumb, and "brands" your victims as you shake hands. Great fun. Any of these choice epithets: Owl, fool, liar, grouch, baby, chicken, hot air, bull, Safety First. Complete with pad and ink, **17c.**



### INKLESS PEN

**WRITES with WATER** 400 words you dip. Makes its own ink. Writes fashionable violet color. Better and cheaper than fountain pens. Writes a long letter with one dip in plain water. No trouble—no bother—no mess. A pleasure to use. With Nickel Plated Reversible Holder **10 CENTS, 3 for 25c**



### The Handy Duplicator

A really efficient apparatus at a very low price. With this outfit, you can, in a few moments, duplicate from 25 to 100 or more letters (hand or typewritten), drawings, circulars, postal cards, etc. Just as well as with the most costly apparatus sold. No trouble at all to use, and no mess. Remarkably clear, legible copies obtained, either in one or any combination of colors. Can be used over and over again. **ALWAYS READY FOR USE.** It is quick, efficient, and clean. Each outfit consists of 1 Duplicator, 1 Bottle of Duplicator Ink, 1 Duplicating Pen, 1 Sponge, and 4 Holders. Made in three sizes: **POSTAL SIZE, 4 1/2x3 1/2 in., Price 50c.** **Price 75c.** **CAP SIZE, 5x3 1/2 in., Price \$1.00.** Extra Ink (choice of black, purple, green or red) 15c bottle. All postpaid, with full instructions.



**JOHNSON SMITH & COMPANY, 7157 N. Clark St., CHICAGO**

All goods on these two pages sent postpaid to any address in the world on receipt of amount. No extra postage on Foreign Orders

## EUREKA SILVER-PLATING SOLUTION

A WONDERFUL PREPARATION

Plates Brass, Copper, Nickel, Bronze or Electro-Plate

Simply Rub it on. Brilliant and Durable.



The Eureka Silver-Plating Solution is a preparation that has been long sought in vain, that is, a cheap, non-poisonous liquid by which table ware and other metal articles could be durably renovated. Many compounds have been offered for the purpose, but all have failed in some way, some required too much skill, others were not lasting, the effect rapidly passing away, while the most effective were exceedingly poisonous. At last, however, the real thing was found. In less than one minute, with very little rubbing, a plating of PURE SILVER is deposited upon spoons, forks, knives and plated ware of all kinds, metal and carriage fittings, lamps, bicycles, brass instruments, tools, etc. The effect is brilliant and lasting, equal in every respect to ordinary electroplating, and it will wear well and keep free from tarnish even to the most discolored ware. The Eureka Solution is far better than any plating material, because it adds to the silver coating and wears it away; those that have been repeatedly polished are not injured as when abrasives are used. The solution is so simple that any child can use the Eureka Solution satisfactorily, and, as it contains no poisonous ingredients, there is no necessity to avoid and repeatedly wash the articles to prevent risk from the poisonous substances ordinarily used, and which make them so dangerous. **PRICE, ONLY 25 CENTS BOTTLE, CONTAINING SUFFICIENT TO PLATE DOZENS OF ARTICLES, POSTPAID, THREE BOTTLES FOR 60 CENTS POSTPAID.** **JOHNSON SMITH & CO., 7157 North Clark Street, CHICAGO**

## TOOTH-ACHE STOP

Easy to Use



**Stops the Pain; Stops the Tooth**

Squeeze a little in hollow of tooth; the **ACHE STOPS INSTANTLY;** the paste hardens, forming an antiseptic filling. Absolutely harmless. Have it ready for the next bad attack. **25c postpaid.**

## "SAFETY 1st" PINS

A clever novelty. The National Safety First Movement has made them very popular. Wear one and show your sympathy with the movement. Also handy for wearing at amateur theatricals and the like. Two sizes, 3/4 in. (gold plated) and 1 1/4 in. (nickel-plated). **6c each, two for 10c p. pd.**

## Potmend

Stops a leak in a minute

The finest repairer for ironware, Agateware, Enamelware, etc. Good for kettles, pots, pans, boilers, and every kind of ironware, also for tin, copper, aluminum, ice boxes, iron pipes, cracks in stoves, broken china, porcelain, brick-a-brack, bisque, crockery, woodenware, marble, etc. Will not chip, burn, bake or boil out. **THE MEND IS THE STRONGEST SPOT IN THE POT.** Could not be simpler: just mix the powder with water. **HARDENS LIKE IRON.** Fire-proof, Water-proof. You can fill a big hole or a small crack. Mended place stronger than new. Replaces chipped enamel. Anyone can do it! **FAILURE IS IMPOSSIBLE.** Better and easier than solder. Three sizes, **15c, 25c, and 50c.**

## Cheap and Interesting Popular Books

Chemical Wonders, Secrets & Mysteries	10c	Tricks with Coins	25c
Money-Making Secrets	10c	250 Parlor Tricks, Games, etc.	25c
Amateur Electrician	10c	Painters' & Decorators' Guide Bk.	25c
100 Dramatic & Comic Recitations	10c	Hoyle's Card Games	10c
No. 1	10c	50 New Card Tricks	25c
No. 2	10c	Fortune Telling by Cards	25c
Book Fun, Magic & Mystery	10c	Old Secrets and New Discoveries	25c
Ventriloquism	10c	Old Dr. Brown's Great Book of Secrets, Winkles, Formulas, etc.	1.00
Humorous Dialogues	10c	(Contains over 400 pages)	
Humorous Recitations	10c	Collection of Famous Songs	15c
Complete Letter Writer	25c	Ready Made Speeches and Toasts	25c
How to Dance	25c	See Coin Guide	15c
Southwick's Monologues	25c	Riddles: How to Breed	15c
Vest Pocket Dictionary (Indexed)	25c	New Guide to Beauty	25c
150 Parodies on Latest Songs	15c	How to Play Checkers, Chess and Dominoes	25c
Vandeville Joke Book	15c	Prof. Gaskell's Course on Penmanship	75c
Complete Letter Writer	25c	3000 Precious Recipes, Formulas, and Trade Secrets	50c
Chess Dances Made Easy	15c	Moore's Universal Assistant & Complete Mechanic cover a million Industrial processes, facts, calculations, receipts, trade secrets, etc. 1616 pages	2.00
Lightning Calculator & Short-Cut Arithmetic	50c	Blakelee's Industrial Cyclopaedia (How to make thousands of useful articles for everybody)	1.50
Hunters and Trappers' Guide	25c		
Song and Joke Book	15c		
How to Become American Citizen	15c		
Irish Song & Joke Book	15c		
How to Play Piano	25c		
"It's It" Violin	25c		
"It's It" Mandolin	25c		
"It's It" Guitar	25c		

**JOHNSON SMITH & COMPANY, 7157 N. Clark St., CHICAGO**

Please Mention Popular Mechanics



The skilled or amateur mechanic should keep a bottle of

## LISTERINE

The Safe Antiseptic

Manufactured only by Lambert Pharmaceutical Company, St. Louis, Mo., U.S.A.



on or near his work bench—immediately available to prevent the infection of cuts or any other small wounds.



### Be Your Own Boss

Do as many others have—Operate a Kingery Peanut Roaster and Corn Popper. Over 50 styles. Liberal terms, excellent profits. No. 50 catalog tells you all about it.

KINGERY MFG. CO., Pearl, East of Broadway, Cincinnati, O.

## AGENTS 500% PROFIT

### Gold and Silver Sign Letters

# N

For store fronts, office windows and glass signs of all kinds. No experience necessary. Anyone can put them on and make money right from the start.

**\$30.00 to \$100.00 A WEEK!**

You can sell to nearby trade or travel all over the country. There is a big demand for window lettering in every town. Send for **FREE** Samples and full particulars.

Metallic Letter Co., 406 No. Clark St., Chicago

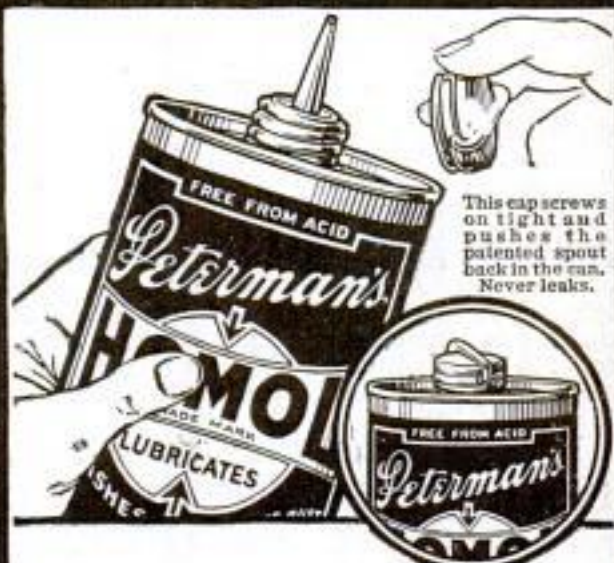

This cap screws on tight and pushes the patented spout back in the can. Never leaks.

Here's an improved can full of the Sportsmen's oil—the kind you've always wanted,

## HOMOL

TRADE MARK

A splendid lubricant for guns, reels, traps, typewriters, phonographs, tools, etc. Prevents Rust. If your dealer has not yet received HOMOL, send us 25c and we will mail you a can at once.

WILLIAM PETERMAN, INC.  
200 Fifth Avenue New York City

## IF IT ISN'T AN EASTMAN IT ISN'T A KODAK

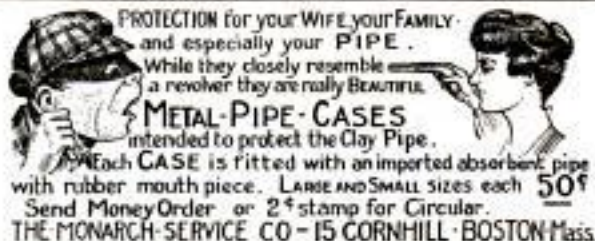

## AGENTS—100% PROFIT GAS SAVER FOR AUTOMOBILES



Saves 20% to 35% gasoline. Fits any car. Anybody can put it on. Big Money saver. Every auto owner buys; demand enormous.

### Biggest Business in the World

Agents coining money. A demonstration makes a sale. Big opportunity for repair-men, garage-men and salesmen with machine. Write today for territory.

GAS SAVER CO., 7648 East Street, DAYTON, O.

## DIAMONDS - WATCHES ON CREDIT

EIGHT Months To Pay  
Wear a Pure, Blue-white Diamond while paying for it on our easy terms of 20% DOWN - 10% A MONTH

Any honest person given credit. No security required. Goods sent prepaid, subject to approval. Billing Guaranteed with each Diamond setting. Quality and value and guarantee for exchanges at full purchase price. - 10% DISCOUNT for cash. Write today for FREE CATALOG No. 5 containing 4000 Photographs of Diamonds, Watches, Jewelry, Silverware, etc. Transactions confidential.

1506 \$37.25  
3232 \$100.  
7070 \$25.  
7079 \$45.  
9738 \$55.  
9734 \$50

**JAMES BERGMAN** Est'd 1896  
37-39 MAIDEN LANE  
NEW YORK CITY



# SAVE MONEY ON CAMERAS



No matter what style or size camera you want, we will save you money on it. The camera users of America are saving 25% to 50% on our low direct-to-you prices.

## 10 Days' Free Trial

Guaranteed satisfaction backs every purchase. 32 years' success proves our prestige. Camera users the country over back our service and business dealings.

## Our Camera Catalog Will Save You Money

Send for it today. Compare our prices on any article with what you know you would pay elsewhere.

### Send for Catalog Now

Our complete catalog shows Cameras, any size or style, Kodaks, Graflex Machines, Lenses, Motion-Picture Outfits and Photo Accessories at money-saving prices. 10 Days' Free Trial—Money-Back Guarantee. Send for your copy now.

### David Stern Company

Everything in Cameras—In Business Since 1885  
10 Davaco Bldg., 1047 Madison St., Chicago, Ill.

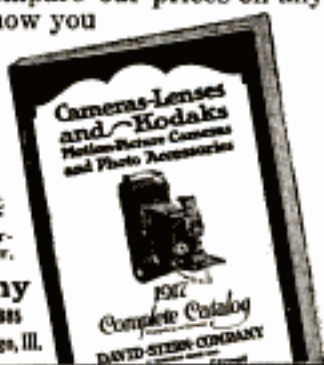

## Fortunes in Mushrooms

Anybody can grow them. Easiest Money-Making proposition you can find. Marvelous returns from small outlay. Others making big money in spare time. **WHY NOT YOU?** No experience necessary. Can be grown in Boxes, Cellars, Barns, etc. Write today for FREE booklet.



**MUSHROOM CULTURE CO.** SUITE 631, 1402 Broadway NEW YORK

## BOYS—Build and Fly a Model War Aeroplane



"Ideal" accurate Scale Drawings enable you to EASILY build 3 Ft. Flying Models of Aeroplanes now used in the European War. Students of Aeronautics, everyone with an aspiring turn of mind, should construct one of these fascinating Models.

Prices of 3 Ft. Scale Drawings:  
Curtiss Flying Boat 25c  
Curtiss Military Trainer 25c  
Hydroaeroplane 35c  
Nieuport M'n'plane 25c  
Hercot Monoplane 25c  
Tubie Monoplane 25c  
Wright Biplane 25c  
Cecil Peeli Racer 25c

Complete Set of Eight, \$1.75 postpaid  
Get our 1917 Aeroplanes Book, containing full information about models, parts, etc., 5c postpaid.

**Ideal Aeroplane & Supply Co., 82-88 West Broadway, New York**

## Try Before You Buy

Select the bicycle you prefer from the 44 styles, colors and sizes in the famous "Ranger" line. We send it on approval and 30 DAYS TRIAL, freight paid to your town. Return if not pleased and the trial costs you nothing.

Write at once for large illustrated catalog showing complete line of bicycles, tires and supplies, and particulars of most marvelous offer ever made on a bicycle. You will be astonished at our low prices and remarkable terms.

**RIDER AGENTS Wanted**—Boys, make money taking orders for Bicycles, Tires and Sundries from our big catalog. Do business direct with the leading bicycle home in America. Do not buy until you know what we can do. Write Today.

**MEAD CYCLE COMPANY**  
DEPT. 8 108 CHICAGO, U.S.A.



## The Adding Machine That Costs Only \$15

### The Ray The Individual Adding Machine for every desk.

Adds with speed and accuracy of highest priced machines, and also actually subtracts. It is the logical development of the adding machine to compact and portable size. Measures only 2x9 inches. Business and professional men are buying the Ray as an individual machine for every desk to save time, labor and mistakes.

The Ray is a constant help in checking invoices, adding loose bills, figuring payrolls, trial balances, etc. The only practical adding and subtracting machine for cross footings and for work on large sheets or volumes.

The Ray is a non-listing machine, but your additions can be proven by its true subtraction feature if checking is necessary.

## 20 Days Free Trial

Send no money, but pin this coupon to your business stationery, and we will send a Ray for 20 days' free trial in your office. Write for yours today, and prove that the Ray is the adding machine you have been waiting for, to save your time and mental labor.



**Ray Subtracto-Adder Co., 1303 Peer Building, Richmond, Va.**  
Without cost or obligation on my part, send me a Ray Subtracto-Adder for 20 days' free trial.

## No Money In Advance

### This Marvelous Camera on FREE TRIAL!

Only 10,000 of these marvelous, instantaneous picture-taking and making cameras to be sent out absolutely on approval without a penny in advance just to prove that it is the most wonderful invention—the camera sensation of the age. No post money sent for it—just think of it—the new Mardel-ette takes and makes finished pictures



INSTANTLY!  
You press the button, drop card in developer and in one minute takes out a perfect, finished post card photo, 2 1/2 x 3 1/2 inches in size. Camera, itself, is about 4 1/2 x 7 inches. Loads in daylight 16 to 40 post cards at one time. No film—no flash—no dark room. Not a bit of the fuss and bother of the ordinary kodak or camera. It is instantaneous photography. Universal focus lens produces sharp pictures at all distances. Pictures develop and print automatically. Can't overdevelop! results simply amazing.

### WE TRUST YOU

No difference who you are, where you live or what your age, we will send you the complete "Mardel-ette" camera absolutely on approval and give you 10 days to test it. If not satisfactory return it. But when you see what elegant pictures it takes—so quick, so easy, with no trouble at all—if you wish to keep it you simply send us \$1.00 per month until our special price of only \$5.00 is paid. Easy Payments—no references. No red tape of any kind. Monthly payments so small you'll not notice them. Lots of fun and big profits. No Experience Required. Plain instructions and everything complete with outfit so you can begin taking pictures the moment it arrives. We guarantee that even a child can operate it. Mail coupon right now. No risk or obligation to keep camera.

Send me at once one complete model Mardel-ette camera outfit, including supply of post cards and instructions. I agree to examine and test it thoroughly and if satisfied keep it and pay you \$1 a month until your special price of \$5 is paid. Otherwise I will return it at the end of 10 days.

Name .....  
St. and No. ....  
Town ..... State .....

Please Mention Popular Mechanics



## Oxy-Acetylene Welding and Cutting

In the manufacture of Packard pleasure cars and trucks, welding plays an important part. Operator is shown welding a part where strength and neatness are essential.



### Better, Stronger Metal Products at Lower Cost

In the manufacture of nearly every metal product, large or small, welding has great possibilities for making it simpler, stronger, neater, and at reduced cost.

Using oxy-acetylene welding as a routine process, progressive manufacturers everywhere are today speeding production, securing increased strength and decreased weight in vital parts, at the same time effecting large savings in manufacturing costs.

If you use bolts, rivets, or threaded joints in the construction of your product, investigation may show a real need for oxy-acetylene welding.

## Prest-O-Lite PROCESS

Employs both gases (acetylene and oxygen) in portable cylinders. Prest-O-Lite Dissolved Acetylene (ready-made carbide gas) is backed by Prest-O-Lite Service, which insures prompt exchange of full cylinders for empty ones. Provides dry, purified gas, insuring better welds, quicker work, and lower cost, and also avoids the large initial outlay and heavy depreciation incurred in making crude acetylene in a carbide generator.

Necessary equipment is not expensive. We furnish high-grade welding apparatus for \$75 (Canada \$100); acetylene service at additional cost. Adaptable for oxy-acetylene cutting by the addition of special cutting blow-pipe. Thorough instructions are furnished free to every user of Prest-O-Lite Dissolved Acetylene—any average workman who understands metals can learn the process quickly and easily.

*Our welding literature contains valuable data and many helpful suggestions. Send for it today—it may point ways for you to increase savings and improve methods.*

#### Real Opportunity for Enterprising Men

Many enterprising mechanics find the job welding business pays them good, substantial profits. If you want to build up a prosperous business of your own, investigate today.

**The Prest-O-Lite Co., Inc.**

U. S. Main Office and Factory  
816 Speedway, Indianapolis, Ind.

Canadian Office and Factory  
Merritton, Ontario

55 Branches and Charging Plants

World's Largest Makers of Dissolved Acetylene



Bob White  
or Quail

### Write for These Books

They tell all about game farming—the profit and pleasure to be obtained from it. "Game Farming for Profit and Pleasure" is sent free on request. It treats of the subject as a whole; describes the many game birds, tells of their food and habits, etc. "American Pheasant Breeding and Shooting" is sent on receipt of 10c in stamps. It is a complete manual on the subject.



**HERCULES POWDER CO.**  
1025 Market Street  
Wilmington Delaware



## Free Shoe Book Saves You \$20



More than a million satisfied customers named our shoes "The World's Greatest." Don't think of buying any shoes until you get our 1917 shoe book. It shows the most complete line of lasts, styles and leathers for every purpose no matter what your requirement. Saves your health and money. Free 10-day try-on.

### 200 SHOE BARGAINS

For Men, Women, Boys and Girls  
Also complete line Ruthstein's Famous Steel Shoes. Big, New 1917 Scientific Footwear Catalog shows over 200 styles and how to save 20 to 50 per cent on shoes for the whole family—FREE on request.

We Retail  
At Less Than  
Wholesale Prices

**Ruthstein Scientific Shoe Co.**  
America's Greatest Mail Order Shoe Factory  
Dept. 651 RACINE, WISCONSIN

## BARODA DIAMONDS

FLASH LIKE THE GENUINE—AT 1-50 THE COST  
SOLID GOLD MOUNTINGS Stand acid test and expert examination. See them first, then pay. Catalog FREE. Patent Ring Gauge included for 5 two-cent stamps.  
The Baroda Co., Dept. 85, 1456 LaSalle Ave., Chicago



## DEAF?

If your hearing is failing, or has failed, you are  
**One of 6,349,240 in the U. S. A.**  
who would be greatly helped by our new invention to aid deafness.

Transparent Im perceptible **AUDI-SHELLS** Wt., only 1/16 oz. Safe and Sanitary

Nothing to insert in the ear, no headbands, cords or batteries. Nothing to break or get out of order. The Audi-Shells are a wonderful help in all degrees of deafness, comfortable to wear and are not as conspicuous as eye-glasses. They are endorsed by eminent aurists and sold by mail at \$5.00 per pair. Write for testimonials of users.

**Globe Ear-Phone Co.,** 82 Tremont Street BOSTON, MASS.



# Easy to Make Your Bike a Motorcycle

## Put Your Idle Bicycle to Work!

**Your Old Foot-Power Wheel Converted into a Speedy, Lightweight, Easy-Running Motorcycle—Quickly and at Small Cost!**

Get out that old bicycle and put life into it. No need for you to pay a big price for a dependable motorcycle now. Your old bike, once fitted with the Shaw Motorcycle Attachment, will take you over city streets or country roads. Plan your vacation now—enjoy the great out of doors—see the country 'round about you. The low price of the Shaw Attachment makes it possible for anybody and everybody to convert an old bicycle into a speedy machine that will bring you all kinds of enjoyment.



## The SHAW Motor Fits ANY Bicycle

### —MAGNETO—

The smallest electrically efficient magneto ever produced. High tension type. **ONE PIECE FRAME** of the cast aluminum, absolutely water-proof, dust-proof and oil-proof. Magnets of high-grade imported steel. This wonderful magneto is supplied with the **SHAW MOTORCYCLE ATTACHMENT.**



No brazing or changing of frame is needed. The Shaw Attachment fits any model of any make—just as simple and easy to detach as to put on, because it is portable. Simple in construction—only a few parts—light in weight. Thousands in use in the United States, Canada and other foreign countries.

### Anyone Can Do It—No Special Tools Required

You can attach the Shaw Motor and full equipment without the aid of a mechanic or any extra expense—no special tools required. Any one who can use an ordinary wrench and a common screw driver can easily attach the outfit in a short time. Every part is complete and ready to attach to your bicycle without special tools or expert work. You'll be surprised at the simplicity of this attachment and how easily you can make a bike a motorcycle.

### FREE BOOK

Use the coupon opposite or a postcard and send at once for an interesting book, "Convert Your Bike Into a Motorcycle." Tells all about the Shaw Attachment and the wonderful Shaw Magneto—weighs only a few pounds. Don't be satisfied with your old bike any longer. Ride anywhere the best motorcycles go—you can do it with the Shaw Attachment.

### Sign and Mail Coupon Today

We will send you full information about the remarkable attachment, prices—also a list of second-hand motorcycles—interesting and instructive. Send now.

**Shaw Manufacturing Co.**

Dept. 182 GALESBURG, KANS.



Shaw Manufacturing Co., Dept. 182, Galesburg, Kans.

Send me your free book, "Convert Your Bike Into a Motorcycle" giving full particulars about the Shaw Attachment, also a special list of used motorcycles of all makes.

Name .....

Postoffice .....

Street or R. F. D. ....

State .....



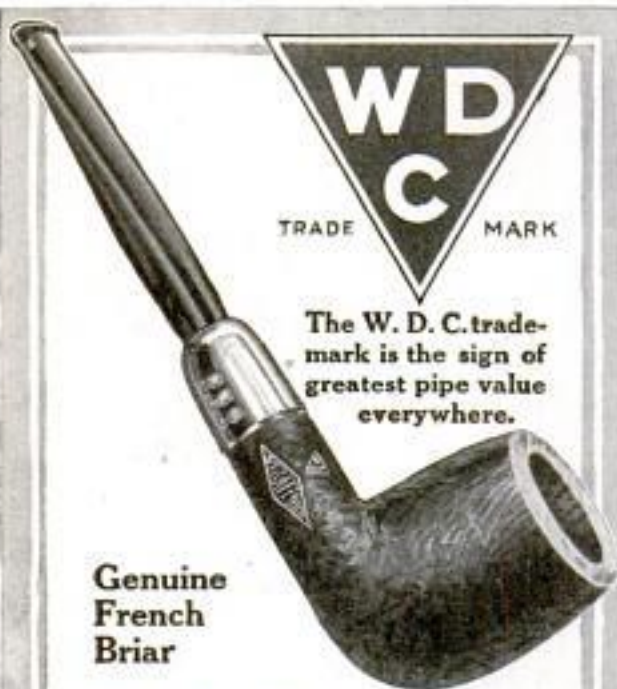

Genuine  
French  
Briar

The W. D. C. trade-  
mark is the sign of  
greatest pipe value  
everywhere.

You'll find your fa-  
vorite style in one of  
the 24 standard  
shapes of these four  
grades of W. D. C.  
pipes:

**BRIGHTON—**

35c, 50c and up,  
according to size.

**WINDSOR—**

50c, 75c and up,  
according to size.

**STRATFORD—**

75c, \$1 and up,  
according to size.

**W. D. C. HAND-  
MADE—**

\$1, \$1.25 and up,  
according to size.

At good dealers'  
everywhere

WM. DEMUTH  
& CO.  
New York

Solid  
Vulcanite  
Bits



## Free Try-On OF AMERICAN METAL SHOES



Yes, free try-on in your own home of these light, water-proof, rust-proof, wear-proof metal shoes; save your money, your feet, your health. No more tired, sore, wet feet. Always warm, dry and comfortable. Warm in winter—cool in summer. One pair outwears many leather pairs. The world's most economical work shoe for men and boys.

**SAVE  
\$30.00**  
ON  
SHOE  
BILLS

The  
Best  
School  
Shoe

### Steel Or Aluminum Soles

Made in all sizes and heights. Guaranteed to fit. Patent rocker bar gives the natural tilt—that light, springy step. Easier to walk in than heavy shoes or boots. We manufacture the largest and most complete line of metal shoes in the world. Send postal today for

#### FREE—Shoe Book—FREE

It describes these money saving, health protecting, comfort giving, ever wearing shoes. Don't buy a work shoe of any kind at any price until you get this book. It tells all about our free try-on offer to every man and boy. Address postal to

#### AMERICAN METAL SHOE CO.

(Combined with Racine Aluminum Shoe Co.)  
40 12th Street RACINE, WIS.

See October and December Popular Mechanics  
for advertising of

## The Pullman Company

## Bausch and Lomb BALOPTICON

THE PERFECT STEREORICON

Bausch & Lomb Optical Co., 576 St. Paul St., Rochester, N. Y.



## PRINT MY OWN

Cards, circulars, menus, book, paper, etc. Press \$5. Larger \$18. Rotary \$80. Save money. Print for others, big profit. All easy, rules sent. Write factory today for illustrated catalog presses, TYPE, cards, samples. THE PRESS CO. D-37, MERIDEN, CONNECTICUT.

## AGENTS WANTED (SPARE TIME)

EARN \$75  
TO \$250  
A MONTH

Knives and Razors made of Car-Van (Old Damascus) steel. Scientifically Tempered. Photographic Handles. Entirely new. Sell on sight. Write for Special Agency Proposition. Send 5c Stamps for Easy Money Booklet—\$1.00 for Sample Knife, your name, address and any emblem in handle.

THE CANTON CUTLERY COMPANY

Dept. 59  
Canton, Ohio



## YOU CAN HAVE THIS

wholly visible (42 key) single shift typewriter, for your own, if you will show it to your friends and let them see wherein it excels other \$100 typewriters, and tell them of our most liberal offer ever made on a strictly modern typewriter and a Woodstock at that. By post card or letter simply say, "Mail Particulars."

WOODSTOCK TYPEWRITER CO., Dept. A 617, CHICAGO, ILL.



## Hang Up a Dodson Wren House

These friendly little brown birds will soon be here looking for a home. Hang up my 4-room Wren Bungalow and a family will move right in and raise two or three broods.

I have studied bird habits and worked for bird protection for 22 years. My houses bring the birds because the birds like them. Entire collection described in catalog with prices. Includes bird baths, feeding devices, etc. All are patented.

**\$5.00**

for this 4-room Dodson Wren House; built of oak; roof of cypress with copper coping. Wrens won't live in a one-room house; they want a fresh room for each brood.

**Bird Book Free**—My illustrated book tells how to attract birds to your garden. With it I send, free, my beautiful "Nature Neighbors" folder, together with a colored bird picture worthy of framing. Write to (11)

**JOSEPH H. DODSON**

Director of the

National Audubon Association

729 Harrison Ave., Kankakee, Ill.

## RAISE GUINEA PIGS

**Big Demand** Thousands needed weekly. Government figures show a profit of \$9.00 each annually. Experience or special knowledge unnecessary. Send for our money making proposition and leg free illustrated book which explains all.

Laboratory Supply Co., Dept. B, 2841 Ridge Ave., Phila., Pa.

**50 EGG**

## ALL STEEL INCUBATOR

10,000 poultry raisers get pleasure and profit out of the **Baby Grand Incubator**

**\$5.00**

Scientifically built and regulated. Will do satisfactory work in your hands. Sent by parcel post or express, charges paid—complete with full directions. Send \$5 today. We are responsible—see your banker. Catalog free. Reliable Incubator & Brooder Co. Box 881 Quincy, Ill.



## RABBITS

Tells all you want to know about Rabbits. Our book: "The Rabbit; How to Select, Breed, and Manage the Rabbit and Belgian Hare for Pleasure or Profit," by breeders of long experience with rabbits. Sixth edition, nicely illustrated, enlarged and much improved. Price 25 cents with sample copy of the *American Poultry Advocate* containing Belgian Hare Department.

POULTRY ADVOCATE, Dept. 257, Syracuse, N. Y.

## SHOEMAKER'S BOOK ON POULTRY

and Almanac for 1917 has many colored plates of fowls true to life. It tells all about chickens, their prices, their care, diseases and remedies. All about incubators, their prices and their operation. All about poultry houses and how to build them. It's an encyclopedia of chicken-dom. You need it. ONLY 15c.

C. C. SHOEMAKER, Box 1107, Freeport, Ill.

## PIGEONS PAY

**Better Than Chickens**  
Young pigeons (Doves) bring 45 to 50c each when 3 to 4 weeks old. Big demand in city markets. Each pair of pigeons easily clear \$4 per year. Always profitable. Very little space and money needed to start. Free Book explains all. MAJESTIC SQUARE CO., Dept. 66, ADEL, IOWA.



## Greider's Fine Catalogue

of fine bred poultry for 1917; 67 breeds illustrated and described; information on poultry, how to make hens lay, grow chicks—all facts. Low price on stock and hatching eggs. Incubators and brooders, 25 years in business. This book only 10 cts. Send today.

R. H. GREIDER, Box 19, RHEEMS, PA.

## BEEES PAY BIG PROFITS

Raise your own honey. We start you right. Send today for Bee Supply Catalog. Sent FREE.

DADANT & SONS Box 56 HAMILTON, ILL.



# Power for YOU!

Power from within! Strength that is **more** than mere muscular strength—the strength of better health, abundant nerve force—the strength of the perfect man. Don't you want it?

Nine people out of every ten are only **half alive!** How about yourself.

## All the Exhilarating Joys of Life Strength Youth

Do you feel just right? If you do not—if you haven't that vigorous "go ahead" feeling all the time—don't fail to send the coupon for full particulars about the White Cross Electric Vibrator. In vibration there exists many of the secrets of life. You now have an opportunity of seeing what vibration will do for you—how every nerve, every fibre in your whole body will fairly tingle. Try this remarkable instrument for yourself—test it. Now is the time for YOU to send for the free book, "Health and Beauty." Thousands have received it. You are invited to write for it, too.



With our Combination Outfits, you may give yourself Swedish Movement, Vibrating Chair Treatments, Electric Baths, Faradic or Galvanic Treatments—right in your own home.

## The White Cross Electric Vibrator

is the result of years of work and experiment. If you have your house wired for electricity, you connect it up as easily as an electric lamp; if not, we can supply you with models operated on their own batteries.

## Special Offer for a Limited Time

For a short time only we are making a remarkable Special Introductory Offer on the White Cross Electric Vibrator, in order to place at least one of these splendid instruments in every city, town, village in the country.

**Free Book** Sign the coupon and mail it today. Get our splendid big FREE book telling you all about the marvels of Vibration. Read what scientists say. Post yourself on what it will do for you. Learn all about the White Cross Electric Vibrator and our limited offer. No obligations at all—send the coupon or a post card or letter today.

Send for This Book



LINDSTROM, SMITH CO.

1100 S. Wabash Avenue Dept. 1194, Chicago, Ill.

Without any obligations on my part, please send me, free and prepaid, your free book on Vibration, full particulars of the White Cross Vibrator and your Special Offer.

Lindstrom, Smith Co. 1100 South Wabash Avenue Dept. 1194, Chicago, Ill.

We also manufacture White Cross Electric Shoes, Irons, Hair Dryers, Electric Lamps, Electric Fans, Electric Automobile Horns, Electric Curling Irons, Heating Pads, Small Motors, etc. Dealers write.

Name.....

Address.....

My Electrical Dealer's Name is.....

Please Mention Popular Mechanics



## "Days of Real Sport"

By Claire Briggs



## Send for the Briggs Book

— full of cartoons of boys having fun with Kings; containing story of the air rifle and how it is made, and listing the full King line with prices.

Send 2c stamp to Dept. E

The MARKHAM AIR RIFLE CO.  
Plymouth, Michigan

OF ALL THE JOYS CONTRIVED for boys to make their playtime glad, the air gun, "King," is just the thing to make a hit with Dad. He fills his boy with thrills of joy by giving him a gun; then straight-away you'll hear him say, "I'll show you how it's done."

He tries his hand to beat the band and makes the target ring; but does his son who owns the gun, enjoy his brand-new King? Well, not till Pop decides to stop and give the boys a turn; perhaps two Kings would better things. Won't fathers ever learn?



1000  
Shot Repeater,  
No. 5 King—the famous  
"Thousand-shootin'" air rifle. Lever  
action. Frame and barrel one piece of  
nickel-plated steel. Walnut stock. Light,  
strong, accurate. At your  
dealer's or direct, prepaid **\$2.50**

**KING**  
AIR RIFLES

## Big Money-Making Opportunity



Buy a Wilt Blade Sharpener—become independent. Large field, big profits. Small investment (\$135 complete with motor). Sharpens, hones and strops all safety razor blades. Act now!

WILT MACHINE CO.  
74 Bagley Ave. Detroit, Michigan

## CANARIES

Will bring sunshine to your home. We carry a full line of household pets, including Parrots Macaws Cockatoos Linnets, Finches, etc. Also Goldfish, Aquariums and Supplies. Illustrated price list and special bulletin FREE

IOWA BIRD CO., Dept. 52 Des Moines, Iowa

PRICE LIST FREE



**FREE**



Fine Tone

**\$20 UKULELE MANDOLIN, VIOLIN, GUITAR OR CORNET**

We have a wonderful new system of teaching note music by mail. To first pupils in each locality, we'll give a \$20 superb Violin, Mandolin, Ukulele, Guitar or Cornet absolutely free. Very small charge for lessons only expense. We guarantee to make you a player or no charge. Complete outfit free. Write at once—no obligation.

SLINGERLAND SCHOOL OF MUSIC, Dept. 190, Chicago, Ill.



CHICAGO

## Phone More

Take Less Time  
All the Usual Bother  
of Phoning Is Gone

No tangled cords sweep-  
ing over your desk—no

reaching—no knocking over and breaking the phone—but—your mind always clear for the big, important things. That's why you need a

**SPERRY TELEPHONE BRACKET**

Complete for \$3.50—not \$5.00

Get this practical bracket. A little push and your phone's out of the way. It must give perfect satisfaction for 5 years—the dealer you buy it from will take it back and return your money if it doesn't.

Write us for the name of the "Sperry" dealer in your town

MODERN APPLIANCE CO.

Dept. B-50, 115 So. Clinton St., CHICAGO, ILL.

## Diamond Banking

WE lend money,  
taking diamonds

as security. When loans are not paid, diamonds are sold. For over 40 years we have offered diamonds 40 to 50 per cent lower than market prices. Free examination.

The ring ideal—for the modern engagement—most different and beautiful design, 1/2-3/32 kt. exact weight. Blue-white, perfect cut genuine diamond of high degree of perfection. Mounted in lady's brand new engraved Shank 14 kt. solid gold ring. Try to match at \$150. Guaranteed Loan \$60. Unpaid Loan Price... \$75

Write Now for New Bulletin

Send name and address to us—TODAY!  
Jos. DeRoy & Sons, 1925 DeRoy Bldg., Pittsburgh, Pa.  
Reference: Marine National Bank





# WANTED A Good Honest AGENT In Each County

## \$1800 to \$5000 This Year

We want a thousand additional agents at once—local agents for townships and counties, and general agents or district managers. **Exclusive county agency free.** A proposition of unlimited possibilities—a **cash opportunity.** Wonderful new business. **No experience required.** No competition. No risk. Sample outfit furnished. Just follow easy instructions and work honestly—for yourself. All or spare time work. A profit for every hour. A customer at every home. A chance that guarantees you independence. Your opportunity. **Act today.** Send your application for free county agency.

## Amazing New Home Invention The Shafer Ventilated Chemical Indoor Closet

**No plumbing—no waterworks—no cesspool. Banishes the outdoor closet.** Revolutionizes living conditions in country and village homes. Solves the one humiliating and perplexing country home problem. An imperative necessity to health, comfort and convenience. Perfected for his own use after years of experimental work by a heating and ventilating engineer. **Tested in over 2000 homes for three years.** Now offered to the homes of the world at a nominal price. Gives positive, guaranteed satisfaction. Demanded everywhere. A sale at every home. Warranted for ten years. **Absolutely odorless, sanitary, germ proof.**

**30 DAYS' FREE TRIAL** Endorsed by physicians, health authorities, schools and thousands of homes. Every day we receive letters such as the following: "I have observed many of them in highly successful operation. In my private practice I unhesitatingly and continually recommend them. **I wish these closets were in every home.**"—Dr. Thomas H. Turner (Health Officer). "I recommend The Shafer Closet in every home as a necessity and as a duty to public health."—Dr. D. B. Henry. "It is a complete success—a splendid invention of great practical use."—O. M. Misener, (Supt. of Schools). "Every home that would put one in and use it for a week would never let it get out of the house."—Arthur B. Ransom, (Farmer).

## \$112 Cash Profit in One Day

That's the record of one man (a plumber) in a single day. **The same man has never sold less than five Closets for any half day's work.** Every home a prospect. Every sale makes dollars—not pennies—of cash profit. **Liberal commission to agents.** Biggest money-making opportunity ever offered, because it is an invention that is positively needed in every home not supplied with waterworks and sewerage system. Listen: L. J. Dulle, Mo., (Insurance Agent) says: "This is an easy thing to sell. **Everybody you go to and talk Closet to has another prospect for you.**" C. A. Carter,

Ill., (former Grain Dealer) says: "I was out today two hours and sold three. Find enclosed check. **Ship me twelve at once.**" W. H. Bartholomew, Wash., (Farmer) says: "Closets arrived yesterday. **Sold one in 15 minutes.**" Seymour L. Vance, N. Y., (Carpenter) says: "I sold nine the first three hours." W. D. Belknap, Ohio (former Real Estate Agent) wired: "Sold ten Closets today—send twelve by express." Do you want more proof of success and profit? Send today for free illustrated book showing pictures of homes and rooms containing this wonderful device, complete description, color plates, letters of endorsement from health authorities, doctors, editors and scores of users with names and addresses. This book is free—send for it today—investigate.

### Send No Money—Agents' Outfit Free

**No order required to start.** Order book, business cards and prospectus with exclusive agency contract **FREE.** Co-operation, advertising, assistance. **Business supplies capital.** We teach you how to make amazing success. Permanent business—all or spare time. Secure your county under exclusive agency contract now—**free.** Don't delay. Write us a letter or postal card, giving your name, address, and the name of your county, and mail it today. **No previous experience necessary or required.** You can make this success. **Your profits will start the first day.** Make \$40 a week to \$5000 a year commencing **NOW.** Risk a stamp to get complete, proved, reliable free information. **This is your part—DO IT RIGHT NOW.**

**The Shafer Mfg. Co., 471 Colton Bldg., Toledo, Ohio**



**No Plumbing—No Waterworks**

Chemicals, which are furnished with the closet, and air currents do the work automatically.

**Price Complete Only \$15**



No Motor  
No Wear  
No Oiling  
No Care



# HEALTH-BEAUTY-VIGOR

Health, Beauty and Vigor are the most desirable things to this big human family. Health brings Beauty and Vigor. Health puts the warm, rich color on the cheeks and the blood fairly tingles with vigor and vitality. Doctors have been recommending vibrators for years, but the price was too high. Nu-System Vibrator is patented, it is a brand new invention, a new principle of vibration that has been thoroughly tested, it has only one working part. We make but one design—of best materials, by best electricians, everything first grade. It is electrically operated without a motor, attaches to electric light fixture. Vibration works Nature's way by producing activity, not by drugging the body to heal it. Vibration is condensed exercise, it does in a few minutes daily what it takes hours of exercise to accomplish. Nu-System Vibrator can be used in home, office or factory.

**\$15 Nu-System Electric Vibrator** Introductory Price **\$9.85**

Nu-System Vibrator is a high grade instrument, it must be for we make but one model and make it the best. It has been used for a long time and is absolutely Guaranteed and is sold on a 30 day money-back Free Trial plan. It has been used in Beauty Parlors, Barber Shops, Hospitals, Sanitariums, Doctors' Offices and Residences, and we have never had one returned! What it has done for others, it will do for you. Any one can use it. It is lightweight and needs no oiling or care. Does not get garments soiled or oily. Nu-System

Vibrators have been used successfully to treat the Blood, Nerves, Stomach, Bowels, Liver, Kidneys, Skin, Complexion, Lungs, Hair, Scalp, Neck, Cheeks, Chin, Shoulders, and for Headache, Backache, Tired, Aching Feet and Brain Fog. Nu-System Vibrators are preventative as well as a curative agency.

## Special Offer

For a limited time we will sell Nu-System Vibrators complete with 5 applicators and packed in a beautiful Leatherette Case, prepaid at \$9.85. Write NOW for literature, testimonials, order blank, etc.—All Absolutely FREE.

**NU-SYSTEM ELECTRIC VIBRATOR CO.**  
24 Lighter Bldg. DETROIT, MICH.

### Absolutely Guaranteed

We guarantee Nu-System Vibrators for one year—it will last a life-time.

### 30-Day Money-Back Free Trial

If after 30 days' trial Nu-System Vibrator does not do us we claim your money will be refunded.

**DEALERS:**  
Write for  
Co-Operative Plan



# TEMCO

## Drills by Electricity Anywhere

This remarkably efficient tool attaches to lamp socket anywhere (A. C. or D. C.). It saves time and labor by quick drilling in metal or wood, tapping threads or in driving and drawing screws.

### Handiest Tool in the Shop

With attachments it will also grind automobile valves and sharpen small tools. It can be put to work in a moment. Gets at work that a big machine tool can't touch. Avoids laborious hand work. Especially adapted to garage work.

#### 12-Lb. Model Shown

Costs only 1¢ an hour to run. Has powerful Temco motor, which reverses instantly at full speed. Made in both larger and smaller sizes, one and two speed types, especially to ½ in. drilling in steel.

#### Get FREE Catalog and Booklet

Showing how other shops and factories use this time and labor saving tool. Every industry can save money with it. WRITE TODAY.

#### THE TEMCO ELECTRIC MOTOR COMPANY

137 Sugar Street,  
LEIPSIG, OHIO

Makers, also, of TEMCO-Alta Shock Absorbers and Temco Shock Absorbers, Master Vibrators and Lock Switches for Ford's.



## THE TOOL OF MANY USES

Please Mention Popular Mechanics

## Vitalic Bicycle Tires Deluxe

\$8 a pair, Brigadier \$5 a pair—made for endurance

Continental Rubber Works, 1964 Liberty St., Erie, Pa.

# Big Money Paid

## MOTION PICTURE Camera MEN



Salaries \$40 to \$150 weekly. Light, easy, fascinating work. Travel everywhere. Demand for trained men exceeds supply. Our full course covers only few weeks, Day and evening classes. No book study; actual practice in up-to-date studio under expert instructors. Call or write for free booklet. Easy terms. Special offer to those enrolling now. Don't delay. Send at once.

**NEW YORK INSTITUTE OF PHOTOGRAPHY**  
2404, 141 W. 36th St. NEW YORK

# Make \$1,200 to \$5,000 Yearly

Success Indoor Closets sell on sight. Make money the first day. Homes without sewerage, plumbing, running water, possible buyers. Doctors and Boards of Health endorse and advise its use. Sells to all classes. Kills disease germs. Eliminates outdoor closet. Is clean, absolutely odorless, germ proof. Use in any room, hall, cellar or shed. Needs but fifteen minutes' attention twice a month. Sells year around. No previous selling experience or ability needed.

#### Sell Success Indoor Closets

Make \$40 to \$100 week. One man sold 12 first week. Another sold 5 in four hours. A farmer with horse and buggy sold 5 out of every 6 calls. Another used auto and made \$12 a day. YOU CAN DO AS WELL.

#### Demonstrator FREE

We give exclusive territory and protection. Demonstrator Free to regular agents. Work all or part of time. Territory being taken rapidly. The Success is an improvement over all others. Guaranteed 30 day free trial at our risk.

**FREE** Agents' Proposition, Literature.

Territory rights free to first in field. Territory going fast. Write now. Success Indoor Closet Co., 404 Success Bldg., Toledo, O.



No dead air space.  
Constant ventilation.



# PATENTS

**IF YOU HAVE AN INVENTION** which you wish to patent you can write fully and freely to Munn & Co. for advice in regard to the best way of obtaining protection. Please send sketches or a model of your invention and a description of the device, explaining its operation.

All communications are strictly confidential. Our vast practice, extending over a period of seventy years, enables us in many cases to advise in regard to patentability without any expense to the client. Our Hand-Book on Patents is sent free on request. This explains our methods, terms, etc., in regard to *Patents, Trade Marks, Foreign Patents, etc.*

All patents secured through us are described without cost to the patentee in the *SCIENTIFIC AMERICAN*.

## MUNN & CO.

SOLICITORS OF PATENTS

672 WOOLWORTH BLDG., NEW YORK  
and 625 F STREET, WASHINGTON, D. C.

## Build This Monoplane \$2



**GEORGE D. WHITE**  
3832 South Main Street  
LOS ANGELES, CALIF.

### USES MOTORCYCLE ENGINE

Think of flying with a motorcycle engine! This is the only aeroplane that will do it. Weighs 150 pounds and lifts 190 pound man with twin cylinder motor. You can easily build one in spare time and learn to fly at home. Ordinary tools and materials used. No special parts to buy. Send \$2.00 a day for complete working drawings with all details. **SEND NOW** of this space in this issue.

## 10-Acre Farm, Best Clay Loam Soil



New 3-room house, 100 chickens, overlooking 2 beautiful lakes, near Hart and Shelby, Mich., surrounded by splendid farms and orchards—only \$525.

**Pentwater Beach Ass'n**  
861 Reaper Bldg., CHICAGO

Only \$5.00 Down and \$5.00 per Month



**\$2.00** and you get it. **Superb Cornet**  
An astounding offer. This Triple Silver Plated Lyric Cornet will be sent to you for only \$2.00. Pay the balance at the rate of only 15c a day. Free trial before you decide to buy.

**WURLITZER FREE Band Catalog!**  
Send your name and address and get our big 250-page Band Catalog. Buy direct from the manufacturer. Rock-bottom prices on all kinds of instruments and accessories. Generous allowance for easy payments. We supply the U. S. Gov't. Write today for Free Band Catalog.

**Free Carrying Case**—with this Superb Triple Silver Plated Lyric Cornet, genuine leather. Write today.  
**THE WURLITZER CO.**  
Cincinnati, Ohio Dept. 2124 Chicago, Illinois

# LE PAGE'S

## CHINA CEMENT

STANDS HOT AND COLD WATER 10¢

Please Mention Popular Mechanics

# The Burlington



## FREE BOOK

**21**  
Jewels

**\$2<sup>50</sup>**  
a Month

Burlington Watch Co., Dept. 8194,  
19th St. & Marshall Blvd., Chicago

Please send me, without obligation, your free book of **newest watch designs**; a so full explanation of your rock-bottom, direct shipment offer (cash or \$2.50 a month).

Name .....

Address .....



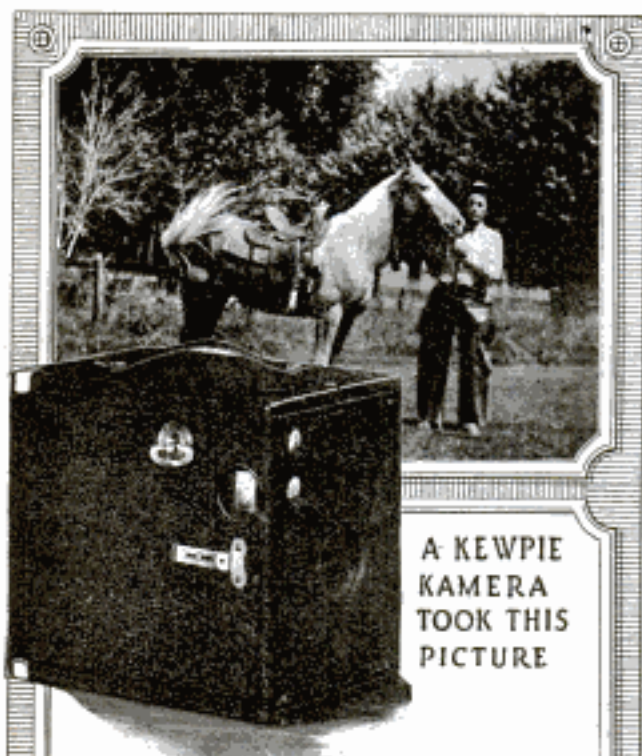

A KEWPIE  
KAMERA  
TOOK THIS  
PICTURE

—this is easy!

IT'S no trick at all to make pictures like this. Even if you have never had a camera in your hand you can make good photographs with a KEWPIE—the Little Fellows as well as the Big Fellows—boys and girls alike. Point the camera and touch a small lever. That's all! And presently you have a collection of photographs money couldn't buy for you—or from you either. We'll take all the chances of your doing it well and liking it. If you don't like it we'll take back the camera and return your money. This is our positive guarantee.

This KEWPIE is a dandy to start with. The small model takes a picture  $2\frac{1}{4} \times 3\frac{1}{4}$  inches. It costs only \$1.65, and a roll of film costs 18 cents. That's only three cents a picture! Packed for shipment the outfit, camera and film complete, weighs 2 pounds. Just order KEWPIE Outfit No. 20BP4590. Enclose \$1.83 for the camera and the film. Add a few cents extra for the postage (your postmaster will tell you how much) and we will ship at once. Full instructions go with each outfit.

If you want a larger size KEWPIE, order Outfit No. 20BP591  $2\frac{1}{2} \times 4\frac{1}{2}$  with one roll of film. Shpg. wt.,  $2\frac{1}{2}$  pounds. Price, \$2.87

TAKE IT  
WITH A  
KEWPIE  
KAMERA

No. 20BP6592  
 $3\frac{1}{4} \times 4\frac{1}{4}$  with  
one roll of film.  
Shpg. wt., 3 lbs.  
Price, \$3.97

No. 20BP6593  
 $3\frac{1}{2} \times 5\frac{1}{2}$  with  
one roll of film.  
Shpg. wt., 5 lbs.  
Price, \$4.99

If you would rather order from our big special Camera Catalog, a postal request for Catalog No. 8973 will bring you a copy without charge. It's a beauty. Ask for that anyhow, whether you buy now or not.

Sears, Roebuck and Co.  
Chicago

Please Mention Popular Mechanics

# \$300 A MONTH

We want a representative in every county at once to advertise, accept orders, deliver our marvelous new Quickedge Knife and Shear Sharpener to every home. No talking necessary. Sold upon absolute money-back guaranty.

**\$10.00  
PER DAY**

Only  
**\$150**  
Selling  
Price



Sharpens any kitchen, paring, carving knife, or shears in 10 seconds. A child can use it. No competition. Low priced. Leave fifty on trial—fifty orders at 200% cash profit.

## NEW INVENTION—JUST OUT

Abolishes dull knives and shears forever from every home. No charge for territory. Business furnishes capital. Profits start first day. No experience required. No delay. Send no money. Just write for complete particulars—FREE. Ray Carter, of Mass., sold 26 in 2 hours—profit \$26. Forest Webb, of Pa., sold 12 in 3 hours—profit \$12. Act at once. Write Now. Send name and address, and give name of your county.

**QUICKEDGE SHARPENER CO.**

675 Sharpener Bldg., 215 N. Desplaines St., Chicago, Ill.

## BUILD THIS CAR OR BUY IT COMPLETE

Lowest Priced Car in the World



Very fast. Economical. Seats 2 full grown persons. Not a toy. Complete Detailed Drawings, 25c. Catalog 6c. Cycle Car and Light Car parts at low prices. Discount to Agents.

Tribune Engineering Co., Dept. P, Owego, Tioga Co., N. Y.

## Every 1915-16 Ford Needs a

Gives  
Strong  
Light at  
Low  
Speed

**VAN SICKLEN**  
AUTOMATIC  
HEAD LIGHT CONCENTRATOR  
FOR FORD CARS  
ASK YOUR DEALER

Plenty  
Light on  
the  
Worst  
Roads

THE VAN SICKLEN CO., Elgin, Illinois



## Build Your Phonograph

Complete Plans and Specifications for This Machine 50c Postpaid. This machine sells for \$50.00. A sample will be shipped live agents for \$24.75. It plays ALL MAKES of Records.

Circulars on phonograph parts mailed you for 10c in stamps. Refund on first order. Electric and Spring Motors, Tone Arms, Reproducers, etc.

**ELECTRO-MECHANICAL PARTS CO.**  
57 Jackson Blvd. CHICAGO, ILL.



## Diamonds on Credit

20% Down; 10% a Month

Every customer is protected by our written guarantee to refund his money if his dealer can duplicate our diamond at our price.

Write for Illustrated Catalog No. 3.

**J. M. LYON & CO.** New York City





## \$100 a week pays for the Black-Beauty-Bicycle

The Black Beauty Bike can't be described in words. You have to see it — you must ride it — to appreciate how different it is. The distinctive color scheme, the substantial frame construction, the "notched" finger grips, the famous Firestone non-skid tires — all get the boys a-talking. And go! — you can beat the best of them.

**Direct from Factory — on Approval  
NO MONEY DOWN**

Let us send (freight prepaid) a Black Beauty on trial. If you don't like it return at our expense. If you do like it, you pay **ONLY \$1.00 A WEEK.**

**Guaranteed for Five Years**

by the Largest Exclusive Cycle House in America. **Five Models.**

**WRITE NOW — Get FREE our beautiful COLOR CATALOG** telling you all about Black Beauty.

**HAVERFORD CYCLE COMPANY**  
Dept. F      Established 1896      Philadelphia, Pa.

## INDOOR CHEMICAL CLOSET

No smell, no germs, sanitary. Use in any room. Needs no plumbing, sewerage or running water. Chemicals in closet kill germs. Fine for the sick and old folks.

**DESTROY OUTDOOR CLOSET**

Put in a warm, Indoor Sanitary Closet. Empty twice monthly, only attention necessary. Satisfied users and Boards of Health endorse it. Fully Guaranteed. 30 Days Free Trial. Write now for **FREE LITERATURE.**

**SANITARY CLOSET CO.,** 24 Colton Bldg., Toledo, O.



## FISHING OUTFIT

### Tackle Box, Rod and Outfit

Here is an offer that all sportsmen will find attractive. For \$2.65 you are able to get a complete fishing outfit containing all the necessary tackle for still fishing or casting. Bought separately you could not get this outfit for anywhere near the price it is offered you here. Everything that goes to make up a first class fishing outfit is included.

Outfit consists of rod, nickel plated reel, gat fish hooks, sinkers, float, stringer, fish line and tackle box.

Take advantage of this offer.

Write for our catalog "The House of Brunswick Sporting and Athletic Goods." It is crammed full of information that will interest you.

**WRITE TODAY FOR  
THIS CATALOG**

**THE BRUNSWICK-BALKE-COLLENDER CO.**  
Dept. 62, 623-633 S. Wabash  
Ave.      CHICAGO



**\$2.65**



Ignatius  
Barnard,  
Pres.

**SAVE 35% ON  
YOU**

# DIAMONDS

**By Direct  
Importing, Smaller  
Profits, Expert Grading**

Compare **BARNARD**

Diamonds with any others — size for size, color for color — and even without expert knowledge you will plainly see the big money-saving I give you! The same Diamond costs 35% less from BARNARD, because I have wiped out the profits of many middlemen. My plan of selling Diamonds all over the world at the smallest profit on each individual sale is the **only right way.**

The expert personal grading which I give to every Diamond in our vast stock is your assurance that you will get **exactly** what we promise, exactly what you **expect** in **fine quality and money's worth!** Perfect cut Diamonds as low as \$77.50 per carat. Blue White, perfect cut Diamonds as low as \$88.00 per carat.



**1/2 Carat  
SPECIAL  
VALUE!**

Exquisite Steel Blue White, fine quality diamond, in 14K solitaire engagement mounting. Value \$100.00. Our import price, complete . . . **\$66.00**



**1/4 Carat  
SPECIAL!**

Fine quality Extra Blue White Diamond Retail value \$38.95. 14K solitaire engagement mounting. Our import price, complete . . . **\$24.88**



**3/8 Carat  
SPECIAL!**

2-8 Carat Steel Blue White, very fine quality diamond, in 14K solid solitaire engagement mounting. Value \$75.00. Our import price, complete, **\$49.88**



**3/4 Carat  
SPECIAL!**

1/2 Carat Extra Blue White, perfect cut diamond in 14K Ideal Tooth solitaire mounting. Retail value \$100.00. Our import price, complete . . . **\$100.00**



**1 1/4 - 3/8 Ct.  
SPECIAL!**

3/4 - 2-84 Carat Wesselton Blue White, fine quality diamond in 14K Tiffany style solitaire mounting. Value \$20.00. Our bargain price . . . **\$15.00**

## Fine Quality Diamonds

We specialize in very fine qualities — Extra Blue White, Steel Blue White, Wesselton and Jagerfontein Violet Blue Diamonds, at prices ranging up to \$288.00 per carat for Diamonds of rare fancy color, which are flawless under a strong glass. Every price proven less than established jewelers must pay wholesale!

## NO MONEY! WE SHIP FREE

any diamond you select by any express or to any bank to prove that I sell the same Diamond for less money or a bigger Diamond for the same money.

## I Give the Only BANKABLE MONEY-BACK GUARANTEE

This is the only Diamond guarantee that you can take to any bank in America and cash in your Diamond investment if you wish to do so. It's a legal certificate of carat weight, quality and value. Permits exchange at full value at any time!

## De Luxe Book of Diamonds FREE! A Costly Bound Book 1917 Edition Now Ready

Mail coupon and get free book even if you have not yet made up your mind to order. True facts about Diamond qualities and values, and thousands of beautiful illustrations of 1917 Diamond Jewelry. References: Lake & State Park, Chicago; Dan, Bradstreet, your banker, 100,000 satisfied customers all over America.

Mail coupon or postal or letter — do it now!

## BARNARD & CO.

Dept. 2688C

N. W. Cor. State and Monroe, CHICAGO, ILL.

## FREE BOOK COUPON

IGNATIUS BARNARD, President  
**BARNARD & CO., Dept. 2688C**  
N. W. Cor. State and Monroe  
CHICAGO, ILL.

Without expense or obligation please send me, Free, postage paid, 1917 DeLuxe Diamond Book.

Name .....

Address .....

**BARNARD**



# SIMONDS

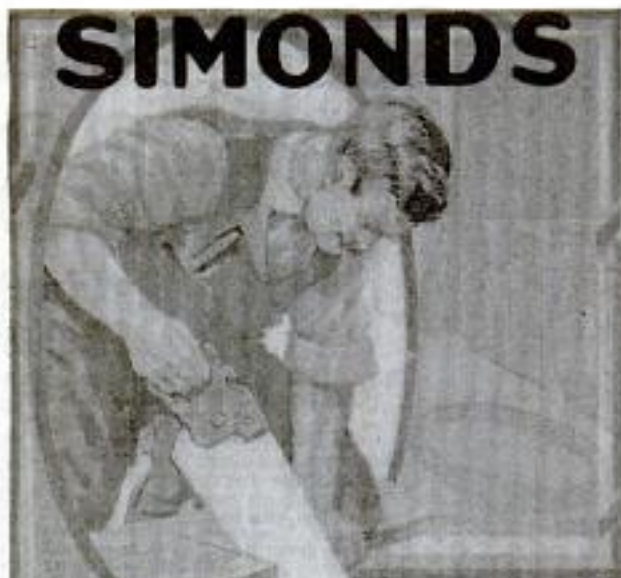

## Satisfaction in Saws

Untried articles backed by mere talk and glowing promises are to be avoided. It is well to remember that

## SIMONDS SAWS

are the result of 85 years' experience. The careful workman always insists upon quality. He gets it in Simonds edge-holding, finely tempered, guaranteed Saws.

Write for prices on any kind or size saw, or for a free copy of "Simonds Guide for Carpenters."

Simonds Manufacturing Company  
Established 1832  
Fitchburg, Mass.

5 Factories 11 Branches

"I Tell You It's  
A Great Saw"



## \$8,000 to \$10,000 YEARLY



### Make Money Out of Others' Fun

Pleasing the Public Pays Big Profits and owners of our famous attractions frequently make from \$8,000 to \$10,000 every year. We make everything in the Biding-Gallery and Carouselle line from the smallest to the highest grade. Bring in hundreds of dollars daily. It is a delightful, attractive, big paying, healthful business. Just the thing for the man who can't stand indoor work, or is not fit for heavy work.

Just the business for the man who has some money and wants to invest it to the best advantage. Our goods are finest appearing, easiest running, and most attractive line manufactured. They are simple in construction and require no special knowledge to operate. Our latest new 1917 Carouselle is mounted on trucks to facilitate and reduce cost of moving and shipping. It reproduces exactly the running horse motion. Greatest Novelty out. If you want to get into a money-making business write today for catalog and particulars.

**HERSCHELL-SPILLMAN COMPANY**  
PARK AMUSEMENT OUTFITTERS  
333 Sweeney St., N. Tonawanda, N. Y., U. S. A.

## National Aluminum Shoes ALUMINUM WORK SHOES



A Work Shoe for Rough and Wet Work on Farms, Cement Floors, Factory, Mines, Railroads, Etc.

GUARANTEED—Buck-proof metal bottoms, Water-proof, rust-proof, noiseless, comfortable, fits fit, easy walking.



NATIONAL ALUMINUM SHOES outwear several pairs all-leather shoes. Keep feet dry and warm in winter, cool in summer, prevent corns, bunions. Snow or mud can't stick to sole. Best leather appears. Sizes 7 to 13 - heights 8 in., 9 in., 12 in., 16 in. Money back if not satisfied. Postal brings free catalog giving full information, how to order, etc.

National Aluminum Shoe Co. Dept. 88  
RACINE, WIS.



## BUILD YOUR OWN PHONOGRAPH

Any type. Big saving. Profits making and selling them. We furnish parts you can't make. Lowest prices. Full instructions, comparison drawings, price list, illustrations, etc., only 25c. CIRCULAR FREE. ASSOCIATED PHONOGRAPH SUPPLY CO., Dept. 8P, CINCINNATI



## Slamasilk Floating Boat Cushion

A comfortable seat and a life preserver that supports one person in water for over 24 hours. Ideal for canoe, rowboat, motorboat and camp. Fitted with arm loops and covered with dark green or khaki-denim \$1.00; with 8 oz. khaki-duck \$1.50. Postpaid. Send for booklet showing Canoe and Camp Mattresses, Life Preservers, Swimming Belts, etc.

**UNIVERSAL SAFETY MATTRESS CO.**  
Dept. 12 31 Nassau Street New York

Please Mention Popular Mechanics



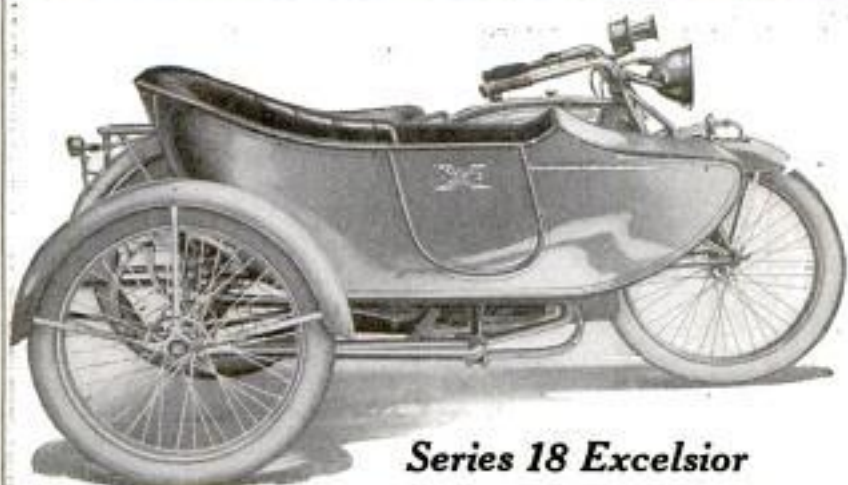

Series 18 Excelsior

MOTORCYCLE, regular equipment . . . \$275.00  
 MOTORCYCLE, Electrically Equipped . . . 310.00  
 EXCELSIOR SIDECAR, with all attachments . . . 80.00

The EXCELSIOR motorcycle, model 18-3, and the new EXCELSIOR SIDECAR, form a complete two-passenger roadster, with all the comfort and road capacity of a high-priced automobile, at less than one-fourth the cost of operation. The sidecar may be detached in less than a minute, simply by the removal of three bolts, and almost as quickly replaced, giving the choice of an individual or two-passenger vehicle.



## Series 18 Motorcycle and Sidecar

A Complete  
Two-Passenger Unit  
Separated in a Minute  
for Individual Use

The EXCELSIOR Model 18-3, big twin, three-speed motorcycle is too well known to require detailed description.

The new EXCELSIOR SIDECAR is brim full of new and exclusive features and of EXCELSIOR quality throughout. See the EXCELSIOR dealer, or write for circular Series 18-M. Do it now and be ready for the road when good weather has made the road ready for you.

## Excelsior Motor Manufacturing & Supply Co.

3702 Cortland Street, CHICAGO

## Russel Internal Gear Drive Axle



The most serviceable and economical motor truck axle made. Write for convincing reasons why your truck should be equipped with the Russel Axle.

RUSSEL MOTOR AXLE COMPANY, Central Ave., North Detroit

## Increase Your Tire Mileage

Buy a Taylor Tire Pump on an investment basis—soon pays for itself in added tire mileage. Easy to use; fastened to end of crank shaft in front of radiator in 30 seconds. Carried in tool box when not in use. Ask your dealer. If he can't supply you send \$10 direct, giving name and model of car.

TAYLOR MFG. CO., 24 Lahser Ave., Redford, Mich. (Suburb of Detroit)



## 4 Weeks' Trial

Any  
Superb



Piano Player  
Piano, choice of 30  
styles, on 4 weeks'  
absolutely free trial.  
No money down, all  
freight prepaid. Return at our expense, or keep  
it at the rock-bottom direct price. Easy terms.

Valuable Book FREE

Write today for "The Book of Complete  
Information About Pianos." Also free catalog.

Wing & Son, (Est. 1868) 9th Ave. and 13th St., Dept. 1194 New York

## US Patents Protect The Correct

When you buy the Correct Coal-Burning Heater, you buy what no other manufacturer can offer at the price. The Correct is patented. Infringements will be prosecuted. This patented device gives perfect ventilation and regulation. Insures raising every chick. Don't Buy An Imitation.

PRICES 41" Canopy \$11.75; F. O. B.  
52" Canopy \$12.85; Factory

Free Circulars describing this big value. Write now.  
CORRECT HATCHER CO., Dept. 20, Leosville, Carroll Co., Ohio



## TWIN FIRE The Spark Plug You Need

Here's the only plug on the market that fires more than one distinct spark. It fires two series sparks—two sparks, each independent of the other but at same time.

Double intense sparks on same current as ordinary plug consumes. Adds a world of "snap" to motor; quicker get-away and more downright pull. Reduces carbon also because each combustion is complete. Go to your dealer today and buy a set of Twin Fires. If he can't supply you send direct. Price only \$1.00 each—you'll say it's the best plug you've ever used. Give size required.



Twin Fire Spark  
Plug Co.

660 Woodward, Ave.  
DETROIT, MICH.

Dealers—There's an enormous demand for Twin Fire Spark Plugs. Easy to sell. Send for particulars.

Please Mention Popular Mechanics





## Conn Instruments Now Sent on Ten Days' Trial

Write today for the Conn catalog and see handsome illustrations of all the Conn instruments you may get on ten days' trial. Practically every famous bandman in America uses a Conn instrument. Sousa's, Washington Marine, Pryor's, Conway's and hundreds of bands of international fame use Conn instruments. And your choice of all the Conn instruments will be sent to you for ten days' free trial, right in your own home.

*If you decide to buy, you may pay the rock-bottom price in small monthly amounts.*

**Write Today for Catalog** Send your name and address today for the Conn catalog and full particulars of this remarkable offer. You will be under no obligations. Here is your chance to own the Conn instrument that you have always wanted. Write today for the catalog.

C. G. CONN, Ltd.

Dept. 1191

Elkhart, Ind.



## The Easy, Low Cost Way of Ironing



Every housewife can save hours of hard, tedious labor and have better ironing, too, by using a "Simplex." The cost for an entire family ironing is only 2 to 4 cents. The

## SIMPLEX IRONER

THE BEST IRONER

is very easy to operate. A size for every home. Use hand, gasoline or electric power. Lasts a lifetime.

**JUST WHAT YOU NEED**

Write today for our handsomely illustrated book, "CLEAN LINEN IN ABUNDANCE."

**American Ironing Machine Co.**  
505-168 N. Michigan Ave., Chicago, Ill.

### THE REEL WITHOUT A RIVAL

The CASTER'S IDEAL

A reel that is really reliable. Faultless in construction. Sturdy in strength. The **GUY-RA-TORY** Reel is entirely new. Fewer parts. Greater simplicity. Spool action distributes line without thumbing. Eliminates cutting in. Dries it on a spool. Prevents back lashes and snarls. Taken apart in jiffy. Other exclusive improvements fully described in attractive catalog. Write at once for copy. It's free.

**Guy-Ra-Tory Reel Co.**  
Dept. 117, 222 Fifth St.  
Racine, Wis.

## COMBINATION LOCK

For Trunks, Tool Boxes, Chests, Etc.

A regular safe lock. Has 63,000 combinations and cannot be picked. Made of cast brass with steel tumblers. Can be easily attached to any trunk, tool box or chest.

**Sent prepaid upon \$2.25 receipt of . . . . .**

Place Your Order Today

**Steen Combination Lock Co.**  
WAUKEGAN, ILL.

## Build This Speedster Yourself For Only \$4



Model "55"

WITH the remarkably simple, sure-fit, **Red-I-Kut System of Patterns**, you can make your Ford Car into one of the classiest Speedsters on the road, with all the appearance of a \$1500 car—in a few hours! Any one can do it with **Red-I-Kut** Patterns, a saw, hammer, screw driver and materials bought at any hardware store. The lines of **Red-I-Kut** bodies are beautiful beyond comparison.

distinctive, different. The bodies stand low. Keep the road, hug the turns at all speeds, weigh less, saving tires, gas and oil, have fender pick up, greater riding comfort—designed on airplane speed principles by our engineers. **Red-I-Kut** Patterns are life size, mistake-proof. Sent with full instructions, from A to Z, on receipt of price. **Model 55, only \$4.00.** Money back if not satisfactory. Get into the \$1500 class. Make everybody in town sit up and take notice. Specify if patterns are for old or new Ford Radiator.

Model K-9—Built low, rides wonderfully easy. Bullet-shaped rear, formed by special metal frame, given free. Complete, \$6.00.



From actual photo

**THE KUEMPEL COMPANY, Design Dept. 14, DUBUQUE, IOWA**



**THE FINAL BLOW**  
to Faulty, Dangerous Vulcanizing Methods—

## "IT'S-IT" VULCANIZER

Is the one wonderful invention—the one remarkable mechanical achievement that has snuffed out the entire horde of vulcanizing evils. It had to come. Motorists were dissatisfied with unreliable devices—afraid, and justly so, of open flame contraptions. Time revealed their imperfections—burnt tubes and a trail of costly conflagrations branded them not only inefficient but positively hazardous. "IT'S-IT" is operated electrically—no gasoline—no combustibles of any sort. You couldn't "set a fire" with the "IT'S-IT" if you wanted to. Accurate in operation. Complete process of vulcanization in 10 minutes' time—in highest wind or lowest temperature. No flame-flickers. No heat variations. No guesswork. No under or over curing—no singed tubes—no failures.

**Costs Only \$1.50 Complete** No chemical pads to buy. No fuel. Connects with any light socket on car. Heat applied through metal disc that needs no replacing. Safe—dependable—economical—ready for instant service on the road—in the garage—**everywhere**. Convenient to carry—to use. Saves tubes and repair expenses. Saves a hundred times its cost. Not an experiment, but a perfect product of proven value. Thousands in use. Supplied in 6 or 12 volts. 6 volt furnished standard. State voltage desired when ordering. Sold by leading dealers everywhere—under guarantee of money back if not satisfied after 30 days' trial. If your dealer won't supply you, write us.

**THE PREMIER ELECTRIC CO., 4041 Ravenswood Ave., CHICAGO**

Exceptionally Good Dealer Proposition Liberal profits. Rapid sales and a lot of them. Write quick for Dealer's Discounts, giving Jobber's name.

**NO MATCHES—  
NO FIRE—  
NO DANGER—  
NO FAILURE!**

**Safe—Sure—  
Economical**



## \$6.00 ELECTRIC FAN COMPLETE!

Price includes plug and 3 ft. cord. Universal motor good on alternating or direct current. Finished in black enamel. 11 inches high. Weighs 7 pounds. **AGENTS AND DEALERS WANTED!** Big money will be made this summer by men who represent us on this \$6.00 Fan. **WRITE FOR OUR OFFER TODAY.**

Kadenz Electric Co., 58 Reside St., New York

## AGENTS WANTED

for our independent hollow-wire lighting systems for homes, stores, public buildings, etc. Use common gasoline. Best and cheapest illumination known.

## AKRON LIGHTING SYSTEMS

are most improved, simplest and safest of all. Shed a clear, soft, bright light of high candle power. Also complete line of portable and street lamps and lanterns. Fully guaranteed. Our Agency Proposition cannot be beat. Exclusive territory. Send quick for catalog and terms.

**Agents' Outfit** Akron Gas Lamp Co., 322 E. High St., Akron, O.



## WEBER THROTTLE-GOVERNED KEROSENE ENGINES

4-Cycle  
**Lowest Priced Throttle-Governed Engine on the Market—Cash or Payments**

Save Half in Fuel. The 1917 model Weber solves the problem of low cost power for all time. Power and speed controlled by throttle, same as steam. No waste of fuel—no violent explosions. Throttle regulates amount of fuel to size of load.

Sold on a Five-Year Guarantee—Two Months' Trial in shop or on farm. Shipped direct from factory at a big saving.

**FREE BOOK—"How to Use Kerosene" and Engine Folder, sent post-paid. Address**

**WEBER ENGINE CO.**

Dept. 171A

Kansas City, Mo.

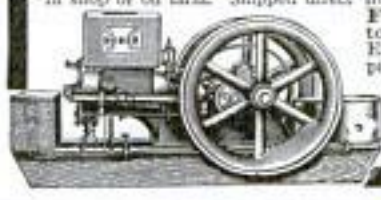

## Temco Comfort Coils for Fords

New—different—wonderful in action. Backs all shock absorbing devices off the boards. Strong statement, but true. The double helical steel springs do the business. They're longer—stronger—more flexible. Bumps and holes are eaten alive. The roughest road becomes almost a boulevard. One man writes: "They're life-savers on rough roads."

**SAVE YOUR VITALITY** Conserve your strength. Be kind to your back and nerves. Jolts and bumps produce fatigue, nervousness, weak spines, headache, trouble with vital organs, etc. Put on a set of comfort coils and avoid all this.

**GET YOUR SET NOW** Once on, you wouldn't take them off for love or money. Words cannot picture the ease and comfort they give. It's wonderful. Nothing like them anywhere. Temco Comfort Coils are supreme. Listen to this: "Have used six different shock absorbers in the past six years, but none satisfied except Temco. Comfort Coils is the right name."

**30 DAY TRIAL** But don't take our word. Send now for your set. Try them 30 days. Money cheerfully returned if you can part with them. Substantial. Will last as long as your Ford. Easy to attach. Any one can do it. No extras to buy. Write quick for full details, and astonishingly low price, prepaid.

**DEALERS AND AGENTS GET BUSY.**  
**THE TEMCO ELECTRIC COMPANY, 2101 Sugar St., Leipsic, Ohio**





**OWN A STORE LIKE THIS!**  
**YOU CAN!**



**POP CORN CRISPETTES**

**BUILT THIS BIG BUSINESS FOR ME**

**FREE SECRET FORMULA FOR MAKING CRISPETTES**

Here's a chance for every ambitious man to get into a big money-making business for himself. Requires no experience and but little capital. Once I was just a struggling candy maker. The profits from Crispettes — the new delicious pop corn confection — built this big business for me. The very same proposition that made me should do the same for you. I'll furnish everything — **teach you Free** — show you how to make Crispettes by my secret formula — show you how to succeed. You can build a business of your own as I did. Get a window — a small store — a cozy nook in a theatre lobby or similar location where the rent is low. Start the business. Keep all the profits.

**Every Nickel You Take In Nets You Almost Four Cents Profit**

The demand for Crispettes is enormous — everybody everywhere likes them. One sale means two, two means four and so it goes. **Think of the fortunes made in 5c pieces.** It's a great business. I found it so. So should you. Come to Springfield and see all this for yourself. Drop in quietly. Ask anybody about Long, about my store. Ask them if what I say isn't the truth. See the Crispette Machine just like I'll furnish you. See Crispettes made. Make a batch yourself. It's so simple, easy. You'll see — know — learn all about this business. Up to a distance of 300 miles I'll pay your railroad fare if you decide to go into the business.

**Send for My FREE Book**

"Dollars and Sense in the Crispette Business." It tells the complete story — gives all information. It's mighty interesting reading. Tells what others have done and what you can do. Write for it today.

**W. Z. Long Company**  
 1328 High St., Springfield, O.



This Machine Makes Big Money

**Electric Light for Your Home**

Uni-Lectric lighting plant generates standard 110-volt direct current; operates from one to 50 lights, electric motor, electric iron, vacuum cleaner, electric toaster, force pump, churn, washing machine, etc.

**No Batteries — No Switch-Board** and a better machine for less money. High speed gasoline motor, generator and automatic governor, all complete in one small, compact unit. Uses standard lamps and fixtures. Simple, easily installed, dependable, economical. Costs less than other systems to buy and to operate.

**WATERMAN MOTOR COMPANY**  
 182 Mt. Elliott Ave. DETROIT, MICH.

Write today for full description and low price.

**Uni-Lectric**  
 GASOLINE-ELECTRIC UNIT LIGHTING SYSTEM



Send 10 Cents coin perforated and we will mail you one

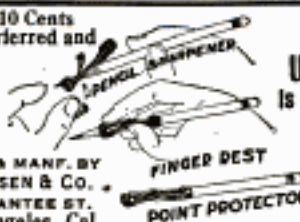

PATD. & MANF. BY  
 S. JENSEN & CO.  
 828 SANTEE ST.  
 Los Angeles, Cal.

Carry it on your Pencil then it is there when you need it

**Universal Pencil Sharpener**

is a time saver & Convenience  
 It protects the point and helps to hold Pencil while carried in Pocket

Price 10 Cents

**LOWEST PRICE BOAT IN THE WORLD**



**\$89** for 15-foot boat finished ready to run, with either inboard or outboard motor.

Builder-Agents Wanted

**\$25** for complete k. d. boat — oak frame — cypress planking. Free Catalog — 100 Boats  
**BROOKS MFG. CO.**  
 8204 Shin St., Saginaw, Mich.



**Your Garage Doors "STAY PUT" WITH THIS HANGER**

**The Perfect Garage Door Hanger Set**

**Use This Hanger on the Garage You're Going to Build This Spring**

Allows use of full door opening without risk of damage to car or door, and door cannot swing or blow shut, as it automatically fastens itself open. No extended run-way on either side of building, and no sticking or getting out of order. Can be opened to any width desired, and is weather-tight when closed. No sawing or cutting of holes necessary to attach. Your doors "STAY PUT."

Ask your hardware dealer — Also send today for descriptive circular, surprisingly low price.

Dealers — Get ready for the big spring garage building season. There's big profit in this device, and there'll be a big demand. Architects — Specify this in your plans and make every client happy. Write for terms.

**Safety Door Hanger Co., 104 Topping Bldg., Ashland, Ohio**



**SPECIAL OFFER!**

"Mill-Cut-to-Fit"  
Homes

at "Before-the-War"  
Prices



The  
"Harrison"  
Size 24' x 24'  
— six rooms  
and bath!

**\$1076**

You don't have to pay War-time prices for your new Home. These matchless "Mill-Cut-to-Fit" Homes are still selling at "Before-the-War" prices.

**Build Now! Save Money!**

Build the modern way. We plan—design—cut-to-fit—mark every piece. Material arrives on the ground ready to put together like the modern skyscrapers.

We save you tremendous lumber waste! We also cut a huge slice from carpenter bills—usually more than cost of materials. Price includes all lumber, hardware, glass, paint, nails, etc.

"Mill-Cut-to-Fit" Homes are famous for architectural beauty, convenience and durability.

Write for details. Homes of every size and style sold at low prices. We challenge comparison. Catalog of Plans Free. Send for it.  
**Bay City Ready-Cut Home Company**  
Dept. 41, BAY CITY, MICHIGAN

**Builders  
and  
Carpenters**

An excellent proposition. Not a large profit per house, but a plan to sell a large number.

The Alaska Board of Road Commissioners evidently dislikes criticism, for in its latest annual report one may read that "Alaska abounds in mineral wealth, fish, and road-commission critics."

**INSYDE TYRES**

Inner tubes for auto tires. Prevent punctures and blow-outs. Double mileage of any tire old or new. Easily applied to any tire between casing and tube. Details free. Agents wanted. Liberal profits.

**AMERICAN ACCESSORIES CO., 417 Gulow, Cincinnati, Ohio**

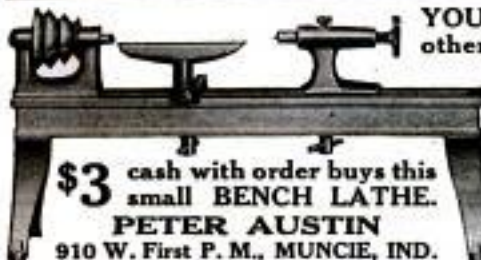

YOU, like many others, have long wanted this **LATHE**—small, low-priced, yet very useful. Swing, 3 in.; 8 in. between centers; shipping wt. 10 lbs.

**\$3** cash with order buys this small **BENCH LATHE**.

**PETER AUSTIN**

910 W. First P. M., MUNCIE, IND.

**Factory to Rider SAVES YOU MONEY**

Buy direct and save \$10 to \$30 on a bicycle. **RANGER BICYCLES** now come in 44 styles, colors and sizes. Greatly improved; prices reduced. Other reliable models \$15.75 up. **WE DELIVER FREE** to you on approval and 30 days' trial and riding test.

Our big **FREE** catalog shows everything new in bicycles and sundries. Write for it.

**TIRES** lamps, wheels, parts and supplies at half-usual prices.

Do not buy a bicycle, tires, or sundries until you get our wonderful new offers, low prices and liberal terms. A postal brings everything.

**MEAD CYCLE COMPANY**  
Dept. 8198 Chicago

Ranger  
Electric  
Lighted  
Motorbike



SHE'S A GREAT CAR UNDER THE HOOD BUT WHO WOULD KNOW IT BY HER LOOKS? GIVE HER A COAT OF **Effecto** AUTO FINISHES

Made in seven colors. Clear Varnish and Top and Seat Dressing. Sold by paint, hardware and auto accessory dealers. Send for Color Card. Pratt & Lambert-Inc. 153 Tonawanda Street, Buffalo, N. Y. In Canada, 99 Courtwright Street, Bridgeburg, Ontario.

**MADE BY THE MAKERS OF PRATT & LAMBERT VARNISHES**

**New Profits from Waste**

EVERY scrap of paper that goes into your waste basket is worth money. Common mixed paper sells as high as \$16 a ton when baled—and this cash is added to your net profits if you own a Woodall Baler. Big companies all over the country are making their Waste paper pay big dividends.

**Baling Press**

Not only paper, but rags, excelsior, scraps and other marketable waste is readily sold when baled. Use the Woodall Baler as a depository for this waste. When you have the press full, merely pull the lever, hook the wires and the bale is ready. Send the coupon now for details.

**30 Days' Free Trial!**

We'll send you a Woodall Baler on 30 days' trial. Find out what it is going to mean in your business before you decide to buy.

**Send for FREE Catalog**

Send the coupon, a letter or a post card for our new circular—it is free—but will show you how to make money from your waste paper, rags, etc. Write today. Don't wait another minute.

**Woodall Mfg. Co.**  
Dept. 1194  
Davenport, Iowa

**Woodall Mfg. Co.**

Dept. 1194 — Davenport, Iowa

You may send me your free circular which tells about profits in waste paper.

Name.....

Address.....

Please Mention Popular Mechanics



# Prest-O-Lite

for  
Motorcycles

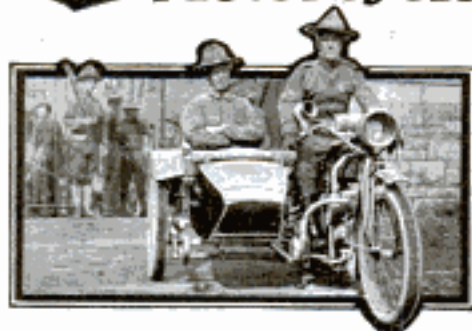

## Makes Night Riding Safe

Your safety in riding at night depends solely on the brilliancy and reliability of your lighting system. Prest-O-Lite furnishes ideal riding light and is always dependable. It enables you to ride safely on *any* road under all conditions—floods the road far ahead with a brilliant, steady, penetrating beam of light, unaffected by bumps and jolts.

Prest-O-Lite will never fail you in an emergency—is sturdy, efficient and trouble-proof. Needs no attention you yourself cannot easily give. With its many advantages Prest-O-Lite costs less to buy and less to use than any brilliant lighting system. That's why it is the first choice of experienced riders everywhere.

You can get it on *any* make machine you buy.

## Get Prest-O-Lite for Regular Service

Any dealer can fit you out with Prest-O-Lite. A popular combination of equipment many dealers are offering at an attractive price is "A Prest-O-Lite tank, a lamp and mechanical horn." This will give you lighting service of the highest order at lowest cost. See your dealer about it today.

Learn the many excellent features of Prest-O-Lite for motorcycles. Write today for interesting literature.

**The Prest-O-Lite Co., Inc.**

World's Largest Makers of Dissolved Acetylene  
265 Speedway, Indianapolis, Ind.  
Canadian Office and Factory  
Merritton, Ont.

Prest-O-Lite Exchange Agencies Everywhere

Please Mention Popular Mechanics

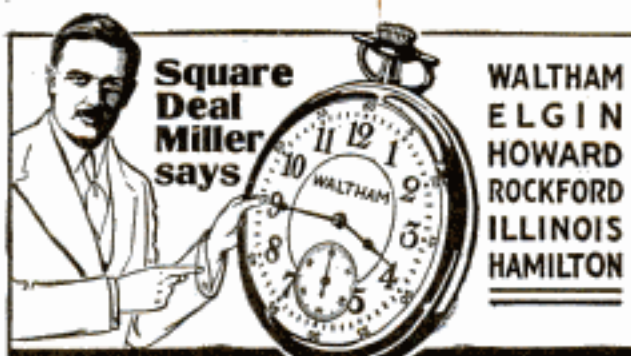

## Any Watch YOU WANT on CREDIT

**One Customer Writes:** "I have had my watch just a year today and our watch inspector says its the best time keeper on the road. Please find enclosed my last monthly payment of \$1.00." We have thousands of such letters on file from satisfied customers, who have bought from us on

### 30 Days Trial Express Paid No Money Down

You take no chances with me. I am "Square Deal" Miller and I trust the people. That is why I am doing the greatest credit Watch, Diamond and Jewelry business in the world.

Watches Guaranteed for 25 Years

### I Smash the Terms

NO REFERENCES DEMANDED

My terms will surely suit you. You get unlimited credit.

**A Charge Account** the same kind of credit you get from your grocer. No matter where you live or what your income might be, you can now own the finest of watches, a beautiful diamond or any rare jewelry and never miss the money.

**Catalog FREE** Send me your name and address so I can mail you Free and postpaid the most beautiful catalog of its kind ever printed. I want you to have this book. It's a gem. Write TODAY.

**SQUARE DEAL MILLER, Pres.**

MILLER-HOEFER CO. 831 Miller Bldg., Detroit, Mich.

## Hartman Will Trust You

### Rock Bottom Prices

Furniture, Carpets, Rugs, Etc.

**Easiest Terms** Hartman's credit terms easiest, most liberal ever offered. No security—no notes—no mortgage. Free from all objections. At the end of a month you may **30 Days Approval** return anything unsatisfactory.

Hartman refunds your money including freight.

**FREE—Big Bargain Book** Over 3,000 bargains. Write today for FREE copy.

**HARTMAN FURNITURE AND CARPET CO.**

3945-47 Wentworth Av., Chicago



## Ford Instruction Book

For Every Ford Owner, Dealer, Salesman and Repairman

Deals fully with construction, operation and repair of the Model T Ford Car.

Cloth—300 Pages—100 Illustrations

Price, \$1.00 Postpaid

POPULAR MECHANICS BOOK DEPT., 6 N. Michigan Ave., CHICAGO

## THE DESTRUCTIVE WORK OF A SUBMARINE

can be best understood by studying our Chart of a Modern Submarine, size 14x28 inches; printed on plate paper and showing and naming over 200 parts. This chart is a cross-sectional view (lengthwise) and shows the entire construction and operation; is really an encyclopedia of a submarine; educational and worth many times its cost.

PRICE 25 CENTS POSTPAID

POPULAR MECHANICS BOOK DEPT.

6 N. Michigan Ave., CHICAGO





House of Mr. Chauncey Olcott, Saratoga, N. Y. Charles Barton Keen, Philadelphia, Architect

**T**HREE of the essentials for success in building a home are—a practical plan, artistic design, and good workmanship. But without the fourth essential—proper selection of materials—the other three are of little avail.

Take the matter of lumber. All woods are not equally good for all uses. One is good for one purpose—another for another. Select woods for their proper uses, and you will have no disappointments.

## WHITE PINE

Any architect, carpenter or lumber dealer will tell you that for the outer covering of a house—subjected to the rigorous onslaught of rain and snow, heat and cold, sun and wind—no other wood is so durable and holds its place so well, without warping, splitting, rotting or opening at the joints, as White Pine.

Address **WHITE PINE BUREAU,**  
1426 MERCHANTS BANK BUILDING, ST. PAUL, MINN.

Representing  
The Northern Pine Manufacturers'  
Association of Minnesota, Wisconsin  
and Michigan, and The Associated  
White Pine Manufacturers of Idaho



"White Pine in Home-Building" is beautifully illustrated and full of valuable information and suggestions on home-building. Send today for this booklet—free to all prospective home-builders.

"The Helen Speer Book of Children's White Pine Toys and Furniture"—a fascinating children's plan book, from which a child may build its own toys and toy furniture. Prepared by Helen Speer, the toy expert. If there are children in your home, sent free on request.



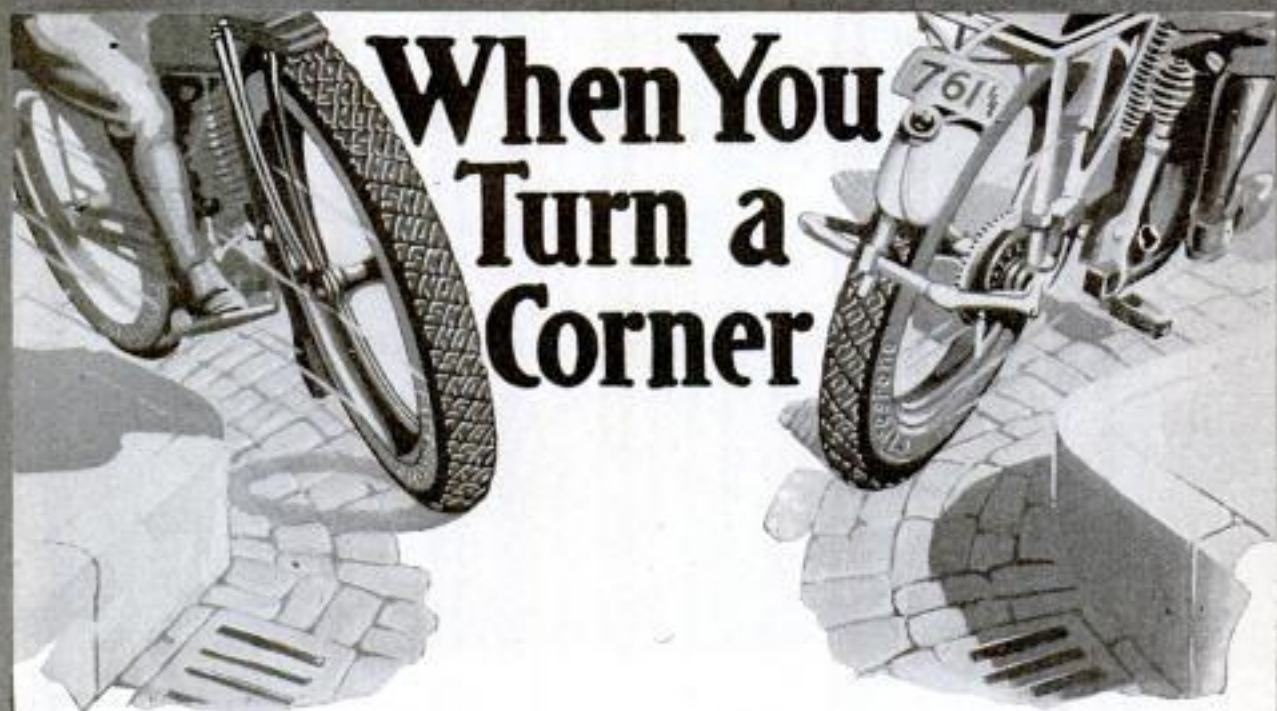

## When You Turn a Corner

**A**N automobile wheel is always perpendicular to the road. But a motorcycle wheel tips as it turns a corner. This means that the traction surface of a motorcycle tire is wider in proportion. Therefore, to give the proper wear, the tread must be wide enough to allow for this extra traction surface. Also just as thick at the sides as in the center.

**T**HESSE leading manufacturers furnish Firestone Tires on their machines without extra charge.

Cleveland  
Dayton  
Emblem  
Excelsior  
Harley-Davidson  
Henderson  
Indian  
Reading Standard  
Schickel  
Thor  
Smith Motor Wheel

Firestone Motorcycle Tires meet every condition of motorcycle riding. They are built to stand up under the strains of all kinds of roads. They are built for the road grip and resilience that will give you the greatest safety and comfort. They are built to give "Most Miles per Dollar."

See your dealer.

FIRESTONE TIRE AND RUBBER COMPANY  
Akron, Ohio      Branches and Dealers Everywhere

# Firestone

## MOTORCYCLE TIRES

Please Mention Popular Mechanics

Copyrighted material



# Free From Straps

**N**O MORE crowds and stuffy air. No more waiting for cars. No more searching through pockets for change. No more delays, traffic blocks and tie-ups. Free and independent of them all—free to come and go as you please on a 1917 new and up-to-the-minute

## *Columbia* Bicycle

Think what all this means: A stand by for work and play: To the office and back—the baseball game in the next town—that little lake packed away in the hills—the open country—the city lights.

Have you seen the new Columbia models? The greatest line of bicycles today on the market. They should be. There is more experience behind them. Thirty-nine years of it! The Columbia was popular before the majority of the present day bicycles were ever heard of. It is the oldest, the recognized standard bicycle of the world.

Look these models over. Each model leads its class.

Line them up and take your choice.

Do you want a Catalog?

Write today.

**Westfield  
Manufacturing  
Company**

Department 15

Westfield,  
Massachusetts.

*Makers of the  
Pope Motorcycle*

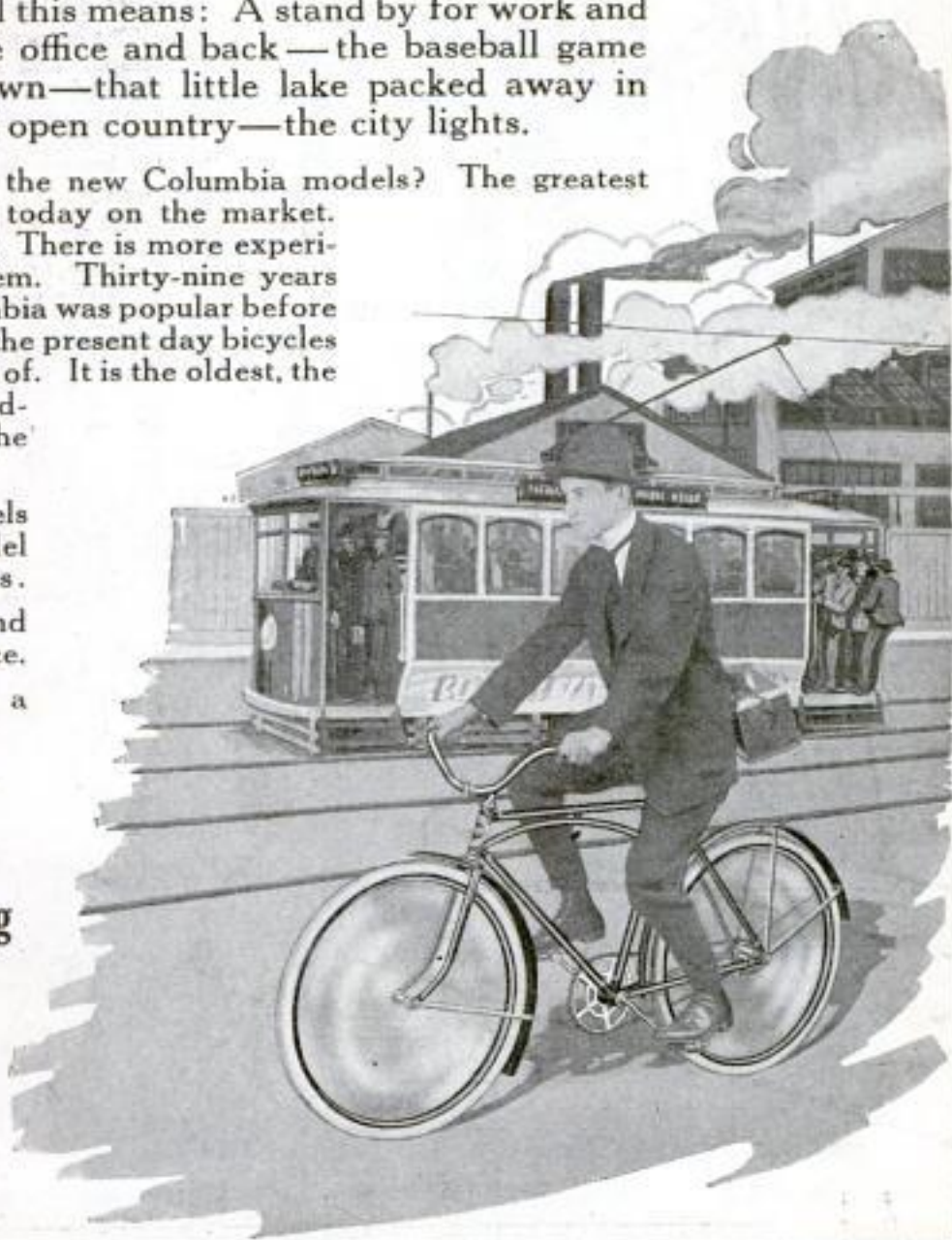



# DISSTON

## SAWS AND TOOLS



### Ask Your Carpenter

He knows saws. Pride in work well-done, and success in his trade, demand that his tools do their part.

Ask the gray-haired carpenter whose Disston saws have built hundreds of homes. Ask the young workman whose Disston saws will build the homes of the future.

The carpenter knows that perfect temper and hang, teeth perfectly adapted to their work—all the qualities a saw should possess—are summed up in the word "Disston." He knows the economy of buying quality.

*Write for Our "Hand-Saw Booklet"*

**Henry Disston & Sons, Inc.**  
PHILADELPHIA, U. S. A.

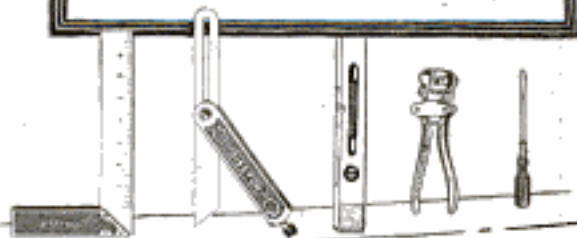

*Please Mention Popular Mechanics*



ACCURACY **STANDARDIZATION** SPEED

## Why the Allies' "Great Drive" Was Delayed

Last Summer the whole world was asking: "When will the Great Drive of the Allies start?" Field Officers and public were equally uncertain. Troops were ready. Transportation, food, ambulances — everything was there, except Guns and Shells.

Shells were needed by the million; orders were placed everywhere, but production had hardly begun. Why? Because nothing can be made rapidly and accurately in large quantity without Gages. Before manufacturers could start their lathes they must have Gages, which require time and skill to make.

## The Men Who Made the Gages Knew Why the Drive Was Delayed

Let American manufacturers apply the lesson that Limit Gages are absolutely necessary for rapid and accurate work. Gages will measure profits in the severe competition after the war.

Limit Gages are for internal and external screw threads, holes, round bars, and a multitude of special purposes.

For example, we show above a thread limit gage in use — gaging a screw. If the screw is too small it will pass both sets of points, as shown at the left. A screw too large will

fail to pass either set of points (center). If just right, it will pass the upper set and hang on the lower, the "touch" being governed entirely by the weight of the screw.

The two sets of points are sealed to a certain variation above and below the required diameter. This variation depends on the work; whatever the product, whether a single piece, such as an "S" wrench, or a complicated mechanism, Limit Gages are a prerequisite to accurate, economical production in quantity. Absolute accuracy is unattainable and unnecessary; a Limit Gage is made to check dimensions within the variation decided upon as permissible, and with it an inexperienced workman can gage thousands of parts in a day.

The parts that pass this inspection will be interchangeable, and will positively fit into the complete machine. Assembly is made easy and rapid. Moreover, since parts can be gaged so easily and cheaply, more frequent inspection is practicable, errors are quickly discovered and corrected, rejections are minimized. The result is a higher quality product at a lower cost, often with magical effect on profits.

For further information, write for General Catalog 37, or Bulletin, "How to Measure Screw Threads."

**Greenfield Tap and Die Corporation**

**Gages-Taps-Dies**

Threading Machines, Reamers, etc.

Greenfield, Mass., U. S. A.



Plug Limit  
Thread Gage



# Every Boy Knows

that the best bicycle in the world is incomplete without the best tires. That is why he always insists on his dealer stocking the twelve different makes of

## United States Bicycle Tires

Heavy Service Traction Tread  
United States Cord  
U. S. No. 77 Chain Tread  
U. S. Blue Dual Tread  
U. S. Road Racer  
U. S. Giant Stud  
Overland Thornproof Oil Resisting

Nonpareil  
G & J Double Clinch Chain Tread  
G & J Double Clinch Corrugated  
G & J Double Clinch Herringbone  
Tread  
Single Clinch (G & J style) United  
States Brand

Because they not only are the very best, but also because *they meet every need of price and use.* Send for our free and beautifully illustrated catalog **Today.**

*Be Sure and Ask for One of the Twelve*

## United States Tire Company

*United States Single Tube Bicycle Tires  
Original Indianapolis Brand G & J Clincher Bicycle Tires*

**1790 Broadway, New York**





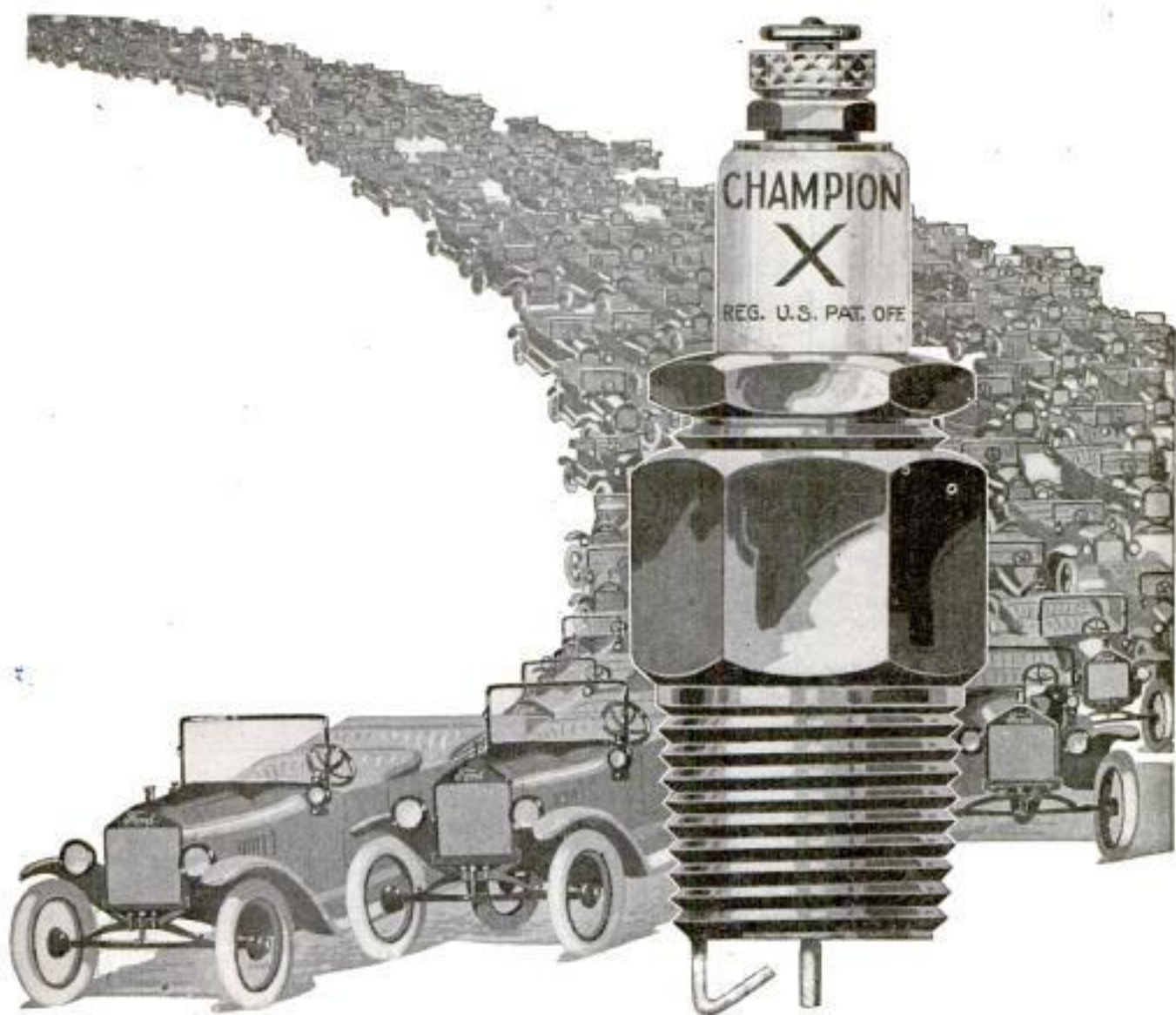

 **Champion**  
**Toledo**

## Dependable Spark Plugs

The gigantic Ford production is factory equipped with Champion X Spark Plugs. They have been standard equipment since 1911 on over one million three hundred thousand Ford cars.

Champion X plays an important part in the efficient performance of the famous Ford motor.

Champions are scientifically built—and elaborately tested.

They show it by their sterling performance.

Dealers everywhere sell Champions—not only for Fords but for any type of motor.

There is a Champion specially designed and built for every type of motor car, motorcycle, marine and stationary engine.

Be sure the name "Champion" is on the porcelain—not merely on the box.

**CHAMPION SPARK PLUG CO.**  
415 Upton Ave. TOLEDO, OHIO





## Your Vanity Doesn't Go Far Enough

**V**ANITY which prides itself merely on a good complexion isn't enough. A thorough-going pride in a healthy body is much more worth while cultivating. You cannot have a good complexion or a healthy body if your system is continually clogged with waste matter.

Nujol, unlike physics or drugs, will effectively relieve constipation without in any way disturbing the normal bowel function. It prevents the intestinal contents from becoming hard, lubricates the intestinal tract, and so facilitates normal movements. Nujol does not gripe or upset the system. Being tasteless, it is not unpleasant to take.

The Standard Oil Company (New Jersey) has used its world-wide resources in producing Nujol and its reputation is behind the product.

*Nujol is the only remedy for constipation we manufacture. The genuine sold only in pint bottles bearing Nujol trade-mark. All bottles filled at our Nujol plant, absolutely modern and sanitary.*

Write today for instructive booklet, using coupon below.

### STANDARD OIL COMPANY

(New Jersey)

Dept. 68

Bayonne

New Jersey

Please send me booklet on the treatment of constipation  
Write your name and address plainly below

Name..... Address..... City..... State.....

Please Mention Popular Mechanics





# \$45 Starts You in the Tire Repair Business

Here is your opportunity to get into this big paying, big profit business. A business of your own in which you can be your own boss—a business that runs hand in hand with the automobile business—that grows with it and is fast becoming the biggest paying proposition in the automobile field. You can start now on small capital—only \$45, and cash in this gigantic opportunity. The coupon below will bring you full details—full particulars. Mail it today.

## Millions of Tires to Repair—Means \$3,000 a Year for You

It is estimated that more than 30,000,000 tires will be made this year. These, with all the old tires now in use, will need repairing—will demand the expert attention—the expert service that you can give as a **Haywood Tire Repair Man**. You can learn this business in a few days. You can open a shop and make money almost at once. Auto owners will come to you—tell their friends, and if you are a live-wire, your business will soon grow from a one-man shop to a big complete tire repair shop and accessory store.

### Complete \$45

### HAYWOOD'S Model D.B. VULCANIZING PLANTS

#### One Machine Will Start You Making Big Money

This machine at its unusual price is practically the last word in efficient, economical tire repairing. It is simple, compact, quick acting, and requires but little room. It will vulcanize and make tire repairs of almost any nature—will do practically everything in the tire repair business except retreading. Just a small investment—\$45—a trifling amount, places you on this road to prosperity—gives you the start in this wonderful business.

#### The Only Nationally Known Tire Repair Service

Through National advertising, Haywood Tire Repair Service is known to auto owners everywhere. When you open a Haywood Shop you have the advantage of an established business—a business of unlimited profits—a business you don't have to wait for—that comes to you with scarcely an effort. In this, most wonderful year of the automobile business, is the time for you to start. More tires are to be used than ever before. The cost of operating cars is steadily climbing. Punctures and blow-outs are still common, and every man now, regardless of wealth, know that keeping his tires repaired, prompt attention to the little cuts and bruises of his tires, is true tire economy. Tires are the biggest item in the up-keep expense of an automobile. You know that.

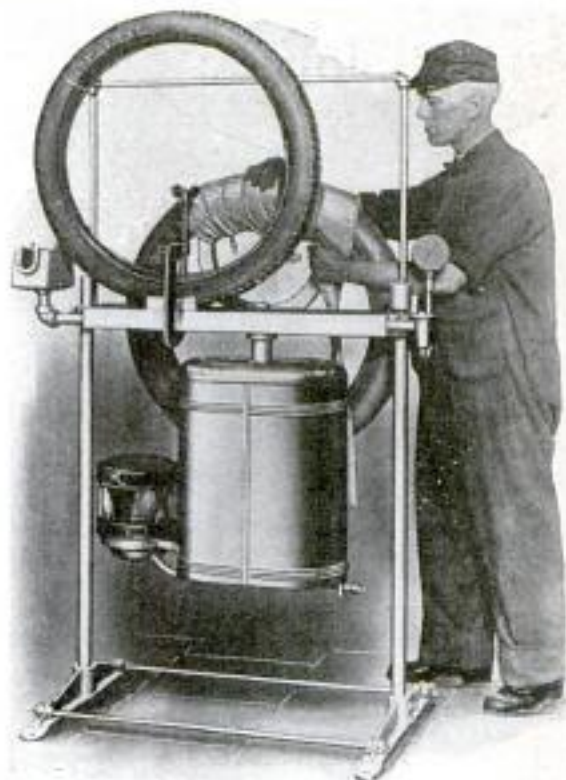

### ACT QUICK—MAIL COUPON / FREE BOOK COUPON

I have published a big interesting book—a book all about tires. Tells how they are made—how they are repaired by the Haywood method. Gives complete details of this wonder machine—this new model D-B at its unusual price. Gives inside figures and profits of the tire repair business. Gives proof of success, letters from others who are now operating Haywood shops and making big money. What these men have done you can do. \$2,500 to \$4,000 a year is the ordinary income of live-wire tire repair men. Send no money. Just mail the coupon—a letter or postal will do.

**HAYWOOD TIRE & EQUIPMENT CO.**  
645 N. Capitol Ave., INDIANAPOLIS, IND.

GENTLEMEN: Please send me full details of the tire repair business and complete description of the new Haywood Model D-B Vulcanizing Plant which you are offering at the unusually low price of \$45.

**Haywood Tire & Equipment Co.**  
645 N. Capitol Ave., Indianapolis, Ind.

Name.....

Address.....



# Complete Protection

**IVER  
JOHNSON**  
Safety  
Automatic **REVOLVER**

## Is your home protected?

**T**HE whole truth of this preparedness idea has just hit me. For years I have carried insurance on my life, health and house. I have tucked away a comfortable nest egg in the bank. I thought this was *all* the protection that any father could throw around his family.

Defending the lives of my loved ones against the attacks of prowling burglars—this never occurred to me.

When I saw the loophole in my scheme of home defence I felt guilty. I hit the trail to the nearest hardware store and bought this trusty Iver Johnson Revolver you see lying here on the table.

\* My trusty, friendly Iver Johnson.

I've never had to shoot at a man. I hope I never shall have to. I never think of my Iver Johnson as a brutal, terrible weapon. I look upon it as a *friend*. The very knowledge that I have it gives me a sense of *security*.

Have you thought of a revolver as a friend before? Will you give your family protec-

tion that is one jot short of *complete* protection?

When you buy a revolver buy a *good* one. The Iver Johnson is the safest small firearm made, because its patented *safety device* makes it absolutely harmless. Hammer model with regular grip, \$6.75; Hammerless model with regular grip, \$7.50.

**Iver Johnson Bicycles** can't be beat for speed, strength, easy riding and long wearing qualities. Racing, Cushion Frame, Truss Frame Roadsters and Mobicycle models. \$35 to \$55. Juveniles \$20 to \$25.

**Iver Johnson Motorcycle** is conceded by engineers to be the most scientifically designed and best built motorcycle ever produced.

### Three Iver Johnson Booklets Sent Free

Indicate which books you want: A—"Arms," B—"Bicycles," C—"Motorcycles."



**IVER JOHNSON'S  
ARMS & CYCLE WORKS**  
307 River Street, Fitchburg, Mass.  
99 Chambers Street, New York  
717 Market Street, San Francisco



Please Mention Popular Mechanics

Copyrighted material





Mail  
Coupon  
for  
"Typewriter  
Secrets"  
**FREE**

**The Rex**

**Now \$200**

**O**NLY \$2.00 down now puts the brand new Rex typewriter in your possession. Then, small monthly payments. Write for "Typewriter Secrets" and all about this great, new Rex offer. The typewriter which was built because the world's greatest merchandise house wanted a better machine. Absolutely the finest typewriter which can be made. Guaranteed for ten years. Sent anywhere on trial. See it—use it before you make up your mind.

With the brand new Rex, we have smashed typewriter prices. This is a \$100 machine if ever a typewriter was; but we have put the price so low we've made them gasp. A startling, revolutionary figure! Don't think of considering the purchase of a possible unreliable typewriter when you can have the new Rex (with every good point of every machine and many exclusive points of its own) at a price which will utterly astound you. Our ten years' guarantee should convince you of the supreme excellence of this machine. Used now by leading merchants, banks, railroads and professional men.

**Mail the Coupon  
For Free Book!**

Find out about our amazing typewriter price-smashing. Get "Typewriter Secrets." A book which has set them all on edge. If you want a \$100 typewriter and want it proved to you that it IS a \$100 typewriter, and want it at a price you won't believe possible until you read how we do it—send this coupon. Get our free book. Mail coupon now.

**Rex Typewriter Co.** Dept. 1194. **Chicago**

**Rex Typewriter Co.,**  
Dept. 1194, Steger Bldg., Chicago  
Please send me your book, "Typewriter Secrets," and your offer on the Rex Typewriter. I assume no obligations in sending this coupon.

Name .....

Address .....



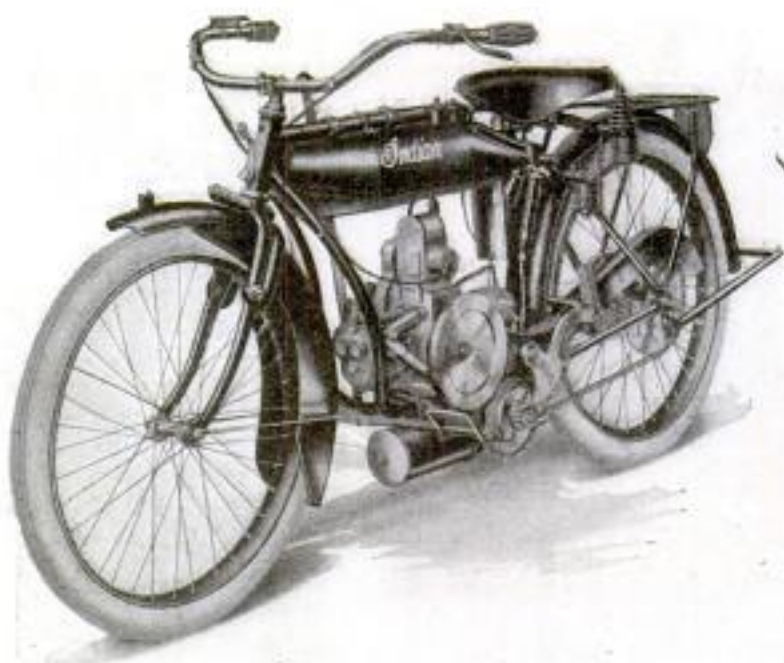

## *Everybody's Motorcycle!*

For workmen of all classes, for business men of all professions and vocations, for boys graduating from the bicycle, for sportsmen, for everybody who seeks a highly perfected, low-cost two-wheel power-driven vehicle, the ideal machine is the 1917

# *Indian Light Twin*

**With Four Cycle Opposed Motor**

Light in weight, modified speed and power, mechanical simplicity, easy to handle, always under perfect control, vibrationless, comfortable; costs little to buy and to run. Not a bicycle with motor attachments, but a high-grade, dependable *motorcycle*, built and backed by the largest motorcycle manufacturers in the world.

*Beautiful 1917 Indian Catalog fully illustrates and describes the 1917 Indian Light Twin, the famous Indian Powerplus Motorcycle, Indian Side Car, Indian Electrically Equipped and ten other model Bicycles. Send for it.*

**HENDEE MANUFACTURING COMPANY, 710 State Street, Springfield, Mass.**

*(Largest Motorcycle Manufacturers in the World)*

*Please Mention Popular Mechanics*



# Big Money-Maker for Live-Wire Dealers

Dearborn  
Truck Unit  
**\$350**  
F.O.B. Chicago

CONVERT FORDS into  
ONE-TON TRUCKS  
the "DEARBORN WAY"

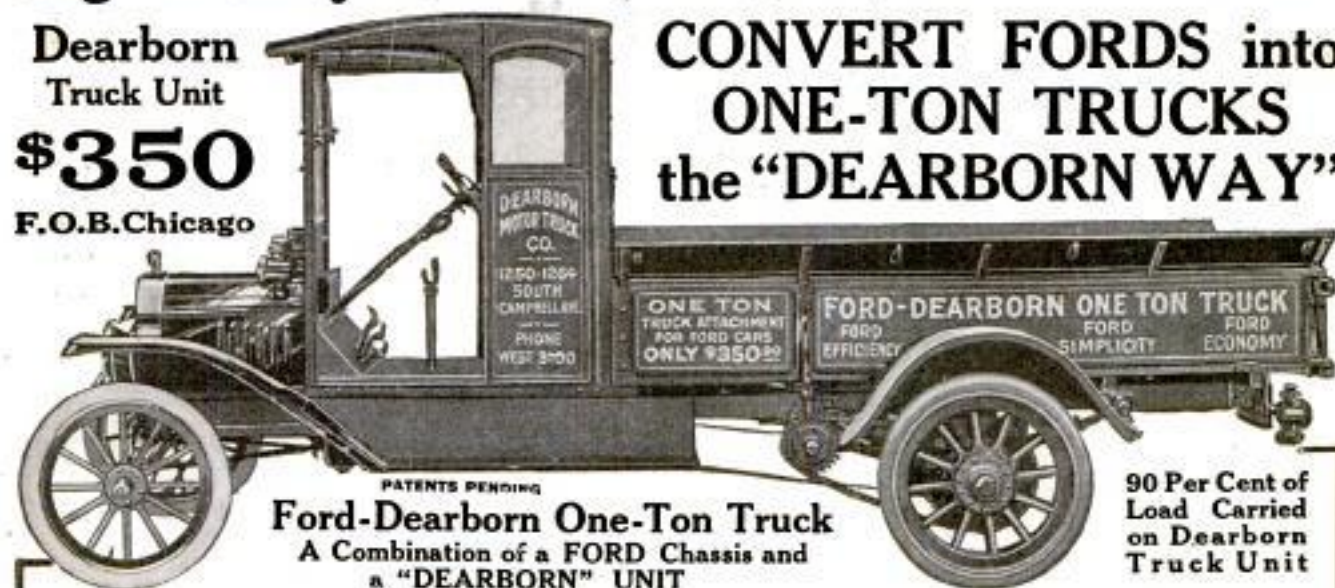

PATENTS PENDING  
**Ford-Dearborn One-Ton Truck**  
A Combination of a FORD Chassis and  
a "DEARBORN" UNIT

90 Per Cent of  
Load Carried  
on Dearborn  
Truck Unit

**T**HE DEARBORN TRUCK UNIT for converting Ford Cars into one-ton trucks is proving a tremendous money-maker for dealers everywhere — because of its **SUPERIORITY** over other Units.

Business men and farmers can secure this sturdy one-ton truck with Ford *Efficiency*, Ford *Simplicity* and Ford *Economy* and Dearborn *STRENGTH* for less than one-half the cost of the average one-ton truck.

The Dearborn Truck Unit is attached to a Ford by any Auto Mechanic in a few hours, full instructions accompanying every Unit. The Dearborn frame is rigidly bolted and riveted to the Ford frame at front, sides and rear. The rear axle assembly on the Ford becomes a jackshaft, and is securely held in place by our specially designed hangers. The Ford wheels are removed and sprockets attached to the Ford hubs in their place. Our frame and various parts differ from other makes and are far superior in material and construction.

"Dearborn Units are *strong* where others are *weak*"



## Important Features

**Carrying Capacity**—Guaranteed One Ton.  
**Frame**—14 ft. long, 4-inch channel steel, braced with I-beam over rear axle, to which cross spring is bolted.  
**Rear Axle**—2 3/4 x 1 3/4 inches, drop forged and heat-treated; 3000 lbs. capacity.

**Bearings**—Heavy Duty Bock Roller Bearings.  
**Springs**—Heavy Truck, 2 x 44 in., 10 leaves, bronze bushings.  
**Wheels**—Artillery, 32 x 3 1/2 in., twelve 2-in. spokes; guaranteed hickory.  
**Tires**—Firestone, solid rubber, 32 x 3 1/2 in.

**Drive**—Double side chains, Baldwin roller chains and steel sprockets.

**Gear Ratio**—27 teeth on jackshaft sprocket and 54 on rear sprocket; about 7 1/2 to 1.

**Loading Space**—Full 9 feet back of cab.

**Wheelbase**—When attached to Ford chassis, 125 inches.

**Tread**—Standard, 56 inches.

**Weight**—Dearborn attachment, 1000 lbs.; attached to Ford chassis, complete, 1850 lbs.

## Big Opportunity for Wide-Awake Dealers

The Dearborn Truck Unit is built in our own factory, under our own supervision by expert auto mechanics and is guaranteed for one year. It is the Biggest Seller in the truck field today. We want a dealer in every town, and offer a liberal exclusive agency proposition to the right man. Territory is being taken quick. Write at once for full particulars and territory desired.

IMMEDIATE DELIVERIES



Rear View Dearborn Unit Completely Assembled

**DEARBORN TRUCK CO.** OFFICE AND FACTORY:  
1244-1264 So. Campbell Ave., Chicago, Ill.

See Aug 16-228



## How Radium is Used on Ingersoll Watches

**T**AKE an Ingersoll "Radiolite" watch home with you; and look at it *in the dark!*

The hands and figures of an Ingersoll "Radiolite" watch are *self-luminous*. "Self-luminous" means that the light comes from *within*. Merely phosphorescent substances borrow their luminosity from outside light; they will glow for two or three hours (at most) after exposure to light. But "Radiolite" is independent of outside light; it gets its illumination from an element *within* itself. That element is radium.

Every particle of radium like a little battery, sends out energy in every direction. This radium—in infinitesimal quantities—is imprisoned within crystals of zinc sulphide, a phosphorescent material. The action of the radium on the crystals is to cause them to vibrate and glow, much as the filament of an electric light glows from the action of electricity.

Ingersoll "Radiolite" watches fulfil the object sought in so many ways by makers of watches—to show time in the dark as well as in daylight. The hands and figures glow brilliantly, showing the time at a glance, even at a little distance, and retain their luminosity unimpaired for at least ten years.

In country or city, motoring or walking at night; boating or camping; in the darkened theatre; or in the bedroom at night, people find them wonderfully convenient. Traveling men, doctors, factory workers, sportsmen, soldiers, and others know the usefulness of the Ingersoll "Radiolite."

Nearly one-third of the Ingersoll watches now sold are "Radiolites." You can see them at the nearest dealer's, with the many plain dial Ingersolls as well. If he is out of the model you want, it can be had on receipt of price by any of the Ingersoll offices named below.



How the "Radiolite" looks in the dark



"Radiolite"



"Radiolite"  
Two-in-One



"Radiolite"  
Strap Watch



Waterbury  
"Radiolite"  
(Jeweled)

ROBT. H. INGERSOLL & BRO., New York, Chicago, San Francisco



Fair List Prices

Fair Treatment



# GOODRICH SILVERTOWN

*Cord Tires*

**LOOK THEIR ARISTOCRACY**

**T**IRE of royal pedigree is Silvertown.

Look down into it where its sinewy *two-ply* cable-cord structure is laid bare, and you will see why the Silvertown, marked with the *Red Double Diamond*, is a tire apart.

*Inside and outside* Silvertown looks its aristocratic lineage.

You see its aristocracy **INSIDE** in that exclusive *cross-wrapped* body, the patent-protected, *rubber-saturated* foundation of a tire, which conquers the great destroyer of tires—*internal heat*.

You see it **OUTSIDE** in the *extra-size* of the tire.

Out of its inimitable making come a *gasoline-saving* economy, a *smoother-riding* comfort, a *greater-mileage*, you can not afford to be without.

**THE B. F. GOODRICH COMPANY, Akron, Ohio**

Also maker of the famous fabric Tires—  
Goodrich Black Safety Treads

Ten Silvertown Cord X-cels:

- |                            |                                      |                                     |
|----------------------------|--------------------------------------|-------------------------------------|
| 1. Increased engine power. | 4. Speedier.                         | 8. Give greater mileage.            |
| 2. Smoother riding.        | 5. Coast farther.                    | 9. More resistive against puncture. |
| 3. Fuel saving.            | 6. Start quicker.                    |                                     |
|                            | 7. Easier to guide.                  |                                     |
|                            | 10. Repaired easily and permanently. |                                     |



Please Mention Popular Mechanics





What lies back of the  
brilliance of a MAZDA  
lamp? All the facilities  
of the world's greatest  
lamp-makers support-  
ing the standards set by  
MAZDA Service. :: ::

# MAZDA

*"Not the name of a thing,  
but the mark of a service"*

## The Meaning of MAZDA

MAZDA is the trademark of a world-wide service to certain lamp manufacturers. Its purpose is to collect and select scientific and practical information concerning progress and developments in the art of incandescent lamp manufacturing and to distribute this information to the companies entitled to receive this Service. MAZDA Service is centered in the Research Laboratories of the General Electric Company at Schenectady, New York. The mark MAZDA can appear only on lamps which meet the standards of MAZDA Service. It is thus an assurance of quality. This trademark is the property of the General Electric Company.



RESEARCH LABORATORIES OF  
GENERAL ELECTRIC COMPANY

6640

Please Mention Popular Mechanics

Copyrighted material



These cuts are made from photos showing comparative growth of pear trees from Spring of 1913 to August, 1914, Bellefont Orchards, Inc., Norfolk, Va.



## Save a Year or More

Experience demonstrates that trees planted in blasted ground grow faster—are healthier—and bear earlier than trees planted in spade dug holes. Prove this fact for yourself by using

### Save Your Shade Trees

Life is difficult for city trees. Side walks and pavements limit moisture area and check their growth. Die-back destroys them. Prevent this destruction by blast-rejuvenation. If instructions are carefully followed this work can be safely done within a few yards of houses or water mains. Find out how now.

**DU PONT**

### Red Cross Farm Powder

when planting trees. First year results will surprise you. First year losses average 3% compared with 33% of spade set trees. The reason is simple, logical and practical. Blasting shatters the heavy "hard-pan" under the top soil and provides for better rootage, increased nourishment and greater moisture control.

### Don't Pot Your Trees

Give them a chance to grow and expand. Our big book tells how. It's a revelation in the use of Red Cross Farm Powder in orchard or farm. Write today for **Handbook of Explosives No. 248.**

**E. I. Du Pont de Nemours & Co.**  
WILMINGTON, DELAWARE



Please Mention Popular Mechanics



# Cut Out the Ice

Iceless Refrigeration, the world's next great business, is now here. *Get into it*

**Big Agents  
Send Coupon**

Fridger, the iceless refrigerating apparatus, has taken the iceman's place. Fridger is going into the homes and solving the ice problem forever. Fridger is the simple, sanitary, economical, low-priced cold storage service. It gives you preserving refrigeration. Dry, cold, hygienic refrigeration. It is silent. It is small. It is out of sight. It is automatic. Fridger is always and eternally on the job. It runs when needed. It stops to save your money. Install a Fridger and forget it. The low price is astonishing. Send the coupon and learn all about it. Learn how you can get a valuable option on a Fridger agency in your locality free. It may be worth thousands to you.

## Fridger

**Cold Storage Plant for the Home**

Every modern home can afford a Fridger. It is a food-saver. It is a money-saver. It is a trouble-saver. It is a worry-saver. It is a health-saver. It is the biggest aid to building health and happiness around your food in your kitchen. It pays for itself over and over again in the money-savings and its many advantages. It gives you a cold storage plant in your home to help you cut the high cost of living. Send coupon today and get the benefit of our limited introductory offer.

### Introductory Offer

Amazing introductory offer. We want every neighborhood to know Fridger, The Little Silk Hat Iceman. Be the first one in your neighborhood. Get the option on a big business. Write today and find out all about this big offer. As a business man, you cannot afford to neglect finding out all about the gigantic opportunity now wide open to you.

### Valuable Option to Big Agents FREE!

Option free in your territory for a limited time. This option may be worth thousands of dollars to you. This offer is open to men who are big enough to see things when they are in sight. The option on the Fridger can make you a big business man. You can get it free today. Any small electric motor ( $\frac{1}{4}$  h. p.) runs it. Put the motor in the basement. Use your old ice box where it is. Get your first Fridger quick and secure option on your territory. This offer is absolutely and positively limited to the first Fridger in the locality.



#### OPTION COUPON

Send this coupon or letter promptly and get agency option free.

**MR. FRED W. WOLF**  
Sole Owner Fridger  
Wells St. Bridge Bldg., Dept. 5248  
CHICAGO, ILLINOIS

Dear Sir: I am interested in your offer of an option on a Fridger agency, free. No obligation.

Name .....

Address .....

**Send Coupon** Send coupon or copy it on a piece of paper. Write today to be sure of getting a valuable Fridger agency option free. Close in on this option while you can. First come first served. Before you do another thing, send for a Fridger and get the option on the Fridger agency. By all means write now, do it today.

**FRED W. WOLF**  
**FRIDGER**

Wells St. Bridge Bldg. - Chicago, Ill.  
Dept. 5248

References: Anybody who knows anything about ice machinery

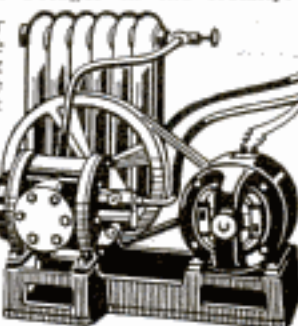



# Lubricate Your Springs

Basic U.S. Patents  
April 11, 1916 May 16, 1916



Makes All Cars Easy-Riding

## The G. L. W. Spring Oiler

IS LIKE AN ARMY OF OILERS AT WORK ALL THE TIME

If an army of workers could follow your Motor car, constantly oiling the springs, mile after mile, they would approximate the service of the G. L. W. Automatic Spring Oiler. This little device that sells for only 20c, takes the place of shock absorbers and expensive spring oiling devices. Gives perfect, uninterrupted service. Saves its price in every hundred miles of travel. Made to fit all makes of springs. Saves you many Repair Bills. Never Rattles—attached in two minutes—avoids shocks and vibration. **Makes Your Car Easy-Riding.**



Awarded Gold Medal at Panama-California Exposition as the Most Efficient and Meritorious Automobile Accessory Ever Invented

—two for each half spring and one for each quarter spring. Price 20c each. If your Dealer cannot supply you write to us. When ordering be sure to give name and model of car.

**Dealers:** Here's the biggest profit winner you ever stocked. Over 494,000 sold first six months. Our present advertising campaign will sell 1,000,000 in the next six months. Our discounts are liberal. Get your share! Write for terms today.

### HUDSON SALES COMPANY

Authorized Representatives 7 E. Jackson Blvd., CHICAGO

Factory Branch: G. L. W. Spring Oiler Co.

**REMEMBER:** Any purchaser of a set of G. L. W. Automatic Spring Oilers, who is not perfectly satisfied with them after using same 30 days, may have his money back.

## WE GUARANTEE

to replace any spring that breaks after G. L. W. Spring Oilers are installed and in use Three Days

—which proves that we know G. L. W. Spring Oilers prevent spring breakage, rust, squeaks and crystallization. They put new life into old springs. A complete set attached in two minutes and require about two minutes' attention once a month. Last a lifetime. The G. L. W. Automatic Spring Oiler consists of a high-grade felt pad with an oil reservoir, contained in a genuine rust-proof polished blue metal case. It is snapped over the main leaf of the spring and the pressure from the spring action causes the oil to be distributed between the leaves and throughout the springs—making your car easy-riding.

### Made to Fit All Makes of Springs

Four to twelve oilers are required for different cars

required for different cars

one for each quarter spring.

**CLIP COUPON AND SEND TODAY!**

Hudson Sales Co., 7 E. Jackson Blvd., Chicago

Enclose find \$..... Send me ..... G.L.W. Spring Oilers and particulars of your Spring Replacement Guarantee with instructions for attaching.

Car.....

Model.....Year.....

Name.....

Address.....



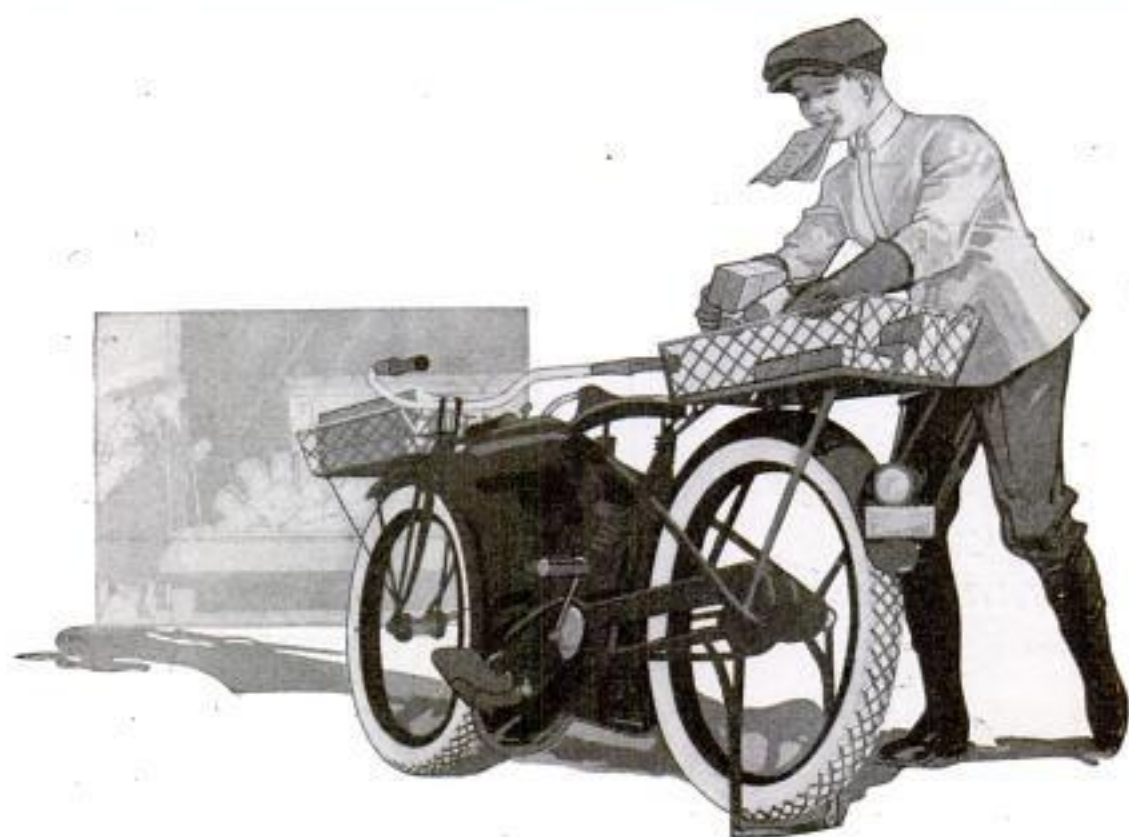

# BLUE STREAKS

Superior delivery facilities have come to be a necessary part of the druggist's business today. The motorcycle contributes speed. And Blue Streak Motorcycle Tires assure unfailing deliveries—speedy, sure, dependable.

You'll likely find Blue Streaks on the druggist's

motorcycle whose service you've admired. They are his first aid to satisfactory deliveries. Nearly everywhere Goodyear Blue Streaks are now chosen for business, pleasure, racing or military service.

*Blue Streaks Deliver: Economy, Mileage, Speed, Service. Everywhere—one standard, one quality, one guaranty.*

The Goodyear Tire & Rubber Co.  
Akron, Ohio

**GOODYEAR**  
AKRON



# BRUNSWICK HOME BILLIARD TABLES



## Someone Says, "Billiards!" And Out Comes the Brunswick Table

Folded up in a closet or in any spare space, the "Quick Demountable" Brunswick Home Table is triumphantly brought forth by eager hands and set up in the center of the room. It is only the work of a minute to push back the chairs, rack the balls and fire the shot that starts an evening of royal sport.

Carom and Pocket Billiards never tire—their charm is endless. Sparkling hours of merry rivalry with those you love—moments of tense uncertainty!

### Expert Playing Qualities

To live a healthy, worry-proof life, to entertain friends and to keep boys home—install a scientific Brunswick Home Billiard Table.

Beautiful oak and mahogany, accurate angles,



"BABY GRAND"  
Combination Carom and Pocket  
Table with Accessory Drawer  
That Holds Full Playing Outfit.

(748)

fast ever-level beds and quick-acting Monarch cushions. Our handsome billiard catalog shows sizes and styles to fit in any home. Write for free copy today.

### Balls, Cues, Etc., Free

Complete High Grade Playing Outfit included with every Brunswick—Balls, Cues, Rack, Markers, Tips, Cue-Clamps, Chalk, Brush, Expert Book of 33 Games, etc.

### Write for Color-Catalog

See these tables in photographs of homes like yours. Get our low prices, easy terms that let you play as you pay and home trial offer.

All contained in our interesting billiard book and color-catalog, "BILLIARDS—THE HOME MAGNET." Send coupon or write for free copy today.

The Brunswick-Balke-Collender Company  
Dept. 49C, 623-633 S. Wabash Ave., Chicago

THE BRUNSWICK-BALKE-COLLENDER COMPANY  
Dept. 49C, 623-633 S. Wabash Ave., Chicago

Without obligation, I should like to receive your color-catalog, "BILLIARDS—THE HOME MAGNET," and details of your free trial offer.

Name.....

Address.....

Please Mention Popular Mechanics





If Your Bathroom is Modern so is Your Home

## INSTALL YOUR OWN PLUMBING AT LOW COST

The modernized *Hardin-Lavin Easy Way* enables you to install your own bathroom. Our method is scientifically perfect, simple, and easy. Any handy man with a few ordinary tools can install a bathroom complete. All our fixtures are designed by experts with knowledge gathered from 40 years of experience in turning out new, modern, practical fixtures. They are made for the handy man, with easy installing features. Look into this now—get the facts before you buy.

### Our Engineers Help You Plan and Install

Send a rough sketch of your bathroom or your plan for any plumbing or heating installation, and our staff of engineers will show you the easiest, cheapest way. They will draw up simple, easily understood installing plans, absolutely free. If necessary we will loan you the tools. You save the high cost of labor, unused materials, costly delays, and high prices. Any handy-man can do the work with the help of our engineers and save all plumbing bills. We make all shipments promptly. Superiority is built right into all our fixtures. Hygienic, artistic simplicity, and easy installation are characteristic of *Hardin-Lavin* products. Our money-back guarantee label is on every fixture. It protects you. When you buy direct from the producer you avoid delay, extra waste of material, and save a dealer's and middleman's profit. Investigate this newer, modern, quicker method of the *Hardin-Lavin Company*. It is the result of 40 years-of constant service, endeavor, and experience.

### Send for Valuable "HANDY-MAN" Book

This book tells you in advance what your plumbing will cost, what fixtures to select, how they will look, and how to install them. Every home owner,

builder, farmer, engineer and mechanic needs one. It explains the new *Hardin Easy Way*, tells you how to save on material, time and labor by putting in your plumbing this new, original, exclusive, practical, and economical way. Free "Handy-Man" Book shows a complete line of all the Latest Improvements and New Designs in Guaranteed plumbing and heating outfits, water supply systems, sinks, roughing-in-goods, pipe, fittings, valves, etc., and all parts and repairs at Wholesale Prices. It also contains practical and exclusive information of value to every handy man. Get our free estimate and reduce the present high cost of building.

#### Cut to Fit Steam, Hot Water or Air Heating Plants

Send for free estimate. We can SAVE YOU 1/2. We furnish easy installing plans and instructions and lend you the tools. Any handy man can do the work OUR NEW EASY WAY.



P. M.  
APRIL '17  
FREE  
"Handy-Man"  
BOOK COUPON

The Hardin-Lavin Co.  
4540-50R Cottage Grove  
Ave., Chicago

Please send me your  
"Handy-Man" Free Book  
showing everything in plumbing  
and heating supplies at  
lowest wholesale prices.

Name

Address

### Highest Quality at Lowest Price

Remember, everything we sell is Grade A guaranteed. Highest quality goods at prices that will surprise you.

Our practical experience enables us to furnish bathroom fixtures, plumbing supplies, heating plants, fixtures and equipments and with new, original features combining quality, economy, simplicity, easy installing and lasting durability.

### 40 Years in Business

at the same address is a record to be proud of. It speaks volumes for our wholesale price policy and money-back guarantee. Send for free "HANDY-MAN" Book and full particulars. \$500,000 plants behind our guarantee.

The Hardin-Lavin Co.  
40 Years at 4540-50R Cottage Grove Ave.  
CHICAGO



Please Mention Popular Mechanics





**F**RIENDS, Mother Nature is a woman, so mere man might as well let her have the last word. Velvet is Nature's last word in tobacco. Let's put that in our pipes an' smoke it. *Velvet Joe*

## Nature has done her best in Velvet—

*Only nature could have done so well.*

If your taste is anything like that of most pipe smokers we know, you won't want a better tobacco than Velvet.

To get a better—someone must invent a better variety of pipe tobacco than Kentucky Burley. That hasn't been done. Someone must beat Nature at Nature's own method—mellowing this tobacco by two years' patient ageing in wooden hogsheads. That's not likely to happen.

Put Velvet to any test *you* think will prove its quality. And make the test *today*.

*Liggett & Myers Tobacco Co.*





# Williams' Shaving Cream Stick Powder Liquid



Lather that comes like a flash—rich, creamy, soothing. Lather that makes man master of his razor, holds its moisture throughout the shave, and leaves the skin like velvet.

Ask for Williams'—W-i-l-l-i-a-m-s'; the cream that stays creamy in the tube and works wonders when released.

*Williams' Shaving Soap comes in several convenient forms:*

Stick, Powder, Cream, Liquid and in round cakes

Send 12c. in stamps for a trial size of the four forms shown here. Then decide which you prefer or send 4c. in stamps for any one.

The J. B. Williams Co.  
Dept. A, Glastonbury, Conn.

*Add the finishing touch to your shave with Williams' luxurious Talc Powder*

