

May

15 Cents

THIS ISSUE 435,000 COPIES

POPULAR MECHANICS MAGAZINE

WRITTEN SO YOU CAN UNDERSTAND IT

Reg. U.S. Patent



War-Zone Children
Wear Gas Masks
to School—Page 691

Copyrighted material

\$789 Buys the Material



BUILD TO STAY

QUALITY ECONOMY SERVICE

THE HARRIS WAY

Our Prices are Still Down!

By several immense cash purchases, and increased material manufacturing facilities, we are able to actually save you hundreds of dollars on your home! *We have not boosted our prices as others must, because of the rising market.*

The Harris Way includes all that is practical and desirable in modern building methods, in addition to many original and exclusive features. The excellence of our materials *Sensibly Cut-to-Fit*; the completeness and correctness of our plans and specifications; the Harris Service and Harris Economy;—they all make the HARRIS WAY the most perfect modern building method.

Sensibly Cut-to-Fit is the keystone in the Harris Way. It means Simplicity with Quality, Economy and Service. To most men building operations are a puzzle, but the Harris Way is acknowledged by builders everywhere to be the most helpful and efficient building system. Our Plan Book explains it in detail.

Materials Guaranteed We furnish clear and knotless lumber in all exposed places, clear millwork, beautiful hardware and all material in harmony with the design. Free blueprints and material specifications.



Send for This Free Plan Book of Harris Homes

It shows our houses, bungalows, garages, etc., in beautiful photographic engravings. It also shows floor plans; gives material specifications, details, description, etc., and much valuable information for every builder. Send the coupon below to-day for your free copy of Plan Book E.O-7.

The house above is Harris Home Design No. 181. An original, beautiful bungalow. Five rooms and bath.

No Money Down! We ship your material in one quick shipment from our Chicago factory. You have the privilege of inspecting every piece before you accept it.

Plumbing Roofing Millwork Be sure to ask for our other free catalogs in the coupon. Our thirty-five great building material departments have an array of bargains that absolutely Smash Prices.

For our liberal terms and absolute binding guarantees get our new free Plan Book of Harris Homes, Number E.O-7.

Through opportune buying we have secured for you the greatest Building Material Snaps of the year. Send coupon now.

Harris Brothers Co. 35th & Iron Sts. Chicago, Ill.

MAIL THIS COUPON!

HARRIS BROTHERS CO., Dept. E.O-7

Send me free of charge the books checked X.

- Plan Book of Harris Homes
- Roofing
- Millwork
- Plumbing and Heating
- Gasoline Engines & Machinery

ADDRESS

NAME

Copyrighted material



Victrola

The instrument of the world's greatest artists

It is natural that in the musical world there should be singers and instrumentalists whose transcendent art places them in the forefront of their profession.

These artists have attained their commanding positions by reason of their superb artistry, and it is no mere coincidence that they have chosen the Victrola as the instrument to carry their sublime art into the home with the utmost fidelity.

The Victrola is the greatest of all musical instruments not only because it brings you the exact renditions of the world's famous artists, but because it has through sheer merit and through world-wide recognition by millions of music-lovers earned this high honor the artists have conferred upon it.

Any Victor dealer will gladly show you the complete line of Victors and Victrolas—\$10 to \$400—and play the music you know and like best.

Victor Talking Machine Co.
Camden, N. J., U. S. A.

Berliner Gramophone Co., Montreal, Canadian Distributors

Important warning. Victor Records can be safely and satisfactorily played only with *Victor Needles or Tungs-tone Stylus* on Victors or Victrolas. Victor Records cannot be safely played on machines with jeweled or other reproducing points.

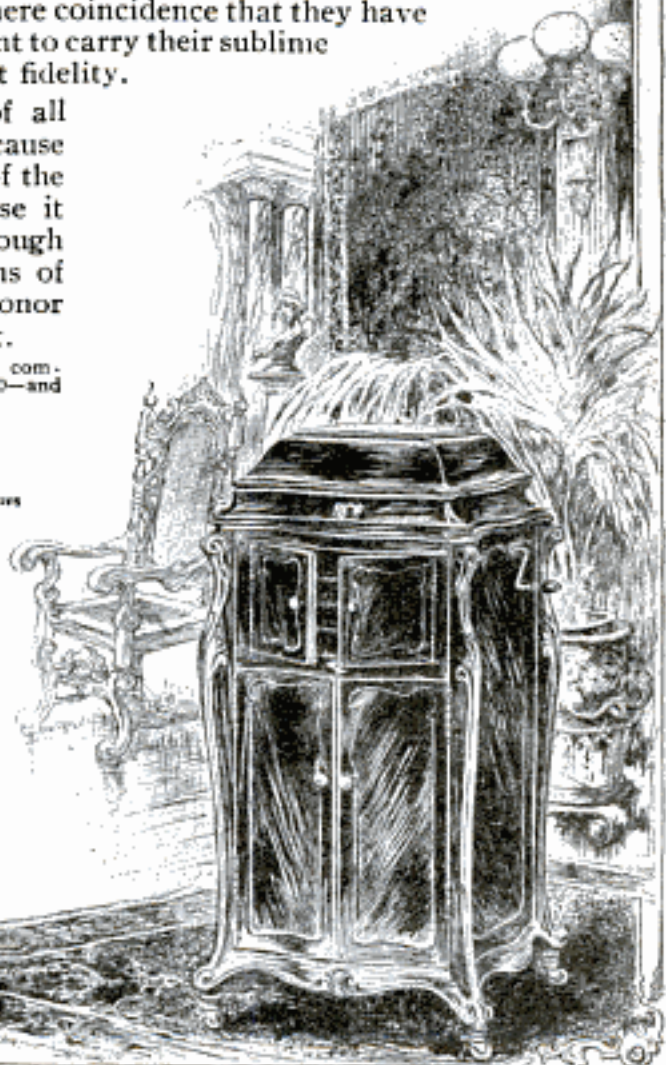

New Victor Records demonstrated at all dealers on the 28th of each month

This One



S5RW-7XJ-920G

material

BUYING TIME NOW—"Get Your Money's Worth"

IN LUMBER—&



"THE WOOD ETERNAL"

HE WHO "LOOKS BEFORE HE LEAPS" BUILDS OF CYPRESS and BUILDS "FOR KEEPS"

"It's the Repair Bills that eat the Holes in the Bank Account." CYPRESS resists all rot-influences.

CYPRESS Pocket Library
VOL. 16 is invaluable to people
with Porches or fences. Write for it.



SHINGLE HOUSE NO. 2
Is a New Cypress home worth
while? Full working plans and
Spec. FREE in VOL. 84.

PERGOLA PEOPLE
and Garden folks all want
VOL. 30 (is complete plans Free)



CYPRESS INTERIORS
and the beauties and surprises
and economical character, are
in VOL. 31. FREE.

COUNTRY PLACES
with Improvements of Cypress
don't "run down." Get VOL. 22.



"THE ROOF ETERNAL"
CYPRESS shingles outlast the
house and don't leak the water.
VOL. 7 is a most cyclopedic.

Also ask for VOL. 1 with complete U. S. Govt. Report on Cypress and full list of 41 other volumes.

When planning a Mansion, a Bungalow, a Farm, a Sleeping-Porch or just a Fence, remember—"With CYPRESS you BUILD BUT ONCE."

Let our "ALL-ROUND HELPS DEPARTMENT" help YOU. Our entire resources are at your service with Reliable Counsel.

SOUTHERN CYPRESS MANUFACTURERS' ASSOCIATION

1219 Hibernia Bank Building, NEW ORLEANS, LA., or 1219 Heard Nat'l Bank Building, JACKSONVILLE, FLA.

INSIST ON CYPRESS AT YOUR LOCAL LUMBER DEALER'S. IF HE HASN'T IT, LET US KNOW IMMEDIATELY.



CROSBY-CHICAGO

Please Mention Popular Mechanics

Copyrighted material

Popular Mechanics Magazine

6 N. Michigan Avenue, Chicago, U. S. A.

EDITED BY H. H. WINDSOR

England: The International News Co.
5 Breems Bldg., Chancery Lane, London, E. C.

Australia:
The Australasian News Co.

ISSUED MONTHLY

SUBSCRIPTION:

SINGLE COPY, 15 CENTS

In United States, and its possessions, Cuba and Mexico, per year, postpaid \$1.50
To Canada 1.75
To all other countries in the Postal Union 2.50

All subscriptions are discontinued at expiration. Please examine the date printed on your wrapper.

Entered as Second Class Matter Sept. 15, 1903, at the Post Office at Chicago, Illinois, under Act of March 3rd, 1879.
Entered as Second Class Matter at the Post Office Department, Canada.

Published monthly by POPULAR MECHANICS CO.

Copyright, 1916, by H. H. Windsor.
Copyright, in France.

Contents for May, 1916

Acrobat with Parachute Leaps from Skyscraper	728
Aeroplane Mail Routes, Eight Proposed	673
Air, Compressed, Now Used to Clean Machinery	710
Announcing System, Simple, for Doctor's Office	676
Automobile Heater and Ventilator, Simple	756
Automobile, New Dual Power, Remarkable Features in	678
Automobile, New, One Key Controls All Parts of	702
Automobiles, Jack and Towing Truck for	697
Automobiles, Playgoers Wait Indoors for	730
Balloon Used to Select Site for Chimneys	721
Bandage Roller Operated Like Sewing Machine	735
Basket of Wicker, Filing, for Desk Purposes	706
Batteries, New Device Holds Plates in Apart	695
Battery Charger, Simple, Compact, for Motorists	739
Bents, Machine for Topping and Harvesting	741
Billiard Tables, Schools', may Check Pool Room Evil	756
Blanks, Special, Simplify Reevaluation of City	680
Blind Civil War Veterans Succor Europe's Blind	741
Blindstitching is Done by Simple Machine	750
Blood Instead of Eggs and Milk in Dough	734
Blotter, Clip Handle for, among Late Novelties	650
Bomb, Oil Well, Explodes High in Air	749
Bottle Protects Contents from Air during Transfer	749
Bridge, Concrete, Typhoon Wrecks in Philippines	708
Bridge, Long, Low Concrete, over Shallow Stream	672
Bridge, New Double Deck, Acetylene Cuts Place for	658
Bungalow Courts of Many Varieties and Styles	714
Buttons and Laces, Substitute for	701
Cake, Wedding, Novel Molded Icing on	747
Calendar, New, Twenty Centuries Covered in	753
Calico, Quaint Old, Greeley Campaign Emblems on	730
Callipers, Instrument Combines Two Types of	760
Camera, Device Operates Automatically	718
Camera, Folding, Delicate Focusing Finder for	676
Camera, Tiny Movie, Used as Radiator Ornament	726
Campanile, Colossal, Built on Pacific Coast	736
Camping Outfit, Motor Car, Home Comforts in	642
Candy, "Paris Hats" Fashioned Entirely in	712
Carriage, Baby, Built Like Automobile	653
Cartridges, Dummy Rifle, Made by Schoolboys	670
Change Making Apparatus Works with Rapidity	644
Check Protector, Simple and Inexpensive	711
Clock, Tower, Has Dials That Are Revolvable	752
Coffee Sorted According to Color by Selenium	738

Copper Parts, Electric Apparatus Made without	672
Corn, Seed, Shortage Makes Farmers Conserve	754
Couplings, Flexible, Stop Strain on Power Shafts	719
Crib, Fresh Air—Giving the City Baby Air and Sunshine	657
Dental Grinding Machine Saves Gold Dust	742
Diamond Fields, Ancient, Produce Many Gems	733
Dome, Cathedral, Collapses under Weight of Snow	734
Drawing Circular Curves, Instrument for	756
Electric Current, California Tramp Cooks Meals with	755
Electric Lantern Shaped Like Watch	755
Engine—Double Connecting Rod Reduces Piston Speed	762
Engine, Traction, Heats Texas High School	706
Explosion, Dynamite, in Missouri Town, Houses Razed by	663
Fan, Electric, Constructed with Adjustable Vanes	713
Fan, Mechanical, Operated by Hand	700
Filing, Letter, Binder Strips Useful in	703
Fire Destroys Many Ships Loaded for Allies	739
Fire Plugs, City, are Used as Drinking Fountains	730
Fire, Sixty-Year-Old Mine, Causes Fresh Trouble	662
Fires, Terrible, Sweep Two Southern Towns	674
Flairion Wire, Arm Band Holds Out of Way	696
Flood—Swollen California River Leaves its Channel	701
Flowers in Blocks of Ice, Florist Displays	699
Fly Swatter, New, is Made of Flexible Rubber	693
Fog Stick Helps Steering of Lake Barges	668
Garage, Adjustable, Built for Motor Owners	655
Gas, Tests Show Gross Errors in Measuring	654
Gates, Double Automatic, for Rail Crossings	703
Gauge, Printing Depths of Cuts Shown by	727
Golf, Indoor, Popular Game in Many Large Cities	680
Grain Loader Does Work of Harvest Hands	737
Gulls, Starving, Feeding on Icebound Lake	677
Guns—Howitzers, Wooden, Used in Film "Invasion"	652
Hairbrush, Collapsible, for Travelers	662
Hammer, Steam, Piles Driven and Pulled by	708
Handcuffs, Prisoners to Suitcases	670
Harvester, Fodder, Cost of Filling Silo Cut by	709
Hemp Fiber Machine Does Work of Many Natives	709
Hickory is Used as Stock by Pecan Growers	735
Hose, Fire, Used as Gas Main after Flood	743
Ice Cutting Machine Does Work of Sixteen Teams	680
Ice, Hills of, Formed on Shores of Lake Erie	712
Index System, Convenient, for Telephone Book	720

[Continued on Page 6]

Popular Mechanics offers no premiums; does not join in "clubbing offers," and employs no solicitors to secure subscriptions. It is for sale by nearly every newsdealer in the United States and Canada.

[Contents—Continued]

Indicator, Test, Designed for Machinists.....	722
Inventions, Many, Sent to Naval Board.....	725
Kites, Studying Upper Air with Aid of.....	665
Lamps, Lighthouse, Tended by Ingenious Device.....	664
Lifeboats, Automatic Davit Launches Quickly.....	757
Light Bowl, Indirect, Clamp Adaptable to Any.....	697
Linotype Heat Regulator Saves Gas.....	740
Locomotives, Fifteen New Powerful, Road Secures.....	655
Looms, Primitive, are Used by Aymara Indians.....	717
Lumber, Western Department Store Retailer.....	678
Lunch Counter, Miniature, Has Two-Foot Frontage.....	716
Magnets Lift Scrap Iron from Bed of Thames.....	694
Mail Letters on Trains Operating in Jersey.....	720
Marksmanship, A School for, by John R. Cox.....	743
Mask for Sand Blasters Worn with Respirator.....	751
Memorial to Explorer of Grand Canon.....	682
Mercury Purified by Simple Process.....	723
Mill Heads, Heavy, Shipped by Fast Express.....	722
Molecular Movements, Apparatus Demonstrates.....	698
Motor in Show Window, Lever in Street Operates.....	738
Motor, New Domestic Aero, of Air Cooled Type.....	670
Motor Truck Hauls Twenty-Ton Gun over Bad Roads.....	727
Mowing Machine, Marine, for Submerged Weeds.....	760
Music, Printed, War Causes Scarcity of.....	752
Musk Odor, Test Shows Persistence of.....	705
Nail, Self-Chinching, Is New Type of Fastener.....	740
Niter Cake Is Substitute for Sulphuric Acid.....	720
Novel and Little Known Accessories for the Home and Its Members.....	758
Nursery, Cozy, Outfitted in Practical Way.....	800
Oil, Force through Tunnel to Quench Burning Well.....	728
Oil Springs, Remarkable, Discovered in Alaska.....	667
Padlock, Novel Keyless, Opened by Gravity.....	684
Panama Canal, Earthquakes Not Menacing.....	700
Paper Rolls, Sheet Iron Bands Protect Edges of.....	736
Partridge Meets Death by Flying against Window.....	688
Periscope, Using to Sell Vacant City Lots.....	631
Phonograph Records, Convenient Cabinet for.....	667
Photographers, Camera Exposure Scale for.....	710
Photographs Persons Who Look at Shoe Display.....	751
Photography, Aero, Educational Possibility of.....	686
Pine Lines, Submarine, for Loading Tank Steamers.....	713
Plumb Bob Adjuster Saves Time.....	702
Porto Ricans as Agents in South America.....	726
Post, Rustproof Binding, Used in Laboratory.....	657
Pulpits, Permanent, Built for Street Speakers.....	735
Rack Disinfects Pencils for School Children.....	716
Railroad, Incline, Steep Colorado Mountain Has.....	725
Railway Problems in Asiatic Turkey, Germany's, by R. J. Bjurstedt.....	647
Respirator for New-Born Infants.....	683
Road—Military Highway Scheme for Pacific Coast.....	694
Roads—Highways Built with Sand in Florida.....	696
Rocking-Horse and Play Table Combined.....	707
Roller Used in Forest Instead of Snowplow.....	719
Roof, Experimental Arched, Made of Clay Blocks.....	696
Roof, Skyscraper, Used for Garden and Henery.....	746
Sand, Nebraska, Now Made into Glass in America.....	718
Ship—Dreadnaught "Pennsylvania" in Trials.....	683
Ship—Schooner Wrecked in Gale on San Francisco Beach.....	751
Ship Stabilizer, Action of, Demonstrated Clearly.....	723
Ships, Bigger Motor, Denmark Company Builds.....	676
Ships, To Make Parts of Interchangeable.....	768
Shoe Tops, Cloth, are Dyed by Compressed Air.....	737
Sign, "Stop," Replaces Flag as Warning Device.....	707
Ski Jumper, American, New World Record Is Made by.....	646
Snow, Railroads Use Clamshells to Shovel.....	695
Springs, Motor, Lubricated by Simple Device.....	749
Sprinkler Easily Moved While in Use.....	749
Stable Doors, Open When Fire Endangers Horses.....	736
Stove, Oil, Heats Motor Radiator and Garage.....	736
Submarines, Mine Laying, of German Navy.....	748
Tanks, Fuel Oil Storage, for Naval Purposes.....	686
Telephone Line, Submarine, from Key West to Cuba.....	604
Telephone List, Names Quickly Found in File for.....	645
Telephones, Regular and Vestibule, Combined.....	755
Tile, Hook Lessens Labor of Handling.....	644
Timer, Automatic, of Race Course Events.....	753
Toy, Novel, Tiny Garage and Car Are Features of.....	721
Tractor, Gasoline Cable, for Aerial Logging.....	669
Tramway, Aerial, Carries Motorists High in Air.....	653
Transformer, Remarkable Million Volt.....	680
Trees, Chestnut, No Way is Found to Check Blight on.....	646
Tunnel Pierces Historic Missionary Ridge.....	681
Umbrella, Paper, for Emergencies.....	762
Vase, Flower, Wicker Adds to Beauty of.....	728
Vegetable Pear New Dish in California.....	671
Vehicle—Car, Novel, Made Chiefly from Old Bicycles.....	718
Villa's Raid at Columbus Told Pictorially.....	677
Walking Backward from Coast to Coast.....	726
War, European: Air Craft, Raiding, French Gunners Destroy.....	687
Camels, War, Work on Desert and Snow Fields.....	682
Church, Old Belgian, Razed to Thwart Enemy.....	684
Fighting in West, Actual, Close Up View of.....	689
Gases, Poison, Imperil Troops and Civilians.....	691
Trenches, Chalk White, in Champagne Region.....	690
Trenches, French, at the Front, Scenes in.....	693
Women, Italian, Carry Shells to Alpine Guns.....	688
Water Supplied to Camp by Ingenious System.....	705
Wells, Drilling by Hand through Limestone.....	761
Windmills, Portable, Used on Western Farms.....	689
Wine Bottles, Sediment in, Frozen before Removal.....	658
Wire, New Method of Tinning Saves Metal.....	785
Wreck—Interurban Car Thrown against House.....	704
Wreck—Two Locomotives Collide near Center of Bridge.....	712
Wreck, Triple Railroad.....	679
X-Ray Equipment Now Used in Veterinary Hospital.....	717
X-Ray Photographs, Tin Foil Used to Label.....	654

SHOP NOTES

Automobile Drivers, Glare Dimmer for.....	766
Automobile Engine, Emergency Methods for Starting.....	770
Automobile Floor, To Prevent Draft through openings in.....	772
Automobile Radiator, To Prevent Spilling Water when Filling.....	781
Automobile Radiators, Locating and Repairing Small Leaks in.....	763
Automobile, Sanding Track for.....	777
Awl, Belt, on Plier Handle.....	782
Bearing Scraper.....	773
Bearings, Heated, Remedy for.....	768
Boiler, Preventing Alkaline Solution from Backing into.....	777
Bricks, Supporting on Roof for Chimney Construction.....	777
Buttonhook, Improved.....	780
Buttonhook, Keeping Handy.....	765
Carburetor Air Valve Shaft Covering.....	766
Cellar Doors, Holder for.....	764
Cigar Holder, Novel.....	766
Cloth, Tracing, Surfacing to Take Fine Ink Lines.....	776
Concrete, Platform for Mixing.....	765
Curtain Guard for Blacksmith's Stock Rack.....	782
Ditch Washouts, Preventing.....	765
Electric Switch, Emergency.....	776
Engines, Small, Improving Compression on.....	782
Flag, Expressman's Signal, Order Holder on.....	781
Gasoline, To Prevent Fire While Pouring through Chamois Skin.....	777
Grinding Machines, Improvement on.....	764
Iron, Cast, To Surface Harden.....	771
Jig, Segment Cutting.....	770
Lavatory, Stopper Holder for.....	782
Light Saving Kink.....	776
Magnet, Small Lifting.....	772
Match Safe Attached to Gas Fixture.....	774
Oil, Linseed, Bleaching.....	772
Oiler for Connecting Rod End.....	774
Oiling a Drill.....	766
Oils, Thinner, Used on Automobiles in Winter.....	764
Paint, Brown Iron, Adding Luster to.....	765
Paper Sheets, Kink for Counting or Grasping.....	774
Pipe Holders, Conductor.....	776
Poultry House, A Colony.....	770
Rake, Homemade Lawn.....	766
Registers, Hot Air, Aprons for.....	776
Rest, Over Arm Steady.....	773
Road Patching.....	786

[Contents Continued on Page 8]

Earn over \$60 a week Repairing Auto Tires

No Experience Necessary— We teach you everything *Free!*

Here's the chance of a lifetime—an opportunity to cash in on the great amount of money spent for automobile repairs, 90% of which goes for tires. Every car owner in your town is a possible customer. Tires blow out every day. Jobs are plentiful—always. The money will come rolling in fast. There's no stopping it once you are known as a tire repair man.

Make Over \$10 a Day

No other proposition ever laid before you offers such a chance to make money without capital or previous experience. You can start right in making money the day you receive the outfit. No need to solicit trade. Your sign "Tires Vulcanized and Repaired" will bring your customers coming to you. If you have a repair shop—so much the better. This outfit will treble your ordinary profits in no time. Work can be done by your present help.

SHALER Vulcanizing Outfits

are coining money for thousands of enterprising men in every part of the country where automobiles are used. Shaler Vulcanizers are the accepted standard and known everywhere. They do as much and as good work as the very high-priced vulcanizing outfits. Instructions are complete and easily understood. Anyone with ordinary intelligence can make a perfect repair the first time they try. Everything is automatic so mistakes are practically impossible.

Week's Business Pays for the Outfit

Think of that! The expense involved in getting started is so small that just about a fair week's business will pay for the Shaler Outfit. Then what you take in afterwards is all "velvet." And the profits are enormous. You will be surprised how easily the money will keep rolling in—the year round.

SEND THE COUPON NOW

Write today—at once. Don't delay—the automobile season is just starting to open up big. Tire repairs will soon be needed every hour of the day. You can get all the business in your neighborhood if you want it. **Send the coupon today—now—at once.**

C. A. SHALER CO., 2003 Seventh St., Waupun, Wis.

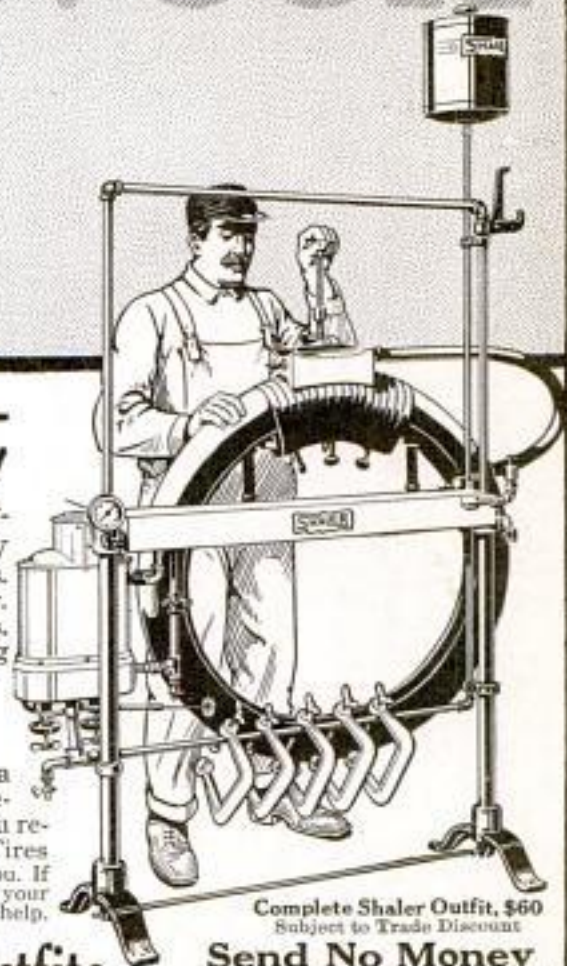

Complete Shaler Outfit, \$60
Subject to Trade Discount

Send No Money

Investigate this now before some other wide-awake fellow gets ahead of you. Don't send a penny. Get all the particulars first. Learn the big possibilities in the tire repair field.

Opportunity Coupon

C. A. Shaler Co.

2003 Seventh St., Waupun, Wis.

Without any obligation on my part, please send me full particulars about the Shaler improved methods of tire repairing, also special offer on tire repairing equipment.

Name

Address

Send



**NOW for DYKE'S
Free 32 PAGE Booklet**

EXPLAINING:

**HOW TO GET INTO
THE AUTOMOBILE
BUSINESS & ITS OPPORTUNITIES
HOW TO LEARN DURING SPARE
TIME BY MAIL AT HOME WITH
DYKE'S NEW IDEA
Working Model Method**

This system is endorsed by Barney Oldfield, Elwood Haynes, Chas. Duryea and other motor authorities.

If we prove to you that we have started hundreds of others into the repair business and as chauffeurs—who had no previous experience and who knew no more about an auto than you do right now—you must admit we can do the same for you. Write me today—now—and let me prove it.

The AUTOMOBILE BUSINESS is Growing

We Assist Students Getting Actual Driving Experience



More help needed and big pay. No other business offers such opportunities. It's easy to learn. An Auto Repairman is not an amehician—his work consists of adjustments

and re-fitting worn parts, "knowing the principle," that's the thing. One of our students writes: "Before I started with your course I was a clerk at \$50 per month. After finishing I followed your instructions, started a repair shop and cleared \$122 the first month—pretty good for the first month." Let us show you this and many other letters. You can learn the same as this young man by

DYKE'S NEW IDEA OF TEACHING BY MAIL WITH WORKING MODELS

On these models you get actual practice, see the actual operation and learn more than you could from the auto itself—it's easy and quick. You don't have to study hard with this system—we teach through the eye—a new idea. Mr. Dyke is the originator of the system of teaching by mail with models—hence he is the initiator.

Our Employment Plan for Students

represents years of work to provide something that no other school had, namely, a way for the student to get started in the practical line of work.

Mr. Dyke has been identified as a pioneer inventor, supply man, etc., with the auto industry since its beginning. He originated the first auto supply co. and published the first book on autos in America. No other man with such experience is today teaching others.

**Mail This Free
Coupon Now**

(a postal card will do)

for Mr. Dyke's 32-Page Booklet. Write for it—now! It is interesting and instructive in itself. Learn how you can get all this training for only \$15. Fill out below or write a postal—but do it now.

This school is a department of the first:

**A. L. DYKE
Pub. & Importer
Box 196 Roe Bldg.
St. Louis, Mo.**

Dyke's Correspondence School of Motoring
Box 196, Roe Bldg.
St. Louis, Mo.

Send me your free 32-page booklet about your New Idea Working Model Course and testimonials and proofs. It is understood I am under no obligations in sending for this.

Name.....

Address.....

Deal with the originators. Beware of imitators.

(Contents—Continued from page 6)

Saw, Band, Care of.....	767
Scraper, Sharpening for Heavy Cut.....	761
Screen Frames, Preventing Rust under Molding on.....	781
Sprinkler, Large Area.....	763
Steam Gauge Dial Glass Casings, Removing....	780
Steel Tempering Thin Pieces of.....	783
Stepladder, Carrying.....	775
Straightening Small Rods in Vise.....	781
Stuffing Box Nuts, Stripped, Emergency Repair on.....	772
Tanks or Silos, Track for Painting.....	784
Tires, Old, Making Retainers Out of.....	775
Tool Grinding, Graduated Index Finger for.....	771
Waterproofing Serving Tray.....	773
Woodwork, Exterior, Repainting.....	774
Wringer, Wash, Repairing Broken Rubber on....	774

AMATEUR MECHANICS

Bell, Cannon Shell Dinner.....	780
Bench Stop.....	798
Camera, Substitute for Ground Glass in.....	792
Canoe, How to Build a: Part II—Sailing the Open Paddling Canoe....	786
Clothespin Basket Hook.....	790
Counter, Easily Made.....	791
Desk Slide in Top of Drawer.....	784
Drawer Handles, Preventing Looseness of.....	785
Electric Bulbs, Incandescent, Repairing Burned Out.....	792
Electric Water Heater, Carbon.....	784
Electrical Dancer.....	785
Ellipsograph, Homemade.....	796
Files, Testing and Caring for.....	790
Flatiron Polisher.....	783
Footstool, Woven Reed.....	783
Magazines, Old, Use for.....	789
Model Making, Common Mistakes in.....	798
Oars, Emergency, Take Down.....	799
Pencil Holder for Workbench.....	792
Photographing Electric Sparks.....	789
Propeller Blades, How to Make Quickly.....	799
Radiator Valve, Ship's Wheel Device for.....	797
Screen Frame, Fly, Repairing Broken.....	784
Teaspoon, Catching Large Fish with.....	791
Temperature of Room, Raising.....	781
Tire Patch, Leather.....	790
Trick—Magic Candles Explained.....	783
Water Basin, Concrete, for Poultry.....	792
Whirligig, Perpetual.....	790
Wicks, Lamp, Easily Made.....	792

JEWELRY ENGRAVING

We teach you, by our new and original method of instruction, this clean, fascinating and profitable business right at your home, and furnish you all tools needed absolutely free. Write for free book to the

WISCONSIN SCHOOL OF ENGRAVING, 508 Bldg., MILWAUKEE, WIS.



Be an Artist.

and Draw for Magazines, Newspapers, Etc. Earn Big Money (Send sample of your work for honest criticism)

All Branches of Art Taught BY MAIL or Local Classes. Write for illustrated booklet, terms and list of successful pupils. **ASSOCIATED ART STUDIOS, 2122 Flatiron Bldg., NEW YORK**



GET ON THE VAUDEVILLE STAGE

I tell you how! Fascinating profession for either sex. Big salaries. Experience unnecessary. Splendid engagements always waiting. Opportunity for travel. Theatrical agents and authorities endorse my methods. Thirty years' experience as manager and performer. Illustrated book "All About Vaudeville" absolutely FREE. Send me your name and address TODAY. **FREDERIC LA BELLE, Ste. 159, JACKSON, MICH.**

Uncle Sam is a Good Boss

He pays good money and the jobs are pleasant, dignified and good for a lifetime. Why not try for a good government job? The examinations are not hard to pass if you let the International Correspondence Schools show you how. Write today for booklet which tells how hundreds have got positions. It's free and without obligation.

International Correspondence Schools
Box 2507, Scranton, Pa.



Please Mention Popular Mechanics

Have YOU These Luxuries?



Partial Contents

- The Law of Great Thinking.
- The Four Factors on which it Depends.
- How to develop analytical power.
- How to think "all around" any subject.
- How to throw the mind into deliberate, controlled, productive thinking.
- Detailed directions for Perfect Mind Concentration.
- How to acquire the Power of Consecutive Thinking, Reasoning, Analysis.
- How to acquire the skill of Creative Writing.
- How to guard against errors in Thought.
- How to drive from the mind all unwelcome thoughts.
- How to follow any line of thought with keen, concentrated Power.
- How to develop Reasoning power.
- How to handle the mind in Creative Thinking.
- The Secret of Building Mind Power.
- How the Will is made to act.
- How to test your Will.
- How a Strong Will is Master of Body.
- What creates Human Power.
- The Six Principles of Will Training.
- Definite Methods for developing Will.
- The NINETY-NINE METHODS for using Will-Power in the Conduct of Life.
- Seven Principles of drill in Mental, Physical, Personal Power.
- FIFTY-ONEMAXIMS for Applied Power of Perception, Memory, Imagination, Self-Analysis, Control.
- How to develop a strong, keen gaze.
- How to concentrate the eye upon what is before you—object, person, printed page, work.
- How to become aware of Nerve Action.
- How to keep the body well poised.
- How to throw off Worry.
- How to secure steady nerves.
- How to train the Hand.
- Difficulties in Mastering Harmful Habits.
- Etc., etc., etc.

A complete list of contents would almost fill this page.

Power of Will

The Secret of Achievement

He had no better chance than you—he simply made the most of that God-given faculty of will, which is latent in all of us. Instead of allowing himself to be everlastingly turned aside by petty fears, by insignificant daily incidents, instead of letting instincts and appetites run away with him—instead of permitting others to control him, he exercised his will—he became master of himself—he learned to dominate others instead of allowing others to dominate him. He learned to get what he wanted and he got it.

Great men—successful men—are born with no greater gifts than others. The secret of their achievements lies in the fact that they use their faculties instead of allowing them to become scotched and dormant.

If you sprained your ankle and didn't touch your foot to the ground for months, it would become so weak you couldn't use it. The same is true of the will. It becomes weakened like a muscle from lack of use.

Complete Course in Will Training

Scientists found years ago that memory can be trained by intelligent exercise. Now it has been proven by over 100,000 people that the will can be strengthened in the very same way by the proper kind of exercise. Professor Frank Channing Haddock, Ph.D., the great scientist, has written a book containing 28 lessons in will-training based on a profound analysis of Will-Power in human beings. He gives actual methods, rules and principles for training, strengthening and developing will-power; and they are so clear, so easily understood that anyone can apply the simple instructions with noticeable results right from the very start.

Is YOUR Will Dormant?

Look back upon your life. Once upon a time, no doubt, you weaved great dreams of what you were going to make of yourself. Are they accomplished now? Why are they not accomplished? Is it not because you lack a strong, powerful, dominating, inflexible WILL? You allowed others to control and influence you to their ends, instead of controlling others yourself. You let trifling daily occurrences everlastingly turn you from your purpose. Gradually—like so many of us—you allowed this God-given faculty of will to become lifeless within you. Dr. Haddock has a message for you—a real message of emancipation from the blinding human curse of indecision and blind habit—a message which every man from 20 to 60 years old should get.

Send No Money—Examine Book First

The publishers will send you a copy free—without deposit—so that you may judge for yourself how much "Power of Will" will help you in your daily life. The price of the book is \$3.00, but send no money now. Merely mail the coupon, enclosing your business card or giving a reference. You can keep the book five days. Then, if you feel you can afford to be without it, send it back and you'll owe nothing. Tear out the coupon now, before you turn this page.



100 pp.
Half-Leather
Gold-Top
Leaves

Pelton Publishing Co.

13-J Wilcox Block, MERIDEN, CONN.

Over 100,000 Users

Power of Will has already helped over 100,000 people—a record equaled by no other single course of any kind in the world. Such men as Judge Ben B. Lindsey; Supreme Court Justice Parker; Wu Ting Fang, ex-U. S. Chinese Ambassador; Lieut.-Gov. McKelvie of Nebraska; General Manager Christeson of Wells-Fargo Express Co.; Ernest Knaebel, Asst. Atty.-Gen. of the U. S.; Asst. Postmaster-General Britt; E. St. Elmo Lewis, and literally thousands of other successful men like them are owners of this great work.

"From what I have already seen I believe I can get \$300 to \$30,000 worth of good out of it."—C. D. Van Vechten, General Agent, No. West Life Ins. Co., Cedar Rapids, Ia.

"Will Power" is a compilation of mighty force. My first week's benefit in dollars is \$900—cost \$3; profit \$897.—J. W. Heistand, 916 Tribune Bldg., Chicago, Ill.

"Send 15 copies to our New York office."—W. M. Taylor, Efficiency Expert, the Overland Auto Co., Toledo.

"He who reads it and puts forth effort will soon find himself out of the common herd."—J. A. Good, President of Nebraska Lumber Dealers Assn., Cowles, Neb.

"Here is \$3 for you. 'Power of Will' received. It is the book I've wished for for years."—J. L. Sewall, Clerk of Supreme Court, State of N. C., Raleigh, N. C.

Pelton
Pub. Co.
13-J Wilcox Bk.
Meriden, Conn.

Gentlemen:—Please send me a copy of "Power of Will" on approval. I agree to remit \$3.00 or return the book in 5 days.

Name.....

Address.....

ELECTRICAL ENGINEERS

Earn \$125 to \$250 a Month

The demand for Electrical Engineers at \$125 to \$250 a month far exceeds the supply. Engineering and power companies everywhere are searching for specially trained men. No previous experience necessary to take up this interesting work. Decide to fit yourself for one of these high-salaried positions.

The **American School** will train you to be a well-paid electrical worker in a short time at small expense. Our staff of practical engineers will give you individual instruction and advice. You can start in right now to prepare yourself for a better job and bigger pay.

Earn While Learning No need to give up your present occupation. We train you at home—solely by correspondence—as we have successfully trained thousands of others in the past eighteen years. Pocket-size textbooks, prepared by famous electrical experts, enable you to study anywhere—at any time. Papers examined and corrected only by experienced technical graduates.

\$500 to \$2400 in Three Years

"The work I did with you advanced my salary from \$500 to \$2400 in three years."—**REPORT** F. Koops, *Dorchester, Mass.* (Graduate, Electrical Engineering.)

Made Chief Electrician

"About two months ago I was appointed Chief Electrician of the Spherotody plant of the American Locomotive Co. — **L. A. WARDEN, JR., Schenectady, N. Y.** (Graduate, Electrical Engineering.)

Free Book Coupon

American School of Correspondence, Chicago, U. S. A.

Without any obligation on my part, please send me your Free Book and complete information regarding a course in Electrical Engineering Telephone Engineering Hydroelectrical Engineering Power House Superintendence Wireless Telegraphy. Pop. Mech. 5-16

NAME.....

ADDRESS.....

Electrical Book FREE

Send the coupon for your copy of our 56-page Free Book. Tells how easy it is to master Electricity, and gives full particulars regarding the course you are most interested in. **Don't hold back because of the money. The cost is small, and you can pay for your instruction as you progress—in small monthly installments.**

Mark and mail the coupon to-day. This is a wonderful opportunity to get into a profession that pays big money. No obligation in sending the coupon. **Mail it now!**

AMERICAN SCHOOL OF CORRESPONDENCE, CHICAGO, U. S. A.



YOU, — GET A GOVERNMENT JOB

Candidates Coached Free

No "layoffs" without pay, because of strikes, financial panics or the whims of some petty boss. If you want immediate appointment, send **TODAY** for free list of positions now obtainable. Any delay lessens your chance of early appointment.

We Will Coach 25
Candidates
Free

Send
Coupon Below
FRANKLIN INSTITUTE
(The pathway to plenty)
Dept. L104, Rochester, N. Y.

This coupon, filled out as directed, entitles the sender to a free copy of our book, "Government Positions and How to Get Them," a full list of positions now obtainable and to consideration for Free Coaching for the position here checked.

COUPON

<input type="checkbox"/> Railway Mail Clerk (\$900 to \$1800)	<input type="checkbox"/> Stenographer (\$800 to \$1500)
<input type="checkbox"/> Bookkeeper (\$800 to \$1800)	<input type="checkbox"/> Internal Revenue (\$700 to \$1800)
<input type="checkbox"/> Postoffice Clerk (\$800 to \$1200)	<input type="checkbox"/> Clerk in the Departments at
<input type="checkbox"/> Postoffice Carrier (\$800 to \$1200)	Washington (\$800 to \$1500)
<input type="checkbox"/> Rural Mail Carrier (\$800 to \$1200)	<input type="checkbox"/> Canadian Govern-
<input type="checkbox"/> Customs Positions (\$800 to \$1500)	ment Positions

Name.....

Address..... L104

Use this before you lose it.

Write plainly

When You Build

please bear in mind that there is still plenty of

WHITE PINE

Send for our free booklet, "WHITE PINE IN HOME-BUILDING"

WHITE PINE BUREAU

1626 Merchants' Bank Bldg. ST. PAUL, MINN.

LETTERING AND DESIGN

Invest your spare time. Learn Card Writing, Sign Painting or Commercial Lettering and Design. Earn a steadily increasing income or start in business. Receiving personal instruction makes course self-paying. P. Weststrom writes "Your lessons are great." Constant demand for graduates makes it obtaining position. Investigate now. **FREE BOOK.**

THE ROSING SCHOOL OF LETTERING & DESIGN
725 Union Bldg. Cleveland, Ohio

If You Are a Shallow Breather

You most certainly are in need of Conscious Evolution to become fully alive and have the benefit of living in full. Why live an inferior life when you can become superior to yourself through Conscious Evolution?

MY NEW BOOK explains the human body as it has never been explained before. It tells of the dangers and after effects of exercise and conscious deep breathing. My free book will prove of great value to you. If you desire to be more successful, to have greater will power and the successful powers, physical, physiological and mental, you cannot afford to be without my free book. Write for it today.

ALOIS P. SWOBODA
1926 Aeolian Hall NEW YORK CITY

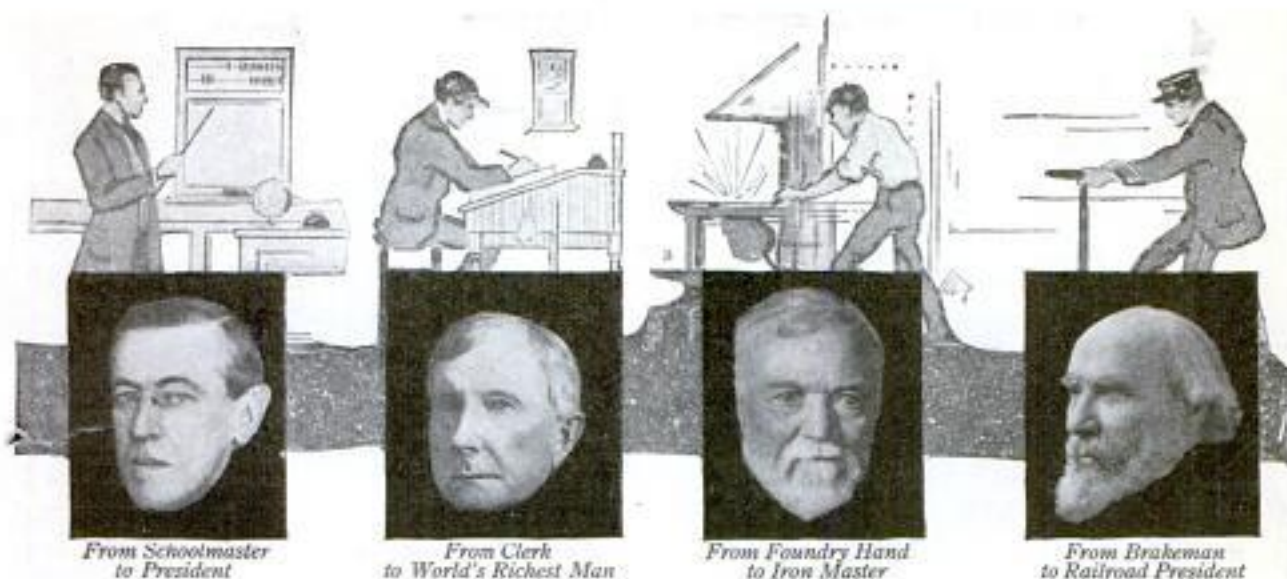

From Schoolmaster
to President

From Clerk
to World's Richest Man

From Foundry Hand
to Iron Master

From Braheman
to Railroad President

One Hint From These Men

may be the turning point
in your life!

SUPPOSE men like Wilson, Rockefeller, Carnegie, and Hill called on you, in your own home and confided to you the innermost secrets of their success! Suppose they stood at your side, constantly guiding you—could you possibly fail to get the things you want most in life?

Well, that is what these men do for you through the Master Workers' Book, written by them for your guidance. It is like a personal and permanent visit from them, full of ideas, plans and methods from cover to cover—and if you get only ONE HINT from them it may change your entire life—may mean greater success for you than you even dreamed possible.

Through this book, in a few hours you can learn what they learned only after years of experience—secrets which you can immediately turn into your own material advantage in whatever position you occupy.

Even though you are now on the road to success—even though you are daily making progress, can you afford to fight alone when the advice of these great leaders is within your grasp?

The text of the Master Workers' Book was originally issued in four volumes but is now printed in one big book well printed and illustrated containing eleven hundred pages crowded with ideas, suggestions, methods and principles which its famous authors have used so successfully in solving the problems they met in their uphill struggle toward world leadership.

How You Can Get This Book For 10c

As separate volumes, the four books which make up The Master Workers' Book, sold for \$6; but the recent great strides in bookmaking have enabled us to put these four books into one splendid volume which we are able to give you for the cost of postage with a year's subscription to World's Work, the greatest interpreter of efficiency and progress—the one magazine which every ambitious person owes it to himself to read.

The subscription price of World's Work alone is \$3 a year. The Master Workers' Book will cost you nothing (except ten cents to cover postage) if you mail the coupon today.

Just Mail the Coupon

Merely enclose 10c (coin or stamps) and by return post, all charges prepaid, you will receive the Master Workers' Book and the current issue of World's Work. Examine the book at your leisure—then if you feel you can afford to be without the great short cuts to success it contains—send it back within a week after you receive it and you will owe nothing. If you decide to keep the book—and we know you will never part with it)—send us \$3 and you will receive World's Work for a year. If in the 1,100 pages of the Master Workers' Book you gain but one single idea that would help you to successfully overcome life's battles, this would prove the most profitable investment you ever made—yet daily we receive letters from owners who say that every page is a gold mine of help. Mail the coupon today—this announcement may not appear here again.

J. M.
May

Doubleday,
Page & Co.,
Garden City, N.Y.

DEAR SIR: I enclose 10c (stamps accepted). Please enter my name for "World's Work" for a year and send me free the MASTER WORKERS' BOOK—bound in cloth. If this book is not valuable to me, I will return it at your expense within a week after it reaches me. Otherwise, I will send you \$3 for the magazine.

Name.....

Address.....

City.....State.....



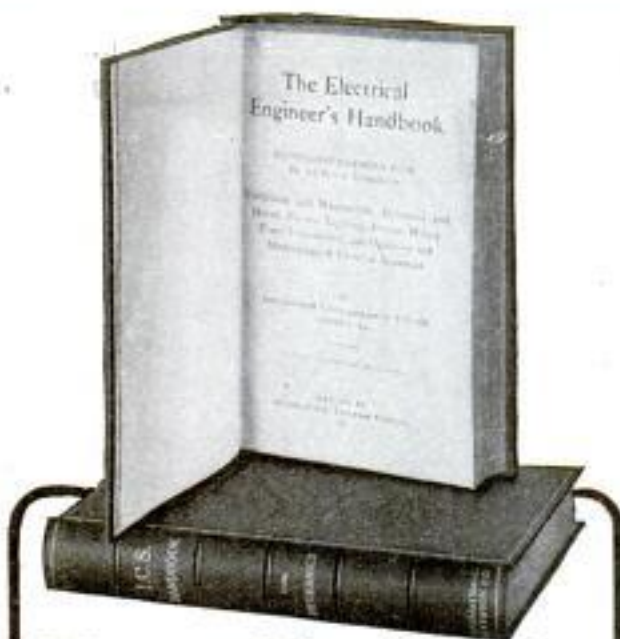

These Handbooks Will Help YOU

When a puzzling formula, an elusive table, or some other equally necessary piece of information slips out of your memory—then it is that one of these little encyclopedias demonstrates its worth. They are written by the well-known textbook writers of the International Correspondence Schools and are so thoroughly indexed that you can turn instantly to any rule, formula, or other information you need. Here is a brief table of the contents of one of them:

ELECTRICAL ENGINEER'S.—Mechanics; electrical units; physical and electrical properties of metals and alloys; temperature for copper wires; wire gauges; magnetism; dynamos and motors; electric batteries; alternating current apparatus; alternators; transformers; wattmeters; electric transmission; electric lamps; wiring; electric heating and welding; electromagnets; controllers; car wiring; etc., etc., etc. The others are equally complete.

Special Offer: For a limited time we are selling shown here in the twenty-two titles listed below, durably bound in silk cloth, averaging approximately 375 pages and 175 illustrations, at a special price for each handbook of only **50c**

International Textbook Company Box 5506, SCRANTON, PA.

I enclose \$_____ for which please send me the books BEFORE which I have marked X.

- | | | |
|---------------------|----------------------|----------------------|
| • Mechanics' | • Mariners' | • Poultryman's |
| • Elec. Engineer's | • Business Man's | • Salesman's |
| • Building Trades | • Plumbs. & Fitters' | • Farmer's |
| • Advertiser's | • Concrete Engi- | • Window Trim'er's |
| • Steno. and Corr. | • neer's | • Chemist's |
| • Bookkeeper's | • Steam Engineer's | • Civil Engineer's |
| • Tel. & Tel. Engi- | • Automobile | • Cot. Tex. Worker's |
| • neers' | • Coal Miner's | • West. Air Brake |

Name _____

Street and No. _____

City _____

State _____

Please Mention Popular Mechanics

LEARN TO

PAINT SIGNS and SHOW CARDS

THERE'S MONEY IN IT

I'll teach you personally by mail. 17 years' successful teaching. Five courses: (1) Complete Lettering, Sign and Card Writing; (2) Show Card and Ticket Writing; (3) Lettering; (4) Advanced Show Card and Ticket Writing; (5) Advanced complete course. You can succeed—big. No limit to the window cards, sale cards, banners, and signs used. Gold lettering on glass and wood valuable feature of course. Teaches everything you need. Pay good, work fascinating, hours short.

EARN \$18.00 to \$45.00 a WEEK

Schwartz, Del., writes: "Yours is the only school that really teaches." Weaver, Canada, writes: "Your course has increased my income 50%." Get in on this big thing, too. Your name and address brings full particulars.

THE DETROIT SCHOOL OF LETTERING
Chas. J. Strand, Founder, Dept. 2050, Detroit, Mich.

Guarantee—
I guarantee to place my graduates in positive paying \$25.00 to \$125.00 when they have graduated and are competent. We have constantly more requests for men at good salaries than we can supply.

Send 55c for New Edition of Book Wiring Houses for Electric Light and do the job yourself

Cloth, 128 pages, 45 illustrations, 9 plates. Gives the latest methods for Conduit, Protected and Armored Cable Wiring, and newest fittings. Digest of Nat'l Underwriters Rules, 1916 Edition.

SPON & CHAMBERLAIN
123 P. M. Liberty St. NEW YORK

DON'T TAKE A COURSE IN MACHINE DRAFTING

until you've read my proposition. Practical, experienced Draftsman, regularly employed in large modern works, will teach a few men by mail. Best way to become a well-paid Draftsman. Special courses in Mathematics also. Instruments furnished. Rates very reasonable. Draftsman, 262 S. Corona St., Denver, Colo.

DOMELRE

Domestic - Electric - Refrigerator The Mechanical Refrigerator Company
718 Fisher Building, Chicago

Factories: Clybourn Avenue and Willow Street, Chicago, Ill.

Own a Profitable Business LET US TELL YOU HOW

Millions of auto owners want proper care and repair of their cars. Experts in big demand. You can soon own a paying garage. Our four-in-one course gives you instruction in auto driving and repair, tractor operation and maintenance, gas engines and garage management. Sell accessories, take agency I.M.I. car—best car on market under \$700—and make big money while learning.



Write today for free car plan
**INTERNATIONAL
MOTOR INSTITUTE**
44 Kesner Bldg., CHICAGO

HAWKINS ELECTRICAL GUIDES

— the recognized standards — famous pocket-size texts
 tell you all you need to know about Electricity

These books solve your electrical problems. They are a complete and up-to-date course in Electrical Engineering—in the form of questions you would ask and the answers—in plain, practical, everyday language; complete, concise, and to the point.

10 Practical Volumes

Leather binding — pocket size

BRIEF OUTLINE OF THE CONTENTS

No. 1 Guide Contains 340 pages, 246 illustrations. Treating on electrical signs and symbols—static and current electricity—primary cells—conductors and insulators—resistance and conductivity—effects of the current—magnetism—electro-magnetic induction—induction coils—**dynamo principles**—classes of dynamo—field magnets.

No. 2 Guide Contains 218 pages, 256 illustrations. Armatures—armature windings—armature theory—commutation and the commutator—brushes and the brush gear—armature construction—**motor principles**—armature reaction in motors—starting a motor—motor calculations—brake horse power—**selection and installation of dynamos and motors**—performance curves—location—foundations—belts—**auxiliary machines**.

No. 3 Guide Contains 276 pages, 280 illustrations. Galvanometer—standard cells—current measurement—resistance measurement—Christie bridge—testing sets—loop tests—potentiometer—**armature voltmeter and wattmeter**—multipliers—electro-dynamometers—demand indicators—**watt hour meters**—**operation of dynamos**—fabrication—troubles—coupling of dynamos—armature troubles—care of commutator and brushes—**heating—operating of motors**—starters—speed regulators.

No. 4 Guide Contains 308 pages, 423 illustrations. Distribution systems—boosters—**wires and wire calculations**—inside, outside, and underground wiring—wiring of buildings—sign flashers—lightning protection—**storage battery**—rectifiers—storage battery systems.

No. 5 Guide Contains 278 pages, 379 illustrations. Alternating current principles—alternating current diagrams—the power factor—**alternator principles**—alternator construction—alternator windings.

No. 6 Guide Contains 272 pages, 538 illustrations. Alternating current motors—**synchronous and induction motor principles**—construction of alternating current motors—A. C. commutator motors—power factor of induction motors—**transformers**—transformer losses—transformer construction—transformer connections—transformer tests—**converters**—rectifiers.

No. 7 Guide Contains 320 pages, 460 illustrations. Alternating current systems—transformation of phases—switching devices—circuit breakers—relays—lightning protector apparatus—regulating devices—synchronous condensers—indicating devices—**meters**—power factor indicators.

No. 8 Guide Contains 388 pages, 330 illustrations. Wave form measurement—switch-boards—**alternating current wiring**—properties of copper wire—power stations—power station calculations—machine practice—**management**—embracing: selection, location, erection, testing, running, care and repair.

No. 9 Guide Contains 576 pages, 849 illustrations. Telephones—telegraph—simultaneous telegraphy and telephony—**wireless**—electric bells—electric lighting—photometry—electric railways—electric locomotives—car lighting—trolley car operation.

No. 10 Guide Contains 704 pages, 730 illustrations. Miscellaneous applications—motion pictures—gas engine ignition—automobile self-starters and lighting systems—electric vehicles—**elevators**—cranes—pumps—air compressors—electric heating—**electric welding**—soldering and brazing—industrial electrolysis—**electro-plating**—electro-therapeutics, X-rays, etc. This number contains a COMPLETE READY REFERENCE INDEX OF THE COMPLETE LIBRARY.

Shipped to You FREE

Send no money. Examine the books first. Decide for yourself that they are the most complete library of Electricity ever published and that you cannot afford to be without them. Every book is complete in itself, but the complete set is the best bargain. The last volumes have just come off the press.

Easy Payments Each page—every illustration will convince you of the big value we are offering. See the books first, then decide. If you decide to keep them you can make settlement at only \$1.00 monthly until paid for.

THEO. AUDEL & CO., 72 Fifth Ave., New York.



3500 Pages—4700 Illustrations

1⁰⁰ A Number Payable 1⁰⁰ A Month

What Users Say

"Every Electrician, Operating Engineer or Student who wants to advance himself in the Electrical field should have a set of these books."
 JOHN KELLEY, 116 Union St., Newark, Ohio.

"For the man not getting a college training, and even in that case, I can sincerely say I do not believe there is a better set of books on the market today."
 LLOYD D. HUFFMAN, Dayton, Ohio.

"We consider Hawkins Electrical Guides the most compact and complete set of electrical references in the market."
 NOGGLE ELECTRIC WORKS, Monterey, Cal.

"Hawkins surely knows the art of condensing information."
 ELDRIDGE P. BELL, Buckland, Conn.

"I think they should be in the hands of everyone who has anything to do with Electricity."
 T. H. MURPHY, Orange, Va.

"For the practical electrician, they are the best books published—worth many times their price."
 L. C. WAGNER, Wyoming, Ill.

"I have gained valuable information from them which has helped me directly in my line of work."
 HERMAN NODENBERG, Hoboken, N. J.

"They are wonderful value. Everything is so clear and concise. Even one who had no knowledge of Electricity would have no difficulty in grasping the facts."
 F. L. TAYLOR, Amesbury, Mass.

"It is the best work an apprentice can study if he wants to get ahead in his trade. As a reference for the experienced worker HAWKINS ELECTRICAL GUIDES are unexcelled."
 I. McCLELLAN, Chillicothe, Mo.

For bigger pay and better position

Send the coupon today for FREE examination of HAWKINS ELECTRICAL GUIDES. These books will mean money to you, as they have to thousands of others. They fit your pocket and your pocket book. Beautifully bound in flexible black leather with gold edges. Easy to read and handle. You can carry each single volume about with you until you have mastered it. Only \$1 per volume and owners of the set say there are no better Electrical books at any price. Send for your set today and use it seven days FREE.

MAIL FREE COUPON TODAY

Theo. Audel & Co., 72 5th Ave., New York
 Please submit me for examination HAWKINS ELECTRICAL GUIDES (Price \$1 each). Ship at once, prepaid, the 10 volumes. If satisfactory I agree to send you \$1 within seven days and to further mail you \$1 each month until paid.

Signature

Occupation

Business Address

Residence

Reference



Machine Shop Practice Complete



No Money Down Small Monthly Payments

You will want to see with your own eyes the Library which is now taking the country by storm. You will want to peer into some of its three thousand pages, and to look over the thousands of drawings which cost a small fortune.

You will want to do this whether you intend to purchase or not. You can see the Machine Shop Library, containing nine volumes and weighing sixteen pounds, without advancing one cent.

A Big Undertaking Completed

The construction of a Library which is to supply the practical man with all the information he needs to advance himself in machine shop work is not a small undertaking.

In addition to the eight authors, all well known in the machine shop world, over two hundred experts from different shops in different parts of the country, assisted in building this monumental work.

Now upon its completion it is replete with the essentials of shop practice in this country today.

Free from Theory The Machine Shop Library is free from theory, that unnecessary evil embodied in the average text book. It contains only enough simple mathematics to bring you to the point quickly. It is understandable even to the beginner, and its treatment of the subjects involved, by revision and correction, is so accurate and correct, that this Library is now an integral part of the foremost machine shops of the country. It is looked upon as a guide and a manual, constantly referred to in all important operations. It is used by experts and beginners alike, because it contains only actual working details.

MACHINISTS ARE PROSPEROUS

The Machine Shop Library affords you a sure means of entering upon a profitable line of work. It is a line in which knowledge, more than muscle, counts. It is a line in which you can earn \$25 to \$50 per week, with always the possibility of reaching some of the higher positions in the service, such as foreman, superintendent, manager, paying you a great deal more. Now is the time to think of the future—return the coupon today.

Titles: Mathematics—Machine Drawing and Design—Composition and Heat Treatment of Steel—American Machinist Gear Book—Accurate Tool Work—American Machinist Grinding Book—Jigs and Fixtures—Automatic Sewing Machines—Practical Die Making.

FREE EXAMINATION COUPON

McGraw-Hill Book Co., Inc., 239 W. 39th St., New York

Gentlemen:—I am interested in your Machine Shop Library. You may send me the nine volumes, charges paid, for my inspection. If satisfactory I will send \$2 in ten days and \$2 per month until I have paid the price of the books, \$16. If the books are not what I want, I will write you for shipping instructions.

SIGNATURE.....

RESIDENCE ADDRESS.....

CITY AND STATE.....

NAME OF EMPLOYER.....

REFERENCE.....

ADDRESS..... P. M. May

Please Mention Popular Mechanics



LEARN THE AUTO BUSINESS

Right Now Is the Time

to start a paying business of your own or earn a splendid salary; three million cars in use this year, hundreds of opportunities ready and waiting. Cleveland is the center of high grade automobile manufacture. Our graduates get jobs quickly; over 3000 are now "making good" in paying positions.

Cleveland Automobile School

12 years of success—oldest and best established
—Latest Equipment—Individual Instruction

No previous experience necessary; we give you up-to-date training in four weeks, including every point worth knowing: oxy-acetylene welding, machine shop practice, testing and driving high-powered late model cars. Silent-Knight and 8 and 12-cylinder cars; up-to-date equipment; experienced, helpful teachers.

COME AND JOIN US NOW

Tuition and board low, right near school. Congenial surroundings; we help you get located. New classes forming. Write for catalog and terms.

The Cleveland Automobile School
CLYDE H. PRATT, Pres.
2338 Euclid Ave.
CLEVELAND, OHIO



BE AN AUTO EXPERT

SHOW CARD WRITERS

EARN \$80 TO \$200 A MONTH
LEARN FREE!



We will furnish a thorough course in Show Card Writing and Lettering absolutely free to introduce our colors if you will purchase an assortment of Alpha Colors to use while practicing. Particulars for stamp.

ALPHA COLOR COMPANY, Inc., Dept. K, 81 East 125th St., N. Y. City

Learn by Expert Wrestler

Mail to be an



Be strong, athletic, healthy, handle large men with ease. Farmer Burns, the world's most scientific wrestler, trainer of Frank Gotch, world's champion, will now teach you by mail. Also complete courses in self-defense and physical culture. Only opportunity ever offered to learn right from champions. For men and boys, all ages. A wonderful course. Low cost.

FREE BOOK Investigate now. You will be under no obligations whatsoever. Send your name, age and address for free booklet about wrestling and full particulars. Write today. Farmer Burns School of Wrestling, 1195 Ramp Bldg., Omaha

FREE to Hunters and Trappers

Fine Taxidermy Book Now Free! 32p. with hundreds of photos of mounted birds and animals. Learn this practical, save your trophies. Decorate your home and den. Great value to sportsmen.

Learn to Stuff Birds animals, game heads, and robes. Quickly learned by men and boys. Big profits from spare time. Intensely interesting. INVESTIGATE! Write Today for Free Book. Only a few free—so rush.

Northwestern School of Taxidermy, 1195 Elwood Bldg., Omaha, Neb.

YOU CAN PLAY PIANO FIRST DAY BY NOTE \$100—TOTAL EXPENSE—\$100

THE ADAMS PIANO AND ORGAN CHART

makes learning to play intensely interesting from the beginning. You learn the notes, where to find them on the key board, and how to play all at once. Simple and easy as A. B. C.'s. Send \$1.00 Now and get Chart by return mail. HENRY T. ADAMS, 6821 South Chicago Avenue, CHICAGO



BART CHALK-TALK

Entertains an audience. Educates you in entertaining. If you draw a little you can do the chalk-talk and make it pay. Bart furnishes you with the ideas, the "patent," the drawings to make, and his own special crayon and equipment—everything he uses in a successful chalk-talk. Write BART, Daily News Cartoonist, Minneapolis. He will tell you about the chalk-talk. See Bart's ad on page 9, May Cartoons



**BE A
TRAFFIC
MANAGER**

**SALARY
\$30 to \$100
WEEKLY**

Trained Traffic Men In Big Demand

Young man, here's your chance to get into a new uncrowded profession—one that lends dignity and prestige, in which the pay is big, the work pleasant—fascinating. Trained traffic men are wanted everywhere. Recently enacted rate laws and Interstate Commerce regulations have literally created **thousands of positions**—only a comparatively few are qualified to fill them.

Be a Traffic Manager

At \$30 To \$100 Per Week

Now is the time to train for this profession. We'll pave the way for your success. Teach you to become thoroughly versed in strategy of shipping, including how to **route shipments**, how to obtain **shortest mileage**, how to **secure quickest deliveries**, how to **classify goods**—and obtain lowest rates. In fact train you so that you can qualify for an important, **high salaried** railroad or industrial traffic position.

We Train You By Mail

in your own home—you need not leave your present occupation or sacrifice your income.

The course is prepared by a number of the greatest traffic experts in America. It covers thoroughly every feature of Traffic and Traffic Managership. It is different from and more complete than any other method of home training. Easier to grasp and thoroughly practical. Anybody who can read and write intelligently can master it. Endorsed and recommended by heads of leading railroads and big concerns of the country who recognize our course as giving the proper training required for important positions in the Traffic and Transportation field.

Train For One of The Big Jobs —It Is Your Opportune Moment

Our graduates qualify for the best positions, because they have the best training by **practical traffic men**. They are better trained because our course, our method of teaching is **easier to master and complete** in every feature.

SEND IN THE COUPON for students' letters and full details concerning the LaSalle University Home Course in Traffic Managership. Send in the coupon now and receive book, letters and full details by return mail.

LaSalle Extension University
World's Greatest Extension University
Dept. 564-C Chicago, Ill.

Short, Complete Course —Small Cost

Our Home Study Course in Traffic Managership fits you in a short time so you can expertly handle a big traffic job. The cost of training is small compared to the big rewards—and we can accept payments to suit you.

Today there are over half a million shippers in the U. S. All need traffic men. Our foreign trade balance is now rapidly approaching the \$2,000,000,000 mark. American goods are being shipped to all parts of the world. The tonnage forwarded by manufacturers and handled by railroads is the heaviest on record. Lake, railroad and ocean routes are literally choked with goods. As a result, big industries and railroads have urgent need for trained traffic men. It is a field which is constantly expanding. The demand for traffic experts is daily increasing and the positions are permanent.

MAIL COUPON TODAY

LA SALLE EXTENSION UNIVERSITY
Dept. 564-C Chicago, Ill.

Send Free proof about opportunities now open to **TRAFFIC EXPERTS** with LaSalle University Training. It is understood that I am not obligating myself in any way.

Name

Address

City..... State.....



Napoleon's Line of March Against Moscow

NAPOLEON'S disastrous Russian campaign marks the beginning of his downfall. The map herewith shows his line of march from Berlin to Moscow, a distance of 1200 miles. This march by Napoleon at the head of over 600,000 trained soldiers was made in less than four months. Moscow was captured, but the Russians burned their famous capitol and all supplies, forcing Napoleon to retreat in mid-winter. He reached Paris with less than 100,000, over half a million of his trained soldiers having fallen along the line of that disastrous retreat.

Once again the thunder of invading armies has awakened Russia from her lethargy. Will the rigors of the Russian climate again prove the salvation of that nation and the turning point in the present tremendous European War? All the causes of the present conflict—the deep racial antipathies, the commercial rivalries, the sting of past defeats, the vaulting ambition for world empire—may be discerned from the pages of history, and the one great history of every empire, kingdom, principality and power, from the beginning of civilization to the present, is the world-famed publication

Ridpath's History of the World



Nine Big Vols.

4000 Pages
2000 Pictures

A Wonderful Bargain

We will name our special low price and easy terms only in direct letters to those sending us the coupon below. Tear off the coupon, write name and address plainly, and mail to us now before you forget it. Our plan of sale enables us to ship direct from factory to customer and guarantee satisfaction. We employ no agents, as our low price does not permit the payment of an agent's commission. You can now purchase this great work at the lowest price ever offered, and pay for it in small sums monthly if you prefer.

America Must Prepare For Defense

Here you discern the causes which have led to the overthrow of monarchies and kingdoms, peoples and races, and if History has proven any fact, it is that the rich and defenseless nation must sooner or later fall beneath the heel of the more warlike and aggressive power. If you would know the fate of the rich and defenseless nation then read the history of ancient Assyria or Chaldea or Persia or Babylon, whose glory now is but a memory. They have been so obliterated that even the location of their splendid cities is unknown. Any man who reads History, who has red blood in his veins, who loves his country, must favor adequate preparation for self defense against the aggression of warlike powers. Dr. Ridpath gives the complete History of every race, every nation, every time, and holds you spellbound by his wonderful eloquence. Nothing more interesting, absorbing and inspiring has ever been written.

FREE COUPON

WESTERN NEWSPAPER ASSOCIATION 4-16
140 So. Dearborn St., Chicago, Ill.
Please mail your 46-page free sample booklet of Ridpath's History of the World, containing photogravures of Napoleon and Czar, map of European War Zone, and write the full particulars of your special offer to Popular Mechanics readers.

NAME.....
ADDRESS.....

Please Mention Popular Mechanics

NEW WAY IN TYPEWRITING

LEARN AT HOME - 10 EASY LESSONS EARN \$25 TO \$40 WEEKLY!

A revolutionary new method is doubling and trebling salaries of stenographers and typists in all parts of the country.

Already, hundreds formerly earning from \$8 to \$15 a week are drawing \$25, \$35 and even \$40 weekly and their work is easier than ever before.

80 to 100 Words a Minute GUARANTEED

Increases speed from first day's use. Entire system quickly learned at home in 10 easy lessons. No interference with regular work. Enables anyone to write 80 to 100 words a minute blindfolded without a single mistake. So certain are results that we offer the entire course on trial. Costs nothing unless you're fully satisfied.

48-PAGE SALARY-RAISING BOOK FREE

Send postal or letter now for 48-page illustrated book explaining system, telling all about the wonderful Gymnastic Finger Training and containing letters from hundreds of graduates whose salaries have already been increased \$300, \$500 and up to \$2,000 yearly. Write for free book today—postal will do—no obligation—we'll send book by return post. But don't delay. Special reduced price offer now to new students in each locality. Address

THE TULLOSS SCHOOL, 105 College Hill, SPRINGFIELD, OHIO

REVERSIBLE
Linene
TRADE MARK
COLLARS

Send 2 Cents
in U. S. Stamps to pay postage and we will send you free a starch-finished

SAMPLE COLLAR
State size and which style wanted

REVERSIBLE COLLAR CO., Dept. U, Boston, Mass.

Finger Print Experts
make from \$5,000 to \$10,000 per year. Be independent. Learn now.
H. C. THODE 2057 Grove Street
SAN FRANCISCO, CAL.

200 KINDS Iron, Wood, Wire & Steel
PUZZLES
Catalog and 2 wire leaders and trick card only 10c.
WESTERN PUZZLE WORKS
ST. PAUL, MINN.

FREE to men and women beginners my eight page folder on butterflies, insects. I buy hundreds for museums, art work, study purposes, and rich collectors for their museums. 5 cents to \$7.00 each paid. Easy outdoor employment.
SINCLAIR, Box 244, D-6, Los Angeles, Cal.

For Artists and Art Students
Publishes Cash Art Assignments, lessons and articles on Caricature, Illustrating, Lettering, Designing and Chalk-Talking. Criticisms amateur's work. Interesting, helpful, artistic, UNIQUE. It will please you. Money back if not satisfactory. \$1 a year, \$10c a copy.
Clare Briggs, Ryan Walker and other noted artists contributors
STUDENTS ART MAGAZINE
Dept. 151, Kalamazoo, Mich.

Send Now \$1 for 12 Issues

Within YOUR reach



The new Encyclopaedia Britannica (^{11th} Edition) puts within your reach

anything you may be curious about—the whole world's knowledge and wisdom and experience.

The "Handy Volume" issue of this work puts within your reach

this great library in convenient volumes, light and easy to hold and read, and small enough to go on ordinary-size book-shelves.

And the low price at which we sell the issue puts within your reach

this valuable tool, this priceless aid to efficiency and success. These low prices must advance when the present stock on hand is exhausted, because the war is forcing up all items of manufacture, raw materials, and labor.

Information about the Britannica is within your reach

if you sign and mail to us the coupon on this page. It will bring you "A Book of 100 Wonders," a pamphlet of 130 pages with 200 illustrations (some of them in colors)—thoroughly interesting reading in itself, but even more valuable to you because it tells just what you need to know about the Britannica to make up your mind quickly, so that you can buy it now, before the price is advanced.

☞ Sign the coupon and mail it to-day to
SEARS, ROEBUCK AND CO.
 Sole Distributors—Chicago

Sears, Roebuck and Co.
 Chicago

Please send me, free, the "**Book of 100 Wonders**" telling about the Britannica, with sample pages of type and illustrations, details of bindings, prices, terms, etc., before the present bargain sale closes.

Name _____

Address _____

18-c

29
 volumes
 on payment
 of \$1 down

the balance
 in small
 monthly
 payments

FREE Complete \$15.00 Set of Drawing Instruments

YES, I will give you this complete set of drawing instruments absolutely free. They are regular working instruments—the kind I use myself and they do not cost you a cent.

And besides the instruments in an exquisite plush-lined leather case, I will give you absolutely free a 20x25 inch drawing board, a 24 inch T square, a 12 inch rule, a supply of drawing paper, two triangles and a French curve, pencils, erasers, thumb tacks, etc., etc. A complete draftsman's working outfit. And I give it to the men who get my personal instruction absolutely free.



Be a Draftsman!

Draw \$125 to \$175 per Month

There is an urgent demand for skilled draftsmen. Companies are issuing calls every day for men to fill positions paying from \$125.00 to \$175.00 per month. Work is light, pleasant and profitable.

Chief Draftsman *Will Instruct You Personally*

I am Chief Draftsman of a large and well known firm. I have been doing the highest paying expert drafting work for a quarter of a century and I know just the kind of training that is demanded from men who get the big salaries. I will give you personal instruction, deal individually with you and give you up-to-date, practical working plans just as your ability and advancement require. I train you by giving you actual work—practical work, the kind that you must be able to do in order to hold permanent, big paying positions. I give you my individual instruction. If your work is right, I will advance you rapidly. If it is wrong, I will show you where, and make you do it right, and do all I can to make you an expert draftsman and designer in a short time. **Write Today Without Fail**

Pay as You Wish! What I want is the RIGHT KIND of men. Don't bother about expense. I will give you the working outfit free if you get in at once. I charge a very small fee for training you to be an experienced draftsman. You can pay the small cost as suits you best. My object is to develop experienced draftsmen.

Chief Draftsman Dobe
Engineer's Equipment Co.
Div. 1195 Chicago, Ill.

Without any obligation on me whatsoever, please mail your book "Successful Draftsmanship" and full particulars of your liberal "Personal Instruction" offer to a few students. It is understood that I am obligated in no way whatever.



Send the Coupon for My Big New Book

Put your name and address on the free coupon or a letter or a post card and send it to me today. I will send you absolutely free and postpaid my new book "Successful Draftsmanship," and the great special offer that I am now making on which you get the \$15.00 Draftsman's Working Outfit absolutely free. You assume no obligations of any kind in sending in the coupon. Get in line now for a big paying position. Getting the book and full particulars of the special offer is the first step. Write today—now.

Chief Draftsman Dobe
Engineer's Equipment Co., Inc., Div. 1195, CHICAGO, ILL.

NAME.....

ADDRESS.....

CLASSIFIED ADVERTISEMENTS

WORLD'S BEST WANT AD MEDIUM

We have records to prove that a classified ad in these columns will find a buyer for almost anything which can be sold. Doubtless you have some article of value to some one else which you no longer need. Why not turn it into money?

Advertisements in this section, 15 cents per word, each insertion, minimum 10 words, payable in advance. To insure ads being inserted under proper classified head in the June issue, copy must reach this office not later than May 1st.

Advertising Department, Popular Mechanics, Chicago, Illinois

Gentlemen: In response for repeat on our "Classified Advertisement" that was run in February issue, beg to advise that this small advertisement "pulled" so everlastingly good it was not necessary for a "repeat." We secured exactly what we desired, and from one answer, which was not exactly in line with what we advertised for, strange to say, we saved in our Buying Department over seven times the cost of this advertisement. 'Nuf said! As soon as we feel the need of such an advertisement again, rest assured you will hear from us. Thanking you, we are,

Yours very truly,

THE E. H. COULTAS CO.,

(Signed) E. H. Coultas, President.

AUTOMOBILES

DRY Clean and Polish Your Automobile like new, with one fourth the work and time it takes to wash it—Just the same as you have seen at the Automobile Show—Costs only twenty cents the pint—Enough for two medium autos. Does not scratch. Dust does not stick to it. Every Garage and Automobile owner should have this formula. Only 25 cents this issue. Riffe, 44 West Mansfield, Ohio.

AUTOMOBILE Repairs—Automobile owners, Garages and Repairmen should subscribe for the Automobile Dealer and Repairer; 150-page illustrated monthly devoted exclusively to the care and repair of the car. The only magazine in the world devoted to the practical side of motoring. The "Trouble Department" contains five pages of numbered questions each month from car owners and repairmen which are answered by experts on gasoline engine repairs. \$1 per year; 15c per copy. Canadian subscription, \$1.50. Postals not answered. Charles D. Sherman, 30 Windsor Road, Hartford, Conn.

ATTENTION, automobile men, garage, repair and welding shops. \$490.00 crank cases saved for \$15.00. Other parts in proportion. So-Luminum, the new, great welding compound for aluminum, is a perfect substitute for acetylene welding in one-fourth time and cost. No flux, no tools; gasoline torch only thing required. Does work that acetylene welding could not perform, saving parts heretofore scrapped. No life taken out of the metals or parts out of alignment. Already used by U. S. Army and Navy, Vickers, Ltd., of England, Packard, International Motor, Pierce-Arrow, and many manufacturing and welding companies. Sample bar \$1.50, per lb. \$3.50. Write for Booklet 1 and endorsements. So-Luminum Mfg. Co., 1799 Broadway, New York.

PAINT Your Car Yourself—Save \$25 to \$75 by doing the work at home with the Arsenal system. Our big free booklet, "The Car Beautiful" tells how. Send for it today. Arsenal Varnish Co., Dept. P, Rock Island, Ill.

THE How and Why of the Automobile—A 200 page book of practical information for seekers after the fundamental facts regarding the gasoline engine and its application to the motor car. Interesting and instructive to both the beginner and the expert. Cloth, 250 Illustrations. Price, \$1 postpaid. Popular Mechanics Book Dept., 6 N. Michigan Ave., Chicago.

THE Modern Gasoline Automobile—Most complete and up to the minute automobile book published. Recognized as the standard book on construction, operation, maintenance and repair showing every recent improvement. Over 700 pages, 500 Illustrations. Cloth. Price \$2.50 postpaid. Popular Mechanics Book Dept., 6 N. Michigan Ave., Chicago.

JUST Out—Modern Starting, Lighting and Ignition Systems—A new book on automobile electricity without an equal. Nearly 400 Pages, 250 Engravings. Cloth. Price \$1.50 postpaid. Complete description sent on request. Popular Mechanics Book Dept., 6 N. Michigan Ave., Chicago.

INFORMATION booklet on House Painting; 12 cents coin or stamps. A. Parelli, 58-42nd, Corona, N. Y.

GET into the Automobile business, as salesman, chauffeur, garage manager, mechanic. Automobile instruction in four weeks' residence course. Send for booklet P. M., West Side Y. M. C. A. Auto School, 218 West 57th St., New York.

ASK for interesting free booklet describing our new automobile and motorcycle instruction books, charts, etc. American Chauffeur Publishing Co., 726 Butler Bldg., Cincinnati, O.

"STANLEY Steamer," ten H.P. Mechanically A No. 1. \$250. R. T. Schurgart, South Jacksonville, Fla.

STANLEY Steamer Coupe. Perfect condition. Kerosene burner. Water automatic. Electric lights. Dr. Patton, 2204 Michigan Ave., Chicago.

CYLINDERS reground, new pistons and rings fitted. Restores lost power. Prompt and efficient service given. Write for prices, giving make and model. The Everts Machine Company, No. 20 Hicks St., Hartford, Conn.

ACCURACY counts in cylinder grinding. Extra light pistons and perfect rings inserted, and we give service. Write for booklet. New Haven Machine Corp., New Haven, Conn.

AUTOMOBILE SUPPLIES

AUTO Repair Parts for Maxwells, Buicks, Chalmers, Thomas, Interstate, Overlands, Regals, Mitchells, Brush, Ford Models N, E, M, F, and Flanders. Gears, Bearings, Axles, Springs, Pistons, Cylinders, Connecting Rods for many others not mentioned. 40 to 50 Radiators and Engines on hand. Auto Parts Co., 4122 Olive St., St. Louis, Mo. No connection with any other Auto Parts companies.

BEAT the high cost of gasoline by using "Gldz," the Modern Auto Fuel. Carbon troubles vanish while you drive your car. Thus saving bills for repairman's time. "Gldz" gives 20 to 25% more power. Dr. B. G. Dyer, Ames, Iowa, writes: "Enclosed find one dollar for another can of 'Gldz'; have not heard a carbon knock since I began using, and am ramping on such a thin mixture I am almost ashamed to look carburetor in the face." 100 Tablets \$1, treats 100 gallons gasoline. Local dealers or remit. Fred M. Giddings, Manufacturer, Galesburg, Illinois. Agents wanted. No samples.

ALL makes engines, magnetos, cylinders, pistons, carburetors, wheels, bearings, etc., and all auto supplies at very lowest prices. Atlantic Supply Co., Long Branch, N. J.

CARBURETORS—New Stromberg 1 1/2 Models A-2 and B-4, \$5 each. City Auto Tire & Supply Co., East 24th St. and Chester Ave., Cleveland, Ohio.

INITIAL Autos. Transfer method. No experience. Perfect results. Sample a dime. Set a dollar. W. C. Smith, Dept. B, Mt. Vernon, N. Y.

EXPLOSION Whistles. Fits priming cup. Most powerful signal made. Rapid seller, owing to real value. Buell Manufacturing Co., 1804 Michigan Bldg., Chicago.

USED Parts. All Maxwells, Buick Ten, Chalmers, Thomas, Interstate, Oldsmobile, 4-6 Stevens, Mitchell, Hess, Bright, Timken and Hyatt Bearings. Kent Auto Co., Logan St., Denver, Colo.

WOOD'S Auto Polishing Cream. Cleans, gives dry, glossy finish. Neither gums, streaks nor gathers dust. Preserves enamel. Easily applied. Satisfaction guaranteed or money back. Agents and dealers wanted. Furnished through dealer or sent postpaid. \$1.00. Wood Auto Polishing Co., Dept. D, Galesburg, Ill.

FLANDERS 20 Eng., \$75; 6-cyl. Thomas, \$175; 50-Hp. Stoddard-Dartton Eng., \$150; 16-Hp. Herrmann Eng., new, \$85; Presto tank, \$9; Master vibrator, \$1.50. Auto Salvage Co., 1436 Wabash Ave., Chicago, Ill.

JURILEE Spark Intermitter. Newest automobile specialty. Banishes spark-plug troubles. Sells on sight. Whirlwind success. Fortune to agents. Write quick. Jurilee Mfg. Co., Dept. P, Omaha, Nebr.

VULCANIZER for shop. Bargain. Vandempool's, Springfield, Ohio.

AUTOMOBILE Owners Attention! Get my new headlight dimmers, kills the glare, but not the light, unbreakable, neatest and best dimmer on the market, send size of headlight glass and we will send you trial pair parcel post. Retail Price \$2.00. Agents wanted. Sanford Auto Specialty Co., 111 South Jefferson St., Chicago, Ill.

A WRITTEN guarantee for 5,000 miles without puncture. European Motorists are getting 10,000 miles out of their tires by increasing them about one-half inch in size. In eight months 20,000 American Motorists have followed their example. It's so easy that you can do it in your own garage in thirty minutes, no matter what condition your tires are in. Send for free catalog, sample and copy of guarantee. Colorado Tire & Leather Co., 543 Tread Bldg., Denver, Colo.

OUR Double Tread Tires are guaranteed for 5,000 miles. Absolutely puncture proof. Two tires in one. Big, Strong, extra heavy, 30x3 1/2, \$7.00; 34x4, \$9.25; 36x4 1/2, \$12.00; 37x5, \$13.00. Big saving on other sizes also. Discount to dealers. Send for list now! State size and type rim. Max Liben & Co., 205B West 48th St., New York.

AUTO Top Roof and Back Curtain Roadster. \$5.75; touring, \$7.95. Parcel post paid. Our instructions make it easy to apply. You save \$7. Samples and catalogue free. S. & H. Top Co., 430 Hunt, Cincinnati, Ohio.

FREE! Just from the press. Our money saver. Wholesale prices on tires, touring, roadster, racing, jitney and commercial bodies for Ford Chassis. Vulcanizer and vulcanizing plants. Radiator tops, accessories. Special Motorcycle Supply Bulletin. Save 30 to 50%. Write today. Sterling Tire and Supply Co., 14th and Michigan, Chicago.

VULCANIZER—Haywood, cost \$375.00. Bargain. Make your price. John Knapp, 1426 N. Ashland Ave., Chicago, Ill.

AUTO caps with goggles from rainproof leatherette, black or tan, 50c. Waterproof Novelty Co., 50 W. 22nd St., N. Y. C.

BATTERY charges earn big profits. City current or engine operates. Easy terms. Robert Brothers, Troy, Ohio.

BEST two, four, six cylinder motor valves for autos, tractors, launches, etc. State your power needs. Badger Motor Company, Milwaukee, Wis.

MODEL N, four cylinder Ford engine, \$30. Two cylinder Metz with Magneto, \$30. A. Sisson, Marshall, Ill.

AUXILIARY Air Valve will increase power of Auto or Marine Engine 25%. Why pay big price? Make one yourself in few minutes. Full details 50 cents. F. C. Barks, Sandusky, Ohio.

AUTOMOBILE Repairing Made Easy—The most needed and useful book on automobiles ever written. Only book of its kind—just out. Covers every phase of automobile repairing practice. 1,054 pages (5 1/2 x 8 in.), 1,000 Engravings. Cloth. Price \$3.00 postpaid. Popular Mechanics Book Dept., 6 N. Michigan Ave., Chicago.

PELLETS Magneto Company, 1083 Michigan Ave., Chicago, Ill. Agents for Eisemann Magneto Co., Atwater Kent Ignition, Conn. Tele. & Elec. Co., K. W. Ignition Co., Gray & Davis, Bijur Motor Lighting Co., Norma Ball Bearing Co., Henricks Mag. & Elec. Co.

MAGNETOS repaired, bought, sold, and exchanged, repairs for any Magneto, coil, lighting or starting system. Electric Service Company, Dallas, Texas.

MAKE Gas-Tonic. See Miller's Advertisement—Business Opportunities.

ACT quick! Automobile gasoline going up. Sell "Gaso-Tonic." Equals gasoline at 3c a gallon. Eliminates Carbon. Dollar an hour profit. Sales guaranteed. White Mfg. Co., Dept. M., Cincinnati, O.

AUTO Rims—All makes, all kinds in stock. New Ford wheels, 30x3", \$1 each. Other sizes and makes of wheels in stock. City Auto Tire & Supply Co., East 24th St. and Chester Ave., Cleveland, Ohio.

DOUBLE Service Tires. Guaranteed 3,500 miles. Size 30x3 \$5.00, 30x3 1/2 \$6.00, 33x4 \$8.00, 34x4 \$9.00, 35x4 \$9.50, 36x4 1/2 \$10.00, 36x5 \$11.00, 37x5 \$11.00. Non-skid \$1.50 extra. 10% required on C. O. D. orders. State of Q. D. straight bead or clincher type. Special discount to dealers. I. Jaffess, 1319 H. Fifth Ave., New York. Branch 282H, Halsey St., Newark, N. J.

RECTIFIERS for garages. All sizes. Charge one to eight batteries, \$12 upwards. American Battery Company, 1129 Fulton St., Chicago.

TO FORD OWNERS

RACEABOUT body easily built by yourself at home. We furnish complete set of copyrighted working specifications with simple instructions for converting your Ford into an up-to-the-minute speedster, including full-size paper patterns for hood and cow. \$3 prepaid. Kuempel Company, Automobile Engineers, 901 Iowa St., Dubuque, Iowa.

FORD Cylinders Rebores, \$15.75 for complete job, including new pistons, rings and pins. We pay freight our way. Our workmanship guaranteed. Hinchley Machine Works, Hinchley, Illinois.

SLEEP in your Ford in McMillin Auto Bed, \$7.50. Free booklet on auto camping. Auto Bed Company, Bellingham, Wash.

WANTED—Ford car owner in every county to demonstrate the all steel \$19 Ajax Ford Starter; \$30 to \$50 weekly. Write at once for 1916 territory to Ajax Ford Starter Co., Keene, N. H.

FORD ACCESSORIES

FOOT Accelerator for Fords, Safety, convenience, economy. Easily installed. Satisfaction guaranteed. \$2.50 delivered. Agents wanted in extreme West. Constant Brothers, Buhl, Idaho.

PERFECT Valve Grinding Set. The best tools for grinding Ford valves. Everything you need and instructions. Repairs use it. Only 60c from your dealer or direct postpaid. Winton L. Smith Machine Works, Newark, N. J.

COMMERCIAL, Speedster, Racing and Cloverleaf Pressure bodies for Fords, \$16 to \$125. Radiator Shell and Stream Line Hood \$15; make Ford look like \$1,000 car. Funny Old Doc Yack Radiator Ornament, \$1. Thomas Dunham, Aurora, Ill.

FORDOWNERS Magazine devoted exclusively to your car, \$1 per year, 10c per copy. H. L. Bond, Westminster, Vt.

45 A WEEK this spring and summer. Pleasant work at home or traveling. Sell the "Lil' Sho-Fur" safety-steerer for Fords. Attached in ten minutes. Simple, perfect. No cans or coiled springs. Details free. White Mfg. Co., Dept. C-1, Cincinnati, O.

FORD Owners, our Safety Ford Starter retails for \$15. By ordering 2 or more you get our new wholesale price, \$4.50. Write for particulars. Safety Ford Starter Corporation, Columbia Theater Bldg., Broadway and 47th St., New York.

"STEER Relief" for Fords. Best accessory, and Ford owners want it. Gives comfort, safety. Big money for agents. Sample \$5, prepaid, with ten-day return privilege. Post & Carr, New London, Ohio.

CYCLECARS AND MATERIAL

FOR Sale—Cyclecar parts. 10 h. p. "V" Motor, \$27.50; Wheels, \$9.00 per set; all other parts at very low prices. This is a well known successful Cyclecar. Send two cents for catalog. Tribune Engineering Co., Oswego, Tioga County, N. Y.

FOR Sale—Oswego Cycle Car, top, windshield, electric lights, \$125. H. S. Bryan, Elmira, N. Y.

MOTORCYCLES, BICYCLES & SUPPLIES

REAL Bargains in second-hand Motor cycles. We have an overstock on all makes, such as Indians, Harley-Davidsons, Excelsiors, Peeps, Reading-Standards, Merckels and four-cylinder Hendersons; all are in A-1 condition and fully equipped. If interested in buying a motorcycle, write for our complete list giving description and prices, which is about half their real value. \$225 new 1915 twin-cylinder Flanders motorcycles, \$138.50. Catalogs upon request. Gotham Sporting Goods Co., 57 Warren St., New York City.

BRAND new motorcycles, standard makes, on easy terms; descriptive circular free. Smith, 610 Centre St., Brockton, Mass.

BARGAINS in second-hand Motorcycles—Indians, Reading Standard, Harley-Davidson, etc. Send for price list. John G. Nuebling, Reading, Pa.

FOR Sale, 1911 Reading-Standard Twin, \$109. Ben Melzian, Vienna, So. Dak.

TWIN Indian, guaranteed perfect mechanical condition, good running order. \$159. Casper Rausch, Mapleton, Minn.

UNUSED Flexible Sidecar with rigid attachment fittings, \$45.00. Thomas Dunham, Aurora, Ill.

REBUILT motorcycles, all makes, like new, \$25.00 to \$200.00. Every machine guaranteed. New bicycles and motor supplies direct to you at factory prices. Write today for big free catalog and latest bargain price list. Western Supplies Co., 52 Larimer St., Denver, Colo.

SAVE one-half on repairs and accessories for all makes. Get circulars. Jones, "The Parts Man," Brockton, Mass.

WRITE for list of bargains on used Motorcycles. Little Falls Motorcycle Co., Little Falls, N. Y.

1911 H-D For Sale, excellent condition; price \$75. Write for particulars. T. W. North, Cambridge, Wis.

USED Motorcycles from \$25 to \$290. Money refunded if machine not satisfactory. Send postal for list. C. H. Lang, 1704 Michigan Ave., Chicago.

LARGE stock of rebuilt motorcycles, new parts for all makes 20% discount; second-hand parts, good as new, 50% discount. Motorcycle Parts Mfg. Co., 2127 Michigan Ave., Chicago.

EASY terms on rebuilt motorcycles—get new list P-4, \$25 up. Rebuilt Motorcycle Co., Brockton, Mass.

MOTORCYCLES. Emblem six horsepower, new—\$150; Henderson four-cylinder equipped \$95; Yale Demonstrator 1915 twin \$160; Indian twin, \$25; Excelsior single \$35; Spark plugs 25c; Heliger Carburetors, new, \$3.50; Motorcycle folding foot rests \$2.50; 28x3 Casings \$5.50; tubes \$1.50; lamp brackets 35c; pedals 60c; rubbers 10c each; grips 25c. Write for bargain bulletin with cuts. Largest motorcycle dealer in United States. Will exchange any goods not satisfactory or money refunded. Waundersee Co., 129 Gratiot Ave., Branch—2996 Woodward Ave., Detroit, Mich.

MAKE Your Bike a Motorcycle with the Kopp Light Weight Magneto Model Motor Attachment—fits any bicycle—powerful motor—good hill climber. Catalog free. Kopp Motor Works, Dept. 5, Akron, O.

FOR Sale—Shaw Motor-Bike Like New, used 500 miles only, \$30. H. C. Co., Box 31, Hidalgo, Texas.

FOR Sale—Miami Motorcycle \$50; guaranteed, Merkel Dealer, Rembrandt, Iowa.

SEND for list of guaranteed used motorcycles. \$40 up. Driscoll & Jeanroy, 209 West 120th St., New York City.

MOTORCYCLES \$35 to \$175, all makes and models, 150 to pick from. Write to-day; save money by buying now. Largest motorcycle store in the world. Lister Motorcycle Co., Cleveland, Ohio.

WANTED: We pay cash for used motorcycles or take them in on exchange for new machines. Write with complete description. State condition of tires, frame, motor, make and model. Shaw Manufacturing Co., Dept. 157, Galesburg, Kans.

BARGAIN—\$285 Harley. Practically new. For \$185. Schweiger, Flora, Ind.

TWIN Excelsior; almost like new, \$110. Geo. Laatsch, Altamont, Ill.

BARGAIN: Indian Twin, guaranteed satisfactory. \$100. Edward Sjoboen, Mora, Minn.

FOR Sale—1913 Harley-Davidson, single, chain drive, Schieber carburetor, Bosch Magneto, Carrier, 6 horse, good tire, best condition, \$72. O. Glass, Martinsburg, Iowa.

MOTORCYCLES, nearly all makes. Cash or easy terms. Write for list. Frank P. Gravatt, Atlantic City, N. J.

1910 INDIAN twin, running condition, \$35. Horace Nichols, Freeport, Maine.

FOUR Cylinder Pierce, fine shape, \$140. H. Allen, Box 363, Winona, Minn.

1914 HARLEY two-speed, good condition, tires nearly new, with Rogers sidecar, \$225. 4 H. P. Wagner \$50. 1912 Indian single, Magneto \$100. S. R. Milbrandt, Alma Center, Wis.

SIDE CAR Snap—Brand new 1916 Indian \$30.00. Box 792, Crystal Falls, Mich.

1913 HARLEY-DAVIDSON Twin in best condition \$90. Geo. Ellguth, 3029 E. 92nd St., Chicago.

BOYS—Here's a chance to earn a motorcycle. Nothing to sell. Full particulars for stamped envelope. Max. A. Mertz, Neenah, Wis.

FOR Sale: Henderson, equipped. Best cash offer. Wm. Nolte, 511 Franklin, Elgin, Ill.

BEST Offer takes 1913 Yale, A-1 condition. Tandem, Prest-o-lite and whistle. Earle Gray, Guthrie, Okla.

\$175 TAKES 1913 Indian 2-cylinder motorcycle, 1916 sidecar and presto equipment. Robert Parkinson, 25 Waldo St., Pawtucket, R. I.

TWO Speed Flanders; sacrifice for fifty dollars. Frank P. Gravatt, Atlantic City, N. J.

DON'T buy a Bicycle Motor Attachment until you get our catalogue and prices. Shaw Mfg. Co., Dept. 27, Galesburg, Kansas.

SUPPLIES—The largest catalogue with prices lower than usual sent free to motorcycle owners. Meco, Hammondport, N. Y.

SEND for latest Bulletin of real Motorcycle Bargains, used and slightly used, all makes, models and prices; if you have \$25 and really want a powerful Motorcycle, send for this Bulletin; hundreds of machines at all prices, new ones on easy payments; tell us what you want and how much you can pay; we can fix you up. Peerless Motorcycle Co., Dorchester, Mass.

BARGAINS in used motorcycles. Write for our revised list of used motorcycles of all makes and models, including the Harley-Davidson, Reading-Standard, Merkel, Thor, Indian, Yale, Shickel, Pope and De Luxe. Our machines are overhauled in every instance and placed in a condition far better than ordinary. The seasons shipments extend from coast to coast, from Florida to Canada to Alaska. All prices have been reduced to a minimum in preparation for the present 1916 spring season. Literature furnished on request. The Place of Satisfaction, Mueller Cycle and Supply Co., Oldest and largest dealers in the northwest, 726 National Ave., Milwaukee, Wis.

BIG bargains in second-hand motorcycles, \$25 up. Indians, Harleys, Thors, Excelsiors and Merckels. Write for description. Howard A. French & Co., Baltimore, Md.

CLOSING out stock of second-hand motorcycles at half their value. Sold on easy payments; send for big list. Howard Cycle Co., 153 N. Broad St., Trenton, N. J.

MOTORCYCLE cylinders reground, fitted with new piston and rings \$5.00, guaranteed. Muncie Piston Co., Muncie, Ind.

NEW Motorcycle Book—Just Published—Motorcycles, Side Cars and Cyclecars, Their Construction, Management and Repair—250 pages, cloth, 350 illustrations. The Dealer, Mechanic and Rider will find this treatise a work of reference without an equal. Price \$1.50 postpaid. Popular Mechanics Book Dept., 6 N. Michigan Ave., Chicago.

BIG bargains in good motorcycles we have taken in exchange on new ones. Send for special bargain list. Shaw Mfg. Co., Galesburg, Kansas.

WANT to sell your motorcycle? I have a method which has sold many. Write me today for free information. F. W. Johnson, Room 900, 73 E. Madison St., Chicago.

WELDING

BRAZING torches forty cents; welding torches ten dollars. Auto Welding Co., Omaha, Neb.

WELDING instructions, illustrated practical book post paid, one dollar. C. H. Graham, Omaha, Neb.

WELDING Plants, \$25 to \$250. Liberal terms. Write Bernco Co., Omaha, Neb., U. S. A.

ATTENTION, automobile manufacturers, garage men, repair and welding shops. Amateurs made expert welders, welding made easy for experts. 80-Luminum, the new, great welding compound for aluminum, runs low temperature. No flux or tools required. Gasoline torch only thing necessary. $\frac{1}{2}$ time and cost of acetylene welding. No parts taken out of alignment, no life taken out of metals. Extensively used by U. S. Army and Navy. Automobile, aeroplane and welding companies. \$1.50 sample bar. \$3.50 per lb. 80-Luminum Mfg. Co., 1790 Broadway, New York.

WELDERS—Do your pre-heating with gasoline, kerosene, or d. sulfate heaters. 3 to 40 per hour. Cheap, efficient. Particulars. P. D. Taylor, 491 N. Va. St., Roswell, N. M.

OLY-ACETYLENE Welding and Cutting, Electric and Thermit Welding. Brand new book of practical instruction in this process. The workman will find all necessary information for handling any kind of welding. 215 pages, fully illus. Cloth, \$1.99; Leather, \$1.50 postpaid. Popular Mechanics Book Dept., 6 N. Michigan Ave., Chicago.

SIMPLE Soldering, both hard and soft—82-page book telling how to join metals. Do your own repairing. 52 illustrations. 25c postpaid. Popular Mechanics Book Dept., 6 N. Michigan Ave., Chicago.

AERONAUTICS

NO high war prices. One standard low price to all made possible only by the health efficiency and manufacturing principle produced by long experience, careful buying in quantities and wonderful efficiency. Save time by being supplied from America's oldest and largest manufacturer. Most complete stock in the world get our catalogues; they tell. Aeronautical supply, 6, Motor 4, and propeller 3 red stars. Heath Aerial Vehicle Co., Chicago.

WE are prepared to teach aeroplane construction by correspondence. Our course recommended by aeronautical engineers. Write for free blue print and particulars. The Aerial Supply Co., 2120 North Clark St., Chicago, Ill.

1917 CATALOGUE and Blueprints of Compressed Airmotor for 15c. Cheapest Supplies, Arrow Model Works, 407 E. 137th St., New York.

MONOPLANE 5 cyl. Anzani motor. Demonstration \$750. Anzani 3 cyl. 30 hp. motor \$175. They are all good values. J. Curran, 217 W. 83 St., N. Y. C.

GET our 1916 Aeroplane Book containing full information about "Ideal" Model Aeroplanes, parts, plans, etc. 5c postpaid. Ideal Aeroplane Co., 82½ West Broadway, N. Y.

LEARN to fly now while the Aviation business is good. Pupils trained especially for the exhibition business. Our first class opens May 1st. Northern Aircraft Co., Center Ave., Bay City, Mich.

BEST and lowest priced Aeroplanes, motors, propellers. Complete catalog. Bates Aeroplane Co., 104 Oak, Chicago.

EVERYTHING Aeronautical. Tractors—Flying boats—Accessories—Drawings. Chicago Aero Works, Chicago.

WANTED—Aeroplane motor about 60 H. P. Address L. B., 453, Albert City, Ia.

BLUEPRINTS 7 horsepower baby monoplane \$10 described March Popular Mechanics, page 353. Complete machines for delivery. George D. White, Los Angeles.

PATENTS Secured through Credit System. Send Sketch. Free Search and Certificate of Patentability. Book and List of Patent Buyers Free. Waters & Co., 4280 Warder Bldg., Washington, D. C.

FOR Sale—Bleriot Monoplane—Curtiss Biplane—Bargains. W. Banning, Lorain, Ohio.

FOR Sale: Two 7-cylinder, rotary aeroplane motors, 45 and 75 H. P. 1406 S. 18th St., St. Louis, Mo.

GET into the Aviation Game now and get into it right. We can and will help you. Benoit School of Aviation, 1291 Webster Bldg., Chicago.

TURNBUCKLES; all sizes, immediate delivery. National Aeroplane Co., Machinery Hall, Chicago, Ill.

THE Benoit School of Aviation announces a new Correspondence Course. Thorough training in Aeronautical Construction and Engineering. For particulars write Benoit School of Aviation, 1291 Webster Building, Chicago.

AVIATION Motors, all makes, up to 150 H.P., \$250 up. Complete aeroplanes, all types, \$500 up. State your needs. Aero Exchange, 33 Park Row, N. Y. C.

LIGHT Weight Gasoline Engines, 2½ lbs. Guaranteed ½ H. P. The Weiss Co., Torrington, Conn.

BUILDING and Flying an Aeroplane—160-page handbook covering the building of small models and full sized gliders and machines. In both biplane and monoplane models the well-known Curtiss and Bleriot types are followed. Fully illustrated with detail drawings. Price, \$1 postpaid. Popular Mechanics Book Dept., 6 N. Michigan Ave., Chicago.

HOW to Make a Biplane Glider—Our book "Amateur Mechanics No. 2" contains a complete detailed description of how to make one. Price of book 25c postpaid. Popular Mechanics Book Dept., 6 N. Michigan Ave., Chicago.

BOOKS AND PERIODICALS

ONE man read book "That Something" and climbed twice to higher salary. 60c postpaid. Satisfaction guaranteed. Dumbard, 1615 Rowena Street, Boston.

ALL kinds correspondence courses exchanged. W. F. Yockey, 2034 Lincoln, Topeka, Kan.

BOOKS, Bargains, Catalog, Higson's, A-2441 Post, San Francisco. (Books bought.)

SEND for Popular Mechanics' complete list of latest and best mechanical books. It's free for the asking. Address Popular Mechanics Book Dept., 6 N. Michigan Ave., Chicago.

WAR in the trenches. "Stories and Letters from the Trenches" read by thousands. Big book, illustrated, only 25c postpaid. Big catalogue free. George W. Baumbach, 95-F St. Marks Place, New York.

MAGAZINES at lowest club prices. Our free clubbing catalogue will show you how to reduce your magazine bill. Send for it today. S. C. Hanson Magazine Agency, 4225 Kinzie St., Chicago.

BOAT Book containing 24 pages interior and exterior views country's largest and fastest motorboats, 25 cents postpaid. Van Berrick Motor Company, Monroe, Mich.

CARTLOAD of Fun, Ten live books in one; 12c postpaid. Morrissett, 2513 S. 2nd, Philadelphia, Pa.

BOOKS, wholesome, instructive and entertaining. Puzzles, Tricks, Novelties. Illustrated catalogues, fine sample trick all for 10c. Autumn Supply Co., Dept. 5B, 7817 Peoria St. Chicago.

ENGINEERS' questions and answers for license, by Hobson, for twenty-five cents postpaid. Send stamps. Beilly's Book Store, Philadelphia, Pa.

SHOE Repairing Self Taught. It's easy, interesting, profitable. Price, fifty cents. W. J. Shuman, North Second Street, Chambersburg, Pa. Write for contents.

PERSONS interested in Drafting or Engineering—send stamp for sample copy of "The Compass," devoted to topics of interest to the Drafting and Engineering Professions. Office 304, McLachlen Building, Washington, D. C.

MECHANICAL Instruction Books, Best published. Lamont Co., Beacon, N. Y.

BINDER for Popular Mechanics magazines. Best adjustable magazine binder on the market made especially to hold any number from one to six copies of this magazine with name "Popular Mechanics" in gold letters on front cover. No laces or cutting or perforating of pages necessary. Simple, unique adjustment; handsome, durable and neat. We buy in quantities and can offer our readers this regular \$1.50 binder for \$1.25, all shipping charges prepaid. Address Popular Mechanics Book Dept., 6 N. Michigan Avenue, Chicago.

EDUCATIONAL AND INSTRUCTION

FREE Slide Rule. Introducing my book, "The Slide Rule Simplified," price \$1. You get Free Richardson's direct Reading Slide Rule (Metal bound), one hundred illustrations, explanation "Written so you can understand it," 64 pages 7x9. Only rule that adds, subtracts, multiplies, divides. Send postal for booklet describing many other types. Our many patents cover all forms of metal slide rules. Beware of infringements; prosecution will sure follow. Geo. W. Richardson, 4219 W. 24th Place, Chicago.

LEARN profession that will give you a business of your own; possibilities unlimited; no job hunting after graduation; when you finish study, business is all ready. We teach you free while paying for first outfit. Naddeo, 4397 Lincoln Ave., Chicago.

MECHANICAL drawing, 50 cents each lesson; pay as you go; \$20.00 drawing outfit free; genuine blueprint lessons; drawing paper and different data sheet free with each lesson; no contract to sign; will assist you to secure position; diploma issued graduates; we invite comparison and furnish references. Remit for first lesson or ask for particulars and samples. Albany Institute Mechanical Drawing, Desk 15, Box 84, Albany, N. Y.

BOOKKEEPING or Shorthand, 25c; Instructive Books, Mechanics, Electricity, Chemistry, etc., cheap. Will A. Marr, Nashville, Tenn.

WONDERFUL Mathematical Marvel; Adding made easy by Halsey's Adding Chart. Price \$1 each. J. G. Halsey, 6248 Drexel Ave., Chicago.

BOOKKEEPING, Expert Auditing, Rapid Arithmetic, 50c. Garfield Commercial School, 1616 Germantown Ave., Philadelphia.

MOULDS and models for ornamental casting of novelties, statuary, garden furniture, in cement, plaster, Italian marble, etc. Free illustrated catalogue displaying large assortment. Roth, A-45 Frost St., Brooklyn, N. Y.

THE Shortest Shorthand—Learn by correspondence. Write today. G. Thomas Churchhill, Chicago Heights, Ill.

BUILD your own home—Hundred Plans, \$1. Catalogue Free. "Drift" 69 Washington, Chicago.

ELEVATORS—Questions and Answers. Book Fifty Cents, Circular Free. Wm. Schmidt, 23 Beach St., Jersey City, N. J.

BECOME an Architect; Earn \$200 to \$300 monthly; I teach you how; particulars free. Andrew Brems, Architect, Corona, N. Y.

SLIDELESS Slide Rule, will do anything that most expensive slide rule will do. Price 50 cents. Leishman Arcoscope & Supply Co., Ogden, Utah.

POOR handwriting easily changed to good. Particulars free. D. B. Jones, Paducah, Ky., Route 3.

LEARN Drafting—one of the most practical subjects and indispensable in many occupations. Individual study at home without an instructor may be successfully carried on with the aid of our book "A Practical Course in Mechanical Drawing," 160 pages, 157 drawings; cloth, Price 50 cents postpaid. Popular Mechanics Book Dept., 6 N. Michigan Ave., Chicago.

EDWARD BOK made good. Stenography started him. We save you three-fourths on standard shorthand course and give a Remington typewriter free. Stenographic Institute, Box 6171, Leadville, Colo.

GOOD Opportunities for Veterinarians. Send for catalogue. Grand Rapids Veterinary College, Dept. Z, Grand Rapids, Mich.

CIRCULAR Scale for Calculating Fractions; quick, accurate; patent pending. Send now. Advertising price only 25c; regular, 50c. Agents wanted. Snyder Calculator, Meadville, Pa.

PREPARE for Optical Examination. 1,000 questions and answers, given by State Boards. Optical Quiz Course, 5930 Madison St., Chicago.

MECHANICAL Drafting and Machine Design taught by expert. Instruments furnished. Small cost, easy payments. Particulars free. Hayner, 3742 Elmwood, Chicago.

LEARN Mechanical Drafting. Cost small. Returns large. Individual instruction by expert. Garfield Drafting School, 523 West 134th St., New York City.

WAR Atlas—Large 20-page (11x15 in.) Atlas of the War in Europe, containing large colored scale maps of the battleground, showing Europe, Austria, Serbia, Germany, England, Belgium, France, Russia, Italy, Greece, the World, etc. Special data showing comparison of armies and navies involved, pictures of rulers, etc. Price 30 cents postpaid. Popular Mechanics Book Dept., 6 N. Michigan Ave., Chicago.

ARTIFICIAL Marble Sanitary flooring, ornamental casting, concrete, plaster, papier-mache, interior decorations, garden furniture, statuary, life casting, elastic moulds, electro bronze depositing (immensely profitable work), complete instructions \$1; particulars, 250 illustrations free. Mahler, D-117 Russell St., Brooklyn, N. Y.

BRIEFHAND, the modern substitute for stenography, uses longhand letters. Easily learned. Complete course \$1.00. Sample lesson free. Premier Briefhand School, Dept. 4, Washington, D. C.

MECHANICAL Identity. Send \$1.00 for complete instructions. A. VanWagoner, Osmon Building, Ridgewood, N. J.

TRADE SCHOOLS

ELECTRICITY, Plumbing, Bricklaying, Mechanical, Architectural and other Drafting Courses. Motion Picture Operating taught by practical work. Largest, best equipped practical trades school in America. Short time to learn. Small cost, easy payments. Write for big illustrated book; it's free. Coyne National Trade Schools, Dept. 8195, Chicago, Ill.

AUTOMOBILE Course, \$8. We give you a complete home study course on the care and management of automobiles. Get booklet. Bedford Correspondence School, 1921 Bedford Ave., Brooklyn, N. Y.

GAS Engineering offers splendid openings owing to great increase in use of Gas Engines. Competent instructors, extensive up-to-date equipment, including latest Diesel Engine at this school. Moderate fees. Catalogue from Seattle Engineering School, Inc., Seattle, Wash.

ENGRAVING Taught—Work for Jewelers, watchmakers, public, Artistic, profitable. Men or women. Attendance course only. Limited class. Under National expert. Rapid progress assured. Brochure free. Newmeyer Engraving School, Cleveland, Ohio.

TELEGRAPHY

TELEGRAPHY—Morse and Wireless—also Station Agency taught. R. H. and Western Union wires and complete Marconi Wireless Station in school. Graduates assisted. Marconi Co. employs our wireless graduates. Low living expense—easily earned. Largest school—established 40 years. Investment \$25,000. Correspondence courses also. Catalogue free. Dodge's Institute, 15th St., Valparaiso, Ind.

TELEGRAPHY—Morse and Wireless—taught at home in half usual time. The Omnigraph Automatic Transmitter combined with sounder or buzzer sends you messages, any speed, just as expert operator would. Used by U. S. Gov't to examine all applicants for licenses. Trifling cost. Catalogue free. Omnigraph Mfg. Co., 41-G Cortlandt St., New York.

TELEGRAPHY for Beginners—Best textbook for students of telegraphy. The standard method. 63 pages, 19 illustrations, 25c postpaid. Popular Mechanics Book Dept., 6 N. Michigan Ave., Chicago.

WIRELESS

FELLOW amateurs, get my copyrighted blue-print chart of "Standard Electrical and Wireless Diagram Symbols." Ready to frame. Your station is incomplete without it. Particulars for red stamp. Latitine, No. R78 Dexter St., Medford, Mass.

WIRELESS Station Photographs, Arlington, Tuckerton, Sayville, 10c. Going fast; get yours now. Dunkle & Balou, 2 Truesdel St., Binghamton, N. Y.

FOR Sale—Wireless outfit, Cheap. Write James Black, 1851 So. Ashland Ave., Chicago.

PICTURES, POSTCARDS, PENNANTS

REAL Red Craze. Novel and original—first and only pictures produced showing famous movie stars in action as they appear on screen. Snappy photos reproduced from new films, size 3"x4" to 3"x10". For prompt action send 25c or write for further information. Filmetto Reproduction Company, 2924 Central Ave., Los Angeles, Cal.

If you really want to exchange postcards, try our splendid club. Lists circulate in many countries. Membership, 10c. Balcon Club, Box 133, Erie, Pa.

NEW YORK, the Wonder City, 22 best views, 15c. coin. Leaby, 2064 Mapes Ave., N. Y. City.

EXCHANGE Post Cards. Join our club. Membership 10c. Pioneer Exchange Club, R. No. 2, Elgin, Ill.

HANDPAINTED water color picture, 3 1/2"x5 1/2", 25c. Exquisitely dainty. Invaluable support. Mack, Collins, Mich.

POSTCARDS from everywhere. Join our Jolly Club. Send 10c. H. J. Teeple, Decatur, Indiana.

POST Cards from everywhere. Join biggest Exchange in existence. Hundreds of members. Join now. Membership 15c. Popular Exchange, Box 125, Emporia, Va.

RECEIVE pretty view cards from many countries. Membership and 6 pretty cards 10c. Riverside Club, Knoxville, Md.

200 ILLUSTRATIONS Free. Beautiful art casts. Mahler, K-117 Russell St., Brooklyn, N. Y.

EXCHANGE pretty postcards with our members far and near. Best card club. Membership, 10c. Jolly Card Exchange, Eighth St., Decatur, Indiana.

MAKE new acquaintances. Join our postcard club. membership 10c. World's Postcard Club, 13 West 42nd, New York.

CAMERAS AND PHOTO SUPPLIES

SNOW White Marking Fluid. "Made in U. S. A." 1/2-oz. Paste Form. Flows perfectly from pens, brushes and air brushes. Will not rub off or powder off when dry. Has received editorial endorsement six Photo Magazines. At dealers, or send 25c in stamps and receive jar prepaid by return mail. J. P. Johnson, P. O. Box 578, Rochester, N. Y.

If you have a high-grade Camera, Lens, Kodak or Motion-Picture Camera, and want to turn it into cash, write us today. State particulars, price, etc. We buy and trade, sell or exchange everything in Cameras from Vest Pocket to Graflex. Prompt, satisfactory service and a square deal to all. David Stern Co., 1947M W. Madison St., Chicago, Ill. In business since 1885.

PHOTOGRAPHIC Chemicals sky high. My price 8x10 enlargements unchanged, 35 cents. Send negative and quarter for sample 8x10. S. R. Kitchin, Moosup, Conn.

WAR Metal unobtainable. Hydrolicon sky high. Developer containing neither. Works on all developing papers. Results equal to metal. Guaranteed formula \$1. Courtright & Sanborn, Bakersfield, Cal.

ROLLS developed and 6 prints, 25c. Prints 25c dozen. F. Kithaus, Box 606, New Rochelle, N. Y.

QUALITY Kodak Finishing. Developing and Printing. A postcard will bring information. Michael Kamb, 65 Harris St., Rochester, N. Y.

ENLARGE your own negatives with your own camera and a Parallax Condenser. Free enlarging booklet tells how. R. D. Gray, Ridgewood, N. J.

FILMS Developed, 10 cents; Prints, 3 to 5 cents. Write for valuable information, and how to get a Free Enlargement. The Salisbury Studio, Cherokee, Iowa.

FILMS developed 10c, all sizes, Prints 2 1/2-3 1/2, 3c; 2 1/2-4 1/2, 3 1/2-3 1/2, 3 1/2-4 1/2, 4c; Post Cards, 50c doz. Work guaranteed and returned 24 hours after receiving. Postpaid. Send negatives for samples. Girard's Commercial Photo Shop, Holyoke, Mass.

FILMS developed, 10c; prints, 3c to 5c. A reputable incorporated company conducting largest existing plant. Price list and special offer. Enlargements our specialty. Chicago Photo Finishing Co., 54 W. Lake St., Dept. A, Chicago.

"FOLLOW the Bargains," get Erker's 1916 Camera and Lens Bargain Price List, all sizes used Kodaks, Promos, Graflexes, Motion Picture Cameras; every one guaranteed perfect. Erker's, 609 Olive, St. Louis, Mo.

DON'T pass this bargain. Brand new postcard size Ingento roll film camera. Retail price, \$26.90. My price, \$12.50. Fine lens, fine shutter. Wonderful value. Makes excellent pictures. Send C. O. D. subject inspection. W. Cab, 5138 N. Claremont Ave., Chicago.

VITOL replaced by Vitel; trial ounce, 25c; other scarce chemicals supplied. Vitel Chemical Company, 118 East 29th St., New York.

Do You Take Pictures? Write for free sample of our 112-page magazine, showing how to make better pictures and earn money. American Photography, 765 Pope Bldg., Boston, Mass.

SECONDHAND Cameras sold and exchanged. Bargains. G. Olive, Willmar, Minn.

KODAK Films Developed, 10c per roll, any size. Prompt attention given mail orders. Prints, 2 1/2"x3 1/2" to 3 1/2"x4 1/2", 3c, 4x5 to 3 1/2"x5 1/2", 4c. J. M. Manning, Box B, 102 Third Ave., New York City.

CUT Rate Bargain List for January just out. Send stamp. Willoughby, 810 Broadway, New York City.

KODAK Films Developed, 10c roll. Prints 2 1/2"x3 1/2", 3c; 3 1/2"x4 1/2", 4c. Best quality work. Quick Service. Oelze, Hazard, Ky.

ROLL Film developed, 10c a roll. Packs 20c each; Prints, Brownies, 2c; 1a, 3x4, 3x5, and Post Cards, 3c each. Work returned next day. Postage paid. Kodak Film Finishing Co., 112 Merchants Station, St. Louis.

FILMS developed 5c. Postcard prints, 4c; smaller sizes, 3c. Dept. C, Hall Photo Finishing Co., Chapman, Kansas.

DON'T Cry Over Spilled Milk. Send your next batch of films to us. We'll develop and print them in an expert manner and charge you no more, maybe less, than you've been paying. Why not ask us for samples and prices? Barbeau's, 37 East Bridge St., Oswego, N. Y.

BIG Money Saved on Photographic Lenses and Apparatus—goods exchanged; repairing done. Ralph J. Golsen, 5123 Kenmore Ave., Chicago, Department P.

FILMS developed 10c, prints 3c, all sizes; work guaranteed and returned in 24 hours. L. Hell, 1052 3rd Ave., New York City.

BECOME a Minute Photographer. Pleasant outdoor work. Experience unnecessary. Best business of the age. Hundreds of men and women make \$10.00 to \$35.00 per day. Sample picture and catalog free. Jamestown Phototype Company, Dept. P, 1126 South Halsted St., Chicago.

THE "Harvey Exposure Meter" is different from all other Meters. Gives exposures for Exteriors, Interiors, Night Photography, Paget and Autochrom Color Plates. Ask your dealer or write to Harvey, 105 S. Dearborn St., Chicago.

ANY film developed, 5c. Prints, 3 1/2"x5 1/2" and smaller, 3c. 24-hour service. National Photo Finishing Co., Dept. 10, Omaha, Nebr.

MOTION PICTURES

1916 THE "Movie" Year. Get in on the Big Money. Do not experiment with cheap new Motion-Picture Cameras. We can sell you the finest makes of cameras and tripods at a saving of 35 to 60%. Guaranteed equal to new. Write us today. David Stern Co., 1947M W. Madison St., Chicago, Ill. In business since 1885.

WRITE Photoplays, Short Stories, Poems. Big demand. No correspondence course. Start writing and selling at once. Details free. Atlas Publishing Co., 504, Cincinnati.

BE a Motion Picture Operator and earn big money for short hours, easy, pleasant work. We teach by practical work on the finest equipment. Write for free catalog. Coyne Trade Schools, Dept. 7195, Chicago, Ill.

BIG Money Writing Moving-Picture Plays. Constant demand. Correspondence course; literary ability unnecessary. Write for free booklet, "How to Write Moving-Picture Plays." Universal Publishing Co., 297 Fergus Falls, Minnesota.

MOTION Picture Film, \$3.00 reel, Dalton Divine, Utica, N. Y.

MOTION Picture Machine Outfit, Power's No. 6. Complete with stereopticon, double asbestos booth. Power's compensator only slightly used. Pastor, 92 N. Monroe Ave., Columbus, Ohio.

MOVING Pictures, 100-foot scenes \$1.00, Davis Film Service, Wilkes-Barre, Pa.

MOTION Picture Operation, Stage Electric and Illusions.—The only practical handbook and guide published for motion picture operators, theater electricians and managers. A thoroughly practical and useful book covering the subject comprehensively. Pocket size, leather, 393 pages, fully illustrated. Price, \$2.00 postpaid. Popular Mechanics Book Dept., 6 N. Michigan Ave., Chicago.

WRITE Photoplays! Big opportunity for beginners. We show you how. Particulars free. Lynch Specialty Co., Joplin, Mo.

WRITE Photoplays—Earn a big income. Our book tells how. Details free. Enterprize Co., PM-3148 Lowe Ave., Chicago.

\$35 PROFIT Nightly—Moving Picture Business—small capital starts you, no experience needed. Teach you—furnish everything. Ralph J. Golsen, 5123 Kenmore Ave., Chicago, Dept. M.

MOVING picture equipment and cameras. Films \$3 reel up. Box 417, Montpelier, Vermont.

MAKE big money writing moving picture plays. Previous experience, literary talent or correspondence course unnecessary. Free details and special offer. E-Z Scenario Co., 609 West 127th St., New York.

BIG money writing Photo-plays; details free to beginners. No correspondence course. Producers League, 239 Wainwright, St. Louis.

MAKE \$50.00 clear nightly. We start you in the moving-picture business on the installment plan. No experience necessary. Write for free catalog. Monarch Film Service, Dept. P, Memphis, Tenn.

EDISON moving picture machine. "Underwriters model 'B,'" complete with Edison Transformer. For Sale. G. N. Reiff, 165 S. 4th St., Reading, Pa.

BUSINESS OPPORTUNITIES

HERE'S your real big business opportunity—your chance to establish yourself in a clean honorable business for life that will make you more money, dollar for dollar invested than any thing else you can get into now-a-days—a business you will like and enjoy every minute you are in it, because it is a clean, honorable business for life, grinding out the golden dollars for you every day in the year. It is milling Flour right in your own locality with the money-making mill wonder of the age, the "Midget" Marvel Self-Contained Flour Mill that is revolutionizing the flour milling business and making such good money for so many others this country over just as it will make it for you. One man in Kentucky writes of a net profit of \$4628.26 in 7 months; one in Kansas, \$5,000 last year, another in South Carolina says he is making \$30.00 a day. You can do as well or better without any previous milling experience with this tested-out-money-making machine. It will make you good steady money from the very day you start its wheels to rolling, because it is a great big roller flour mill system all condensed into one machine, requiring so little power, capital or attention to run. Runs by any kind of power, turns waste power of factories and other plants into big profits. Some wide-awake red-blooded man in your section will sooner or later put in a "Midget" Marvel and make the big profits you yourself can make and should be making right now. People must have flour. There's a market at your very door for every barrel you can make and we will help you get that market with our confidential free sales help. It is your golden opportunity—you who want to increase your income and get independent—quick—rise up and grasp it! Be the first in your place to write for our free illustrated book, "The Story of a Wonderful Flour Mill" 30 day free trial offer, prices, terms, letters from hundreds of owners telling what the "Midget" Marvel is making for them and will make for you. Better write today. Anglo-American Mill Co., Inc., 18 to 22 Trust Bldg., Owensboro, Ky.

STOP Here.—Do your present earnings satisfy you? Would you like to better your position—by getting into the automobile business, the third largest industry in the world? Do you realize how many different branches of business this industry represents? If you care to know how to step into any one or a combination of these with little or no capital, write for classified information. Auto Industrial Co., 882 W. Delavan Ave., Buffalo, N. Y.

1,000 FORMULAS 9c. 75 Manufacturing secrets, 19c. Resilvering Mirrors, Renewing Dry Batteries, 25c each. Guaranteed. All 50c. "Ideal," 3311-E Belleplaine Ave., Chicago.

DENTISTRY is Expensive. Like to go? Using tooth-brushes, pastes, powders, picks or medicines alone will not preserve teeth. My invention absolutely prevents decay between teeth. Instrument works wonderful. Lower jaw performs service. Always ready. Lasts forever. Pleasant use. Carried in purse. Everybody needs, wants and buys one. All dentists admire it. You like it at sight. Genuine sample, literature, agents' terms, 50c postpaid. Dr. W. Mark Muchow, Evanston, Ill.

We Are Looking for You! If you are ambitious and willing to work hard in a business of your own, write us at once for free booklet, "Get Out of the Rut!" Make the start now, today! Write Thos. Hill, Mgr., 210 Guardian Trust Bldg., Denver, Colo.

LET the parcels post help you. Add (\$15 to \$25 weekly) to your present salary or income. Start during spare time and build up a permanent mail-order business of your own. We show you how and help you make good. No canvassing. Experience unnecessary. The Parcels Post makes success doubly sure. Our new ideas and up-to-date plans bring the money. No so-called "Course of Instruction" to sell. We give that free. Write today. Address Pease Mfg. Co., Inc., Dept. A, 79 Broadway, Buffalo, N. Y.

IF you work in a shop find out if the company has any lathes, turret lathes, screw machines or milling machines for sale and write me full particulars and price asked. I will pay you \$5 for each machine I buy. Planner, 122 Water St., New York, N. Y.

STOP Here! Let me start you in a home business that will bring you money every day. Experience unnecessary. Spare time. No canvassing. I furnish everything. Send for proofs. Vochies, Desk C. R., Omaha, Neb.

HOW to Operate a Mail Order Business. 30 Big Profit Plans and year's Mailing service sent for 10c. Mail Dealers' Wholesale House, 521 Franklin Bldg., Chicago.

EARN \$30 weekly at home, silvering French mirrors; no capital. Free instruction booklet. D. Malin, 284 Pacific, Brooklyn, N. Y.

FREE. Six Money-Making Formulas, Worth dollars, but they are free. Send stamp. M. W. Rand, Box 233, Spokane, Wash.

LEARN how to make more money mailing circulars for others. Our new booklet tells all. Copy free. Send red stamp to pay postage. American Mailers Union, Room 36, 1327 Jefferson Ave., Brooklyn, N. Y.

3,500 NAMES mail-order buyers, from original letters, only \$2.50. Anton, 2308 N. Sydenham St., Philadelphia.

WILL sell State right to manufacture Gasoline Saver for Automobile. 1501 W. Mountain, Fort Collins, Colo.

LEARN Merchandise Brokerage, the business that makes men rich. Our complete set of three books teach you how. Write for free booklet. American School of Brokerage, Davenport, Iowa.

"HIRE Yourself as Boss." Big corporation will back you in Money-Making Mail-Order Business selling guaranteed Goods. Start spare time. Small capital. No canvassing. Wm. J. Dick, Mgr., Dept. J-10, 20 W. Lake St., Chicago.

WITH a mould of Pres. Wilson or Lincoln and Plastography instructions, you can produce beautiful plastic medallions 3 1/2 x 5 1/2 inch oval framed. Remit \$1.00. P. B. Spahr, York, Pa.

MAKE Money making Rubber Stamps! \$35 buys complete "While-U-Wait" outfit. Takes only few minutes to make any kind of stamp by this new process. Barton Mfg. Co., 59-A Duane St., New York.

HOW to Succeed in the Mail-Order Field. Build a business of your own. I will show you how. Address: Sweetman, Box 662, Portland, Maine.

We will start you in the cleaning and dyeing business. Little capital needed, big profits. Write for booklet. Ben-Vonde System, Dept. C, Charlotte, N. C.

"DOLLARS" yearly in your back yard. No ginseeng, mushroom dope. New Ideas never before published, particulars free. Metz, 313 E. 89th St., New York.

ADVERTISE—20 words in 100 monthlies, \$1; 100 weeklies, \$1.50; 10 big dailies, \$2. P. Cope Agency, St. Louis.

WONDERFUL Opportunity! New Tartaric Mirror Silvering Process opens enormously profitable business. Particulars free. H. Barstow, 514 23rd St., Oakland, Calif.

I MADE \$50,000 in five years with a small mail order business; began with \$3 in my own home. I will show you how to do the work; no canvassing. Send for free booklet; tells how. Hancock, Box 867, Lockport, N. Y.

BIG Money manufacturing the best remedy known for catching flies. Complete instructions, \$2. Particulars, two dimes. C. P. Bronson, Cerritos, N. Y.

FORMULAS. Schemes. Money-making Plans. 64 Pages Chuck Full, 10c. "Ideal," 3311-E, Belleplaine Ave., Chicago.

YOU can make money making small Phonographs, unequaled by costly machines, under our licensed instructions. Small expense. Francis Co., 305 York St., Jersey City, N. J.

THE Story of Fred Taylor's success, who laid the foundation of a fortune in one year, through our unique Cooperative Realty plan, will be sent on request. If you desire to make big money and be your own boss, write today. Previous experience unnecessary. McDonnell, Dept. 317, 1428 You St., Washington, D. C.

REPRESENTATIVES Wanted—For big money making Mail Order book proposition. Large profits on small outlay. Write Rollins, Box 5272, Boston.

MAKE More Money! Be Successful! Success and Prosperity reduced to a Science. "The Purple Road to Fortune" on a "Solid Rock Foundation." Tells how! Only Fifty Cents Postpaid. Money cheerfully Refunded if you want it. Particulars upon Request. Royal Road Co., 150 Daigee Bldg., Vanadium, Colo.

OPEN a Mirror Factory at Home. Illustrated Booklet; Lesson and Guaranteed Formula, 10c. (None Free.) Hullinger, Francesville, Ind.

PATENTS low as \$17. Why pay more? Patent News, 31, Washington, D. C.

DON'T enter the mail order business until you get our plan, Particulars free. Advance Advertising Agency, Box 2792, Boston, Mass.

MAIL order dealers—We furnish attractive literature; reliable goods; new profit sharing plan. Delyle Distributing Co., Baltimore, Md.

25 WORD advertisement in 100 monthly magazines, 3 months, \$1. Quadri Co., 442 East 184th St., New York.

\$5.00 MAKES \$10.00, \$27.50 makes \$490.00. Big, honest business. Postal brings particulars. Address Schroeder Oil Co., 291, Norwood, Mass.

MAKE big money in the dyeing, cleaning and pressing business. We show you how. Advance Agency, Box 2792, Boston, Mass.

WONDERFUL moneymaking plan. No capital needed; no mailing or canvassing scheme. Complete, 25c. Details for stamp. Prentice Dean, Dalton, Pa.

CHEMICAL analyses, research formulas done by Pele's Laboratories, Cicero, Ill. Advice free.

MAKE Big Money! Operate our Mail Order Plan. All printed matter for this plan on trust; pay when established. Hunter Company, Tompkins Place, Glendale, New York.

CONDUCT a Candy Kitchen—Clear \$10 daily; practically no capital required; booklet free. Kennen School, 603 North Clark St., Dept. A, Chicago.

YOU can start mail order business profitably your own. No outfits. Plans other advertisers free. 200 opportunities and magazine, three issues, 5c. P. Hyde, 389 William, East Orange, N. J.

FREE! Booklet describing 1,600 ways, plans, schemes, formulas, opportunities for making money, with 24 other big Money Makers at 10c. Northern, 1515 Metropolitan Block, Chicago.

CANDY making a profitable and pleasing trade. Be your own employer. Our Candy Book tells how. 25c. Auburn Supply Co., Dept. C5, 7817 Peoria St., Chicago.

MAKE Gas-Tonic (Carbo-Cide) and other latest Automobile Specialties. I furnish correct guaranteed Formulas for these and other Profitable Lines. If you are looking for new sure money-maker with exclusive rights, send stamp for particulars, proof and latest Formula Lists. Miller, Analytical Chemist (since 1897), Tampa, Florida.

I PUBLISH a wonderful magazine of money making plans, ideas, suggestions and inspiration! It will show you how to make more money. Sample, 10c. Booster Magazine, Northwestern Bldg., Chicago.

BUILD a \$5,000 business in two years. Let us start you in the collection business. No capital needed; big field. We teach secrets of collecting money; refer business to you. Write today for Free Pointers and new plan. American Collection Service, 101 State Street, Detroit, Mich.

INVENT Something; your ideas may bring wealth; our free book tells what to invent and how to obtain a patent, through our new credit system; write today. Waters & Co., 4162 Warder Bldg., Washington, D. C.

START in business for yourself, whole or spare time. Manufacture Puffed Crisp. Fine Confection. 5c package costs 1c. Machine, instructions complete, \$7.50 prepaid. Send 10c for samples. Mohler, Moonen Bldg., Chicago.

THERE is Money for You in the mail order business. Start at home in spare time. Send postal asking free details. Federal Mail Order Association, Dept. D, Palace Arcade, Buffalo, New York.

MIRROR resilvering is a paying trade. We have best instructions, 25c. Auburn Supply Co., Dept. B5, 7817 Peoria St., Chicago.

INDEPENDENCE and fortune quickly attained in the Manufacturing Mail Order business. I furnish Formulas, Manufacturing Processes and Trade Secrets in all lines. Sold under positive guarantee; 18 years' practical experience. Beriston and improvement of Formulas and Processes—reduction of manufacturing cost—utilization of waste materials, etc., a specialty. Booklet, Formula List, and Valuable Information Free. W. L. Cummings, Ph. D., 127 Standard St., Syracuse, N. Y.

\$1 MAKES \$3.00 and starts profitable tire business. See Kelp Puncture Proofing Co., Colgrove, California.

ADVERTISERS, Mail Dealers. Our 1916 Rate Book lists 2,000 Principal Publications, rates, circulation. Includes 30 Mail-Order Plans. Price 10c. Dearborn Advertising Agency, 210 Franklin Bldg., Chicago.

FOR SALE—Practical invention, cheap; chance to make quick money. Herbert Sanders, 114 W. Van Buren St., Chicago.

\$25,000—I MADE it in Mail Order Business; started small with \$3 at home; no canvassing. Free booklet tells how. 2c postage. Alb. Scott, Cohoes, N. Y.

\$1 BUYS 100 Successful Sales-Letters. Complete Letters on 100 Different Lines. "They've Pulled the Dollars." Thousand raw sales arguments. Satisfaction guaranteed. Rosenblum (Advertising Authority), 1116 Broadway, New York.

INVENTORS: We develop and perfect inventions, make models, dies, tools. Metal stamping and special manufacturing. Gerding Bros., Lion Bldg., Cincinnati, O.

MANUFACTURERS, Promoters and Patent Buyers are invited to write us stating the line of invention in which they are interested, as we can supply their wants in any class of patents. Victor J. Evans & Co., 162 Ninth St., Washington, D. C.

I WILL start you earning \$4 daily at home, silvering mirrors; free instructive booklet. G. F. Redmond, Dept. 396, Boston, Mass.

LEARN the real estate business. Our complete instruction book teaches: listing, appraising, management, salesmanship, insurance, brokerage, advertising, renting agency, forms, etc. 121 subjects. Excelsa \$20.00 correspondence course. Buckeye cover 15c; silk cloth \$1.00, postpaid. Catalogue free. Realty Book Company, 5882 Euclid Ave., Cleveland, Ohio.

WE start you in business, furnishing everything; men and women, \$30.00 to \$200.00 weekly operating our "New System Specialty Candy Factories" home or small room anywhere; no canvassing. Opportunity lifetime; booklet free. W. Ragsdale Co., East Orange, N. J.

PATENTABLE ideas wanted—Send for 3 free books. H. B. Owen, 36 Owen Bldg., Washington, D. C.

LEARN to collect money. Good income; quick results. Send for free booklet, "Skillful Collecting." Collectors' Association, Long Street, Newark, Ohio.

WOULD you like to own a good-paying Mail-Order Business? We have a line that gets repeat orders all the time. You can start in spare time; invest a dollar or two a week and soon own a nice business of your own. Particulars free. Nadicco, 4313 Lincoln Ave., Chicago.

HERE'S a new way to make from \$20 to \$60 a week, building a permanent, stable business for yourself. Learn Cole's Secret Process and clear 86 cts. on every Dollar. Art Promotion Service, 337 Cass Bldg., Detroit, Mich.

BUSINESS FOR SALE

WISH to correspond with person who wants good Shoe Repairing Business, doing from seven to ten thousand dollars a year; also Auto Tire Repair business just started in connection. Fine prospects. Jno. C. Bennett, 107 E. Main St., Norristown, Pa.

FOR Sale—Patents—Tools, stock material and made-up goods. Best Truss ever invented for holding rupture. Sells readily at \$15, costs \$3. Big supply catalogs, etc. Splendid opportunity for mail-order business. Bolte, 125 So. Racine Avenue, Chicago.

A POTTERY, making only Flower pots, wishes to sell immediately for cash; in business for 30 years. Further particulars write to J. C. Lueck, Robinson Ave., cor. Ward St., Milwaukee, Wis.

SACRIFICE. Going business manufacturing hand soap formula and sufficient material for 3,000 cans. Capacity 700 cans daily. Reasonable offer considered. J. A. B., 21 Sylvan Ave., Meriden, Conn.

TO MANUFACTURERS

WANTED — Specialties for Mercantile trade. Communicate with Canadian Wholesale Agency, 359 Talbot St., London, Canada.

MANUFACTURERS—We want articles that are money makers, and fast sellers. California Agency Co., San Francisco.

PATENTS Secured through Credit System. Send Sketch. Free Search and Certificate of Patentability. Book and List of Patent Buyers Free. Waters & Co., 4280 Warder Bldg., Washington, D. C.

MAIL ORDER SUPPLIES

INCREASE your sales. Place your proposition before the readers of "Cartoons Magazine." 20,000 copies guaranteed every month. Classified rate 2c per word. Mail in a trial ad today. Cartoons Classified Dept., 78 E. Madison St., Chicago.

FOR ADVERTISERS

REACH Real Buyers—28 words in sixty country weeklies, \$1.00. We represent 6,000. Lists free. Stanford Agency, Sebring, Ohio.

PICTO blueprints, best catalogues, 20 for 20c. Send Negatives. G. Ewing, Newton, Mass.

YOUR thirteen-word adv. in our 8x12 magazine reaching 20,000 boys for 25c. Extra words, 2c. Country Boy Magazine, 2180 Mallers Bldg., Chicago.

20 WORDS ad in 30 Magazines, \$1. A. Barnes, 5 Helena, Ark.

BUSINESS SERVICE

INCORPORATORS, Lawyers, Promoters Recommend Nevada Charters. Unequaled advantages, economy, simplicity, convenience. Charterguide P.M.I. Free. Corporation Service System (P.M.), Reno, Nevada; Clarkburg, West Virginia; Incorporates companies everywhere.

LETTER-HEADS designed, \$1. Monograms, 25c. Cuts of either, \$1 extra. Oakes Sign Service, New London, Wis.

INCORPORATE. Our lawyers do the work, saving you time, annoyance and money in incorporating under the most liberal laws of Arizona. Laws and forms free. Southwestern Securities & Investment Co., Box 1488, Phoenix, Ariz.

LETTER SPECIALISTS

ADVERTISING Letter expert prepares pulling, profit-producing letters at only \$3 each. (One brought \$700 increase over customer's best). Catalogues, circulars, booklets, written to order. Send fullest particulars for free advice. Tenth year. Harry Stern, 1127 Gaylord, Denver, Colo.

AGENTS WANTED

AGENTS! 500% Profit. \$25.00 to \$50.00 a week; that's what our agents are making selling our new metallic sign letters for office windows, store windows and glass signs. For a quick, easy money making proposition for agents, salesmen and sign painters, there is nothing to equal the selling and putting up of our new metallic letters and numbers. There is no experience necessary to put up these signs. Anyone can succeed and make money right from the start. We will send you full particulars and you will see how easy it is to make money in this business. One agent says: "Have already put up 14 signs in this little burg and more in sight. Your letters are the best thing I have seen in years. Will soon be in a position to buy in 5,000 lots." Another says: "I am getting all the work I can do and the letters have given entire satisfaction everywhere." We are daily receiving such letters from agents who have started in the sign letter business. This is the only field that is not overcrowded. There is a big demand for window and glass signs in every town. You can sell to nearly trade or travel from town to town all over the country as you please. We would be pleased to send you a free sample and full particulars. Write today. Address The Metallic Sign Letter Co., 407 N. Clark Street, Chicago, U. S. A.

AGENTS: You can make big money taking orders for our fine made-to-measure clothes, so write quick for 60 beautiful cloth samples, 32 smart styles in rich colors, wholesale and retail price lists, lowest prices and best offer to agents, \$5.00 to \$10.00 a day easy. Big outfit, over 250 samples free to live wires. No experience needed—no capital. We furnish everything free—pay postage or express charges—back you, boost you, show you how and clearly explain everything. Costs nothing to try. Let us make you a stylish suit to measure to prove our fine quality and style. Send postal or letter today. Paragon Tailoring Co., Box 514, Chicago.

WANTED—Young Men in each town to sell my household necessity. Send 25 cents for sample; no attention will be given to any other reply. John L. Yeager, 119 N. Franklin St., Allentown, Pa.

LARGE manufacturer wants representatives to sell shirts, underwear, hosiery, dresses, waists, skirts, direct to homes. Write for free samples. Madison Mills, 586 Broadway, New York City.

MARVELOUS gasoline economizer for Automobiles. Sells like wildfire. Thousands want it. 100% profit. Exclusive territory. Sample, \$1.25. The Auto Specialty Company, Engineers Building, Cleveland, Ohio.

AGENTS Wanted Everywhere—To sell our attractive theatre Brass Poster Frames, Changeable Signs, Building Directories, Brass Signs, Brass Railings, Bank Fixtures, Adjustable Electric Light Brackets. Big demand; easy sales. Established 1882. Newman Manufacturing Company, Cincinnati, Ohio.

MAKE \$50.00 Weekly selling Photo pillow tops. New Novelty, Sample, 15c. Mack Brothers, 9136 Baltimore, Chicago.

START a mirror factory at home without tools; Illustrated Booklet; Lesson; Formula, 10c (None Free). Hullingers, Francesville, Ind.

ENDLESS Neckties—Something new; twelve ties in one; costs no more than old style; man made \$70 three days; woman made \$92 week; write for special agents' offer. Endless Neckties Mfg. Co., Dept. 10, Kansas City, Mo.

EVERYBODY! Indian Finger Traps; Fast seller. Sample, 10c; Gross, \$2.50. William Fisher Company, Harrisburg, Pa.

TAILORING Agents Wanted—Big, complete sample outfit and case, nearly 300 large cloth samples, 3 price lists and everything needed for canvassing or use in store, free to live agents, \$25.00 to \$50.00 a week; may make more. Write us today for free elegant outfit to begin, cloth samples, wholesale prices, special offer on a suit for yourself and full information—see our wonderful values, beautiful fabrics and styles. Established 28 years. Every garment made to measure—everything guaranteed and express prepaid. Just send a postal. American Woolen Mills Co., Dept. 514 Chicago.

AGENTS—Handle a big money-making, order-getting winner. New, useful article. Write for particulars. House, 4245 N. Lamon Ave., Chicago, Ill.

COMMODITY consumed in every home and business. Repeats continually. Canadian rights disposed of. Samples fifty cents to genuine, legitimate mail order and agents. No others considered. "Cutlers," Toronto, Canada.

231% PROFIT selling our 25c Sheet Music at 5c. Particulars Free; 3 samples, 10c. Keller, Robson & Munk, 36 W. 118th St., New York.

READ the Agents Magazine and make more money. 2 issues 10c. Agents Magazine, Chicago.

AGENTS Wanted—To handle remarkable money-makers, easy to handle, easy to sell, many repeat orders. Write quickly. Doras Novelty Co., 540 2nd Ave., New York.

SUITS \$3.75. Pants \$1.00, made to measure. For even a better offer than this, if you live in a small town, write and ask for free samples and styles. Knickerbocker Tailoring Co., Dept. 371, Chicago, Ill.

NEW Auto Power Pump Appliance, not attached to engine. Pumps tire sixty seconds. Ford tire 35 seconds. Selling like hot cakes, \$3.75. Healy Company, Buffalo, N. Y.

AGENTS or Salesmen Wanted. "Dri-foot" waterproofs shoes, 25c. No free samples. Mulhoney, Paxtang, Pa.

HOUSEHOLD Necessity, 200% profit, success assured. Sample 25c. Sharpshoot Co., Logan, Philadelphia.

AGENTS, Make your pile this summer by selling our adjustable 250 candle power Searchlight for motorboats, yachts, etc. Can be taken on shore and used as a lantern in camps or as a table and wall lamp in tents. A boon for fishermen. Grand Rapids Novelty Co., 553 Woodlawn St., Grand Rapids, Mich.

AGENTS, Sell Buckeye Raincoats, \$4.98 up. Big sellers. New proposition. Write for particulars. Dept. P. Buckeye Manufacturing Company, 1 Union Square, New York City.

THEY sell on sight! Our marvelous Nibco Auto Washer for cleaning automobiles. Also our adjustable floor and wall mops, dustless dusters, sanitary brushes and other household specialties. Complete line; immense profits. Write now. Silver-Chamberlain Co., Dept. M, Clayton, New Jersey.

MAIL-ORDER Opportunities: 25 new Propositions. No competition! Make 10c profit on dollar order; complete outfit 10c. Mail Dealers Wholesale House, 521 Franklin Bldg., Chicago.

MARVELOUS Expanding Cuff Button spreads two inches; Presto, cuffs over elbows without unbuttoning, lower cuffs they close automatically; stay where placed upon forearm; greatest laundry and shirt saver invented; combines utility with convenience, invisible; endorsed everywhere; no competition; demanded everywhere; high grade article with merit; DeWilde, Shebogan, Wis., sold 750, 16 days profits \$408. You can do as well. Most sensible cuff button invented; exclusive territory. Money back if not as represented; no fake goods. High grade specialty agents make big money; Fakers, Pickers and Sample Grabbers save your postage. Flexo, Shebogan, Wis.

BIG Profits! New Tartaric Mirror Silvering Process opens enormously profitable business. O. Barstow, 514 23rd St., Oakland, Calif.

HERE'S an unusual business chance—A rare opportunity to make money and build a big, permanent, profitable business. Sell Crystal. It's a wonder; washes clothes without rubbing or boiling, without injury to skin or fabric; a whirlwind seller and repeater. Full particulars and sample on request. Utility Mfg. Co., Chippewa Falls, Wis.

RAPID selling calculating instruments, six kinds, varying from 50 cents to \$5.00. Leishman Arcoscope & Supply Co., Ogden, Utah.

OUR Custom Raincoats are the fastest sellers. Biggest commissions. Best free offers. Imperial Raincoat Co., Clark 5, Boston, Mass.

PURE & Pull Screen Door Plates. New and different. 400% profit. Quick sales. No "outfit" to buy. Sample pair and proposition free. Hardenburgh-Signs, 101 Cedar, Missoula, Montana.

AGENTS: Brand new \$1.50 article, 100% profit selling grocers, general stores, restaurants, 30,000 already sold. Great side line for salesmen. Some making \$30 weekly. Eugene Manufacturing Co., Canton, Ohio.

WE want capable, live wire General Agents and Crew Managers to sell an absolutely new Household Specialty guaranteed by \$200,000 Corporation. It's a big value household necessity that no woman can resist. Easy sales mean big profits. Our follow-up is unusual, and we give you exclusive territory, and advertise the business for you. Wm. J. Dick, Dept. J-21, 20 W. Lake, Chicago.

ONLY Two Sales a Day means \$3.00 net profit; more sales, more dollars. You can do it. Just investigate our latest Aluminum Combination Set, the women go wild over, and let me show you how to make at least \$3.00 a day. Sales Manager, 1423 Westmoreland St., Philadelphia.

MAKE and sell your own goods. Formulas by Expert Chemists. Manufacturing processes and trade secrets. Formula Catalog for stamp. Blake Mystic Company, Washington, D. C.

AGENTS—\$10-\$30 a day introducing our high-grade specialties. Write quick. Van Wyatt Bros., Richfield, N. C.

\$10 DAILY refinishing chandeliers, brass beds, etc., by new method, producing amazing results; no capital or experience necessary; write for information. Gunmetal Co., Ave. H, Decatur, Ill.

WANTED live State Agents for patented Sanitary Sugar bowl. Quick sales, large profit, exclusive territory. No triflers. Schoenholt & Pease, E. E., Pittsburgh, Pa.

"MAKE Gas-Tonic" See Miller's Advertisement—Business Opportunities.

A MAN with sales ability and gift-edge references can establish himself in permanent territory selling high-grade reproductions of the world's best paintings to consumers. New sales plan by which dealer introduces you to his trade and helps you sell them. Commission contract worth \$50 to \$150 weekly to live wire. Proposition sold as a rock, backed by ten million dollar corporation. The Cincinnati Fine Arts Company, 28 Beech St., Cincinnati, Ohio.

NEW Electric Water Purifier and Sterilizer purifies drinking water instantly from all kinds of bacteria or germs through electricity; endorsed by physicians; costs \$1, sells on demonstration for \$2; exclusive territories granted. Triumph Products Co., Transportation Bldg., Chicago, Ill.

AGENTS, Dealers, wonderful new invention. Patent necktie presser, removes wrinkles from neckties, makes them look like new. A time and money saver. Not bulky, fits in your grip. A live one. Retail \$50. Send 25c for sample and terms. Burdett Necktie Presser Co., 20 Park Ave., Claremont, N. H.

MEN and Women Agents: Money talks—how much are you making? If you are earning less than \$200 a month, no matter what your locality, you will positively be delighted with our adjustable Burglar Alarm proposition. Many agents easily earn \$15.00 daily. Brand-new invention. Sells quickly on sight to homes, offices. Patented. No competition. Instantly attached any door knob. Impossible turn knob without ringing bell. No batteries, screws, nails. Handsomely nickel-plated. Retail \$1.50. Provides cheap burglar insurance. It's a big money maker. Let us prove why. If you mean business write today for liberal terms to agents. Keyless Lock Co., 693 Jackson Blvd., Chicago.

SELL the "Penup"—Makes every pen a fountain pen. Sells like wildfire. Every office buys from one to a gross. Attach to any pen, writes 500 words with one dipping. Price 10c—145% profit to agents. Send 15c for sample and full particulars. Penup Sales Co., 592 Coleman Building, Phila., Pa.

AGENTS—Send for sample "Fretnot"—the wash day wonder. Be convinced you can do a whirlwind business. You can clear at least \$20 to \$100 weekly, according to spare or whole time. You don't have to talk, if she doesn't buy at sight, leave sample, she will be looking for you long before you are able to make the rounds again. Samples furnished free. Premiums for your customers. Exclusive territory granted to agents who can produce. Credit given. Don't call. P. M. Motter & Sons, 3213 Warren Ave., Chicago.

RELIABLE People Wanted to place our Orangeade Powder in stores and apportion agents. Makes the most delicious drink you ever tasted by just adding cold water and sugar. Enough for 17 glasses and particulars 15c postpaid. Chas. A. Morrissey Company, 4417 Madison St., Chicago.

SEND 25c in coin for my Wonder Stocking or Hose Heel Protectors. Please Novelty Co., 1746 N. Campbell Ave., Chicago.

OUR Agents making \$50 to \$75 weekly. You can do same. Write for terms. Free sample. Chicago Germicide Co., Ogden, Jackson, Hermitage, Chicago.

AGENTS. Articles which housewife cannot resist. W. H. Walters, 212 South Clinton St., East Orange, N. J.

SIGN Letter Agents and Painters; 500% Profit Gold and Silver Sign Letters for Stores and Office Windows. Anyone can put on. Big demand. Free samples. Metallic Letter Co., 404 N. Clark St., Chicago.

AGENTS make big money and become sales managers for our goods. Fast office sellers. Fine profits. Particulars and samples free. One Dip Pen Company, Dept. 2, Baltimore Md.

AGENTS Wanted. We start you in business in your own town with \$25 capital; new incandescent nitrogen lamp, giving a very brilliant white light, cuts electric light bill in half; tremendous field, exclusive territory given. Write for full particulars. Ernest Rubes Company, 229 Taaffe Place, Brooklyn, N. Y.

AGENTS—Splendid opportunity to make money selling our Egg Testers to Merchants and others. Exclusive territory. Rapid Egg Tester Co., 326 W. Madison St., Chicago.

\$2.50 PER day salary paid one man of woman in each town to distribute circulars and take orders for non-alcoholic flavors in tubes. Permanent—easy work. Ziegler Co., 7P, E. Harrison St., Chicago.

FAST Selling "Kantleak" Raincoat proposition. Cooper earned \$69 in 3 days. Bridge \$88 in 6 days. We deliver and collect. New 1916 watches free. Write today. Comer Mfg. Co., 200 Paige St., Dayton, Ohio.

MAKE good money selling Feeny Vacuum Cleaners and clothes-line reels. Live proposition. Write quick. Feeny Mfg. Co., D-75, Muncie, Ind.

AGENTS are coining money selling our big 10c Packages of 20 Assorted Postal Cards, "5,000 Varieties." "Big Profits." Sell everywhere at sight. Sample Packages 10c. Particulars Free. Sullivan Card Co., 1224 Van Buren St., Chicago, Ill.

AGENTS, Stop! Look at this. No better work on the market in Portraits. Work guaranteed, low prices, free sample roll, prompt shipments. F. A. Wanderley, Wheaton, Ill.

PHOTO Pillow Tops, Portraits, Frames, Sheet Pictures, Photo Plates, Pennants. Rejects credited. Prompt shipments; samples and catalogues free to agents; 30-days' credit. Jas. C. Bailey Co., Desk A5, Chicago.

ONE Thousand Dollars Reward—We will forfeit \$1,000 if this is not the greatest money-making house-to-house proposition advertised in these columns. N.H.G. Little Wizard Labor Saver washes clothes in 10 minutes absolutely without rubbing. It contains no paraffin or wax and there is nothing like it on the market. Sells for 15c; enough for five family washings. We supply you with all the free samples you need. All you do is to leave the free sample with the housewife and when you call again she is waiting to become your steady and permanent customer. This is positively the most scientific and wonderful labor saver of the age, and you will make a great mistake if you do not secure territorial rights at once. A one-cent postal card brings full particulars. Farquhar-Moon Mfg. Co., Dept. C-200, 140 W. Van Buren St., Chicago, Ill.

\$5.00 TO \$10.00 Daily—Sell necessary article every home, office, store, restaurant, hotel, club, etc.; buys in lots 1 to 12 or more. Magic Sticky Fly String—beats old style paper poisons, sticky ribbons, swatting. Half hour test—six feet of "Magic" caught 52 flies, while 14 sheets fly paper caught but 27. Two hour test—21 inches of "Magic" caught 17, while same length 2 inch wide, double coated ribbon caught but 7. Can last twelve weeks. Biggest sensation of the day! Enormous profits. Write quick. Sample postpaid 20c (refunded). Rodolph, Northwestern Building, Chicago.

GOOD opportunity for "Live Ones" to sell electrical wonder. Violet Ray machine. Operates on both currents. Endorsed by physicians; wonderful seller; sells to doctors, dentists, bartenders, beauty parlors, homes, etc.; fine proposition for able salesmen. Eastern Electric Company, Cleveland, Ohio.

AGENTS—Make big money selling iron sheet holder. Write for particulars. Sample 25 cents. Otis Novelty Sales Co., 123 Cushing St., Providence, R. I.

MEN and Women with spare time can earn big weekly profits by our new advertising plan. No investment. No selling. No soliciting. Write today for details for this new money maker. Crown Mfg. Co., Dept. J-1, 20 W. Lake St., Chicago.

AGENTS—Men and women; make \$39 to \$59 weekly selling the New Improved Monitor Self-Heating Iron—the "World's Best." Over 750,000 in use. Positively the easiest, fastest selling, lowest priced, best known iron made. Binding Guarantee. Big profits for all or part time. Evans, N. Car., sold two dozen on Saturday. Mrs. Nixon, Vt., sold eight first half day. New low terms. Exclusive territory. Sample free to workers. Write today. The Monitor Sad Iron Co., 740 Wayne St., Big Prairie, Ohio.

THE Cutest Thing! Sell our wonderful Baby picture. Sells at sight with novel selling plan. Big money for you. Exclusive territory. Retail 25c. To you \$1.50 doz., \$15 gross or \$60 thousand cash with order. Everyone agonizing about the Baby. Two samples to try out 25c; none free. Miller P. M. Co., 1220 Hood Ave., Chicago.

POSTCARDS 90c per 1,000 up; Fountain pens, razors, flycatchers, books, jewelry, etc.; 10c brings samples. P. Gross Onard Co., 2147 Arthur Ave., New York.

MAKE \$3,000 this year. Start in a business of your own. Represent us in your town. No experience required. Write today for great proposition to wide-awake people. Darling Company, Dept. 13, Washington, D. C.

AGENTS free sample and particulars Delbare's Naptha Washing Tablets. Wash clothes without rubbing. Guaranteed not to injure the finest fabric. No acids, lime nor caustics. Manufactured and sold by Naptha Washing Tablet Co., 718 So. Dearborn, Chicago, Ill.

MANAGER wanted in every city and county; send out agents to sell Amber polish to every home, automobile owner, cafe, etc.; repeat orders make you big money; new selling plan. Write only to N. L. Pedersen, 602 Driggs Ave., Brooklyn, N. Y.

AGENTS, \$40 a week to travel by automobile and introduce our 300 candle power coal-oil lantern. Write for particulars of our auto offer. Thomas Co., 862 North St., Dayton, Ohio.

AGENTS, crew managers, aluminum salesmen—you can make \$50.00 to \$75.00 per week selling our 35-piece Leap-Year Aluminum Kitchen Set at \$3.98. Samples free. Write for territory quick. Aluminum Ware Company, Maywood, Illinois.

AGENTS—Here's the best line of food flavors, perfumes, soaps, toilet preparations, etc., ever offered. No capital needed; complete outfits furnished free to workers. Write today for full particulars. American Products Co., 3383 Third St., Cincinnati, O.

AMAZING, startling, sensational, stupendous, new guaranteed easy insurance protection plan. Hustling agent 18 to 60 wanted in each locality to represent big sick and accident company. W. G. Critchlow, Dept. 2721, Covington, Ky.

AGENTS—Just out: \$5 Machine for making any size compression or tension springs; garages, shops, mechanics buy at sight. Year profit \$2.50. National Mfg. Co., 399 Huron St., Toledo, Ohio.

AGENTS—New mighty money making marvel: 3 men order 47,620 pkgs., first 10 days; Kalomite revolutionizes clothes washing ideas; \$100 weekly repeat order business; abolishes rubbing, washboards, washing machines; \$1,000 guarantee absolute harmless; Kalomite works wonders; women astounded; no experience necessary; credit granted; write for overwhelming proof; Equitable Corporation, Dept. 357, 215 W. Superior St., Chicago.

AGENTS, sell and smoke "The American Pipe of Peace." Every puff a delight, cool, healthy, delicious. The Pipe of Peace, Prosperity and Plenty. Retail price 50c. Special agent's price 25c. U. Delandock, 585 Fifth Ave., New York City.

BIG Profits. New Gold and Silver Sign Letters for store and office windows. Anyone can put on. Free samples. Flexible Letter Co., 1642 Division, Chicago, U.S.A.

AGENTS Wanted—Agents make 500 per cent profit selling "Novelty Sign Cards." Merchants buy 10 to 100 on sight. 300 varieties. Catalogue free. Sullivan Co., 1234 Van Buren St., Chicago, Ill.

GET cash for names, information, ideas, formulas. Turn what you see, hear and know into money. Instructive booklet for stamp. Information System, 233 Marietta, Ohio.

AGENTS—Our gold window letter proposition beats 'em all. Stahlrite Co., Dept. P., Long Island City, N. Y. Established 1905.

MAKE \$8 to \$10 a day handling the Imperial Floor Sander—every Contractor, Carpenter and Painter buys. Nothing like it on the market. Write for our money making proposition. Imperial Pump & Tool Co., 2442 West 12th St., Chicago, Ill.

WE manufacture Packs Pineapple Eye-snip. Sample 25c. Schlicker Mfg. Co., 12 Bloomington St., Rochester, N. Y.

"DON'T SHOUT—Just Whisper." Phone-Mega makes telephone conversation easy and private; sells 50c; Bonanza for live agents. Sample 25c. Phone-Mega Mfg. Co., 504 Pine St., St. Louis, Mo.

AGENTS wanted for fast selling guaranteed household article; every housewife a buyer; no talking necessary, as the valuable premium given with each purchase gets the business; write today for particulars. Charles Sharpe, Box 943, Edgar, Wisconsin.

AGENTS—Big Summer Seller. Something new—Concentrated Soft Drinks; just add water. Delicious drinks in a jiffy. Popular for the home, picnics, parties, socials, etc. Small packages; carry in pocket. Enormous demand; agents making \$6 to \$12 a day. Outfit free to workers. Just a postal today. E. M. Feitman, 4746 3rd St., Cincinnati, O.

WRITE for our profitable agency offering selling automatic pipe and nut wrench. Superior Wrench Co., Box 1326, Marshalltown, Iowa.

LUMINOUS Crucifix—Catholics buy on sight. Old Paducah, Paducah, Ky.

"GOLDLINE" Sign Letters—1,000% profit. Particulars free. Johnston Co., Quincy, Ill.

AGENTS—Every Housewife wants our new practical fast-selling specialties. Samples and catalogue free. C. O. Urquhart, 634 West 131st, New York.

AGENTS—Get newest, quickest sellers direct from the makers; full list free. Nat'l. Agents Ass'n., 6122 Michigan Ave., Chicago.

New Gas Saver cuts gas bills on cooking $\frac{1}{2}$; saves \$20 yearly; fits every gas range; sensational demonstration; sells at sight 50c; 150% profit; every gas user buys from 3 to 4. American Gas Reduction Company, 2171 Transportation Bldg., Chicago.

COMBINATION Electric Stove & Toaster operates at an expense of 1c per hour; demonstration creates sensation; costs \$35; sells at sight \$3. Triumph Company, Transportation Bldg., Chicago.

AGENTS—We manufacture fastest selling household article on the market. Fine profits. Pelham Manufacturing Company, Pelham, N. Y.

100% PROFIT—"Little Giant" Door-holder and Stop; 15c; every householder buys; sample 15c; write for territory, prices. Marshall & Clemenson, 844 Home, Oak Park, Ill.

MORE Money, Less Effort. Sell our new, sanitary, "Sav-Ice" Cloth; presents useless melting of ice, reduces ice-bills half, 200% profit. Retail at 25c. Harsch Mfg. Co., Columbus, Ohio.

INVENT something; your ideas may bring wealth; our free book tells what to invent and how to obtain a patent, through our new credit system; write today. Waters & Co., 4192 Warder Bldg., Washington, D. C.

FASTEST Dollar Seller Ever Invented: "Lumino" Changeable Letter Sign; metal sign with 270 letters; something new; every merchant buys; 200% profit. Write today. Changeable Sign Co., East 102nd Street, Cleveland.

"QUICK and Shiny" Metal Polish. Best polish made. Jennings in Dayton made \$79.00 on 157 gallons. Send for sample. Cardinal Mfg. Co., 1714 Columbus Rd., Cleveland.

AGENTS—Make your own goods. "75 Genuine Money-makers." Everyone tested, 20c. "Ideal," 3311-E, Bellefaine Ave., Chicago.

YOU can be your own boss with our Key Check outfit. Good for \$5 a day stamping names on pocket key checks, fobs, etc. Sample check with your name and address, 15 cents. Press Die Works, Dept. M., Winchester, N. H.

PORTRAIT Agents: Our goods will make you big profits. Delivery guaranteed. Rejects credited. Prompt shipments. Low prices. Send for latest catalogue and prices. Adam J. Kroil & Co., 692 Blue Island Ave., Chicago, Ill.

AGENTS—Salary or commission. Greatest seller yet. Every user pen and ink buys on sight; 200 to 500 per cent profit. One agent's sales \$620 in six days; another \$32 in two hours. Monroe Mfg. Co., X 6, La Crosse, Wis.

AGENTS—100% profit—sell machine to saloons. Two sales a day \$15 profit. Free sample, salesmanship course to workers. Mohler, Monon Bldg., Chicago.

OWN your own business. Permanent monthly income. Carry no stock. Just sample. S. O. S. Electric Pulser, new, powerful. Big special agent's proposition now. Commonwealth Mfg. Co., 440 Bialto, St. Louis, Mo.

AGENTS—400% profit. Samples for stamp. Mat Falkenstein, Sauk City, Wisconsin.

MAKE \$3,000 this year. We'll show you how to start in a good business of your own. Make big money representing us in your town. No experience necessary. Write today for great proposition to wide-awake people. Darling Company, Dept. 14, Washington, D. C.

AGENTS—Sell the Primus, genuine Swedish wickless, coal-oil stoves. Smokeless, odorless. Twice the heat of gasoline at one-eighth the cost. No danger of explosion. Big profits. James Anderson & Sons, Sidney, Ohio, American distributors.

\$1,000 PER Man per County. Strange invention startles world—agents amazed. Ten inexperienced men divide \$40,000. Korstad, a farmer, did \$2,200 in 14 days. Schleicher, a minister, \$195 in first 12 hours. \$1,200 cold cash made, paid, banked by Stoneman in 30 days; \$15,000 to date. A hot or cold running water bath equipment for any home at only \$6.50. Self-heating. No plumbing or waterworks required. Investigate. Exclusive sale. Credit given. Send no money. Write letter or postal today. Allen Mfg. Co., 121 Allen Bldg., Toledo, Ohio.

MEDALLIONS—300% profit. Make up your own goods and be independent. Catalogue free. Resag Co., 1265 Randolph St., Chicago.

HOSIERY manufacturer offers permanent position supplying regular customers in home town at mill prices. \$50.00 to \$100.00 per month. All or spare time. For particulars address, D. Parker Mills, 2733 No. 12th St., Phila., Pa.

ACT Quick! Automobile Gasoline going up. Sell Gaso-Tonic. Equals gasoline at 3c a gallon. Eliminates Carbon. Dollar an hour profit. Sales Guaranteed. White Mfg. Co., Dept. M, Cincinnati, Ohio.

\$6 COMMISSION each sale and repeat orders. Traveling salesmen every state. Main or sideline. New, rapid selling automobile accessory used all make cars. Samples loaned. Weekly settlements. Toledo Cable Co., 119 Daris Bldg., Toledo, O.

YOUNG Man, would you accept a tailor-made suit just for showing it to your friends? If you live in a town smaller than 10,000, write Banner Tailoring Co., Dept. 272, Chicago, and get beautiful samples, styles and a wonderful offer.

WHO wants to make more money selling brushes that every household needs? Special method of getting entrance to demonstrate. Fuller Sanitary Brushes are nationally advertised—largest output—best terms and prices—western distributing stations. Your territory is valuable. Write, Fuller Brush Company, Hartford, Conn.; Rock Island, Ill.

AGENTS—Here's a brand new article, just ready for market. Make over 100% profit with satisfied customers. Every mechanic needs one, sells quickly on sight; no competition. Our proposition is a winner. Don't wait. Write for it now. The Security Aluminum Rule Holder Co., Ivanpah, Calif.

YOU can make \$455 as our general or local agent. Household necessity; saves 80 per cent; permanent business; exclusive territory; salary or commission; free sample; credit. J. Pitkin, 113 Redd St., Newark, N. Y.

AGENTS—Stamping names on Pocket Key Protectors; sample Check with your name and address, 12c. Stamping Outfits, Emblem Checks, Check Fobs, Name Plates, Hart Mfg. Co., Desk 2, 303 Degraw St., Brooklyn, N. Y.

BIG Profits for You! Manufacture Barley Crisp. New Confection, 5c package costs you 1c. Machine instructions complete \$7.50 prepaid. Send 10c for samples. Barley Crisp Co., 1205 Broadway, San Francisco.

SELL New Speednut Wrench; world's quickest nut wrench; whole kit of wrenches in one; best proposition for agents; endorsed by leading railroads and manufacturers; every auto owner a quick buyer; sells on sight to anyone requiring a wrench. Evans Mfg. Co., 608 S. Dearborn, Chicago.

AGENTS can make Big Money selling history of exceptional quality at prices that cannot be secured elsewhere. Big repeater. Write for particulars today. Fisher History Co., Dept. X, 721 Sterling Place, Brooklyn, N. Y.

AGENTS—Brand new specialty Aluminum Triplicate Sauce Pan with detachable handle. Cooks 3 different foods on one burner. Saves gas. Lasts lifetime. \$190 to \$300 per month easy. Send for our catalogue of 400 other specialties. American Aluminum Mfg. Co., Div. J, 10, Lemont, Ill.

WE manufacture food products. Rapid sellers. Big profits. Exclusive agency. R. Colvin Company, South Bend, Ind.

CARPENTER agents get new Roof-Framing Gauge Free. Unequaled. Marks seventy pitches. Each in five minutes. John Parkhill, Rochester, Minnesota.

NON-BREAKABLE Lamp Chimneys and Smokeless Burners are sure sellers. F. Finch's, Grand Rapids, Mich.

MAKE your own Extracts and Perfumes. H. Lake Co., Adair, Ill.

AGENTS—Ho-Ro-Co Skin Soap and Toilet Goods plan beats everything for agents' profits. Rothen, 212 N. 2nd, St. Louis, Mo.

EARN \$2 each call and get a Reeves \$5 Vacuum Cleaner free by showing it to your neighbors. Reeves, 56 Broad St., Milford, Conn.

AGENTS—Steady Income. Large manufacturers of Handkerchiefs and Dress Goods, etc., wishes representative in each locality. Factory to consumer. Big profits, honest goods. Whole or spare time. Credit given. Send for particulars. Prospect Mfg. Co., 59 Main St., Brooklyn, N. Y.

STOP Here! Let me start you in a home business that will bring you money every day. Experience unnecessary. Spare time. No canvassing. I furnish everything. Send for proofs. Voorhies, Desk C. R., Omaha, Neb.

AGENTS—30 Calling Cards 10c. F. Shepard, Rome, N. Y.

NEW \$2.50 pocket adder. Sell 10 daily easy. Excellent profit. Everyone buys. No competition. A. Bassett, 3921 Indiana Ave., Chicago.

RELIGIOUS novelties, quick sellers, big profits, fine proposition for Agents. Write for particulars immediately. Novelty Altar Co., Dept. P, Stamford, Conn.

AGENTS—Make real money this year; not "paper money." Sell our wonderful Luminous articles. "They shine in the dark." Crucifixes, Match Boxes, Pull Chain Bulbs, Switch Plates, Clocks. Startling! Everlasting! Mysterious! Pioneer Portrait Co. (Luminous Specialists), 1259 West 63rd, Chicago.

AGENTS—Sell rich-looking imported 3x5 68 Rugs, \$1 each. Carter, Tenn., sold 115 in 4 days. Profit, \$57. You can do same. Write for sample offer selling plan; exclusive territory. Sample rug by parcel post prepaid, 85c. H. Condon, Importer, Stonington, Maine.

1916's SENSATION! Eleven-Piece Toilet Article set selling like blazes at \$1. With \$1 carving set free! Enormous profits! Tremendous hit! Eagle made \$51.00 first week. Write quick! Pierce Co., Dept. P, 906 Lake St., Chicago.

LADY or gentleman, fair education, to travel for old-established firm. No canvassing. Salary, \$936 per year, payable weekly, pursuant to contract. Expenses advanced. Address G. M. Nichols, Philadelphia, Pa., Pepper Bldg.

EASY, pleasant work for Mechanics, Shop Men, Clerks, during spare hours, will add many dollars to their salaries. Also want persons who can give full time. Big wages assured. Novelty Cutlery Co., 47 Bar St., Canton, Ohio.

I WILL start you earning \$1 daily at home, silencing mirrors; free instructive booklet. G. F. Redmond, Dept. 306, Boston, Mass.

AGENTS make \$100 monthly selling our 500 handy household articles, Catalogs free. Scheff Company, Des Moines, Ia.

\$15.00 MADE first day by 13-year-old boy with Shmoscope. Woman made \$8.00 first hour. Particulars free. Shmoscope Mfg. Co., 523 W. 13th St., Kansas City, Mo.

AGENTS—\$5 daily selling our Handy Tool, 12 articles in one. Lightning seller. Sample free. Thomas Mfg. Company, 702 North St., Dayton, Ohio.

MAKE 100% profit selling new patent polishing cloth to Automobile owners, garages and the home. Sells on sight. Write for particulars or send 25c for sample of 200 square inches. Address, Dept. C, The Iron Screen Sales Company, 720 Helen Ave., Detroit, Michigan.

SOLICITORS: Make \$50 weekly; each merchant and physician a prospect; free outfit. One man made \$145 first ten days, that was last June, he is still working. Address, Secretary, 343 Wells Bldg., Quincy, Illinois.

\$75 EVERY week you sell Big 4 Pilots for Ford Cars. Makes steering easy. Every sale makes a booster. Get prices and description at once. G. M. Tilford, Dallas, Texas.

BIG Opportunity—Agents introduce high grade repeat-order specialties. Quick sales; big profits. Send for particulars. Anville Specialty Co., Palmyra, Pa.

MAKE Big Money, sell the latest household article. Every housewife buys when shown. One agent sold 10,000 in a week. Sample and particulars 16c (conf.). Marvel Mfg. Co., Desk A, New Haven, Ct.

AGENCIES WANTED

ARTICLES wanted, suitable Household, Office, Workshop, for Trade Houses, Mail Order, Agents, Canvasers, Streetmen, Fairmen, from manufacturing companies only. Particulars, Catalogues, Samples, Absolute lowest Jobbers' terms, to "Webster's" 41, Newington Butts, London, S. E., England.

USEFUL Articles from manufacturers, Agents all over Canada, A. Jarvis, Runnymede Rd., Toronto, Canada.

WANTED—Agencies for reliable Manufacturers and Patentees, Novelty Sales Co., Waterville, Wash.

EDWIN A. MANSFIELD & CO., 12, Beckenham Road, New Brighton, England, will be glad to hear from firms who wish specialties to be placed on British and Continental Markets.

WE want to represent manufacturers in Washington, Idaho and Oregon, articles retelling from \$1.00 to \$7.00 preferred. Northwestern Sales Co., Spokane, Wash.

SALESMEN WANTED

WE Want Salesmen. Our line—Groceries, Provisions, Paints, Automobile and Machine Oils, Roofing, Stock and Poultry Food. Sells to Farmers and other citizens who eat, have buildings, or own live stock. Sells because the goods have the quality and the price that we can give by selling in large quantities direct to the consumer. Our salesmen make \$500.00 to \$5,000.00 per year. Their ability and activity govern that. We give them the right goods and at the right price and the fact that all of them don't make the big money only proves that all men are not equal as salesmen. You or anyone else who answers this ad can get our proposition, but don't answer unless you know that you can't make a dollar without putting in a dollar's worth of work. Hitchcock Hill Co., Wholesale Grocers, Chicago, Ill.

A NEW way to make money—\$10 to \$100 for information only. No selling, soliciting, no real work. We want associates with us—each city—in building and operating "M-8" improved real estate. (Patent construction insures 50 to 100% greater income.) Our hardest job is not securing their co-operation, but to find right people. We will pay you \$10 to \$50 or more for information you now possess. Don't delay. Cash in on this; write Sales Director, Merrill System, Menon Building, Chicago.

UNQUESTIONABLY, above others, every bank account holder buys for \$5.00 the O. V. C. Check Protector Machine. Free sample, perfected selling plans to right man. Orick, 25 West 42nd St., New York.

WANTED—500 Salesmen to sell Magic Motor Gas. One quart, price \$2, equals 59 gallons gasoline. Greatest product ever discovered. Large profits. Auto Remedy Co., Eighth Ave., Cincinnati.

DA-NITE-FLASH Art Glass signs with Art Glass changeable letters; hundred beautiful signs in one; quality excellent, price low. Manufactured by McReynolds & Co., 307 Grand Ave., Milwaukee, Wis.

SALESMEN—Our Force Feed Oiler works with a plunger. Successful salesmen wanted everywhere to represent us. An excellent side line. State territory covered. E. M. De Camp, 920 Lawrence Ave., Chicago.

SALESMEN: Leatherette Change and Bill Fold; handiest purse made. Advertising Novelties, Security Mfg. Co., Dept. A, 222 N. Wabash, Chicago.

TRAVELING Men Wanted for Money-Making Side Line. Largest Vacuum Sweeper Factory in the world wants side-line men in all States to sell Vacuum Sweepers from photographs. No samples to carry. Liberal commission on all re-orders. Big season right at hand. Act quickly. Write fully—state territory covered and trade you sell. United Vacuum Sweeper Co., 1815 W. Congress St., Chicago.

PROGRESSIVE Salesmen sell Dumbo Rug Border. Mill to merchant prices, liberal commission. Write for two pound samples. J. C. Dunn & Co., Camden, N. J.

SALESMEN: Acquainted with merchants. Large demand. Lib. comm. Pocket samples. Wirth Salesbook Co., Chicago.

EXCLUSIVE county rights. Sell Tankii; modern auto fuel. Profitable. Tankii Chemical Co., Cleveland, Ohio.

HELP-A-PHONE: the profitable side line for salesmen. Write Ebnard, 415 Belden Ave., Chicago.

NEW auto fuel; one-third cheaper; unlike any other; County and District agencies open; 10-year contract; guaranteed. Inajiffi Fuel Co., Akron, O.

WANTED—Advertising moving picture film representatives. \$50 week up possible. Animated Advertising, 3028 S. Michigan Ave., Chicago.

FACTORY foremen or employees or tradesmen can add \$100 to \$200 monthly to their incomes acting as our representatives. Spare time. No capital. We furnish everything. Recommendations from many prominent bankers. We want one representative in each town. Write at once for particulars. Address R. F. Woods, Jr., 230 Stewart Bldg., Houston, Texas.

WANTED—Representatives everywhere. Exclusive territory. Gold sign letters for stores and office windows. Any one can put on. Write today for free sample. Metallic Letter Co., 405 N. Clark St., Chicago.

SALESMEN wanted to sell Shinson Products to retailers and jobbers. All trades handle. Consumption big. Lowest prices and attractive deals. 18-year quality reputation. Big commissions net handsome income. All or part time. Shinson Co., Rochester, N. Y.

HOW much do you earn? Wanted—Live, energetic men over 25 years for small towns and country trade; we teach you how to easily make \$150 to \$500 monthly selling groceries, paints, oils and stock remedies—all necessities; big line, big money; build homes and bank accounts as hundreds do; regular trade quickly, easily covered; old, established, reliable house; ask your banker. Write today for our booklet, "The Way to Success in Business." John T. Sexton & Co., Wholesale Grocers, Lake and Franklin Sts., Chicago.

SIDELINE salesman acquainted with retail or wholesale cigar trade, to sell new, highly successful utility. If you have an established trade and won't shy at \$10.00 a day on the side, write Universal Mfg. Co., 608 Locust, St. Louis, Mo.

SALESMEN — Make Big Money on our Convex Portraits 38c. Frames 35c. Glass 2c. Largest house in America. Est. 15 years. Samples Free. The Cultor Co., Box 104, Westerville, O.

SALESMEN—Get our plan for Monogramming Automobiles and Motorcycles by transfer methods. Very large profits. Motorists' Accessories Co., Ashland, O.

SALESMAN. Sell beautiful 28x38 Art-kraft felt rugs for \$13.50 per doz. Your profit, \$3 per doz. Kelsco, Battle Creek, Mich., sold 30 doz, last week. His profit, \$75. Write for exclusive territory and selling plan. Prepaid sample, 75c, refunded on first order. H. Condon, Mfr., Stonington, Maine.

EARN \$5,000 to \$20,000 yearly. New business necessity. Retails \$5 to \$200. 100—200% profit. Purchaser satisfied or money refunded. No competition. Exclusive territory. Free samples. Sagers, 408 Wainwright, St. Louis.

HELP WANTED

GOOD Position, excellent salary for you by training as Topographic Draftsman for Government service. Complete course by mail; also Mechanical Drafting with which a set of Aliender instruments is furnished. Get particulars now, Columbia School of Drafting, McLachlen Bldg., Washington, D. C.

CHAUFFEURS, get \$18 week. Learn while earning. Sample lessons free. Franklin Institute, Dept. J-802, Rochester, N. Y.

GO on the Stage, Vaudeville career offered you. Experience unnecessary. Managers endorse my method. Instructive vaudeville book free. Write today. Frederic LaDelle, Sta. 10, Jackson, Mich.

STOP Here! Let me start you in a home business that will bring you money every day. Experience unnecessary. Spare time. No canvassing. I furnish everything. Send for proofs. Voorhies, Desk C. R., Omaha, Neb.

WANTED—Men-Women. \$75.00 month. List Government Jobs open, free. Franklin Institute, Dept. J-21, Rochester, N. Y.

GET a Government Job! See ad on page 28. Write now—today! Patterson Civil Service School, Rochester, N. Y.

FIREMEN and Brakemen: \$100 monthly. Experience unnecessary. Hundreds needed by the best railroads everywhere. Particulars free. 810 Railway Bureau, East St. Louis, Ill.

THOUSANDS Government Jobs Now Obtainable. List free. Franklin Institute, Dept. J-21, Rochester, N. Y.

\$10 DAILY refinishing chandeliers, brass beds, etc., by new method, producing amazing results; no capital or experience necessary; write for information. Gunmetal Co., Ave. G, Decatur, Ill.

WANTED—Men and women to qualify for Government positions. Several thousand appointments to be made next few months. Full information about openings, how to prepare, etc., free. Write immediately for booklet CG-29. Earl Hopkins, Washington, D. C.

U. S. GOVERNMENT wants Clerks, Men—Women, 18 or over. \$75.00 month. Write immediately for free list of positions now obtainable. Franklin Institute, Dept. J-21, Rochester, N. Y.

\$20 TO \$35 per month extra money to any employed person without interfering with regular work. No selling, no canvassing. Positively no investment. Unemployed need not apply. Address The Silver Mirror Co., Inc., 119 W. Madison St., Chicago, Ill.

PLEASANT spare-time work; mailing circulars. Good pay. No scheme. Details free. Home Pub. Society, 46 N. 12th, Philadelphia.

EARN \$20 weekly collecting names and information. What you see, hear and know is worth money. Send stamp for instructive booklet. Information System, 232 Marietta, Ohio.

MEN—Women, Wanted. \$75.00 month. Government Jobs. Vacancies constantly. Write for list positions now obtainable. Franklin Institute, Dept. J-21, Rochester, N. Y.

CIVIL Service Examinations open the way to good Government positions. I can coach you by mail at small cost. Full particulars free to any American citizen of eighteen or over. Write today for booklet CE-29, Earl Hopkins, Washington, D. C.

MEN wanted to make toy soldiers as sideline or business larger scale. War stopped impetration; enormous demand here. We buy everything till Christmas, paying \$1.50 to \$2.1. Complete casting outfit, \$2.50. Booklet, information free. Toy Soldier Manufacturing Co., 23 Union Square, New York.

BRIGHT man guaranteed \$100 position when competent. Some special home preparation necessary. Write Civil Service School, Denver, Colo.

BE a Detective; \$50, \$100 weekly; travel over the world. Experience unnecessary. American Foreign Detective Institute, 106 Chemical, St. Louis.

THOUSANDS Men and Women Wanted. Get U. S. Government positions. \$75 month. Steady work. Common education sufficient. Write immediately for free list of positions now obtainable. Franklin Institute, Dept. J-21, Rochester, N. Y.

BIG money writing Photo-plays; details free to beginners. No correspondence course. Producers League, 230 Wainwright, St. Louis.

INVENT something; your ideas may bring wealth; our free book tells what to invent and how to obtain a patent, through our new credit system; write today. Waters & Co., 4102 Warder Bldg., Washington, D. C.

FIREMEN, Brakemen, all railroads everywhere; \$120 monthly; experience unnecessary. Promotion, conductor, engineer. \$150-\$200. Railway Association, Dept. 298, Brooklyn, N. Y.

WANTED—Young Men as Railway Mail Clerks. \$75.00 month. Sample examination questions free. Franklin Institute, Dept. J-21, Rochester, N. Y.

DISTRIBUTORS—Wanted of Advertising matter everywhere (good pay); send dime for Contract Magazine (none free). Address Oliver A. Barkley, Mount Pleasant, Pennsylvania.

\$6 COMMISSION each sale and repeat orders. Traveling salesmen every State. Main or sideline. New, rapid selling automobile necessary used all makes cars. Samples loaned. Weekly settlements. Toledo Cable Co., 118 Davis Bldg., Toledo, O.

LEARN auto trade in most modern school on Coast. Courses practical and complete; expert supervision; time unlimited; reasonable rates. Will help you earn your living while learning. Catalog free. National School of Engineering (Established 1905). Los Angeles.

PROSPECTIVE Chauffeurs, Salesmen, etc. Learn repairing and driving any car. Small cost. Earn \$20 and up weekly. Modern Auto Co., 1381 Ridge Avenue, Philadelphia, Pa.

SILVERING mirrors. Plating tableware, auto-brass. Home booklet plans free. Clarence Sprinkle, Dept. 28, Marion, Ind.

DETECTIVES earn from \$25 to \$100 per week and traveling expenses. We show you how. Write National School of Detectives, Room 536, 489 Fifth Avenue, New York.

BE a Detective—Earn from \$150.00 to \$300.00 per month. Travel over the world. Write C. T. Ludwig, 340 Westover Building, Kansas City, Mo.

GOVERNMENT Examinations. Most thorough preparation, \$5; returned if not appointed; particulars free. American Civil Service School, Washington, D. C.

WANTED—An Idea! Who can think of some simple thing to patent? Protect your ideas; they may bring you wealth. Write for "Needed Inventions" and "How to Get Your Patent and Your Money." Randolph & Co., Patent Attorneys, Dept. 144, Washington, D. C.

I WILL start you earning \$4 daily at home, silvering mirrors; free instructive booklet. G. F. Redmond, Dept. 396, Boston, Mass.

BECOME Detectives. Large salaries; easy work. Write Chief Wagner, 1243 Lexington Avenue, New York.

PARTNERS WANTED

PARTNER wanted to manufacture patent hayfork; cost 25c each. P. O. Box 69, Haverhill, Mass.

WANTED

WANT Oxy-Acetylene Welding Outfit in exchange for industrial stock. Write for particulars. Address Box 13, Lomax, Ill.

75c YOUR old false teeth per set. Jos. Lynn, 198 W. Springfield St., Boston, Mass.

FOR SALE

REAL bargains in high-grade Cameras. Lenses, Kodaks, Binoculars, Microscopes, Surveyors' Transits, etc. All goods used, but equal to new. Away below regular prices. Write us today. David Stern Co., 1617-F W. Madison St., Chicago.

FIFTY-SIX inch new Simplex Ironer, \$30. Also Motorcycle. S. J. Griffin, Ogden, Utah.

BARGAIN—Box Ball Alley in good second-hand condition. Cost \$208.40. Will take \$40. Box 523, Corinth, Miss.

FOR Sale—Esk, sheep and deer heads. Reuben Sawyer, 497 Broadway, Dayton, Ohio.

CIVIL Engineering. I. C. S. course, \$25.00. For particulars address Robt. Stoesser, 1456 Fletcher St., Chicago.

FIELD and Marine, Day and Night Glasses, with beautiful case, 25-mile adjustment; \$30 value, only \$7.50. Money back if not satisfied. Well's Curiosity Shop, 20 S. Second St., Philadelphia, Pa.

NEW One Hundred Dollar Standard Visible Typewriter for Thirty-five Dollars. Millison Office Supply Co., Wichita, Kansas.

FIELD Glasses; a few pairs left. 9 power, \$6.00, Zebrbach, Leipzig, Ohio.

FOR Sale—Part interest in practical invention; cheap. Sanders, 116 W. Van Buren St., Room 906, Chicago.

BATTLE Creek Union Steam Pump, size 5x3x4, nearly new, \$50. A. F. Erclesfermer, Niles, Mich.

LARGE Rifle Hydraulic Ram, 8" drive pipe. First-class condition. Cost \$400, will sell for \$150, Merritt W. Pharo, Bourse Bldg., Philadelphia, Pa.

TYPE and Printing Material at bargain prices. Now is the time to buy. All sizes rebuilt Job Presses very cheap. Catalogue free. Philadelphia Printers' Supply Co., 14 So. Fifth St., Philadelphia.

SALE OR EXCHANGE

COMPLETE Threshing Outfit, Bargain, Haypress, Motorcycle, Microscope, Moving Picture Outfit, Music Box, Large List. Part trade. Offers? Fleury, Avoca, Mich.-Ill.

EXCHANGE Law Books, Camera, Printing Press, other articles, for typewriter or offers. Rankin, Spencer, Iowa.

YOU can sell or exchange almost anything through these classified pages. Tell me what you have and I'll send you some interesting information. No obligation whatever. Write me today. F. W. Johnson, Manager of classified advertising, 6 N. Michigan Ave., Chicago.

WE buy and sell everything needed for theatres and road shows. We sell moving picture machines, \$50; Films, \$3.00 a reel; Motors, \$3.00 up. H. D. Theatre Supply, 711 South Kedzie Ave., Chicago, Ill.

LET'S Swap! Hundreds of offers. Three months Dime free advertising. Swap Bulletin, Detroit.

GUNS, SPORTING GOODS, ETC.

PETERS bait 25c; bait tie 10c; absolutely weedless fish hook 25c; collapsible line-drying reel \$1. Fits any tackle box. Used by all real fishermen. R. D. Peters, Mgr., Peters Bait Co., Knox, Ind.

DON'T Be Mushy. Postal will bring catalogue of Famous Home Exercisers, direct from the Manufacturers. Peerless Athletic Supply Co., 383 Pearl St., Brooklyn, N. Y.

FIREARMS—Old-time and modern. Buy, sell, exchange all sorts. Stephen Van Benschel, 49 Front St., New York City.

ENGINE CASTINGS AND BLUEPRINTS

STEAM Engine Castings for 1/2 hp., \$3; 3/4, \$5, and 1, \$12. Modern Model Eng. Co., 3601 N. Central Park Ave., Chicago.

GASOLINE Engine Castings, with drawings. Cheap. Catalog for stamp. Novelty Manufacturing Co., 853 West 6th St., Cincinnati, Ohio.

FLOUR & FEED MILLING MACHINERY

SPECIAL bargains in second hand Attrition mills, burr mills, crushers, corn shellers, bran dusters, dust collectors, purifiers, reels, double, single, 2 and 3-pair high roller mills, sterc bolters, receiving separators, scourers, etc. Write for description and prices. Sprout, Waldron & Co., P. O. Box 429, Muncy, Pa.

MACHINERY, TOOLS AND SUPPLIES

100 NEW Vises \$1.09 per inch width of jaw, all sizes 2 1/2 to 5 inches. Send for circular. Lucas & Son, Fox St., Bridgeport, Conn.

SIDNEY Tool Co. Combination Tonn Machine and Mortiser. Nearly new. Price \$110. Boyd M. Heitman, Bellevue, O.

MACHINERY for manufacturing chewing gum. For sale. Crane, 334 Genesee, Buffalo, N. Y.

PULLEYS, Gears, Sprockets, Shafting, Hangers; see display ad this issue. W. A. Jones Foundry & Machine Co., Chicago.

ENGINE Lathes, swings 3 1/2 in., takes 25 in. between centers. Complete set gears cutting all size threads 3 in. to 49 in., \$45.50. Grammas & Sons, Allentown, Pa.

"RED Devil" Mechanic's piler (drop forged steel). Most efficient, 5" size 60c. Style 50. Tool booklet free. Smith & Hemenway Co., 161B Chambers Street, New York City.

STERE Name Stamps for marking tools. 3 initials. 75c. Names with initials, 20c per letter. Brass and steel dies for all purposes. Partridge Scottford Co., 12A West 16th St., Kansas City, Mo.

LATHES—Ten second hand speed lathes, all prices; send for list. Lucas & Son, Bridgeport, Ct.

FOR Sale; New Power Hack Saw, capacity 4"x4", \$16.75. New 10" Sensitive Bench Drill Press, complete with chuck, capacity 3/4", \$15.00. Passman Bros., 59 S. Green St., Chicago, Ill.

FOR Sale; Automatic Double Spindle Screw Machine. Will take stock up to 3/8". Goshen Eyelet Co., Goshen, Ind.

ENGINES, MOTORS AND DYNAMOS

FOR Sale—Cheap—Semi-Speed Launch, 40 HP. Trebert Engine. Eldredge-Whittaker Hydroplane End Engine, 18-25 Sterling Engine complete. Eldridge 3-cylinder, 27 HP. Engine. C. D. T., 818 Granite Bldg., Rochester, N. Y.

GUARANTEED rebuilt alternating and direct current motors. Bargain prices. Reliable makes only. Westinghouse, Wagner, General Electric, Century, Emerson. Sizes from 1/20 H. P. upwards. Satisfaction guaranteed or money refunded. Write today for illustrated price list supplies and motors. Hyve Electric Co., 613 W.T. South Dearborn St., Chicago.

2-HORSE Marine Motor \$20. Frazer Bros., Adams, N. Y.

SACRIFICE—Marine Engine Sale. Get list. Morley, Harbor Beach, Mich.

FOR Sale—3 1/2 Hp. Gasoline Engine (new), Whitecomb, Saugatuck, Mich.

REMARKABLE Bargain: 16hp. 3-cylinder 2-cycle Knox Marine engine. Paragon gear, jump-spark outfit, carburetors, propeller in perfect condition, \$180. Address: R. C. Bixby, Newton, Conn. Mass.

REAL Bargains: Dynamo, \$20; 3-Hp. M. C. engine, \$16; large ammeter, \$6. Hall, 632 W. 42nd St., Chicago.

100 KW., 250-Volt, Direct-Current Triumph Generator. First-class condition. An excellent bargain. The D. Hummel Building Co., Station B, Cincinnati, Ohio.

DYNAMOS, 30-50-100 light. Payments \$10 per month. Hobert Brothers, Troy, Ohio.

AEROTHURST Motor in good order at \$35. Russell & Poland, Mt. Pleasant, Mich.

BANKRUPTCY Sale: A. C. motors, all new. 1/2 h. p., \$15; 3/4 h. p., \$20. Small generators, \$8. Motor generators and other size motors less than factory cost. Johnston, Evans Ave., Ingram, Pa.

AUTO Engines—Atlas 40 hp., 4 cylinder, \$35; Hupp, 20 hp., E. M. P., 30 hp.; also 2 Canoe Engines, \$20 each. Johnston, Evans Ave., Ingram, Pa.

35 H. P. Gas Engine for sale. Good condition. 2 cyl., 10" bore, 14" stroke. R. P. M. 258. Write Adv. Dept., Allen Motor Co., Fosteria, Ohio.

TEN second hand engines cheap. Send for description. Lucas & Son, Bridgeport, Conn.

SMALL Auto motors, 4 cylinder, 4 cycle 2-5/8x4, bare or equipped, Bargains, Universal Motor Co., Oshkosh, Wis.

WESTINGHOUSE Vertical Gas Engine, 40 H. P. Now running. In best possible condition. Selling because of purchase of a larger unit. Delivery at once. The Acklin Stamping Co., Toledo, O.

REBUILT Engines—We have on hand a number of rebuilt "Buffalo" engines, guaranteed, at greatly reduced prices. Write for bargain list. Buffalo Gasoline Motor Co., 1298-1305 Niagara Street, Buffalo, N. Y.

FOR MECHANICS

REMOVES Grease and Dirt instantly without water. We guarantee that one tablespoonful of Waterless Washer will remove grease in one minute from hands that have been dirty for years, and leave them snow white. Removes quickly dirt, ink stains, or grease from the most delicate fabrics without slightest injury. Wonderful for sore feet, chapped hands, and cleanses cuts; fine shampoo, greatest help in washing clothes ever discovered. Once used you will never be without it. Used in Europe for years; we are offering it now for the first time in America. Wonderful, startling, and positively harmless, yet any child can make in your own kitchen. For \$1 we send, prepaid, enough material with instructions to make 16 pounds. Money refunded if not satisfactory. Waterless Washer Laboratories, 1428 Michigan Blvd., Chicago.

BOATS, LAUNCHES, ETC.

FOR Sale: Truscott Launch, 25 ft. (chairs), 12 hp., 2-cyl. eng. Monahan eng. 1 mo. old. Magneto and clutch, \$250. Also 15 hp. 2-cyl. eng. used 7 mo. F. S. Kenfeld, Augusta, Mich.

ELECTRIC Portable Propeller for any rowboat. Attached and detached in a moment; are absolutely practical. Selling half price. J. Hopwood, Meosauonic, Wis.

BUILD your own Steel boat from patterns. Material furnished, also finished boats. Catalogue free. Darrow Boat Co., Albion, Mich.

MOTORCRAFT Encyclopedia—A 150-page book that tells 1001 things every motor boatman should know. How to overcome engine troubles. Price \$1, postpaid. Popular Mechanics Book Dept., 6 N. Michigan Ave., Chicago.

FOR THE SHOP

PROTECT your arms from grease and dirt. Wear our "Oil-Proof Sleeves." 30¢ a pair. Waterproof Novelty Co., 50 W. 22nd St., N. Y. C.

JUST Published—Popular Mechanics Shop Notes for 1918—525 Easy Ways to Do Hard Things in every department of mechanics. Over 600 illustrations. 224 pages (size 6 1/2x9 1/2 in.). Price 50 cents, postpaid. Popular Mechanics Book Dept., 6 N. Michigan Ave., Chicago.

FOR That Boy—He will appreciate a copy of the great boy's book "The Boy Mechanic" that tells about 700 different things for boys to do and has 800 pictures. 788 (7x10) pages, cloth, big, handsome book for the price, \$1.50 postpaid. Popular Mechanics Book Dept., 6 N. Michigan Ave., Chicago.

BLACKSMITHS

BLACKSMITHS. Listen: Wear the smile that won't come off, by doing hard jobs easy with Toy's Modern Methods on blacksmithing. Making all welds solid, tempering all tools to a standard with colored tempering charts. All for one dollar. Samples free. W. M. Toy, Sidney, Ohio.

ELECTRICAL

ILLUSTRATED wholesale pricelist supplies and motors. Write today for guaranteed bargain. Hyre Electric Co., 613 TF, South Dearborn St., Chicago.

TATTOOING Outfits. Electric and Hand, \$1 up. Roberts Company, 635 West Ave., Buffalo, N. Y.

DRY Batteries and Their Construction for All Purposes. A practical handbook of 69 pages with 39 illustrations dealing with batteries for automobiles, gas engines, medical and coil work, electric bells, alarms, telephones, experiments, etc. Price 25 cents postpaid. Popular Mechanics Book Dept., 6 N. Michigan Ave., Chicago.

PATENTS Secured through Credit System. Send Sketch. Free Search and Certificate of Patentability. Book and List of Patent Buyers Free. Waters & Co., 4280 Warder Bldg., Washington, D. C.

PRACTICAL Electricity—Universal handy book on every-day electrical matters, alarms, batteries, bells, carbons, connections, coils, dynamos, wires, lamps, motors, telephones, etc. 135 pages, 124 illustrations. 25¢ postpaid. Popular Mechanics Book Dept., 6 N. Michigan Ave., Chicago.

PRACTICAL Applied Electricity—Here is a book written in plain English for the practical man. There has been great need of such a work. Practical examples are given to illustrate theory and this serves as a greater aid in fixing the subject matter firmly in the mind of the reader than a bare statement of principles, laws, etc. Pocket size, 450 pages, 823 illustrations, leather. Price \$2.00 postpaid. Popular Mechanics Book Dept., 6 N. Michigan Ave., Chicago.

STAMP COLLECTING

A STAMP Album. A Collection of rare Mexican War stamps, incl. Mexico, etc., 100-page catalog. Perf. gauge and mill, scale, coupons, etc., all for 5¢. App. sheets 64¢ to 84¢ comm. Agents Wanted. We buy stamps. Hussman Stamp Company, 85, Louis, Mo.

STAMPS, 75, all different, free. Postage 2¢. Mention paper. Quaker Stamp Co., Toledo, Ohio.

24 VARIETIES Cuban stamps, 10 cents. List of 6,000 low-priced stamps free. Chambers Stamp Co., 111 P. Nassau St., New York City.

129 DIFFERENT Stamps 7¢. Fine approvals. E. R. Fride, Dept. C, Honoree Falls, N. Y.

FREE—201 Different Foreign Stamps, 185 Mexican War packet, 25 Persia, 50 Africa, 50 Australian, 100 United States, 60 Japanese, 50 Sweden, 65 British Colonials with Mekeel's Stamp Weekly, Beverly, Mass., six months. Choose one. Remit 25¢. Mention magazine.

FREE—209 mixed stamps, Perforation Gauge, our 14¢ list subscription blanks to Stamp Journals, etc., for two cents postage. Pagan Stamp Co., 138 N. Wellington St., Los Angeles, Calif.

1,000 STAMPS from 30 different countries, 12¢. Lathberry, Wallingford, Conn.

STAMPS—30 China and twenty pairs 10¢. Wolverine Stamp Co., Centerville, Mich.

FREE: 25 different used United States Stamps including Postage, Revenues, Envelopes and Dues, to applicants for our high-grade approval selections. Send 2¢ for postage. The Edgewood Stamp Co., Dept. H, Milford, Conn.

BRAZIL—1,000 Brazilian stamps (50 varieties), value Stanley Gibbons \$8 free for \$4. Order now. H. Carvalho, Goncalves, Dias 31, Rio Janeiro, Brazil.

25¢ BUYS \$1.50 catalog value, Nicaragua. Premiums. H. Chitraro, 509 W. 133d St., N. Y. City.

45 DIFFERENT stamps from Warring Nations, Monster Australian packet, Canadian packet, Tasmanian packet, 10¢. C. Martin, Ingoquoit, Ont.

STAMPS. Send for our low priced approvals. Premium given to new customers. Ideal Stamp Co., 528 Scott St., Milwaukee.

BOYS, get a set of parcel post stamps before too late, low prices. E. H. Frank, 929 W. 5, Cincinnati, O.

FREE! Rare New Zealand war stamp for requesting Colonial approvals. Hanlon, Box 24, Schenectady, N. Y.

AMERICAN Packet Free—Old Issues, Commemoratives Galore, Dues, Revenues, etc., 2¢ postage. Midland Stamp Company, Midland, Ontario.

25 DIFFERENT British Colonials to applicants for stamps on approval. Postage 2¢. Nickles, 122 Florida Ave., Washington, D. C.

20 UNUSED stamps free. All different. Postage, 2¢. Fish Stamps, Toledo, Ohio.

PACKET "A" 100 varieties foreign, 20¢ worth the money! Desirable stamps on approval to collectors with satisfactory references. F. J. Pope, Box 45, Charlotte, Vermont.

FREE—50 different stamps with 60% approvals. Enclose 2¢. Seidenberg, Beecher, Illinois.

FREE premiums to approval applicants. Postage 2¢. Hawkins, Raton, N. Mex.

LOW Priced Stamps on Approval. \$10 Confederate bill free to applicants furnishing satisfactory references. G. V. Lovering, 2715 13th St., N. W., Washington, D. C.

STAMPS—12 different from warring nations, 10¢; 10 different foreign coins, 15¢; 20 Belgian stamps, 13¢. Lists free. Toledo Stamp Co., Toledo, Ohio.

LOW priced approvals. Mention paper and receive unused Department Stamp Free. S. E. Colman, 631 Keefer Place, Washington, D. C.

STAMPS—105 China, etc., stamp dictionary and list, 2¢. Bullard, Sta. A, Boston.

STAMPS sent on approval at 70% discount. Precanceled, 1/2¢ each. Reference required. Emory Renold, Hanover, Pa.

PACKET of 23 stamps; no two countries alike, 500 hinges. Set of \$1 and \$2 U. S. Rev., all for 5¢. Mention paper. Miami Stamp Co., Toledo, Ohio.

107 PHILIPPINES, etc.; new paper four months, 10¢. Year 25¢. Philatelist, Norfolk, Nebraska.

HAYTI 1898, 8 varieties, 15 cents; 1904, 6 varieties, 15 cents; ditto surcharged, 20 cents. Approvals. Neel, 889 Clarkson Ave., Brooklyn, N. Y.

RARE COINS

WILL pay \$750.00 cash for \$5 gold piece dated 1822 (without "In God We Trust"); \$50.00 for 1853 half without arrows; \$5.00 to \$50.00 cash for large cent 1799, etc. We pay cash premium for all large cents, eagle cents, 2¢ pieces, etc., and all rare U. S. and foreign coins, bills and stamps to 1912. Thousands of rare coins wanted. Many valuable pieces are in circulation. Send 4¢. Get our Large Illustrated Coin Circular containing valuable information. It may mean much to you. You certainly have nothing to lose. Send to Numismatic Bank of Texas, Dept. H, Fort Worth, Texas.

THREE Large United States Cents 25¢, Six 45¢, Moore Coin Company, Commerce, Texas.

OLD Coins. Spring Catalogue, large list coins for sale (Free). Catalogue quoting prices paid for coins, ten cents. William Hosslein, 101 Tremont St., Boston, Mass.

OLD Coins made into tie pins, fobs and cuff links and gold plated, very cheap. We want a boy in every town to sell our pins, rings and fobs. Earn big money. Send stamp for prices. Coin Exchange, New Rochelle, N. Y.

COINS—Antique Belles, 5 curious rare coins with catalogue, 10¢. Ray Chapin, New Berlin, N. Y.

\$4.25 EACH Paid for U. S. Flying Eagle Cents dated 1856. We pay cash premiums on hundreds of Old Coins. Send ten cents at once for New Illustrated Coin Value Book 45¢. It may mean your fortune. Clarke & Co., Coin Dealers, Box 15, Le Roy, N. Y.

GAMES AND ENTERTAINMENTS

PLAYS, Vaudeville Sketches, Monologues, Dialogues, Speakers, Minstrel Material, Jokes, Recitations, Tableaux, Drills, Musical Pieces, Entertainments for all occasions. Make-up Goods. Large Catalog Free. T. S. Denton & Co., Dept. 11, Chicago.

JUMPING String, Diminishing Card, Quarter Trick, Immovable Card, Twister-scope, All for Ten Cents, Merlin, 3218 Snyder Ave., Brooklyn, N. Y.

LARGE catalog of magic tricks, puzzles, novelties, etc., free. Sales Co., Box 15, Howell, Indiana.

MYSTIC Photos: 32 for 10 cents, with catalogue of tricks, etc. Petterson, 17 1/2 32nd St., Brooklyn, N. Y.

MORE Funabout Fords—New book of funny "Ford Stories." The popularity of Funabout Fords has resulted in the publication of an entirely new collection of about 100 of these stories that the whole nation has laughed at. Either book 25 cents postpaid or both books for 50 cents postpaid. Popular Mechanics Book Dept., 6 N. Michigan Ave., Chicago.

WIGS, Makeups, Tricks, Puzzles, Jokes, Magic Goods, Mind-reading Acts, Sensational Escapes, Illusions, and Stage Supplies. Big catalog free. Oaks Magical Co., Dept. 317, Oshkosh, Wis.

USED Magic Goods and Supplies that please. Hargan Catalogue free. Glinow, Morgan Park, Chicago.

BE a handuff king. We teach you. Escape from handcuffs, boxes, ropes, etc. Secrets of 20 sensational escapes \$1. Particulars free. The Magcraft Co., Dent, A, Box 251, Detroit, Mich.

BUZZ—The musical aeroplane. Sample 10¢, six for 25¢. New Spec. Mfg. Co., 637 Oak St., Buffalo, N. Y.

MAGICIANS' tricks, escapes, Ventriloquist and Punch Figures. All the latest. Big catalog and bargain sheet free. Sylvian's Magic Parlors, B-192 Clifford, Providence, R. I.

WE manufacture exclusive magic specialties. Big catalog, special lists, copy of brightest magic paper, 25 cents. F. G. Thayer, 287 S. San Pedro, Los Angeles, Cal.

WONDERFUL Pack of Magic Trick Cards 10c, with Magic Catalogue. Cabinet of Tricks, 39c. Walwen Company, 130 Nassau St., New York.

SUPERIOR magical apparatus for parlor and stage. Clever pocket tricks with cards, coins, handkerchiefs, etc., easily learned by anyone. New and practical magical effects for advanced amateurs and professionals. 50-page catalogue free. Large, illustrated, professional catalogue 10c. Donald Holmes, 3709 Olive St., Kansas City, Mo.

MAGIC—Tricks, Books and Supplies. For Amateurs as well as the Great Professionals. Any one can learn through our instructions. Feature Acts in Mind Reading, Spiritualism, Rope Ties, etc. Large Illustrated Professional Catalogue, 10c. Chicago Magic Co., Dept. B, 72 West Adams Street, Chicago, Illinois.

"FORD" Joke-book, a good one, 16c coin. Mono Pkz. Co., So. Norwalk, Conn.

HIGH Class Magical Apparatus. Immense stock. Immediate shipments. 50-page illustrated Catalog, 1916 New List and New Bargain Sheet No. 28, free. Large 223-page Illustrated Professional Catalog, 10c. A. Rotenberg, 152 West Ontario Street, Chicago.

FOR BOYS

ENJOY camp life at Boothbay Camp, Bath, Maine. Booklet, A. Webster, 1323 Cypress St., Cincinnati.

BIG New Book for Boys—The Boy Mechanic, Vol. II—Just Out—A sequel to, but containing nothing found in Vol. I. Tells all about 1,803 interesting things to make and do. 486 Pages; 295 Illus. Cloth, Price, \$1.50. Postpaid. Send for descriptive circular. Popular Mechanics Book Dept., 6 N. Michigan Ave., Chicago.

JUST Out—Amateur Mechanics No. 7. For everyone that enjoys building home-made contrivances of every description this book will afford a wealth of practical ideas and suggestions of things both ornamental and useful. Over 200 articles. Fully illustrated. 128 pages (size 6 1/2 x 9 1/2 in.). Price 25 cents postpaid. Popular Mechanics Book Dept., 6 N. Michigan Ave., Chicago.

FOR MEN

OUR Patent Cuff Link opens like a glove. \$1 pair; circular free. The Hub Button Co., Attleboro, Mass.

REDUCE your Cigar Expenses; Havana Midgets, 3 1/2 inches, 100 for \$1.65; Panatelas, 4 1/2 inches, 100 for \$2.50; with Sanitary Amberol Holder. Send Money Order. Money back if unsatisfactory. W. P. Fink Co., 217 West 125th St., New York.

WONDERFUL contrivance: Ash-tray, Match-container, and cigar cutter combined. Clamps to chair arm or edge of desk, flush with top. A dollar bill brings one postpaid with full guarantee. Beacoms Sales Co., 1715 California St., Denver, Colo.

SAFETY BLADES SHARPENED

SAFETY razors sharpened; two cents each. Guaranteed. Blade box free. Electro Strapping Co., 134 Shelby St., Detroit, Mich.

FOR THE HOME

MISSION Furniture—Make your own at little expense. Complete instructions, working drawings and stock lists for 96 different pieces. Price \$1.50 postpaid for set of three books. Send for complete descriptive matter. Popular Mechanics Book Dept., 6 N. Michigan Ave., Chicago.

BED-BUGS and Roaches. Exterminate them and their eggs easily. Formula only. 25c. Perleg, Dept. 4, 4312 Indiana Ave., Chicago.

GUARANTEED Burglar Proof; new "Security Window Lock"; allows ventilation top and bottom; prevents rattling. 25c postpaid; money back if not satisfied. Agents wanted. Wilder, Hearst Bldg., San Francisco.

DIAMONDS, WATCHES AND JEWELRY

GENUINE perfect cut diamonds at \$97.50 per carat is the lowest price in America. Regular retail value \$150.00 per carat. Send now for your free copy of our beautiful 1916 Deluxe Diamond Book, printed in color and profusely illustrated. It explains our wonderful and protective, iron-clad money-back contract and also our offer to ship any diamond for your free examination at our expense and without obligating you. Send postcard or letter for this valuable book to L. Busch & Co., Dept. Y2400, State and Quincy Streets, Chicago, U. S. A.

PIANOS AND MUSICAL INSTRUMENTS

YOU can tune and keep your own piano or player piano in perfect condition. Van Atta's book on The Piano and Player Piano not only tells you but shows you every movement in their care, repair and tuning. 156 Pages. 51 Illustrations. Cloth. Price \$1.50 postpaid. Popular Mechanics Book Dept., 6 N. Michigan Ave., Chicago.

MUSIC

"A RAGTIME War." The song that is selling in thousands. A beautiful edition. Direct from us, 10 cents. Individual Music Co., Princeton, N. J.

RECORDS for Victors, Columbia and Edison (disc or cylinder) Talking Machines. Edison Standard, 9c; Blue Amberol, 25c; Victors, 15c; bought, sold and exchanged. Permanent Jewel Needle, \$1; Jewel point attachment for Victrola or Grafonola to play Edison disc records, \$2. Send for record list. Well's Curiosity Shop, 20 S. 2nd St., Philadelphia, Pa.

LATEST Song "Hits." Words and Music complete, 15c postpaid. Write for list. Wilder, Hearst Bldg., San Francisco.

UNUSUALLY pretty songs: "Lullaby," "You've Carried Off My Heart." Send for them now. Postpaid 25c a copy. Catalogue free. F. Roscoe Webber, Old South Bldg., Boston, Mass.

BE a Good Little Chicken and Lay in My Lap. The season's hit. Fifteen cents. Song Lovers League, Buffalo, N. Y.

FAVORITE Old Home Songs—No home in the land should be without this book of 200 of the familiar old songs everybody loves. Words and music complete in a substantial volume 9 1/2 x 7 inches in size. Price 50 cents postpaid. Popular Mechanics Book Dept., 6 N. Michigan Ave., Chicago.

FORMULAS AND TRADE SECRETS

RESILVERING Mirrors, renewing dry batteries and 500 formulas. 25c. "Ideal," 3511-E, Belleplaine Ave., Chicago.

LUMINO—New and startling—the famous Ink which shines in the dark! Easily read at night; wonderfully beautiful in effect. Formula, complete, 15c. J. Byron Long, Box 356, Salem, Iowa.

HOW to Gold and Silver plate. Send 15 cents. F. F. Hamer, 140 Maple St., Jersey City, N. J.

BEST Tanning formula in existence. 50 cents. Runkle, El Reno, Okla.

EVERYBODY—Doublelife your shoes; formula 25c. C. Sanborn, Bakersfield, Cal.

HIGH Grade Guaranteed Formulas for almost any occasion. Prices reasonable. Cole Chemical Co., Chicago.

RESILVER Mirrors; full instructions. 25c (coin). H. E. Aten, Garden Grove, Iowa.

20,000 FORMULAS—Price \$1, postpaid; complete list 4c stamps. Edm. Bromley, Watervliet, N. Y.

GET my fifteen selected flavoring extract formulas. 25 cents, coin. Lattime, No. 178 Dexter Street, Medford, Mass.

PATENTS Secured through Credit System. Send Sketch. Free Search and Certificate of Patentability. Book and List of Patent Buyers Free. Waters & Co., 4280 Warder Bldg., Washington, D. C.

WE analyze everything. Reliable formulas furnished by experts. B. Laboratories, 657 Madison Ave., New York.

300 FORMULAS, Trade Secrets, Manufacturing Recipes, etc., three business plans for home manufacture, all for 25c. Formulary, Box 154M, St. Paul, Minn.

10,000 SELECTED scientific, chemical, technological, and practical recipes and processes, including hundreds of so-called trade secrets for every business, alphabetically arranged in one large volume of 800 pages. Price \$3 prepaid. Popular Mechanics Book Dept., 6 N. Michigan Ave., Chicago.

TYPEWRITERS AND SUPPLIES

GOOD, serviceable typewriters, \$19 and up. Post card brings list. First class ribbons, any standard machine, 35c. Hub Typewriter Co., 284 Devonshire St., Boston.

SPECIAL Note: If you want a real bargain in a dandy high-class, substantially guaranteed rebuilt typewriter of any make—on time, rental or cash—be sure to write the big house today. Young Typewriter Co., Dept. 258, Chicago.

NEW One Hundred Dollar Standard Visible Typewriter for Thirty-five dollars. Millison Office Supply Co., Wichita, Kansas.

TYPEWRITERS—Prices wrecked. Save 10 to 50% today. All Makes Nearly New and Rebuilt. \$5.00 up. Coronas and other portable machines, \$10.00 up. Write for Cat. 50. Beran Typewriter Co., 58 W. Washington St., Chicago.

LARGEST Stock of Typewriters in America. All makes: Underwoods, Oliviers, Remingtons, etc., one-fourth to one-half manufacturer's price, rented anywhere, applying rent on price; free trial; installment payments if desired. Write for Catalogue 19. Typewriter Emporium (Estab. 1892), 34-36 West Lake St., Chicago, Illinois.

GREATEST clearing out sale in history. Don't fail to get price list Sixty. Typewriter Exchange, Cincinnati.

OFFICE EQUIPMENT

MIDGET Calculator will multiply, divide, figure payrolls, etc. Real time saver. Price 50 cents. Leishman Arcoscope & Supply Co., Ogden, Utah.

DUPLICATORS AND DEVICES

ROTARY Mimeographs, practically brand new, \$14.00 net. Year's guarantee. We pay expressage. Office Specialty Co., Bourse, Philadelphia.

MAKE your own Duplicator; cost small; 50-100 copies, guaranteed. Formula 25c coin. Charles Weygang, Box 1139, Los Angeles, Cal.

OUR "Modern" Duplicator—Yours for \$2.40. No Glue or Gelatin. Always ready. All sizes, Free trial, 34,000 users. Standard for 13 years. Booklet free. Sole infra., J. E. Durkin & Reeves Co., 339 Fifth Ave., Pittsburgh, Pa.

DUPLICATORS, 9x12, price \$1. Make 50 copies from pen or typewritten original. Booklet Free. Scientek Laboratories, Dept. 1, Madison, Maine.

MAILING LISTS

NEW private names. Purcell, 80 43rd St., Corona, N. Y.

BOHEMIANS, list of five thousand in Texas—\$10. Albert Fabian, Hallettsville, Texas.

2,000 NAMES for sale. Taxable. Best wheat country. Novelty Sales Co., Waterville, Wash.

PRINTING, ENGRAVING, MULTI-GRAPHING

LETTERHEADS, Billheads, Envelopes; 500 each, \$5. Thousand each, \$7.50. Best grade Hamormill Bond. Lowest prices on all kinds printing. Send copy for estimate. Satisfaction guaranteed. Langhorne Printery, Langhorne, Pa.

LETTERHEADS—1,000, \$2.00; 2,000, \$3.50; 5,000, \$7.50; good grade bond paper, 16 pound; others charge more for same quality; samples free. Girard Job Shop, Dept. L-2, Girard, Kansas.

GOOD Printing at low prices. 1,000 good letterheads, envelopes, cards, billheads, labels, circulars, \$2.50. Samples free. Catalogues, booklets, and circulars our specialty. Ernest L. Fantus Co., 523 S. Dearborn St., Chicago.

ENGRAVED Wedding Announcements, \$6, Invitations, \$7.50. Nichol, 1016 Chestnut, Philadelphia.

STATEMENTS, cards, noteheads, envelopes; 500, \$1.25; 1,000 3x8 circulars, \$1. Samples free. O. Dickey, Bayonne, N. J.

GUMMED Labels direct from the producers; 2,000, 75c. Catalog No. 102 on request. Royal Label Company, 468 Cherry, Philadelphia.

150 BOND Letterheads and 150 Envelopes, postpaid, \$1. Geo. F. Jacob, Emporium, Pa.

"NEARGRAVURE" Printed Stationery, facsimile embossing. Distinctive. Samples. Soliday's, Knox, Ind.

PRINTED—500 6 1/2 envelopes, \$1.05; 500 cards, \$1.00; 500 statements, \$1.95; 500 bond letterheads, \$1.60; 1,000 3x6 circulars, \$1.00. T. H. Dickey, 1172 Stout, Denver, Colo.

LEON Miller, Printer, 1952b German-town Ave., Philadelphia. Specialties, Booklets, Circulars.

1,000 3x6 CIRCULARS, 100 words, 85c. 100 Business Cards, 25c. Chas. Walter, Lancaster, Ohio.

IMITATION Embossing—250 Letterheads and Envelopes, \$1.25; Samples Free. Russell, 4335 43rd Ave. S., Minneapolis, Minn.

GOOD Printing—1,000 Bond Letterheads, \$2.50; Bill Heads, Envelopes, Business Cards, \$2.00. Wolverine Press, 37 Harrison, Detroit, Mich.

MAIL Order Dealers—1,000 Multigraph letters complete with letterheads (two colors), \$3.00. Exact imitation typewritten letters. Samples Free. Superior Letter Company, Huntington, Indiana.

GUMMED Labels—All kinds, 500 with name and address, 25c. Eastern Label Co., D-1, Clintonville, Conn.

RARE Bargains in imitation typewritten letters, art ad slips, envelopes, letter heads, circulars. Bargain list and elegant set Samples free. Good's Printery, Harrisonburg, Va.

FOR Sale—At a bargain. Chalk-plate stereotyping outfit. All condition. Troy Carver, Colchester, Ill.

FOR \$1.25 postpaid 100 each: Letterheads, Envelopes, Cards. Your order, Samples. Lincoln Novelty Co., 477 N. Goodman, Rochester, N. Y.

100 GOOD letterheads and 100 envelopes, 85c postpaid. Oec. Hanson, Mentor, Minn.

FINE Envelopes or Note Heads, neat print, 35c each 100. Prompt, 50 cards, 20c. Engraved tone, Royal Print, Mt. Carmel, Pa.

250 LETTERHEADS and Envelopes prepaid \$1.25. Hoyt Bros. Pittsfield, N. H.

PRINTING that's up to a standard, not down to a price. Portfolio of samples, 4c. Printe Shoppe, New London, Ohio.

ADVERTISING GUMMED Labels—All kinds—any business; get catalog 115. Desk Calendar 2c. Stephens-Wetzel Co., 101 Madison Square, New York.

GUMMED Labels, 3,000 \$1.00. Catalogue 2 cts. MacFarrart, 1235 Arch, Philadelphia, Pennsylvania.

QUALITY Printing Prepaid—500 either envelopes, noteheads, cards, statements, \$1.25; 1,000 \$1.85; 1,000 envelope slips, \$1.1,000 6x9 circulars, \$1.75. 500 linen finish letterheads or envelopes, \$1.75; 1,000, \$3. printing prepaid. Imitation typewritten letters. Stamp brings samples. Model Company, Manchester, Iowa.

EMBOSSSED Letterheads on good Bond Paper \$3.75 per 1,000. Send for samples. Commercial Embossing Co., Wilkes-Barre, Pa.

ILLUSTRATE your printing; cuts made from photographs, 85c. We print anything. Samples free. Commercial Press, Batavia, Ohio.

1,000 LETTERHEADS or Envelopes on 20 pound Bond Paper, \$2.00. 1,000 Statements or Cards, \$1.75. John D. Mesler, Cobden, Ill.

HIGH Grade Business Stationery—500 Letterheads, Envelopes, Billheads, Cards, Statements, \$7. Write for Samples. Chas. R. Hartmann, Printer, Box 22 Hudson City Station, Jersey City, N. J.

SPLENDID Quality 250 Bond Letterheads and Envelopes, \$1.25. 1,000 Circulars, 5x8, \$1.25. Hoyt Brothers, Pittsfield, New Hampshire.

PRINTING Outfits—Presses, type, supplies, type novelties. Send stamp for catalogue. Model Press, York, Penna.

250 BOND Letterheads or Envelopes, white, blue or buff, printed to order, \$1.00 prepaid. Both for \$1.75. Samples free. Commercial Press, Beaver Falls, Pa.

MULTIGRAPH Letters, Letterheads—1,000 complete, \$3. Letters, purple, heads black. Samples for stamp. Perfection Letter Company, Muncie, Indiana.

PRINTING Presses, Type and Supplies. Low Prices. Big Stock. List for Stamp. Popular Bargains, Richland, Pa.

PATENT ATTORNEYS

PATENTS—Herbert Jenner, patent attorney and mechanical expert, 696 F St., Washington, D. C. I report free of charge if a patent can be had and its exact cost. Send for circular.

PATENTS—Trade-Marks. Send for my free book, "How To Get Them." It's full of information you should know. Joshua R. H. Poets, 8 Dearborn St., Chicago; 929 Chestnut St., Philadelphia; 805 G St., Washington.

PATENTS that protect and pay. Advice and books free. Rates reasonable—highest references; best results. Watson E. Coleman, Patent Lawyer, 624 F St., N. W., Washington, D. C.

THE Patentome is free. An education in obtaining patents. Established 1863. Anderson & Son, Attorneys, 707 7th St., Washington, D. C.

PATENTS Manufacturers B-U-Y are the kind we obtain for our clients. For evidence and free book of greatest interest and real value to inventors, write R. S. & A. B. Lacey, Patent Lawyers, 729 Barrister Bldg., Washington, D. C.

PATENTS explained in my free books, telling what you should know—what to invent—what not to invent—how to sell your patent, etc. Write today, H. L. Woodward, 902 G St., Washington, D. C.

PATENTS as low as \$17 entire cost. Why pay extortionate attorney's fees? Patent News 99, Washington, D. C.

PATENTS Secured Through Credit System. Send Sketch or Model for Free Search of Patent Office records and Certificate of Patentability which establishes Proof of your invention until application is filed. Manufacturers writing us for new ideas. Valuable Book, Advice and List of Patent Buyers Free. Waters & Co., 4280 Warder Bldg., Washington, D. C.

PATENT your invention, \$10.000 offered for inventions wanted. Booklet and opinion free. Milo B. Stevens & Co., Established 1864. 635 F St., Washington, 353 Monadnock Block, Chicago.

H. F. LOWENSTEIN, Patents, Mechanical and Electrical Expert, McGill Building, Washington, D. C. Send sketch and description for advice, statement of total cost and manner of payment. For personal search of Patent Office records with special written report, remit \$5.00.

"PATENTS and Patent Possibilities" is a 72-page treatise which tells all about patents, what to invent and where to sell it. It gives honest advice to inventors and tells about the successes of some of my clients, also explaining what are frequent causes of failure. Manufacturers are constantly writing for protective patents upon all kinds of sound inventions. Can you help supply their wants? The book is free. Write for it today. H. S. Hill, 905 McClachlen Building, Washington, D. C.

PATENT Secured—Trade Marks registered. Validity and infringement searches made. Patent suits conducted. Instructions sent on request. Wm. N. Hoach, Jr., Attorney-At-Law and Solicitor of Patents, 950 McGill Bldg., Wash., D. C.

PATENTS—Send sketch for free search and report. Books on patents and book of reference letters sent free. John S. Duffie & Co., 610 F St., Washington, D. C.

PATENT what you invent. It may be valuable. Write me. No attorney's fee until patent is allowed. Estab. 1892. "Inventor's Guide" free. Franklin H. Hough, 522 Loan & Trust Bldg., Washington, D. C.

PATENT Your Ideas—\$9,000 offered for certain inventions. Books, "How to Obtain a Patent" and "What to Invent," sent free. Send rough sketch for free report as to patentability. Manufacturers constantly writing us for patents we have obtained. We advertise your patent for sale at our expense. Established 20 years. Address Chandler & Chandler, patent attorneys, 828 F St., Washington, D. C.

NO Attorney fees until patent allowed. Send sketch for free report. Books free. Frank Fuller, Washington, D. C.

C. L. PARKER, Ex-member Examining Corps, Patent Office, Patent Attorney, McGill Bldg., Washington, D. C. Inventor's handbook, "Protecting, Exploiting and Selling Inventions," sent free upon request.

PATENTS That Pay. Proof given, Two wonderful guide books free. E. E. Vrooman & Co., 871 F St., Washington, D. C.

PROTECTIVE patents procured promptly. 112 page blue book on patents sent on request. Trade-marks registered. Robb & Robb, 211-215 Southern Bldg., Washington, D. C.

DON'T lose your rights to patent protection. Before proceeding further send for our blank form, "Evidence of Conception," to be signed and witnessed. Book, suggestions and advice free. Lancaster and Alwine, 221 Ouray Bldg., Washington, D. C.

PATENTS secured or fee returned. Actual search free. Send sketch. Latest complete patent book free. 1914 Edition. (Ninety pages.) Free sales service. It should never require more than two days to report upon the patentability of your invention; nor longer than six days to prepare your case for filing. Longer delay amounts to gross neglect. For prompt personal service write: George P. Kimmel, 212 Barrister Building, Washington, D. C.

PATENTABLE Ideas Wanted—Send for 3 free books. R. B. Owen, 30 Owen Bldg., Wash., D. C.

PATENTS: Send model, sketch or drawing. Advice, 161 Mechanical Movements and 50 Perpetual Motions, Free. Fred G. Dieterich & Co., 61 Ouray Bldg., Washington, D. C.

PATENTS obtained through D. Swift being promptly sold to manufacturers. Write today for free books of "Inventions Needed" and surprising references. D. Swift, 317 Seventh St., Washington, D. C.

WANTED—New Ideas. Write for List of Inventions Wanted. \$1,000,000 in prizes offered for inventions. Our Four Books sent free upon request. Victor J. Evans & Co., 140 Ninth St., Washington, D. C.

FOR INVENTORS

INVENTIONS developed and models constructed. Articles perfected for economical manufacture. Efficient service. Your inquiry will be appreciated. E. H. Pickett, Department "E," Pontiac, Michigan.

HAVE you a Patent to sell? You'll be interested in my proposition. Write now for free particulars. Don't call. F. W. Johnson, 6 N. Michigan Ave., Chicago.

SUBSCRIBE to Invention. It publishes news of recent patents, real opportunities and inventions actually wanted, inventions that succeed, and why; inventors who have made fortunes. It helps inventors to save money on attorney's fees and to advertise their inventions, and to make money out of their patents. One dollar a year, published monthly. Address: Invention, 215 G Street, N. W., Washington, D. C. Special Offer: 5 months 25c if sent now.

PATENTS, Trade-Marks and Copyrights. Our handbook on patents will be sent free on request. All patents secured through us are described without cost to the patentee in the Scientific American. Munn & Co., Patent Attorneys, 672 Woolworth Bldg., N. Y. Washington, D. C., office, 625 F St.

PATENTS Manufacturers B-U-Y are the kind we obtain from our clients. For evidence and free book of greatest interest and real value to inventors, write R. S. & A. B. Lacey, Patent Lawyers, 729 Barrister Bldg., Washington, D. C.

WANTED—Information regarding good patent for sale. Send description and price. R. G. List, Minneapolis, Minn.

INVENTOR'S Advocate, A, Washington, D. C., one year \$1, including all forms and full instructions for preparing and filing patent applications.

PATENTS and unpatented inventions sold for subscribers or no charge, advertised free. Inventor's Advocate, Washington, D. C. \$1 per year.

PATENTS Secured through Credit System. Send Sketch, Free Search and Certificate of Patentability. Book and List of Patent Buyers Free. Waters & Co., 4280 Warder Bldg., Washington, D. C.

INVENTORS! Send 5c for Book and List of Inventions Wanted. Sanders, 7 Webster Building, Chicago.

WE are looking for improvements, suggestions and inventions on Player Pianos. What have you? Also inventions, etc., on Player Pianos operated by electricity. Player Piano Patent Purchasers Agency, P. O. Box 128, Madison Square, New York City.

PATENT Sales Specialists. Best Location and Facilities. Fuller, 500 5th Avenue, New York.

PATENTABLE Ideas Wanted—Send for 3 free books. R. B. Owen, 30 Owen Bldg., Wash., D. C.

PATENTS without advance attorney's fees. Send sketch for free report. Books free. Frank Fuller, Washington, D. C.

INVENTORS: My patent made a fortune. Particulars free. Let me sell yours. Eugene Pearl, M28 Union Square, New York.

WANTED—An Idea! Who can think of some simple thing to patent? Protect your ideas; they may bring you wealth. Write for "Needed Inventions" and "How to Get Your Patent and Your Money." Randolph & Co., Patent Attorneys, 426 F St., Washington, D. C.

HAVE You an Idea? If so, you should protect it by a patent. Send us a model or sketch for free opinion as to patentability. Write for our Four Books sent free to any address, Victor J. Evans & Co., 157 Ninth St., Washington, D. C.

GREAT opportunities exist for inventors, but a patent is not everything. My free books tell what you should know. Horace L. Woodward, 962 G, Washington.

INVENTIONS—Patenting and Promoting. A book containing practical advice and directions for inventors and manufacturers. Book, suggestions and advice free. Lancaster and Allwine, 221 Ouray Bldg., Washington, D. C.

INVENTIONS commercialized on cash and royalty basis. Two free books. Inventors and manufacturers write. Adam Fisher Mfg. Co., 2051 Ry. Ex., St., Louis, Mo.

PATENTS FOR SALE

OUTRIGHT or royalty. Reversible rubber heel. Patent No. 1154917. Most practical heel ever invented. A fortune in this for Banister, Geo. H. P. Foster, 4342 N. Hobey St., Chicago.

FOR Sale, patented baby's Teething device. Fine Mail Order article. J. Golden, 3120 W. 84th St., Cleveland, Ohio.

FOR Sale—Hospital Bed. U. S. Patent applied for. Write, Mrs. Salome Fillion, Lake Linden, Mich.

BEST puller and topper; saves time, trouble and money. Price, \$10.000. Larson, Canterbury, Conn.

"TAIL-LIGHT" for Automobiles. Efficient and very practical. Splendid opportunity for safe investment. Investigate. J. J. Lindsey, 1526 Routt Ave., Pueblo, Colo.

PATENTS and inventions for sale or on royalty. My clients have valuable inventions for market. No better investment for manufacturers or individuals. Full information without charge. Mention line of invention interesting you and data will be sent. Richard B. Owen, Patent Lawyer, Owen Building, Washington, D. C.

AEROPLANE. Boat propeller for sale. Elmer C. Blackwell, Salem, Mo.

SALE or Royalty—Combined soap and glass holder. Nails or screws to fasten unnecessary. Charles Hennecke, 232 Vine St., River Forest, Ill.

FOR Sale—Patent on metal window-pane fastener. W. T. Day, 16 Richardson Road, Newton Upper Falls, Mass.

FOR Sale—Combination Tobacco can and match holder. Patented. Carry matches bottom of can. Adam Lochner, Chandler, Okla.

FOR Sale—Insulator patents. Without tie wires. Adam Lochner, Chandler, Okla.

HEAR from parties interested in buying new useful patent. W. H. Jackson, Jackson, Mich.

THE latest and most efficient fastening devices for shoes and may also be used on garments. Have made application for Canadian rights. Address Frank Stryffeler, Diamond, Ohio.

FIRE Escape for Sale. Fully tested and been improved. Can take down fifty persons a minute. Can be set in any window and be moved to another part of the building in very short time. Joseph T. Boufford, Lenwood, Mass.

SIMPLE good United States and Canadian Patents 146,535. Hen's nest. Chickens cannot pick nor soil the eggs when laid. Patents pending. Indicating door lock for closets, etc., and electric light holder in any position. Royalty or sale. Nick Wenz, Lewiston, Minn.

FOR Sale or Royalty. Wonderful invention. First and Second Class Mail, Self-Opening Envelopes. Sure money maker. Mary B. Gaston, New Castle, Pa.

FORTUNE making patents and inventions for sale on most reasonable terms. Patent News, 52, Washington, D. C.

VALUABLE patent, cultivator fan. Practical farmers' necessity. Grant Craver, Searsboro, Ia.

GOLDMINE Patent for sale, outright or royalty. Device for taking place of shoe-lace. Millions in it for party who is able to handle it. Address Wm. Houseman, 615 Wells St., Chicago, Ill.

LAMP Chimney attachment. Eliminates leakage. Superior to any other on market. Manufactured cheap. Sale or Royalty. B. McFranklin, Diamond, Ohio.

THREE hundred dollars will buy recently allowed low-priced Green Bone Cutter, metal patterns, and cuts for circulars. G. Sanford, 808 South Twelfth St., Newark, N. J.

"WHIP Socket"—It holds the whip firmly and absolutely eliminates the loss of whips by thievers. Very simple in construction, low cost of manufacture. Will accept reasonable offer. B. Amundsen, Standard Mine, Silverton, B. C., Canada.

IMPROVED Auto trouble or electric portable lamp; it has many good advantages. Write for circular. Homer Kimura, Rock-springs, Wyoming.

FOR Sale or Royalty—U. S. Motor Skate Patent. Very interesting. Surely a money maker. Jos. Felley, R. No. 1, Paterson, N. J.

FOR Sale Outright or on Royalty—Patented Automobile Steering Device. Especially adapted for Ford Autos. N. S. Matson, Fargo, N. D.

FOR Sale or Royalty—Patented paper cup to contain Mineral Water or soft-drink preparation in powder form. Drink ready for use when cup is filled with water. Andrew Mills, Weir, Mass.

FOR Sale—Patent right for simplest and most efficient crude oil burner for steam boilers. Geo. F. Timkham, Box 1307, Washington, D. C.

NON-REFILLABLE Bottle. At last a practical article. Don't hesitate. Investigate this money-maker. M. J. Souza, R. F. D. 2, Box 78, Selma, Calif.

FINGER tip Safety Razor. Entirely new principle. Have all the dies to manufacture. Never put on market. Have other business. J. D. Miller, 638 Summit Ave., Milwaukee, Wis.

FOR Sale—Patent on Fast Flowing Automobile funnel. Great time and labor saver. Simple and will not become air bound. Ed. W. Mueller, Bensenville, Ill.

GREAT safety device for ships in case accident or struck by torpedo or mine. Opening can be plugged immediately; delay sinking. May save ship. A. K., 3256 Seminary Ave., Chicago.

PATENT rights two piece piston ring. Outright or royalty. Superior to any ring on market. Frank Anderson, 2819 Eads Ave., St. Louis, Mo.

CHEAP for cash. The only Electric toaster and boiler for hotels, unlimited capacity, easily constructed. 1116442. Hugh F. Kirkwood, Augusta, Me.

PATENTED Automatic Mitre Box. Absolute success. Kawalle Co., Manitowoc, Wis.

PATENT pending on Sanitary Cuspidor. Ornamental design. Outright or royalty. Robert R. Adams, 2837 Observatory Rd., Hyde Park, Cincinnati, O.

PATENTS for sale—Patent No. 1,092,986, April 14, 1914. Means for indicating broken rails on railroads. Of interest to dealers in railroad supplies. Address Jos. J. Gartside, 719 N. 40th St., Phila., Pa.

PRINTING Press manufacturers. Notice: I have a patent on form lock extension for sale cheap; it's a necessity. Particulars free. John Johnson, 718 Sims St., St. Paul, Minn.

ELECTRIC door unlocking, opening and closing means for automobiles. Especially adapted for closed cars. K. Wm. Kurtz, 39 Mowry Apts., Syracuse, N. Y.

NEW pocket article. Cash or trade for best automobile. L. 525, Power Bldg., Montreal.

NEW invention—Snow removing device, a labor saving machine with unlimited possibilities; scoops up the snow off streets, walks, etc., and deposits same into wagons more rapidly than a thousand men; U. S. patent rights for sale. Eckardt, 17 South Essex St., Dover, N. J.

FOR Sale—U. S. and Canadian Patent on Dustless Ash Sifting Shovel, operated under furnace, easy to manufacture, and in ready demand at a good profit. Best cash offer takes them or cash and royalty. W. J. Davidson, 311 Tribune Bldg., Winnipeg, Canada.

PUSH Tractor—Patent No. 1171732, for sale. Send for copy of patent. N. A. Lyle, Box 646, Bancroft, Idaho.

PATENT Buyers are invited to address our sales department for information on any class of Patents they wish to purchase or lease on a royalty. We have secured a number of valuable patents in all lines of invention. Mail Order, Department Store and Household Novelties a specialty. Victor J. Evans & Co., 160 Ninth St., Washington, D. C.

"RADIATOR Cover." Automatically opens and closes radiators of automobiles, aeroplanes. Prevents freezing. Practical and economical device. Strictest investigation invited. E. M. Vaughan, 1225 Bushwick Ave., Brooklyn, N. Y.

MODELS AND MODEL SUPPLIES

PRODUCERS of Results: Inventions developed. Models. Experimental work, anything special in metal to order, novelties, spinning, forging, castings in any material, electrical devices, patterns of all kinds, plating, general manufacturing, designing, special tools, punches and dies, stampings. Send drawings or sample. Expert information free. The John's Machine & Stamping Works Company, Dept. C, Cleveland, Ohio.

IF you have something to be made write us. Models, Experimental Work and Manufacturing. Quality is the keynote of success. The United Machinery Company, Cincinnati, Ohio.

WE develop models, are equipped for die work, plating, and stamping of specialties. Experts employed. Automatic Machine Mfg. Company, Kansas City, Missouri.

WE make working models for inventors; also dies and stamping of specialties, and carry a complete stock of brass gears and model supplies. Send for catalogue. The Pierce Model Works, 8465 Pierce Ave., Chicago, Ill.

INVENTORS who have models, dies, tools, metal specialties, special manufacturing and experimental work, don't fail to get our estimates. Our 22 years' experience is at your command. Backer & Gerding Mfg. Co., 121 Opera Place, Cincinnati, Ohio.

FREE catalogue of model supplies. Castings, metal specialties on contract. North Chicago Tool Works, 15 Grove Ave., North Chicago, Ill.

MANUFACTURING

INVENTIONS perfected and manufactured. Reference: Your Banker. Russell Machine Co., Dallas, Texas.

PATENTED Articles, Models, Brass work, Dies, made. Baum's Metal Specialties, Kansas City, Mo.

WE can furnish machined castings of Cast Iron, Brass and Aluminum. Lewis Steel, Iron & Machine Works, North Chicago, Illinois.

LIGHT manufacturing. Lathe and Drill Press work successfully handled. Modern Model Eng. Co., 3901 N. Central Park Ave., Chicago.

MODELS, tools, dies, experimental work. Rates reasonable, expert workmanship. Seibergel Mfg. Co., Darton, Ohio.

LET Our factory be Your factory. Metal specialties developed and correctly manufactured. L. R. Nelson Mfg. Co., Peoria, Ill.

PREPARED to manufacture metal specialties of all kinds. Also dies, tools and models. Our consultation department at your service free. Hall Mfg. Co., Muncie, Ind.

WIRE Goods, all kinds, made to order. Cooley Mfg. Co., 553 W. Monroe St., Chicago.

WE do Metal Stamping and forming of all kinds, also make dies. Goshen Eyelet Co., Goshen, Ind.

WANTED—Specialties with merit to manufacture and sell, particularly automobile specialties. Well-equipped manufacturing and merchandizing facilities. Hastings Mfg. Co., Hastings, Mich.

GINSENG

GINSENG Seeds \$1.00 thousand, planting instructions free. Specialty Farm, Rockford, Minn.

GINSENG Culture, 16c. Golden Seal estimate \$6,000 an acre. Booklet giving my experience, 16c. W. N. Long, Florence, Ky.

Additional Classified Ads Page 34

Learn the Automobile from A to Z

FOR OWNERS, DRIVERS AND REPAIRMEN

Every Motor Car in use today is fully described and illustrated in every particular in these

NEW 1916 BOOKS



Brookes Automobile Handbook

Revised to March 1, 1916. By H. P. Manly. Over 700 pages of practical information on the automobile—over 400 pages on 1916 equipment, with 355 illustrations and diagrams and 12 tables. Every subject is treated in non-technical language—you can understand it. Extensive treatment of Carburetors, Ignition, Starting and Lighting. Subjects are arranged alphabetically and indexed. Special attention is given to adjustments and repairs—what to do and what not to do. Handsomely bound in limp leather, round corners, red edges, gold stamping, pocket size. Price, postpaid, \$2.00.

Automobile Starting and Lighting

By H. P. Manly. (Published March 15, 1916.) This book is devoted entirely to 1916 starting and lighting equipment. It is non-technical and is intended for the owner and the repairman. A series of illustrations and diagrams supplement the text. The following divisions of the book show its scope: I. Electric Lighting and Engine Starting Equipment; II. Lighting Dynamics and Starting Motors; III. Storage Batteries; IV. Lamps and Wiring; V. Control Parts; VI. Dynamo and Motor Drives; VII. Current Measuring and Indicating Devices; VIII. Starting and Lighting Troubles. Also words and terms used in electrical work. Index. 200 pages, fully illustrated, pocket size, cloth, postpaid, \$1.00. Full Leather, red edges, gold stamping, postpaid, \$1.50.

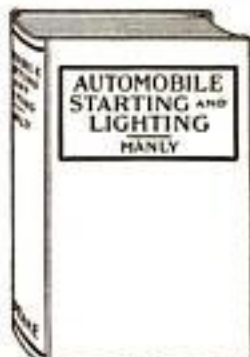

200 pages, fully illustrated, pocket size, cloth, postpaid, \$1.00. Full Leather, red edges, gold stamping, postpaid, \$1.50.

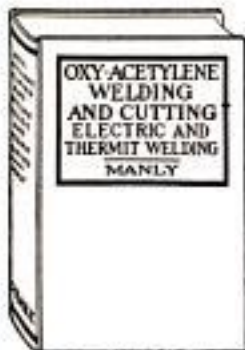

Automobile Catechism and Repair Manual

By C. F. Swingle and H. A. Tarantous. Pocket size. Full Leather, stamped in gold. Red edges. 165 pages. Fully illustrated with folding charts and line drawings. Price, postpaid, \$1.25. This book comprises over 400 questions and answers on the construction, care and operation of the automobile. Part I comprises the questions and answers. Part II is devoted entirely to automobile repairs. It gives complete instructions for locating troubles and making adjustments and repairs of all kinds. The following subjects are covered in detail from the repair standpoint: Motor knocks, carburetion, ignition, valve troubles, fitting piston rings, and tires. Numerous practical illustrations show just how to follow the directions.

Oxy-Acetylene Welding and Cutting Electric and Thermit Welding

By H. P. Manly. 215 pages, fully illustrated. Cloth, \$1.00. Leather, stamped in gold, red edges, \$1.50. The extensive use of the oxy-acetylene flame in welding and cutting has created an active demand for a practical book explaining this process. In addition to the oxy-acetylene welding are included electric and thermit welding, also a chapter on hand forging and welding. In order to make a complete book on welding, the following subjects have been included: annealing, tempering, hardening, heat treatment, and the restoration of steel. Much practical information is given on the uses and characteristics of the various metals. Thus, in this book the garage man, the manufacturer and the workman will find all necessary information and data required in handling any kind of welding.

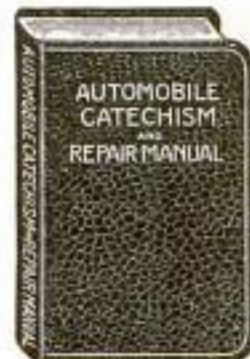

lene welding are included electric and thermit welding, also a chapter on hand forging and welding. In order to make a complete book on welding, the following subjects have been included: annealing, tempering, hardening, heat treatment, and the restoration of steel. Much practical information is given on the uses and characteristics of the various metals. Thus, in this book the garage man, the manufacturer and the workman will find all necessary information and data required in handling any kind of welding.

The World's Greatest Practical Electrical Books \$1

By HORSTMANN, TOUSLEY, MORETON, LOWE

Fit You for Any Kind of Electrical Work. Written in non-technical language. You don't need a college education to understand them. They are strictly up-to-date in every respect and uniform in type, illustrations, diagrams and binding. A whole electrical library at \$1.00 per volume, postpaid. These books have never been sold at less than \$1.50 and \$2.00 a volume. All bound in limp cloth, uniform, pocket size, 4 1/2 x 6 1/2 in.

Electrical Measurements and Meter Testing
By PROF. MORETON. All meters carefully described. 328 pages, 191 illustrations and diagrams.

Modern Electrical Construction
By HORSTMANN AND TOUSLEY. 440 pages, 263 illustrations.

Drake's Telephone Handbook
By PROF. MORETON, of Armour Institute. 286 pages, 161 illustrations and diagrams.

Armature and Magnet Winding
By HORSTMANN AND TOUSLEY. 200 pages, 153 diagrams and illustrations.

Electrical Tables and Engineering Data
By HORSTMANN AND TOUSLEY. 300 pages, 150 diagrams, tables and illustrations.

Drake's Electrical Dictionary
By P. E. LOWE. 320 pages of electrical words, terms and phrases, carefully defined and explained.



Electricians' Operating and Testing Manual
By HORSTMANN AND TOUSLEY. 360 pages, 211 illustrations and diagrams.

Modern Electric Illumination
By HORSTMANN AND TOUSLEY. 274 pages, 40 illustrations and diagrams, 21 tables.

Wiring Diagrams and Descriptions
By HORSTMANN AND TOUSLEY. 300 pages, 230 illustrations and diagrams.

Electric Motors, Direct and Alternating
By PROF. MORETON. 250 pages, fully illustrated.

Motion Picture Operation—Stage Electrics and Illusions. By HORSTMANN AND TOUSLEY. 393 pages, 216 illustrations.

Alternating Current, Theory, Practice and Diagrams. By HORSTMANN AND TOUSLEY. 300 pages, fully illustrated.

Guarantee: We will send postpaid one or all of these books upon receipt of price. If after 5 days' examination you are dissatisfied for any reason, return the book or books and we will refund your money.

Send for our large catalogue of practical mechanical books for Electricians, Engineers, Telephone Men, Machinists, Railroad Men, Automobilists, Carpenters, Plumbers, Sign and Card Writers, Scene Painters, etc. It is **FREE**

FREDERICK J. DRAKE & CO.
Dept. 8, 1006 Michigan Ave., CHICAGO

Continued from Page 32

REAL ESTATE AND FARM LANDS

FLORIDA Opportunity—During the past year, which has been one of financial depression, panics, hard times and scarce money, we have sold to bankers, doctors, brokers, investment experts, lawyers and the choicest class of business men, about 17,000 acres of first-class orange, grapefruit and Natal hay land in Lake County, Fla.; this in spite of the fact that other companies in Florida have been doing little or nothing in the selling line. There is a reason why we have been able to do this and the reason is—the land. Let us show you as those who have bought have already been shown. Lake County Land Owners' Association, No. 93 Lake Ave., Fruitland Park, Florida.

YOU'D like it in North Carolina, Maryland or Virginia. Farm Lands \$15.00 per acre up. Easy terms—on railroad, near market. Write for list. Mild summers, short winters, good markets. If you will send names of two friends interested in the South will send you year's subscription free to Southern Homeseeker. Write F. H. LaBaume, Agri. Agt., Norfolk & Western Ry., 250 N. & W. Bldg., Roanoke, Va.

FRUIT and Poultry Raisers—5 acres, 20 hens, 3 pigs, 50 Pecan, Orange and other fruit trees, 1,400 Strawberry plants. Price, \$250. Cash \$5, monthly \$5. Write for pamphlet, "What 5 acres on Mississippi Gulf Coast Will Do." Dudley Scheffer, Ocean Springs, Miss.

TEN acres, richest land for fruit, in U. S.; near Council Bluffs St. car, and "White-Pole Iowa Highway;" also twelve acres, with modern house. You might subdivide, for suburban homes; one mile to city school; 2 miles to 7 railroad stations. Owner, J. E. Officer, Council Bluffs, Iowa.

MONEY-Making Farms throughout 15 eastern states: 1 to 1,000 acres, \$15 per acre up; several with live stock and tools included to settle estates. Illustrated catalogue. "Latest Farm Bargains" mailed free. E. A. Strout Farm Agency, Dept. 3043, 47 W. 34th St., New York.

100% PROFIT: Buy now, 40 acres Cut Over Land in Langlade & Oneida County, Wisconsin, for \$150. Fine soil, 1/2 down, balance on time. Wm. Hardt, 855 West North Ave., Chicago, Ill.

SELL your property quickly for cash, no matter where located. Don't pay big commissions. Particulars free. Real Estate Salesman Co., Desk B, Lincoln, Nebr.

HOW much do you want for your farm? A. Mohler, Monon Bldg., Chicago.

NOW is the time to buy Arkansas land. We own what we sell and have genuine bargains. Parker Brothers Nursery Co., Fayetteville, Ark.

210-ACRE improved farm, 2 1/2 miles Mound City, Kas.; for quick sale \$35 per acre. Address F. O. Box 696, Okmulgee, Ok.

EAST North Carolina, 700 acres level black cut-over pine land, 1 1/2 miles to Co.-seat. \$4,500 cash. Jay Finch, Cortland, Ohio.

I HAVE a successful way of selling farms and farm lands. Write me for free particulars. No obligation whatever. Don't call. E. J. Zimmer, 925 Tower Bldg., Chicago.

MICHIGAN Fruit, Dairy, Poultry and general farms. Write for list. Chas. Schmieding, Shelby, Mich.

FREE Government Land in Florida. Over 100,000 acres open to homestead. Send 25c for book of information. V. W. Gould, Box 922, DeLand, Fla.

\$5 DOWN, \$5 monthly; 20-acre fruit, poultry farm; Osarks; \$100; good hunting, fishing. 1975 N. 5, Kansas City, Kans.

RELIABLE Information about prosperous, growing regions in Alabama, Florida, Georgia, Kentucky, Mississippi, North Carolina, South Carolina, Tennessee, Virginia, Southern Illinois and Southern Indiana will be sent, on request, to homeseekers, manufacturers and investors. M. V. Richards, Commissioner, Room 64, Southern Railway, Washington, D. C.

FARMS for sale or exchange anywhere in the U. S. or Canada, direct from the owners. State where you want to locate. Information free. American Investment Association, 37 Palace Bldg., Minneapolis, Minn.

TWENTY acres in San Joaquin Valley, California, in fruits, vegetables, alfalfa, with cows, pigs, poultry and bees, will pay you steady, substantial profits. Delightful climate, rich soil, good schools, churches, fine roads. Thrifty, hospitable neighbors. Write for free books. C. L. Seagraves, Gen. Colonization Agent, AT&SF Ry., 1916 Ry. Exch., Chicago.

FARM of 120 acres located 2 1/2 miles from Jonesville in Hillsdale Co. A splendid farm equipped for dairying, fine house, large barns and will make an ideal home. Price, \$13,500.00. Easy terms. Address F. L. Farnsworth, Hillsdale, Mich.

REAL Estate Educator—Containing inside information not generally known. "Don'ts" in Real Estate, "Pointers," Legal Forms, etc. It gives in condensed form the essential knowledge of the Real Estate Business. New revised edition covers Workmen's Compensation Act, Income Tax Law, Employers' Liability Act, Statute of Frauds, How to Sell Real Estate, etc. What you need to know; ought to know and want to know. 256 pages, cloth, \$1 postpaid. Popular Mechanics Book Dept., 6 N. Michigan Ave., Chicago.

DOGS, BIRDS, POULTRY, PETS

RAISE Guinea Pigs. Big profits. Great demand. Small capital needed. Buy all you raise. Free particulars. Booklet on Pigs 10c. Edward F. Tobener, 2828 Woodland, Kansas City, Mo.

"BUCKEYE Egg Dater," \$4.50. Rubber stamps. Catalogue 10c. Buckeye Stamp Works, Dayton, Ohio.

ENGLISH Setter Puppies, whelped Feb. 21st, 1916. Sire, McDonald's Teddy (32163 F. D. S. B.); Dam, Buena Vista Queen (29999 F. D. S. B.). Prices reasonable. L. D. Richards, Stevens Point, Wis.

GOLDFISH—Rare specimens, artistic aquariums, waterplants. Circular free. Pioneer Goldfish Hatchery, Racine, Wis.

RAISE Guinea Pigs. We furnish stock, show you how and buy all you raise. Big demand. Thousands needed yearly. Easy to raise, very prolific and profitable. Particulars and contract for two-cent stamp. Cavies Distributing Co., 797 West 74th St., Kansas City, Mo.

MAKE money breeding Plymouth Rock squabs, 1916 demand biggest ever. How to sell by parcel post, how to get \$4 to \$8 dozen. Start small, grow big. Small space needed. Write today for big free book. Plymouth Rock Squab Company, 634 Howard St., Melrose Highlands, Massachusetts.

PERSONAL

FREE—Stop using Tobacco. Free. We will give free information how to conquer the habit easily and permanently. Results Guaranteed. Anti-Tobacco League, 613 Paxton Block, Omaha, Nebr.

BROTHER—Accidentally discovered root cures tobacco habit. Gladly send particulars. F. Stokes, Mohawk, Florida.

STOP Tobacco Without Harmful drugging, quickly, secretly, inexpensively. Free booklet tells how. Hotex Remedy Company, Dept. B, Houston, Texas.

MISCELLANEOUS

ARTISTS, Designers, Draftsmen will be interested in the Hoffman universal adjustable drawing-board bracket. Write for circular 5, A. Hoffman & Co., 51 Kenwood Ave., Rochester, N. Y.

CUTS anybody can make. Simple Etching Process, \$1. Particulars, specimens, for stamp. M. Day, Windfall, Ind.

INDIAN Baskets, Belles, Price free. G. Gilham, Highland Springs, Cal.

\$2.50 POCKET Adder, Send for circular. Bassett, 5911-K Indiana Ave., Chicago.

"UNITED Cigar Store Certificates" or Profit-Sharing Coupons wanted. Will pay 70c per hundred for certificates. J. Z. Room 925, 78 E. Madison St., Chicago.

ELECTRIC Customer Combination, Patented. New; nothing like it ever sold before. Tell us how to put it on the market. Pelletier Company, Kansas City, Mo.

WAR—Indian Belles; Old Stamps, Books—Sale—Exchange. List Free. Rodemeyer, Centralia, Mo.

CUSHION Rubber Stamp with your name in script, 25c. Luther Cope, Scottdale, Pa.

MAKE Indian Bead-Rings. Costs 3c; sells 35c. Information Free. Pierine, 346 Second St., Brooklyn, N. Y.

INVESTIGATE—our portable stove before going to camp or on your auto trip. Collapsible. No bolts, screws or tools required; put together or taken apart in one minute. Can be carried in small suitcase. Weight approx. 15 lbs. \$3.50 delivered anywhere in U. S. east of Miss. River. West \$4. Mican Sales Co., 23 Manchester Place, Buffalo, N. Y.

ERADIUM (Luminous) Pull Chain Bulb for Electric or Gas Light pull chain or key. Shines at night. Locates your chain in a "jiffy." Sample 35c. Agents wanted. Auburn Supply Co., Dept. 5PC, 7817 Peoria St., Chicago.

"MAKE Gas-Tonic." See Miller's Advertisement—Business Opportunities.

100 VISITING Cards 19c. Lists engraved announcements, wedding invitations, cards. Bond Co., 4443 Calumet, Dept. PM, Chicago.

SIX hundred farmers' addresses Five Dollars. Ralph Ryley, San Mateo, Calif.

PUT your initials or signature on your tools with Mark-O. Best process known. Marks steel, copper and brass. Outfit 50c postpaid. Send money order, no stamps. Mark-O Co., Box 15, St. Paul, Minn.

PATENTS low as \$17. Why pay more? Patent News, 33, Washington, D. C.

GENUINE Sioux Indian Beadwork and Curios, also Elk Teeth, Moccasins, Fobs, Belts, Hatbands, Pouches, Warrucis, Indian Costumes. Send 10c. for price list. Strong Curio Co., Gordon, Neb.

INVENT something; your ideas may bring wealth; our free book tells what to invent and how to obtain a patent, through our new credit system; write today. Waters & Co., 4102 Warder Bldg., Washington, D. C.

MAKE Rope at home. Special tools unnecessary. A quarter brings detailed directions. D. B. Van H., Box 904, North Loup, Nebr.

TATTOOING Machines. I now manufacture an Electric Tattooing Machine for \$1.00. A machine that runs on four dry cells and gives satisfaction. Best line of tattooist's supplies in the world. Everything for the tattooist. Get my catalog. Prof. J. Barber, 70 1/2 Brush St., Detroit, Mich.

IDEAL Atlas—Just Published—Contains large scale maps, yet is a book of handy size. Has special maps of all war zones in addition to all regular maps found in a good atlas. Is self-revising, that is, contains a certificate entitling the purchaser to a supplement of new maps after the war is over. Genuine flexible leather binding. 512 pages, 256 pages of maps, 256 pages of text. Price \$1.65 postpaid. Popular Mechanics Book Dept., 6 N. Michigan Ave., Chicago.

BUFFALO Greenbacks. Finest imitation possible. 5000—\$6.00; 1000—\$1.50; 100—35c. Roll—10c. Samples for stamp. Gilmore, Morgan Park, Chicago.

NEW 300-page book on the Ford car for every Ford owner, dealer and repairman. Deals fully with construction, operation and repair. 140 engravings. Best and most complete Ford book published. Price, \$1.00 postpaid. Also Ford Engine Chart, 25x38 in. Location of engine troubles made easy. Price, 25 cents postpaid. Popular Mechanics Book Dept., 6 N. Michigan Ave., Chicago.

GRANDFATHER'S Clock Works. \$5. Slightly shop-worn, quantity limited, others with chimes, all prices; also several nice Grandfather's Clock cases, exceptional bargains. Clock Company, 1873 Ruffner St., Philadelphia, Pa.

PENCILS—Special stamped with your name and address in gold. 12 for 75 cents. United States Pencil Company, Saginaw, Michigan.

SECURE Some Villa Currency Now.—Popular and attractive as souvenirs; a \$1.00 bill secures \$100.00 pesos, two pictures and short sketch of his career as the most notorious and daring bandit leader of all Mexico. Old Mexico Export Co., Mills Building, El Paso, Texas.

BIRD Houses. A. Neely Hall's Bird House Plans, and membership in "American Bird House League," 25 cents. 6,000 built in Pittsburgh. Earn big money in spare time. Put-Together Shop, 8, Oak Park, Ill.

You Can Now Learn To Speak In Public



Learn to speak forcefully and convincingly. The ability to speak effectively in public means greater influence, greater opportunities and greater financial returns. Fit yourself for leadership. Your speech tells what you are. Your place among men is decided by what you say and how you say it.

You can now become a self-reliant, persuasive and impressive public speaker. The man or woman who can speak in public wins. "Stage fright" and embarrassment can be easily overcome if you know how. If your worst fears are realized when you are called upon to speak, you need our

Effective Public Speaking Course

It will easily and quickly train you to

- speak forcefully in public
- address board meetings
- respond to toasts
- enlarge your vocabulary
- develop your self-confidence and personality
- speak before your club, lodge or union—
- at any occasion, without awkwardness or embarrassment.
- converse effectively
- sell more goods
- train your memory

We Train You By Mail—At Home—In Spare Time

Just fifteen spare minutes daily devoted to our Effective Public Speaking Course will train you to speak at dinners or public meetings without resorting to notes—will give you a complete command of the English language—will teach you to argue effectively and convincingly—express your thoughts logically and forcefully—give you the power to "think on your feet"—to "say your say" in earnest, concise, convincing language.

Mr. Harold A. Holmes, a leading business man of Des Moines, Iowa, says: "Your Course in Public Speaking is the best that has been offered. I make this unqualified assertion without hesitation because I am familiar with all the courses and books that have been published on this subject."

Mr. G. M. Cassitt, Assistant Cashier, La Grange State Bank, La Grange, Illinois, says: "Not only has it enabled me to speak before friends and strangers in a way that is most gratifying to me, but it has helped me tremendously in business as well."

Mr. H. H. McDonald, Secretary and Treasurer, North American Railway Construction Company, Chicago, writes: "I have found your Effective Public Speaking Course interesting, beneficial and educational and I feel fortunate in having the opportunity to take advantage of this splendid course."

Mr. G. C. Hoffmann, Corsicans, Texas, states: "To my mind the Effective Public Speaking Course is a most valuable training to anyone who desires to be able to speak in public without embarrassment or awkwardness."

Mr. W. C. Wernoth of Cavender, Kaiser & Wernoth, Lawyers, Chicago, Illinois, says: "Your Course brings out and builds up many hidden qualities. It not only enables a man to become a convincing speaker, but tends to develop a strong and winning personality."

Special Limited Offer Send the coupon for full particulars of our Special Limited Offer—FREE. This wonderful offer is made for advertising purposes and may be withdrawn at any time—nothing to investigate. Here is your chance to find out how you can learn to speak in public even though you never made a speech in your life.

Send The Coupon Today

Be sure to investigate this great opportunity NOW. The coupon brings you full particulars without cost or obligation of any kind. Men who never hoped to be able to speak in public are getting marvelous results from this Course. You can too. Find out for yourself. Just clip the coupon and mail it NOW.

Public Speaking Department
American Correspondence
School of Law
1195 Manhattan Building, Chicago

MAIL THIS COUPON NOW

Public Speaking Department
American Correspondence School of Law
1195 Manhattan Building, Chicago.

Gentlemen:—Please send me full particulars of your New Effective Public Speaking Course and your Special Advertising Offer. I am not obligating myself in any way.

Name.....

Street.....

City..... State.....

Please Mention Popular Mechanics



The \$100,000 Man Who Went to School Again

This is an inspiring story of a big-minded business man. Despite his wide experience, despite his huge income, he left his business for a year while he *learned the fundamental principles* behind the problems of his complicated business.

Many Big Men Doing the Same

The brainiest men in America today are doing what he did, for exactly the same reason he did it. The only difference is that they do not now have to leave their business as this man did. Instead, the Alexander Hamilton Institute now brings this business training right to their desks or to their home reading tables.

The Advisory Council

Judge E. H. Gary, Chairman of the U. S. Steel Corporation; Frank A. Vanderlip, President of the National City Bank; John Hays Hammond, the great engineer; Joseph French Johnson, Dean of the New York University School of Commerce; and Jeremiah W. Jenks, the statistician and economist, compose the Advisory Council.

How Men Make Good

What our Modern Business Course and Service has done for its 35,000 subscribers will probably never be known in its entirety. But daily there filter into the headquarters in New York many intensely human stories, showing how men are helped. One day you hear of a brilliant lad of twenty-two, in a big New York bank, rising to a \$9,500 job and giving credit to the Institute for his success. The next day a factory manager writes that the Course has just helped him save his firm \$7,000 a year, and that "a fair slice" of this went to increase his salary. Or a man in a western concern tells how he saved the firm \$37,000 a year by one suggestion, and what happened then to his salary.

These are only typical cases. There are literally hundreds of them described in the 128 page book, "Forging Ahead in Business," a copy of which will be sent you, free.

ALEXANDER HAMILTON INSTITUTE
191 Astor Place New York City

Send me "Forging Ahead in Business"—FREE



Name

Business Address

Business Position

Be An Automobile Salesman

Enter this big money-making field. No previous experience needed. Work is interesting, pleasant and profitable. Factories and Dealers need trained men. Opportunities in every town to work on salary or commission. Men who KNOW how to sell automobiles easily

Make \$1800 to \$5000 a Year

The "Automobile Salesmanship" course, prepared by us, is written in clear, concise and comprehensive English. We train you along practical lines. The course is written by experienced men who have made big success. Automobile salesmanship field is not crowded; 750,000 cars sold last year—more than a MILLION will be made and sold this year. Learn at home during spare time. Get our FREE literature. Act at once.

AUTOMOBILE PUBLISHING CO.
625 Chamber of Commerce Bldg. DETROIT, MICHIGAN



Oh, You Skinny!

Why stay thin as a rail? You don't have to! And you don't have to go through life with a chest that the tailor gives you; with arms of childish strength; with legs you can hardly stand on. And what about that stomach that pinches every time you try a square meal? Are you a pill-feeder?

Do you expect Health and Strength in tablet form—through pills, potions and other exploited piffle?

You can't do it; it can't be done.

The only way to be well is to build up your body—all of it—through nature's methods—not by pampering the stomach. It is not fate that is making you a failure; it's that poor, enfeebled body of yours; your half-sickness shows plain in your face and the world loves healthy people. So be healthy—strong—vital. That's strong. Don't think too long; send 4 cents in stamps to cover mailing of my book, "INTELLIGENCE IN PHYSICAL AND HEALTH CULTURE," written by the strongest physical culture instructor in the world.

LIONEL STRONGFORT
PHYSICAL CULTURE EXPERT
Dept. 856 Atlantic City, N. J.

A BOOK OF NEW MISSION FURNITURE DESIGNS



Part 3—Mission Furniture HOW TO MAKE IT

A 128 page collection of 36 excellent new designs that have never before been published and that are entirely different from those in the books Parts One and Two previously issued.

Handsome Cloth Binding

Price 50c Postpaid

This new number has just been published and those already in possession of Parts One and Two will find this an even greater value in variety and excellence of the plans.

A feature of the New Book is a

Complete Set of Dining-Room Furniture

Designed to Harmonize Perfectly

If you are at all handy with tools, you will find that the plainly written directions, dimension drawings and half-tone illustrations will enable you to

Make Your Own Furniture and Save Two-Thirds

The many who use tools for pleasure will find this book a working guide which will furnish many moments of delightful and profitable occupation while several of our readers have been able to devote their entire time to this work by disposing of what they have made at a nice profit. One man made and sold \$400 worth of one piece alone.

Parts One and Two in this series are also 50 cents each postpaid

Ask Your Book Dealer or Address the Publishers

POPULAR MECHANICS BOOK DEPT.
6 N. Michigan Ave. CHICAGO

\$25 to \$45 Weekly

New Positions Ready



New profession just being created—only uncrowded field. Big positions with lucrative salaries to start for men and women. You are needed now—learn at our risk—**Be CONFIDENTIAL SECRETARY**

— the new executive position — right-hand aid to the big boss. Learn his secret methods — step into official position. Thousands now needed in large and small towns. You can qualify through the remarkable new discovery—the salary-raising **Hotford**

NEW METHOD IN TOUCH — the speed system that advances employ-
Typewriting. New idea—write 50 per cent faster without looking. Steno-
graphers everywhere will soon discard slow, old-time sight systems.

Big Position While Learning
by mail, in spare time. W.F. Geisler, 1123 Drummond Pl., Chicago, writes: "Am only half through course and I secured high-salary position as Confidential Secretary to Gen. Mgr. of largest firm of its kind in the world. Knew nothing before about Typewriting." Write for action letters like this. No matter what your present work, we qualify you easily — quickly. Stenographic or office experience unnecessary. If already a stenographer, double your salary.

SUCCESS OR MONEY BACK — you risk no money — entire course on trial. Write for blank proof. Don't hesitate—tuition payments to suit you. One of these big positions is possible for you. Begin now while the need is great.

START FREE **SEND NO MONEY** — No advance fee — simply write for complete first lesson **FREE**.

Special limited offer — act NOW! Write for proof of graduation needed and letters of success. Learn how we loan \$100.00 Typewriter while learning. **Shorthand—FREE** first lesson. If you wish to learn Short Hand only, write for special offer on Hotford Simplified Course—used by world experts. Address James Patrick Ward, Pres. **BOTSFORD INSTITUTE**, 1123 Bedford Building, CHICAGO

\$100.00 Typewriter FREE While Learning

A GOOD POSITION

with **UNCLE SAM** is most desirable. Life positions, pleasant surroundings, good pay, steady work, short hours, promotions on merit. Both sexes. No political pull. Thousands of appointments yearly. Most thorough preparation \$5. Returned if not appointed. Full information and questions used by the Civil Service Commission free.

AMERICAN CIVIL SERVICE SCHOOL WASHINGTON, D. C.

Do You Like to Draw ? Cartoonists Are Well Paid

We will not give you any grand prize if you answer this ad. Nor will we claim to make you rich in a week. But if you are serious to develop your talent with a successful cartoonist, so you can make money, send a copy of this picture, with 6c in stamps for portfolio of cartoons and sample lesson plate, and let us explain.

The W. L. Evans School of Cartooning
821 Leader Bldg., Cleveland, O.



The Library of Original Sources at a great bargain

10 beautiful, big volumes. Easy monthly payments. See our ads on page 59 February issue and page 56 March issue Popular Mechanics.

UNIVERSITY RESEARCH, Dept. G, Milwaukee, Wisconsin

AT HOME
Learn to SING Send 2-cent Stamp for Helpful Booklet, "The Voice Made Beautiful."
HARVEY SUTHERLAND, 813 President St., Brooklyn, N. Y.

LEARN WATCHMAKING
and become independent. Good-paying positions secured. Easy to learn. Send for **FREE CATALOG**.

ST. LOUIS WATCHMAKING SCHOOL, Dept. 5, ST. LOUIS, MO.

DRAWING

Calligraphy, Cartoon, Comic, Commercial, Fashion, Newspaper and Magazine illustrating taught by mail. Illustrated book de in stamps. **THE BOSTON SCHOOL OF DRAWING, 755M Boylston St. BOSTON, MASS.**

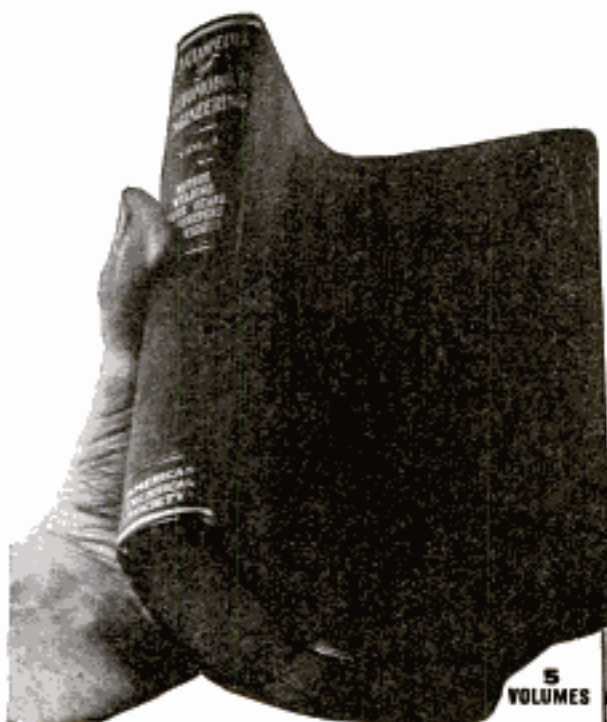

NEW 1916 EDITION AUTOMOBILE ENGINEERING

Here is your opportunity to get, at an inside price, a brand new library covering every conceivable motor subject. Here is your chance to secure the most practical, most authoritative set of books ever written on the construction, operation and repairing of motor cars, motorcycles and motor boats. Contains 350 pages alone on ignition, starting and lighting systems.

This five volume auto library, one volume of which is shown above, contains 2,200 pages (15 1/2 by 8 1/2 inches), together with 2,000 illustrations that make technical points as simple as A-B-C; full page plates that literally pick the mechanism to pieces before your very eyes; drawings and diagrams that show the principles employed in various types of motors. Flexibly bound in solid morocco leather, gold stamped. These five volumes are a remarkable value at the regular price of \$25.00, yet we offer a limited number of sets at a special introductory price of \$14.80—payable \$2.00 a month.

SHIPPED FREE Test these books before you buy. You don't buy a motor until you have tried it out. Buy books the same way. We send the full 5 volumes to you, express prepaid, for 7 days' free examination. Use them a whole week free. See if they don't help you work out the problems that come up in your garage or repair shop. If the books are what you want, send us \$2. Otherwise we'll take them back, paying the express both ways ourselves.

Subjects Covered

Explosion Motors—Welding Repairs—Gasoline Car Features—Ignition Systems—Lighting Systems—Electric Starters—Electric Pleasure Cars—Storage Cells—Electric Motors—Care and Operation of Electric—Automobile Driving—Road Troubles—Private Garages—Repairs—Electric Delivery Wagons—Electric Trucks—Gasoline Delivery Wagons—Trucks—Taxis—Tractors—Trailers—Road Trains—Traction Engines—Maintenance and Costs—Steam Cars—Motorcycles—Motor Boats—Glossary of Automobile Terms.

FREE !! \$12.00 Consulting Membership

We give you absolutely free our \$12 consulting membership. This privilege puts our whole staff of experts at your service for a whole year without cost to you. Ask them any motor question you want. They will give you practical help. The solution of a single problem might easily be worth more than what you pay for the books—you get this service free.

The moment you see the books you will realize that you need them. There is no limit to the good they can do you every day. It costs you nothing to look them over, to use them for a whole week. You run no risk, you incur no obligation. The books come back at our expense if you say so. Send in the coupon now—today.

FREE COUPON

Worth \$10.20 to You
American Technical Society
Chicago, U. S. A.

Please send me Cyclopedia of Automobile Engineering for 7 days' free examination. If I decide to buy, will send \$2 in 7 days and balance \$2 a month until \$14.80 has been paid, when \$25 books and \$12 consulting membership will be mine free. Otherwise will notify you and hold books subject to your order. Title not to pass until fully paid. Pop. Mech. 5-36

AMERICAN TECHNICAL SOCIETY
Chicago, U. S. A.
NAME.....
ADDRESS.....
As I have had no previous dealings with you, I refer you to.....

Please Mention Popular Mechanics

STOP USING A TRUSS

Do Away With Steel And Rubber Bands

FREE TRIAL



Inner surface is made adhesive to secure the PLAPAO-PAD firmly to the body, keeping the PLAPAO continually applied and the pad from slipping. No straps, buckles or springs attached. Soft as velvet—easy to apply.

PATD
APRIL 6
1909

FREE to 5,000 Truss Sufferers

To the first 5,000 Sufferers who write, I will send, ABSOLUTELY FREE, a sufficient quantity of the Plapao to positively convince them that this is the only logical, common-sense way of treating rupture. Plapao is a highly astringent medication placed within the Plapao-Pad and being absorbed through the skin, creates a wonderful feeling of relief and at the same time tends to strengthen the weakened muscles and thus permanently close the rupture opening. The process of recovery is natural, so you'll have no use for a truss—you can throw it away forever! Old and young have testified under oath that the Plapao-Pads cured their rupture—many of them long-standing, aggravated cases—without delay from work. Patent allowed in U. S. and foreign countries. Awarded Gold Medal at Home and Grand Prix at Paris.

Send No Money—for a sufficient quantity of the Plapao is sent without charge to enable you to give it a thorough test; you pay nothing for this trial now or ever. Write for it and full information today. Address Plapao Laboratories, Block 1427 St. Louis, Mo.

Deafness



Perfect hearing is now being restored in every condition of deafness or defective hearing from causes such as

Relaxed or Sunken Drums, Roaring or Hissing Sounds, Perforated, Partially Destroyed Drums, etc.

Wilson Common-Sense Ear Drums

"Little Wireless Phones for the Ears"—

require no medicine but effectively replace what is lacking or defective in the natural drums. They are simple devices, which the wearer easily fits into the ears where they are invisible. Soft, safe and comfortable to wear at all times.

Write today for our 168 page FREE book on DEAFNESS, giving you full particulars and plenty of testimonials.

WILSON EAR DRUM CO., Incorporated

962 Inter-Southern Building

LOUISVILLE, KY.

Don't Wear a Truss

Brooks' Appliance, the modern scientific invention, the wonderful new discovery that relieves rupture will be sent on trial. No obnoxious springs or pads.

Brooks' Rupture Appliance

Has automatic Air Cushions. Binds and draws the broken parts together as you would a broken limb. No salves. No ties. Durable, cheap. Sent on trial to prove it. Protected by U. S. patents. Catalogue and measure blanks mailed free. Send name and address today.

C. E. BROOKS, 1817A State Street, Marshall, Mich.



Read
What
Dr. Upham
Says of the

DEAF?

1916 Acousticon

W. C. Upham, M. D., of Washington, D. C., writes us—
"Where I could not possibly hear a word of conversation, with the ACOUSTICON I hear distinctly. No person who is hard of hearing should fail to get this Instrument if possible to obtain it."

The unstinted praise of 250,000 satisfied customers and many letters like the above from eminent physicians lead us to urge you and every deaf person, entirely at our risk, without a penny of expense, to give the 1916 ACOUSTICON a thorough trial in your own home, absolutely and entirely

No Deposit **FREE** No Expense

All you need do is to write saying that you are deaf and will try the ACOUSTICON. The trial will not cost you one cent, for we even pay delivery charges.

WARNING! There is no good reason why everyone should not make an liberal trial offer as we do, so do not send money for any instrument for the deaf until you have tried it.

The ACOUSTICON has improvements and patented features which cannot be duplicated, so no matter what you have tried in the past, send for your free trial of the ACOUSTICON today and convince yourself—you alone to decide. Address

GENERAL ACOUSTIC CO., 1307 Candler Bldg., NEW YORK
Toronto, Ont., Office, Royal Bank Bldg.



We are
Under
Govt.
Bond

RELIEF TO TRUSS USERS

Any appliance is a truss. Ruptured people must wear some kind of support. Our New Sponge Rubber Pad (pat'd) is velvety, soft to the skin, pliable, cannot slip, extremely comfortable, adapts itself to ruptured parts with less pressure, is sanitary, long lived. Massages and strengthens muscles, allows blood circulation and produces many cures.

New Scrotal Pad Needs No Leg Strap

Our new scrotal pad (pat'd) holds hernia perfectly without strap between legs in 8 out of 10 cases.

FREE SAMPLE PAD A Sample Akron Sponge Rubber Truss Pad (pat'd) will be sent absolutely FREE upon request, also booklet "Help to Truss Wearers." It's full of help. Ask your dealer, or write us. THE AKRON TRUSS CO., Dept. 105, AKRON, OHIO

NO MORE BALD HEADS



WHEN our VACUUM CAP is used a few minutes daily. We accept no pay until you have tried the Cap 30 days and are satisfied. The Vacuum Cap is an appliance that draws the blood to the Hair Roots and starts a new healthy crop of hair. It stops Dandruff, stops the hair from falling out.

Bought by Doctors and men who know that it is the only reasonable HAIR GROWER known to science. No Drugs Used. Write for application blank, testimonials, and booklet on "HAIR," sent sealed in plain envelope. FREE.

THE MODERN VACUUM CAP CO.

D. 559 BARCLAY, DENVER, COLO.



Tobacco Habit BANISHED

in 48 to 72 Hours



Immediate Results

Trying to quit the tobacco habit unaided is a losing fight against heavy odds, and means a serious shock to your nervous system. So don't try it! Make the tobacco habit quit you. It will quit you if you will just take Tobacco Redeemer according to directions.

It doesn't make a particle of difference whether you've been a user of tobacco for a single month or for 50 years, or how much you use, or in what form you use it. Whether you smoke cigars, cigarettes, pipe, chew plug or fine cut or use snuff Tobacco Redeemer will positively remove all craving for tobacco in any form in from 48 to 72 hours. Your tobacco craving will begin to decrease after the very first dose—there's no long waiting for results.

Tobacco Redeemer contains no habit-forming drugs of any kind and is the most marvelously quick, absolutely scientific and thoroughly reliable remedy for the tobacco habit.

Not a Substitute

Tobacco Redeemer is in no sense a substitute for tobacco, but is a radical, efficient treatment. After finishing the treatment you have absolutely no desire to use tobacco again or to continue the use of the remedy. It quiets the nerves, and will make you feel better in every way. If you really want to quit the tobacco habit—get rid of it so completely that when you see others using it, it will not awaken the slightest desire in you—you should at once begin a course of Tobacco Redeemer treatment for the habit.

Results Absolutely Guaranteed

A single trial will convince the most skeptical. Our legal, binding, money-back guarantee goes with each full treatment. If Tobacco Redeemer fails to banish the tobacco habit when taken according to the plain and easy directions, your money will be cheerfully refunded upon demand.

Let Us Send You Convincing Proof

If you're a slave of the tobacco habit and want to find a sure, quick way of quitting "for keeps" you owe it to yourself and to your family to mail the coupon below or send your name and address on a postal and receive our free booklet on the deadly effect of tobacco on the human system, and positive proof that Tobacco Redeemer will quickly free you from the habit.

Newell Pharmacal Company
Dept. 300, St. Louis, Mo.



Mail Coupon NOW for FREE Booklet

NEWELL PHARMACAL CO.,
Dept. 300, St. Louis, Mo.

Please send, without obligating me in any way, your free booklet regarding the tobacco habit and proof that Tobacco Redeemer will positively free me from the tobacco habit.

Name

Street and No.

Town..... State.....

Please Mention Popular Mechanics

Get Into a Business that Pays Big Money

Driving \$80 to \$125 a Month — Repairmen and Salesmen \$300 and Up!

Lots of driving and touring jobs now open in all large cities and good chances (if you are ambitious) to start a garage, do repairing, sell cars, etc. 1,000,000 more automobiles this year than last. Every small town in the country needs a Real Expert Auto Repairman. We teach you — and we do it right — the way you would like to learn. We put you to work in overalls, with tools, on all kinds of automobiles, in a real shop and garage. Plenty of actual driving and repairing. Our method is down-in-the-grease — and out-on-the-road. No time limit — you stay till you learn thoroughly and are perfectly satisfied. Here is a chance to "Double Your Pay." If you are out of work or dissatisfied with your present job change now — Get into

THE COMING BUSINESS
NATIONAL AUTO SCHOOL 2625 Reading Rd.,
 CINCINNATI, O.

Write your name and address on margin of this page, tear out and mail to us — we'll send you our catalog and full information.



Music Lessons Sent FREE

You, too, can now quickly and easily satisfy your musical ambitions—learn to sing or play your favorite instrument, whether for pleasure, social prestige or to teach music, by our wonderful home study lessons under great American and European teachers. The lessons are a marvel of simplicity and completeness, endorsed by Paderewski and other great authorities.

Any Instrument or Voice

Write us the course you are interested in, age, how long you have taken lessons if at all, etc., and we will send you six lessons, free and prepaid, any of the following Complete Courses: Lessons in PIANO (students' or teachers' courses) by the great Wm. H. Sherwood, HARMONY by Dr. Frotheroe and Rosenbecker, PIPE ORGAN by Clarence Eddy, VOICE COURSE (with aid of phonograph) by Crompton, PUBLIC SCHOOL MUSIC, by Frances E. Clark, VIOLIN, CORNET, MANDOLIN, GUITAR, BANJO, REED ORGAN, CHORAL CONDUCTING, by equally eminent teachers.

This offer is Free—we do not ask you to pay one cent for the six lessons, either now or later. We want to prove in this remarkable way what fine lessons they are—SEEING IS BELIEVING. This offer is limited, so write today. A few Special Introductory Scholarships now being awarded by our Faculty. Full particulars sent along with free lessons. Send no money.

SIEGEL-MYERS SCHOOL OF MUSIC,

CLARENCE EDDY, Dean
 1506 Siegel-Myers Building CHICAGO, ILL.



HE TUNES PIANOS So Can You

He was taught at home in leisure hours by correspondence, in a way that is open to all who wish to learn. He says that **HE MAKES \$50 A WEEK**. Send for his name and read his letter. What we have done for him and others we can do for you. The TUNE-A-PHONE, our patented instrument for precisely indicating comparison of sound-beats in tuning proof intervals, makes it easy for any man or woman to become a proficient piano tuner. This device intelligently teaches first principles that you never forget and is then discarded. It makes progress work or faculty start. Our course includes Action Regulating, Voicing and Fine Repeating. Action model and tools loaned. Diploma granted. Graduates are Big Money makers on salary or at work for themselves. Many of our most successful tuners had no previous musical knowledge. 18 years of correspondence teaching by unending and practical plans.

Investigate at our expense. A postal request brings indisputable facts, FREE.
Niles Bryant School of Piano Tuning
 455 Music Hall, Battle Creek, Michigan.



Learn Chemical Oil Painting AN ART MASTERED IN A DAY

In two or three days you can earn \$2.00 to \$10.00 a day painting portraits or giving lessons. Every one who has a photo wants a painting. Done in an hour and selling at \$2.00 to \$10.00. We give all formulas, saving you many dollars, full instructions and methods to make money. Work spare time or set up a regular office, canvass for pictures or travel. Full information about this fascinating art FREE.

BRAM ART CO. Box 176 H, Balboa, Calif.



WHENEVER you need a book on any mechanical subject and do not know where to obtain it, write **POPULAR MECHANICS BOOK DEPARTMENT, 6 North Michigan Ave., Chicago**

Stop Making Mistakes

Ropp's Calculator Figures out, in the twinkling of an eye, every conceivable problem that occurs in the Office, Store, Shop, Bank, Farm or Factory. Greatest time and labor-saving work on figures in the world. Edition of 1912 vastly improved. Three different sizes.

Prices \$1.25, \$1.00, and 50c.

Popular Mechanics Book Dept., CHICAGO



Earn \$50 to \$100 Weekly You Can Easily Become a Traffic Manager

BIG DEMAND FOR GOOD TRAFFIC MEN

Train your brains—learn transportation—become efficient. You can do this easily. In a short time you can be holding a responsible, high salaried position as a Traffic Manager. You can be a man among men—giving orders instead of taking them. Get ready to do this—prepare NOW. A man's idle hours are worth \$30 each—don't waste yours.

Easy, Pleasant Study During Your Spare Hours

You can easily acquire valuable traffic knowledge during your idle hours at night. The American Commerce Association is an organization of Traffic Men by Traffic Men for Traffic Men. It numbers among its members and endorses many of America's noted traffic authorities. Its methods are thorough and practical. You can get in condensed form the training and knowledge which these traffic experts acquired only after many years of hard work and tedious study.

Ask us for a FREE copy of one of these valuable books, "Opportunities Along the Trails of Traffic," by H. G. Wilson. Straightforward and informative. "Traffic Efficiency," 92 pages. Tells the need of high salaried, efficient Traffic Men. "Millions Wasted in Traffic." Gives actual cases. Intensely interesting. Tells of Traffic Saving Opportunities.

AMERICAN COMMERCE ASSOCIATION

Dept. 524
 The Rookery
 CHICAGO, ILL.

IF you are a Man

of affairs, and would like to know what the world is thinking

IF your time is limited

and you want a "Cook's Tour" through the realm of world thought

IF a Monthly Review

in Cartoon and Comment of Current Events appeals to you

IF you want

the viewpoint of other nations

IF you would like

to read history in the making in its most attractive form

GET A COPY OF

Cartoons Magazine

Published by H. H. Windsor
Publisher of Popular Mechanics Magazine

IT is the only magazine in the field mobilizing the pen-and-ink satirists from the four corners of the world, men who are fighting silent battles on their drawing boards. It presents the history of the world war as the people see it, with all their prejudices and enthusiasms. Contributors to the symposium include England, France, Russia, Italy, Holland, Spain, Germany, Austria, Australia, New Zealand, South Africa, India, Canada, United States, and Japan. Thus you get first-hand information. You learn what other nations think of each other—and of us.

25c ON ALL **\$3**
A COPY NEWS-STANDS A YEAR

CARTOONS MAGAZINE
6 N. Michigan Ave., CHICAGO

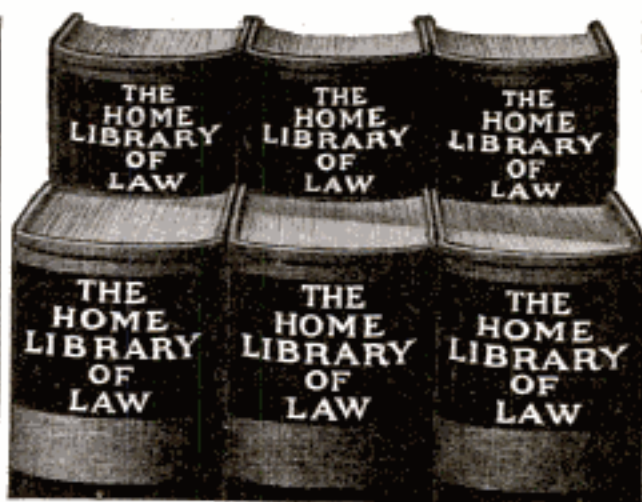

All the \$ **9.00**
LAW (Pay \$1 a Month)

EVERY important legal question answered for you in this complete, authoritative law library—now sent on a very special offer. Save attorney's fees. Know the law yourself. Why spend money for advice when you can have these books right on your library shelf? The lawyer gets his information from books. You can do the same. And this great library which covers the whole field of law is now yours for less than one fee you would pay for an attorney's advice. All this exhaustive, indexed legal information only \$9.00 and on time. Send the coupon today—at once.

These Books Tell You All About

Wills	Partnerships	Automobile	Promissory
Mortgages	Stock holders	Laws	Notes
Deeds	Dividends	Patents	Checks
Farm Laws	Marriage	Contracts	Bills of Exchange
Landlord and Tenant	Assault	Fraud	Bonds
Leases	Defamation	Damages	Agents
Copyrights	Libel	Negotiable Paper	Bankruptcy
Trade Marks	Criticism	Indorsements	Bank, Etc.
	Self Defense		

Also has complete series of Legal Forms of all kinds.

Shipped FREE!

Not a cent to pay until you see the books. Sent for free examination. No obligation. We even pay express charges. Read the books for seven days. Then, if you keep them, send \$1 down and \$1 a month until \$9 is paid. Otherwise return at our expense.

Send the Coupon

Act on this offer now.

Examination costs nothing. Get this great library while our offer holds good. Yours for only \$1 a month. Send for it on free examination offer. Mail the coupon today.

Doubleday Page & Co.
Dept. 1195 Garden City, N. Y.
Send me the 6 vol. Law Library, Express prepaid, for seven days' free examination. If I keep the books I will send \$1 down, then \$1 a month until \$9 is paid. Otherwise I will return them at your expense.

Name.....

Address.....

Doubleday Page & Co.

Dept. 1195 Garden City, N. Y.

Please Mention Popular Mechanics

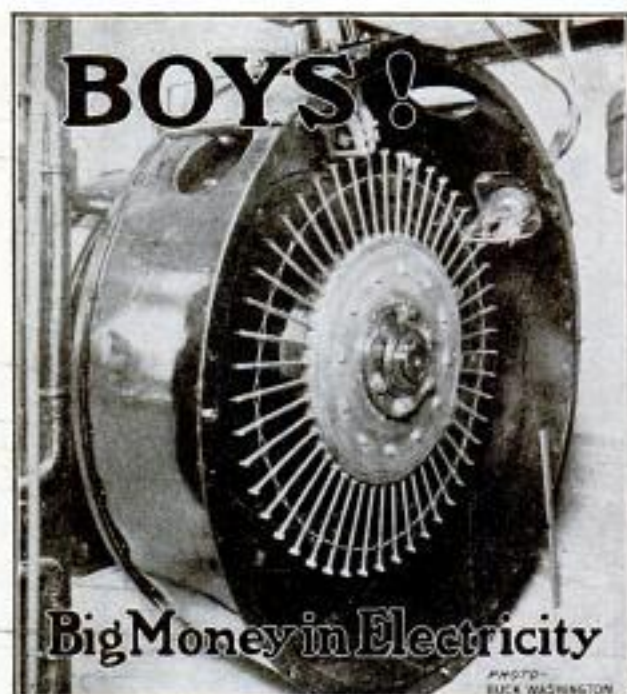

Rotary Spark Gap, Spark Transmitter, Arlington (N.A.) Radio Station

The electrical industries offer wonderful opportunities to boys. The salaries paid to trained men are large, promotion is rapid and the work is fascinating.

The discovery and development of new lines, such as wireless telegraphy and telephony, promise attractive and paying fields to those who wish to specialize. The *will to do* and *Special Training* will bring success to you.

The International Correspondence Schools can help you to become an expert in electrical work, no matter what branch you like best. Thousands of young men have won success through I. C. S. help. You can do as well, *if you try*. Everything is made so clear that you can learn in your spare time, no matter where you live or what your work.

There's Big Money in Electricity! Get after it by marking and mailing the coupon today. Finding out costs you nothing.

I. C. S., Box 5505, Scranton, Pa.

TEAR OUT HERE
INTERNATIONAL CORRESPONDENCE SCHOOLS

Box 5505, SCRANTON, PA.

Explain, without obligating me, how I can train for the position before which I mark X.

- | | |
|----------------------------------------------------|------------------------------------------------|
| <input type="checkbox"/> ELECTRICAL ENGINEER | <input type="checkbox"/> ARCHITECT |
| <input type="checkbox"/> Electrician | <input type="checkbox"/> Blue Foreman or Supt. |
| <input type="checkbox"/> Electric Wiring | <input type="checkbox"/> Chemical Engineer |
| <input type="checkbox"/> Electric Lighting | <input type="checkbox"/> Business (Complete) |
| <input type="checkbox"/> Electric Car Running | <input type="checkbox"/> Bookkeeper |
| <input type="checkbox"/> Electric Machine Designer | <input type="checkbox"/> Stenographer |
| <input type="checkbox"/> Telegraph Engineer | <input type="checkbox"/> Advertising Man |
| <input type="checkbox"/> Telephone Engineer | <input type="checkbox"/> Salesmanship |
| <input type="checkbox"/> MECHANICAL ENGINEER | <input type="checkbox"/> Window Trimmer |
| <input type="checkbox"/> Mechanical Draftsman | <input type="checkbox"/> Civil Service |
| <input type="checkbox"/> STEAM ENGINEER | <input type="checkbox"/> AGRICULTURE |
| <input type="checkbox"/> GAS ENGINEER | <input type="checkbox"/> Poultry Raising |
| <input type="checkbox"/> CIVIL ENGINEER | <input type="checkbox"/> AUTOMOBILES |
| <input type="checkbox"/> Structural Engineer | <input type="checkbox"/> Auto Repairing |

(The I. C. S. teach 280 different courses; write down the name of the one YOU want, if not in this list.)

Name _____

Present Occupation & Employer _____

Street and No. _____

City _____ State _____

Please Mention Popular Mechanics



BOYS! You Can Have Good Times This Summer

with the interesting devices for outdoor sports described in our big book

The Boy Mechanic

VOL. 2

(A Sequel to, but Containing Nothing Found in Vol. 1)

Plain directions are given that enable any handy boy to make at only slight expense the most satisfactory

Boats of many kinds — Camps and Camp Equipment — Fishing Tackle — Swimming Rafts — Springboards — Water Wheels — Windmills — Wind Vanes — Kites — Gliders — Houses of Poles — Cyclemobiles — Sailing Wagons — Pushmobiles — Roller Coasters — Sunlight Flashers — Heliographs — Ferris Wheel — Stilts — Swings — Merry-Go-Round — Catapults — Hurdles — Bicycle Horns — Muskrat Traps — Cameras — Lawn Tennis Markers — Wireless Telephone — Electric Fountain — Grape Arbors, Etc.

The articles mentioned are only a few taken at random from the list of

1000 Things Boys Like to Make and Do

found in this greatest of all boys' books. The contents include devices for summer and winter sports, both indoors and outdoors, art-craft work, mechanical and electrical contrivances, games, tricks, magic, also practical articles for household use.

480 Pages (6 3/4 x 9 3/4 in.)
995 Illustrations
Handsome Cloth Binding

Price \$1.50

Sent Postpaid to Any Address
Upon Receipt of Price by Publishers

Popular Mechanics Book Dept.
6 N. Michigan Ave., CHICAGO



Learn Electricity

Earn \$2500 to \$4000 a Year

Your CHANCE has come! Your chance for big money. Your chance to do the kind of work you'll be proud of. Your chance to go into business for yourself. Think of it! You can now qualify AT HOME for that most wonderful of all fields open to the ambitious man—the great field of ELECTRICITY! Yes, no matter who you are, where you live or what you do, I will take you in hand and make you an EXPERT ELECTRICIAN so that you should easily earn \$2,500 to \$4,000 a year and more. And I'll do it so quickly and with so little effort on your part that you'll wonder how it was possible.

**A. W. Wicks,
E. E.**

Formerly with
the General
Electric Com-
pany; former General
Manager of company
manufacturing Jen-
ney Electric Motors;
also formerly with Fair-
banks, Morse & Co.;
now Consulting En-
gineer and Director
of the Wicks Elec-
trical Institute.

LEARN AT HOME

What if you don't know a thing about electricity! What if you've never had a bit of electrical experience. All I ask is that you give me a little of your spare time. I will instruct you personally and make the whole matter so simple for you that you can't help but learn. You don't have to buy a lot of books or equipment. You can master MY personal instructions easily right at home. I've solved this question of teaching electricity. I'll show you I have by giving you 20 personal lessons ABSOLUTELY FREE. Almost from the very first instructions you will have the knowledge and skill to do practical, electrical work—work that you can demand good money for doing. You can earn as you learn—more than pay for your instruction as you go along.

Be An Electrician

Think! When you have finished my instructions you are an EXPERT ELECTRICIAN! You are right then and there ready to take a big paying job or start in for yourself. I will train you until you consider yourself competent regardless of the time it takes. I not only show you how to do expert electrical work but show you how to estimate on jobs so you can take contracts at big profits. That's what it means to be personally trained by a man of my practical experience in every phase of electricity. Decide today to take advantage of my big free 20 personal lessons offer. Don't let the question of money bother you. I make the cost so small and the payments so easy that you won't miss the money.

MEN WANTED Wherever you go there's always urgent demand for Expert Electricians and at big pay. That's because the watchword of the age is, "DO IT ELECTRICALLY." Electricity advances so fast that there's a big shortage of competent electricians. And the demand is constantly increasing every day.

20 Complete Lessons FREE!

That's the sensational offer I am making now to a few more ambitious men. I make it for two reasons. 1st. To show you how easy my personal instructions are to master. 2nd. To secure quick action on the part of a few more prospective students. This offer means that you get 20 complete personal lessons ABSOLUTELY FREE! But you must act quick. The offer closes in 23 days. Send coupon or postcard at once. I'll send full particulars immediately. Mail coupon today—sure!

**A. W. WICKS, E. E., Director Wicks Electrical Institute,
81 West Randolph St., Dept. 148, Chicago, Ill.**

Send this
Coupon

**A. W. WICKS,
E. E., Director,
WICKS ELEC. INSTITUTE,
81 West Randolph St.,
Dept. 148, Chicago, Ill.**

Without any obligation on
me whatever, please send me
full description of your personal
instructions in Electricity and
particulars of your special offer of
20 of your lessons free.

Name.....

Street and No.....

City.....State.....

Please Mention Popular Mechanics



H. J. RAHE, President
Automobile Training School
Kansas City, Mo.

Big Money For YOU

Any Ambitious Man Who Wants to Get Out of the Small Wage Class Can Prepare Himself for the Automobile Business in Six Weeks

Rahe's Automobile Training School of Kansas City—one of the largest institutions of the kind in the world, has trained thousands. Hundreds of our graduates are in business for themselves as garage owners, factory representatives, agents, dealers, etc. Many are holding responsible positions in some of the largest automobile factories in America. Hundreds more are getting fancy wages as managers of garages, repair men, drivers, demonstrators, tractor and power farming experts. These men earn from

\$75 to \$300 or More Per Month

They earn big money because they are **TRAINED MEN** in all branches of the automobile business. The same opportunity is before you—you can do as well. The growth of the automobile business is the wonder of the world. Nothing else compares with it. **Thousands of Trained Men are Needed**—the big jobs are open and they pay big money right from the start. No special education is required to take up our course. **Ambition is all you need.**

Only Six Weeks Required to Train You

That is all we ask—six weeks and you will be ready to start in—ready to enjoy bigger money than you

FREE SCHOLARSHIP AND BOOK COUPON

H. J. Rahe, Pres.
RAHE'S AUTOMOBILE TRAINING SCHOOL
1040 Locust St., Kansas City, Mo.
Send me your 60-page book "How to Make Money in the Automobile Business."

Name.....

Town.....State.....

Street or R. F. D.....

are now making. Henry J. Rahe, President and Founder of Rahe's Automobile Training School, is the originator of **Rahe's System of Practical Automobile Instruction**—the acknowledged standard. We claim to have more expert instructors, more equipment, more floor space and more successful graduates than any other similar school in the entire world. **All Work is Practical.**

No Charts or Books Used. No Tools to Buy

Our students work on **real cars—not theories.** We own and operate two of the largest garages and repair shops in the West. Hundreds of cars and trucks of all makes are at our command. Our students work on these cars—make real repairs.

FREE—\$50 SCHOLARSHIP—FREE For a limited time we are giving away a combination course in **Tractor and Stationary Engineering.** Enroll now and get one of these free scholarships and receive complete instruction in Power Farming, in addition to our regular instruction in all branches of the automobile business. There is a tremendous field for men who understand tractors and farm engines. **Act promptly and get this added instruction free.**

H. J. RAHE, President RAHE'S AUTOMOBILE TRAINING SCHOOL
(Largest in the World) 1040 Locust St., KANSAS CITY, MO.

How To Make Money
IN THE
AUTOMOBILE BUSINESS

—RAHE—



Send for Big
Free Book Today

Put your feet on the fast
road of the ladder of
success **Right Now**—send
for our book—**"How to
Make Money in the Au-
tomobile Business."**

Earn More Money



Reproduce Photographs of persons
and scenes upon watch caps, dials,
china, etc. Work easily done. Knowledge of
photography not necessary. **TRIAL OUTFIT**
with directions, 52 postage—Contains enough
chemicals to make 15 reproductions (watch cap
each) that you should sell from \$1.50 to \$2.50
each. Satisfaction guaranteed. **ORDER TODAY.**

American Arts & Crafts Company, Dept. D1, Boston, Mass.

LEARN RAG TIME

Let me teach you Rag-Time Piano Playing by Mail. You learn easily—in just a few lessons, at home. My system is so simple you'll play a real ragtime piece at your 5th lesson. Whether you can play now, or not, I'll teach you to play anything in happy ragtime. **"Money Back Guarantee."** Write at once for special low terms and testimonials.

AXEL CHRISTENSEN, "Czar of Ragtime,"
Room 15 526 So. Western Ave., Chicago, Ill.



Practical Electrical Education

Our practical course in Electrical Science and Engineering trains you to get and keep the big-pay jobs. Enter at any time, no matter what your education. Advance as fast as you can master what we teach. Course combines theory with actual practice in all branches of electrical work. Individual instruction. Positions paying \$1,500 a year up, waiting for graduates. **WRITE FOR FREE ILLUSTRATED CATALOG.** Eleventh year. Spring term now open.

School of Engineering of Milwaukee, 250 3rd Bldg., Milwaukee, Wis.



IF YOU STAMMER



Attend no stammering school until you get my big FREE book and special rate. Largest and most successful institution of its kind in the world. Two large modern school buildings fully equipped for treatment of stammering under my advanced natural method. No sing-songing or time-beating

Established 14 years. Known everywhere as the best. Personal instruction given each student. Write today for full particulars. Lee Wells Millard, Pres. North-Western School for Stammerers, 2317 Grand Ave., Milwaukee, Wis.

Chicago Correspondence School of Law

Prepares Students at Home for the Bar. Four Courses of Study: College, Post-Graduate, Business Law and Bar Examination Review. **Actual Daily Lessons by a recognized School that is approved by Bench and Bar.**

Write today for FREE Catalog and Rules for Admission to the Bar.
520 Reaper Block. Chicago



LEARN WATCH REPAIRING

Be a watchmaker—you can learn this profitable trade by correspondence in a few weeks in your own home by the DeSelms Chart System. After you complete the course you will know a watch from A to Z. You will know just what the matter is and how to repair one. When you graduate you will be a practical watchmaker and repairer and competent to fill any position. Positions for our graduates.

Ask for our Free Book. It explains our system and terms.
THE DeSELMS WATCH SCHOOL
23 Perry Street ATTICA, INDIANA



Study at Home
Make \$25 to \$75.00 A Week
As A **Commercial Artist**

Advertisers are in constant need of Men and Women trained in this profession. Commercial drawings often bring \$50 to \$500 each. We train you at home for this work. You learn quickly in spare time by our new easy simple method and

WE GUARANTEE A POSITION backs this offer. Hundreds have become successful. We have more positions open now than we can fill. Demand for artists getting bigger. You can't waste your efforts under our \$500 Bond insurance and you are sure of a position.

Write At Once For Free Book and samples of other students work. Students whom we have trained and are now making \$25, \$50, \$75 and over \$100 a week. Perhaps you possess this talent but do not know it. We can develop it. Don't wait. Position is waiting for you. Send postal or letter now.
SCHOOL OF APPLIED ART, 18 Art Bldg., Battle Creek, Mich.



The Start

The Finish



\$18⁰⁰ to \$20⁰⁰
Per Week

\$3,000 to \$10,000
Per Year

Don't Stop When You've Just Begun

The prizes in the race never go to men who stand still or look back. The men who get away from the post and try are the men who win. The same is true in business. The man who is dissatisfied with his present position and trains for a bigger, better job, is the man who succeeds.

There is a big field waiting for such men. Over 500,000 firms need Expert Accountants—and there are only 2,000 certified public accountants in America to do the work.

We
Train
You By
Mail

Be An Expert
ACCOUNTANT
At \$3,000 to \$10,000 a Year

Small Cost
Easy Terms

Begin now. The tuition fee is surprisingly small and terms so easy you will scarcely miss the money.

Write your name and address in the coupon and find out how quickly you can enter a profession that is practically new—the field unlimited—the demand many times greater

in spare time—at home—to qualify for one of these big, high-salaried positions paying from \$3,000 to \$10,000 a year. We train you so that you can direct others in big business matters, be looked upon as one of the really important factors in the conduct of any business and one of the first men consulted in all matters of finance and management.

Our course in Higher Accountancy is prepared to give you such instruction as you need in the shortest possible time. Under the personal supervision of our instructors and the coaching of our experts you learn every phase of Practical Accounting, Theory of Accounts, Auditing, Cost Accounting, Business Organization, Business Management, Business Laws, etc. In fact, no effort is spared to give you the personal training needed to suit your exact requirements whether as an executive in the employ of big institutions, corporations, etc., or in business for yourself as a Certified Public Accountant.

Your Instruction Will Be Under Direct Supervision of William Arthur Chase, C. P. A.

Ex-President of the National Association of C. P. A. Examiners and Ex-Secretary of the Illinois State Board of Examiners in Accountancy and other experts of national prominence.

The lessons are practical, directly to the point, all needless text-book theory having been entirely eliminated. This prepares you for a rapid advancement to an executive position commanding a high salary.

The LaSalle course trains you from the ground up—takes into consideration your individual knowledge or lack of knowledge. In other words, it provides complete and comprehensive instruction according to your individual needs—from the simplest bookkeeping principles to the most advanced accounting problems. Whatever training you may need on the subject of bookkeeping we'll give you without any extra expense to you.

LaSalle Extension University,
Dept. 564-H Chicago, Illinois

than the supply—and the salary, the largest paid to professional men. Take the first step now. Mail the coupon today.

The LaSalle Guarantee

We give you a written agreement, signed by our Treasurer, that if, upon completion of the course you should fail to pass C. P. A. Examination held in any state, we will give you special instruction and help—without additional charge—until you do pass. We further agree to refund entire amount of tuition, according to our Guarantee Bond, if dissatisfied with the course.

You owe it to yourself to learn all the facts about this course. Write us for full information. We will send you a book which tells the whole story—about the truly remarkable opportunities in store for you. How to pass State examinations, the salaries paid, etc. Take the first step now. Mail the coupon for full facts today.

MAIL COUPON TODAY

LaSalle Extension University,
Dept. 564-H Chicago, Illinois

Send at once, without cost or obligation to me, your valuable book of Accounting facts and full details of your course in Higher Accountancy; also advise me about Special Reduced Rate and Convenient-Payment Plan.

Name.....

Street and No.....

City.....State.....

Please Mention Popular Mechanics



\$125⁰⁰ to \$300⁰⁰ A Month—For You

HAVE you the training that equips you to hold a position paying \$125 to \$300 a month? Have you the same knowledge as the man who gets the fat pay envelope? If you are ambitious—**send the coupon below** and find out about the opportunities that await you in the profession of Signal Engineering. **Salaries are paid to men who know.** You can get just the kind of training you need to accept one of the big jobs, right in your own home during your spare time. **We need men.** Send the coupon today for our new book telling you all about it.

Be a Signal Engineer

The profession of Signal Engineering is only in its infancy. There are thousands of miles of block signals to be installed. Signal Engineers, supervisors, inspectors and foremen are required to superintend this installation. Hundreds of maintainers and battery men are needed to maintain the systems already in use.

Your duties may take you from coast to coast. Free transportation is liberally awarded. You can be located steadily at one place, if you prefer. The high place and fat pay envelope may be yours. Send coupon for free Signal Book today.

\$125⁰⁰ to \$300⁰⁰ a Month

That is an ordinary salary for Signalmen—many Signal Engineers make much more. In the Signal Department positions of authority, paying from \$175 a month up, are open to the men who have had the kind of training you can get right in your own home. Get your name and address on the coupon.

We Need Men

The profession of Signal Engineering is calling to ambitious men. Our ranks are not overcrowded. There are opportunities—golden ones, awaiting the men who answer the call. In our profession you will have the chance you have been looking for. **We are calling you.** Write.

TWO BIG OUTFITS FREE

Complete Signal Engineer's Outfit and Complete Draftsman's Outfit given away absolutely FREE to our students.

Department of Signaling
Room 1195
1810 Wilson Ave.
Ravenswood Station
Chicago, Illinois

Gentlemen: Please send me absolutely free and prepaid your new book on Signal Engineering. Also full particulars about your great special free outfit offer. It is distinctly understood that I assume no obligations of any kind.

Name.....

Address.....

Age..... Occupation.....

Send the Coupon for Big New Book

Put your name and address on the coupon or on a letter or a post card now, and send it to us. Absolutely no obligations of any kind. We will send you our big new book absolutely free and prepaid. Read about the opportunities that await you. The book is free. Send the coupon for it now—it's the first step toward the realization of your ambitions. Do it right now.

Department of Signaling

Room 1195
1810 Wilson Ave.
Ravenswood Station
CHICAGO

"LEARN BY DOING"

Five minutes of Actual Practice properly directed is worth more to a man than years and years of book study. Actual Practice is the only training of value. Graduates of The N. Y. Electrical School have proven themselves to be the only men that are fully qualified to satisfy EVERY demand of the Electrical Profession.

At this "Learn by Doing" School a man acquires the art of Electrical Drafting; the best business methods of Electrical Contracting; together with the skill to install, operate and maintain all systems for producing, transmitting and using electricity.

School open all year. Individual instruction. A school for young and old. Write for information.

44 West 17th St. New York City
The N. Y. ELECTRICAL SCHOOL

You Can Now Learn to Speak in Public

Be the man who moves the crowd from laughter to tears and from tears to laughter. Dominate your audience with the brilliance of your diction. Learn at home to be a convincing speaker. Fifteen minutes a day—that's all the time you need. A remarkable brief and scientific course of training.

Write Now for Special Offer. Send quick for details of our special limited offer. 250 facts you can use. No obligation. Write while this offer lasts. American Correspondence School of Law
Public Speaking Dept. 6955 Manhattan Bldg., Chicago, Ill.

MUSIC TAUGHT FREE

 IN YOUR OWN HOME

You can read Music like this quickly. Write today for our booklet. It tells how to learn to play Piano, Organ, Violin, Mandolin, Guitar, Banjo, etc. Beginners or advanced pupils. AMERICAN SCHOOL OF MUSIC, 51 Lakeside Bldg., Chicago

GOVERNMENT POSITIONS

offer employment for life at a salary ranging from \$800 to \$1800 per year, with short hours under pleasant conditions and no fear of "lay-offs" or strikes. American citizens 18 or over are eligible. Our 64-page booklet contains list of positions, requirements, etc., and tells how you can prepare for "Exams" under the personal supervision of a former U. S. Civil Service Secretary-Examiner. Booklet is FREE, without obligation. Write today
PATTERSON CIVIL SERVICE SCHOOL
117 Irving Place ROCHESTER, N. Y.



DON'T TRY TO BE A CHAUFFEUR

GET THIS BOOK FIRST. or go to ANY SCHOOL to learn, or part with your hard earned dollars until you have read our valuable guide FIRST. It tells what you should PAY and what you should GET. Do not be deceived by schools which claim everything and give you nothing. YOU CAN'T AFFORD TO SPEND ONE CENT TILL YOU GET OUR GUIDE. It costs nothing and may save you many dollars. Write now for this FREE BOOK.
PRACTICAL AUTO SCHOOL, 68 Beaver St., New York

LEARN TO WRITE ADVERTISEMENTS. EARN \$25 to \$100 A WEEK. We can positively show you by mail How to increase your salary. BOOK MAILED FREE.
PAGE-DAVIS CO., 112 Page Building Chicago, Ill., or 150 Nassau St., New York

Learn to PAINT SIGNS and SHOW CARDS. I'll teach you personally by mail. 17 years' successful teaching. Big field for men and women. You can Earn \$18.00 to \$45.00 a Week. Scherer (Chicago) writes: "Your instruction is great. Highly pleased." Full details promptly on request.
DETROIT SCHOOL OF LETTERING
Chas. J. Strong, Founder Dept. 205, Detroit, Mich.



YOU Can Earn \$2000 a Year

The demand for trained engineers at \$2000 to \$5000 a year becomes greater every day. Any man with engineering training can practically demand his own price. NOW—as never before—is the time to enter a profession that pays big money—a profession in which the demand for trained workers far exceeds the supply.

The **American School** will make you an expert engineer in a short time at small expense. Our staff of experienced engineers will give you individual instruction and advice. No previous experience necessary. You can start in immediately to prepare yourself for one of the countless high-salaried positions always open. You run no risk—we **guarantee** you more pay.

Gained \$3600 Position
 "The same day I received my Diploma I secured a position at \$3600 a year. My present success is due to the knowledge gained through your school."—Robert Knight, Chicago, Ill.

Now Gets \$2000 a Year
 "I now have a position that pays me \$2000 a year, which I never could have obtained had I not been for your school."—Robert T. Hendrickson, Fremont, Ohio.

Salary 400 Per Cent Greater
 "I am now Assistant Chief of the Engineering Department, and my present salary is 400 per cent greater than when I started the course."—Frank C. Krohn, West Allis, Wis.

Earn While Learning No need to give up your present occupation. We train you at home—solely by correspondence—as we have successfully trained thousands of others in the past nineteen years. Pocket-size text books enable you to study anywhere—at any time. Papers examined and corrected only by technical experts. Most thorough correspondence instruction in America.

\$40 Drafting Outfit and Library FREE

First of all we will teach you drafting—the foundation of all engineering professions. We will give you a \$20 drafting outfit and a \$20 drafting library (4 vols.) **ABSOLUTELY FREE!** Then, after you have mastered drafting and are getting actual working experience as an engineer's draftsman, we will train you in your choice of Civil, Mechanical, Structural or Architectural Engineering. Thus, for a little more than the cost of a course in drafting alone, you get the training that enables you to fill a responsible, well-paying position as engineer. **Be sure to investigate this offer if you have been thinking of enrolling in any drafting course.**

Engineering Book FREE

Send the coupon today for your copy of our 248-page Free Book. Tells how easy it is to become an engineer, and gives full particulars regarding the course you are most interested in. **Don't hold back because of the money. The cost is small, and you can pay for your instruction as you progress—in small monthly installments.**

Mark and mail the coupon today. This is a wonderful opportunity to get into a profession in which the possibilities for advancement are unlimited. No obligation, so mail the coupon **now!**

AMERICAN SCHOOL OF CORRESPONDENCE, CHICAGO, U. S. A.

Free Book Coupon

American School of Correspondence, Chicago, U. S. A.

Without any obligation on my part, please send me full particulars of your Engineering Offer and a copy of your 248-page Free Book. I am interested in a course in Architectural Structural Mechanical Civil Engineering. Pop. Mech. 5-16

NAME.....
 ADDRESS.....

WANTED

Railway Mail Clerks
\$900 to \$1800 a Year
(\$75 to \$150 a month)



Business Boom means hundreds of appointments

Rapid advancement to higher Government Positions. "No lay-offs" because of STRIKES, WARS, FINANCIAL FLURRIES or the WHIMS OF SOME PETTY BOSS. THE POSITION IS YOURS FOR LIFE.

Country residents and city residents stand the same chance for immediate appointment. Common-sense education sufficient. Political influence NOT REQUIRED.

Write immediately for free list of Government positions now obtainable. Don't delay. Every day you lose means the loss of just so much chance of your early appointment.

FRANKLIN INSTITUTE, Dept. L 106, Rochester, N. Y.

FRANKLIN INSTITUTE (The Pathway to Plenty), Dept. L 106, ROCHESTER, N. Y.
 This coupon, filled out as directed, enables the reader to free specimen questions, a free copy of our book, "Government Positions and How to Get Them," a list of Government positions now obtainable, and to consideration for Free Coaching for the position here checked.

COUPON

Railway Mail Clerk... (\$900 to \$1800) ..Customs Positions... (\$500 to \$1500)
 Bookkeeper..... (\$800 to \$1500) ..Stenographer.... (\$800 to \$1500)
 Postoffice Clerk.... (\$800 to \$1200) ..Internal Revenue... (\$700 to \$1800)
 Postoffice Carrier... (\$800 to \$1200) ..Clerk in the Departments
 Rural Mail Carrier... (\$500 to \$1200) ..at Washington..... (\$900 to \$1500)
 Auto Chauffeur..... ..Canadian Gov't Positions.....

Name..... Address..... L 106
 Use this before you lose it. Write plainly.

Please Mention Popular Mechanics

FREE BOOK

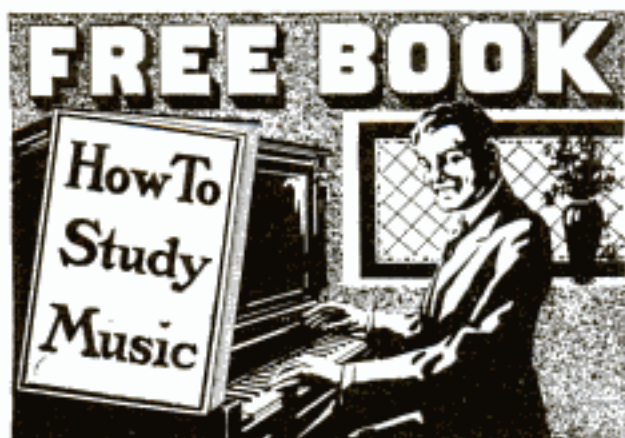

How To Study Music

Learn Piano 4 Times Faster

Our interesting 64-page free book shows the keen delight which a musical training will bring you; and how you can obtain this training easily and thoroughly in your own home at one-quarter the usual cost. It explains the social advantages of musical accomplishment, and tells how you can greatly increase your earning power by professional playing or by giving musical instruction in your spare time. It fully describes a method of home study which brings you all the comprehensive features of the best foreign conservatories, at less than 43 cents a lesson. All music furnished free. Write for this valuable book today. It is free.

Dr. Quinn's COURSE IN PIANO or ORGAN

by the written method, has revolutionized the study of music. By the use of Dr. Quinn's remarkable device, the UOLOROTONE (patented) you save three-quarters of the time and effort usually required for learning piano or organ. You play chords instantly and a complete piece, in every key, within a few lessons. The method is scientific and systematic, yet practical and simple. It is endorsed by leading musicians and heads of state conservatories. Equally effective for children or adults, beginners or experienced players. Practice in spare time, whenever convenient. Successful graduates everywhere. Diploma granted. Special reduced terms this month. Investigate without cost or obligation by writing today for free book, "How to Study Music."

QUINN CONSERVATORY, Box 650KR, CHICAGO

Learn Watchmaking At Home



You can learn by our modern and original system of instruction every part of the Watchmaker's Trade at home as good or better than at a shop. You can earn money while learning and secure a well paying position or start in business after completing our course of instruction. Good watchmakers are always in demand and earn from \$20 to \$35 per week. For particulars apply to the Wisconsin School of Watchmaking, 514th St., Milwaukee, Wis.

COPY THIS SKETCH

and let me see what you can do with it. Illustrators and cartoonists earn from \$20 to \$125 a week or more. My practical system of personal individual lessons by mail will develop your talent. Fifteen years' successful work for newspapers and magazines qualifies me to teach you. Send me your sketch of President Wilson with 5c in stamps and I will send you a test lesson plate, also collection of drawings showing possibilities for you.

The Landon School of Illustrating and Cartooning
1438 Schofield Building, CLEVELAND, O.



Ohio Mechanics Institute

(Institute of Applied Arts)

Thorough instruction and practical shop work in Mechanics, Electricity, Architecture, Industrial Art and Design, Chemistry, General Science, Lithographic Art, Printing, Household Arts and Sciences, Applied Art Trades—Machine Work, Cabinet and Pattern Making, Art Forging, Interior Decorating, Plastic Work. Special Department for Teachers, Superior Laboratory and Shop Equipment. Our Graduates in great demand at good salaries. Full catalogue C mailed on application.

JOHN L. SHEARER, Pres., CINCINNATI

SPEAK A FOREIGN LANGUAGE !!!



The War has created unlimited commercial opportunities for those who know Spanish, French, German or Italian. Take advantage of the war situation! Better your position and increase your salary. Extend your business. Establish export trade with South American countries. Equip yourself to read foreign books and papers. Brush up on the language you studied at school or college and make it of practical use. Acquire a new language at home, by the

LANGUAGE-PHONE METHOD

And Rosenthal's Method of Practical Linguistics (Highest Award Panama-Pacific Exposition)

This is the natural way to learn a foreign language. You hear the living voice of a native professor pronounce each word and phrase. He speaks as you desire—slowly or quickly, for minutes or hours at a time. It is a pleasant, fascinating study; no tedious rules or memorizing. It is not expensive—all members of the family can use it. You simply practice during spare moments or at convenient times, and in a surprisingly short time you speak, read and understand a new language.

Write for free "Language Treatise," particulars of Trial Offer, Easy Payments. Our records fit all talking machines.

The Language Phone Method, 961 Putnam Bldg., 2 W. 45th St., N.Y.

ENGINEERING

MECHANICAL, ELECTRICAL, STEAM, GAS

In the summer session beginning June 5th and closing July 29th, the work is arranged to suit the previous education and training, however limited or advanced, of each individual, and special attention is given to the practical subjects such as drawing, shop work and elementary electricity. Requests for men trained in this school have always exceeded the number of graduates. Fees and living expenses very low. For particulars write

W. E. Freeman, Professor of Electrical Engineering and Director of Summer School
F. Paul Anderson, Dean, College of Mechanical and Electrical Engineering
UNIVERSITY OF KENTUCKY, LEXINGTON



\$4.50 STARTS YOU Towards the Big Job

The profession of Meter Engineering needs men. Positions are open. Big Money is being paid. Now—on a great special offer you can start for the big job for only \$4.50. BE THE BOSS—be the man who gets the fat pay envelope. Don't miss this offer.

Write Today for Big New Book Your name and address is filed out about the great opportunities in our profession. Write today—now. Ft. Wayne Correspondence School, Dep. 1195, Ft. Wayne, Ind.



BE A TRAVELING SALESMAN

Hundreds of good positions now open. No experience required to get one of them. Write today for list of openings offering opportunities to earn Big Money while you learn and testimonials from hundreds of our students who are earning \$100 to \$200 a month. Address nearest office, Dept. 501 NATIONAL SALESMEN'S TRAINING ASSOCIATION Chicago, New York, San Francisco

Drafting will Promote You!



Great demand for trained men. Your spare time is enough to master Architectural, Mechanical, Electrical or Structural Drafting, Plan Reading, Estimating, etc. Send at once for our new book—its free!

This Outfit FREE CHICAGO TECHNICAL COLLEGE
1050 Lake View Bldg., Chicago, Ill.

STAMMERERS

Our course of private lessons will correct your impediments.
BOSTON STAMMERERS' INSTITUTE
Founded 1897 by Prof. T. B. J. L. Grady.
246 Huntington Ave. BOSTON, MASS.



Civil Service Examinations

Good pay, easy hours, regular promotion, dignified, pleasant work, and a secure future are yours if you work for Uncle Sam. Start now to get your training to pass the examinations, for the job you want, from the International Correspondence Schools. Write today for free booklet about hundreds who have secured positions.
International Correspondence Schools
Box 5595, Scranton, Pa.



You Can Break the Shackles of Fear!

What This Book Teaches You

- How to overcome Timidity.
 - How to conquer Bashfulness.
 - How to have "nerve."
 - How to demand "your own."
 - How to face people you have always felt inferior to.
 - How to develop Self-Confidence.
 - How to deal with people on their own level.
 - How to successfully face embarrassing situations.
 - How to "rise to the occasion."
 - How to be Forceful and Dominant.
 - How to eliminate Nervousness in dealing with big men.
 - How to act calmly and naturally on occasions that usually excite you.
 - How to banish Fear, physical as well as mental.
 - How to stop Worry.
 - How to become a Man among men.
 - How to get rid of Superstition.
 - How to face old age calmly.
 - How to maintain poise in public.
 - How to assert yourself in Business as well as in the Home.
 - How to develop courage to swing big deals.
 - How to dominate Circumstances.
 - How to defy old time habits of Hesitation.
 - How to insure a healthy, virile, intrepid grade of Brain.
 - How to stir into electrical activity, latent leadership qualities, which Nature has tucked into the make-up of every normal man or woman.
 - How to mass the myriad cell-forces of your Mind into a strong, tearing, goal-gaining plan of conduct.
 - How to break open the door to a new world of Thinking—rare in beauty, practical in application.
 - How to blaze the way to unthought-of fields of self-expression.
 - How to add to your physical buoyancy a tingle and zest hitherto missing.
 - How to impress others with your poise, purpose and power.
- A complete list of contents would almost fill this page.*

Do you lack confidence in meeting other people? Are you conscious of another's personality and your own lack of it? Do you feel inferior to others? Are you superstitious about anything? Do you worry about your loved ones or about conditions? Are you afraid of approaching old age? Do you seem to be blinded by petty fears? Are you frightened in public? Are you afraid of your ability to "put things over"? Are you afraid to assert yourself in your home or in business? Do you fear the opinion of others? Have you the courage of your convictions? Do things that other men and women are doing seem impossible of accomplishment by you? Are you afraid to go in business for yourself or afraid to take the risks you used to? Are you able to brush aside all obstacles in order to arrive at your destination? Are you conscious of your power, self-confident and eager, demanding what you want, or do you stand cringing, hat in hand, and whine for it? If any of these subjects even touch on your condition, "Culture of Courage" will prove a godsend!

Fear of self—fear of people—fear of the future—fear of things—fear for others (worry)—are what keep men and women down when they should and could be on top.

But not until the shackles are broken—not until fear is eliminated—not until courage is properly cultivated, can man come into his own.

"Culture of Courage"

by Frank Channing Haddock, Ph. D.

This great work by the famous author of "Power of Will"—a scientist whose name ranks with James, Royce, and Bergson, is not an inspirational book which merely admonishes you to "Destroy Your Fears" and "Be Courageous." Instead, it is a practical course in how to overcome each particular kind of human fear, physical as well as mental, to which we are all subjected. It contains actual principles, rules, methods, and exercises which any one can easily follow and become ten times bigger—ten times more successful—ten times happier than you had even dared hope.

A Ghost-Scattering Searchlight

In "Culture of Courage" the author opens up into some of the most important problems of existence; he throws a ghost-scattering searchlight into the shadows that have scared people from rich fields of life; he tears away the straw-and-gossamer entanglement which has held men and women in subjection; he pulls off the imagination-created masks of various fears, superstitions and bugaboos which in all ages have paralyzed the brain's energies and constantly dined in eager ears the failure slogans, "I'm afraid," "I dare not try," "I haven't the ability," etc.

As you study this new system, you will learn definitely how Reason, Thought, Analysis, and Sanity can scatter to the high heavens the senseless visions of fear that are causing unalterable losses, embarrassments and failures.

This book will startle you, will awaken strains of thought that may easily change the entire course of your career, just as it has that of thousands of other men and women in all walks of life who have learned its wonderful back-bone building secrets.

Send No Money While published in book form, "Culture of Courage" is a comprehensive system of courage-building and contains more material than many \$25 correspondence courses. It has 14 main divisions, and fills 460 pages. Beautifully bound in half-leather, gold top leaves, big readable print—yet the price is only \$3.00, and we are offering it for five days' examination without a penny from you in advance.

Send no money—merely mail the coupon enclosing your business card or giving a reference. If, after you have it in your own home, you feel you can afford not to own this wonderful guide to a broader life, to things worth while, send it back. The examination will not have cost you a penny. Tear out, fill in and mail the coupon right now before you turn this page, as this announcement may not appear in this magazine again.



460 pp.
Half Leather
Gold Top
Leaves

PELTON PUB. CO. 70-J Wilcox Block
Meriden, Conn.

What Readers Say:

"In it I found rules, principles and regimes which make it worth its weight in gold to me." — District Attorney Goodwin, Oil City, Penn.

"It is a 'wonder.' The more one reads it, the more forceful ideas he can draw from this storehouse." — J. F. Ellis, Pres. Nat. School of Sales'p, Minneapolis, Minn.

"It is simply magnificent; I shall highly recommend it and wish everybody could read it." — L. I. Hall, Rochester, N. Y.

"It stands absolutely at the head of anything I have ever come across; Mr. Haddock is certainly a Master Mind. As a teacher I can say that no greater good could come than the abolition from superstition this book brings about." — James Stratwell, Reynoldsville, Pa.

"These books are a gold mine of 'energizing material' for the progressive mind." — A. A. Martin, M. D., Pierce, Neb.

"Enclosed is my check; send another copy." — W. H. Smith, Pres., Herring-Hall, Marvin Sale Corp., New York.

"I have read 'Culture of Courage.' Shall want anything its author may produce. This is the most sincere tribute I can pay the books." — C. A. Drinkwitz, Evanston, Ill.

"'Culture of Courage' is superb. It is clear, forceful, scientific, practical in every form and manner: ALIVE with the rich, the high, the ideal, the sublime. It's an inspiration from beginning to end. IT JUSTIFIES ALL CLAIMS." — F. Stanley Peters, Res. Master, Wesley College, Colombo, Ceylon.

"Enclosed is check for which send me another copy for one of my friends. Dr. Haddock's works are superior to anything I have ever read for the development of the individual. He is entirely in a class by himself." — Chas. E. Ward, D.C., Houston, Me.

Pelton Pub. Co.,
70-J Wilcox Block
Meriden, Conn.

Gentlemen: Please send me a copy of "Culture of Courage" on approval. I agree to remit \$3.00 or return the book in 5 days.

Name.....

Address.....

Power Plant \$1 PER MONTH Engineering No Money in Advance



The Most Used Among engineers, and those who are studying steam and electrical engineering, the Power Plant Library is now the most used library in existence. **Why?** Because it was written by practical men who are recognized authorities. Because it is free from higher mathematics and technical descriptions, and covers the whole field, including steam, electricity, turbines, refrigeration and mathematics.

Practical Men Wrote These Books

Its present rate of sale, about 800 sets per month, is convincing evidence that the practical man requires and demands records of actual performances in the engine room, facts without theory, as contained in the Power Plant Library. The fact that this Library is known and used in nearly every power plant in the United States proves conclusively that the so-called technical writer lacking in actual experience cannot possibly supply the thousands of details of operation necessary to be known by the engineer.

Systematic Instruction The learner of steam and electrical engineering, in order to advance rapidly towards the higher positions, must have his instruction course arranged systematically and in order. The text arrangement of the Power Plant Library enables him to commence with the simplest principles of operation, say proper firing or oiling, and then to proceed without interruption through every branch of power plant work, until he is able to take charge of the largest plant.

Nothing Omitted To the chief engineer or superintendent earning \$150 to \$400 per month these books are just as valuable as to the learner, because they contain nothing but practice and there is no detail omitted.

Pay Nothing Until You See the Books

The eight volumes contain nearly 3,000 pages, 1,500 illustrations and weigh 14 pounds. They are beautifully and durably bound, and with reasonable care will last a lifetime. They will be sent to you by parcel post prepaid upon receipt of the coupon below. No money in advance is required. If for any reason whatever you do not wish to keep them we will send you return charges. If you are satisfied send us \$1 per month for twelve months.

Contents Mathematics—Engine Running—Valve Setting—Boilers—Electricity—Piping—Pumps—Skating—Belting—Governors—Steam Turbines—Refrigeration—Ice Making.

FREE EXAMINATION COUPON

McGraw-Hill Book Co., Inc., 239 W. 39th St., New York
Gentlemen:—Ship the Power Plant Library, eight volumes, for my inspection. If satisfactory after examination, I will send you \$1 in ten days and the balance at the rate of \$1 per month until I have paid the price of the books, \$12. If not satisfactory I will write for shipping instructions.

SIGNATURE.....
RESIDENCE ADDRESS.....
CITY AND STATE.....
NAME OF EMPLOYER.....
REFERENCE.....
ADDRESS..... P.M. May

Please Mention Popular Mechanics

Learn to Write

I Teach by Mail

I CAN make a good penman of you at your home during spare time, no matter where you live or how poorly you now write. My simplified system has shown thousands of others the way to good penmanship during the past twenty years—it can and will do the same for YOU!

Beautifully Illustrated Book
"How to Become
a Good Penman"

It contains general information, with testimonials and beautiful specimens of penmanship showing what others have accomplished by the Tambllyn System. **FREE!**
(Your name rightly written on a card if you enclose stamp for postage.) WRITE TODAY. Address

F. W. TAMBLYN

418 Meyer Bldg., Kansas City, Mo., U. S. A.

F. W. Tambllyn

LAW STUDY AT HOME BECOME AN LL.B.

Only recognized resident law school in U. S. Conferring Degree of Bachelor of Laws—LL. B.—by correspondence. Only law school in U. S. conducting standard resident school and giving same instruction, by mail. Over 450 class-room lectures. Faculty of over 30 prominent lawyers. Guarantees to prepare graduates to pass bar examination. Only law school giving Complete Course in Oratory and Public Speaking. School highly endorsed and recommended by Gov. Officials, Business Men, Noted Lawyers and Students. Send today for Large Handsomely Illustrated Prospectus. Special Course for Business Men and Bankers.
HAMILTON COLLEGE OF LAW, 405 Advertising Bldg., CHICAGO, ILL.



LEARN TO DRAW

Illustrators—Cartoonists—Designers are in demand. Many of our pupils obtain paying positions before completing the course. Personal instruction by artist of thirty years' experience. Correspondence and Local School. Copy this sketch and send to us for free criticism, and 5 cents in stamps for illustrated book.

Artist's outfit FREE to enrolled students.

Washington School of Art
923 F St., N. W., Washington, D. C.

BE AN ILLUSTRATOR.

Learn to draw. We will teach you
by mail how to draw for magazines and newspapers.
Send for Catalog

Learn to draw. We will teach you
School of Illustration
112 Page Bldg.
Chicago, Ill.

SELF-CONSCIOUSNESS

Are you timid? Do you lose your nerve and become confused easily? Do you lack confidence, courage, aggressiveness, faith in your own ability? These faults are a big handicap in social or business affairs. My Illustrated Treatise tells you how they may be overcome. It's FREE! Write for it today.

M. DeBETTS, Sta. 89, JACKSON, MICH.

LEARN WATCHMAKING AND ENGRAVING



Earn while learning. Most practical watch school. Individual instructions. Graduates in great demand. Book free.
Chicago School of Watchmaking, 63 E. Van Buren St., Chicago

Stop Forgetting!



The average mind resembles a scrap pile.

Makes
Your
Mind
a File
—Not
a Pile



The Dickson Trained mind is as well ordered as a cross-indexed file.

Is your mind like a scrap pile—heaped up with a lot of unrelated, unclassified, unindexed facts? When you want to remember a name, place or date, must you grope uncertainly in this mixed-up pile seeking in vain to locate the desired information? And finally in embarrassment give it up? Summoned on any occasion to give facts and figures—does your mind become a blank? When suddenly called upon to speak—do you seek wildly to collect your thoughts—utter a few commonplace remarks—and sit down—humiliated? *Without Memory all the knowledge in the world becomes worthless. Stop Forgetting makes your mind a file—not a pile.*

I Can Make Your Mind as Systematic and Forget-Proof as a Card Index File

I can make you master of your mind's infinite ramifications—instead of a victim of its disordered details. The Dickson Method of Memory and Mental Training, perfected by 20 years' experience, is universally recognized as the most thorough, efficient, practical, simplest and popular system of its kind now before the public. Fully endorsed by leading educators and men of the day. This system so thoroughly trains the memory that you will be able to classify impressions, ideas, names, facts and arguments and have them ready at a moment's notice—at any time. It develops concentration and mental control—overcomes self-consciousness—enables you to think on your feet and to address an audience intelligently without notes.

Dickson Memory Training Has Helped Thousands

Mail the coupon, or give me your name and address on a postal, and I will send you statements from students in every walk in life—men who had exceedingly poor memories and developed them to an amazing perfection—men with remarkably good memories, who made them even better. Give me ten minutes a day of your time, and I will make your mind an infallible classified index, from which you can instantly select facts, figures, names, faces, arguments. *Perfect your memory and you can command what salary you will.*

Special Offer on "How to Speak in Public"

This deluxe, handsomely illustrated, richly bound book—regularly priced at \$2.00—for a limited period, I will present to every student who enrolls for the course in Memory Training, absolutely FREE. The book will train you to think on your feet—to express yourself clearly, logically and convincingly whether talking to one person or a thousand.



Prof. Henry Dickson

America's foremost authority on Memory Training, Public Speaking, Self-Expression, Lecturer and Principal of the Dickson Memory School, Hearst Building, Chicago.

Prof. Henry Dickson, Principal Dickson School of Memory 705 Hearst Building, Chicago, Ill.

Send me free Booklet "How to Remember," also particulars how to obtain a free copy of Dickson's "How to Speak in Public."

NAME _____

STREET _____

CITY _____

STATE _____

Book
FREE

Get My Book On
"How to Remember"

Simply send your name and address on the coupon for this remarkable book. I will also send you a free copy of my unique copyrighted Memory Test. Make the mailing of the coupon your first step towards SUCCESS.

Please Mention Popular Mechanics

LEARN ELECTRICITY

At America's Greatest Trade School
EARN \$100 TO \$300 A MONTH



Learn by Doing

What a glorious chance for big money, for big work this, THE ELECTRICAL AGE offers you! How vast the field already! How more wonderful it is growing! No wonder there is such a need for the trained man! Enter the field of Electricity now with Coyne training, which is prized above all for its practical, workable value and success is yours!

Be a Coyne Trained Man

Get a complete training by actual practice. Our graduates in Electricity, Plumbing, Bricklaying, Drafting and Motion Picture Operating are preferred everywhere. Why? Because their knowledge isn't mere "book" smattering. We teach these trades under actual working conditions right in our big shops! We furnish all tools and equipment FREE. Day and evening instruction. You may earn while you learn—start any time.



Coyne National Trade Schools

Plumbing, Bricklaying, Drafting, Motion Picture Operating also practically taught. Estimating and Plan reading included in ALL Courses. 16 years of success backs this great institution. Largest and best equipped of its kind in America. Free Employment Bureau for our students. Tuition fee amazingly small. You can pay a little at a time. Here is the chance you've wanted.

Send Coupon for FREE Book

Resolve to better your condition. Be independent in the mastery of a trade that pays. No experience necessary to start. Send today for our free book of trades. See what we have done for others. Send coupon or postal for book and all particulars.

MAIL NOW!
COUPON

B. W. COOKE, Director,
Coyne National Trade Schools,
39-51 E. Illinois St., Dept. 1195, Chicago, Ill.

Dear Sir: Without cost or obligation to me, please send me your book of trades and full particulars—all FREE.

B. W. Cooke, Director,
Coyne National
Trade Schools,
39-51 E. Illinois St.,
Dept. 1195
Chicago, Ill.

Come to Chicago,
the busiest
city in the
world.

NAME.....

ADDRESS.....

Please Mention Popular Mechanics

SHORTHAND IN 30 DAYS

We absolutely guarantee to teach shorthand complete in only thirty days. You can learn in spare time in your own home, no matter where you live. No need to spend months as with old systems. Boyd's Syllabic System is easy to learn—easy to write—easy to read. Simple. Practical. Speedy. Sure. No ruled lines—no positions—no shading as in other systems. No long lists of word signs to confuse. Only nine characters to learn and you have the entire English language at your absolute command. The best system for stenographers, private secretaries, newspaper reporters and railroad men. Lawyers, ministers, teachers, physicians, literary folk and business men and women may now learn shorthand for their own use. Does not take continual daily practice as with other systems. Our graduates hold high grade positions everywhere. Send today for booklets, testimonials, etc.

Chicago Correspondence Schools
969 Unity Bldg., CHICAGO, ILL.

Traffic **WANTED** Inspectors

(BY THE R. R.'s)

**\$4 Per
Day**

Here's a new profession for ambitious men (not rating but new, outdoor work). Positions now open pay \$4 Per Day to start; chances for advancement and travel unlimited. We train you thoroughly, quickly; give you all necessary experience. Find out how men like you—clerks, salesmen, railroad men—are earning real money and advancement. Here's your big chance!

Write for Free Booklet A3 now, lest you forget!
Frontier Prep. School, Buffalo, N. Y.

LEARN MUSIC AT HOME!

SPECIAL OFFER—EASY LESSONS FREE—Piano, Organ, Violin, Banjo, Mandolin, Guitar, Cornet, Harp, Cello, or to sing. You pay only for music and postage—which is small. No extras. You learn by note. Beginners or advanced pupils. Plain, simple, systematic. 16 years' success. Start at once. Send your name and get free booklet by return mail. Address U. S. School of Music, Box 132B, 225 5th Ave., N. Y. City.

DRAWING

Learn by mail in your own home. Cartooning, Newspaper, Magazine and Commercial Illustrating, also

Water-Color and Oil Painting

Learn Drawing or Painting for profit and pleasure. We can develop your talent. This school has taught thousands. Free Scholarship Award—special limited offer. Your name and address brings you full explanation and our handsome Illustrated Art Annual by return mail. Don't delay. Write today.

FINE ARTS INSTITUTE, Studio 215, Omaha, Neb.



BE A BANKER

Splendid opportunities. Pleasant work, short hours, all holidays off, yearly vacation with pay, good salary. Learn at home. Diploma in six months. Catalog free. EDGAR G. ALCORN, Pres.

AMERICAN SCHOOL OF BANKING, 419 E. State Street, COLUMBUS, OHIO



LEARNED BY ALMOST ANYONE VENTRILLOQUISM AT HOME

Send today 2c stamp for particulars and proof.
O. A. SMITH, Room D 138, 823 Bigelow St., PEORIA, ILL.

Book on Law Free



Write today for our new 171-page book on "The Power of Law Training." It carries a vital and inspiring message to every ambitious man. Find out about the opportunities that await the law trained man. Find out how you can learn from masters of the law right in your own home. No obligations. The book is free, now while we are making a special reduced price offer.

Write Today—
AMERICAN CORRESPONDENCE SCHOOL OF LAW
1195 Manhattan Bldg., Chicago, Illinois

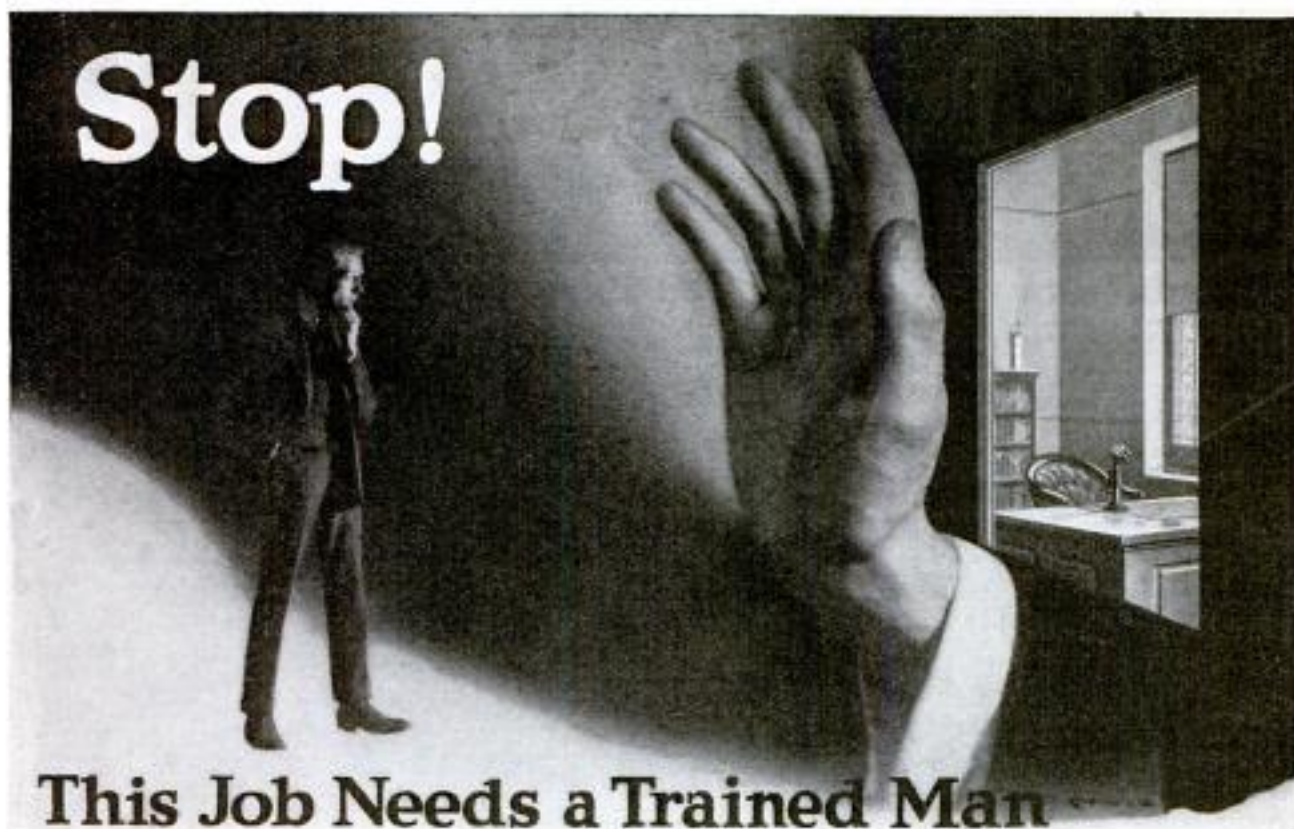

Stop!

This Job Needs a Trained Man

You've reached your limit. You can't expect to step into a job that pays a big salary until you've prepared yourself for it.

It's a serious question, this problem of getting ahead. There is only one solution—you must have *training*; you must be able to do work that others *can't* do, or your pay will stay on a level with theirs.

The business of the International Correspondence Schools is to help just such men as you to get good positions and hold them.

Right now over one hundred thousand ambitious men are preparing themselves through I. C. S. courses for the bigger jobs ahead. Last year nearly five thousand reported increased pay as the result of I. C. S. training. These men got their training in spare time and in their own homes. What the I. C. S. have done for others they surely can do for you. But you must make a start—the same start that they made—and the way has been made easy for you. Mark and mail this coupon.

I. C. S., Box 5504, Scranton, Pa.

Reports on 27,000 typical I. C. S. students show 14,990 now receiving \$1500 a year or more; 2451 receiving \$2500 or more; 413 receiving \$5000 or more; 20 receiving \$10,000 or more; and 8 with annual incomes of \$25,000 or more.

WHAT OTHERS HAVE DONE YOU CAN DO

INTERNATIONAL CORRESPONDENCE SCHOOLS

Box 5504, SCRANTON, PA.

Explain, without obligating me, how I can qualify for the position, or in the subject, before which I mark X.

- | | |
|-----------------------------------------------------|----------------------------------------------------|
| <input type="checkbox"/> ELECTRICAL ENGINEER | <input type="checkbox"/> SALESMANSHIP |
| <input type="checkbox"/> Electric Lighting | <input type="checkbox"/> ADVERTISING MAN |
| <input type="checkbox"/> Electric Car Running | <input type="checkbox"/> Window Trimmer |
| <input type="checkbox"/> Electric Wiring | <input type="checkbox"/> Show Card Writer |
| <input type="checkbox"/> Telegraph Expert | <input type="checkbox"/> Outdoor Sign Painter |
| <input type="checkbox"/> MECHANICAL ENGINEER | <input type="checkbox"/> ILLUSTRATOR |
| <input type="checkbox"/> Mechanical Draftsman | <input type="checkbox"/> DESIGNER |
| <input type="checkbox"/> Machine Shop Practice | <input type="checkbox"/> BOOKKEEPER |
| <input type="checkbox"/> Gas Engineer | <input type="checkbox"/> Stenographer and Typist |
| <input type="checkbox"/> CIVIL ENGINEER | <input type="checkbox"/> Cert. Public Accountant |
| <input type="checkbox"/> Surveying and Mapping | <input type="checkbox"/> Railway Accountant |
| <input type="checkbox"/> MINE FOREMAN OR ENGINEER | <input type="checkbox"/> Commercial Law |
| <input type="checkbox"/> Metallurgist or Prospector | <input type="checkbox"/> GOOD ENGLISH |
| <input type="checkbox"/> STATIONARY ENGINEER | <input type="checkbox"/> Teacher |
| <input type="checkbox"/> Marine Engineer | <input type="checkbox"/> Common School Subjects |
| <input type="checkbox"/> ARCHITECT | <input type="checkbox"/> CIVIL SERVICE |
| <input type="checkbox"/> Contractor and Builder | <input type="checkbox"/> Railway Mail Clerk |
| <input type="checkbox"/> Architectural Draftsman | <input type="checkbox"/> AGRICULTURE |
| <input type="checkbox"/> Concrete Builder | <input type="checkbox"/> Textile Overseer or Supt. |
| <input type="checkbox"/> Structural Engineer | <input type="checkbox"/> Navigator |
| <input type="checkbox"/> PLUMBING AND HEATING | <input type="checkbox"/> Poultry Raising |
| <input type="checkbox"/> Sheet Metal Worker | <input type="checkbox"/> AUTO RUNNING |
| <input type="checkbox"/> CHEMIST | <input type="checkbox"/> Auto Repairing |
| | <input type="checkbox"/> Spanish |
| | <input type="checkbox"/> German |
| | <input type="checkbox"/> French |
| | <input type="checkbox"/> Italian |

Name _____

Occupation & Employer _____

Street and No. _____

City _____ State _____

Please Mention Popular Mechanics

MEN WANTED

To Drive and Repair Automobiles and Tractors

Tear Off and Mail the Coupon Herewith Today—Right NOW

It may mean to you all the difference between success and failure. Will you, by training yourself in a few short weeks, become a competent, expert automobile man? **Cash in on your time.** How would you like to have an earning capacity of \$5 a day and up? How would you like to have a trade that will always insure you good wages, independence, opportunity to see the world? How would you like to be in demand? Have employers looking for you—have big opportunities for a successful career spread out before you? Now young man, you can't do this simply by wishing. But you can do it.

By the Sweeney System You Can Learn in Six Weeks

There's only one place in the world to learn by the Sweeney System; and that is at the School of practical experience where you learn without text books and by doing the work with your own hands; and that's the Sweeney Automobile School of Kansas City, Mo. I want every young man mechanically inclined to send today for my big catalog. It costs me 50 cents, and is a complete encyclopedia on the subject. It is like a moving picture as the 123 actual photographs show men at work in every department, at every job. It explains the wonderful Sweeney System. I will send it free, to those who answer this announcement, together with a special advantageous offer. A \$50 Tractor Scholarship Free. Use Coupon Today—NOW.



*****FREE COUPON*****

E. J. SWEENEY, President
SWEENEY AUTO SCHOOL
1163 E. 15th St., KANSAS CITY, MO.

Send free tractor scholarship offer and catalog. Also magazine.

Name

Address

Earn Big Money in the Automobile Business

The Sweeney School can give you the names and addresses of over 5,000 graduates who are now chauffeurs, repair men, factory experts, garage owners, salesmen, etc. These men came to us untrained. They got interested by reading our advertising, just as you are reading now. They acted on the same impulse that moves you now to investigate. And then after a few weeks' instruction they went out of this school completely equipped, got employment, and today are **Prosperous, Happy and Respected.** You can do likewise. I will teach you so that you have a chance to qualify yourself for a **Business Success** handling or repairing automobiles. It will cost you nothing to investigate, and let me tell you the actual experiences of my graduates.

Make \$5 Per Day and Up 21,000 tractors were sold this year. Over 700,000 automobiles. Who's going to drive and repair them? Men are in big demand. Our school is doing double the business it did last year. Nothing succeeds like success. Don't you want to make \$5 a day and up? There's money in the automobile business for you.

E. J. SWEENEY SWEENEY AUTOMOBILE SCHOOL
1163 E. 15th Street, KANSAS CITY, MO.

ELECTRICAL ENGINEERING

Men with training are always in demand. Having trained over 2000 young men in the past 23 years in the fundamentals of Applied Electricity, The Illinois Electrical School, with its well-equipped shops and laboratories, is peculiarly well qualified to give a condensed course in Electrical Engineering



including Mathematics, Steam and Gas Engines, Mechanical Drawing, Shop Work, and Theoretical and Practical Electricity, in all branches. Students actually construct dynamos, install wiring and test efficiency of electrical machinery. Course, with diploma, complete

IN ONE YEAR

For practical young men with limited time. 24th year opens Sept. 25th. Catalogue on request. 104 Takoma Ave., Washington, D. C.

Learn Watchwork, Jewelrywork and Engraving.

A fine trade commanding a good salary, and your services are always in demand. Address HOROLOGICAL, Dept. P, Bradley Institute, Peoria, Ill., for our latest catalog.



Learn a Paying Profession

that assures you a good income and position for life. For twenty years we have successfully taught

PHOTOGRAPHY

Photo-Engraving and Three-Color Work

Our graduates earn \$20 to \$50 a week. We assist them to secure these positions. Learn how you can become successful. Terms easy—living inexpensive. Write for catalogue—NOW!
ILLINOIS COLLEGE OF PHOTOGRAPHY, 999 Wabash Avenue, Effingham, Ill.

ESTAB. 1892
BODEE TRADE DENTAL SCHOOL

15-17 W. 44th St. NEW YORK CITY

LEARN IN 3 MONTHS TO EARN \$1300 TO \$4000 A YEAR

Our valuable book "P" tells how. It's Free—write for it. Anyone from 16 to 60 years old can easily learn Mechanical Dentistry. The Demand is like a gold mine. Unexplored. We constantly have calls for good salaried positions. Why not qualify for one? No book study. All practical work. We guarantee that you can earn while learning. Installment Payments. Licensed by Regents of N. Y. State.

LEARN TELEGRAPH

Morse and Wireless—R. R. Accounting (Station Agency) taught. Splendid opportunities. Positions secured. Marconi Co. takes our wireless graduates. We own and exclusively occupy two large modern buildings equipped with R. R. and Western Union wires and complete \$5,000 Marconi Wireless Station. Largest School—established 67 years. Investment \$25,000. Endorsed by Railroad, Marconi and Western Union Officials. Expert practical teachers. Low living expenses; easily earned if desired. Tuition low. Easy payments. Correspondence courses also. Catalogs Free.
Dodge's Telegraph, Ry. & Wireless Institute
8th Street, Valparaiso, Ind.

BE A DETECTIVE

Earn from \$150.00 to \$300.00 per month; travel over the world. Write

C. T. LUDWIG, 133 Westover Bldg., Kansas City, Mo.

The University of Chicago

HOME STUDY

in addition to resident work, offers also instruction by correspondence.

For detailed information address

24th Year U. of C. (Div. 20) Chicago, Ill.



Michell Tower

Ambition

-take a Lesson
from Life

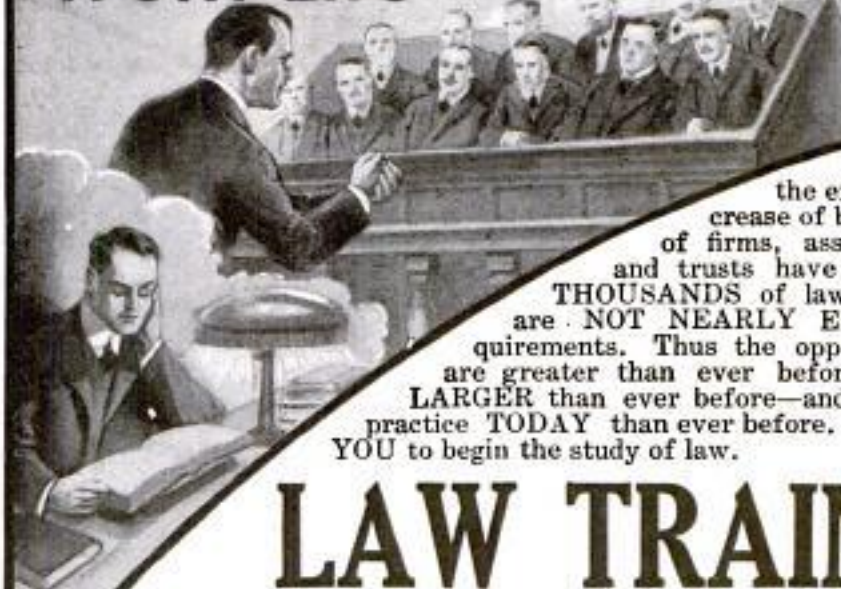

The great growth of the departments of the Government; the extension of Commerce; the vast increase of business; the endless multiplication of firms, associations, corporations, combines and trusts have created new opportunities for THOUSANDS of lawyers. In the United States there are NOT NEARLY ENOUGH GOOD lawyers to fill requirements. Thus the opportunities for legally trained men are greater than ever before—the FEES paid to lawyers are LARGER than ever before—and it is far EASIER to start a law practice TODAY than ever before. Therefore, NOW is the time for YOU to begin the study of law.

LAW TRAINED MEN

Earn \$3,000 to \$10,000 a Year

We Train You By Mail

It is NOT very difficult, after all. Don't be discouraged because you think it is necessary to memorize a great MASS of technical detail—for it is NOT. ALL the technical detail of the law is contained in the LIBRARY we furnish you. We teach you the PRINCIPLES of the law and JUST HOW TO APPLY them. Becoming a lawyer is PRINCIPALLY learning HOW TO APPLY the law—HOW TO SELL the knowledge contained in the LAW BOOKS. By the LaSalle system of "cross-reference" the principles of the law are easily found—and by the "case" system their application is soon learned. Under our guidance you will obtain this training—the ONLY difference between yourself and a successful lawyer earning from \$5,000 to \$20,000 a year. The law is powerful. In a comparatively short time it will qualify you to advance from low salary and position into good income and high station. It will make you a MAN among men. If you are in earnest—if you have average intelligence—if you will make proper effort—failure is IMPOSSIBLE.

America's Greatest Men Studied Law

It is a fact that the study of law has brought wealth, fame and position to MORE men than any other profession. The majority of our most successful BUSINESS MEN have a fair knowledge of the principles of law. Nearly ALL of our GREATEST STATESMEN have had legal training. United States presidents, cabinet officers, congressmen, representatives, ambassadors, politicians, officials of our states and great cities are NEARLY ALL men of legal training. Many of these men were born in POVERTY AND OBSCURITY and were RAISED into positions of POWER by the law. DETERMINE to do your best. RESOLVE to follow in the footsteps of these great men. The LaSalle Extension University's Great Home-Study Course in Law will make the path EASY for YOU.

Mail Coupon NOW! Don't "put off" this matter. Send the Coupon today for the Free Booklets and full information concerning this special law course. Don't allow lack of money to interfere—WE WILL MAKE TERMS TO SUIT YOUR PURSE. Remember that the LaSalle is the largest Home-Study Extension Law School in America—enrolls MORE students than any other. There is a reason. Send the coupon and learn WHY. No "extras" to buy—we supply everything—including the LaSalle Standard Law Library IF YOU ENROLL NOW.

LaSalle Extension University,
Dept. 564-F Chicago, Ill.

at your home by the simplified LaSalle System of Law Instruction. You keep your present position and learn while you earn. We have adapted the instruction methods of the leading resident law colleges to correspondence work. Everything is so fully explained—and in such a clear and simple manner—that you cannot help but understand. The LaSalle method takes all the "hard work" out of reading the law—it will save you many months of laborious study. It not only teaches you law, but also how to PRACTICE law.

Special Course For Business Men

Many of our students are business men who recognize the necessity of legal knowledge. Write now for facts about business men's course.

FREE Complete Course in Public Speaking

Our training by mail, will positively teach you the fine art of persuasive speech. Every lawyer—every successful man—should be a forceful speaker. Our course is highly indorsed an most complete and authoritative—prepared by Frederick B. Robinson, A. B., A. M., Ph. D., Professor Public Speaking at College of City of New York, formerly Editor Public Speaking Review. Write and learn how you can NOW secure this valuable course, absolutely free, if you become one of our law students.

MAIL NOW!
COUPON

14 Volume Law Library furnished FREE if you enroll

LaSalle Extension University
Dept. 564-F Chicago, Ill.

now.
Size 8x10
3/4 Sheep
Over
6,000
Pages,
etc.

Without obligation on my part, send me, by return mail, information concerning your Course in Law with the free books: "Evidence" and Valuable Law Guide—also concerning your offer of FREE Course in Public Speaking.

Name

Street and No.

City.....State.....

Please Mention Popular Mechanics

MICHIGAN STATE AUTO SCHOOL
MICHIGAN STATE AUTO SCHOOL
MICHIGAN STATE AUTO SCHOOL

Come to Detroit
the automobile center
and

LEARN THE AUTOMOBILE BUSINESS

Detroit trained men get preference over all others and get jobs quickly. No other city, no other school can give you what Detroit offers. Think what it means to learn in Detroit. Every factory knows us, endorses our school, glad to get our graduates, offers them best territory in which to sell cars and start garages. Unlimited opportunities here. You're right in the middle of the great auto activity. Men are needed everywhere as testers, repairmen, chauffeurs, garage men, and salesmen. Splendid chance to start in business. Hundreds of our graduates are doing it.

Earn \$75 to \$300 a Month

We teach you to handle any auto proposition. Our equipment is complete. Students actually build cars from start to finish, getting regular factory training in assembling, block-testing, road testing, everything. That's the Detroit way. Special complete course in Oxy-Acetylene brazing and welding, separate from regular course. All leading types of starting, lighting, and ignition systems in operation. Learn to time motors, adjust carburetors, magnetos, valves, bearings quickly and accurately. Six-cylinder Lozier and 8-cylinder King are used for road instruction. We have a new Chalmers "6" chassis with overhead camshaft motor, the latest thing out. Just added 1916 Delco System as used in Buick, Hudson and Packard Twin "6."

Detroit is the Place to Learn—Start Any Time

There are 44 auto factories in Detroit, and hundreds of accessory and parts factories. Our students have the privilege of going through any or all of them, including Detroit electric service department, while taking our course. You can't get these advantages anywhere else. Detroit is the automobile center. You make faster time here and you get practical instruction. Come to Detroit and learn the business right. Enter classes any time, any day. Three classes daily, morning, afternoon and evening. You can work in the factory in day time and take course at night. There is a great demand for Detroit trained men. Garages throughout the country write us for men. Auto factories write and phone for men constantly to fill permanent places. Why not fit yourself for one of these good paying positions?

The demand is greater than the supply for competent trained men. The following were clipped from daily papers in all parts of the U. S.

Wanted—Experienced motor mechanics, bearing scrapers, assemblers, repairmen; good wages. Henderson Motorcycle Co., 1158 Cass.

Wanted—Chauffeur, must be good driver, steady and reliable; one with knowledge of Pierce-Arrow cars preferred; no other but good mechanic need apply. Address Box B, No. 100 Free Press.

Wanted 10 Road Testers, 20 garage repair men, final assemblers. Maxwell Motor Co., Inc., Oakland Ave. Plant.

Wanted 40 Drivers. Come ready to work. Maxwell Motor Co., Inc., Oakland Ave. Plant.

Wanted Block Testers. Apply Continental Motor Mfg. Co.

Wanted—High grade retail automobile sales manager. Box E. No. 52.

Follow the Crowd to the Michigan State Auto School. Come to Detroit



THIS IS ONE OF OUR JANUARY 1916 CLASSES. OVER 350 MEN IN THE PICTURE.

Start a Garage and Sell Cars—Be Independent

We have made the biggest deal yet. Just completed arrangements with the Automobile factories to put them in touch with men who intend going into business for themselves. Think of getting inside information as to best territory and where the garages will make most money. The auto factories keep close watch—they are looking for Detroit trained men to represent them and start garages. Men who know the Auto business from A to Z are in biggest demand. Come here and start right—go through the factory. Learn the best selling points—get the information first handed and don't wait, jump on a train and come now.

We have made arrangements with a large eastern investment firm (with millions of dollars), to back competent, reliable, Michigan State Auto School Graduates, who want to go into the garage and selling business. These Capitalists know where the money is to be made—they are ready to back the right kind of men—Men who are trained at the Michigan State Auto School and are competent. Have you been waiting for such an opportunity? Then come to Detroit as hundreds of men have done, hurry, don't wait. You can complete the course in from six to eight weeks. Then go into business for yourself. BE INDEPENDENT. Make the big money. Get started NOW.

Money-Back Guarantee

We guarantee to qualify you in a short time for a position as chauffeur, repairman, tester, salesman, demonstrator, garage man, or automobile dealer, paying from \$75.00 to \$300.00 monthly or refund your money. We have consistently more requests for Detroit trained men at GOOD salaries than we can supply.

SEND THIS COUPON TODAY

Michigan State Auto School
Dept. 305, 11-19 Selden Ave., Detroit, Mich.
Gentlemen: Send to me absolutely FREE "Auto School News" and New Catalog or better still you can expect me about.....

Name

Street

Town.....State.....

Automobile Industry Offers Biggest Possibilities

No other field is so big—no other business so permanent. Every place, no matter how small, will support a garage. Think of it—nearly a million new automobiles will be sold this year. Think of the money in selling and repairing. Are you going to reap some of the golden harvest?

Act Quickly—NOW

Fill in the coupon and mail it now, get full particulars—get "Auto School News" and New Catalogue fresh from the press. They are both ABSOLUTELY FREE. Or better still, jump on a train, as hundreds have done, and come to Detroit, the "Heart of the Automobile Industry" and learn right. Remember, you can enter classes any time any day. Act quickly, NOW.

Michigan State Auto School

The Old Reliable School
Dept. 305, 11-19 Selden Ave., Detroit, Mich., U.S.A.

DETROIT THE HEART OF THE AUTO INDUSTRY





Sailors in Winter Camp at Guantanamo, Cuba

WINTER DRILLS IN THE NAVY

DURING the winter months, the U. S. Atlantic Fleet proceeds to Guantanamo Bay, on the South Coast of Cuba, where are conducted the various ship and fleet drills and maneuvers.

The sailors go into camp overlooking the bay, affording plenty of fresh sea breezes at all times. While ashore in divisions the men practice with small arms on the Rifle Range, the largest in the world. They participate in numerous shore drills, such as scaling walls, landing an armed force, artillery maneuvers, etc. Camp life is a pleasant diversion from the routine on shipboard, and adds to the interesting features of the Naval service.

While the fleet is at Guantanamo, athletics of all kinds are encouraged, especially base ball, boxing and boat races. It is at Guantanamo that the annual cup races of the Fleet are held, and the many handsome Navy trophies contested for. Moving pictures are shown nightly, and minstrel shows are of frequent occurrence.

The men return North in the Spring, bronzed and in prime health from their winter spent in the tropics. Upon arrival in home ports, the sailors are granted furloughs to visit their homes.

THE NAVY offers an attractive career to young men of good habits. If you are an American citizen over 17 and under 30, it will pay you to investigate the Navy's opportunities. Call at the nearest Navy recruiting station, and talk it over. Costs nothing to be examined.

If there's no recruiting station in your vicinity, write to Box 70

Bureau of Navigation NAVY DEPARTMENT
WASHINGTON, D. C.



A Dust-Proof Polish

on your car minimizes the work of cleaning. With but very little effort you can keep the finish of your car like new—all you need is Johnson's Cleaner and Prepared Wax.

JOHNSON'S CLEANER

really cleans—it entirely removes all stains, discolorations, scum, road oil, tar and grease from body, hood and fenders. Even those spots that are ground in—mud freckles—and surface scratches you thought were permanent—will disappear like magic under Johnson's Cleaner. And it doesn't injure or scratch the varnish—simply cleans and prepares it for the wax polish.

JOHNSON'S PREPARED WAX

is the proper polish to use on your car. It preserves the varnish and protects it from the weather, adding years to its life. It covers up mars and scratches—prevents checking—and "sheds water like a duck's back."

Makes a "Wash" Last for Weeks

Mud and dust do not stick to Johnson's Prepared Wax. After a dirty, dusty trip, just wipe off your car—it isn't necessary to wash it. Many people even wax the **under side** of their fenders because the mud comes off so easily.

Old Cars require both Cleaner and Wax—the Cleaner two or three times a year—and the Wax every six or eight weeks. **New cars** need only the Wax—to protect the varnish. This will keep your car like new indefinitely.

USE COUPON FOR TRIAL CANS

S. C. JOHNSON & SON, Racine, Wis. PA5

I enclose 10c for a trial can each of Johnson's Cleaner and Johnson's Prepared Wax—sufficient for cleaning and polishing a large car.

Name.....

Address.....

City and State.....

My Accessory Dealer is.....

Please Mention Popular Mechanics

Popular Mechanics Magazine

REGISTERED IN U. S. PATENT OFFICE

WRITTEN SO YOU CAN UNDERSTAND IT

Vol. 25

MAY, 1916

No. 5

Using Periscope to Sell Vacant City Lots

AT Los Angeles a real-estate dealer has devised an original and unusually interesting method of showing lots in a subdivision near his office to prospective purchasers. Instead of being taken to the tract itself, interested persons are first ushered into an octagonal room which constitutes the second floor of the agent's building. This is about 10 feet in diameter, windowless, and finished with black walls. In the middle of the room is a circular table covered with white oilcloth, while immediately above it at the peak of the cone-shaped roof is a turret with an opening on one side through which the property is clearly visible. Mir-

rors are arranged to catch the light rays admitted through the aperture



The Image is Reflected upon the Glazed Table Top, Thus Affording Not Merely a Novel but a Minutely Accurate, Detailed Map of the Subdivision

and reflect them upon the table so that the image of the tract is sharply shown upon the white surface. With the aid of a pointer he indicates different lots just as if a large map were being used. The novelty of the arrangement causes

his spectators to give close attention to the lots in question. Property offered by rival firms is in this way also kept entirely out of a "prospect's" view until the agent has him well in hand for a deal.

1609 HOME COMFORTS IN MOTOR-CAR CAMPING OUTFIT

What is one of the most elaborate and at the same time most compact camping outfits designed as an adjunct to an automobile consists of a telescopic attachment which can be quickly fastened to or detached from any roadster. This outfit includes comfortable sleeping accommodations for two, a sheltered shower-bath compartment which can be warmed and supplied with warm water, a complete kitchen equipment, including a two-burner gasoline stove, a chest containing three commodious drawers, special storage for two suitcases, a camp table and two camp chairs, six incandescent

lights supplied by a battery, and other conveniences.

The entire outfit is inclosed in a steel cylindrical case, and when closed measures 3 ft. 4 in. long, 4 ft. 4 in. wide, and 3 ft. 8 in. high. At the rear is a door hinged at its lower edge. By letting this door down and resting its outward end on two adjustable legs, the bed, a portion of which folds up against the door when the latter is closed, is laid out flat. When the compartment has been opened in this manner, two chests or cases are revealed occupying part of the space above the bed. By drawing these toward the



The Camping Outfit in Use, with the Shower-Bath Shelter, or Dressing Room, Set Up at the Rear of the Berth. Lower View: An Inviting Bookshelf is Located over the Head of Bed

Inventor and Manufacturer
 Gustav de Bretteville
 Claus Specials Bldg., San Francisco

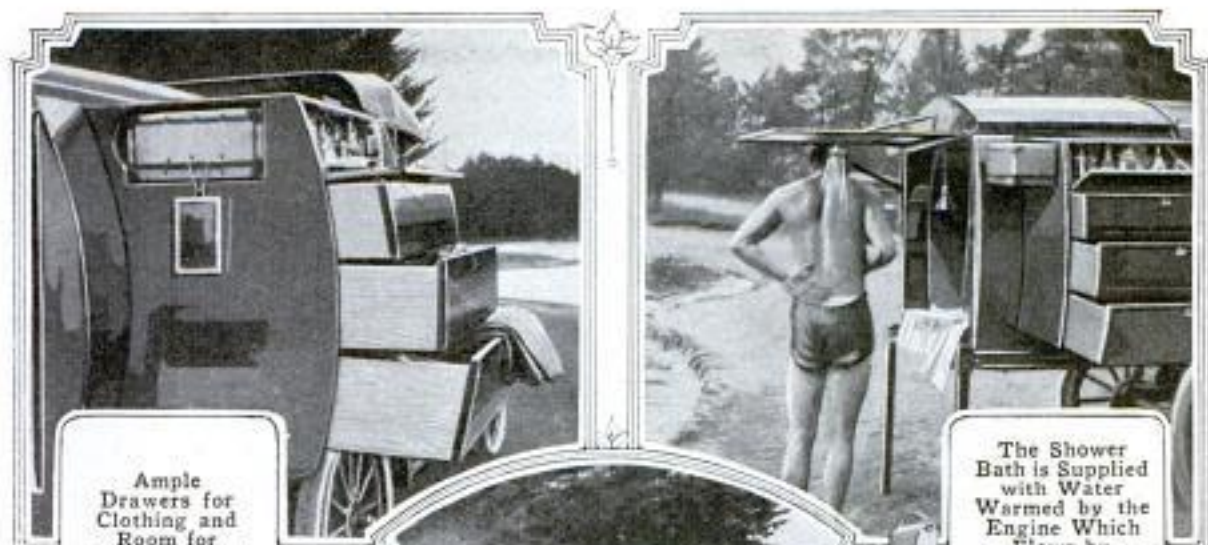

Ample
Drawers for
Clothing and
Room for
Toilet Articles
and a Suitcase

The Shower
Bath is Supplied
with Water
Warmed by the
Engine Which
Flows by
Gravity from the
Tank under the
Roof



"All the Conveniences of Home";
The Collapsible Automobile Camping
Outfit Showing the Berth Made Up,
the Chest of Drawers, the Kitchen Equip-
ment, and the Dining Arrangement.
Below: The Camping Outfit Closed



At Each Side of the Head
of the Bed is a Window
That Furnishes Ventilation
in Addition to the Window
in the Rear



rear their full length, together with a telescoping roof, they are then in a position from which they can be pushed to the right and left, respectively, thus leaving the bed unobstructed. If preferred, the roof need not be drawn out over the bed. A hinged shield can be let down at the end of the extended roof and sides, thereby completely inclosing the berth. Two windows with sliding blinds are situated, one at either side, at the forward end of the compartment.

By opening the door of one of the chests an arrangement of utensils similar to that in a kitchen cabinet is displayed. The door can be used as a shelf on which to set the gasoline stove,

etc. The other chest has a hinged shelf that can be used as a writing desk, and contains three drawers for clothing. In the top of each chest is space for a suitcase. An optional supplementary feature is a 10-gal. tank which can be connected with the engine's radiator for heating water; it is located just under the roof. A tentlike shelter with a metal roof, having a suitably connected shower-bath spray, can be set up at the rear of the car adjoining the berth and can be used either as a bathroom or as a dressing room. This shelter can be heated by air warmed by the engine. The inventor claims that the outfit can be used to advantage as an emergency hospital.

1510 HOOK LESSENS LABOR OF HANDLING TILE

A simple hook has been designed recently which lessens the labor of handling tile and prevents the rapid wearing out of workmen's gloves and the bruising of their hands. It consists essentially of an iron rod bent double and then bent again to somewhat resemble an angular "S." The lower portion of the "S" consists of two parallel prongs by means of which two tiles can be lifted at a time. The upper end of the "S" has been made into a handle by inserting between the

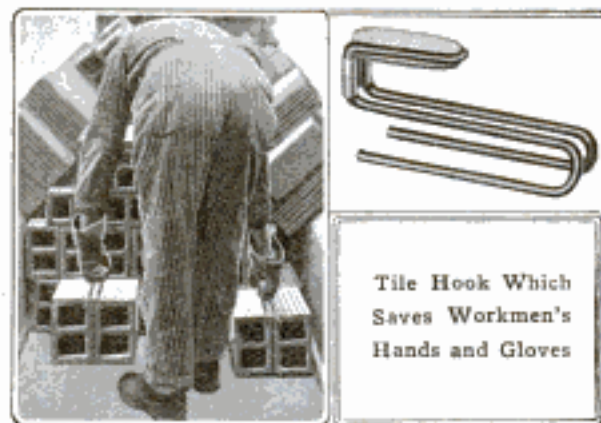

parallel portions of the iron bar a rounded piece of wood. With this tool tiles can be lifted and deposited quickly.

1533 CHANGE-MAKING APPARATUS WORKS WITH RAPIDITY

In business places where patrons come in contact with a cashier, time is saved and the chances of errors lessened by the use of a mechanical money-changing device of recent development. It determines and delivers the difference between the sum paid and the purchase amount and requires but little mental exertion of its operator. The apparatus works accurately and at high speed, facilitating the handling of crowds at city elevated and subway-transportation stations, cafeterias, and similar places. A somewhat different model of the same machine is especially designed for banks and large offices for payroll and other work. The former type has 26 numbered keys arranged like those of a typewriter and is set to make change from one dollar. By pressing certain readjusting keys, however, it will make change from smaller denominations, such as 75, 50, or 25 cents. In operating it the cashier presses a key corresponding to the amount of the purchase. The machine then does the rest, delivering the proper amount of change into a saucer-shaped receptacle from which the patron removes it, or into a money pocket from where it is taken by the operator. The

*The Cleveland Tile Hook Co.,
1473 W. 110th St.,
Cleveland, O.*

"The Lightning Change Maker"



The Insert Indicates the Keyboard Arrangement, While Below the Inside of the Apparatus Is Visible

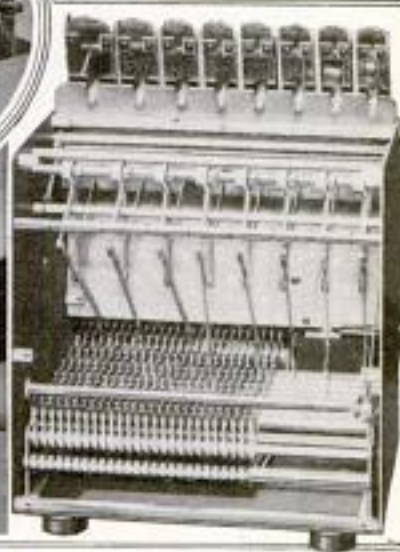

The Difference between the Sum Paid and the Amount of a Purchase is Computed and Delivered by the Machine Shown in Operation at the Left

apparatus is smaller than the average adding machine and is housed in a neat metal case. On top at the back it supports a coin tray, while at the front, in the same relative position as that of a typewriter, is its keyboard. Nineteen of the keys represent amounts from 5 to 95 cents in multiples of five. If one dollar is handed a cashier in payment for a 10-cent purchase, the "10" key is pressed and 90 cents delivered. If, on the other hand, 50 cents were given instead of a dollar, the operator would press a red key marked "50"—adjusting the machine to make change from a half dollar—and then use the "10" key, causing the delivery of 40 cents. A similar procedure is followed when change is to be made from other sums. In the middle of the keyboard there is a series of white keys which control the penny stacks in the coin tray. They pay out from one to four cents, according to the numbers they bear, and are employed when the amounts of purchases end in sums not multiples of five. The second model instead of making a deduction from a larger amount delivers change in sums corresponding to the amounts indicated on the various keys. If 65 cents is

wanted, for instance, the key so marked is used.

NAMES QUICKLY FOUND IN 1600 FILE FOR PHONE LIST *index*

A new device for making the names and numbers of a "live" telephone list instantly available consists of a case, or rack, containing a number of cards set on edge. A proper number of the cards are supplied with alphabetical index guides on their upper edges. All the cards are so fastened that they can be sufficiently separated at the top to allow the user to see at a glance any desired card. A spring closes the file when not in use. Immediately in front of the cards is a convenient memorandum pad. The device can be fastened to a telephone instrument or allowed to stand on a desk.



Meilicke Calculator Co.
 350 No. La Salle
 Chicago

Copyrighted material



Making the Winning Ski Jump of 192.9 Feet and
Breaking All Existing Records

NEW WORLD RECORD IS MADE BY AMERICAN SKI JUMPER

During a skiing contest recently conducted at Steamboat Springs, Colo., Ragnar Omtvedt, an American, captured the world's championship honors by establishing a new record. Before a large crowd of enthusiasts he succeeded in making a jump of 192.9 ft., breaking the existing record, which was held by Amble Omundsen of Christiania, by 15 ft. The man has been a prominent professional for several years and taken a number of titles. He belongs to a Chicago ski club and held the previous American record of 169 ft. At the national tournament of the American Ski Association in 1914 he took first place with jumps of 153 and 161 ft. and a total of 340 points. It is understood that the new record is official and will stand.

*over
N.W. part of Colorado
1914*

NO WAY IS FOUND TO CHECK CHESTNUT BLIGHT / 630

Forest pathologists of the Department of Agriculture have been unable to find any practical way of controlling the bark disease which during the past 12 years has spread into 19 states and done approximately \$50,000,000 damage to chestnut trees. The blight now affects all of the northern half of the country's native groves and gives no indication of abatement. Extended investigations have shown, however, that Asiatic species of the tree have for centuries manifested great resistance to the disease. From this it appears that the best way of coping with the present serious situation lies in substitution, and in breeding by hybridization for the production of new varieties especially suited for our needs. Already hybrids between the Japanese and native chinquapin have been developed. These have formed into quick-growing dwarf trees bearing heavy crops of excellent nuts at an early age. The trees have also shown high resistance to disease. Intercrossing of Japanese and Chinese varieties is also resulting favorably.

Lewis R. Freeman,

Navarre Hotel 7th Av. & 38th St
New York

1530 GERMANY'S RAILWAY PROBLEMS IN ASIATIC TURKEY

By R. J. BJURSTEDT

GERMANY'S plans for the commercial exploitation of Asiatic Turkey date back thirty years, but her active campaign to bring about a practical realization of these ambitions has not occupied much more than the last decade. Things were rushed during that decade, however, and in scarcely any of the "places in the sun" over which the German flag actually floated had more headway toward complete Teutonification been made than in Asia Minor, Syria, and Mesopotamia. The main factor in winning commercial, if not political, control of this incalculably rich region was to be a comprehensive railway system, gridironing the agricultural sections and linking up the principal strategic points with modern trunks capable of transporting powerful military forces wherever they were most needed for offense or defense.

In 1912, at Aleppo, a German engineer traced for the writer 7,576 miles of railway upon the map of Asiatic Turkey, stating that this represented the preliminary scheme of development. "The completion of these lines," he said, "will make it possible, first, to bring the products of Asiatic Turkey's principal agricultural and mineral regions to market, and, second, for the Turks to put up a stiff defense against their principal enemy, Russia, on the north, or against any threat to Mesopotamia from the east or south, or to Palestine from the south and west." Nothing was said about offense; but Meissner Pasha, chief engineer of the Bagdad and Hedjaz railways, practically admitted to the writer that "strategic considerations" were not lost sight of in running the survey of the former line hundreds of miles away from the direct route between Aleppo and Bagdad, so as to flank Armenia on the south and Persia on the west, and that a potent factor in determining the Turks to have the northern end of the Hedjaz Railway built through the desert south of Damascus instead of

the more fertile coastal region, was to make it safe from naval attack in the event operations were being carried on against Egypt from Palestine.

But however well prepared Germany was for the great struggle in Europe, in Asia the crisis was precipitated several years before she was ready for it. Feverishly as she had been working in the three or four years immediately preceding the war, August, 1914, found her with only something like one-third of the great 7,800-mile railway system she had projected for the development of the 800,000 square miles of Asiatic Turkey completed, and, worse still, not even were the two great military trunks which were to have formed the backbone of defense finished throughout all of their respective lengths. As a consequence there have been two kinds of battles waged beyond the end of the Mediterranean—one of the Turks against their enemies, in an endeavor to drive back the invading Russians and Britons, and the other of the Germans against the forces of nature in an endeavor to provide their ally with adequate transportation facilities. Neither Turk nor German has come anywhere near a sweeping success in their respective endeavors so far. With whomever ultimate victory rests, however, enough is known of what the Germans, in the face of apparently prohibitive odds, have accomplished in railway construction to make their achievements historic from an engineering standpoint, if from no other.

Since the whole of Asiatic Turkey lying beyond the longitude of the eastern end of the Mediterranean is barely able to feed its scanty population in normal times, and has no manufacturing facilities whatever, it will readily be understood why, with the sea closed to the central allies, a first-class railway system would be almost a *sine qua non* to extended military operations in this region. Such a line there was from Scutari, opposite Constantinople on the Bosphorus, to the Taurus Moun-

tains, while in Syria and Palestine there were also modern railways, and even the beginnings of one—the Bagdad—in Mesopotamia. But between the systems of Asia Minor and those of the rest of Asiatic Turkey, there was, when the war started, not only the break of twenty or thirty miles of heavy rock work in the Taurus, but a similar stretch of almost equally difficult construction in the Amanus Range, which forms the ultimate barrier between Asia Minor and Syria.

When the writer traversed the Amanus and Taurus passes in 1912 by caravan the German engineers in charge of construction expressed themselves as "hopeful" of finishing the last tunnels by the middle of 1917, in time to open up through-service between the Bosphorus and Bagdad by the fall of that year, when the "golden spike" of the great trans-Mesopotamian line was expected to be driven somewhere along the Tigris. My own impression then was that this hope was too sanguine.

When Turkey came into the war in October, 1914, the difficulties in the way of construction in the Taurus and the Amanus were greatly increased by the closing of the sea routes, so that what had hitherto been the main line of supply—the steamer service to the Gulf of Alexandretta—was no longer available. With rail communication between the Bosphorus and Germany already severed in the Balkans, the German engineers toiling to throw the "Turkish life line" across the Taurus and Amanus mountains were left very much "on their own." In the countries of the entente group, as the writer had good opportunity to observe, the general impression was that railway work in all parts of Turkey in Asia would be practically brought to a standstill for lack of materials, and in London and Paris the opinion was confidently expressed that the gaps in the two great ranges of Asia Minor could not possibly be closed in the duration of the war.

There was little news of railway work in Asia Minor during the first eight months of 1915, and then, like

lightning from a clear sky, came the announcement from Constantinople that the three-mile Bagtche tunnel through the backbone of the Amanus ridge had been completed, and that trains were expected to run between Adana and Aleppo by November or December. London openly scoffed at the report, and the writer must confess to having held much the same attitude toward it until, under date of September 3, 1915, he read in the Daily Commerce Reports of the American Consular Service a detailed description of what had been accomplished in the region in question. After telling in a general way how, in spite of the delays occasioned by the war, this most important piece of railway construction in Turkey had passed the problematical stage, the report gives the following specific details, which will leave no doubt in the mind of one familiar with the work in hand that the most important difficulties have been surmounted:

"Leaving Mamoure, the last station of the Bagdad Railway on the Cilician plain, the line begins, at an altitude of 394 ft., to climb the slopes of the Amanus Mountains, which are intercepted by ravines crossed by eight steel bridges and seven small tunnels, the latter having a total length of 6,355 ft. Thus it arrives at Bagtche station, situated at an altitude of 1,754 ft., near the entrance of the great tunnel which bears its name. Before reaching the mouth of this tunnel, the line runs through two other tunnels, having a length of 236 and 394 ft. respectively, and over a small bridge. The great tunnel has a length of 16,028 ft. For about 8,000 feet it ascends to 246 ft. above the level of the entrance, and then begins to descend and emerges at the other end 197 ft. above the level of the eastern entrance. Between this point and Islahie station, which is still building, there are four more tunnels having a combined length of 3,500 ft. The total length of the tunnels necessary to construct in crossing this range of mountains is, therefore, 26,250 feet."

How this miracle—for it is scarcely



Desert Water Tank on Hedjaz Road Which, through Connecting Line, Reaches Bagdad Railway at Aleppo. Line is Double-Tracked between Damascus and Maan



Showing the Respective Routes of, and the Principal Points Reached by, the German-Built Railways Extending through Asiatic Turkey



Station at Aley, Syria, Located on a Switch-back: Because of the Rough Character of the Country in This Region Difficulty is being Experienced in Changing the Line from a Narrow to a Standard Gauge

less—has been wrought it is only possible to conjecture at this time. Even if the Germans, with characteristic foresight, had provided adequate supplies of materials in anticipation of being cut off from their main sources, it is still almost beyond understanding how so much tunnel and bridge work could have been accomplished in so short a period, especially since it is authoritatively stated that several hundred yards of pure quartz had to be pierced in the Bagtche bore, and this of so refractory a nature that drills of special construction had to be devised to make an impression upon it. At any rate, there is now no reason to doubt that the work in the Amanus Mountains is done, and a similar announcement regarding that in the Taurus may be expected at any time.

It is probable that such railway work as the Germans have been able to do since the outbreak of the war in Syria, Palestine, and Mesopotamia has depended upon accumulated stores of material rather than upon that which could have been laboriously transported by mule and camel over the passes of Taurus and Amanus. At the outbreak of the war the western railhead of the Bagdad Railway had been advanced some distance beyond the Euphrates, but last fall military experts in London were confident that, in the year that had elapsed since the inauguration of hostilities with Turkey, it could not have been pushed farther than Ras-el-Ain, midway between Aleppo and Mosul, on the Tigris. The unexpected appearance at Bagdad of the overwhelming Turkish forces which defeated General Townshend at the end of last November, however, furnish good base for the belief that the "unbridged" gap between the Mesopotamian railheads is very much less than had been anticipated by the British. There is no possibility, as some so-called military experts in America have held, that the Bagdad Railway is completed throughout its length, but even the establishment of service to Mosul would be of great help to the Turks, as from that point,

which is the site of ancient Nineveh, munitions and supplies can be expeditiously rafted down the Tigris to Samara, to which point rails had already been laid from Bagdad when the war started.

In Syria the principal effort of the German engineers will have been directed to broad-gauging the 250 miles of meter-gauge French-built line between Aleppo and Damascus, so that it will conform with the 4-ft. 8½-in. gauge of the Bagdad and Hedjaz railways, of which it forms the connecting link. Except for the tunnels and bridges where this line crosses the Anti Libanus Mountains, between Reyak and Damascus, this task is not a heavy one, but it would seem that something of the same sort of engineering "wizardry" which was performed in the Amanus Range will have to be called into play if the heavy steel and rock work incident to broad-gauging this division is to be completed in time for the threatened "spring drive" on the Suez Canal.

In Palestine, also, all efforts have been bent to preparing the way for an attack upon Egypt. There is no reason to doubt the truth of the report that the Hedjaz Railway has been double-tracked between Damascus and Maan, southeast of the Dead Sea, as, given the material, the laying of additional rails across the level desert of this region could be done very quickly. A more ambitious piece of construction is a line running from E'Futeh, on the Deah-Haifa branch of the Hedjaz Railway, via Lydda and the plain of Sharon to Beersheba, near the southern frontier of Palestine. The writer has unquestioned authority for believing that not only was this line completed to Beersheba in the middle of January, this year, but that the embankments and culverts were ready for the rails from that point on to the Egyptian frontier. Indeed, should the threatened Egyptian campaign actually be launched, and should the British—as it is now probable they will—confine their defense to the immediate region of the Suez Canal, there is no

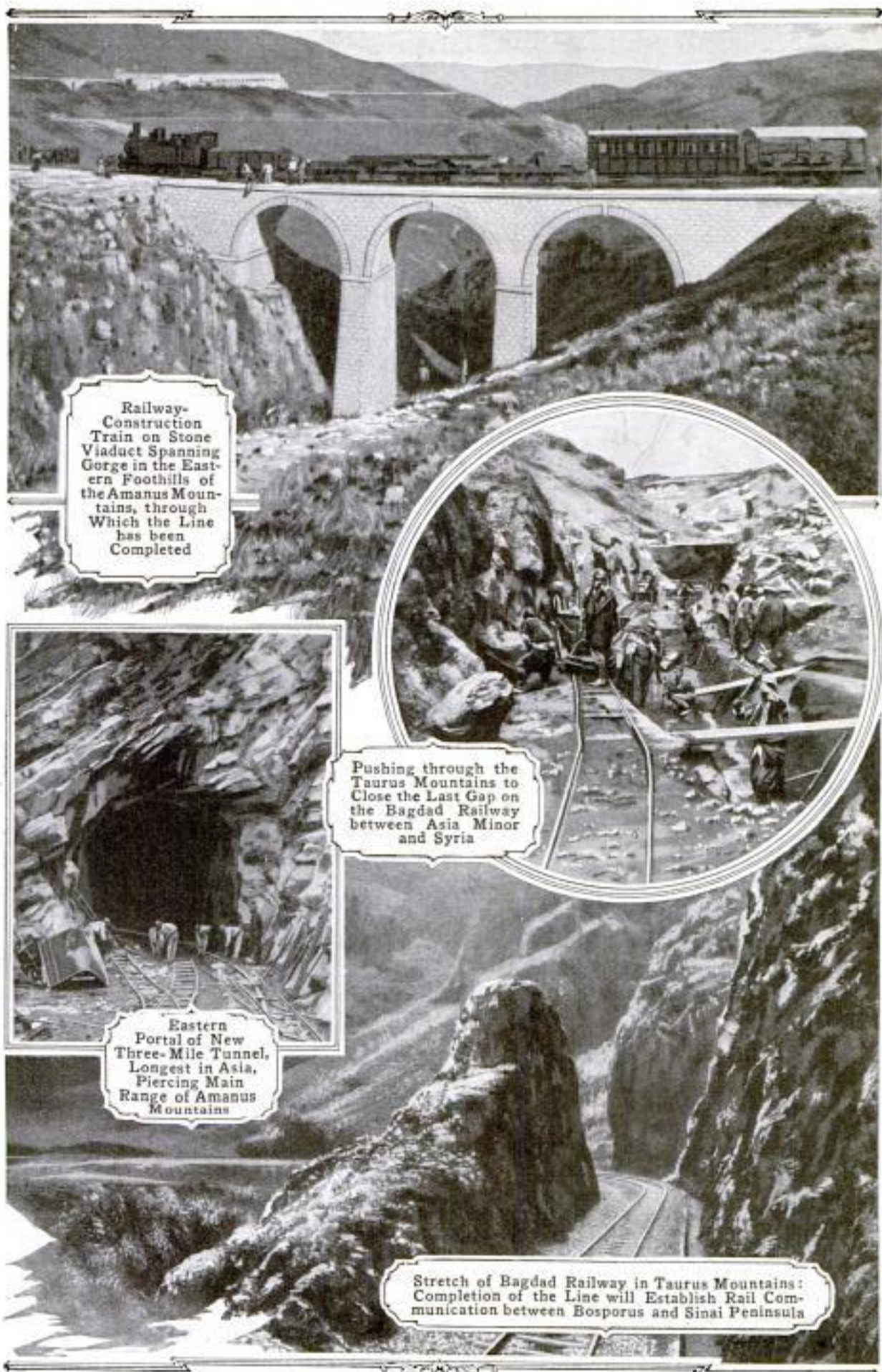

Railway-
Construction
Train on Stone
Viaduct Spanning
Gorge in the East-
ern Foothills of
the Amanus Moun-
tains, through
Which the Line
has been
Completed

Pushing through the
Taurus Mountains to
Close the Last Gap on
the Bagdad Railway
between Asia Minor
and Syria

Eastern
Portal of New
Three-Mile Tunnel,
Longest in Asia,
Piercing Main
Range of Amanus
Mountains

Stretch of Bagdad Railway in Taurus Mountains:
Completion of the Line will Establish Rail Com-
munication between Bosphorus and Sinai Peninsula

doubt that this line will be pushed some distance across the Sinai peninsula before giving way to portable railways in the rear of the Turkish armies.

Notwithstanding their almost superhuman efforts in Asiatic Turkey, the writer does not believe it possible for the Germans to develop a line of railway communications from the Bosphorus to the Sinai peninsula adequate to munition and feed a large enough army—it would have to be close to 500,000 strong to stand any chance of success—seriously to threaten the

Suez Canal; and it is by no means unlikely that uncertain communications may make it impossible for the Turks to drive the British out of Mesopotamia or the Russians out of Armenia. In spite of these possibilities, and no matter to which side the military victory goes, no unprejudiced observer can deny that, considering the difficulties with which they have been faced from the outset, the achievements of the German engineers in Asiatic Turkey are worthy to rank with the most remarkable of their kind in history.

1574 WOODEN HOWITZERS USED IN FILM, "INVASION"

Stanley W. Todd, 327 Mc Donough St, Brooklyn, N. Y.

There have recently been manufactured in this country a number of ponderous howitzers made chiefly of wood; to every outward appearance they are the counterpart of the deadly weapons in Europe, of which comparatively few photographs have been taken, but of which much has been written. These formidable-looking guns were built to be used in the

production of a motion-picture presentation of an invasion of this country by an armed force. When they are "fired" a powder is used which gives off a dense smoke that photographs very distinctly. These howitzers and other pieces of artillery, including imitation ammunition carriages, present a very realistic appearance on a field. Uniformed actors operate the guns.



One of a Battery of Ponderous Guns Made Chiefly of Wood, Discharging a Dense Smoke but No Projectiles; These Guns were Manufactured for the Purpose of Producing Motion-Picture Films Dealing with a Supposed Invasion of This Country

Proprietary

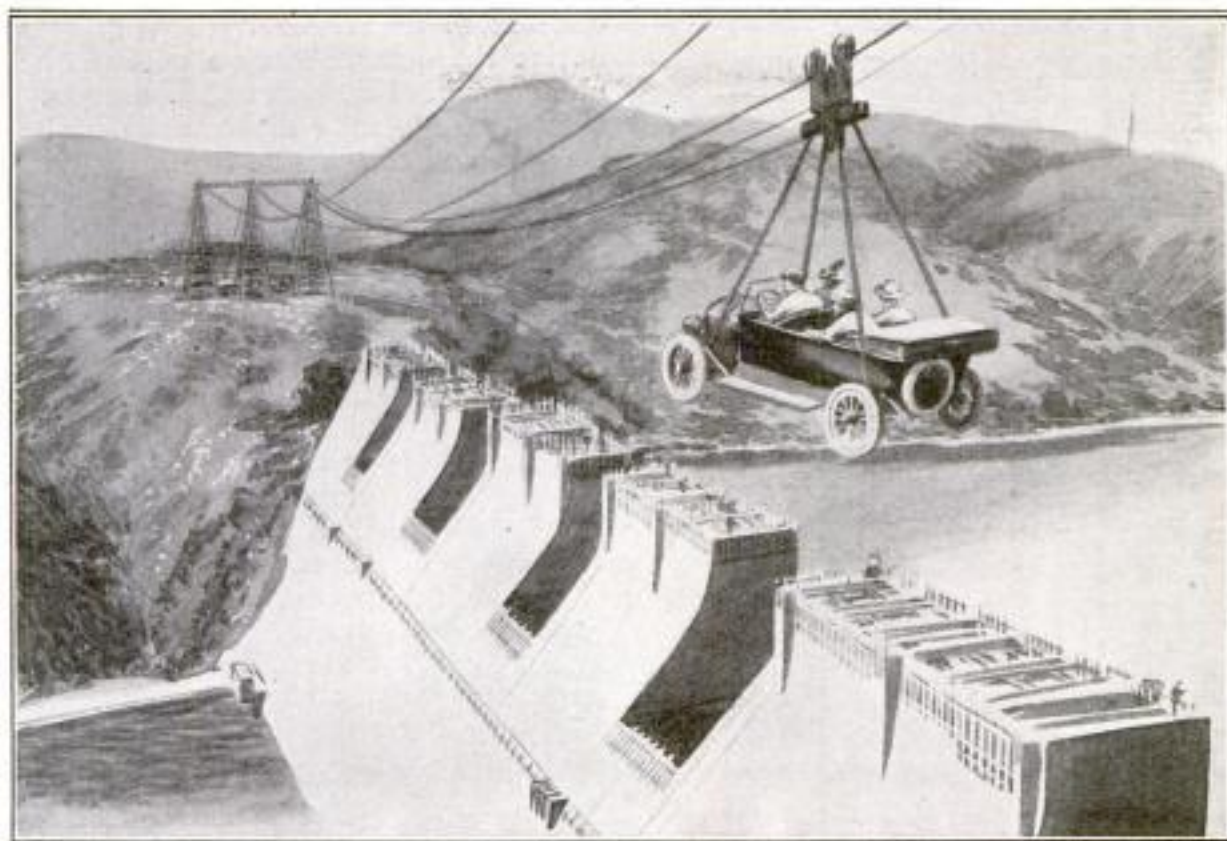

A Party of Four Motorists and Their Car, 255 Feet in the Air, Supported by the Aerial Electric Tramway at the Elephant Butte Dam

1388 AERIAL TRAMWAY CARRIES MOTORISTS HIGH IN AIR

Recently persons in the vicinity of the Elephant Butte dam in New Mexico had the startling experience of seeing a touring car and four passengers transported by cable through the air 255 ft. above the earth. To accomplish this rather thrilling feat the motor car was fastened by strong ropes to a carrier of the aerial electric tramway used in conveying material to the great dam. The crown of the barrier rises 255 ft. above the stream, and the car was carried without mishap along a line level with the top of the dam.

1513 BABY CARRIAGE BUILT LIKE AN AUTOMOBILE

A luxurious baby cab is now on the market, the reed body of which is shaped much like a motor-car body. The engine hood is well reproduced and openwork reed in front represents a radiator. Below the radiator may be

hung a metal sign on which appropriate figures can be printed. Other features are the reed mud guards, a windshield of the regular design, and small lamps, one at each side. The hood of the cab extends forward even with the wind-



A Windshield, Number Plate, Lamps, and Fenders Are Features of This Baby Cab, Designed to Resemble an Automobile

shield and has a round glass window in either side. The upholstery is of corduroy.

*Heywood Bros. & Wakefield Co., Gardner, Mass.
1415 So. Mich. Av., Chicago*

Inventor. Dr. A. de Yoanna, 565 Henry St
Brooklyn, N. Y.

654

POPULAR MECHANICS

Gen. W. Brady Res. 754 So. Western Av., New York

TIN FOIL USED TO LABEL

X-RAY PHOTOGRAPHS

1438

A new method of labeling X-ray photographs, or radiographs, with identification data, which is simpler than the

celluloid plates are inserted. With this device the data is made a part of the photograph. But such letters are cumbersome and easily disarranged. The new method consists in writing with a stylus, or typewriter, on very thin sheet lead, or tin foil, and placing this sheet on or beside the object to be photographed. Because those portions of the tin foil that are made thinner by the stylus or typewriter offer less resistance to the X-rays than the rest of the sheet, the writing appears in the photograph, which may be reliably identified thereby.



An X-Ray Photograph, Including the Reproduction of the Tin-Foil Label on Which Data has been Written

means now employed, has been patented by a New York physician. Wherever large numbers of radiographs are taken it is essential that each one be marked with the proper name, date, etc., in such a manner as to avoid mistakes in use. Reliable identification is very necessary where plates are being used as legal evidence. In many states the courts will not accept radiographs as evidence unless unmistakably labeled. At present a celluloid container is commonly used, into which letters and figures mounted on

versely as the pressure applied to it. While this holds true regarding "ideal gas," it does not apply accurately to natural gas except at pressures close to atmospheric. As it happens, much natural gas is measured at pressures as high as 300 lb. per square inch. These tests, which were conducted with Pittsburgh gas, showed that at 100-lb. pressure there is an error of three per cent if this law of physics is applied without correction; at 375-lb. pressure, the error is 11 per cent. This means that if a distributing company buys gas at

TESTS SHOW 1526
GROSS ERRORS IN MEASURING GAS

Investigation by the Bureau of Mines has revealed the fact that gross errors—sometimes amounting to 10 per cent and more—in many cases have been made in measuring natural gas under pressure. This is due to the false assumption that a certain law of physics applies to natural gas, namely, that its volume varies in-

G. A. Buvell, Chemist,
Bureau of Mines
Washington, D. C.
Copyrighted material

J.A. Butler
Perennial Kansas City Mo.

high pressure without making a correction as to measurement and sells at low pressure it may sell more gas than it pays for.

1589 ROAD SECURES FIFTEEN NEW POWERFUL LOCOMOTIVES

Fifteen passenger locomotives of the "Pacific" type, which well illustrate the steady tendency that has existed for many years to build larger and larger engines, have recently been put into service by the Chicago, Burlington & Quincy Railroad. These new giants of the rails are 75 ft. long with tender, 15 ft. 3 in. high, and weigh 215 tons; their drivers are 74 in. in diameter and they have a tractive power of 42,000 lb. Ordinary engines used by this road on other than its main lines are 53 ft. long with tender, weigh 77 tons, and have a tractive power of 13,000 lb. The great weight of the new locomotives is so evenly distributed that they do not pound the rails as do some of smaller size, and it is said they subject the track to less wear and tear than many lighter engines. Their power is more than sufficient to haul their loads.

Baldwin Locomotive Works
500 N. Phila.



One of 15 New Engines Recently Put into Service on a Western Road: The Weight of Each, Which is 215 Tons, is so Evenly Distributed That It does Not Subject the Track to as Much Strain as is Caused by Some Smaller Locomotives

ADJUSTABLE GARAGE BUILT FOR MOTOR OWNERS

One of the features of a new type of sheet-metal portable garage which has been developed of late is that it may be

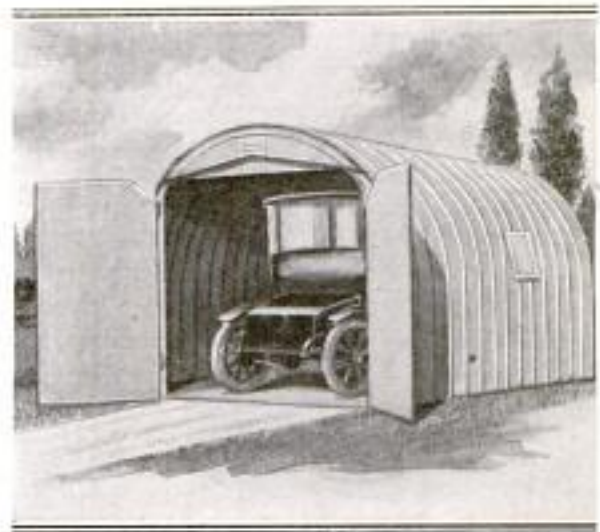

This Metal Garage may be Expanded to Fit Cars of Various Sizes

enlarged at any time by bolting additional sections to it. This enables an owner to expand the housing upon purchasing a new machine which is larger than his former one, thus

eliminating the expense of purchasing a more commodious shelter at the same time. The sections are made in sizes which may be conveniently handled, so that the work of moving the housing after it has been taken apart is simplified. It is provided with a rounded roof and fitted at both ends and sides with wire-glass windows.

ARM BAND HOLDS FLATIRON 1240 WIRE OUT OF WAY

In order to keep the wire connected with a flatiron up and out of the way



of the user, an arm band has been designed by a North Dakota woman which, if worn by a laundress, will hold such a line so that it will not be an interference. Attached to the band, which buckles above the elbow of the

right arm, is a short cord provided with a stud and socket fastener. This is intended to be looped about the wire so that no slack occurs in the latter at a point where it can hinder the operator. When the iron is set at one side, and the laundress wishes to have her arm free, a slight jerk unfastens the loop and drops the wire.

FUEL-OIL STORAGE TANKS 1628 FOR NAVAL PURPOSES

With the increased use of oil-consuming engines in naval vessels has come the problem of devising means of storing large quantities of fuel in such a way that it will be accessible when needed and also safe from bom-

bardment by an enemy. As a result a British firm has lately designed two types of storage tanks which have attracted interest. One of these is submersible and consists essentially of a cylindrical shell, 150 ft. long and 30 ft. in diameter, fitted with curved ends and internal dividing bulkheads of dished form. A ballasting compartment is provided at each end, the total capacity of which is greater than the reserve buoyancy of the loaded vessel, enabling the device to be sunk to any reasonable depth of water, or to the bottom of a harbor. The fuel capacity of this tank is 2,400 tons. To return the tank to the surface after sinking it, compressed air is used to force out the ballast. When this means is not feasible, the vessel may be raised by pumping out a quantity of oil or water from its compartments. The other type of tank is larger than this, being 450 ft. long and about 50 ft. in diameter. Its capacity amounts to 20,000 tons. It is intended to remain afloat when loaded, and is arranged so that water takes the place of oil as the latter is discharged, giving the tank almost the same draft at all times.

CLIP HANDLE FOR BLOTTER AMONG LATE NOVELTIES

With the intention of making it easier to find one's blotter when a desk



is littered with papers, and also to insure against the wrong surface being used through accident, a button clip has been devised which may be fitted to one edge. It is raised sufficiently to en-

able it to be used as a handle and is not so large as to be clumsy. It may be attached or detached quickly, and when in place grips the blotter firmly so that there is little likelihood of its slipping off.

W. Doxford & Sons, Ltd.,
Pallion, Sunderland,
England

Specialty Mfg. Co.
92 Griswold St.
Detroit, Mich.
Copyrighted Material

GIVING THE CITY BABY AIR AND SUNSHINE

1454

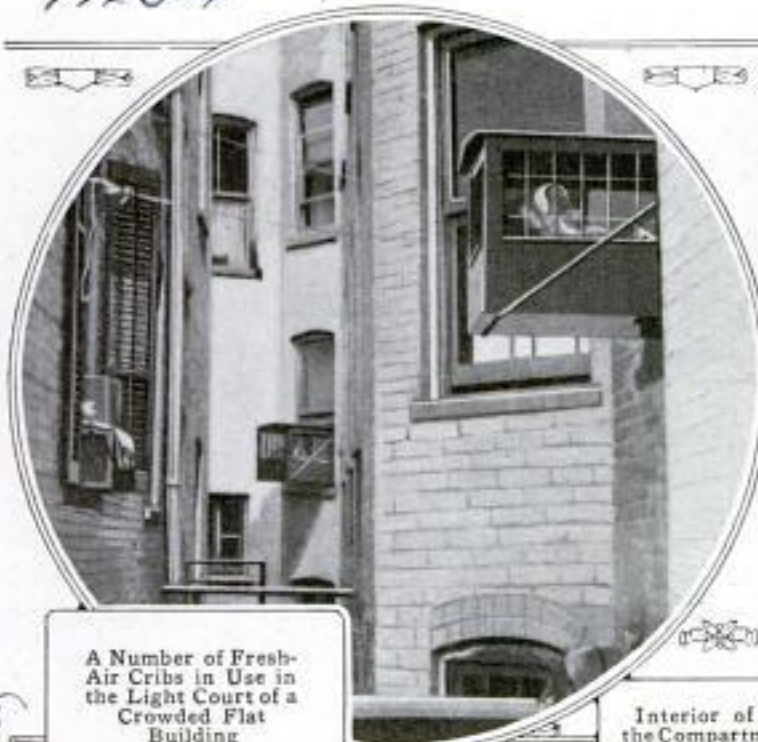

A Number of Fresh-Air Cribs in Use in the Light Court of a Crowded Flat Building



Interior of One of the Compartments and a Collapsible Metal Carriage Designed to Slip Inside of It

U. U.



One of the Cribs Shown Suspended Several Stories above a Street

In order to provide a means whereby babies confined in city apartment buildings and tenement houses may get plenty of sunshine and fresh air, a crib has been designed that may be suspended from a window. The device, a box-shaped housing made of metal, will sustain a load of fully 500 lb. when anchored in place, so a child within it is safe and needs no more attention than if in a nursery cradle. The crib is heavily screened on three sides and tightly roofed. Air and sun-

shine are admitted, but flies and other insects are kept out. A neat steel carriage with a wire body is built as a part of the outfit, and is arranged so that it may be collapsed and slipped into the little house. This eliminates the necessity of employing a special basket in the latter. Since verandas and lawns are as unknown in the residence-apartment section of a big city as in the slums, the window cribs are to be seen in both well-to-do and poor districts. It is not uncommon for them to be anchored in windows four or five stories above the pavement, or in the light shafts of buildings.

**RUSTPROOF BINDING POST
USED IN LABORATORY 1518**

In an eastern chemical laboratory a noncorrosive binding post has been devised for use with electrolytic apparatus. Ordinarily contact is made through the setscrews that hold the electrodes in position. The current is eventually interfered with by the

*Bridgeport Testing Laboratory,
Bridgeport, Conn.*
Copyrighted material

*X-Winslow Crib Co., Inc.,
7 E. 42nd St.,
New York*

deterioration of these members, which is due to the action of acid that escapes in the form of spray. This difficulty has been obviated by making the elec-



Noncorrosive Binding Post in Use

tric contact entirely independent of the screws. Hard rubber, or some similar material, is used for the arm which holds the electrodes at its outer end by means of a pair of brass pieces provided with setscrews and attached at opposite sides. Two glass tubes, each with a platinum wire fused through its sealed end, are countersunk in the upper side of the arm. The other ends of these wires are joined to copper wires leading to a switch. The tubes are filled with mercury. By bending down the wire stems of the electrodes, so that they are shaped like hooks, and dipping them into the vials of mercury, a noncorrosive contact is formed.

Ⓒ Mines are said to have been set adrift with imitation periscopes projecting therefrom with the hope that enemy ships will be sunk when they attempt to ram what appear to be submarines.

SEDIMENT IN WINE BOTTLES FROZEN BEFORE REMOVAL

An odd as well as ingenious use is being made of an electric refrigerating apparatus by a New York wine merchant. He has some 700,000 bottles of Italian wine in storage and has devised a means of materially lessening the loss which results when the dregs are blown out after the products of fermentation have settled. Refrigerating coils are arranged beneath a large table provided with holes into which the necks of bottles may be fitted. After the wine has fermented and settled, the bottles are placed neck down in these openings. In this position the sediment is allowed to freeze at the cork while, by lowering the temperature of the liquid, fermentation and the activity of the carbonic acid are checked. By then removing the cork from a bottle a small piece of ice containing the sediment is blown out and not more than 2 per cent of the wine lost. Sometimes by the ordinary method as much as 10 per cent of the liquid escapes.

1587

ACETYLENE CUTS PLACE FOR NEW DOUBLE-DECK BRIDGE

Chicago's \$650,000 double-deck bascule bridge at Lake Street and the Chicago River—said to be the greatest bridge of its kind ever built—was completed in March of this year, taking the place of a swinging bridge having the same location. The new structure has been building since March, 1914, but for only one week—while the old bridge was being torn away—was traffic entirely shut off on the elevated line. Preliminary plans for the new bridge were drawn in 1912 and described in the September issue of Popular Mechanics Magazine of that year.

This bridge, like its predecessor, is to be used by both elevated trains and street-level traffic. It was imperative that it be closed as brief a time as possible. To meet this difficult requirement the two leaves of the bridge were built perpendicularly above the ends of the old structure, enough of the frame-

Cold Storage & Prosecco Review 1/20/16

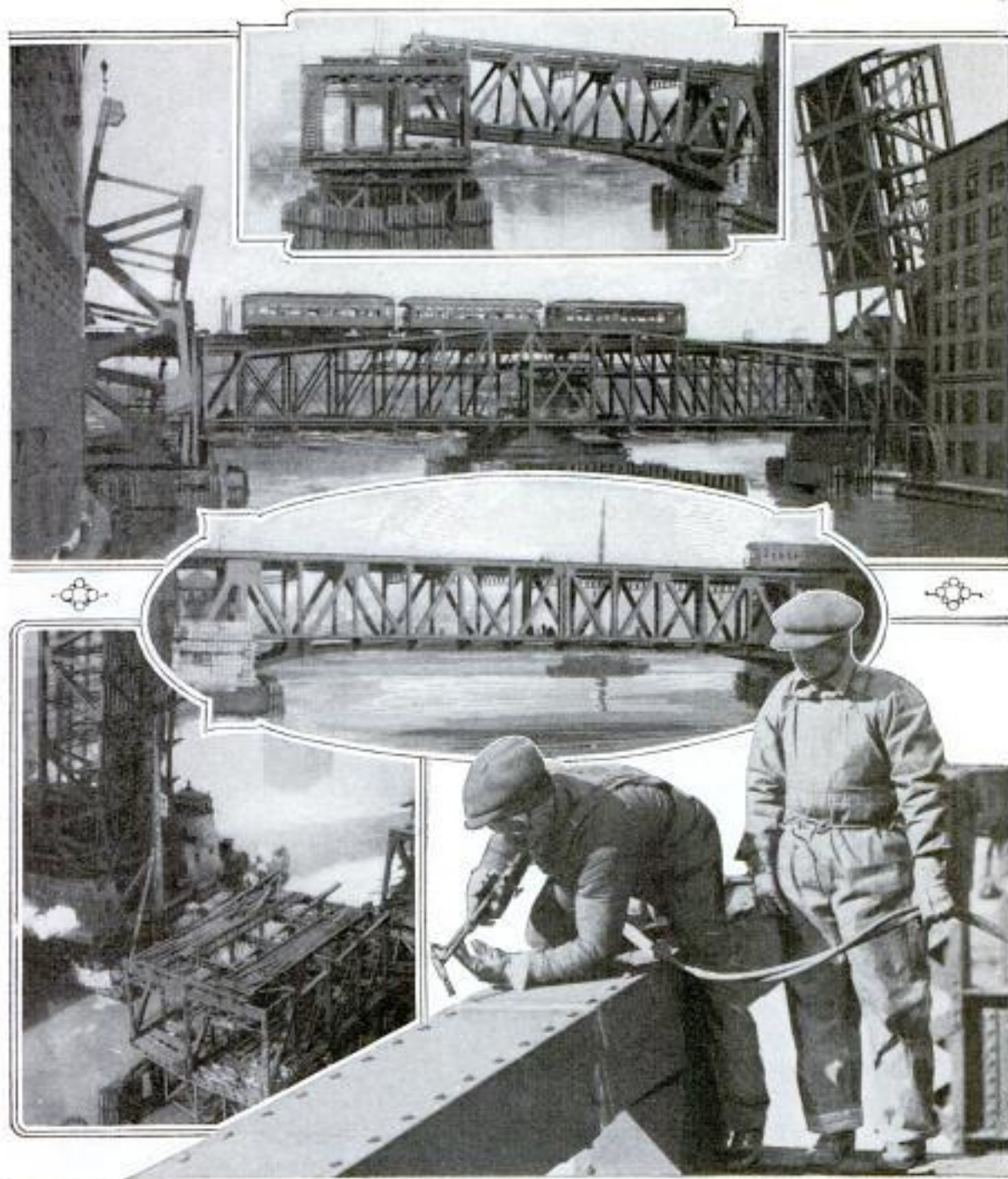

Insert, Top: The Old Double-Deck Bridge Swung Open and One Leaf of the New Bridge Almost in Place, Projecting into Gap Formed by Cutting Away Center of Old Structure with Acetylene Torches. The Large Upper Picture Shows the Leaves of the New Bridge being Built above the Old One in Such a Way as Not to Interfere with Traffic. Oval Insert: Elevated Train Using New Bridge after Traffic had been Blocked Only a Week. Below, Left: Old Bridge Showing Where Central Portion was Cut Out by Use of Acetylene Torches. Below, Right: Workmen with Acetylene Torch Cutting Away a Center Section of the Old Bridge to Allow the New Leaves to be Lowered as Shown in the Upper Insert

work between the sides of each leaf being left out to allow elevated trains to use the upper level without hindrance. When all was in readiness the old bridge was swung open and its ends blocked up on previously prepared structures in the center of the river.

Men with acetylene torches then set to work as rapidly as possible to cut away the central portion of the old steel structure, thus making room for the new leaves to be lowered in place. After this had been done the remainder of the old bridge was dismantled.

Inventor: *L. H. Thordarson*
Thordarson Electric Mfg. Co.
561 So. Jefferson St. Chicago

REMARKABLE MILLION-VOLT TRANSFORMER

144 C

DURING the last few days of the Panama-Pacific Exposition both scientific and popular interest was centered upon a 60-cycle, 1,000,000-volt transformer which was publicly demonstrated. The apparatus is one of the late and noteworthy inventions of the electric world and was used in carrying out a series of interesting investigations. The peculiar conditions relating to high-tension currents and their long-distance transmission were particularly considered during the course of these experiments.

The instrument represents a radical change in the design and construction of electric transformers. Its arrangement is simple, especially from the mechanical viewpoint, and apparently has a number of advantageous features. The principle is to be used in the development of commercial transformers of various capacities. Some of the outstanding points presented in its favor are its ability to withstand severe abuses, the ease with which its coils may be repaired, its attainment of the highest full-load efficiencies, its great overload capacity, and the indestructibility of the coils by short-circuiting. The apparatus was built and installed at an approximate cost of \$36,000, and raised a 60-cycle, 2,200-volt current to a potential of about 1,000,000 at the same frequency.

While in use at San Francisco it was mounted in an open, V-shaped, metal-lined, concrete tank, sunk in the ground and filled with insulating oil so that the electrostatic shield was submerged about six inches. The transformer house was a large frame structure which, in order that the danger of fire might be avoided, was held together by bolts placed parallel with the high-tension wires. Nails were not used in its construction.

Four hundred miles of paper, copper, and aluminum ribbon were used in winding the low and high-tension coils. The primary consists of 122 sections wound with copper ribbon and double layers of paper. These coils are designed for 1,150 volts and divided into

61 groups, connected in parallel with bus bars. The windings are safeguarded against static trouble by the grounding of one of the bus bars to the transformer frame. The high-tension coil has 190 sections, each capable of developing 5,300 volts, wound with aluminum ribbon. Three thicknesses of insulating paper are used between each turn. A unit, 5 ft. 7 in. long and 2 ft. 4 in. in external diameter, is formed by the assembled primary coils, while the high-tension members form a cylinder, 5 ft. 11 in. long and 4 ft. 3 in. in outside diameter. A paper tube, weighing approximately 2,000 lb., and having a length of 7 ft. 7 in. and a thickness of 6 in., insulates the primary from the secondary element by being inserted between them.

At a distance of about 100 feet from the transformer house an aerial screen, 50 ft. square, was suspended from four tall poles. This was stretched 35 ft. above the ground, and 10 ft. beneath it a second network, made of hemp rope impregnated with insulating material, was erected for safety purposes. The high-tension leads were held by similarly insulated ropes, and at the suspension points were provided with wire baskets to prevent the combustion of the latter being caused by corona discharges. An adjustable horn gap was provided in the main lead to the screen. This consisted of a metal disk suspended in the air immediately over a water jet, the nozzle of which projected several inches above the ground. In one corner of the transformer house a grounded metal cage was provided for the operator. This inclosed and protected the switches, circuit breaker, and other controlling instruments.

When the transformer was in action the house was so charged with electricity that sparks could be drawn from bolts, door hasps, padlocks, and other metal articles. The aerial screen was highly luminous and hummed with a peculiar sound. The safety net of impregnated rope was so highly charged that sparks a foot in length could be

Insert at Right Shows Million-Volt Transformer in Its V-Shaped, Metal-Lined Vault. The Corona Effects Visible in the Surrounding Field are Illuminating a Pair of Insulating Baskets and the Aerial Conductor. The Beautiful Static Display Pictured Below Resulted When the Current was Grounded through a Stream of Water Directed against a Metal Disk Suspended from the Conductor Wire



Transformer House and Adjustable Horn Gap, Indicated by Arrows, Are Above at the Right. The Man before the Building is Imparting a Charge to a Spectator by Holding Aloft an Iron Rod and Extending an Umbrella toward Latter's Uplifted Hand. At Right: Crowd beneath the Aerial Screen Holding Hats and Other Objects in Air to Observe Electrostatic Effects, Exaggerated Here for Clearness

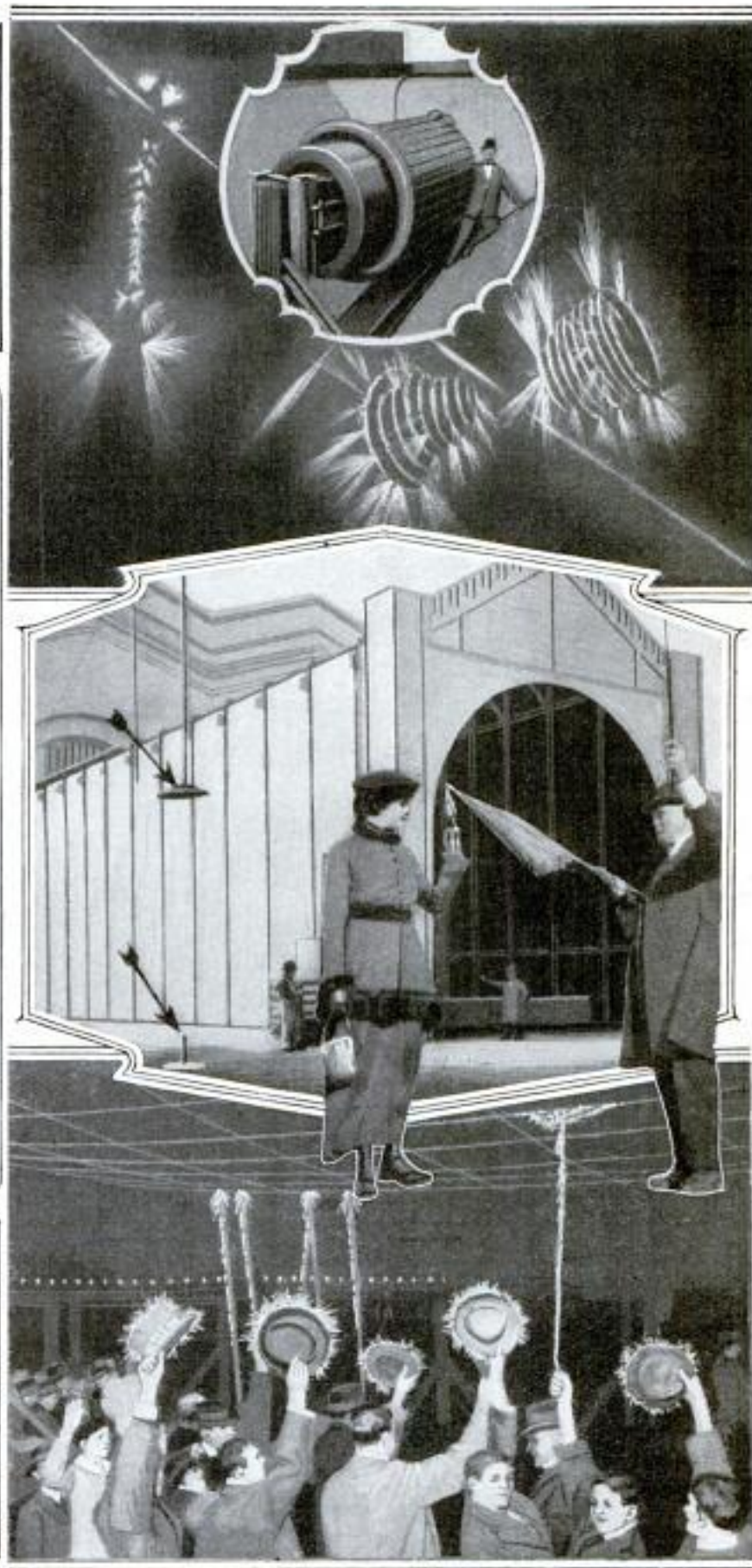

drawn from it with grounded conductors. When the horn gap was closed and a discharge made to the earth from the screen, spectators beneath the aerial noticeably felt the retarding effects of the electricity, which gave them sensations likened to those experienced by divers when walking under water. Persons could stand on wooden boxes and draw sparks from 3 to 6 in. in length from passers-by. Vacuum tubes and incandescent lamps glowed

when brought beneath the screen, while umbrella ribs, wires, and other metallic objects glowed with corona and emitted sparks. Hairpins, brooches, and like articles, were frosted with sparks and the atmosphere permeated with the odor of ozone.

The transformer is to be installed at Chicago, where its inventor will continue the experiments, which were cut short at San Francisco by the closing of the exposition.

COLLAPSIBLE HAIRBRUSH

1535 FOR TRAVELERS

Particularly for the convenience of travelers, a hairbrush has been invented which is collapsible. The bris-

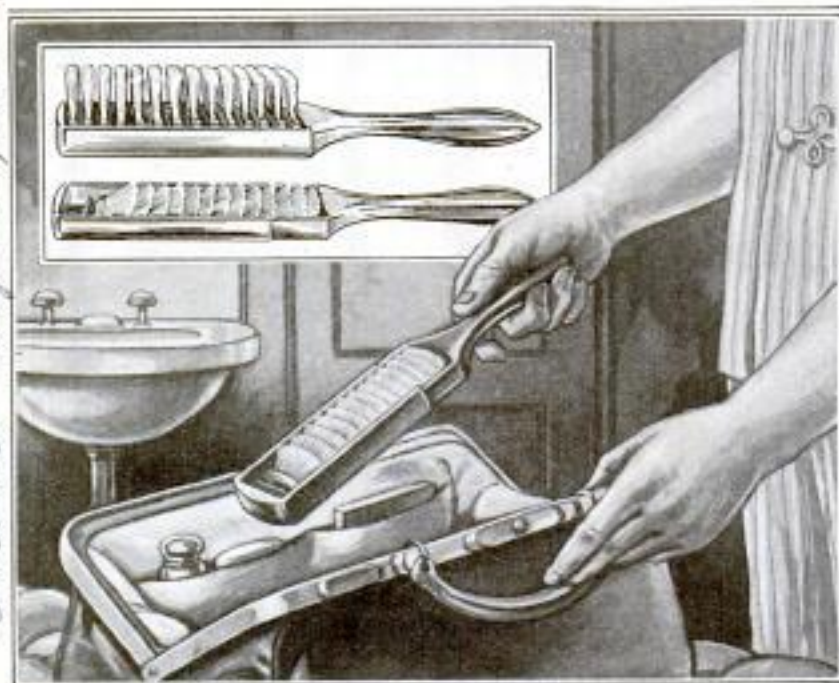

This Collapsible Hairbrush, Designed Especially for Travelers, is Operated by Sliding the Handle Back and Forth

tles are set in transverse rows in flat steel frames which are so fastened to the back of the brush that they can be made to lie down flat by pulling the handle. In this position they are fully protected by the sides of the metal back. By pressing the handle back into place the bristles are made to resume their upright position. The construction is simple, and if of good material such brushes will wear well.

SIXTY-YEAR-OLD MINE FIRE

1457 CAUSES FRESH TROUBLE

For more than 60 years a subterranean fire has been raging in one of the great anthracite-coal veins near Summit Hill, Pa. A number of years ago, at a cost of approximately \$1,000,000, an enormous concrete wall was erected in the path of the fire in order to confine it. This is some 15 ft. thick and extends to a depth of about 100 ft. in the ground. Reports were recently circulated that the fire had made its way past this barrier and was threatening one of the world's richest anthracite veins in the Panther Creek Valley. The chief engineer of the company controlling the fields refutes this assertion, but states that there is

some likelihood of the fire continuing in a westerly direction at a level below that of the concrete wall. In anticipation of this, numerous holes are being drilled into the old workings to permit their being slushed with a mixture of water and culm. Steam shovels are also at work in the burning vein removing the coal ahead of the fire. These operations are being conducted a short distance west of the barrier.

F. Taylor Peers
Grand Rapids, Mich.

Cool
Fidelity Coal & Navigation Co.
Carnival, Penna.



Above is Pictured Nearly a Block of Frame Residences Wrecked beyond Hope of Repair by the Explosion of a Half Ton of Dynamite. The Condition of the House Below at the Left Is Typical of That of Others Standing Adjacent to the Place Where the Detonation Occurred. In the Lower Right-Hand Corner is Shown All That Remained of a Motor Car and Its Garage

HOUSES RAZED BY DYNAMITE BLAST IN MISSOURI TOWN

Two persons were killed and nearly a hundred others injured when a half ton of dynamite recently exploded in a residence section of Maplewood, Mo. The force of the detonation demolished a dozen houses and smashed windows for several miles in all directions. Large buildings were rocked in neighboring towns and the concussion was felt over a large area. The explosive was stored in a small shanty erected by a construction company engaged in building a sewer. From some unknown cause fire broke out in the structure and caused the explosion. Two blocks of frame houses were shattered, many

of them entirely beyond repair. At one place the rear ends of a whole row of frame dwellings were blown off. The explosion dug a hole approximately 20 feet in diameter and 10 feet deep in the ground where the dynamite shed had stood. Practically all of the damage was done by the blast, as the few fires that developed were readily controlled.

NEW FLY SWATTER IS MADE OF FLEXIBLE RUBBER

Quite a number of apparently good points are embodied in a fly swatter of recent invention which is being introduced. The paddle part of the device is made of soft, perforated rubber instead of wire or screening. Its flex-

ibility renders it effective wherever used, for the rubber conforms to the shape of the surface against which it is struck. Furthermore there is no



Since It Is Flexible, the Rubber Swatter Conforms to the Shape of the Surface against Which It is Struck and does Not Mar Polished Furniture

danger of scratching highly polished furniture with it. Since it is free from metal, it is especially adapted for coast cities where the atmosphere is more or less salty. It may be washed frequently and kept in a perfectly sanitary condition.

SUBMARINE TELEPHONE LINE FROM KEY WEST TO CUBA

Plans are now being perfected for establishing a telephone line between the United States and the island of Cuba. The project, which should mean much to the commercial interests of both countries, has the hearty support of the Cuban government. It is proposed to extend a line down the

east coast of Florida to Key West and to lay a cable from that point across to the island, a distance of about 90 miles. It will be the first submarine telephone line between these two countries.

1499 — LIGHTHOUSE LAMPS TENDED BY INGENUOUS DEVICE

Several of the government lighthouses have of late been equipped with an apparatus designed to place a new incandescent lamp before the lens in case the one in service should burn out or for some similar reason fail to function. The device consists of a three-socket disk mounted on a horizontal shaft. A set of three lamps are held 120° apart, the upper of them being the only one in focus or ignited. Fixed at one end of the shaft is a coil spring of sufficient strength to revolve the lamp holder once, while at the opposite end a latch, controlled by electromagnets, and an escapement wheel, with three teeth set equidistantly about its circumference, permit a movement of only 120° at a time. When the upper of the lamps—or in other words, the one in service—burns out, the circuit passing through one set of magnets is broken and the other immediately energized, causing the armature to be drawn over, the latch released, and the shaft to make a third of a revolution. This brings the sec-

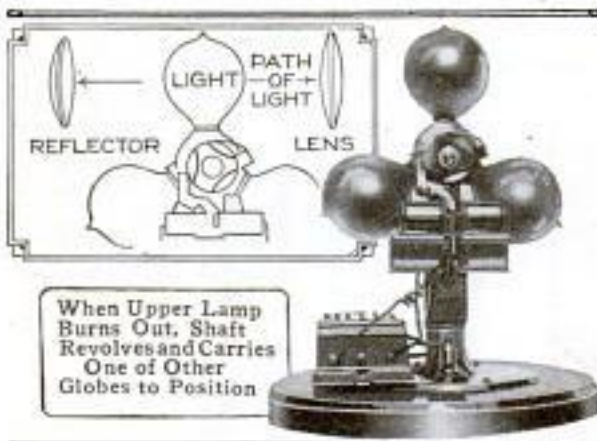

When Upper Lamp Burns Out, Shaft Revolves and Carries One of Other Globes to Position

ond lamp into position and lights it. The action is completed in a fraction of a second.

U. S. Light House Service
 Wash. D. C.
 Copyrighted material

STUDYING UPPER AIR WITH AID OF KITES



The Humidity, Temperature, Barometric Pressure, and Wind Velocity are Recorded by This Small Instrument Which When in Use is Attached to Kite



Computing the Altitude of a Kite with the Assistance of a Theodolite

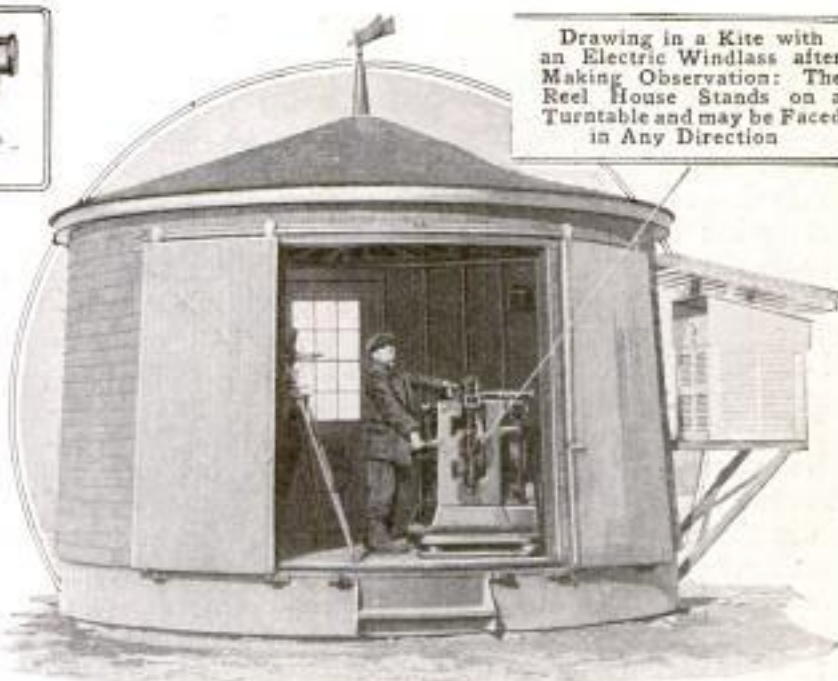

Drawing in a Kite with an Electric Windlass after Making Observation: The Reel House Stands on a Turntable and may be Faced in Any Direction



String of Three Kites Used at the Nebraska Aerological Station: The Cloth at Top of Each is White and That at the Bottom Black. Thus They Are Visible Whether Flying against a Light or Dark Cloud

To assist the Weather Bureau in making its forecasts, and also to enable a systematic study of the mechanics of the upper atmosphere, the government has established an aerological station near Elk City, Neb., where meteorological observations are being made daily. Conditions prevailing at elevations up to approximately two miles are being determined by means of self-recording instruments attached to box kites which are flown regularly.

In the past our weather predictions

have been based upon observations made at the ground, or in the lower strata of air. The place where storms originate, however, is in the zone lying between one and three miles above the earth. The inaccuracies of forecasts are due largely to the observer's ignorance of conditions existing in the actual storm region. By having a fairly continuous record of the wind velocity, temperature, barometric pressure, and humidity of the upper air, a forecaster has quite complete data

from which to make accurate determinations. It is primarily for the purpose of collecting information of this kind and obviating the greatest chances for mistakes in weather predictions, that the kite-flying station is being operated.

The results of the work accomplished at Elk City will doubtless determine whether other stations will eventually be established elsewhere in the West. While the observations made in Nebraska are expected to be of considerable value, it is not assumed that this single station will be at all adequate for the needs of the bureau. The institution was first located at Mount Weather, Va., but the efforts made there were of little value in forecasting, because storms develop in the West and move toward the Atlantic seaboard. For that reason the plant was transferred to its present site a short time ago.

While systematic observations of this kind are being made for the first time in this country, Europe has had aerological stations for a number of years. Records of conditions in the upper air are made at various points on the Continent, and before the war different foreign stations cooperated with each other to a certain degree. It has also been found that the information thus gathered is of great value to the military aerial forces. Likewise, it

is considered that such stations would be of much benefit to our fliers should the government ever decide to develop a real aeronautical force.

The Nebraska aerological station has about 35 kites of different sizes at its disposal. A reel house, mounted on a turntable so that it can be faced in various directions, is provided in the middle of a 40-acre tract of ground. In this an electric motor and windlass are used in drawing down the kites from the clouds after observations have been made. Often kites are kept up continuously throughout a day and night, while at other times ascensions are made periodically. During cold weather the wire holding the kites often becomes thickly coated with ice, while during thunderstorms it is not unknown for it to be burned in two by electricity. The reel is heavily insulated as a protection against the static electricity, which is sometimes of very high voltage. Three or four kites are usually attached to one wire, the uppermost carrying the meteorological instruments which make permanent records on a chart fitted around a drum that is revolved by clockwork. At the present time those in charge of the station are making records at various heights every day. The average altitude reached is two miles. The observers make their reports regularly to Washington by wire.



Section of Experimental Arched Roof Made of Clay Blocks

1511 EXPERIMENTAL ARCHED ROOF MADE OF CLAY BLOCKS

Clay blocks have been used in constructing an arch which stands alone, seemingly without any clear purpose, on the grounds of the Iowa Agricultural Experiment Station at Ames. The structure, however, represents a model section of a proposed roof for barns. Attempts have been made for some time to design a thoroughly practical type of fireproof building for agriculturists, and this odd-looking member, strengthened by reinforced-concrete ribs, is the result of an experi-

W. G. Kaiser

**W. B. Van Valin
Turlock, Calif.*

ment made to determine the feasibility of using one material for both the walls and the roof of a structure. One-half of it appears black, which is due to paint which has been applied. It is probable that in the near future a complete building with this type of roof will be constructed at the station.

259 **CONVENIENT CABINET FOR
PHONOGRAPH RECORDS**

A simply constructed cabinet for holding phonograph disk records consists of a series of narrow, vertical compartments, in each of which one record may be set on edge. At the top of each compartment is a push button, lettered or numbered for the convenience of the owner; each button operates a simple set of levers. By pushing one of these buttons the corresponding record is moved forward an inch or two so that it projects from the cabinet and can be easily grasped by the hand. The floor of the case slants slightly downward to the rear so that records will not roll out. An



By Pressing One of the Buttons at the Top of This Record Cabinet the Corresponding Record is Moved Far Enough Forward to be Grasped by the Hand

alphabetical index shows the compartment in which each record is placed.

☉ Replicas of quaint old English lanterns with horn sides are coming into use for halls, dens, and the like.

1477 **REMARKABLE OIL SPRINGS
DISCOVERED IN ALASKA**

Five marvelous springs of oil, which, according to the discoverer, surpass similar phenomena in well-known oil



The Oil as It Flows from One of Five Oil Springs Recently Discovered in Alaska North of the Arctic Circle

regions, have been located in Alaska far beyond the arctic circle. The discoverer is a member of the United States Bureau of Education. With reindeer he traveled 450 miles to see the phenomenon of "liquid that never freezes," about which the wondering natives told him. The oil deposits a residue, amounting to about five per cent of the volume; this deposit has formed a mound around the springs about 50 feet high and 600 feet in diameter. The oil flows into a small lake, on the surface of which ducks and geese often alight never to rise again. The heavy oil so clots on their wings that it is almost impossible for them to fly.

The discoverer reports that there are hundreds of tons of semifluid oil here which has the appearance of vaseline, a large part of the mound surrounding the springs being composed of this valuable substance.

1379 FOG STICK HELPS STEERING
OF LAKE BARGES

When a large barge is towed behind a tug or steamer during murky weather on the Great Lakes, a device known as

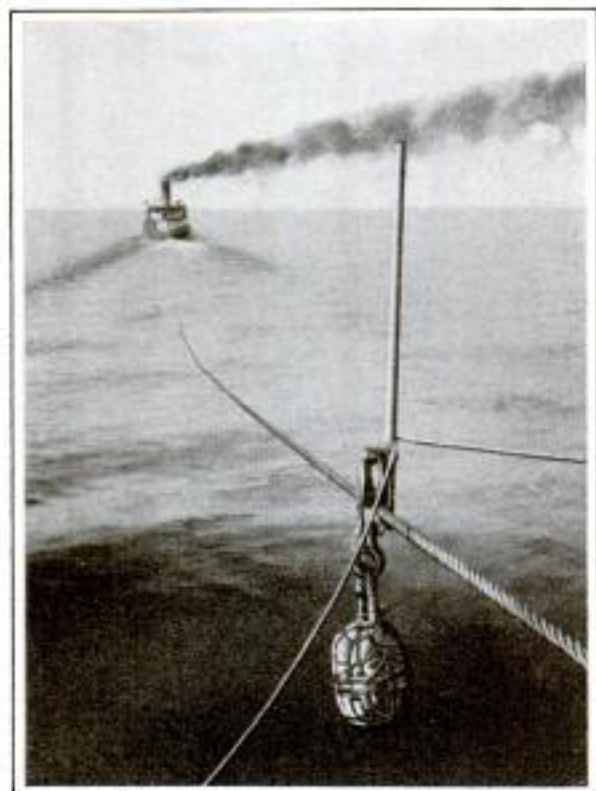

This Shows One of the Sticks in Place on a Towing Cable ahead of a Barge. Just the Top of the Fog Stick Is Visible to a Man at the Wheel

a fog stick is frequently employed to assist the helmsman in steering the trailer. This consists of a short pole leashed to a pulley which is let out some distance forward of the bow on the barge's towline and kept in an upright position by means of a weight, such as a sandbag or stone. Thus when the atmosphere is so foggy that it is impossible to see the tug from the barge, the stick, which is held in one position by ropes, indicates the direction in which the cable is being pulled. At night a lantern is swung from the top of it so that the stick continues to fulfill its function.

Spanish officials at Madrid have approved of a new type of radiogram receiver that does away with ear pieces and is said to have a range of 3,100 miles.

1203 GASOLINE CABLE TRACTOR
FOR AERIAL LOGGING

Western
An ~~eastern~~ lumberman has patented a tractor which operates on a suspended cable as an aerial tramway and is designed to be used for aerial logging. The three sheaves to which the propelling power of the tractor is transmitted are so placed that the cable, in passing over one and under the other two, is bent slightly, giving the sheaves a grip on the cable which increases as the load increases. A 30 to 35-hp. gasoline engine and a hoisting drum and cable are suspended on a platform immediately below the sheaves. The engine operates both the hoisting drum and the sheaves. The operator is strapped to the tractor and has the advantage of having his work in full view at all times.

This tractor is designed to operate on a 2-in. cable, the distance between the cable's supports being about 1,800 feet. The engine is geared to travel in either direction up to 1,800 ft. per minute. Its maximum speed for lifting is 12 ft. per minute, and for lowering, 60 ft. per minute. The invention dispenses with all secondary lines, since the system does not necessitate the use of the usual trip line, or haul-in line. Difficulties which have suggested themselves as to the practicability of the invention commercially have to do with the ponderousness of the 2-in. cable and the tractor, which in logging must be moved frequently; the excess weight that the tractor puts upon the cable, and the possibility of personal danger to the operator. But the inventor believes that these difficulties have been sufficiently overcome to make his machine commercially profitable. It is proposed to use a small gasoline engine for spotting cars and putting up the cable.

It has been estimated that the tractor is capable of yarding and loading 18 cars per day with a crew of six men, comprising the operator, two men to place the chokers, a rigging slinger, and two men to spot the cars and place the load.

Drawn: N. E. Ayer
Pres. St. Johns Lumber Co., Portland Ore.

1203

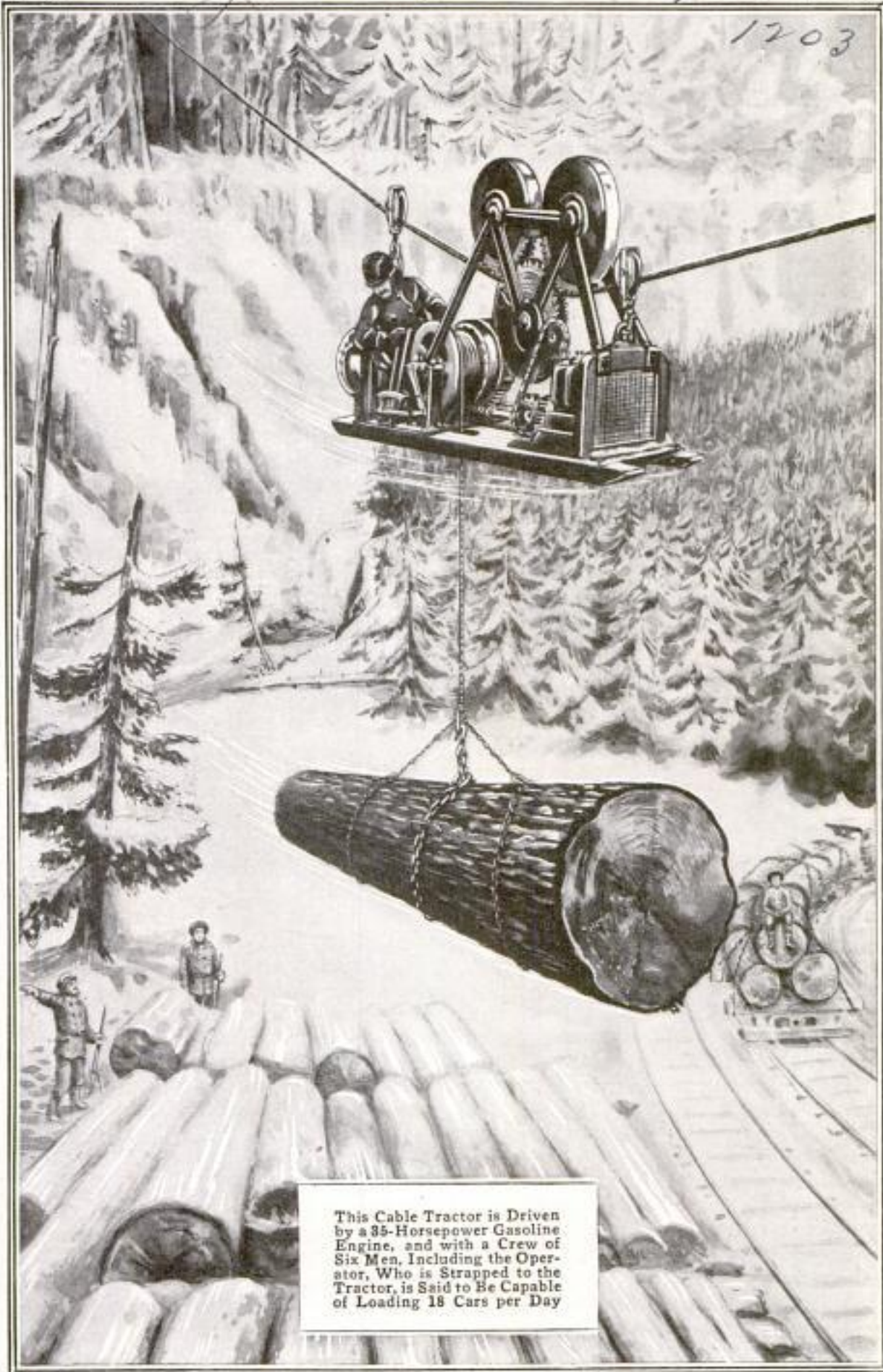

This Cable Tractor is Driven by a 35-Horsepower Gasoline Engine, and with a Crew of Six Men, Including the Operator, Who is Strapped to the Tractor, is Said to Be Capable of Loading 18 Cars per Day

1164910 - Dec 21 - 1915 -
Pat. Exp. 221 - 846.

1573 SIMPLE ANNOUNCING SYSTEM FOR DOCTOR'S OFFICE

To eliminate confusion in his waiting room, a Battle Creek physician has devised an announcing system which

simplifies the attendant's work and assures each patient of being received in proper turn. At one side of the waiting-room entrance is a board holding 18 numbered pegs. As a patient enters the place he withdraws one of these. When admitted to the physician's private office he fits the peg into its proper hole in a similar board attached to the wall beside the latter's door. When the visitor leaves the doctor after consultation, the office attendant by glancing at this second board and seeing that peg number 7, for instance, was the last one inserted, knows that the person holding number 8 is next in order. The scheme has been in use for some time and has worked quite satisfactorily. Obviously it could easily be adapted to serve a like function in offices of other kinds.



Instructions Printed across Each of the Boards Explain the Routine to New Patients

1633 DUMMY RIFLE CARTRIDGES MADE BY SCHOOLBOYS

British schoolboys at Leeds are assisting the war office by voluntarily manufacturing dummy cartridges for the use of recruits in machine-gun and musketry practice. The work is being done daily by pupils and their instructors in various grade schools, but more especially by those at technical institutions and in the manual-training departments of elementary schools. Not only have they turned out large quantities of the needed cartridges, but they also have developed the machines for making them. Bicycles, sewing machines, and many other devices, have been converted to meet their needs. The work consists of cutting hard wood into lengths that can be driven into cartridge cases provided by the

military authorities. When the wood is hammered into place the case is inserted in a machine which punctures the neck so that the slug is held firmly. The wooden end is then shaped into the rounded form of a bullet by another machine. Subsequently four pin pricks are made in the cases so that dummy cartridges may be distinguished from loaded ones after the wooden ends become blackened by use.

1569 NEW DOMESTIC AERO MOTOR OF AIR-COOLED TYPE

Several very interesting features have been incorporated in a new American-built aeronautical engine of the self-cooling type which has lately made its debut. It is a 12-cylinder motor of 105 hp. and presents an exceedingly small amount of head resistance. The

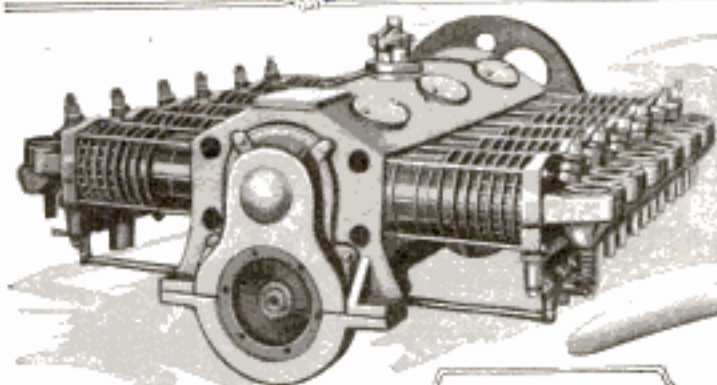

Upper Photograph Shows Cylinder Arrangement, Which Gives Minimum Over-All Length, and Indicates Way Crank and Propeller Shafts are Geared. Manifolds may be Seen at Side in Other View

cylinders are directly opposed, instead of being staggered, and give the plant a minimum over-all length. This arrangement is made possible by the use of specially designed connecting rods. Twenty-four small air ducts extend through apertures pierced in the flanges on the outside of each of the cylinders. The flutes are open to the atmosphere at one end and lead into circular chambers in the heads. From there manifolds carry the excess heat to the carburetor. This plan enables low-grade gasoline or even kerosene to be used successfully as fuel. All of the cylinders and heads can be removed in 20 minutes to permit their examination and that of the pistons, bearings, and other parts, all of which are interchangeable. Instead of having a direct connection between the crank and propeller shafts, the two are geared so that the latter makes 900 revolutions a minute to the crankshaft's 1,800. The motor consumes $11\frac{1}{2}$ gal. of low-grade gasoline an hour, weighs 360 lb., and has a forced-feed oiling system. It has been tested on monoplanes and both tractor and pusher biplanes and flying boats with apparently good results.

☉ The second national exposition of chemical industries will be held in New York in September of this year. It aims to promote the development of natural resources utilized in the chemical industry.

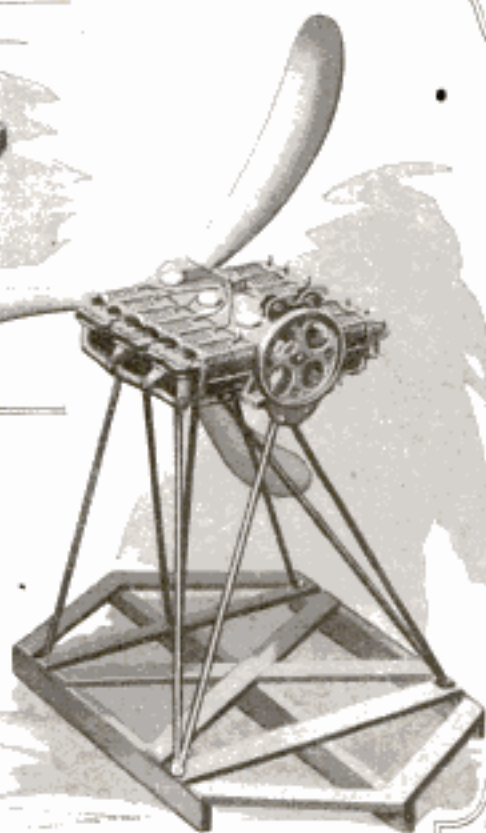

VEGETABLE PEAR NEW DISH

456 IN CALIFORNIA

Edholm

Among the little-known vegetables which have been introduced on the Pacific coast of late is the chuchu, a pear-shaped variety of squash known in Mexico as the chayote. It grows on a perennial vine which assumes large proportions and bears abundantly. The skin is smooth and bright yellow in color. When mature the vegetable usually weighs about a half pound. It contains a single seed which when cooked has a flavor similar to that of roasted chestnut. The vegetable itself is not highly flavored and for that reason may be used in numerous ways. On the coast it is employed in making both soups and salads. It may be stuffed with seasoned chopped meats and baked, or boiled or fried alone. It also is often pickled and preserved. The chuchu, which is commonly sold under the name of "vegetable pear," is firmer and has less water than the squash, and is understood to be quite

1642

substantial as a food. It has appeared on the markets a few times in eastern and middle-western cities, but because people rarely know how to prepare it



The Chuchu, Which Came to This Country from Jamaica by Way of Mexico, Resembles a Pear in Shape. As may be Seen Here, the Vine Grows Prolifically. It Is Perennial and Bears Heavily

properly no particular demand has as yet been created for it in these places. In California, however, it is gaining popularity. It is very easily grown and requires little attention.

ELECTRIC APPARATUS MADE WITHOUT COPPER PARTS

Electrical Review 2/18/16

Germany's serious shortage of copper has been the cause of a number of very interesting developments. Among other things it is reported that electrical firms have for several months been manufacturing transformers entirely without copper. The windings of these apparatus are of zinc. At the present time generators and motors with windings of the same material are being produced. Commutators are also being made of steel. These practices were adopted after an order was issued by the government some time ago directing firms to make a return of their stocks of electric apparatus in which copper was used. This procedure was taken in order that the military authorities might requisition the machines for the copper they contained whenever necessity dictated.

1502

LONG, LOW CONCRETE BRIDGE OVER SHALLOW STREAM

A bridge of unusual design has been constructed near Farmington, Mo., across a shallow stream, the bed of which is treacherous because of shifting quicksand. There being very low banks on either side, a level concrete bridge 16 ft. wide and 100 ft. long was built, which required no approaches. It clears the water by about 2 ft. and connects two sections of an excellent road. The bridge is supported by piers of concrete about 8 ft. apart. The cost of the structure was 750 dollars.



This Concrete Bridge, Which Is so Low as to Require No Approaches, Is 100 Feet Long and 16 Feet Wide, and Cost \$750

County Clerk, Farmington, Mo.
 Built by the County Authority

EIGHT AEROPLANE MAIL ROUTES PROPOSED

The establishment of a number of aeroplane mail routes is being considered by the Post Office Department and as an initial step in this direction it is seeking bids for carrying mail by air craft over eight routes, one in Massachusetts and seven in Alaska. Both regions present serious weather conditions at certain times of the year. If these routes can be successfully operated, it will be the first time in the history of the country that other than temporary aerial mail service has ever been maintained. It is believed that a permanent aerial service would be

gested that possibly a hydroplane could be used here. Among the principal points on the seven Alaskan routes are Seward, Fairbanks, and Nome; the

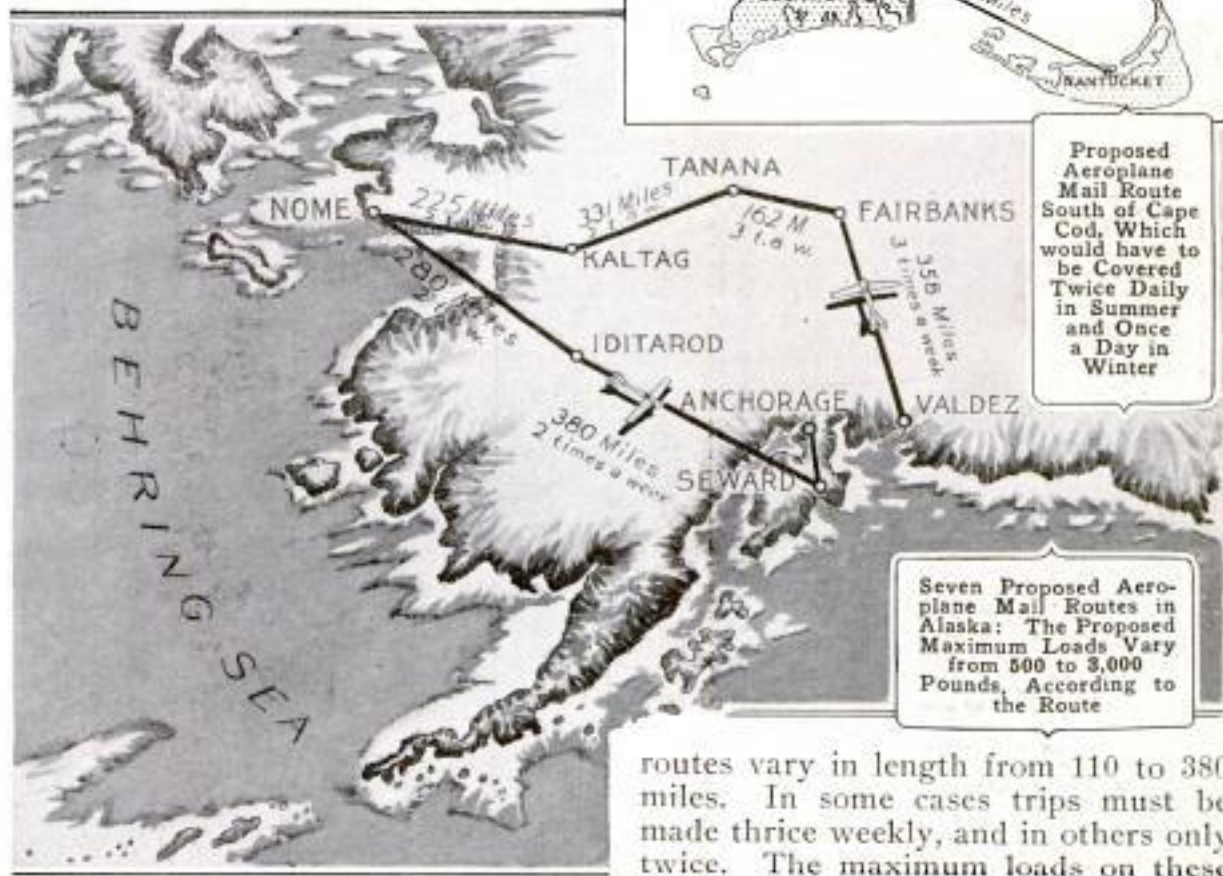
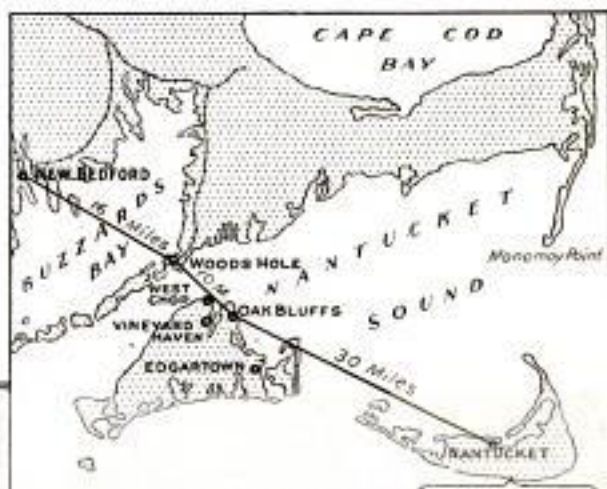

Proposed
Aeroplane
Mail Route
South of Cape
Cod, which
would have to
be covered
twice daily
in summer
and once
a day in
winter

Seven Proposed Aero-
plane Mail Routes in
Alaska: The Proposed
Maximum Loads Vary
from 500 to 3,000
Pounds, According to
the Route

a great stimulus to the development of the nation's aerial defenses.

In Massachusetts it is proposed to fly between New Bedford and Nantucket with stops in between; this 112-mile round trip must be made 13 times a week during the warm months and six times a week for the rest of the year. The maximum weight of mail per trip would be 3,000 lb. It is sug-

gested that possibly a hydroplane could be used here. Among the principal points on the seven Alaskan routes are Seward, Fairbanks, and Nome; the routes vary in length from 110 to 380 miles. In some cases trips must be made thrice weekly, and in others only twice. The maximum loads on these routes range from 500 or 1,000 lb. to 1,500 or 3,000 lb., an option being given in each case. At present, several weeks are required to reach some of these Alaskan points, which are the important mining centers in the territory. Bids will be opened May 12; it is proposed to begin service October first of this year. It is known that a number of persons backed by sufficient capital are considering making bids.

1731 # Joe Noyes
Paris, Tex. H. & H.

TERRIFIC FIRES SWEEP TWO SOUTHERN TOWNS



Ruins of What Was a Residence Section of Paris, Texas, with Tottering Chimneys Standing as Tombstones in a Graveyard of Hundreds of Homes, as Seen Following the Disastrous Fire of March Twenty-First



Local Federal Buildings Gutted by the Flames, Which Threatened to Raze the Entire Town



A Study in Contrast: A Modern Bank Building Which was Injured, but Not Demolished



Main Street, Principal Business Thoroughfare, in Ruins: The Fire Started in a Warehouse and, Fanned by a Stiff Wind, Swept Away Many Blocks of Buildings

U+U. 1721

RAZING BUSINESS AND RESIDENCE DISTRICTS



Ten Blocks of Business Structures and Some 600 Dwellings were Wiped Out by a Conflagration at Augusta, Georgia, March 22. A Section of the Residence District in Flames is Pictured Above, While Below, Broad Street, the Principal Thoroughfare, is Shown with the Fire at Its Height. Burning at Left is 16-Story Empire Life Building, and, before Confederate Monument, 10-Story Augusta Chronicle Building. Many of the City's Oldest Landmarks were Destroyed. Three Thousand Persons were Made Homeless. The Loss is Estimated at \$5,000,000



1656 PRISONERS HANDCUFFED TO SUITCASES

A Michigan sheriff has devised a simple way of handcuffing a prisoner so that he can be taken along a public



Instead of Handcuffing This Prisoner to an Officer He is Shackled to a Heavily Laden Suitcase so That Ordinarily the Manacle will Not be Seen

thoroughfare without letting it appear to passers-by that the man in custody really is in shackles. Instead of locking a prisoner to an officer, which arrangement makes the handcuffs rather conspicuous, the prisoner is handcuffed to a heavily laden suitcase which he is required to carry. The suitcase is filled with bricks and weighs from 20 to 50 lb., making escape very difficult.

Attachment

1739 DELICATE FOCUSING FINDER FOR FOLDING CAMERA

By adapting the principle of the telemeter to the needs of the camera, a focus-finding device has been developed which eliminates guesswork in estimating distances and enables an amateur operator to get properly focused, sharp pictures. The apparatus is applied to an instrument of the folding type and is built into the base of

Eastman Kodak Co. Rochester N.Y.
applied only to the 3-A Special Folding
Pocket Camera & is made a part of it.

the metal standard that supports the front part of the bellows. Roughly, it consists of three small, rectangular mirrors set at an angle of 45° , and an adjustable prism which when moved up or down causes the bellows to move simultaneously back or forth. Two of the mirrors are mounted in the same plane on one side of the standard, but separated by a distance equal to the width of one of them. The third mirror is on the opposite side of this frame in the same vertical plane. When the camera is turned on its side, as the opening between the other two reflectors. The prism is interposed above the third mirror, so that, in looking down, one's line of vision must pass through it in order to see the mirror beneath. The device is used the same as a range finder. In focusing the camera, a straight line, such as the railing of a porch or the fire wall of a building, must be looked at. The image is reflected in three sections, which may or may not form an unbroken line. If this line is unbroken the camera is properly focused without further adjustment. If, however, it is disjointed, the middle section, for instance, being higher or lower than the two side parts, the lens is out of focus. By turning a screw the prism is then moved until the three lines coincide and the image appears in normal form.

1705 DENMARK COMPANY BUILDS BIGGER MOTOR SHIPS

In connection with the rapidly increasing use of motor ships, it is interesting to note that Denmark is still taking the lead in developing these craft. It was recently announced by a director of one of Copenhagen's large shipbuilding firms that the company is now constructing motor vessels of 12,000 tons. These ships are 500 ft. in length and carry engines that develop 6,000 hp. In contrast to this, the first motor ship, built only a few years ago at Copenhagen, was of 7,000 tons and had a length of 375 ft. Orders for some 50 big motor vessels have been placed with the aforementioned firm.

Patented in U.S.A. & Main U.K. & Foreign

1738 (Inter-N. F. S.)

VILLA'S RAID AT COLUMBUS TOLD PICTORIALLY



Military Funeral of the Seven Troopers of the 13th United States Cavalry Killed during the Border Assault

COPYRIGHT, INTERNATIONAL FILM SERVICE, INC.



Ten Civilians were Murdered by Pancho Villa's Mexican Outlaws. Six of Them were Burned to Death in the Commercial Hotel, the Ruins of Which are Indicated by the Cross



This Shows the Irrigation Ditch, and in the Distance the Railroad, along Which the Attack was Made Early on the Morning of March 9. Our Troops were Encamped on One Bank and the Outlaws Crossed from the Other, Spreading through the Town, Firing Its Buildings, Shooting at Random, and Some of Them Escaping on American Cavalry Horses

The Woods Motor Vehicle Co.
2501-2571 E. W. Chicago.
Cabinet

REMARKABLE FEATURES IN NEW DUAL-POWER CAR

What is by far the most radical and interesting development recently carried out in electric-vehicle construction is represented in a new dual-power car that has just made its appearance. In designing the machine an attempt has been made to embody the best features of both the gasoline and electric cars. The result is a truly remarkable vehicle which has the body lines and general appearance of an electric, the speed and touring radius of a gas car, the comforts of both, and the drawbacks of neither.

The power plant consists of a four-cylinder, 14-hp. engine mounted at the front of the chassis immediately ahead of a motor generator on the same driving shaft with a magnetic clutch between them. The batteries are carried at the rear, but only one-half as many are needed as are usually employed.

The control mechanism on the steering wheel resembles that of the gasoline car. There are two finger levers. The outer of these is the electric controller and the inner the engine throttle, which, when moved from neutral, actuates the magnetic clutch, connecting the motor and the engine. A foot brake is provided, but for ordinary driving is not needed, since the car may be brought to a stop quickly and without danger of skidding by dynamic braking. Thus the machine can be started, put through all possible speeds, and stopped with the thumb and forefinger. There are no gears to change and no hand levers to shift.

With this arrangement the car is capable of unusual performances. It can be driven on gasoline power alone, electric alone, or both at the same time. A maximum speed of about 35 miles an hour is attainable. When driving on gasoline, the surplus power, or that developed in excess of what is actually needed to carry the machine at a desired speed, is saved, for the motor automatically becomes a generator and charges the batteries. Should the gasoline supply run short at any time

the batteries are good for 30 miles. When a steep hill is to be climbed a driver has the advantage of two forms of motive power. The danger of stalling the car is entirely obviated, for should the engine stop, the motor would instantly begin turning it over at several hundred revolutions a minute. Thus it would not be stalled for as much as a second, if in good condition, and in any event the motor would keep the car moving.

From an economic standpoint the machine is unusual. Road tests have shown that it is possible to get 45 miles out of one gallon of gasoline. For a car of the size and weight of this one, the record at first thought seems incredible. While driving on the engine alone about 30 miles is possible with a gallon of fuel. While doing this, however, the batteries are charged for an additional 15 miles. It will be seen that the trouble and expense of battery charging, present in all electric cars, are absent here.

The weight of the machine is 3,100 lb. as against 4,200 lb. of the electric of which it is an outgrowth. Since the battery space is lessened by half, room is available at the rear to conceal an extra tire. The only way in which the car differs in appearance from the conventional brougham is that the hood has a streamline effect and a neat, V-shaped radiator is provided at the front. It should be understood that there is no transformation of power except that which otherwise would be wasted. This distinguishes the car from those known as gasoline-electrics.

1713

WESTERN DEPARTMENT STORE RETAILS LUMBER

A Portland, Ore., department store has broadened its field by establishing a lumber section where patrons may purchase material in short lengths and small quantities. This innovation was made in order to provide a way for the retail lumber dealers to dispose of odds and ends and use the package-delivery system of the department store, thus reducing the cost of haulage.

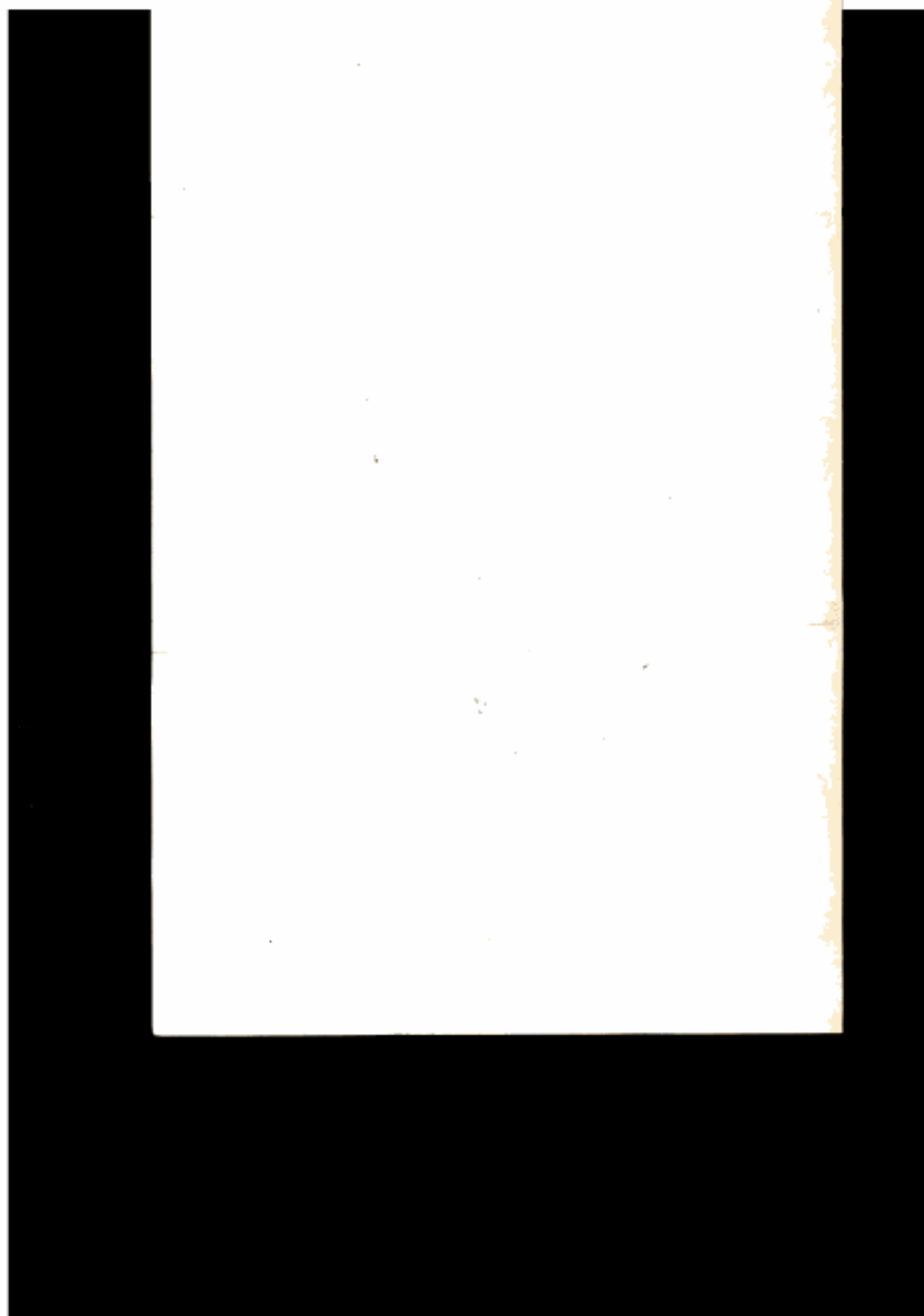

BURLINGTON, IOWA.

725 North Seventh Street,

E. F. EVANS,

Has the capacity of twelve ploughs
which I am now introducing to the
trade. For particulars write to

A Patent has been granted
(PATENT APPLIED FOR.)

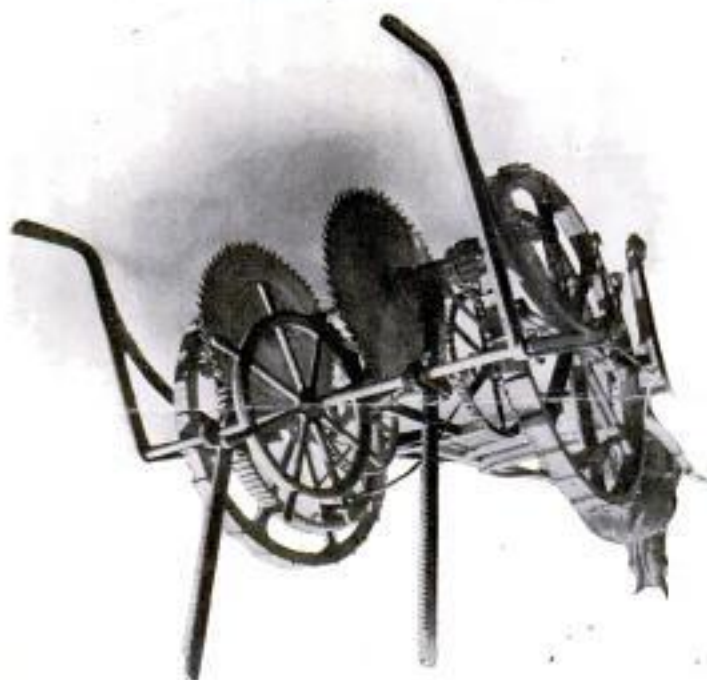

Ice Cutting Machine

*6-8-12
(cont.)*

(Machine)

1743

Amherst O.
Railroad

NEW YORK CENTRAL TRIPLE WRECK KILLS MANY

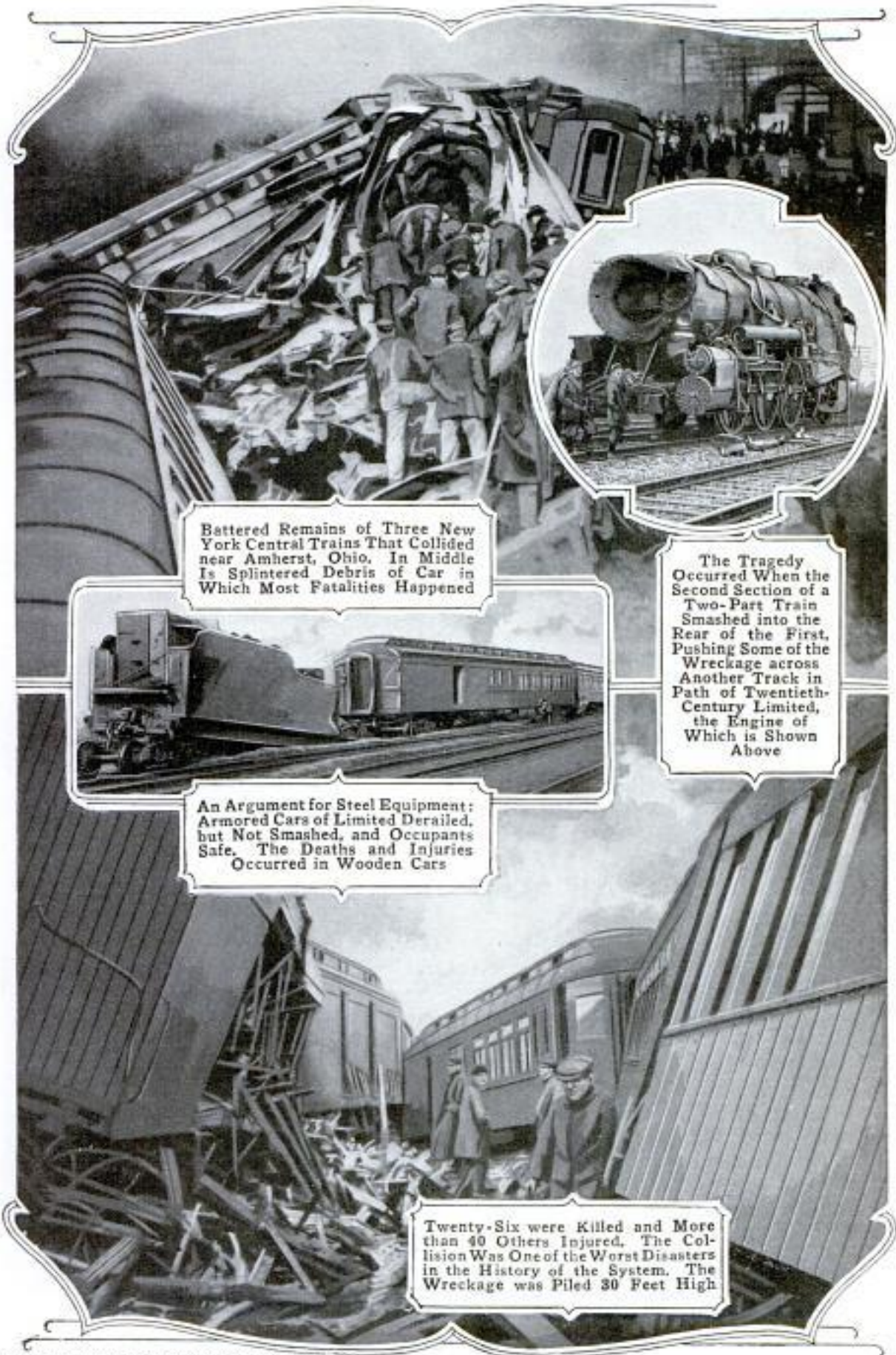

Battered Remains of Three New York Central Trains That Collided near Amherst, Ohio. In Middle Is Splintered Debris of Car in Which Most Fatalities Happened



The Tragedy Occurred When the Second Section of a Two-Part Train Smashed into the Rear of the First, Pushing Some of the Wreckage across Another Track in Path of Twentieth-Century Limited, the Engine of Which is Shown Above



An Argument for Steel Equipment; Armored Cars of Limited Derailed, but Not Smashed, and Occupants Safe. The Deaths and Injuries Occurred in Wooden Cars

Twenty-Six were Killed and More than 40 Others Injured. The Collision Was One of the Worst Disasters in the History of the System. The Wreckage was Piled 30 Feet High

Inv: John F. Oehler,
La Crosse, Wis.

680

1612

POPULAR MECHANICS

1666

ICE-CUTTING MACHINE DOES WORK OF SIXTEEN TEAMS

A self-propelled ice-cutting machine, which it is claimed will do the work of 16 teams, has been invented by

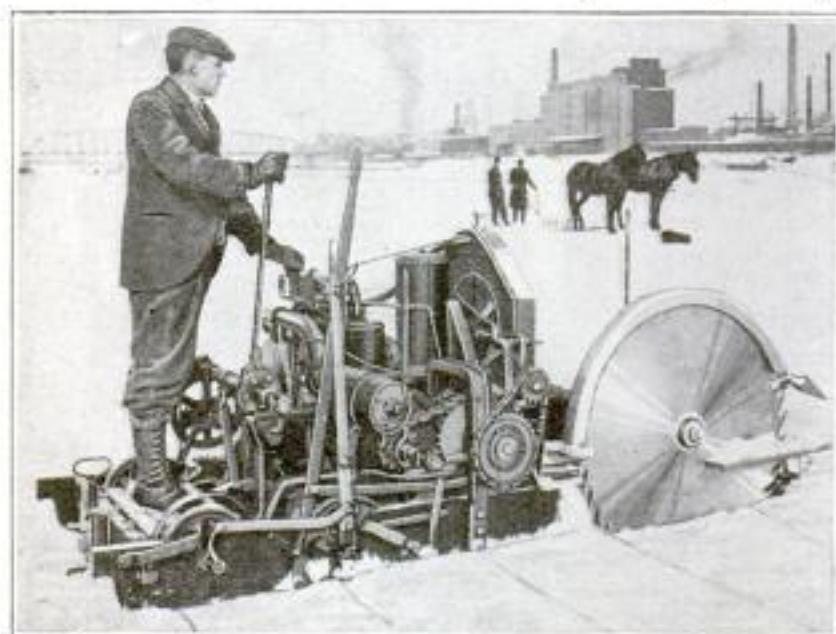

This Machine is Run by a 35-Horsepower Gasoline Engine, Is Self-Propelled, and will Cut 30,000 Cakes of Ice per Day

three Wisconsin brothers. A 35-hp. gasoline engine operates a circular saw and at the same time propels the machine across the ice, under the guidance of one man. By means of a friction disk the speed of the machine can be regulated as desired. It is capable of cutting one complete cake per second, or 30,000 cakes per working day. The saw can be adjusted to cut any depth down to 16 in. In ice thicker than that the cakes can be easily broken off with a splitting bar. The machine will work moving forward or backward, can cut on a straight or curved line, and runs under its own power to the place where work is to be done.

Encouraged by the success of "Electrical Prosperity Week" in 1915, the week of Dec. 2-9, 1916, has been designated by electrical interests as "America's Electrical Week." Those seven days will be devoted to intensive publicity relating to electricity and its many uses.

SPECIAL BLANKS SIMPLIFY REVALUATION OF CITY

The Bureau of Appraisal of the county and city of Los Angeles recently completed a detailed and systematic revaluation of

200,000 buildings within a certain area. The work of gathering the necessary data was expedited by the use of specially prepared blanks, of which there were six different kinds, that contained in condensed form a place for all desired information. The general subjects specified on one of these forms include the following: "class," "foundation," "plumbing," "finish," "occupancy," and "lighting." Each of these heads is subdivided to indicate something important

about the grade or equipment of the building. On each blank, also, is a square ruled off to a stated scale on which a contour plan of the building may be drawn. One of these blanks, when filled out, shows at a glance all the data needed to arrive at a fair valuation of the building in question, even to the number of rooms on each floor and the kind of bookcases and refrigerators built into the walls. After the number of square feet in a structure had been computed from the diagram, a unit value per square foot was placed on it by an expert, who was able to work rapidly with the data in this form.

INDOOR GOLF POPULAR GAME IN MANY LARGE CITIES

In a number of the large eastern and middle-western cities indoor golf became a most popular form of recreation during the past winter months. Inside and roof "courses" were established at some of the big hotels for the benefit of their guests, while many

1697



At the Side a Golf Devotee is Practicing at One of the Indoor "Courses" at Cincinnati. Besides Refreshing One Mentally and Physically after a Number of Hours in an Office, the Game Enables a Player to Improve His Skill during the Winter Months and Make a Good Showing When the Season Opens in the Spring. Below, a Prominent Player is Making a Drive into a Net Placed on the Roof of One of New York's Hotels for the Benefit of the Guests

practice "links" were opened in the business districts and conducted much the same as bowling alleys and billiard parlors. They were frequented not alone by title holders and adept enthusiasts, but also by mediocre players and beginners in need of practice and professional coaching. Since the inside game permits a player to drive 300 or 400 balls in an hour or so, giving him more actual club work than he would ordinarily get in several afternoons on a real course, it enables a person to make great improvement in a comparatively short time. And this is one of the particular reasons for its popularity. At Cincinnati some 500 devotees played golf in this way through out the closed season. The necessary paraphernalia for an indoor "course" are not elaborate. Driving and pitching nets, putting greens, and canvas bunkers usually suffice. The former are made in different forms, the canvas backstops of some having pockets into which the balls fall, these being marked to show the values and characters of different shots; and others being supplied with charts indicating the approximate distance a ball would have gone, whether it was a low slice, a high pull, or a drive out of bounds.

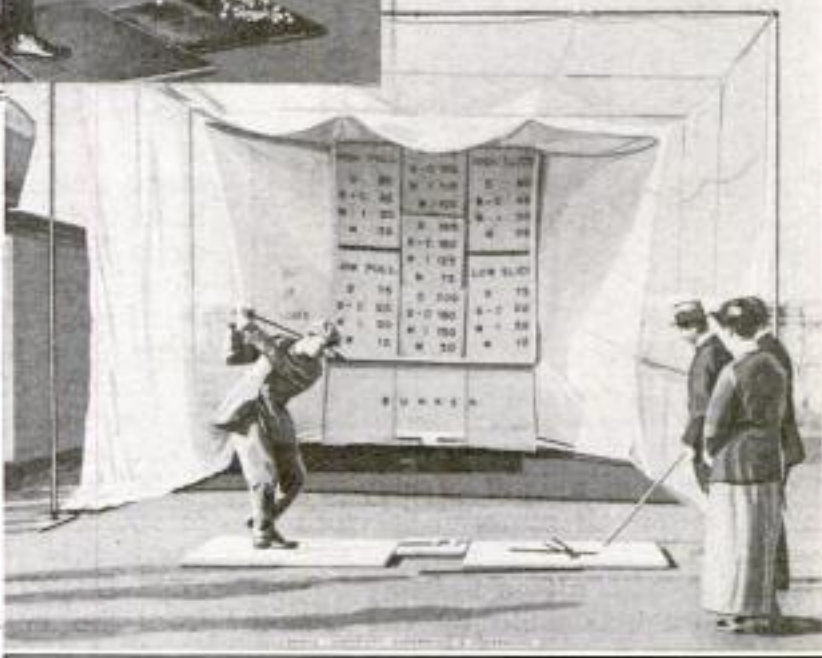

The pitching net gives a player practice at mashie shots, for when a ball falls into a sand pit that is provided, it is up to the player to get it out.

TUNNEL PIERCES HISTORIC MISSIONARY RIDGE

Historic Missionary Ridge, near Chattanooga, Tenn., has been pierced by a highway tunnel 933 ft. long. The uneven region, which presented strategic problems to the contending armies of the Civil War, has long presented difficulties in highway construction because of the steep grades involved in getting over the ridge. The tunnel, which was completed three years ago, has a uniform grade of five per cent, whereas the road which it supplanted had a 12-per-cent grade. The bore is 30 ft. wide and 23 ft. high, and is paved

Mr. Windsor
 # Bruce S. Crabtree
 40 News, Chattanooga, Tenn.

with concrete in which car tracks have been laid in anticipation of a trolley-line extension; the cost was \$130,000. The ridge contains no solid rock, but



A Highway Tunnel, 933 Feet Long, Which Pierces Historic Missionary Ridge, Three Miles from Chattanooga, Tennessee

is composed of a kind of clay which proved a difficult material to work in because of frequent cave-ins. The population of the rich farming region made more accessible by the tunnel

has more than doubled since the bore was completed, and land values have increased at an even more rapid rate. The tunnel is well lighted at all times with electricity.

MEMORIAL TO EXPLORER 1658 OF GRAND CANON

The United States Government has recently completed a \$5,000 memorial monument, or altar, on the rim of the Grand Cañon in northern Arizona in honor of Maj. John Wesley Powell and his associates who explored the cañon nearly half a century ago. The monument is of roughly hewn blocks of stone, and measures 21 by 28 ft. at its base and is 18 ft. high. A flight of steps leads to an area at the top inclosed by a stone wall, about three feet high. On this wall, opposite the steps, is a bronze tablet, including a medallion of Major Powell. The major, the inscription states, was the "first explorer of the Grand Cañon, who descended the river with his party in rowboats, traversing the gorge beneath this point Aug. 17, 1869, and Sept. 1, 1872." A fine view is obtained from the monument.

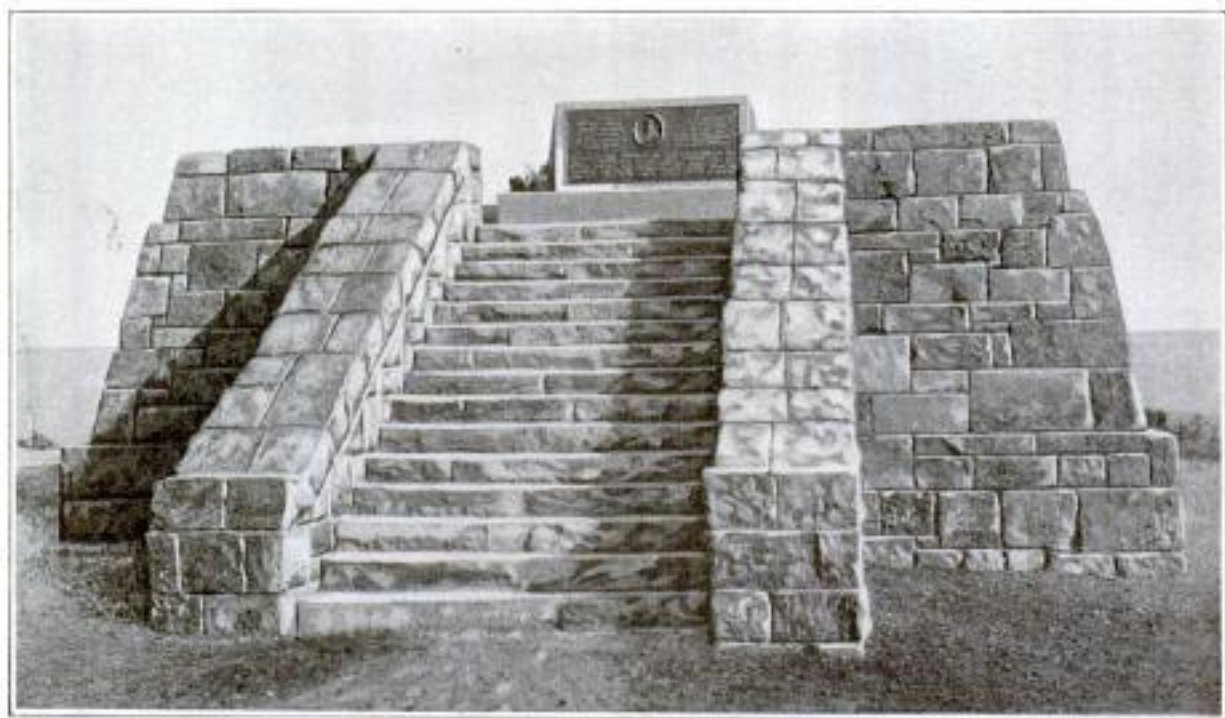

Monument Recently Erected on the Rim of the Grand Cañon in Honor of Maj. John Wesley Powell and His Associates, Who Were the First to Traverse the Cañon in Rowboats

11. Little ships

1557

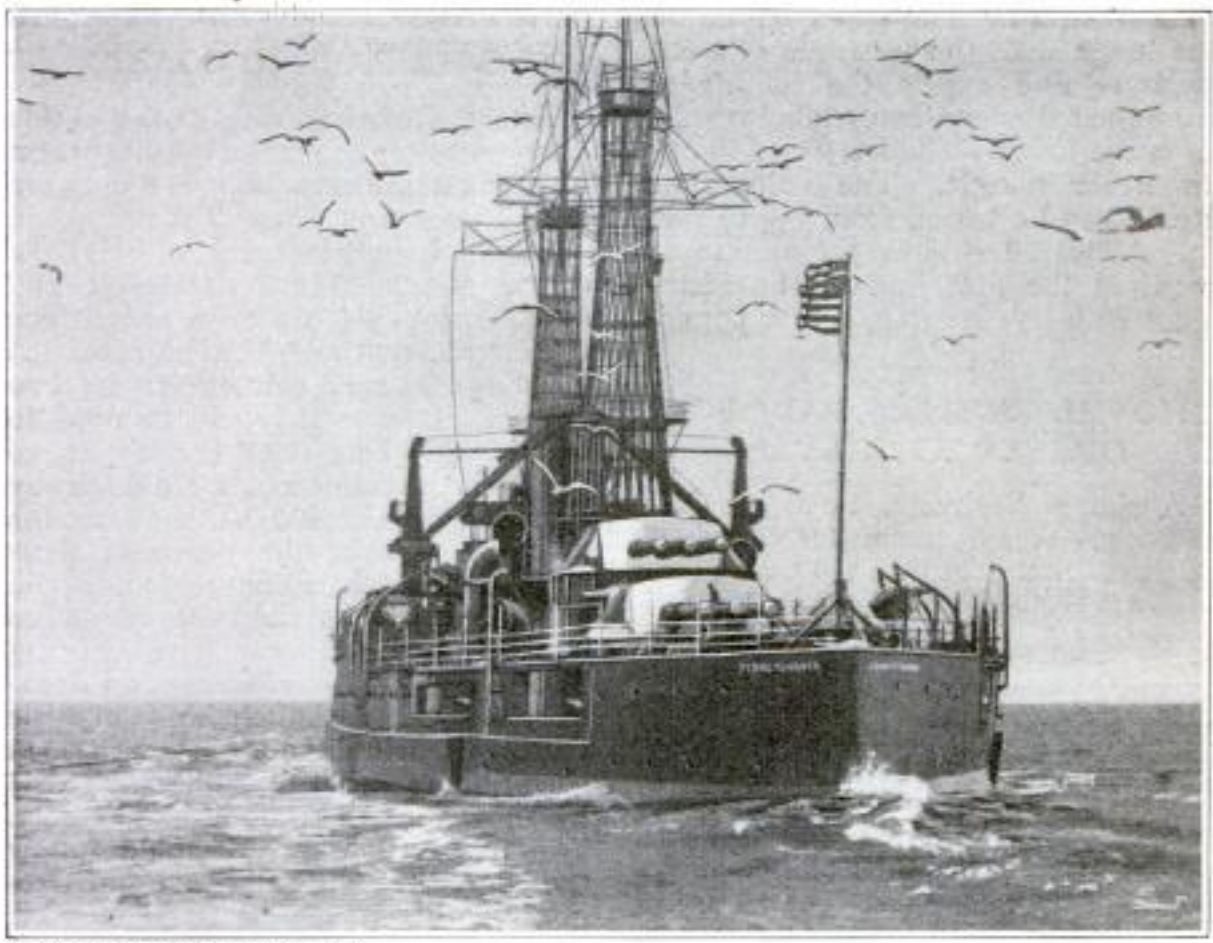

COPYRIGHT, INTERNATIONAL FILM SERVICE, INC.

NEW DREADNAUGHT "PENNSYLVANIA" IN TRIALS

STERN view of the "Pennsylvania," America's latest and greatest dreadnaught, during recent trials off the coast of Maine, when hundreds of gulls circled it. The vessel has an overall length of 680 feet, a normal displacement of 31,400 tons, and a designed speed of slightly more than 24 miles an hour. It is the sister ship of the "North Carolina," which should be completed in July, and the first fighter to carry twelve 14-in. guns arranged in threes in superimposed turrets ahead and astern. Its additional armament consists of twenty-two 5-in. rifles and four submerged 21-in. torpedo tubes. Sixteen-inch armor is used amidships. Oil is employed as fuel, and the engines are designed to develop 31,500 horsepower.

RESPIRATOR FOR NEW-BORN INFANTS

1677

An artificial respirator for infants, similar to instruments devised for resuscitating adults, is now coming into use. It is employed to produce artificial respiration in a new-born baby whose breathing is insufficient or wholly lacking. The instrument, which may be clamped to a table, consists of two cylinders with pistons operated by a single handle. A rubber tube leads from each cylinder to a rubber mask held over the infant's nose and mouth. The upward stroke of the pistons draws air from the lungs into one cylinder and fills the other cylinder

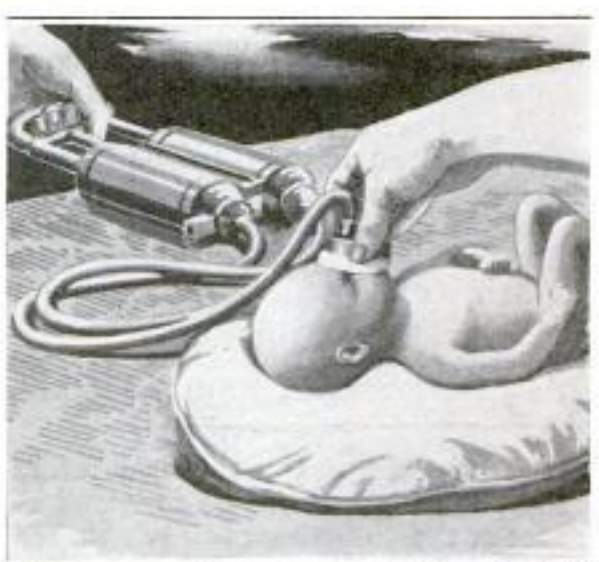

This Instrument is Designed to Produce Artificial Respiration in a New-Born Infant

*Life Saving Devices, Inc.,
180 N. Market St., Chicago*

Inventor: Chas. W. Fowler
2119 Fremont St., Chgo.

with fresh air. The down stroke fills the lungs with the fresh air at a safe pressure and expels the impure air from the cylinder already filled with air from the lungs. The fresh and impure air never mingle. The volume per stroke can be varied from $2\frac{1}{2}$ to 8 cu. in. About 60 strokes per minute are required the first hour. The instrument with its case weighs four pounds.

1601

NOVEL KEYLESS PADLOCK OPENED BY GRAVITY

A simple keyless padlock has been patented which furnishes adequate



protection against the ordinary unskilled thief. It consists of a body resembling an ordinary padlock, from which projects a shackle, or bail, that describes an arc of about 270 degrees and fits into a semicircular

passage in the body of the lock; by sliding the shackle back and forth in this passage the device is closed or opened. Radiating from the semicircular passage are one or more short passages, each of which contains a steel ball. When the lock is closed, or locked, and hangs in its normal position these balls drop by gravity each into a pocket in the side of the shackle, making it impossible to move the shackle. To unlock the device it is necessary to know at just what angle, or angles, it must be tilted to cause the ball, or balls, to drop from their obstructing positions. By similar methods some of the locks can be rigidly fastened open as well as locked.

It is possible that in the near future a light touring car will be provided as a part of the equipment of each United States battleship when on a long cruise.

MILITARY-HIGHWAY SCHEME FOR PACIFIC COAST

Efforts are being made on the Pacific coast to bring about the establishment of a great military highway between San Diego and Port Townsend, in order that, in the event of war, the armed forces of the northwest and southwest could act as a unit. The project, as outlined, contemplates the building of a road below snow level so that at all times it would be open to traffic. San Diego and San Francisco are already connected by a highway system which could be used as the southern link of the proposed thoroughfare, which, if developed, would have great commercial value as well as strategic importance. The existing Pacific Highway connecting San Francisco and Seattle is held to be of little military worth because it reaches an elevation of 4,000 ft. and is blocked by snow four to six months annually. The proposed highway would follow the coast through California and Oregon to the mouth of the Columbia River, extend along the latter to Portland, then cross into Washington, turning west to the sea and following the coast to the Strait of Juan de Fuca, where it would bend inland and reach Port Townsend. It has been proposed that the road be called the "Balboa Highway." The promoters suggest that the surveys be made by the government and the cost of construction be met with the revenue coming from the sale of timber from forest reservations in the states affected. If this plan were adopted it would devolve upon the counties cut by the road to provide a 100-ft. right of way.

1579

MAGNETS LIFT SCRAP IRON FROM BED OF THAMES

In seeking a method to clear certain portions of the London harbor in the Thames of scrap iron which had accumulated in the river bed for years, electromagnets were employed which speedily did the work that it would

Planned by
F. W. Harris
Renton, Wash.



have been costly and perilous for divers to undertake because their diving outfits were liable to be cut by jagged pieces of metal. These magnets and their connections were made waterproof so that when submerged there was no short-circuiting. In one instance a single magnet lifted from the river 250 tons of loose iron and steel in six days. Most of these hoisting outfits employed 36-in. magnets. In lifting large pieces of iron they could control anywhere from 500 to 900 lb. per load; where the pieces were smaller, 300 to 500 lb. was their capacity. Being frequently submerged, the overheating which might otherwise have resulted was avoided. The salvaged iron was alongside docks at which scrap iron had been handled for many years. The pieces which accidentally fell overboard made piles so high that finally they scraped the bottoms of vessels and their removal became imperative.

— 1657

PARTRIDGE MEETS DEATH BY FLYING AGAINST WINDOW

The astonishing swiftness and force with which birds fly was strikingly illustrated when a partridge crashed through a large window in a country residence near Red Wing, Minn., recently. The window was glazed with plate glass, $\frac{1}{4}$ in. thick. The bird, which weighed 20 oz., was found dead in the living room 11 ft. from the win-

dow. The impact of its body broke a hole in the heavy glass about three feet in diameter. This window is more than five feet square and close to the ground. It overlooks a large lawn which at certain times of the day is very vividly reflected in the glass. It is thought that the bird was deceived by the reflection and supposed it was

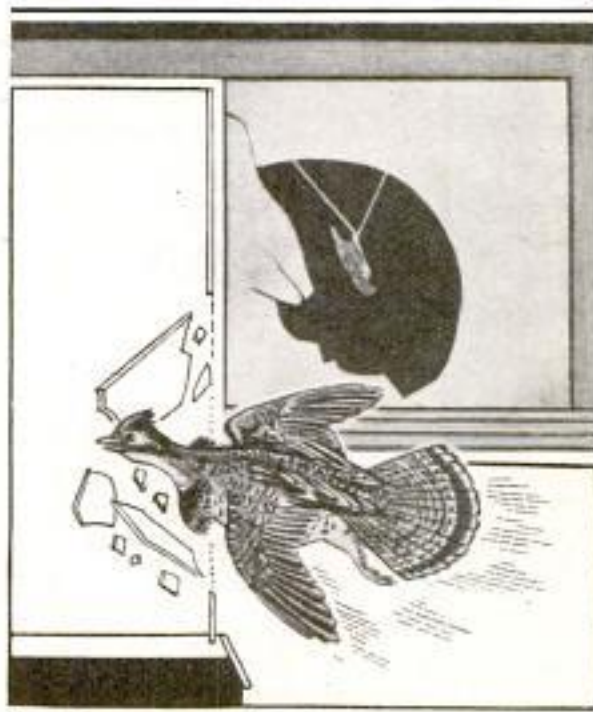

This Plate-Glass Window, One-Fourth of an Inch Thick, was Shattered When a Partridge Flew against It and was Killed

flying through an opening when it met its death. All but two or three very small pieces of the broken glass were thrown into the room.

H. S. M. Erbar, Red Wing, Minn.

1611

EDUCATIONAL POSSIBILITY OF AERO PHOTOGRAPHY



IN addition to its great military value, aerial photography, which is coming more and more into the foreground with the increased use of the air craft, may eventually prove to be of considerable importance in the educational field. The accompanying illustrations, giving panoramas of Palm Beach, Fla., (above) with Lake Worth on one side and the Atlantic Ocean on the other, and Wallacks Point, Stamford, Conn., (below) present graphic examples of the way the camera, assisted by the aeroplane, might be employed by the geographer and others. The pictures show with minute accuracy the contour of these two coast points and give a clear understanding of the topography of the land. The significant part is that while providing vivid, detailed views, they represent the work of only a few minutes' time. Without accomplishing as much as this, a draftsman labors for days.

COPYRIGHT, UNDERWOOD & UNDERWOOD



COPYRIGHT, BROWN & DAWSON

FRENCH GUNNERS DESTROY RAIDING AIR CRAFT



CONTRIBUTED BY INTERNATIONAL FILM SERVICE
 Wreckage of Zeppelin "L 77," Which was Recently Brought Down near Brabant-le-Roi by an Incendiary Shell



The Decisive Shot was Fired by This French "75" While the Craft Was at a Height of 7,500 Feet



Remains of a German Aero-plane Felled "Somewhere in France." The Engine Was in Good Condition after the Fall



Flames Enveloped the Airship as It Plunged to Earth. Later a Morbid Touch of Romance was Added by the Discovery in the Debris of the Slender Feet of a Woman Trimly Clad in Kid Boots

ITALIAN WOMEN CARRY SHELLS TO ALPINE GUNS



One of the Many Ways in Which Girls and Women are Helping the Italian Soldiers in Their Sanguinary Campaign against the Austrian Forces is Illustrated Herewith. The Picture Explains How Artillery Ammunition is Carried to Some of the Nearly Inaccessible Mountain Positions. The Heavy Shells are Lugged in Baskets Strapped to the Backs of the Women, Who Often Form Almost Continuous Processions along the Rugged Alpine Paths

CLOSE-UP VIEW OF ACTUAL FIGHTING IN WEST



Few Action Photographs of This Kind have Made Their Way to America Since the Outbreak of the War Abroad. It was Snapped by a Stretcher Bearer during the Heat of an Attack and Shows a Group of French Fighters Engaged at Close Quarters with the Enemy

CHALK-WHITE TRENCHES IN CHAMPAGNE REGION



Contrary to the First Impression
One Gets upon Glancing at the
Accompanying Photograph the
Trench Extending Far into the Back-
ground is Not Lined and Bordered
with Snow. Its Appearance is Due
to the Chalky Character of the Clay
in This Part of the Champagne
Region. The Zigzag Excavation
Ahead is a Communication Trench
through Which Masses of French
Troops are Pushing to the
Firing Line

COPYRIGHT, MEDEM PHOTO SERVICE

POISON GASES IMPERIL TROOPS AND CIVILIANS



Pupils of One of the Primary Schools at Rheims Wearing Respirators to Protect Themselves against the Asphyxiating Gases Blown Back from the Battle Lines



Hundreds of School Children and Other Non-combatants Don Masks of this Type



INT. FILM SERVICE, INC.
In Many Villages Families Are Supplied with Respirators and the Community Warned When Gas Clouds Approach



Small Detachment of German Marines, Equipped with Respiratory Masks, being Drilled for Land Service along Sandy Coast of Belgium

WAR CAMELS WORK ON DESERT AND SNOW FIELDS

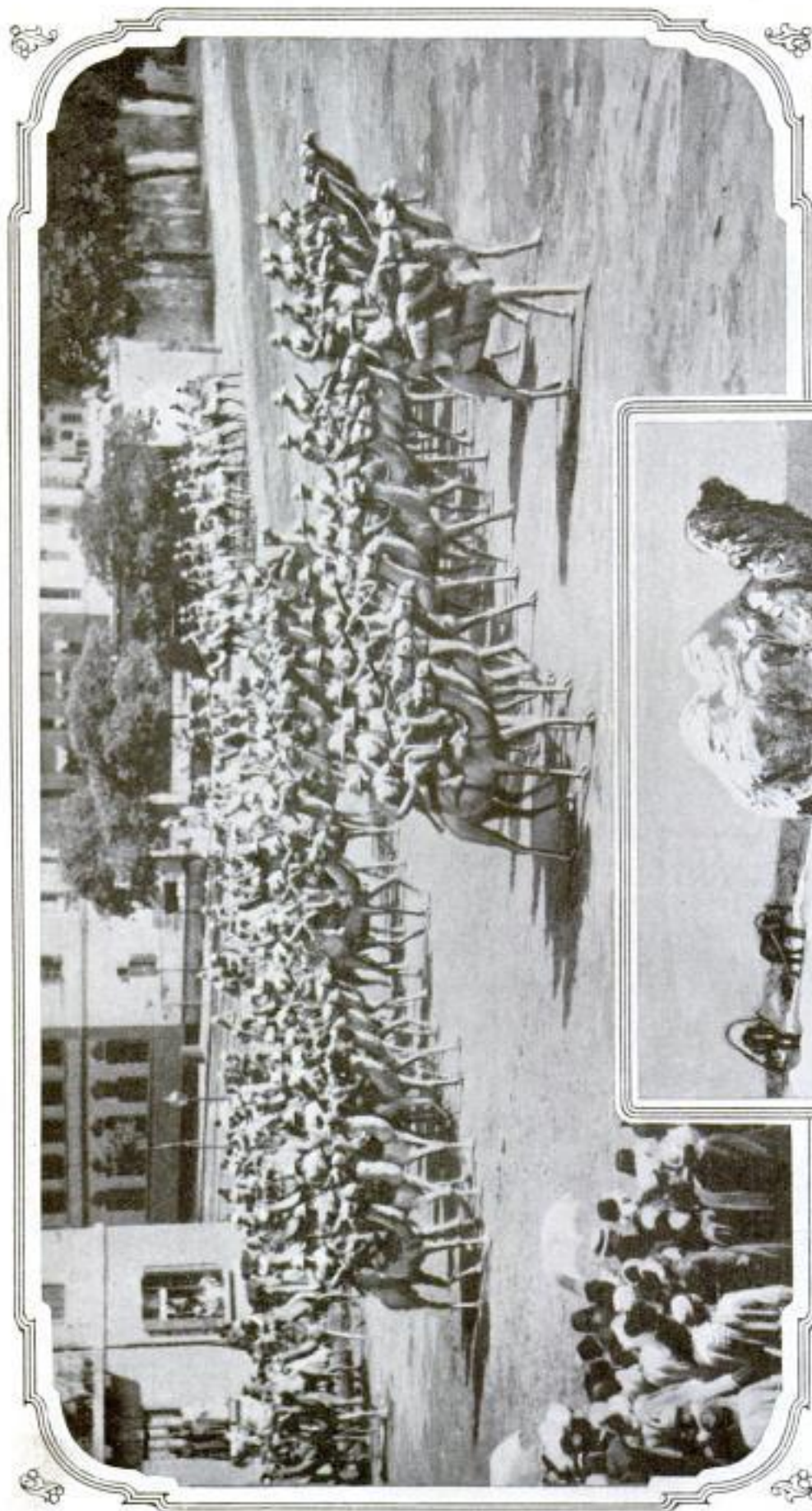

Left, One of Many Camels Used on the Snow-Packed Fields of Russia. Owing to the Lack of Adequate Railway Facilities the Czar's Army has been Greatly Hampered throughout Its Campaign and This Picture Throws a Significant Light on the Situation



Above, an English Camel Regiment is Shown Leaving Cairo to Guard the Suez Canal against Seizure by the Enemy. Should the Central Powers Be Able to Move a Strong Turkish Force across That Waterway, British Control in the East would be Seriously Threatened

PHOTO-COPYRIGHT, UNDERWOOD & UNDERWOOD

SCENES IN FRENCH TRENCHES AT THE FRONT



French Troops
Intrenched Outside
of Saloniki.
The Steel Rods
Visible above the
Parapet are Used
to Hold the Bags
in Place

COPYRIGHT,
INTERNATIONAL FILM SERVICE, INC.



Serving Soup in
a First-Line Trench:
The Big Boots Worn
by the Seated Soldier
Protect His Feet
from Freezing
When Standing for
Hours in Mud
and Water

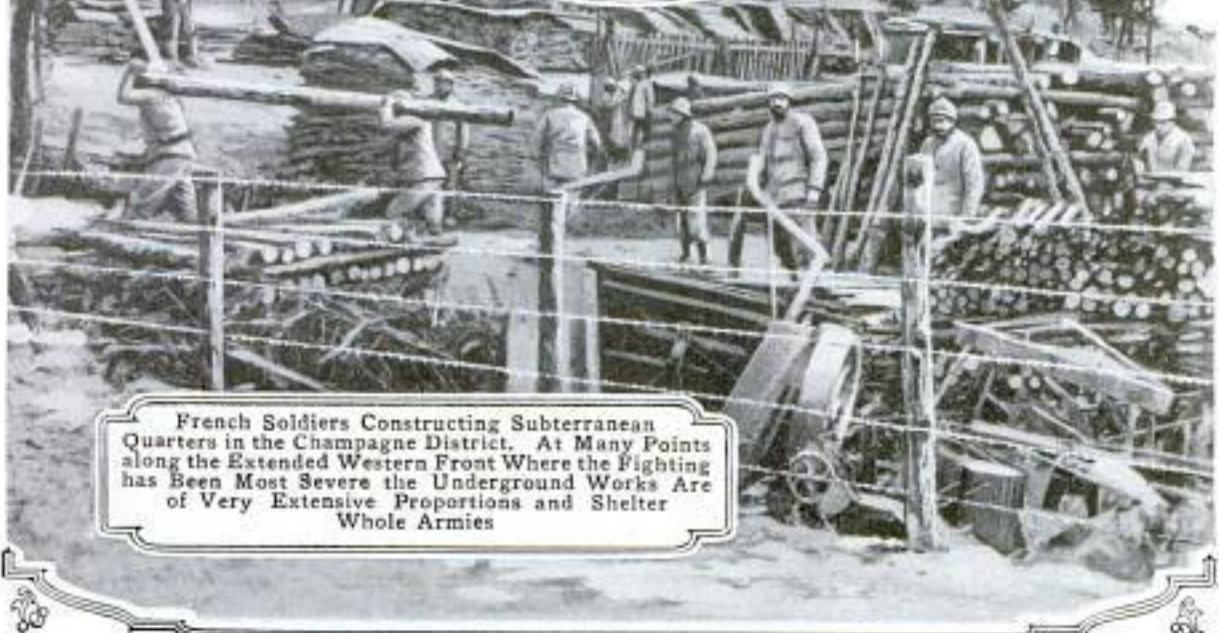

French Soldiers Constructing Subterranean
Quarters in the Champagne District. At Many Points
along the Extended Western Front Where the Fighting
has Been Most Severe the Underground Works Are
of Very Extensive Proportions and Shelter
Whole Armies

OLD BELGIAN CHURCH RAZED TO THWART ENEMY



Because This Church Helped German Gunners to Get the Range of the Belgian Lines It was Destroyed



During the Fighting the Structure had been Badly Battered by Shells, as Is Evident Here



The Building was Mined and Blown Up; This Picture was Taken at the Instant the Explosion Occurred



All That Remained of the Edifice after Its Destruction by the Military Authorities for Strategic Reasons

Inventor: Blaine Childs,
Calumet, Mich.



A Clamshell in Operation, Devised Especially for Removing Snow

Clamshells were Used in Cutting This Path through Snowdrifts in Northern Michigan

RAILROADS USE CLAMSHELLS 1553 TO SHOVEL SNOW

In clearing their right-of-ways through the great snowdrifts of northern Michigan during the past winter the railroads and mining companies in the vicinity of Calumet employed steam shovels and large clamshells operated on traveling derricks. The clamshells were devised by an employe of a mining company for the special purpose of handling snow. One of the enormous shells takes a bite 16 ft. wide and 5 ft. deep and operates on an arm having a sweep of 40 ft. It does the work of 100 men. In many places the snow was 8 and 10 ft. deep.

NEW DEVICE HOLDS PLATES 1395 IN BATTERIES APART

A new feature for batteries used in automobile self-starters, etc., which it is claimed doubles the life of the batteries, consists of a device for keeping the plates in the cells apart. Each battery is composed of series of alternating positive and negative plates immersed in acid and separated only by very thin mats, generally of wood. If the plates touch, through deterioration or softening of the mats, the resulting short circuit renders the cell useless.

In the new batteries the wooden mats are supplemented by four notched strips of hard celluloid. Slits in the four corners of each plate permit these strips to be inserted through the openings. By means of the notches in the edge of the strips the plates are locked rigidly apart and remain in that position regardless of the condition of the

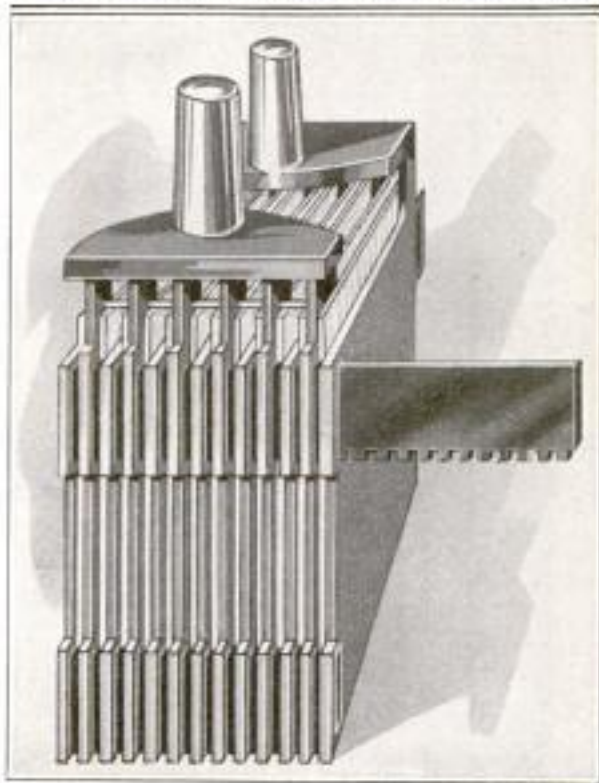

Notched Strips of Celluloid in This Battery Hold the Positive and Negative Plates Apart, Thus Preventing the Short-Circuiting Which Results When Softened Mats Allow Them to Touch

mats. The celluloid members can be removed only by removing the series of plates from the cell.

Vesta Accumulator Co.
2100 Indiana Av., Chgo.

**HIGHWAYS BUILT WITH SAND
 1467 IN FLORIDA.**

The man who built his house upon the sand would rub his eyes if he saw some of the country roads in Florida. The composition of the roads is almost entirely sand, for with all her varied natural resources, stone and gravel are not found in many places in Florida. Freight rates are very high, which makes the shipment of ordinary road-building rock material from the North prohibitive. Various attempts have been made to mix oil and other materials with sand, which is obtainable throughout the state. None of these efforts have been entirely satisfactory.

About two years ago an experienced northern road engineer began experimenting with asphalt and sand and has worked out a method which produces a most pleasing result, and which, if it stands the test of time, as seems highly probable, will work a revolution in road building in the state. The six inches of foundation are laid

The discovery consists in the fact that very few natural sands, as found, will bind permanently. To provide sand which will bind, it has been found that there must be a definite proportion of coarse, medium, and fine sands, and these proportions are a trade secret. When a natural-sand supply is decided on, repeated tests are made to determine its exact proportion of coarse and fine grains, and any variance from exact requirements of coarse or fine grains is remedied by addition of the lacking size, which is secured by screening. These screenings are then added to and mixed with the mass in a mixing machine. After spreading, the asphalt surface is rolled with a steam roller. The working outfit is quite extensive, one machine weighing 21 tons. In a comparatively short time after completion this heavy machine travels over the asphalt-sand road without injury to the road, and constitutes as severe a test as the road is likely ever to sustain, as there is little of the heavy trucking common in the North. How long roads built in this manner will last remains to be demonstrated. The builder believes 15 years a conservative estimate.

The universal presence of sand in the state, and the fact that the asphalt-sand roadway can be built at a little more than



The Road is Given a Clay Base When Possible and Surfaced with a Special Mixture of Asphalt and Sand, Applied Hot and Rolled

with clay, where obtainable, or made of shell, which is well rolled. The sand and asphalt are then put on hot after mixing in a rotary heater. This has been done before, however without success.



Stretch of Sand-Asphalt Turnpike Extending through Rural District in Florida. This Type of Highway Presents a Good Appearance, but the Length of Its Life Is Yet to be Determined

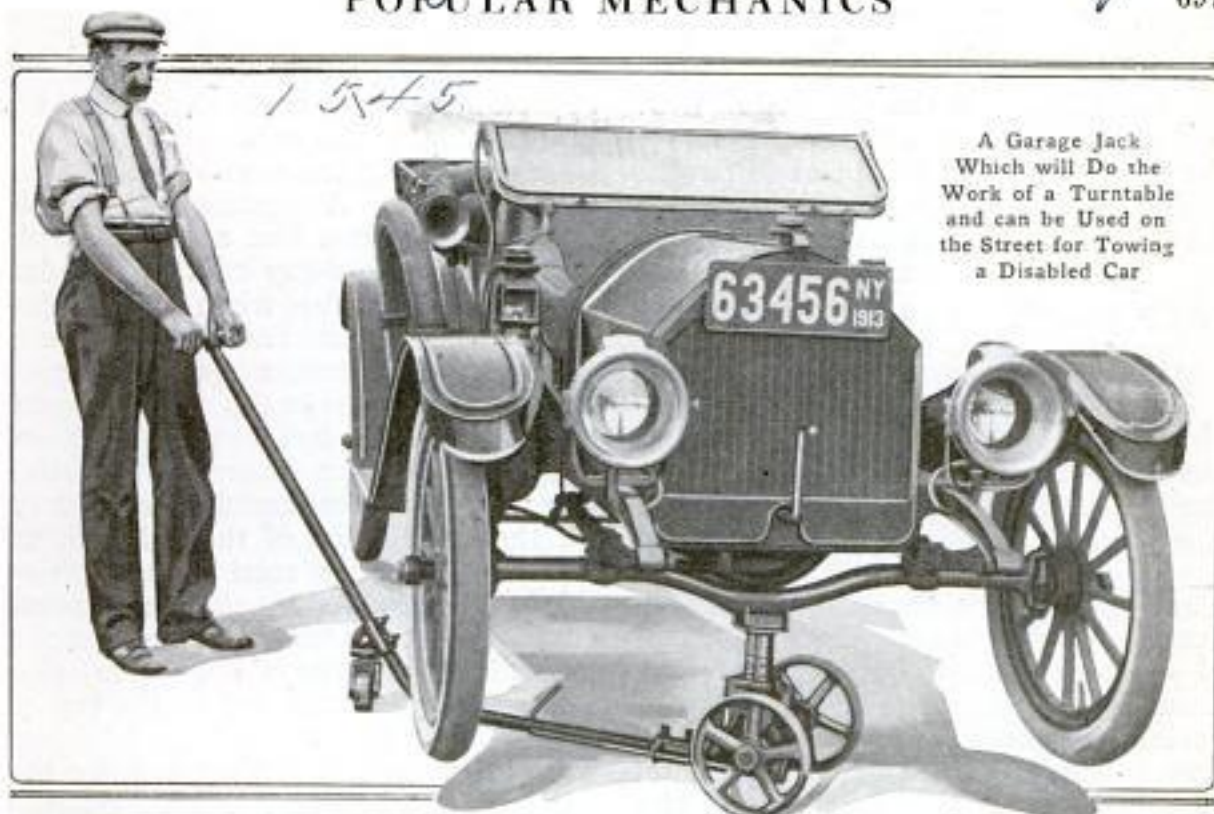

A Garage Jack
 Which will Do the
 Work of a Turntable
 and can be Used on
 the Street for Towing
 a Disabled Car

one-half the cost of brick highway, with the further great advantage of never being subjected to a heavy frost, make the method particularly adaptable to this region.

Florida is now wide awake to the value of good roads, and county after county is voting a million dollars each to secure them. Several hundred miles are already finished, and in the very near future the state will afford a winter paradise for the motor tourist within short and easy motoring distance of three-fourths of the entire population of the country.

**JACK AND TOWING TRUCK FOR
 1545 AUTOMOBILES**

A combination jack and towing truck for automobiles has been invented which consists of two 10-in. iron wheels supporting a lifting post and drawn by a long bent handle which has a wheel on a swivel near its bend. A lever for raising and lowering the post, about 30 in. long, projects from the jack parallel with the handle. To raise a car the jack, previously adjusted, is rolled under the axle with the curved end of the lever turned up. By pressing this down the axle is

raised so that if desired the low-lying handle can be drawn back under the wheels. The device can easily be made to do the work of a turntable. For towing a disabled car on a thoroughfare a straight handle is substituted and a special top and clamp are fastened to the post by which the axle is held firmly in position.

**CLAMP ADAPTABLE TO ANY
 INDIRECT-LIGHT BOWL**

A clamp that is adapted to hold almost any style of indirect-light bowl consists of a clamp arm and an ornamental portion adjustably fastened to it. There are two screws on the arm inside the bowl. By means of these the clamp and ornamental portion are drawn tightly about the lip of the bowl. The upper end of the arm forms a hook which fastens to a supporting chain; a light socket is located at the lower



J. H. White Mfg Co.
 111 N. 3rd St.
 Brooklyn, N. Y.

*Jas. G. Biddle
1211 Arch St. Phila.*

end. The ornamental portion, outside the bowl, conceals the connection with the chain and has an arm projecting far enough beyond the bowl to permit the hanging of a direct-light globe. This arm is detachable.

1441

APPARATUS DEMONSTRATES MOLECULAR MOVEMENTS

What is claimed to be the only mechanical device for visibly illustrating the molecular motion of gases and the fundamental laws governing such movements, has lately been developed by a Princeton University physicist. The apparatus is constructed for the purpose of clearly showing the change of pressure when the volume of a gas remains constant while its temperature varies; the change of volume when the temperature of a gas at a constant pressure increases or decreases; the viscosity of gas; the so-called Brownian movements, an irregular motion of small particles suspended in a gas, and other phenomena.

The molecules of gas are represented by some 16,000 steel spheres, each $\frac{1}{16}$ in. in diameter, which are kept in motion by mechanical means within the apparatus. The latter has a cylindrical metal base resting on leveling screws

and supporting a hollow glass cylinder, approximately $9\frac{3}{4}$ in. high and $8\frac{1}{2}$ in. in diameter, which is bound at the top by a metal ring and partly lined by an iron cylinder. A floating glass disk arranged to move like a piston head, is suspended midway of the cylinder from a cross member when the motions of gas molecules and the pressure caused by their impact against the container walls are to be illustrated. Four rotators, driven by a motor and arranged in pairs to revolve in opposite directions, are mounted horizontally on the base inside of the cylinder, to give motion to the steel balls, or "visible molecules." The change of pressure incident to temperature variations is demonstrated by a scale arm with sliding weights attached at the top of the cylinder to measure the pressure exerted upon the floating disk by the impacts of the flying balls. Attachments are provided to accurately regulate the speed of the rotators. The balls are uniformly distributed and their velocity bears a definite relation to the speed of the rotating members. Since by increasing the rate of the latter the velocity of the balls is advanced, the variation of it amounts to the same as varying the temperature of a gas.

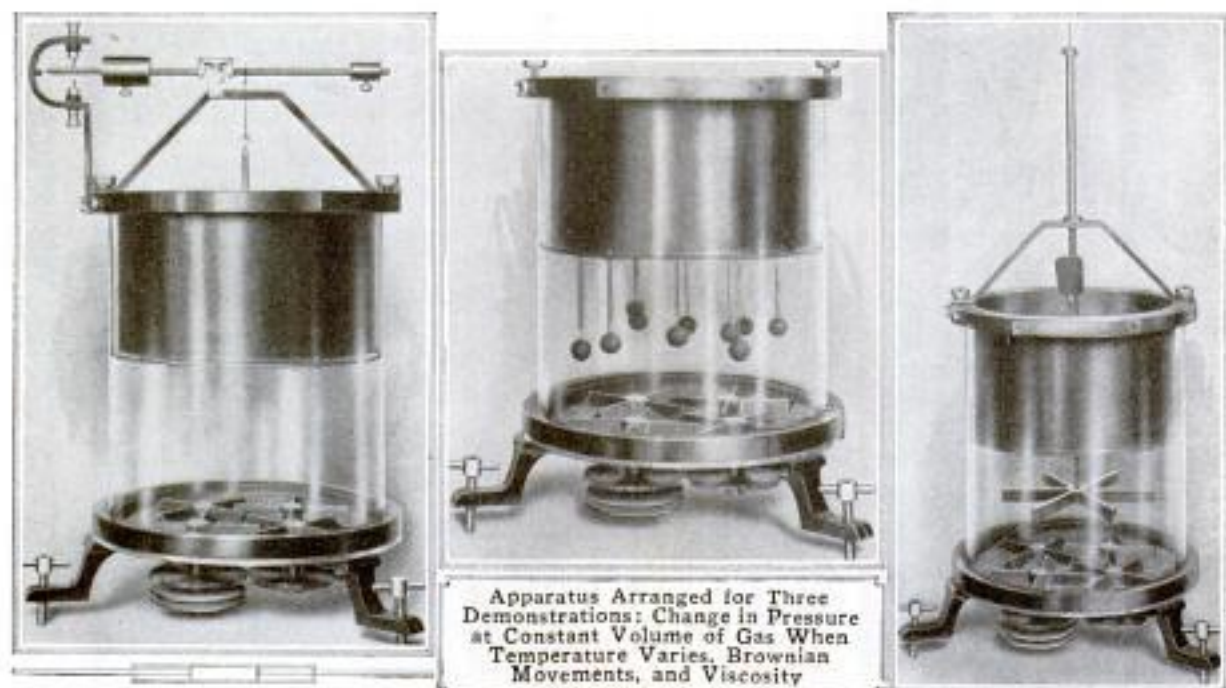

When the viscosity of gas is to be illustrated the glass disk is replaced by a steel one held in a fixed position at the lower end of the metal cylinder. Suspended from a rod passing through the center of the disk is an iron hub having six spokes. To give inertia to the system the top part of the rod on the upper side of the disk passes through another and heavier disk. The whole system is suspended on a wire so that it can be given an oscillatory motion about a vertical axis. These oscillations are made distinctly visible by an index, and when once started the system will continue to move for some time without noticeable decrement, providing the metal balls, or "visible molecules," and their rotators are at rest. When the latter are started, however, causing the cylinder to become filled with flying balls, the oscillations quickly cease. This demonstrates what takes place when the oscillations of a disk suspended in a gas decrease in amplitude because of the viscosity of the gas.

In demonstrating the phenomena of the Brownian movements a hub with ten spokes of various lengths is fastened to the under side of the aforementioned disk. From each of the arms a wooden ball is suspended on a light coil spring. When motion is given to the "visible molecules" by the rotating wheels, they strike the suspended wooden balls—representing particles floating in a gas—and cause them to move about irregularly.

1503 — PORTABLE WINDMILLS USED —ON WESTERN FARMS

In sections of Missouri and other farming communities where a certain amount of stock is raised and water is available at depths of 10 or 20 feet beneath the surface of the ground, portable windmills are coming into quite common use. The steel towers of these are mounted on wooden skids, so that they may be moved from one point to another without trouble, and range from 10 to 12 feet in height. When it is desired to change a feeding yard,

the pump is removed, the pipe drawn out, and the windmill taken to the new location, where the pump is reinstalled. Outfits of this kind are also being used



The Windmill is Mounted on Skids and may be Moved from One Point to Another without Difficulty

by threshing crews in some districts in preference to hauling water in tank wagons.

FLORIST DISPLAYS FLOWERS IN BLOCKS OF ICE / 3 8 1

Bouquets of roses, carnations, and chrysanthemums frozen in large cakes of ice, formed an exhibit of a Missouri florist at an agricultural conclave held in that state not long ago. The idea was also carried a step farther by another exhibitor who displayed wheat, oats, barley, and corn in a similar manner, arranging the grain in layers. In doing this, a block of ice is frozen part way through and then removed from the can. The water filling its



*Aermator Co. Campbell St.
1146 So. Campbell St.
Chicago.*

core is then emptied and the flowers, or whatever is to be used, are placed in the hollow space in the middle. When they are arranged in the proper position water is poured about them gently and the freezing process recommenced. The flowers, upon the completion of the operation, are frozen solidly in the middle of the block, where they will remain in good condition until the ice melts away.

MECHANICAL FAN OPERATED 154V BY HAND

A mechanical hand fan, having four blades constituting a wheel about 5 in. in diameter and fastened to the end of



By Turning the Wheel under the Thumb the Radiating Blades of This Mechanical Fan can be Made to Revolve Rapidly

a suitable handle in which is the operating mechanism, has been patented. Projecting from the side of the handle, where it can be easily turned by the thumb, is a rubber-bound wheel. This is connected by gearing with a shaft. At either end of the shaft is beveled gearing, that at the upper end connecting with the fan. By turning the rubber-bound wheel with the thumb the fan is made to revolve rapidly, throwing a breeze in any desired direction.

Inventor:
 Jno. Presma,
 51 70 Main St.,
 So. Norwalk, Conn.

EARTHQUAKES NOT MENAC- ING PANAMA WATERWAY

Contrary to the popular impression, there is no evidence to substantiate the theory that the Panama Canal is in danger of eventually being ruined by earthquakes. The relation between geologic and topographic conditions and some of the engineering problems encountered in the construction of the waterway form the subject of a bulletin lately issued by the Bureau of Mines, in which this point is considered. Investigation has shown that during the last 300 years there have been but two seismic disturbances of consequence in the region, and that neither of these were of sufficient force to seriously damage the most delicate parts of the now existing canal. The tensile strength of the rocks in the zone is low and would prevent any great accumulation of stress, it is believed. Outside of the isthmian shore waters the ocean bottom has been sinking for years. This has been the chief cause of the earthquakes, each of which has brought about a slight uprise of the land mass. There is a record of four oscillations and the beginning of another elevation, according to the government, but the average uplift for the past 1,000 years is estimated at less than .03 ft. annually, which is too slight to justify concern. It is also stated that the reason for the trouble encountered with slides has been chiefly due to structural breaks caused by oversteep slopes at points where the banks were high and the rocks weak. The remedy has been to remove the unbalanced pressure and lessen the slopes. It is interesting to note that these slides have made it necessary to excavate some 30,000,000 cu. yd. more earth than was first estimated as necessary at Gaillard Cut, formerly known as Culebra.

That Yale's rowing crews might have a clear practice course, dynamite was used this spring to clear the Quinipiac River of ice.

A. T. & S. F.
Azusa, Calif.

SWOLLEN CALIFORNIA RIVER LEAVES ITS CHANNEL

1560

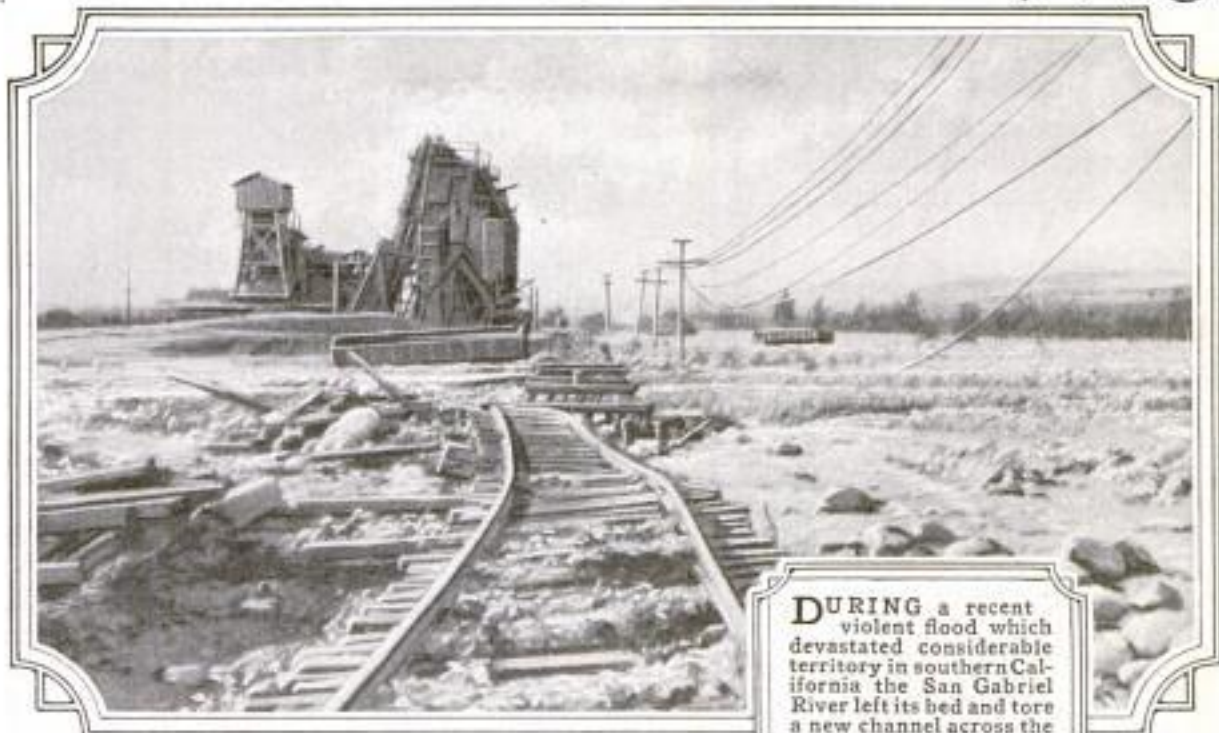

DURING a recent violent flood which devastated considerable territory in southern California the San Gabriel River left its bed and tore a new channel across the lowlands. A big steel bridge, wide enough to span the flood had it remained in the channel, was left high and dry because the stream changed its course. The most damage was done to the Santa Fe railroad. Gondola cars loaded with sand, used to weight the track, were swept away with a 600-ft. section.



PLUMB-BOB ADJUSTER

1470 **SAVES TIME**

A device for quickly adjusting the length of a plumb-bob string by the use of only one hand, has been placed

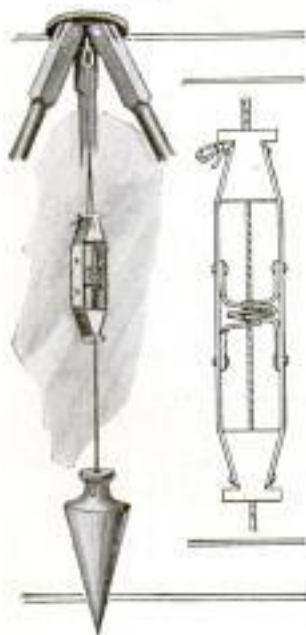

on the market. When this attachment is used the string extends from the bob up through the simple framework of the device, then through an eyelet on the under side of the transit and thence back to the upper end of the adjuster, where it is tied. In passing through the adjuster the string also

passes through two overlapping wire loops of irregular shape, one of which is fastened to each of the two sides of the frame, which is of flexible metal. The loops are so positioned that normally they grip the cord firmly. But

the adjuster can be slid freely up and down the string simply by pressing the sides with the thumb and finger, thereby releasing the cord and allowing the bob to be raised or lowered.

ONE KEY CONTROLS ALL

1577 **PARTS OF NEW CAR**

The latest model of one of the more expensive makes of automobiles is so constructed that a single Yale key will operate all the locks on the car, and one turning of the key will so lock and disconnect the machinery that this feature furnishes almost absolute protection against theft. The lock switch, which is located on the dash, or cowl, can be set in any one of three positions. When set at the position designated as "night," the signal lights are turned on and locked and cannot be turned off from the main switch and the car cannot be started; when

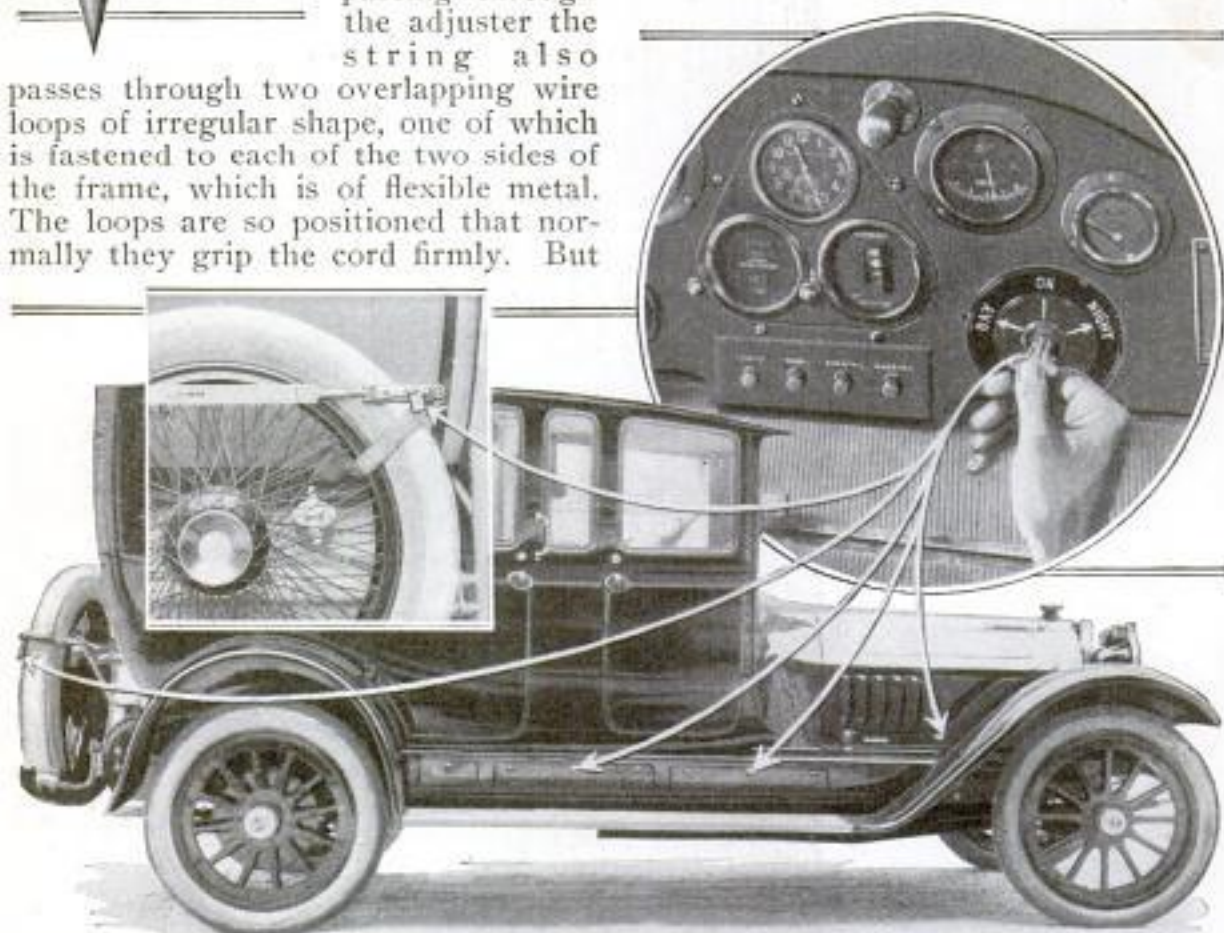

With the New Electric Lock on This Car the Signal Lights, Starter, Magneto, and Horn can be Disconnected by One Turn of the Key. The Same Key is Used to Lock the Hood, the Tires, or Wheels at the Rear, and the Tool Compartments in the Dust Shield of the Running Board

*Locomobile Co. of America,
Bridgeport, Conn.*

Inv. Jay Briggs, Los Angeles,
 R. 506 - 112 W. 9th St } 1914
 no. 838 S. Grand Av.
 POPULAR MECHANICS

1552



These Automatic Gates are Designed to Guard Users of the Crossing against Switching Operations and against Approaching Trains or Trains Passing in Opposite Directions

the key is turned to "day," the magneto is grounded, the lamps cannot be lighted, and the starter and horn will not work; when the key is turned to "on," everything is released for operation. The same Yale key opens the tool compartments, unlocks the bonnet, or hood, which is in two parts that can be removed separately, and operates the lock protecting the tires or wheels fastened at the rear.

DOUBLE AUTOMATIC GATES

1552 FOR RAIL CROSSINGS

Double automatic railway-crossing gates which are electrically operated, and are intended to guard against every possible movement of trains, are being tested on a railway in Illinois. On each side of the tracks is placed a metal housing from which extend two arms that point upward when the tracks are free. As a train approaches within 2,000 ft. of the crossing a warning bell rings, a circuit having been closed; when the train is 1,500 ft. away, one arm descends either side of the track. At night a red light marks the position of the barrier. After the train has

passed, another circuit is closed and the arms rise. The second pair of arms operates when a second or returning train or engine approaches the crossing just after the first pair has been freed. Thus a very common cause of crossing accidents is guarded against. A portion of a train can stand near a crossing indefinitely without keeping the gates down, but on the other hand they furnish full protection during switching operations regardless of the number of tracks. The gates are operated by storage batteries in combination with a 1/4-hp. motor. Out of 6,000 operations the gates failed only four times; this was caused by faulty adjustment which was remedied during the early part of the test.

BINDER STRIPS USEFUL IN 8884 LETTER FILING

A type of letter file lately originated makes use of gummed tabs fastened to a long strip of cardboard, as the filing element. In use, letters are attached to the strip, at two different points by the tabs, it being possible to hold as many as two dozen sheets of

U. File - M. Binder Mfg Co.

F. J. Strobell, Distributor
 1606 Tribune Bldg, Chgo.

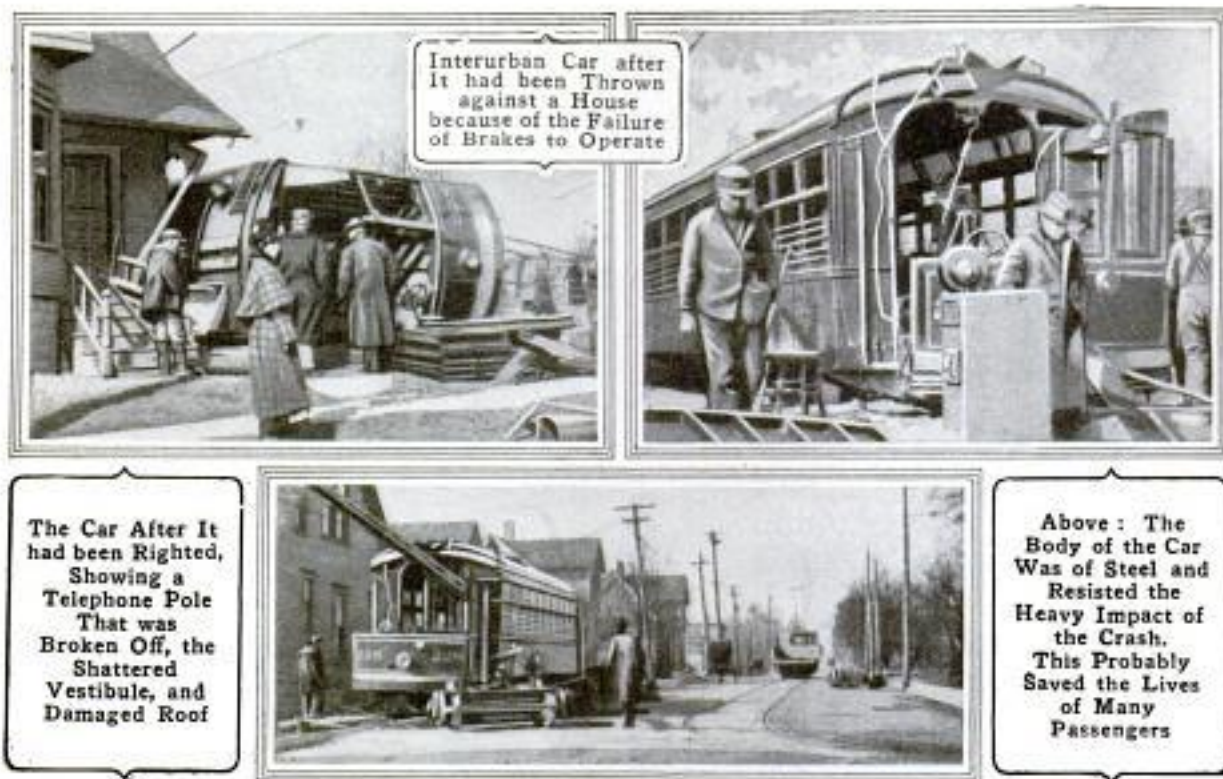

Interurban Car after
It had been Thrown
against a House
because of the Failure
of Brakes to Operate

The Car After It
had been Righted,
Showing a
Telephone Pole
That was
Broken Off, the
Shattered
Vestibule, and
Damaged Roof

Above: The
Body of the Car
Was of Steel and
Resisted the
Heavy Impact of
the Crash.
This Probably
Saved the Lives
of Many
Passengers

paper to the same strip in this manner. In some cases a stiff Manila cover is provided to protect the sheets after filing. By the use of tabs the necessity for punching holes in the letters, as in some other files, is avoided. The gummed strips and tabs are made up in a variety of forms and lengths to suit the requirements of different office systems.



Strips of Gummed Tabs are Used to Hold Letters
Together in New Filing System

INTERURBAN CAR THROWN 551 AGAINST A HOUSE

The air brakes of a new, all-steel interurban car refused to work while rounding a sharp turn in Joliet, Ill., recently, with the result that the car left the track, struck the street curb sideways, and turned over on its side tight against the side of a frame house. The reason the broadside of the car struck the curb was that the front trucks held to the rails until the rear truck left them. There were 19 passengers, six of whom were injured rather seriously; none was killed. Had the conveyance been of wood the car would probably have crumpled and the accident would have been much more serious. The car broke off a telephone pole which crushed the vestibule and furnished a means of escape for the passengers. The overturned stove started a blaze which was soon extinguished. The porch of the house that was struck was partly demolished and the whole dwelling so shaken that a woman in an upper bedroom was showered with plaster and almost thrown from bed. The accident did not seriously interrupt traffic.

Detlef Schultz,
917 Orinda St.
Joliet, Ill.

1258
**TEST SHOWS PERSISTENCE OF WATER SUPPLIED TO CAMP BY
 1363 MUSK ODOR**
Engineering Jan. 16

Minute measurements of the decreasing weight of musk caused by its giving off odor, were completed recently in the laboratories of the University of Pennsylvania. After being dried in an oven at a temperature of 120° C. a lump of musk weighing 1.32245 milligrams was subjected to a steady current of dry air for a period of seven months. Scales of the greatest delicacy showed that the musk lost weight each day, beginning at .00318 milligram a day and diminishing to .00002 milligram a day. At the end of seven months the musk had lost all odor. This was not due to loss of moisture, for it remained odorless when freshly moistened. It would seem that

While camping in the Sierras some time ago, members of a western outing

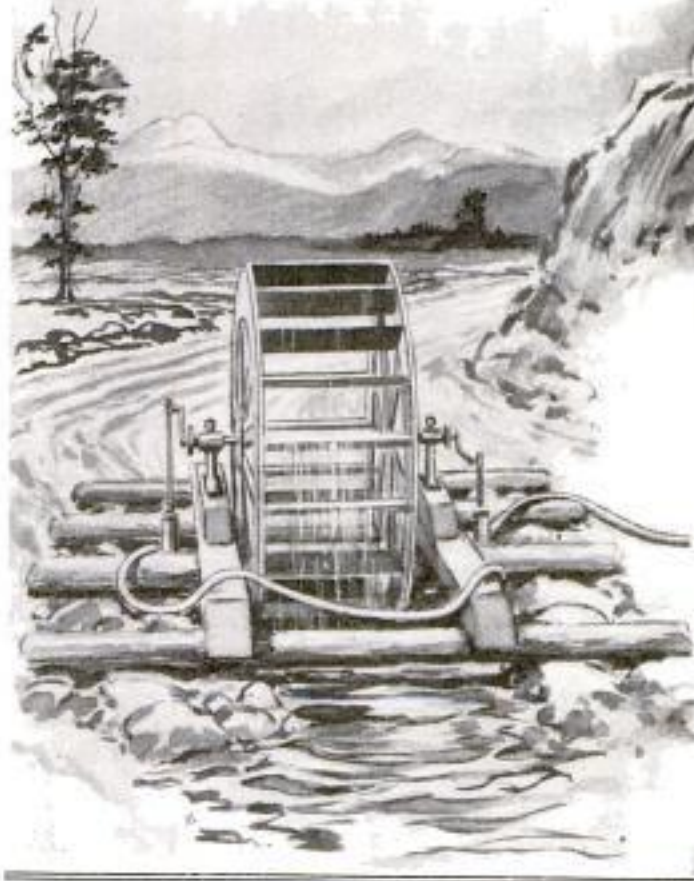

The Wheel Operates the Pumps and Raises the Water to a Height of About 50 Feet

all the volatile constituents of the musk were carried away by the current of air.



club improvised a water system which worked effectively and proved to be a great convenience. A water wheel of medium size was placed in a swift mountain stream about 50 feet below the point where the tents were pitched. A small pump was set on either side and the piston of each connected with a crank extended from the axle. The water was forced to a canvas tank constructed on the slope above. From there it was conveyed to the camp through a rubber hose. A continuous flow of water was thus provided and much inconvenience averted by a small expenditure. With the proper materials at hand, an apparatus of this kind can easily be constructed in camp.

*Sierra Club, Tuolumne Meadows, High Sierras.
 #18. Howell, 1947 Elmer and Lewis, Merced, Calif.*

S. Flory Mfg. Co.

Sanger, Pa.

HEMP-FIBER MACHINE DOES WORK OF MANY NATIVES

A machine for stripping hemp fiber has been designed by an American mechanical engineer in the Philippine Islands, which, it is said, will produce 600 lb. of fiber per day. One man and an assistant are required to operate it. Approximately 15 pounds is the amount of fiber that four Philippine natives can produce with present crude methods, which often involve a waste of 60 per cent.

The waste by the new process is estimated at 10 per cent, and it is the belief of the inventor that the uniformity of his product will make it worth 25 per cent more than the common grade.

The machine is about 3 ft. wide and 10 ft. high, and the iron framework divides it into two slender parallel sections. The hemp is first prepared by reducing it to strips about 6 in. wide, 1/4 in. thick, and as long as the plant. These strips are fed into the machine, one at a time, whereupon carriers, moving on an endless chain horizontally across the top of the machine, seize the upper end of a strip and carry it into the first section. Here it is held firmly in position by another clamp, while four sharp knives, moving vertically, pass over it lengthwise, shaving it and leaving nothing but the fine fiber. These knives are carried on endless chains which extend the length of the machine and travel at the rate of 20 revolutions per minute. After

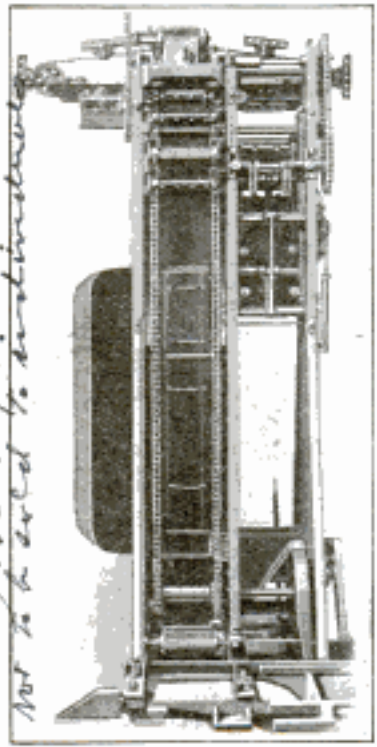

this process, the carrier again seizes the fibers and moves them into the second section of the machine, where they are pressed between four rubber rollers. The long, fine shreds are then taken out and dried and made ready for the market.

1483

TRACTION ENGINE HEATS TEXAS HIGH SCHOOL

A traction engine was used to supply steam to the heating plant of the Sanger, Texas, high-school building following an accident to the regular heating system. In the midst of a severe cold spell during the past winter the boiler exploded and the school board was in a quandary as to how to heat the building, which was not constructed so that stoves could be installed. The problem was solved by backing a traction engine up to the south side of the building and placing the janitor in charge of it, after connection had been made between it and the steam pipes. The result was very satisfactory.

1291

FILING BASKET OF WICKER FOR DESK PURPOSES

For the office man a filing basket that may be used on top of a desk is a neat accessory that is now being introduced.

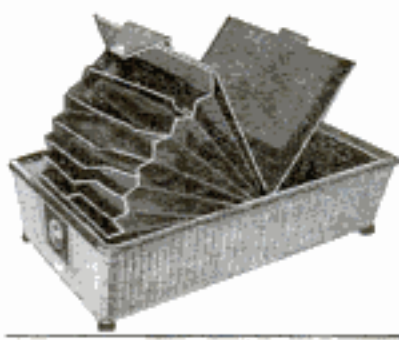

The body of this is substantially made of

tan-colored wicker, and is 11 by 15 1/2 in. in size. It contains an alphabetically indexed file that fits snugly in place. When closed, the cover may be locked securely, giving the device a slightly appearance. It may be used for filing current correspondence, orders, or reference sheets, and is especially serviceable when drawer space is none too adequate.

Max Cross
404 5th av.
New York

Inventor: Wm. Alfred Brown, Manila, P. I.
Patent: E. Allen
Abasa Product, Co., Manila (Does not) will operate several hundred.

806

Suburban Crossing

1493 "STOP" SIGN REPLACES FLAG AS WARNING DEVICE

In its campaign to minimize grade-crossing accidents, the Chicago & North Western Railway has discarded the customary red flag as a warning sign for watchmen in suburban towns on the Milwaukee division and substituted a white-enamelled disk bearing in large black letters the word "STOP." Upon the approach of a train this device is displayed by a guard so that it is clearly visible to pedestrians and vehicle drivers and leaves no doubt in their minds as to what is meant. A similar sign has been employed for some time by one of the eastern transportation companies, but in the West and most other parts of the country the idea is

a new one. A further precautionary step has been taken by making crossing watchmen special policemen, uniformed and invested with the authority to make arrests when warnings are



The "Stop" Sign Which is Used Instead of a Red Flag by Crossing Watchmen in Chicago Suburban Towns

deliberately disregarded by careless pedestrians or motorists.

1288 ROCKING-HORSE AND PLAY TABLE COMBINED

A brightly painted wooden rocking-horse that can be converted into a game table is a new toy for the play room. Both the saddle and the rockers can be removed. When the latter are detached the horse stands on four casters. The sides of the horse consist of flat boards hinged at the upper edge; by drawing these sides up like the leaves of a table a small table is formed. That part of the table top which is concealed when the saddle is in place has a checkerboard painted on it. A knapsack and a bridle are part

of the equipment. Between the "sides" of the horse is a convenient shelf which

12.50 to 15.00

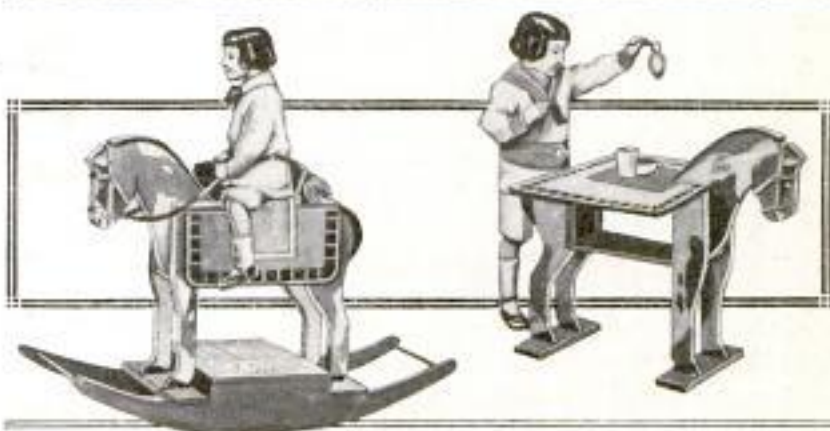

A Substantial Rocking-Horse That can be Transformed Readily into a Play Table

is accessible when these sides are turned up.

P. O. E. Cent. Warehouse Construction
361

**PILES DRIVEN AND PULLED
BY STEAM HAMMER**

By a simple rearrangement of a steam hammer, such as is used in pounding piling into the ground, steel

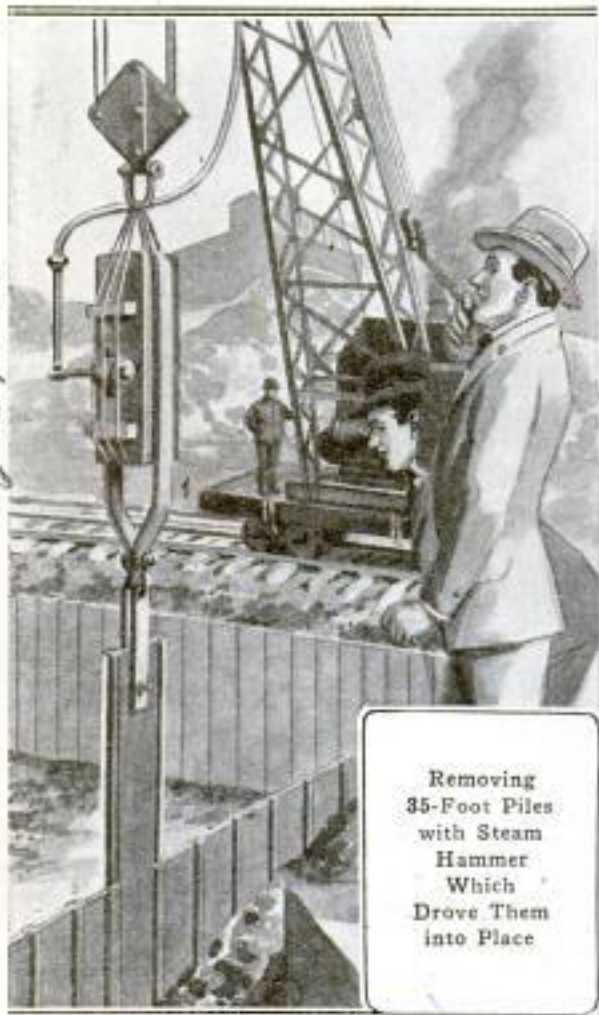

Removing
35-Foot Piles
with Steam
Hammer
Which
Drove Them
into Place

cofferdams had also been back filled before the removal work was commenced. Several carloads of piles were pulled in this manner, and nearly every one of them was in good condition for immediate reuse after the operation.

1598

TO MAKE PARTS OF SHIPS
INTERCHANGEABLE

Engineering 14-76

A New York shipbuilding company proposes to standardize the building of many of its ships, particularly freighters, so that corresponding parts of vessels in the same class will be interchangeable. This, it is claimed, will make possible a saving of 25 per cent in construction and will promote greater speed in building. All parts will be assembled before construction begins. It is estimated that by this method a 6,000-ton freighter can be thrown together in 30 days at the start; later the time may be reduced to 15 days.

1437

**TYPHOON WRECKS CONCRETE
BRIDGE IN PHILIPPINES**

The havoc wrought by a typhoon which recently swept over a portion of the island of Luzon in the Philippines, is illustrated by the destruction of a heavy reinforced-concrete bridge which spanned a small stream near Los Banos. The foundations of the bridge were undermined, the approaches swept away, and the span itself broken in the middle so that the two parts fell forward into the middle of the stream, which for the time being had become a resistless torrent.

cofferdams had also been back filled before the removal work was commenced. Several carloads of piles were pulled in this manner, and nearly every one of them was in good condition for immediate reuse after the operation.

1598

**TO MAKE PARTS OF SHIPS
INTERCHANGEABLE**

Engineering 14-76

A New York shipbuilding company proposes to standardize the building of many of its ships, particularly freighters, so that corresponding parts of vessels in the same class will be interchangeable. This, it is claimed, will make possible a saving of 25 per cent in construction and will promote greater speed in building. All parts will be assembled before construction begins. It is estimated that by this method a 6,000-ton freighter can be thrown together in 30 days at the start; later the time may be reduced to 15 days.

**TYPHOON WRECKS CONCRETE
BRIDGE IN PHILIPPINES**

The havoc wrought by a typhoon which recently swept over a portion of the island of Luzon in the Philippines, is illustrated by the destruction of a heavy reinforced-concrete bridge which spanned a small stream near Los Banos. The foundations of the bridge were undermined, the approaches swept away, and the span itself broken in the middle so that the two parts fell forward into the middle of the stream, which for the time being had become a resistless torrent.



A Reinforced-Concrete Bridge in the Philippines as It Appeared after a Recent Typhoon

Greenville Haslam
Bagois School
Bagois, P. I.

COST OF FILLING SILO CUT BY FODDER HARVESTER

*Royer Ensilage Harvester Co.
214 S. Wichita St.
Wichita, Kansas.*

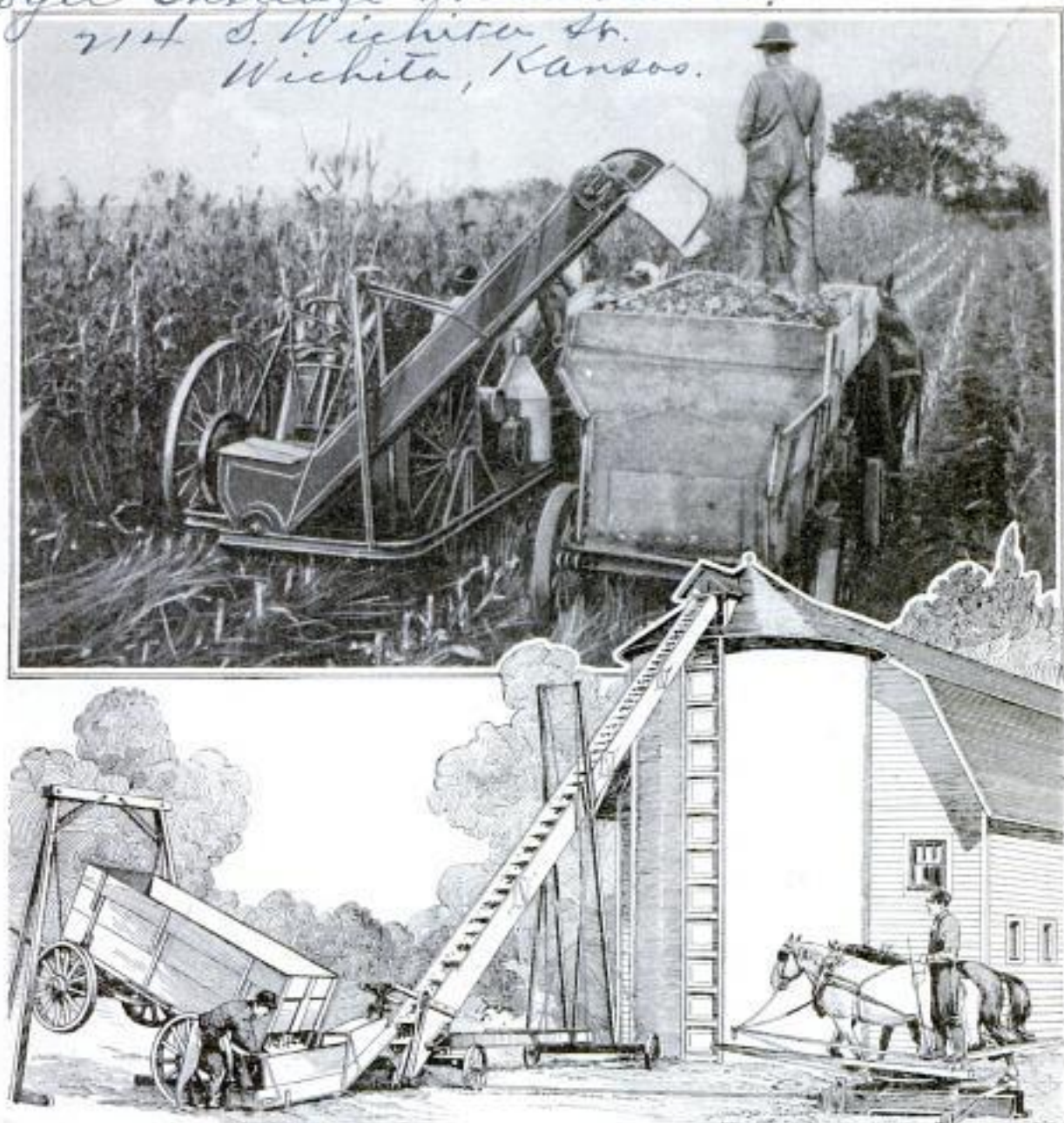

The Harvesting Machine Which Cuts the Fodder, Grinds It into Silage, and Delivers It into a Wagon, and the Conveying Apparatus Employed in Filling a Silo, are Shown in Operation

Both the time and labor usually consumed in cutting fodder, chopping it into silage, and storing it in a silo are materially lessened by a harvester lately developed by a Kansan. The machine cuts the fodder a few inches above the ground, throws it into a grinder operated by a small gasoline motor, and then discharges the fresh silage into a wagon driven alongside. At the silo the contents of the wagon

are dumped into a bin which automatically feeds a conveyor. At no time during this process does the fodder or silage come in contact with the earth. The operation is completed quickly, and the product stored before there is any opportunity for it to dry. It is obvious that better than ordinary results are obtainable in this way. Four men and as many teams are able to harvest from eight to ten acres of fodder and store the resulting silage in a day's time with the outfit.

CAMERA-EXPOSURE SCALE FOR PHOTOGRAPHERS

For the use of amateur and other photographers, a universal exposure table has been arranged in a very convenient form so that the proper timing under various light conditions for different classes of subjects may be de-

making pictures. On one side of the device a small pointer slides in a slot between two lists of cities, states, and latitudes, grouped in paragraphs under the headings of summer and winter. The indicator is moved to the middle of the paragraph containing the name of the point nearest the user. Immediately below this table is another,

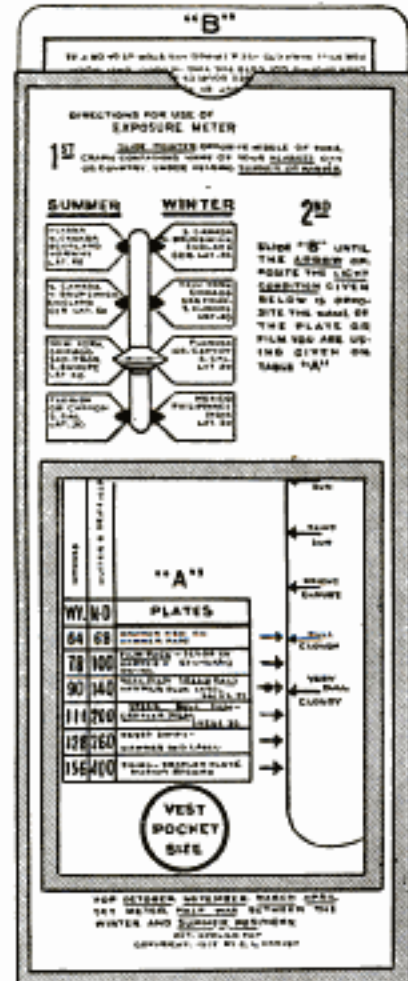

which presents the names of various kinds of plates and films. To the right a slot makes visible a narrow margin on the reverse side of the exposure card upon which is listed the various light conditions. By sliding this one way or another until an arrow adjacent to "faint sun," for instance, points to "roll film," the device is adjusted. Then, by turning it over to its reverse side, a very complete chart is given which shows instantly the proper time to use with any stop and any subject. With the meter set for Alaska, summer, bright sun, and roll film, one may readily determine that to take a picture of a snow scene and use a 16 stop, a 1/10-second exposure should be made. By drawing the

adv. Feby 16-156

The Device Gives the Time Necessary for All Classes of Subjects with Any Stop Desired, Enabling a Beginner to Make Good Photographs

terminated quickly and accurately. It is made in vest-pocket size and consists of a sliding scale, fitted within a transparent celluloid case, which takes into consideration nearly all possible conditions of light, various latitudes, different plates, and films and stops. It obviates the necessity of making mathematical calculations, and if properly used, would undoubtedly eliminate a large percentage of the failures experienced by the beginner, while being of almost equal service to those who are prone to exercise care when

sliding chart out, tables covering night pictures of various kinds, shutter speed to stop motion, and daylight interiors, are given.

1487

COMPRESSED AIR NOW USED TO CLEAN MACHINERY

The cleaning of electric motors, generators, and other machinery with compressed air has been found by many manufacturing concerns to be the most thorough and practical method of keeping such equipment in working

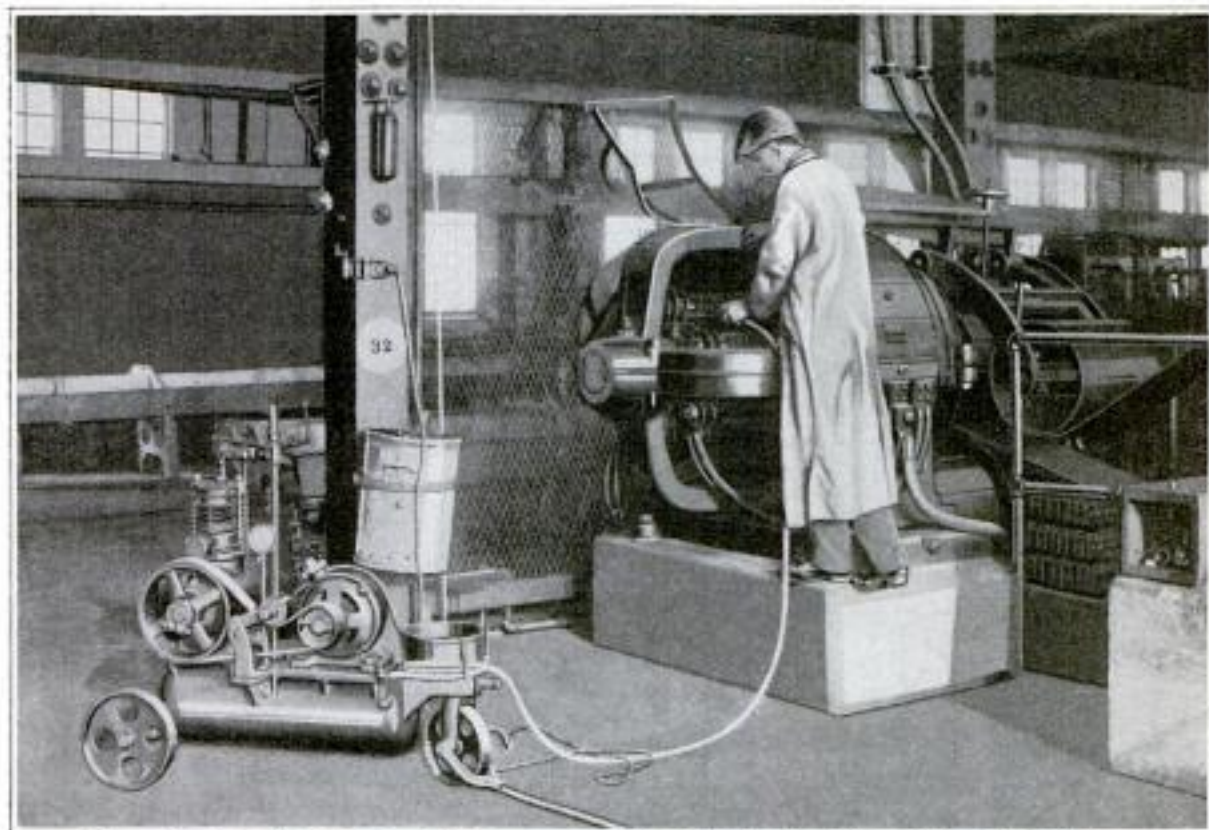

A Portable Electrically Driven Air Compressor being Employed to Clean Electrical Machinery

order. Despite all precautions, machinery or motors in sawmills, textile mills, flour mills, etc., will accumulate dust. This may settle on brushes and commutators, for example, in sufficient amount to cause serious trouble. Neither vacuum cleaners nor brushes are practical for cleaning the uneven and hidden surfaces. As a substitute for simple hand cleaning, compressed air is used. It may be supplied through pipes from a centrally located tank, or by a portable, electrically driven compressor which can be connected with any light socket. Such a machine is equipped with a long hose, at the end of which is a small nozzle having an opening of $\frac{1}{16}$ to $\frac{1}{8}$ of an inch in diameter. A pressure of from 10 to 60 pounds may be secured. A spring valve operated by the thumb keeps the air jet shut off except when needed. This machine is mounted on three small wheels and can be drawn about easily.

ⒸThe Navy Department is listing all of its men who have a knowledge of some foreign language so that it can use them as interpreters, etc., if needed.

**SIMPLE AND INEXPENSIVE
 CHECK PROTECTOR 11/04**

Compactness and simplicity are two of the outstanding features of a pocket-size check protector lately invented by a Californian. The device consists of a short holder which mounts a pair of rollers at one end. The largest of these is an embossing cylinder and is supplied with ink by a second member which is fitted above it. The paper is both pricked and inked as the roller is moved over it. This makes it impossible for a check to be raised without attracting immediate attention.

ET NEW.
 The E. M. W. Safety Check Protector



The Check Protector Is Small Enough to be Carried in One's Pocket Conveniently

Invo. Carl H. Epple.
Oakland Calif.
1217
(Stewart & Co.)

Safety First Check Protector
1134 E. 12th St.
Oakland, Calif.
Orstedtor Co
P. O. Box 643

Copyright Material

TWO LOCOMOTIVES COLLIDE NEAR CENTER OF BRIDGE

Though railway collisions are still rather common despite increased safety



Two Engines as They Appeared Immediately After They had Collided near the Center of a Small Bridge: The Freight Train was Backing onto a Siding to Make Way for the Other, a Fast Milk Train

an accident occurred recently on a small bridge near Janesville, Wis. While a freight was slowly backing onto a siding to allow a fast milk train to pass, the latter came unexpectedly around a bend. The milk-train engine crashed into the freight engine near the center of the bridge at that point, but the impact did not hurl either from the track. The engine crews escaped by jumping from their cabs. The first freight car was shattered and forced up on end; the front end of the car behind it was propped up in the air about 10 feet. The cab of the milk-train engine was dislodged, and both tenders were damaged. The wreckage blocked the track for some time.

provisions, a head-on collision on a bridge is rare and spectacular. Such

"PARIS HATS" FASHIONED ENTIRELY IN CANDY

Dainty, stylish millinery creations which so far as attractiveness is con-



Tastefully Trimmed Hat of Pleasing Shape Made Entirely of Candy. It was Recently Shown in a Confectionery Exhibit at One of the New York Hotels

New York hostelrys. In all, three hats were shown, each so artfully fashioned that it was hard to believe that it was composed principally of sugar. One of these was made of overlapping folds of glistening, strawlike ribbon. The brim turned up at the front and was trimmed with a candy dahlia, delicately colored and set off by green, velvety leaves. A broad band circled the flower-decked crown and ended in a bow at the back. Another hat was pale green in color and trimmed with pink-hued roses and soft, satiny ribbons. The third was rose-colored and adorned with foxgloves and lilies.

HILLS OF ICE FORMED ON SHORES OF LAKE ERIE

A phenomenon which often excites much interest in winter is the piling up of great ice hills along the shores of large bodies of water. These sometimes extend a considerable distance out from the land. On certain portions of Lake Erie's shore ice masses

cerned might have satisfied the demands of almost any modish feminine dresser, were recently displayed in a confectionery exhibit at one of the

Martha Washington Hotel Co.,

New York

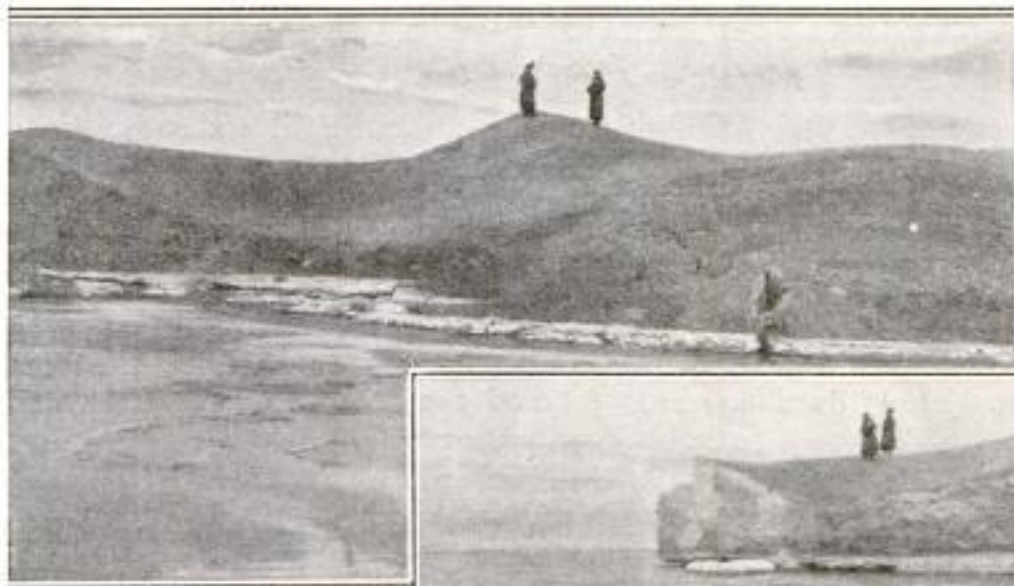

Great Hills of Ice, Some of Them 60 Feet High, Formed by the Wind and Waves on the Shore of Lake Erie



of this character have been built to a height of 60 ft. In some instances these hills have had their beginnings in large cakes of ice that have become anchored in shallow water, against and over which other blocks have been hurled. The mass slowly solidifies of its own weight. With the approach of spring portions of these hills break off and float away.

1421 Oil

SUBMARINE PIPE LINES FOR LOADING TANK STEAMERS

JNL Transfer Institute Jan

A number of oil companies in Mexico, which ship much of their product by tank steamers, have overcome difficulties due to comparatively shallow water along the coast where the oil is stored by laying pipe lines on the bed of the ocean to such a distance from shore that tankers can anchor and, by using these pipes, load without difficulty. One of these lines, which is typical of the others, terminates in 43 ft. of water, which is below wave action. At the end of the pipe is attached 120 ft. of armored flexible hose, the free end of which is closed and lies on the sea bottom when not in use. Its position is marked by a buoy with which it is connected by a chain strong enough to raise it to the surface. In this depth the largest tank steamers can load at any time, and the dredging of deep channels to the shore is avoided.

ELECTRIC FAN CONSTRUCTED WITH ADJUSTABLE VANES *1343*

Adjustable blades, which permit the volume of the breeze given off by an electric fan to be regulated mechanically instead of by the means of rheostats, are a new feature of an apparatus of the ceiling type. A rod extending from the base of the fixture terminates in a pear-shaped handle with which the vanes may be turned to various angles so as to meet different demands. This presents a simple as well as adequate way of making such regulations. Heretofore the blades have been constructed without any convenient ar-

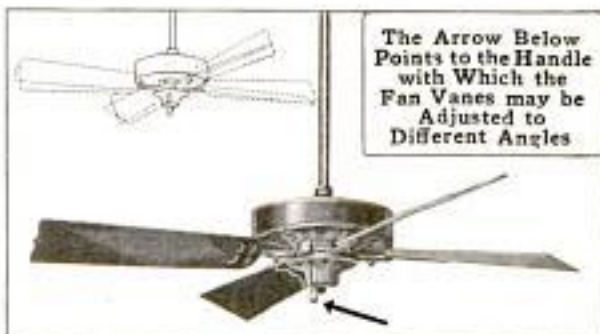

The Arrow Below Points to the Handle with Which the Fan Vanes may be Adjusted to Different Angles

angement being given for changing their pitch. The new attachment does not make any noticeable difference in the appearance of the fixture. The adjusting rod locks the blades firmly and prevents them from working loose.

*Western Electric Co.
500 S. Clinton City
463 West St., New York*

BUNGALOW COURTS OF MANY VARIETIES AND STYLES

The bungalow court, or "community court," is one of the practical and attractive solutions of the dwelling-house problem which continues to gain favor in cities and suburbs of the western coast. Under this plan residence lots of 50-ft. frontage, or more, are improved with from two to 16 bungalows, set facing a courtyard which opens onto the street. These dwellings are

preferred to apartments, for they afford more room and light and more easily take on the aspect of homes. They are generally rented furnished. Those of the better quality cost \$2,500 to build, while others cost as little as \$700, or even less.

The number of dwellings about a court depends on the depth of the lot and the amount of space devoted

*Albert Mayole 322 Boynton St. Tropic
Colif.*



At the Left Is a Two-Dwelling Court Occupying a Corner Lot and Approached by Concrete Steps. A Retaining Wall Makes Possible a Level Lawn and Flower Beds between the Two Bungalows



Above, Right: A View of a Court upon Which Face Bungalows Costing about \$2,500 Each. These Dwellings Are of Solid-Wall Concrete and are Fitted with Every Modern Convenience. The Other Half of This Court is Shown on the Opposite Page. Below: A Court with 16 Bungalows, No Two of Which Are Alike. Along the Center of the Eight-Foot Cement Walk Are Flower Beds and a Series of Artistic Electric Lighters

to the central courtyard, which may or may not include a drive. Frequently this court is laid out with great skill and may contain a fountain and shade trees. Almost every known variety of building material is used in these structures, including concrete, cobblestones, stucco, brick, shingles, weatherboards, etc. The number of rooms varies from four to six or eight. Sometimes 12 or 16 bungalows are built about a court, no two of which are alike as to style

or plan. One such court in Pasadena contains structures suggesting the architectures of Japan, India, Italy, Switzerland, the mission style, and other and more modern variations.

⊕ Despite submarine perils, approximately 400,000 passengers crossed the Atlantic last year; of these, 250,000 traveled on vessels owned by belligerents.



Facing the Cement Walk, Which Extends the Length of This Narrow Court, Shown in the Oval at the Right, Are Frame Bungalows Costing About \$700 Each



A Court Occupying a Lot 102 by 277 Feet: Here Are 11 Bungalows Designed in as Many Different Styles of Architecture, Including Japanese, Italian, Swiss, and Mission. These Dwellings, Furnished, Represent an Investment of \$20,000, Exclusive of the Land. Common Courts Such as This One Afford an Opportunity for Pleasing Landscape Treatment. These Grounds Generally are Cared For by the Landlord

Dr. E. E. Webster,
219 So. Duross, Chgo.

**DEVICE OPERATES CAMERA
AUTOMATICALLY**

One of the simplest and most compact devices so far designed for automatically actuating the shutter of a camera and enabling an operator to include himself in a picture, is being introduced. Its size makes it especially attractive, for it is only 3 1/2 in. long and no greater in diameter than a fountain pen. In principle it is somewhat similar to a pneumatic door closer. It is arranged at one



end to be attached to a cable release, while a spring within it, the action of which is retarded by compressed air, operates a piston that strikes the plunger normally pressed with one's thumb. By adjusting a valve, provided at the lower end of the piston, the action of the instrument may be regulated to suit the user.

114 51

**RACK DISINFECTS PENCILS
FOR SCHOOL CHILDREN**

Lead pencils are germ carriers which may transmit disease, especially to children, most of whom have the habit of putting pencils in their mouths. A New Jersey inventor has devised a disinfecting rack to guard against



this danger. This rack consists of a square metal frame, or case, about three inches deep. In its top are small holes through which pencils may be

E. S. Mathis
131 West End W.
Haddonfield, N. J.

inserted. Beneath the top is a tablet of clay composition in which are depressions corresponding to the holes above. Into these the pencil ends project, without touching the clay, and are disinfected by formalin gas exuding from the clay, which has been previously charged with that disinfectant. The pencil of each child may be assigned a certain place in the rack.

1130

**MINIATURE LUNCH COUNTER
HAS TWO-FOOT FRONTAGE**

What is undoubtedly one of the narrowest business houses in the



country is a lunch counter in Harrisburg, Ill., having a frontage of just 24 in. This miniature eating establishment is located between two ordinary-sized business blocks which for some reason were not set close together. The intervening space has

been inclosed and equipped as a lunch counter. The narrow space is 54 ft. long. A neat awning and two large electric globes adorn the front. Beneath the awning is a counter at which one can purchase coffee, sandwiches, and other staple foods. Beside the counter a small show case displays appetizing dishes.

Can artificial silk fiber, which it is claimed rivals real silk, is now made by use of chrysalis oil and mulberry cellulose dissolved in a proper solvent, which liquid is forced through minute holes.

"Wait-a-Minute"

Prof. V. W. Harrison

Ed. Sawyer
Comm. Dept.
2/25/16

X-RAY EQUIPMENT NOW USED IN VETERINARY HOSPITAL



Above: A Horse Strapped to an Operating Table with a Veterinarian's X-Ray Apparatus Adjusted above Its Head

Right: The Horse in a Sling Standing beside the Tilted Top of the Operating Table, Which Is about to be Righted

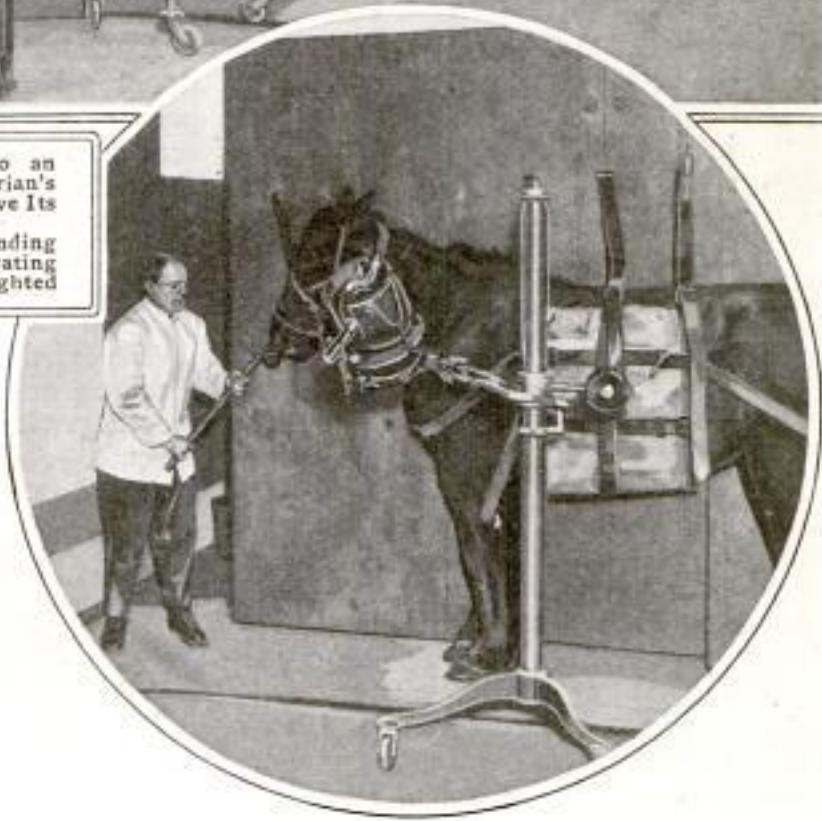

What is believed to be one of the first instances in which X-ray equipment has been permanently installed for use in a veterinary hospital is that of an institution in New York City, the director of which, aided by electricians, has devised equipment and altered ordinary apparatus so as to make X-ray examinations of animals, large and small. Here dogs, cows, horses, cats, birds, and even monkeys have been brought during the past year. For horses and cows the veterinarian employs a large table with a tilting top operated by an electric motor. The animal to be examined is stood alongside the table, with the top tilted on edge, and is put in a sling and shackled. The top is then turned to a horizontal position, carrying the beast with it. By means of pulleys, wires,

and an adjustable standard the X-ray tube can be easily swung to any desired point over the animal's body.

PRIMITIVE LOOMS ARE USED BY AYMARA INDIANS 1327

Heavy woolen ponchos, or capes, are woven on the most primitive kind of looms by the Aymara Indians in the cold, barren puna region of the Bolivian Andes. These are usually made

Dr. L. Griesman's
Yonville Vet. Hosp. & X-Ray Lab.
1896 1st Av. New York

Robert H. Beemer
Dept of Zoology

718

POPULAR MECHANICS

Field Museum, Chicago

in bright colors and are worn for protection against the cutting winds which sweep through the valleys and across the table-lands from the snow-

1337



Typical Aymara Indian Weaving a Poncho on a Primitive Loom in Bolivia

covered mountains. It is not uncommon to see both men and women working at looms, almost the same as doubtless were used by their ancestors several centuries ago. The crude contrivances are frequently constructed in the open air at one side of a hut or wall. The garments are commonly made of wool taken from the llama, an animal which is used as a beast of burden, or the alpaca.

1486

NEBRASKA SAND NOW MADE INTO GLASS IN AMERICA

One result of the present war is that "quartz glass," largely used in laboratory equipment, which was formerly made chiefly in Germany, by processes controlled by the Germans, is now being manufactured in this country. What is pronounced by some to be

the finest quartz sand, or silica sand, that is available for commercial use is found in Nebraska and, rather strangely, it is this sand which Germany used in large quantities and later exported to this country in the form of silica ware, despite a high duty. Test tubes, retorts, and many other pieces of scientific apparatus, are made of this sand and are acid-proof and heat-resisting. Quartz sand, of course, is found in many parts of the world, but that mined in Nebraska is 99.8 per cent silica, which makes it superior for manufacturing purposes.

NOVEL CAR MADE CHIEFLY FROM OLD BICYCLES 937

A Colorado dealer has devised a novel self-propelling vehicle by supporting a body, which includes a 3-ft. seat and parts of bicycle frames, on three bicycle wheels. The two rear wheels are 4 ft. apart and between these a motor wheel is attached, which is able to drive the vehicle at a speed of about seven miles per hour, on the level. The front wheel is fastened to a frame of a woman's bicycle, and a steering wheel is used instead of handlebars. A hand lever is connected by a chain to a coaster brake on one of the

E. F. Sherrin,
La Junta, Colo.



This Vehicle is Constructed Chiefly from Parts of Old Bicycles and will Carry Two Passengers at the Rate of Seven Miles per Hour on Level Roads

rear wheels. The seat is furnished with cushions from a motorcycle. The cost of running this vehicle is small.

Henry Naumann, Inc.,
Dept. S I S I O
17 Madison Av., New York

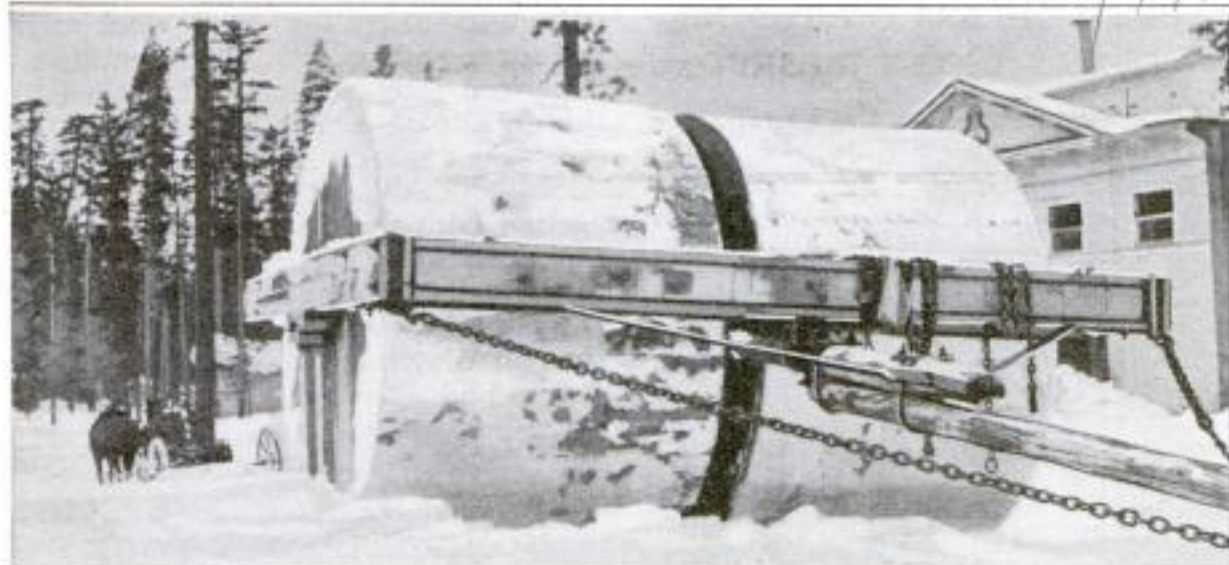

COPYRIGHT, A. ANDERSON

ROLLER USED IN FOREST INSTEAD OF SNOWPLOW

THE problem of breaking a roadway through the snow-carpeted forests to or from lumbering camps has been solved by a western lumber company by the use of a giant snow roller. It has been found that it is preferable to snow shovels or snowplows. The twin cylinders used are so heavy and of such large diameter that they are able to break through almost any snowdrift. A team of 16 horses is required to haul this roller. After it has passed over a road the snow is packed so hard and smooth that sled runners can quickly make the icy tracks which are so desirable for hauling heavy loads of logs.

987

FLEXIBLE COUPLINGS STOP STRAIN ON POWER SHAFTS

Shafting on which pulleys and similar apparatus are mounted in factories comes in comparatively short lengths and is often more or less crooked due to inevitable mishaps in handling. Even though the bends may be so small as to be invisible to the unaided eye, they interfere seriously with the smooth running of the shafts when in use. To obviate this difficulty a new form of flexible coupling has recently been devised. It consists of two cast-iron spiders mounted on the abutting ends of two shafts. Between the interlocking arms of the spiders rubber cylinders are placed, these taking up any unevenness in the

long rods as they revolve. Thus the heating up of bearings and general vibration is eliminated. The coupling

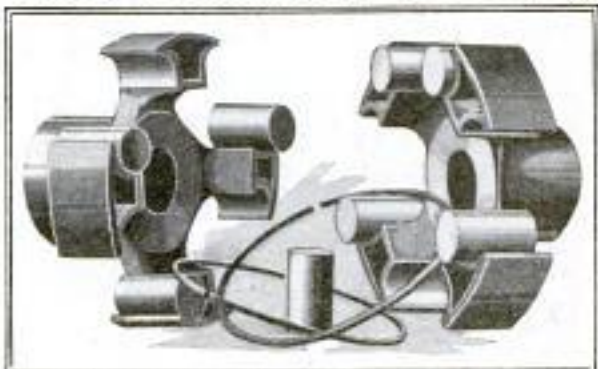

A Flexible Coupling Which Relieves Strain on Shafting: The Rubber Cylinders are Inserted between the Members to Lessen the Play and Vibration

finds particular application in the joining of armature shafts of electric generators with those of the driving engines.

R. D. Nuttall Co. Pittsburgh, Pa.

E.O. Catford
Platte Rouge, Guernsey, Eng.

720 897 POPULAR MECHANICS

Parry

POST LETTERS ON TRAINS OPERATING IN JERSEY

Jersey, Channel Island, Trains

In order to facilitate the handling of the mails in Jersey, the largest of the Channel Islands, mail drops are pro-



Mailing a Letter on a Train in Jersey: This Practice Gives the Island Quick Postal Service. Collections are Made at a Terminal Where Letters are Sorted and Distributed

vided in certain of the cars on every train running over the insular railway systems. Collections are made from these boxes at a terminal station, and the mail is subsequently sorted and distributed. Although the island has an area of only 45 square miles, it has a large number of towns and villages in addition to the city of St. Helier. By following the practice of posting letters on the trains, people living in the various parishes are afforded good service.

extraction of grease from wool suds and for rag stripping. The attention of American interests has been called to this by the government on account of the great quantity of the material produced here during the last year in connection with the manufacture of nitric acid. About 30 per cent of the weight of the cake is sulphuric acid. Apparently the best method of using it consists in dissolving it with the aid of steam and employing it in solution while hot.

— 1259

CONVENIENT INDEX SYSTEM FOR TELEPHONE BOOK

Patent rights have been granted to a California inventor who has devised an index system for bulky telephone directories. The index is so made that it may be removed quickly from an old book and inserted without difficulty in a new issue by the user. It consists of 26 sheets of heavy paper, to each of which is attached in the proper position a lettered thumb tab. A special binding for the volume carries rings at the top and bottom which hold the index sheets the same as does a loose-leaf book. While it is of obvious con-



Convenient Index System for Telephone Directories, Arranged so That It may be Transferred to New Volumes as They are Issued

venience for the telephone subscriber, it also offers space for 52 pages of advertising matter.

NITER CAKE IS SUBSTITUTE FOR SULPHURIC ACID

Encouraging results have attended the experiments made of late in England with niter cake as a substitute for sulphuric acid. It has been used on a broad scale in a number of Yorkshire mills in different ways, such as for the

Commerce Reports
2/3/16

*Inv: E. J. Mills,
2929 Clement St.,
San Francisco.*

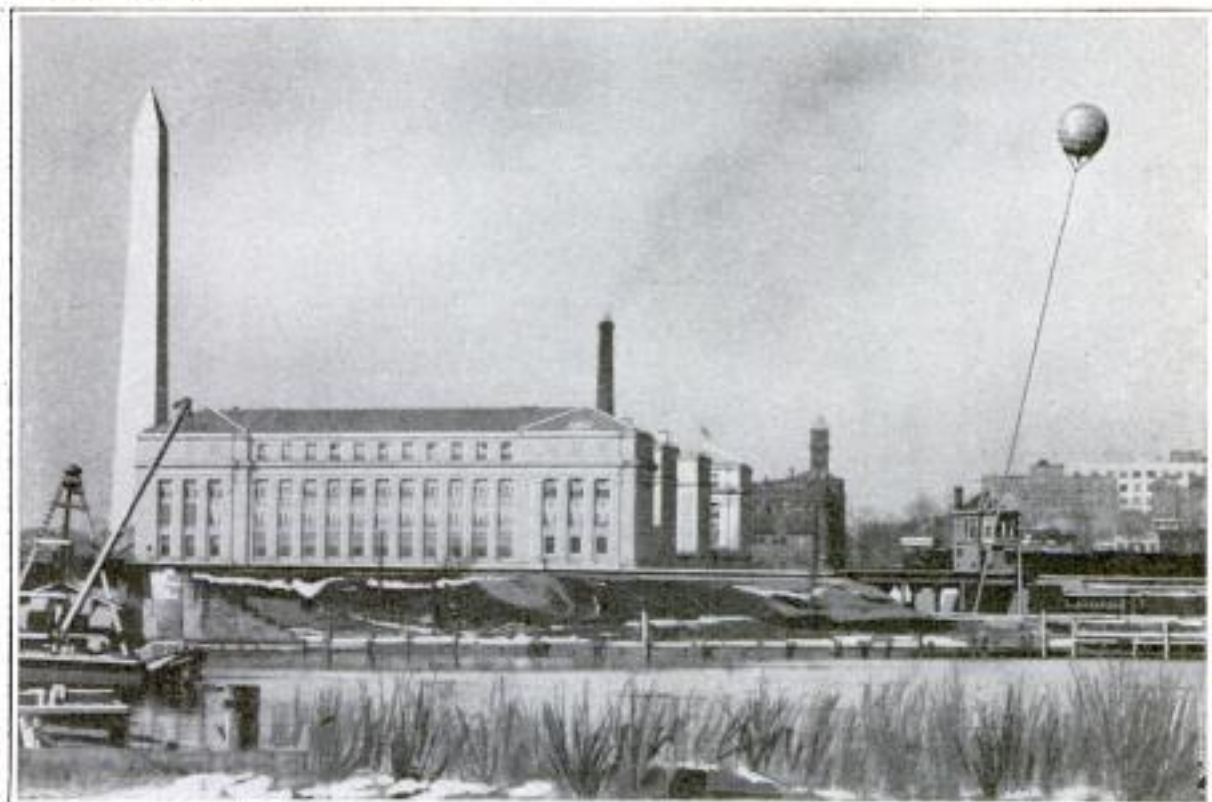

The Question of How Much the Landscape would be Marred by Four Proposed Smokestacks in Washington, D. C., was Studied Recently by Allowing This Captive Balloon to Ascend over the Site to the Height of the Proposed Stacks

BALLOON USED TO SELECT SITE FOR CHIMNEYS

A captive balloon was recently sent up in the city of Washington to a height of 170 ft. for the purpose of ascertaining whether or not four proposed smokestacks of that height would mar the view of the landscape from the White House, the Capitol, the Lincoln Memorial, and other public buildings. The stacks were to be a part of a central heating plant designed to serve several public edifices. The National Fine Arts Commission, and other bodies, opposed the location of the plant on the ground that the stacks, particularly, would be offensive to the eye. By placing the balloon over the site at the height of the proposed chimneys it was possible to ascertain to just what extent they would appear in various vistas.

ⒸThe printing of Japanese school-books in Roman letters has begun in Honolulu. Japanese there predict that in 50 years Japan herself will be using the Roman characters exclusively.

TINY GARAGE AND CAR ARE FEATURES OF NOVEL TOY

A novelty, which is proving popular because it requires skill and patience to operate, consists of a circular metal box, 2 in. in diameter and $\frac{1}{2}$ in. high, covered with a glass top. In the box is a miniature automobile which moves about with the slightest tilting of the toy. At one side of the circular inclosure is a miniature garage. Amusement is furnished by attempting to get the automobile into the garage.

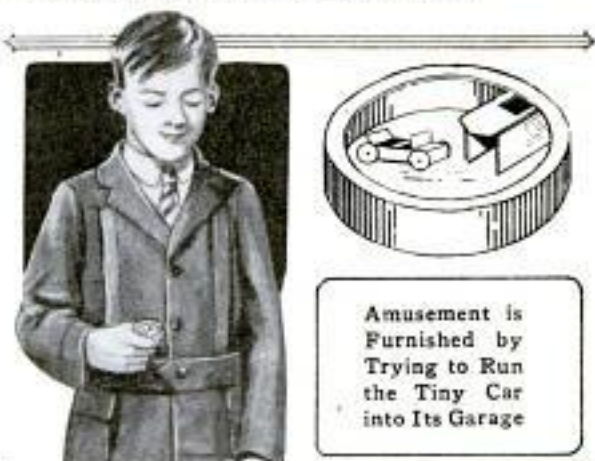

Amusement is
Furnished by
Trying to Run
the Tiny Car
into Its Garage

Geo L. Allen & Bros.
Box 907 Bflo, N. Y.
28 Bremer St

Inw: J. G. Xander,
Reading, Pa.

**TEST INDICATOR DESIGNED
1340 FOR MACHINISTS**

For the use of machinists an indicating device has been invented which



When the Point of the Needle Comes in Contact with a Raised or Irregular Place on a Piece of Work a Connection is Made and the Tiny Lamp Ignited

relieves all strain on the eyes when one is truing up work. It permits

an operator to proceed considerably faster than when he is depending chiefly upon his vision to detect slight irregularities, and it also insures accuracy. It may be employed with a surface gauge on almost any machine or lathe. In part it consists of a small cylinder on the top side of which a long, curved needle is held in an adjustable mounting. In the front end of the tube is a tiny electric lamp, back of which is a battery. When the point of the needle in moving above a surface touches a raised place a contact is made and the bulb lighted. The flash indicates the position of the irregularity so that the work can be shifted accordingly and the defect corrected immediately.

**HEAVY MILL HEADS SHIPPED
802 BY FAST EXPRESS**

In order to prevent a partial tie-up of an Arizona copper plant, three

crushed in a mill, similar to a tumbler, made up of a pair of these heads bolted together and supported at either end on trunnions.

When it came time to load the heavy castings for shipment it was found that they were too large to pass through the doors of an express car. It was finally necessary to cut out one end of a car, remove the sheathing to a height of about 18 in. on both sides, chisel away $\frac{1}{2}$ in. of the uprights, and take out the lighting and heating fixtures before the castings could be set in place. Even

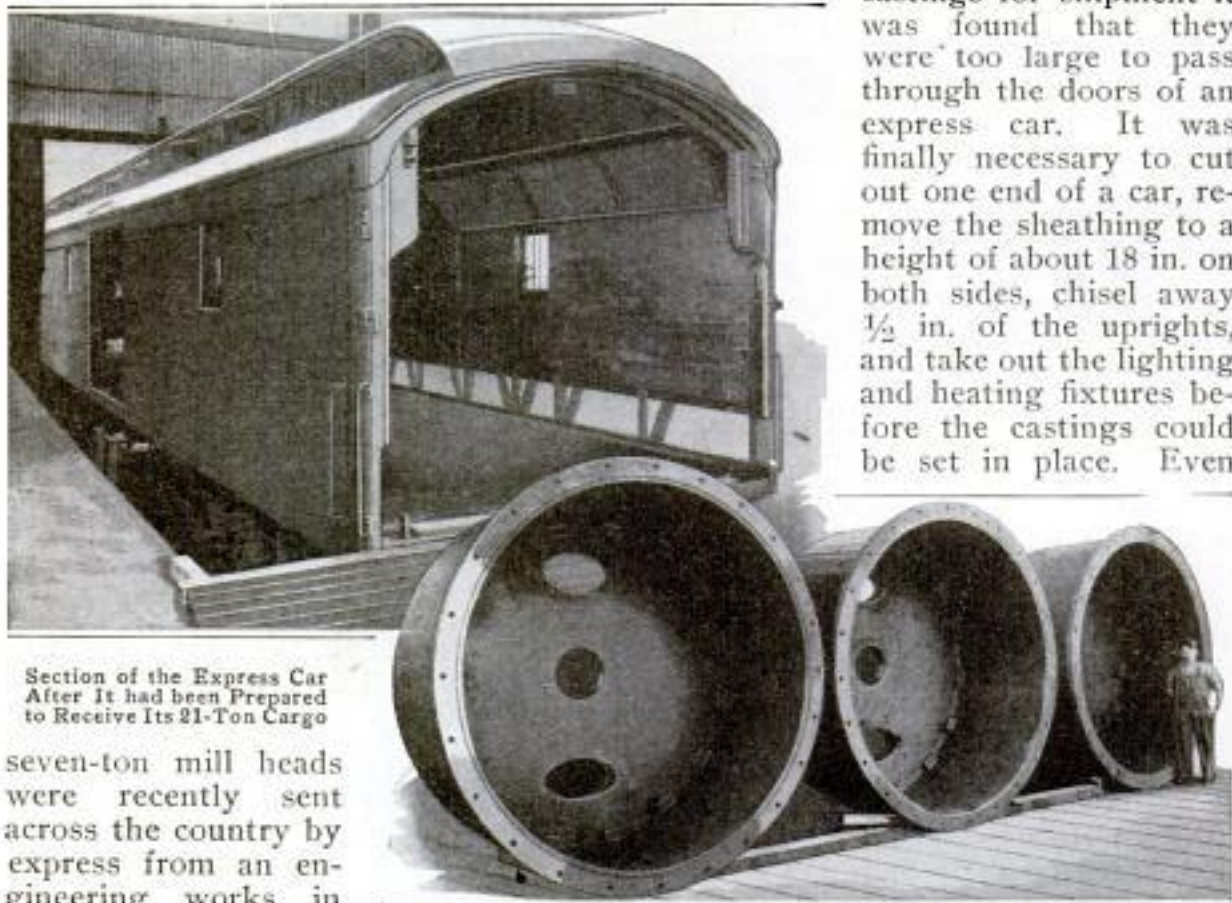

Section of the Express Car After It had been Prepared to Receive Its 21-Ton Cargo

seven-ton mill heads were recently sent across the country by express from an engineering works in Pennsylvania. Ore is

The Three Mill Heads Ready for Shipment to Arizona

Treadwell Engineering Co.
Easton, Pa.

M. Margot,

Geneva,

Switz.

then it was a close fit, for the mill heads were wider at the base than the car floor. The loading was done with the assistance of cranes, and the castings were moved on rollers to their respective places, where they were securely bolted to the floor to prevent them from breaking loose during the journey.

1347 —

MERCURY PURIFIED BY SIMPLE PROCESS

Sc. Am. Supplement 1/20/16

A European chemist has perfected an old process for the purpose of purifying mercury. It promises to be preferable to the methods more commonly employed. Mercury used in laboratories gradually becomes contaminated with dirt, zinc, copper, lead, etc. It can be purified by a series of distillations or by treatment with nitric acid, both of which processes require much time. The newly perfected process consists in passing through heated mercury a current of air which oxidizes the metals held in solution. For this purpose an iron tube, about 5 ft. long and 1 in. in diameter, is placed on two supports in a slightly inclined position. At the two extremities of the tube two tubular necks are attached, one serving to admit air and the other mercury. A Bunsen burner provides heat from 150° to 160° C. With this apparatus about 22 lb. of mercury can be purified in 24 hours.

— 1468

SHIP STABILIZER'S ACTION DEMONSTRATED CLEARLY

One of the interesting exhibits at a recent motorboat show in the East was that of a well-known gyroscopic ship stabilizer. The apparatus itself has been described previously in this magazine and is being employed on naval and other vessels to enable them to ride smoothly at all times. To display the instrument to advantage, a wooden device resembling a section of a cruiser's hull was mounted in a frame so that it could be rocked from one side to the other by a motor. The stabilizer was set on the deck without

being secured by bolts or clamps. When the gyroscope was started, the hull immediately stopped rocking, the

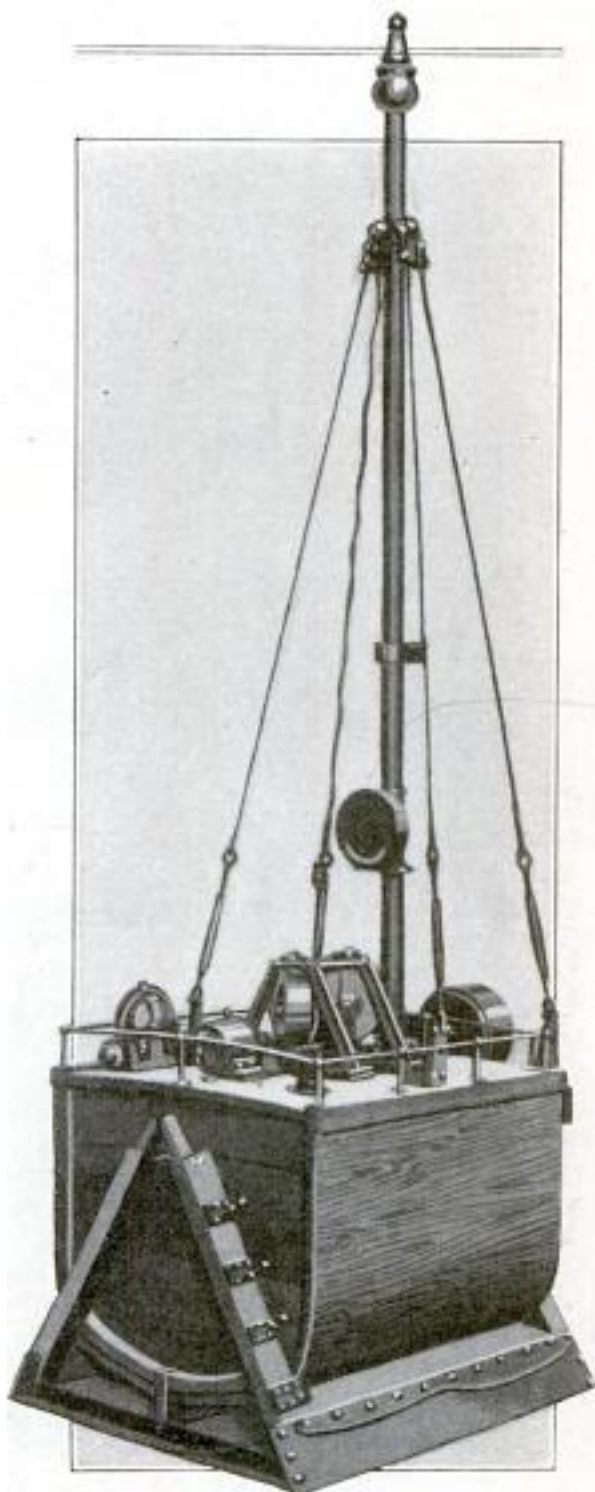

The Gyroscopic Stabilizer was Set on the Deck and When Brought into Use Stopped the Rocking Movement Given the Hull by a Motor

effect of the former offsetting that of the opposing mechanism and thus graphically illustrating the power of the apparatus.

Sperry Gyroscope & Stabilizer Co.
126 Nassau St
Brooklyn N.Y.

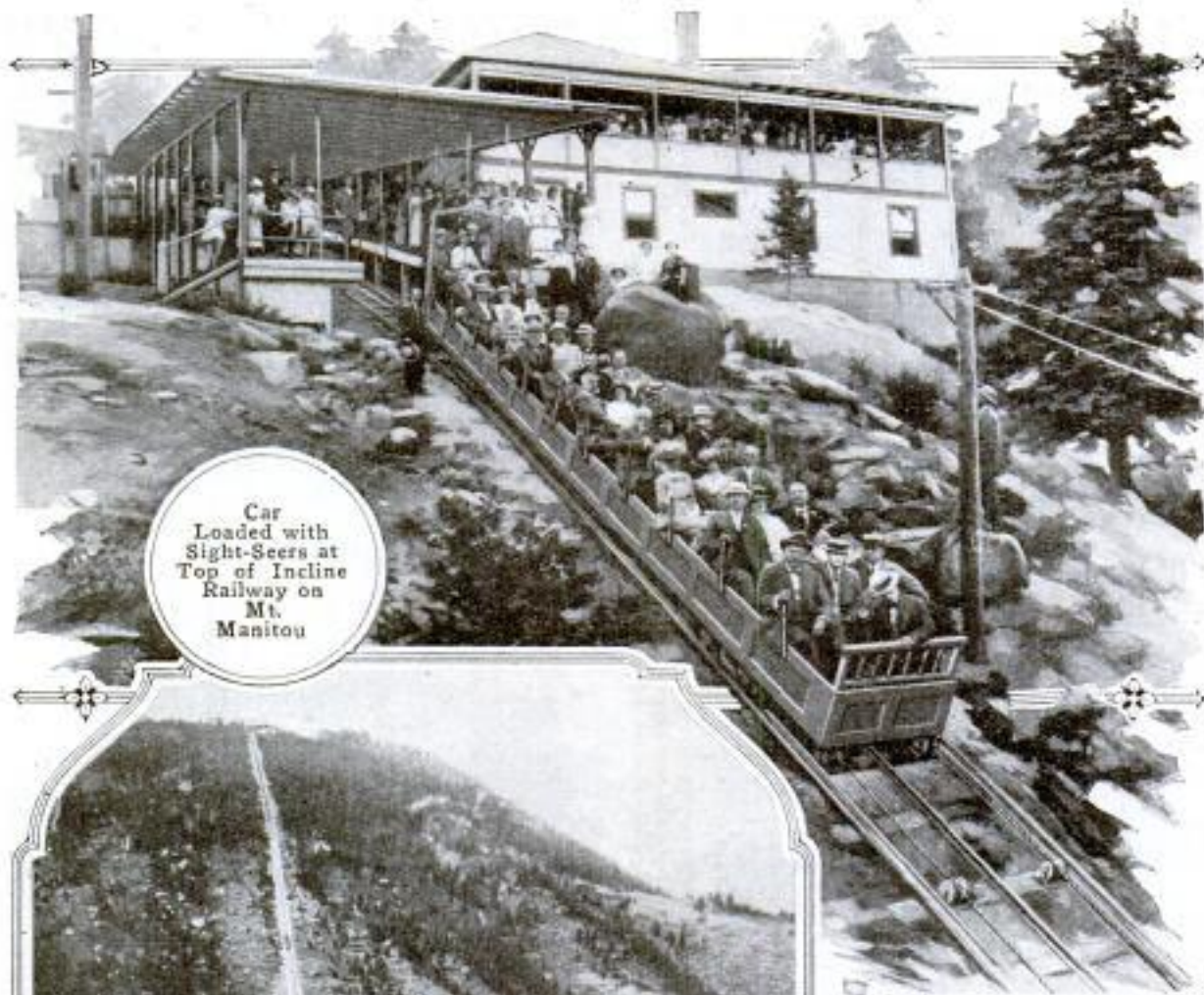

Car
Loaded with
Sight-Seeers at
Top of Incline
Railway on
Mt.
Manitou

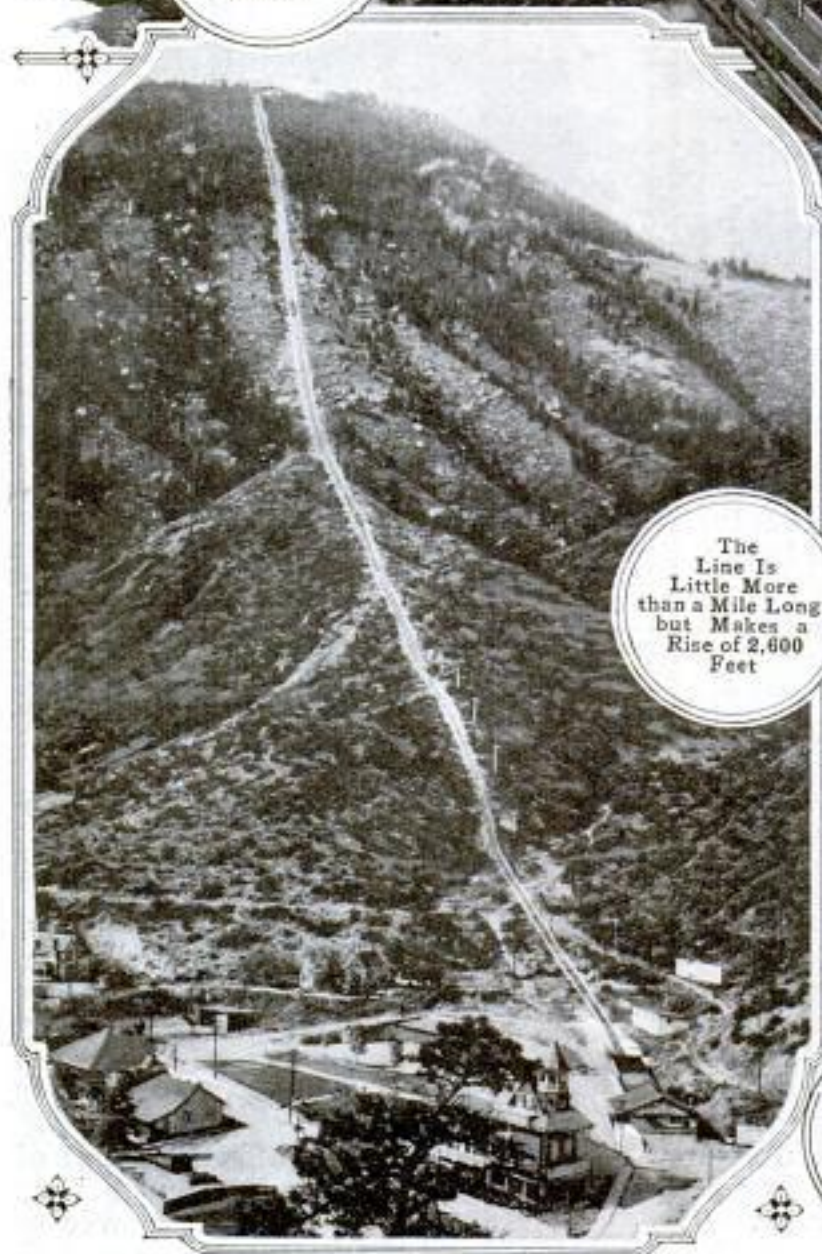

The
Line Is
Little More
than a Mile Long
but Makes a
Rise of 2,600
Feet



Section
of Three-
Rail Track:
Safety Cables
Are Imme-
diately Inside
the Outer
Rails

N. L. Drew, The Mgr.
Pike Peak Auto Highway Co.
Colo. Springs, Colo.

1439 **STEEP COLORADO MOUNTAIN HAS INCLINE RAILWAY**

MANY INVENTIONS SENT TO NAVAL BOARD 1547

An incline railway which scales Mt. Manitou in Colorado has a maximum grade of 68 per cent, and makes a rise of 2,600 ft. in a distance of 1 1/4 miles. It operates two cars, one at either end of a heavy steel cable which is wound about two 7-ft. sheaves at the upper terminal. As one of the cars, each of which has a capacity of 33 passengers, descends, the other ascends. A three-rail track extends up the mountain and merges into a four-rail double track at a halfway point where the two cars pass each other. In most technical respects the system is the same as others of its general type. Auxiliary cables pass through safety clutches beneath the cars to insure against accidents. Hydroelectric power is used in driving the machinery, and is developed at the foot of the mountain with water led down through a 22-in. main from Seven Lakes on Pike's Peak, which is adjacent. The railway has been in operation for a number of years and last season handled more than 40,000 passengers. From the top of the line the plains of Kansas are visible on a clear day.

Since the creation of the Naval Consulting Board, with Thomas A. Edison as its head, that advisory body has received in seven months no less than 5,000 inventions and suggestions, an invitation having been extended to the public to submit ideas. These have come from persons of every class, including lawyers, ministers, miners, farmers, etc., as well as experienced navy men. The board has attracted attention outside the country, and letters have been received from inventors in more than 25 foreign lands. Protection against torpedoes and means for rescuing submarine crews are the problems receiving the most attention of these inventors. All communications for this board should be addressed to the Navy Department, Washington.

A
Magnificent
View of Mountain
and Plain Country
may be Had from
This Lookout
at the Top of
the Incline

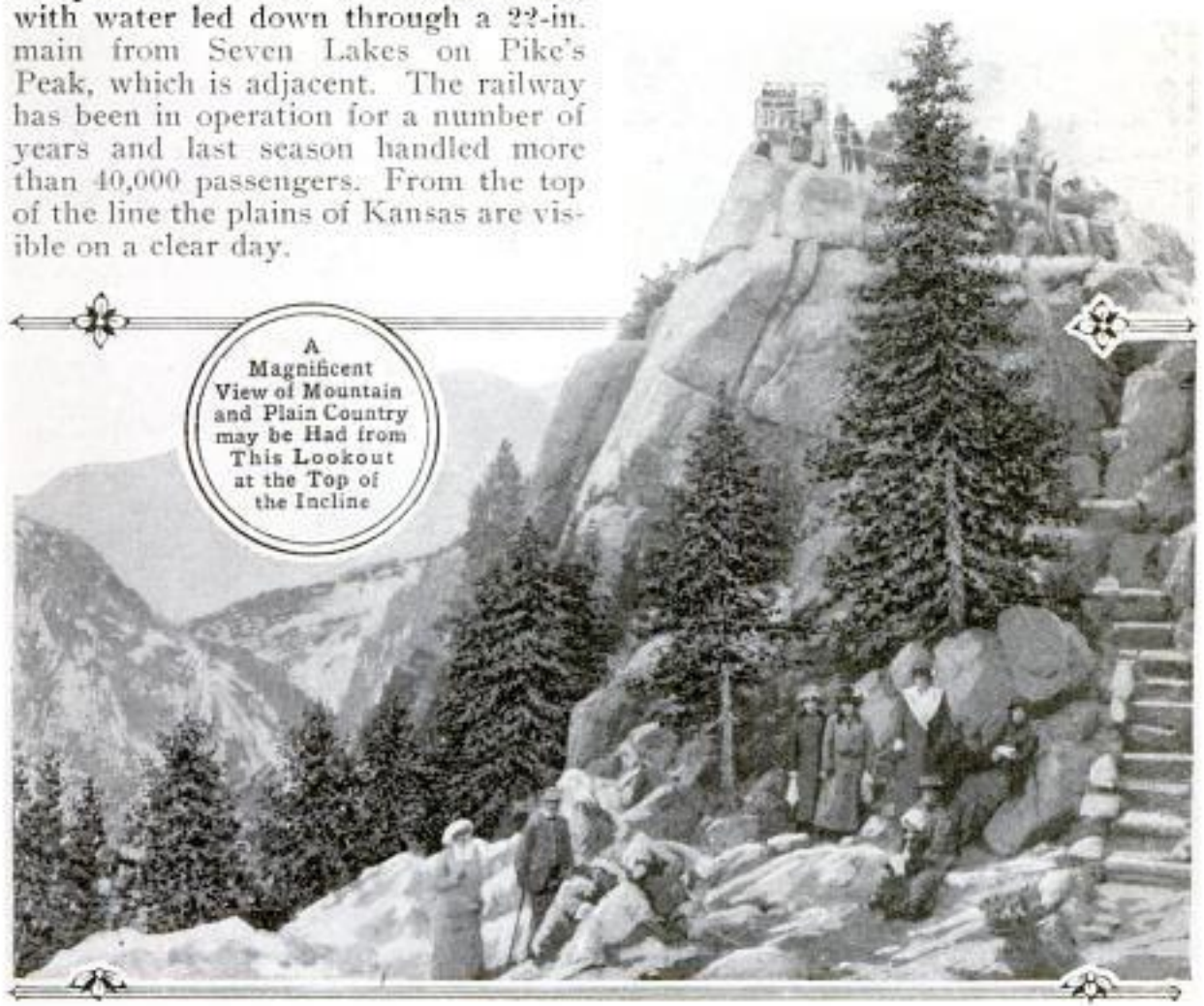

Inv: Clara Irvine
305 Haas Bldg., Los Angeles

726

1351 POPULAR MECHANICS

TINY MOVIE CAMERA USED AS RADIATOR ORNAMENT

As an ornament for the radiator of a motor car, a miniature moving-picture camera mounted on a tripod has been designed. The device is about five inches in height and bears a very close resemblance to the real instrument. The box is made

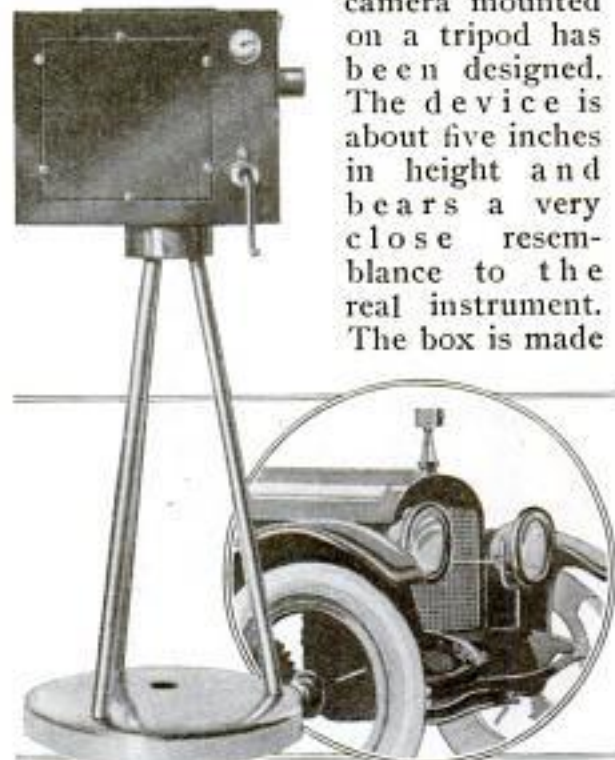

Close View of Miniature Camera, Showing Its Details, and a Glimpse of the Ornament in Place on a Radiator, are Given Above

of polished mahogany and is fitted with a tiny crank, film meter, lens, and other characteristic parts. It has been introduced on the Pacific coast, where it is becoming quite commonly used by those who are connected with the photoplay industry.

1491 PORTO RICANS AS AGENTS IN SOUTH AMERICA

The free-employment bureau maintained by the Porto Rican insular government is offering to this country's exporters to South America, and to prospective exporters, the services of a number of young Porto Ricans who have been educated in the American-conducted high schools and schools of commerce in the island, are familiar with business courtesy and business methods, and speak both English and Spanish. Ignorance of Spanish has been one of the chief obstacles to the

Chief, Bureau of Labor
San Juan, P. R.

United States' trade expansion in South America. The bureau believes that these young men can perform just the service which has been largely lacking heretofore in efforts to secure Latin America's trade, because of their familiarity with its customs and life.

WALKING BACKWARD FROM COAST TO COAST 1485

For the sake of earning a wager of \$20,000 a man 50 years old is walking backward from San Francisco to New York. The performer of this out-of-the-ordinary feat left the west coast Aug. 5, 1915, and passed through Chicago February 8 of this year. He is equipped with a mirror so supported by a standard and straps that it affords him a view of the path along which he is moving backward. The remainder of his simple equipment is carried in a pack on his back. To win the wager he must complete the journey in 260 days. The distance is estimated at 3,900 miles; the rate for the first two-



* Patient Harms *

The Man with the Mirror above His Shoulder is Walking Backward from San Francisco to New York. If He Accomplishes the Feat in 260 Days He Wins a \$20,000 Wager. The Other Man Is a Traveling Companion

thirds of the trip was 15 miles a day—just sufficient, if continued, to take the traveler to the end within the time set.



Military TRUCK HAULS TWENTY-TON GUN OVER BAD ROADS

AMERICA'S commercial invasion of Europe is well illustrated by this powerful American-made motor truck which is shown hauling a 20-ton gun over a European road. The gun is 26 ft. long. Its great weight caused the broad wheels of the trailer to sink into the earth at times, but the motor was strong enough to continue with its load and complete the journey of 11 miles in an hour and a half. Formerly it took a day and a half to haul similar guns this distance.

1481 PRINTING DEPTHS OF CUTS SHOWN BY GAUGE

To displace guesswork with accuracy, a delicate gauge which measures the printing depths of half-tones, electrotypes, and stereotypes, and thus indicates at a glance whether or not they are properly made, is being brought into use. With this device, poor printing due to imperfect plates is forestalled, while the time-worn practice of pressmen charging their mistakes against the engraver or electrotyper, and vice versa, is eliminated. The instrument is made in different styles, one of which measures to $\frac{80}{1000}$ of an inch. A "shallow cut" is instantly discernible. On the other hand if the gauge shows a half-tone to be of standard depth, and the printing comes out poorly, no room is left for arguments in fixing the blame. The device is less than 3 in. in height and has a 2-in. dial with large spacings which are easily read. The measuring is done

by a needle which projects from the bottom of the instrument between two level standards on which the latter rests. To make a measurement, the gauge is placed on the cut as shown.



The Gauge in Measuring Position on a Cut, Showing the Printing Depth

A. J. Wende 1916
(super.)
(inv.) *W. J. Jacson Blvd,*
Chicago.

Fred Owens, Jacksonville, Fla. 1/1
Equitable Film Co.

ACROBAT WITH PARACHUTE LEAPS FROM SKYSCRAPER

For the benefit of a motion-picture concern an acrobat, clinging to a parachute, recently jumped from the top of a skyscraper in Jacksonville, Fla., and landed on the ground without serious mishap. The parachute did not open until the man had fallen about halfway; thereafter the descent was much less rapid, and a landing was made about 20 ft. from the point immediately below the starting point. The acrobat missed the trolley wires of the adjacent street by a short distance and alighted on both feet, the force of the fall throwing him forward on his face. He was only slightly injured.



Grand Bldg

ed on both feet, the force of the fall throwing him forward on his face. He was only slightly injured.

1512

FORCE OIL THROUGH TUNNEL TO QUENCH BURNING WELL

By driving burning oil from a burning oil well through a small covered passageway into a temporary pit, a gang of men were able in 15 minutes to extinguish a costly blaze near Houston, Texas, which was caused by defective electric wiring. But it required 16 hours to prepare for this effort, during which time \$6,000 worth of oil, and well rigging worth \$5,000, were burned. The first step was to throw up a levee about the well, inclosing an area about 100 feet across, which area was soon ablaze. A pit was dug 100 ft. from the inclosure and all but connected with it

oil well near Humble, Tex.

by a trench in which was laid an old smokestack that was covered with earth. Near by steam boilers to the number of 27 were all connected to four steam-pipe mains that were laid up close to the fire; near each a water pipe was laid. Men were assigned to the steam and water pipes, and finally the barrier between the burning inclosure and the smokestack was torn down; the steam gang, with water playing on them to protect them from the heat, rushed forward and with the steam from 27 boilers literally drove the oil through the smokestack, thereby smothering the flames. From the pit at the far end the oil was pumped into containers.

WICKER ADDS TO BEAUTY OF FLOWER HOLDER *1289*

Many new flower containers of pleasing design are now being in-



COURTESY OF THE
LADIES' HOME JOURNAL

closed in loosely woven wicker or reed. One of the most graceful of these is a tall, slender bud vase about which are twined a few strands of wicker, forming a very decorative coarse mesh. A handle of the same material extends in a long, sweeping curve from the neck of the vase to its base.

*The Travers Shop
Pittsburgh, Pa.*

According to London's new motor-car regulations, not only are all headlights prohibited, but in electric side lamps bulbs exceeding 12 watts cannot be used and the front glass must not exceed 6 in. in diameter. The whole front of the glass must be obscured with one sheet of white tissue paper.

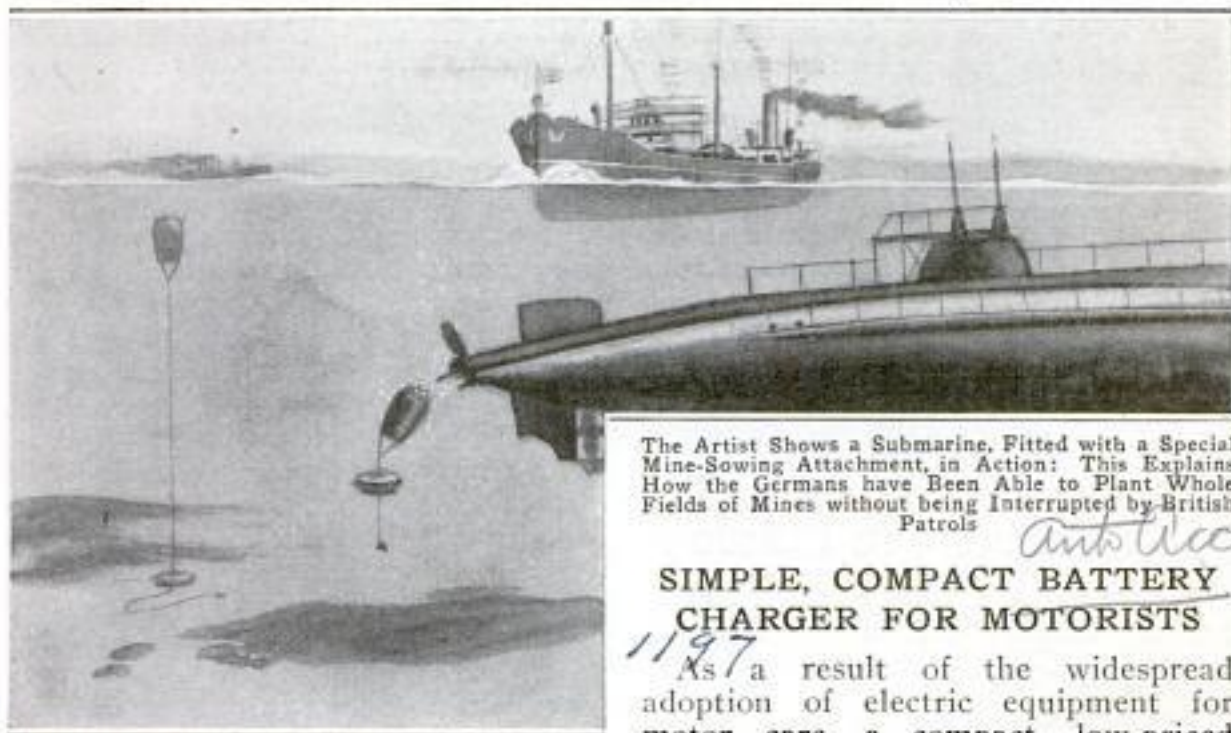

The Artist Shows a Submarine, Fitted with a Special Mine-Sowing Attachment, in Action: This Explains How the Germans have Been Able to Plant Whole Fields of Mines without being Interrupted by British Patrols

SIMPLE, COMPACT BATTERY CHARGER FOR MOTORISTS

As a result of the widespread adoption of electric equipment for motor cars, a compact, low-priced storage - battery charger has been developed. It consists essentially of a step-down transformer and a magnetic rectifier mounted on a metallic base and incased in a neat housing. It may be connected with an ordinary house-lighting circuit and its positive and negative wires attached to the binding posts of any six-volt battery. As the line voltage is cut down properly for charging purposes, the current is passed through the rectifying element, consisting of a master-spring armature, carrying two opposite subsprings, to each of which is attached a copper electrode that makes and breaks the circuit with a carbon electrode. This causes all of the current to flow into the battery in the same direction. Arrangement is

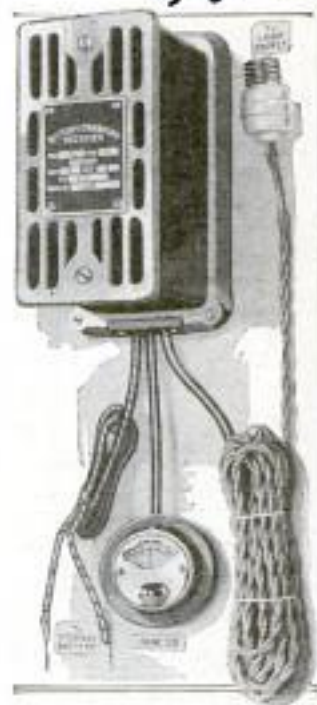

MINE-LAYING SUBMARINES

OF GERMAN NAVY

German mine-planting submarines have been mentioned frequently in cable dispatches from Europe, but considerable vagueness has surrounded their design and method of operation. According to British advices, it appears that instead of being constructed especially for this one function, craft of the usual design are merely provided with a special apparatus which permits them to eject mines of the contact type. The sowing is done in a very simple way. A reel inside of a sinker holds a line attached to a floating mine. The lower end of a cord extending down from this sinker, or anchor, carries a plummet. When first thrown into the water from a submarine, the mine lifts to the surface as the line unwinds, allowing the anchor and the smaller weight to drop. When the latter strikes the bottom it locks the reel and prevents more line from being paid out. The sinking anchor then commences to draw the mine down with it, thus carrying it to the proper depth beneath the surface, where it remains out of sight until exploded or removed.

Ohio Electric Works
Cleveland O.

Geo A. Walton
259 Washington St.

Director

made to eliminate any difference in the lag between the vibrations of the armature and the current reversals, thus adapting the apparatus for alternating-current circuits. Since both alternations of a line current are utilized, the rectifier furnishes a steady unidirectional flow. The construction is such that the discharge of the battery through the rectifier, in the event that the line current should be temporarily cut off, is prevented.

GREELEY CAMPAIGN EMBLEMS

1409 ON QUAIN OLD CALICO

A rare and quaint piece of calico was recently discovered in a New England attic which was made about 1812 when Horace Greeley ran for the presidency. Its pattern is suggestive of the picturesque campaign methods employed at that time. A tall hat of the style of post-bellum days, and a pair of heavy-bowed spectacles, both articles suggestive of Greeley, are the motif

of the most prominent stripes printed on the cloth. The letters "H" and "G" appear in orange, in columns at one side of the hat and spectacles, and rows of sickles and axes are printed on the other side. These last emblems are supposed to suggest that the famous editor was also a farmer.

Experiments are being made in crushing and washing of matrix rock bearing platinum taken from a lode of dunite said to carry platinum amounting to about \$4 per ton. If these efforts are successful similar lodes will be sought elsewhere.

**PLAYGOERS WAIT INDOORS
UNTIL CARS ARRIVE 1433**

Pop Post 2/11/16
Certain eastern theaters and music halls are inaugurating a system of summoning the patrons' motor cars after a performance and announcing the cars' arrival at the theater entrance in a manner that makes it unnecessary for playgoers to wait on the sidewalk while the proper car is being megaphoned or otherwise signaled to. Under the new arrangement numbers which have been given to automobile drivers earlier in the evening are communicated by telephone from the sidewalk to the interior of the theater, as the cars drive up. Inside an operator displays the numbers on cardboards in a frame. In this way theater patrons are permitted to wait comfortably indoors until the arrival of the right car is announced.

**CITY FIRE PLUGS ARE USED
AS DRINKING FOUNTAINS 1455**

Sanitary drinking fountains designed to be attached to fire hydrants have been installed at a number of places in Rochester and New York City for the benefit of pedestrians. The device is an invention of an employe of the Department of Public Works of the former city and is being installed in Gotham by a temperance society and social-welfare

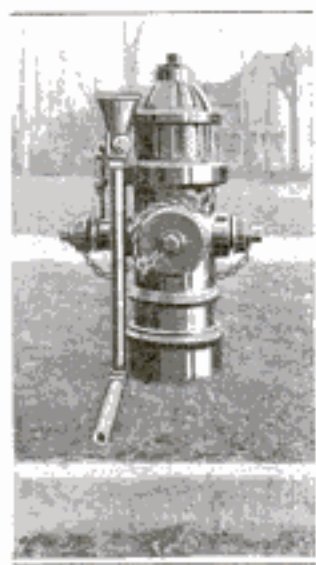

organization in districts where a drink is a difficult thing for a person on the streets to get except in saloons and soda emporiums. The contrivance is of the bubbling-cup type and drains through a waste pipe into a gutter adjacent to the plug to which it is attached. It has

*See E. Crisp
Water Works Repair Dept.
Dewey av. & Bloss St.
Rochester, N. Y.*

the advantage of being of little intrinsic value, a thing which safeguards it against unauthorized removal; and also of being easily and inexpensively installed. It does not interfere with the use of a hydrant in case of fire, and drains well, so that a puddle is not formed about its base. As an indication of the serious need for such fountains in cities, 40 New Yorkers were recently observed to use one of the devices in a 10-minute period.

1460—

STABLE DOORS OPEN WHEN FIRE ENDANGERS HORSES

A large packing concern in California has installed an automatic means for opening the doors of its horse stable which allows the horses to escape at any time of the day or night if there is danger of fire. The device is operated in much the same manner as an automatic sprinkler. When the temperature in the stables

rises to a certain point a weight is released which falls on a lever that in turn releases all the doors simultaneously. At the same instant certain noises are made mechanically which frighten the horses from their places. The releasing lever is occasionally operated by hand to give the horses a fire drill. Each horse soon learns to trot from its stall when the door opens and the alarm sounds.

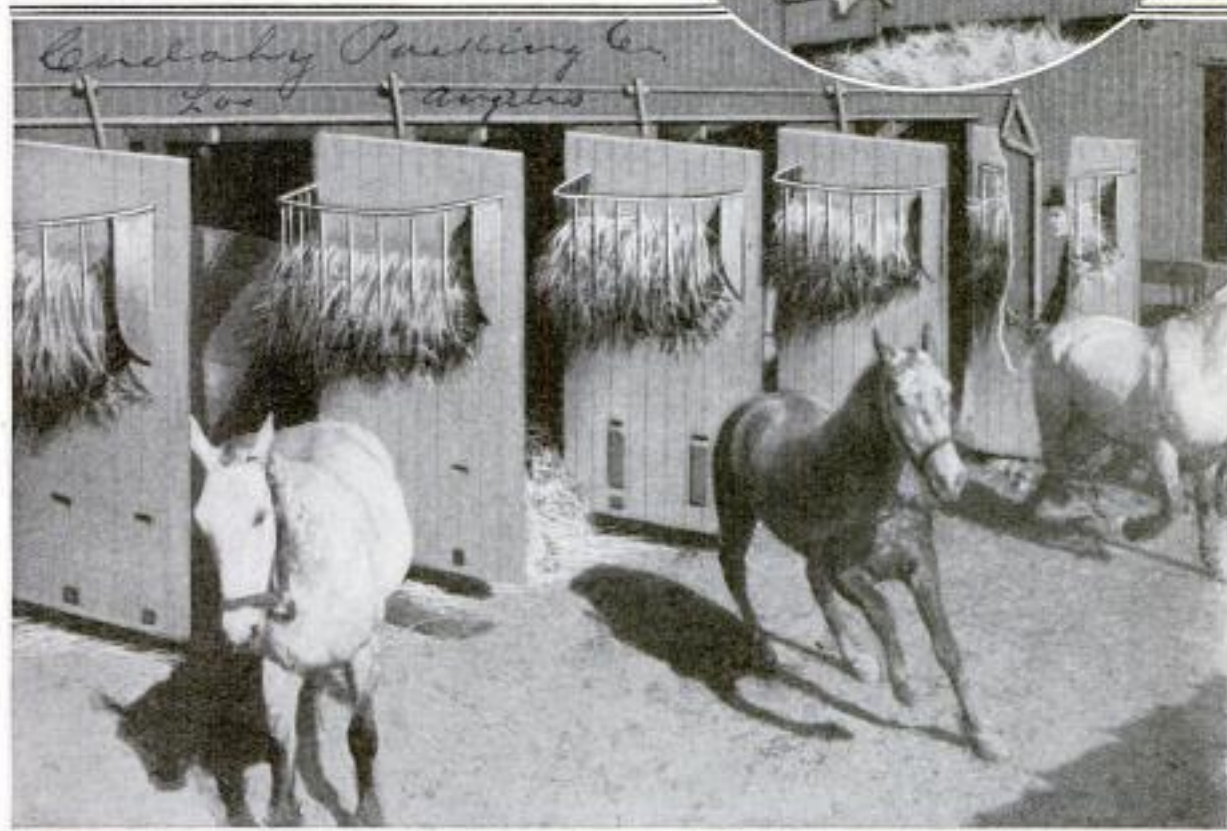
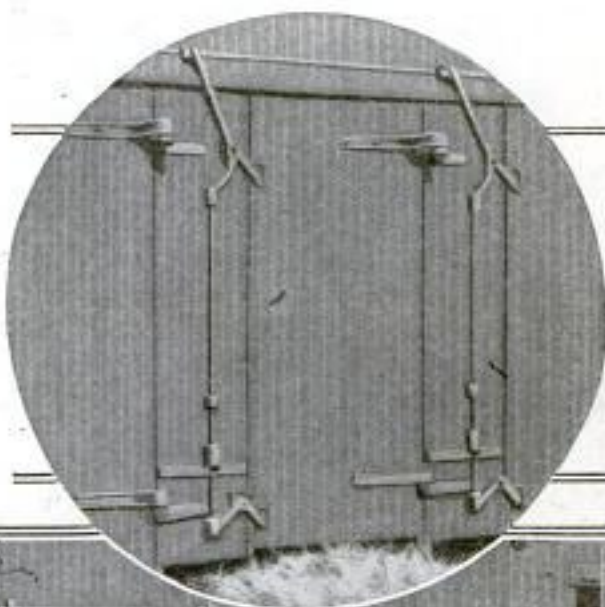

COPYRIGHT, INTERNATIONAL FILM SERVICE, INC.

Horses Running from Their Stalls Just After the Doors have been Thrown Open by the Automatic Device and the Alarm has been Sounded Inside. Above: Stable Doors Locked by Levers Which are Drawn Back Automatically When the Temperature in the Stable Rises above a Certain Point

Saw: John Betty
1087 W. 35th St., Los Angeles

1325

Field Mus. Nat. Hist.

Robert H. Beaman, Dept. of Zoology, Chicago



Diamond Fields in Lavras District, Bahia, Brazil, Which for Over a Century Practically Supplied the World with Diamonds. Though South Africa Now Has Supremacy in Diamond Mining, These Natives, Employing Primitive Methods, Still Dig for the American Market Many Thousands of Dollars' Worth of Very Superior Stones Annually. Gravel Heaps near the Huts Consist of Pay Dirt That has been Worked. Fashion

ANCIENT DIAMOND FIELDS PRODUCE MANY GEMS

1325



Above: A Cave in the Brazilian Diamond Fields Occupied as a Home by the Native Miners

Left: The Primitive Method Which the Miners Employ in Washing the Pay Dirt



Right: A System of Artificial Waterfalls Employed in Roughly Sorting the Diamond-Bearing Material

The Larger Picture Shows a Heap of Gravel Piled on the Ledge Ready to be Washed in the Pool Below

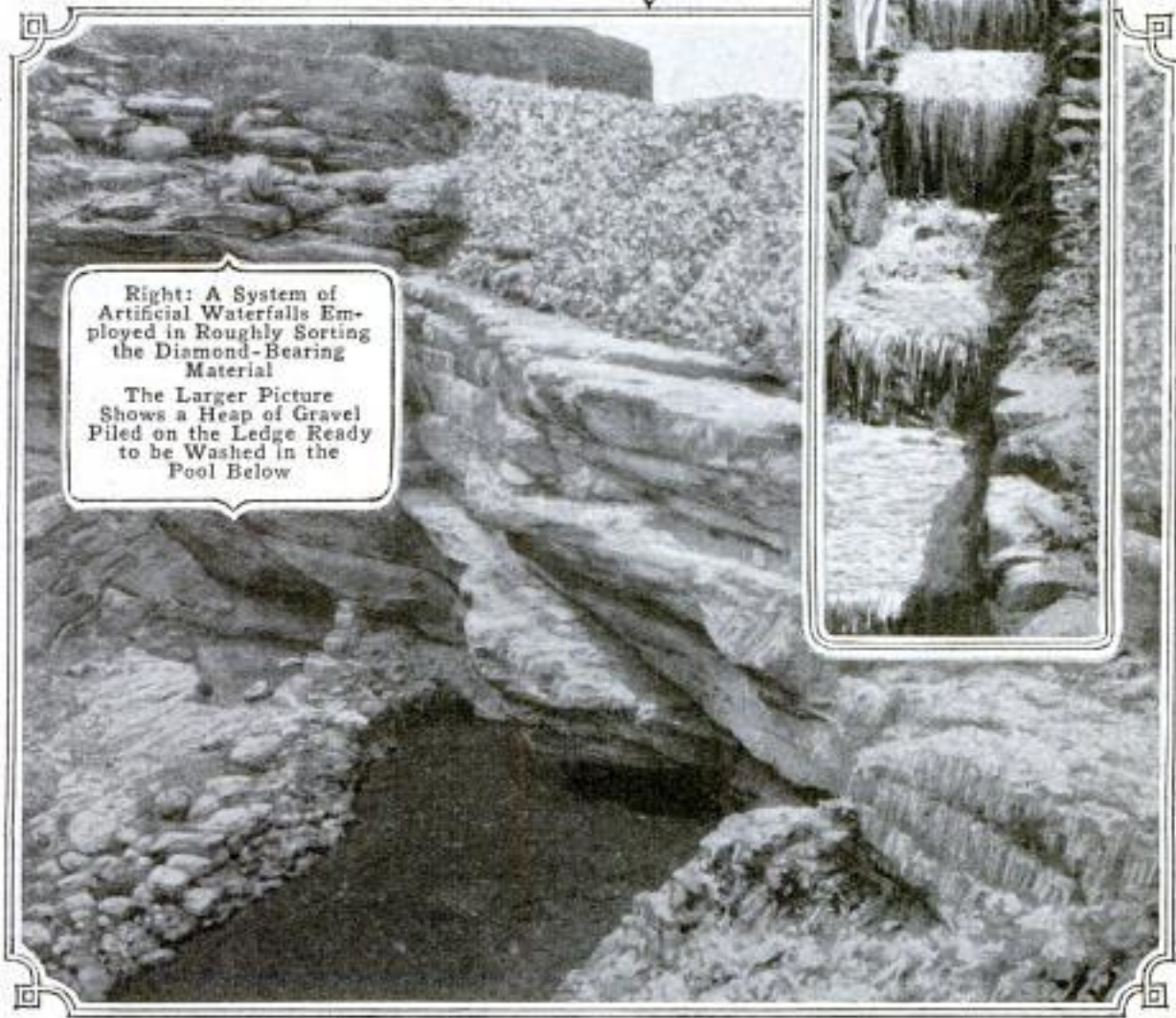

1528
**CATHEDRAL DOME COLLAPSES
 UNDER WEIGHT OF SNOW**

As an aftermath of an exceptional blizzard at Seattle early in February, a 43-ft. dome crowning the St. James



Interior of St. James Cathedral at Seattle After Dome had Collapsed under the Weight of Wet Snow

Cathedral collapsed under the weight of wet snow packed on all sides of it. The tower and dome were supported by four intersecting steel trusses, one of which failed under the strain. The storm lasted for 36 hours, during which time the wind continually shifted. This caused snow to be piled to a depth of about seven feet in the pockets around the base of the dome. The weight of this is estimated to have been about 30 tons. Seattle rarely experiences heavy snowstorms, and the supports, it is said, were not designed

to carry as great an overload as was imposed upon them. It is also believed that steel in one of the trusses was defective, an examination of the fracture showing almost no elongation. The top of the dome was 115 ft.

above the cathedral floor. The structure was completed in 1906 at a cost of approximately \$400,000. The damage amounts to about \$15,000.

1445
**BLOOD INSTEAD
 OF EGGS AND
 MILK IN
 DOUGH**

"Denatured blood," bleached, deodorized, and sterilized, is the substance proposed by a German food chemist to be used in making rich dough as a substitute for such highly nutritious ingredients as milk and eggs, the cost of which is steadily increasing. Blood, which occurs as a necessary by-product of abattoirs, is not only rich in energy-producing nitrogenous compounds but also in those mineral salts which are needed in building up the body.

The bleaching, sterilizing, and deodorizing is done by the aid of hydrogen peroxide. The German chemist claims to have been using this "blood bread" in his home for several years. At first he employed a 30-per-cent solution of ordinary peroxide, but later a special perhydrite was used. After allowing the blood to cool for a day or a day and a half it is strained to eliminate the clots. The remaining liquid is used instead of water in mixing the dough, after which the peroxide is added. In this blood bread no yeast is necessary, as the

*Dr. (R)
 Hannover, Germany.
 Staff Apothecary &
 Food Chemist*

liberated oxygen permeates the mass with the same effect as is produced by growing yeast. This oxidizing agent also destroys objectionable bacteria in the flour. The prepared bread is good, it is said, not only for bread, but for biscuits and cakes as well.

1464

BANDAGE ROLLER OPERATED LIKE A SEWING MACHINE

An invention that doubtless has been prompted by the war is a bandage-rolling device which can be attached to any sewing-machine frame of new or old design. The treadle and lower belt wheel of the machine are used to operate the new attachment. This consists essentially of a shaft on which the bandages are wound. To it is rigidly attached a grooved wheel which is connected with the wheel below by a belt. At the opposite end is a crank handle for starting the machine by hand. On the shaft are movable guides which can be set for bandages of any width. If desired, the bandages can be caused to pass between bars



A Device, Mounted on a Sewing-Machine Frame, on Which Bandages of Various Widths can be Wound

set close together, thereby removing wrinkles before the cloth is wound. The attachment is fastened to wooden supports, which in turn are screwed to the sewing-machine top.

9699

PERMANENT PULPITS BUILT FOR STREET SPEAKERS

Before a plaza in one of the public parks at Los Angeles, two concrete rostra have been erected for the open-

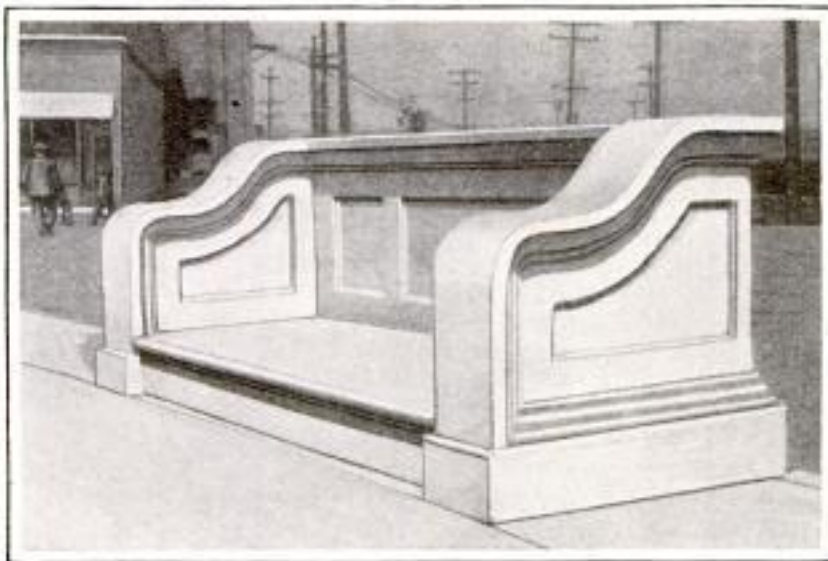

Concrete Rostrum Erected for Public Speakers before a Plaza in One of the Parks of Los Angeles

air speakers who frequent the place and attract crowds of people of many different nationalities. These men talk on various phases of political and religious subjects in any one of a half dozen languages, while the audiences assemble in the broad street surrounding the park almost as did the ancients in the days of the Forum at Rome. The continuance of this practice has caused the city to construct permanent pulpits for the speakers, who are free to use them at will. Each of these is built on somewhat classical lines and is 11 ft. in length and 3 ft. 8 in. in height. The platform in both instances is elevated 10 in. above the sidewalk level.

Rose Mfg. Co.,
910 Arch St., Phila.

736

1396

POPULAR MECHANICS

OIL STOVE HEATS MOTOR RADIATOR AND GARAGE

A kerosene stove is being manufactured which heats and circulates the water through the water jacket and

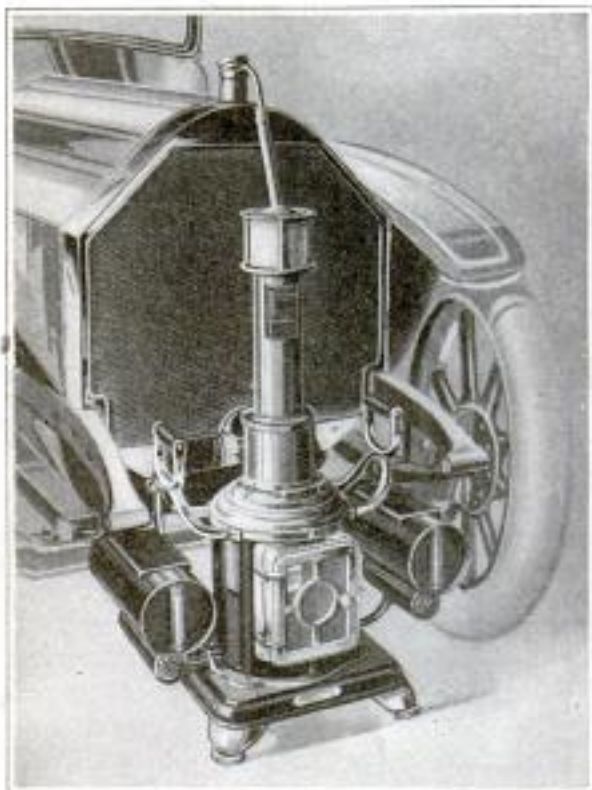

This Stove is Connected by Tubes with the Car Radiator, and will Keep the Water in It Warm and Circulating for 36 Hours, or More, by Burning Two Gallons of Kerosene

radiator of a motor car while in a garage. It is so devised that by connecting it with the radiator drain cock, by means of a rubber tube, the water flows into a copper coil located above the flame, whence it rises through a pipe which carries it back to the engine through the opening in the top of the radiator. In external appearance the stove somewhat resembles an ordinary oil stove except that two tanks, each with a capacity of 1 gal., are fastened to the frame either side of the burner. These feed through intermediate chambers, making it safe to fill the tanks when the heater is lighted. Oil gauges are fitted to one end of each tank. By means of two rigidly fastened handles the stove can be moved about easily. It will burn from 36 to 48 hours with one filling. The burners give a blue flame which produces no carbonizing.

As a safeguard against explosions due to outside gases, the flame is thoroughly protected with a safety screen similar to that used on a miner's lamp. The stove gives off a good deal of surplus heat which moderates the temperature of the garage, thereby benefiting the car as a whole. Other designs of this stove employ gas and electricity.

1335

SHEET-IRON BANDS PROTECT EDGES OF PAPER ROLLS

To protect heavy rolls of paper from injury during transportation, crimped sheet-metal bands are being used to bind the ends. These members are slightly smaller in circumference than the rolls and when snapped in place at a mill fit very tightly. They have a twofold advantage, for not only are the edges of the paper safeguarded, but the handling of the rolls is materially facilitated. Newspaper stock and similar paper can be loaded on end in cars without deleterious effects, and trucking is likewise made easier. The bands can be slipped off without diffi-

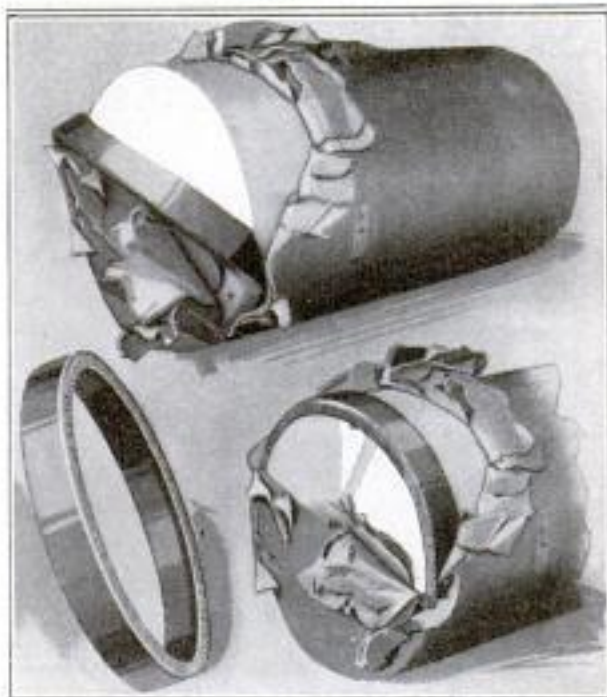

The Ends of a Roll of Paper, When Bound, are Not So Easily Injured in Shipment as Otherwise

culty when the wrapping is removed preparatory to swinging a roll into a press. (Inve)

F. R. Misegades
c/o W. F. Hall Pty. Co.
466 W. Superior St.
Chicago.



With This Grain Loader Fewer Wagons are Needed to Supply Grain to a Threshing Machine and No Laborers are Required to Pitch Bundles onto the Wagons

**GRAIN LOADER DOES WORK
 1/4 OF HARVEST HANDS**

A labor-saving agricultural machine has been developed which dispenses with harvest hands employed in the field in loading grain to be stacked or to supply a threshing machine. It is called a shock loader and will fill a wagon rack in less than two and a half minutes. It weighs 2,800 lb., is drawn by four horses, and is operated by the driver alone. The principal parts of the machine are the "pickers" and three carriers. The pickers, whose position is analogous to that of the cutting knives on a binder, lift the bundles of grain and deposit them on a carrier by which they are transferred to a horizontal carrier at the rear; from this the grain is raised on an inclined elevator and dropped into wagons which move alongside the machine. The pickers are 6-in. spikes fastened to a 6-ft. steel bar. They grasp the bundles and the turning of the bar deposits them on the carrier. The pickers also gather up the loose grain about the shocks. A 20-in. drivewheel operates the carriers, pickers, etc. The machine will do the work of several men pitching bundles in the field and can load six wagons fast enough to supply a threshing outfit as rapidly as

12 wagons can under the old method. This loader is also used advantageously in loading alfalfa, for it does not shake off the dry leaves, as is done in hand loading.

**CLOTH SHOE TOPS ARE DYED
 BY COMPRESSED AIR**

When one of the large manufacturing companies found some time ago that it was oversupplied with shoes



having light colored cloth tops, it was decided that the entire stock should be dyed black. In order to accomplish this without discoloring the

Hanan & Son
 390 Fulton St.
 Brooklyn

*H. J. W. Seymour
 358 Henry St.
 Brooklyn N.Y.*

linings and ruining the internal appearance of the shoes, a special dye was made and applied by means of compressed air instead of a brush. The device is similar to some of those employed in spraying paint, and practically the same in general principle as an atomizer. The shoes were suspended from a line stretched in front of a screen while being worked upon. The work was done quickly, neatly, and without injuring the linings.

1465 ———
**LEVER IN STREET OPERATES
 MOTOR IN SHOW WINDOW**

An unusually effective method of demonstrating the operation of an electric motor that was displayed in a



By Means of This Foot Lever in Front of His Show Window a Pittsburgh Dealer Allowed Passers-By to Operate the Electrically Driven Sewing Machine on Display Inside

show window as an attachment for a sewing machine, was employed by a dealer in Pittsburgh, Pa., recently. The motor was connected with a foot lever which was set on a standard of convenient height on the sidewalk in front of the window. Any passer-by could set the machine inside the store running at any one of five speeds simply by placing his foot on the lever. Placards either side of the machine invited spectators to use the lever.

1401
HICKORY IS USED AS STOCK

BY PECAN GROWERS

Luther Burbank Santa Rosa Calif
 By uniting the scions and buds of the pecan with the hickory tree, attempts are being made to carry it into districts in which it is not commonly grown and where the latter tree abounds. Since the hickory is very sturdy and also closely allied to the pecan, it has been considered probable that in certain localities it would serve advantageously as a stock. The plan apparently permits the quick introduction of the pecan into new places and, it is hoped by some, may enable the conversion of inferior nut-bearing trees into good ones. Grafting of this character has been done in Louisiana, Florida, Oklahoma, California, and other places, for experimental purposes and kindred reasons. In Florida the pecan has been found to unite readily with the mockernut and grow quickly, until a certain stage is reached, where the progress slackens. According to the Department of Agriculture, other hickories have been tried in different places, and while the early growth in many instances has been strong, few of the trees have borne satisfactorily. It has not yet been fully determined whether the cause of this unfruitfulness is attributable to the influence of the hickory stock or to a lack of cultivation. Recent reports from Oklahoma seem more encouraging. In certain districts the experiment has apparently proved profitable. The grafting there is said to have been done in the spring of the year, to young hickories which had been girdled in the fall. One of the best authorities in the country asserts that there is no reason to believe that such a process will of itself produce better nuts, regardless of the stock, unless the very best varieties of pecans are used. He also points out that the pecan will freeze as quickly on one root as on another, and that therefore the hardness of the hickory makes no difference in that particular. Although still largely experimental, it appears that in some localities the plan can be followed successfully.

FIRE DESTROYS MANY SHIPS LOADED FOR ALLIES



THE fact that large quantities of munitions of war for the allies were being loaded onto ships at the foot of Pioneer Street, Brooklyn, is believed to have been responsible for the mysterious \$5,000,000 fire which broke out February 16 among these ships, partly or wholly destroying three large vessels and 37 lighters and barges. The fire was preceded by several unaccounted-for explosions. The havoc wrought on the New York Dock Company's 900-foot pier is shown at the left. Below is a view of the "Bolton Castle," showing a decided list due to water pumped into its hold by the firemen.

PHOTO COPYRIGHT UNDERWOOD & UNDERWOOD

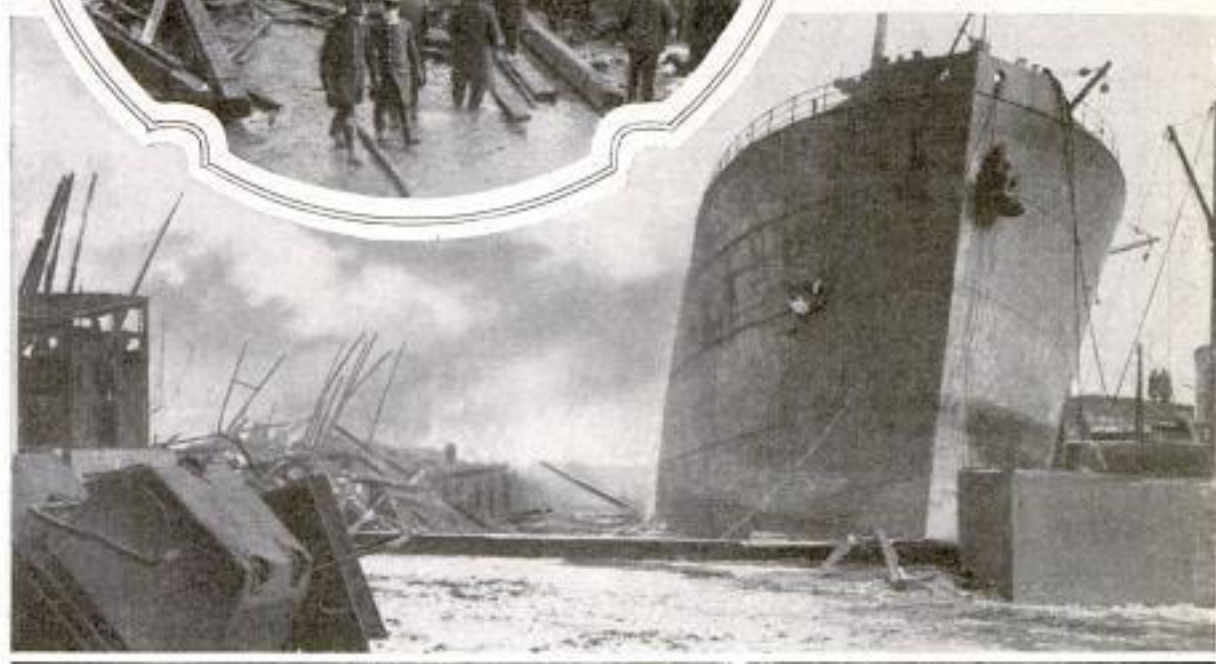

1489

COLOSSAL CAMPANILE BUILT ON PACIFIC COAST

One of the most beautiful campaniles of modern construction that is to be found anywhere has recently been completed at the University of California, where it rises to a height of 302 ft. above the campus. It has been erected in honor of one of the patrons of the institution and is probably, with the exception of the Washington Monument, the highest memorial tower in America. As explained in the

Berkeley, Calif.

December, 1914, issue of this magazine, the structure has been designed to resist seismic disturbances. Its concrete foundation, laid on bedrock, is 48 ft. square and 8 ft. thick. The frame of the building is of structural steel. In order to avoid rigidity, cross bracing was eliminated in alternate stories. The campanile is 34 ft. square at the ground and tapers to 30 ft. at the loggia, or observation portico, which is at a height of 200 ft. and is reached by stairs and an elevator. Immediately beneath the latter point is a clock with

dials 16 ft. in diameter. The chimes, costing \$25,000, will hang above the loggia. The pinnacle of the tower is



Three-Hundred-Foot Campanile on University of California Campus Built to Resist Earthquakes

crowned by a bronze lantern of pleasing form, the light of which is visible at night from the decks of ships entering the Golden Gate.

LINOTYPE HEAT REGULATOR 513 SAVES GAS

A gas flame is used on linotype machines to keep the supply of type metal melted. Often the metal is heated to a

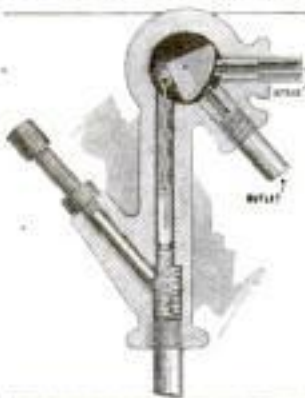

higher temperature than is necessary, resulting in a waste of gas. To prevent this automatically a new regulator has been devised. It is mounted at the upper end of a metal pipe containing a column

of mercury. The mercury is affected by the heat of the type metal, rising and falling with changes in temperature. A float rests on the upper end of the mercury and with the aid of a small chain operates a pivoted valve. When the float rises unduly, due to too

high a temperature in the type-metal bath, the pivoted valve swings over and rests against the gas-intake port, lessening or cutting off entirely the fuel supply. When the metal cools down, the mercury recedes and gas is again allowed to flow. A setscrew in the side of the regulator pushes against the mercury column, and with it the height and temperature range of the column may be adjusted.

9488 SELF-CLINCHING NAIL IS NEW TYPE OF FASTENER

A fastener of entirely different principle from ordinary types has lately made its appearance upon the market.

It is intended to hold anything together from two pieces of hard leather to metal lath against a hollow-tile wall. Only a hammer is needed to drive these "nails" home, a screwdriver or other tool being unnecessary.

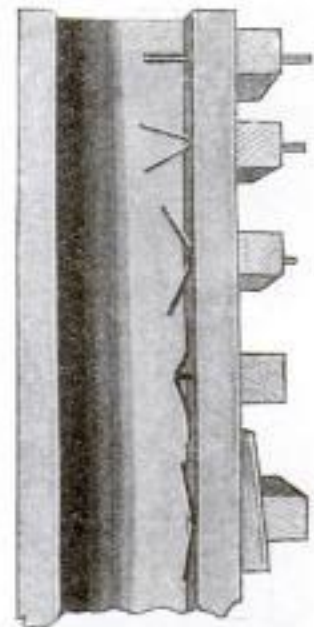

The fasteners are made from a narrow strip of metal bent to a double "U" shape, the various folds being flattened out and properly shaped in the stamping machine. In use, the longest end of the fastener is placed in the hole and the other end struck with a hammer. This results in forcing the extra length of the "nail" through the hole, causing it to bulge out on the other side, the bulge taking on a more or less flattened shape due to depressions in the center portion of the fastener. After being driven home, this center portion acts merely as a wedge to hold the bent-over sidepieces in proper place. It is unnecessary to use any clinching device on the side opposite the

Inv. Geo. L. Hopping,
Los Angeles.

Self-clinching
Nail Co.,
44 N. 4th St.,
Phila.

099,414. BEET TOPPER AND HARVESTER. HOWARD E. WILLIAMS, Compton, Cal. Filed Nov. 19, 1912. Serial No. 732,387. (Cl. 55-107.)

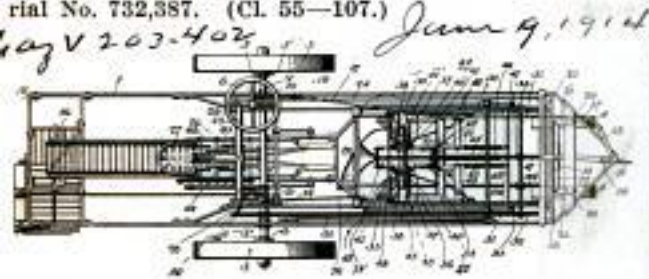

1. In a beet topping machine, the combination of a frame, cutters drawn by said frame, height regulating means for said cutters, adapted to run on top the beets, means connecting said cutters with the height regulating means to raise and lower the cutters with the height regulating means, and means adapted to engage the beet or operating said connecting means to lower the cutters relatively to said height regulating means in correspondence with the dimensions of the beet.

2. In a beet topping machine, the combination of a frame, cutters drawn by said frame, height regulating means for said cutters adapted to run on top the beets, means connecting said cutters with the height regulating means to raise and lower the cutters with the height regulating means for operating said connecting means to lower the cutters relatively to said height regulating means, said lowering means for the cutters comprising means for engaging with the side of the beet and controlling the connections between the cutters and the height regulating means.

3. In a beet topping machine, the combination of a machine frame, a cutter frame connected to said machine frame and movable vertically thereon, cutter means carried by said cutter frame, a regulating frame movably mounted on said cutter frame, height regulating means carried by said regulating frame, spring means connecting said regulating frame with said cutter frame to cause said frames to move together to raise the cutter means in correspondence with the height regulating means, arms movably mounted on said cutter frame and adapted to engage with opposite sides of the beets, and connections between said arms and said regulating frame to lower the cutter frame relatively to the height regulating means when the said arms are spread apart.

4. In a beet topping machine, the combination of a machine frame, a cutter frame connected to said machine frame and movable vertically thereon, cutter means carried by said cutter frame, height regulating means carried by said regulating frame, spring means connecting said regulating frame with said cutter frame to cause said frames to move together to raise the cutter means in correspondence with the height regulating means, arms mounted to move independently on said cutter frame and adapted to engage with opposite sides of the beets, and connections between said arms and said regulating frame to lower the cutter frame relatively to the height regulating means when the said arms are spread apart, comprising an equalizing lever connected to said arms and to said regulating frame, and spring means connected to said equalizing lever to hold the same in normal position.

5. In a beet topping machine, the combination of a frame, cutters drawn by said frame, height regulating means for said cutters adapted to run on top of the beets, means connecting said cutters with the height regulating means to raise and lower the cutters with the height regulating means, and means for operating said connecting means to lower the cutters relatively to said height regulating means, said lowering means for the cutters comprising independently movable means for engaging with opposite sides of the beet and controlling the connections between the cutters and the height regulating means.



Library for the Blind Marking Playing Cards for European Soldiers
Sightless Women Knitting for the Sufferers of Europe

ing en-
ctured,
uniting
similar
is long
greater
al lath
terra-
RANS
ND

blind
in pre-
or the
he Na-
Wash-
soldiers
use of
st their
ting or
ard so
by the
nt sim-
achine
is also
or the
women
dress-
lace of

absorbent cotton, which is very scarce. These loosely knit articles can be used many times if properly cleansed.

5315

MACHINE FOR TOPPING AND HARVESTING BEETS

What appears to be a practical machine for topping and harvesting sugar beets has been invented and patented. The fact that there is a standing prize of \$10,000, offered by one of the leading American sugar companies for a successful beet harvester, is evidence that such a machine meets a real need in the beet-sugar industry, while the shortage in imports from abroad, with the resulting rise in prices, still further accentuates the importance of any machine that will reduce the cost of producing sugar in this country.

This new machine is mounted on a light truck and is designed to be pulled by horses or propelled by engine power. It consists of a topper and puller with elevators that drop the topped beets in rows or piles, as desired by the operator, the entire mechanism being driven by the rear wheels of the truck. One of the difficulties in devising a beet-harvesting machine is the necessity for cutting the tops at

Inv:
Howard E. Williams
Compton, Cal.

Expired Dec 1, 1915
 Was offered by
 Great Western Sugar Co.
 Denver, Colo.

varying heights, the requirement being that a large beet must be cut lower than a small one. This difficulty is

speed. One feature of this control is an endless belt with its lower side moving backward with reference to the

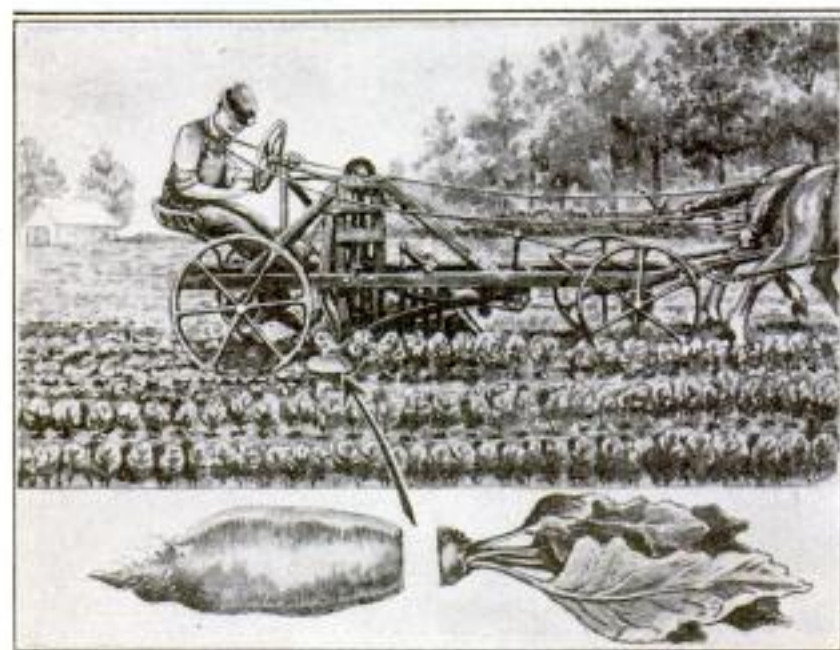

Sugar Beets are Topped, Removed from the Ground, and Piled in Rows as the Harvester is Driven Along. The Arrow Indicates the Cutting Disks

overcome by an ingenious measuring device that controls the height of the topper, which consists of two horizontal disks driven at a high rate of

beets are then raised by an elevator, conveyed to the side of the machine, and dropped in rows or piles on the ground.

DENTAL GRINDING MACHINE

1521 SAVES GOLD DUST

For the benefit of dental practitioners an efficient, power-driven grinding tool embodying a number of attractive features has been developed. It is intended as an attachment for a dental

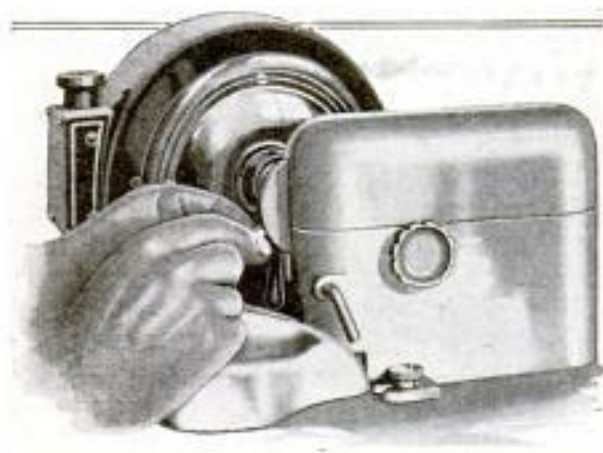

The Dental Grinding Attachment in Use, Showing Its Position in Relation to the Motor

lathe, and is arranged so that it collects and saves the particles of gold often wasted in finishing crowns, bridges, and inlays. A fine carborundum wheel is kept properly moistened to prevent the overheating of porcelain work. A truing device, which is brought into action by drawing a small lever back and forth a few times when necessary, provides a ready means of keeping the stone smooth and in alignment. Immediately in front of the wheel and designed as an integral part of the housing is an arched bed which forms a support for the operator's hands. Held in a belt arrangement inside of the device, so that it comes in contact with the wheel, is a rubber sponge which wets the stone and collects the gold particles from it. This passes down through a tray of water at the bottom and then between rollers which remove the superfluous moisture and grindings.

Inventor: Dr. H. E. S. Chayer
 mfg. Neometric Dental Instrument Co. Inc.
 7-11 W. 45th St., New York

A SCHOOL FOR MARKSMANSHIP

1496
By JOHN R. COX

511 Eleventh St., Wash., D.C.

AN inconspicuous speck on the newer maps serves to denote the location of Winthrop, Md. A bold headland jutting on the Potomac River, between two of its tributaries, it attracts little notice from the thousands of passengers on that picturesque stream, a two-and-a-half-hour sail below Washington. Very few tourists on the river steamers realize that they are passing a place of any consequence. Yet, despite its modest position in the atlas, Winthrop is a significant factor in our system of military effectiveness, for it is the base of small-arms marks-

manship of the United States Navy and Marine Corps.

Winthrop derives its name from a former assistant secretary of the navy, Beekman Winthrop, who did much to encourage the promotion of small-arms shooting in the marine corps. The tract, comprising 1,100 acres, was formerly known by the uneuphonious name of Stump's Neck, but since it has been given the dignity of a government station, it is officially designated as the Marine Rifle Range, Winthrop. Its isolation affords ideal facilities for the work in which it is engaged.



Practice after a Freshet on the Government's Rifle Range at Winthrop, Md., Where Sailors, Soldiers, and Civilians Learn to Shoot



Giving a Lesson in the Use and Construction of Rapid-Fire Guns so That the Mechanism of the Pieces is Thoroughly Understood



Rear of the Target Butts at Winthrop with Which All must Become as Familiar as with the Use of Various Small Arms

Every newly enlisted man in the eastern division of the marine corps must undergo the course at Winthrop, and qualify before he is assigned to general service. As these recruits mostly come from the interior with little or no previous experience with the rifle, they have a great deal to learn; but two weeks of intensive instruction works wonders with them, and they are sent to marine detachments with an excellent working knowledge of the use of small arms, and no longer "gun-shy."

But Winthrop is not merely a rifle range. It is also a school for coaches in rifle and revolver shooting; and it is there that the foundation is laid for small-arms practice in both the sea-going services of the United States' fighting force. Sailors, from chief petty officer to ordinary seaman, are detailed from naval vessels in squads of ten men each during periods when they can best be spared from their respective ships without interference with the ship work. This branch of training is fully as important as the instruction imparted to recruits. Indeed, it may be said to be the main object of the station, for it is technically known as the Navy School for Small Arms Coaches. Teaching these men to shoot, while very essential, is only incidental to the primary purpose of educating them to be able to coach others on board men-of-war and at naval stations. When the men undergoing the course have completed the regular period of instruction, they are turned out well-rounded small-arms experts, competent to perform any work on the range, the salient idea being to provide a coach for every firing point, and to qualify men to handle the rifle butts and to direct the firing line. Especially are they trained for duty at the big range at Guantanamo, Cuba, where the entire Atlantic fleet assembles each winter for practice.

But the activities at Winthrop are not confined to the instruction of marine recruits and the education of small-arms coaches. The range is open to all who desire to learn to shoot, and

civilians are welcomed if they evince a sufficient interest in the serious business in which the station is engaged. High-school cadets, militiamen, shooting clubs, and other organizations, as well as individual citizens, may go to Winthrop and be instructed in the art of shooting. They are assigned coaches who teach them how to handle the rifle and revolver, and they fire the regular courses. They are supplied with guns and accessories for shooting; more than that, they are equipped with shooting clothes, and are even given a nominal pay of 30 cents a day, with tent, mattress, and blankets free. This feature of Winthrop is already attracting the attention of the young men of Washington, and it is predicted that by next season there will be no lack of applicants for the privilege which the range affords.

The training of civilians to shoot is in a sense experimental, but if it proves popular, as it now promises, the work will probably be extended. Capt. W. C. Harlee, U. S. Marine Corps, Assistant Director of Target Practice of the Navy, who is assigned to the small-arms section of that office, and author of the "Firing Regulations for Small Arms in the U. S. Navy," has evolved a plan whereby the facilities for learning to shoot, now offered civilians at Winthrop, may be extended to embrace all parts of the country. His plan is to utilize the several state rifle ranges for the training of citizens to shoot. Instead of maintaining these ranges for a month's shooting in the summer, he would keep them employed throughout the open season. Sixty soldiers would man a range of 20 targets, furnishing sufficient men to serve as coaches, markers, target men, telephone operators, cooks, and for other duties incidental to the operation of the range. Civilians living in the vicinity of the range would thus be encouraged to fire the regular courses, and upon qualifying, they would be registered as marksmen at Washington, and a certificate to that effect issued to them. As a measure of preparedness, the plan has much to commend it. The expense would be



A Marine Team Firing Prone on the Ground at 600-Yards Range. Score Boards are Shown Also



Young Men Who have Finished the Course of Instruction at Winthrop and are Leaving, Loaded with Their Packs



There Is a Good Deal of Ordinary Hard Work to be Done at Winthrop; These Men are Taking Their Turn at Keeping the Camp Clean

inconsiderable as compared with a large standing army, and there would be a minimum of interference with civic vocations.

The routine of instruction at Winthrop is very simple. The men attend school daily except Sundays and legal holidays. A regular program of lessons is followed, covering navy small-arms firing regulations, the marine corps and army textbooks. The practical school work includes, among other things, the task of taking apart and putting together, under instructors, the parts of rifles, automatic pistols, machine guns, and 3-in. field guns.

The scope of training navy coaches covers not only navy courses, but also army and marine-corps courses, so that the navy corps of instructors will feel when they have completed their instruction that they know the business of small-arms firing from all angles, even to instruction in estimating distances.

Sailors under instruction shoot not

only the regular navy-qualification courses, but also those of the army, with pistol, machine gun, collective fire, national-match course, long-range firing, etc. They perform all coaching in navy courses, even when the marines fire, and they are also sometimes employed in coaching in the army courses.

After the first week of instruction the men themselves coach every day for a half day, attending school for the other half-day periods. They acquire practical experience first in marking in the butts and in scoring on the firing line, and later in commanding the butts and firing line, telephone service, and, in short, every detail of range work.

The men from the ships are expected to bring only their blankets and old clothes. Any kind of shooting clothes goes at Winthrop. There are no parades and no pomp and circumstance at the rifle range, nothing but hard work and plenty of it, but interesting

withal. Upon arrival they are issued tents, cots, mattresses, and all equipage which will be needed at the range. They are accorded all the privileges of the place enjoyed by the permanent corps of instructors, including the facilities of a well-appointed post exchange, use of canoes on the back river, fishing, baseball, and the like. The messing arrangements are splendid, the station maintaining its own garden, poultry farm, and dairy. A drove of thriving pigs gives promise of fresh pork and bacon. Plenty of fresh milk and eggs are supplied from the station farms, and the robust hunger induced by a half-day's steady drilling is abundantly satisfied with appetizing food.

Notwithstanding the very strenuous grind, the boys like it and become keenly interested in their work. It is not unusual for members of the squad to ask in a body to remain over with the next succeeding party, foregoing their furlough in order to extend the period of instruction beyond the allotted time. These stay-overs become in turn a part of the faculty.

One of the gratifying results of the system in vogue at Winthrop is the good feeling which prevails between the bluejackets and marines. The traditional hostility commonly supposed to exist between these two arms of the service does not prevail.

The working garb of all is reduced to a dead level of uncomeliness, consisting mostly of dungarees, old shirts, and marine campaign hats. A conspicuous feature of the range is its democracy. Officers and men, marines and bluejackets, fire under practically identical conditions. The marines have demonstrated that they like to have bluejackets coach them, because the sailors are enthusiastic and come well prepared to teach the work. The absence of ship drills is appreciated by sailors fresh from the fleet.

Besides the instruction of regulars, arrangements have been made to detail, from each battalion of navy militia, during the summer and fall two petty officers for a two weeks' period of

coaching. Under the navy firing regulations, no distinction is made, the militiamen firing under exactly the same conditions as the sailors and marines.

A feature of Winthrop which deserves special attention is the manner in which it was constructed. The entire station was built by enlisted marines—roads were graded, a telephone system installed, water and sewer systems laid, the old farm buildings repaired and new ones constructed, ranges laid out, rifle butts erected (including a substantial concrete butt just completed), sidewalks and docks built, etc. The visitor finds well-equipped carpenter shops, blacksmith shops, gunsmith shops, and plumbing and paint shops for all classes of repairs. The range, by reason of its isolation, is virtually self-sustaining. The marines man the station and perform all the work, including the care of live stock, the building of new fences, gathering of crops, and the like. At the armory they make all repairs on small arms, and can even construct a new gun.

The officers in charge of the school emphasize the fact that no man should desire to remain away because he knows nothing of small-arms firing. The less the men know about shooting before they go the better, the instructors say. They then have nothing to unlearn. No man can undergo the course of instruction at Winthrop without becoming well qualified in the use and the mechanism of the rifle and pistol.

1193

SKYSCRAPER ROOF USED FOR GARDEN AND HENNERY

What is declared to be a very successful substitute for suburban life is enjoyed by a family which occupies a six-room suite constructed on the roof of a 20-story building just off Broadway, New York. The head of this family is superintendent of the building, and it is he who has transformed the flat roof into a yard and garden. In numerous boxes filled with earth are grown flowers and vegetables. Tobacco

Robert Surridge
Arona Bldg.,
38-40 W. 32d St.
New York

and cotton are also being experimented with. In one corner of the "yard" is a coop and runway in which chickens and ducks are kept from early spring until late in the fall. A sundial and vases lend an artistic touch to the lofty retreat. At the close of the day when work in the big building is done, one may find the superintendent enjoying an hour before sunset digging among his plants or attending to the needs of his feathered friends just as though he were in the country.

1434
NOVEL MOLDED ICING
ON WEDDING CAKE

An elaborately iced wedding cake was recently completed by a *Miss* *Alaba* woman after five days of labor which illustrates the manner in which icing is now modeled or molded instead of being applied so as to make merely embossed patterns. The artistic piece of confectionery is pure white. From its sides hang scores of white strands, or festoons, on which are fastened hearts



COPYRIGHT, UNDERWOOD & UNDERWOOD

Flowers, Vegetables, Cotton, Tobacco, and Even Chickens and Ducks, are Raised in This Substitute for a Suburban Yard Located on the Roof of a 20-Story Building

of icing. An open-work basket of molded icing surmounts the cake. This is surrounded with ferns, tuberoses, etc., all fashioned by hand and spread



Cake Decorated with Modeled or Molded Icing Which Affords Many Opportunities for Producing Striking Effects

over the top of the viand. Rising within the basket is an array of lilies of the valley, daffodils, roses, and leaves wrought with skill and patience. The standard of the cake holder is decorated with icing and a bow of tulle.

1497

COFFEE SORTED ACCORDING TO COLOR BY SELENIUM

La Nature 7/13/16

At the present time the sorting of coffee beans according to color is done by hand, but recently a device has been tried out in certain of the British colonies which performs this painstaking task automatically. Coffee beans are sorted both according to size and color, but the latter is the more important of the processes. This machine's operation is based on a well-known property of selenium, namely, that this element's electric conductivity is increased in the presence of light. With

the new device the beans are carried by a conveyor under a selenium cell. As the light-hued beans reflect more light against the cell than the others, additional current is transmitted through it, which actuates a deflecting needle. This in turn operates a device that diverts the light-colored beans into a separate channel. If the speed of the machine and its first cost make it more economical than hand sorting, it is quite probable that the same principle will be used in sorting grains, tobacco, and many other products in which color is a distinguishing mark of quality.

1488

FIRE HOSE USED AS GAS MAIN AFTER A FLOOD

About 25,000 people living in southern California, in Santa Ana and vicinity, were supplied for several days recently with natural gas received through an ordinary fire hose. The washing away of a 100-ft. section of the bridge over the Santa Ana River, which carried the gas main, cut off the supply of natural gas from a large area. But within 24 hours the employes of the gas company and the telephone company had stretched a cable across the gap and from this they suspended a fire hose which was



Fire Hose being Used to Bring Gas across a River After the Floods had Carried Away Part of the Bridge and Gas Main

connected with the gas mains at either end. In this way service to gas users was reestablished.

OIL-WELL BOMB EXPLODES

1723 HIGH IN AIR

A strange explosion which shattered windows in buildings within a radius of many miles occurred recently near Tulsa, Okla., while workmen were attempting to blow an oil well. Blowing an oil well consists in dropping into a newly drilled well a dynamite charge to which is attached a fuse so timed that it will explode the bomb at the bottom of the well. The explosion breaks away the last barrier of sand and permits the oil to gush forth. In this instance the oil gushed forth without artificial aid an instant after the bomb had been dropped. The up-rushing oil hurled the dynamite and its burning fuse more than 100 ft. higher than the derrick, at which point the explosion took place.

110

BOTTLE PROTECTS CONTENTS FROM AIR DURING TRANSFER

A bottle recently devised for the use of physicians and chemists has a stopper intended to protect liquids from the air during removal to another container. The stopper is hollow and has a perforation in one side which may be lined up with a similar perforation in the neck of the bottle. Through this opening the tip of a syringe may be inserted and any amount of liquid drawn off without exposing any of it to excessive air. Laying the bottle on its side aids this process. Twisting the stopper part way round brings the holes out of line and closes the bottle until again needed.



*Inv. Dr. Siegmund Levy,
 Cöln-Marnsfield,
 Germany.*

SPRINKLER EASILY MOVED

90° WHILE IN USE

An ingenious professor in a western university has combined a lawn sprinkler with a dismantled lawn mower in

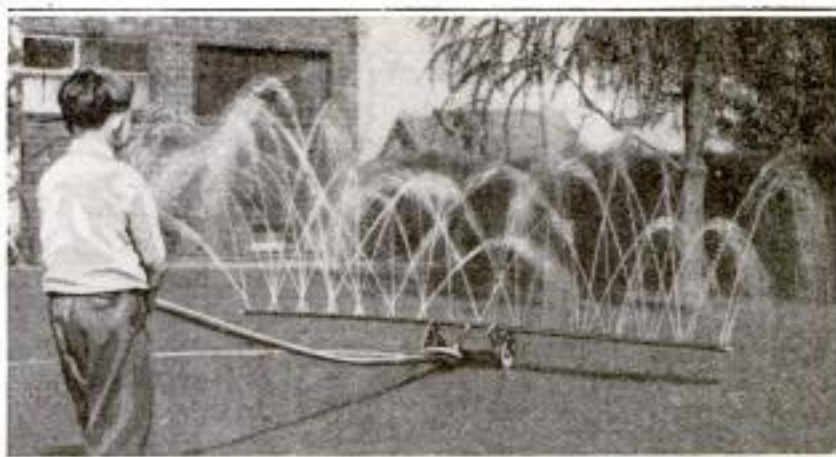

Lawn Sprinkler with an Extra-Long Handle Which can be Moved About While Water is Running

such a way that one can move the sprinkler about the lawn while it is running, without getting wet. The long crossbar of the sprinkler was clamped to the bottom of the mower after the blades had been removed. In place of the ordinary handle a long pole was attached to the transformed mower, which reached well outside the range of the running water. This permits one to move the device about the lawn without the inconvenience of turning off the water.

1517

MOTOR SPRINGS LUBRICATED BY SIMPLE DEVICE

For keeping the spring leaves of a motor car continually oiled, so that they work properly and do not rust or squeak, a very simple and effective appliance has been invented. It consists of a box formed by two grooved castings, each of which holds a felt pad saturated with oil. These members are bolted to a spring so that the pads are pressed against its edges and the lubricant drawn between the leaves by capillary attraction. Oil passes from a small reservoir into the pads and keeps them soaked. These may be filled weekly with the aid of an ordinary oil-can. When springs are properly oiled

*Patented Spring Oiler Co.
 6536 Carnegie Dr.
 Cleveland, O.*

in this way there is practically no danger of water working into the pockets between the leaves and causing corro-

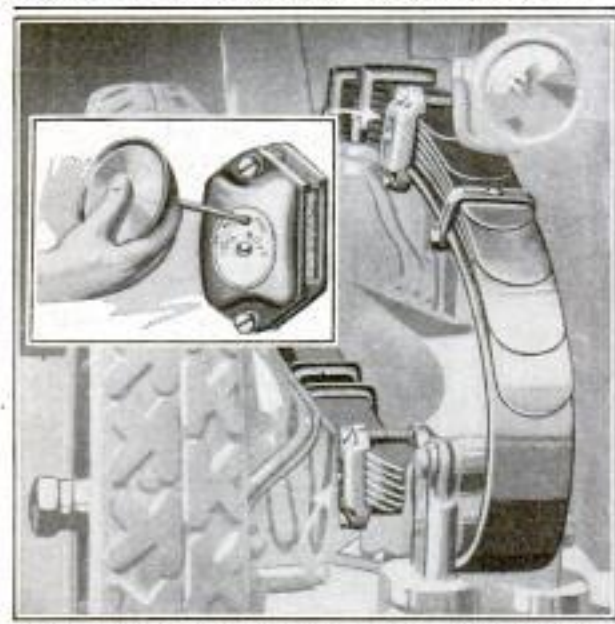

This Indicates How the Boxes are Applied and Where They are Placed on a Three-Quarter Elliptic Spring

sion. Two units are supposed to be applied to each half-elliptic spring. The time-consuming and troublesome process of periodically separating the

BLINDSTITCHING IS DONE BY 880 SIMPLE MACHINE

Blindstitching of both leather and fabrics of various thicknesses is now accomplished mechanically, although it is not long since all of this kind of work had to be done by the tedious hand process. When such sewing is done, the thread does not pass through the exposed surface of the material. The edges of two pieces of leather, or of fabric which will not fray, are thus joined together without the stitches being exposed on the face of the work. On the other hand, a hem may be turned on a skirt made of a light grade of Panama, and sewed without the thread showing through. The counter pockets of heavy work shoes are frequently made of four pieces of material. The edges of these are set together and blindstitched, making a perfect seam. When such work was done by sewing through the leather, the continual rubbing against the seams wore out the thread and often caused the pockets to collapse. The machine



PANAMA CLOTH



LEATHER STITCHED



CLOTH STITCHED



BLINDSTITCHED COUNTER POCKET



ORDINARY METHOD OF SEWING COUNTER POCKETS

Even When Very Thin Fabric is Sewed, the Needle does Not Pass through the Exposed Surface of the Material

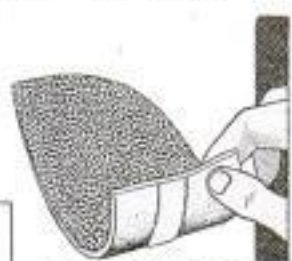
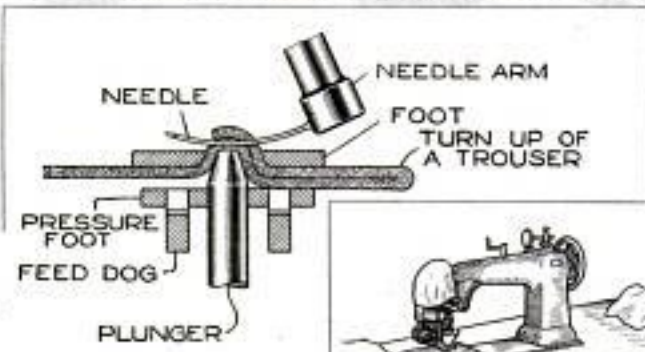

FOOT LININGS IN BOOTS

Leather and Various Kinds of Cloth may be Blindstitched with the Machine

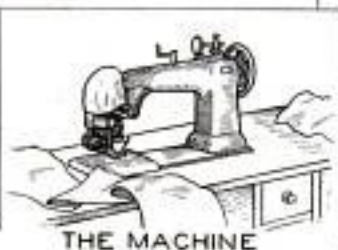

THE MACHINE

leaves, removing rust, and inserting oil and graphite, is thus eliminated. The oilers are easily applied.

which does this character of sewing uses a curved needle. This is held in an arm which moves back and forth,



What Remained of the Ill-Fated Schooner "Aberdeen" after Its Futile Attempt to Ride Out the Storm

instead of up and down, and the sewing is done on the reverse side of the goods. When a hem is stitched, the thread is passed entirely through the upper layer and only part way through the next. If the edges of two pieces of material are held together, however, the needle does not go all the way through either of them. The machine may be adjusted to the thousandth part of an inch, enabling it to be used on quite thin cloth.

~~1495~~ 1566

PHOTOGRAPHS PERSONS WHO LOOK AT SHOE DISPLAY

An unusual advertising scheme which was employed by a shoe dealer in Atlantic City, N. J., consisted in secretly taking a photograph of some one person each week, chosen from among those who stopped to look at the shoes displayed in the store window. The camera was concealed at the rear of the store window and no one looking in ever knew when a snapshot was taken. Each week the picture was published and the person photographed was entitled to a pair of \$5 shoes free.

Levy's
Tennessee Ave.
Atlantic City
N. J.

SCHOONER WRECKED IN GALE ON SAN FRANCISCO BEACH

During one of the most severe storms that have visited San Francisco in a number of years, the schooner "Aberdeen" was recently wrecked and its crew of nine men lost. The ship was caught by a 95-mile gale which had it entirely at its mercy. It was utterly impossible for the craft to ride out the storm, and during the most terrific part it was thrown onto the beach south of the Cliff House and literally smashed into kindling wood by the breakers. Broken timbers and other debris were piled high on the sands, and but little remained of the ship after the storm subsided.

— 1378

MASK FOR SAND BLASTERS WORN WITH RESPIRATOR

To protect sand blasters in foundries from the deleterious effects incident to the inhalation of fine, sharp particles of foreign matter, a mask is made which is intended to cover the worker's head and be worn in addition to a respirator. This is constructed of durable fabric

Multi Metal Separating
Screen Co.
68-72 E 131st St.
New York

and fitted with four large multiple-screened openings which permit a free circulation of air but prevent the passage of sand particles. An adjustable



By Wearing the Mask over the Head a Sand Blaster Escapes Much of the Danger of His Work

frame fits the crown of the head and holds the mask away from the face of the wearer, while at the bottom the device is tied about the neck. The largest of the screened spaces covers the front of the helmet, affording a normal angle of vision. The others appear at the ears and at the back of the head. Besides safeguarding the wearer, the mask permits him to work with greater ease and freedom than is possible with a respirator alone.

WAR CAUSES SCARCITY OF 1599 PRINTED MUSIC

The war has occasioned a rather serious shortage in copies of many musical works because heretofore Germany has controlled much of the market; furthermore she has the master plates of many famous productions, and it is difficult to reproduce these, both because of the cost entailed and

E. S. Monitor 2/26/16

the skilled processes employed. English firms are profiting by their chance to increase their business, branches of certain German houses in Great Britain have been taken over, and for the present their profits are appropriated by the government. But these channels are unable to supply the market fully.

1479 TOWER CLOCK HAS DIALS THAT ARE REVOLVABLE

A feature of the ^{U. S.} post office and customhouse at Newbern, N. C. is a clock with a revoluble dial on each of the four sides of the building's tower. Instead of numerals, each face is studded with opalescent globes which are electrically lighted at night. The dials are of openwork pattern somewhat resembling large wheels. One window behind each is used in replacing the light globes. That this may be done easily the dial is revolved until the defective light is within reach. Near the tips of the aluminum hands are red electric bulbs which aid in showing the hour at night. The machinery of the clock is especially designed to carry the additional weight of the globes and wiring.

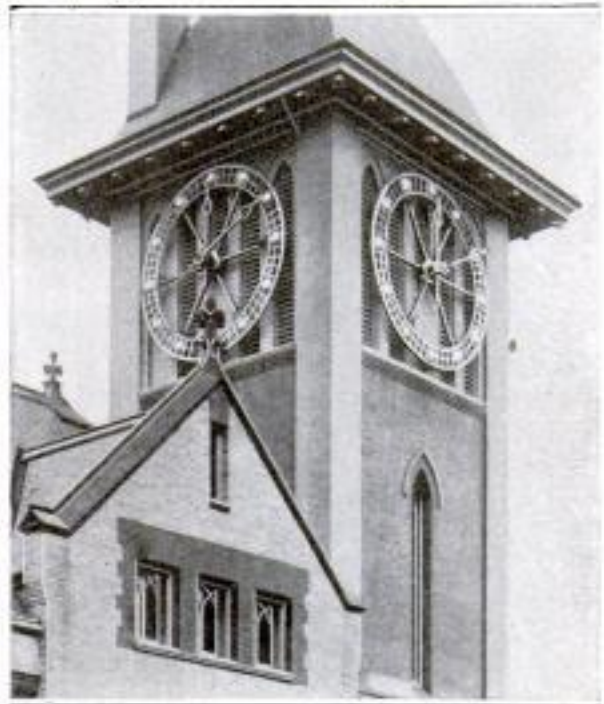

These Dials are Revoluble so That the Electric Globes Which Mark the Hours Instead of Numerals can be Replaced Easily

Pat. Aug. 2



Either Firing a Revolver or the Impact of a Racer will Operate This Automatic Timer

AUTOMATIC TIMER OF RACE- 621 COURSE EVENTS

Races of many kinds are started with the firing of a revolver. When, however, one of the timekeepers has to wait until he hears the gun report before starting his stop watch, an element of error is introduced, due to the slowness of human movements. With the obvious intention of eliminating such an error, a mechanism has been patented which is intended to work a stop watch automatically. Firing off the gun makes the exploded gases hit a paddlelike lever mounted on the end of the gun, causing a switch to be closed. This in turn works an electromagnet which starts the stop watch by pulling down on a lever. Another switch, consisting of a long arm projecting out over the speedway, is provided, which also may actuate the stop watch through the electromagnet. This second switch may take the place of the revolver, and is operated by the

impact of a passing racer. Firing the revolver starts the stop watch and the impact of the racer stops it at the last lap of the race.

— 1130 —
**TWENTY CENTURIES COVERED
IN NEW CALENDAR**

Simplicity of arrangement is one of the outstanding features of a 2,000-year calendar which has lately been devised by a New Jersey man. Its span reaches from the year 100 to 2,100, offering a ready means of determining on what day of the week any date within this period fell, or will fall. The Gregorian rule of intercalation is followed throughout. The calendar consists of a chart, printed in pocket size, containing five column divisions under the headings of months, days, key, centuries, years. Underlined numbers in the years column represent leap years, while in the months column dashes following January and February mean that the numbers appearing with those

Geo. N. Garrison Co.,
East Orange
Copyrighted material

respective months should be used only in making leap-year calculations. Elsewhere in the column the two months

MONTHS	DAYS	KEY	CENT	YEARS
MAY	1-8-15 2 2-29	THU -4 FRI -5 SAT -6 SUN -7	20-16 12-5	05-11-16-22 33-39-44-50 61-67-72-78 89-95
FEB— AUG	2-9-16 23-30	MON -8 TUE -9 WED 10 THU 11	19-11-4	04-10-21-27 32-38-49-55 65-66-77-83 88-94
FEB MAR NOV	3-10-17 24-31	FRI 12 SAT 13 SUN 14 MON 15	10-3	09-15-23-26 37-43-48-54 65-71-76-82 93-99
JUN	4-11-18 25	TUE 16 WED 17 THU 18 FRI 19	18-9-2	03-08-14-25 31-35-42-53 59-64-70-81 87-92-98
SEP DEC	5-12-19 26	SAT 20 SUN 21 MON 22 TUE 23	15-8-1	02-13-19-24 30-41-47-52 58-69-75-80 86-97
JAN— APR JLY	6-13-20 27	WED 24 THU 25 FRI 26 SAT 27	17-14-7	01-07-12-15 29-35-40-46 57-63-68-74 85-91-95
JAN OCT	7-14-21 28	SUN 28	13-6	00-06-17-23 28-34-45-51 56-62-73-79 84-90

By Making a Simple Calculation, This Calendar Shows on What Day of the Week Any Date, Since the Year 100, Fell

again appear with other numbers which are intended to be used ordinarily. To illustrate the manner in which the calendar is employed, Sept. 14, 1890, may be taken as a test date. In the months column September is designated by the figure 5 in a triangle at the lower right-hand corner of the square. In the days column the fourteenth is similarly designated by the figure 7. In the century column the unit number for 18 is 4, and likewise in the years column 5 appears with 90. Adding these figures, 5, 7, 4, and 5, the sum 21 is reached. Sunday appears opposite this number in the key column. Therefore Sept. 14, 1890, fell on Sunday. If Feb. 2, 1932, were taken, it should be remembered that this will be a leap year, and that in making the calculation the number accompanying the "February" which is followed by a dash should be used. The computations are simple and may be made in a moment's time.

SHORTAGE MAKES FARMERS CONSERVE SEED CORN

The prospect of the most serious shortage of seed corn that this country has experienced in years has resulted in an extensive campaign for the conservation of seed corn, particularly in what is known as the Corn Belt. Special emphasis has been laid on properly storing seed corn and testing it so that only good seed will be planted this spring. Bankers, school-teachers, and preachers have shared in the agitation. Many farmers had planned to use 1914 corn for seed, but the war has made it scarce. In any event, such corn should be tested, say agricultural experts. The cold, rainy summer of 1915 produced much corn that was immature, had an excessive amount of moisture, or was otherwise unfit for seed. By properly hanging the selected ears in a dry place, and by germinating a few kernels from each ear, farmers have been able to select only such seed as will give a profitable yield.

ELECTRIC LANTERN SHAPED LIKE A WATCH 9653

A convenient electric lantern, just placed on the market, is shaped somewhat like an unusually large watch and is provided not only with a bail but with an easel-like support by which it is held in upright position when set on a flat surface. The lantern can be adjusted so that it either produces a general illumination or throws a small searchlight beam a hundred feet ahead. Current is supplied by a standard flash-light battery that can be obtained at any electrical store and is easily removed and replaced. The light is switched on and off by a thumbscrew at the top of the case.

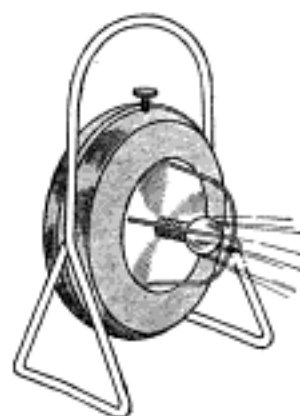

*Sturmpf Novelty Co.
105 W. Madison
Chgo.*

NEW METHOD OF TINNING

WIRE SAVES METAL

London Times Weekly 1/14/16

A system of tinning wire which effects a considerable saving by preventing oxidation of the melted metal has been introduced in England. The melting pot of the furnace is surmounted by a dome-shaped casting through which pass the waste gases from the Bunsen burners that heat the pot. Because of this oxygen-free atmosphere there is an absence of oxidation of the melted metal, which results in a saving of \$1 per ton, it is estimated. The metal is maintained at the proper fluidity by a thermostat which governs the flow of gas. The gas is fed from the municipal mains at low pressure without the use of fans, blowers, or compressors. The wire is run through the melting chamber and into the melting pot, a method of spring control preventing the breaking of the strands. A fixed wiper, which acts on the wire as it leaves the melting pot, causes the drips to fall back into the melted mass.

1371

REGULAR AND VESTIBULE

TELEPHONES COMBINED

Elec. Rev. & W. Electrician 1/29/16

Since telephones instead of speaking tubes are now generally used in large apartment houses between the entrance vestibule and each apartment, an adaptation of a telephone system used in some offices has been designed, which dispenses with an operator in the vestibule and likewise makes two telephones in each apartment unnecessary. A telephone instrument is installed in the vestibule and connected with a common-battery substation telephone in each suite. Connected with the vestibule instrument is a set of buttons, or other means of ringing an ordinary vibrating bell in any apartment with which communication is desired. The tenant answers by throwing a cam switch key into a certain position. If a call comes from the city exchange, it rings the regular telephone bell, and communication is established by throwing the key into another position.

Western Electric Co.
500 So Clinton, Chgo.
463 West St., New York.

CALIFORNIA TRAMP COOKS

MEALS ELECTRICALLY

Baltimore Star 1/17/16

Out of Marysville, Cal., comes a story of a hobo who prepares his food on an electric hot plate instead of



Hobo Prepares Meals on Hot Plate by Tapping Current of Electric Interurban Lines

cooking it over an open fire kindled with brushwood picked up from the wayside. He camps along the right of ways of electric-traction lines and thus always has an abundant supply of current at his command. He carries a small folding gridiron, on the under side of which is a series of resistance coils. When mealtime comes he places the device on a couple of bottles or a stone, grounds it by making contact with a rail, and then throws an insulated wire, fitted at one end with a

hook, to an overhead transmission line, or fixes it to a third rail. It is not a trick to be attempted without great care, however, for a dangerous shock is as likely as not to result.

1310

SIMPLE MOTOR-CAR HEATER AND VENTILATOR

A motor-car heater and ventilator which utilizes surplus heat from the engine by the aid of a forced-draft



system is now manufactured for practically all types of gasoline cars. A small register is set in the floor in front of the front

seat and is connected with a sleeve which is placed over the exhaust pipe

in such a position that the draft from the fan and the air current caused by the forward movement of the car will strike it. There is no contact with exhaust gases. By tacking a piece of cloth, about 9 inches square, to the under side of the front floor board a cold draft from the pedal holes is deflected, and by using a piece of rubber matting with a slit in it the opening about the side lever is practically closed.

1524

SCHOOLS' BILLIARD TABLES MAY CHECK POOL-ROOM EVIL

An experimental effort to counteract the lure and the vicious influence of the pool rooms of Chicago with billiard tables placed in wholesome surroundings is being made in that city by installing a pool table in each of two public schools. The tables are placed in the game rooms and are used on the evenings when the building is open as a social center.

*Scanlon School
 Home of the Future by Chas. McVinley*

9540

INSTRUMENT FOR DRAWING CIRCULAR CURVES

Wm. S. Weston Co., 1431 Marquette Bldg., Chicago

A new drafting instrument that is intended to replace the set of curve templates commonly used in drafting offices, is an adjustable ruler with which circular arcs of from 3½ to 100-in. radius can be drawn. This instrument can be used with either a concave or a convex ruling edge. The flexible rule is mounted on end plates which are provided with slots that engage pins carried on the rigid scale bar, and with this arrangement the rule can be slid from one side of the scale bar to the other. When the rule is on one side of the scale bar the ruling edge is convex, and when on the other side the ruling edge is concave.

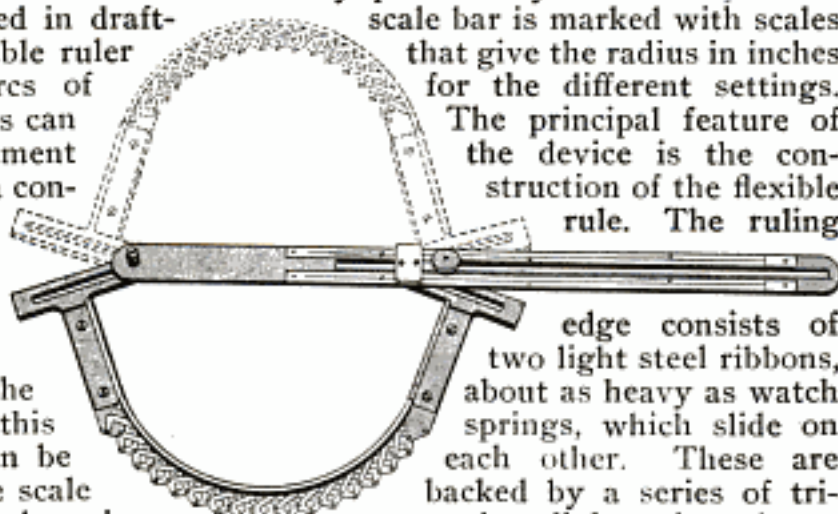

This Rule can be Set for Any Circular Arc from 3½ to 100-Inch Radius. Full Lines Show Rule Set for Concave Curve; Dotted Lines, Convex

One of the pins is fixed to the end of the scale bar, while the other slides in a slot which runs longi-

tudinally of the bar and can be fixed in any position by a setscrew. The scale bar is marked with scales that give the radius in inches for the different settings.

The principal feature of the device is the construction of the flexible rule. The ruling

edge consists of two light steel ribbons, about as heavy as watch springs, which slide on each other. These are backed by a series of triangular links pivoted together and so connected with the ribbons that the same degree of curvature is maintained over all of the ruling edge. The flexible part connects at each end with a straight section that forms a tangent to the curve.

Inventor: *Richard Tjader,*
"Vikingsburg", Darien, Conn.

POPULAR MECHANICS

1116956-*Nov 10, 1914 -* *Mag. V. 208-557 - other pending* 757



Automatic Davit Lowers Boatload in Less than One Minute's Time through Aid of Quadrant Arms Supported upon Rocker Base

5960

AUTOMATIC DAVIT LAUNCHES LIFEBOATS QUICKLY

Since the "Titanic" went down, law-making bodies have been prolific in mandates setting forth what shall be done to increase safety of life at sea. Strongest emphasis is placed on a sufficient number of lifeboats and a proper method for their launching. An automatic davit, recently invented, seeks to satisfy the latter requirements in some degree. Consisting of two steel quadrant arms supported by suitable standards at each end of a lifeboat, the contrivance differs materially from the sort of davits and tackle ordinarily used.

At the moment when passengers are piling into one of the boats the stand-

ards are in vertical position and the boat's keel is held steady with a special claw which grips it securely until released by a hand lever. A hook, caught on the gunwale, also aids in the steadying process. Pushing the forward lever releases the whole apparatus and the quadrant arms slide slowly down an inclined plane until, projecting far out over the ship's side, they are in position to lower the boatload safely. One of the men in the boat holds a rope tied to a brake arm on the hoisting mechanism above. With this he is enabled to control the speed of descent. The whole operation of releasing and lowering the boat may be performed in less than one minute if necessary. There is little danger of the ropes jamming and causing trouble.

Marine Efficiency Co.,
17 Battery Place,
New York

Copyrighted material

"The Columbia"

SOME NOVEL AND LITTLE-KNOWN ACCESSORIES



1
False Top, Made of Tongued and Grooved Sections, Converts Any Table into a Commodious Round One When Guests are to be Entertained at Dinner

2
Hairpin of New Type Available in Various Sizes and Colors, Designed with Gripping Member Which is Intended to Hold It Securely in Place



3
Within a Half Hour after Ingredients are Placed in This Vacuum Freezer, Ice Cream is Ready to Serve. It is Especially Convenient for Motorists



4
Neat-Appearing and Convenient Holder for Toothbrush, Having Antiseptic Vaporizer Which Sterilizes the Bristles and Keeps Them Sweet and Germless without Special Attention on User's Part



5
This Scoop Has a Weighing Mechanism and Indicating Dial Embodied in Its Handle, While Intended for Stores, It might Also be Employed Advantageously in Large Kitchens

6
Motor Attachment Illustrated at the Right Enables Any Phonograph to be Operated Electrically: The Device is Not Permanently Mounted, but Merely Set so That Its Propulsion Wheel is in Contact with the Rim of the Turntable

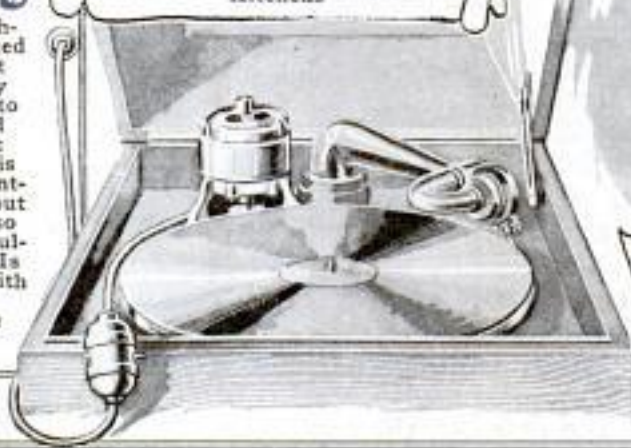

7
Cover Plate and Bail for Milk Bottle, Enabling the Latter to be Carried Easily and Its Contents Protected. Device is Unfastened by Raising Cap

SHOW

1580

- 1 BANQUET TABLE TOP-- *Stotas & Davis Furniture Co, Grand Rapids- Mich*
60" to 96"
8 " 16 people
12" " 47"
- 2 HUMP HAIR PIN-- *Hump Hair Pin Co., Chicago. 1732 So. Mich. Av.*
5 x 108
- 3 VACUUM FREEZER-- *Auto Vacuum Freezer Co., 10 Wall St. New York-*
15 Beacon St., Boston.
- 4 TOOTHRUSH HOLDER-- *Sanit-Air Company, 204 W. 23rd. St., N. Y.*
Refills 10¢ (Vaporizer)
- 5 SCOOP AND SCALE--
 1,116,727. WEIGHING-SCOOP. JAMES A. PICKENS, Mo-
 bile, Ala. Filed May 28, 1914. Serial No. 841,632.
 (Cl. 73--46.) *V208-477 Nov 10 '14*
- 6 PHONOGRAPH MOTOR-- *Shelton Electric Co., 30 E. Randolph, Chicago.*
30 E 42nd St. New York
Arnold Electric Co., Racine, Wis.
make a similar - "Phonomotor"
- 7 MILK BOTTLE TOP-- *John Carney, Pawtucket, R. I., Inventor--*
- 8 "KANT-KLOG" SALT SHAKER-- *Humboldt Mfg. Co., 830 Humboldt St.*
Brooklyn, N. Y.
- 9 MILK TESTING APPARATUS--
J. R. G. M. 1178044
Tested & recommended by Dr. Winckel
& Dr. Seclinski, sworn commercial
chemists, Munich, Bavaria.
- 10 MANICURE SET--
Majestic & Well 1586 1/2 1st St. W. London
172 Regent "W"
& "A. V. Hornum" "E.C."
- 11 FOLDING PARASOL--
Harman's 115 So. 13th, Phila.
25" 35" 50"
- 12 SIDE-DRAIN REFRIGERATOR-- *Ranney Refrigerator Co., Greenville, Mich.*
- 13 HEATLESS TROUSER PRESS-- *Invention Mfg. and Sales Co., 10 Wall St. N.*
 1,112,922. PANTS-PRESS. THOMAS F. LEAHY, Pough-
 keepse, N. Y. Filed Sept. 4, 1913. Serial No. 788,130.
 (Cl. 100--57.) *V. 207-178-006 '14*
- 4 GOLF GLOVES-- *Mark Cross, 404 5th. Ave., N. Y.*

Reed
mch 6 1916
B

DEVELOPED FOR THE HOME AND ITS MEMBERS



8
The Spiral of Noncorrosive Metal in the Cellar is Revolved by Turning the Knob at the Top. This Breaks Up the Salt and Allows It to Flow Freely Even When Damp



9
Hydrometer Designed as a Household Instrument for Testing the Quality of Milk: Instead of being Graduated in the Usual Way, the Tube is Divided into Three Colored Sections

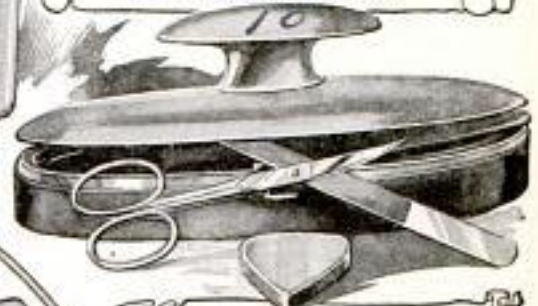

10
This Manicure Set, Which Fits in a Large Buffer, is Available in Different Qualities. Its Compactness Makes It a Convenient Accessory for the Traveler's Toilet Case



11
In Addition to Having an Adjustable Handle, This Parasol is Designed so That It may be Folded and Slipped into a Small, Attractive Case. It is Suited for Beach, Canoe, or Open Car



12
The Refrigerator Shown at Right is Provided with an Attachment Which Permits Water from the Melting Ice to be Drained into a Kitchen Sink



13
When Packed in a Trunk or Suitcase, Men's Trousers may be Kept in a Presentable Condition if Held in a Pressing Form Such as is Shown Here. The Device is Made of Fiber and Weighs 20 Ounces



14
Correct Gloves for Golf Players: The Right One is Made Entirely of Chamois, While the Palm and Inside of Fingers of Left Are of Tan Capped Skin. Both Have Open Knuckles and Button on the Outside of the Wrist

1156100-Oct 12-1915 Vol. 219-270

Charles Roth, New Philadelphia, O. Assignor
of 1/2 to Joseph Maggi, " " "

760

POPULAR MECHANICS

filed 9/24/14 Serial 863338 [Cl-33-149]

**INSTRUMENT COMBINES TWO
927 TYPES OF CALIPERS**

Calipers with bifurcated members of a design which makes them adapted to a wide range of uses in taking both in-

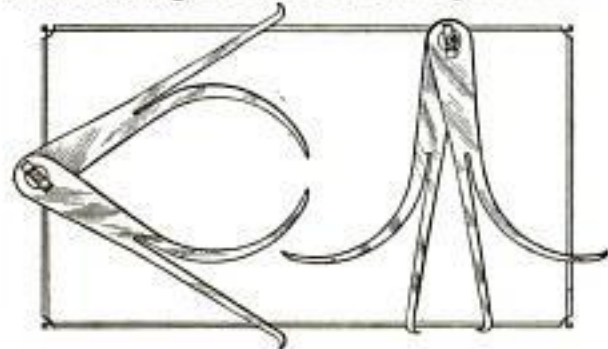

These Calipers with Reversible, Bifurcated Members can be Used in Measuring Articles of a Great Variety of Shapes

side and outside measurements, have been patented. This instrument consists of a pair of members pivoted at their upper ends and so constructed that they allow a reversal of their positions by rotation about the pivot, to which is attached an ordinary thumb-screw for setting them in any position. Of the two limbs resulting from the bifurcation of each member, one is straight except at the tip, which curves outward, and the other is curved, being of quadrant formation. The curved limbs of the two members normally project inward. By drawing the two

straight legs into almost parallel positions, with the curved tips extending outward, the instrument can be used to measure exceedingly narrow spaces. Another of the many uses of these calipers is ascertaining outside distances at the far side of an intervening pipe or other obstacle. This is accomplished by extending the curved legs around the obstruction, to the object to be measured.

159

**MARINE MOWING MACHINE
FOR SUBMERGED WEEDS**

To clear off water lilies, reeds, and the assorted weeds which habitually overrun shallow lakes, an Ohio experimenter has recently brought out a marine mower, operated by a gasoline engine and moved from place to place by boat. The sickle on the contrivance much resembles that on the ordinary farm mower, and is suspended beneath the boat by means of suitable rods. A gasoline engine of the type used for driving rowboats furnishes power for the sickle through the aid of a connecting shaft running down into the water. Another and similar engine drives a propeller at the rear end of the boat, and forces the whole affair against the weed beds at any rate desired by the operator.

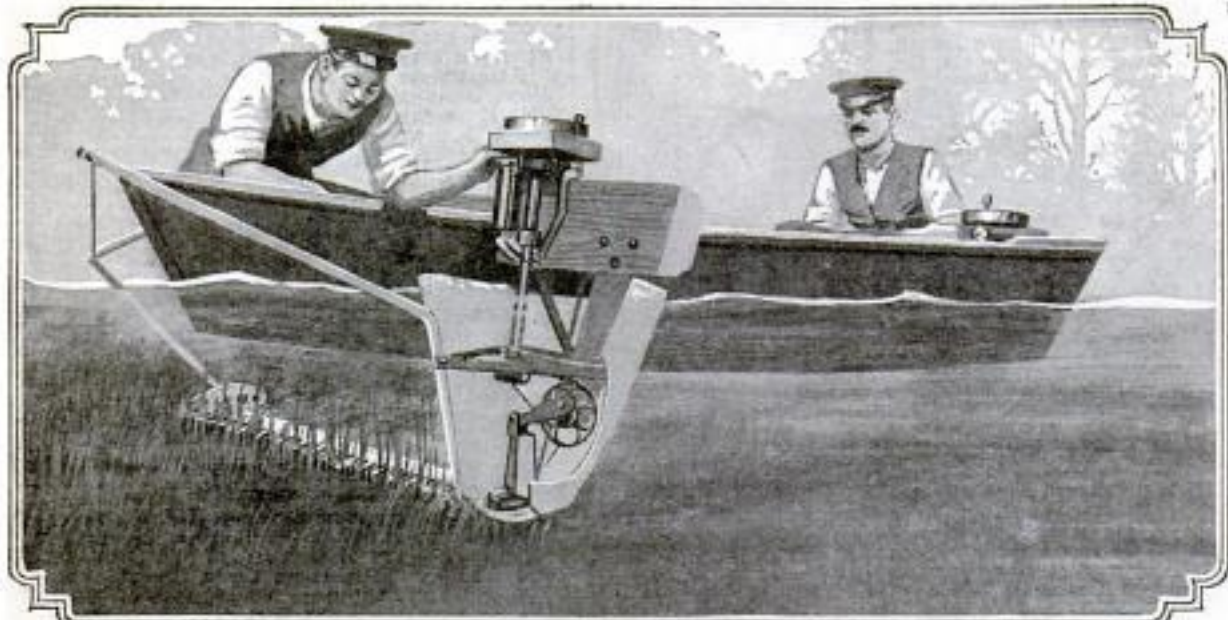

Sickle Set Up beneath Rowboat Mows Under-Water Weeds of Shallow Lakes. A Gasoline Engine Drives the Sickle and a Second Engine Propels the Boat into the Weed Beds

Inventor: A. H. Wilson
90 A. H. Wilson Motor Car Co.
Canton, O.

Inv: J. Nadel
148 E. 92d St.
New York
761

DRILLING WELLS BY HAND THROUGH LIMESTONE

Quite a simple and inexpensive plan of driving a well in limestone formations is commonly followed in Dade County, Florida, on a strip of high ground extending between the Everglades and the ocean. The material, which is very porous and soft, is covered by only a few inches of soil. It offers little resistance and is easily penetrated with almost any tool. This has led to the practice of cutting a series of teeth in one end of a coupling, screwing a length of pipe into the other end, and using the implement thus formed in place of a drill. Two men, standing opposite each other, grip the pipe and strike into the limestone with it. The teeth provided in the coupling quickly chip into the soft rock and in a very short time a good start can be made. A small amount of water is poured into the hole at intervals to facilitate the work. With each stroke the pipe is turned slightly. Usually surface water is struck at about 15 ft., and unless quicksand is encountered, a pipe can be driven that distance in a couple of hours. When water is wanted for drinking purposes, however, a bore is commonly carried to a greater depth. At times a pipe is driven down 50 or 60 ft. by this hand method, and since labor is cheap, a very small expense is incurred. At the lower depths salt water is often reached, making it necessary to draw back. When a pipe has once been put down, the bore forms a casing for it and permits it to be withdrawn and its screen cleaned or repaired at any time conditions may demand. The natural trend of the water in the Everglades at this point is to flow through the porous formation to the sea. Because of this, it is not unusual to find a fresh-water spring in close proximity to salt water.

¶To protect army surgeons in active service from being accidentally fired on, it has been proposed that the surgeons of all nations wear similar uniforms of some vivid color.

SUBSTITUTE FOR BUTTONS AND LACINGS 1263

A hookless and buttonless fastener which takes the place of laces, shoe



A Shoe Fastener Which Dispenses with Buttons and Laces. Insert Shows How the Tiny Metal Members may be Made to Interlock Simply by Pulling the Tongue in the Center

buttons, etc., is being manufactured. To the edges of two pieces of material to be fastened together are clamped rows of small metal loops which project slightly beyond the material. They are set far enough apart so that the ends of the loops on one piece of material may be fitted between the ends of the other series of loops. One side of each loop end is concave and the other is convex, so that when the two series are fitted together they interlock firmly. To separate the projecting ends slightly, in order that the two series may engage each other, the two edges are fed through a Y-shaped metal guide entering at the top of the "Y," as shown. The edges emerge from the lower end of the "Y," firmly interlocked. To fasten or unfasten the two edges it is only necessary to move the guide up or down.

**DOUBLE CONNECTING ROD
REDUCES PISTON SPEED**

La Nature 2/6/15

A double connecting rod recently brought out by a European inventor affords an interesting study in mechanical movements.

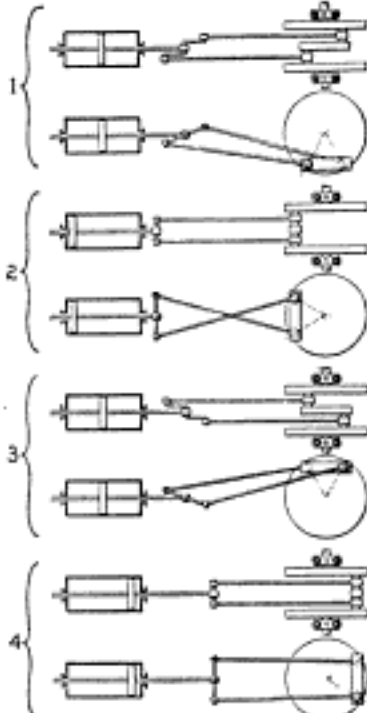

- 1—Showing Top and Side View of Piston and Connecting Rods in the Middle of a Stroke
- 2—Here the Piston has Reached the End of Its Stroke and the Connecting Rods are Crossed, Reducing Their Effective Length. During the Crossing Process the Piston Slows Up
- 3—This is the Same as the First Position Except That the Crank is Now in the Upper Half of Its Stroke
- 4—Here the Straightening Out of the Connecting Rods from an Angular to a Parallel Position Results in Reduced Piston Speed at This End of the Stroke

much resembles the pedal crank on a bicycle. To the outer ends of this crank two long spindling rods are attached, these running to two individual cranks a small angular distance apart on the main, or flywheel, shaft of the engine. Hence the force supplied by the piston is carried to the flywheel through this double connecting rod, instead of a single, as in the ordinary engine. The advantages claimed for this arrangement are several. Due to the fact that the connecting rods are attached to a double-ended lever at one end, and to two pins on the same side

of the driven axle at the other, they are at times crossed and at other times parallel during a revolution, as is shown by the drawing. This has the effect of lengthening and shortening the distance between piston rod and crank. As a result, the piston speed at both ends of the cylinder is less than it otherwise would be. In consequence it is maintained that this arrangement allows for high flywheel speed with as little vibration due to reciprocating parts, as other engines with an ordinary connecting rod attain at a lower speed. Furthermore, in the case of a gas engine, the low piston speed at each end of the cylinder makes admission, combustion, and exhaust easier to accomplish. This is an attainment often desired in combustion engines running at high speeds.

of the driven axle at the other, they are at times crossed and at other times parallel during a revolution, as is shown by the drawing. This has the effect of lengthening and shortening the distance between piston rod and crank. As a result, the piston speed at both ends of the cylinder is less than it otherwise would be. In consequence it is maintained that this arrangement allows for high flywheel speed with as little vibration due to reciprocating parts, as other engines with an ordinary connecting rod attain at a lower speed. Furthermore, in the case of a gas engine, the low piston speed at each end of the cylinder makes admission, combustion, and exhaust easier to accomplish. This is an attainment often desired in combustion engines running at high speeds.

1069

**PAPER UMBRELLA FOR
EMERGENCIES**

A paper umbrella, for use in emergencies, which its makers claim is rain and wind-proof has recently been put on the market. It is designed to be sold at news stands, elevated-railroad stations, restaurants, cigar stores, etc. The article consists of a metal frame of special design to give it unusual flexibility, a wooden handle, and oiled-

"Emergency Umbrellas"



In This Umbrella Oiled Paper is Used Instead of Cloth. It is Comparatively Inexpensive and is Designed for Use in Emergencies

paper covering. It is light and folds compactly, while with ordinary care it can be used several times.

*R. 10 36 Beekman St.
F. W. Howard New York*



Locating and Repairing Small Leaks in Automobile Radiators

A slight leak in a radiator is very often hard to locate and in some cases almost impossible. Such a leak may be found quite readily by removing the radiator and, after plugging all the openings except one, running the end of a tire pump through a cork of suitable size and placing this cork in the remaining opening. Put the radiator in a tub or tank of water and pump air into it, and bubbles will issue from the points of leakage. These points should all be carefully marked before the radiator is removed from the water. The surface of the metal around the hole should be thoroughly cleaned and then soldered. It is always best to test the radiator after making the repairs, as very often the opening is not completely closed.

In some cases small leaks may be closed by using ordinary bran mixed with water and placed in the radiator instead of clear water, but such a practice is not recommended, as it tends to produce a poor circulation, and the engine will heat.

Small leaks may be sealed as a result of cleaning out the circulating system with a strong alkali, such as soda. The soda coming into contact with some of the metals forms an insoluble filling and may close the opening entirely.

A convenient means of making a temporary repair in a leaky honeycomb radiator is to take two small washers with sheet-rubber surfaces and place them on opposite ends of the opening through the radiator in which the leak occurs, and draw them together with a piece of small wire, or short spiral spring.

Large-Area Sprinkler

Pipe fittings of standard sizes were used in making the sprinkler shown in the illustration. The area watered varies from 100 to 120 ft. in diameter, according to the water pressure. The device may be made easily by buying the fittings and joining them, as shown, with white lead rubbed into the joints. A farmer at Quilcene, Wash., used several of them with great success during a dry spell.—Contributed by F. B. Willoughby, Katalla, Alaska.

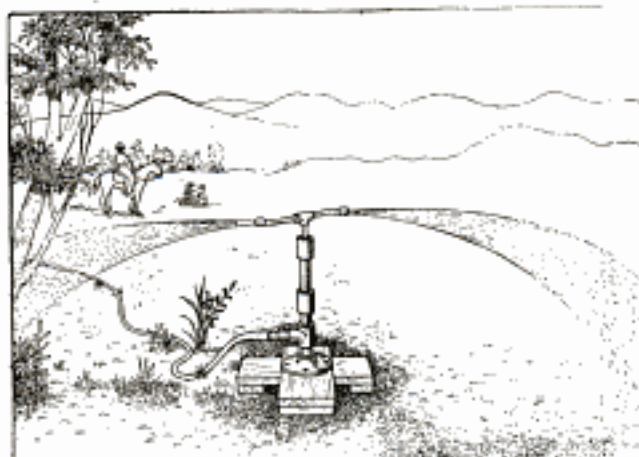

This Homemade Sprinkler Sprays an Area 100 Feet Across

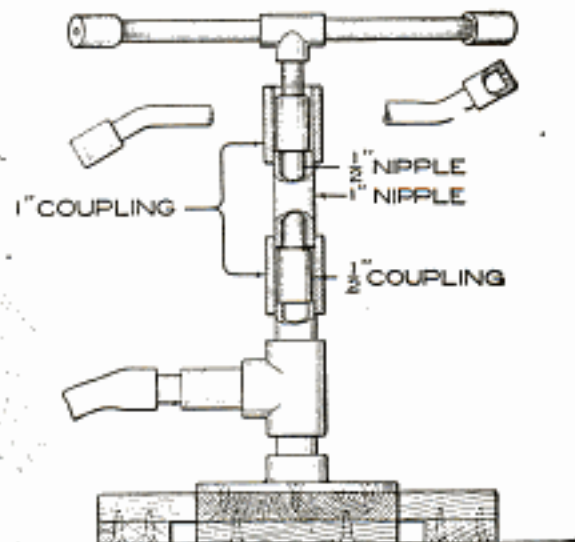

Track for Painting Tanks or Silos

Tanks and silos on the farm, or elsewhere, must be painted from time to time and with

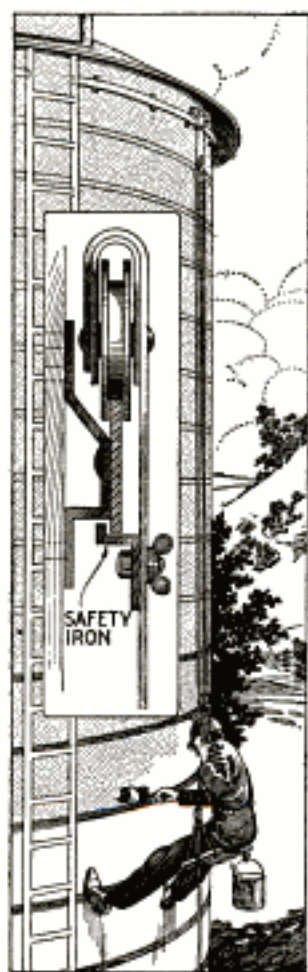

changes in the seasons their bands should be adjusted. This work is troublesome because a ladder must be moved frequently in order to do the work. The device shown in the sketch obviates this and is of simple construction. If it is made properly with a safety iron, as shown, there should be no danger.

The workman is suspended in a sling seat and raises and lowers himself by means of blocks and tackle. The rigging is suspended from a double-roller

hanger which rides on a track made of band iron. The hanger and the rigging may be readily put into place and as readily removed when the work is completed. Its compact form makes it convenient for storing, when not in use. —Contributed by I. L. Sears, Waverly, Illinois.

An Improvement on Grinding Machines

An improvement for grinding machines in general can be applied as follows: On all machines having a variable speed through a belt and cone pulley, the marking can be cut on the cone. Where a variable-speed motor is used, the same result may be obtained by marking the switch or, prop-

erly speaking, the controller, instead of the faces of the steps on the cone pulley. This idea will surely eliminate many accidents and prevent considerable loss by broken wheels.

The idea is quite simple and consists in stamping, or etching, on the face first the speed of the grinding spindle when the belt is on that particular step of the cone, in revolutions per minute; the largest size wheel it is safe to use at this speed, a safe average being taken for cup wheels, dish wheels, straight-face wheels, etc.; and to this may be added, if desired, the surface speed of the maximum-size wheel in feet per minute.

All the information needed may be readily obtained from the catalog of any manufacturer of abrasive wheels. Many well-known firms will sanction this idea as being of practical value.

Thinner Oils Used on Automobiles in Winter

As cold weather tends to thicken oils, it is quite necessary to remove this oil from the gear sets on an automobile, and lubricate them with a thinner oil. In doing so, drain the heavy oil and flush out the box with kerosene, to remove any gummy deposit.

Holder for Cellar Doors

Four pipe fittings and five pieces of pipe can be fashioned into an excellent device for securely holding two cellar

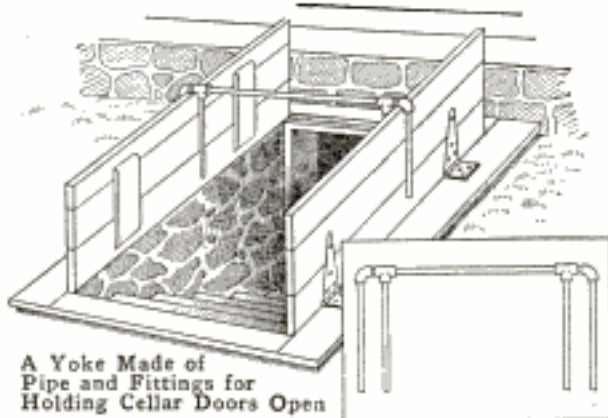

A Yoke Made of Pipe and Fittings for Holding Cellar Doors Open

doors open. The holder is slipped over the doors after they are raised into a vertical position.

Adding Luster to Brown Iron Paint

Brown iron-oxide paint has been noted to lose its luster soon, and while this may be partly due to the possible addition of turpentine, yet the flat drying is rather a peculiarity of the paint, and it is helped by using boiled oil with it instead of the raw oil and omitting all turpentine or benzine driers.

Platform for Mixing Concrete

Concrete has become one of the best materials for building construction on the farm, as elsewhere, and knowledge as to its proper mixing is of importance. One of the requisites is a mixing platform, and that shown in the illustration may be made readily. Farmers, or others who prepare concrete from time to time, will be repaid for the making of such a platform.

The materials necessary are three pieces, 12 ft. long and 4 in. square, for the runners; 14 planks, 7 ft. long, 10 in. wide, and 2 in. thick, and two pieces of 2 by 4-in. material, 12 ft. long. It is built on skids so that it may be hauled from place to place. The planks should be surfaced on the upper sides so as to be suited for the shovel-

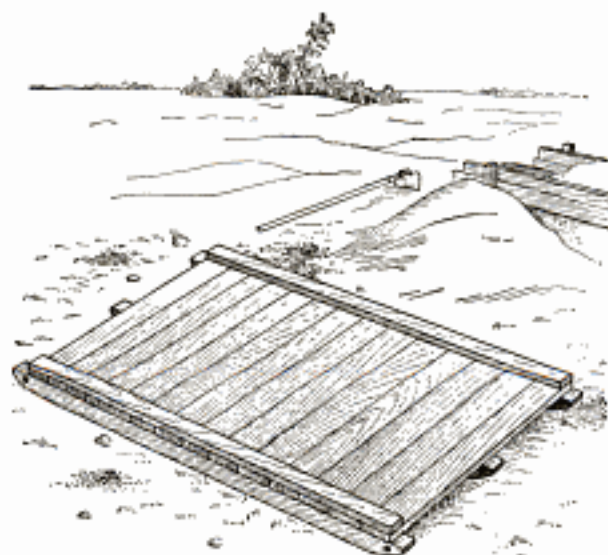

The Concrete-Mixing Platform may be Hauled into Place Readily

ing of concrete. Holes are bored in the rounded ends of the skids so that clevises may be attached to them.

Preventing Ditch Washouts

Spillways placed in irrigation and mining ditches on hilly ground prevent washouts during periods of high water.



Spillways in Irrigation and Mining Ditches on Hilly Ground Prevent Washouts

The spillways may be made of wood and should be placed as shown in the sketch, about one-fourth of a mile apart. The bottom of the trough should be grooved into the sides to make a substantial construction.—Contributed by H. W. Offins, Grants Pass, Oregon.

Keeping the Buttonhook Handy

Suspending the children's shoe buttonhook on a piece of fishline above a footstool ended the daily search for the hook when the youngsters were in haste to dress for school. Each one goes to the buttonhook, knowing that it will be in place, instead of carrying it away and causing another a search. The stool was also found convenient in that it spared furniture from the marks of shoe nails.—Contributed by J. F. Long, Springfield, Mo.

A Novel Cigar Holder



A unique cigar holder can be fashioned from the claw of a lobster. It not only answers the purpose well, but its color is much more pleasing than many a meerschaum. — Contributed by James M. Kane, Doylestown, Pa.

Carburetor Air-Valve Shaft Covering

The bushing that guides the shaft on the auxiliary air valve of my carburetor was of the open type, and the dust and grit would collect between the shaft and the bushing, causing the valve to stick badly. I decided that the bushing must be closed in some manner, which resulted in the repair illustrated herewith. The hole in the bushing was redrilled to a larger size, and a piece of thin steel tubing was pressed into it, as shown. A thread was provided at the upper end of the tubing for the purpose of attaching a small cap. This cap was turned from brass-bar stock. — Contributed by Adolph Kline.

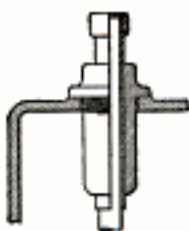

Oiling a Drill

Oil may be constantly applied to a drill point as shown in the sketch. Wrap a small piece of cotton waste around the drill at the top, and saturate it with oil. If the drill becomes heated the oil will flow more freely and keep the point well lubricated. — Contributed by Harry Quinter, Steelton, Pa.



Emery powder may be kept handily in an old salt shaker.

Glare Dimmer for Automobile Drivers

A 6-in. disk of transparent, green celluloid, pasted to the windshield a trifle below the normal line of vision, will prevent the momentary semi-blindness which the glare of an approaching headlight inflicts on the automobile driver. By stooping slightly over the steering wheel one can look through the disk into the glare without eye strain.

A Homemade Lawn Rake

A round piece of wood, about 18 in. long, constitutes the head for the rake teeth, and is marked for $\frac{1}{4}$ -in. holes, about $\frac{1}{2}$ in. apart, whereupon the holes are drilled and the teeth inserted. The latter are made of $\frac{1}{4}$ -in. iron, about 4 in. long, with the projecting ends made round. The teeth must be the same length and project from the head the same distance. The end holes are used for the runners. These are also made of $\frac{1}{4}$ -in. round iron, somewhat longer than the regular teeth, and bent as shown. The runners extend about $\frac{1}{4}$ in. farther than the teeth, thus preventing them from injuring the roots of the grass. A rake of this kind is easy to use and will make a good, clean job. — Contributed by Charles Homewood, Waterloo, Iowa.

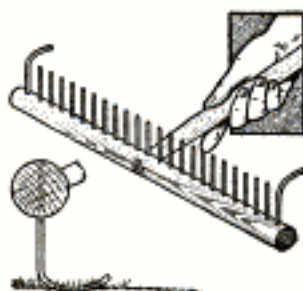

A Remedy for Heated Bearings

Prepare an oilcan by filling it with kerosene and flake graphite, about 1 part graphite to 7 parts of oil, and have it ready for any bearings that are likely to become heated. Force the mixture into the heated bearing until it flows out between the bearing surface and the shaft, then follow with a small quantity of thin machine oil.

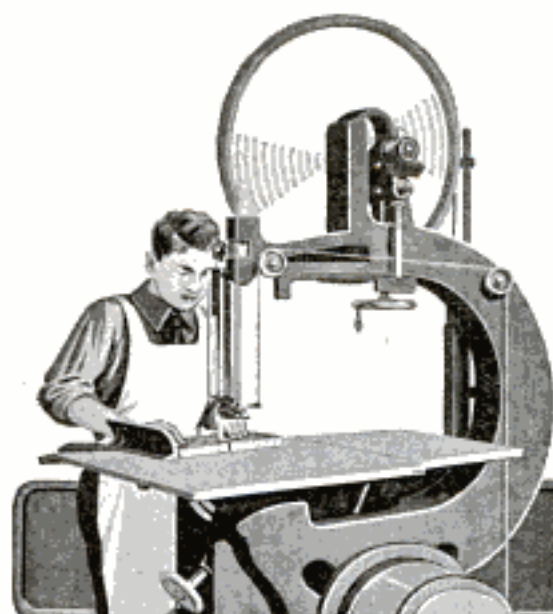

CARE of the BAND SAW

by Charles A. King

MAXIMUM output and a high grade of work on a band saw are possible only with the combination of a skillful workman and a well-designed machine, having a blade without kinks, brazed, set, and filed properly.

The machine should be set level and firmly, so that its vibration is reduced to a minimum; the wheels should be balanced and their rubber rims must be in good order. The edges and side of the blade should run at right angles to the table, when in its normal position, and the machine should be fitted with an efficient, adjustable saw guide. A makeshift will not permit the saw to attain its maximum efficiency, and shortens the life of the blade.

A band saw should not be permitted to stand overnight at the tension necessary for satisfactory operation, as the night temperature of a shop may cause the blade to break. This danger has been minimized in the best types of modern machines by an arrangement of springs which regulates the tension so that a serviceable saw is not in danger of breaking. It is best, however, not to keep the saw at high tension longer than necessary, and the upper wheel should be dropped a little whenever the saw is not in use, for a saw may be slightly defective and yet give no evidence to the naked eye.

In starting a band saw, test the blade with the fingers to insure that it has the proper tension, and give the

upper wheel a turn or two by hand before shifting the belt. The friction of the blade on the lower, or power, wheel causes it to turn the upper wheel. The motion communicated from the upper to the lower wheel will permit the belt to be shifted more evenly, and will minimize the starting strain. It will also insure that obstructions are not in the way of the wheels.

An important condition in the efficiency of a band saw is the speed at which it is operated. If the countershaft travels at the speed recommended by the manufacturer, it will be satisfactory, but if this information is not available, the blade should be operated at a rate of 10,000 ft. a minute.

Judgment must be applied in adapting a saw to the work in hand, and frequently small blades are ruined by attempting extremely heavy cuts with them. Do not force a wide saw to cut around a curve of small radius; this should be attempted only with a narrower one. Take time to change, or sharpen, saws, rather than use one that is improperly set or sharpened. Use the largest blade which the nature of the work will permit. The larger saw resists the tension better, and there is less danger of breaking it, or of pulling it from the wheels, when necessary to back out of a cut.

A band saw will run for some time after the belt has been shifted to the loose pulley. To stop it quickly, apply

moderate pressure to the lower edge of the top wheel with a piece of wood. A thick piece of wood must not be pressed against the blade to stop the machine. The diminishing power does

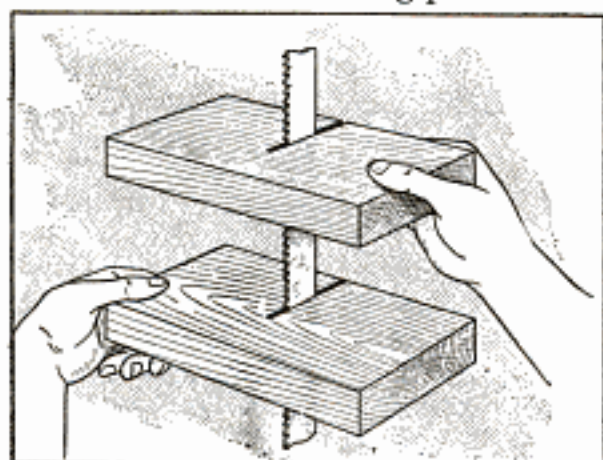

FIG. 1

Grasp the Blocks and Apply the Proper Pressure to Remove Kinks or Twists

not permit the teeth to cut properly nor to clear themselves, causing undue strain on the blade.

Straightening a kinked, bent, or twisted saw blade so that it will cut smoothly, is difficult. The defect may be remedied to a considerable extent, and sometimes apparently removed. A minute crack in the saw may result from a small bend, and in time may cause a break. After a blade has been broken while running and has suffered incidental bends and twists, it is more likely to break. To reduce a kink or twist in a saw, make a cut in one edge of each of two small pieces of wood, and holding them as indicated in Fig. 1, apply a twisting pressure as required.

Handle the blade very carefully when removing it from the machine. Do not hang it up at full length, but fold it into a circle of three turns, in which form it can be handled easily and safely. Every one who has occasion to handle a band saw should understand the method of folding the blade, illustrated in the sketches herewith, as by following it a blade may be arranged in compact form without harm to bystanders, the operator, or the saw. The method is shown in Figs. 2 to 6 and is as follows:

The saw blade should be held vertically with the teeth toward the ope-

rator, as shown in Fig. 2, and grasped by each side, at the middle of its height. Permit the bottom loop to rest lightly upon the floor. The hands should be in the position indicated; the thumbs at A and B, upon the outside of the blade, being the essential feature of this part of the process. Hold the saw firmly to prevent it from turning in the hands. Turn the thumbs in and down, as at A and B, Fig. 3. This will give the loop C a tendency to drop. Permit it to touch the floor about 2 ft. away and in front of the lower loop D. Cross the loops A and B, passing the left through the right, or A through B, changing hands as they pass, and the loops will be in the positions indicated at A and B, Fig. 4.

Move the left hand from B and grasp the front crossing of the loop at E, Fig. 4, as indicated at E, Fig. 5, and with a swinging motion of the left hand, draw the outer loop C, Fig. 4, upward and to position CC, Fig. 5. Reach through the loops A and B, as at F, Fig. 5, with the right hand and grasp the loop C, at the same time grasping the back crossing of the loops at G, Figs. 4 and 5. Holding the crossed loops G and the loop C in that position, open the fingers of the left hand, and permit the two loops forming the crossing E, to drop lightly forward into the third loop D, which has not been moved from its original position.

Do not drop the blade to the floor in the final stage of the process, in a spectacular manner, for this is likely to turn the edges of some of the teeth. The saw is now in the form of three circles, probably of different sizes, Fig. 6. Make them uniform by adjustment. Hang the saw where it will not be endangered. It should be unfolded correctly when used again, as blades are more often injured in unfolding than in actual use, or in folding them.

Some workmen pick up the loop with which the hands first come in contact and shake the blade until it straightens itself, so that it can be placed upon the machine. Sometimes this method results satisfactorily;

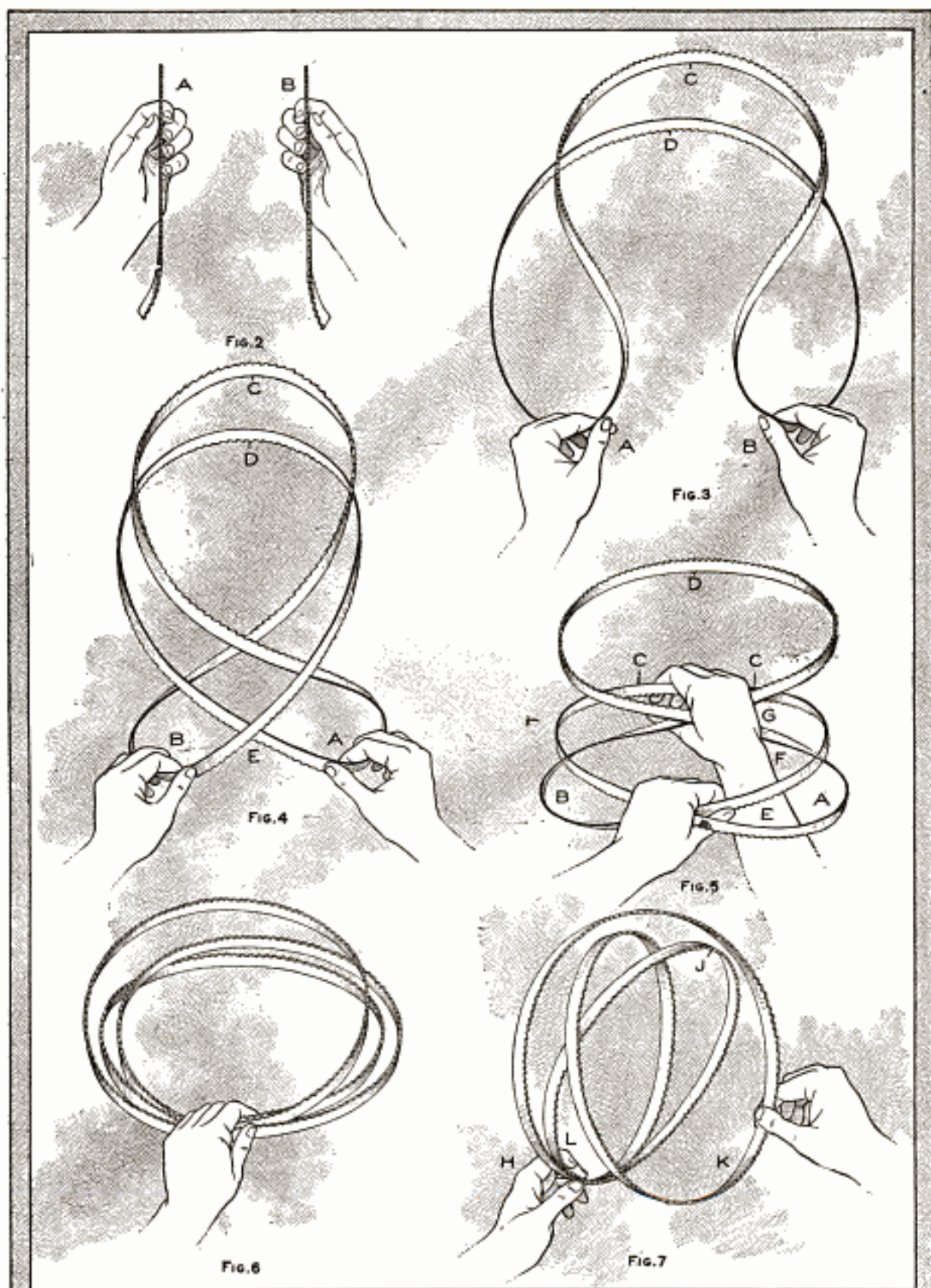

How to Fold and Unfold a Band Saw without Injury to Bystanders, Operator, or Saw: Grasp the Blade at the Middle of the Sides, Fig. 2, Thumbs on the Outside, Teeth toward Operator, Lower Loop Touching Floor Lightly; Turn the Thumbs In and Down, Fig. 3, Permitting Loop C to Touch Floor in Front of Loop D. Pass Loop A through Loop B, as in Fig. 4, Changing Hands. Draw Loop C Forward with Left Hand, Applying Pressure at E, Fig. 5, and Grasp Crossing G and Loop C in Right Hand, F. Release Hold of Left Hand at E, Fig. 5, Permitting the Three Loops to Spring Together, as in Fig. 6. Grasp Blade with Left Hand, as in Fig. 6, and Make Circles Uniform. To Unfold, Grasp Loop K in Right Hand, Fig. 7, and by Controlling Pressure at L Gradually Permit Blade to Spring Open

more often it causes a kink in the saw. In order to avoid this danger, hold two of the three loops at H, Fig. 7, with the left hand, the teeth of the saw being toward the right. Using both hands, separate the folds carefully until they are in the position indicated. Make sure that loop J is not interlocked with either of the others. Drop loop K to the floor from the right hand, which will give loop J an upward impulse. Assist this by an upward swing with the left hand at H, and loop J may then be caught by the right hand. Release the crossing of the loops in the

left hand at H, retaining the under loop L. Raise the hands shoulder high, and the blade will straighten itself without undue strain. The teeth will be toward the operator, in proper position for placing the blade upon the machine.

☞ A solution which will provide an excellent dimmer for headlights for automobiles may be made by dissolving Epsom salts in water. The solution applied to the inside of the glass will produce a fairly permanent frosted effect.

A Segment-Cutting Jig

Segments for circular patterns and similar work are sometimes made in a slipshod manner and consequently are

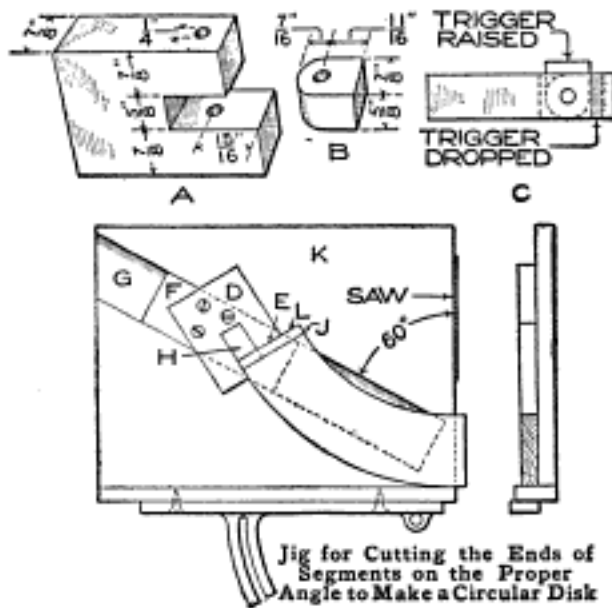

expensive. They are often cut $\frac{1}{8}$ to $\frac{1}{4}$ in. longer than the actual length of the segment, and the surplus is cut off on a trimmer or by planing, as each piece is fitted in building up the pattern.

The jig shown in the sketch has been found efficient and is for use on a circular saw. By its use the segments may be assembled as they are cut at the saw. Time is thus saved, and this method is further valuable in that the sawed ends have a superior gluing surface.

The parts A and B, assembled as at C, constitute the regulator D. The face of the regulator must always be at an angle of 60° to the line of the saw cut. To keep it in this position for any radius, the regulator is fastened to a block, F, which slides in a groove, G, of the fence board K, 1 in. wide and $\frac{1}{4}$ in. deep.

In adjusting the jig, make a template the exact length of the segment to be cut. Drop the trigger H, and shove it up against the template, as at J, allowing the opposite end of the template to clear the saw as it is pushed alongside of the latter. Screw the regulator to the fence K, and the jig is ready for the cut.

After having sawed the required number of segments, leaving them $\frac{1}{4}$ in. longer at each end than the true length, raise the trigger H and place a segment, as at L. Saw off the opposite end, then reverse the segment, drop the trigger, placing the freshly sawed end against it, and saw off the other end.—Contributed by D. D. Gurnee, Hempstead, N. Y.

Emergency Methods for Starting Automobile Engine

Occasionally the starter on an automobile fails to operate, and the driver is compelled to resort to the crank, if he is fortunate enough to have one. An emergency method for starting the engine may be used instead.

Throw the transmission gear into high speed. The car may be pushed along, causing the engine shaft to revolve, and unless there is something wrong, it should start after it is turned over a few times. It may also be pulled along by another automobile. This method is of service in starting an engine that has been taken down for repairs and must be worked into shape. Another method that may be resorted to, when neither help nor another car is available, is as follows: Put the gear into high speed, jack up one of the rear wheels, and turn the engine over by turning the raised wheel. In any of these methods it is best to have some one at the wheel to control the car. This is essential in the latter method.

Graduated Index Finger for Tool Grinding

Grinding cutting tools, such as reamers, milling cutters, boring cutters, countersinks, counterbores, and kindred tools, is usually a matter of guesswork in so far as the clearance is concerned, yet the clearance is as important as the quality of the tool steel used in the cutter. The sketch illustrates an easy method of substituting certainty for guesswork, and any angle may be produced perfectly.

The emery wheel used is cup-shaped and small. The cutter shown is carried on an arbor in the spinning head, or sometimes a special head is supplied with the tool grinder by the manufacturer. The spinning head is set square on the table, as is also the bracket, both being fastened with bolts. The index finger is held in the outer end of the bracket and is adjustable vertically.

The machine shown is set for a square cut; that is, no clearance. If the flat spring, shown in solid shade, is lowered until the figure 10 is flush with the top of the bracket boss, when the bracket is adjusted laterally on the table, the wheel will grind a clearance of 10° , and so on. While it is not necessary that the center line of the grinding spindle be central with the cutter,

it is better to have it so if possible. The table is raised and lowered as required by means of the screw provided for that purpose.

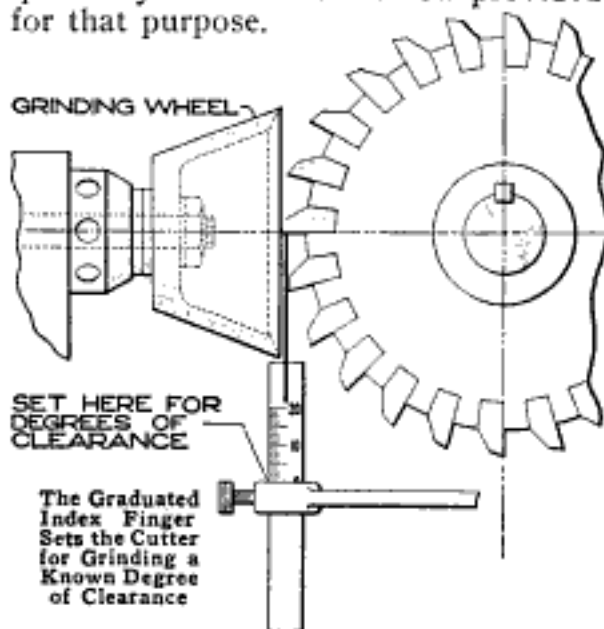

The index finger is easily graduated. If a 12-in. cutter is placed in the machine, the distance from the center is 6 in. If the tooth is lowered .5 in. from the horizontal, the face of the tooth will have an inclination of 1 in. to the foot, and so on. A table of "tapers and angles" will give the number of degrees and center line of this taper, or inclination, thus making the graduation easy and certain. Graduate in whole degrees only.

In the sketch the clearance shown is exaggerated to make it clear. Actual clearances cannot be given, as they vary with material, also for machines and general conditions, such as lubrication, degree of finish required, etc.—Contributed by J. B. Murphy, Plainfield, N. J.

To Surface-Harden Cast Iron

Small castings, such as gears, cams, etc., that are subjected to wear, can be made quite hard on the surface and toughened considerably by heating them to a dull red, then quenching them in a saturated solution of cyanide of potash while it is as near the boiling point as possible. An iron pot, filled with the solution and kept near the fire, will make it handy for the workman.

Small Lifting Magnet

Persons working about an automobile will find the lifting magnet shown in the illustration of great service in recovering bolts, nuts, or other small

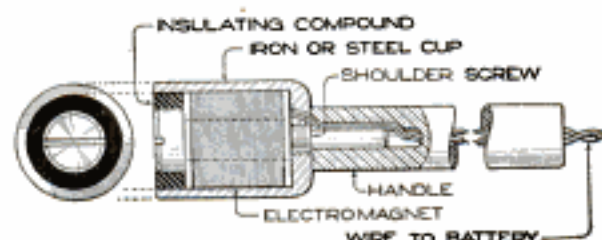

The Magnet Aids in Recovering Small Machine Parts Otherwise Inaccessible

parts, from oil pans or other partly inaccessible places into which they have fallen.

Its lifting power is derived from an electromagnet which may be obtained from an old electric bell. The magnet is held in an iron, or steel, cup by means of a shoulder screw. Its power is derived from dry cells, which should be connected with the cords at the end of the handle.

An insulating compound should be used to seal the space between the head of the shoulder screw and the cup.

To Prevent Draft through Openings in Automobile Floor

The discomfort due to cold drafts coming through the openings in the floor of an automobile, around the various levers and pedals, may be greatly



reduced by attaching a piece of rubber, or very heavy canvas, with a slit in it, on the under side of the floor, as shown in the sketch. This covering is especially serviceable on cars which have short mud pans, or none at all, as the chassis is very open under the floor of the front compartment, and the cold air may readily enter through the openings in the floor.

ⒸA hand reamer should never be used for power reaming.

Bleaching Linseed Oil

If it is desired to bleach linseed oil for some special purpose, mix it with some five per cent of peroxide of hydrogen in a tin, or glass, vessel and shake it from time to time. It will require only a few days to bleach the oil, which then may be poured off, the peroxide having been reduced to oxide of hydrogen, water. There are several ways of bleaching linseed oil which require about a month in making the change, but this is the simplest and quickest method.—Contributed by A. A. Kelly, Frazer, Pa.

Emergency Repair on Stripped Stuffing-Box Nuts

Stripped stuffing-box nuts on small steam, water, or air pumps are quite a common occurrence, and sometimes they cause considerable delay, as the application of a new stuffing box requires the removal of the pump heads, and the taking out of

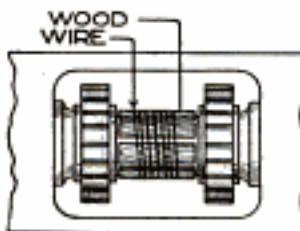

the piston, to get a new box over it. Working near a construction job when a stuffing-box nut stripped from the box on a small water pump that was draining the water accumulating in a pit in which a number of men were working, I made the repairs as follows: Complete repairs to the pump would have delayed the work, with much damage to the pit and loss of time. The sketch shows the temporary repair. Small wood strips were cut and wired to the piston, the strips being of a length exactly the distance between the two nuts when both were securely drawn up against their respective packing glands. This made a very satisfactory repair that worked just as well as if the box and nut had been held together with perfect threads.

This kind of a repair can be used in almost every case where two packing nuts are within reasonable distance

from each other, on any kind of a pump, and will, in many instances, prevent a serious delay on important work until complete repairs can be made.—Contributed by F. W. Bentley, Missouri Valley, Iowa.

Waterproofing a Serving Tray

Serving trays are frequently spoiled by liquid coming into contact with the embroidery, picture, or other work which may be placed beneath the glass to beautify the tray. In order to prevent this, a water-tight joint between the edge of the glass and the edge of the tray, extending over the glass, should be made.

To do this, bicycle tape, about $\frac{7}{8}$ in. wide, should be inserted into the joint. Remove the bottom from the tray, and then the glass. Clean the inner edge of the tray frame of glue and rough spots. Press the tape into the square corner around the edge of the frame. The four corners may be turned by cutting the tape on the upper edge and stretching it into the proper form. If the tape is cut in two at the corners there is more likelihood of a leak. The open spaces in the corners should be filled with small pieces, but care must be taken not to form lumps. Replace the glass and see that it rests evenly on the tape all the way around, and reassemble the tray.

A Bearing Scraper

When old journal bearings need re-babbiting they are usually placed in a former and babbitted. Often it is necessary to true up the bearing with a scraper. This method is not satisfactory, as it does not give a true bearing surface and leaves some high spots.

A better arrangement for truing up babbitt in bearings is shown in the illustration. The four cutters are made of steel and threaded with eight V-threads to the inch. When it is desired to true up a journal bearing it is placed upon the appropriate cutter and rubbed back and forth until a true bearing surface is obtained.

The shavings from this operation drop into the wooden box below, which may be cleaned readily from time to

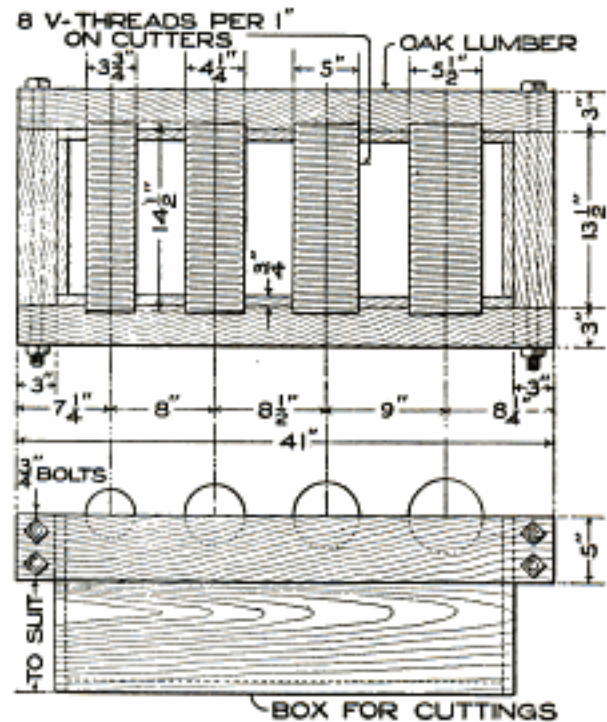

A Journal-Bearing Scraper That will Insure True Bearing Surfaces

time. Whenever desirable the cutters may be revolved in order that all parts of the threaded portion may be used.—Contributed by J. R. Minter, Washington, Ind.

An Over-Arm Steady Rest

The over-arm steady rest shown was designed to hold long shafts of small diameter while machining them, without using a cumbersome steady rest. A steel block was bored out to fit the tailstock spindle, and also had a hole drilled in it to receive the over-arm bar, both holes being fitted with set-screws. The end of the bar was drilled

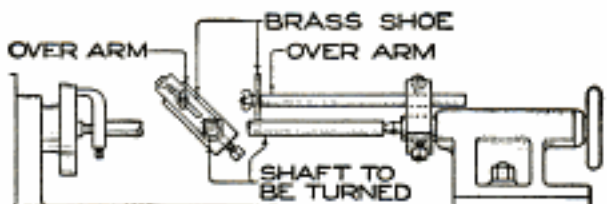

A Handy Over-Arm Steady Rest for Lathe Work on Long Shafts of Small Diameter

and tapped, and a stud screwed in. A slotted brass shoe, a washer, and a wing nut completed the outfit.

Kink for Counting or Grasping Paper Sheets

Sheets of paper, handbills, or similar matter, may be counted easily or arranged in a convenient pile from which to take single sheets by a simple process shown in the sketch.

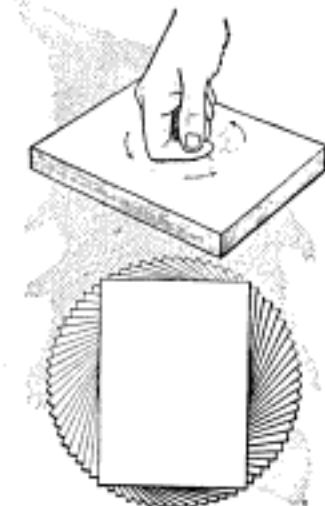

Place the pile of sheets on a table, and arrange them evenly. Place the second joint of the forefinger on the center of the pile, and with a moderate pressure turn the hand in the direction of the arrows. The finger may be raised in order to secure a new contact. The result will be surprising, and interesting to observe. A pile of sheets, as shown in the lower figure, will result.—Contributed by George H. Holden, Hill-Crest Lodge, Chesterfield, England.

Match Safe Attached to Gas Fixture

Finding matches in the dark in order to light a gas fixture is often a trying experience. Suspending a

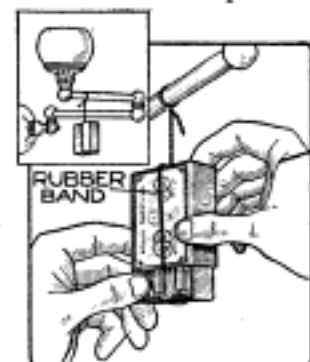

match safe from the fixture, as shown in the illustration, solves the difficulty. The match box is suspended on a string and a rubber band is placed around it. While the matches are being withdrawn the box is held open, and as soon as it is released the band closes it. This makes it safe to strike the match on the box without danger of igniting other matches.—Contributed by J. Davis, Poughkeepsie, N. Y.

Repairing Broken Rubber on Wash Wringer

While washing one day some time ago, I had the misfortune to damage the upper roller on my wringer, and wishing to finish quickly, I repaired it in the following manner: I wrapped a piece of stout bandage, about 4 in. wide and 18 in. long, tightly around the injured roller. This was intended to be used only temporarily, but it served so long that I found it unnecessary to procure a new roller.—Contributed by Mrs. Anna M. B. Romig, Allentown, Pennsylvania.

Oiler for a Connecting-Rod End

The upper portion of a connecting rod on an automobile engine is lubricated by the oil splashed in the crank



case, but in quite a few cases this method does not work satisfactorily. In making repairs on an engine where the bushings were burned out, caused by inefficient oiling, an attachment was tried out with success. This

consisted in making a small oiler, similar to a regular oil cup, and screwing it into a hole drilled and tapped into the upper part of the bearing. An oil groove was cut in the new bronze bearing to connect with the hole of the oil cup. It was easy to maintain a constant supply of oil to the bearing with this device.

Repainting Exterior Woodwork

Exterior woodwork painted the first time fails to show as good and lasting a result as when it has been painted again after two years' wear. Repainting over a good white-lead surface that has become dry and flourey will yield a good wearing finish. The chalking of white-lead paint is no disadvantage, for in this condition it will take the new paint better than a hard surface, and will not scale.

Emergency Electric Switch

When a temporary electric switch is needed in the home, or shop, where a stock of electrical supplies is not available, a satisfactory switch may be made of a lamp socket and key. In order to transform a socket into a switch, screw a fuse plug into the place intended for the lamp. The circuit may be opened or closed by turning the key as if turning on or turning off a light. Fuse plugs for the purpose are usually to be found in a home, as they should be on hand to replace fuses blown out.—Contributed by F. W. Buerstatte, Pullman, Wash.

Carrying a Stepladder

A handle, fixed on the side of a stepladder so that the ends balanced, overcame the difficulty ordinarily experienced in carrying it. It is worth while to spend sufficient time in fastening the handle to insure that it will be

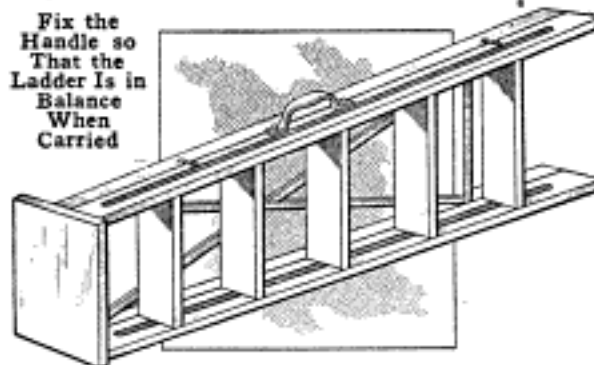

at the proper place.—Contributed by W. C. Loy, Rochester, Ind.

Making Reliners Out of Old Tires

Re liners, with which to support portions of automobile or other tires worn considerably, may be readily made out of old tire casings. The tool necessary for the trimming of the casing into a reliner, with a featheredge all around, as shown in the sketch, may be made from a table knife.

Nick the surface of the knife blade with a cold chisel on a diagonal as at AB. Grind the edge along this line smooth, after breaking the blade by striking it a sharp blow as the point

end of the blade is held fast in a vise or clamp. The jaws of the vise or

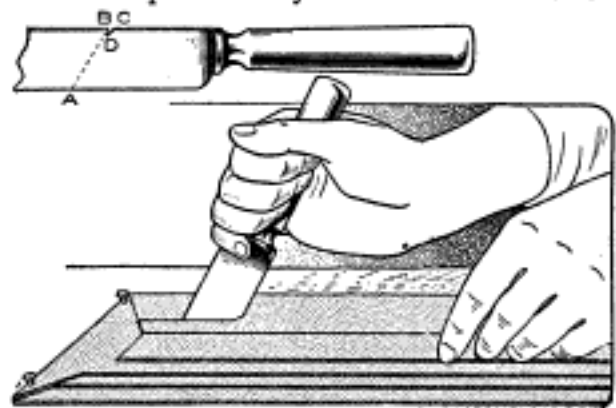

Insert the Point of Knife into Top Layer and Cut along Line

clamp should be even with the line AB. Now grind a V-shaped nick into the back edge of the blade as shown at C. Grind the edge BD as sharp as possible and smooth off the other adjoining edges.

The material for the reliners is obtained as follows: Cut out the better portions of an old casing, in such a way that the cut edges would be in direct line with the spoke nearest them, if the tire were on a wheel. Then cut off the tire beads by which it was held in the rim. Rip off the more badly worn outer layers from the casing.

Lay the section of the casing flat on a bench, the inner side down. With a pencil, or a piece of crayon, mark off the "steps" in the several layers of the casing by the cutting of which the featheredge is to be produced, gradually thinning out. Insert the point B of the knife into the top layer and trim along the chalk line, cutting the smaller of the oblongs shown. Repeat this process, tearing away the outer portions of each layer, around the oblong for that layer.

The reliners may be made of various lengths and breadths to meet the requirements of tires of various sizes and worn portions of similar range.—Contributed by H. W. Bohrman, Los Angeles, Cal.

☞ Dirty materials will not make first-class concrete, either in strength or appearance.

Conductor-Pipe Holders

Three designs are shown of holders for conductor pipes on houses. Two of the three illustrated are made of wire,

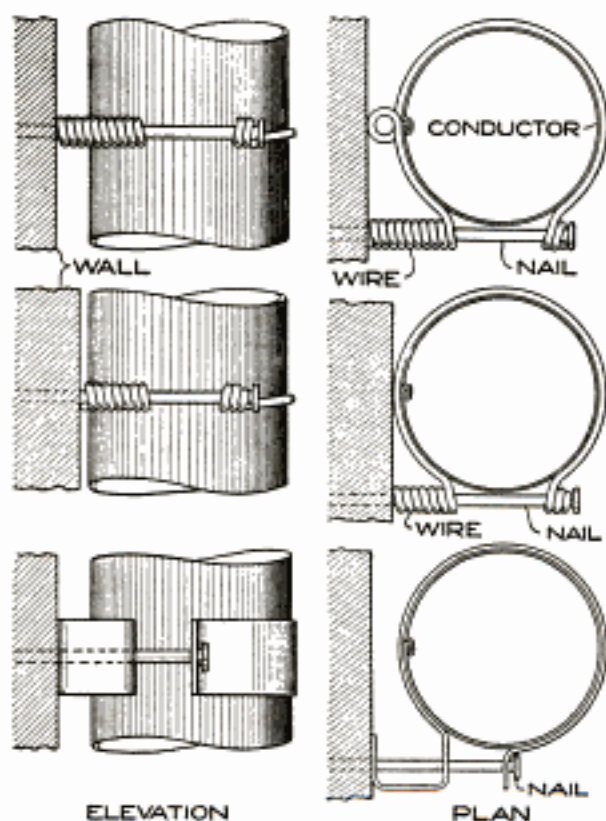

Methods of Holding Conductor Pipe by Using Only One Nail with Wire or Sheet Metal

coiled about a nail and around the pipe, and the third consists of a strip of sheet metal, all three being fastened with a nail driven into the siding. These holders have considerable advantage over the ordinary hook and will hold the pipe firmly in place.

Surfacing Tracing Cloth to Take Fine Ink Lines

Many methods are in use for preparing the surface of tracing cloth to receive the ink, but I have found the following way to work best where very fine lines are to be drawn. The dull, or unglazed, surface of the cloth is used, and after stretching the cloth on the board, it is sized as follows. Moisten the cloth well with gasoline and go over the entire surface, rubbing lightly to remove all dirt and surface grease. While the cloth is still wet

with the gasoline, sprinkle well with talcum powder of the grade used in automobile tires, and then rub vigorously. This fine abrasive roughens the surface so that fine, close-drawn lines take well. Wipe clean, and the tracing cloth is ready for use.—Contributed by M. Burr Bennett, Bridgeport, Conn.

Light-Saving Kink

Electric-light bills are sometimes increased needlessly through permitting light to burn unnoticed in the pantry, coal room, or other small rooms. I cut round holes in the upper panels of the doors of these rooms and placed glass in them. This caused the otherwise forgotten lights to attract attention, and there was small likelihood of these lights burning needlessly.—Contributed by John Hoeck, Alameda, Cal.

Aprons for Hot-Air Registers

It is a common experience that dust is blown into the rooms of a house from the registers through which the hot air from the furnace passes. This was overcome by placing a piece of cheesecloth over the register. The air has sufficient force to blow the cloth away from the register slightly, thus permitting the warm air to enter, while most of the dust is caught in the cloth.

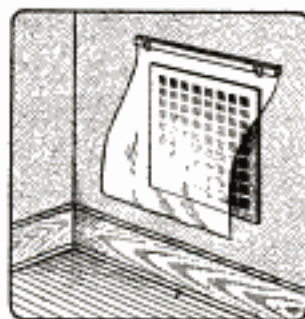

The strips by which the cloth is held can be made of wood and finished to match the woodwork of the room. The bolts are fastened in the piece of wood nearest the wall and holes are bored in the front piece at corresponding points. The piece in which the bolts are secured is then fastened to the wall with screws, care being taken that they strike the studding. By releasing the wing nuts fresh cloth may be inserted.—Contributed by J. A. Fitzpatrick, Altoona, Pa.

Sanding Track for an Automobile

Occasionally in winter when the streets are covered with ice an automobile gets stuck in a rut, or for some other reason the wheels turn around without moving the car. This sometimes happens even if the car is equipped with chains. This difficulty can be easily overcome by carrying a box, or bag, of sand under the seat and sprinkling it on the surface under the wheels, as in sanding the track on a railroad.

Preventing an Alkaline Solution from Backing into Boiler

A hot alkaline solution used in an establishment had a way of attacking the seat of the steam valve and forcing its way back into the boiler, causing the water in the boiler to foam. A steam fitter rigged up the device shown in the illustration so as to prevent the solution from coming in direct contact with the seat of the steam valve.

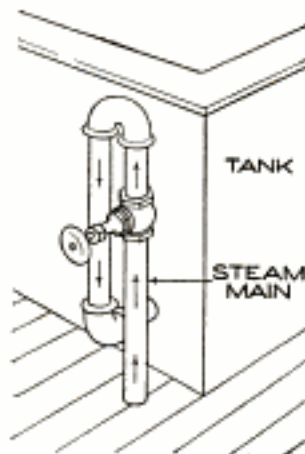

To Prevent Fire While Pouring Gasoline through Chamois Skin

Fires occurring without apparent cause while gasoline was being poured into automobile tanks through chamois skin were found to have been caused by electric sparks from ungrounded funnels. The pouring of gasoline through chamois skin develops static electricity, which accumulates in the funnel, if it is set into a wooden seat or similar place while in use.

When a considerable accumulation has taken place a sharp contact of the funnel and the metal edge of the tank may cause a spark, resulting in an explosion. In order to prevent the ac-

cumulation of electricity the funnel should be grounded by fastening a light chain to it, as shown in the sketch. The chain should be long

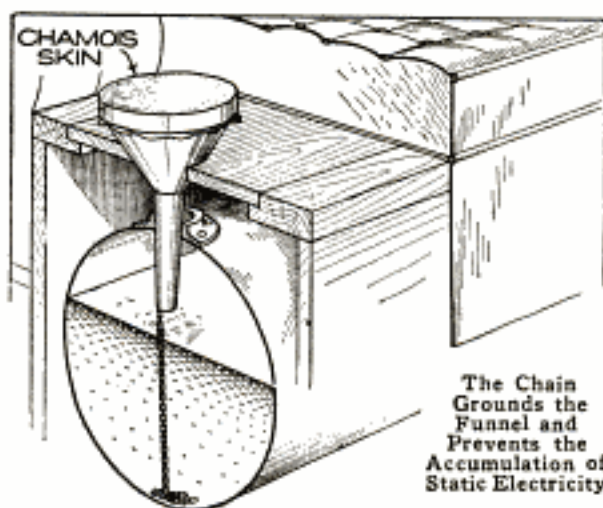

enough to remain in contact with the bottom of the tank.—Contributed by E. A. L., Ames, Ia.

Supporting Bricks on a Roof for Chimney Construction

Bricks and material for the reconstruction of a chimney may be safely and conveniently placed on a roof by using the frame shown in the sketch. It is simple in construction and requires less lumber than a platform.

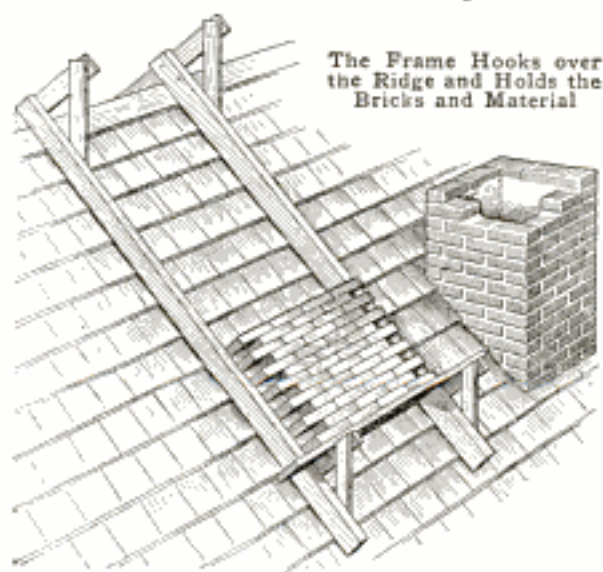

The latter, if rested on the roof gutter, may cause damage, and if the gutter is not in good condition an accident may result.

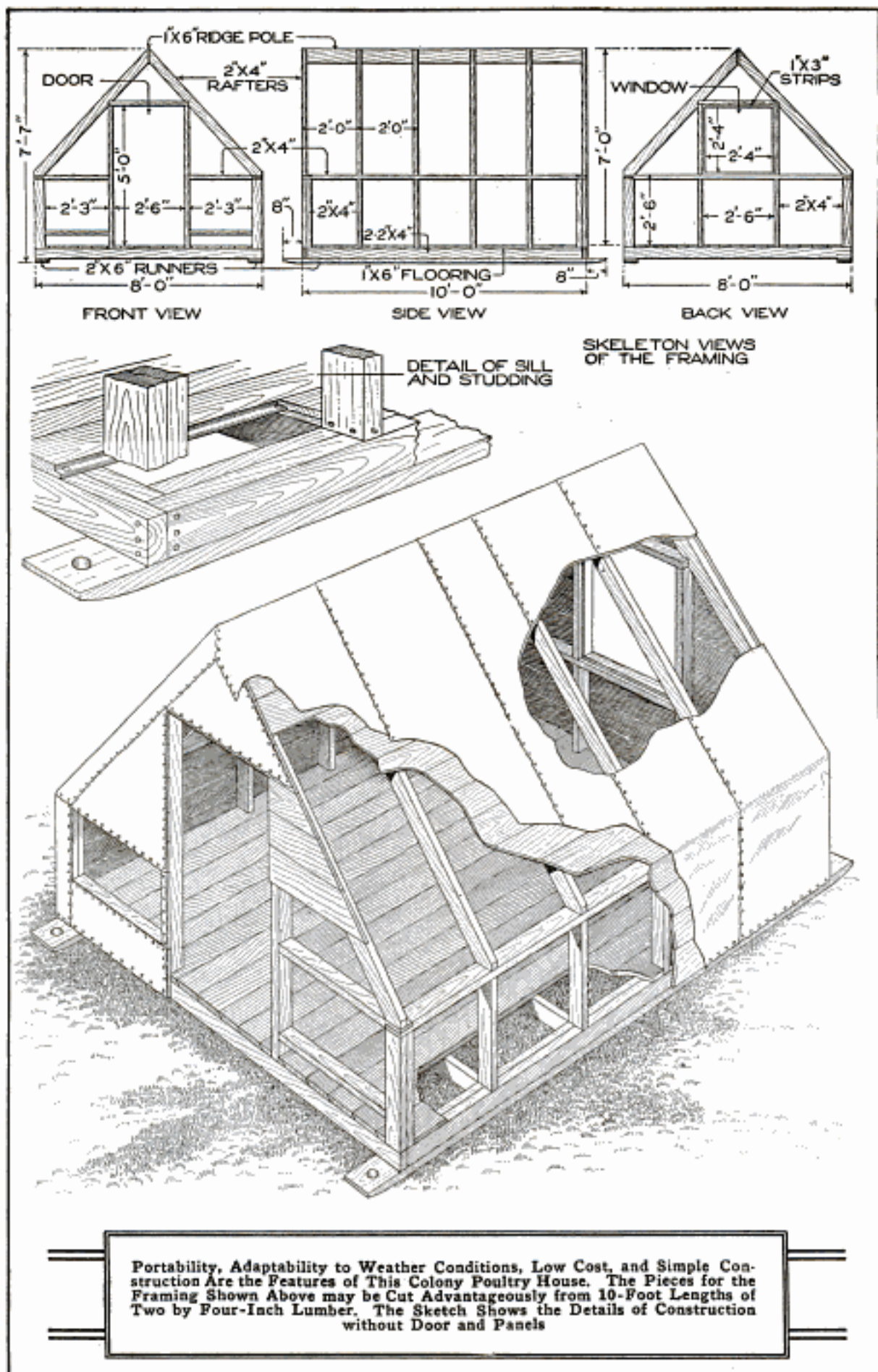

Portability, Adaptability to Weather Conditions, Low Cost, and Simple Construction Are the Features of This Colony Poultry House. The Pieces for the Framing Shown Above may be Cut Advantageously from 10-Foot Lengths of Two by Four-Inch Lumber. The Sketch Shows the Details of Construction without Door and Panels

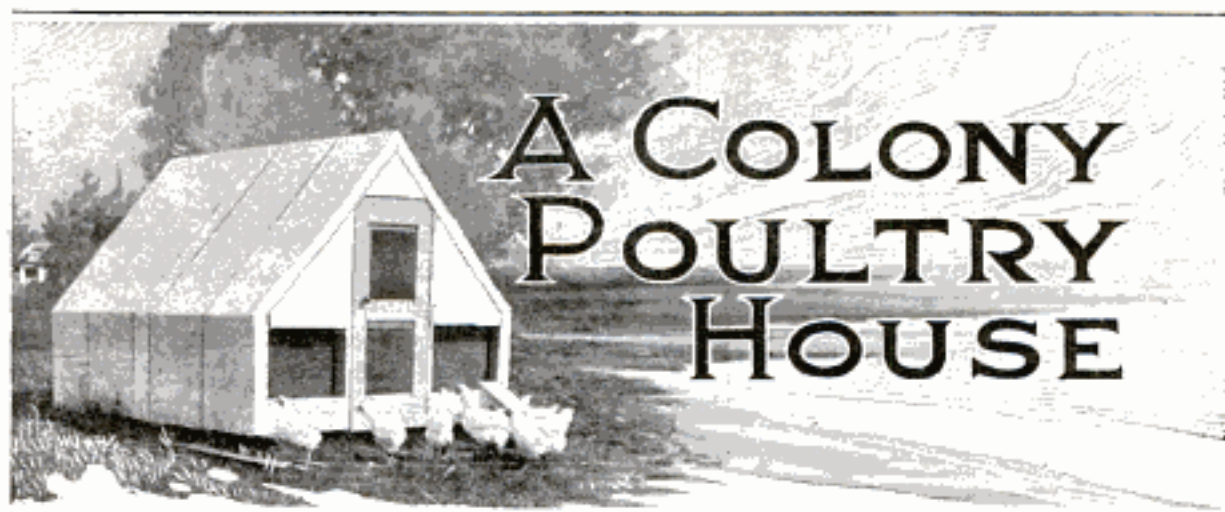

By W. E. FRUDDEN

PORTABILITY, adaptability to weather conditions, low cost, and simple construction are the features of the colony poultry house shown in the illustration. It is in use on a farm in Iowa and has been found satisfactory for 20 hens for the winter, and for the raising of chicks in flocks of over a hundred. It is built on skids so that it may be transported on rollers. Ventilation and shade are provided for with screens. For winter use, there are hinged doors, which may be lifted off easily in the summer.

The lumber for the house is all standard-size stock. The frame is built of 2 by 4-in. material, joined at the sill and corners to form 4 by 4-in. sections, and the skids are of 2 by 6-in. planks. The floor and sheathing boards are 6-in. shiplap. The house is covered with a prepared-roofing material.

Diagrams of the framing are shown in the upper figures of the plate of illustrations. The skids may be shaped first. Next spike together the sill of 2 by 4-in. material, as shown in the detail of sill and studding, and nail the skids in place.

Plan to cut all the pieces of the same size in a series, and make a measuring stick, or template, for each, particularly the rafters. Nail the floor joists into place, then the studding, door and window frames. The plate, which is nailed on top of the studding, should be fixed with a half-lap joint at the corners.

The floor should be nailed down

next, as it is convenient to have it in place when the rafters are raised. The rafters are cut off flush with the sides of the house so that the siding and roofing material may be applied more easily. Nail the siding on the ends and sides, and on the rafters. The house may then be covered with roofing material.

The casements for the window openings should be made next. They are made of $\frac{7}{8}$ -in. material, 3 in. wide, one edge being nailed flush with the inner edges of the framing around the openings.

Details of the construction of the door are shown in the smaller illustration. It is built up of two thicknesses of boards, arranged so that the joints are reinforced, the horizontal rails on the inner side crossing the joints which appear on the front. Screws should be used to fasten together the pieces of the door, although properly clinched nails may also be used. The strips forming the inner side of the door are 1 in. narrower than those on the front, so that the $\frac{1}{2}$ -in. wire mesh may be fastened in place by quarter-round molding.

The panels in the door are similar in construction to those to be fitted into the other openings, at each side of the door and at the gable end of the rear of the house. The hinges are of the type used on storm windows, and permit the panels to be lifted off when raised nearly vertical. Oiled muslin may be fitted to hang by the upper edge in

each of the openings, so that when the panels are removed shade from the summer sun may be provided. For purposes of ventilation the panels may

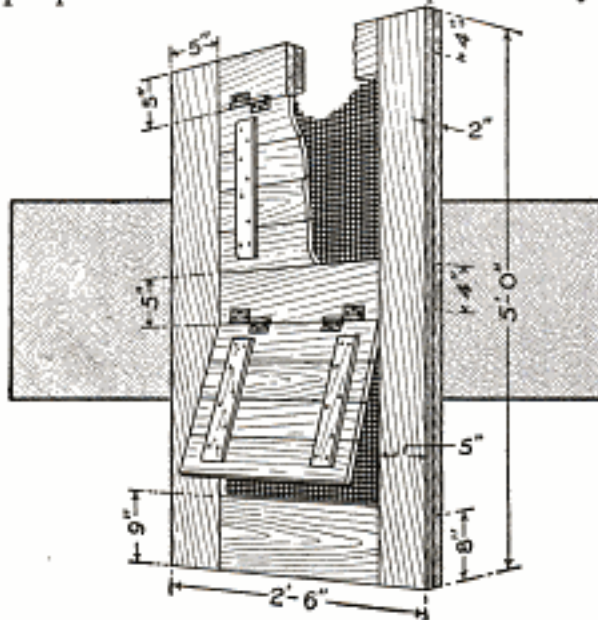

The Door is Built Up of Two Thicknesses Arranged to Reinforce the Joints

be opened or removed temporarily. If the window in the rear-gable end is not provided, a ventilator should be placed at the ridge. Roosts may be built in the rear part of the house, and nests arranged along the sides in the space adjoining the door, but not too close to the ventilating openings.

The stock bill for the construction of the colony poultry house is as follows:

- 2 pieces, 2 by 6 in. by 11 ft., 4 in., for skids.
- 1 piece, 1 by 6 in. by 10 ft., for ridge pole.
- 5 pieces, $\frac{3}{4}$ by 3 in. by 10 ft., for casings, for openings.
- 2 pieces, $\frac{3}{4}$ by 9 in. by 10 ft., for door.
- 30 pieces, 2 by 4 in. by 10 ft., for framing.
- 330 ft., $\frac{3}{8}$ by 6 in. by 10 ft., shiplap flooring for floors, sides, and roof.
- 2 pieces, $\frac{3}{8}$ by 10 in. by 10 ft., for nests and fittings.
- 250 sq. ft. roofing material for outer covering.

Improved Buttonhook

Time, temper, and finger nails may be spared by using a string as an improvised buttonhook in emergencies. The twine should be fairly strong, and a loop should be pushed through the buttonhole, hooked around the button, and drawn through the hole, bringing the button into place easily and quickly.—Contributed by W. W. Baldwin, Washington, D. C.

Road Patching

The modern scheme of protecting road surfaces with sprayed oil has developed a new method of patching holes. Gravel is mixed with a heavy road oil, which acts as a binder. This is prepared in advance and carted to the place where the patching is to be done. Less gravel is needed than when it is used dry, because the hole need be filled only level and tamped, while with the ordinary method the patching gravel must be heaped above the normal surface of the road. Where patching on a large scale is to be done, a concrete mixer can be used to prepare the mixture.

Removing Steam-Gauge Dial-Glass Casings

Steam-gauge dial-glass casings are often hard to unscrew from the body of the gauge, due to the heat, and other influences, to which the gauge is continually subjected. This is aggravated by the fact that the covers are difficult to get hold of, and that it is not practical to apply any strong gripping device because of the danger of rupturing the material. The sketch shows how they can be removed with but very little trouble. One side of the gauge is lightly pinched between protected jaws of a vise, and the lower portion of the cover is set on a block of wood. Two bolts are placed in the holes in the back side of the body, and a narrow strip of metal is used as a lever. Any dial cas-

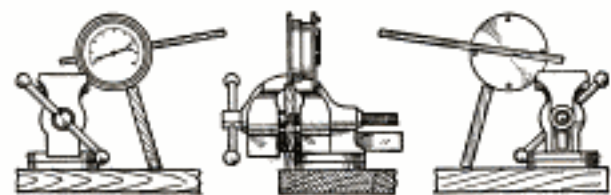

Removing a Glass-Cover Casing on a Steam Gauge with the Aid of a Vise

ing, after it has been turned one revolution, can be easily removed by hand. Getting it started is the difficulty. The most obstinate cover casing can be removed in this manner with no danger of disfiguring or rupturing it.

Preventing Rust under Molding on Screen Frames

Window-screen wire usually gives away near or under the small strip of molding that holds it to the frame. This is caused by the dampness retained in the joint after a rain, which results in the wire rusting. In placing new wire on a frame, be sure to paint it well on the edge after tacking it to the frame and before applying the molding.

Order Holder on an Expressman's Signal Flag

An expressman in a small city had the local druggist act as his agent. Orders received by the agent were written on slips of paper and placed in a pocket on the signal flag, which was placed in its socket beside the door to inform the expressman that he should call. Considerable delay in making inquiries for possible orders was thus avoided.—Contributed by Harry L. Dixon, Chicago, Ill.



Sharpening Scraper for Heavy Cut

Scrapers for finishing wood surfaces may be sharpened on their several edges for both light and heavy cuts, and this arrangement will be found more convenient than sharpening all the edges in the same manner. For light cuts, the edge of a scraper should be filed and honed square to the side of the scraper. For a heavy cut it is better to file the edge at a slight angle, and to turn over the acute corner with a round steel rod or a burnisher, rubbed along the edge with considerable pressure.—Contributed by L. E. Fetter, Portsmouth, N. H.

To Prevent Spilling Water on Automobile Radiator When Filling It

When filling an automobile radiator it is almost impossible to keep from spilling the water over the outside unless extreme caution and considerable time is taken at the end of the filling. The spilling can be prevented by making a stopper to fit the inside of the funnel in the small end. The stopper should be made of material that will not float. A cork will do, if a recess is formed in the center and filled with lead. A small wire, extending down from the lead and with the end turned, will provide a means of raising the stopper by pressing the bent end against the radiator filler. Just as soon as the funnel is lifted the stopper falls into place and prevents the water remaining in the funnel from spilling over the outside of the radiator.

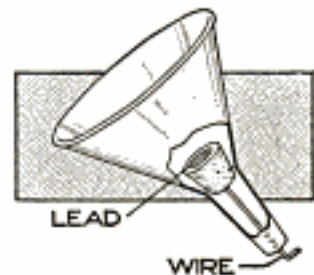

Straightening Small Rods in a Vise

Rods of some length and a diameter of an inch or even more may be straightened by the use of a comparatively light hammer, but the straightening of short rods is more difficult. This may be accomplished without marring the surface of the rods by the use of the grooved vise pads A, shown in the sketch.

The pads should be made of copper or other moderately soft metal. The small strip riveted to the top of each pad will make it possible to use the three pads without using the hands to hold them in place.

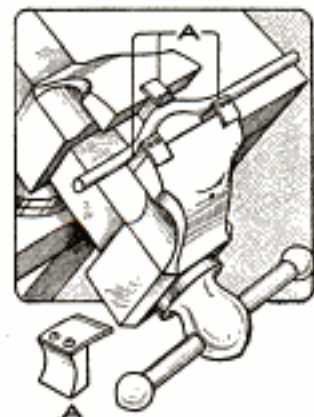

Belt Awl on Plier Handle

Having quite a number of belts to lace about the shop, I often found it necessary to use a belt awl and also a



Belt Awl Shaped on the Blunt Handle End of the Pliers

pair of pliers. Having to lay one tool down to use the other is sometimes inconvenient, as they are apt to drop out of reach, or to the floor if working on a high place. To make my pliers so that I would have both tools in one, an awl was formed on the end of one of its handles.—Contributed by Chas. G. England, Washington, Pa.

Curtain Guard for Blacksmith's Stock Rack

Danger from contact with exposed ends of iron bars in blacksmith shops is overcome by the device shown in the

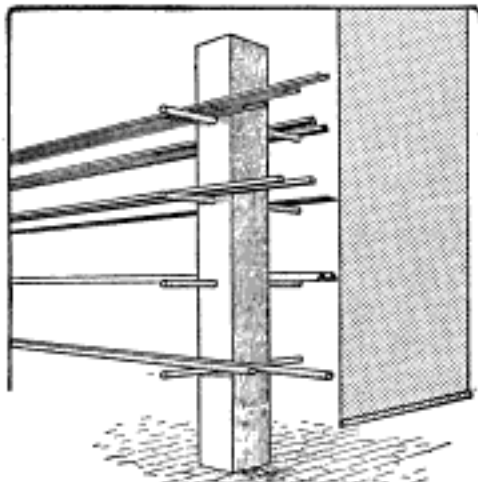

The Curtain Gives Warning of the Danger

sketch. A curtain was hung at each end of the stock rack so that when there was danger of striking the exposed ends the curtain gave warning.

This device was found to be of especial advantage where the stock rack is placed in a dimly lighted portion of the shop. The curtain may be drawn aside or arranged to lift to the ceiling with a cord, when stock is being removed.—Contributed by J. J. O'Brien, Buffalo, N. Y.

Improving Compression on Small Engines

When the piston rings of small motorboat and automobile engines become so loose that they will allow a loss of compression, the difficulty can often be overcome by placing a piece of corset steel behind them. The spring of the corset steel makes up for the lack of elasticity in the rings.

Stopper Holder for a Lavatory

The illustration shows an arrangement for a stopper in a washbasin to avoid the annoyance of the stopper falling into the hole and being in the way when it is desired to clean out the basin. When the stopper is released from the discharge pipe the small weight back of the fixture will pull the stopper up out of the way. The chain passes through the hole in the fixture which formerly held the ring at the end of the chain.—Contributed by B. O. Darrow, Sacramento, Cal.

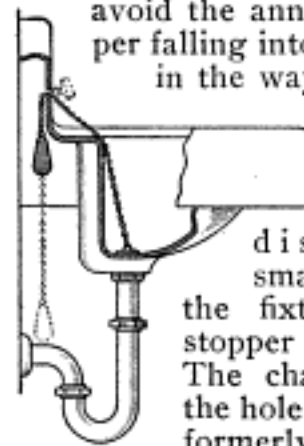

Tempering Thin Pieces of Steel

It is often difficult, after hardening small, thin pieces of steel, to draw them to the required temper without unevenness. Flames and fires are apt to be hot in spots or so intense that the article is not heated evenly. To avoid this, heat sand in a metal dish and dip the article in it, moving it continually until the required color is obtained. The sand must not be too hot, and the article must be bright.



Magic Candles Explained

By CLIFFORD WAYNE

CLEVER and baffling though it may be, the magic-candle trick may be performed easily and with professional skill by a person who has made a few simple preparations. The illustration shows the candles arranged on a table made of a music stand.

Candles, cigars, or pencils may be used, but for the purpose of this description the former will be used. The candles are of different colors but of the same size and weight. The manipulation is as follows:

Exhibit a tube of brass, cardboard, or other suitable material, just large enough to contain a candle. Then retire from the room, leaving the tube on the table while one of the spectators selects one of the candles and places it into the tube, covering the end of the latter securely with a small cap. The other candles are hidden before the performer is permitted to return. The trick is to announce the color of the candle contained in the box by merely passing the hand over it several times. The box and candle are passed out for inspection and will bear it if properly prepared.

The secret of the trick is this: The first candle, for example, the white one, is unprepared. The second, a blue one, has concealed in it, $\frac{1}{2}$ in. from the top, a small piece of magnetized steel. The third candle, a red one, has a similar bar concealed at the middle; the fourth, a magnetized bar $\frac{1}{2}$ in. from the bottom, and the fifth candle has the bar

at a point halfway between the middle and the bottom. The candles are made of wood and the magnets may readily be imbedded in them. They are made of two pieces glued together like a pencil.

The performer hides a small compass in his palm. It is held in place by a wire clip, gripped between the second and third fingers near the knuckles. A wave of the hand over the tube containing a candle will affect the

compass if any candle other than the white one is used. Its needle will vibrate when approaching the concealed magnet, and by determining quickly the position of the magnet, the color may be announced.

Those who offer guesses usually insist that some electrical device is used.

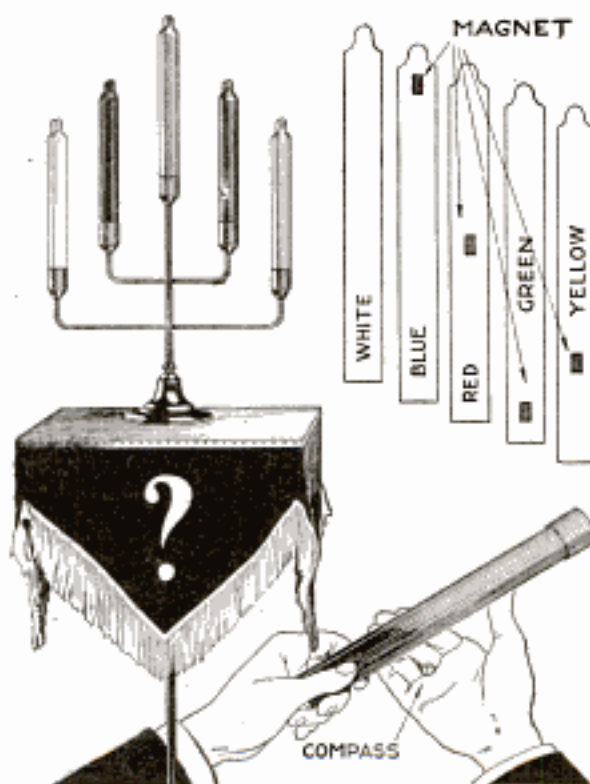

Mysterious Passes over the Concealed Candle are Made and Its Color Announced

Desk Slide in Top of Drawer

Placing a lock lid in the top of a desk drawer provided a writing board

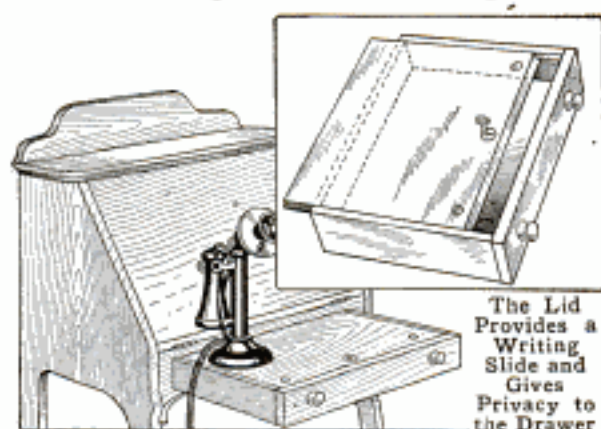

The Lid Provides a Writing Slide and Gives Privacy to the Drawer

and also gave privacy to the drawer, as shown in the sketch.

A lady's desk in a nicely furnished room was used for the telephone and as the desk was often locked there was no place on which to rest the instrument or to take notes. The drawer lid, locked with a chest lock, proved effective. The lid may be moved back so as to expose the contents of the drawer. It was finished to match the desk.—Contributed by Victor Labadie, Dallas, Tex.

Repairing a Broken Fly-Screen Frame

An old broken fly-screen frame was made quite rigid with the use of metal braces, cut as shown and fastened with nails to each corner. The brace was cut from sheet metal, and the edges A and B were cut and bent at right angles to the main part, with their extreme

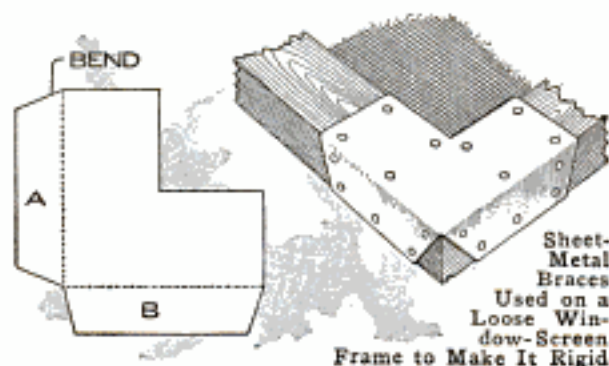

Sheet-Metal Braces Used on a Loose Window-Screen Frame to Make It Rigid

edges bent over the frame. These were sufficient to make the frame as rigid as a new one.

Raising the Temperature of a Room

The temperature of a room may apparently be raised several degrees with the same expenditure of heat, and greater comfort will result by the application of a simple principle. In summer a moist day seems warmer than a dry one though the thermometer registers the same. By permitting steam to escape from a radiator or keeping a kettle boiling on the stove, the air is moistened and feels warmer.

A Carbon Electric Water Heater

The water heater illustrated is for use on a 110-volt circuit without added resistance. It consists of two electrodes

which are immersed directly in the water; and while it is not as artistic as the usual nickel-plated heater, it is usually more economical and has the distinct advantage that it cannot be burnt out. It may be made as rapid in action as desired, is inexpensive and very convenient where water is required for experimental or industrial purposes.

For the electrodes, procure two 1/2-in. uncoppered carbons, and drill a hole in the top of each of these so that feed wires can be attached. The handle is shaped from a piece of hard wood. The lower end is hollowed out half round at either side, so that the carbons will fit in snugly. Four small holes are then drilled through from side to side, for binding wires, and a large hole is made in the center for the feed wires. Two smaller branch holes are then drilled to join the center hole, so that the double feed cord may be branched out to reach both electrodes. The outer edge of the handle is neatly rounded off and boiled in paraffin so as to render it impervious to moisture.

Remove sufficient insulation from the feed cord to make a good connec-

tion with the carbons. Fish the wire through the handle from the upper end. Pull each of the two ends pretty well through, so that they can be securely leaded into the holes previously made in the carbons. Have the latter quite hot and run in as much solder as possible, forcing it in with the end of a match as it becomes plastic. Remove all traces of the flux, and paint the connection with some melted pitch, taken from the top of a discarded dry cell. The feed cord may then be pulled up tightly, which will draw the carbons in place. They are then bound by threading through several strands of copper wire. If the holes in the wood are slightly countersunk, and two small grooves filed around each carbon at the right places to let the holding wires in, the binding feature may be disposed of very neatly.

In some localities the water is so free from all mineral salts that it will not carry the current freely, which means that the electrodes must be placed closer together, or else a small pinch of common salt may be added to the water. Although, in sterilizing instruments, boiling eggs, or something of that sort, this would be of no advantage, the salt greatly hastens the boiling.

Preventing Looseness of Drawer Handles

Drawer handles frequently become loosened and sometimes cause further annoyance by falling to the floor or becoming lost, because the bolt fastening, as shown in the sketch, is not secure. This may be avoided by inserting a rubber band between the head of the bolt and the drawer front. When the knob is drawn up tightly the pressure of the rubber band prevents it from becoming loosened.—Contributed by O. F. Germaine, Akron, Ohio.

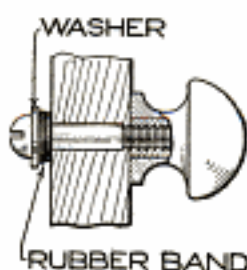

An Electrical Dancer

The modification of the well-known mechanical dancer shown in the illustration is based on the principle of the

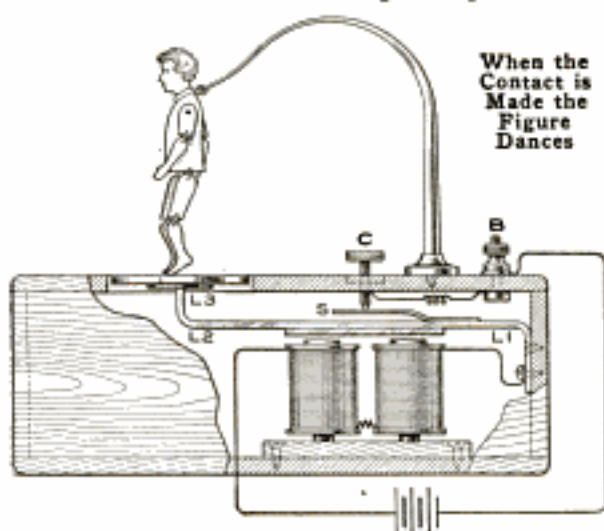

electric bell. While the amusing antics of the mechanical dancer are controlled by the hand, the manikin shown is actuated by the electromagnet.

The mechanism is contained in a box. It consists of an electromagnet with a soft-iron armature carried by a spring. A wire from the battery goes to the magnet. The other terminal of the magnet connects with the armature spring at L1. The spring is bent at a right angle at its other end, L2, and carries a platform, L3, strengthened by a smaller disk underneath. The dancer performs upon this platform.

A contact spring, S, is carried by the armature spring. A contact screw, C, is adjustable in its contact with the spring S. A wire runs from the contact screw to the binding post B, to which the other battery wire is connected.

The current keeps the platform in constant vibration, causing the dancer to "dance." By means of the screw C, the action of the current may be varied, and the "dancing" will vary correspondingly.

The figure is made of wood with very loose joints and is suspended so that the feet barely touch the platform.—Contributed by Edward C. Connelly, Wilkesbarre, Pa.

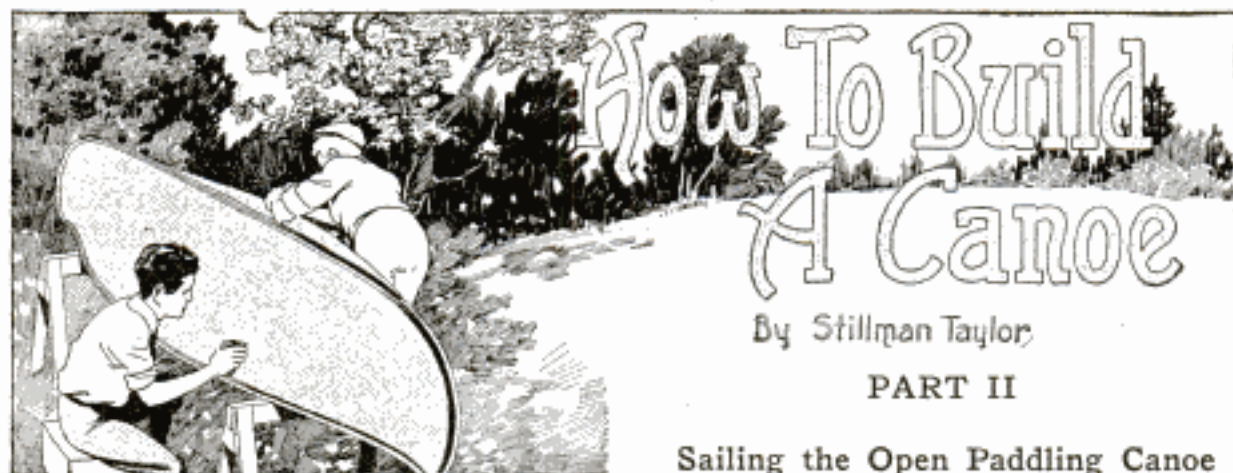

By Stillman Taylor

PART II

Sailing the Open Paddling Canoe

SAILING and its recreations are afforded the owner of an open paddling canoe, for a satisfactory sailing rig may be provided at small cost. A regulation sailing outfit may be purchased, but it is rather costly, and if the canoeist cannot use a sail frequently, purchasing an outfit is unduly expensive. A sailing rig may be constructed even by one of only moderate skill, who will devote a few hours to it. The specifications given, if carefully followed, will enable one to make a sailing rig as serviceable as a ready-made outfit, and at about one-half the cost.

The specifications and list of material for a sailing outfit suitable for a 16-ft. open canoe are as follows:

- 1 piece bamboo, 1½ in. in diameter, 6 ft. 10 in. long, for mast.
- 2 pieces bamboo fishing rod, 1 in. at butt, 10 ft. long.
- 1 piece, cedar or white pine, 5 ft. long, 4 in. wide, and ¾ in. thick, for leeboard thwart.
- 2 pieces, cedar or pine, 28 in. long, 10 in. wide, and ¾ in. thick, for mast thwart.
- 1 piece, cedar or pine, 27½ in. long, 3½ in. wide, and ¾ in. thick, for mast thwart.
- 1 piece, cedar or pine, 5 in. long, 2½ in. wide, and 1 in. thick, for mast step.
- 8 yd. unbleached cotton sheeting, 1 yd. wide, for making sail.
- 30 ft. ¼-in. cotton rope, for halyard and main sheet.
- 4 brass lantern-board hooks, for clamping mast thwart and leeboard thwart to canoe.
- 2 brass stove bolts, 3 in. long and ⅝ in. diameter, with washers and thumb nuts, for clamping leeboards at desired angle.
- 1 brass single-boom jaw for canoe, 2 in. long, for keeping boom on mast.
- 3 brass screw eyes, 1½ in. long with ½-in. eye, one for halyard, two for spars.
- 1 brass split ring, 1½ in., for fastening ends of spars together.
- 1 brass "S" hook, 1¾ in. long, for fastening ends of spars.

In converting the paddling canoe for sailing, it is desirable that it be unmarred, as far as possible. The rig described represents the result of experiments with various arrangements, and has been found to be safe and con-

venient. The original outfit has been in use for six years and will still serve for some time.

The lateen rig is best for an open canoe, because a shorter mast is required for the same sail area. An open craft is less suited for carrying sail than one which is decked fore, aft, and amidships. It is not safe to rig a canoe too heavily, and the rig described has been found to be well proportioned.

Bamboo is best for the mast, because it is lighter and tougher than a solid wood spar of the same dimensions, and is readily procured. Dealers in rugs use bamboo of 1½ to 2-in. diameter on which to roll carpets, and it may usually be purchased of them.

Cut the bamboo to a length of 6 ft. 10 in., and whittle a wooden plug, about 3 in. long, tapering it so that it will wedge firmly inside, taking care not to split the cane. Bore a small hole through the cane 2 in. from the top, plug it and fix a screw eye into the plug. Drive small brads through the cane into the plug to prevent the former from splitting. A brass ferrule fitted over the end of the bamboo will make a strong and neat finish.

The sail is made in the form of a triangle and measures 9 ft. on each side. It is best to have it sewed on a machine. The sail is bighted with parallel strips, or folds, ½ in. wide, spaced 6 in. apart, as shown at the left in the illustration. First cut the canvas to the approximate size and shape by laying the spars over it and marking the outline with a pencil. Next sew the separate widths together, lap-

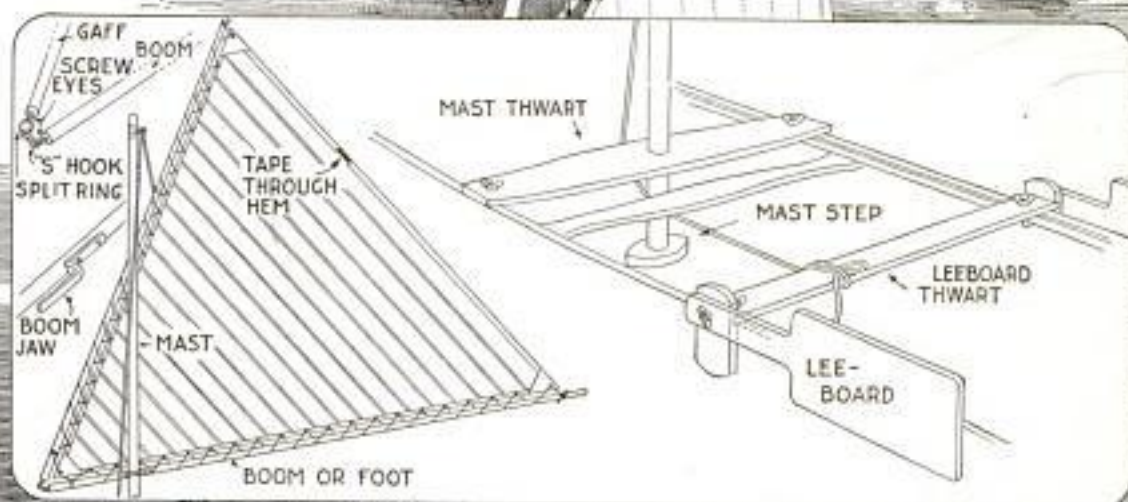
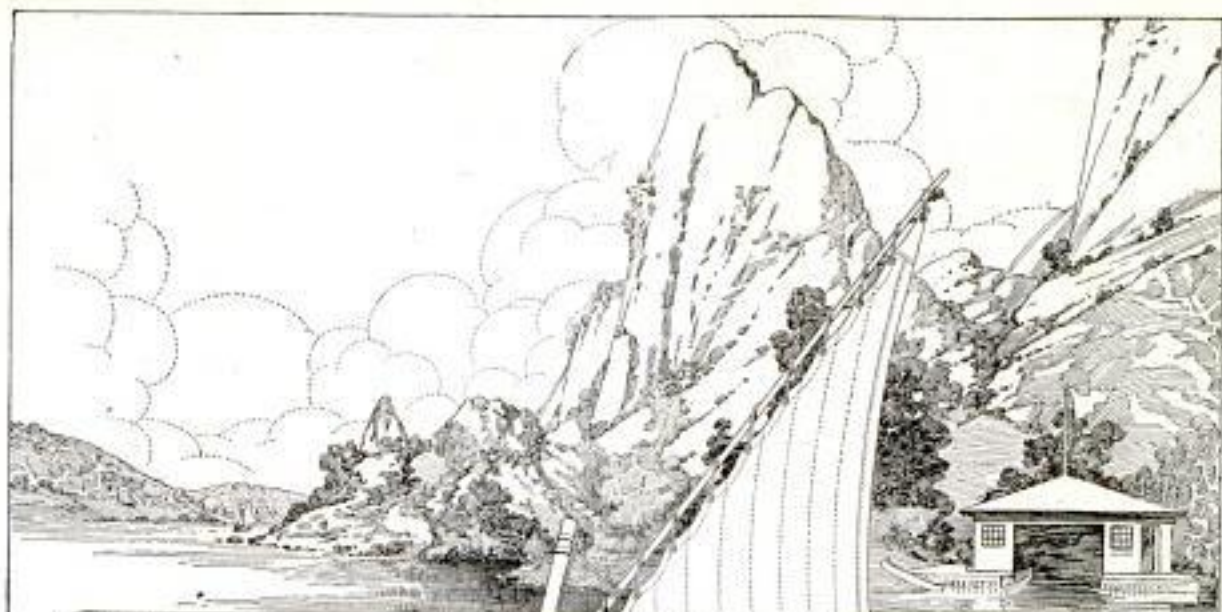

Sailing and Its Recreations are Afforded the Owner of an Open Paddling Canoe, for a Satisfactory Sailing Rig may be Provided at Small Cost. The Canoe is Practically Unmarred, yet the Sailing Outfit is Installed Substantially and may be Removed Quickly. The Canoe is Shown Running Nearly Free—before the Wind—and the Leeboards are Therefore Only Partly Submerged

ping one edge over the other about $\frac{1}{2}$ in., and sewing close to both edges. The bights or folds run at an angle and parallel with the loose ends of the leech of the sail. The sail should then be reinforced at the corners by sewing segments of cloth at these points. Along the edges which are to be lashed to the spars, fold over a strip of canvas and sew it to make a 1-in. hem. Run a $\frac{1}{2}$ -in. tape into the fold along the leech while sewing the hem. This tape is fastened to the spar at each end, to take up the slack caused by the stretching of the sail after use, thus preventing that bugbear of sailors—a flapping leech.

The mast thwart is made as shown at the right in the illustration, and has a hole cut in the center to fit the mast. It is also provided with two lantern-board hooks, one at each end, with which to clamp the thwart to the gun-wales. The mast is supported at the bottom by means of the mast step, which is a block of wood, shaped as shown to give a neat appearance. It is fastened to the grating, or to the ribs if no grating is used.

The leeboard thwart is also shown in the sketch, at the right. The short upright ends are set at an angle so that they conform to the curve of the canoe and wedge the thwart into place immediately aft of the mast. The ends are grooved to fit the thwart and fastened with screws. A carriage bolt is fitted through each end piece and provided with a wing nut, which holds the leeboard in place on each side. The leeboards may thus be adjusted at the desired angle by fixing them with wing nuts. No dimensions are given, for it is obvious that they will vary on different styles and sizes of canoes. A finish in keeping with that of the canoe should be applied. Smooth all the work as carefully as possible with sharp tools and sandpaper it lightly. Three coats of spar varnish will give a satisfactory finish.

The sail is hoisted by running the halyard through the screw eye at the top of the mast, until the gaff spar is close to the mast top, as illustrated.

The boom jaw is fastened on the boom, with the open end 18 in. from the forward end of the boom. This will permit the forefoot of the sail to extend forward of the mast. By tying the halyard at various points along the gaff, the point of balance may be found. For the sake of safety the halyard should not be tied to the forward thwart, but run under it to the stern, within easy reach of the canoeist. The main sheet should never be made fast, but the rope merely looped around the thwart and held in the hand or beneath the foot, so that it may be released quickly if a puff of wind should strike the sail.

Steering is done with a paddle. This method is more convenient than a rudder where the single sail is used. The paddle is always used on the lee side—away from the wind—and the wake keeps the blade close to the side of the canoe, without much effort on the part of the person guiding it. When turning about make the regular paddling stroke, but finish it by thrusting the blade of the paddle away from the canoe. This will tend to keep the canoe in its course, and the paddle will not be drawn across the wake, which would affect the headway of the craft.

The lower the weight is placed in a canoe, or boat, the greater will be its stability. Hence, in sailing a canoe, sit on the floor of the craft, and when turning about, turn against the wind and not with it. The experienced canoeist can shift his course readily, but the novice must be cautious, even in a moderate breeze. It would be well to sail in shallow water and to wear only bathing costume when learning to sail a canoe. When tacking and sailing close-hauled the leeboard is the most effective, but as the boards are thin both may be kept down without greatly reducing the speed. When running before the wind both boards may be raised to give the greatest speed.

☞ Paint may be readily removed from windows by applying a cloth dipped in hot vinegar or acetic acid. This applied to brushes will soften them.

Photographing Electric Sparks

Electric sparks may be photographed with simple equipment, and the process offers a diversion from the common subjects for photography. The materials necessary are a spark coil and current source, a photographic plate, facilities for developing it, and a sheet of tin foil. The illustration shows a typical photograph of an electric spark, and the variety possible is unlimited.

The process, which must be performed in a dark room with a ruby light, is as follows: Over the mouth of a small glass bottle, partly filled with talcum powder, tie a piece of cheesecloth, to act as a sieve. Arrange the material on a table, the sheet of tin foil lying flat, and a photographic plate on top of it, coated side upward.

Spread a thin layer of the powder on the plate, through the sieve. Attach a needle to an electric wire and fix the

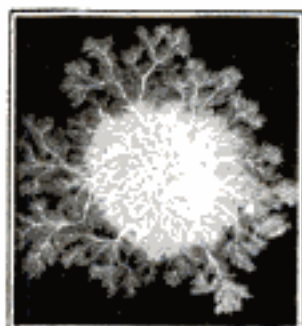

the needle that only the insulated portion, where it is joined to the wire, comes in contact with the fingers, or a shock may result. Place the point of the needle near the middle of the plate and turn on the current, permitting it to produce a spark of not more than one second's duration. If the exposure is longer than that the result will not be satisfactory. Wipe off the powder and develop the plate. If care has been taken in the process, a photograph similar to the one shown in the illustration will result.

Shoulder hooks fixed about a shop, so that handsaws may be placed on them by the handle, will save damage to saws.

Cannon-Shell Dinner Bell

Being called to dinner by the stirring peal of a bell made of a cannon shell is

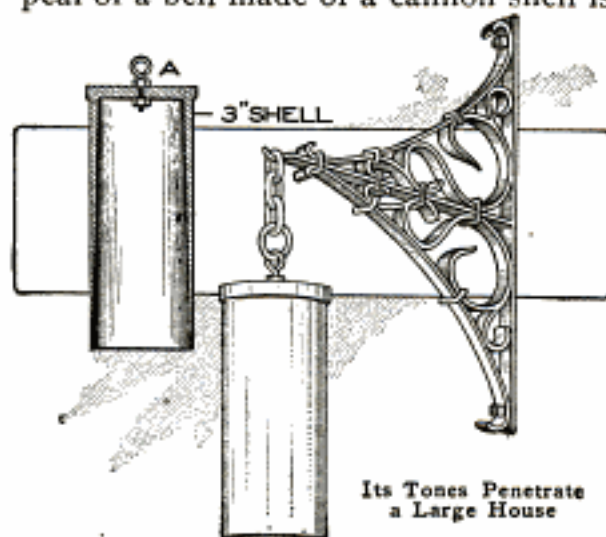

a novelty in use in Toronto. The bell shown in the sketch was made of a 3-in. brass shell, and when struck with a gavel gives out tones that penetrate throughout a large house.

The cap piece was removed at A, and an eyebolt fastened in place with a nut on each side. The gong was suspended from a wall bracket made of a band of brass fastened to the wall.—Contributed by James B. Noble, Toronto, Canada.

Use for Old Magazines

Magazines are often thrown away because of the rapidity with which they accumulate. Since most readers care to save only certain articles, a good plan is to tear the magazines apart, removing the desired articles and binding them in a separate volume. If this is carefully and systematically done, and an index prepared, the volume will be of value and interest.

Flatiron Polisher

Housewives, and others who appreciate the need for a smooth surface on a flatiron, will find the polisher shown in the sketch a convenient aid in keeping their irons in proper shape.

A wooden block, about 4 in. wide and 6 in. long, was fitted with five thin

patches of beeswax as shown in the upper sketch. The holes bored into the wood were made large enough to fit the

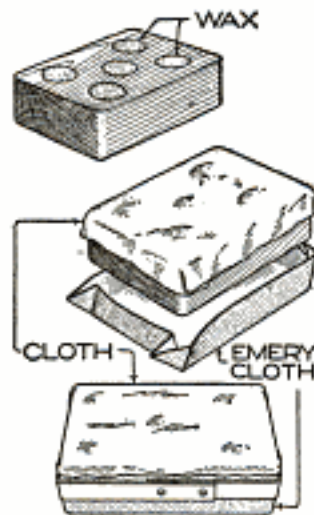

wax, which may be purchased in large thimble-shaped pieces. A double layer of linen, or other strong cloth, was fitted over the side having the wax imbedded in it, and a piece of fine emery cloth was folded over the other side of the block. A

band of sheet iron riveted together so as to fit snugly over the edges holds the cloth and emery cloth in place.

The flatiron may be polished by rubbing it on the emery-cloth side of the block and waxed slightly by rubbing it over the cloth side.

Clothespin-Basket Hook

To conveniently support a clothespin basket along the line on which the clothes are being hung, a wire support can be provided, bent to form a hook at both ends and the center



shaped into a V-bend. With the basket supported by the two ends, the wire can be slid along the clothesline as required.—Contributed by N. R. Moore, Cherokee, Iowa.

Varnishing should as a rule

be done in a room having a temperature of 80° F., and in some instances 15° higher is desirable.

Leather Tire Patch

A leather patch fixed over a tire puncture with shellac will be found to give satisfaction and may be attached easily. Cut the patch somewhat larger than the puncture and thin out its edges with a knife. Melt flakes of shellac in a flame, fusing them, and rub the hot mixture on the patch and tire, smoothing it down quickly. Such a patch may be placed over a plug and will aid in holding it in place.—Contributed by Robert C. Knox, Petersburg, Fla.

A Perpetual Whirligig

Camphor is the motive power which drives the device shown in the illustration, and it will cause the whirligig to revolve for several days, or until the camphor is consumed.

The whirligig is made of a piece of cork, ½ in. square, with a needle stuck into each of its four sides. Smaller pieces of cork, to which pieces of camphor have been



fixed by means of sealing wax, are attached to the ends of the needles. Care should be taken to keep the needles and cork

free from oil or grease, as this will retard their movement. As soon as the device is placed in a dish of water it will start whirling and continue to do so as long as motive power is supplied. A small flag or other ornament may be attached to the center cork.

Testing and Caring for Files

To test a file hold it so that the light will be reflected sharply from the teeth and observe whether their edges are flattened and appear as white lines. If so, the file is dull and should be recut if of considerable size and value.

Files should not be thrown into drawers and mixed with other tools, but should be carefully set in racks or

drawers for the purpose. A mechanic would not throw a straightedge into a drawer containing other tools, and a file should be given similar consideration, as every nick in the teeth impairs the efficiency of the file.

Files may be sharpened by dipping them into sulphuric acid, but care must be taken not to permit the acid to come into contact with one's clothes or person. Water is used to wash off the acid.

Files should be provided with individual handles. This prevents injury to the hand of the worker and aids in the proper use of the file. Handles should be carefully fitted and be made of a size proportionate to the file. In removing a handle from a file, strike the handle at the end nearest the file, by sliding a piece of hard wood along the surface of the file, as the blow is struck with it. Do not use another file or metal object in thus removing a handle, as it will injure the latter.

Catching Large Fish with a Teaspoon

Teaspoons may be made into alluring trolling spoon hooks, of a size suitable for catching large fish, by the addition of hooks, as shown in the sketch.

Drill $\frac{1}{8}$ -in. holes near the end of the spoon handle, the tip of the bowl, and near the handle of the latter.

Procure three sets of triple hooks, a line swivel, and a strip of lead, about 1 in. long. Rivet one end of the swivel and the loop of one of the triple hooks into the hole of the handle. Wire the lower end of this triple hook to the handle and with the same piece of copper wire secure a second triple hook at the thin part of the handle. Drill a hole through the lead strip and rivet it, together with a third triple hook, into the upper hole of the bowl. Fix the lower end of this hook by binding it with copper wire, through the hole near the tip of the bowl.

This hook has been tested in the waters of Puget Sound and is a deadly lure for rock cod, and other fish weighing up to 12 lb. The famous barracuda

and rock bass of the Catalina Islands have also been caught with it. By permitting the lure to sink to the bot-

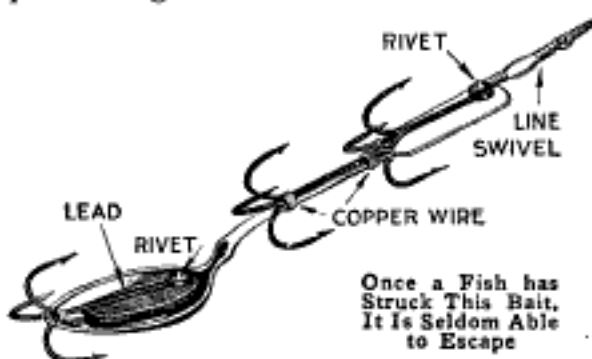

tom and bringing it up a yard or two with a quick jerk, it acts as a "jig" bait. It may also be used in trolling. Once a fish has struck, it is seldom able to escape.—Contributed by O. P. Avery, Los Angeles, Cal.

An Easily Made Counter

From unruled paper cut a piece, as shown at A in the sketch, and make slits parallel and evenly spaced with a sharp knife. Also cut six strips, similar to the one shown at B, to fit the slits cut in A. The strips are numbered as shown and inserted on the under side of A, and by pulling the strips as shown, one can count up the

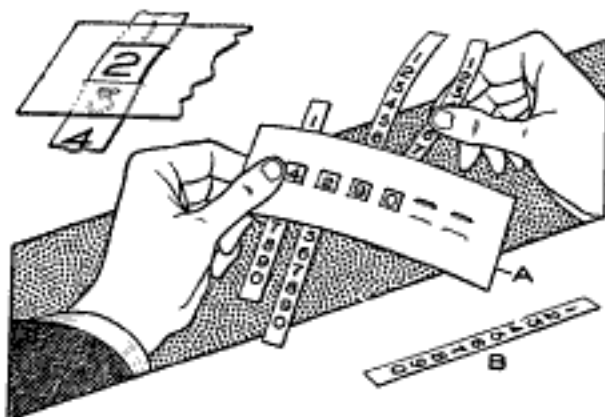

An Accurate Account can be Kept of Parts or Score for Any Game by Pulling the Strips

number of parts or keep tally on any game. By making more slits and using more strips very large numbers can be recorded.

Be sure to keep the screw and nut in the jaws of a drill chuck clean and well oiled, to prevent broken screws.

Lamp Wicks Cheaply Made

Lamp wicks may be made cheaply at home from an old soft-felt hat. The hat should first be brushed clean and

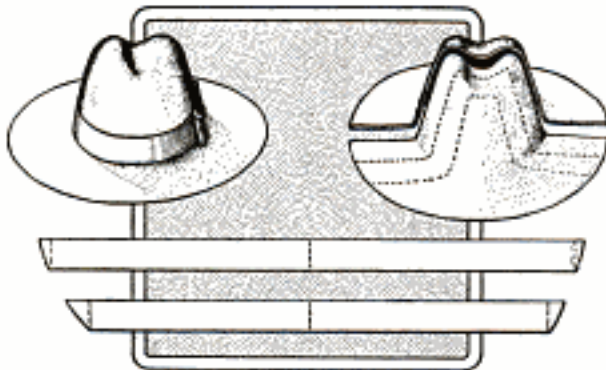

Cut the Hat into Halves and Then Cut It into Strips, from Which the Wicks are Made

the brim flattened by ironing it. The greatest number of wicks may be obtained if the hat is cut into halves with a pair of scissors, and then cut into strips of the required size, as shown in the sketch. Soak the strips in vinegar for two hours, dry them out of doors, if convenient, and they are ready for use. — Contributed by George H. Holden.

Concrete Water Basin for Poultry

A concrete worker was asked by a farmer to build a concrete basin for watering the poultry. Having no forms at hand, the mechanic used an ordinary washbasin and a wood box as shown in the illustration. The basin was greased before it was placed in the concrete.



An Ordinary Washbasin was Used to Shape the Depression in the Concrete

The completed concrete basin was buried with its upper surface level with the ground.—Contributed by James M. Kane, Doylestown, Pa.

Substitute for Ground Glass in Camera

The ground glass in my camera was broken while arranging to take a picture of a party one evening, and being unable to obtain another, I substituted a piece of white tissue paper drawn over a piece of plain glass. It did the work so well on that occasion that I have used it continuously since, and have found it better than the ground glass. It produces superior definition in the views on the glass, especially when working in a poor light, and is a good focusing screen.—Contributed by C. W. Smalley, Des Moines, Ia.

Pencil Holder for Workbench

Mechanics, and others who have occasion to use a pencil on a workbench, will appreciate the pencil holder shown in the sketch. It was made by soldering the small brass ferrule into the bottom of a portion of a brass knob, and weighting the knob with lead. The pencil will be held in an upright position where it may be easily seen.—Contributed by R. F. Hoffman, Chicago.

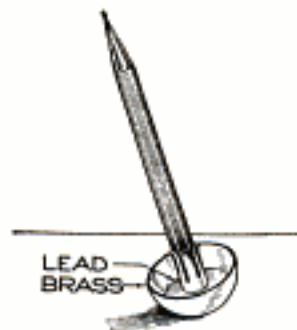

Repairing Burned-Out Incandescent Globes

Incandescent electric bulbs that have been burned out may be repaired by shaking them, in order to cause the broken ends of the metal filament to strike together. By examining the broken filament one can determine in what direction to shake the globe. The sudden passage of the current upon contact causes an arc at the broken ends of the filament, welding them. A globe thus repaired should be placed in a socket where it will not be given undue disturbance and will then last for a considerable period.

See April '15 - 623
July '16 - 153

A Woven-Reed Footstool

By CHARLES M. MILLER

[The various materials referred to in this article by number or size were described in detail in an article on "A Reed Basket," in the April, 1915, magazine, page 625.—Editor.]

REED furniture has become very popular within the last few years, and the newer designs and methods have been so attractive as to place this constructive effort among the handicraft series of modern art. It is possible so to analyze, simplify, and illustrate this work as to make it feasible for amateurs, and at the same time there are possibilities which involve problems that may try the ability of the skilled workman. In other words, there are possibilities of progress in this kind of furniture making. There are places where careful weaving is the principal aim; again particular attention will be given to corners, or, perhaps, a nicety of modeling will be found necessary to bring out the proper curves involved.

Each piece of reed furniture has a framework, usually of dowels, but it may also be made of boards in such models as small tables, dressers, bedsteads, chests, etc. The board

construction is more often covered with flat reed. In footstools there are both kinds of framework. The illustrations show the same parts marked with the same letters throughout the series of sketches.

The framework of the stool is shown in Fig. 1, in which the rails and posts are made of dowels, $\frac{3}{4}$ in. in diameter, and the braces of dowels, $\frac{5}{8}$ in. in diameter. It will be noticed that the posts extend to the top of the frame for strength in this manner of construction. If the rails rested on top of the post S, the nails would have to be driven into the end grain of the wood, which makes the strength depend en-

tirely on the holding power of the nail in this position, as there is no binding of the upper part to the posts in the weaving. With the post extending to the top, the nail passes through the upper part of the post and into the end grain of the rails, and the rails are bound together horizontally by the weaving.

The material for the frame consists of the following dowel stock: two pieces for rails, $\frac{3}{4}$ in. by 14 in. long; two pieces for rails, $\frac{3}{4}$ in. by 9 in. long; four posts, $\frac{3}{4}$ in. by 7 in. long, and two braces, $\frac{5}{8}$ in. by 17 in. long. These pieces are shown in Fig. 2. If notches are cut with a small saw, a coping saw preferred, in the ends of each rail and in the braces, as shown in Fig. 3, they

will fit to the posts better and make a stronger joint. While different makers use a finishing nail; a barbed or corrugated, nail; or a cemented, or glue-coated, nail, I find the best to be an ordinary 4-penny nail, which answers

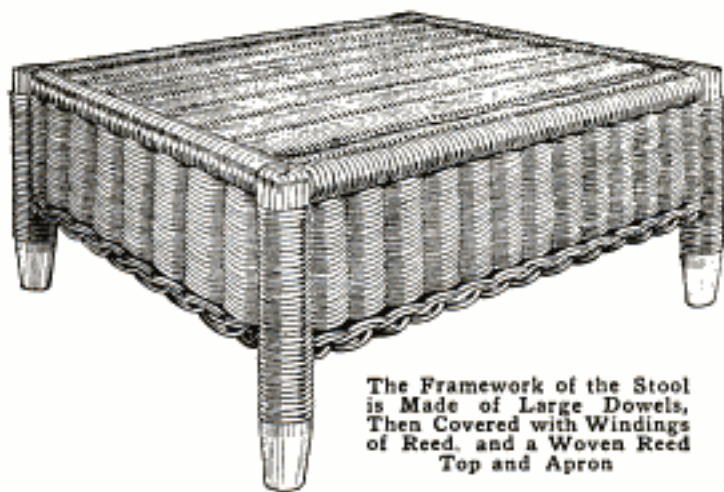

The Framework of the Stool is Made of Large Dowels, Then Covered with Windings of Reed, and a Woven Reed Top and Apron

the purpose well. Do not drive the nail through the posts without first drilling a hole with a $\frac{1}{16}$ -in. drill. A small hand or breast drill will be needed for this work.

Before nailing the frame together, the holes for the spokes in weaving should be drilled in the rails. The spokes may be No. 4 and the weavers No. 3 reed. The No. 4 reed requires a $\frac{1}{8}$ -in. hole. The hole for the top and end side spokes may be combined, as shown in Fig. 4. The dotted lines show the vertical and horizontal diameters, and E the outside and F the inside of the rail, one hole being represented as sawed in two. The spokes

for the top extend down and out at the ends, and each may be of one piece, $3\frac{1}{2}$ in. long. As there are no spokes at the top extending to the side pieces, short spokes must be inserted at the right time for the side weaving. The location of the holes in the side rails is shown in Fig. 2. The holes in the side rails may be drilled straight in the wood.

The pieces may now be nailed together to form the frame, as shown in Fig. 1. If the top of the side rails A are set about $\frac{1}{16}$ in. below the tops of the posts, the weaving will be almost level, as the winding reed is thinner than the round reed. The braces D are halved at the center, on a slant, to bring their upper surfaces on a level when they are in place. The length of 17 in., as given in the material list, is not accurate, as sufficient length is given to allow the ends to be cut, in fitting them in place after the frame is assembled. The posts should stand vertical and square. Try the braces before nailing them in place, to see that they do not draw the frame out of shape.

The first operation in weaving is to cover the tops of the four posts, which is started as shown in Fig. 5. A short piece of winding reed, G, is first tacked in place. A round reed can be split if one is careful, in case winding reed cannot be obtained. Tacks used by shoemakers are just the thing for fastening these weavings in place. After fastening the weaving G in place, another, H, is put on in an opposite direction, whereupon J is fastened on the same as G, and so on, until the post is covered, as shown in Fig. 6. Perhaps a better way to cover the posts would be to tack all eight pieces on the post part C, and then weave them down together. It may not be necessary to tack them all on the rails.

After the corners are all covered, the end rails B are wound with the winding reed, the start being shown in Fig. 7, where the frame is shown in an inverted position. The reed is tacked, at K, to the side rail, and whenever the winding comes to a hole, a pencil mark

is made to locate the hole later. This mark is shown at L. When the two end rails are wound, push a bodkin, or other steel point, in between the windings where the marks are located, to make way for the insertion of the spokes. It may appear to an observer that the spokes could be put in before the winding, but the winding cannot be properly done after the spokes have been inserted, as the windings would separate too much around them. The hole must be opened up through to the opposite side of the rail. Single spokes go through the rail, and they are only put through one end rail at first, as the weaving is much easier with one end of the spokes free, but, of course, they must be inserted in the other end before the weaving gets within 2 or 3 in. of that end. An extra spoke is inserted beside each spoke, as the weaving proceeds and after a strip has been woven $\frac{3}{4}$ in. wide. These short spokes are cut just long enough to fit in between the end rails. The weaving is done with a single weaver, and it is passed over and under double spokes as if they were one. When the weaver comes to the side rail, it is wound twice around the rail, to take up the space for the two strands across. If the weaver does not go twice around the side rails each time, either the weaving will take a curve or the side winding will be loose. The starting of the weaving is shown in Fig. 8, where the extra spokes are inserted along the side of each spoke that runs through the end rails.

After the spokes have been inserted in the opposite end rail and the weaving in the top completed, the braces and posts should be wound. Where the braces D connect to the posts C, three strips of the winding reed are passed around the post and tacked on both sides of the braces, as shown at M, Fig. 9. Where the braces cross, the winding passes around both pieces for a short distance, as shown at N. It is quite appropriate to use the brass caps O on this model, but on many stools their use has been discontinued and the winding continues down to within $\frac{1}{8}$ in. of the bottom of the post.

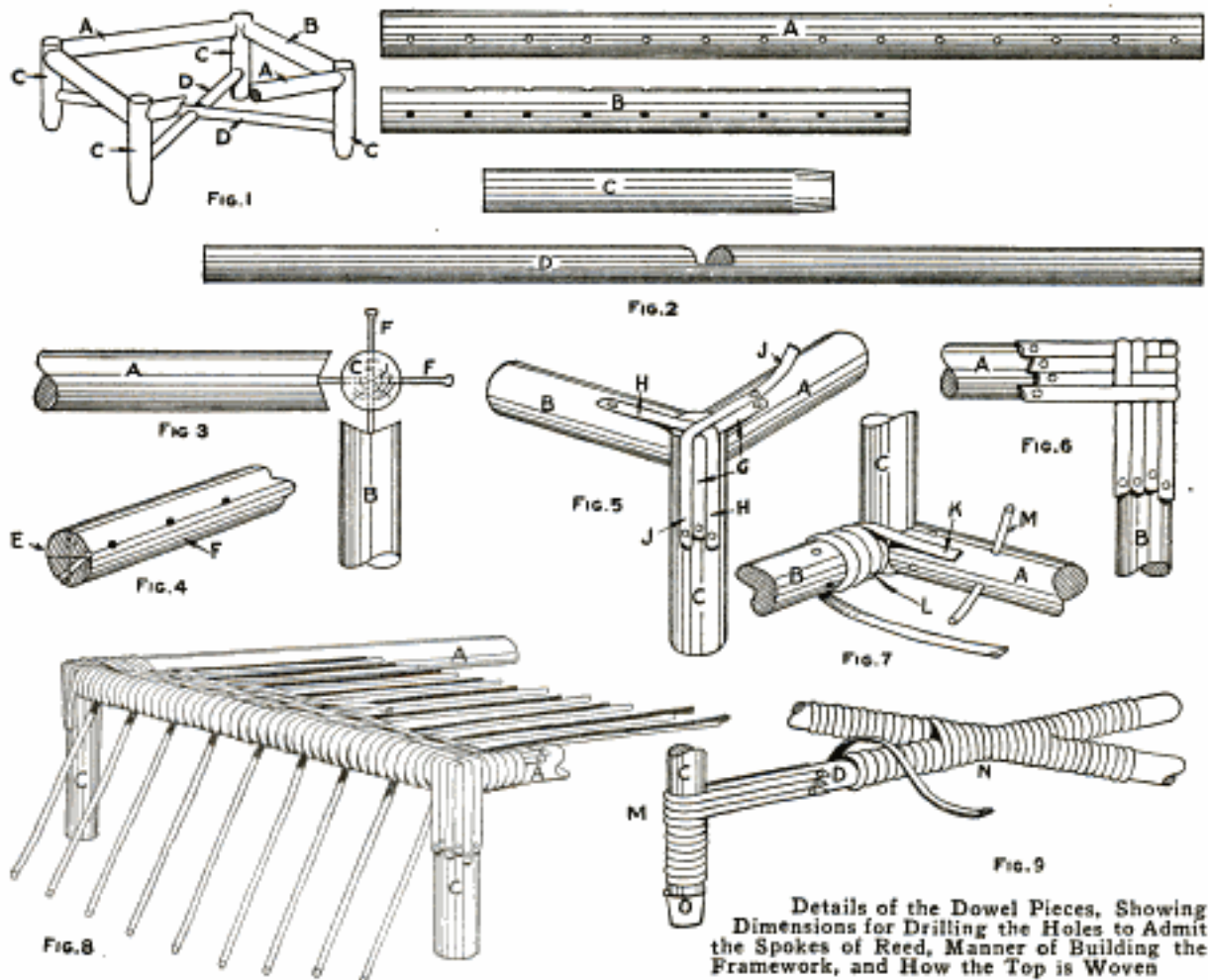

Details of the Dowel Pieces, Showing Dimensions for Drilling the Holes to Admit the Spokes of Reed, Manner of Building the Framework, and How the Top is Woven

In case the brass cap cannot be obtained, the winding may be used also on this model.

The side weaving is called the apron, and in this case the pairing weave is used. The short spokes will have to be inserted in the under side of the side rails, and the extra spokes are added after the weaving is started and a small strip woven. The pairing weave is shown in Figs. 10, 11, and 12. The two weavers are represented by the letters P and Q. The weaver P passes back of spoke T and out between T and U. The weaver Q is then used in the same manner, and so on, around the stool. When the post is approached the weaver that comes out between the last spoke and the post is passed around the post and in behind the next spoke on the other side. It will be seen in the pairing weave that the weaver behind is always thrown over the other weaver. This gives the appearance of a rope twist to the weaving, and also

cinches it to the spokes and prevents slipping. Always pass the one weaver around the post twice to take up the space for the one that cuts across the corner. The weaving of the sides or apron is done with the object turned upside down, where it is in a good position for finishing off, which is sometimes called breaking down.

If the weaving has been carried far enough, the extra spokes are cut off even with the weaving, and the breaking down may be done as follows: The spoke R, Fig. 13, is shown turned down back of the spoke S, and S back of T and out. The spoke R, as shown in Fig. 14, is back of S, in front of T, back of U, and out between U and V, but as R is brought out, the spoke T is brought down back and parallel with R. Likewise the spoke S passes back of V, and U is brought down with it. The spoke T is brought back of W and V is brought down back of it. The short end of R is inserted under the

roll, between the roll and the weaving, and is left extending on the inside. If

more workable, the wet reed, held in place until dry, stays curved in the

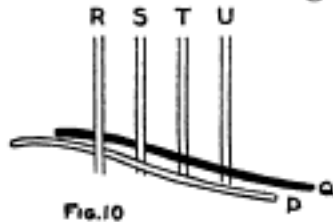

Fig. 10



Fig. 11



Fig. 15



Fig. 12

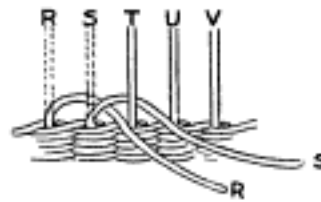

Fig. 13

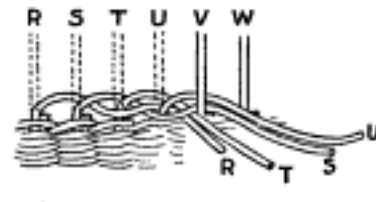

Fig. 14

The Weaving of the Apron is Done in the Same Manner as in Making a Basket, with the Break Down to Form the Edge

it is too long, it can be cut off close to the inside of the weaving. In Fig. 15, all the short ends are shown brought through to the back as far as the weaving is illustrated. At the corners, the posts are used as spokes. To finish the roll, the spokes will have to be inserted through the roll, to correspond with the rest of it; hence, the beginning of the roll should be left loose, as in Fig. 13.

In weaving, the weavers should be kept wet, but not the spokes. Do not put the reed in water and leave it for any length of time, as it will become discolored. About 15 minutes will be sufficient to make the reed pliable, then it is best to have a sponge and bucket of water at hand, to dampen long weavers frequently by drawing the reed across the wet sponge. Besides being

form woven much better. Some workmen leave the reed in water for a long time and depend on bleaching to whiten it, but so much of the bleached work looks like a poor job of painting that it is much better to keep it white from the start. In case bleaching is found necessary, a little chloride of lime in water makes a good bleacher. Avoid making the solution too strong. It should be put on with a brush, so as to get it into the interstices of the weaving, whereupon the work is placed in the sunshine to dry.

Any kind of reed used will have some of the small hairlike fibers sticking out after the weaving is complete, and this should be singed off with a gas flame. A blowtorch is good for this purpose. Be careful not to scorch the weaving.

A Homemade Ellipsograph

By J. A. SHELLY

The instrument illustrated was designed to take the place of the two nails and a piece of string for drawing ellipses of different sizes. It is made of hard wood, preferably maple or beech, and consists of a bar with one fixed and one sliding head, the latter having a wedge clamp to hold it at any point desired on the bar.

In the ends of the heads are driven two coarse needles that have been broken off about $\frac{5}{8}$ in. from the eye

end. These ends should be placed $\frac{1}{8}$ in. from the inside of each head and the same distance from the bottom, and driven in until the eyes are each $\frac{1}{8}$ in. from the surface. A piece of linen thread is run through the eye of the needle that is in the end of the sliding head and knotted to prevent its pulling out, and the free end is run through the needle eye on the fixed head. The thumb tack in the fixed head is to secure the free end of the thread. The

tack is driven in at an angle so that one edge sticks up enough to allow the thread to be pulled under it.

To operate the ellipsograph lay out the length of the major axis on a center line, then bisect the distance between these points and erect a perpendicular. On this line lay off half the minor axis, measuring from the center line; then from this point locate the foci by setting the dividers to half the major axis and scribing arcs of circles to cut the center line. Set the heads of the instrument so that the projecting needle ends will be the same distance apart as the foci, and clamp the sliding head with the wedge. Set the instrument so that the needle eyes will be exactly over the points where the foci are on the center line. A pencil, with a little groove filed $\frac{1}{8}$ in. from the point, for the thread to run in, is set to half the minor axis and the thread is pulled taut and secured by the thumb tack. The pencil should be held perfectly perpendicular while scribing the line. The instrument must be reversed to draw the other half of the ellipse.

To draw an ellipse that will be an exact projection of a circle at any given

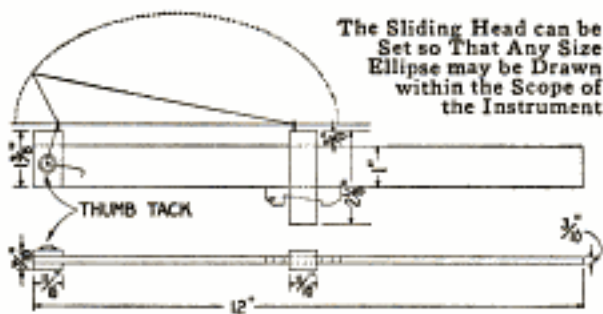

angle it is necessary to determine the length of the major axis. This may be done by laying out the circle, either full size or to scale, and projecting two parallel lines equal to the diameter of the circle, or its scale, and connecting these lines with a line drawn to the required angle. The length of this line is the major axis.

⚠ Never run a glass cutter over the same line twice, as this will ruin the cutter. Alcohol rubbed along the line to be cut aids in the process.

Ship's-Wheel Device for a Radiator Valve

Leaving one's comfortable bed to open the valve of a radiator in a cold room is an unpleasant task. The de-

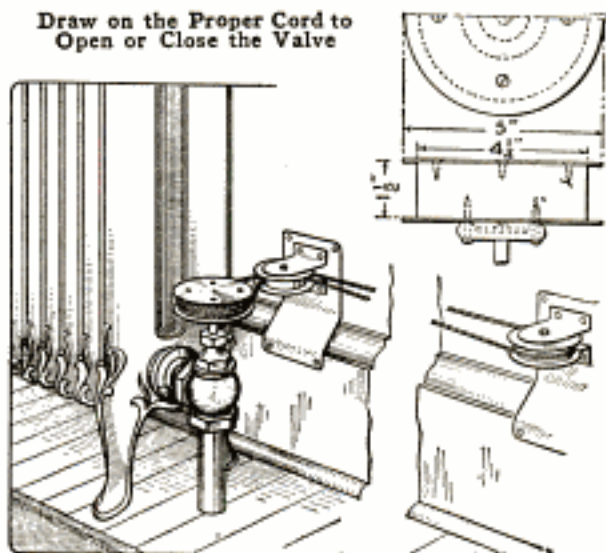

vice shown in the sketch obviates the necessity for leaving the bed, yet gives as positive control over the valve as if the hand were on the valve wheel.

The construction of the pulley attached to the top of the valve wheel is shown in the small sketch at the right. It is built up of a center section of wood and flanges of sheet metal, fastened with screws. The pulleys attached to the wall are built in the same way, but are smaller. Any size that is convenient may be used for the larger as well as the smaller pulleys, but the larger pulley must be small enough so that it will not rub against the end of the radiator.

The cord is wound around the pulley at the valve handle, several times, like the steering cord on a motorboat. This gives a positive grip on the pulley. The cord may be conducted directly from the large pulley to the nearer small pulley, the other small one being omitted.

To operate the device draw on the proper cord to open and close the valve. It would be well to mark the cords with tabs so that they may be readily distinguished.—Contributed by P. D. Norton, Chicago, Ill.

Common Mistakes in Model Making

By H. J. GRAY

MODELS made as a pastime or for exhibition purposes should represent correctly the full-sized machine, not only as regards general design but also in the proportioning of parts, the finish, and the choice of materials. The satisfaction derived from the possession of a model is greater when it is truly representative. Study and careful measurement of the original are necessary to attain this result, and provide valuable experience in the application of correct mechanical principles.

The most conspicuous, though perhaps not the most frequent, errors made by amateurs are in the proportioning of the various parts. This usually arises from insufficient study of the original machine, and is often sufficiently glaring to attract the attention even of a casual observer. The foundation or base of a model stationary engine, for example, is often painted to resemble brickwork. This is correct, provided the spaces are proportioned so as to represent bricks and not three-ton slabs of granite.

Mistakes are made in the selection

of pulley wheels, both as regards the character and the size of the pulley that would be suitable for the particular purpose.

The "cheese-head" or flat-head machine screw appears to have a peculiar fascination for the model maker, judging from the frequency with which it is misplaced. It is only necessary to consider what would happen in a full-sized machine if such screws were used for making joints in valve rods, cylinder covers, slide bars, for fixing bearing caps, and the like, to realize how completely such a defect mars the appearance of a model to a discriminating eye. Bolts, or, in some cases, studs and nuts, should be used to give an appearance of correct workmanship.

Many novices make a serious mistake in the character of the finish given to the various parts. This usually results through devoting insufficient attention to the method of manufacture adopted in engineering practice. Under the impression that a mottled appearance gives an ornamental effect, they will make a shaft end with a

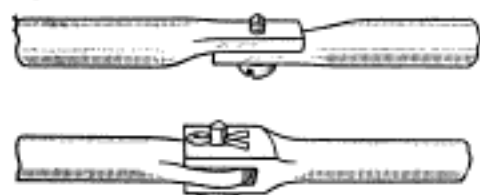

FIG. 1

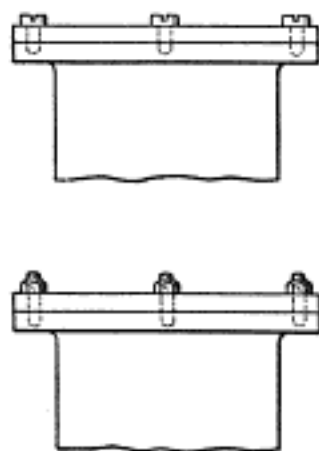

FIG. 2

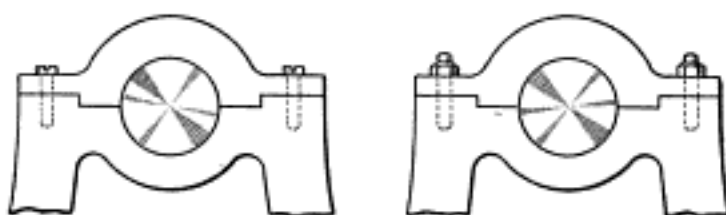

FIG. 3

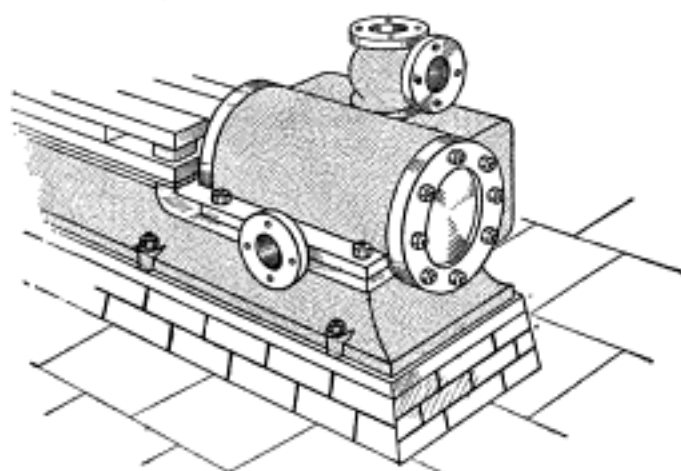

FIG. 4

Details of Correct and Incorrect Practice in Model Making: Fig. 1, Valve Rod Joined by "Cheese-Head" Screws, Wrong, and Joined by Joint and Pin; Fig. 2, Bearing Cap Fixed with Flat-Head Machine Screws, Wrong, and with Studs and Nuts; Fig. 3, Cylinder Cover Fixed with Flat-Head Machine Screws, Wrong, and with Studs and Nuts; Fig. 4, Representation of a Brick Foundation, Incorrectly on Side, and Correctly on End

scraped finish. To the casual observer there would be nothing amiss, but a mistake of this kind would offend the trained eye of an engineer, because it is entirely unrepresentative. The object of scraping sliding surfaces is to obtain a greater degree of flatness by removing small inequalities. As the subsequent use of a file would only undo the work of a scraper, the surface is permitted to remain mottled, as left by the scraping tool. But the end of an engine shaft is not a sliding surface, and in engineering practice would be finished in a lathe.

Nickelplating is often resorted to in order to produce a brilliant and supposedly pleasing finish to the model of a casting. This is obviously wrong, for the actual casting—which might weigh tons—would be painted, and not electroplated.

Locomotive wheels or stacks of polished brass add to the appearance of a model only in the eyes of the uninitiated. Few persons would care to risk a railroad journey if the engine had brass wheels. Iron or steel is the correct material to use. Brass is also often used instead of iron for cylinders, connecting rods, and starting levers on models, or for steam pipes, which should be made of steel or copper.

In certain cases there may be unusual difficulties in using the correct material for a machine part made to a small scale. It is then permissible to use other material, provided some attempt is made to disguise the fact by means of an appropriate finish. Copperplating, for example, may be used to disguise some other material, if the parts should properly be made of copper. It is often convenient to make a model boiler of brass. It should not be polished but bronzed, to represent the iron or steel plates of a full-size boiler.

Take-Down Emergency Oars

Owners of sail or power boats will find the take-down oars shown in the sketch easily made and of value in an emergency far out of proportion to the space occupied in a boat. A pair of

ordinary oars was cut as shown, and pipe fittings were attached to the ends to form a detachable joint. When

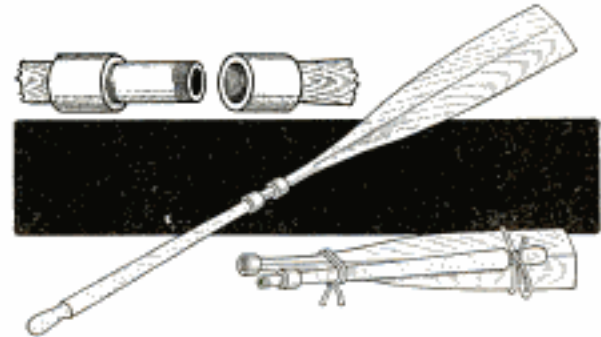

When Knocked Down the Oars Occupy Small Space in a Boat

knocked down the oars may be stored in a seat cupboard, or other convenient place.—Contributed by H. E. Ward, Kent, Wash.

How to Make Propeller Blades Quickly

Requiring a number of propeller blades for use in making models of windmills, and other constructions, I found that I could save much time and obtain a satisfactory set of propeller blades by using ordinary shoehorns of the same size. The small ends of the horns were flattened out so that they could be fastened to pieces of wood for bearings, and then hammered to the proper shape for cutting the air, or receiving the force of the wind.

Bench Stop

Serviceable bench stops may be made by grooving pieces of maple, or other close-grained, hard wood and fitting strips of clock spring into them, as shown in the sketch. The

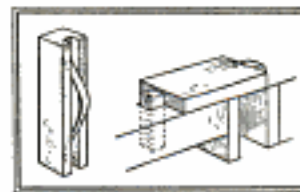

pieces must fit the holes in the bench top snugly, and the spring will then prevent them from slipping out. The end of the spring fastened to the stop should be annealed so that a hole for the screw may be drilled into it readily.—Contributed by Stanley Mythaler, Spring Valley, Minn.

Miss Louisa Brigham (Designer)
16 Horatio St., N. Yc.

800 1265 POPULAR MECHANICS

COZY NURSERY OUTFITTED IN PRACTICAL WAY

*Palace of Education
Pan-Pac. Exposition.*

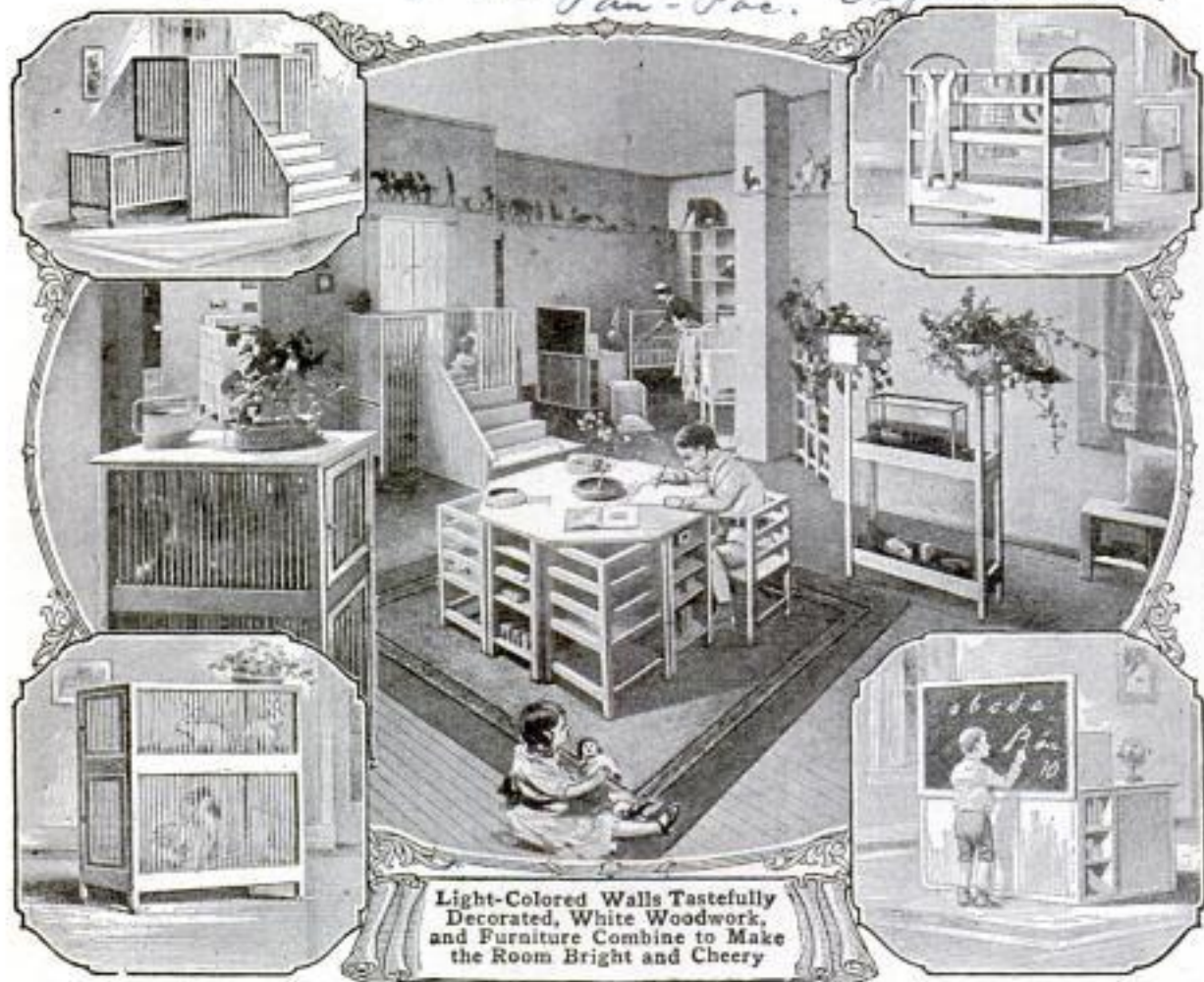

PHOTO BY CARDWELL VINCENT, COPYRIGHT BY PANAMA-PACIFIC INTERNATIONAL EXPOSITION

BECAUSE of its cheery appearance and unusual convenience of arrangement, the nursery illustrated herewith presents a number of pleasing and practical suggestions to the householder. Everything, from the decorations to the appointments, merges to produce a desirable atmosphere. The nursery may justly be called the most important room in a home, and here is one in which simplicity, durability, and harmony are afforded without needless extravagance. The furniture, all of which is finished in white enamel, combines the features of service, propriety, and ingenuity. The octagonal table used in the middle of the room has four box-shaped chairs which fit beneath its cut-off corners. A series of small shelves are also provided on four sides and offer convenient spaces for toys and books. At the left is a barred hutch, made in the form of a cabinet, which serves as a novel depository for stuffed animals when the latter are not in use. On the other side is a stand supporting flower boxes and an aquarium. The gallery in the background is raised to the level of a window and provides a cozy place where a baby can bask in the sunlight. The space beneath it is used to receive a crib, while the steps are in reality drawers in which playthings may be kept in order. At the back of the room is a desk with shelves at the top and sides and a blackboard hinged to the back, while near it is a rack on which all of the little clothes may be hung at night. Cribs, shelves and racks for toys, and other fittings occupy the alcove.

IN accordance with the editorial policy of this magazine never to accept compensation in any form for what appears in our reading pages, and also to avoid all appearance of doing so, we are obliged to omit the name of the maker or the seller of any article described. This information, however, is kept on file and will be furnished free, by addressing Bureau of Information, Popular Mechanics Magazine, Chicago. [Editor.]

A New Aladdin

\$828



7 Room Modern Aladdin Home

Highest
AWARDS
WORLD'S
FAIR

Here's a new home fresh from the Aladdin designing rooms. It was completed too late for classification in this year's catalog. This new Aladdin was designed to meet the needs of the average American family. Just right in size for the average city lot. Has a delightful porch, generous living room, lovely dining room, an efficiency kitchen, inside cellar entrance, three fine bedrooms, bath room and closets. To really appreciate this wonderful new home design you must see the plan or room arrangement. The Aladdin price on this design saves you from \$300.00 to \$400.00 over the lumber dealer's price. First, other lumber manufacturers have raised their prices from \$4.00 to \$10.00 per thousand this year. Aladdin prices remain unchanged. Second, Aladdin houses save waste of lumber—all material cut to fit.

Aladdin System Cuts Out Waste

The Aladdin Readi-Cut System designs houses to use mill run lengths of lumber—just as it comes from the forest—and your carpenter does not need to waste any material by cutting during the erection of your house. Waste of lumber is here reduced to 2%—you pay only for what is used and no more. You can build your Aladdin yourself—complete instructions and illustrations show you how to build it and save big money.

Bungalows, Dwellings, Summer Cottages

Buy direct from the forest—from Aladdin—and make four savings. You make a substantial saving on the lumber, on the millwork, on the hardware and on the labor. The big Aladdin catalog tells all the facts you want to know, gives photographs, floor plans, prices and descriptions of a hundred modern homes, Bungalows, Dwellings, Summer Cottages and Garages. Send for it today.

North American Construction Co.

5-Room Home \$298

Price Includes All Materials

297 Aladdin Ave.
Bay City, Mich.



TEAR HERE
North American Construction Co., 297 Aladdin Ave., BAY CITY, MICH.
Enclosed find stamps for your book "Aladdin Homes" No. 180.

Name _____
Street _____
City _____
State _____



*The New
Arrows*

*Ashby 2 $\frac{1}{8}$ in
Lexicon 2 $\frac{1}{2}$ in*

Arrow Collars

Because the Arrow fabric is extraordinarily fine, smooth and durable, the domestic satin laundry finish is possible. The satin finish marks

the difference between the ordinary and the *high quality* 2 for 25¢ collar, and is the Arrow's distinguishing mark of quality.

CLUETT, PEABODY & CO Inc., *Makers of Arrow Shirts*
Troy, N. Y.

BLUE STREAKS

Makers and Riders Choose These Tires

Goodyear Blue Streak Motorcycle Tires have been proved best both by manufacturers and by riders.

The manufacturers of all leading makes of motorcycles have adopted Goodyear Blue Streaks as standard equipment. *Three out of every four* new motorcycles will be Goodyear equipped in 1916.

They tested Blue Streaks in every possible way — and proved to their own satisfaction that Blue Streaks gave the best service and the longest mileage at the lowest cost to the rider.

And in every-day service, riders have proved Blue Streaks just as conclusively.

Every important world's record for speed and endurance on track and road is held by Goodyear Blue Streaks.

Big and hardy, good-looking and easy riding, safe and sure, no other tire is so well fitted to give unusual mileage, to lessen trouble, to increase speed and save power.

Use Blue Streaks on your old machine. Get them on the machine you buy.

Any motorcycle dealer can sell you Blue Streaks. Ask for them.

The Goodyear Tire & Rubber Co.
AKRON, OHIO

GOOD YEAR
AKRON
Motorcycle Tires

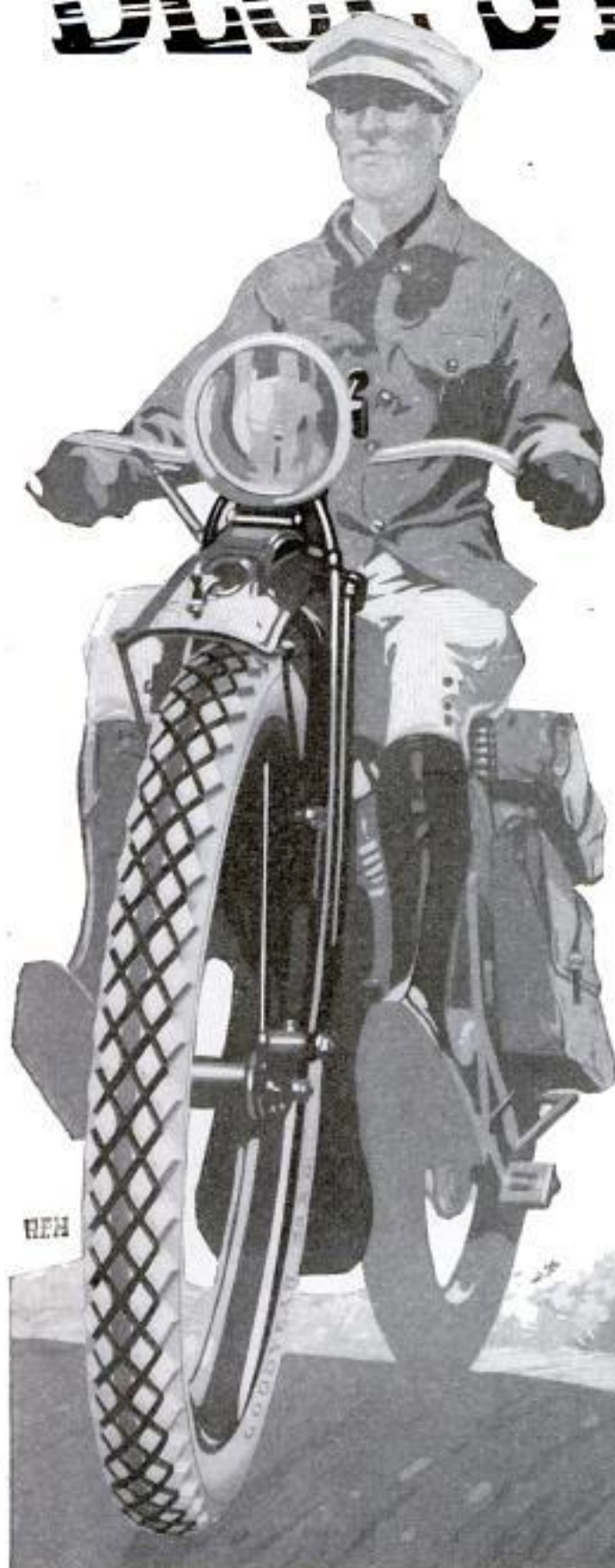

Please Mention Popular Mechanics



The
Wild Turkey

Its restoration is important because domestic turkeys are decimated by a disease from which the wild variety is free.



in
the
field



When Our Land Is Filled With Game

A FEW years ago America was the greatest game country in the world. Our woods, our fields, our water-ways, were teeming with game birds. Wild turkeys, quail, grouse, ducks, were familiar sights—to the sportsman; on the table; and in city markets.

These conditions should again prevail. They may successfully be brought about through game farming.

Game farming does not necessarily require a large amount of land and involves little expense in time and money. The work in itself is intensely interesting and affords both profit and pleasure to those who indulge in it.

Results from Game Farming

In the first place game birds of many kinds command high prices in city markets. Their eggs are eagerly sought by breeders. Secondly, if you are fond of hunting, the birds you raise will provide excellent sport and food. Or if you prefer, and if you own large acreage, you may lease the privilege of shooting over your land. This does not mean that the sport of hunting, so far as the general public is concerned, will be restricted. On the contrary it will be increased; for game raised for sporting purposes cannot be closely confined in any given area.

If you are interested in game farming from any standpoint, you should write for a booklet which takes up the subject in a broad way and gives much interesting and valuable information regarding it.

The book is called "Game Farming for Profit and Pleasure." It is well worth reading. Write for a copy. Use the coupon below.



Game Breeding Department, Room 101
HERCULES POWDER CO
Wilmington, Delaware

Manufacturers of Explosives; Infallible and "E. C."
Smokeless Shotgun Powders; L. & R. Orange Extra
Black Sporting Powder; Dynamite for farming.

Game Breeding Department, Room 101
Hercules Powder Company, Wilmington, Del.

Gentlemen:—Please send me a copy of *Game Farming for Profit and Pleasure*. I am interested in game breeding from the standpoint of.....

Very truly yours,

Name.....

Address.....





Copyright U.S.A. 1915 by
The B.V.D. Company

“Day Off” or “Day On,” Keep Cool in B.V.D.

WHETHER you hike for “the game” or the country, or must stay strapped to a desk, B. V. D. Underwear will give you more genuine comfort than you ever had before.

Loose fitting, light woven B.V.D. Underwear starts with the best possible fabrics (specially woven and tested), continues with the best possible workmanship (carefully inspected and re-inspected), and ends with complete comfort (fullness of cut, balance of drape, correctness of fit, durability in wash and wear).



If it *hasn't*
This Red
Woven Label



If it *isn't*
B. V. D.
Underwear

(Trade Mark Reg. U. S. Pat. Off. and Foreign Countries)

B.V.D. Closed Crotch
Union Suits (Pat.
U. S. A.) \$1.00 and
upward the Suit.

B.V.D. Coat Cut Under-
shirts and Knee Length
Drawers, 50c. and
upward the Garment.

The B. V. D. Company, New York.



Please Mention Popular Mechanics

America's Leading Motorcycle Builders Equip With

Firestone

—and at no extra cost to you.

Manufacturers are glad to have you specify Firestones because they know it means one more feature of sure satisfaction with their machines.

The manufacturer knows that Firestone builds for the big, heavy, speedy machine of today. He knows of the extra rubber, the extra fabric and the extra workmanship put into Firestone Tires. He knows that Firestone toughness gives Most Miles per Dollar.

These leading motorcycles are equipped with Firestone Tires without extra cost to you:

Cyclone	Dayton	Emblem	Excelsior
Harley-Davidson		Henderson	Merkel
Reading-Standard		Smith Motor	Wheel
	Thor		Yale

FIRESTONE TIRE AND RUBBER COMPANY

"America's Largest Exclusive Tire and Rim Makers."
AKRON, OHIO — Branches and Dealers Everywhere



Are You Shave-Conscious?

Shave-consciousness and self-consciousness—

Both are bad business, and especially bad in business.

Most men are shave-conscious because the daily shave makes their faces burn, smart, fret and sulk.

You can't have your mind on face matters and fiscal matters at the same time. Efficiency flees; concentration takes a hop, skip, and a jump to parts unknown.

Mennen's Shaving Cream has kept millions of faces from being shave-conscious by the soothing healing of its scientific and incomparable lather.

Mennen's absorbs water like a sponge and remains moist for about ten minutes. No need of frequent re-lathering or "rubbing in."

It is without those torturing little stilettos of free caustic that lurk in other shaving soaps and make shaving a torture.

Mennen's saves 50 per cent in time and 75 per cent in trouble.

Mennen's energizes the "once-over" into twice its ordinary efficiency. It rejuvenates many a discarded razor-blade.

Each 25-cent tube contains a shave a day for months—will last almost a year if you shave but four times a week, provided you follow directions. Performance weds economy in Mennen's Shaving Cream.

Gerhard Mennen Chemical Company
Newark, N. J., U. S. A.



This Coupon brings you two samples for 10 cents

GERHARD
MENNEN
CHEMICAL CO.
Laboratories:
2015 Orange St.,
Newark, N. J.

Enclosed is 10c for which please send me a medium-sized tube of Mennen's Shaving Cream and, free, a trial can of Mennen's Talcum for Men.

Name _____

Address _____

City _____

State _____



A real tire for a real boy!

It lets you "speed 'er up" with safety, for its "safety bars" dig down and grip the road preventing slips, just as your father's *black tread Goodrich Auto Tires* do. Everybody in the country is talking about these big "*Black*" *Auto Tires*, and we have put the same gristly rubber tread on the "*Giant*" for your bicycle.

Goodrich "GIANT"

Black Safety Tread Tire

"Giant" is the strongest Bicycle Tire ever made with actually heavier, stronger fabric than many small sized Auto Tires. This fabric is loosely woven—different from any other bicycle fabric—allowing the rubber layer to sink through its mesh so that when cured they are welded together into a single piece of solid rubber from tread to lining. Although it costs a trifle more, they are guaranteed for a year and will outlast several ordinary tires.

And to every boy who buys a "Giant" we will give the following—

FIRST—A Goodrich "Boy's Guide Book" telling how to make a boomerang, how to build a camping tent, how to signal by semaphore, and many other "pointers."

SECOND—A rich Maroon or Blue Felt Pennant with Sparkling Frosted Letters.

If the tire dealer near you does not carry Goodrich, write us. We will tell you where to go to get *Pennant, Guide Book* and "*Giant*" Tire.

Address

**The B. F. Goodrich
Company**

Advertising Dept., AKRON, OHIO

Makers of the Celebrated Goodrich Auto-
mobile Tires—"Best in the Long Run"





The
Grand Prize
Machine

Indian

THE only Grand Prize awarded a motorcycle at the Panama-Pacific Exposition was given to Indian.

Two months ago a 1916 Indian with Powerplus Motor covered 1000 miles in 21 hours and 3 minutes—a world's record. These are the big kind of honors that Indian is always earning for itself.

This year the name Indian means more to the purchaser than ever before because he can have a \$275 Big Twin, a \$150 Featherweight or a moderate priced Bicycle, all bearing the Indian nameplate.



At the left—1916 Indian Featherweight—2½ horse power, 3 speed, Indian Starter—Indian Cantilever Comfort Saddle—\$150.

At the right—Indian Motobike—little brother of the Big Indian Motorcycle and built along the same style lines. Electrically equipped. Price \$40. 10 other models, \$25 to \$40.



Look up the Indian Dealer in your city before you buy anything on two wheels.

Send for Motorcycle or Bicycle Catalogue

Hendee Manufacturing Co., 711 State St., Springfield, Mass.

(Largest Manufacturers of Motorcycles in the World)

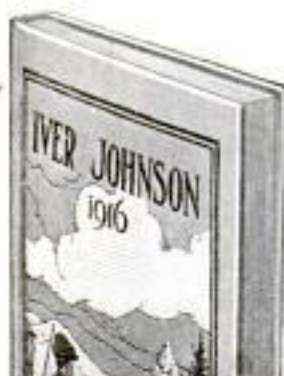

Send for
Free Book



Six Shot, 32 cal.
with Western Grip
\$7.50

IVER JOHNSON

ONLY about three machine shops in the country have fine enough machinery to make a revolver. You can possess, in an Iver Johnson Revolver, as perfect a mechanism as was ever made of tempered steel. It will give you a lifetime of protection. An Iver Johnson is safe because accidental discharge is absolutely impossible. You can Hammer the Hammer.

This same wonderful quality of machine workmanship produces the Iver Johnson Bicycle. Which explains why, since bicycles were first invented, the Iver Johnson has led. There is no more comparison between an Iver Johnson Bicycle and an ordinary bicycle than between a fine watch and an alarm clock. This superiority shows in speed and ease of riding, long life of bearings and absence of repairs. Also the Iver Johnson finish of five coats of baked, hand-rubbed enamel is better than the usual paint and varnish finish. The frame is of seamless steel tubing, not welded tubing.

Before you buy a shot gun, inspect our new double gun and our splendid line of single barrel shot guns.

Our 82-page Book

Tells all about Revolvers, Shot Guns, Bicycles and Motor Cycles. It tells you what you must know to get highest value for your money. Your copy is free.

Iver Johnson's Arms & Cycle Works

307 River St.,
Fitchburg, Mass.
99 Chambers St. New York
717 Market St., San Francisco

Everybody's
Riding This
Year



This is
our \$40 Model
the finest roadster we ever
made. Other models from \$25
to \$55. Juveniles \$20 to \$25.



Like the Boys Who Ride Them—

Sturdy, strong, upstanding
and very good to look at.

'Chain' Tread Bicycle Tires

are made to fit the needs of youngsters and oldsters, too, who want long service anti-skid tires on their "wheels."

Ride on 'Chain' Treads

See how they cling to the slipperiest road—how they fairly lift you out of loose sand, and how hard it is to puncture them, or wear them out; and you, too, will join the great army of bicycle riders who say—"There's no tire quite so good as a 'Chain' Tread."

Good tire dealers always sell 'Chain' Treads—and those same dealers have Dan Beard's new book for boys which they will give free to any boy who asks for it.

United States Tire Company

'Chain' Tread Single Tube 'Chain' Tread G. & J. Double Tube

BICYCLE TIRES



DENBY TRUCKS

FOR TRAIL OR PAVEMENT

Denby trucks are superior trucks at lower prices. Denby methods make Denby prices possible. Denby standards guarantee Denby quality



1-ton . . \$1020
(With Express Body)

1½-ton . . \$1575 2-ton . . \$1790 2½-ton . . \$2090

DENBY MOTOR TRUCK COMPANY
DETROIT, MICHIGAN



HERE'S FUN FOR YOU

A day in the woods with a Hawkeye Basket. Fish, hike, smoke, read and rest in the woods and take along the eatables and drinkables in a

Hawkeye BASKET REFRIGERATOR

the wonderful woven reed basket with the nickel plated interior that keeps food and drink cool, clean and fresh for 36 hours—all from a small lump of ice placed in the ice compartment of the basket. Practical, handsome, light weight and cleanly. The Hawkeye Basket Refrigerator has been the keynote of hundreds of enjoyable "days in the woods." **Price \$4.00 and up**

Try a Hawkeye Basket—30 days without expense—That's how good they are. Ask for Booklet No. 32.

BURLINGTON BASKET COMPANY
104 Lee Street BURLINGTON, IOWA
WE WANT MORE DEALERS

Please Mention Popular Mechanics



Buy It Fresh From Our Factory

Before it has had to make profits for people all along the way between the factory and the hour. Come-Pack furniture saves these profits. You get it practically at factory cost, plus freight, which is very low, because Come-Pack is sent in sections. You put it together yourself. That's why it's so staggeringly cheap—so cheap that some people can't realize, until they see it, that it compares with the finest furniture made.

Remember this when you
Read Our New Catalog

We'll send you one free.

It shows you where you can save in every room in the house, on furniture that your friends will exclaim over, and that your children will be proud of in bedrooms. The table shown here is an example of Come-Pack Savings. Price tables that can be compared with it, at any good furniture store. That will convince you.

Factory Price

\$28.75



48-in. Top

COME-PACK
FURNITURE CO.
501 Durr Street
Toledo, Ohio

COME-PACK
FURNITURE

HOW
TO
SAVE
ON
FURNITURE

Extra money for you now

You need more money this summer—and here's a dignified, easy way to get it. Take orders for the

Wisconsin Detachable Motor Row Boat

Equip your boat with a guaranteed Wisconsin—enjoy yourself while demonstrating and making money. Thousands in use. Everyone interested. Has many exclusive features including self-locking tiller and patented top adjustment, which make the Wisconsin the best row boat or canoe motor to use, and the easiest to sell. Ask for our agents' plan. Ask for catalog G.

WISCONSIN MACHINERY & MANUFACTURING COMPANY
11 Minor St., Milwaukee, Wisconsin

Highest Award Panama-Pacific Exposition. Purchased by U. S. Government, after competitive tests.





All You Need is a Road Map

THROW away your railway time tables and choose your own road. No buying of tickets or waiting for trains—just mount and ride any time, any place—in safety and comfort. You can do this when you own a Harley-Davidson Motorcycle. The

Harley-Davidson

throws open for you the gates of the big outdoors. On the broad, smooth city pavements, in the winding country roads, in the woodland by-paths that lead to the wild places—you can satisfy that travel hunger and find hours and hours of keen, healthful recreation—priceless pleasure.

The 1916 Harley-Davidson will win you with your first ride. You will catch the "motorcycle" spirit before you have ridden half a mile. You will experience a thrill of pleasure you never knew before. Decide now that you will learn to laugh at distances.

Telephone your Harley-Davidson dealer for a demonstration.
He will probably make terms to suit your convenience.
Write for catalog.

Harley-Davidson Motor Co., 468 B STREET **Milwaukee, Wis.**
Producers of High-Grade Motorcycles for More Than Fourteen Years

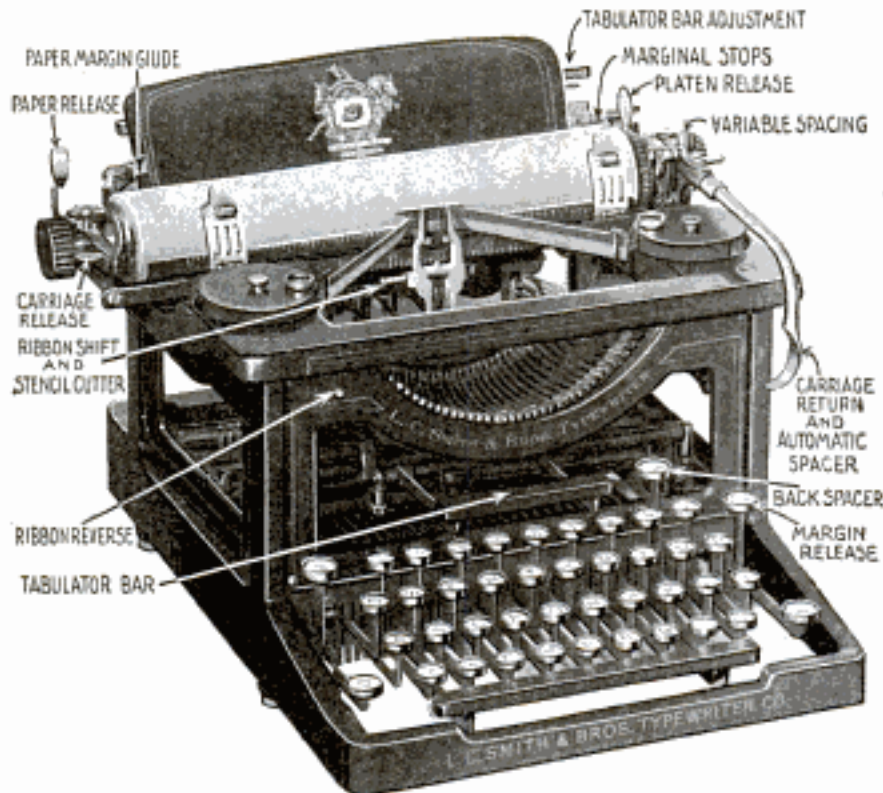

I want, through this advertisement, to establish as friendly business relations with you as I possibly can. I want you to realize also, that it is my earnest effort and intention to give you full honest value for every dollar that you spend with me. This is the only way I can succeed. The publisher of this magazine will vouch for my square dealings during the four years and more my advertising has appeared.

I am building up my business on the foundation of good value and square dealings. I am saving thousands of satisfied customers thousands of dollars, by supplying, perfect—late style—visible writing—typewriters, at remarkably low prices.

All my transactions are handled throughout by personal correspondence, I assure you every courtesy and consideration, in your dealings with me. Your order will have my prompt, careful, personal attention. I will be glad to do business with you.

Harry A. Smith

TYPEWRITER SENSATION

Free TRIAL—Use As You Pay

Send me only \$2.50 a month until the low total price of \$48.80 is paid, and the machine is yours

This is absolutely the most generous typewriter offer ever made. Do not rent a machine when you can pay \$2.50 a month and own one. Think of it—Buying a \$100.00 machine for \$48.80. Cash price, \$45.45. Never before has anything like this been attempted.

Standard Visible **L. C. Smith** Model Number 2

Perfect machines, Standard Size, Keyboard of Standard Universal arrangement writing 84 characters—universally used in teaching the touch system. The entire line of writing completely visible at all times, has the tabulator, the two color ribbon, with automatic reverse, the back spacer, ball bearing type bars, ball bearing carriage action, ball bearing shift action, in fact every late style feature and modern operating convenience. Comes to you with everything complete, tools, cover, operating book and instructions, ribbon, practice paper—nothing extra to buy.

You cannot imagine the perfection of this beautiful reconstructed typewriter until you have seen it. I have sold several thousand of these perfect latest style Model No. 2 machines at this bargain price and every one of these thousands of satisfied customers had this beautiful, strictly up-to-date machine on five days' free trial before deciding to buy it. I will send it to you f. o. b. Chicago for five days' free trial. It will sell itself, but if you are not satisfied that this is the greatest typewriter you ever saw, you can return it at my expense. You won't want to return it after you try it—you cannot equal this wonderful value anywhere.

H. A. SMITH
Room 510-231 N. Fifth Ave.
CHICAGO, ILL.

Ship me a No. 2 L. C. Smith F. O. B. Chicago, as described in this advertisement. I will pay you the \$40.00 balance of the SPECIAL \$48.80 purchase price, at the rate of \$2.50 per month. The title to remain in you until fully paid for. It is understood that I have five days in which to examine and try the typewriter. If I choose not to keep it I will carefully repack it and return it to the express agent. It is understood that you give the standard guarantee for one year.

You Take No Risk—Put In Your Order Now

When the typewriter arrives deposit with the express agent \$8.80 and take the machine for five days' trial. If you are convinced that it is the best typewriter you ever saw, keep it and send me \$2.50 a month until my bargain price of \$48.80 is paid. If you don't want it, return it to the express agent, receive your \$8.80 and return the machine to me. I will pay the return express charges. This machine is guaranteed just as if you paid \$100.00 for it. It is standard. Over one hundred thousand people own and use these typewriters and think them the best ever manufactured.

The supply at this price is very limited, the price will probably be raised when my next advertisement appears, so don't delay. Fill in the coupon today—mail to me—the typewriter will be shipped promptly. There is no red tape. I employ no solicitors—no collectors—no chattel mortgage. It is simply understood that I retain title to the machine until the full \$48.80 is paid. You cannot lose. It is the greatest typewriter opportunity you will ever have. Do not send me one cent. Get the coupon in the mails today—sure.

HARRY A. SMITH, 510-231 N. Fifth Ave., Chicago

Name

Address

.....Pop. Mech. May

EMERSON PHONOGRAPH

only \$ **3**
complete

\$3.50

West of the Rockies

Dealers:

The Emerson is taking a strong hold everywhere! It is an item that will bring new customers and big profits. Get in touch with us regarding our attractive proposition. Write or wire. Earliest inquiries receive first preference.

For JOLLY TIMES— GET AN EMERSON

When the fellows call, don't let them sit around wishing they hadn't come. Put life and pep into the crowd—play the Emerson. Everybody will sing, dance and be happy. The chaps will call again and again—your room will be a regular club.

EMERSON RECORDS At 10c and 25c

are wonderful features. Never before have operatic records, sung by the greatest singers, been offered at 10 cents. The Emerson list comprises all the latest popular dance music, medleys, duos, songs, etc., as well as string and orchestra selections.

6 inch records are 10c
7 inch records with music both
sides—2 different selections 25c

SPECIAL INTRODUCTORY OFFER

EMERSON PHONOGRAPH CO.
9 West 35th Street, New York

Gentlemen: Enclosed find \$..... for which send me, all charges paid, 1 Emerson Phonograph Type 1A, at \$3.00 (\$3.50 west of the Rockies).

..... Emerson Discs (6 inch) at 10c.
..... Emerson Double Discs (7 inch) at 25c. (plays both sides). Send me FREE Pamphlet Record List.

Name

Street

Town..... State.....



Will play all makes of disc records, without extra attachments.

Hand regulated spring motor, guaranteed to play largest disc records with one winding.

Sound box is of strongest construction—made to last many years.

Plain Oak finish, size 9½ x 9½ x 12 inches. Weight, packed, 8½ lbs., unpacked, 6½ lbs. Easily carried in a suitcase.

Just the machine you've wanted

A Phonograph which will play any disc record made. It is the most wonderful Phonograph value ever offered.

A fully adjusted musical instrument which plays rag-time, opera, vocal and instrumental selections with equal clarity of sound.

The horn is a feature—it makes the volume of sound it produces equal to that of any machine you can buy at ten times the price.

The motor is mechanically perfect and sturdy of construction. The sound box is of special design and can be adjusted to play any disc record made. The entire machine is compact and can easily be carried from place to place.

It's the ideal Phonograph for camp or bungalow, pleasure boat, canoe or nursery. It will give pleasure to grown-ups and delight the children. It is for all places where a more expensive Phonograph is impractical or not available.

FREE Complete list of records including Charlie Chaplin's "Peace Patrol," "Mother," "I Love a Piano," and all the other big hits.

Send the coupon and get this pamphlet which gives all the details of this wonderful Phonograph, the greatest value ever offered at the price.

Order your Emerson today—it will be sent you all charges paid. Order records at the same time. We will send you the newest numbers.

The Emerson Phonograph Co.
9 West 35th Street, NEW YORK

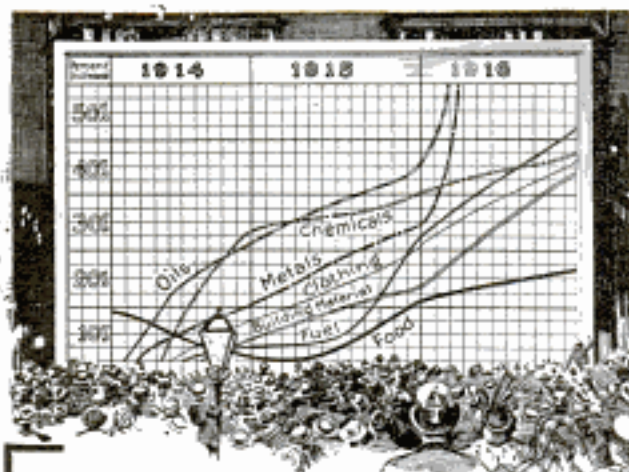

Rising Costs Confront Everybody

No statistical chart is needed to prove that this is a period of price advancement without parallel. The effect of higher prices is felt by everyone. It is a time for taking advantage of every opportunity that offers a genuine saving.

Certain-teed

Roofing lowers the cost of building

CERTAINEED offers a substantial saving in roof construction. It costs less to buy, less to lay, less to maintain and less per year of life. The General is able to make the best roofing at the lowest cost because of economies effected by enormous resources, modern machinery, favorably located mills and tremendous production (the General makes one-third of all the roll roofing made in America).

CERTAINEED Roofing is made of the best quality roofing felt thoroughly saturated with the General's own blend of soft asphalts and coated with harder asphalts which keep the inner saturation soft and prevent the drying out process so destructive to ordinary roofing. CERTAINEED is guaranteed for 5, 10 or 15 years, according to ply. Experience proves that it lasts longer.

CERTAINEED is sold by responsible dealers everywhere at reasonable prices — investigate it before you decide on any type of roof.

Save Rags — They're Valuable

Rags now bring eight times as much as a year ago. The demand for rags for making roofing felt, writing paper, etc., has reached tremendous proportions—a half million tons of rags being used last year. The increase in price of rags used by the roofing mills alone amounts to \$40,000 a day. Gather up all the rags around the place and sell them at present high prices. If you are not offered their real value, write our nearest office.

General Roofing Manufacturing Co.



World's Largest Manufacturers
of Roofing and Building Papers.

New York City	Chicago	Philadelphia
St. Louis	Boston	Cleveland
Pittsburgh	Detroit	San Francisco
Cincinnati	New Orleans	Los Angeles
Minneapolis	Kansas City	Seattle
Indianapolis	Atlanta	Richmond
Houston	London	Sydney

Prest-O-Lite

for
Motorcycles

The Light for Constant Service

Prest-O-Lite furnishes ideal riding light. It enables you to ride safely on any road under all conditions—provides a flood of brilliant, penetrating light and never fails you in emergencies.

Road shocks, jolts and vibration do not injure it.

Prest-O-Lite is truly as sturdy as your motorcycle and never needs attention that you yourself cannot give easily, quickly and inexpensively.

Because it has proved its superiority, you'll find more riders using Prest-O-Lite than all other systems combined. It is the utmost in economy, lasting efficiency, practical convenience and reliability. You can get it on any make motorcycle you buy.

When You Buy Complete Equipment

Buy equipment that will stand hard and continued use. On any motorcycle you buy, your dealer can furnish this attractive equipment combination—"Prest-O-Lite, a lamp and a good mechanical horn," at a very attractive price. Saves money on original cost, and costs less to use.

The Prest-O-Lite Co., Inc.

The World's Largest Makers
of Dismantled Automobiles

265 Speedway, Indianapolis, Ind.
Canadian Office & Factory, Merriton, Ontario

Prest-O-Lite
Exchange
Agencies
Everywhere





Refreshing as a May Morning

That piquant, fresh-as-the-morning flavor you get in a cigarette of "Bull" Durham tastes as cheerful and bracing as the crisp air of the hunting field. Life and spirit — vim and vigor — they're all in a smoke of "Bull" Durham!

GENUINE "BULL" DURHAM SMOKING TOBACCO

The one tobacco in the whole world with real distinctiveness in its flavor and real uniqueness in its aroma is "Bull" Durham.

Deliciously mellow-sweet and delightfully fragrant, "Bull" Durham is most wholesome—most satisfying.

"Roll your own" with "Bull" Durham and learn the joy of smoking *fresh-made* cigarettes.

THE AMERICAN TOBACCO COMPANY

Ask for FREE
package of
"papers" with
each 5c sack.



Please Mention Popular Mechanics

The Magic of Motor Wheeling

THERE'S a world of wholesome fun and ready service in a bicycle. Thousands are returning to the two-wheeler.

But to endow your bicycle with motor life—new riding power—obedient at the slight touch of a thumb lever—that is to lend real enchantment to bicycling.

And *there* is the magic of Motor-Wheeling.

The **SMITH MOTOR WHEEL** attaches to *any* bicycle in five minutes, and the

Smith Motor Wheel
DETACHABLE

first short spin will foster friendship. Two pedal turns awaken the power and your foot work is done.

The sturdy motor affords any speed from four miles to twenty. And you ride safely, clean, without vibration. No special riding togs are necessary.

Up to 125 miles of new pleasure in every gallon of gasoline. There are more than 10,000 motor-wheelists now!

You will want to join them.

See your dealer today, or write for our book, "Motor-Wheeling"

MOTOR WHEEL DIVISION

A. O. SMITH COMPANY, Milwaukee, Wisconsin

World's Largest Manufacturers of Automobile Parts

Dealers: A few exclusive territories are still open. Write for particulars.



Please Mention Popular Mechanics



EVINRUDING—
IS ROWBOAT MOTORING

Double the Pleasures of Summer Days

YOU'VE waited for the coming of summer—for the call of the great outdoors with its healthful, pleasurable sports. Like thousands of others who are answering that call, you too, can double the pleasures of summer days—Evinruding. Just clamp an

EVINRUDE

DETACHABLE ROWBOAT & CANOE MOTOR

on the stern of that old rowboat of yours. Then, a turn of the wheel and you're off—skimming over the water at 7 or 8 miles an hour—with no thought of a long row home again. Today, tomorrow, any time you wish—long, healthful hours of pleasure are yours, if your rowboat is Evinrude-equipped.

There's more speed, more power in the new EVINRUDE four-cycle Twin—and it's free from vibration. There's more speed too, and other improvements in the single cylinder models. The 1916 Evinrude models are equipped with the Automatic Reverse and the Evinrude Magneto—Built-in Fly-Wheel Type

Mail the Coupon or Write Today for Handsomely Illustrated 1916 Evinrude Catalog

EVINRUDE MOTOR COMPANY, 357 Evinrude Block, Milwaukee, Wis.

*Distributing Branches—69 Cortlandt Street, New York, N. Y.; 214 State Street, Boston, Mass.
426 Market Street, San Francisco, Cal.; Front and Morrison Streets, Portland, Ore.*

EVINRUDE MOTOR COMPANY
357 Evinrude Block
Milwaukee, Wis.

Kindly send me a copy of the
1916 Evinrude Catalog.

Name _____

Address _____

City _____ State _____



Over 60,000 Sold

Please Mention Popular Mechanics



WITTE "SURPLUS SIX"

SOLD FOR 6 H.P.
PULLS 9 H.P.
ONLY
\$ 97⁷⁵



KEROSENE, GASOLINE, NAPHTHA,
DISTILLATE OR GAS.

ANY SIZE - 2, 3, 4, 6,
8, 12, 16, OR 22 H.P.
ALL LESS THAN
\$17⁵⁰ Per H.P.

90 DAYS IN WHICH TO TRY A WITTE

MY 1916 Model engines are the greatest value that I have known to be offered at anything like the price. All sizes will pull from 30 to 50 per cent over factory rating. They are sturdy and dependable — expert built and high quality in every respect. Lowest cost of operation.

Trial Offer I want you to be the judge of my engine. Write today for my free trial offer. Find out for yourself that WITTE engines are not "cheap" engines but are high quality engines **priced low**. Use one on your farm — try it out thoroughly — and let me know your decision.

→ **GET THIS FREE BOOK!**

Don't buy **any** engine blindly. Send for this book. Learn "inside" facts about the engine business. Full of interesting — some startling — information.

ED. H. WITTE, Witte Engine Works
1746 Oakland Ave., Kansas City, Mo.
1746 Empire Building Pittsburgh, Pa.



DIAMONDS ON CREDIT

Whether for personal use, or as a gift, nothing can compare with a Diamond, *if it be of pure quality.*

Lyon Diamonds are absolutely free from flaws or imperfections and of the rich Blue-white color. Every honest person is offered our liberal terms of

20% Down and 10% A Month

With every Diamond we furnish a Guarantee Certificate attesting the quality and value, and providing for exchange at full purchase price. Send for Catalog No. 3, showing splendid line of Watches, Jewelry and Silverware. Goods sent prepaid for inspection, subject to approval. 10% Discount Allowed for Cash.

J. M. LYON & CO., Est'd. 71-73 NASSAU STREET
1843 NEW YORK CITY, U. S. A.

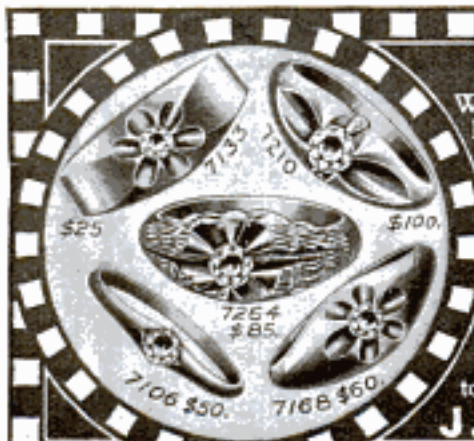

Brand New Glove for Mechanics

Made from Peccary Pigskin

In the forests of Central America roams the Peccary Hog. It is hunted almost exclusively for its hide, which has been found to fill all requirements of leather for sturdy work gloves.

The skin differs widely from that of the common domestic hog—being heavier and softer. One pair of gloves made from this leather will outwear several pairs of the domestic kind.

Get the Peccary Pigskin Glove—it's one of the new

Grinnell-Gloves

Best for every purpose

To give the greatest amount of hand protection, a work glove must be heavy and durable. But it also must be soft and pliable—and this is why the Peccary Pigskin leather is so satisfactory. Delicate adjustments can be made with barehanded ease.

Peccary leather samples, free

Write for some of this wonder leather, also our new booklet, "Glove Styles." Both sent free. Please give dealer's name.

Morrison-Ricker Mfg. Co.

(Established 1886)

141 Broad St., Grinnell, Iowa



New heavy work gauntlet—made from Central American Peccary Pigskin.



Actual photo of Peccary Pigskin, showing remarkable strength and grain of the leather.



Please Mention Popular Mechanics



Manager Joe Tinker of the Chicago Cubs selects his apparel with the same care that he picks players for his team. He wears

PARIS GARTERS

He favors these comfortable garters because they always make good; hold up his socks neatly and give long service.

25 and 50 cents

Look on the back of the shield for the name PARIS.

A. Stein & Co.
Chicago New York



PARIS
GARTERS

No metal
can touch you

They die
outdoors!



No
mixing
No Spreading—
No Mess—No Trouble
Just crumble on a
Rat Bis-Kit

about the house. Rats will seek it, eat it, die outdoors. Easiest, quickest, cleanest way. Large size 25c. Small size 15c. All druggists or direct prepaid. THE RAT BIS-KIT CO., 1935 North Lawrence St., Springfield, Ohio.

For
roaches
and water
bugs use Rat
Bis-Kit Paste
—the new Poison
in the Tube—25c.

23
Jewel
Movement

20
Year
Guarantee



This Superb Watch SENT FREE

Get full particulars of our smashing direct price offer. Buy direct—save all middlemen's profits. This masterpiece of watch manufacturing—23 jewels, adjusted to temperature and isochronism. Thin model, guaranteed 20 year gold filled case sent free on request.

NO MONEY IN ADVANCE If you decide to keep it, pay only \$1.80 a month on our confidential inside price. You can easily afford to own a perfect timepiece on our easy payment plan. Get our amazing low direct price to you. Watches, Diamonds, Jewelry, etc., on the easiest Monthly payments as illustrated in our Catalog De Luxe No. 6.

A REMARKABLE OFFER OUR DIAMONDS are absolutely guaranteed and can be returned if not satisfactory. A binding guarantee furnished with each diamond. Exchangeable at any time at an increase of 7% per cent more than you paid. A postal will bring full details of this great offer. Don't let an opportunity like this slip through your fingers. Write today—NOW.

L.W. SWEET & COMPANY Dept. 5, 2 & 4 Welden Lane
NEW YORK CITY
The World's Greatest Diamond Merchants



Write for this free booklet

about Modern Firearms. It tells you all about the latest improvements, contains descriptions and illustrations of all models made up by The REMINGTON ARMS UNION METALLIC CARTRIDGE CO., Dept. 5-P, NEW YORK

JENKINS' BRASS BAND AND ORCHESTRA INSTRUMENTS



We save you money and give easy payments. Biggest line of Band and Orchestra Instruments; Cornets, Trombones, Clarinets, Drums, Saxophones, Violins, Guitars and all wind and stringed instruments. Send for free catalog of instrument you want. We give a fifty-lesson FREE certificate with each instrument. Tell us the instrument you wish to play.



JENKINS MUSIC CO., 81 Jolin Bldg., KANSAS CITY, MO.



SMALL ENGINES

Perfect Gasoline Engines— $\frac{1}{2}$, 1 and 1 $\frac{1}{2}$ h. p.—for Farm and Shop use. Price \$19.00 and up. Also

INCUBATORS

We ship on trial. Send for Booklet and Special Offer. SIEVERKROPP ENGINE CO. 1224 18th St. RACINE, WIS.

STARTER for FORD CARS

Runs on Alcohol



anywhere. No electricity, wires or springs. Convenient. Much cheaper to operate than other fans. 12-inch blades. Roller bearing. Reliable. Brings genuine comfort and satisfaction. Ideal for the sick room. Third season. A proved success. The WONDER FAN. Price, \$16.50 cash with order only, delivery prepaid in the continental U.S.A.

LAKE BREEZE MOTOR, 122 N. Jefferson St., Chicago

Velvet Joe's Able Assistants--

FATHER TIME

MOTHER NATURE

Velvet
TOBACCO

Velvet
TOBACCO

Velvet
TOBACCO

Velvet Joe

Mother Nature and Father Time made diamonds out of carbon. But pshaw! Look what their method does with tobacco. Two years of it make VELVET.

FOR VELVET is matured by two full years of ageing in Nature's patient way. The result is that mellow aged-in-the-wood smoothness that no other smoking tobacco possesses.

You can't get that smoothness in any other way.

Liggett & Myers Tobacco Co.

Please Mention Popular Mechanics



Wash With Electricity Without Muss or Fatigue

Right in your own laundry—in the electric light socket—is all the power necessary to do your washing. Why go on with the old-fashioned washboard or hand-washer way? Why not take advantage of the help so close at hand and which costs so little?

The newest, most useful, most convenient laundry appliance is the

Western Electric Washer and Wringer

No paddles, agitators or other contrivances to mash, twist or tear the clothes. No injury to most delicate laces. The wringer is reversible. All mechanism is enclosed.

You can arrange for a *Two Weeks' Trial* in your own home. Take advantage of this opportunity. Write to us for particulars. Drop a post card to our nearest house, and ask for Booklet No. 92-AW.

WESTERN ELECTRIC COMPANY

INCORPORATED

463 West Street, New York

500 South Clinton Street, Chicago

Houses in All Principal Cities



DO YOU INTEND TO BUILD?

50 PRACTICAL PLANS

California Bungalows and Houses especially suited to any climate. New, attractive designs with valuable building suggestions all in handsome **1916 Art Plan Book**. Price 50c postpaid. Send today for your copy. Save time, trouble. Money refunded if not satisfactory. Address

BUILDING DEPARTMENT

AURELIUS SWANSON COMPANY, Inc.

1001 State Nat'l Bank Bldg. OKLAHOMA CITY, OKLA.



3 YEARS TO PAY

Meister Piano ^{30 days free trial} _{in your own home}

\$1 A WEEK or \$5 A MONTH Price \$175.00

No cash payment down. No interest—no extras. Piano stool and scarf free

ROTHSCHILD & COMPANY
Dept. 16V CHICAGO, ILL.

THIS BUNGALOW \$900 CAN BE BUILT FOR

This and many others in my new book, *Building Plans for Modern Homes*, will save you hundreds of dollars. One of the most complete and comprehensive books of plans ever published by any architect. Fifth edition just off the press. Two hundred and fifty floor plans and photographs of bungalows, etc., costing from \$200 up; gives sizes and cost to build. Sent postpaid for \$1.00



FREDERICK H. GOWING
ARCHITECT

18 Tremont St., BOSTON, MASS.

Write
for the
Wholesale
Price

Get This All Metal, Snowy White KITCHEN KABINET

direct from Kalamazoo factory. Unlike any other kitchen cabinet—sanitary, easy to keep clean as a china bowl; sweet smelling; cannot warp; easy sliding doors; good for lifetime use.

Write today **Free Trial, Cash or Credit** for offer on

Now is the time—save work when housecleaning. We pay freight—ship within 24 hours—30 days' trial, 300 days' approval test, \$100,000 guaranty.

FREE 8-piece crystal set, white glass rolling pin, patented bread board with each cabinet. Write today for prices and beautiful art catalog No. 15.

KALAMAZOO STOVE COMPANY
Manufacturers—Kalamazoo, Michigan

We also make gas ranges, furnaces, and 500 styles of stoves and ranges. We have four catalogs—state which you want.



A Kalamazoo
Trade Mark
Registered **Direct to You**



**Free!
This Book
on Easy Ironing!**

You want to banish ironing drudgery, Mrs. Housewife, so send today for this intensely interesting Free Book. Learn how your entire ironing—except dresses and shirt waists—can be done quickly, economically and pleasantly by the easily-operated—

SIMPLEX IRONER
THE BEST IRONER

30 Days' Free Trial—Easy Terms
At a cost of only 2c to 4c for an entire ironing, the Simplex irons your Table Cloths, Napkins, Dotted Bedspreads, Pillow Cases, Blankets, Towels, Handkerchiefs, Underwear, Kitchen Aprons, Hosiery, Play Suits, etc. Simplex Ironer is operated by hand, belt or electric power. Heated by gas, gasoline or electricity. Lasts a lifetime. Highest award at Panama-Pacific Exposition. Write today. Get Free Book!

AMERICAN IRONING MACHINE CO.
505, 100 N. Michigan Ave., CHICAGO, ILL.

No More Ironing Drudgery!

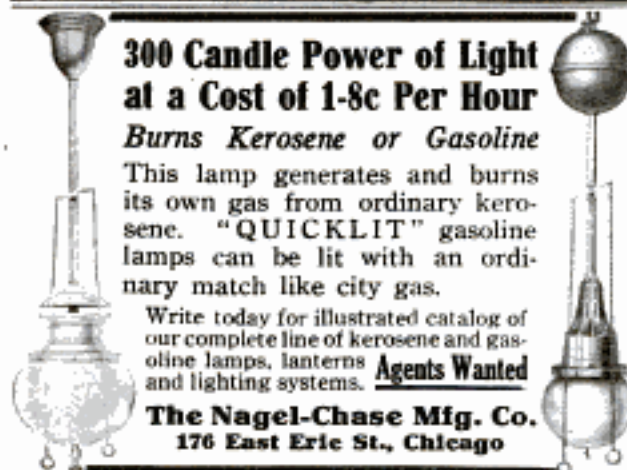

**300 Candle Power of Light
at a Cost of 1-8c Per Hour
Burns Kerosene or Gasoline**

This lamp generates and burns its own gas from ordinary kerosene. "QUICKLIT" gasoline lamps can be lit with an ordinary match like city gas.

Write today for illustrated catalog of our complete line of kerosene and gasoline lamps, lanterns, Agents Wanted and lighting systems.

The Nagel-Chase Mfg. Co.
176 East Erie St., Chicago

1/3 SAVED Buy Direct From MANUFACTURER



FREE BOOK
Do Your Own Plumbing and Heating NEW HARDIN EASY WAY

Get our "Handy-Man" Free Book. Every home needs it. Shows new home improvements and everything in plumbing and heating supplies EXCLUSIVELY at wholesale prices—complete heating plants, bathroom outfits, sinks, pipe, fittings, water systems, lighting plants, etc. Any handy man can install our goods with this free book and free easy installing plans. \$500,000 plants behind our guarantee. Write today.

The Hardin-Lavin Co. 40 years at 4540-50 Cottage Grove Ave. Chicago

Lowest Prices Ever Made on World's BEST Roofing

Absolute "rock bottom" prices have now been reached on the greatest roofing. Don't invest a cent in new roof covering, siding or ceiling for any building until you first get Edwards wonderful freight prepaid money-saving offer direct from the world's largest factory of its kind.



Reo Steel Cluster Shingles

EDWARDS TIGHTCOTE REO STEEL SHINGLES

outlast three or four ordinary roofs—yet they actually cost less! No painting or repairs necessary; rot-free-weather-rust-proof. Insurance cost is less because Edwards guarantee their roof against lightning. Easy to lay—no special tools needed.



Spanish Metal Tile

Every sheet of Edwards Galvanized Steel Shingles, Roofing, Siding, Ceiling or finish is extra heavy galvanized, piece at a time, by our exclusive Tightcote patented process after sheet has been stamped and resquared. Side and edges are as heavily galvanized as body of sheet. Means no weak spots to rust and corrode. Edges and nail holes can't rust.



Edwards Patent "Grip-Lock"

Garage \$69.50 Up

Wide variety, many styles, all sizes of Portable, Fireproof, Metal Garages, \$69.50 and up. Lowest prices ever made. Postal brings 64-Page Garage Catalog—FREE.



Corrugated

FREIGHT PREPAID OFFER

on the lowest prices ever made on world's best roofing. We make and sell direct from biggest factory of kind, Edwards Reo Tightcote Steel Shingles, V-Crimped, Corrugated, Standing Seam, Painted or Galvanized Roofing at bed-rock bargain prices, saving you all "in-between" middlemen's profits. Write for Free Roofing Samples and your copy of Roofing Catalog No. 550.



Garage

THE EDWARDS MFG. CO.
500-550 Pike Street
Cincinnati, Ohio

WORLD'S GREATEST ROOFING BOOK

Note construction of Patent Interlocking Device, protecting nail heads from the weather and making the roof absolutely water-tight

SPECIAL OFFER COUPON

THE EDWARDS MFG. CO.,
500-550 Pike St., Cincinnati, O.

Please send FREE samples Freight-Paid prices and World's Greatest Roofing Book No. 550.

Name.....

Address.....

Largest Makers of Sheet Metal Products in the World



Benjamin The Double Duty Electric Plug 92

WHY delay longer? Buy it today and get double service from one electric outlet.

You need Benjamin 92 in the office, for yourself and your clerks.

You need it in your home for a dozen reasons. Ask your wife and daughter.

This little device screws into any ordinary socket. Requires no extra wiring—is of no bother to install, and will "stay put" if desired—for every socket in the building can house one of these double duty plugs.

One Dollar
at Your Dealer's
Or Direct by Mail to You

"Im Yours for
Double Duty"

**Benjamin Electric
Manufacturing Co.**
126 So. Sangamon Street
Chicago

114 Liberty St., New York
590 Howard St., San Francisco
11-17 Charlotte St.
Toronto, Canada



Cut Cost of Your Furniture In Two

Any Piece Assembled in
Ten Minutes

Shipped in sections, knock-down—saves factory space—packing costs and freight charges. Direct from factory to you saves dealer's expenses and profits.

"Period Furniture"—over 100 designs—everything for the home, office or club. Every piece from selected quarter sawed oak.

Hundreds of dealers are assembling Brooks "Master-Built" Furniture in their stores and selling it from forty to fifty per cent above our prices.

Home Exhibitors Wanted

Exchange spare time for furniture or cash commissions. A new business for men or women. We ship from a single piece to car-load lots. Free Catalog with full particulars.

Brooks Mfg. Co.
2705 Rust Ave., Saginaw, Mich.
Largest Plant of Its Kind
in the World



\$40 Value at
\$19.75

Extension
48 to 84 in.

\$9.75

Worth \$17



Rocker No. 10
Height, 35 in.
Width, 31 in.; Depth, 21 in.



50x63x15 in.
Desk and Bookcase
Value \$60 Price \$29.75

BUY PLUMBING and HEATING SUPPLIES



at WHOLESALE

Will Save
You 30%

Don't pay retail prices. Full stock on hand for prompt shipment. Send for free catalog.

B. P. KAROL, 800-802 South Kedzie Ave., CHICAGO

Hartman Will Trust You

Rock Bottom Prices

Furniture, Carpets, Rugs, Etc.

Easiest Terms Hartman's credit terms easiest, most liberal ever offered. No security—no notes—no mortgage. Free from all objections. At the end of a month you may return anything unsatisfactory. Hartman refunds your money including freight.

FREE—Big Bargain Book Over 8,000 bargains. Write today for FREE copy.

HARTMAN FURNITURE AND CARPET CO.
3945-47 Wentworth Av., Chicago



BUY YOUR FURNACE \$10 DOWN \$10 A MONTH



Our monthly payment plan of selling direct saves you the dealer's profits and charges for installation. The

JAHANT FURNACE

with the patented "Down Draft System" is best for residences, schools, hotels, churches, etc., because it delivers plenty of heat wherever and whenever desired at a saving of 1/3 to 1/2 in fuel bills. Install the JAHANT yourself. We send complete outfit, freight prepaid with special plans, detailed instructions and all necessary tools for installation. Satisfaction guaranteed or money refunded.

WRITE FOR FREE ILLUSTRATED BOOK

THE JAHANT HEATING CO.

225 Steiner Avenue

AKRON, OHIO

Save 1/3 to 1/2 on Fuel Bills

Please Mention Popular Mechanics

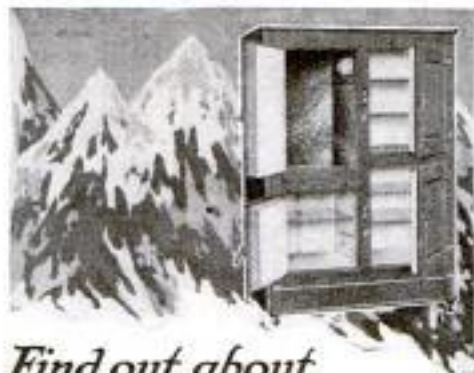

Find out about
the **GLACIER** before
You Spend Your Refrigerator Money

Send for the wonderful free Glacier Book — a Nature-story of the frozen North and greatest presentation of refrigerator facts ever written. Learn why the Glacier Refrigerator keeps food cold, clean, sanitary. Why the solid one-piece white porcelain lining, and ten walls keep out heat and keep in cold. See how easily cleaned. Approved by Good Housekeeping Institute. 100 styles. We pay freight.

GET THE BOOK

The Glacier Book tells how to protect health by storing food in circulating fresh air. Get it BEFORE you spend that refrigerator money. The Glacier Book tells you why the Glacier is YOUR kind of a refrigerator — full of hard-fact truths. Write today. It will PAY you WELL.

NORTHERN REFRIGERATOR CO.
776 Crofton Ave., Grand Rapids, Mich.

DIAMONDS

ON CREDIT — \$
TERMS AS LOW AS

250

A MONTH

Ladies' Lottis
Fetich Ring
Designed
to make
diamond
appear
larger
than
it
is.

Great Reduction
in Credit Terms
and Prices

Think of it! A high grade, guaranteed, genuine diamond, perfect in cut and full of fiery brilliancy, set in solid gold or platinum mounting for only \$2.50 a month — 8 cents a day.

The Lottis
7-Diamond
Cluster Ring

Contains 7 Diamonds set so that the cluster has the appearance of a beautiful solitaire diamond that costs 3 or 4 times as much.

Send for 116-page Jewelry Catalog containing over 2000 beautiful illustrations of Diamonds, Watches, Silverware, etc. Make a selection either for yourself or as a gift for a friend or loved one. We will send the article for your examination, all charges prepaid by us. You assume no risk; you are under no obligation.

You Don't Pay a Cent until you see and examine the article. If perfectly satisfied pay one-fifth of the purchase price and the balance in eight equal monthly payments. If not entirely satisfied, return at our expense. Whether you buy or not, get Our Catalog. It is an education in Diamond and Jewelry values and easy credit buying. Send for catalog today—before you forget. It is FREE.

LOFTIS BROS. & CO., The National Credit Jewelers
Dept. N894, 100 to 108 N. State Street, Chicago, Illinois
(Established 1858) Stores in: Chicago Pittsburgh St. Louis Omaha

Try My **Rapid** Fireless Cooker
30 Days—FREE



Cook every meal on it. If you are not satisfied and delighted I will refund every cent. Get my SPECIAL LOW FACTORY PRICE

direct to you. Cooker is aluminum lined throughout. Full set of famous "Wear Ever" aluminum cooking utensils comes with it. Ask for free book of valuable recipes. **WILLIAM CAMPBELL CO.** Dept. 64, DETROIT, MICH.

300 HOME PLANS Free

This House for Only \$744 5 rooms and bath; Craftsman slash grain fir finish. Lumber, millwork, hardware, paint — all wholesale.



Write a Postal and Save \$500 to \$1500

A postal card brings our two big plan books
Ready-Cut Homes } Standard Material cut to fit
Standard Homes } Material in the Standard Way

We can save you \$500 to \$1,500 on the cost of material for a fine new home. All prices cut to the quick. Shipped anywhere!

Safe, Prompt Delivery and Satisfaction or Money Back

We are the oldest and largest building material concern selling direct to consumers. All or any part of any building wholesale! Three big banks and 100,000 customers behind our guarantee.

Write! Get the Great 5000 Bargain Building Material Catalog and also our 2 Plan Books of 300 Houses—all FREE! Write today.

GORDON-VAN TINE CO.
819 Federal St. Davenport, Iowa

Four Weeks' Trial



Choice of 38 Styles
of the Superb

Wing

Yes, we will ship you on four weeks' absolutely free trial direct from our own factory your choice of 38 new styles of the highest-grade Wing Piano or Player Piano.

One of 38 Styles **No Money Down**

Not a cent of freight to pay — no C. O. D. — no security. Use it and enjoy it four full weeks; then, if you wish, ship it back at our expense. You alone are the judge. You will be amazed at our rock-bottom, direct price on the superb Wing, guaranteed 40 years. Easy monthly payments or cash—but first 4 weeks free trial. Write today.

Valuable Book—FREE "The Book of Complete Information About Pianos" sent free and postage paid. Tells how to choose piano. Beautiful art catalog also sent and particulars of great Free Shipment Offer. Write today—now. Wing & Son (Est. 1868), Wing Building, 9th Ave. & 13th St., Dept. 1145, New York



What Standardization Means to Motor Car Buyers

IT means VALUE. Just to the extent that a car is standardized does the buyer's dollar approach the maximum of purchasing power.

Standardization means definite, proved quality, known manufacturing costs and reduced selling costs.

Of the million autos that will be sold in 1916, 75% will be standardized cars selling for less than \$1000.00 each. This remarkable American achievement is the direct result of standardization.

Finally the upholstery has been standardized by the almost universal adoption of



MOTOR QUALITY

40% of all 1915 cars sold were upholstered in this proved, guaranteed material and in 1916 the total will be at least 60%.

Fabrikoid is the standardized automobile upholstery. It wears better than coated splits (commonly sold as "genuine leather") and has the artistic appearance and luxurious comfort of the best leather.

Raynite Fabrikoid for tops, single or double texture, is guaranteed one year against leaking, but made to last the life of the car.

To get the most for your money, buy a standardized car

Du Pont Fabrikoid Co.
Wilmington, Delaware
Canadian Factory and Office, Toronto



Our collection of rare old violins is one of the largest in America. Write for special art catalog.

10 Days Free Trial

YES we will send you the violin of your choice for the full ten days' trial. Play on it—test it in every way before you decide whether you wish to buy or not—then if you are not more than satisfied send it back at our expense. Write today for special new violin circular.

Your Choice

The products of the leading violin makers of the world are yours to choose from—Farny, Baader, Glier, Heberlien, Fiedler, Wurlitzer and many others. Violins of the highest grade as well as those of moderate price—all special values. Priced from \$2.70 to \$50 and from \$50 to \$250.

WURLITZER

209 years of instrument making

Get the benefit of our mammoth facilities for buying in large quantities. The house that supplies the U. S. Government now makes a startling money-saving offer direct to you. Write for circular.

Pay As You Wish

If you decide to keep the violin after you have tested it out for ten full days, pay only the rock-bottom price at the rate of only a few cents a day.

Write for Special Circular

Put your name and address on a letter or a postcard today and get the special circular that describes this remarkable assortment of violins. No obligations. Write today, now!

The Rudolph Wurlitzer Co., Dept. 1195
E. 4th Street, Cincinnati S. Wabash Ave., Chicago

10c a Day



Now boys this superb Lyric Cornet Ebonite triple silver-plated long model Lyric Cornet direct to you on a startling offer. 10 days free trial before you decide to buy. Liberal allowance for old instruments. Write today for 25-page Catalogue—also in a 25¢ instrument that you have to choose from.

AGENTS—Make \$100 to \$300



per month easy selling our new Triplicate Sauce Pan. Cooking utensil for 3 different foods on one burner. 400 Specialties—all whirlwind sellers. Write quick for exclusive territory and large catalogue.
AMERICAN ALUMINUM MFG. CO.
Div. S 61 LEMONT, ILL.

Build a WAR Aeroplane

"Ideal" accurate Scale Drawings enable you to EASILY build 3 Ft. Flying Models of Aeroplanes now used in the European War.

Students of Aeronautics, everyone without inquiring term of mind, should construct one of these fascinating Models.

Prices of 3 Ft. Scale Drawings

Curtiss Flying Boat	25c	Bleriot Monoplane	15c
Curtiss Military Trainer	25c	Fokker Monoplane	25c
Hydroaeroplane	35c	Wright Biplane	25c
Nieuport M'n'plane	25c	Cecil Peel's Racer	25c

Complete Set of Eight, \$1.50 postpaid.
Get 50-page Aeroplane Book, containing full information about models, parts, etc. 5c postpaid.
Ideal Aeroplane & Supply Co., 82-88 West Broadway, New York

Taube

WIGGINS Peerless Patent Book Form CARDS

Are used by many of America's largest card users because of the skill and care exercised in engraving a Wiggins plate. This clientele realizes that there is far more to the card question than merely buying so many as so much.

Ask for tab of specimens, detach the cards one by one and observe their clean-cut edges and the protection afforded by their being encased in convenient book form style.

Engravers **The John B. Wiggins Company**
Plate Makers Established 1857
Die Embossers 62-64 East Adams Street, Chicago

GENUINE PERFECT CUT \$97.50 Per Carat DIAMONDS



No. F9.
14 karat solid gold, iridium tipped pen. Perfect coin and clip self-filler. Name inlaid with gold free! We guarantee free repairs for one year. \$4.00 retail value. Actual length of pen 7 inches. Our special price—

F10 Mounting with
1/2 c. dia. \$12.00
3/4 c. dia. \$21.25
1 c. dia. \$35.00
3/8 c. dia. \$48.75
1/2 c. dia. \$60.00
3/4 c. dia. \$71.25
1 carat dia. \$101.25

F11 1/2 c. dia. Price \$50.50

F12 1/2 c. dia. Price \$21.50

F13 Child's Ring, 1/2 c. dia. Price \$12.75

F14 Spec. Solid gold wedding ring, 1/2 c. dia. Price \$2.50

F15 Gold lavaliere, 1 dia. 2 pearls. Complete, \$4.35

F16 Gold Tie Clasp, 1 dia. Special price, \$1.00

Child's Ring, 1/2 c. dia. Price \$12.75

Gold lavaliere, three dia. Compl. \$8.75

YOU SAVE 35%
by buying from Basch—the direct importer of diamonds. All middlemen's profits eliminated. At \$97.50 per carat we give you beautiful, brilliant, genuine perfect-cut diamonds that retailers sell for \$150.00 per carat.

You Can Examine Any Diamond FREE At Our Expense
And this will not obligate you in any way and it won't cost you one cent. We send any diamond to you to examine thoroughly and if you don't think it's the greatest value you have ever seen simply return it at our expense.

Money-Back Guarantee!
Nothing equal to this iron-clad contract in the whole diamond business. Permits you to return diamond any time within a year and we refund in cash full price less 10 per cent. Also allows full price in exchange at any time. It further certifies exact carat weight, quality and value of the diamond.

Beautiful 1916 De Luxe Diamond Book FREE!

Send for your free copy NOW! Contains thousands of illustrations of diamonds and jewelry priced at remarkable saving of money. Select your Easter jewelry from this authoritative book. Gives expert facts about diamonds needed to buy safely. Mail coupon or write us a letter or postcard for your free copy NOW!

Please mail me FREE, without obligation, 1916 Basch De Luxe Diamond Book.

Name.....
Address.....

\$1.00 (Retail Value) **L. Basch & Co.**
Dept. Y2470 State and Quincy Streets
CHICAGO, U. S. A.

L. BASCH & CO.
Dept. Y2470 State & Quincy Sta.
CHICAGO, U. S. A.

You put your own personality in your handwriting.

What Your Handwriting Reveals

TO supply the great demand for this remarkable book, which illustrates and interprets nearly every style of handwriting, a *new edition* has just been printed. This book has been prepared by us at large expense for those who desire to study the subject. It is written by William Leslie French, the celebrated Graphologist, whose articles in leading magazines have caused country-wide interest and discussion.

If you are interested in the significance of handwriting and desire a copy of this book, it will be sent with twelve samples of Spencerian Steel Pen on receipt of ten cents.

SPENCERIAN PEN CO., 349 Broadway, N. Y. P.M.

I enclose ten cents for twelve different kinds of Spencerian Pens and a copy of the book, "What Your Handwriting Reveals."

Name _____ City _____
Street No. _____ State _____

SPENCERIAN PEN COMPANY, 349 Broadway, New York



Easiest to Empty

BISSELL'S Vacuum Sweeper is not only most efficient as a dust getter, it is also the most convenient to operate. Runs as lightly as a vacuum machine can and thoroughly extract the dirt. Litter pans dump with a finger movement. Dust-bag comes out with the nozzle in one piece, emptying from the rear—a process so simple that it doesn't even soil the hands. Handsome, too; beautifully finished and finely made—altogether a machine of which any housewife may well be proud.

BISSELL'S Vacuum Sweeper

Use this *BISSELL'S* for thorough general cleaning and *BISSELL'S* Carpet Sweeper for the daily brushing up of surface dust and litter, and you solve the big problems of housecleaning in an easy and thoroughly sanitary manner.

Vacuum Sweepers and Cleaners (with and without brush) at \$7.50 and \$9.00. Carpet Sweepers, \$2.75 to \$5.25. Slightly higher in the West, South and in Canada. Sold by dealers everywhere. Booklet on request.

BISSELL CARPET SWEEPER CO.
Largest and Oldest Exclusive Manufacturers
of Carpet Sweeping Devices in the World
Dept. 191, Grand Rapids, Mich.
Made in Canada, too



CLASS PINS

FACTORY TO YOU

M3249 Made to your special order, any style or material. Write to-day for free catalog of 1915 designs. Special offer, either style of pins here illustrated with any equal number of letters and figures, with one or two colors of best hard enamel. SILVER PLATE, \$ 15 each, \$1.50 per dozen; STERLING SILVER, \$.30 each, \$3.00 per dozen; GOLD PLATE, \$.35 each, \$3.50 per dozen; SOLID GOLD, \$1.50 each, \$15.00 per dozen.
BASTIAN BROS. CO. 825 BASTIAN BLDG., ROCHESTER, N. Y.

SUPERIOR SINCE 1904

Over 100,000 in Use

Mostly sold through recommendation. For PERSONAL DESK or GENERAL OFFICE. It checks mental calculations. Buy through your Stationer. Write for 10-day trial offer.

B. GANCHER, A. A. M. CO.
148 Duane Street New York

AGENTS WANTED

GANCHER Portable Adding and
LISTING \$50

Golden Gem PORTABLE Adding Machine



Multiplicates—Subtracts
The "FORD" in Its Field
MACHINE—Just Out!

DIAMONDS- AND WATCHES ON CREDIT

E
A
S
Y
T
E
R
M
S

GREAT DIAMOND SALE

The most astounding sale of perfect cut diamonds ever offered.

TERMS LOW AS \$1.50 PER MONTH

This is your opportunity to get that long wanted diamond at a bargain. This is an extraordinary saving.

SPECIAL \$39.50 GENUINE DIAMOND RING

A wonderful value \$4.50 per month. A written guarantee with every purchase you make from **ALFRED WARE**.

SENSATIONAL ELGIN WATCH SALE.

\$12.50 Elgin Watch 17 Ruby Jewels 25 year guaranteed double gold strata case. Factory tested and adjusted.

Payments \$2.00 Per Month.

30 Days Trial

No Money Down Express Paid

Any watch you want on easy payments. Be sure to send for our 16 page catalogue. Over 2000 suggestions. Watches, Jewelry, Diamonds. This book describes our big bargains in all lines. All sold on Easy Payments and Free Trial. Send for it this minute. A postal will bring it.

ALFRED WARE COMPANY. Dept. 539 St. Louis, Mo.

Big Free Catalog

MONEY
IN
MUSHROOMS

FREE BIG BOOKLET TELLING
HOW TO GROW
MUSHROOMS

at home all the year. Big profits. Take advantage of this wonderful opportunity to become independent. Write **Nat'l Spawn Co., Dept. 12, Boston, Mass.**

Unusual Trial Offer for 10¢

Best Kodak Developing. Any size roll, 10c. Six prints free with first roll. Or, send six negatives, any size, and 10c (stamps) for six prints. 8x10 Enlargements, 25c each.
Roanoke Cycle Company, 2006 W. Campbell Ave., Roanoke, Va.

Make Music Rolls

If your rolls cost you more than 10c each you should have one of our music-roll perforators. Details free. **THE LEHARJAN MFG. CO. DEPT. B HAMILTON, OHSO**

Bausch and Lomb BALOPTICON

THE PERFECT STEREOPTICON

Bausch & Lomb Optical Co., 576 St. Paul St., Rochester, N. Y.

Typewriters

-- All makes, factory rebuilt by the famous "Young Process"; look like new, guaranteed like new. Our big business insurance "Square Deal" and permits lowest cash prices -- \$10 and up; also machines rented -- or sold on time. No matter what your requirements are, we can best serve you. Write and see - NOW.

YOUNG TYPEWRITER CO. Dept. 359 CHICAGO

TYPEWRITERS ALL MAKES ALL PRICES

Look at these bargains! Typewriters Rebuilt in our own factories and guaranteed for one year.

Remingtons \$15 to \$60	Smiths \$18 to \$30
Underwoods \$25 to \$65	Roysls \$30 to \$45
L. C. Smiths \$28 to \$40	Oliverts \$35 to \$45

Brand new No. 2 Smith-Premiers \$45

We have others, of course. Send for catalog describing them. Branch offices in principal cities.
American Writing Machine Co., Inc., 345 Broadway, N. Y.

TORREY Razors

make
smooth
shaving
a daily
delight

With a **Torrey** you always shave clean and smooth, because it has the perfect shaving edge. Adjusted to glide over the face at the right angle. Cuts close, without pulling, without roughing the skin.

A Real Man's Razor—

this beautiful razor is one of the finest examples of Torrey skill in razor making. It guarantees comfortable shaving. If your dealer hasn't Torrey razors, write to us; we'll tell you where to get them, and send you FREE booklet, "How to Shave."

The Torrey Hoisting Strip has no equal

The J. R. Torrey Razor Company
Dept. P, Worcester, Mass.



Have Your Suit Made To Order and Take

6 MONTHS TO PAY.



Here it is—the biggest sensation in the history of high class tailoring! Think of getting a suit tailor made strictly according to your own individual measurements and having six whole months to pay for it! Yes, no matter who you are, where you live, or what you do, we will make you the finest, the richest, the snappiest suit you ever saw and give you an entire half year to pay for it! Don't miss this amazing opportunity.

Save Half

You actually and positively get the suit at about half of what it would ordinarily cost you! Our tremendous woolen buying gives us the pick of the world's greatest mills at lowest prices known. Therefore we can cut the price in half and still give you six months to pay. Don't buy cheap "ready mades" and pay double our price. Don't pay other tailors two or three times as much as we charge.

Only \$2.50 Per Month

You wear the suit while paying for it. Payments so marvelously easy you won't miss the money. We trust you absolutely. Your word is all the security we ask. No reference, no red tape, no delay, no collectors. No strings attached to this credit whatever. It's yours to use as freely as you wish. Don't class us with ordinary tailoring houses. We are "different!" You'll be delighted.

Get This Free Sample Book

The most sumptuous style book ever published—our 1916 Spring and Summer Style Book! See the actual cloth samples of most beautiful weaves and patterns—the newest and latest. Also illustrations of choicest designs from world's greatest style centers. You'll marvel

\$1,000 REWARD

To anyone who proves that we do not make all garments to individual measurements of each customer. Beware of houses that try to palm off altered "ready mades" claiming them to be made-to-order.

at this wonderful book.

Send Coupon

or postal or letter if you wish—but do it NOW! Get the magnificent free style book and full particulars of our startling offer. Don't delay! Write today.

Stanley Rogers Company,
544 S. Clark St.,
Chicago, Ill.

STANLEY ROGERS CO.,
544 S. Clark St., Chicago, Ill.

Please send me, FREE, your new DeLuxe Style Book and full particulars of your great offer.

Name.....

Address.....

City.....State.....

Please Mention Popular Mechanics



BEAUTIFUL PINS

For any school or class. No. 46, any letters or date, hard enameled, two colors, silver plated 15c each, \$1.50 doz. Sterling silver, 30c each, \$3.00 doz. CATALOG FREE.

Metal Arts Co., Inc., 91 South Ave., Rochester, N. Y.

START A MOVING PICTURE SHOW



MAKE MONEY FAST

COMPLETE OUTFIT, MACHINE, FILM AND EVERYTHING FURNISHED. EASY PAYMENT PLAN. NO EXPERIENCE NEEDED.

WRITE FOR FREE CATALOG

NATIONAL MOVING PICTURE CO. Dept. P., Ellsworth Bldg. CHICAGO

BIG CHANCE FOR AGENTS



You can earn BIG MONEY

selling the most complete line of guaranteed transparent handle Knives and Razors with Photo, Name and Lodge Emblem—also full line of cutlery. Write today for catalogue and terms. Golden Rule Cutlery Co., 554 W. Lake St., Dept. 328, Chicago, Ill.

\$22.00 for \$3.36



AGENTS 10 Piece Aluminum Set

makes 15 Combinations enough for whole Kitchen Outfit. Worth \$22.00; retails \$3.36. Biggest value ever offered. \$100 a week easy. Be first in your territory. Write quick. Address

AMERICAN ALUMINUM MFG. CO., Div. RP., LEMONT, ILL.

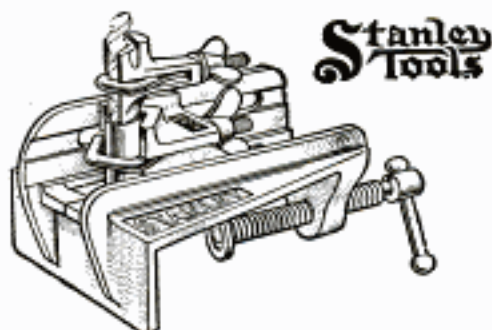

Stanley Doweling Jig

A new and most unique tool that will enable the user to bore dowel holes in the edge, end or surface of work with the greatest ease and with absolute accuracy. A tool that will immediately commend itself to Carpenters, Cabinet Makers, Pattern Makers, — in fact, to every artisan or amateur who has occasion to do any kind of doweling.

Price, Each, \$1.75

If you cannot procure this tool from your hardware dealer, we will send same, postage prepaid, on receipt of the price mentioned above.

ADDRESS

STANLEY RULE & LEVEL CO.
NEW BRITAIN, CONN. U.S.A.



A Constant Water Supply for Your Farm Home

Don't depend on a windmill or the back-breaking hand pump to fill your water tank. It's more reliable and economical to install a

RIFE RAM

and be sure of a constant supply of fresh water, without fuel or attention. The Rife Ram operates by the flow of any stream having a fall of 3 feet or more and a supply of 3 gallons or more per minute. Will maintain air pressure system. Simple to install. Over 11,000 in use. Satisfaction guaranteed.

Write today for catalog and free estimate

RIFE ENGINE CO.
3131 Trinity Building NEW YORK

Make Water Pressure Work and Save Your Back



The Divine Red Devil Water Motor built with bucket-wheels like big water wheels—easy to install, has nothing to get out of order and does work at very low cost.

4 in. Motor Complete, \$3. Including Emery, Buffing Wheel and Pulley for household use. With pulley for sewing-machine only \$4.50.

6 in. Motor with Pulley, \$5. For Mechanics, Tradesmen, Doctors and Dentists and the Home. Will run washing machine easy. Guaranteed to give satisfaction or money back. Order direct NOW or ask for descriptive Booklet FREE. Give size of pipe and water pressure, and work to be done.

DIVINE WATER MOTOR CO.
Dept. P., Utica, N. Y.

CRESCENT Wood Working Machinery

is very popular with those particular users who always insist on having the best. Send today for our catalog illustrating and describing band saws, jointers, saw tables, planers, and matchers, disk grinders, swing cut off saws, shapers, borers, hollow chisel mortisers, universal wood workers, variety wood workers.

The Crescent Machine Co.
93 Columbia Street, LEETONIA, O.

BABY FAR AT SEA SAVED BY WIRELESS—A wireless message recently picked up by the Cape Hatteras station received such prompt attention that a life was in all probability saved thereby. The message stated that a baby on board a vessel several hundred miles away was critically ill and that the ship's physician had



LATHES

9 to 18-inch Swing

List price \$75 and up according to size. When ready to buy send for Lathe Catalog and prices.

W. F. & John Barnes Co.
100 Ruby Street, ROCKFORD, ILL.



South Bend Lathes

For the Machine and Repair Shop

How to Run a Lathe
A 50 cent book for 10 cents. Postpaid, stamps accepted.

Straight or Gap Beds. Send for free catalog giving prices on entire line.
SOUTH BEND LATHE WORKS
423 Madison St., South Bend, Ind.

SEBASTIAN LATHES HIGH QUALITY LOW PRICES

If you delight in good tools you will delight in Sebastian Lathes. For 25 years we have built lathes, and lathes only, employing skilled labor always, and improving equipment and machinery every year. Sebastian Lathes are

STANDARD FOR QUALITY—LOW IN PRICE

They are accurate, economical, simple and durable. Many re-orders and voluntary letters from users of Sebastian Lathes prove this. The Sebastian reputation is back of every Sebastian Lathe. You are judge and jury when you buy a lathe. We are not satisfied until you are. Look over the complete line in our new catalog. It shows Lathes for general repair work, garage and automobile work, etc.

When you buy a lathe, say "Sebastian"

ADDRESS (FOR THE CATALOG)

THE SEBASTIAN LATHE COMPANY, 107 Culvert St., Cincinnati, Ohio

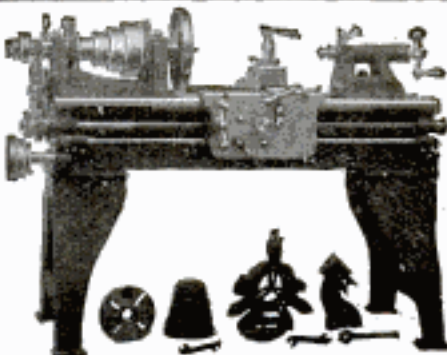

"YANKEE" TOOLS



"YANKEE" No. 75 is the Push Brace that holds same tools as a bit-brace, but revolves *by pushing*. Rapid work!—like "Yankee" Spiral Screw-driver. Chuck holds up to $\frac{1}{2}$ in. squares. Has right- and left-hand ratchet. Price, \$2.80.

Drives $\frac{3}{8}$ " auger bit through hardwood; larger in soft. Drills $\frac{3}{16}$ " holes in metal. Drives or draws screws.

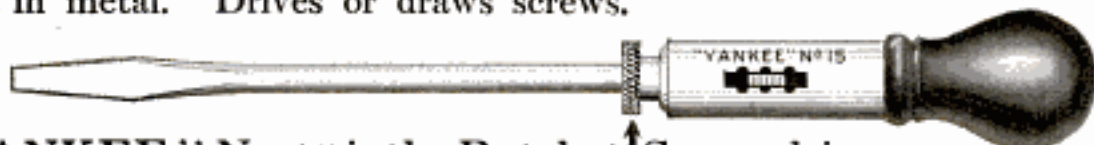

"YANKEE" No. 15 is the Ratchet Screw-driver that starts wobbly screws. You turn Knurled (see ↑) Washer with thumb and forefinger while the hand steadies driver and screw. Then ratchet home.

2-in. blade, 40c; 3-in. 45c; 4-in. 50c; 5-in. 55c; 6-in. 60c; 8-in. 70c.

"YANKEE" TOOLS *Make Better Mechanics*

Your dealer can supply you

North Bros. Mfg. Co., Philadelphia

Write us for "Yankee Tool Book," showing all the "Yankee" wood- and metal-boring and screw-driving tools

exhausted his skill without avail and appealed to any physician who might get the radio to prescribe for the infant. With the symptoms given, the operator at Cape Hatteras sent the message to a physician near by. The doctor gave him a prescription which was flashed through the air, and a few hours later the operator received another wireless saying the prescription had been filled and that the child had shown immediate improvement and was considered out of danger.



Portable Cases

FOR TOOL MAKERS
AND MACHINISTS

Twelve styles, felt lined drawers, solid brass trimmings, best of material, beautiful finish, low prices, satisfaction guaranteed. Ask for booklet of cases built for service.

The Pilliod Lumber Co.
SWANTON, OHIO



Save Your Clothes

Putting
Suit On

If you have any work to do on your car, around the house or in the factory, and want something to protect all your clothes, slip on a

Shanhouse MOTOR SUIT

It is a one-piece garment, made of high-grade olive khaki. On in a minute, off in a second. Roomy, comfortable, durable and washable. A handy over-garment for all kinds of odd jobs.

If your dealer cannot supply you, send \$2.00, giving chest measure and dealer's name. We will send you one direct, prepaid. Money back if not satisfied.

W. Shanhouse & Sons, Dept. 101 Rockford, Ill.

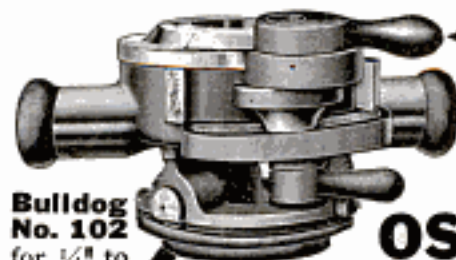

**Bulldog
No. 102**
for $\frac{1}{4}$ " to
2" pipe.

Ask for the booklet "*The Bulldog Tale*"—it shows you eleven convenient sizes of this tool, plain or ratchet types. Free by return mail on request.

THE OSTER MFG. CO.
2100 East 61st Street CLEVELAND, OHIO

Opens up when the thread is cut

Note the lever at the end of the arrow. When the thread on the pipe is cut, throw this lever to the left and the dies expand, clearing the thread. That is just *one* of the *five* big features of

**OSTER BULL-
DOG**

DIE-STOCKS



Please send "*The Bulldog Tale*" to

Name.....

Business.....

Address.....

(2100-5)



Starrett Hack Saws for Every Job

A Hack Saw that cuts iron pipe would not do satisfactory work in cutting sheet steel.

Good machinists know this and also know that there is a Starrett blade for every purpose.

Seventeen different blades — some differ in shape and size of teeth, some in composition, some in hardness.

Send for free catalog No. 20A.P. It tells what saw to use. Guided by this your work will be clean and rapid and your blades will have long life.



The
L. S. Starrett Co.
"The World's Greatest Tool Makers"
Athol, Mass.
New York London Chicago



Every Builder and Contractor Needs this Level

10 Days' Free Trial

We have been makers of transits and levels since 1863 and our instruments are the standard of the world. Prove the superior quality of the Aloe Convertible Level by giving it a 10 days' free trial. Use it on your every-day work laying out buildings, leveling up foundations, walls and floors, aligning, shafting, piers, etc., for getting angles or levels anywhere.

Easy Monthly Payments

If you decide to keep it, the instrument will earn its way while you make monthly payments so small that you hardly feel them. Costs no more than to pay all cash. No red tape about it, no embarrassing questions, everything confidential.

Aloe Convertible Level

is the finest instrument ever offered at anywhere near its price. Permits taking of sights both above and below the horizontal. For taking vertical sights it is provided with a special convertible bracket rigidly and permanently attached to cross bar; telescope, fitted with permanent axis, rests in bracket bearings and held by special clips which can be easily and quickly released.

Aside from being a level, it is a modified transit that permits such wider range of work than is possible with the ordinary architect's level. With it the man without technical training can obtain the same absolutely accurate results as the expert. Write today for descriptive circular.

A. S. ALOE CO.
512 OLIVE ST., ST. LOUIS, MO.



MUSK OX NEARING EXTINCTION—The musk ox is fast following the buffalo to commercial extinction, and its fur will in a few years be as hard to find as a first-class buffalo robe is today, says the Los Angeles Tribune. The animal is found on the shores of the Arctic Ocean in the Mackenzie district. Eskimos hunt the musk ox, which is very gentle and easily taken. The pelts are shipped by dog team and canoe down to the fur-trailing posts of the Canadian West. Very few skins can be brought down at a time, and the number of robes on the market each season is necessarily limited. The musk

THE GILSON DUPLEX SLIDE RULE

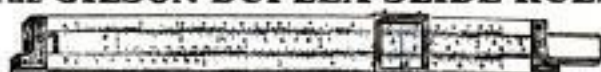

This pocket slide rule will solve any problem involving multiplication, division, proportion, even and uneven roots and powers, Logarithms, and Sines and Tangents. The scales are printed on a white facing, mounted on wood. The runner is made of aluminum, with a glass indicator. Four scales are shown in the illustration and there are five scales on the reverse side. Size 7 1/4". Price, with instructions and Leatherette Case, \$1.25. Order a Gilson Duplex Slide Rule. You can learn to use it in ten minutes. Keep it five days, and if you are not perfectly satisfied send it back and your \$1.25 will be promptly returned.

THE GILSON SLIDE RULE CO., NILES, MICH.

Before You Lose Another Expensive Tool, Get a

Style A



UNION Tool Chest

Has a place for every tool. You know immediately if one is gone, misplaced or borrowed. Plain or quartered oak or leatherette cover. Drawers strong and perfectly fitted, some lined with felt. Keeps tools clean, safe and free from moisture. Write now for catalog and prices. If we have no dealer near you, get our special offer.

Union Tool Chest Works
22 Railroad St.
ROCHESTER, N. Y.



For All Mechanics

Speed up your work and make it easier by getting a good kit of tools. A well-chosen equipment of high grade tools always indicates a skillful mechanic who takes pride in his work.

Brown & Sharpe Tools Famous for Fifty Years

They are regarded as the standard for accuracy, for fine finish, and for handiness by expert workmen all over the world. These are some suggestions from the big line—look them over.

Universal Bevel Protractor, for laying out angles exactly; lays flat on work.

Vernier. Takes outside or inside dimensions from 0 to 6" by .001".

Combination Set. Rule, level, depth gauge, square, centre gauge, bevel and protractor all in one.

Caliper. For diameters; well made to stand wear.

Hook Rule. Handy on circular work, or through holes or for setting dividers, etc.

Good hardware stores will show you many other B. & S. tools.

FREE, a 600-page Catalog. Just revised and up-to-date. Full of information of interest and help to shop foremen, mechanics and apprentices. Drop a postal asking for Catalog No. 136.

Brown & Sharpe Mfg. Co.
Providence, R. I.

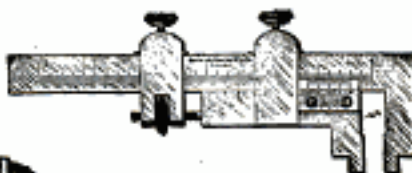

ox has very thick fur. At the base of the long, flowing hair, sometimes 40 in. long, there is a thick growth of wool, so that a robe made up from one of these pelts is capable of withstanding any cold.

YOU NEED THIS TOOL

**GASOLINE
SOLDERING IRON
BLOW-TORCH**



Address Dept. 1, Emmelmann Bros. Mfg. Co., Indianapolis, Ind., U.S.A.



ToolCases for Toolmakers and Machinists

Keep your tools orderly arranged in a Gerstner Portable Tool Case. There's a place for every tool in one of the 24 lined drawers. Every up-to-date mechanic needs one and you'll find our Cases the best built, easiest and most practical on the market. We guarantee to please or refund all money. Write for our free booklet.

Gerstner Sons

Mfrs. of Mechanics' High Grade Tool Cases
808 Columbia St., DAYTON, OHIO



"Red Devil" Combination Cutting Plier

Insured for 2 Years' Service
and You Pay No Premium

A very strong and heavy tool for handling bolts, nuts, pipes, wires, etc. Cuts and stretches wire, acts as a hand vise, etc. This is just one of the styles of

"Red Devil" Dependable Tools

It is insured for 2 years' hard service by a signed bond, or will be replaced free. Style No. 999, size 8 1/2 inches, sample 65 cents.

Tool Booklet sent on request

SMITH & HEMENWAY COMPANY, Inc.
161 Chambers Street NEW YORK CITY

Sharp Tools Pay Big

80% of all edged tools used in America are sharpened by the makers on "Cleveland Grindstones"—the natural abrasive stone that best preserves the temper of the steel.



Profit by their experience. Keep your own tools at their best with the recognized standard—"Cleveland Grindstones."

Our Little Giant

is built for all ordinary grindstone work in the shop or on the farm. Fitted for hand, treadle or power; 24" by 3 1/2" to 4" stone; ball bearing; latest improvements.

\$1 Special Introductory Offer

To prove the superior grit and toughness of "Cleveland Grindstones," we will send this handy "Harvest King, Jr." for kitchen or tool box, charges prepaid as far west as the Dakotas, Nebraska, Kansas, Oklahoma and Louisiana, on receipt of one dollar.



Send \$1 today. Get Free Catalog on Complete Line.

THE CLEVELAND STONE CO.
1111A Leader-News Bldg. Cleveland, Ohio

"Cleveland Grindstones" Save Tool Temper



Makers
of
Mr. Punch



Buy This—

The Famous Stratton Level

Made in that same slow, careful, accurate way as they were over 45 years ago. You can take it for granted that the man who numbers one of these levels in his tool kit is a good mechanic—a good judge. Every glass in Stratton levels is rigidly tested for accuracy, wood is thoroughly kiln-dried and brass bound levels are made moisture-resisting. All styles to meet all classes of work.

Made and Sold by Goodell-Pratt Company
Makers of 1500 GOOD Tools

You eliminate chance when you call for a Goodell-Pratt tool. The line includes Screw Drivers, Braces, Hack Saws, Bench Lathes, Bench Grinders, Levels, Foot Powers, Precision Tools, Glass Cutters, Vises, Automobile Tools.

Write for "The Story of the Stratton Level"

Goodell-Pratt Company, *Toolmakers*
Greenfield, Mass.

**GOODELL
PRATT**

1500 GOOD TOOLS

CRESCENT TOOLS



Fig. 1 Fig. 2 Fig. 3

**CRESCENT HAMM-HANDL
SCREW DRIVER**

YOU start the screw by using the handle as a hammer (Fig. 1). Then use as an ordinary screw driver (Fig. 2). When the screw is nearly set and difficult to turn, spring the handle into position and finish easily (Fig. 3).

MADE IN THREE SIZES—

Style	Length of Blade	Width of Point	Price
K-24	4 inch	$\frac{1}{4}$ inch	\$0.65 each
K-25	5 inch	$\frac{3}{8}$ inch	.70 each
K-26	6 inch	$\frac{1}{2}$ inch	.75 each

Drop Forged, Hardened and Oil Tempered

At your Dealers or sent prepaid upon receipt of price.

CRESCENT TOOL CO.
Manufacturers of Famous Crescent Wrench
JAMESTOWN, N. Y.

Greater New York now has 200 theaters and 951 moving-picture houses, with a combined seating capacity of 712,584.

Machinists and Tool Makers

Save money buying **Quality Tool Cases** direct from the factory. Write for **SPECIAL PRICE LIST**.
Detroit Leather Goods Co., 341 Woodward Ave., Detroit, Mich.

THE AWL YOU WANT



Is the genuine MYERS \$1.00 "Lock Stitch" Sewing Awl with the exclusive feature. See thread reel in front of handle under the finger tips. Natural tension. Sews heavy or light material, diamond point, full grooved needles used to protect the thread when sewing.
C. A. MYERS COMPANY, 6339 University Ave., Chicago, Illinois

**MILLERS FALLS
TOOLS**

Braces Hack Saws
Drills Mitre Boxes

Do Better Work and Last Longer
Write for catalog showing complete line
MILLERS FALLS CO., Millers Falls, Mass.

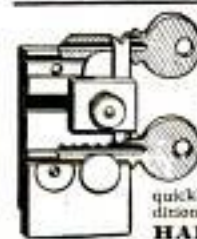

**THE HARRISON M. I. P.
KEY FILING MACHINE**

Makes duplicate Pin Tumbler Keys with absolute accuracy, and without injuring the original key. Price \$1.00. Special diamond shaped files 35c each or 4 for \$1.00. Net Cash. \$4.00 for the outfit complete.

THE HARRISON C. K. KEY CLAMP will make duplicate Common Keys of all kinds for Doors, Padlocks, Trunks, Cabinets, Lockers, etc., quickly and accurately. Price \$1.00. Both machines unconditionally guaranteed. Parcel Post Prepaid.

HARRISON & CO., 81 New St., New York

Please Mention Popular Mechanics

Veeder CLUTCH SPEED Counter



No. 21



Two-Third Size

This is the best instrument for finding revolutions per minute of a shaft or any revolving part. Will measure high or low speeds. No stop-watch required. Cut is two-thirds size. Price..... **\$3**

Veeder Counters are built as carefully as a watch and are the most accurate counters made. Ask any engineer.

We make a counter for your machines, one for your automobile, or your bicycle—one for practically every purpose. Write for our booklet and see for yourself.

Cyclometers, Odometers, Tachometers and all kinds of counters. Fine Die Castings.

Veeder Mfg. Co. 4 Sargeant Street HARTFORD, CONN.

Russia will present the most promising field for the development of American trade after the war, surpassing either South America or the Orient, in the opinion of trade experts. It has more than twice the population of all the South American countries combined and a greater purchasing power than the Orient.

TOOL CASES

For Up-to-Date TOOLMAKERS and MACHINISTS

We carry the finest and most complete line of mechanics' toolcases and tools in the country. We guarantee to please you or refund money. Write for free catalogue.

J. M. WATERSTON

75 Woodward Ave., E., Detroit, Mich.

SAMPLE 50c



THE SPEEDY Stitcher

The greatest invention with which the unskilled man can repair leather goods or any heavy material. Needles and thread are inside the handle. **FAST SELLER.**

Agents Wanted Foreign trade solicited. Advertising circulars in different languages. Stewart-Skinner Co., 26 Herse St., Worcester, Mass., U.S.A.

Dutch Boy White Lead

That beautiful, smooth-spreading material which the painter brushes on your house. Most people call it paint.

Ask for Paint Tips 34 and learn more about white lead paint.

National Lead Company
 New York Boston Cincinnati
 Cleveland Buffalo Chicago
 San Francisco St. Louis
 (John T. Lewis & Bros. Co., Philadelphia)
 (National Lead & Oil Co., Pittsburgh)

Luther Grinders Keep Tools Sharp

Dimo-Grit (artificial diamond) wheels do faster, better, easier work than grinding stone or emery. **Can't draw temper.** Many styles, with labor-saving attachments. Write for free book on tool sharpening.

Luther Grinder Mfg. Co., 928 Point St., Milwaukee, Wis.

Special Offer An Auger Bit FREE

Send us the price of one bit and we will make you a present of a Caldwell High Speed "Z" Twist Auger Bit not exceeding the value of the one purchased at the following prices:

4/16.....35c	7/16.....38c	8/16.....40c
9/16.....45c	10/16.....50c	11/16.....55c
12/16.....60c	14/16.....60c	15/16.....65c
16/16.....65c		

Sets of 11 bits **\$6.** This offer good in the month of May only

SEND FOR CATALOG

The CALDWELL AUGER BIT CO., Lebanon, N.H.



MOTOR DRIVEN BENCH SAW

Saws Wood and Soft Metals Indispensable and most economical. For shop or private use. Full description and circular on request.

H. G. CRANE Cypress Street, Brookline, Mass.

Hand Forged Razor Steel Blades. No. 57



This **\$2 KNIFE 83c** DIRECT AT FACTORY PRICE

Handy shaped blade makes this knife best for mechanics, sportsmen and farmers; light but strong; resharpened easily. Stag handle, German silver finish; blades file tested, hand forged from razor steel and warranted. Sample \$1c, 3 for \$1 postpaid. Choicest pearl \$2 each. Send for our 80 Page List and "How to use a Razor" **FREE**

MAHER & GROSH CO., 106 A. St., Toledo, Ohio.

Please Mention Popular Mechanics

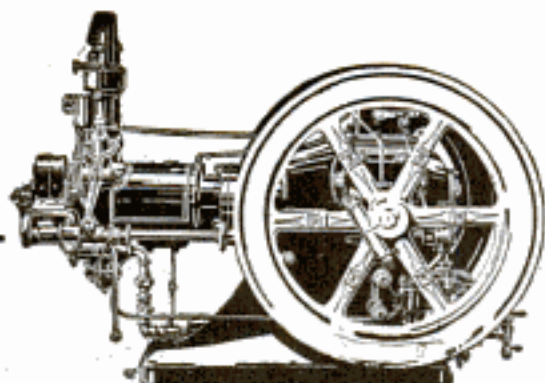

Own a Mogul Kerosene Engine

Do you want a really economical engine—that is, one that does the most work at the least expense? If you do, don't miss an opportunity to compare Mogul kerosene engines with any others when you need new power or more power.

Learn enough about Mogul engines so that you can make comparisons of weight distribution, valve sizes, fuel systems, bearing materials and sizes, equipment, oiling systems, safety devices, etc.

Then you can buy surely, safely, and easily, the really cheap engine you need—a Mogul kerosene engine of the right size and style for your work.

International Harvester Mogul engines are made in sizes from 1 to 50 horse power, and in every approved style. They operate perfectly on kerosene and even lower grade fuels, and on gas or alcohol.

When you buy this engine, the engine is not all you get for your money. Our service also has built up a reputation. Write us for full information.

International Harvester Company of America

(Incorporated)

16 Harvester Building Chicago U S A



2 H.P. \$35 Auto Throttle Governed

not hit and miss governed. One of the many exclusive features found in no other low priced engine.

Auto Throttle Governor means smooth, even, economical power for every work. Wonderful engine valve. Will operate electric light plant, run machinery, pump water, etc. Blower cooled. Price complete with gasoline tank, electrical equipment, etc., ready to run, only \$35. Further details and catalog free. Write today.

C. BENNINGHOFFEN & SONS, Dept. 125, Hamilton, Ohio

9c A DAY Is All It Costs For 1 1/2 H.P.



A REAL Kerosene Engine

• Biggest value ever offered in a 1 1/2 H. P. engine. Same cylinder capacity as many 2 1/2 H. P. engines. Throttling governor adjustable while running; crank shaft extends both sides. Runs either way. Starts without cranking. Patent Fuel Device guarantees successful operation on cheap oils.

Just the engine for pumping, separating, churning, corn shelling, sawing shop work, lighting and dozens of other light jobs. Easy to operate and move.

Sold on 30 Days' Trial Guaranteed 10 Yrs. Freight Prepaid

Also other sizes 3 to 18 H. P., vertical and horizontal, single or double cylinders.

Write today for valuable Engine Book telling how to judge and buy an engine and special prices.

ELLIS ENGINE COMPANY
2925 E. Grand Boul., DETROIT, MICH.

Please Mention Popular Mechanics

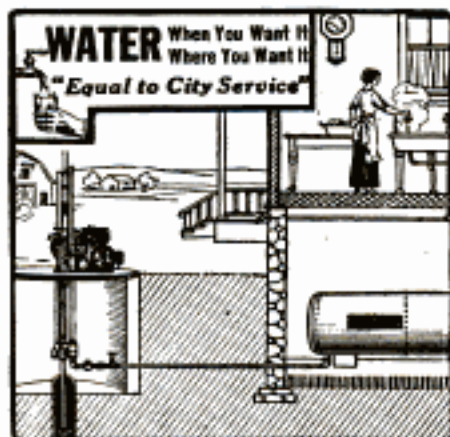

Water under pressure in your home will make housework easier, add to comfort, and increase the property value.

All water requirements of farm homes are met at moderate cost with our pneumatic pressure outfits.

May we give you details?

Fairbanks, Morse & Co.

New York CHICAGO San Francisco

(449-611)

JITNEY BUS IS NOT A TOOL—The driver of a "jitney," whose car had been seized to satisfy a debt,

POWER

for farm, ranch, shop, to pump, saw, excavate, hoist, irrigate, can be had in Galloway engines from 1 1/2 to 16 h.p. All styles. 200,000 customers testify to quality. Prices from 1/2 to 1/2 what's usually asked. Low freight.

WM. GALLOWAY COMPANY

Box 945

WATERLOO, IOWA.



BESSEMER KEROSENE ENGINE

FREE TRIAL 30 DAYS

A Real Kerosene Engine

and not a converted gasoline type, which is highly important on account of the high price of gasoline. Runs on cheap kerosene, or coal oil. This wonderful engine, 2 to 8 H. P., explained in free catalog "K." Also, fuel oil engines, 15 to 165 H. P., explained in free catalog "O."

THE BESSEMER GAS ENGINE CO.
121 Lincoln Ave. Grove City, Pa.



WEBER THROTTLE-GOVERNED KEROSENE ENGINES

4-Cycle

Lowest Priced Throttle-Governed Engine on the Market—Cash or Payments

Save Half In Fuel. The 1916 model Weber solves the problem of low cost power for all time. Power and speed controlled by throttle, same as steam. No waste of fuel—no violent explosions. Throttle regulates amount of fuel to size of load.

Sold on a Five-Year Guarantee—Two Months' Trial in shop or on farm. Shipped direct from factory at a big saving.

FREE BOOK—"How to Use Kerosene" and Engine Folder, sent post-paid. Address

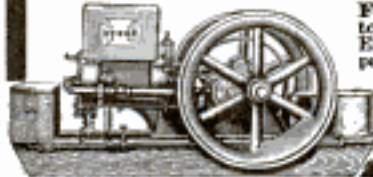

WEBER ENGINE CO.
Dept. 117B
Kansas City, Mo.

Meco ENGINES

Gasoline, Kerosene & Gas

Prove Their Quality

Write us, giving dealer's name and we will tell you how to get a high-grade Meco Engine for trial, and send you our Engine Catalog to select the kind of engine you want.

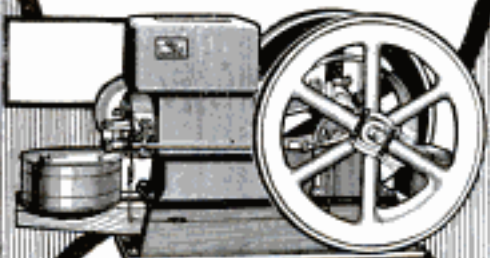

COSTS YOU LESS

2 H-P, \$35.10; 3 H-P, \$52.65; 4 H-P, \$70.20; 6 H-P, \$100; 8 H-P, \$140.40; 12 H-P, \$210.90.

Built for hard, heavy work, compact, easy to run; few parts, and save their cost in fuel first year.

Guaranteed 5 Years

Don't pay more than our prices for any high-grade engine until you have tried the Meco. Write for Catalog today.

Manufacturers Engine Company

1821 Crystal Avenue, Kansas City, Missouri.

IF IT ISN'T AN EASTMAN IT ISN'T A KODAK

in vain pleaded before a Wisconsin municipal court that the car was the only tool wherewith he earned his living. The judge decided that a jitney bus is not a tool within the meaning of the law.

FARM VIM MARINE ENGINES

Get a VIM Engine and save money. VIM Midget 1 1/2 H.P. Farm Motor shown below does all the churning, cleaning, washing, pumping, separating, straining, etc. Women operate easily. No complicated parts. Weighs only 75 lbs. Water cooled, automatic lubrication. Comes ready to run. Gasoline. Full line marine engines 1/2 to 27 H.P.; 1, 2 and 3 cyl.; speed, pleasure and heavy duty types. Gasoline or kerosene.



Double ignition. Non-backfiring. Strong, simple, accessible—absolutely dependable. Built for a lifetime. The boat-builder's stand-by, the boat-owner's pride. When writing for catalogs, please mention whether interested in stationary or marine engines, or both. Ask for attractive agency offers. The Vim Motor Company, 105 Water St., Sandusky, Ohio.

WE PAY CASH

For Diamonds, Jewelry, Watches, Old Gold, Silver, Platinum, Emeralds and Pearls. Send any old jewelry and turn it into cash.

WE PAY HIGHEST PRICES

Send by Registered Mail or Express. We guarantee to pay highest prices. We remit cash the same day goods are received. If our offer is not satisfactory, we return goods at our expense. All business strictly confidential. References: Colorado National Bank, Denver, Colo. Capital and Surplus \$2,000,000.00.

COLORADO JEWELRY MANUFACTURING CO.

1526 1/2 CHAMPA ST. Established Diamond Importers DENVER, COLO.

APPLIED ELECTRICITY FAMOUS \$35 SET



NOW \$19.80—50c A WEEK

Greatest reference work on electrical subjects ever published. Most exhaustive electrical cyclopedia of modern times. 7 big books written by 32 famous experts: 3300 pages, 3000 illustrations, full page plates, diagrams, simple explanations, etc., with hundreds of valuable facts and figures. Bound in half red morocco.

Earn \$150 to \$250 Monthly

Electrical Engineers earn from \$150 to \$250 a month. The work is pleasant—the hours short. These great books will fit you—in your spare time—to enter this fascinating, well-paid work. No previous experience necessary.

SENT FREE To prove what these books will do for you, we will trust you seven days before you spend one penny. They must make good with you or we take them back at our expense without question or annoyance. On receipt of coupon below we ship the entire set to you—express prepaid—at our risk for absolutely free examination.

Read These Subjects Carefully

Elements of Electricity—Electrical Measurements—Underwriter's Requirements—Theory, Calculation, Design and Construction of Direct Current Generators and Motors—Types of Generators and Motors—Management of Dynamo-Electric Machinery—Electric Lighting—Alternating Current Machinery—Power Transmission—Electric Railways—Self-Propelled Railway Cars—Power Stations—Switchboards and Switching—Storage Batteries—Applied Electrochemistry—Electric Elevators—Electric Welding and Heating—Wire and Wireless Telegraphy.

Free \$12.00 Consulting Membership

Our 32 electrical experts answer every question you want to ask on electrical subjects absolutely free for a full year to every holder of a set of these books. This privilege has always cost \$12.00 and now tell us it is worth twice that amount in settling one problem alone. You get this service free if you buy the books after examination.

This means \$15.20 saved if you act now. Read the coupon carefully. Then fill it out and mail today. The books will reach you promptly—express paid by us. After seven days send us \$2.00; otherwise, notify us for their return.

Don't wait. You take no chances whatever. It costs nothing to inspect and you are nothing out if you do not care to buy. Mail the coupon today.

FREE COUPON

Worth \$15.20 to You

American Technical Society:

Please send me Cyclopedia of Applied Electricity for seven days' free examination. If I keep the books will send \$2.00 within seven days and \$2.00 a month until \$19.80 has been paid, when \$15 books and \$12 consulting membership will be mine. Otherwise will notify you and hold books subject to your order. Title not to pass until fully paid.

Pop. Mech. 6-18

AMERICAN
TECHNICAL
SOCIETY
Chicago,
U. S. A.

NAME

ADDRESS

As I have had no previous dealings with you, I refer you to

Please Mention Popular Mechanics

Get the Big End of the Profit!

EARN \$3,000 A YEAR REPAIRING TIRES

Do you want to succeed — earn big money — be independent? Are you tired of letting someone else take the profit from the work you do? The Tire Repairing Business offers the opportunity of a lifetime.

The One Big Paying Trade That Isn't Overcrowded

Thousands of tires are being sold every day. More than a million new cars will be sold in 1916 and two million are already in use. Each 100 cars in your community will furnish \$3,000 worth of tire repair work this year. And the business is easy to get when automobile owners know you have the

Akron-Williams Tire Repair Equipment

Used and Endorsed by More Than Sixty Leading Tire Manufacturers

An Akron-Williams Repair Outfit is a big capacity plant. Built of the best materials — does the kind of work that enables you to hold your customers and make the biggest profit on every job.

Grasp this opportunity today. WRITE FOR FREE BOOKLET "YOUR SHARE OF THE 100 MILLION DOLLARS." It gives you facts and figures about this wonderful business. Gives the details of our business building aids that start you on a good paying basis from the very first day. NOW is the best time to get into Tire Repairing—right at the start of the touring season. Write us at once.

The Williams Foundry & Machine Co., 50 Cherry St., Akron, Ohio

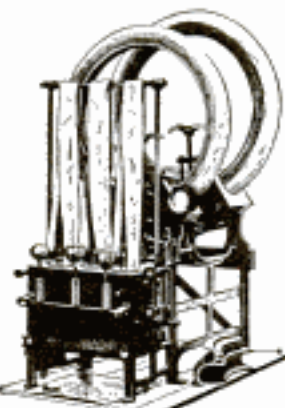

LET THE *Cyclemotor* PEDAL

Fits Any Make

YOUR BIKE!



This marvelous two-stroke, high-speed motor (including magneto) weighs but 21 lbs., speeds up to 25 miles, controlled entirely by one lever. You simply turn on the power, then sit still and steer.

Gives all the pleasures of motorcycling at no extra expense. Full details in Booklet "X." When writing give name of your bicycle dealer.

CYCLEMOTOR CORPORATION
Arlington Bldg.
ROCHESTER, N. Y.

\$40 Motorcycles and Bicycles at Cut Prices



Second-hand and rebuilt motorcycles, singles and twins, \$25 to \$100. Motorcycle tires, \$5. Automobile tires, \$3. Second-hand bicycles, \$5; tandems, \$10. New bicycles and motorcycles at factory prices. Buy direct, save dealer's profits.

SEND FOR CATALOGUE
DENINGER CYCLE CO., Rochester, N. Y.

We Save You \$\$\$\$



Buy Motorcycle Accessories from the largest and cheapest supply house in the United States.

Our 1916 catalog listing 3015 accessories sent **FREE**

You can't be an up-to-date rider without it. It is the one others try to copy. You need it, so send-us your name and address today.
MOTORCYCLE EQUIPMENT CO., Hammondsport, N. Y., or Los Angeles, Cal.

BOYS, BUILD A REAL AUTO

You can do it yourself. Our plans make it easy, simple, accurate. You have a regular auto when finished. Even carries a man. Wheelbase 62 inches. Use our engine or yours. Buy all parts at once or one at a time. We furnish them all. Inexpensive. Do errands—carry papers, etc. Send 16c today for latest improved blue prints and price list of parts.

Fun to build.
Fun to ride.



SYpher
MFG. CO.
145 WARREN ST.
TOLEDO, OHIO

BICYCLES

\$15⁹⁸

High-grade, guaranteed Bicycle. Worth $\frac{1}{3}$ to $\frac{1}{2}$ more. Seamless steel tubing frame, triple truss forks, arch crown design.

NEW SERVICE MODEL

Motorcycle type anti-skid, puncture-resisting tires. Superb enamel finish. Send for Free Bicycle Book today.

Montgomery Ward Co. Dept. G133
New York Chicago Kansas City
Fl. Worth Portland

Write home most convenient

The Pleasure of Cycling

Summer is coming — wipe the dust off that wheel of yours and get ready for the good times ahead! One of the first things to do is to select a good brake, and here there is only one choice — the

ORBIN Duplex Coaster Brake

With this famous brake equipped to your hub, the roads, the hills, the crowded streets are yours to command. It adds new interest to the sport of bicycling because it enables you to control the speed of your wheel with absolute ease and surety. It answers to the slightest pressure of the foot — you can coast at will, slow down gradually, come to an instantaneous stop.



Make the Corbin Duplex Coaster Brake your choice for 1916. Specify it for your new wheel, equip it to the old. At all dealers.

Send for a free 1916 catalog and Liberty Pin.

The Corbin Screw Corporation

The American Hardware Corporation, Successor
201 High St. NEW BRITAIN, CONN.

BRANCHES: New York Chicago Philadelphia
Makers of Corbin-Brown Speedometers



NOTE REAR VIEW ABOVE. BACK WHEEL OF MOTORCYCLE IN CENTER.

“On or Off in 30 Seconds”



Fits Any Standard Motorcycle

Safe Practical Economical

You can go to work on your motorcycle — and in the evening hitch on your Rear Car and take two adults and a child for a joy ride.

One For Pleasure One For Business

You can, with same low upkeep for motorcycle, attach our Rear Car for Delivery Work.

P. M. Cygnet Rear Car Company Buffalo, N. Y.

Panel or Open Body Types.

Gentlemen: Without obligation to me send full particulars about Rear Car for Business

Cygnet Rear Cars can not tip over or skid.

Be sure to send name of motorcycle and name of your dealer.

Name.....

Address.....

Cycle Make.....

Use This Coupon

Your Dealer.....



Garage \$69.50

10x12feet "Steelcote" Edwards ready-to-use garage, \$69.50 complete. Factory price. Fireproof. Portable. Quickly set up. All styles and sizes of garages and portable buildings. Send postal for illustrated catalog.

THE EDWARDS MFG. CO.
320-370 Eggleston Ave., Cincinnati, O.



Used Indian Motorcycles

We specialize in 'em. Don't handle anything else. Nothing but the best, at rock bottom prices. If you want a guaranteed second-hand machine that will give the service that you have every right to expect, write for our big, descriptive list. Reference, State Street Trust Co., Boston.

George N. Holden, Indian Motorcycle Agent
186 Massachusetts Ave. BOSTON, MASS.



A Real Auto For Boys
You Can Build It

Send a quarter for drawing, description, instructions and price list of parts. They make it easy.

THE MOTOR BOB, Dept. 1, BUFFALO, N. Y.

On Time
Without Fail!

When he rides to work on

VITALIC
TRADE MARK
TIRES

No more fooling with cheap tires, for men who have tried Vitalics. It simply doesn't pay. A little more invested in Vitalics, prevents embarrassing delays and saves money besides, for they last more than twice as long as ordinary tires.

The reason is simple: Only the finest quality white rubber goes into Vitalic tires, while in even the best of other tires, cheaper grades of rubber are used. The difference is instantly felt in the soft, flexible Vitalic tread, which holds its life long after other tires have dried out. Then, under the Vitalic tread there are two layers of genuine motorcycle fabric—not just ordinary bicycle fabric put in other tires.

A tire like that costs a little more, and men with an eye to economy gladly pay the difference because they know it saves both money and time. Write for folder, "From Boston to San Francisco on One Set of Tires"—told by the man who rode the bicycle.

Continental Rubber Works
1964 Liberty St., Erie, Pa.



Used Motorcycle Bargains!



Get our wholesale prices on used and demonstration machines. Here's a sample — Indian, 7 H. P. Twin, 1912 Model, \$35.00. Many others at prices you can't resist. All machines guaranteed to be in first class running condition, including tires. Our prices mean quick sales; don't run the risk of being disappointed, but write us today for prices and full particulars.

Olive Cycle & Motor Co., 1047 N. Grand Ave., St. Louis, Mo.

RUNATIRE REPAIR SHOP

BIG MONEY—
FROM THE START Model F

Every auto owner needs frequent tire repairs. Badger Equipment makes the work quick and easy. Small investment puts you into a business of your own—paying up to \$200—\$300 a month.

WE TEACH YOU FREE

No experience needed. We teach you at factory or by mail. Show you how to get the business and handle your shop. Best system, best machines and money-making FREE AID SERVICE.

Write for **Catalog** Tells how to get into this lucrative field right. Full description of Badger outfit. It's free—write.
TIRE REPAIR EQUIPMENT CO.
601 Johnson St. Appleton, Wisconsin



Free Motorcycle Book

A book you ought to have, whether you are a motorcycle enthusiast or merely considering the purchase of a machine. Full from cover to cover of interesting and instructive information about the buying and care of a machine. Describes in detail the construction of our machine and explains why it is today the choice of every discriminating rider from Maine to California.

EMBLEM

Motorcycles are built for the red blooded, outdoor man who appreciates the throb of a powerful motor; the unhesitating sweep up and over the worst sort of hills; the unfailing, faithful drive that sends the Emblem without faltering through sandy and treacherous roads.

The Emblem has a stout heart—it will take you where no other machine will attempt to go, and will bring you back. It is the motorcycle for you. Your name on a postal NOW will bring our Motorcycle Book and a full description of the Emblem by return mail.

EMBLEM BICYCLES are made by the same organization that builds the Emblem Motorcycle. They embody the same sturdiness of construction; the same ability to stand up and perform under every sort of hard work and abuse. Bicycles are once more coming into their own—and the Emblem is leading the way. We have an Emblem Bicycle Book here for you and will send it as soon as we get your name—a postal will do.

Emblem Manufacturing Company

Station A
ANGOLA, Erie County, N.Y., U.S.A.

Pack of **EMBLEM 60c Playing Cards** sent on receipt of 10c in stamps.



The value of American-made motor cars, sold to foreign lands, doubled in 1915.



Mobiloils

A grade for each type of motor



START FORD
YOUR FORD
FROM THE SEAT

Throw away your crank. Start from the seat with the famous never-fail

Sandbo Two-Compression Starter

\$2,000 sold. Differs from all others. Sold on 30 days trial—positively guaranteed. \$14
Now improved 1916 model—Price \$14. Write

AUTO STARTER COMPANY, 26 Sandbo Building, CHICAGO, ILL.

SOME CAR! BOYS! Send for Booklet Today



The Lad's Car

Send 20c today for Booklet, telling how to build this automobile. Complete instructions and descriptions of parts and sizes, illustrated with diagrams, blue print, cuts made from photographs, and price list of parts.

SPECIAL INDUCEMENT to first boy in your town
Niagara Motor Car Corp'n, Dept. A, Niagara Falls, N.Y.

1/2 PINT 1/2 DOLLAR



Buy the big Household or Factory Size 3-in-One and get 8 times as much oil for your money.

3-in-One keeps almost everything in home, office or store perfectly oiled—also as clean and bright as a new silver dollar.

Always use 3-in-One on sewing machines, typewriters, razors, cameras, talking machines, furniture, bath room fixtures, guns, reels, and hundreds of other things.

The 3-in-One Dictionary, with every bottle, shows you scores of ways this good oil makes hard work easy.

FREE Generous sample bottle sent on request. Try before you buy.

SOLD AT ALL GOOD STORES

3-IN-ONE OIL COMPANY

42 CNH. Broadway, New York

Housewives — Try 3-in-One for Dusting.

STANWELD Cold Drawn Tubing

Seamless Steel

Lightest, smoothest, strongest Steel Tubing made. World's largest manufacturers of bicycles, motorcycles and automobiles use it exclusively. Send for Folder "A."

THE STANDARD WELDING COMPANY

Main Office and Factory

CLEVELAND, OHIO

5-16 H. P. 1916 Peerless Motorcycles

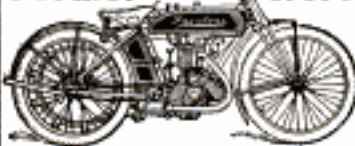

with Free Engine, Bosch Magneto, together with the best there is in Motorcycle construction. Power, Speed, Silence, Endurance, and those wearing qualities so essential for low cost of maintenance.
5 MILES FOR ONE CENT
Agents Wanted—Liberal Discount!

PEERLESS MOTORCYCLE CO., 179 Hastings Ave., Boston, Mass.

Don't Throw Away Your Worn Tires

For over three years European motorists have been getting from 10,000 to 15,000 miles out of their tires by "half-selling" them with Steel Studded Treads. In eight months 20,000 American motorists have followed their example and are saving \$50 to \$100 a year in tire expense.

We ship on Approval without a cent deposit, prepay the express and allow you to be the judge.

Durable Treads double the life of your tires and are sold under a signed guarantee for 5,000 miles without puncture. Applied in your own garage in thirty minutes.

Special Discount offered to motorists in new territory on first shipment direct from factory. A postal will get full information and sample within a week. State size of tires. Don't wait—write today. Address nearest factory office.

THE COLORADO TIRE & LEATHER CO.

544 Tread Bldg., Denver, Colo. E. 44, Transportation Bldg., Chicago, Ill.
720-445 Woolworth Bldg., New York, N. Y.



Name your own increase in salary

To any one not familiar with the work of the Blackstone Institute, this may sound extravagant, especially if you are not acquainted with the fact that business organizations large and small today demand the services of the Law Trained Business Man—and this demand exceeds the supply. But from your own experience and your knowledge of the experience of others, YOU KNOW THIS TO BE TRUE.

The Law Trained Business Man is the man of the hour—he uses his knowledge of law as a stepping stone to a larger income—and in many cases is able to write the amount in his own salary check.

Never before in the history of our country has the legal profession offered such unlimited opportunities for honor, prestige and an increased income. The services of the thoroughly trained lawyer are in demand everywhere. Through our Modern American Law Course and Service, we prepare you to practice law in most of the states, same as we have already done for so many others.

The Course is clearly written in simple, non-technical language. It is practical, yet reads like an interesting story. Specific preliminary education is not necessary. You can read in spare time at home, and you will benefit from the day you start. It will equip you to become a leader in business or public life—and to attain positions of honor and profit open only to law trained men.

Through a knowledge of law these men reached their present positions in the political and business world—President Wilson, John S. Runnels, President of the Pullman Co., Theo. P. Shontz, President N. Y. Traction System, Gary of U. S. Steel Co., Whelan of United Cigar Stores Co., Chas. G. Dawes, former Comptroller of Currency and leading banker, and many others equally prominent.

Write today You, too, with the proper law training, will have an opportunity to become a leader in business or politics. Send coupon for our book, "The Law Trained Man" and our "Special 1916 Offer." Address Extension Division 1355—

BLACKSTONE INSTITUTE
20 W. Jackson Blvd.
Chicago



Send me all charges prepaid your book, "The Law Trained Man" also Special 1916 Offer—no obligation on my part. I'm interested

Name _____

Address _____

Blackstone Institute
Extension Division 1355
20 W. Jackson Blvd., Chicago, Ill.

Please Mention Popular Mechanics

WE ARE HEADQUARTERS FOR ELECTRICAL GOODS and WIRELESS APPARATUS

OUR 216 pp. CATALOG IS THE BEST ONE PUBLISHED

THIS IS THE Experimenter's Reference Book

It's the latest edition of the famous *Amco Catalogue*, contains over 200 pages and is fully illustrated. Complete description and prices of the latest electrical and experimental apparatus—Storage Batteries, Rectifiers, Transformers, Induction Coils, Wireless Apparatus, Lamps, Flashlights, Motors, X-Ray, Books, Tools, Electric Railways, Steam Engines, Water Motors, Dynamos, Motors, Telegraphs, Telephones, Electrical Supplies, Model Aeroplanes and Parts for building your own apparatus. **Get in stamps will bring you this wonderful book.** Best catalog of Wireless and Electrical Apparatus, etc., published. Send for this catalog right away. Our prices will save you money. Go in stamps brings it by return mail.



LOTS OF FUN FOR BOYS!

351 volt, 2 C. P. FUNGSTEIN lamp, switch, socket, 20 ft. insulated wire and 3 cells of dry battery all ready to install. May be used to light a dark closet or hall.
Price only 80c. Postage extra 15c



LITTLE GIANT MOTOR

Is nearly 3 in. high. Runs at high speed on a single cell of battery. Very powerful and may be used to run small toys, etc. Just the motor every boy has been looking for.
Sent postpaid for only 50c



THE SIMPLEX TELEGRAPH OUTFIT

An opportunity for every boy to learn to telegraph and to get up a line with his chum. This is a full sized telegraph set, consisting of a fine key and sounder, mounted on a polished base. Will work any distance. An excellent Field Telegraph for Boy Scouts. Price, 95c. Postage Extra. Wt. 2 lbs.



FUN WITH ELECTRICITY

Here is a rare chance to get started right in your study of electricity. This wonderful outfit contains 68 pages of instructions and all the apparatus for performing 40 interesting and spectacular experiments which will give any boy a practical knowledge of electricity.
Price Only 50c. Postage 10c Extra



ADAMS-MORGAN COMPANY "The Experimenter's Supply House"
25 Alvin Place UPPER MONTCLAIR, N. J.

DEPENDABLE KNAPP Dynamo Motor FOR BOYS \$5
ELECTRIC SPECIALTIES

For producing current for inductance coils, re-charging storage batteries, electroplating, and hundreds of other uses. Well constructed throughout, exceptionally smooth running and highly efficient. A good, strong, durable dynamo.

At all live dealers. Or order direct from us. Complete catalog on request.

KNAPP ELECTRIC & NOVELTY CO.
519 W. 51 St., N. Y. City



BOYS! TRY THIS PLAN:
Form a kind of league with fellows in nearby town. "Talk" with each other at certain times each day and exchange local news. You'll make new friends and enjoy your wireless twice as much. Brandes Head Sets greatly increase your range. They're light, and fit you exactly. Send 4c for catalog P. It has the information you want.

C. BRANDES, Inc., Res 817, 32 Union Sq., New York

BRANDES WIRELESS RECEIVERS

ELECTRIC LIGHT PLANTS Complete gasoline engine, dynamo, switchboard and storage battery \$240.
Agents wanted. American Battery Co., 1189 Fulton St. Chicago: Estab. 1889.)

ELECTRIC LOCOMOTIVE WITH SMOKESTACK
—Such a superfluous accessory was seen on an electric engine, recently arrived at the Pennsylvania Railroad

DUCK'S No. 9—320 pp. Electrical and Wireless Catalog
JUST OFF THE PRESS

40 new pages of wireless instruments at startling prices. Many new items in the electrical line. This unrivaled catalog mailed upon receipt of 8c in stamps or coin, which may be deducted from first dollar purchase. Great cost of catalog and low prices prohibit distribution otherwise. This catalog contains anything and everything in the field of wireless and electrical supplies.

YOU CANNOT AFFORD TO BE WITHOUT IT

The Wm. B. Duck Co., 223-227 Superior Street, Toledo, Ohio



CACHOO! Make the whole family and all your friends "just sneeze their heads off" without knowing why, with Cachoo, the new long distance harmless snuff. Sent anywhere for 10c. 3 for 25c. 1 doz. and special premium for 90c. **AMERICAN SUPPLY CO., St. Paul, Minn.**



ELECTRIC HOME, FARM, THEATRE, STORE and TOWN LIGHTING PLANTS.
\$15.00 Rectifier Charges Storage Batteries from Lamp Socket Lighting Your Auto Electrically for ONE CENT an hour. Lamps; Dynamos; Engines; Bells; Medical and Storage Batteries; Bells; Books; Sewing Machine, Fan and Power Motors; Railways; Bikes, Carriage, Fish, Surfing, Auto and Flash Lights; Massage and Ozon Machines; Telephones; **MOTION** Picture Theatre Traveling and Permanent Equipments. Big Profits. Ten Cents on Hour Lights Theatre and M.P. Machine. Catalog 3 cents.

OHIO ELECTRIC WORKS, CLEVELAND, OHIO

Send 10c for Copy of Our New Wireless Manual No. 2
YOU GET YOUR MONEY BACK ON AN ORDER OF \$1.00

It contains 120 pages and tells how to erect and maintain wireless telegraph stations. Shows a number of diagrams. Has the Morse and Continental Telegraph Codes. Illustrates the best instruments to use; tells what they are for and how to use them. Has many new diagrams and other valuable information not contained in any other book. Do not wait. Send your request now. Get the best 10c value you will ever buy.

Send for Our Pocket Catalog P28

It contains 212 pages, with over 1,000 illustrations, and describes in plain, clear language all about Bells, Push Buttons, Batteries, Telephone and Telegraph Material, Electric Toys, Burglar and Fire Alarm Contrivances, Electric Call Bells, Electric Alarm Clocks, Medical Batteries, Motor Boat Horns, Electrically Heated Apparatus, Battery Connectors, Switches, Battery Gauges, Wireless Telegraph Instruments, Ignition Supplies, Etc.

MANHATTAN ELECTRICAL SUPPLY COMPANY
NEW YORK, 17 Park Place CHICAGO, 114 So. 5th Ave. ST. LOUIS, 1106 Pine St. San Francisco, 604 Mission St.



WIRELESS

OUR TRADE MOTTO:

"Everything for the Experimenter"

Send for our big 275 page Electrical Cyclopaedia containing 658 illustrations, Treatise on Wireless Telegraphy, complete code chart of Morse, Continental and Navy Codes besides list of call letters



Smallest Flashlight Made Gives powerful light. Fits vest pocket. Wt. 4 oz. Postage extra. Price 50c

of all the U. S. Ship and Shore wireless stations. This wonderful book sent for 4c in stamps or coin to cover postage only.

It's the "Livest Catalog in America," and one book you simply must have.

The Electro Importing Co., Mfrs.
233A Fulton St., New York City

Retail Stores: 317H Livingston St., Brooklyn, N. Y.
69H W. Broadway, New York City

ELECTRICITY

yards in Indiana Harbor from San Francisco, where it had been part of an exhibit at the exposition. The reason for the smokestack was that the owners, wishing to insure its safe and prompt return from San Francisco, had sent with it a personal-tracer for whose comfort a cab had been erected which included a small coal stove.

CRYSTALOID

The Highly Sensitive, Permanent Wireless Detector
REDUCES STATIC ONE-HALF

All live dealers. If your dealer cannot supply you, write us. Catalog "G" sent on receipt of 6c in stamps.

Eugene T. Turney Co., Inc. 2896 3rd Avenue NEW YORK

LEARN TO PITCH

Lessons by "MATTY," ED. WALKER, "DOC" WHITE, WALTER JOHNSON, "NAP" BUCKER, "SMOKEY JOE" WOOD.
PITCH THE FADEAWAY, SPITTER, KNUCKLER, SMOKE BALL, etc.
Clearly described and ILLUSTRATED by 66 Pictures. Entire COURSE OF LESSONS SENT POSTPAID for 50 cents.

J. C. DORN, 721 S. DEARBORN ST., DEP. 270, CHICAGO, ILL.

2 Catalogs of WIRELESS and ELECTRICAL APPARATUS

FOR 160 pages fully illustrated, everything from a wireless telegraph set to a complete lighting plant, sent for 6c in stamps to cover mailing.

Our manufacturing experience of ten years insures fair prices, fair dealing, and above all, one quality—the best.

6c CLAPP - EASTHAM COMPANY
147 Main Street, Cambridge, Mass.



THIS BIG NEW SET SENT FREE TO YOU

We will send this big Civil Engineering library—1916 edition—to you, EXPRESS PREPAID, for seven days' free examination; returnable at our expense. If you decide to keep the books, you can buy them at about two-thirds the regular price, payable in small monthly installments. Whether student, worker, or expert, you can gain from these nine volumes an intimate knowledge of Civil Engineering—knowledge that will mean greater success and higher pay. The work of twenty-seven experts, this library is recognized as a standard reference work by technical schools, libraries and practical men throughout the country. Remember, this is a brand new edition—just off the press—and contains important subjects included in no other work on Civil Engineering.

Earn \$150 to \$250 Monthly Civil Engineers earn from \$150 to \$250 a month. The work is pleasant—the hours short. These great books will fit you—in your spare time—to enter this fascinating, well-paid work. No previous experience necessary.

The 1916 Edition Cyclopaedia of Civil Engineering

contains 3,900 pages, 7x10 inches, 3,000 illustrations, full page plates, diagrams, etc.; hundreds of valuable tables and formulas; carefully cross-indexed for quick, easy reference. The books are substantially bound in half red morocco, gold stamped, and are printed in large, clear type on special quality paper.

Important Subjects Covered

Plane Surveying—Plotting and Topography—Highway Construction—Railroad Engineering—Earthwork—Steel Construction—Estimating for Steel Buildings—Stations—Roof Trusses—Civil Specifications and Contracts—Bridge Engineering—Strength of Materials—Masonry and Reinforced Concrete—Water Supply—Sewers and Drains—Hydraulics—Water Power Development—River Improvement—Harbor Improvement—Cost Analysis Engineering—Dams and Weirs—Irrigation Engineering.

Sent Absolutely Free—Express Prepaid

The complete nine volumes, not a sample volume, will be sent, express prepaid, for seven days' free examination; returnable at our expense if they do not contain the information you want. If you keep the books, pay \$2.00 seven days after receipt and then \$2.00 a month until you have paid the special introductory price of \$29.80. The regular price of this great Cyclopaedia is \$45.00.

Another Great Free Offer

With every set is included a year's Consulting Membership, regular value \$12.00, entitling you to the free advice of a staff of expert Civil Engineers. This will give you practical help in handling working problems which are too specific to be taken up in detail in the cyclopaedia. There will be no limit to this service. A single problem solved for you might be worth more than the first cost of the books.

AMERICAN TECHNICAL SOCIETY, CHICAGO, U. S. A.

FREE EXAMINATION COUPON

American Technical Society, Chicago, U. S. A.

Please send set Cyclopaedia of Civil Engineering for 7 days' free examination. I will send \$2.00 within 7 days and \$2.00 a month until I have paid \$29.80, or notify you and hold the books subject to your order. Title not to pass until fully paid.

Pop. Mech. 4-16

NAME

ADDRESS

As I have had no previous dealings with you, I refer you to

Please Mention Popular Mechanics.

Prosperity in Canada

\$900,000,000

In New Wealth Added in 1915

**ENORMOUS CROPS and LOW
TAXATION Make Farmers Rich**

CANADA, enjoying wonderful prosperity from the products of the farm, the orchard, and the centers of industry—Canada has come into her own. No country wrote a brighter page of history in agricultural and industrial development during 1915 than Canada. All industrial plants working overtime. Wheat average, 36.16 bushels per acre in Alberta; 28.75 bushels per acre in Saskatchewan; 28.50 bushels per acre in Manitoba. All other grains showed similar large yields per acre. Taxes average \$24 and will not exceed \$35 per quarter section. This includes all taxes. No taxes on improvements.

Come and Get Your Share of This Prosperity

—the greatest wealth-producing era the Dominion has ever known. Free schools and full religious liberty. Good climate. World-renowned livestock. Prizes won at International Fairs prove this. Here is your opportunity! What chance have you to provide a farm for your children in your present location, where land prices are so high?

Get Your Farm Home from the Canadian Pacific Ry.—20 Years to Pay

Good land from \$11 to \$30 per acre. Irrigated lands from \$35, and the Government guarantees your land and water titles. Balance after first payment extended over nineteen years with interest at 6%. Privilege of paying in full at any time. Long before final payment becomes due your farm should have paid for itself.

\$2000 Loan in Improvements. We will lend you up to \$2000 in improvements in certain districts with no security other than the land itself. Particulars on request. Twenty years for repayment of loan with interest at 6%.

Ready-Made Farms for Sale. Farms which we have developed by providing house, barn, well and fencing and in some cases cultivation for sale. Special easy terms.

\$1000 Loan for Livestock. In defined districts after one year's occupation under certain conditions, we advance cattle, sheep and hogs to farmers up to a value of \$1000.

We Want You, We Can Afford to Help You. We own the land. We want the land cultivated. Our interests are mutual. Buy direct and get your farm home from the Canadian Pacific Railway. Send for free book.



J. S. DENNIS, Assistant to the President

Canadian Pacific Ry.

39 Ninth Avenue

CALGARY, Alberta, Can.



GREEN AUTOMATIC MACHINE



LARGE PROFITS FROM SMALL CAPITAL

Start a business of your own bringing an income of \$5 to \$10 a day with practically no experience or overhead expense.

The GREEN AUTOMATIC MACHINE

Sharpens, Hones, and Straps all kinds of safety razor blades, in one operation, from four to six blades per minute. For both Quality and Quantity this machine is in a class by itself. There is nothing like it on the market. Let us send you our free booklet explaining everything, including the "AMERICAN" Key Cutter—cuts square, angular or round slots.

AMERICAN SHARPENING MACHINE CO. (Inc.), Dept. 5, 184 W. Washington St., CHICAGO



Please Mention Popular Mechanics

MURDOCK Wireless Receivers

2000 ohm complete double set \$4.00

3000 ohm complete double set 5.00

We guarantee that these 'phones are real wireless receivers of standard double pole construction, wound with genuine copper wire, and fitted with best quality headband and cord.

Fourteen Days' trial allowed and money refunded immediately on return of 'phones, if you are dissatisfied in any way.

OUR CATALOG IS FREE

Wm. J. Murdock Co. 10 Carter St. CHELSEA, MASS.

BOYS!

Automatic-Repeating Pistol

SHOOTS a hole in a paper tape—fifteen hundred load reports from one charge. Made of blue gun-metal—8 inches long—easy action—absolutely harmless—no powder or projectile—permitted in any community.

THREE EXTRA ROLLS 10c

THE AIRMATIC PISTOL CO.
370 Citizens Building CLEVELAND, OHIO

50c

Postage
Prepaid
U. S.
or Can.

Moving-picture houses of the United States, of which there are some 20,000, are said to be using regularly approximately 120,000,000 ft. of film.



Every Boy His Own Toymaker

Greatest boys' book ever written. Tells how to make a Steam Engine, Telephone, Magic Lanterns, Boats, Aircs, balloons, electrical and mechanical toys, traps, fishing tackle. 200 illustrations; also catalog of 100 puzzles, puzzle picture card and "Double Treater" worder and bird call all for only 10c. WESTERN PUZZLE CO., ST. PAUL, MINN.

The Electrical Experimenter



THE big electrical Magazine for those who dabble in electricity and Wireless. The "How-to-Make-It" magazine, chock full of experiments and the latest electrical progress. Foremost authority on WIRELESS in the United States. Official organ of the **Radio League of America**. Over 200 wonderful illustrations with over 100 articles in each number. You are not keeping abreast with the times unless you read the **Electrical Experimenter**. One copy will convince you. Every issue also contains the snappiest and most up-to-date scientific stories that will delight you.

\$1.00 a Year, 10c at Newsstands

Send 10c for three numbers

**THE ELECTRICAL
EXPERIMENTER**
234 Fifth St., NEW YORK CITY

"Old Town Canoes"

Make Canoeing the Real Summer Sport

"Where the stream in witchin' play goes laughin' on, jest pushin' all the lilles out his way."



Busy men and pent-up housewives, as well as the young folks, enjoy their "Old Town Canoes." "Old Town Canoes" provide the ultimate in canoe luxury, comfort and safety. 4,000 canoes ready—\$30 up. Easy to buy from dealer or factory. Send for catalog of canoe views and facts.

OLD TOWN CANOE COMPANY
1565 Middle Street, Old Town, Maine, U. S. A.

AGENTS \$60 A WEEK

We want Special Agents to travel by automobile selling our **300 Candle Power Outdoor Lamp and Safety Lantern**

Burns Kerosene. Can't explode. Can't set fire to anything. Burns in all kinds of weather. Rain proof, wind proof, bug proof. For farmers, teamsters, hucksters, plumbers, dairymen, campers—everybody needs it.

This Auto Given



Write for plan how we furnish each representative with an automobile. This is no selling contest, where only one person wins. Anybody can earn this auto.

THOMAS MFG. CO., 1048 East St., DAYTON, OHIO

Mammoth Jubilee Book Free

Picturing 5152 Home Things

Make your own Credit Terms—1 to 3 years' time.

SPIEGEL, MAY, STERN CO., 1409 W. 35th St., Chicago

Over 30,000 French school-teachers, it is said, are now fighting at the front.

Home Builders

Write quick for Wonderful Building Book of Expert Architect's Plans. Shows how to save 1-1/2 labor bill, eliminate material waste and buy building materials at amazingly low prices. Explains wonderful two-years-to-pay credit plan. Send 10c for postage.

International Mill & Timber Co., Dept. P. M. 5, Bay City, Mich.



Amazing Profits In Mushrooms

Anybody can add \$10 to \$40 per week to their income. In spare time, entire year growing mushrooms in cellars, sheds, barns, boxes, etc. I tell you where to sell, at highest prices.

Free Illustrated Instruction Booklet

HIRAM BARTON

Desk 2, 329 W. 48th St., New York

BOYS! GIRLS! Auto Given Away



This \$250 **CULVER RACER AUTOMOBILE** is a real gasoline propelled Motor Car for boys and girls. 5 Horsepower—25 miles per hour on high—60 miles on 1 gal. gasoline. Given to the boy or girl getting most votes in **FARM LIFE** Contest just starting. Send your name and will send you 1000 Votes **FREE** and tell you just how to win Auto. Many other Prizes and Cash given. Whether you win Auto or not you get **VALUABLE PRIZES and CASH REWARDS**. In case of tie duplicate prizes awarded. Write today.

FARM LIFE, Box 25, SPENCER, INDIANA

ROWBOAT MOTOR FERRO

Make Your Own Motorboat—It's Easy

You can equip it with a complete power plant. Beach high-tension magnets, full-hood, feed, water-tight, stainless rubber, wood-proof propeller, rudder and tiller at small expense. Simply clamp the Ferro on your rowboat. Speedy, reliable, easy to operate. 20 H.P. Ferro Motors in pleasant, profitable work. You only need buy one motor for demonstration. Some fine territory open for the best-owners. Ask for agency proposition No. 215.

\$85 with Beach high-tension magnets, \$45 with water-proof batteries.

The Ferro Machine & Foundry Company
512 Hubbard Avenue, Cleveland, Ohio



DON'T GO ROWING - GO FERROWING

GENUINE DIAMONDS BLUE WHITE PERFECT CUT



The biggest sensation in the history of the diamond business—Genuine Blue White Perfect Cut Diamonds at the astonishing price of only \$88 per carat. Small sizes as low as \$8.25. Same quality that middlemen-to-jeweler methods demand \$140 per carat for. How do we do it? By importing direct from European cutters to you at one small profit, you get the benefit of importer's prices, 35 per cent less than the jeweler's price—far less than the jeweler must pay even wholesale. And you get guaranteed blue white quality diamonds from us—not orange-white or other inferior stones.

Small Sizes as Low as \$8.25

PER CARAT



NO MONEY IN ADVANCE

Select the diamond and mounting you want to see from our book and we'll send it to you without a cent in advance. A REAL PRICE guarantee. Send back the diamond or keep it as you decide for yourself. No cost or risk to you. No obligation to buy. Our plan is your safe way to buy a diamond.

BANKABLE LEGAL Money-Back Guarantee

The only bankable cash refund contract in the entire diamond business. Issued in writing with every diamond we sell, permits its return direct, or through any bank in America, for instant cash refund! No delay or red tape. Full price guaranteed in exchange at any time! Color, carat weight and value legally certified.

DIAMOND BOOK FREE

Write for it today. A postal will do. A wonderful diamond book. Profusely illustrated. First to show 1916 styles. Helps you to buy diamonds like an expert. Get it for all means. Write today—NOW!

BARNARD & CO.
Dept. 588C S. W. Corner
Wabash & Monroe, Chicago, U.S.A.



It Starts With a Starter



THERE'S no hand-blistering, back-breaking, arm-aching cranking with a Caille Five-Speed Motor. It starts with a starter. And it starts so easily that a pull of a few pounds on a little handle (as shown below) does the trick. The starting mechanism is fully enclosed in a drum and mounted on top of the flywheel. It is positive in action and mechanically perfect. The

CAILLE **5** Speed DETROIT Motor

can be instantly attached to any rowboat and gives you five speeds—a high speed (7 to 10 miles per hour) to hurry you to the fishing or hunting grounds—an ideal trolling speed—a neutral—a slow and fast reverse. And, mind you, all speed changes are made without stopping, reversing or altering the speed of the motor. It always runs at normal speed. When set at neutral, the boat stands still while the motor remains running.

Other Caille Features

include water cooled silencer on exhaust; magneto in flywheel; self-lubrication; speed propeller; water-tight gear housing; cushioned steering handle. You'll receive full details when you send for Catalog No. 10.

Dealers Wanted

We also build marine motors from 2 to 30 h.p. Details in special catalog No. 24. When writing please give dimensions, style and purpose of boat to be powered.

The Caille Perfection Motor Co.

1523 Caille St. Detroit, Mich.

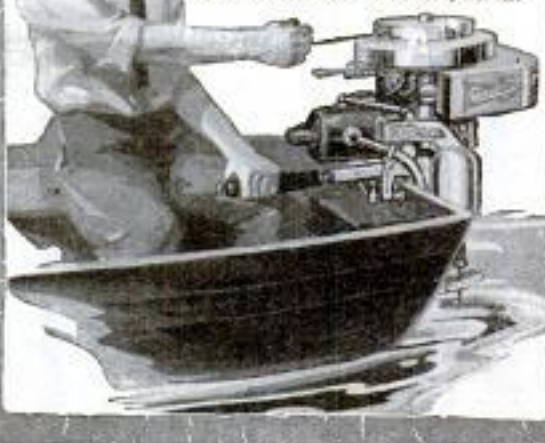

Please Mention Popular Mechanics

FREE Camp Guide Send Post Card for a copy

Every one, boy or man who spends much time in the open should have a copy of the new **FREE Camp Guide**, which gives **EXACTLY** the information that is most necessary for campers, hunters, trappers, fishermen, Boy Scouts, etc. Get a copy, and profit by the experience of others who have many times gone through the things you contemplate.

7 x 7 foot Wall Tent \$5.50

Serviceable, water, storm, and wind-proof. Perfectly suited for camping trips of all kinds. Made of 8-oz. single-filling duck of first quality. Made with a fly. Easy to erect, carry, or take down. Made in more than 25 sizes, at low prices.



Scout Tent No. 1, \$2.50



Similar to tents used by U. S. soldiers on active duty. Excellent for troops of Boy Scouts, fishermen, hunters, trappers, etc. Easy to carry, take down or erect. Also called Shelter Tents. Wind, weather and storm proof. Fine for Boy Scouts to carry on hikes. 5 feet 3 inches, by 4 feet 6 inches wide, by 3 feet 9 inches high.

No. 1, Special white cloth	-	-	-	\$2.50
No. 2, Special khaki cloth	-	-	-	3.00
No. 3, Yacht drill	-	-	-	3.75
No. 4, Khaki drill	-	-	-	4.75

Indian Wigwams

First-class lawn tents for use of children. Set with tripod. All clear space inside. No center pole, decorated in handsome designs. Special size for boys and children, height 4 feet, diameter 5 feet - \$1.50



H. CHANNON COMPANY
Dept. 5 Chicago, Illinois

Hildebrandt Baits Hook & Land 'Em



Made in 3 shapes, 11 sizes and 6 finishes. Reversible blades, interchangeable flies, providing outfits for any kind of game fishing. Send for Tackle Catalogue with color sheet. Logansport, Ind. John J. Hildebrandt Co. 1335 High St

GET THIS CATALOG
FULL OF VALUABLE INFORMATION TO EVERY
BOAT OWNER ON
**RACING PROPELLER WHEELS,
REVERSE GEARS AND
MARINE ACCESSORIES**
LARGE CATALOG FREE. SEND TODAY
MICHIGAN WHEEL CO.
1139 MONROE AVE. GRAND RAPIDS, MICH.

Motor Perfection

is what you get in Watkins Class "B" all iron motors. Especially fine for canoes and light boats. Constant and efficient.

3 H. P. single cylinder	45 lbs.
6 H. P. double cylinder	85 lbs.
12 H. P. four cylinder	155 lbs.

Are light, at the same time strong, accomplished by using semi-steel castings, high carbon steel shaft, bronze bearings, high class workmanship.

THE WATKINS MOTOR CO.
837-839 W. 6th Street Cincinnati, Ohio

Toledo MARINE MOTORS

Special Cash Prices for this month only—

3 H. P. 1 cyl. complete	\$ 55.00
6 H. P. 1 " "	72.00
7 H. P. 2 " "	100.00
12 H. P. 2 " "	140.00
18 H. P. 3 " "	210.00

Fully guaranteed by a responsible concern. 2 cycle, 2 part, 2 1/2 and 4 1/2 hp. Send for free catalog "C."

THE UNIVERSAL MACHINE CO., 104 Pike Ave., Bowling Green, O.

Rest From Business Cares

Hours and hours, miles and miles of keen invigorating pleasure in the waterways of the world. Days and evenings crowded with healthful recreation—unhampered freedom. All these will come to you when you own a

Mullins Boat

And you'll be proud of it because of its beauty, grace, speed, efficiency and safety. Designed by America's foremost naval architects and built in the world's largest boat factory. Mullins steel boats can't sink, leak or waterlog—never need calking. Two and four-cycle engines—silent, under-water exhaust. 60,000 in use. 1916 models ready for delivery.

Handsome, interesting catalog on request.
Write today.

The W. H. Mullins Company

707 Franklin Street

SALEM, OHIO

World's largest manufacturers of steel and wooden pleasure boats



MULLINS STEEL BOATS CAN'T SINK



Fastest Boat in the World

Two Views—17-Footer

\$45 Complete k. d. boat as described.

\$95 Finished boat ready for motor.



Utilize your spare time or make \$10 and up per day putting these boats together for your local trade. No skill required. We furnish the knock-down boat complete (best oak and cypress), everything cut to shape and fitted, with hardware and fittings. The k. d. prices quoted include everything except paint. This is a real business opportunity. We have started hundreds.

BUILDER-AGENTS WANTED

10 to 32 Miles With 4- to 25-H.P.

A comfortable family launch or a racer. Semi-V bottom design—roomy, staunch and seaworthy. Becomes a stepless hydroplane with 12-h.p. or more. We furnish the finished boats, painted, varnished, with fittings and steering gear, already for the motor at the prices quoted. Get our prices with 4- to 25-h. p. motor installed ready to run.

Big Boat Book Free

Showing over 100 designs. Cruisers—launches—sailboats—rowboats and canoes.

BROOKS MFG. CO.
8205 Rust Avenue
SAGINAW, MICH., U. S. A.



Two Views—15-Footer

Complete k. d. boat **\$25**

Finished ready for motor **\$45**

With inboard or outboard motor installed **\$89**

Lowest Price Boat in the World





Norman Durant, 6 years old, steers a Koban.

Unmatched Speed

NO VIBRATION

Absolutely dependable—Easy to start—Easy to manage—Without question the Finest Rowboat Motor Made.

The Great 2-Cylinder KOBAN

ROWBOAT MOTOR

New Features

Tilting Device, Variable Speeds, Fool Proof Carburetor, Aeroplane Type Magneto, and many others.

Does Not Shake the Boat

Vibration is entirely eliminated by opposed cylinders that fire at the same time. Reverses by simply pressing the button. Runs perfectly at trolling speed or can skin nine out of ten launches at high speed. Send for 24 page illustrated catalog.



Built-in Magneto or Battery Ignition.

Koban Mfg. Co. 291 So. Water St. Milwaukee, Wis.
Our line also includes a 2 cylinder vibrationless tubed motor for small launches, canoes, etc.

10 NEW FEATURES

in the 1916 Waterman Porto



Our new catalog describes in detail all the latest features of the 1916 Waterman Porto, including built-in high tension fly-wheel, magneto, unlimited speed control, automobile type carburetor, double capacity fuel tank, larger bearings, newly designed pump, etc., etc. The Waterman Porto has the perfect speed control of an automobile. Simple shift lever to get any speed desired, forward or reverse. Wonderful flexibility. You can stop your boat in half its length—dock without stopping your engine. Trol at any speed with any type or size of boat.

Demand these essentials or you will not be getting full value for your money.



Send for this book today

You will find it full of valuable and interesting information about the new features of this original outboard motor, and it also tells the story of the first outboard motor ever built.

Waterman Motor Company
230 Mt. Elliott Ave., Detroit, Mich.



KENNEBEC

CANOE BOOK FREE

Send for it at once and insure a fine summer and a healthful one.

This new booklet is of vital interest to you. Tells all about our paddling, sailing, motor and sponson models; tells you just what a canoe should be for a given purpose.

Kennebec models are the result of years of experience in canoe building, and an intimate knowledge of canoeing. The materials used are the best that can be obtained.

Write now for booklet. Address

Kennebec Canoe Company, 49 R. R. Sq., Waterville, Me.



Four-cylinder, four-cycle, 9 to 12 H. P. Fits any boat 14 to 30 feet. Magneto, rear starter, propeller equipment.

Write now for catalog

Universal Motor Co., Dept. P., Oshkosh, Wis.

FREE!—3 Books on BOATS

- 1—Special Boats of 130 Leading Boat Builders.
- 2—Gray 2 and 4 cycle Motor Engine Catalogue.
- 3—Book of Boat Models for work, fishing, cruising.

Ask for any (or all) of them if you are interested in boating for pleasure, or profit. Book 1 shows more boats than motor show.

Gray Motor Company
598 Gray Motor Bld'g.
Detroit, Mich.



Get the Newest LA Engine Book

AN LA ENGINE FOR EVERY PURSE AND PURPOSE.

The question of selecting the right engine for that boat of yours is an important one. It will pay you well to get all the information possible before making your final decision, as the satisfaction you get from your outfit will depend largely upon the care you take in choosing your motor. You will find the new L-A engine book brims full of valuable hints and interesting engine information. It describes the complete line of L-A inboard and outboard motors for canoes, rowboats, pleasure boats, work boats, etc., and gives complete details of our liberal

30 DAYS' TRIAL PLAN

whereby you can have the privilege of proving out the quality of L-A Motors before making your final decision. Write for YOUR copy to-day.

Lockwood-Ash Motor Co.
1130 Horton Av. Jackson, Mich.





PATENTS

IF YOU HAVE AN INVENTION which you wish to patent you can write fully and freely to Munn & Co. for advice in regard to the best way of obtaining protection. Please send sketches or a model of your invention and a description of the device, explaining its operation.

All communications are strictly confidential. Our vast practice, extending over a period of seventy years, enables us in many cases to advise in regard to patentability without any expense to the client. Our Hand-Book on Patents is sent free on request. This explains our methods, terms, etc., in regard to *Patents, Trade Marks, Foreign Patents, etc.*

All patents secured through us are described without cost to the patentee in the *SCIENTIFIC AMERICAN*.

MUNN & CO.
SOLICITORS OF PATENTS
672 WOOLWORTH BLDG., NEW YORK
and 625 F STREET, WASHINGTON, D. C.



"NEW-SKIN"

— for cuts

Use New-Skin to prevent infection. It is an antiseptic liquid for cuts, scrapes, and little hurts. When it dries, it forms a water-proof "film" that protects the cut and allows it to heal.

Carry it with you always. Keep a bottle in the house.

See directions and circular. Prices (in U. S.): 10c., 25c. At all druggists. Or send us 25c. in stamps for the larger size by mail. Be sure to get the genuine. Always in glass bottles; red and gold paper cartons.

NEWSKIN CO., NEW YORK

A Baseball Jersey



Be the First in Your Club

School, City or Town, to wear this pure, all wool sweater, double collar and cuffs. Your choice in colors. This jersey was selected by 10,000 of my customers for last season. Your club will recommend it. My 1916 illustrated catalogue is now ready. Write me and learn my offer for your club's order. Popular Prices. Best Grade Sporting Goods—Baseball, Basketball, Tennis, Golf, etc. WRITE ME NOW.

JACK SHANNON CO., Dept. 46, 54 E. Monroe St., Chicago

Free Book on WASHING

Tells how to get a good-sized washing done in an hour with the **Thor Electric Washing Machine**. Also tells how the Thor pays for itself by saving wear on clothes and cost of help. Write for this big 48-page book, fully illustrated. *Sent absolutely free.* And we will also tell you about the special offer we are making. **Write Today** Get this book and information now.

HURLEY MACHINE CO., Dept. 1195, Chicago, Ill.

"E-Z" Coin Safety Self-Filler Pen



A new safety self-filler for every man at any man's price. To fill merely insert coin or other article in slot and press once. Safety Cap prevents leakage if carried point down. Holder of Diamond Chased Vulcanized Rubber. 14 Kt. Gold Pen. Every part guaranteed. **No. 315 Vest-Pocket size \$1.75. No. 316 Regular size \$2.00** Free Catalogue. Agents Wanted.

J. C. ULLRICH & CO., 27 Thames St., NEW YORK



HERE YOU ARE, BOYS

A medallion pin of Foxy Grandpa. Everyone will notice it on the lapel of your coat and try to get a closer look at it. All you have to do is press the bulb. Foxy Grandpa will finish the job by squirting a fine stream of water over the inquisitive one. Will squirt 20 feet. Greatest joke out. Order one today and fool your friends. Price 15c. Foxy Grandpa and Hooligan both for 25c. 5 for 99c or 1 doz. for \$1.00. A beautiful fountain pen free with every \$1.00 order.

AMERICAN SUPPLY CO., 918 Union St., St. Paul, Minn.

This Book Written By Five Great Poultry Experts

Sent Free on Your Request

Just Out. Tells about feeding for eggs, chicken market or show. A postal brings it. Read the facts. Then go to the dealer in your community who handles Red Comb feeds. Investigate!

EDWARDS & LOOMIS CO. 347-B No. Elizabeth Street, CHICAGO, ILL.

Also Manufacturers of the Famous Red Horn Dairy Feeds.



DIAMONDS - WATCHES ON CREDIT

Write Today for FREE CATALOG No. 5 containing 4000 Photographs of Diamonds, Watches, Jewels, Silverware, etc. Transactions confidential.

JAMES BERGMAN ESTD 1896 37-39 MAIDEN LANE NEW YORK CITY

WANTED IDEAS



Inquiries from Manufacturers and Other Buyers of Patents
Who Are Looking for Good Ideas

Protected by Owen Patents

Are constantly being received. Hundreds of ideas are wanted—a market exists for them to-day. YOURS may be one of them. Send for my free books and see for yourself—read the requests for inventions protected by me. Many are simple. You can help supply this demand.

As soon as my clients' rights are protected I aid in every practicable way, without charge, to sell. Their applications are advertised free—their patents are called to the attention of the proper prospective buyers—every necessary thing is done. Get my booklets and see.

THESE ARE FREE

You will incur no obligation by writing me. A simple request will bring them to you—the finest, most reliable and instructive patent books published. A postal will do.

"Successful Patents"—a 72 page guide book, tells how to proceed; describes my advantageous business methods; gives references, testimonials, etc.

"Stepping Stones"—gives hundreds of hints of inventions wanted; articles from interviews of noted authorities; tells the truth about prizes for inventions.

"Patent Promotion"—tells you how to sell; why some inventors fail; discusses the value of your idea; how I aid my clients; manufacturing aids furnished you; recent successful patents, etc.

You will also be sent from time to time, as new inventions are wanted, full information concerning them. Only in this way can you keep up to date.

Write for These To-day

Advice costs nothing. All communications confidential. Your work will receive my personal supervision—but my fees are no higher than others.

Results Speak Loudest—But Here Are Some References

Columbia National Bank,
Washington, D. C.
National Lockfile Co.,
Washington, D. C.
The Carnahan Press,
Washington, D. C.
Lightning Gun & Cycle Works,
Oklahoma City, Okla.
Antholene Mfg. Co.,
Hutchinson, Kans.

National Rack Co.,
61 Hannover St.,
Boston, Mass.
The C. J. Loftus Co.,
13 Spring Common,
Youngstown, Ohio
Whitehead Hosiery Mills,
Burlington, N. C.
Dickinson Mfg. Co.,
Des Moines, Iowa.

A LARGE NUMBER OF OTHERS IN MY BOOKLETS.

RICHARD B. OWEN 9-303 OWEN BLDG.
WASHINGTON, D. C.

Inventors submitting their inventions to me are protected in a tangible manner until their applications are filed.

Nuts for You to Crack

Invent something for which a demand exists—for which there is a waiting market. Here are abstracts from a few recent requests—hundreds are published in full in my literature. Can you invent any of these? Watch this list each month.

A big manufacturer wants "a dish-washing device that will wash any style or size of dish with one handling."

Another company has asked me for a patented perfume vending machine—one that will enable milady to drop a penny or nickel in the slot and have her handkerchief perfumed.

A man with money to invest writes that he wants an improvement in "an automatic lighter to take the place of matches" and the same man is looking for "a small vacuum cleaner for clothes, that is, one that will do the same work as a common brush broom, except that it would take out all the dirt in the cloth besides brushing it."

A big steel and iron company wants "patents on a first-class cow stanchion, litter carrier or feed grinder."

SPECIAL FREE REPORT

Send sketch or model of your invention for free report on patentability, practicability, etc.



World-Wide Call for New Inventions

By a WASHINGTON PATENT ATTORNEY

War Closes Factories in Europe—America Becomes World Market—Golden Opportunity for Inventors

Europe's factories are closing. The war has taken its toll of industries as well as of men, and with hundreds of foreign factories idle, America has become the market-place of the entire world. The highest daily exports from America were reached during the past few months and this may be taken as a significant indication of what American manufacturers will be called upon to supply when the conflict is over.

Hundreds of manufacturing concerns realize this, and are on the look-out for articles patented here, which will give them the exclusive right to manufacture and ship abroad. It is up to the American inventor to supply the demand.

Not only are articles wanted for export, but for home consumption as well. There is a demand for devices in almost all lines. Many inventors have already heeded the call and have made good. There is equal opportunity for others.

The rubber-faced metal clip to go on the end of the curtain-shade stick to prevent noise when it blows against the window frame is having wonderful success and shows what may be done with even a simple article. Another simple thing is the Sure-Grip Towel Holder that the inventor is selling with wonderful returns. The Concrete Cesspool illustrated has brought the inventor more than \$50,000 in the sale of state and county rights in addition to royalties.



THE SURE-GRIP
TOWEL HOLDER

A big business
built on a small
invention of
Towel Holder.

THE BIG DEMAND

The demand for good patents seems to be bigger at present than ever before. The firm of attorneys of which the writer is a member is constantly receiving requests from manufacturers for inventions in all lines. For instance, a New York Specialty Co. wants a dish washer, odorless garbage can and mail order articles, while a man from Illinois asks for anything that can be manufactured in a

wood-working factory. A Lockport concern wants patents on articles for household and office use, while a Newark concern writes: "What have you in a peanut vending machine that can be bought from the owner?" A Chicago man says: "I wish you would put my name on your list and keep it there. I wish to buy a patent or operate on a royalty."

We have more than forty requests for patents on dish washers and drainers, sixteen requests for devices for turning sheet music, twenty-eight for attachments for automobiles, twenty-four for vacuum cleaners, and many others for advertising novelties, ash receptacles, clothes pressing devices, envelope fasteners, fly traps, fruit pickers, games, mail boxes, toys, vegetable slicers, water filters, window cleaners, window screens, and other things.

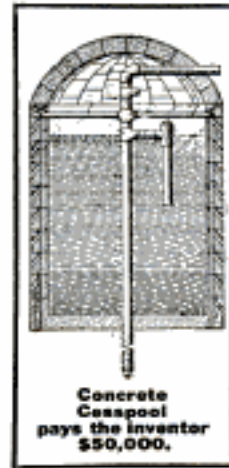

Concrete
Cesspool
pays the inventor
\$50,000.

There are hundreds of other requests. Some mention particular inventions; others want any good patented article. This proves the wonderful present demand.

Our firm has compiled a booklet entitled, "What to Invent," giving a list of many inventions about which inquiries have been made. We are always glad to mail it free to anyone, together with "How to Obtain a Patent," another book which explains how to protect inventions. We also give opinions regarding the patentability of inventions, without charge. Any reader of this article is at liberty to send us a sketch and description or model of any invention that he may have, when we will at once render an opinion concerning its patentability. To those who become our clients, we supply the names and addresses of the above mentioned manufacturers, without cost.

Both our books and opinions concerning patentability are free, and we are always glad to hear from anyone who wishes information on patent matters. The address is Chandler & Chandler, 969 F Street, Washington, D. C.

PATENTS SECURED OR FEE RETURNED

Latest and Most Complete Patent Book Ever Published for Free Distribution

WRITE FOR IT

Compare My SERVICE and TERMS with Those of Any First Class Attorney

Send Sketch, Photograph, or Model of your invention for an ACTUAL SEARCH of the Records of the Patent Office and report as to patentability — FREE. I give every detail of every case my closest personal attention and do not entrust your interests to assistants. Impartial advice on your ideas. I help you sell your patent. Terms moderate. My 90-page book (1916 edition) tells what inventors should know before they apply for a patent.

GEORGE P. KIMMEL, *Patent Lawyer*, 200 Barrister Bldg. Washington, D. C.

U.S. PATENTS



REGISTERED ATTORNEYS

LANCASTER & ALLWINE

204 OURAY BLDG. WASHINGTON, D. C.

Don't Lose Your Rights

We publish forms called "Evidence of Conception" by which you can establish your rights before sending the invention to anyone. It is your best protection. We issue up-to-date bulletins of improvements wanted; aid inventors to promote their rights; render reliable opinions free of charge and secure valuable patents and trade marks on reasonable terms. Personal service assured by our Service Guarantee Contract. References: 2nd National Bank, Washington; John P. Roth Packing Co., Cincinnati.

SIMPLY MAIL COUPON

LANCASTER & ALLWINE, 204 Ouray Bldg., Washington, D. C.
Send me free, book "Inventions—Patenting and Promoting," Bulletin of Improvements Wanted and blank form, "Evidence of Conception."

Name

Address



A complete line of appliances for the transmission of Power. Anything from a bolt to a complete mill or factory outfit. Send for catalogue. Largest Manufacturers of Poles in the country. 1409 N. North Ave. **W.A. Jones Foundry & Machine Co., CHICAGO**

Please Mention Popular Mechanics

IDEAS = MONEY
PATENTS THAT PAY \$

Over \$600,812.00 made by clients. Proof given. Send data for free advice.

2 WONDERFUL GUIDE BOOKS FREE
Don't miss these books. Mail postal today.

E. E. VROOMAN & CO., 871 F St., WASHINGTON, D. C.

The moving-picture industry of the United States uses about 15,000,000 oz. of silver a year for sensitizing, it is estimated.

PATENTS

Secured Through Credit System

Send Sketch or Model for Free Search of Patent Office records and Certificate of Patentability which establishes Proof of your Invention until application is filed. Manufacturers writing us for new ideas. Valuable Book, Advice and List of Patent Buyers Free.

WATERS & CO., 5103 Warder Building, WASHINGTON, D. C.

PATENTS **C. L. PARKER**
Formerly Member Examining Corps, U. S. Patent Office
PATENT LAWYER
MCGILL BLDG.
WASHINGTON, D. C.

Patents, Trade Marks, Copyrights, Patent Litigation

Handbook for Inventors, "Protecting, Exploiting and Selling Inventions" sent free upon request.

INVENTORS!

"Let Us Be Your Factory"

We manufacture Special Machinery, Patented Metal Specialties of all kinds, Electric Articles, Hardware, Contract Manufacturing, Development, Sample Work. You get the advantage of our splendid equipment, up-to-date methods and wide experience. We Do It All. Tools, Dies, Stampings, Lathes, Screw Machine Work, Milling Machine Work, Metal Spinnings, Metal Drawings, Castings, Plating of all kinds, Enameling, Japanning, Tinning, Galvanizing, Wood and Metal Patterns, Drafting, Designing, Blue-print Work. Send sample for expert advice. **Our 25c Book Free**, containing tables and valuable information. **WRITE FOR IT TODAY.** Address **THE EAGLE MFG. CO., 1606 Blue Rock St., CINCINNATI, O.**

TOOTH-ACHE STOP Stops the Pain & Stops the Tooth

Agents Wanted

TOOTH-ACHE STOP

PRICE 25 CENTS 3 for Postpaid 50 Cents

ENOUGH TO STOP 1 Easy to use

30 TOOTHACHES

Squeeze a little of this paste into hollow in the tooth and the ACNE STOPS INSTANTLY, then the paste hardens, forming an airtight Sealing for the Tooth, excluding the air and preventing a recurrence of the agony. Guaranteed Absolutely Harmless—will not spread and burn mouth. Get it ready for the next bad attack. A perfect godsend at two in the morning.

NATIONAL CHEMICAL CO., 7143 No. Clark Street, CHICAGO

Wanted—Ideas

Inventors! Send for these Remarkable FREE BOOKS, Today

"Inventions Needed"

This book lays before you a description of the active and profitable field of invention. It tells you the inventions the world needs today, the devices manufacturers are seeking for their business, the ideas for which the public will pay big money.

"How to Get Your Patent"

This book is a guide to the inventor. If you have invented something and desire to learn what it will cost you to get your patent and what you must do to find your market, read this book.

"Special Bulletin of Patent Buyers"

This bulletin contains letters from men who are seeking to purchase patents. We act as intermediary without one cent of charge, between the man who invents and the man who invests.

Send Model or Sketch and description of your invention for Free Opinion as to patentability

Rejected and Difficult
Cases are Our
Specialty

RANDOLPH & CO.

600 F St., N.W., Washington, D.C.

RANDOLPH & CO.
600 F St., N. W., Washington, D. C.

Gentlemen: Please send me without obligation on my part, the books indicated on margin of this coupon. (Write on margin of coupon, names of books desired.)

NAME.....
STREET.....
CITY.....STATE.....



Chewing gum, it is stated, was first made by a Louisville, Ky., druggist, recently deceased, who some 45 years ago discovered a combination of balsam tolu and chicle, from which has grown up the enormous chewing-gum industry of today.

**Models
and
Gears**

Experimenters—Inventors

Developing inventions and making working models our specialty. Well equipped shop and staff of experts at your service. Carry complete stock of gears. Shipments same day order received. ESTABLISHED 1882.

UNION MODEL WORKS, 121 S. Clark St., CHICAGO

Send for FREE BOOK { WHAT TO INVENT
WHAT NOT TO INVENT
HOW TO SELL YOUR PATENT
Copies of nearest Patents and report in every case without charge
H. L. WOODWARD, 9th and G Sts., WASHINGTON, D. C.



MECHANICAL SUPPLIES AND MATERIAL of all kinds.
EXPERIMENTAL AND LIGHT MACHINEWORK to order.
132 MILK STREET, BOSTON



Models and Supplies

We make working models of any description and material, also dies, tools and sheet metal stampings. Send your drawing or sample for estimate. Write for catalog of gears and model supplies.

The Pierce Model Works, 3405 Pierce Ave., Chicago, Ill.



MODELS BUILT FOR INVENTORS

Practical, economical and modern methods of Model and Machine construction. Scientific Experimental Work. Expert designing and building of special Models, Tools and Machinery. Our staff of Skilled Mechanics assist customers to develop and perfect ideas, Patents and Inventions, etc. Let us take care of your mechanical requirements.

Regal Model & Tool Works, 122 S. Clark St., Chicago



BRASS GEARS

Cut by an entirely new process. The most accurate made and at prices that cannot be equalled by others. Every gear has a hub, center painted ebony black, edges turned true, highest grade red brass, and much heavier than others. We carry the largest stock in the world and every gear listed is always shipped on date of order.

SEND FOR CATALOGUE
CHICAGO STOCK GEAR WORKS
16 S. Fifth Av. Chicago

Protective Patents

Procured Promptly. No fee refund, no guarantee certificate, no so-called prize or free search schemes used in our business. Inventors 104 page Blue Book sent on request.

Robb & Robb, 211-215A Southern Bldg., Washington, D. C.

TELL TOMORROW'S



White's Weather Profit forecasts the weather 8 to 24 hours in advance. Not a toy, but a scientifically constructed instrument working automatically. Handsome, reliable and everlasting.

AN IDEAL PRESENT
Made doubly interesting by the little figures of the Peasant and his Good Wife, who come in and out to tell you what the weather will be. Size 6 1/2 x 7 1/2; fully guaranteed. Sent postpaid to any address in U. S. or Canada on receipt of **\$1**

AGENTS WANTED

DAVID WHITE, Dept. 17, 419 E. Water St., Milwaukee, Wis.

Well-known patents worth many hundreds of thousands of dollars, obtained through us and sold or licensed to well-known manufacturers, including some of the largest corporations in the world, are evidence that we obtain for Inventors

PATENTS BUY MANUFACTURERS BUY

Particulars, and book of greatest real interest and value to Inventors—a book that may prove worth a very large sum of money to you if you read it before you apply for a patent—will be mailed free on request.

Lowest fees for best service is the basis of our terms. Submit your invention and we shall promptly and without charge render you reliable opinion as to patentability and quote you cost of patenting.

R. S. & A. B. LACEY, Patent Lawyers
Established 1869 724 Barrister Bldg., Washington, D. C.

Please Mention Popular Mechanics

Patents Trade Marks and Copyrights Secured

SPECIAL OFFER — Free Opinion as to Patentability

Send us a model or sketch and description of your invention, and we will give a free opinion as to the patentability of the invention. If we report the invention patentable, we will furnish a certificate of patentability.

This Certificate of Patentability will protect the inventor and serve as proof of the invention until the case can be filed in the U. S. Patent Office.

Obtaining Assistance for Inventors

Our certificate is of great assistance to inventors who require financial aid to obtain patents.

Our Five Books Mailed Free

(SEE COUPON BELOW)

to any address. Send for these books—the finest publications ever issued for free distribution.

How to Obtain a Patent

Our illustrated eighty-page Guide Book is a book of reference for inventors, and contains 100 mechanical movements illustrated and described.

Money in Patents

Tells how to invent for profit, and gives history of successful inventions.

What to Invent

Contains a valuable LIST OF INVENTIONS WANTED and suggestions concerning profitable fields of invention; also information regarding prizes offered for inventions, among which is

Prize of One Million Dollars

offered for one invention, and \$10,000 for others.

Patents That Pay

Contains letters from our clients who have built up profitable enterprises founded upon patents procured by us; also endorsements from prominent inventors, manufacturers, Senators, Congressmen, Governors, etc.

We Advertise Our Clients'

Inventions Free

In a list of Sunday newspapers with two million circulation, in manufacturers' journals and in the World's Progress. Sample Copy Free. We save you time and money in securing patents. After the patent is granted we assist you TO SELL YOUR PATENT.

Foreign Patents

WE HAVE DIRECT AGENCIES IN ALL THE PRINCIPAL FOREIGN COUNTRIES and secure FOREIGN PATENTS in the shortest possible TIME and at the LOWEST COST. Write for our Illustrated Guide Book on Foreign Patents, sent free to any address.



VICTOR BUILDING

Our new \$200,000 building opposite U. S. Patent Office
SPECIALLY ERECTED by us for OUR own use

WANTED NEW IDEAS

Send for LIST OF PATENT BUYERS who consult us when purchasing patents. Contains requests from MANUFACTURERS, MAIL ORDER HOUSES and PROMOTERS for patents secured by us, and suggestions as to New Ideas they wish to purchase. We invite manufacturers and promoters to address our Sales Department regarding the purchase or leasing of a number of meritorious patents secured by us.

REFERENCES

Second National Bank, Washington, D. C.; Union Savings Bank, Washington, D. C.; Chamber of Commerce, Washington, D. C.; Pitner Gasoline Lighting Co., Chicago, Ill.; R. G. Dun & Co., Washington, D. C.; Smethport Glass Co., Smethport, Pa.; The Melvin Gauge and Signal Co., Scranton, Pa.; M. Winter Lumber Co., Sheboygan, Wis.; National Savings and Trust Co., Washington, D. C.

FREE COUPON!

VICTOR J. EVANS & CO., Patent Attorneys

NEW YORK OFFICES: 189-191 Broadway

PHILADELPHIA OFFICES: 1429 Chestnut St.

Main Offices: 765 Ninth St., N. W., WASHINGTON, D. C.

GENTLEMEN: Please send me FREE OF CHARGE your FIVE Books as described above.

NAME..... ADDRESS.....

PATENTS

THAT PROTECT AND PAY

SEND FOR FREE BOOKS

Advice free. Terms reasonable. Highest references. Best results. Send sketch or model for FREE examination and opinion.

BONDED and recommended Patent Lawyer in the Rand-McNally Directory of Bankers and Attorneys Published by Rand-McNally & Co., Chicago, Ill. Recommended Patent Attorney in the Bankers Register and special list of selected lawyers published by the Credit Company, Pontiac Building, Chicago, Sharp & Alleman's Directory of Lawyers and Bankers published in Philadelphia, Martindale's American Legal Directory published in New York City, and the Con. P. Curran Directory of Bankers and Lawyers published in St. Louis.

ALL BUSINESS GIVEN PROMPT AND PROPER ATTENTION
A large list of strong recommendations furnished free

Read the following Testimonials

THEY SPEAK FOR THEMSELVES
 SEE WHAT OTHERS SAY

Miner E. Worden,
 Architect and Builder.

Montrose, Pa., March 30, 1916.

The rapid manner in which you are pushing my patent along is certainly a revelation to me. During my thirty years' experience in taking out patents this is the first time I have not felt the waiting anxiety of previous years.

MINER E. WORDEN.

Cleveland, Okla., April 27, 1915.

I just received notice that my patent was granted. I thank you for your promptness. I was certainly surprised, as I wasn't expecting it for at least six months yet. You may be assured of being my attorney if I need any more services in that line.

SALEM R. HART.

Kenton, Ohio, Jan. 29, 1915.

I received patent papers all O. K. of Spark Plug and the drawings and the broad claims you have made is surely fine. It is 100% better than other attorneys made for me. Your work surely proves your ability in handling patent work, and if I have any more work, I want you to do it and will recommend you to others.

W. M. ELLIS,
 R. D. No. 2.

The Eclipse Furnace Regulator Co.
 F. A. Richards, Inventor.

Muscataine, Iowa, June 29, 1914.

I was very much surprised in receiving your letter containing notice of allowance from the Commissioner of Patents. I did not expect to get a patent in less than five or six months. Allow me to thank you for your prompt attention.

FRANCIS A. RICHARDS,
 620 Walnut St.

Philadelphia, Pa., October 5, 1914.

I have received your letter of Sept. 28th, containing the drawings, specifications and claims, and must say that I am very well pleased in every respect with the manner you have executed this business. The drawings are perfect and specifications and claims explain and take in everything that the invention contains, and they also could be no better, and for promptness I must say you put the thing through much sooner than I expected. I can say that I am more than pleased with your work.

CHARLES H. DIENER,
 2315 W. Somerset St.

R. N. Hawkins,

Clerk of State Board of Examiners.

Helena, Montana, April 17, 1915.

I am in receipt of the Patent Papers from the Patent Office. Kindly accept my thanks for the efficient manner in which you have handled my application.

R. N. HAWKINS.

Elberton, Ga., May 21, 1915.

Your letter, together with the notice of the allowance of my patent, received, and I must say that owing to a period of only six weeks since I trusted my claims to your care, I was very much surprised, as I did not expect it so soon. Your good service in this case will always afford me with much pleasure in recommending you to others, and for which I thank you most heartily.

R. L. EVANSON.

Carbondale, Pa., Jan. 27, 1915.

I am in receipt of yours of Jan. 22d, and am much pleased to know you have my application on file in the Canadian Patent Office. It is evident by documental dates that no time is allowed to slip by in doing your part.

C. L. OAKLEY.

Halliday Elevator Co.
 Grain Dealers.

Cairo, Ill., Dec. 21, 1914.

We feel that the manner in which you handled the case that we placed in your hands certainly justifies our cordially recommending you to anyone who desires the services of a live wire in the patent line. You need have no hesitancy whatever in referring to us on any occasion you may desire.

HALLIDAY ELEVATOR COMPANY.

Lukemont, Pa., June 29, 1914.

I am in receipt of your favor of recent date containing official notice of allowance of patent on Window Shade Protecting Caps. I wish to thank you for prompt and efficient service in this matter. I consider it quick work—45 days from date of application to date of allowance.

WM. A. FRY.

Youngstown, Ohio, Sept. 10, 1914.

I wish to thank you for your speedy and efficient work in getting me a patent. It was something like two and one-half months after my application had been filed when you notified me that the claims had been granted.

F. A. TRUESDELL,
 76 Fall Ave.

WATSON E. COLEMAN, Patent Lawyer, 624 F St., Washington, D. C.

Indigo — Going Up

War is advancing the price of genuine indigo-dyed fast blue

HEADLIGHT OVERALLS

Buy now
Save money

"A smile of satisfaction with every pair"

HEADLIGHT OVERALLS

will outwear
two pairs of
ordinary
kinds



Look for
this ticket

Larned, Carter & Co., Detroit

World's Greatest Overall Makers

Factories: Detroit and Port Huron, Mich. St. Louis, Mo.
San Francisco, Cal.
Canadian Factory, - Sarnia, Ont.

(19)

EXTRA WATCH OFFER

A limited number of the Famous "Santa Fe Special" Watches will be sold at FACTORY PRICE to introduce this remarkable time-piece to Popular Mechanics readers.

This Offer is Made for
A Limited Time Only



The Santa Fe Special

is the one watch that's guaranteed to last you all your life. Thin model — either 17 or 21 jewels, adjusted to positions, adjusted to temperature, adjusted to in-chronism. Guaranteed to pass railroad inspection.

EASY PAYMENTS

Our "direct to you," easy payment plan is explained fully in the Santa Fe Special catalog. Payments are so small you will not miss the money, only \$2.50 a month and you wear the watch right from the start.

Sent on Approval without One Cent Down

NEW CASE DESIGNS

The new watch book shows all the very latest designs of the world's most talented engravers, each case illustrated in beautiful color combinations, showing three color inlay monograms, engraved monograms, fraternity emblems, French art and special designs.

A postal brings the new watch book. Address Dept. M-104

SANTA FE WATCH CO.
Topeka, Kan.



MAZDA

Always etched on electric lamps to which MAZDA Service has been applied.

There are 615 electrical enterprises of various kinds in Japan with a combined capital of \$303,410,786.



AETNA-IZE Protect yourself and your family in case of sickness or accident. \$50 a week, and as high as \$15,000 for death. Write for particulars.

AETNA LIFE INSURANCE COMPANY

Drawer 1341

Dept. PM. 5-16

Hartford, Conn.

WHEEL CHAIRS AND TRICYCLES



A Wheel Chair is often an invalid's greatest comfort. We offer over 25 styles of invalid's rolling chairs and tricycles with latest improvements. Ship direct from factory to you and sell on

THIRTY DAYS' TRIAL

Liberal discounts to all sending for FREE Catalog now.

GORDON MFG. CO.

353 Madison Ave. Toledo, Ohio

Ten Days' Free

Trial Without one cent advance payment we will ship you this

Late Model
UNDERWOOD TYPEWRITER



equipped with the late improvements, 2-color ribbon, back spacer and tabulator. After you have tried the machine you pay your express agent our cash price of **\$43.85** (less than one-half the manufacturer's price) or we can arrange an easy payment plan for you.

All our machines are guaranteed for five years.

The quantity is limited, so write today

METRO. TYPEWRITER CO., 78 Front St., B'klyn., N. Y.

Please Mention Popular Mechanics

LAW BOOK FREE



Do you know that the incomes of many lawyers exceed that of the President of the United States? Are you aware that the President himself, as well as practically every other man prominent in public life, is a lawyer? Then you owe it to yourself to get and read this interesting 80-page law book. Doing so may change your whole future! It shows that the demand for legally-trained men in business and public life was never greater than today, and points out the importance of a thorough knowledge of law in many lines of work. It compares resident and correspondence instruction, and explains just what a law course should contain to give you the training absolutely necessary to success. It enables you to weigh and judge the claims of correspondence schools; shows you how to choose the best school in which to take up the study of law, and describes thoroughly the American School's new and efficient method of acquiring a legal education at home—in your spare time.

FREE 13 Volume Law Library and 60 Text Books

With each course we furnish 60 new pocket size text books, 34 Case Books, and instruction for five years if necessary. Our big 13-volume Law Library—the most splendid reference work of its kind ever published covering the entire field of American law and practice—included absolutely free. Course contains 28 more subjects and 30 more authors than any other correspondence law course. Written in plain, simple, easily understood language—the easiest, best, most complete and practical correspondence law course ever devised. Only law course ever written especially for correspondence instruction. Send for "How To Acquire a Legal Training" today. It is absolutely free—just mail the coupon.

American School of Correspondence
Chicago
U. S. A.

FREE BOOK COUPON

Pop. Mech. 8-16
A. S. of C.

Gentlemen: Please send me your FREE Law Book, "How To Acquire a Legal Training," and full particulars regarding your wonderful new system of correspondence law instruction.

NAME

ADDRESS

This 13-vol. Law Library and 60 Text Books Free with every Course

Power for You

Power from within! Strength that is more than mere muscular strength—the strength of better health, abundant nerve force—the strength of keen relish. Write and find out what the White Cross Electric Vibrator may do for you. May be operated either on its own dry cells or may be connected with light socket.

Write for Free Book Your name and address on a post card and we will send you our book, "Health and Beauty." It's FREE—if you write at once.

LANDSTROM, SMITH CO., 1100 S. Wabash Ave., Dept. 1195, Chicago

"I Would Not Part with It for \$10,000"

So writes an enthusiastic, grateful customer. "Worth its weight in gold," says another. In like manner testify over 100,000 people who have worn it.

The Natural Body Brace For MEN and WOMEN.

Develops erect, graceful figure, overcomes WEAKNESS and AILMENTS of Women & Men.

Brings womanly beauty and manly strength, restful relief, ability to work and enjoy life.

Banishes All These Troubles

Does away with the strain and pain of standing and walking; replaces and supports misplaced internal organs; reduces enlarged abdomen; straightens and strengthens the back; corrects stooping shoulders; develops lungs, chest and bust; relieves backache and nervousness. Comfortable and easy to wear.

Wear It 30 Days Free at Our Expense

Write today for illustrated booklet, measurement blank, etc., and read our very liberal proposition.

HOWARD C. RASH, Pres. Natural Body Brace Co.
223 Rash Building SALINA, KANSAS



For Children Also

UNCLE SAM WANTS YOU



Get a U. S. Government Job \$75 to \$150 a Month

Rapid advancement to higher Government Positions. No "Layoffs" because of STRIKES, WARS, FINANCIAL FLURRIES or THE WHIMS of SOME PETTY BOSS. THE POSITION IS YOURS FOR LIFE.

Country residents and city residents stand the same chance for immediate appointment.

Common sense education sufficient. Political influence NOT REQUIRED.

We Will Coach 25 Candidates Free of Charge

Write immediately for full list of many positions now obtainable. Don't delay. Every day you lose means the loss of just so much chance of early appointment.

FREE COACHING COUPON

FRANKLIN INSTITUTE, Dept. L 97, Rochester, N. Y.

This coupon, properly filled out, entitles the sender to full list of positions now obtainable, a free copy of our valuable, copyrighted book, "Government Positions and How to Get Them," and to consideration for FREE COACHING for the Civil Service position here checked.

... Railway Mail Clerk (\$900 to \$1800)	... Customs Positions (\$600 to \$1500)
... Postoffice Clerk (\$800 to \$1500)	... Internal Revenue (\$700 to \$1800)
... Postoffice Carrier (\$800 to \$1200)	... Stenographer (\$800 to \$1500)
... Rural Mail Carrier (\$600 to \$1200)	... Panama Canal Clk (\$1200 to \$1800)

Name

Address

Use this before you lose it. Write plainly.

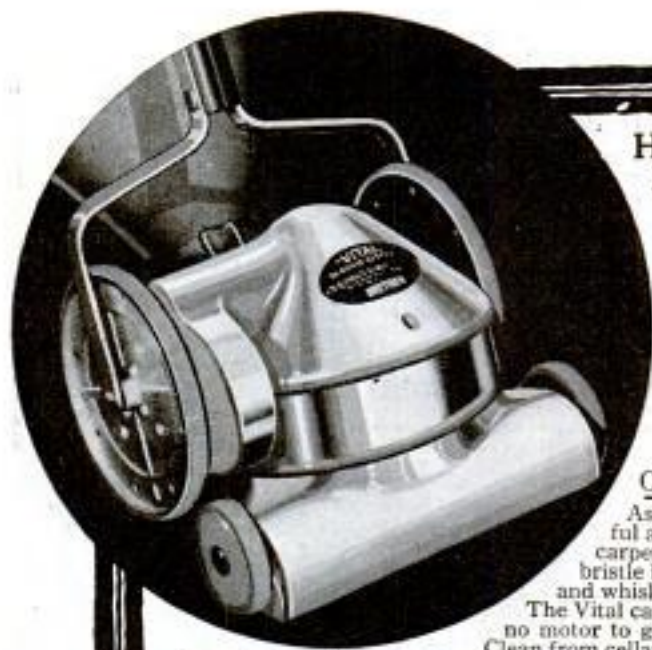

Here is the Suction Cleaner You Have Demanded! Let the Vital do Your Spring Cleaning!

Housewives have for years wished for a portable and efficient cleaner that could be operated without Electric current! Here it is—the

VITAL SUCTION CLEANER

Operated by hand—Generates its own power.

As you lightly glide the "Vital" across the floor, a powerful and continuous suction is set up. It gives your rugs and carpets a cleansing bath, of pure fresh air. The revolving bristle brush in the nozzle picks up all the dirt, dust, and lint—and whisks it into the sanitary dust proof bag.

The Vital can be used in every home. There are no wires to attach, no motor to get out of order. The Vital will enable you to Spring-Clean from cellar to garret without fatigue. It does not consume expensive current—therefore there is no cost of operation.

Easy to operate—light in weight—efficient in cleaning power—and simple in construction.

These features enable you to use the Vital every day—just as you now use a carpet sweeper. So compact that it searches out the dirt under the chairs, davenports, etc., with the greatest ease. Extremely reasonable in price, thoroughly guaranteed, and will last for years. Ask your dealer—or write us—now—and have a Vital take the burden of Spring cleaning from your shoulders.

\$17.50

Attractive opportunity for Dealers and Agents.

Write today for details!

The Bigsby-Rotary Manufacturing Co., Cleveland, U. S. A.
San Francisco, 428 Sutter St. Los Angeles, 721 S. Olive St.



Only \$1.00 After Trial

Yes, you may keep this

New Edison and your choice of records, too, for only a single dollar. Pay the balance at the rate of only a few cents a day. Write today for details.

Free Trial Try the new Edison in your own home before you decide to buy. Have all the newest entertainments. Entertain your friends. We'll send it to you without a cent down. **Write Today** for Our New Edison Book. Send your name and address for our new book and pictures of new Edison photographs. No obligations in writing for book.

F. K. Babson, Edison Phonograph Distributors
1195 Edison Block, Chicago, Illinois

\$2.50—For the Price of One—\$1.25



You buy the Glove—We give the Ball. To introduce our big line of sporting goods we offer this Pearl or Gray \$2.50 Backskin Fielder's Glove, leather lined, welt seams, lightly padded, all broken ready for use, and one of our Official League \$1.25 Baseballs, made according to National and American League specifications, 9 in. 5/8 in., with pure Para Rubber Center, finest wool yarn wrapping, and special tanned horsehide cover double stitched by hand, guaranteed for a full game regardless of number of innings, for the price of the glove alone. Send postpaid.



Including one of our big 1916 Illustrated Sporting Goods Catalogs. Right reserved to withdraw this offer without notice. Send no money order today.
JACK SHANNON CO., Chicago's Big Sporting Goods House, CHICAGO
Dept. 52, 54 E. Monroe Street.

QUICK MONEY

Growing Mushrooms

How to really make big money in mushrooms is fully explained in the wonderful book, "The Truth About Mushrooms." Everything explained from A to Z, at first hand, from the greatest practical authority in America. Add \$10 to \$15 a week to your income. Demand exceeds supply. Grow in cellars, sheds, boxes, etc. Small capital to start. Profits bigger and quicker. Anyone can do it. Women and children, too. Now is the best time. Send for FREE book of information.

Bureau of Mushroom Industry, Dept. 283, 1342 N. Clark St., Chicago

PRIZE FISH

are caught and landed with "Bristol" Steel Fishing Rods because the action of the steel is so quick that the wary wise "big ones" cannot get away before the hook is driven home to stay.

"Bristol"

The Prize Winning Rods

are perfect in material, workmanship, design, finish, action and ability to hold the fish until settled. Each "Bristol" guaranteed three years. 19,800 dealers sell 38 different "Bristol" from \$3.50 to \$25.00. If your dealer doesn't have the exact "Bristol" you want, you can order from us at no additional expense. Send your fishing photos.

THE HORTON MFG. CO.
196 Horton St. Bristol, Conn.

FREE Catalogue and full particulars about **Free Scale** Offer. Write today.

SENT ON APPROVAL NO MONEY DOWN \$2—A—MONTH

Buy a genuine Elgin Now, 17, 19 and 21 Jewels—25 year gold cases direct to you at rock-bottom prices. Write today for **New Free Catalog**

Our Special Offer enables you to own a fine Elgin or any other standard watch or a perfect Diamond without missing the money. 200,000 satisfied customers. Get posted. Write today.

HARRIS-GOAR JEWELRY CO.
Dept. 1902 Kansas City, Mo.

Rider Agents Wanted

We want a Rider Agent in every neighborhood to ride and exhibit the new "RANGER." You can select the particular style suited to your own needs, Boys and young men in all parts of the country are riding "Rangers" and taking orders from their friends. Our great output, perfected methods and machinery, enable us to sell "quality" Bicycles at prices below all competitors.

THIS
NEW MODEL



30 DAYS
Free Trial

"Motorbike" Model—One of the 94.

Your Choice of Ninety-Four (94) Styles,

Colors and Sizes in the famous line of "RANGER" Bicycles, shown in full color in our big new 1916 Catalogue for \$11.75, \$13.75, \$15.75, up.

There is a MEAD Bicycle for every rider, at prices made possible only by our FACTORY-DIRECT-TO-RIDER sales plan.

SEND NO MONEY but write TODAY for the new 1916 Catalogue of "Ranger" Bicycles, Tires and Sundries at prices so low they will astonish you. Also, full particulars of our great new offer to deliver to you all charges prepaid your choice of any of the 94 kinds of "RANGER" Bicycles you may select, for ONE MONTH'S FREE TRIAL. This wonderful offer is absolutely genuine.

TIRES, LAMPS, Built-up Wheels with Coaster-Brakes, Inner Tubes, Electric Lighting Outfits, all the newest ideas in Bicycle equipment and Sundries, as well as the Repair Parts and Combination Offers for refitting your old Bicycle—all shown fully illustrated, at HALF USUAL PRICES. Our new Catalogue is the largest ever issued by any Bicycle concern. Even if you do not need a new Bicycle now, or Repair Parts, Tires, etc., for your old Bicycle, you need this Catalogue to tell you the prices you should pay when you do buy.

MEAD CYCLE COMPANY, Dept. R-108

CHICAGO, ILLINOIS

POULTRY PAPER

44-124 PAGE periodical, up-to-date; tells all you want to know about care and management of poultry for pleasure or profit. Four months for 10 cents. POULTRY ADVOCATE, Dept. 98, SYRACUSE, N. Y.

Convert Your Bicycle into a Motor-Cycle Motor fits any wheel. BEST, MOST RELIABLE. Best hill climber. More STEFFEYS in use than all others. Stamp for circulars. STEFFEY MFG. CO., 5007 Brown Street, PHILA., PA.

10
Days
Shipments

Standard Fenestra steel windows can be shipped to you within 10 days after receipt of your order in Detroit.

DETROIT STEEL PRODUCTS CO., Dept. E8, DETROIT, MICH.

Fenestra
SOLID STEEL WINDOWS
REG. U.S. PAT. OFF.

The Acetylene Blow Torch Prest-O-Torch

Costs less to buy than a good gasoline blow torch and costs less to use

In all soldering and brazing, the Prest-O-Torch avoids the delays and uncertainties of gasoline outfits. Provides a concentrated, intense flame that doesn't blow out even in a high wind. Needs no attention whatever. Used with handy sizes of Prest-O-Lite cylinders—ready-made gas. Style "A" sells for 75c (Canada \$1.00). Used with the small MC size Prest-O-Lite. Will brace up to 3/4 inch round rod. Can be fitted with handle and hook for added convenience in bench and overhead work. Style "C" Prest-O-Torch, for use with the larger sizes of Prest-O-Lite, is recommended for large work. Will brace up to 1 1/2 inch round rod. Sells for \$2.25 (Canada \$2.75).

Write for special literature and learn where you can see the Prest-O-Torch in operation.
THE PREST-O-LITE CO., Inc., 816 Speedway, Indianapolis, Ind.
Canadian Factory, Merritt, Ont. Exchange Agencies Everywhere

SHARPENS SAFETY BLADES PERFECTLY

At last, the perfect sharpener—the Stag Sharpener. The only sharpener that both hones and stropps all makes of safety blades. Keeps blades in perfect shaving condition. Makes old blades better than new. Surprisingly simple. Roller in holder automatically sets blade always at correct honing and stropping angle. Thumb lock makes it easy to insert and remove blades. Heavily nickled holder, barber's hone and stropp in neat box, complete, postpaid, \$1.00. Try it 10 days; money back if not satisfactory.

Dealers Write for Special Introductory Offer
STAG CO., 22 So. State St., CHICAGO

BUTLER ROUND RUF METAL GARAGE

Portable Fire Proof
LOW IN PRICE STRONG AND CONVENIENT

10x14 ft. and larger. Also for two or more cars. Easily erected by anyone. No mechanics or skilled laborers required. Absolutely fireproof because made entirely from steel—not a piece of wood in the entire structure. All seams absolutely weather proof. Adjustable windows; ventilators; locking doors; painted inside and out. Extra sections easily added at any time to increase length.

If your dealer does not handle, write for full information and price of size for your car.

Butler Mfg. Co.
204 Butler Bldg.
KANSAS CITY, MO.
911 6th Ave. S. E.
MINNEAPOLIS, MINN.
Dealers and Representatives Wanted

Please Mention Popular Mechanics

THE PIPE OF PEACE



Because it is no trouble to keep clean—it has removable moisture well that empties, can be put down anywhere —and IT WILL SIT UP! That's why we call it

SITTING BULL

It can't spill. The hot bowl itself does not rest upon anything.

Mouth moisture can't get by the well and foul the bowl and smoke channel, which means **A CLEAN, DRY AND FRAGRANT SMOKE**. Moistened tobacco means immediate deterioration that changes its rich flavor. **SITTING BULL** will give you the richest smoke you have ever enjoyed. Don't blame the innocent tobacco any more. You can earn from \$5 to \$20 a week in or out of a job during your spare time selling the **SITTING BULL**. You take no risk. No experience required. We tell you how. Many of our men have met with such wonderful success that they are now devoting their entire time to this work. It is the cleanest, highest grade way to earn extra money. **WRITE AT ONCE** asking for particulars. **SITTING BULL CORPORATION, 607 W. 51st Street, NEW YORK CITY**

SITTING BULL Sturdy shape with bowl and smoke channel of rich-boned genuine French briar; nickel plated connecting band; super-gutta percha mouthpiece—**75 CENTS**. Same with sterling silver band, **\$1.00**. Sent by parcel post anywhere in the world. **Money back if not satisfactory.**

Men, in Your Leisure Moments

have met with such wonderful success that they are now devoting their entire time to this work. It is the cleanest, highest grade way to earn extra money. **WRITE AT ONCE** asking for particulars. **SITTING BULL CORPORATION, 607 W. 51st Street, NEW YORK CITY**

"IDEAL" Lawn Mower Grinder



Grinds all makes of Mowers perfectly in 15 minutes without removing wheels, ratchets or reel-knife. Ball-bearing; operated by either hand or power. Skate Sharpener Attachment for sharpening skates.

"You Grind It As You Find It"

Write Today for full information of this great labor-saver and money-maker. Will do the work so much better, quicker and easier you cannot afford to do without it. The only practical machine for sharpening Lawn Mowers on the market. Over 7000 in use. Fully warranted. Write today. Don't delay.

THE ROOT-HEATH MFG. CO., Plymouth, O.

Private Weather Bureau

IN EVERY HOME

**A Reliable Barometer
An Accurate Thermometer**

Actual Size 13 Inches High

Indispensable to the farmer, business man, professional man, automobilist. In fact, to everybody who should know in advance what the weather will be. Will save you money and time.

FORECASTS WEATHER

WEATHEROMETER

HOURS IN ADVANCE

\$1.00 ONLY — Reduced from \$3.00

Send us no money. Mail your order today and Weatherometer will be sent to you C. O. D. (10c extra). If you prefer you may enclose \$1.00 bill or money order with order. Satisfaction guaranteed.

This Instrument Imprinted Makes an Excellent Advertising Article

WITTINGTON INSTRUMENT CO.

5 South Wabash Avenue, Dept. 24, CHICAGO



Go into MOVING PICTURE BUSINESS

Small Capital Starts You

on our easy payment plan. Begin now and get your share. We sell everything. Write TODAY.

Atlas Moving Picture Co.
Dept. 40 525 S. Dearborn St., Chicago

WOULD YOU

show this standard high grade 42 key fully visible typewriter to your friends and let them see wherein it excels any other \$100 typewriter, if by doing this and rendering other small assistance, you could easily have one to keep as your own? Then by post card or letter to us simply say, "Mail Particulars."

GIVEN YOU
WOODSTOCK TYPEWRITER CO., Dept. Y 204, Chicago, Ill.

Print Your Own
Cards, circulars, book, paper. Press \$5. Larger \$15. Rotary \$60. Save money. Print for others, big profit. All easy, rules sent. Write factory today for catalogue of presses, TYPE, cards, paper, samples. It will pay you well.
THE PRESS CO. Meriden, Connecticut

IMPERIAL SELF HEATING IRON BURNS KEROSENE

Unquestionably the most efficient self-heating iron ever made. Absolutely safe. Simple. No odor. Convenient size and shape—irons 8 hours for 1c! Produces beautiful finish. Soon saves cost. Takes drudgery out of ironing day—saves walking back and forth.

HIGH GRADE AGENTS WANTED — MEN AND WOMEN

No experience necessary. Every home a prospect. Every housewife, mother, seamstress needs this wonderful iron. Liberal guarantee. Write today for details of quick selling plan.
Imperial Brass Mfg. Co., Dept. 303, 1210 W. Harrison St., Chicago



Design No. 524
by Jud Yoho.
Estimated Cost
\$2800.

ALL ABOUT BUNGALOWS

BUNGALOW BOOK, 1916 De Luxe Edition

Contains the cream of 1000 practical and distinctive bungalows actually built for \$400 to \$4000, suited to any climate, with photos of exterior and interior views, plans, size of rooms, cost, etc. Also valuable suggestions on bungalow building written by an expert. The largest exclusive Bungalow Book published, 112 pages. Price, \$1.00. Worth many times its cost to any prospective builder. A smaller edition of same, only 50 cents. Send check, money-order or stamps. Money back if not satisfactory.

JUD YOH0, The Bungalow Craftsman, 56 Bungalow Bldg., SEATTLE, WASH.

BUSH CAR

Electric Lighting and Starting

28 H. P. 112 Wheelbase



Special Offer to You

To the readers of Popular Mechanics who apply within 30 days we will make an astounding offer that you cannot afford to let get away.

We are prepared to make you a special low price on a **BUSH CAR** through Popular Mechanics Magazine.

Give this your immediate attention. It's worth while

BUSH MOTOR COLLEGE, Inc.
517 Bush Temple CHICAGO, ILL.

SOLID GOLD MIDGET BUTTONS

50c  50c

All societies, also Pins, Buttons, Rings, Charms. Agents wanted.
F. M. STANLEY, 45 CORNHILL, BOSTON, MASS.

HOTEL LABELS



50 assorted genuine hotel baggage labels from U. S., Canada and Mexican hotels. Sent for \$1.00, 20 for 50c.

Satisfaction Guaranteed.

AMERICAN LABEL CO., JANESVILLE, WIS.

MAKE \$3000 THIS YEAR

START IN A SPLENDID MONEY-MAKING BUSINESS OF YOUR OWN. We'll show you how. No experience required. Represent us in your town. Start at once, with us back of you, and MAKE BIG MONEY FROM THE FIRST DAY. If awake for good proposition write today for free details.

DARLING COMPANY Dept. 12 WASHINGTON, D. C.

Bohner's Self-Cleansing Filter



Agents Make \$25 to \$40 PER WEEK
Easy Money. Takes less than 5 minutes to attach, demonstrate and sell. Protects Health against danger of disease germs in unfiltered and impure water. Every Home needs one.

Bohner Manufacturing Co.
1009X So. Wabash Ave., Chicago, Ill.

Write for new Booklet "H"
Partin-Palmer "32" \$695
Commonwealth Motors Co., Chicago



Superb Idea

In Setting. Diamonds arranged to show their beauty to the utmost. The setting which has always been most admired. The diamonds are set so closely and skillfully that the facets shape up like one huge diamond. Now offered at net prices, direct to you. No jobbers—no retailers to pay. Send for our *Diamond Book*, listing exquisite

Clusters

Pins and rings set in this artistic style. Every stone a brilliant of superb quality. Splendid opportunity now to buy these wonderful, scintillating cluster diamonds. Full information free. Send the coupon today for *Diamond Book*. Do it now.

Diamonds

Rings in all styles of settings, Tiffany, Belcher, etc., La Vallieres, Brooches and other diamond jewelry. Every diamond a perfect gem. Selected by a famous expert. Perfectly cut to give maximum brilliancy. Richly mounted in solid gold settings.

Free Examination Not a cent down—you see the diamond before you accept it. We want you to compare these diamonds with others at twice their price. Write today.

\$2.50 Monthly
Yes, only \$2.50 a month will make you the wearer of a beautiful diamond.

Other terms, \$3.50, \$4.50 and up—and middlemen's profits cut out.

Write
Burlington Watch Co.
Dept. 1195
Chicago - Illinois

For Net Price List and
Diamond Book

Shows the different gems, styles of mountings and gives our importer's net prices with terms of payment. Do it now.

BURLINGTON
WATCH CO.
Dept. 1195
Chicago, Ill.

Name

Address

Without obligations send me your net price offer on diamonds; also send *Diamond Book*.

Please Mention Popular Mechanics

4 OUT OF 5
ARE EQUIPPED WITH
Champion
Dependable Spark Plugs

HERE is the official estimate of the Automobile Chamber of Commerce on automobile production this year.

One million four hundred thousand cars.

Of these, over a million will be Fords, Overlands, Studebakers and Maxwells, equipped with Champion Dependable Spark Plugs.

The manufacturers of *one hundred other cars* will equip this year *exclusively* with Champions.

Their production will exceed 120,000 cars.

So of all the automobiles produced this year it is apparent that more than four out of five will be dependably equipped—with Champions.

Champions have been selected by one hundred and more manufacturers because their exhaustive tests have shown that the Champions designed for their motors *give the best results*.

Remember *their* conclusions when you order your stock of plugs.

Champion Spark Plug Company
406 Avondale Avenue TOLEDO, OHIO



Highest Award Gold Medal San Francisco Exposition

Your Washing Done for 2c a Week
Electric or Water Power Will Do the Work

I have built a new "1900" power washing machine. I consider this machine the most wonderful washer ever put on the market. Tub built entirely of high quality sheet copper, it is the strongest and most durable machine made. It is constructed on a brand new principle and I will guarantee that this machine will not tear clothes, break buttons or fray the edges of the most delicate fabric. It will wash everything from heavy blankets to the finest lace without damage to the goods.

This new "1900" washing machine can be connected with any electric socket instantly and is started and stopped by a little "twist of the wrist" and it will do your washing for 2 cents a week.

I also make a lighter power machine which can be run by water or electric power. On most of these machines the motor will run the wringer too. Just feed in the clothes and this power wringer will squeeze the water out so quickly and easily you will be astonished. It will save 50% time, money and labor every week. The outfit consists of washer and wringer and either electric or water motor, as you prefer, and I guarantee the perfect working of each.

I will send my machine on 30 days' free trial. You do not need to pay a penny until you are satisfied this washer will do what I say it will. Write today for illustrated catalog. Address: H. L. Barker, 4224 Court St., Birmingham, N. Y., or, if you live in Canada, write to the Canadian "1900" Washer Co., 255 Yonge St., Toronto, Canada.

BARODA DIAMONDS

FLASH LIKE THE GENUINE—AT 1-50 THE COST
SOLID GOLD MOUNTINGS Stand acid test and expert examination. See them first, then pay. Catalog FREE. Patent Ring Gauge included for 5 two-cent stamps.
The Baroda Co., Dept. K5, 1458 Laird St., Chicago



"THE PENKUP"

Makes Every Pen a Fountain Pen



One dip writes over 500 words. Will attach to any pen. Saves time and improves writing.

10c For Sample, Postpaid

\$1.00 per dozen.

AGENTS—Our agents are making from \$25 to \$100 per week. Offices buy in gross lots, 10c brings sample and particulars. Write to-day.
PENKUP SALES CO., 502 Coleman Bldg., Phila., Pa.

Superior Small Engines

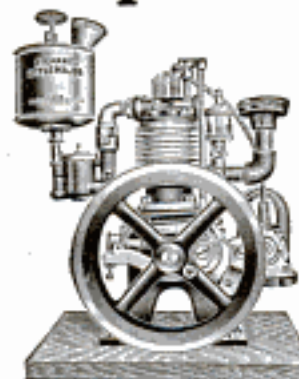

Our Stewart small engines, made only in 1/2, 2 and 3 h. p. are marvelously perfect. Design, materials, workmanship and finish of a high order. Use a minimum of fuel for a maximum of work; gasoline only. Write for special engine booklet.

Chicago Flexible Shaft Co.

4617 N. La Salle St., Chicago

Just Out Amateur Mechanics No. 7

200 Articles
211 Illustrations
128 Pages
Price 25c Postpd.



A BOOK FOR THOSE
WHO LIKE TO MAKE THINGS

(Actual Size 6½ x 9½ in.)

A few of the many practical things described:

Mile-O-View Camera—Houses Made of Poles—Houseboat—Pushmobile—Ice Glider—Electric Chime Clock—Bucket Ball Game—Musical Doorbell—Snowshoes—Child's Playhouse—Ice Boat and Catamaran—Poultry Coop—Coasting Bebeled—Candy Floss Machine—Snowball Maker—Lantern for Spot and Colored Lights—Skating Merry-Go-Round—Skiff—Steering Wheel—Photographic Work Table—Skates Made of Wood—Water Meter—Foot Boats—Graining Tools—Roller Skates, etc.

The other numbers of *Amateur Mechanics* are equally interesting and will be sent postpaid at 25 cents each.

POPULAR MECHANICS BOOK DEPT.
6 N. Michigan Ave., CHICAGO

YOUNG MAN! LEARN DRAFTING

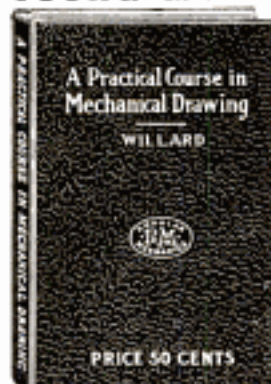

ONE of the most practical subjects of study today; an essential in most lines of engineering; indispensable in many occupations and often the secret of successful advancement; of no less importance to the farmer than the mechanic. There is bound to come a time when you will feel the need of the ability to "lay out" something in accordance with the rules and conventions used in the drafting profession.

Individual Study

may be successfully engaged in with the aid of our new enlarged edition of the book

A Practical Course in Mechanical Drawing

By WM. F. WILLARD

(For several years instructor in Mechanical Drawing at Armour Institute of Technology, Chicago)

160 PAGES—SIZE 5x7—157 DRAWINGS—CLOTH COVER

Price 50 Cents, Postpaid

There has been a real need for a book of this kind, as it clinches each problem in the mind of the student by giving the practical application of that problem to every day practice in some phase of the world's work. It meets every modern requirement and is in advance of any other work on the subject. Excellent for use in shop classes, trade or high schools. A complete detailed description of the contents of this book sent free upon request.

Order of your Book Dealer or direct from the publishers

POPULAR MECHANICS BOOK DEPT.
6 N. Michigan Ave., CHICAGO



Our Direct Factory to Home
plan saves you money.

WE PAY THE FREIGHT
and ship to you any piano or player piano
you select from our catalog.

25 YEARS GUARANTEE
on all our pianos and player pianos.

FREE MUSIC LESSONS
to all who accept our offer. Write for handsomely illustrated piano catalog and full details of our selling plan.

SCHMOLLER & MUELLER PIANO CO.
Established 1899 Capital and Surplus, \$1,000,000
Dept. P. M. 056 Omaha, Nebraska

-----Send This Coupon Today-----

SCHMOLLER & MUELLER PIANO CO.,
Dept. P. M. 056, Omaha, Nebraska
Send me your Piano Offer and Free Catalog.

Name

Address

Will You Take Orders



Your spare time is worth \$10 a day demonstrating the 1917 Model, Steel, 18-in-1 **Automatic Handi-Tool**. Equals separate tools costing \$160. Lifting and pulling jack; fence building tool; stump and post puller; baler; press; hoist; vise; etc. No experience needed. Demonstrator free. Credit given. Exclusive territory. Write for special factory agency offer.

Chas. E. Benefiel Co., 293E Industrial Bldg., Indianapolis, Ind.

IF \$10 to \$20 a Day Profits LOOKS GOOD TO YOU

Let us send you a Free Booklet of our
Automatic Card Printing Press

Printing is ever-lastingly a big money-making enterprise anywhere. Don't delay. Write today.

S. B. FEUERSTEIN & CO.

Patentees and Manufacturers
542 West Jackson Boulevard CHICAGO



The Litl Sho Fur

The Wonderfully Successful
FORD STEERING DEVICE



Thousands sold. One end of flat spring clamped to center of front axle, other end moves with the rod. No coiled springs, cams or bearings. Lightest weight. Only 2 lbs. Perfect action. Eliminates danger. Price \$3 and tire wrists. **Price \$3 and tire wrists.** Circular Free. Dealers, Ford Owners and Agents, get money-making proposition.

WHITE MANUFACTURING CO.
Dept. P CINCINNATI, OHIO

Pay as You Wish

We'll send you a genuine Lachnite for you to wear for 10 full days. If you can tell it from a real diamond send it back at our expense. Costs but 1-30th as much. If you decide to keep it pay only a few cents a month. Write for catalog.

Genuine Lachnite Gems

keep their dazzling fire forever. Set in solid gold. Cut by world renowned diamond cutters. Will stand fire and acid tests. All kinds of jewelry at astonishing low prices. Easy payments. **WRITE TODAY.**
H. Lachman Co., 12N. Michigan Av., Chicago, Dept. 1195



Oxy-Acetylene Welding and Cutting



Oxy-acetylene welding repair on aluminum casting used for automobile transmission.

Makes the Manufacture of Metal Products Easy and Profitable

The ease and certainty with which metal manufacturing is accomplished by the oxy-acetylene process, the low cost and high quality of the finished work are important considerations in every factory and repair shop. Oxy-acetylene welding makes intricate jobs of metal joining simple routine work. The welded portion can be made as strong as any other part, and even stronger.

The same economy and efficiency that have made the oxy-acetylene process so widely used in metal manufacturing make it universally useful in metal repairing.

Any shop, large or small, can utilize the oxy-acetylene process in its most efficient and simplest form by adopting the

Prest-O-Lite PROCESS

Employs both gases (acetylene and oxygen) in portable cylinders. Prest-O-Lite Dissolved Acetylene (ready-made carbide gas) is backed by Prest-O-Lite Service, which provides dry, purified gas, insuring better welds, quicker work, and lower cost, and also avoids the large initial outlay and heavy depreciation incurred in making crude acetylene in a carbide generator.

The necessary equipment is not expensive. We furnish high-grade welding apparatus for \$60 (Canada, \$75); acetylene service at additional cost. Also adaptable for oxy-acetylene cutting by the purchase of a special cutting blow-pipe. Thorough instructions are furnished free to every user—any average workman who understands metals can learn the process quickly.

Build a Profitable Business of Your Own

To enterprising men, commercial job welding offers a splendid opportunity to make positive profits quickly. There is a wide and growing demand for this class of work.

If you are interested in developing extra profits in your plant—in repairing, manufacturing or construction work—investigate oxy-acetylene welding. Fully illustrated literature sent free on request.

The Prest-O-Lite Co., Inc.

The World's Largest Makers
of Dissolved Acetylene

Main Office and Factory
816 Speedway, Indianapolis, Ind.
Canadian Office and Factory
Merritton, Ontario

53 Branches and Charging Plants



Learn to PAINT SIGNS and SHOW CARDS

Get into this interesting, profitable and fascinating business where the field is not crowded. Thousands of cards used weekly. Department stores, clothiers, movie shows, etc., pay big prices—work done quickly and easily—profits large—hundreds of jobs all around you. My students can more than pay for course doing jobs in spare time while studying. Increase your salary, get a better job or go into business for yourself.

Earn \$18.00 to \$45.00 a Week—Easily

I will train you to fill a big salaried job. I personally correct every lesson. 17 years' successful teaching. Thousands of successful graduates all over the world. No town too small, no job too big for my graduates. Get my training—start now.

Big Money in Card, Sign and Bulletin Business

No other profession pays such profits—work comes to you in abundance—no job will stump you—my students learn all. All the newest, well-

FREE Outfit

Write now for special literature and prices on 5 courses—terms, testimonials, sample lessons and Free Outfit offer. All Free—Don't delay, act quickly.

est designs, how to run the business, how to hire men, how to keep records. In fact gives you a complete training. You can finish my course in a short time. Read my guarantee—don't be out of a job or work at low wages any longer—

Guarantee

I guarantee to place competent graduates at \$85.00 to \$175.00 monthly. The demand for trained competent men is far greater than the supply.

Get Started Now.
Detroit School of Lettering, Dept. 205 Detroit, Mich.

AGENTS—Every Ford owner will buy a Lewis Nojar Rubber-Retained Steering Wheel AUTO CLOCK

on sight. Also made for all other makes. Write today to Dept. 3 for this quick-profit proposition. Made and guaranteed by one of the largest rubber manufacturers.



Pennsylvania Rubber Co., Jeannette, Pa. Retail Price \$2.50



Profit on Every Dime

\$25.00 a Day Easy!

that's what you can make every day in the year "snapping the crowds" at Bathing Beaches, Ball Parks, Fairs, etc., with a

DIAMOND POST CARD GUN

marvelous all-steel camera that takes, develops, finishes & sizes of Post Cards, including Official size photo buttons at the rate of 6 to 8 a minute. No experience needed, no plates, film or dark room required. Write for free booklet to Dept. N 12, International Metal & Ferry Co., Chicago



FULL yet EMPTY

Magic MATCH BOX

Open this ingenious Match Box in the ordinary way, and it is full of matches. Pass it to a friend, and behold it is EMPTY. There is a secret way of doing it, which you must know. Besides being useful and an endless source of amusement, it is a great conjuring trick. Any small article will disappear or return in the most mystifying manner. BEST SOUVENIR GIFT. We'll mail a nickel-plated, simple, striker for "safety." PRICE 25¢ (postage extra), 4 for \$1 postpaid. Agents, send for quantity prices. Mail order dealers and beginners furnished with circulars and novelty catalogs (32 or 64 p.).

JOHNSON SMITH & CO., 7129 N. Clark St., Chicago

RENT OR BUY UNDERWOODS LESS THAN 1/2 PRICE

10 Days' Free Trial—5-Year Guarantee



RENTED
APPLYING RENTAL ON PRICE, or
SOLD

for CASH or on EASY PAYMENTS.

A typewriter is almost as much a necessity in the home as in an office. Let us send you one on 10 Days' Free Trial. Get a world famous Underwood. Ask for circular No. 102. Write for agency proposition. TYPEWRITER EMPORIUM, Chicago (Est. 1882)

Please Mention Popular Mechanics



TUNE UP!

Make your spark more powerful, your Wireless set 200% more efficient with a

THORDARSON Wireless Transformer

You can transmit as high as a thousand miles, if you have a THORDARSON Wireless Transformer. The standard wherever wireless transformers are used. Connects direct to alternating circuit; no batteries needed. Magnetic Shunt regulating device gives instant adjustment of current without disconnecting or cutting off power—similar to big commercial stations. 3, 4 and 1 K. W. capacity; special windings to order. Write for our interesting booklet.

Thordarson Electric Mfg. Co., 518 S. Jefferson St., Chicago

LEPAGE'S GLUE 10¢

THE HANDY MAN
ABOUT THE HOUSE

CORONA

Weights 6 lbs. Occupies little space. Durable, efficient. Costs but \$50. Write for booklet No. 13. CORONA TYPEWRITER CO., Inc., BRIDGE, N. Y. New York: 141 West 42nd Street



Put Perrin "No Glare" On Your Car's Headlights

Avoid all danger from light-dazzled oncomers. Enjoy long, low, powerful light on both streets and country roads, with complete safety. Recommended by Police officials. Placed on lamp bulb permanently—always working—no buttons or levers. Over 100,000 in use.

\$1 per set of two. At your Dealer's or Garage or sent postpaid. Patented. Reject all imitations. Insist on the Perrin "No Glare". PERRIN MFG. CO., Detroit, Mich.

MECCANO Toy Engineering for Boys

Have piles of sport building working models of towers, bridges, cranes, derricks and anything you want to; build models of real things and learn how they work. Fine fun, too. MECCANO builds more models, better ones; builds easier and quicker. Every part is interchangeable; girders are ready to use, strong and rigid. It's the most practical, instructive and amusing construction toy for boys.

10,000 Models

were entered in our last prize contest. MECCANO builds real models of actual machinery, structural works and all kinds of other things. Boys—get MECCANO-wise!

MECCANO outfits cost \$1.00 to \$36.00. Some, costing \$3.00, \$5.00 and \$7.50, have the MECCANO Electric Motor. See them at your dealer's. Get one and build models! Send the names and addresses of five boys and get the 144-page story-book catalogue Free. Send the names today!

**MECCANO
COMPANY, Inc.**

Room 15
71 West 23rd Street
New York City



Touring-Camping OUTFITS from \$25^{UP}

This is the life which pays compound interest in Health and Happiness—unselfishly and equally alike to every man, woman and child member of a motoring Family, and one single Doctor bill for a single case will often buy the best Touring-Camping outfit on earth, which will be a family joy to all forever. If you own a motor car, just think this over.

Besides: if you could only use a Camping Outfit for your week-end trips your actual capital invested would come back several times over in the hotel bill saving, for just one season.

A Full Sized U. S. Good Roads Map and copy of "SERVICE NEWS" is sent



FREE

to all
MOTORISTS
giving name and
type of car used

KANSAS CITY
**AUTOMOBILE
SUPPLY CO.**

1504 Grand Avenue
Kansas City, Missouri

NOT A SINGLE HOME COMFORT NEED BE SACRIFICED, because we now have outfits with four double sleeping compartments accommodating eight people—a private bath—Kitchenette and Dining Room all elevated up off the ground to answer every possible requirement between the one night stand and a permanent home in the great out of doors, or when desired, we can also supply the simplest type of Tent for Two.

We are not only the pioneers in this business but positively the largest Touring-Camping Equipment Specialists in the world and for further information, remember,



KANSAS CITY AUTO SUPPLY CO., Kansas City, Mo.

I have a _____ automobile.

You may send me a free copy of your Touring-Camping "SERVICE NEWS". All I require is to look it over.

Name _____

Address _____



"Here's My Private Car"

"I travel on my own schedule. I pick my own routes. I have a choice seat every trip. I'm seeing a bit of the country and getting fresh air in the bargain. I'm my own boss on the road and what's best of all—the cost doesn't bother me one minute."

His "private car" that's always on the job, ready to take him where he wants to go, when he wants to go, is his dependable, powerful—

Pope Lightweight Motorcycle
Costs only \$150

You get one too, and find out what real living means.

Everybody who knows motorcycles will tell you that this model is the most popular lightweight in America. It doesn't weigh much more than you do—175 pounds. It doesn't take up much more space than a bicycle.

But it's a *real* motorcycle, with a 4 horsepower motor that will carry you from 5 to 45 miles an hour, which is about as fast as you want to travel. It is equipped with a Schebler carburetor, Spartan V-belt, Herz magneto, Eclipse clutch, Corbin brake, and U. S. motorcycle tires. It is simple to operate and practically trouble-proof.

The Pope Lightweight brings you health, pleasure, and money in your pocket.

Our catalog gives complete description—write for it. If there's no dealer nearby we have a mighty interesting agency proposition to make you.

Westfield Manufacturing Company

(Successors to the Pope Mfg. Co.)

15 Lozier Ave. WESTFIELD, MASS.

Largest Manufacturers of High-Grade Bicycles in the World.
Makers of the Columbia, Crescent, Tribune, Rambler, Cleveland and Pope Bicycles.

NOW a \$10 Vacuum Cleaner that Really Cleans

Here is a real suction Vacuum Cleaner. Works on the same principle as an electric machine, but needs no electric current—cleans with the same thoroughness and efficiency. Can be used anywhere at any time. No heavy weight to carry—aluminum construction. No awkward electric cord to attach or to become tangled in furniture or fixtures.

Whirlwind Vacuum Cleaner

An absolutely new idea in vacuum cleaners. No effort required. Sliding handle converts manual operating movement of arms into power which whirls suction fan at 3600 r.p.m. A child can operate it with ease. Cleans rugs, carpets, floors, overstuffed furniture, curtains, draperies. Our liberal trial offer enables you to use the Whirlwind 10 days in your own home—with your order refund \$5.00—test the Whirlwind thoroughly for 10 days; if not entirely satisfied return it to us express collect and your money will be refunded immediately. If you are pleased in every way send the additional \$5.00 and the Whirlwind is yours. Remember—we pay express both ways, so you run no risk whatever. Give us an order today.

Agents & Dealers
Write for Prices

A. E. JENNINGS CO.
125 Detroit Street
ANN ARBOR, MICH.

\$10

First cost
is the
only cost

AGENTS \$60 WEEKLY



Robinson Folding Bath Tub, Big Seller. Costs little, no plumbing, little water. Weight 15 pounds, folds into oval roll. Full length bath, far better than tin tubs. Guaranteed 10 years. \$10 a day easily made. Write for free tub offer.

ROBINSON CABINET MFR. CO., 4023 Eastwood Blvd., Toledo, Ohio

JAPANESE ROSE BUSHES

The Wonder of the World

Japanese Rose Bushes bloom all the year round. Just think of it. Six weeks after planting the seed, the plants will be in full bloom. It may not seem possible, but we positively guarantee it to be so. They will bloom every ten weeks, Summer or Winter, and when three years old the bush will be a mass of roses, bearing from five hundred to a thousand roses on each bush. The flowers are in three shades—white, pink, and crimson. The plants will do well both in and out doors. We guarantee at least three bushes to grow from each packet of seed. Price, including our big catalogs (900 pages) of other novelties and curiosities, only 10c packet, 3 pcks. for 25c postpaid.

Another remarkable Botanical Curiosity you should have is the SHOO-FLY PLANT. Quite free from odor, yet flies will not remain in a room where it is grown. Bears very pretty blossoms; grows easily from seed. PRICE 15c per packet; 3 for 40c.

JOHNSON SMITH & CO., 7129 N. Clark St., CHICAGO

4 H.P. Cushman Weighs Only 190 lbs. 8 H.P. 2 Cylinder Only 320 lbs.

Discussing light-weight motors recently, the Scientific American said: "Efficiency means light weight, reduced friction, and above everything else, lowered operating cost." Cushman Light-weight engines are today recognized as the leading American light-weight, high efficiency, all-purpose motors, challenging comparison in minimum weight per horsepower, reduced friction, quality of material and workmanship and cost of operation.

Double
Cylinder
8 H.P.
Weight
320 lbs.

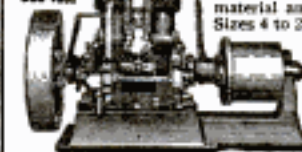

Sizes 4 to 30 H.P. Throttle Governor, Schebler Carburetor, Forced Water Cooling System. Moving parts enclosed and run in bath of oil. Not cheap engines, but cheap in the long run. ENGINE BOOK FREE.

Cushman Motor Works
882 N. 21st St., LINCOLN, NEB.

The Wall that Won't Fall



Earthquakes or explosions won't crack or shake down Beaver Board walls and ceilings.

When they're up, they're up to stay.

As to sanitary advantages — you have only to remember that the Beaver Board wall does away with plaster and unsanitary wallpaper forever.

When it's done you'll have a room that will please the most particular.

In new homes Beaver Board takes the place of lath, plaster and wallpaper and provides not only more attractive walls and ceilings but more substantial as well.

Our free Design and Decoration Service will help you plan.

BEAVER BOARD

The BEAVER BOARD COMPANIES
632 Beaver Road Buffalo, N. Y.
Branches in 16 Cities

DOVE NOT FIT PEACE SYMBOL—Although the dove has held undisputed sway as a symbol of peace since time immemorial, it is not in the least fitted for this place. In fact, it is one of the most pugnacious little animals and fights a large part of its waking hours. At least so an expert ornithologist and moving-picture photographer stated before an Audubon society in a lecture illustrated by motion pictures which bore out his statement. He explained he had not disturbed the birds in taking the pictures and that they were seen acting in a perfectly natural manner.

Make \$22.00 A Day!



Something entirely new—The **Acorn Self-Heating Flat Iron**. New Plan brings you **SAMPLE FREE**. Light—low in price—costs only a penny a week. You can sell a dozen a day easy—your profit, \$22.00. Write immediately for startling new offer. Exclusive territory—being snapped up fast—don't delay—right now is best selling season—Write tonight. **Acorn Brass Mfg. Co., Dept. 107, Chicago**



Pull Easily Through the Bad Spring Roads

You get the maximum of power; you abolish skidding, slipping and sidesway; you save money on fuel, oil and tires—when you equip your car with the

BAILEY Gearless Differential

Thousands in use—every one sold on a 30-day money-back offer. You'd hardly know it was the same car—try it and see. See dealer, or write for circular.

Ford, Overland and Chevrolet 490 Replacements Now Ready.

Gearless Differential Co., 892 Woodward Ave., Detroit, Mich.

Save
25% on
Gasoline
and
Permanently
Eliminate
Carbon

The
VAPOR
HUMIDIFIER
Saves This
—and
More



30
Days'
Free
Trial

We can show you how to make your car or truck give 25% to 50% more power—more speed—and more mileage from a less amount of gas and we can guarantee 100% less motor trouble resulting from carbon formation—all through a simple device that costs you only \$5.00. Mail the coupon below—make us prove our claims.

Vapo Humidifier \$5.00

Here's the wonder of the Automobile World today. The VAPOR HUMIDIFIER increases the explosive power of gasoline by producing a better vaporization, and more combustible mixture, through injecting the warm VAPOR from the Radiator into the Manifold, thereby reducing the flow of gasoline from the carburetor, and at the same time increasing the power and speed of the motor. The chief cause of motor trouble—the formation of Carbon—is permanently removed. Fits any car. Attached in a few minutes by any mechanic or garage man. Never wears out. Price \$5.00 complete.

Cuts Operating Costs on Both Pleasure Cars and Trucks

Increases power and decreases operating cost on Motor Trucks and Pleasure Cars alike. In daily use by some of the biggest firms of the country. Froehling & Heppes of Chicago, wholesale meat dealers, write: "Having used your Vapo Gasoline Saver on our Vellie Truck, also our 6-cylinder Stearns-Knight, we find that it shows a saving in gasoline of about 25 per cent. A number of our customers have bought your device on our recommendation, and all of them are very much pleased with the same." *Guaranteed unconditionally.* If after 30 days' use you are not thoroughly satisfied, return the VAPOR HUMIDIFIER and your money will be cheerfully refunded.

DISTRICT MANAGERS Here's the opportunity of a lifetime for high-grade agents. The VAPOR HUMIDIFIER is new—fills a new need now satisfied by no other device. Our advertising creates business for you—sales come easy and profits are good. A number of choice territories still open—write for particulars—stating your qualifications in full now—NOW.

THE AUTO GAS SAVER CO.

Desk A, 948 National Life Building, Chicago, Illinois

30 DAY FREE TRIAL COUPON

AUTO GAS SAVER CO.

Desk A, 948 National Life Bldg., Chicago, Ill.

Enclosed find \$5.00 in payment for one VAPOR HUMIDIFIER, it being agreed that after 30 days' use if I am not entirely satisfied with same, you will refund the \$5.00 on receipt of the instrument.

Name of Car _____

NAME _____

ADDRESS _____



A YEAR AHEAD

EXCELSIOR AUTOCYCLE MODEL 17-3

Price **\$265.00**

17-3-E. Electric **\$295.00**

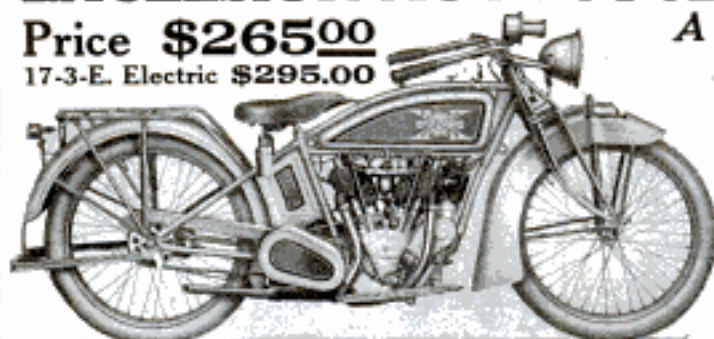

*A Machine a Year Ahead
of the Minute*

with new features never before put in a motorcycle.

Every one of them fully developed to mechanical and practical perfection.

The Ultra Power motor is the most powerful engine ever put in a motorcycle and the superimposed valves insure perfect cooling at all speeds and under all conditions.

The new combination Clutch and Brake Control automatically releases the clutch before the brakes are applied, thus saving the engine the strains due to applying the brakes against the pull of the motor and insures the greatest possible efficiency of the brakes.

The Automatically Operated Compression Control eliminates the necessity of juggling the exhaust valves in starting the motor.

Write for our new Series 17 catalog which gives full details of the "17" line including the Ultra Power 17-3, Short Coupled racer, and the Lightweight.

All models now ready for demonstration and delivery by *Excelsior dealers everywhere*

Excelsior Motor Manufacturing & Supply Co.
3702 Cortland St., CHICAGO

NOW YOU NEED A GOOD ATLAS

Never before in the World's History has an atlas been so constantly necessary to an intelligent understanding of the World's News.

Here is the IDEAL ATLAS

Hammond's Comprehensive Atlas is a compact octavo volume, bound in flexible leather. It solves the problem of

Large Scale Maps in a Book of Handy Size

Contains 512 pages, 256 pages of large scale maps of all States, Canadian Provinces, Countries of the World, etc., also 256 pages of text, index, compilations, gazetteer, statistics of population, etc.

Self-Revising After the War

Each copy contains a certificate entitling the purchaser to a supplement of maps showing the new boundaries after the war is over, making this atlas self-revising.

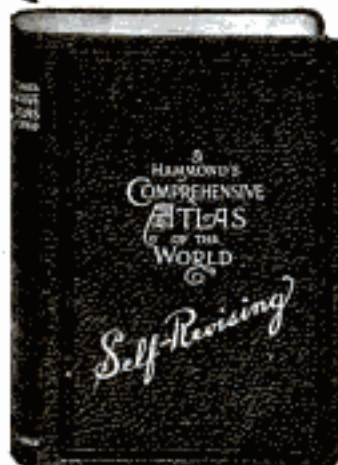

Size $9\frac{1}{2} \times 6\frac{3}{4} \times 1\frac{3}{4}$ inches

Special New Maps Show the Several War Zones

Get your atlas now. Use it during the great war when you need it most and rest assured it will be up-to-date after the war is over. Price \$1.50. Postage 15c Extra

Return Privilege Any purchaser who is not more than satisfied with this atlas may return same and have his money promptly refunded.

POPULAR MECHANICS BOOK DEPT.
6 N. Michigan Ave., CHICAGO



JUST PUBLISHED!

Motorcycles, Side Cars and Cyclecars

Their Construction, Management and Repair

BY VICTOR W. PAGE, M. E.

Author of "The Modern Gasoline Automobile"

Contains over 350 specially made illustrations showing the most valuable series of drawings pertaining to motorcycle design and construction ever published.

550 Pages Price \$1.50 Postpaid 3 Folding Plates

The only complete work published for the Motorcyclist and Cyclecarist. Describes fully all leading types of Machines, their Design, Construction, Maintenance, Operation and Repair.

This treatise traces the motorcycle from its earliest forms to the approved models of the present day. It outlines fully the operation of two and four cycle power plants and all ignition, carburetion and lubrication systems in detail. Describes all representative types of free engine clutches, variable speed gears and power transmission systems. Gives complete instructions for operating and repairing all types. Considers fully electric self-starting and lighting systems, all types of spring frames and spring forks and shows leading control methods.

The Dealer, Mechanic and Expert Rider will find this treatise a work of reference without an equal.

POPULAR MECHANICS BOOK DEPT.
6 N. Michigan Ave., CHICAGO

Are You Mechanically Inclined?

If so, this list of Practical, Up-to-Date Electrical and Mechanical BOOKS at **25c each, postpaid**

WILL INTEREST YOU

Each one is a complete, dependable treatise and worth the price several times over.

	Pages	Illustrations
Practical Electrics	135	126
Study of Electricity for Beginners	88	54
Dry Batteries, Their Construction	59	30
Modern Primary Batteries	105	55
Electric Gas Igniting Apparatus	101	57
Alternating Currents	90	33
Electrical Circuits and Diagrams — Part I	72	217
Electrical Circuits and Diagrams — Part II	80	78
Magnets and Magnetism	94	49
Small Electrical Measuring Instruments	90	59
Woodwork Joints	101	178
How to Build a Bi-Plane Glider	60	31
Model Vaudeville Theatres	90	34
Windmills and Wind Motors	83	76
A. B. C. of the Steam Engine	30	6
Steam Engine Design	102	34
Inventions, How to Protect, Sell and Buy Them	108	1
Simple Soldering, Both Hard and Soft	82	52
Induction Coils, How to Make and Use Them	75	35
Experimenting With Induction Coils	73	26
Wimshurst Machine, How to Make and Use It	112	30
Simple Experiments in Static Electricity	72	51
Making Wireless Outfits	61	27
Wireless Telephone Construction	74	43
Telegraphy for Beginners	63	19
Small Accumulators, How to Make and Use	80	40
Wiring Houses for Electric Light	93	42
Low Voltage Electric Lighting	92	23
Electric Bells, Annunciators and Alarms	95	70
Magneto Telephone	86	23

A uniform series, size 5x7 inches. Paper cover. You will be surprised at how much good reliable information 25 cents will buy.

Any of the above books sent postpaid to any address upon receipt of price by

Popular Mechanics Book Dept.
6 N. Michigan Ave. CHICAGO

Are You Satisfied with Life?

Are you achieving business and social success? Your earning power—are you steadily increasing it?

Is your memory retentive, or is it failing? Why do some men and women succeed, while others fail?

Are your faculties of reasoning, your powers of analysis, sharp, clear and keen?

ARE YOU A LEADER OR A FOLLOWER?



The Start

Do you feel health, strength and vim bounding through your veins?

Have you considered why some people are content with a menial position and poverty in their old age?

Now every thinking person knows that there must be a cause for all of this. Of course there is a cause, but what is it? I will tell you:



The Start

Success or failure depend upon—

- (1) Your Mental Condition
- (2) Your Physical Condition
- (3) Your Facial and Outward Expression
- (4) Your Knowledge of How to Apply What You Know



Third Month

The keenness of your intellect, your ability to analyze conditions, your powers of straight thinking, all depend upon the quickness of your brain to generate nerve power, while this in turn is dependent upon the richness of your blood, the sunniness of your disposition, the earnestness of your concentration, the strength of your will and the reliability of your memory. It is the harmonious development and co-ordination of all these that insure success.



Third Month

In 6 Short Months I Can Remake You!
MEN AND WOMEN, YOUR DESTINY IS IN YOUR OWN HANDS!

The Nicholson-Wase Course Gives You Virility of Speech—Power to Combat Difficulties as They Arise—Sureness in Business—Strength of Purpose—Power of Observation and Analysis—Retentive Memory—Power of Facial Expression—Graceful Carriage—Strong Nerves and a Balanced System.

It Trains You in Self-Possession and Control It Makes You Strong and Forceful



Sixth Month

This message is for those men and women who realize the value in life of vigorous health, personal magnetism, a keen and analytical mind, the ambition to succeed and the ability to achieve success.

It costs you nothing but a postage stamp to fill in and mail to me the attached coupon.

There is no complicated system, there are no unpleasant or difficult rules to follow. The Nicholson-Wase Course has no relation to sex, but is equally efficient for men and women.

Fill in this coupon and mail it to me today. In a short while you will thank me for the offer I will make you.



Sixth Month

MAIL THIS COUPON TODAY!

Charles A. Wase, M.A., Ph.D.
1476 Broadway, New York:

Please send me booklet, folder synopsis and pamphlet FREE.

NAME.....

ADDRESS.....

The arrows show why two million wearers prefer

FINCK'S

"DETROIT-SPECIAL"

Overalls and Work Garments

The famous garments which "WEAR LIKE A PIG'S NOSE"

Absolutely protect your clothes from the grime, grease or dirt incident to any kind of mechanical, farm, garden or automobile work.

They really feel comfortable because they are made right throughout, by men who know how. Made of the best obtainable material, in light or dark blue denim, or khaki. If your dealer hasn't them write us today.

High Back Overalls . . . \$1.50
 Suspender Overalls . . . \$1.50 Combination Suits . . . \$2.50
 Jacket 1.50 Vest High Back Overalls . 1.75

Also an unusually attractive proposition for dealers

W. M. FINCK & COMPANY, 1154 Gratiot Ave., Detroit, Mich.

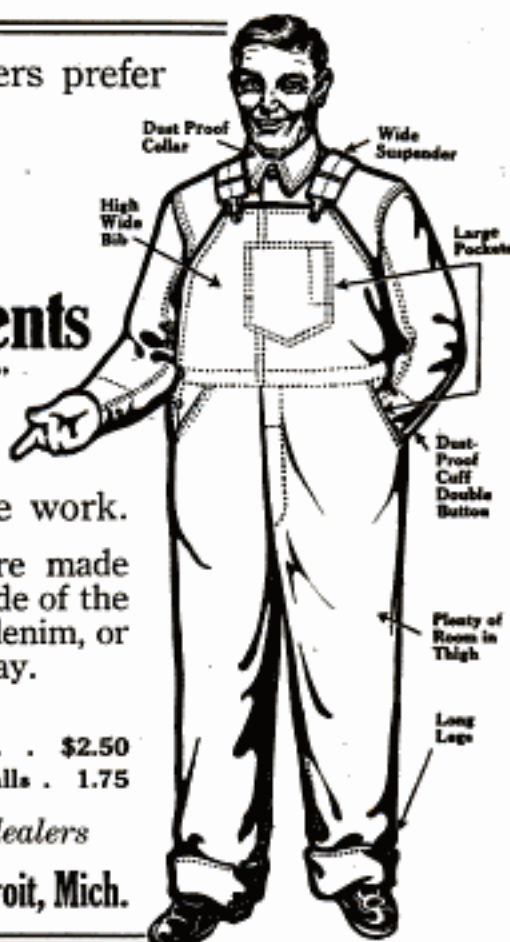

NEW AND USEFUL
 OUR UP-TO-DATE
Pen and Pencil
Clasp
 with complete yearly calendar. Buy from your dealer or send 15c for sample and particulars

ARGUS MFG. CO.
 128 S. Honore St., CHICAGO

Another industrial development arising from the necessity of creating supplies stopped by the war is found in the special treatment of mica by an American company, says the Edison Monthly. This concern is extracting the mica in large amounts, and is cutting and stamping it in various kinds of pieces, such as washers, disks, etc., for use with magnetos, rheostats, and other electrical apparatus. Special work of a sort heretofore done in Germany has made it imperative for the company to double its working force.

PITNER MANTLE LANTERN
 The first and only mantle lantern ever made that will give satisfaction in actual practical and continuous use.
200 Actual Candle-power
 as much light as forty kerosene lanterns, and will burn twelve hours on one quart of ordinary low grade gasoline.
ABSOLUTELY STORM PROOF
 simple in construction and operation, safer than kerosene lantern will last a life time.
USED EVERYWHERE
 in the city and in the country, by automobilists, home-owners, farmers, summer-resorters, contractors, showmen, yachtsmen and thousands of others.
Agents Wanted
 to handle exclusive territory.
 Pitner Gasoline Lighting Co., 8 East Kinzie St., Chicago

BIG PROFITS
 made with Kingery Popcorn and Peanut Machines. Others are doing it—you should do as well or better. Pay for machine in easy payments out of big monthly profits. Over 50 styles \$11.50 and up. See big book and select size and style you want. Send postal for free book and full information.
 KINGERY MFG. CO., 412 E. Pearl St., Cincinnati, Ohio

NO JOKE TO BE DEAF
 — Every Deaf Person Knows That
 I make myself hear after being deaf for 25 years, with these Artificial Ear Drums. I wear them day and night. They are perfectly comfortable. No one sees them. Write me and I will tell you a true story, how I got deaf and how I make you hear. **Address**
GEO. P. WAY, Artificial Ear Drum Co. (Inc.)
 11 Adelaide Street, DETROIT, MICH.

VIOLET-RAYS! Newest form of electricity for regaining Health, obtaining Beauty, and producing Efficiency.
THE VIOLETTA
 High-Frequency instrument is endorsed by thousands of physicians who use it daily. Wonderfully quick results are obtained in treating **SCALP, FACE, and BODY** (Rheumatism).
FREE BOOK Write now for our illustrated booklet VIOLETTA telling all about the marvels of VIOLET-RAYS. Read what scientists and doctors say.
BLEADON-DUNN CO., Dept. M, 208 N. Fifth Ave., CHICAGO

An Electrical Luxury
 causing neither muscular contraction or pain. Produces a pleasant stimulation and generates **OZONE** which is taken up by the blood.

7 CENTS A DAY Buys This Standard Visible Oliver Typewriter

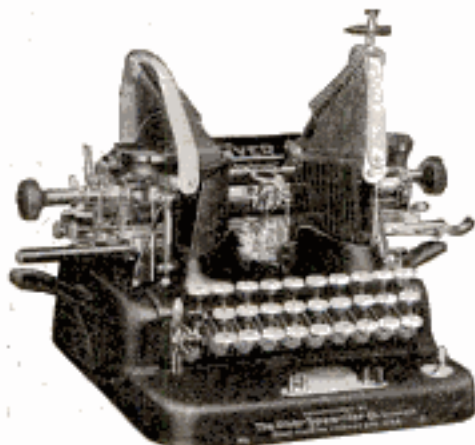

Much Less than Half Price FREE Trial—10-Year Guarantee

This is the best typewriter offer ever made. The typewriter is the genuine model No. 5 Standard Visible Oliver with complete, brand-new equipment. Perfect machines only. Not shop worn, not damaged, not inferior. Back spacer and tabulator—no features lacking. Warranted to be the equal in quality of any other \$100 typewriter.

This offer is not on some ancient style of blind typewriter, but on an up-to-date, standard, visible machine, the same kind of typewriter that many thousands of the world's best business firms are today using.

Oliver Points:

Nearly one-half million Olivers have been sold. Its record has never been equaled. It is easily "The Favorite."

Its simple efficiency, lightness and durability place it in a class ahead of all others; writing always in sight; writes in many different colors without changing the ribbon. Has the universal keyboard, back spacer, tabulator, ruling device, disappearing indicator. The type is beautiful; it is so hard that nothing can mar it. It outwears type found on other machines.

It is the lightest of all the standard typewriters. It is the only practical, portable typewriter. It has the lightest key action. Its speed is unlimited. It has the patented "U" shaped type bar which insures perfect alignment of the letters. One can write on ruled lines with it or it can be used to draw lines. It makes an efficient billing machine as well as correspondence machine.

The downward stroke of the type bar gives greater power. The Oliver is nearly always chosen for manifolding—some firms write as many as 20 copies at one writing. It does any practical thing which any typewriter can do.

It has the fewest parts. It requires the least adjustments. There is nothing to wear out. We guarantee it for 10 years.

While it is the choice of the experts, it is so simple in its design that anyone can learn to write on it in 10 minutes' time.

Sensational Reduction

Many thousands of purchasers paid \$100.00 for typewriters of this model. They were satisfied that at that price they were getting the best value that the market afforded.

Now, without any reduction in quality and with brand new standard equipment, our price to you is but \$42.80—a saving of over half, and we give you over a year in which to pay.

Our Offer Is This

Send the coupon and we will forward one of these typewriters with complete equipment on ten days' trial. We will ship it by express. When it arrives you leave \$4.80 with the express agent to be held while you try the typewriter.

If you do not find it to be the best typewriter that you ever examined, satisfactory in every respect, the best value offered anywhere, then you simply return it to the express agent, who will give you back the \$4.80 and return the typewriter to us at our expense.

If you decide to keep it, the express agent will forward the \$4.80 to us and it will be deducted from the \$42.80 price, leaving a balance of \$38.00, which you can pay at the rate of \$2.00 per month, the first monthly payment not being due until one month after date of delivery.

There are no interest charges, no red tape, no salesmen, no collectors, no bother. The simple coupon is all we require.

Send the coupon today. Make sure of getting this bargain, as we will only supply 100 typewriters at this price.

United States Typewriter Exchange
Dept. 351, All Light Bldg., CHICAGO, ILL.

Trial Order Coupon

United States Typewriter Exchange
Dept. 351, All Light Bldg., CHICAGO, ILL.

You may send me a No. 5 Oliver Typewriter on approval. When it arrives I will leave with the express agent \$4.80 with the understanding that if I do not wish to keep the typewriter the \$4.80 will be returned to me by the express agent when I return the typewriter to him within ten days from the date I receive it.

Otherwise I will keep the typewriter and the \$4.80 will be forwarded to you to apply on your special purchase price of \$42.80, and I will pay the balance of \$38.00 in 19 consecutive monthly installments of \$2.00 each, commencing one month from date of delivery.

The title of the Oliver Typewriter remaining in you until it is totally paid for.

Name.....

Address.....

References.....

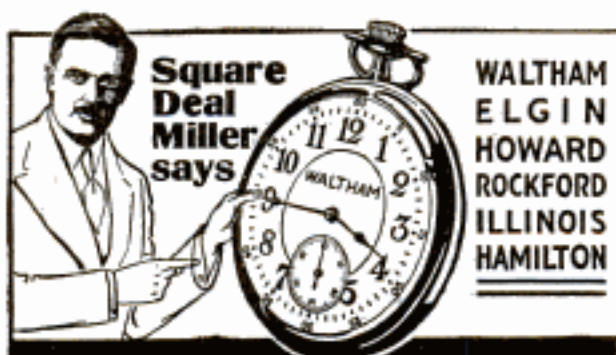

Square Deal Miller says

**WALTHAM
ELGIN
HOWARD
ROCKFORD
ILLINOIS
HAMILTON**

Any Watch YOU WANT on CREDIT

One Customer Writes: "I have had my watch just a year today and our watch inspector says its the best time keeper on the road. Please find enclosed my last monthly payment of \$1.00." We have thousands of such letters on file from satisfied customers, who have bought from us on

30 Days Trial Express Paid No Money Down

You take no chances with me. I am "Square Deal" Miller and I trust the people. That is why I am doing the greatest credit Watch, Diamond and Jewelry business in the world.

Watches Guaranteed for 25 Years

I Smash the Terms

NO REFERENCES DEMANDED

My terms will surely suit you. You get unlimited credit. **A Charge Account** the same kind of credit you get from your grocer. No matter where you live or what your income might be, you can now own the finest of watches, a beautiful diamond or any rare jewelry and never miss the money.

Catalog FREE Send me your name and address so I can mail you Free and postpaid the most beautiful catalog of its kind ever printed. I want you to have this book. It's a gem. Write TODAY.

SQUARE DEAL MILLER, Pres.

MILLER-HOEFER CO. 672 Miller Bldg., Detroit, Mich.



A 16 Ft. Outboard Motor Boat

Smooth planked, roomy and sea-worthy. Built with sufficient buoyancy at stern to turn properly with the extra weight of operator and motor.

\$48 Buys the Completed Boat Ready to Use \$32

Rowboats \$18.50 to \$40.00. Shipment made same day order is received. Write for catalog. Special prices to livestock.

DUNPHY BOAT MFG. CO., Box 20, Eau Claire, Wis.

Big Money for Live Agents

Marvelous new Radiosene Lamp—valveless, wickless, smokeless. Burns vaporized kerosene by means of mantle—newly invented process. First of its kind on the market. Gives more light than Tungsten electric bulb from cheapest, safest of fuels—10 cents worth of oil lasts average week.

RADIOSENE

Simple and reliable to use. Perfectly safe, lighted or extinguished. Gives 150 candle power of white brilliant light—steady and restful to the eyes. Splendid money making proposition for agents. Write at once for terms and exclusive territory.

SUPERIOR MANUFACTURING CO. 294 Second St. Ann Arbor, Mich.



\$7.50
Canadian Price \$9.50

THE NEW VALVE-LESS WICK-LESS LAMP



AGENTS—Make Clean Fortune From Unclean Millions! Make \$1000 Cash in 3 Months

Sensational new invention. Just out, yet half million already sold. Tremendous rapid sale. Agents happy—banking enormous profits daily. **\$80 clear in 2 days**—one man's record. Never sold goods before. Experience unnecessary. Hagen sold 100 in 2 days; Walters \$1 first day. Hamser writes: "Only 45 families in town—have sold all." **Grab's Scientific Shoe Scraper** sells itself. Every family in the land wants one on their doorstep. Millions to be sold. Replaces unsightly, unsanitary, crude door mat. Automatically removes mud, dirt, ice from shoes in one operation. Cleans sole, side, heel. Works like magic. Saves drydockery, time, money, shoes, rugs, carpets, floors. Attaches without screws, nuts, bolts. Rotates for sweeping. Has 16 blades, 10 dirt rollers, adjustable and removable brushes, compressed springs. Can't clog. Selling price strong feature—only \$1.00. Your profits big. Satisfaction guaranteed. Write quick for free catalog. Investigate sure.

\$300 A MONTH

We want a representative in every county at once to advertise, accept orders, deliver our marvelous new Quickedge Knife and Shear Sharpener to every home. No talking necessary. Sold upon absolute money-back guaranty.

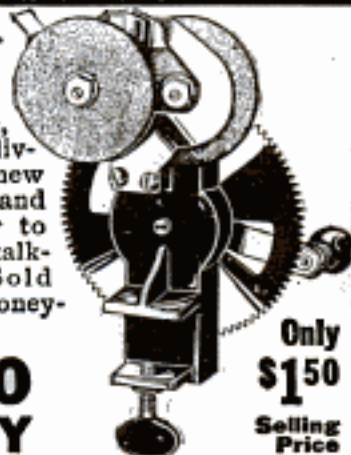

\$10.00 PER DAY

Only \$150 Selling Price

Sharpens any kitchen, paring, carving knife, or shears in 10 seconds. A child can use it. No competition. Low priced. Leave fifty on trial—fifty orders at 200% cash profit.

NEW INVENTION—JUST OUT

Abolishes dull knives and shears forever from every home. No charge for territory. Business furnishes capital. Profits start first day. No experience required. No delay. Send no money. Just write for complete particulars—FREE. Ray Carter, of Mass., sold 35 in 2 hours—profit \$20. Forest Webb, of Pa., sold 12 in 3 hours—profit \$12. Act at once. Write Now. Send name and address, and give name of your county.

QUICKEDGE SHARPENER CO.

592 Sharpener Bldg., 215 W. Schiller St., Chicago, Ill.

Investigations as to the source of occasional interruptions in the operation of electrical-transmission lines in Japan have revealed that reptiles make a practice of climbing the towers to take sun baths on the cross arms, and, getting across the conductors, cause short circuits.

WEAR THIS BUTTON.

"OLD GLORY FIRST." The flag in full color on a shield of gold, beautiful expression of patriotism for all true Americans, endorsed and worn by national leaders and members of Congress. By mail 10 cts., three for 25 cents. Will refund if not satisfactory. Wrap coin in paper. Address

ASHLAND PRESS COMPANY,

324 Orange St. Ashland, Ohio.



"Bow Legs and Knock-Knees" Unsightly Send for booklet showing photos of men with and without **The PERFECT LEG FORMS**

Perfect Sales Co., 140 N. Maplefield Ave., Dept. 5, Austin Station, CHICAGO, ILL.

I will send my 25c Book **Strong Arms** for 10c in stamps or coin **For MEN, WOMEN and CHILDREN**



Illustrated with twenty full-page half-tone cuts showing exercises that will quickly develop, beautify and gain great strength in your shoulders, arms and hands, without any apparatus.

PROF. ANTHONY BARKER 649 Barker Building, 110 W. 42nd St., NEW YORK

AUTOMOBILE REPAIRING MADE EASY

(Just Published)

The most needed and useful book on Automobiles ever written.

By VICTOR W. PAGE, M.E.

1056 Pages

1,000 Specially Made Engravings

10 Folding Plates

Price, \$3.00 Postpaid



(Size 5 1/2 x 8 x 2 in.)

A comprehensive, practical exposition of every phase of modern automobile repairing practice. The only book of its kind. It fills a real demand.

The information given is founded on practical experience and covers everything necessary to

Carry On the Automobile Repairing Business Successfully

Contains special instructions on Electric Starting, Lighting and Ignition Systems; Tire Repairing and Rebuilding; Autogenous Welding; Brazing and Soldering; Heat Treatment of Steel; Latest Timing Practice; Eight- and Twelve-Cylinder Motors, etc.

A guide to greater mechanical efficiency for all repairmen. You will never "get stuck" on a job if you own this book. Send for Complete Description and Synopsis of Contents.

ADDRESS

POPULAR MECHANICS BOOK DEPT., 6 N. Michigan Ave., Chicago

JUST OUT

OXY-ACETYLENE WELDING AND CUTTING

ELECTRIC AND THERMIT WELDING

By H. P. MANLY

Chief Engineer

of the Bureau of Engineering

215 pages, Fully Illustrated. Cloth, Price \$1.00; Leather, stamped in gold, red edges, Price \$1.50 (each postpaid).

The extensive use of the oxy-acetylene flame in welding and cutting has created an active demand for a practical book explaining this process. In addition to the oxy-acetylene welding are included electric and thermit welding, also a chap-

ter on hand forging and welding. In order to make a complete book on welding, the following subjects have been included: annealing, tempering, hardening, heat treatment, and the restoration of steel.

Much practical information is given on the uses and characteristics of the various metals. Thus, in this book the manufacturer and the workman will find all necessary information and data required in handling any kind of welding.

Sent postpaid upon receipt of price by

POPULAR MECHANICS BOOK DEPT.
6 N. Michigan Ave., CHICAGO

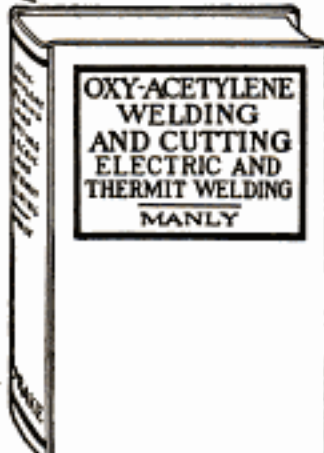

"HEAD FOR THE RELIABLE TIRE REPAIR SCHOOL"

Get Into The Tire Repair Game

Biggest End of The Auto Business

START WITH SMALL INVESTMENT

TAKES ONLY 30 DAYS TO LEARN



Easiest to start—bigger opportunities than in any other branch of the auto business. A broad claim, but easy to prove. Listen! Not one single auto factory can build cars fast enough. Everybody is auto crazy. 2,000,000 autos now in use. Four tires to each. That means 8,000,000 tires to repair. Just think of it—8,000,000 tires! Each car wears out its cost in tires alone.

Each tire is repaired many times before it is worn out. Punctures and blowouts are common. Vulcanizing, patching, retreading, etc., must be done. Retreading alone—the new and better process brings big money. Every day the demand for repairing increases. Repair shops are running over with work. Big profits are flowing into the pockets of those who are repairing tires by the **Reliable Process**.

Earn \$3000 to \$8000 a Year

Begin now. In every city, town, village, and hamlet there is a fine chance to start. Soon you will be on easy street. Sounds too good to be true? Couldn't happen to you? Why couldn't it? Why can't you get the big money? There's no "corner" on the business. Money is no respecter of persons. Of course, you've got to hustle, but hustling where the hustling is good is fun. Slaving where the picking is thin is what hurts. Is that what you're doing?

Start with Small Investment

Just a little money starts you. No wait for business—business is waiting for you. How can you prove the field for you is big? Listen! New tire factories are springing up like mushrooms. All making good—all busy. Never too many tires, because the auto business is growing so fast. Remember, every tire made has to be repaired sooner or later. Why, the old bicycle days, when there was a repair shop on every corner, don't hold a candle to this new and bigger business.

No Experience Necessary We Teach You in 30 Days

We teach you the new **Reliable process** from A to Z. You know just how to go at it to make a big success. At least investigate. Remember, **your interests are ours**. Perfect preparation is half of success. Instruction is thorough. Every process—every detail—is clearly explained. You do actual practical work on tires—no theory stuff. Now is the time to learn. Best season approaching when cars are used the hardest. Write today for free catalog—or to save time and get real action take the next train for Detroit. Get right on the ground where we can show and prove everything. Use the coupon.

Reliable Tire Repair School
105 Reliable Bldg., Detroit, Mich.

COUPON

RELIABLE TIRE REPAIR SCHOOL

- () I will start for Detroit.....
() Send me your free catalog and full particulars about the tire repair business.

Signed.....

Address.....



Build Big Business for Yourself - \$250 to \$600 Per Month

I want live, bright, ambitious, capable men to read this. Then if you're not afraid to talk business with the most successful men in your community; if you want to make as much in an hour as you now make in an entire day; if \$8 to \$20 a day looks good to you; if you're tired of the grind of working for someone else; if you want to build a BIG business of your own, have other men working for you and make a profit on their labor; if you're looking for a permanent, profitable business opening; if you've got the sort of stuff in you that successful men are made of; if you feel that the reputation and assistance of a successful, established concern will help you toward wealth and independence—I want you to write to me personally for full particulars of our proposition, which I'll send to you by return mail **ABSOLUTELY FREE.**

\$8 to \$20 a Day; Be Your Own Boss

No experience necessary; no big capital required; no stock to carry; no advanced education needed; no correspondence course scheme or school to attend; no books to buy or sell; no house-to-house canvassing. Ours is a straightforward, legitimate business proposition which lifts you out of the "shirt sleeve and overall class" and establishes you in your office where you transact your business and from which you boss your men. Your business can be as large as you have the ability to make it. We help you to succeed. Your success is necessary to our business. We must know that you're honest, capable and ambitious. So send us as references the names of three reliable people when writing. And be sure to write **TODAY**, for only one man in a community—the first who measures up to our requirements—can take advantage of this most remarkable money-making opportunity. Just say, "Explain your proposition to me."

Write for Full Particulars

If you're the ambitious kind of a man who isn't satisfied with his present long hours and small pay and who believes he has in him enough ability to put him in the "\$10,000.00 a year class," you'll **prove** it by sending today for our explanatory booklet. Our proposition is too big and there is too much to it for us to tell about it here. It's too big a proposition for you to pass up without writing for full particulars **TODAY** before someone else beats you to it. We will help lift you from your present tedious, hard and small paying job to a successful, prosperous and permanent business of your own.

A. L. RIDDIFORD, Pres., 2011-2015 West Lake St., CHICAGO, ILL.

Quicker Results — Doubled Efficiency

When you work
with electricity.



Attaches to
any light plug.

Garageman's Machine Shop

Hundreds of automobile repair men declare that the Temco Model B Drill is the best part of their shop equipment. Built to use emery wheel and reseater attachments. Has multitude of uses. Does away with tiring hand work.

First cost
and operating
expense
are both
low.

TEMCO Garage Outfit

Drilling, tapping, valve grinding, sharpening tools, etc., all performed quickly and cheaply with these wonderful tools. Weighs only 12 pounds. Connect to any lamp socket (AC or DC). Cheap to operate. Reverses instantly on full speed. Guaranteed not to burn out. Doubles working capacity of your shop.

Ask your jobber for one today, or write us. The sooner installed, the quicker your profits will increase.

The Temco Electric Motor Company
Main Office and Factory, 125 Sugar St., Leipsic, Ohio

Measures 15 inches
over all including
chuck. Drilling capacity
3/8 inch. Equipment includes
standard chuck, cord
and attachment plug.

Building and Flying an AEROPLANE

By CHAS. B. HAYWARD



A PRACTICAL Handbook covering not only the building of small models, but of full-sized gliders and machines.

The author has followed, in both biplane and monoplane models, the well-known types of Curtiss and Bleriot, choosing each as the simplest representative of its class in matters of construction and design. Detail drawings are given, with dimensions of all parts, the methods of shaping the struts and ribs, the form of running gear, the form and size of ailerons and rudders, the stretching of the fabric, the mounting of the motor, and assembling of the complete machine. The general instructions for flying, in so far as they can be given, are carefully laid down; the method of making a start; the conditions under which flights should be undertaken;

methods of control; banking on the turn; and what to do in case of failure of any part or the stopping of the motor. The article on Accidents and Their Lessons has been given principally with the idea that every young operator should realize the fatal results of foolhardiness, lack of experience, and poor building, and should correct these shortcomings as far as possible. It is hoped that the book may not only be of invaluable assistance to the amateur builder, but may also be the means of turning into safer and more established paths the too confident inventor who might be tempted to follow his own ideas in an untried field.

160 pages, 5 1/2 x 8 1/2, fully illustrated with detail drawings. Price \$1.00 postpaid to any address.

POPULAR MECHANICS BOOK DEPT.
6 N. Michigan Ave., CHICAGO

MEN!**Big Money
For YOU**

**In the Tire
Repair Business
\$250 A Month
AND UP
With This New Machine**

No Guess-Work About It There are nothing but facts to prove that you will make a success—**Big Money, Yearly, Repairing and Retreading Automobile Tires.** No matter where you go, where you look, where you live—on the farm, in a town, in the city—everywhere there are automobiles—millions of them and all with tires to repair. **Get into this business** at the beginning of its most prosperous period. **Fifteen Million Tires** will be made this year and every one will need repairing. More tires than in all time before. **Success, Wealth, Power and Independence—\$3,000 a year** and up, from the start, awaits any man with ambition, nerve and energy—the man who is tired of working for others—who is seeking to break all bonds of low wages—who strives for something better in life and **who can see this opportunity before him.** Write today for big book of facts on the tire repair business. **Investigate** by mailing the coupon below.

Haywood's 1916 Tire Repair Plants

Complete machines that do all the work—**Vulcanize** and mend tires from the smallest puncture to Retreading. Every plant is the last word in efficient and economical tire repairing. Business comes easy as soon as people find out that you repair tires with Haywood Equipment. It means work that satisfies—work that brings back the customers—all at big profits to you.

Punctures & Blow-outs Common

Autoists clamor for tire repair work. Not a day passes but thousands of tires blow up. Thousands of punctures are made. Repairing is a necessity. The work has to be done. It will come to your shop and pay you **big profits** if you make a bid for it.

A Year Round Business

Autos are used both summer and winter. No dull seasons. Keep busy day in and day out. One

machine will give you a start—a small investment—\$50 and up, trifling for such a big proposition. You build a big business from there. You are soon a manufacturer—your own boss and making the big end of the profits instead of the small.

No Experience Necessary

Not even a knowledge of tires. We teach you the work when you get a machine. **You learn in a week to handle all kinds of jobs.** Just follow directions is all that is necessary. Do the work yourself at the start. **Open a small shop.** You don't need a store. You can start in your home if you prefer. It's well worth your while to investigate this opportunity. **Be the first in your town.** Fortunes are to be made while the business is **yet young.** This coupon or post card brings complete information. Send it today.

Get All the Facts From Big FREE CATALOG

Learn all the secrets of this proposition. A big **FREE CATALOG** gives all details. Tells all about tires and how to repair them. Shows outfits in use. Gives actual proof of successes—Letters from men who have already started and are well on their way to success and fortune. What these men have done, **you can do,** and maybe better. There is really an important message for every ambitious man in this valuable book. Send your name and address at once. Use the coupon—a letter or post card.

Haywood Tire & Equipment Co.
609 Capitol Ave. Indianapolis, Ind.

FREE CATALOG COUPON

M. E. HAYWOOD, Pres.
Haywood Tire & Equipment Co.
609 Capitol Ave.
Indianapolis, Ind.

Dear Sir: You can send me your book and full particulars about your tire repairing device. This, of course, without any obligation on my part.

Name.....

Address.....

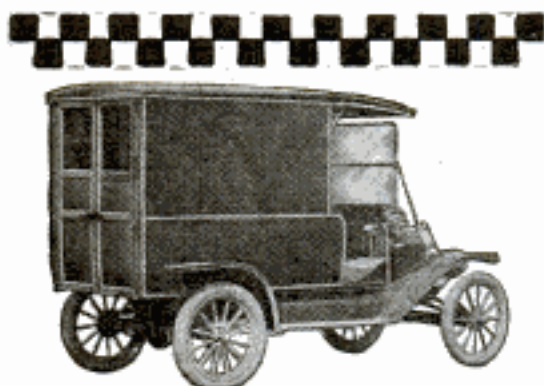

Highland Commercial Bodies Not Shipped Knocked Down

Every Highland commercial body is completely assembled by our own skilled workmen in our own plants. Unskilled hands might do damage amounting to many times the difference in freight, and apt to do slipshod work.

There is a standard Highland body, with twenty-five years of knowing-how back of it, for every line of business using the Ford for delivery purposes. Hundreds of Ford dealers have our complete catalogs on file. Or we shall be glad to send you illustrations of your delivery wagon, if you'll write us, together with our

Free Booklet—"Body Blows"

Tells a lot you'll want to know about delivery bodies and how they are built. Write today.

The Highland Body Mfg. Co.
502 Elmwood Place CINCINNATI, OHIO

DEALERS: Write for interesting and profitable proposition



Cut Next Winter's Coal Bills

Install a New-Feed UNDERFEED Furnace or Boiler. $\frac{1}{2}$ to $\frac{3}{8}$ fuel saving guaranteed. Over 35,000 enthusiastic users are saving fuel money. Find out how you can, too. Write today for valuable book, "From Overfed to UNDERFEED."

The WILLIAMSON HEATER COMPANY
245 Fifth Avenue CINCINNATI, OHIO

"Interlox" SAVES TIME, TEMPER AND TROUBLE

MASTER SLIDE RULE
The Only Interlocking Rule made—and the Only one whereby inside measurements of doors, windows, etc., can be taken rapidly and accurately. Also superior to all others for outside measurements of walls, ceilings, etc. (If your hardware dealer hasn't this Rule, send us his name and the per foot on any length from 2 to 8 ft.) and it will be sent prepaid.

Liberal Proposition for Dealers and Agents

DAHL MFG. CO., 51P E. 42nd St., NEW YORK

ROBERTS MOTORS

—the speediest, most powerful, compact and flexible motors ever built—throttle down to 250 r. p. m., or jump to 1000 r. p. m. in an instant. Run with a silent hum. Equipped with patent Cellular Bypass, prevents backfiring absolutely, and makes a mixture with a "wallup."

Runs on Gasoline or Kerosene

without special attachment. Types from 1 cyl. 4 H. P. to 12 cyl. 350 H. P. Write for catalog.

THE ROBERTS MOTOR MFG. CO.
504 Roberts Bldg., Sandusky, O., U. S. A.

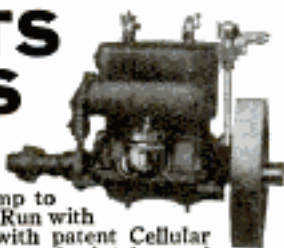

If You Have RIG or AUTO, Earn \$83 to \$325 a Month

working spare time or steady in your own locality for largest concern of its kind in the world. Work consists of leaving in homes on free trial a wonderful new household necessity needed in every rural home. Awarded Gold Medal. Greatest invention of the age. Tested by the U. S. Bureau of Standards and 30 leading universities in comparison with articles now in general use, and found to be four times as efficient. Benefits every member of the family; brings cheer and happiness to the home. **No investment required.** We furnish goods.

Christophe, Wisconsin, says: "Have never seen any article that sells so easily." Norring, Iowa, says: "\$2 per cent of homes visited bought." Phillips, Ohio, says: "Every customer becomes a friend and buyer." Kemering, Minn., says: "No flowery talk necessary. Sells itself."

Send your name and address, stating your regular occupation, what selling experience you have had, age, mar. sta. or single; whether you have rig or auto; whether you wish to work spare time or steady; how much time you have to devote; when you can start; about how many homes are within six miles of you in each direction. Name townships most convenient for you to start to work in.

Address **A. D. SHEPPY, Gen'l Sales Manager**
168 North Halsted Street, Chicago, Illinois

LITHOGRAPHIC MODELS

IN COLORS

show and name every part of the following: Mallet Compound Locomotive—Atlantic Type Locomotive—Automobile—Steamship—Steam Engine—Steam Turbine—Dynamo—Gas Engine—Wireless Telegraph. Size 10x14 in. **PRICE 50c EACH. Set of Nine Models \$4.00 Postpaid**

POPULAR MECHANICS BOOK DEPT., 6 N. MICHIGAN AVE. CHICAGO

Vol. II—The Boy Mechanic—Vol. II

GREATEST BOYS' BOOK PUBLISHED

Tells all about 1000 interesting things to make and do and has 995 illustrations; 480 pages.

PRICE \$1.50 PREPAID

POPULAR MECHANICS BOOK DEPT., 6 N. MICHIGAN AVE., CHICAGO

THE ISLAND OF BLACK CATS—So the Chatham Island in the Pacific Ocean, about 730 miles west of the coast of Ecuador, has been appropriately called. It is overrun with cats; all of them uniformly black. They live in the crevices of the lava foundation near the coast.

Symphonic Pianos and Player Pianos

NO INTEREST TO PAY—4 YEARS' TIME

Symphonolas play all Victor and Columbia Records.

SEND FOR CATALOG

Larkin Co. Dept. P. M. 516, Buffalo, N. Y.

WRITE

Hettrick Bros., Toledo, Ohio

For Prices on Tents, Awnings and Canvas Goods

Comfort Indoor Closet Odorless Sanitary Germ-Proof

Every home without sewerage needs one. Put a Comfort Toilet in your home, a guarantee of healthy, sanitary conditions. A boon to sick people. Can be placed anywhere in house.

FLY BREEDING PRIVY CAN BE DESTROYED

Help swat the flies. Have modern city conveniences. Germ-life killed by chemicals in retort. Emptied once a month—no trouble. Needs no other attention. Boards of Health endorse it. Write now for literature, prices, etc. Agents Wanted—Exclusive territory.

COMFORT CHEMICAL CLOSET CO.
385 Factory Bldg., TOLEDO, OHIO



Send on **Free Trial**
30 days

CHICAGO, *March 23* 1916 No. *9462*

National Bank of Chicago

PAY TO THE ORDER OF *You* \$

DOLLARS

AMERICAN MANUFACTURING CO.
L. Smith Pres.



**YOU FILL IN
THE AMOUNT**

Follow the vocation nature intended you for and we will guarantee to increase your pay check 50 per cent in three years!

Do you know why ninety-five per cent of the people in the world are working for the other five per cent? Do you know why most of them are living from hand to mouth—why many have to exist on odd jobs or are without work of any kind?

Here are the reasons for this condition:

First—A large majority of men are doing work for which they are absolutely unfitted.

Second—Ninety men out of a hundred are not properly trained for the work they are doing.

Third—Only one man out of a hundred—even if properly trained—is able to sell his services for what they are actually worth.

How do **you** measure up to your job? Are **you** sure that you are doing the sort of work for which nature intended you? Isn't it possible that you could make more money in some other occupation?

The Vocational Experts of the **American School** will—**absolutely without charge**—make a thorough investigation of your case. They will, by means of a series of personal questions that you will be asked to answer, determine whether or not you are following the work for which you are best suited by nature and experience. They will give you advice that may change your whole future. Anyone may take advantage of this **free service** simply by mailing a postal.

Students of the **American School** will be thoroughly trained for the positions for which our analysis shows they are best fitted. Furthermore, our Free Employment Department will aid them in selling their services for the highest salary obtainable. **We actually guarantee all students who follow our instructions faithfully while studying, a 50 per cent salary increase within three years' time.**

A postal addressed to Department M will bring full particulars of this remarkable **Salary Increase Guarantee**, and a list of questions for you to answer that will enable our experts to personally analyze your case. You get this service whether you enroll as a student or not. Write today.

American School
of Correspondence, Chicago, U.S.A.

Please Mention Popular Mechanics



The Trip That Satisfies

Summertime will soon be here and with it the joys of a vacation trip. Where are you going? The Great Lakes is the mecca for particular and experienced travelers on business and pleasure trips. The D. & C. Line Steamers embody all the qualities of speed, safety and comfort. The freedom of the decks, the cool refreshing lake breezes, the commodious staterooms and parlors and unexcelled cuisine, makes life aboard these floating palaces a source of continual enjoyment.

"D. & C. a Service Guarantee"

Daily service between Detroit and Buffalo and Detroit and Cleveland. During July and August delightful day trips between Detroit and Cleveland—also two boats every Saturday and Sunday nights. Four trips weekly from Toledo and Detroit to Mackinac Island and Way Ports. From June 25th to September 10th Special Steamer Cleveland to Mackinac Island direct, making no stops enroute except at Detroit, each direction. Daily Service between Toledo and Put-In-Bay, June 10th to September 10th.

Railroad Tickets Accepted

For transportation on D. & C. Line Steamers between Detroit, Buffalo and Cleveland, either direction. Send for Illustrated Pamphlet and Great Lakes Map, showing routes, rates, etc. Address L. G. Lewis, General Passenger Agent, Detroit, Mich.

D. & C. TALISMAN—Send \$1.00 cash or money order, for D. & C. Good Luck Frog Charm. Men's Scarf Pin or Women's Brooch Pin, set with Mexican rubies and emeralds.

DETROIT & CLEVELAND NAVIGATION CO., 25 WAYNE STREET, DETROIT, MICH.

PHILIP H. McMILLAN, President

A. A. SCHANTZ, Vice Pres. and Genl. Mgr.



JUST PUBLISHED

Popular Mechanics

Shop Notes for 1916

529 Easy Ways
To Do Hard Things
469 Illustrations
224 Pages
Price 50c Postpaid

Reprinted from Popular Mechanics Magazine and comprising a series of 529 articles covering every department of mechanics with useful time and labor-saving kinks for all the trades. The following partial list of contents gives an indication of the wealth of material one will find in this book:

(Actual Size 6 1/2 x 9 1/2 in.)

Boat Dump—Automatic Siphon—Electric Door Lock—Gardener's Weeding Cart—Installation of Water-Heating Plant—Handy Jack—Spark Plug Tester—Steam Water Heater—How to Make a Log Canoe—Chute for Fish to Pass Over Dam—Decarbonizer—Tire-Fluid Gun—Home Made Folding Bed—Portable Oxycetylene Welding Outfit—Lining Up Shafting—Proper Fireplace Construction—Outdoor Fireplace—Small Crane for Wagon—Home Made Engine-Driven Tire Pump—Lift Pump—Concrete Mixer—Inexpensive Wood Pulleys—Iceless Refrigerator.

Complete series of Shop Notes consisting of 12 volumes \$6.00 prepaid or any single volume 50 cents postpaid.

POPULAR MECHANICS BOOK DEPT.
6 N. Michigan Ave., CHICAGO

A New 300 Page Book for Every Ford Owner, Dealer, Salesman and Repairman

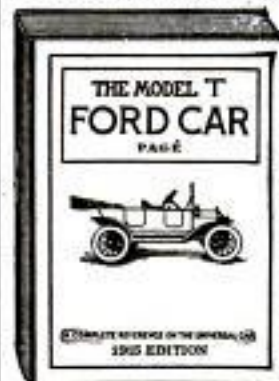

Deals Fully With
Construction
Operation
Repair
Over 100 Special Engravings
Price \$1 Postpaid

This is the Most Complete and Practical Instruction Book ever published on the Ford Car. All parts of the Ford Model T Car are described and illustrated, in a comprehensive manner—nothing is left for the reader to guess at. The construction is fully treated and Operating Principles made clear to everyone. Complete instructions for Driving and Repairing are given. Every detail is treated in a non-technical yet thorough manner. This book is written specially for Ford Drivers and Owners, by a recognized automobile engineering authority and an expert on the Ford, who has driven and repaired Ford Cars for a number of years. He writes for the average man in a practical way from actual knowledge. The illustrated chapter on Repairing and Overhauling alone is worth many times the price of this book. Special description of book sent on request. Also

A NEW FORD ENGINE CHART

makes location and correction of engine troubles easy. Size 25x38 in. PRICE 25c POSTPAID. Your money back if not satisfied.

Popular Mechanics Book Dept.
6 N. Michigan Ave., CHICAGO

Easy to Make Your Bike a Motorcycle

**Your "Foot-power" Bicycle Quickly
Converted into a Speedy, Light-
weight, Easy-running Motorcycle at
Small Expense**

Have you envied the fellow with a dependable motorcycle—the kind that gives perfect service at ALL times? Have you longed for one like his—but couldn't have one because of the high prices demanded for a really good motorcycle? Don't worry about high prices any longer—don't envy the owner of the best motorcycle made. You can make your dreams come true without further delay—and at small expense. Just attach a Shaw Motorcycle Attachment on your bicycle and ride anywhere the expensive motorcycles go. Now is the time to prepare for the fine days that you should enjoy in the great out-of-doors, without effort and with trifling expense. Plan your vacation now—with your bike transformed into a dependable motorcycle.

The SHAW Motor Fits ANY Bicycle

No brazing or changing of frame is needed. The Shaw attachment fits any model of any make. Just as simple and easy to detach as to put on—because it is portable. You can attach the Shaw motor and equipment without the aid of a mechanic or any extra expense. Anyone who can use an ordinary wrench and a common screwdriver can easily attach the outfit in a short time. Every part is complete and ready to attach to your bicycle without special tools or expert work.

Free Book Send right now for our interesting book "CONVERT YOUR BIKE INTO A MOTORCYCLE." Tells all about the Shaw attachment and the wonderful Shaw magneto. Don't think of paying the high prices demanded for motorcycles if you have an ordinary bicycle. The Shaw attachment fitted to your bike will mean a motorcycle of the highest type. Not an experiment. Thousands of Shaw attachments are in use in the United States, Canada, and other foreign countries.

Sign and Mail Coupon TODAY

We will send you full information about this remarkable attachment, prices, etc., also a list of second-hand motorcycles.

Shaw Manufacturing Co.
Dept. 171 GALESBURG, KANS.



A Few Points About the Shaw Attachment

The Shaw motorcycle attachment consists of the famous Shaw Motor— $2\frac{1}{2}$ H. P. all finished, assembled and tested, ready to be clamped to any bicycle frame. The Shaw Motor is strongly built, air cooled, of the four-cycle type. The Shaw weighs much less than other motors.

The Shaw motor will take you up hills of 20% grade—will go through sandy roads and surprise you with its pulling power. No ordinary road is too rough for it, nor hill too steep. Every piece and every part represents the highest grade materials that can be had. That is why we do not hesitate to cover each part and each piece with our broad and liberal guarantee against any defective material and workmanship.



**Sign-
MAIL NOW!**

Shaw Manufacturing Company, Dept. 171, Galesburg, Kans.
Send me your free book "Convert Your Bike Into a Motorcycle," giving full particulars about the Shaw attachment, also a special list of used motorcycles of all makes.

Name.....
Postoffice.....
Street or R. F. D.....
State.....

REFLEX

Spark Plugs

Built for the man who wants a better plug than is usually furnished with his car. Factory equipment on Henderson Motorcycles, White, Winton, and other high grade motor Cars. There is a REFLEX SPARK PLUG that will exactly meet the requirements of every motor. Every Reflex Plug is guaranteed—sold on

FREE TRIAL Offer

Buy a Reflex—use it 30 days. If it doesn't give you full satisfaction—prove the best plug you have ever used—return it and get your money back.

CONICAL REFLEX

\$1.00 postpaid, or at your dealers. State make of motor when ordering.

Dealers and Local Representatives Wanted Everywhere

The Reflex Ignition Company
1713 Payne Ave., Cleveland, Ohio



DEAFNESS!

The Audi-Aid is a new mechanical aid to hearing—no wires or batteries; nothing to get out of order. No more trouble than a pair of glasses.

AUDI AID \$7.50

Do you realize the hardship you are imposing on those who have to converse with you? This remarkable little instrument is neat—light—sanitary and convenient, yet it answers every purpose for those who are moderately hard of hearing.

Send today for our booklet about the Audi-Aid and information about our trial offer.

GLOBE EAR PHONE CO. 82 Tremont St. Boston, Mass.
Mfgs. of the famous Lorgnette Phone and Desk Ear-Phone



\$5.50 ELECTRIC FAN COMPLETE!

Price includes plug and 8 ft. cord. Universal motor good on alternating or direct current. Finished in black enamel. 11 inches high. Weighs 7 pounds.

AGENTS AND DEALERS WANTED!
Big money will be made this summer by men who represent this \$5.50 fan. WRITE FOR OUR OFFER TODAY.

Kasden Electric Co., 49 E. 21st St., New York

Thumb Brander



NEW & NOVEL JOKE to play on your friends. Fits on your thumb, and 'brands' your victims as you shake hands. Great fun. Won't wash off very easily, either. Any of these choice epithets: Owl, fool, liar, grooch, baby, chikka, hot air, bull. Complete with post and ink, 15c (post 2c), or any other brand made to order 25c complete.

JOHNSON SMITH & CO., 7129 North Clark Street, CHICAGO

INKLESS PEN



WRITES WITH WATER 600 words you dip. Makes its own ink. Writing indelible violet color. Lighter and cheaper than fountain pens. Writes a long letter with one dip in plain water. No trouble—no bother—no mess. A pleasure to use. With Nickel Plated Reservoir. Holder 10 CENTS, 2 for 25c postpaid. Points only 5c, 4 for 25c.

MORE-Power-Speed-Mileage

Magic MOTOR GAS

MAGICAL POWER FOR MOTORS
CUTS GASOLINE COST ONE-THIRD. Removes carbon deposits, improves lubrication, increases efficiency. Non-injurious. Guaranteed. Get 14 to 16 more power—more mileage. Guaranteed. At a cost of less than 1c per gallon of gasoline. One tablespoonful of this Wonderful Fluid added to every five gallons of gasoline energizes the sleepy, choked-up motor with new life—new vitality. Acts instantly—Keeps motor in a well lubricated and oily condition. Price Low. \$2.00 a Quart. Treats 100 gallons. Money refunded if not satisfied.

Exclusive Agents and Dealers Wanted
Big advertising campaign creating tremendous demand. Agents and Dealers needed at once in unoccupied territories. Big opportunity offered to live, ambitious men. Write at once. Profit \$25 to \$75 a week sure. An independent business. Investigate Now.
AUTO REMEDY COMPANY
110 Auto Bldg., CINCINNATI, O.



Save Now—Smile Later

Would you save \$10.00 monthly for a few years if you felt reasonably certain it would earn an income for you of \$1000 to \$1500 annually? This is what a DIXIE ESTATE planted to Avocado, Grapefruit and Oranges should do. We plant and care for DIXIE ESTATES for three years in the most up-to-date scientific manner. \$10.00 monthly pays for one, which will undoubtedly prove the biggest and best investment you could possibly make. We want a co-operative agent in every town to organize DIXIE ESTATE Clubs among his friends and neighbors. Splendid opportunity to earn large commissions.

Write today for free illustrated booklet and full information.

North Tampa Land Co., 836-140 S. Dearborn St., Chicago, Ill.

10-Second Balihone

Sharpen your razor in 10 seconds with a Balihone—ordinary or safety blade. Special offer. Balihone sent prepaid on 30 days' free trial, only \$1. Money back if not pleased. Safety blade holder 25c. Send today.

BALIHONE CO., Dept. 5248, Wilmette, Ill.

OIL PAINTING ON GRAIN OF CORN—Nearly 50 years ago a New Jersey artist executed a painting on a grain of corn, which he had picked up on the estate of President Buchanan while attending his funeral. It represents a winter scene, and is executed with great skill. This queer bit of art has had a remarkable story. It was lost about 40 years ago while on a journey of exhibition in European capitals, and was just recently restored to the artist, who has now decided to have the painting shown in this country.

WE WILL MAIL YOU \$1 PER FULL SET OLD FALSE TEETH

On Rubber or Metal Plates. Partial Plates in Proportion. Highest cash prices paid for Old Gold, Silver, Platinum Crowns, Bridgework, Mercury and Broken Jewelry. Send your package today by Parcel Post to

MUTUAL GOLD REFINING CO.
10 East Long Street COLUMBUS, OHIO

OLD AGE CAUSE AND CURE

Are you feeling the signs of old age—stiffening joints, weak eyes, rheumatic pains, poor memory, loss of mental force, weak digestion, lessening bodily powers? A man, young at 75, has a message of untold value for you! Write for our free booklet—or we will send you instructions, book and magazine. Keep the book five days. If you like it, send us your check for \$2.00 for book and a year's subscription to **Physical Culture Magazine**. If not, return the book only and owe us nothing. Address

PHYSICAL CULTURE PUB. CO., 2615 Flamingo Bldg., New York

Invisible INK

The most confidential messages can be written with this ink, for the writing **MAKES NO MARK**. Cannot be seen unless you know the secret. Invaluable for many reasons. Keeps your postals and other private memorandums away from prying eyes. Great fun for playing practical jokes. Only 15c Bottle



VANISHING INK

Most people are "a bit off" when in love; they write the most ardent letters, yet their affection soon cools. This remarkable ink is just the thing to record such fleeting love, for it is a copy of words the writing **vanishes completely**. Price 15c. **LUMINOUS INK**, visible only at night. Shines like fire. 15c.



JOHNSON SMITH & CO., 7129 North Clark Street, CHICAGO



5
DAYS'
FREE
TRIAL

That's all there is to the proposition we make you on the **SPLENDID, GENUINE**

Underwood Latest Style **\$58⁵⁰**
Standard Back Spacer
Visible Typewriter

Don't send a cent, just write us if you want to take advantage of our five days' free trial offer. No deposit is required. All we want is your permission to send you one of these machines on approval. The machine must then sell itself. The decision rests entirely with you.

You have never seen such typewriter value as we are offering in these Underwood machines. If we were to tell you how good they are you would say we were exaggerating. So we want you to see and use one right in your own office. That's the reason we are making, and can make, this five days' free trial offer.

If you like it send us only four dollars a month. But you pay not one cent till you have seen and used the machine for five days!

This machine we are offering is not the old style Model No. 4, but the latest style Underwood typewriter with the **Back Spacer** (the greatest improvement in typewriting since visible writing was introduced); this machine also has the two-color ribbon, the automatic ribbon movement, in fact every late style feature and improvement of this famous and most popular typewriter. Over one million of them have been manufactured and sold.

Every machine is complete with waterproof cover, tools, instruction book, etc. Remember, these machines are guaranteed to be absolutely perfect. They are guaranteed for one year, which is as long as any guarantee. And they are shipped anywhere on approval, without deposit, subject to five days' free trial and examination in your own home or office.

If you find the slightest thing to criticize, if you think you can get better value elsewhere for your money—return the machine at our expense. Surely no fairer offer could be made. And, bear in mind, this liberal proposition is made on the Underwood, the acknowledged leader of visible writers, of which over 10,000 are sold every month. And if you are renting a typewriter you can, by paying us a little more each month, own one of these high-grade, standard visible writers in a short time. Just think of it! A few cents a day for ten months and one of these typewriters is yours!

SPECIAL! No. 3 Model Underwood with 14-inch carriage, the regular way-bill machine with standard pica type, at a special low price of \$65.00—\$5.00 down, and \$5.00 a month, or less 6% for cash.

Fill out the coupon and mail it today. You take no chances. If the machine is not the greatest value you ever saw, just send it back at our expense. **ACT NOW**, as we have only a limited number of machines, and they will go like hot cakes on this wonderful offer.

ACCUMULATED STOCK DEALERS

When you write, just give us the names of two or three people who know you, merely as an evidence of good faith, etc.

ACCUMULATED STOCK DEALERS

TYPEWRITER INST. COMPANY, 229 No. Wells St., CHICAGO

FREE TRIAL ORDER BLANK

Typewriter Inst. Co., 229 No. Wells St., Chicago

Gentlemen—Please ship me a No. 4 Underwood Typewriter, E. O. B. Chicago, per your Ad. in Popular Mechanics Magazine. I will either accept the typewriter within five days of its receipt, or I will return same to you at your expense. If I accept the typewriter I will remit \$6.50 within the five days and pay the balance in monthly installments of four dollars each until the price \$58.50 has been paid. Title of machine to remain in your name until machine is fully paid for. **Cash price, 6% off, or \$55.00 cash.**

Name..... Address.....

References Required.....

Easy to own this good engine now

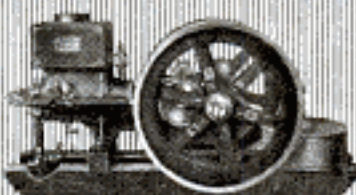

Send for my new, money-saving offer, before you arrange to try any engine, for any price. Compare my engine with any other, consider my low prices — (easy terms, if you wish), and you will see your advantage in having one of my

BAUER ENGINES

Kerosene, Gasoline, Distillate, Gas

Sizes, 2, 3, 5, 7, 9, 12, 15, and 18 horsepower. Now sold only direct from my own factory at prices averaging under \$16.50 per H. P. All sizes are of the up-to-date, long-stroke, valves-in-head, even speed type of engine. You can more intelligently select your engine after you have studied my engine book and my newest offer.

Guaranteed 5 Years Sold Direct from Factory to User

Over 21 years ago I made my first engine with my own hands, and the many thousands I have since made by their record of easy usefulness and great durability, prove that you take no risk when you get a BAUER engine.

Write for My Free Book

Send me your full address, now, so I can send you by return mail, my free book, which fully explains my engines, and shows how easy you can own a good engine, for a live-and-let-live price. Send the coupon or write me today.

**A. F. BAUER
ENGINE CO.**

478 Bauer Block
KANSAS CITY, MO.

Gentlemen: — Please send me without obligation on my part, your Free book and latest offer.

**A. F. Bauer
Engine Co.**

478 Bauer Block
Kansas City, Mo.

Name

Address

City.....State.....

Please Mention Popular Mechanics

Popular Mechanics Handbooks



PRICE
50 Cents
EACH, POSTPAID

A series of high-class, up-to-date books on mechanical subjects, "Written so you can understand it." Clearly printed on high-grade book paper and durably bound in cloth. Size, 5x7 inches. Each book contains many original illustrations.

Mission Furniture, How to Make It
(In Three Volumes) — Each book gives plain directions and working drawings.

Part 1 — 30 Designs, 128 Pages — 69 Illustrations.
Part 2 — 32 Designs, 128 Pages — 69 Illustrations.
Part 3 — 36 Designs, 128 Pages — 77 Illustrations.

Wood-Working for Amateur Craftsmen

Explains every cut, joint and process, proper use and care of tools, working up of material.
128 Pages, 125 Illustrations.

Arts-Crafts Lamps, How to Make Them

16 beautiful lamp designs with instructions, working drawings and illustrations.
96 Pages, 50 Illustrations.

Lamps and Shades in Metal and Art Glass

19 designs in four different kinds of construction; built up, soldered, etched and sawn shades.
128 Pages, 64 Illustrations.

Metal Work and Etching

A complete manual for art metal workers. Tells how to make a variety of articles, such as desk sets, jewelry, hinges, match boxes, pipe racks, etc.
96 Pages, 50 Illustrations.

Electroplating

One of the best books ever written on this subject. It is by a practical plater of 30 years' experience.
112 Pages, 62 Illustrations.

Wireless Set, How to Make

Explains the construction of an outfit for transmitting four or five miles.
96 Pages, 11 Illustrations.

Metal Spinning

A practical working manual on this fascinating art.
80 Pages, 33 Illustrations.

Heat

An immensely interesting and instructive book pertaining to heat and its relation to modern mechanics.
128 Pages, 50 Illustrations.

The Kingdom of Dust

A remarkable book dealing with a scientific subject in a non-technical manner.
128 Pages, 40 Illustrations.

ADDRESS

Popular Mechanics Book Dept.
6 N. Michigan Ave., CHICAGO



No Money In Advance

This Marvelous CAMERA ON FREE TRIAL

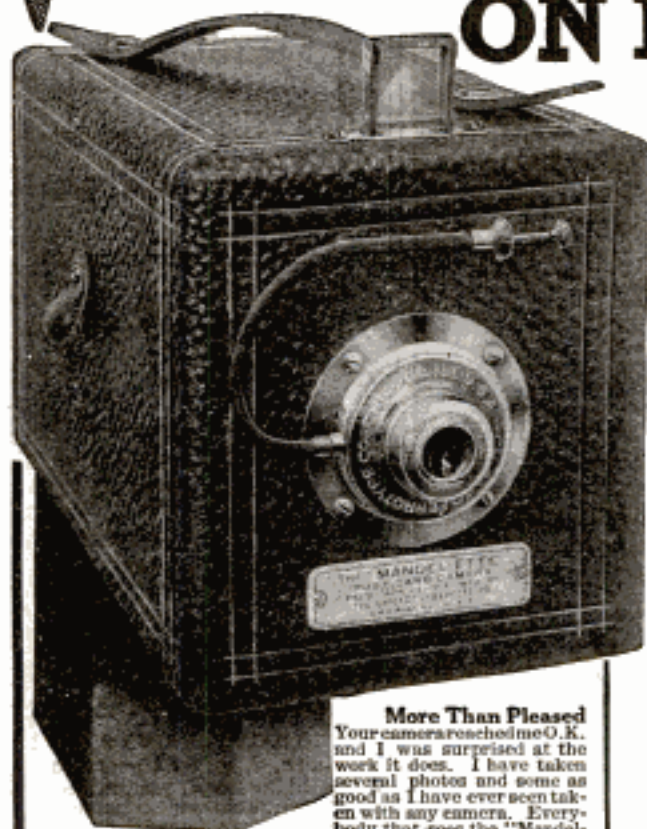

Only 10,000 of these marvelous instantaneous picture-taking and making cameras to be sent out absolutely on approval without a penny in advance just to prove that it is the most wonderful invention—the camera-sensation of the age. So you must send for it quick! Just think of it—the new Mandel-ette

Takes and Makes Finished Pictures INSTANTLY!

You press the button, drop card in developer and in one minute take out a perfect, finished post card photo $2\frac{1}{2} \times 3\frac{3}{8}$ inches in size. Camera is about $4\frac{1}{2} \times 5 \times 7$ inches. Loads in daylight 16 to 50 post-cards at one time.

No Films—No Plates—No Dark Room

Not a bit of the fuss and bother of the ordinary kodak or camera. It is instantaneous photography! Universal focus lens produces sharp pictures at all distances. Pictures develop and print automatically. Can't over-develop. Results positively amazing.

We Trust You

No difference who you are, where you live or what your age, we will send you the complete "Mandel-ette" outfit absolutely on approval and give you 10 days to test it. But when you see what elegant pictures it takes—so quick, so easy, with no trouble at all—if you wish to keep it you simply send us \$1.00 per month until our special price of only \$5.00 is paid.

Easy Payments—No References

No red tape of anykind. Monthly payments so small you'll not notice them. Simply fill out and mail coupon today. Send no money. No references required. Lots of fun—big profits.

Chicago Ferrottype Co.,
Desk 252 Ferrottype Building,
Chicago, Illinois

Send me at once one complete model Mandel-ette Camera outfit including supply of postcards and instructions. I agree to examine and test it thoroughly and if satisfied keep it and pay you \$1.00 a month until your special price of \$5.00 is paid. Otherwise I will return it at the end of 10 days.

Anyone Can Use Them

Received the "Mandel-ette" and supplies Saturday evening. Sunday morning we began to take pictures and had very good luck. It is sure simple enough. Anyone can use them. We couldn't get along without ours.

MRS. R. U. IDDINGS,
Mapleton, Ia.

Amazed At Minute Camera

I am enclosing pictures taken with my "Mandel-ette" to show you gentlemen what I am making. Nobody taught me but your instructions. I am making pictures with great pleasure and my friends are amazed at your very high grade minute camera.

C. SATURN,
Santa Ana, Alaska

More Than Pleased

Your camera reached me O.K. and I was surprised at the work it does. I have taken several photos and some as good as I have ever seen taken with any camera. Everybody that sees the "Mandel-ette" says it is fine and I am more than pleased with it.

VERNIE BOYLE,
Northome, Minn.

Beats All Things Yet

The "Mandel-ette" received and opened and in 20 minutes I took a splendid picture of my wife, fully developed and ready to look at. My, this beats all things yet.

T. J. HOUTS, Pastor,
Methodist Episcopal Church,
South, Welch, West Va.

Takes Pictures On Dark Day

I am perfectly delighted with the "Mandel-ette." I have had very good success never before to have handled a camera at all. I can say it will do all you claim. I have taken a picture which shows a Mt. more than 4,000 feet away and on a very dark day.

JAS. H. HUBBARD,
Penhook, Va.

No Experience Required

Plain instructions and everything complete with outfit so you can begin taking pictures the moment it arrives. We guarantee that even a child can operate it. Mail coupon now. No risk or obligation to keep camera.

Chicago Ferrottype Co., Desk 252 Ferrottype Bldg.,
Chicago, Illinois

Name.....

Address.....

Town..... State.....

Please Mention Popular Mechanics

The Burlington SMASHES ALL WATCH PRICES



Look!

- 9 19 Ruby and Sapphire Jewels—
- 9 Adjusted to the second—
- 9 Adjusted to temperature—
- 9 Adjusted to isochronism—
- 9 Adjusted to positions—
- 9 25-year gold strata case—
- 9 Genuine Montgomery Railroad Dial—
- 9 New Ideas in Thin Cases.

Only \$2⁵⁰ A Month

And all of this for \$2.50—only \$2.50 per month—a great reduction in watch prices—direct to you—positively the exact prices the wholesale dealer would have to pay. We do not care to quote these prices here, but write—write before you buy. Think of the high grade, guaranteed watch we offer here at such a remarkable price. Indeed, the days of exorbitant watch prices have passed.

See It First

You don't pay a cent to anybody until you see the watch. We won't let you buy a Burlington Watch without seeing it. Look at the splendid beauty of the watch itself. This model, handsomely shaped—aristocratic in every line. Then look at the works. There you see the pinnacle of watch making. You understand how this wonder timepiece is adjusted to the very second.

Every fighting vessel in the U. S. Navy has the Burlington Watch aboard. This includes every torpedo boat—every submarine as well as the big Dreadnaughts.

Send Your Name on This Free Coupon

Get the Burlington Watch Book by sending this coupon now. You will know a lot more about watch buying when you read it. You will be able to "steer clear" of the double-priced watches which are no better. Send the coupon today for the watch book and our offer.

Burlington Watch Co.

19th St. & Marshall Blvd., Dept. 1195, Chicago, Ill.

Burlington Watch Co.

19th Street and Marshall Blvd.
Dept. 1195 Chicago, Ill.

Please send me (without obligation and prepaid) your free book on watches with full explanation of your cash or \$2.50 a month offer on the Burlington Watch.

Name

Address

Please Mention Popular Mechanics

Copyrighted material

PLAY BILLIARDS

At Home For a Life-Time Soon Paid at 10c a Day



Famous Brunswick
"BABY GRAND"
Combination Carom and Pocket
Billiard Table that brings you
33 rollicking games

TO get full enjoyment out of home life, accept our 30-day trial offer and sample the witchery of carom and pocket billiards *in your home*. These games put new blood into grown-ups.

Daughters soon develop gracefulness and poise around these expert Brunswick Home Tables. Such fair opponents and such royal sport

make any home the rendezvous of young folks!

Parents write how billiards builds the sinews of manhood in their boys, teaches love of home and *clean companions*.

Send today for our free billiard book and read the endorsements of doctors, ministers, educators and mothers.

Brunswick Tables \$27 UP

In Sizes to Fit All Homes

Yes, regardless of room, there is now a man's size Brunswick that *your home* will easily accommodate.

Regardless of size or style, these tables are masterfully built of rare and beautiful woods. Genuine Monarch Cushions—the choice of experts; fast, ever-level billiard beds and accuracy unexcelled.

"Quick Demountable" Brunswicks can be set up anywhere and taken down in a jiffy.

"Grand" and "Baby Grand"

Are really the celebrated Brunswick regulation tables, modified only to harmonize with home surroundings.

"Convertible" Brunswicks form perfect dining and library tables when not in play.

Balls, Cues, Etc., FREE!

Complete Playing Outfit—Balls, Cues, Rack, Markers, Cue-Clamps, Tips, expert book of 33 games, etc., all included without extra cost.

See these beautiful tables in realistic colors, get low factory prices, easy terms and 30-day home trial offer—all shown in our widely-read book, "Billiards—The Home Magnet." *IT'S FREE*. Send the coupon today.

This Brings Billiard Book FREE

The Brunswick-Balke-Collender Co.
Dept. 33X, 623-633 S. Wabash Ave., Chicago
Send free, postpaid, your color-photo book

"Billiards—The Home Magnet"
and tell about your home trial offer.

Name

Address (534)



The Kingdom of the Subscriber

In the development of the telephone system, the subscriber is the dominant factor. His ever-growing requirements inspire invention, lead to endless scientific research, and make necessary vast improvements and extensions.

Neither brains nor money are spared to build up the telephone plant, to amplify the subscriber's power to the limit.

In the Bell System you have the most complete mechanism in the world for communication. It is animated by the broadest spirit of service, and you dominate and control it in the double capacity of the caller and the called. The telephone cannot think and talk for you, but it carries your thought where you will. It is yours to use.

Without the co-operation of the subscriber, all that has been done to perfect the system is useless and proper service cannot be given. For example, even though tens of millions were spent to build the Transcontinental Line, it is silent if the man at the other end fails to answer.

The telephone is essentially democratic; it carries the voice of the child and the grown-up with equal speed and directness. And because each subscriber is a dominant factor in the Bell System, Bell Service is the most democratic that could be provided for the American people.

It is not only the implement of the individual, but it fulfills the needs of all the people.



**AMERICAN TELEPHONE AND TELEGRAPH COMPANY
AND ASSOCIATED COMPANIES**

One Policy

One System

Universal Service

Please Mention Popular Mechanics



Read!

1. Tilt back paper shelf.
2. Extra wide platen.
3. Line space lever.
4. Two color ribbon shift.
5. Shift lock.
6. Back spacer.
7. Right hand shift keys.
8. Universal keyboard.
9. Left hand shift keys.
10. Margin release key.
11. Tabulator key.
12. Two color ribbon.
13. Carriage release key.
14. Feed roll release lever.
15. Paper fingers.
16. Removable platen.
17. High writing line.
18. Tool steel center guide.
19. Line lock.
20. Stencil cutting.

\$250
A MONTH

Buy this **Brand New 1916 REX**, The King of Typewriters. Absolutely the Finest, Standard equipment—10 year guarantee. You don't pay a cent to use it for 10 days. You try it **before** you **buy** it—no money in advance.

SPECIAL!
Record Breaking
OFFER!
Typewriter Prices
SMASHED!

WRITE—Write Before You Buy

Don't spend a cent, not even \$15 until you get our competition defying, amazing, rock bottom, factory price! Nothing like this new, startling, revolutionizing price ever heard of in the history of typewriters. **THIS ASTOUNDING PRICE** is lower than the regular wholesale price—about what you would have to pay for a good, late model, second hand. We prove the REX to be superior to any other \$100 typewriter made—tested for eight years—used by America's leading merchants, banks, railroads and professional men.

Free Instructions
in Typewriting

REX TYPEWRITER COMPANY
Dept. 111, Steger Building, Chicago, Illinois
Please send (prepaid postage) your free catalog and wonderful special cut price—easy payment offer on REX Typewriters.

SEND THIS COUPON →

For **FREE CATALOG** and valuable free information about typewriters and the cost of making and selling them—no charge—no obligation—send today—**NOW**.

REX TYPEWRITER COMPANY
Dept. 111, Steger Building, CHICAGO, ILLINOIS

Name.....

Address.....



It's
a short
shave.
that has
no
burning



— that is if you use

COLGATE'S RAPID-SHAVE POWDER

TRADE MARK

The plentiful, softening, soothing lather of Colgate's Rapid-Shave Powder is quickly and easily made. Moisten the face, sprinkle a little powder on the wet brush—then *lather*.

The beard is softened quickly—the lather is worked up on the face; no mussy "rubbing in" is necessary.

A little powder makes an abundant, creamy lather—there is no after-smart or burn, but on the contrary the face is left with a soothed, comfortable feeling. Colgate's lather does not cling to the razor edge and is easily rinsed from the face.

The same perfect lather with Colgate's Shaving Stick and Colgate's Perfected Shaving Cream for those who prefer.

Sold everywhere—or a trial size of Stick, Powder or Cream sent for 4c. in stamps

COLGATE & CO.

DEPT. 81
NEW



199 FULTON ST.
YORK

Makers of Clorox Disinfectant Soap—luxurious, lasting refined