

THIS ISSUE 440,000 COPIES

# POPULAR MECHANICS MAGAZINE

WRITTEN SO YOU UNDERSTAND IT

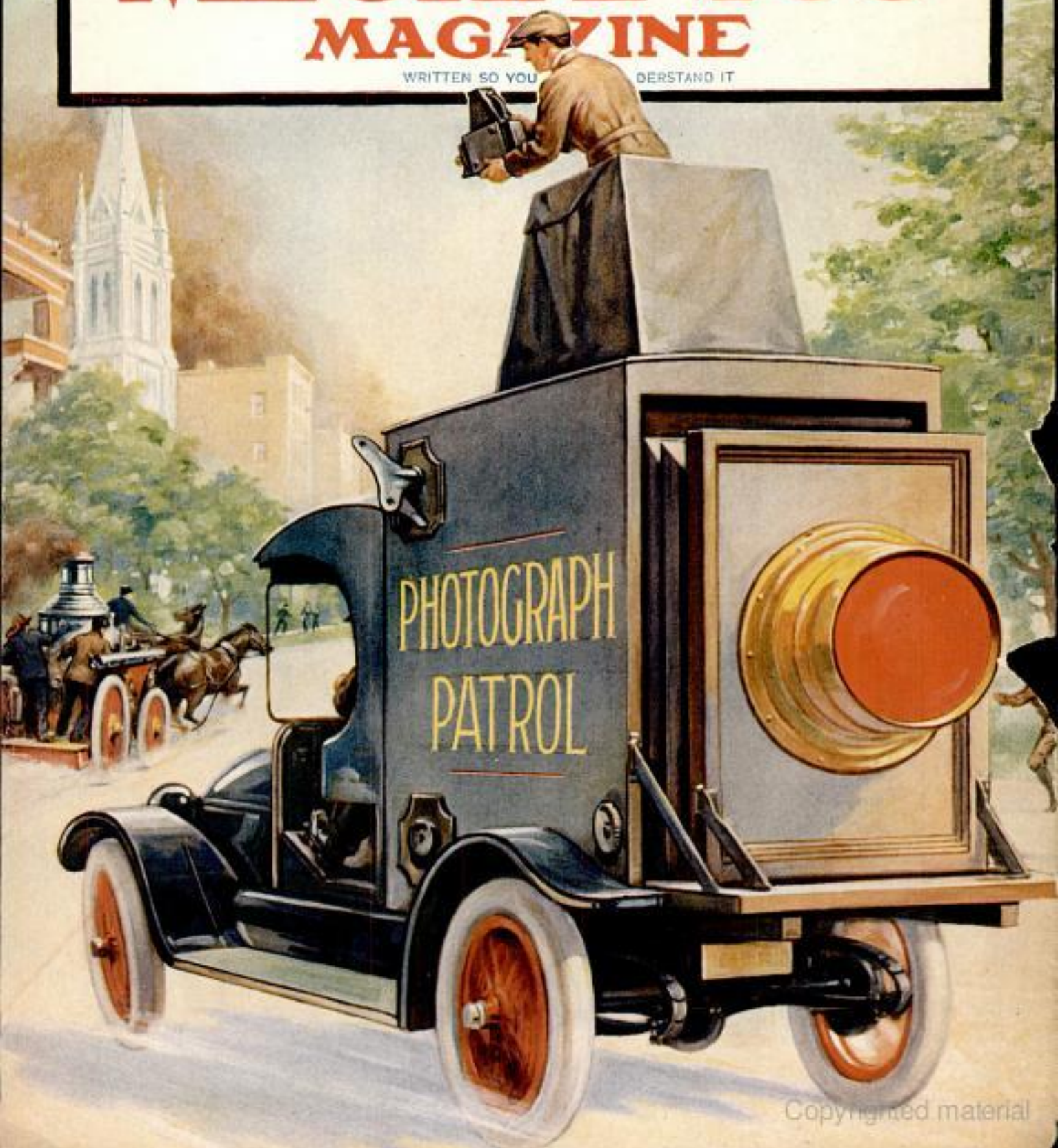

# NOW IS THE TIME TO BUY! Prices Are Bound to Go Higher



**\$767** Harris Home  
No. 161  
6 rooms, bath, etc.

## Build Your Home The Harris Way Read This News!

While the prices of all building materials continue to soar sky-high we announce several mammoth purchases that secured us materials at one-third to one-half under regular market prices.

While all others have boosted their last year's prices much higher, we give you the advantage of B-U-S-T-E-D prices on all materials and Harris Homes.

**Harris Homes are sensibly cut-to-fit**—built under the most perfect building system ever devised. It took us (the originators) a quarter of a century to perfect it, and you get the benefit of our experience free. Send for our new Plan Book of Harris Homes which shows over one hundred modern American houses and bungalows in beautiful engravings, with floor plans, material specifications and complete information.



**\$583** Harris Home  
No. 61  
6 rooms, bath, etc.

**No Money Down!**  
We furnish free, perfected plans, guaranteed bills of material, correct specifications, and full directions to work by.

**Harris Homes are** shipped to you in one quick shipment from our Chicago factory. No money down. You have the privilege of inspecting the material before accepting it. Our liberal terms are explained in our Free Plan Book of Harris Homes.

## Guaranteed Material

For all Harris Homes we furnish clear and knotless lumber and millwork in all exposed places, clear modern Craftsman style interior finish, Creosoted foundation wall plates, beautiful doors, satin finish hardware, guttering and down-spouting, etc. All materials in harmony with the designs. All guaranteed and backed by our \$10,000,000 capital. Our free Plan Book of Harris Homes gives full details.

## Save \$35 to \$85 on Heating Plants



We also secured a great stock of heating plants of all kinds and now offer you the greatest heating plant proposition of the year. Our prices actually save you  $\frac{1}{3}$  to  $\frac{1}{2}$ .



**\$135** buys a complete brand new Hot

Water plant for a six-room house, including low fire-box heater, pipe, radiation, etc. **\$125** buys a complete steam heating plant for the same size house. Get our new free Plumbing and Heating Book and write us a letter stating your needs, etc.

### Roofing 38c Per Roll

Our **AJAX** roofing is a very high grade covering—the biggest roofing value offered today. Get our free samples and roofing book.

**Galvanized \$2.25 Per Sq.** We can furnish galvanized and all metal roofing and Ornamental Ceiling Plates, etc., at big savings. Get our new Roofing Book.



**\$29.75** Buys This Bathroom Set

This bargain bathroom set is only one of the many similar bargains in our Plumbing and Heating Book. This set includes a 5-ft. roll rim porcelain enameled bath-tub, "D" shaped wren lavatory, Poppen Jet low-down closet toilet. All complete with trimmings and guaranteed by us.

We offer a complete Warm Air heating system for a six-room house for \$57. We also can furnish pipeless furnaces for the same size houses, at the low price of \$45 each. Get our new, free Plumbing and Heating Book—write us a letter stating your needs.

## World's Best Engines Save \$10 Per H. P.



We secured an enormous stock of McVicker and Humely Olds gasoline engines. Our prices save you \$25 to \$100 per engine. Get our Gasoline Engine Bargain Price List.

### SEND THIS COUPON

Harris Brothers Co., Dept. E1-7.

Send me free of charge the books checked X

- |  |   |
|--|---|
| <input type="checkbox"/> Plan Book of Harris Homes | <input type="checkbox"/> Plumbing and Heating |
| <input type="checkbox"/> Gasoline Engine Bargains  | <input type="checkbox"/> Roofing              |
| <input type="checkbox"/> Machinery & Equipment     | <input type="checkbox"/> Paints               |
| <input type="checkbox"/> Building Material         |   |

Name.....

Address.....

## ALL THESE BOOKS ARE FREE!

Each catalog shown here is a complete encyclopedia of the subject it treats. Any or all sent free. Ask for them in the coupon.



**Harris Brothers Co.** 35th & Iron Sts. CHICAGO, ILL.



make records for the Victor

## Victor Records have familiarized millions with the masterpieces of music

A comparatively few years ago the soul-stirring arias and concerted numbers that have immortalized the names of the great composers were hidden mysteries with only an occasional opportunity, at rare intervals, to hear and become familiar with them.

Today millions of people are familiar with them through the wonderful achievements of the Victor. The Victor Records of these musical treasures have revealed their sublime beauty to music-lovers in every part of the world.

They are presented in all their grandeur by the world's greatest artists whose exquisite renditions are the standard by which the artists' actual performances are judged.

They are noteworthy achievements in the art of recording that have established Victor supremacy on a basis of great things actually accomplished.

Any Victor dealer in any city in the world will gladly play any music you wish to hear and demonstrate to you the various styles of the Victor and Victrola—\$10 to \$400.

**Victor Talking Machine Co., Camden, N. J., U. S. A.**

Berliner Gramophone Co., Montreal, Canadian Distributors

**Important warning.** Victor Records can be safely and satisfactorily played only with Victor Needles or Tunga-tone Stylus on Victors or Victrolas. Victor Records cannot be safely played on machines with jeweled or other reproducing points.



**The Famous Sextet from Lucia**  
by Tetrizzini, Caruso, Amato, Journet, Jacoby, Bada (96201)

# Victrola



New Victor Records demonstrated at all dealers on the 28th of each month

"The money you *don't* have to put into repairs is **ALL PROFIT**—

— **USE CYPRESS**"



"THE WOOD ETERNAL"

"AN ARTISTIC PERGOLA EXTENDS THE 'HOMEY' FEELING TO 'ALL OUT-DOORS.'"

## PERGOLA DAYS ARE HERE

and **CYPRESS** is the pre-eminent pergola wood because "**CYPRESS** lasts practically forever" — **DEFIES ROT-INFLUENCES** which destroy other woods—does not warp, shrink or swell like most woods—takes paint and stain perfectly.

A well-planned Pergola is the finishing touch to the architectural and landscape perfection of elaborate grounds—it is "the one thing needful" to confirm the artistic character of a typical modest homestead — and it may be fully relied upon to redeem and beautify even the smallest yard, or one that is lacking in natural advantages.

**VOL. 30**  
OF THE **CYPRESS**  
**POCKET**  
**LIBRARY**  
**FREE ON**  
**REQUEST**

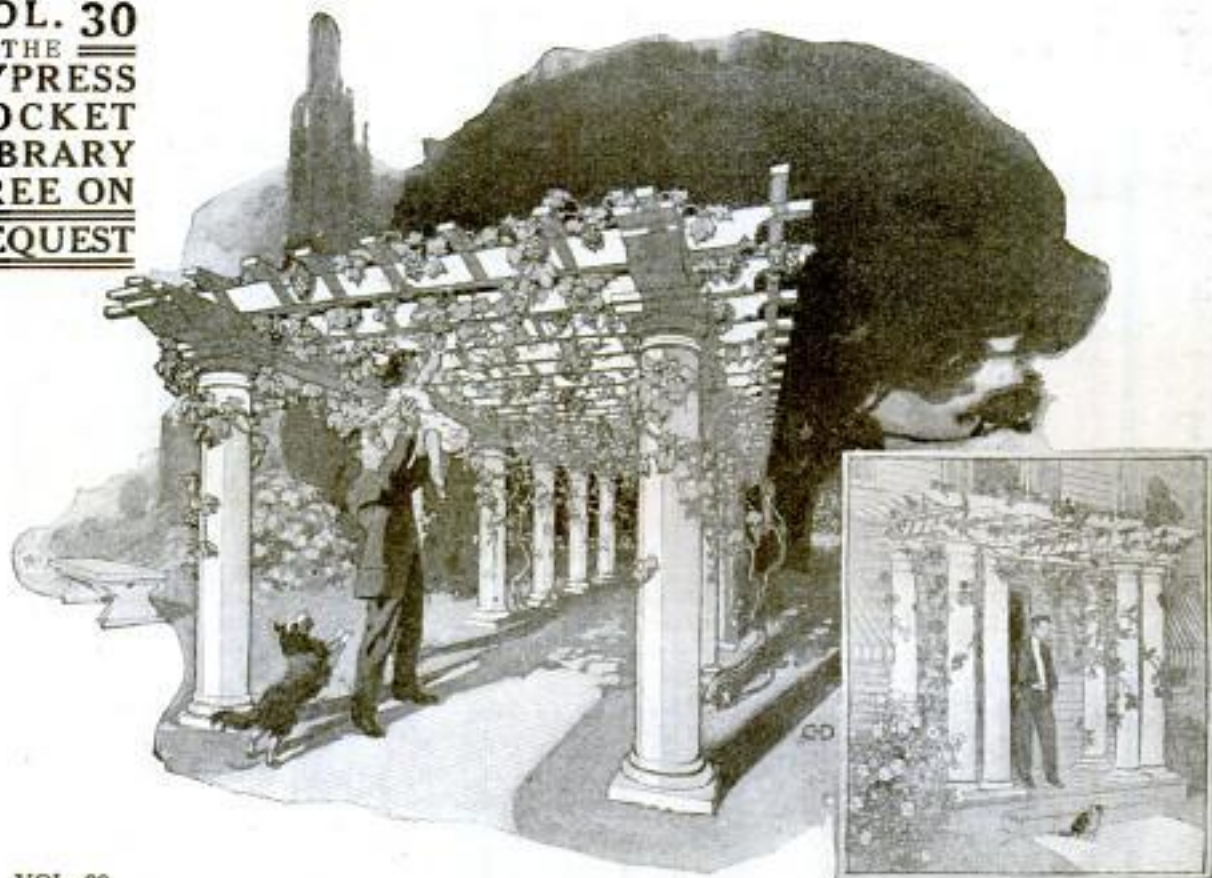

**VOL. 30**

contains ORIGINAL SKETCHES, DETAILED WORKING DRAWINGS (on sheet 24 x 36 inches) and FULL SPECIFICATIONS for erecting a VARIETY of PERGOLAS, GARDEN ENTRANCES, SEATS, etc., of many different artistic styles, and costing from a few dollars up to several hundreds. Not "stock patterns"—each was SPECIALLY DESIGNED for us. WRITE TODAY for VOL. 30.

When planning a Pergola, Mansion, Bungalow, pasture-fence or sleeping-porch, remember — "With **CYPRESS** you **BUILD BUT ONCE**."

Let our "ALL-ROUND HELPS DEPT." help YOU. Our entire resources at your service with Reliable Counsel.  
**SOUTHERN CYPRESS MANUFACTURERS' ASSOCIATION**  
1219 HIBERNIA BANK BLDG., New Orleans, La., and 1219 HEARD NATIONAL BANK BLDG., Jacksonville, Fla.

INSIST ON CYPRESS AT YOUR LOCAL LUMBER DEALER'S. IF HE HASN'T IT, LET US KNOW IMMEDIATELY

# Popular Mechanics Magazine

6 N. Michigan Avenue, Chicago, U. S. A.

EDITED BY H. H. WINDSOR

England: The International News Co.,  
5 Breems Bldg., Chancery Lane, London, E. C.

Australia:  
The Australasian News Co.

ISSUED MONTHLY

SUBSCRIPTION:

SINGLE COPY, 15 CENTS

In United States, and its possessions, Cuba and Mexico, per year, postpaid . . . . . \$1.50  
To Canada . . . . . 1.75  
To all other countries in the Postal Union . . . . . 2.50

All subscriptions are discontinued at expiration. Please examine the date printed on your wrapper.

Entered as Second Class Matter Sept. 15, 1903, at the Post Office at Chicago, Illinois, under Act of March 3rd, 1879.  
Entered as Second Class Matter at the Post Office Department, Canada.

Published monthly by POPULAR MECHANICS CO.

Copyright, 1916, by H. H. WINDSOR.  
Copyright, in France.

*Paper Photographic Raw 565*

## Contents for April, 1916

Aeroplane, Domestic, Good Speed Showing Made by . . . . .	520
Agricultural Implement—Checker, Rice Land, Builds Levee in One Operation . . . . .	492
Air Cooler for Sleeping and Sick Rooms . . . . .	601
Air Craft, Enemy, Apparatus for Combating . . . . .	498
Airships—Experiencing a Zeppelin Raid, by R. I. Bjurstedt . . . . .	513
Animals, Electrical Cabinets for Execution of . . . . .	592
Animals, Dental Room for in Boston Institution . . . . .	565
Ash Tray and Match Holder, Ornamental . . . . .	553
Athletic Field on Roof of Business House . . . . .	557
Automobile Carries Boat and Hunting Outfit . . . . .	559
Automobile, Light, Simple Lock is Designed for . . . . .	554
Automobile, Novel Body of Used as Dark Room . . . . .	493
Automobile Specially Equipped to Aid Other Motors . . . . .	558
Automobile Tires, Maching Tests Quality of . . . . .	591
Automobiles, Storm Curtain Opener is Convenience for . . . . .	579
Bag, Traveling, with Disappearing Handle . . . . .	599
Basements of Hotels Become First Floors . . . . .	508
Bench, Vine Canopied, is Pleasing Park Feature . . . . .	577
Binding Rare Old Books is Interesting Art . . . . .	512
Bird House, Cleanliness of Invites Tenants . . . . .	545
Boiler, Mud in Causes "Bag" in Its Shell . . . . .	552
Bread Pans, Machine Cleans and Greases . . . . .	537
Bricks, Cement, are Made by Hand Apparatus . . . . .	498
Bridge, Great Two Level, Erected at Cleveland . . . . .	587
Bridge, Long Spans of Floated into Place . . . . .	479
Building of Unusual Design, El Paso School . . . . .	484
Building—Y. M. C. A. Plant, New, Costs Million and Half . . . . .	602
Buildings, Old Venetian, Sand and Masonry Shield . . . . .	547
Calendar, Desk, Thirteen Weeks of Dates Shown on . . . . .	568
Canopies, Portable, Shield Workers from Sun . . . . .	576
Carnival of Winter Sports at St. Paul . . . . .	494
Casket, Clay, Practically Indestructible . . . . .	604
Clock, Strange, Many Years Required to Build . . . . .	580
Concrete Bench Marks, Stovepipe for Molding . . . . .	595
Concrete Blocks, Toy Outfit for Making . . . . .	594
Concrete Reinforcing, Spacing Bar Simplifies . . . . .	590
Concrete, Working in Cold Months with . . . . .	502
Costumes—Recreation Togs with Snap for the Girl . . . . .	511
Couplers, Electromagnet, Expedite Switching . . . . .	523
Current Readings Taken under Difficulties . . . . .	554
Dam, New, Beauty as Well as Bigness Feature of . . . . .	560
Deaths, Motor Car, Lessen as Machines Increase . . . . .	600

Dishes Washed by Machine in Minute's Time . . . . .	552
Door Knocker, Hand Decorated . . . . .	598
Drafting Instruments, One Tool Combines Three . . . . .	547
Driftwood Catcher Built Like Fence . . . . .	503
Driftwood Rich Harvest for River Lumbermen . . . . .	500
Dry Dock, Boston's Great, Now under Construction . . . . .	506
Electric Arc, New, Low Operating Charge Aim of . . . . .	496
Electric Devices, Homes Entirely Equipped with . . . . .	581
Electric Lamp for Wagon or Carriage . . . . .	589
Electric Lamp, Powerful Photographic, with Blue Bulb . . . . .	490
Electrocution, Danger of in Bathrooms . . . . .	546
Engine Drivers, Effective Lookout Shade for . . . . .	528
Exhibit, Reconstruction in France to be Aided by . . . . .	588
Eye, Human, Accounts for Vanishing Ghosts . . . . .	586
Fan, Folding, Which may be Carried in Hand Bag . . . . .	598
Fan, Water Cooled Breezes Emanate from . . . . .	566
Ferns Sold by Florists, Where Come from . . . . .	500
Fire Damp, Electric Instrument Detects . . . . .	521
Fire Ruins Canada's Parliament Building . . . . .	490
Fireless Cooker, Wall Cabinet, for Kitchen . . . . .	598
Fireplace, Coal Dealer's, Made of Hard Coal . . . . .	543
Fish, Alaskan, Shipped via Canada to United States . . . . .	595
Fish Lifted over Falls by Ingenious Elevator . . . . .	482
Flag, Grant's, Preserving against Disintegration . . . . .	505
Flash Light Gun Operates Camera Shutter . . . . .	589
Flood and Wind Sweep Southern California . . . . .	527
Floor, Moving, Innovation at New York Cafe . . . . .	545
Foot Warmer of New Type . . . . .	599
Fork, Convenient Toasting, Which Telescopes . . . . .	599
Freight Rates and Rules Altered by New Law . . . . .	548
Fruit Collector, Simple, Saves Labor . . . . .	544
Fur from Many Lands Used in Making Felt Hats . . . . .	590
Furniture—Chiffonier and Cedar Chest Combined . . . . .	485
Gas Engine, Two Cycle, New Type of . . . . .	593
Glass, Stained, Parrot of Novel Transparency . . . . .	509
Gloves, Women's, New Artistic Designs in . . . . .	519
Heater, Automobile Engine and Radiator Kept Warm by . . . . .	496
Heater, Convenient, Made for Small Car . . . . .	592
Hogs, Device for Holding While Ringing Them . . . . .	592
Home, New Cripples', Many Desirable Features in . . . . .	499
House Plan—Bungalow, Pleasing Brick, of Moderate Cost . . . . .	640
Household Arts Taught in Model House on Wheels . . . . .	496
Ice, Cutting from Snow Incrusted Fields . . . . .	525

[Continued on Page 6]

Popular Mechanics offers no premiums; does not join in "clubbing offers," and employs no solicitors to secure subscriptions. It is for sale by nearly every newsdealer in the United States and Canada.

This One



0HWD-65N-6X7E Copyrighted material

## [Contents—Continued]

Indians, Eastern Canada's, Called to Colors.....	600
Irrigation Project in India, Great, Completed....	594
Kids, Angola, Individual Shelters Used to Protect	497
Kitchen Utensil—Vegetable Corer.....	599
Kitchenette, Modern, Made Household Labora- tory.....	548
Knife Sharpener, Londoner Attaches to Bicycle..	549
Lathe, Gun, of Napoleon's Time Operated by Horses.....	597
Laundry Drier Utilizes Heat from Gas Stove....	582
Letter Opener, Hand Operated, Saves Time.....	528
Light Dimming Prevented by New Regulator....	558
Lightning Rods Protect Straw Stacks.....	570
Mail, Alaska, Undelivered for Eight Months....	526
Mail Box, Glass, Presents Artistic Appearance..	560
Man, One Armed, Lepless, Motorcycle Tourist... 555	
Mask Enables Person to Sleep in Daytime.....	598
Men, Drowned, Hat Thrown into Stream Locates	578
Milk Dispenser Designed for Soda Fountain....	510
Milk Shaker Resembles Shrapnel Shell.....	498
Mirror Device, Old World, Also Used in America	548
Mirrors, Burnished Metal, for Soldiers.....	595
Monograms on Radiator Caps Is New Practice..	592
Monoplane Gives Germans Prestige in Air.....	481
Mop, Scouring, Cleans Pots and Pans Quickly... 598	
Mosaic, Fine Specimens of in Memorial Chapel..	569
Motor Control, Compact, of Interesting Type... 562	
Motor Trucks, New Snowplow Attachment for... 520	
Motorcycle Engine Primed with Acetylene.....	598
Mountain, Chiseled Granite, Will Commemorate Confederacy.....	488
Moving Picture Drama, "Safety First" Car Shows	580
Moving Plan, Odd, Adopted by Wholesale House	492
Multiplying Device, Small, Clamps to Pencil... 480	
Novel and Practical Things for the Home.....	598
Oil Feed Indicator Stops Motor and Limits Speed.....	546
Opals, Costly Black, Australia Alone Produces..	566
Orchards, Ice Is Used in to Retard Budding....	590
Ostrich Farming a Profitable Enterprise, by Robert H. Moulton.....	555
Paper Hanging Machine Does Work of Three Men.....	578
Paper Outfits Protect Airmen from Cold.....	548
Patents, Minor Motor Car, to Be Cross Licensed	598
Penknife and Pencil, Combination.....	599
Petition, Arms Embargo, Largest on Record....	509
Photography—Snapshots, Night, Making without Flash Lights.....	498
Pin, Drawing, Has Movable Handle.....	602
Pipe Line Built across Rugged Country.....	582
Pines, Water, Instrument Detects Leaks in.....	522
Platforms, Cork, Traffic Squad Uses in Winter..	585
Playhouse, Elevated, Built in Clump of Trees... 512	
Potash Content, Wyoming Hills Found Rich in.. 490	
Printing Process, New, Imitates Engraving....	505
Prison Life, Real, Shown in Exhibits and Film..	592
Pumice, Floating Mass of near Fiji Islands....	554
Pusher and Four Horses Do Work of Many Men	553
Rabies, First Case of in England in Many Years..	512
Railroad Cars, New Sliding Buffer for.....	550
Refuse Holders, Artistic, for New York Park... 524	
Roads, Flower Bordered, in Reach of Motorists.. 510	
Sea, Sulu, Trade Route Changed by Survey in... 502	
Seed Tester, Low Priced, of Serviceable Type... 565	
Sewer Cleaning Machine Floods Pipe Interiors.. 544	
Ships, Lake, Safety First Plans Worked on.....	539
Ships, Signal with Air Sirens.....	564
Shoes, Child's, Rubber Covered Disks Fitted to Shutter and Screen, Steel, for Residence Window.	591
Soda, Ice Cream, Provided Easily in Home....	508
Spark Plug Tester, Handy for Motor Car Owner.. 484	
Spoon, Medicine, Arranged in Nest Form.....	598
Standardizing a Nation's Products, by J. Crosby McCarthy.....	571
Stoves, Gas, for Motor and Yacht Parties.....	597
Street Car Carried to Jury in Damage Suit....	594
Street Cut, Kansas City's, Proves Costly.....	584
Submarine, British, Glazed with Ice after Raid.. 520	
Subway Station Supports Large Building.....	551
Sundial at Miami Street Corner, Many Depend upon.....	587
Table, New Serving, Made for Quick Lunch Room	587
Tank and Tower are Built of Reinforced Concrete	496
Telephone Numbers, Much Used, Directory for... 600	
Telephones, Antiseptic Mouthpiece for.....	578
Thermostat Adjusts Self Twice Daily.....	510
Time, How Washington Signals to Canal Zone... 543	
Tire Valve, Cap Acts as Pressure Gauge.....	500
Top, Aerial, Flies as It Spins.....	557
Tree, Peach, Protector Shields against Borer... 584	
Typewriter, Pocket Size, of Queer Design.....	491
Typewriters, Erasing Attachment Made for....	601
Umbrella, Saber, Latest Military Novelty.....	521
War, European: Austrian Camps, Things of Interest Seen in... 538	
Children Refugees from Stricken Serbia.....	532
Conveyances Used in Transporting Wounded..	533
Sanitary Precautions Observed by Germans... 540	
Serbia, Great Teutonic Host Penetrating.....	529
Serbia, King Peter and His Court Fleeing....	530
Serbia, War Razed, Land of Want and Death..	531
Trenches, Armored, Use of Heavy Artillery Bringing into Existence.....	534
War, Odd Sidelights on Snapped by Camera... 537	
Western Theater, Grim Side of War Seen in... 536	
Washing Machine, Two Tub, for Household Use.. 568	
Water Bottle Designed for Infant's Needs.....	554
Weapon, Murderous, Ring Is, at Short Range... 593	
Wheel, Car, Lock for Used in Removing Brasses	520
Windmill Surmounts Silo and Water Tank.....	502
Windows, Device Prevents Rattling of.....	602
Winter Views at Front within German Lines... 541	
Wireless, Checker Games are Played Nightly by	577
Wireless Instrument, Direction Finding, Invented	522
Wireless—Radio Men, Nation's Amateur, Show Preparedness.....	520
Wreck—Three Trains Crash Together on New Haven.....	523
Wringer, Conveyor Belt Extends Usefulness of.. 542	

## SHOP NOTES

Automobile Crank Cases, Welding.....	619
Automobile Crank Handle, Covering Space on... 614	
Automobile Light, Temporary.....	622
Babbitt, Banking Material for Pouring.....	616
Barrels, Open, Nail Guard for.....	620
Boat, Cradle for.....	604
Brake Lever Handle, Repairing Broken.....	613
Candle Holder, Improvised.....	628
Clamps, Pipe, Forming Tool for.....	613
Concrete Work, Waterproofing.....	603
Dresser as a Drafting Table.....	612
Flag, To Prevent from Winding around Pole... 615	
Gauges, Pressure Kam Indicator, Protection Hood for.....	620
Glass, Slide Rule, Substitute for.....	613
Hammock, Swinging Chair.....	616
Iron, Galvanized, Preparing New Surfaces of for Painting.....	620
Labels, Druggists', To Typewrite on.....	613
Ladder, Replacing Broken Rung in.....	621
Latch Bar, Spring to Hold Down.....	618
Lock for Sliding Doors.....	614
Locomotive Link Hangers, Twisting.....	618
Milk House, Concrete Block.....	617
Motorcycle Trailer and Camp Outfit.....	605
Oiling Inaccessible Bearings.....	621
Packing, Air Cylinder, to Prevent Leaks.....	621
Pawl, Toothed, for Removing Lost Motion....	622
Penknife, Removing Corkscrew Attachment from	614
Pins, Foundry Flask.....	622
Piston Rings, Starting in a Cylinder.....	620
Plants, Transplanting.....	609
Safety Pin, To Prevent from Coming Loose... 614	
Screwdriver, Handy Form for.....	615
Shade Holder for Chandelier.....	619
Shaft Hanger, Homemade Flexible.....	623
Signboard, Advertising, for Farmers' Products.. 604	
Stud in a Partition, to Locate.....	618
Telephone, Holder for.....	614
Valves, Poppet, Removing.....	619
Wall Paper Window Display Machine.....	603
Water Heater, Instantaneous.....	619
Waxing a Varnished Floor.....	616
Weather Vane with Inside Indicator.....	615
Well Casing, Pulling a.....	604

## AMATEUR MECHANICS

Bushing Made of Brass Tip on Cartridge Fuse.. 639	
Camera, Box, Direct View Finder for.....	625
Cameras, Focusing Screen for Enlarging.....	622
Clamp, Tennis Racket, Opening Springs for.... 639	
Cross, Metal, Repairing Broken.....	637
Current, Alternating, Seeing in Mirror.....	638

The 1916

ARROW

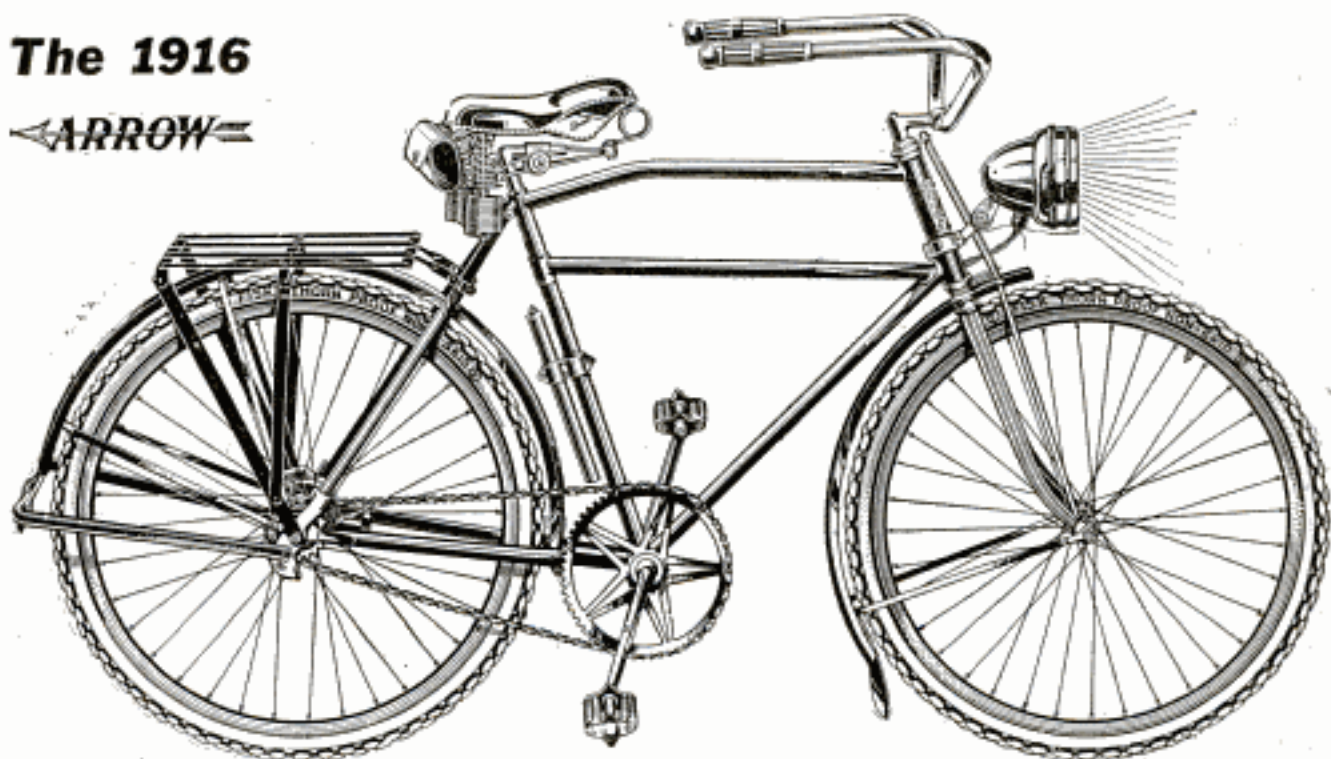

# New Motorcycle Type

## 1916 Features

### Electric Light

Reinforced motorcycle frame—large, easy motorcycle saddle—long, rubber grip, motorcycle handlebars—New Departure coaster Brake—special motorcycle pedals—motorcycle mudguards, stand and luggage carrier—imported anti-friction chain—Fisk Thora Proof, Non-Skid Tires—beautiful enamel finish—other new features. Write now.

Send the coupon below today for free catalog of the 1916 Arrow Bicycle. Read the remarkable improvements and new features in the new 1916 model. Built with all the durability and elegance of the highest grade motorcycles. Guaranteed for 5 years. The new Arrow offers to bicycle riders the utmost in speed, comfort and easy riding. If you ride an Arrow you will have every reason to be proud of your bicycle—no one in your neighborhood will have one to equal it. You can have the Arrow in a wide variety of new models—the motorcycle type shown above and others. All sizes for boys, men and women. Send the coupon today for free catalog.

## Pay As You Ride

Find out about our special, rock-bottom, direct offer on this new 1916 Arrow. A special, 30-day, reduced price offer. We ship the bicycle to you without a penny down. Start riding and enjoying the Arrow right away. And pay the special, rock-bottom, reduced price—a small amount each month—while you ride. Now, why should you even consider paying cash for a bicycle when you can get the wonderful 1916 model Arrow at the lowest, rock-bottom cash price and on small, easy monthly payments while you are riding it. Send the coupon now for new catalog.

## Make Money Riding An Arrow

Just ride your Arrow around. People will admire your handsome bicycle and ask about it. Just answer their questions. You can pay for your Arrow and get extra money besides. Send the coupon for this liberal offer.

**Free Inspection** The ARROW is sent to you without a penny down. If you do not agree when you see it that this new 1916 model Arrow is one of the most wonderful bicycle bargains you ever saw, you may send it back at our expense. You alone will be the judge. It will cost you nothing if you decide you do not want the Arrow.

## Send Coupon—NOW! Catalog Showing All Models

Don't delay. Learn about the sensational 1916 Arrow right away. Take advantage of our special, 30-day, rock-bottom price offer. Get full particulars about the wonderful 1916 improvements. Get the free catalog and details of our easy rider-agent offer by which the Arrow will pay for itself. Also full particulars of our liberal, easy-payment offer and rock-bottom prices. See also all the beautiful new Arrow models. No obligations. Send coupon, letter or post card now.

**ARROW CYCLE CO.** Dept. 9194 19th St. & California Ave. Chicago, Ill.

**Arrow Cycle Co.**  
19th St. & California Ave.  
Dept. 9194, CHICAGO, ILL.

Please send me free catalog of the new 1916 Arrow and particulars of your 30-day, rock bottom "pay-as-you-ride" offer and rider-agent proposition.

Name.....

Address.....

# Send



**NOW for DYKE'S  
Free 32 PAGE Booklet**

EXPLAINING:

**HOW TO GET INTO  
THE AUTOMOBILE  
BUSINESS & ITS OPPORTUNITIES  
HOW TO LEARN DURING SPARE  
TIME BY MAIL AT HOME WITH  
DYKE'S NEW IDEA  
Working Model Method**

This system is endorsed by Barney Oldfield, Elwood Haynes, Chas. Duryea and other motor authorities.

If we prove to you that we have started hundreds of others into the repair business and as chauffeurs—who had no previous experience and who knew no more about an auto than you do right now—you must admit we can do the same for you. Write me today—now—and let me prove it.

**The AUTOMOBILE BUSINESS is Growing**

We Assist Students Getting Actual Driving Experience



More help needed and big pay. No other business offers such opportunities. It's easy to learn. An Auto Repairman is not a machinist—his work consists of adjustments and re-fitting worn parts. "knowing the principle," that's the thing. One of our students writes: "Before I started with your course I was a clerk at \$50 per month. After finishing I followed your instructions, started a repair shop and cleared \$122 the first month—pretty good for the first month." Let us show you this and many other letters. You can learn the same as this young man by

**DYKE'S NEW IDEA OF TEACHING BY MAIL WITH WORKING MODELS**

On these models you get actual practice, see the actual operation and learn more than you could from the auto itself—it's easy and quick. You don't have to study hard with this system—we teach through the eye—a new idea. Mr. Dyke is the originator of the system of teaching by mail with models—hundreds of imitations.

**Our Employment Plan for Students**

represents years of work to provide something that no other school had, namely, a way for the student to get started in the practical line of work.

Mr. Dyke has been identified as a pioneer inventor, supply man, etc., with the auto industry since its beginning. He originated the first auto supply co. and published the first book on autos in America. No other man with such experience is today teaching others.

**Mail This Free Coupon Now**

(a postal card will do)  
for Mr. Dyke's 32-Page Booklet. Write for it—now! It is interesting and instructive in itself. Learn how you can get all this training for only \$15. Fill out below or write a postal—but do it now.

This school is a department of the firm:

**A. L. DYKE  
Pub. & Importer  
Box 196 Reo Bldg.  
St. Louis, Mo.**

Dyke's Correspondence School of Motoring  
Box 196, Reo Bldg.  
St. Louis, Mo.

Send me your free 32-page booklet about your New Idea Working Model Course and testimonials and proofs. It is understood I am under no obligations in sending for this.

Name.....

Address.....

Deal with the originators. Beware of imitators.

(Contents—Continued from page 6)

Cutting Glass Bottle with Electricity.....	626
Door Check, Homemade Screen .....	633
Electrically Heated Devices, To Determine the Efficiency of .....	634
Game, An Indian Snake.....	632
Grotto, Cement, for Aquarium.....	631
Hook, Wire Coat, To Prevent from Turning....	631
Kitchen for Hikers .....	636
Locomotive Model and Track System, Homemade Electric:	
Part I—The Motor .....	627
Matches, Waterproofing .....	626
Mustard Pots, Earthen, Used as Acid Jars.....	635
Nail Cabinet with Muffin Pan Trays.....	626
Paste, Squeezing from Tubes.....	635
Rug, Heavy, Hanging on Line for Beating.....	633
Scales and Name Plates, Imitation Celluloid....	625
Solder, String, Making .....	631
Trick—Magic Paper Fortune Telling.....	639
Trick, Match Box .....	626
Views, Fireside Dissolving .....	623
Wood for Cabinet Work, Storage of.....	633



**HE TUNES PIANOS So Can You**

He was taught at home in leisure hours by correspondence, in a way that is open to all who wish to learn. He says that **HE MAKES \$50 A WEEK**. Send for his name and read his letter. What we have done for him and others we can do for you. The TUNE-A-PHONE, our patented instrument for precisely indicating comparison of sound-beats in tuning, prevents intervals, makes it easy for any man or woman to become a proficient piano tuner. This device un-erringly teaches first principles that you never forget and is then discarded. Eliminates guesswork or faulty start. Our course includes Action Regulating, Voicing and Fine Repairing. Action model and tools learned. Diploma granted. Graduates are Big Money makers on salary or at work for themselves. Many of our most successful tuners had no previous musical knowledge. 15 years of correspondence teaching by unending and practical plan.

Investigate at our expense. A postal request brings indisputable facts, FREE.

**Niles Bryant School of Piano Tuning**  
635 Music Hall, Battle Creek, Michigan.



**Buy Nobema Colors and Get**



**FREE**  
Complete Correspondence Course in Show Card and Sign Writing in Chicago School of Lettering—Including nice set of brushes—All FREE. Offer made solely to have you try the famous ready-to-use NOBEMA COLORS. This free course gives practical training and, with NOBEMA COLORS and brushes, you can earn big money or establish paying Show Card and sign business of your own. Most anyone can learn. Illustrated circulars and information FIDEL NOBEMA Pen MFG. CO., CHICAGO.

**SHOW CARD WRITERS**

**EARN \$80 TO \$200 A MONTH  
LEARN FREE!**



We will furnish a thorough course in Show Card Writing and Lettering absolutely free to introduce our colors if you will purchase an assortment of Alpha Colors to use while practicing. Particulars for stamp.

**ALPHA COLOR COMPANY, Inc., Dept. K, 41 East 125th St., N. Y. City**

**LEARN WATCHMAKING AND ENGRAVING**



Earn while learning. Most practical watch school. Individual instructions. Graduates in great demand. Beek free. Chicago School of Watchmaking, 63 E. Van Buren St., Chicago



**Finger Print Experts**

make from \$5,000 to \$10,000 per year. Be independent. Learn now.

**H. C. THODE** 2067 Grove Street  
SAN FRANCISCO, CAL.



**FACTORY TO RIDER**

Saves you big money. Buy direct and save \$10 to \$20 on a bicycle. **RANGER BICYCLES** now come in 74 styles, colors and sizes. Greatly improved; prices reduced. Other reliable models, \$11.95 up. **WE DELIVER FREE** to you on approval and 30 days trial and riding test. Our big **FREE** catalog shows everything new in bicycles and sundries. Write for it. **TIRES, lamps, wheels, parts and supplies at half usual prices.**

Do not buy a bicycle, tires or sundries until you write and learn our wonderful new offers, low prices and liberal terms. A postal brings everything. Write now.  
**MEAD CYCLE CO. DEPT. P108 CHICAGO**



# Not One Cent In Advance

The Machine Shop Library Now Ready.

Nine Volumes Containing Nearly 3000 Pages, 2800 Illustrations.

The Most Successful Attempt Ever Made to Cover the Practical Side of Machine Shop Work.



**A Complete Machine Shop Education Now for the First Time Within the Reach of Everyone**

Small Monthly Payments

You Can Now Qualify for One of the Thousands of Open Positions in the Machine Shop Field.

The Coupon Below Brings the Books.

**The Machine Industry Now the Fastest Growing One in America. Its Growth is so Rapid that the Demand for Trained Men Will Probably Never be Met.**

### Have You a Trade or a Profession?

If so, is it one in which advancement is sure, and employment certain? Now is the time to consider these matters seriously.

**Machinists, Tool-Makers, Die-Makers, gauge-makers, draftsmen, are earning \$20, \$30 or \$40 per week and over. Foremen, superintendents, managers and those in other high positions in the machine shop are earning a great deal more. We are constantly in touch with these men, and know whereof we speak.**

We do not claim to be expert ad. writers, and are not going to try to create a false impression by the use of fancy words. We are not going to tell you that you can do a lot of things which common sense tells you is impossible—we are merely going to tell you about the Machine Shop Library and what it will do for you—and it must do these things.

We, as long-established publishers of standard and practical books for those engaged in the different mechanical and engineering professions, have for years applied ourselves closely to the solving of the thousand and one problems of the machine shop man—and the Machine Shop Library stands as a monument, and as a result, of our long and varied researches and experiences in this great industry.

### More Than Experience Now Necessary

Recognizing, especially in recent years, that technical training and advancement in the machine field go hand in hand, and that the acquirement of the former was heretofore practically an impossibility for the worker, we determined at the outset that every item of information in this new library should be self-explanatory, and easily understood, without the aid of an instructor. In other words we determined that it should embody the principles of a complete mechanical education.

This Library comprises nine handy, beautiful and strongly bound volumes, 6x9 inches, about three-thousand pages, and two-thousand-eight-hundred illustrations.

### Eight Authors and Two-Hundred Contributors

The authors of these books are eight in number, all practical men—each widely known in the machine shop world—each fully conversant with the practical side of the particular branch of the work which he has covered. They are men who thoroughly understand the needs of the man, and his requisites for success. Not only that—these authors had the co-operation of over two-hundred experts situated in different shops in different parts of the country, so that the demands of everyone interested in any phase of machine shop work might be readily supplied.

As we have said in the beginning, the machine industry is now the fastest growing one, which should settle the question in your mind "What trade or profession should I take up?"

Let us send the Machine Shop Library for your inspection before you decide. No advance deposit required. Just return the attached coupon.

*McGraw-Hill Book Co., Inc.*

Publishers of Books for Machinists Since 1876  
239 W. 39th Street, NEW YORK

### To Those Already in the Business

Especially in machine shop practice, you want facts—facts and details which must be unvarying in their practical application to the work you are doing. No experimentation must be indulged in.

When you read educational books you do so in order to improve upon your own methods—to increase your knowledge and earning power. There are no other incentives. Books designed to tell how to improve methods, knowledge and earning power in the machine-shop field must necessarily be of a high standard, otherwise they could not possibly receive recognition at the hands of the machine-shop man of today, who demands accuracy, authoritativeness, conciseness.

### The Man Who is Exacting When It Comes to Machine-Shop Literature will Appreciate the Machine-Shop Library

because every page was written by a practical man. Each of the eight authors, and the hundreds of contributors, are advocates of the highest standards of efficiency in shop operation.

### Just Facts—Plainly Stated

Any man interested in any branch of machine shop work will instantly recognize in the Machine Shop Library a helpful and distinct method of bringing out in detail and simplifying even the most intricate operations in machine work. These methods, while accurate in every sense, are put into such plain language and figures that even the beginner or apprentice can readily understand them.

### For Reference or Study

—or both—the Machine Shop Library will pay you back for its price in a short time. Its methodical system of making man and machine more efficient is never-failing.

We will send by parcel post prepaid the nine volumes weighing about sixteen pounds to you upon receipt of the coupon below. No advance remittance is required.

## FREE EXAMINATION COUPON

McGraw-Hill Book Co., Inc., 239 W. 39th St., New York

Gentlemen:—I am interested in your Machine Shop Library. You may send me the nine volumes, charges paid, for my inspection. If satisfactory I will send \$2 in ten days and \$2 per month until I have paid the price of the books, \$16. If the books are not what I want, I will write you for shipping instructions.

Signature.....

Residence Address.....

City and State.....

Name of Employer.....

Reference.....

Address..... P. M. Apr.

Come to Detroit  
the automobile center  
and

**LEARN THE AUTOMOBILE BUSINESS**

Detroit trained men get preference over all others and get jobs quickly. No other city, no other school can give you what Detroit offers. Think what it means to learn in Detroit. Every factory knows us, endorses our school, glad to get our graduates, offers them best territory in which to sell cars and start garages. Unlimited opportunities here. You're right in the middle of the great auto activity. Men are needed everywhere as testers, repairmen, chauffeurs, garage men, and salesmen. Splendid chance to start in business. Hundreds of our graduates are doing it.

**Earn \$75 to \$300 a Month**

We teach you to handle any auto proposition. Our equipment is complete. Students actually build cars from start to finish, getting regular factory training in assembling, block-testing, road testing, everything. That's the Detroit way. Special complete course in Oxy-Acetylene brazing and welding, separate from regular course. All leading types of starting, lighting, and ignition systems in operation. Learn to time motors, adjust carburetors, magnetos, valves, bearings quickly and accurately. Six-cylinder Lozier and 8-cylinder King are used for road instruction. We have a new Chalmers "6" chassis with overhead camshaft motor, the latest thing out. Just added 1916 Delco System as used in Buick, Hudson and Packard Twin "6."

## Detroit is the Place to Learn—Start Any Time

There are 44 auto factories in Detroit, and hundreds of accessory and parts factories. Our students have the privilege of going through any or all of them, including Detroit electric service department, while taking our course. You can't get these advantages anywhere else. Detroit is the automobile center. You make faster time here and you get practical instruction. Come to Detroit and learn the business right. Enter classes any time, any day. Three classes daily, morning, afternoon and evening. You can work in the factory in day time and take course at night. There is a great demand for Detroit trained men. Garages throughout the country write us for men. Auto factories write and phone for men constantly to fill permanent places. Why not fit yourself for one of these good paying positions?

The demand is greater than the supply for competent trained men. The following were clipped from daily papers in all parts of the U. S.

Wanted—Experienced motor mechanics, bearing scrapers, assemblers, repairmen; good wages. Henderson Motorcycle Co., 1158 Cass.

Wanted—Chauffeur, must be good driver, steady and reliable; one with knowledge of Pierce-Arrow cars preferred; no other but good mechanic need apply. Address Box R. No. 100 Free Press.

Wanted 10 Road Testers, 20 garage repair men, final assemblers. Maxwell Motor Co., Inc., Oakland Ave. Plant.

Wanted 40 Drivers. Come ready to work. Maxwell Motor Co., Inc., Oakland Ave. Plant.

Wanted Block Testers. Apply Continental Motor Mfg. Co.

Wanted—High grade retail automobile sales manager. Box E. No. 52.

Follow the Crowd to the Michigan State Auto School. Come to Detroit



THIS IS ONE OF OUR JANUARY 1916 CLASSES. OVER 350 MEN IN THE PICTURE.

## Start a Garage and Sell Cars—Be Independent

We have made the biggest deal yet. Just completed arrangements with the Automobile factories to put them in touch with men who intend going into business for themselves. Think of getting inside information as to best territory and where the garages will make most money. The auto factories keep close watch—they are looking for Detroit trained men to represent them and start garages. Men who know the auto business from A to Z are in biggest demand. Come here and start right—go through the factory. Learn the best selling points—get the information first handed and don't wait, jump on a train and come now.

We have made arrangements with a large eastern investment firm (with millions of dollars), to back competent, reliable, Michigan State Auto School Graduates, who want to go into the garage and selling business. These Capitalists know where the money is to be made—they are ready to back the right kind of men—Men who are trained at the Michigan State Auto School and are competent. Have you been waiting for such an opportunity? Then come to Detroit as hundreds of men have done, hurry, don't wait. You can complete the course in from six to eight weeks. Then go into business for yourself. BE INDEPENDENT. Make the big money. Get started NOW.

### Money-Back Guarantee

We guarantee to qualify you in a short time for a position as chauffeur, repairman, tester, salesman, demonstrator, garage man, or automobile dealer, paying from \$75.00 to \$300.00 monthly or refund your money. We have constantly more requests for Detroit trained men at GOOD salaries than we can supply.

### SEND THIS COUPON TODAY

Michigan State Auto School  
Dept. 304, 11-19 Selden Ave., Detroit, Mich.  
Gentlemen: Send me absolutely FREE "Auto School News" and New Catalog or better still you can expect me about.....

Name.....  
Street.....  
Town.....State.....

### Automobile Industry Offers Biggest Possibilities

No other field is so big—no other business so permanent. Every place, no matter how small, will support a garage. Think of it—nearly a million new automobiles will be sold this year. Think of the money in selling and repairing. Are you going to reap some of the golden harvest?

### Act Quickly—NOW

Fill in the coupon and mail it now, get full particulars—get "Auto School News" and New Catalogue fresh from the press. They are both ABSOLUTELY FREE. Or better still, jump on a train, as hundreds have done, and come to Detroit, the "Heart of the Automobile Industry" and learn right. Remember, you can enter classes any time any day. Act quickly NOW.

**Michigan State Auto School**  
The Old Reliable School  
Dept. 304, 11-19 Selden Ave., Detroit, Mich., U.S.A.

### DETROIT

THE HEART OF THE AUTOMOBILE INDUSTRY





**NAPOLEON'S** disastrous Russian campaign marks the beginning of his downfall. The map herewith shows his line of March from Berlin to Moscow, a distance of 1200 miles. This march by Napoleon at the head of over 600,000 trained soldiers was made in less than four months. Moscow was captured, but the Russians burned their famous capitol and all supplies, forcing Napoleon to retreat in mid-winter. He reached Paris with less than 100,000 men, over half a million of his trained soldiers having fallen along the line of that disastrous retreat. Once again the thunder of invading armies has awakened Russia from her lethargy. Will the rigors of the Russian climate again prove the salva-

tion of that nation and the turning point in the present tremendous European War? All the causes of the present conflict—the deep racial antipathies, the commercial rivalries, the sting of past defeats, the vaulting ambition for world empire—may be discerned from the pages of history, and the one great history of every empire, kingdom, principality and power, from the beginning of civilization to the present, is the world-famed publication,

## Ridpath's History of the World

Dr. Ridpath is universally recognized as America's greatest historian. Other men have written histories of one nation or period; Gibbon of Rome, Macaulay of England, Guizot of France, but it remained for Dr. Ridpath to write a history of the entire World from the earliest civilization down to the present. We offer the remaining sets of the last edition, brand new, down to date, beautifully bound in half morocco,

### At a Great Sacrifice in Price and Easy Terms

We will name our special low price and easy terms to all readers who mail us the coupon below. Tear off coupon, write name and address plainly, and mail now before you forget. We employ no agents as our low price does not permit an agent's commission. The beautiful sample pages will give you some idea of the splendid illustrations and wonderfully beautiful style in which the History is written.

### America Must Prepare For Defense

Here you read of the rise and fall of nations—the splendor that was Greece and the glory that was Rome. You discern the causes which have led to the overthrow of monarchies and kingdoms, peoples and races, and if History has proven any fact it is that the rich and defenseless nation must sooner or later fall beneath the heel of the more warlike and aggressive power. If you would know the fate of the rich and defenseless nation then read the story of ancient Assyria or Chaldea or Persia or Babylon whose glory now is but a memory. They have been so obliterated that even the location of their splendid cities is unknown. Any man who reads History, who has red blood in his veins, who loves home and country must favor adequate preparation for self defense against the aggression of warlike powers. Dr. Ridpath gives the complete History of every race, every nation, every time and holds you spellbound by his wonderful eloquence.

### 46 Page Booklet Free

We will mail our beautiful forty-six page free booklet without any obligation on your part to buy. It will show Ridpath's wonderfully beautiful style. He pictures the great historical events as though they were happening before your eyes; he carries you with him to see the battles of old; to meet kings and queens and warriors; to sit in the Roman Senate; to march against Saladin and his dark-skinned followers; to sail the southern seas with Drake; to circumnavigate the globe with Magellan. He combines absorbing interest with supreme reliability.

**Western Newspaper Association**  
Chicago



FREE  
COUPON

Western  
Newspaper  
Association  
H. E. Sever, Pres.  
140 So. Dearborn St.,  
CHICAGO, ILL.

Please mail, free, 46-page sample booklet of Ridpath's History of the World, containing photographs of Napoleon, Socrates, and Caesar, map of European War Zone showing all fortified cities, and write me full particulars of your special offer to Popular Mechanics readers.

NAME .....

ADDRESS .....

MAIL THIS COUPON

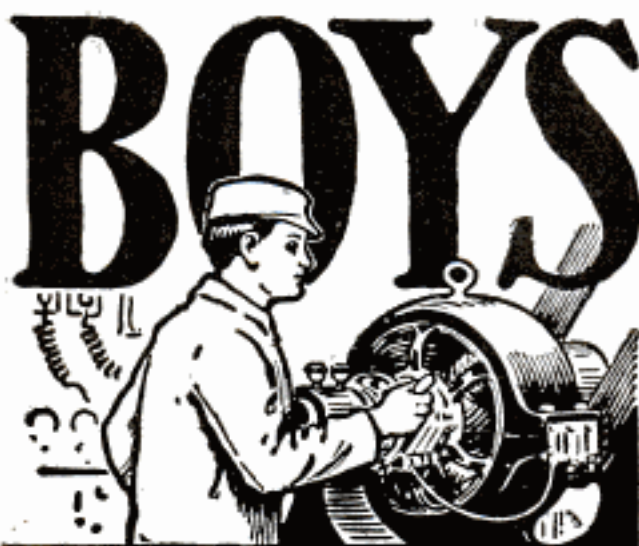

## Big Money in Electricity

The electrical industries offer wonderful opportunities for boys with a liking for electricity. The salaries paid to trained men are large, promotion comes rapidly, and, best of all, the profession is not overcrowded.

The opening of new lines from time to time (such as wireless telegraphy and telephony) promise attractive and paying fields to those who wish to specialize. The *will to do* and *Special Training* will bring success to you.

The International Correspondence Schools can help to make you an expert in electrical work. Hundreds of boys have already won success through I. C. S. help. You can do the same. Everything is made so clear that you can learn in your spare time, regardless of where you live or what you do. No books to buy. There's big money in electricity. Get after it by marking and mailing the attached coupon today. Finding out costs you nothing. Mark the coupon—NOW.

TEAR OUT HERE

## INTERNATIONAL CORRESPONDENCE SCHOOLS

Box 5503, SCRANTON, PA.

Explain, without obligating me, how I can qualify for the position, or in the subject, before which I mark X.

- |   |  |
|---|--|
| <input type="checkbox"/> ELECTRICAL ENGINEER        | <input type="checkbox"/> SALESMANSHIP                                    |
| <input type="checkbox"/> Electric Lighting          | <input type="checkbox"/> ADVERTISING MAN                                 |
| <input type="checkbox"/> Electric Car Running       | <input type="checkbox"/> Window Trimmer                                  |
| <input type="checkbox"/> Electric Wiring            | <input type="checkbox"/> Show Card Writer                                |
| <input type="checkbox"/> Telephone Expert           | <input type="checkbox"/> Outdoor Sign Painter                            |
| <input type="checkbox"/> MECHANICAL ENGINEER        | <input type="checkbox"/> ILLUSTRATOR                                     |
| <input type="checkbox"/> Mechanical Draftsman       | <input type="checkbox"/> DESIGNER  |
| <input type="checkbox"/> Machine Shop Practice      | <input type="checkbox"/> BOOKKEEPER                                      |
| <input type="checkbox"/> Gas Engineer               | <input type="checkbox"/> Stenographer and Typist                         |
| <input type="checkbox"/> CIVIL ENGINEER             | <input type="checkbox"/> Cert. Public Accountant                         |
| <input type="checkbox"/> Surveying and Mapping      | <input type="checkbox"/> Railway Accountant                              |
| <input type="checkbox"/> NINE FOREMAN OR ENGINEER   | <input type="checkbox"/> Commercial Law                                  |
| <input type="checkbox"/> Metallurgist or Prospector | <input type="checkbox"/> GOOD ENGLISH                                    |
| <input type="checkbox"/> STATIONARY ENGINEER        | <input type="checkbox"/> Teacher   |
| <input type="checkbox"/> Marine Engineer            | <input type="checkbox"/> Common School Subjects                          |
| <input type="checkbox"/> ARCHITECT                  | <input type="checkbox"/> CIVIL SERVICE                                   |
| <input type="checkbox"/> Contractor and Builder     | <input type="checkbox"/> Railway Mail Clerk                              |
| <input type="checkbox"/> Architectural Draftsman    | <input type="checkbox"/> AGRICULTURE                                     |
| <input type="checkbox"/> Concrete Builder           | <input type="checkbox"/> Textile Overseer or Supt.                       |
| <input type="checkbox"/> Structural Engineer        | <input type="checkbox"/> Navigator <input type="checkbox"/> Spanish      |
| <input type="checkbox"/> PLUMBING AND HEATING       | <input type="checkbox"/> Poultry Raising <input type="checkbox"/> German |
| <input type="checkbox"/> Sheet Metal Worker         | <input type="checkbox"/> AUTO RUNNING <input type="checkbox"/> French    |
| <input type="checkbox"/> CHEMIST                    | <input type="checkbox"/> Auto Repairing <input type="checkbox"/> Italian |

Name \_\_\_\_\_  
 Occupation & Employer \_\_\_\_\_  
 Street \_\_\_\_\_  
 and No. \_\_\_\_\_  
 City \_\_\_\_\_ State \_\_\_\_\_

## If You Are a Shallow Breather

You most certainly are in need of Conscious Evolution to become fully alive and have the benefit of living in full. Why live an inferior life when you can become superior to yourself through Conscious Evolution?

**MY NEW BOOK** explains the human body as it has never been explained before. It tells of the dangers and after effects of exercise and conscious deep breathing. My free book will prove of great value to you. If you desire to be more successful, to have greater will power and the successful powers, physical, physiological and mental, you cannot afford to be without my free book. Write for it today.

ALOIS P. SWOBODA  
 1926 Aeolian Hall NEW YORK CITY

## Learn How to WRESTLE

In Your Own Home  
 By Mail

Yes, learn to become an expert wrestler right in your own home, by mail, from the greatest wrestler the world has ever known. Be an athlete, be strong, be healthy. Learn how to throw and handle big men with ease. Learn to defend yourself. All taught in our course of lessons, and illustrated with hundreds of charts and actual photographs by

## Farmer Burns and Frank Gotch

Farmer Burns, "the grand old man of the mat," taught Frank Gotch, the present World's Champion, all he knows about wrestling, as Gotch says. He will now teach you Scientific Wrestling—Physical Culture—Jiu-Jitsu—Self Defense. Every man and boy in America, no difference what age, needs this wonderful course of lessons. Write today—your name, age and address on a postcard or letter brings you our free book absolutely free—no obligation of any kind. A splendid book on wrestling and physical culture. Write today stating your age.

Farmer Burns School of Wrestling 1194 Range Bldg., Omaha

This  
 Free  
 Book  
 FREE

## LAW STUDY AT HOME

We give our Complete Resident Course by mail. Guaranteed to prepare for Bar of ANY State. LL. B. Degree Conferred. Indorsed by Bench and Bar. 20 Standard Law Text-books. Faculty of over 50 Distinguished Jurists and Lawyers. CATALOG FREE.

OKLAHOMA UNIVERSITY, 906 Colcord Bldg., OKLAHOMA CITY, OKLA.

## What Is It STAMMER?

Costing You to FAULTY SPEECH. Fear and Failure to talk when conditions demand? I was myself thus afflicted for over 30 years and well know its terrible effects. MY NATURAL METHOD of treatment never fails to cure. PRIVATE INSTRUCTION ONLY. Write or call for particulars.

William E. Bassett, Principal and Instructor

The Bassett Institute, Nevada Bank Building, San Francisco, Cal.



### THE BART CHALK-TALK

Entertains an Audience. Educates you in entertaining. If you draw a little you can do the chalk-talk and make it pay. Bart furnishes you with the ideas, the "patter," the drawings to make, and his own special crayon and equipment—everything he uses in a successful chalk-talk. Write BART, Daily News Cartoonist, Minneapolis. He will tell you about the chalk-talk. See Bart's ad on page 9, April Cartoons.

The Library of Original Sources  
 at a great bargain 10 beautiful, big volumes. Easy monthly payments. See our ads on page 59 February issue and page 56 March issue Popular Mechanics.  
 UNIVERSITY RESEARCH, Dept. G, Milwaukee, Wisconsin

## SEXUAL KNOWLEDGE A \$2 BOOK FOR ONLY \$1

By Winfield Scott Hall, Ph.D. Noted authority and lecturer. Plain Truths of Sex Life that young men and young women, young wives and husbands, fathers, mothers, teachers and nurses should know. Sex facts hitherto misunderstood. Complete, 320 pages—illustrated. In plain wrapper. Only \$1, postage 10c extra.  
 American Publishing Co., 416 Winston Bldg., Philadelphia

Please Mention Popular Mechanics

# Know Your Car—

## It Means Money to You

Audels Automobile Guide—the world's most scientific book on automobiles—will enable you to quickly solve every problem of driving, repairing, locating of trouble. It is recognized as the authority by experts. Its value is unlimited. It tells you everything you should know about your car. Sent

to you for free examination.

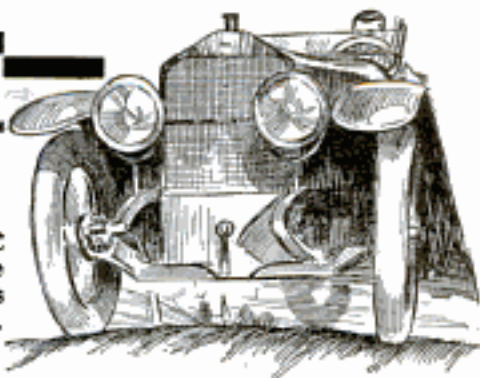

### If you are an Owner

You are losing money every time you run with ill-adjusted Carburetor, with faulty ignition, with your engine at the wrong speed, or with a score of other faults. You may be a careful student of your car and take all the precautions you know of. But unless you know the technical details of driving and operation, and know them right, your car is an expense burden instead of a pleasure.

### If you are a Chauffeur

We don't need to mention the things you must have at your fingers' ends in order to manage your car at top efficiency. Here are a few of the points you may be in doubt about:— How to care for batteries and keep them operating at maximum voltage. How to wire a car for Electric Starting, Lighting and Ignition according to the most modern systems. How to overhaul the car. How a car is best lubricated, etc.

### If you are a Mechanician

Then more than anyone else you will realize the importance of knowing the details of design of every part of your car. New inventions in design and construction are coming up every day, which puzzle the untrained man. Do you know these things?—Methods of cooling—Timing and Balancing—Designing Clutches—Design of ball and roller bearings, etc.

## Audels Automobile Guide

Solves every single one of these problems and solves them in a way that you can understand. It's a value you cannot afford to miss. It will save you many times its cost before you have had it a week.

### Text Arranged in QUESTIONS AND ANSWERS

The story is told in the best known way,—in the form of questions you would ask and the answers to them,—in plain, practical, everyday language, complete, concise, and to the point. The book is easy to handle and easy to study. There are 30 chapters covering every single phase of Automobile engineering and Automobile operation. Every chapter is modern, concise, and practical.

handsomely bound in durable full flexible leather, Pocket Size. It is easy to handle and easy to study. There are 30 chapters covering every single phase of Automobile engineering and Automobile operation. Every chapter is modern, concise, and practical.

### Written by Practical Men for Practical Men

There is no idle theory in Audels Automobile Guide. Every paragraph is written to help you in the easiest, most practical way. The chapters on carburetors, ignition, gas engine operation, How to run an Automobile, overhauling the car, Battery Troubles, and Starting and Lighting Systems, are alone worth the price asked for the 30 complete chapters. There are 700 information-full pages, with 550 illustrations that show you in picture just what you want to see.

#### HERE ARE SOME OF THE SUBJECTS

Parts—Operation—Care—Management—Road Driving—Carburetor—Wiring—Timing—Ignition—Motor Trouble—Lubrication—Tires, etc. Chapters on Storage Batteries—Electric Vehicles—Overhauling Car—Special Chapter on Self-Starters and Lighting Systems, etc., etc.

### Sent to You FREE

We don't ask you to take our word for the merits of this book. Seeing is believing, so we will send you the book without deposit. You will say at once that as books go it is worth at least twice what we ask for it. Use it seven days in connection with your car. Then if you are not satisfied that Audels Automobile Guide is positively the best book on the subject, send it back to us. But if on the other hand you decide that you need it, that it is the one book for you, remit us only \$1.50.

### Mail This Free Coupon TODAY

Do not delay. Put your name and address on the coupon today. The book will be mailed to you at once for FREE examination. Convince yourself of the wonderful assistance this book will be to you. Send for it today—now.

THEO. AUDEL & CO., 72 Fifth Ave., New York

### FREE Examination Coupon

Theo. Audel & Co., 72 Fifth Ave., New York  
Without obligation please mail for free examination "AUDELS AUTOMOBILE GUIDE." If I find it satisfactory I will remit \$1.50. Otherwise return it to you.

Name .....

Occupation .....

Address .....

P. M. Apr.

# LEARN ELECTRICITY

At America's Greatest Trade School  
**EARN \$100 TO \$300 A MONTH**



Learn by Doing

What a glorious chance for big money, for big work this, THE ELECTRICAL AGE offers you! How vast the field already! How more wonderful it is growing! No wonder there is such a need for the trained man! Enter the field of Electricity now with Coyne training, which is prized above all for its practical, workable value and success is yours!

## Be a Coyne Trained Man

Get a complete training by actual practice. Our graduates in Electricity, Plumbing, Bricklaying, Drafting and Motion Picture Operating are preferred everywhere. Why? Because their knowledge isn't mere "book" smattering. We teach these trades under actual working conditions right in our big shops! We furnish all tools and equipment FREE. Day and evening instruction. You may earn while you learn—start any time.



# Coyne National Trade Schools

**Plumbing, Bricklaying, Drafting, Motion Picture Operating** also practically taught. Estimating and Plan reading included in ALL Courses. 16 years of success backs this great institution. Largest and best equipped of its kind in America. Free Employment Bureau for our students. Tuition fee amazingly small. You can pay a little at a time. Here is the chance you've wanted.

## Send Coupon for FREE Book

Resolve to better your condition. Be independent in the mastery of a trade that pays. No experience necessary to start. Send today for our free book of trades. See what we have done for others. Send coupon or postal for book and all particulars.

**B. W. Cooke, Director,**  
Coyne National  
Trade Schools,  
39-51 E. Illinois St.  
Dept. 1194  
Chicago, Ill.

**B. W. COOKE, Director,**  
Coyne National Trade Schools,  
39-51 E. Illinois St., Dept. 1194, Chicago, Ill.

Dear Sir: Without cost or obligation to me, please send me your book of trades and full particulars—all FREE.

**MAIL NOW!  
COUPON**

Name.....

Address.....

Please Mention Popular Mechanics

## Learn to PAINT SIGNS and SHOW CARDS

Get into this interesting, profitable and fascinating business where the field is not crowded. Thousands of cards used weekly. Department stores, clothiers, movie shows, etc., pay big prices—work done quickly and easily—profits large—hundreds of jobs all around you. My students can more than pay for course doing jobs in spare time while studying. I increase your salary, get a better job or go into business for yourself.

### Earn \$18.00 to \$45.00 a Week—Easily

I will train you to fill a big salaried job. I personally correct every lesson. 17 years' successful teaching. Thousands of successful graduates all over the world. No town too small, no job too big for my graduates. Get my training—start now.

### Big Money in Card, Sign and Bulletin Business

No other profession pays such profits—work comes to you in abundance—no job will stump you—my students learn all. All the newest, swell-

#### FREE Outfit

Write now for special literature and prices on 5 courses—terms, testimonials, sample lesson and Free Outfit offer. All Free—Don't delay, act quickly.

est designs, how to hire men, how to keep records, in fact gives you a complete training. You can finish my course in a short time. Read my guarantee—don't be out of a job or work at low wages any longer—**Get Started Now.**

#### Guarantee

I guarantee to place competent graduates at \$25.00 to \$75.00 monthly. The demand for trained competent men is far greater than the supply.

Detroit School of Lettering, Dept. 2040 Detroit, Mich.

## TYPEWRITE THE NEW WAY

**80 to 100 Words a Minute GUARANTEED**

Totally new system. Based on Gymnastic Finger Training! Brings amazing speed—perfect accuracy—BIG SALARIES. Easy for anyone. First day shows results. Learn while working. **48-Page Book Free** illustrates and explains all. Gives letters from hundreds with salaries doubled and trebled. A revolution as to speed and salary possible to typists. Postal will do, but write today—NOW.

Tulless School of Typewriting, 104 College Hill, Springfield, O.

## Chicago Correspondence School of Law

Prepares Students at Home for the Bar. Four Courses of Study: College, Post-Graduate, Business Law and Bar Examination Review. Actual Daily Lessons by a recognized School that is approved by Bench and Bar.

Write today for FREE Catalog and Rules for Admission to the Bar.

520 Reaper Block, Chicago



BE AN ILLUSTRATOR  
by mail how to draw for magazines and newspapers  
Send for Catalog

Learn to draw. We will teach you School of Illustration 112 First Illinois Chicago, Ill.

## LEARN WATCHMAKING

and become independent. Good-paying positions secured. Easy to learn. Send for FREE CATALOG.

ST. LOUIS WATCHMAKING SCHOOL, Dept. 5, ST. LOUIS, MO.

## BE A DETECTIVE

Earn from \$150.00 to \$300.00 per month; travel over the world. Write C. T. LUDWIG, 133 Westover Bldg., Kansas City, Mo.

## DON'T TAKE A COURSE IN MACHINE DRAFTING

until you've read my proposition. Practical, experienced Draftsman, regularly employed in large modern works, will teach a few men by mail. Best way to become a well-paid Draftsman. Special courses in Mathematics also. Instruments furnished. Rates very reasonable. Pay a part after in position. Draftsman, 252 S. Corona St., Denver, Colo.



Taxidermy  
Book  
FREE

## Mount Birds

We teach you by mail to stuff and mount all kinds of Birds, Animals, Game Heads. Also to tan skins and make rugs. Be your own taxidermist. Decorate your home with your beautiful trophies or increase your income selling specimens and mounting for others. Easily, quickly learned in spare time by men and women. Highest endorsements by thousands of students. Write today for our great free book "How to Mount Birds and Animals" Free—write today.

N. W. School of Taxidermy, 1194 Elwood Bldg., OMAHA, NEB.

# Equip Yourself to Win

Here is your opportunity to know the meaning of those strange new words *kinetophone*, *cathenics*, *dreadnought*, etc. Insure against embarrassing errors in spelling, pronunciation, and poor choice of words. Know the meaning of puzzling war terms. Increase your efficiency, which results in power and success.

## WEBSTER'S NEW INTERNATIONAL

DICTIONARY, *The Merriam Webster*, is an all-knowing teacher, a universal question answerer, made by specialists to meet your needs. Hundreds of thousands of people in all walks of life use and enjoy this vast fund of information.

### THE MAN OF AFFAIRS

finds the fitting word or phrase to convey clearly his meaning in business letter, contract, or agreement.

### THE TEACHER

gains from this supreme authority facts in word study, history, biography, geography, sports, etc., so necessary for the pupils' training.

### THE FARMER

has confidence that this library in a single volume contains a final answer to his questions about soil, seed, crops, stock, feeding, and thousands of other subjects.

### THE LAWYER

relies on the New International for the accurate authoritative treatment of law terms. Examine the words *felony*, *extradition*, *debenture*, *caveat*, etc., and you will understand why Supreme Court Judges concur in its favor.

IN THE HOME the work is a constant source of interest, value, and enjoyment to all members of the family. The wise parent directs the inquiring mind to this storehouse of information. The child soon forms the "Dictionary Habit."

WRITE for specimen pages of both Regular and India-Paper Editions.

FREE—A set of Pocket Maps if you mention this publication.

G. & C. MERRIAM CO.,  
SPRINGFIELD, MASS., U.S.A.



THE AUTOMOBILIST readily learns the meaning of the scores of technical words used in advertisements and catalogues. Turn to *internal-combustion engine*, *carburetor*, *automobile system*, *tuner*.

### Proof that settles the matter

when it comes to selecting a Dictionary: The NEW INTERNATIONAL is the standard of the Federal and State Courts. The standard of the Government Printing Office. The standard of nearly all the schoolbooks. Indorsed by State School Superintendents. Universally recommended by Statesmen, College Presidents, Educators and Authors. Adhered to as standard by over 99% of the newspapers. All States (30 in number) that have taken official action regarding the adoption of dictionaries recognize the Merriam Series as authoritative. GRAND PRIZE (Highest Award) at Panama-Pacific Exposition. The above cannot be said of any other dictionary.



### Salient Features:

- 400,000 Vocabulary Terms.
- 30,000 Geographical Subjects. 12,000 Biographical Entries. Thousands of other References.
- Color Plates.
- 6,000 Illustrations.
- Hundreds of NEW words not given in any other dictionary.
- 2,700 Pages.

Why Not Act Now?

G. & C. MERRIAM CO., Springfield, Mass.  
Graduates: Please send me specimen pages of the Regular and India Paper Editions, etc. Include FREE Pocket Maps per Pop. Mech.  
Name.....  
Address.....

## WANTED

Railway Mail Clerks  
\$900 to \$1800 a Year  
(\$75 to \$150 a Month)

Rapid advancement to higher Government Positions. "No lay-offs" because of STRIKES, WARS, FINANCIAL FLURRIES or the WHIMS OF SOME PETTY BOSS. THE POSITION IS YOURS FOR LIFE.

Country residents and city residents stand the same chance for immediate appointment. Common-sense education sufficient. Political influence NOT REQUIRED.

We will coach 25 candidates free of charge  
If you want to be one, send coupon immediately

FRANKLIN INSTITUTE, Dept. K106, Rochester, N. Y.



Business Boom means hundreds of appointments

FRANKLIN INSTITUTE (The Pathway to Plenty), Dept. K106, ROCHESTER, N. Y. This coupon, filled out as directed, entitles the sender to a free copy of our book, "Government Positions and How to Get Them," a list of Government positions now obtainable, and to consideration for Free Coaching for the position here checked.

### COUPON

- |   |  |
|---|--|
| ..Railway Mail Clerk. (\$900 to \$1800)   | ..Customs Positions.. (\$900 to \$1500)                          |
| ..Bookkeeper..... (\$900 to \$1800)       | ..Scenographer..... (\$900 to \$1500)                            |
| ..Postoffice Clerk.... (\$900 to \$1200)  | ..Internal Revenue... (\$700 to \$1800)                          |
| ..City Mail Carrier.... (\$900 to \$1200) | ..Clerk in the Departments<br>at Washington... (\$900 to \$1500) |
| ..Rural Mail Carrier... (\$300 to \$1200) | ..Canadian Gov't Positions.....                                  |
| ..Auto Chauffeur.....                     |  |

Name..... Address..... K106

Use this before you lose it. Write plainly.

Please Mention Popular Mechanics



# Be 1 of the 1000

that order today **The Encyclopaedia Britannica** in the "HANDY VOLUME" issue

which we are selling for \$1.00 down and small monthly payments; at a price two-thirds less than the big-volume form of the same work; and under our guarantees that this is the complete Britannica, and that everyone will be perfectly satisfied with it—or have his money back.

- ☞ This is not merely our advice. The fact that nearly a thousand people a day are ordering, is sufficient proof that this is a wonderful bargain. The American public is generally quick to recognize a good thing when it sees it. Order your set now.
- ☞ We didn't commence advertising the "Handy Volume" issue of the Britannica until the publishers had 50,000 sets, on the famous India paper, ready for immediate shipment. We expected a big sale. As a matter of fact, the publishers apparently won't have enough stock on hand to fill our orders. That means a record-breaking sale. You can see that a sale of 1000 a day will soon use up 50,000 sets.
- ☞ New stock on India paper is a very great problem. It is daily becoming more difficult to obtain India paper in large quantities. The European war has practically shut off the foreign supply; and the one American mill making such paper—its entire output being taken by the publishers of the Britannica—finds it about impossible to import necessary raw materials.



## Therefore, Act Now—Today

- ☞ This is the reason why you should act today. If you have copies of our previous advertisements or circulars, look them over, get out an order form, sign it, and send it to us at once.
- ☞ If you haven't a copy of our booklet about the Britannica in this attractive and low-priced form, write today for full information. Sign the coupon on this page and mail it now. We will promptly send the information you need and you will probably be in time to enter your order while there still is stock of India paper sets.

### Read These Letters

UNITED STATES Senator James E. Martine, of New Jersey, under date of Jan. 31, 1916, compares the Cambridge issue (in big volumes) which he bought and the Handy Volumes, costing one-third as much:

"I believe, had the 'Handy Volume' size been on the market and I had the choice to make between it and the Cambridge issue, I should have selected the former, regardless of price."

And many others have been surprised to find the "Handy Volume" set as handsome as the Cambridge issue and really worth more, apart from price, because it is so convenient.

ONE of the early subscribers to the "Handy Volume" issue, William S. Patterson, Esq., 2116 Mt. Royal Terrace, Baltimore, on Jan. 27, 1916, wrote as follows:

"The 'Handy' Encyclopaedia came to hand Monday in perfect condition, and they are *even more than you claim for them*—have been reading ever since they arrived and cannot stop."

This letter is typical. We have received many others equally enthusiastic. *You* will be just as well pleased as Mr. Patterson was.

Sears, Roebuck and Co.  
Chicago  
Sole Distributors

SEARS, ROEBUCK AND CO.  
CHICAGO

Please send me, free, full information about the "Handy Volume" Encyclopaedia Britannica, with sample pages of type and illustrations, details of bindings, prices, terms, etc.

Name \_\_\_\_\_

Address \_\_\_\_\_

18-D \_\_\_\_\_

# \$60 Drafting Course Free

I AM offering an opportunity to a few workers to get my entire Drafting Course, (value \$60,) absolutely free. Write and I will tell you all about it—how, by my system for enrolling other students, you may get my complete course of instruction without paying a penny in money. Almost no time or trouble.

*Notice the other big offers I am making in this announcement. I am giving away a \$15.00 draftsman's outfit without cost.*

## \$125 a Month

Draftsman's work is pleasant and profitable. \$125 a month is an ordinary salary.

Positions are open to intelligent men in the best surroundings. They are open everywhere. Men are needed who have just the kind of training I will give you. You can get this training during your spare time in your own home.

## Mail the Coupon

for my valuable book—"Successful Draftsmanship." It explains how YOU can become a successful draftsman in a short time. This book is free at present, so write at once—NOW.

## Chief Draftsman Will Train You Personally

on practical Drafting-room work *until* you are competent and *until* you are in a permanent position at a salary paying at least \$125 per month. This is an exceptional opportunity for a few selected ambitious men, between the ages of 16 and 40, whom I will train personally.



## FREE!

### This \$15 Draftsman's Working Outfit

These are regular working instruments, the kind I use myself. I give them free to you if you enroll at once. Besides these instruments I also give you free a 20x25 inch drawing board, a 24 inch T square—a 12 inch rule, a supply of drawing paper, two triangles, French curve pencils, erasers, thumb tacks, etc. All FREE. Send coupon today.

### Chief Draftsman Dobe

Engineer's Equipment Co.  
Div. 1194 Chicago, Ill.

Without any obligations to me whatsoever, please mail your book "Successful Draftsmanship," and full particulars of your liberal "Personal Instruction" offer to a few students. It is understood that I am obligated in no way whatever.



## Pay as You Wish!

What I want is the RIGHT KIND of men. Don't bother about expense. I will give you the working outfit free if you get in at once. I charge a very small fee for training you to be an experienced draftsman. You can pay the small cost as suits you best. My object is to develop experienced draftsmen.

## Mail the FREE Coupon

at once for my book, "Successful Draftsmanship." Tells you all about the profession and the wonderful opportunities that are now open. Here is your chance to get into the big money class.

## Chief Draftsman Dobe

Engineer's Equipment Co. (Inc.) Div. 1194, Chicago

Name .....

Address .....

# CLASSIFIED ADVERTISEMENTS

WORLD'S BEST WANT AD MEDIUM

We have records to prove that a classified ad in these columns will find a buyer for almost anything which can be sold. Doubtless you have some article of value to some one else which you no longer need. Why not turn it into money?

Advertisements in this section, 15 cents per word, each insertion, minimum 10 words, payable in advance. To insure ads being inserted under proper classified head in the May issue, copy must reach this office not later than April 1st.

Jersey City, N. J., February 6, 1916.

Popular Mechanics, Chicago, Ill.

Dear Sirs: I placed an ad in your magazine last month offering a machine for sale. I sold the machine some time ago, after receiving inquiries from every state in the Union, including Cuba. I still get two or three letters a day. Is there no way you can stop these letters, as I don't have the time to answer them?

Yours truly,  
J. E. WYNKOOP.

## AUTOMOBILES

**ATTENTION, Automobile Men, Garage, Repair and Welding Shops.** So-Luminum, the new, great welding compound for aluminum. A perfect substitute for acetylene welding in  $\frac{1}{2}$  time and cost. No flux—Gasoline torch only thing required. Does work acetylene welding cannot perform, saving parts heretofore scrapped. No life taken out of the metals or parts out of alignment. Already used by U. S. Navy, Vickers Ltd. of England, Packard, International Motor, Pierce-Arrow and hundreds of manufacturing and biggest welding shops. Sample bar \$1.50, per lb. \$3.50. Write for booklet 1 and endorsements. So-Luminum Manufacturing Co., 1790 Broadway, N. Y., Sole Manufacturers.

**CYLINDERS** reground, new pistons and rings fitted. Restores lost power. Prompt and efficient service given. Write for prices, giving make and model. The Everts Machine Company, No. 20 Hicks St., Hartford, Conn.

**PAIGE Sedan \$690.** Guarantee every part good as new. W. F. Cooper, Norwalk, Ohio.

**ACCURACY** counts in cylinder grinding. Extra light pistons and perfect rings inserted, and we give service. Write for booklet. New Haven Machine Corp., New Haven, Conn.

**AUTOMOBILE Repairs**—Automobile owners, Garages and Repairmen should subscribe for the Automobile Dealer and Repairer; 150-page illustrated monthly devoted exclusively to the care and repair of the car. The only magazine in the world devoted to the practical side of motoring. The "Trouble Department" contains five pages of numbered questions each month from car owners and repairmen which are answered by experts on gasoline engine repairs, \$1 per year; 15 cents per copy. Canadian subscription, \$1.50. Postals not answered. Charles D. Sherman, 30 Windsor Road, Hartford, Conn.

**GET** into the Automobile business, as salesman, chauffeur, garage manager, mechanic. Automobile instruction in four weeks' residence course. Send for booklet P. M., West Side Y. M. C. A. Auto School, 218 West 57th St., New York.

**PAINT** Your Car Yourself—Save \$25 to \$75 by doing the work at home with the Arsenal system. Our big free booklet "The Car Beautiful" tells how. Send for it today. Arsenal Varnish Co., Dept. P, Rock Island, Ill.

**WANTED:** \$20 brings three samples Shock-Absorbers. Large Cars and Fords. Double money, become Agent. Auto Improvement Co., 1230 St. James St., Philadelphia.

## AUTOMOBILE SUPPLIES

**"QUICK Attachable" Fan Belts** for "Overlands" 75c; "Dodges" 50c; "Buicks" 50c; "Maxwells" 50c; "Dorbs" 50c. Post-paid anywhere. Belts for all "flat belt" cars—prices, send dimensions overall. Durable—noiseless. See our adv. in "Ford Accessories." Garage and "Repair-men" wanted as Agents. Lakewood Fabric Belting Co., 1516 Highland Ave., Lakewood, Ohio.

**BEAT** the high cost of gasoline by using "Gidz" the Modern Auto Fuel. Carbon troubles vanish while you drive your car, thus, saving bills for repairman's time. "Gidz" gives 20 to 25% more power. 100 Tablets \$1, treats 100 gallons gasoline. Local dealers or remit. Fred M. Giddings Manufacturer, Galesburg, Illinois. Agents wanted. No samples.

**AUTO Repair Parts**—E. M. F. 30; Chalmers Model M; Moon Models C and 40; Regal; Hupmobile 20; Overland; Courier; Buicks Model 10; Ford Model N; Maxwells, K and AA; R. C. H.; Krit; Mitchell; Interstate. Wheels, axles, cylinders, pistons, connecting rods, for most any make of car. We have from 40 to 50 engines and radiators on hand. Write us your wants. Auto Parts Co., 4116 Olive St., St. Louis, Mo. No connection with any other auto parts company.

**"ALWASHOLD** Auto Patch." The modern inner tube repair. Why vulcanize? Alwashold will make repairs cheaper, quicker, better, anywhere, anytime and anything from a pin hole to blowout 5 by 17 inches. Applied in five minutes, no heat or tools required. In heat or cold they always hold. This has been proven in the hot sands of Florida and the cold of the far north. Complete outfit and 108 square inches of material enough for 150 repairs. Price \$1.50 complete, postage prepaid. Exclusive territory to live agents. Alwashold Auto Patch Co., 6251 Dorchester Ave., Chicago.

**A WRITTEN** guarantee for 5,000 miles without puncture. European Motorists are getting 10,000 miles out of their tires by increasing them about one-half inch in size. In eight months 20,000 American Motorists have followed their example. It's so easy that you can do it in your own garage in thirty minutes, no matter what condition your tires are in. Send for free catalog, sample and copy of guarantee. Colorado Tire & Leather Co., 443 Tread Bldg., Denver, Colo.

**OUR Double-Tread Tires** are Guaranteed for 3,500 miles. Two tires in one. Big, strong, extra heavy, 30x34, \$7.00; 34x4, \$9.25; 36x4 1/2, \$12.00; 37x5, \$13.00. Big saving on other sizes also. Send for list now! State size and type rim. Max Liben & Company, 205B West 48th, New York.

**MOUNT** your vacuum cleaner on your auto. Buy parts, assemble. \$50 cost—earns \$15 daily. Vacuum Supply Co., Ann Arbor, Mich.

**ACT** quick! Automobile gasoline going up. Sell "Gas-Tonic." Equals gasoline at 3c a gallon. Eliminates Carbon. Dollar an hour profit. Sales guaranteed. White Mfg. Co., Dept. M., Cincinnati, O.

**CADILLAC** Parts at less than half price while they last. Everything for old models, including parts of electric equipment. Allen, 2015 Commerce St., Dallas, Tex.

**RECOVER** your own auto top and save money. We furnish complete outfits for all makes of cars ready to slip on. Roof and back complete for Ford touring, \$6.45; roof and back complete for Ford runabout, \$5.45; Ford seat covers, runabout \$4.50, touring \$7.00. Complete tops for all makes of cars, mohair, or auto leather, runabout, \$15.00; touring, \$30.00. American Auto Top Mfg. Co., 1449 Washington Boul., Chicago, Ill.

**CHALMERS** Unit Power Plant, \$125. Flanders 20 hp. Eng., \$75. 6 cyl. Thomas, \$175. 50 hp. Stoddard Dayton motor, \$150. D. H. Bosch Mag., \$30. Vesta Generator, \$13. 16 hp. Herrmann motor, \$85. New Northway Eng., \$100. Auto Salvage & Parts Co., 1436 Wabash Ave., Chicago.

**AUTO Rims**—All makes, all kinds in stock. New Ford wheels, 30x3", \$1 each. Other sizes and makes of wheels in stock. City Auto Tire & Supply Co., East 24th St. and Chester Ave., Cleveland, Ohio.

**USED** parts, for all Maxwells, Buick Ten, Chalmers, Thomas, Inter-state, Ford N-8, Locomobile, Big-Little Stevens, Mitchell, and others. Kent Auto Co., 1743 Logan, Denver, Colo.

**THE Oxygenerator**—Permanently attached to your engine, automatically removes carbon, saves fuel (10 to 20%), increases power (10 to 15%), no additional cost for operation, nothing to wear out; in use 365 days in the year. Passed by all technical societies—a sale whenever shown. Owners of autos, regardless of make of car, investigate. Price \$10. Salesmen wanted everywhere. The Oxygenerator Co., 1510 Ft. Dearborn Bldg., Chicago, Ill.

**PHENOMENAL** values in Eisemann and Bosch magnetos. Bosch D-4 \$30.00. DU-4 \$37.50 guaranteed. Pellet's Magneto Exchange, 1606 Michigan Avenue, Chicago, Illinois.

**AUTOMOBILE** parts bought and sold for all makes. New Tops, Curtains, Hoods, etc. Write us what you want. Motor Parts Listing Co., Detroit, Mich.

**AUTO Tops** direct from factory—one-half usual prices. \$7.25, \$9.25, \$10.25, without frame, to fit any car. \$19.25, \$25.00, Ford "One Man" Tops complete. Seat Covers, Ford, \$3.45, \$5.89, \$7.00. Buick, \$5.00, \$7.00, \$10.50. Overlands, \$4.65, \$5.60, \$9.45. All makes same rate. Catalogue, samples free. Special exclusive agency proposition. Auto Specialty Factory, Dept. 109, Cincinnati, O.

**TRUCK** axles, wheels, springs, transmissions, Buick opposed motor with trans. R. E. Atkinson Mach. Co., Fowler, Ind.

**VULCANIZER'S** Outfit. Williams' three-cavity vulcanizer, complete for tire and tube repairing. Box 178, Washington, Iowa.

**FREE!** Just from the press. Our money saver. Wholesale prices on tires, touring, roadster, racing, jitney and commercial bodies for Ford Chabats. Vulcanizer and vulcanizing plants. Radiator tops, accessories. Special Motorcycle Supply Bulletin. Save 30 to 50%. Write today. Sterling Tire and Supply Co., 14th and Michigan Ave., Chicago.

**WRITE** today for money-saving list—specialties that lower tire cost—lower cost automobile operation. A. E. Atchison, 1920 South Sawyer Ave., Chicago.

**SALESMEN** or Agents wanted. We have well known and attractive line showing big profit to automobile, hardware, drug, optical and jewelry dealers. Liberal commissions paid. Big salaries possible. The line warrants full time. The Harry H. Reynolds Company, 1326 Michigan Ave., Chicago.

**WOOD'S** Auto Polishing Cream—One bottle will keep your automobile looking like new a whole year. Gives even, high polish. Does not gum, streak or gather dust. Preserves enamel. Easy to apply. Agents and dealers wanted. No free samples. \$1 post-paid. Wood's Auto Polishing Co., Dept. D, Galesburg, Ill.

**CARBURETORS**—New Stromberg 1 1/2" Models A-2 and B-4, \$5 each. City Auto Tire & Supply Co., East 24th St. and Chester Ave., Cleveland, Ohio.

**BIG** Profits from Battery Chargers. Engine or city current operation. Easy terms. Hobert Brothers, Troy, Ohio.

**DOUBLE** Service Tires. Guaranteed 3,500 miles. Size 29x3 \$5.00, 30x3 1/2 \$6.00, 33x4 \$8.00, 34x4 \$9.00, 36x4 \$9.00, 36x4 1/2 \$10.00, 36x5 \$11.00, 37x5 \$11.00. Non-skid \$1.00 extra. 10% required on C. O. D. orders. State if Q. D. straight bead or clincher type. Special discount to dealers. I. Jaffess, 1319 H. Fifth Ave., New York. Branch 282H, Halsey St., Newark, N. J.

**RECTIFIERS** for garages. All sizes. Charge one to eight batteries, \$12 upwards. American Battery Company, 1129 Fulton St., Chicago.

**TIRES.** New Fisk Metric Oversize, 5 to 7 layers of fabric. 36x3 1/2 Plain \$9.00, Non-skid \$11.80; 34x4 Plain \$13.80, Non-skid \$16.90; 35x4 1/2 Plain \$17.80, Non-skid \$21.25; 36x4 1/2 Plain \$19.00, Non-skid \$22; 35x5 Plain \$21.15, Non-skid \$24.25. Tuxedo Tire Co., Bronx, New York.

**GASOLINE** reduced 25%. Motor efficiency increased every way. Guaranteed with Parker Vaporizer. Highly successful. Sent on 15-day free trial. No money required for test. Pay when satisfied. Postal request will do. C. Parkop Mfg. Co., Philadelphia, Pa.

**JUBILEE** Spark Intensifier. Newest automobile specialty. Banishes spark-plug trouble. Sells on sight. Whirlwind success. Fortune to agents. Write quick. Jubilee Mfg. Co., Dept. P, Omaha, Neb.

**ALL** makes engines, magnetos, cylinders, pistons, carburetors, wheels, bearings, etc., and all auto supplies at very lowest prices. Atlantic Supply Co., Long Branch, N. J.

**VULCANIZER** for shop. Bargain. Vandervoort's, Springfield, Ohio.

**MAKE** your automobile pay. Attach Vacuum Cleaner to your automobile wheel. go into the Carpet Cleaning Business, earn an income of \$15.00 a day upwards. Thurman Vacuum Cleaner Co., Dept. A, St. Louis.

**EXPLOSION** Whistle. Fits priming cup. Most powerful signal made. Rapid seller owing to real value. Buell Manufacturing Co., 1141 E. 46th St., Chicago.

#### TO FORD OWNERS

**THE** American "Ford" Owners Association, National Headquarters, Albany, N. Y., will mail free, 100-page sample copy of their "Official Monthly" on receipt of your address.

**WANTED**—Ford car owner in every county to demonstrate the all steel \$10 Ajax Ford Starter; \$30 to \$50 weekly. Write at once for 1916 territory to Ajax Ford Starter Co., Keene, N. H.

#### FORD ACCESSORIES

**"QUICK** attachable" fan belts for "Fords." Come complete. Patent Fastener permits quick installation or repair—indispensable to Salesmen, Tourists, etc. Grease, heat, water-resisting—"noiseless." Outlast ordinary belts. Postpaid anywhere, 50c each, three for \$1.25 (Postage Stamps accepted) "Repair-men" wanted as Agents. Lakewood Fabric Belting Co., 1516 Highland Ave., Lakewood, Ohio.

**\$45 A WEEK** this spring and summer. Pleasant work at home or traveling. Sell the "Lil' Sho-Fur," safety-steerer for Fords. Attached in ten minutes. Simple, perfect. No cans or coiled springs. Details free. White Mfg. Co., Dept. C-1, Cincinnati, O.

**FEAR NOT** Shock Absorber. For Fords. Positively checks the rebound of springs. Enky Packard comfort at Ford prices. Sold on money-back, life-of-car guarantee, for \$6 a full set. Why pay more? Free trial on your car. We leave the verdict to the user. Not sold by jobbers. Liberal terms to live dealers and agents. A. E. Andrews, Distributor, 1140 Michigan Ave., Chicago.

**THE "Startford."** We believe one is entitled to know that a Starter for a Ford car is absolutely right before he pays for it. That's why we send the Startford complete with Priming Device, C. O. D. \$12.50, allowing ten days' trial, instructing express company to return deposit to customer if he returns Startford—and it don't come back. Live salesmen wanted. Symons Brothers Co., Winnetka, Ill.

**FORD** Owners, our Safety Ford Starter retails for \$15. By ordering 2 or more you get our new wholesale price, \$4.50. Write for particulars. Safety Ford Starter Corporation, Columbia Theater Bldg., Broadway and 47th St., New York.

**"STEER** Relief" for Fords. Best accessory, and Ford owners want it. Gives comfort, safety. Big money for agents. Sample \$5, prepaid, with ten-day return privilege. Post & Carr, New London, Ohio.

**REPAIR** Parts for Ford Cars to the trade only at prices that are money-makers, and quality, fit and workmanship guaranteed. Grossman Auto Parts Company, White Plains, N. Y.

**EASY** Rider Shock Absorbers \$4.00 set of Four. H & H Company, Forest City Bank Bldg., Cleveland, Ohio.

#### CYCLECARS AND MATERIAL

**TWIN** Cyclecar engine, for sale cheap. Harry Whitteley, Atwater, Ohio.

**FOR** Sale—Cyclecar parts, very cheap. These are parts of a well-known successful car. Motors, wheels, transmission, axles, etc. Tribune Engineering Co., Inc., Owego, Tioga County, N. Y.

#### MOTORCYCLES, BICYCLES & SUPPLIES

**BARGAINS** in used motorcycles. Write for our revised list of used motorcycles of all makes and models, including the Harley-Davidson, Reading-Standard, Merkel, Thor, Indian, Yale, Shickel, Pope and De Luxe. Our machines are overhauled in every instance and placed in a condition far better than ordinary. The seasons shipments extend from coast to coast, from Florida to Canada to Alaska. All prices have been reduced to a minimum in preparation for the present 1916 spring season. Literature furnished on request. The Place of Satisfaction, Mueller Cycle and Supply Co., Oldest and largest dealers in the northwest, 726 National Ave., Milwaukee, Wis.

**DON'T** buy a Bicycle Motor Attachment until you get our catalogue and prices. Shaw Mfg. Co., Dept. 27, Galesburg, Kansas.

**UNUSED** Flexible Sidecar with rigid attachment fittings, \$45.00. Thomas Dunham, Aurora, Ill.

**1915 MIAMI** Power Bicycle. Used very little. Just overhauled. Excellent condition. Cost \$150. Worth \$100. Bargain at \$80. Hugh Gill, Atoka, Okla.

**MOTORCYCLES** \$35 to \$175, all makes and models, 150 to pick from. Write today; save money by buying now. Largest motorcycle store in the world. Lister Motorcycle Co., Cleveland, Ohio.

**SUPPLIES**—The largest catalogue with prices lower than usual sent free to motorcycle owners. Mero, Hammondspoint, N. Y.

**SEND** for latest Bulletin of real Motorcycle Bargains, used and slightly used, all makes, models and prices; if you have \$25 and really want a powerful Motorcycle, send for this Bulletin; hundreds of machines at all prices, new ones on easy payments; tell us what you want and how much you can pay; we can fit you up. Peerless Motorcycle Co., Dorchester, Mass.

**EXCELSIORS**, Indians, Harleys, twin clutch magneto, '11s, \$45; '12s, \$60; '13s, \$80; '14s, \$110; '15s, \$140. Others \$15. Twins \$30. New, Excelsior, Henderson, Tiger, Installments, Exchange, Knights, 3223 Locust, St. Louis, Mo.

**1915 TWIN** Indian, five horse, good as new, \$185. Vernon Elgert, Middlebury, Ind.

**\$1.00—TWO** colored Dimmer goggles, sample to rider agents 25c. Motorcycle parts to all machines, 50c saving. O'Brien's, 6550 State, Chicago.

**BARGAIN** in new Harleys. Overstocked. Crenshaw, Rocky Comfort, Mo.

**BARGAIN**—1914 Harley-Davidson 5-hp., in fine running order; electric horn, good tires, \$100 if taken now. John C. Baker, R. P. D. 1, Volga, S. Dak.

**USED** Motorcycles from \$25 to \$200. Money refunded if machine not satisfactory. Send postal for list. C. H. Lang, 1794 Michigan Ave., Chicago.

**EASY** terms on rebuilt motorcycles—get new list P-4, \$25 up. Rebuilt Motorcycle Co., Brockton, Mass.

**SAVE** one-half on repairs and accessories for all makes. Get circulars. Jones, "The Paris Man," Brockton, Mass.

**MERKEL** twin, magneto model, used very little, in A No. 1 shape, \$65, or will trade for 2-cylinder Kohan row-boat motor. Box 203, Tipton, Iowa.

**USED** Motorcycles in good running order. Guaranteed, \$25 up. Many makes, all bargains. Send for list. Seeber & Hofbeins, Buffalo, N. Y.

**1914 JEFFERSON** twin, excellent condition, very speedy \$75. Two Harley frames, wheels, clutch, handlebars, forks, cheap. John Ottman, Oberlin, Ohio.

**BIG** Bargain 1914 Indian, run 1,500. Equipped. W. P. Petts, Hendersonville, N. C.

**FOR** Sale—1913 Twin Indian, perfect condition, \$75. William Houston, Charleroi, Pa.

**1913 HARLEY-DAVIDSON** Twin, absolutely afloat. \$110. Tom Detlep, Jr., Upland, Neb.

**BRAND** new motorcycles, standard makes, on easy terms; descriptive circular free. Smith, 619 Centre St., Brockton, Mass.

**FOR** Sale—M. M. Motorcycle magneto, \$30. Box 225, Willow Lake, S. Dak.

**EXCELSIOR** Twin, Bosch Magneto, bargain \$100. Box 41, Lynd, Minn.

**BARGAINS** in second-hand Motorcycles—Indians, Reading Standard, Harley-Davidson, etc. Send for price list. John G. Nuebling, Reading, Pa.

**MOTORCYCLE** and Bicycle Encyclopedia and Catalog of Supplies, the finest catalog ever issued. It will save you dollars. Send 3 cents in stamps. Five cents credit and a watch fob on first order. Saufley Supply Co., Kansas City, Mo.

**REAL** Bargains in Second-hand Motorcycles. We have an overstock on all makes, such as Indians, Harley-Davidsons, Excelsiors, Pops, Reading-Standards, Merckels and four-cylinder Hendersons; all are in A-1 condition and fully equipped. If interested in buying a motorcycle, write for our complete list giving description and prices, which is about half their real value. \$225 new 1915 twin-cylinder. Flanders motorcycles, \$138.50. Catalogs upon request. Gotham Sporting Goods Co., 57 Warren St., New York City.

**MOTORCYCLES** and Accessories—Henderson 4-Cylinder, fully equipped, \$100.00; Pope 8 H. P. Twin, 1915 Model, ridden 300 miles, like new, \$100.00; Indian single cylinder, \$35.00; Excelsior Auto-cycle, \$25.00; Heltzer Carburetor, \$3.50; Short Grips, 25c; Spark Plugs, 25c; Bosch Magneto for any motorcycle, \$10.00; Foot-Rests to fit any motorcycle, \$3.00; Harley-Davidson Brackets, 25c; Motorcycle Pedal Rubbers, 10c; Pedals, 60c. Write for April Bargain Bulletin with cuts. Largest Motorcycle Store in the United States. Exchange any goods not satisfactory or money refunded. W. E. Wandersee Co., 129 Gratiot Ave., Branch Store, 2996 Woodward Ave., Detroit, Mich.

**LARGE** stock of rebuilt motorcycles, new parts for all makes 30% discount; second-hand parts, good as new, 50% discount. Motorcycle Parts Mfg. Co., 2127 Michigan Ave., Chicago.

**\$40** BUYS my single cylinder Roadster Motorcycle. Guaranteed. L. Ludden, Abington, Mass.

**YALE** 1914—2 Speed \$100. Bargain! L. Kinney, 26 East Elm, Brockton, Mass.

**BARGAIN** Nifty Harley Sidecar, fully equipped. Dr. Lewis, Bennington, Vt.

**DAYTON** 1913-14 H. P. Twin. Fast. Powerful \$75. Charles Ludden, Brookville, Mass.

**BIG** bargains in second-hand motorcycles, \$25 up. Indians, Harleys, Thors, Excelsiors and Merckels. Write for description. Howard A. French & Co., Baltimore, Md.

**1913 TWIN** X, guaranteed in perfect mechanical condition and running order. Fully equipped, \$85.00 cash buys it. Send money, care Popular Mechanics, J. G. Adler, 1947 W. Madison St., Chicago, Ill.

**CLOSING** out stock of second-hand motorcycles at half their value. Sold on easy payments; send for big list. Howard Cycle Co., 152 N. Broad St., Trenton, N. J.

**SEND** for list of guaranteed used motorcycles, \$40 up. Driscoll & Jeanroy, 209 West 126th St., New York City.

**WANTED:** We pay cash for used motorcycles or take them in on exchange for new machines. Write with complete description. State condition of tires, frame, motor, make and model. Shaw Manufacturing Co., Dept. 157, Galesburg, Kans.

**BARGAINS**—Used motorcycles and motorwheels. Edward Ryan, Poughkeepsie, New York.

**MOTORCYCLE** cylinders reground, fitted with new piston and rings \$5.00, guaranteed. Muncie Piston Co., Muncie, Ind.

**NEW** Motorcycle Book—Just Published—Motorcycles, Side Cars and Cyclecars, Their Construction, Management and Repair—550 pages, cloth, 350 illustrations. The Dealer, Mechanic and Rider will find this treatise a work of reference without an equal. Price \$1.50 postpaid. Popular Mechanics Book Dept., 8 N. Michigan Ave., Chicago.

**BIG** bargains in good motorcycles we have taken in exchange on new ones. Send for special bargain list. Shaw Mfg. Co., Galesburg, Kansas.

**WANT** to sell your motorcycle? I have a method which has sold many. Write me today for free information. F. W. Johnson, Room 900, 78 E. Madison St., Chicago.

**MOTORCYCLE** Bargains—Nearly New Three-Speed Harley Twin \$195. Thor Twelves—Fifteen Models—\$125—Good as new. Guaranteed. All makes. Lists Free. Childs & Company, Ottumwa, Iowa.

**NEW** 1916 Henderson two-speed for best offer. D 1400 West 25th Street, Cleveland, Ohio.

## WELDING

**ATTENTION, Automobile Mfrs.,** garage men, repair and welding shops. Amateurs made expert welders—welding made easy for experts. So-Luminum, the new, great welding compound for aluminum. Runs low temperature—no flux—gasoline torch only thing required— $\frac{1}{2}$  time and cost of old way of welding—no parts taken out of alignment—no life taken out of metals. Used by U. S. Navy and Army, Vickers, Ltd., of England, International Motor, and hundreds of largest manufacturing, automobile, aeroplane and welding companies. \$1.50 sample bar, \$3.50 per lb. Guaranteed strongest, cheapest and best welding compound ever discovered. So-Luminum Mfg. Co., 1790 Broadway, New York, Sole Manufacturers and Distributors.

**OXY-ACETYLENE** Welding, Cutting and Brazing taught thoroughly and practically. Write for particulars. Cosmopolitan School of Welding, Dept. D, 231 West 54th Street, New York.

**OXYACETYLENE** welding. Aluminum soldering. So-Luminum \$1.50 bar, \$3.50 lb. E. D. Pendleton, North Fond Du Lac, Wis.

**OXY-ACETYLENE** Welding and Cutting apparatuses, Acetylene generators for welding. Our prices will surprise you. Hamilton Welding & Mfg. Co., Hamilton, Ohio.

**WELDING** Plants, \$25 to \$250. Liberal terms. Write Berino Co., Omaha, Neb., U. S. A.

**BRAZING** Torches forty cents each, Welding Torches ten dollars each, postpaid, guaranteed. Auto Welding Company, Omaha, Neb.

**OXY-ACETYLENE** Welding and Cutting is the title of a brand new practical instruction book on the methods of doing this work. It includes the operation and care of Acetylene Generating Plants and the Oxygen Process for removal of carbon. 290 pages, 76 illustrations, pocket size, cloth, \$1.00; leather, \$1.50 postpaid. Popular Mechanics Book Dept., 6 N. Michigan Ave., Chicago.

## AERONAUTICS

**PARTNER** with 80-h. p. Gnome or Anzani, to fly new Deperdussin monoplane, exhibition work. Address John C. Wilson, 416 West 1st St., Hutchinson, Kans.

**GET** into the Aviation Game now and get into it right. We can and will help you. Benoist School of Aviation, 1291 Webster Bldg., Chicago.

**TURNBUCKLES**; all sizes, immediate delivery. National Aeroplane Co., Machinery Hall, Chicago, Ill.

**BALLOONS**, parachutes and accessories for sale; get our price list. Thompson Brothers Ballooning Company, Aurora, Illinois.

**AIRCRAFT**—America's aeronautical authority, illustrated monthly, \$2 per year. Send for sample, 37 E. 28th Street, N. Y.

**CATALOG "H"** off the press, most complete aeronautical catalog ever published, sent for 6 red stamps. Motor Catalog, 8c; propeller catalog, 6c. Heath Aerial Vehicle Co., Chicago.

**THE Benoist School of Aviation** announces a new Correspondence Course. Thorough training in Aeronautical Construction and Engineering. For particulars write Benoist School of Aviation, 1291 Webster Building, Chicago.

**LIGHT** Weight Gasoline Engines, 2½ lbs. Guaranteed  $\frac{1}{2}$  H. P. The Weiss Co., Torrington, Conn.

**FOR** Sale—Roberts 50 motor in good running condition. Rare bargain. Aviator, 324 9th St., Des Moines, Iowa.

**NEW** 8 cyl. 60 H. P. Hall-Scott Motor \$1,200. H. C. Mummert, 649 East 102, Cleveland.

**MODELBUILDERS** send 7c for 1917 catalog of Aeroplane Models and Compressed Airmotors. Cheapest supplies. The Arrow Model Works, 467 E. 137th St., New York City.

**EVERYTHING** Aeronautical. Complete Machines—accessories—plans. Chicago Aero Works, Chicago.

**WANTED**—Motor, also supplies for Monoplane construction—cheap. Box 336, Wheatland, Ind.

**GET** our 1916 Aeroplane Book containing full information about "Ideal" Model Aeroplanes, parts, plans, etc. 5c postpaid. Ideal Aeroplane Co., 82½ West Broadway, N. Y.

**AVIATION** Motors, all makes, up to 150 H.P., \$250 up. Complete aeroplanes, all types, \$500 up. State your needs. Aero Exchange, 38 Park Row, N. Y. C.

**AVIATION** School, will open at Sandusky, Ohio. Enroll now. Pay after you have learned. Andrey Lashbin, Lefor, N. Dak.

**FOR** Sale—Bleriot Monoplane—Curtiss Biplane—Bargains. W. Banning, Lorain, Ohio.

**BUILDING** and Flying an Aeroplane—160-page handbook covering the building of small models and full sized gliders and machines. In both biplane and monoplane models the well-known Curtiss and Bleriot types are followed. Fully illustrated with detail drawings. Price, \$1 postpaid. Popular Mechanics Book Dept., 6 N. Michigan Ave., Chicago.

**HOW** to Make a Biplane Glider—Our book "Amateur Mechanics No. 2" contains a complete detailed description of how to make one. Price of book 25c postpaid. Popular Mechanics Book Dept., 6 N. Michigan Ave., Chicago.

## BOOKS AND PERIODICALS

**FIFTEEN** books on Tractor Engineering and Tractor Farming written by experts and published by the largest company of exclusive tractor builders in the world. Sent on 3 days' free approval. No money to pay until you see the books and decide that you want them. This is a complete correspondence school course. Price for the set, \$3.50 or 25c for each book. Master these books and you can run a tractor. Jobs are waiting everywhere for expert tractor engineers. Send name and address. Hart-Parr Co., Box M, Charles City, Iowa.

**FREE!** 55 Valuable Formulas, Trade Secrets, Money Making Plans, etc., contained in our Valuable Magazine. Two issues free. Allan Co., Box 65, South Chicago, Ill.

**ENGINEERS'** questions and answers for license, by Holson, for twenty-five cents, postpaid. Send stamps. Reilly's Book Store, Philadelphia, Pa.

**PALMISTRY** Revealed—Complete illustrated instructor, 10c. G. Elsea, Owosso, Mich.

**"CRIPPLE** Tom" and seven other Gospel Tracts, 13 cents. St. Louis Tract Depot, 1427 Locust, St. Louis.

**BOYS**, look, how to run an auto—it's only 10c. Wright Co., Brewster, N. Y.

**ROPE** Splicing—knots—bitches—rigging—complete handbook 100 illustrations 10c coin. G. Brady, 764 Jackson, Chicago.

**SHOE** Repairing Self Taught, It's easy, interesting, profitable. Price, fifty cents. W. J. Shuman, North Second Street, Chambersburg, Pa. Write for contents.

**EVERY** sportsman should have one. The greatest and best book ever published. Send twenty-five cents for a copy. Special offer limited. Wide Awake Novelty Company, Department B, St. Marys, Penna.

**BOOKS** For Sale: "Progress of Nations." Unused, Cost \$28.50, Sell cheap. D. M. Ferguson, McFall, Mo.

**CHARLEY** Chaplin Joke Book, 10c. Richard Lavery, Asbury Park, N. J.

**PEISONS** Interested in Drafting or Engineering—send stamp for sample copy of "The Compass," devoted to topics of interest to the Drafting and Engineering Professions. Office 304, McLachlen Building, Washington, D. C.

**BOOKS**, wholesome, instructive and entertaining. Puzzles, Tricks, Novelties. Illustrated catalogues, fine sample trick all for 10c. Auburn Supply Co., Dept. 4B, 7817 Peoria St., Chicago.

**MECHANICAL** Instruction Books, Best published. Lamont Co., Beacon, N. Y.

**METAL** Work and Etching—A 96-page hand book for art metal workers telling how to make a great variety of useful and ornamental objects, such as desk sets, artifacts, jewelry, etc. Price, 50c postpaid. Popular Mechanics Book Dept., 6 N. Michigan Ave., Chicago.

**BINDER** for Popular Mechanics magazines. Best adjustable magazine binder on the market made especially to hold any number from one to six copies of this magazine with name "Popular Mechanics" in gold letters on front cover. No laces or cutting or perforating of pages necessary. Simple, unique adjustment; handsome, durable and neat. We buy in quantities and can offer our readers this regular \$1.50 binder for \$1.25, all shipping charges prepaid. Address Popular Mechanics Book Dept., 6 N. Michigan Avenue, Chicago.

**BUILD** Yourself a Boat, a Racing Cat or Speed Launch. Send for catalog, Yacht and Boatbuilding Books. Read "The Rudder," the Magazine for Yachtsmen. The Rudder Publishing Co., 256 West 34th Street, New York, N. Y.

**USED** BOOKS—Extraordinary Bargains. Catalog. Higens's, A-2441 Post, San Francisco.

**READ** these great books about the War: 1. Germany and the Next War, by Gen. F. Von Bernhardi (discloses Germany's war plans for crushing England and France. Price 85 cents). 2. Secrets of the German War Office (by A. K. Graves, for twelve years a spy in the Kaiser's service. Price \$1.60). 3. Germany's Fighting Machine (by E. P. Henderson. Divided into three parts, The War, The Army and The Navy. Price \$1.35). 4. Men Around the Kaiser (by F. W. Wile. Tells about those men who figure most prominently in the affairs of Germany at the present time. Price \$1.35). 5. The Germans (by I. A. B. Wylie. A graphic picture of the German people on the eve of the great conflict. Price \$2.15). 6. The War and America (by Hugo Munsterberg, the great German-American. Price \$1.10). 7. War's Aftermath (a study of the deterioration of the quality of stock occasioned by the lamentable waste of war. Price 85 cents). Popular Mechanics Book Dept., 6 N. Michigan Ave., Chicago.

## EDUCATIONAL AND INSTRUCTION

**\$10 PER** day made laying tile. We teach you how in one lesson so that you can go right out and close contracts for tile floors. Price \$2, including box of tile. Address Tile Dept., 612 Oxford Bldg., Chicago.

**LEARN** profession that will give you a business of your own; possibilities unlimited; no job hunting after graduation, when you finish study business is all ready. We teach you free. Our new plan is yours free. Nadico, 4307 Lincoln Ave., Chicago.

**LEARN** to read Blue Prints, Big demand for men who can read and understand blueprints. We teach you. Details free. Modern Mechanics Institute, Dept. P., Cincinnati.

**ARTIFICIAL** Marble Sanitary flooring, ornamental casting, concrete, plaster, paper-mache, interior decorations, garden furniture, statuary, life casting, elastic moulds, electro bronze depositing (immensely profitable work), complete instructions \$1; particulars, 206 illustrations free. Mahler, D-117 Russell St., Brooklyn, N. Y.

**GERMAN** Magazine for Americans, now in 7th volume. Vocabulary. Well illustrated, fascinating, extremely simple, 50c for trial subscription. Three years, \$1.00. "Nah & Fern," 336-332 Webster Ave., Chicago.

**CIVIL** Engineering and Architecture; spring, summer and fall courses. Technical Institute, Greenville, Ohio.

**CALCULATOR** for fractions, multiples, divides, adds, subtracts, quick as lightning; special advertising price 25c; regular 50c; circulars free. Snyder Calculator, Meadville, Pa.

**STUDY** Bacteriology, Public Health and Sanitation. Positions pay \$3,000 to \$5,000. Interesting home study course. Previous experience unnecessary. Degree granted. We help secure positions. Write for prospectus. American College of Bacteriology, Dept. 4002, Chicago.

**STENOGRAPHERS** are always employed. Our copyrighted shorthand course prepares you for paying position. Study at home in spare time. Special terms to Popular Mechanics readers. American School of Phonography, Cleveland, Ohio.

**BIG** pay in drawing. Pleasant, profitable work. Let us develop your talent. Send six cents in stamps for book on art study. Washington School of Art, 992 F Street, Washington, D. C.

**BOOKKEEPING**, Expert Auditing, Rapid Arithmetic, 50c. Garfield Commercial School, 1016 Germantown Ave., Philadelphia.

**BRIEFHAND**, the modern substitute for stenography, uses longhand letters. Easily learned. Complete course \$1.00. Sample lesson free. Premier Briefhand School, Dept. 4, Washington, D. C.

**BOOKKEEPING** or Shorthand Home Study; practical, simplified textbook, 25c. Will A. Marr, Box 285, Nashville, Tenn.

**GENUINE** Altimeter instruments furnished with our mail courses in Mechanical or Topographic Drafting. (For limited time.) Write Mechanical Department, Columbia School of Drafting, 10th and G Streets, Washington, D. C.

**STUDY** Optical Business by our Correspondence or Residence course. Recognized profession. Many Optometrists earn from \$25 to \$75 a week steady. Degrees granted. Write for catalog. Chicago School of Refraction, Dept. 4008, Chicago.

**GOOD** Opportunities for Veterinarians. Send for catalogue. Grand Rapids Veterinary College, Dept. Z, Grand Rapids, Mich.

**POOR** handwriting easily changed to good. Particulars free. D. B. Jones, Paducah, Ky., Route 3.

**MOULDS** and models for ornamental casting of novelties, statuary, garden furniture, in cement, plaster, Italian marble, etc. Free illustrated catalogue displaying large assortment. Roth, A-45 Frost St., Brooklyn, N. Y.

#### TRADE SCHOOLS

**GOOD** openings in Pacific Northwest for Trained Mechanics in Mines, Lumber Mills, Canneries, Farm Machinery. Seattle Engineering School offers three to twelve months' courses. Steam, Gas, Electrical. Splendid equipment. Free Catalogue.

**AUTOMOBILE** course, \$8. We give you a complete course on the care and management of automobiles. Get booklet. Bedford Correspondence School, 1021 Bedford Ave., Brooklyn, N. Y.

**ELECTRICITY**, Plumbing, Bricklaying, Mechanical, Architectural and other Drafting Courses. Motion Picture Operating taught by practical work. Largest, best equipped practical trades school in America. Short time to learn. Small cost, easy payments. Write for big illustrated book; it's free. Coyne National Trade Schools, Dept. 8194, Chicago, Ills.

**NEW** Handy Manual on Plumbing, Heating, Ventilating and Mechanical Refrigeration. A practical book for practical men. 380 pages fully illustrated with cuts and diagrams. Pocket size. Cloth. Price, \$1.15, postpaid. Popular Mechanics Book Dept., 6 N. Michigan Ave., Chicago.

#### TELEGRAPHY

**TELEGRAPHY**—Morse and Wireless—also Station Agency taught. R. R. and Western Union wires and complete Marconi Wireless Station in school. Graduates assisted. Marconi Co. employs our wireless graduates. Low living expense—easily earned. Largest school—established 40 years. Investment \$25,000. Correspondence courses also. Catalog Free. Dodge's Institute, 15th St., Valparaiso, Ind.

**TELEGRAPHY**—Morse and Wireless—taught at home in half usual time. The Omniograph Automatic Transmitter combined with sounder or buzzer sends you messages, any speed, just as expert operator would. Used by U. S. Gov't to examine all applicants for licenses. Trifling cost. Catalog free. Omniograph Mfg. Co., 41-G Cortland St., New York.

#### WIRELESS

**WIRELESS** station photographs of Arlington, Tuckerton and Sayville, 10c. Dunkle & Ballou, 2 Truesdel St., Binghamton, N. Y.

**WIRELESS** Set. How to Make—96-page book telling how to construct at small cost an outfit suitable for transmitting four or five miles. Price, 50 cents, postpaid. Popular Mechanics Book Dept., 6 N. Michigan Ave., Chicago.

**\$10 COMMERCIAL** Keys for \$1. Massey Wireless Telegraph Co., Providence, R. I.

#### PICTURES, POSTCARDS, PENNANTS

**RECEIVE** pretty view cards from many countries. Membership and 6 pretty cards 10c. Riverside Club, Knoxville, Md.

**POSTCARDS** from everywhere. Join our Jolly Club. Send 10c. H. J. Teeple, Decatur, Indiana.

**200 ILLUSTRATIONS** Free. Beautiful art casts. Mahler, K-117 Russell St., Brooklyn, N. Y.

**POSTCARDS** from everywhere. Full membership 10c. Universal Correspondence Club, 1809 Rudy, Harrisburg, Pa.

**POST** Cards from everywhere. Join biggest Exchange in existence. Hundreds of members. Join now. Membership 15c. Popular Exchange, Box 125L, Emporia, Va.

**COLLEGE** and State Pennants, size 9 1/2 x 26 inches. 15 assorted 50c; 6 assorted 25c. Postpaid. Lynch Specialty Co., Joplin, Mo.

**MEMBERSHIP** printed immediately 10c. Pacific Card Exchange, Bryn Mawr, Wash.

**EXCHANGE** pretty postcards with our members far and near. Best card club. Membership, 10c. Jolly Card Exchange, Eighth St., Decatur, Indiana.

**IF** you really want to exchange postcards, try our splendid club. Lists circulate in many countries. Membership, 10c. Balcyon Club, Box 133, Erie, Pa.

**MAKE** new acquaintances. Join our postcard club, membership 10c. Worlds Postcard Club, 13 West 42nd, New York.

**25 ASSORTED** post cards, Views, Holiday, Comic, etc. Postpaid 10c. Arthur M. Whelpley, Belleville, N. J.

**CROSS-SECTIONAL** view of ocean liner "Britannic," showing interior arrangement of ship in colors, size, 14x20 inches, on heavy plate paper for framing or hanging. Very interesting. Reproduced from front cover design of July issue Popular Mechanics. Will be sent postpaid to any address in the world on receipt of 4 cents in stamps to cover packing and mailing. Popular Mechanics Magazine, 6 N. Michigan Ave., Chicago.

#### CAMERAS AND PHOTO SUPPLIES

**ROLL** Film developed, 10c a roll. Packs 20c each: Prints, Brownies, 2c; 1a, 3rd, 8x5, and Post Cards, 3c each. Work returned next day. Postage paid. Kodak Film Finishing Co., 112 Merchants Station, St. Louis.

**DON'T** Cry Over Spilled Milk. Send your next batch of films to us. We'll develop and print them in an expert manner and charge you no more, maybe less, than you've been paying. Why not ask us for samples and prices? Harbeau's, 37 East Bridge St., Oswego, N. Y.

**FILMS** developed 5c. Postcard prints, 4c; smaller sizes, 2c. Dept. C, Hall Photo Finishing Co., Chapman, Kansas.

**FILMS** developed, 10c; prints, 3c to 5c. A reputable Incorporated Company conducting largest existing plant. Price list and special offer. Enlargements our specialty. Chicago Photo Finishing Co., 54 W. Lake St., Dept. A, Chicago.

**FILMS** developed 10c, prints 3c-5c. Work guaranteed. Frey & Son, Citrus Center, Fla.

**MAKE** your camera pay. Take local views and let me print them on photo cards at \$1.50 per 100, postpaid. Sample for 2c stamp. R. P. Young, Centre Harbor, N. H.

**POCKET** Photo Outfit. Cute French novelty. Prepaid, 10 cents. Warfel, Photographer, Cadiz, Ohio.

**HAVE** you a Camera? Send a quarter, just half price, for latest issues of my three helpful magazines, American Photography, Popular Photography, Practical Photography. F. R. Fraprie, 704 Pope Bldg., Boston, Mass.

**SIX** exposure film developed, printed and one 8x10 enlargement for 25 cents. Ashton Photo Works, Ashton, Illinois.

**BIG** Money Saved on Photographic Lenses and Apparatus—goods exchanged; repairing done. Ralph J. Golsen, 5125 Kenmore Ave., Chicago, Department P.

**FINISH** Your Photos in beautiful life-like colors. Easy, new process. Inexpensive outfit. Photokromo Co., Box 117, Scranton, Pa.

**FILMS** developed 10c, prints 3c, all sizes; work guaranteed and returned in 24 hours. L. Hell, 1052 2nd Ave., New York City.

**ONE** Dollar makes your Camera twice as valuable. Formulas and instructions for Ceramic, enamels and watch dial photographs, including 24 latest fads in photography. J. Wertz, Box 1664, Butte, Mont.

**BECOME** a Minute Photographer. Pleasant outdoor work. Experience unnecessary. Best business of the age. Hundreds of men and women make \$10.00 to \$35.00 per day. Sample picture and catalog free. Jamestown Ferrotyping Company, Dept. P, 1126 South Halsted St., Chicago.

**IF** you have a High-grade Camera, Lens, Kodak, or Motion-Picture Camera, and want to turn it into cash, write us today. State particulars, price, etc. We buy and trade, sell or exchange everything in Cameras from Vest Pocket to Graflex. Prompt, satisfactory service and a square deal to all. David Stern Co., 1047M W. Madison St., Chicago, Ill. In business since 1885.

**PHOTOGRAPHIC** Retouching taught—Cheap course; learn at home. Y. & M. Retouching Co., Dept. M, Marshall, Mich.

**EXPERT** Film Finishing. Our work pleases the most critical customers. Send film or negative with return postage for samples of our work; prices right. Gates Studio, Colebrook, N. H.

**THE "Harvey Exposure Meter"** is different from all other Meters. Gives exposures for Extérieurs, Intérieurs, Night Photography, Paget and Autochrom Color Plates. Ask your dealer or write to Harvey, 105 S. Dearborn St., Chicago.

**"FOLLOW** the Bargains," get Erker's 1916 Camera and Lens Bargain Price List, all sizes used Kodaks, Premos, Graflexes, Motion Picture Cameras; every one guaranteed perfect. Erker's, 609 Olive, St. Louis, Mo.

**FILMS** developed 10c, all sizes. Prints 2 1/2-3 1/4, 3c; 2 1/2-4 1/4, 2 3/4-3 3/4, 3 1/4-4 1/4, 4c; Post Cards, 50c doz. Work guaranteed and returned 24 hours after receiving. Postpaid. Send negatives for samples. Girard's Commercial Photo Shop, Holyoke, Mass.

**CUT** Rate Bargain List for January just out. Send stamp. Willoughby, 810 Broadway, New York City.

**LET** me finish your next roll of Kodak Films. Send 10c for trial order. Slocum, 406 Main, Peoria, Ill.

#### MOTION PICTURES

**MOTION** Picture Outfits, Bargain lists free. National Equipment Company, Duluth, Minn.

**WRITE** Photoplays—Earn a big income. Our book tells how. Details free. Enterprise Co., PM-3348 Lowe Ave., Chicago.

**BIG** Money Writing Moving-Picture Plays. Constant demand. Correspondence course; literary ability unnecessary. Write for free booklet, "How to Write Moving-Picture Plays." Universal Publishing Co., 296 Fergus Falls, Minnesota.

**BE** a Motion Picture Operator and earn big money for short hours, easy, pleasant work. We teach by practical work on the finest equipment. Write for free catalog. Coyne Trade Schools, Dept. 7194, Chicago, Ill.

**WRITE** Moving Picture Plays; constant demand; big prices paid; past experience or literary ability unnecessary; details free. Gleason Co., 243 Whiteman St., Cincinnati, Ohio.

**MOTION** Picture Films, \$1.50 Reel Up. Hatch, 284 Market Street, Newark, N. J.

**WRITE** Moving Picture Plays. Good pay. We will show you how. Ripless Pub. Co., Brockton, Mass.

**\$35** PROFIT Nightly—Moving Picture Business—small capital starts you, no experience needed. Teach you—furnish everything. Ralph J. Golsen, 5125 Kenmore Ave., Chicago, Dept. M.

**SAVES** Half Your Lighting Bills. Direct current Arc Dynamo operates from your engine or motor. No resistance wastes. Easy terms. Hubert Brothers, Troy, Ohio.

**MOVING** picture equipment and cameras. Films \$3 reel up. Box 417, Montpelier, Vermont.

**SPOT** cash paid for second-hand high-grade Motion-Picture Cameras, Lenses, etc. Write us today. David Stern Co., 1047 W. Madison St., Chicago, Ill.

**PHOTOPLAYS** Wanted. Big prices paid. We show you how. Details free. Rex Publishers, Box 175 A-3, Chicago.

**MAKE** big money writing moving picture plays. Previous experience, literary talent or correspondence course unnecessary. Free details and special offer. E-Z Scenario Co., 609 West 127th St., New York.

**BIG** money writing Photo-plays; details free to beginners. No correspondence course. Producers League, 230 Wainwright, St. Louis.

**MAKE** \$50.00 clear nightly. We start you in the moving-picture business on the installment plan. No experience necessary. Write for free catalog. Monarch Film Service, Dept. P, Memphis, Tenn.

**WRITE** Photoplays, Short Stories, Poems. Big demand. No correspondence course. Start writing and selling at once. Details free. Atlas Publishing Co., 304, Cincinnati.

**MAKE** a complete Motion Picture Camera and Projector from instructions given in our book Amateur Mechanics No. 4. Full details given. Not hard to construct. Worlds of enjoyment taking and exhibiting subjects dear to the heart. Price of book only 25c, postpaid. Popular Mechanics Book Dept., 6 N. Michigan Ave., Chicago.

**MOTION** Picture Work—A large 618-page book covering every phase of the moving picture, its production and its theatre. Indispensable for reference and instruction to the thousands of workers in the motion picture field. Price, \$3, postpaid. Popular Mechanics Book Dept., 6 N. Michigan Ave., Chicago.

## BUSINESS OPPORTUNITIES

**INDEPENDENCE** and fortune quickly attained in the Manufacturing Mail Order business. I furnish Formulas, Manufacturing Processes and Trade Secrets in all lines. Sold under positive guarantee; 18 years' practical experience. Revision and improvement of Formulas and Processes—reduction of manufacturing cost—utilization of waste materials, etc., a specialty. Booklets, Formula List, and Valuable Information Free. W. L. Cummings, Ph. D., 127 Standard St., Syracuse, N. Y.

**WANTED** aggressive, financially sound general distributor to sell garage trade E-Z Ford Car Devices, line comprises starters, shock-absorbers, auxiliary steering device, demountable agricultural belt work pulley, lowest prices, biggest values, easy sellers, quick repeaters, big money making, exclusive contract. Geo. H. Wilson, 497 Northwestern Building, Minneapolis, Minnesota.

**LEARN** to read blue prints. Big demand for men who can read and understand blue-prints. We teach you. Details free. Modern Mechanics Institute, Dept. P., Cincinnati.

**\$25,000—I MADE** it in Mail Order Business; started small with \$3 at home; no canvassing. Free booklet tells how. 2c postage. Alb. Scott, Cohoes, N. Y.

**A FEW** agencies open—New York Company wants local responsible exclusive agent in every town, open office, manage salesmen for phonograph, tone equalizing any costing \$200; wonder of century; guaranteed; retails \$15; plays any size record; clear \$3,000 upward annually. Marquise, 108 Weath St., N. Y.

**\$1 MAKES** \$3.00 and starts profitable tire business. Sea Kelp Puncture Proofing Co., Colgrove, California.

**CONDUCT** a "Candy Kitchen"—Clear \$10 daily; practically no capital required; booklet free. Kennon School, 144 West Ontario St., Dept. A, Chicago.

**ADVERTISEMENTS**, Mail Dealers. Our 1916 Rate Book lists 2,000 Principal Publications, rates, circulation. Includes 30 Mail-Order Plans. Price 10c. Dearborn Advertising Agency, 210 Franklin Bldg., Chicago.

**FOR** Sale—Practical invention, cheap; chance to make quick money. Herbert Sanders, 114 W. Van Buren St., Chicago.

**LEARN** the tile business. We teach you how to lay tile in one lesson so that you can go right out and figure contracts for tile floors. Price \$2, including box of tile. Particulars free. Address Ceramic Company, 612 Oxford Bldg., Chicago.

**MONEYMAKER** to you for 3c stamps. H. Jurgensen, Station F, Louisville, Ky.

**WE** publish two wonderful magazines chock full of money-making opportunities. Sample copies 10c. Atlas Supply Co., 1851 So. Ashland Ave., Chicago, Ill.

**I MADE** \$50,000 in five years with a small mail-order business; began with \$5 in my own home. I will show you how to do the work; no canvassing. Send for free booklet; tells how. Heacock, Box 867, Lockport, N. Y.

**DO** you want position or seek you agents in South America? Read the "Star" for all trades. Both sexes. Mailed you every 14 days. Three months' subscription 70c. Rud. Braun, Puerto Colombia, Republic Colombia, South America.

**LEARN** Dry Cleaning—Profitable, fascinating profession. Complete instructions, 25 cts. The Wiener Co., Madisonville, Ky.

**QUIT** Working for Others. Start a Cleaning and Dyeing Business. No experience and but small capital needed. Tremendous money-maker. Greatest re-order business known. Send for free booklet "A" today. Full details. White Wonder Co., 270 Guardian Trust Bldg., Denver, Colo.

**"HIRE** Yourself as Boss." Big corporation will back you in Money-Making Mail-Order Business selling guaranteed Goods. Start spare time. Small capital. No canvassing. Wm. J. Dick, Mgr., Dept. H-10, 20 W. Lake St., Chicago.

**WINDOW** Letter Manufacturing business, which increase of my store business forces me to sell. Complete. My instructions enable any one to make them. Have put in four hundred dollars. Sell for one hundred, or trade for equivalent. Regal Store, South Amboy, N. J.

**"HOW** to Sell Unpatented Inventions" free on request. Inventor's Advocate, Washington, D. C.

**RESILVERING** Mirrors, renewing dry batteries and 500 formulas, 25c. "Ideal," 3311-D, Belleplaine Ave., Chicago.

**READ** Good Results—Greatest Mail Dealers—Agents Magazine published. Two big issues, 10c. Good Results, Industry Bldg., Chicago.

**OPERATE** success-proven mail business under guarantee by reputable corporation—established twelve years. Everything furnished—no stock to carry. Meerford Company, Incorporated, Dept. 156, Chicago.

**START** a market and exchange business at home. Profits \$5.00 daily up. Every community needs one. No selling. No canvassing. Pleasant, Permanent. Pay for instructions from earnings. Free booklet. Charles Murphy, Bloomington, Indiana.

**EASY** money making Sanitary Fireproof Paint. Costs about 20 cents gallon. Will not crack, blister or peel off. Privilege and process, \$2.00. Sample, 25 cents. Sanitary Paint, 1073-P East Main, Columbus, Ohio.

**MANUFACTURE** our proven Commercial Automobile formulas. No capital. "Absolutely bona-fide." Price 25c. Commercial Research Co., Box 598, San Jose, Calif.

**EARN** \$30 weekly at home, silversmithing French mirrors; no capital; free instructive booklet. D. Mallin, 284 Pacific, Brooklyn, N. Y.

**OPERATE** a Mail Order Book Business, make 90c profit on dollar orders; we show you how. Brand new proposition free. Bamberg's Supply House, Northwestern Building, Chicago.

**INTERESTED** in mail order business? Letters asking for advice, information, and plans with my answers in my magazine. Copy 10c. Any questions? P. Hyde, 390 William, East Orange, N. J.

**FORTUNES** in this! If you think all advertised plans impractical or misrepresented, get mine and be undeceived. Make \$40.00 weekly! Easily worked; no canvassing. Complete plan 25c—refunded if dissatisfied! Andrews, 2117 Cornelia Ave., Chicago.

**SILVERING** mirror formula and 150 other money-making formulas and Digest, one year, 25c. Digest, Grand Rapids, Mich.

**IF** you want to market, develop, finance or promote anything, anywhere, we can help you. Bureau of Information, St. Louis, Mo.

**I PUBLISH** a wonderful magazine of money-making plans, ideas, suggestions and inspiration! It will show you how to make more money. Sample, 10c. Booster Magazine, Northwestern Bldg., Chicago.

**HOW** to make Printing Cuts cheaply; 150 selected formulas, 20c. "Ideal," 3311-D, Belleplaine Ave., Chicago.

**\$1 BUYS** 100 Successful Sales-Letters. Complete Letters on 100 Different Lines. "They've Pulled the Dollars." Thousand new sales arguments. Satisfaction guaranteed. Rosenblum (Advertising Authority), 1416 Broadway, New York.

**DON'T** Start Mail Order Business until you get 100 special service opportunities, suggestions, propositions, and sample magazine—all 2c. Stanford Service, Sebring, Ohio.

**EXCLUSIVE** Formulas of the Better Sort for latest Specialties in all lines (Guaranteed). Lists of New Food Products, Automobile Specialties, Newest Summer Sellers, Stamp, Miller, Chemist, Tampa, Florida.

**MIRROR** resilvering is a paying trade. We have best instructions 25c. Auburn Supply Co., Dept. B4, 7817 Peoria St., Chicago.

**DEPARTMENT** Stores, Jobbers, Agents, Canvassers. We manufacture one of the best Pineapple Eyeglasses. Sample 25c. Schlicker Manufacturing Co., 12 Bloomingdale St., Rochester, N. Y.

**"NUGGETS"**—Wonderful journal of plans, schemes, formulas. Six months, 10c. "Nicholson," Publisher, Bristol, Indiana.

**CANDY** making a profitable and pleasing trade. Be your own employer. Our Candy Book tells how, 25c. Auburn Supply Co., Dept. C4, 7817 Peoria St., Chicago.

**\$25.00 DAILY**. We made it working our directory plan. Plan and instructions 25c. The Fell Company, Box 123, Vinton, Iowa.

**BIG** Profits. Open a dyeing and cleaning establishment, little capital needed. Write for booklet. Ben-Vonde System, Dept. C, Charlotte, N. C.

**LARGE** Profits operating Mail-Order Book Business. Small outfit required. For particulars write Rollins, Box 572, Boston.

**WANTED** to hear from owner of some good patent right for sale cheap. O. O. Mattson, 201 Andrus Bldg., Minneapolis, Minn.

**HERE'S** your real big business opportunity—your chance to establish yourself in a clean honorable business for life that will make you more money, dollar for dollar invested than any thing else you can get into now-a-days—a business you will like and enjoy every minute you are in it, because it is a clean, honorable business for life, grinding out the golden dollars for you every day in the year. It is milling Flour right in your own locality with the money-making mill wonder of the age, the "Midget" Marvel Self-Contained Flour Mill that is revolutionizing the flour milling business and making such good money for so many others this country over just as it will make it for you. One man in Kentucky writes of a net profit of \$4928.26 in 7 months; one in Kansas, \$5,000 last year, another in South Carolina says he is making \$30.00 a day. You can do as well or better without any previous milling experience with this tested-out-money-making machine. It will make you good steady money from the very day you start its wheels to rolling, because it is a great big roller flour mill system all condensed into one machine, requiring so little power, capital or attention to run. Runs by any kind of power, turns waste power of factories and other plants into big profits. Some wide-awake red-blooded man in your section will sooner or later put in a "Midget" Marvel and make the big profits you yourself can make and should be making right now. People must have flour. There's a market at your very door for every barrel you can make and we will help you get that market with our confidential free sales helps. It is your golden opportunity—you who want to increase your income and get independent—quick—rise up and grasp it! Be the first in your place to write for our free illustrated book, "The Story of a Wonderful Flour Mill" 30 day free trial offer, prices, terms, letters from hundreds of owners telling what the "Midget" Marvel is making for them and will make for you. Better write today. Anglo-American Mill Co., Inc., 1610 Fourth St., Owensboro, Ky.

**ENCYCLOPEDIA** Business Opportunities and Trade Secrets—Two volumes, 1,600 chapters, ideas, secrets, etc. Regular price, \$3.99; special this month, \$1.00. Descriptive booklet, stamp. Northern Supply, Metropolitan Block, Chicago.

**INVENTORS**: We develop and perfect inventions, make models, dies, tools. Metal stamping and special manufacturing. Gerding Bros., Lion Bldg., Cincinnati, O.

**MANUFACTURERS**, Promoters and Patent Buyers are invited to write us stating the line of invention in which they are interested, as we can supply their wants in any class of patents. Victor J. Evans & Co., 162 Ninth St., Washington, D. C.

**SPOT** cash paid for second-hand high-grade Cameras, Lenses, Kodaks, Motion-Picture Cameras, Microscopes, Binoculars, Surveyors' Levels, Tra-sits, etc. David Stern Co., 1047 W. Madison St., Chicago, Ill.

**I WILL** start you earning \$4 daily at home, silversmithing mirrors; free instructive booklet. G. F. Redmond, Dept. 386, Boston, Mass.

**START** a business of your own during spare time. Original successful plans. Details free. E. J. Buchholz, Norwood, Ohio.

**PHOTOPLAYS** Wanted. Big prices paid. We show you how. Details free. Rex Publishers, Box 173, A-3, Chicago.

**15** MONEY making outdoor businesses fully explained in my free literature. Send for it. Address Black, Sunnyside, Wash.

**LEARN** the real estate business. Our complete instruction book teaches: listing, appraising, management, salesmanship, insurance, brokerage, advertising, renting agency, forms, etc. 121 subjects, Excels \$20.00 correspondence course. Buckeye cover 75c; silk cloth \$1.00, postpaid. Catalogue free. Realty Book Company, 5982 Euclid Ave., Cleveland, Ohio.

**INVENT** something; your ideas may bring wealth; our free book tells what to invent and how to obtain a patent, through our new credit system; write today. Waters & Co., 4162 Warder Bldg., Washington, D. C.

**ADVERTISE**—20 words in 100 monthlies \$1; 100 weeklies \$2.50; 20 Sunday papers \$5; all \$8. Cope Agency, St. Louis.

**"DOLLARS"** yearly in your back yard. No ginseng, mushroom dope. New ideas never before published, particulars free. Metz, 313 East 89th St., New York.

**WANT** Big Profits? Learn Tartaric Mirror Silversmithing. New process opens enormously profitable business. Particulars free. H. Barstow, 514 23rd Street, Oakland, Calif.

WE start you in business, furnishing everything; men and women, \$30.00 to \$200.00 weekly operating our "New System Specialty Candy Factories" home or small room anywhere; no canvassing. Opportunity lifetime; booklet free. W. Ragsdale Co., East Orange, N. J.

**PATENTABLE** ideas wanted—Send for 3 free books. H. B. Owen, 30 Owen Bldg., Washington, D. C.

**LEARN** to collect money. Good income; quick results. Send for free booklet, "Skillful Collecting." Collectors' Association, Long Street, Newark, Ohio.

I WANT to send you proof of the wonderful pulling power of Popular Mechanics classified pages. What's your proposition? Write me today. F. W. Johnson, Classified Dept., Popular Mechanics Magazine, 6 N. Michigan Ave., Chicago.

IF you work in a shop find out if the company has any lathes, turret lathes, screw machines or milling machines for sale and write me full particulars and price asked. I will pay you \$5 for each machine I buy. Pinner, 123 Water St., New York, N. Y.

WOULD you like to own a good-paying Mail-Order Business? We have a line that gets repeat orders all the time. You can start in spare time; invest a dollar or two a week and soon own a nice business of your own. Particulars free. Nadio, 4313 Lincoln Ave., Chicago.

HOW to Operate a Mail Order Business. 20 Big Profit Plans and year's Mailing service sent for 10c. Mail Dealers' Wholesale House, 521 Franklin Bldg., Chicago.

STOP Here! Let me start you in a home business that will bring you money every day. Experience unnecessary. Spare time. No canvassing. I furnish everything. Send for proofs. Voorhies, Desk C. R., Omaha, Neb.

LET the parcels post help you. Add (\$15 to \$25 weekly) to your present salary or income. Start during spare time and build up a permanent mail-order business of your own. We show you how and help you make good. No canvassing. Experience unnecessary. The Parcels Post makes success doubly sure. Our new ideas and up-to-date plans bring the money. No so-called "Course of Instruction" to sell. We give that free. Write today. Address Pease Mfg. Co., Inc., Dept. A, 70 Broadway, Buffalo, N. Y.

START in the carpet or house cleaning business. Thurman Process unequalled for commercial cleaning; show you how. Only \$125 capital needed to earn good income in towns 2,000 and over. Attach one to your automobile wheel. Thurman Vacuum Cleaner Co., manufacturers all types cleaners. Dept. H, St. Louis.

#### BUSINESS FOR SALE

OPPORTUNITY of a lifetime. Machine shop. Automobile Repair and Accessory Business. Established 23 years—must be sold. Falling health. Look Box No. 156, New Carlisle, Ohio.

#### TO MANUFACTURERS

WANTED—Mail-order goods, direct from manufacturers. V. Kanerva Co., L. Box 533, Bingham, Utah.

MANUFACTURERS—We want articles that are money makers, and fast sellers. California Agency Co., San Francisco.

GET your goods in our catalogues. Send samples and prices. World's Royalty Co., Rockford, Ill.

PATENTS secured through credit system. Free search. Send sketch. Book and advice free. Waters & Co., 4280 Warder Bldg., Washington, D. C.

#### MAIL ORDER SUPPLIES

SELL Joker's Novelties! 16 samples, 10c. Chambers Works, Plainwell, Mich.

INCREASE your sales. Place your proposition before the readers of "Cartoons Magazine." 20,000 copies guaranteed every month. Classified rate 2c per word. Mail in a trial ad today. Cartoons Classified Dept., 78 E. Madison St., Chicago.

#### BUSINESS SERVICE

INCORPORATE. Our lawyers do the work, saving you time, annoyance and money in incorporating under the most liberal laws of Arizona. Laws and forms free. Southwestern Securities & Investment Co., Box D488, Phoenix, Ariz.

#### FOR ADVERTISERS

**BARGAIN** Advertising rate, 20 words, one insertion, 40,000 circulation and one year's subscription 25c. Extra words, 1c each. Digest, Grand Rapids, Mich.

**EIGHTEEN** Word Advertisement in ten big Sunday Papers, \$4.00 (over 2,000,000 circulation); extra words, \$1.00 per six. Magazine and Newspaper advertising—lowest rates. Ads prepared free by experts for clients. Form letters prepared—full of "Punch" and "Ginger"—the kind that pull the coin, \$2.00. Stanford Service will save you money. Stanford Advertising Agency, Sebring, Ohio.

**25** WORD advertisement in 100 monthly magazines, 3 months, \$1. Quadri Co., 42 East 184 St., N. Y.

**YOUR** thirteen-word adv. in our 3x12 magazine reaching 29,000 boys for 25c. Extra words, 2c. Country Boy Magazine, 2189 Mallers Bldg., Chicago.

#### ADVERTISING SERVICE

**CATCH** Phrase makes business remembered, booklet and special matter for you, 5c, stamps of coin. Munson, 304 Barclay Block, Denver, Colo.

#### COLLECTIONS

**ACCOUNTS.** Notes Collected Anywhere. Collection guaranteed or no charges. May's Collection Agency, Somerset, Kentucky.

#### LETTER SPECIALTIES

DO more business by mail. Consult me. I write strong, result-getting letters, advertisements, catalogues, booklets, circulars; moderate rates. Helpful advice free. Tenth year. Harry Stern, 1127 Gaylord, Denver, Colo.

#### PERSONAL

**RENO** Lawyers—Humphrey, Brown & Soshy. Advice any Nevada laws.

**STOP** Tobacco Without Harmful drugging, quickly, secretly, inexpensively. Free booklet tells how. Hotex Remedy Company, Dept. B, Houston, Texas.

**BROTHER**—Accidentally discovered root cures tobacco habit. Gladly send particulars. F. Stokes, Mohawk, Florida.

**FREE**—Stop using Tobacco. Free. We will give free information how to conquer the habit easily and permanently. Results Guaranteed. Anti-Tobacco League, 618 Paxton Block, Omaha, Neb.

#### AGENTS WANTED

**MEN** and Women Agents; Money talks—how much are you making? If you are earning less than \$200 a month, no matter what your locality, you will positively be delighted with our Sentinel Burglar Alarm proposition. Many agents easily earn \$15.00 daily. Brand new invention. Sells quickly on sight to homes, offices. Patented. No competition. Free exclusive territory. Instantly attached any door knob. Impossible turn knob without ringing bell. No batteries, screws, nails. Handsomely nickel-plated. Retail \$1.00. Provides cheap burglar insurance. It's a big money maker. Let us prove why. If you mean business write today for liberal terms to agents. Marshall Dobbins & Co., Manufacturers, 1422 Marquette Bldg., Chicago.

**TAILORING** Agents Wanted—Big complete sample outfit and case, nearly 800 large cloth samples, 3 price lists and everything needed for canvassing or use in store, free to live agents, \$25.00 to \$50.00 a week; may make more. Write us today for free elegant outfit to begin, cloth samples, wholesale prices, special offer on a suit for yourself and full information—see our wonderful values, beautiful fabrics and styles. Established 28 years. Every garment made to measure—everything guaranteed and express prepaid. Just send a postal. American Woolen Mills Co., Dept. 414, Chicago.

**TASCO** Polishing Cloths Sell themselves. 100% Profit. Send Four Stamps (Mailing charges) for Sample and terms. Tasco, 1477 J Rowland Street, New York City.

**AGENTS**—Sell the Primus, genuine Swedish wickless, coal-oil stove, Smokeless, odorless. Twice the heat of gasoline at one-eighth the cost. No danger of explosion. Big profits. James Anderson & Sons, Sidney, Ohio, American distributors.

**FASTEST** selling proposition out. Fully protected territory on auto tire power pump appliance for all cars. Absolutely new. Not attached to engine. Retail \$5.00. Can make \$3000 to \$5000 in this county in year with our wonderful co-operative selling plan. Write now for full particulars. Auto Appliance Co., 5542 S. State St., Box 14, Chicago.

**"SNOW White"**—Means all the name implies. A washing compound to be used when boiling clothes. Guaranteed Absolutely Harmless. Trial will convince any housewife that she cannot be without it. Makes washing a pleasure. We want 500 representatives to handle it. Beats anything on the market. Over 100% profit and repeat orders will mean a future permanent business. Sample 10c. We want you to try it before ordering. Lewis Company, 1530 S. Lawndale, Chicago.

**AGENTS**—Sell heatless trouser presses; no irons; they work while you sleep; full information free. Dennison Sales Co., Dept. 41, Box 67, Lawrence, Mass.

**\$1,000 PER** Man per County. Strange invention startles world—agents amazed. Ten inexperienced men divide \$40,000. Korstad, a farmer, did \$2,200 in 14 days. Schleicher, a minister, \$105 in first 12 hours. \$1,200 cold cash made, paid, banked by Stoneman in 30 days; \$15,000 to date. A hot or cold running water bath equipment for any home at only \$6.50. Self-heating. No plumbing or waterworks required. Investigate. Exclusive sale. Credit given. Send no money. Write letter or postal today. Allen Mfg. Co., 121 Allen Bldg., Toledo, Ohio.

COULD You Sell Gasoline at 2½ cents a gallon? If so, sell Carbonvold to automobileists for \$1.00; 300% profit. \$1.00 tube equivalent to 40 gallons of gasoline. Removes carbon. Sample 50c. Gasoline going up. Carbonvold Chemical Works, Asbury Park, N. J.

**AGENTS!** 1916 bonanza!—Put up your own goods. We supply in bulk. Enormous profits. Great sellers and repeaters. Catalog and exceptional offer free. G-N Specialty Co., Porter Block, Brockton, Mass.

**MEDALLIONS**—300% profit. Make up your own goods and be independent. Catalogue free. Resag Co., 1205 Randolph St., Chicago.

**\$10 DAILY** refinishing chandeliers, brass beds, etc., by new method; producing amazing results; no capital or experience necessary. Information free. Gunmetal Co., Ave. H, Decatur, Ill.

**AGENTS**—Another sensation—household necessity with premium—wonderful seller—big profits—write quick—Glock, 180 Woodward Ave., Buffalo, N. Y.

**MARVELOUS** Expanding Cuff Button; Spreads two inches; Presto, slip cuffs over elbows without unbuttoning; Pull down, close automatically; Stay where placed upon forearm; Greatest laundry and shirt saver invented; Combines utility with convenience; Invisible. Endorsed as an article with merit everywhere; DeWilde sold 750—10 days, profits \$345.00; Money back if not as represented; No Competition; exclusive territory, large profits; no phony goods; Our selling plan is worth \$100 to you; Wanted, high-grade specialty agents everywhere to sell direct to wearer. Flexo Mfg. Co., Sheboygan, Wis.

**EXCLUSIVE** selling rights for our Wonderful Triplex Folding handbag and other sellers. None sold in stores. Write for terms and catalogue. Diamond Bros., 35 West 21st Street, New York.

**ACT** Quick! Automobile Gasoline going up. Sell Gaso-Tonic. Equals gasoline at 3c a gallon. Eliminates Carbon. Dollar an hour profit. Sales Guaranteed. White Mfg. Co., Dept. M, Cincinnati, Ohio.

**BIG** Profits. New Gold and Silver Sign Letters for Store and Office Windows. Anyone can put on. Free Samples. Flexible Letter Co., 1642 Division, Chicago, U. S. A.

**HIGH** class selling agents for line of fine household specialties that sell themselves. Send for free book. The Florence Company, 890 St. Nicholas Avenue, New York.

**AGENTS**—Everyone crazy about preparedness. Sell Military League fobs. Make \$5.00 day. Free particulars or beautiful sample prepaid for 25 cts. The Wiener Co., Madisonville, Ky.

**AGENTS** for patented automobile duster; won't scratch or mar. Particulars for territory. Auto-Vac Duster Co., Jackson, Michigan.



**AGENTS**, we furnish you with ad and material that will bring you big money every day. Complete instructions 10c. Novelty Co., 6669 15th St., Kansas City, Mo.

**HOSIERY** manufacturer offers permanent position supplying regular customers in home town at mill prices. \$50.00 to \$100.00 per month. All or spare time. For particulars address, D. Parker Mills, 2733 No. 12th St., Phila., Pa.

**MECHANICS** use Amundine, Mexican Soap Powder for the hands. Trial box 10c. Agents wanted. Amundine Manufacturing Company, 2012 Baringer, Louisville, Kentucky.

**AGENTS**: New mighty, repeat money making marvel: strange scientific discovery; eight men order 47,030 Pkgs. first 16 days. Kalomita revolutionizes clothes washing ideas; \$50 to \$150 weekly repeat order business; positively abolishes rubbing, washboards, washing machines; \$1000 guarantee; absolutely harmless; nature's mighty elements work wonders; women astounded; territory protection; no experience necessary; credit granted; pocket big profits; hurry! write today; get overwhelming proof. Equitable Corporation, Dept. 354, 215 W. Superior St., Chicago.

**AGENTS** get particulars of one of the best paying propositions ever put on the market. Something no one else sells. Make \$4000 yearly. Address E. M. Feltman, Sales Mgr., 3294 Third St., Cincinnati, O.

**AGENTS**, send 10c for Desk Fountain Pen. None better. Profits 5c. Catalog eight new novelties, mostly mechanical. 10c to \$5.00, 100% profit. Purchasers, Offices, Schools, Shops, Book-stores, Printing offices, Hardware, Households, Street, Byler, Sole Mfr., Clinton, Mo.

**AGENTS** Deal in Dollars—Make Dollars. Jules Folding Portable Electric Lamp contains new exclusive patented features. Sells in homes, offices, hospitals. Rose-Strauss Co., 215 W. 48th, N. Y.

**AGENTS** Wanted for enlarged portraits. Get in touch with the artist that makes portraits. Write for price list. F. A. Wanderley, Wheaton, Ill.

**AGENTS**, Don't miss this. New proposition. Send stamp. Erickson, 806 South Frio, San Antonio, Texas.

**AGENTS** Wanted—Sell men's, ladies' raincoats, cheapest prices; golden opportunity to make big money, outfit free. American-European Raincoat Co., 175 East Broadway, New York.

**AGENTS**: You can make big money taking orders for our fine made-to-measure clothes, so write quick for 60 beautiful cloth samples, 32 smart styles in rich colors, wholesale and retail price lists, lowest prices and best offer to agents. \$5.00 to \$10.00 a day easy. Big outfit, over 250 samples free to live wires. No experience needed—no capital. We furnish everything free—pay postage or express charges—back you, boost you, show you how and clearly explain everything. Costs nothing to try. Let us make you a stylish suit to measure to prove our fine quality and style. Send postal or letter today. Paragon Tailoring Co., Box 414, Chicago.

**AGENTS** make big money selling our waterproof aprons. Wonderful sellers. Fine profits. Pelham Manufacturing Company, Pelham, N. Y.

**MEN** and Women with spare time can earn big weekly profits by our new advertising plan. No investment. No selling. No soliciting. Write today for details for this new money maker. Crown Mfg. Co., Dept. HL, 20 W. Lake St., Chicago.

**50 COMMISSION** each sale and repeat orders. Traveling salesmen every state. Main or sideline. New, rapid selling automobile accessory used all makes cars. Samples loaned. Weekly settlements. Toledo Cable Co., 119 Davis Bldg., Toledo, O.

**LARGE** Manufacturer wants representatives to sell shirts, underwear, hosiery, dresses, waists, skirts, etc., direct to homes. Write for free samples. Madison Mills, 590 Broadway, New York.

**AGENTS**—Men and women; make \$30 to \$50 weekly selling the New Improved Monitor Self-Heating Iron—the "World's Best." Over 750,000 in use. Positively the easiest, fastest selling, lowest priced, best known iron made. Binding Guarantee. Big profits for all or part time. Evans, N. Car., sold two dozen on Saturday. Mrs. Nixon, Vt., sold eight first half day. New low terms. Exclusive territory. Sample free to workers. Write today. The Monitor Self-Heating Iron Co., 740 Wayne St., Big Prairie, Ohio.

**AGENTS! 500% Profit. \$25.00 to \$50.00** a week; that's what our agents are making selling our new metallic sign letters for office windows, store windows and glass signs. For a quick, easy money making proposition for agents, salesmen and sign painters, there is nothing to equal the selling and putting up of our new metallic letters and numbers. There is no experience necessary to put up these signs. Anyone can succeed and make money right from the start. We will send you full particulars and you will see how easy it is to make money in this business. One agent says: "I have already put up 14 signs in this little burg and more in sight. Your letters are the best thing I have seen in years. Will soon be in a position to buy in 5,000 lots." Another says: "I am getting all the work I can do and the letters have given entire satisfaction everywhere." We are daily receiving such letters from agents who have started in the sign letter business. This is the only field that is not overcrowded. There is a big demand for window and glass signs in every town. You can sell to nearly trade or travel from town to town all over the country as you please. We would be pleased to send you a free sample and full particulars. Write today. Address The Metallic Sign Letter Co., 467 N. Clark Street, Chicago, U. S. A.

**ONE Thousand Dollars Reward.** We will forfeit \$1,000 if this is not the greatest money-making house-to-house proposition advertised in these columns. N. H. G. Little Wizard Labor Saver washes clothes in 10 minutes absolutely without rubbing. It contains no paraffin or wax and there is nothing like it on the market. Sells for 15c, enough for five family washings. We supply you with all the free samples you need. All you do is to leave the free sample with the housewife and when you call again she is waiting to become your steady and permanent customer. This is positively the most scientific and wonderful labor saver of the age, and you will make a great mistake if you do not secure territorial rights at once. A one cent postal card brings full particulars. Parquhar-Moon Mfg. Co., Dept. B 200—140 W. Van Buren St., Chicago, Ill.

**AGENTS** For country sales with auto or wagon. Hustlers making \$100 week; April to December. Reysburn-Hunter, established 1849, 430 N. Sangamon St., Chicago.

**YOUNG** Man, would you accept a tailor-made suit just for showing it to your friends? If you live in a town smaller than 10,000, write Banner Tailoring Co., Dept. 272, Chicago, and get beautiful samples, styles and a wonderful offer.

**WHO** wants to make more money selling brushes that every household needs? Special method of getting entrance to demonstrate. Fuller Sanitary Brushes are nationally advertised—largest output—best terms and prices—western distributing stations. Your territory is valuable. Write, Fuller Brush Company, Hartford, Conn.; Rock Island, Ill.

**A MAN** with sales ability and gill-edge references can establish himself in permanent territory selling high-grade reproductions of the world's best paintings to consumers. New sales plan by which dealer introduces you to his trade and helps you sell them. Commission contract worth \$50 to \$150 weekly to live wire. Proposition solid as a rock, backed by ten million dollar corporation. The Cincinnati Fine Arts Company, 25 Berea St., Cincinnati, Ohio.

**COMBINATION** Electric Stove & Toaster cuts housework 3/4; demonstration creates sensation; costs 75c in quantities, sells at sight \$3; twenty sales daily easy. Triumph Products Co., Transportation Bldg., Chicago.

**AGENTS**—to handle remarkable Money Makers. We have the latest article marketed—called "Hold-No-Fone"—Write for particulars. Dorsa Novelty Co., No. 560 2nd Ave., N. Y.

**ALUMINUM** Fireless Cooker. Recent Invention. Entirely different. Installments. Sample light. Good salesmen and Local Managers make \$200 monthly. Chamberlen Co., Commonwealth, Portland, Ore.

**AGENTS**—Here's a brand new article, just ready for market. Make over 100% profit with satisfied customers. Every mechanic needs one, sells quickly on sight; no competition. Our proposition is a winner. Don't wait. Write for it now. The Security Aluminum Rule Holder Co., Ivanpah, Calif.

**AGENTS**—Send for sample "Fretnot"—the wash day wonder. Be convinced you can do a whirlwind business. You can clear at least \$20 to \$100 weekly, according to spare or whole time. You don't have to talk, if she doesn't buy at sight, leave sample, she will be looking for you long before you are able to make the rounds again. Samples furnished free. Premiums granted to agents who can produce. Credit given. Don't call. P. M. Motter & Sons, 3213 Warren Ave., Chicago.

**668 WAYS** to make money. 2,716 formulas in Encyclopedia Business Opportunities, 3 volumes, price \$3, yours for \$1. Ideal Book Shop, 3111-D, Belleplaine Ave., Chicago.

**YOU** can make \$355 as our general or local agent. Household necessity; saves 80 per cent; permanent business; exclusive territory; salary or commission; free sample; credit. J. Pitkin, 113 Redd St., Newark, N. Y.

**INDUSTRIOUS**, willing agents, looking for article of highest merit, permanent successful business. Covered top for gas ranges, saves half the gas, appeals at once to the good house-wife. Send references with application. The Economy Store Top Co., Trenton, N. J.

**AGENTS**—Stamping names on Pocket Key Protectors; sample Check with your name and address. 12c. Stamping Outfits, Emblem Checks, Check Fobs, Name Plates, Hart Mfg. Co., Desk 2, 303 Degraw St., Brooklyn, N. Y.

**1,000 AGENTS** wanted at once, to introduce "Makus" Polish, sell to the trade, home, hotels, everywhere there are varnished or japanned surfaces. 100% profit, big sales. Grab this at once, this advertisement may not appear again. Phillip C. Silbs, 18 East Elm, Oneida, N. Y.

**GET** into your own business. Cut loose from lay-offs, short hours, and wage slavery. Our catchy soap and toilet combinations have put thousands on Prosperity Road. Tremendous saving to consumer—200% profit for you. Send postal quick for details. E. M. Davis Co., R64 Davis Bldg., Chicago.

**BIG** Profits for You! Manufacture Barley Crisp. New Confection. 5c package costs you 1c. Machine instructions complete \$7.50 prepaid. Send 10c for samples. Barley Crisp Co., 1205 Broadway, San Francisco.

**LIVE** Agents who appreciate a quick-selling article; agents now making from \$30 to \$75 per week. Write for particulars, Rudy Supply House, 545 Adams St., Dayton, Ohio.

**HIGH** class agents to sell specialty used by every man continually; constant repeater; good, permanent income for ambitious worker. Marrett Laboratories, Oak Park, Ill.

**LADIES** or Gents: Classy household article. Big profits. New selling plan free. Dept. 9, 1314 N. 10th St., Philadelphia, Pa.

**AGENTS**—Every Housewife wants our new practical fast-selling specialties. Samples and catalogue free. C. O. Urquhart, 634 West 131st, New York.

**SELL** New Speednut Wrench; world's quickest nut wrench; whole kit of wrenches in one; best proposition for agents; endorsed by leading railroads and manufacturers; every auto owner a quick buyer; sells on sight to anyone requiring a wrench. Evans Mfg. Co., 608 S. Dearborn, Chicago.

**AGENTS** are coining money selling our big 10c Packages of 20 Assorted Postal Cards. "5,000 Varieties." "Big Profits." Sell everywhere at sight. Sample Packages 10c. Particulars Free. Sullivan Card Co., 1234 Van Buren St., Chicago, Ill.

**AGENTS** can make Big Money selling hosiery of exceptional quality at prices that cannot be secured elsewhere. Big repeater. Write for particulars today. Fisher Hosiery Co., Dept. X, 721 Sterling Place, Brooklyn, N. Y.

**200% SELLING** Sheet Music for 5c. Samples 10c. Korte, 5479 Dorchester, Chicago.

**SOLICITORS**: Make \$50 weekly; each merchant and physician a prospect; free outfit. One man made \$145 first ten days, that was last June, he is still working. Address, Secretary, 343 Wells Bldg., Quincy, Illinois.

**AGENTS** make 400% profit handling new changeable signs, novelty signs, window letters, etc. Catalog Free. Hinton Co., 6142 40th Court, Chicago, Ill.

WE want capable, live wire General Agents and Crew Managers to sell an absolutely new Household Specialty guaranteed by \$200,000 Corporation. It's a big value household necessity that no woman can resist. Easy sales mean big profits. Our follow-up is unusual, and we give you exclusive territory, and advertise the business for you. Wm. J. Dick, Dept. H21, 20 W. Lake, Chicago.

AGENTS—You can make lots of money applying metal weather strips to windows and doors; every home a prospect; we start you and furnish everything; write today. Morgan Metal Weather Strip Co., 2218 Pine St., St. Louis, Mo.

\$129.00 SURE Congenial work at home among church people. Man or woman. 60 days or less. Spare time may be used. No experience required. International Bible Press, Dept. MN, Philadelphia.

ORGANIZE your own business. Sell dealers direct Jap-Silk nonbreakable Gas mantles. We'll give you manufacturers' prices lots 500 up. Big profits, quick turnover. Splendid growing income. Jules, 265 W. 48th, N. Y.

\$2,100.00 PROFIT for Faucet 1915 Selling Feeny Vacuum Cleaners—the Gold Medal Winner San Francisco Exposition. More live agents wanted. We also manufacture Star and Handy Clothes Line Reels. Write for special proposition. Feeny Mfg. Co., C-75, Muncie, Indiana.

AGENTS—Delicious Soft Drinks in concentrated form. Always ready—just add water—economical—absolutely pure. Every housewife wants them—14 different kinds. Enormous demand—Big summer sellers—money comes easy. 250 other popular priced, fast selling, household necessities. We furnish free outfits. Write today—now—American Products Co., 4765 American Bldg., Cincinnati, O.

AGENTS! Earn big commissions selling \$20 value all-wool made-to-measure suits for \$10.75 retail. No experience necessary. Chicago Woollen Mills, Dept. 100, 833 Jackson Blvd., Chicago.

PHOTO Pillow Tops, Portraits, Frames, Sheet Pictures, Photo Plates, Pennants, Rejects, credited. Prompt shipments; samples and catalogues free to agents; 30 days' credit. Jas. C. Bailey Co., Desk A4, Chicago.

AGENTS—Manufacture your own goods. Save middlemen's profits. 24 formulas and 100 other Business Opportunities, 10c. M. Keller, 321 E. 43rd St., Chicago.

DEMONSTRATORS and Agents Wanted—250% profit. Big money being made. Sales Manager's opportunity for the right man. Send for particulars and samples today. Harrison Mfg. Co., Baltimore, Md.

BE prepared. Burglar proof Pocket Safety Lock for doors and windows. No nails or screws. Big profits. Sample, 25c. Other specialties. The SESCO Company, Desk A, Rockville Centre, New York.

AGENTS 500% Profit. Gold Sign Letters for Windows. Anyone can put on. Sample mounted on glass 25 cents; unmounted free. Latimer Mfg. Co., Dept. 11, Detroit, Mich.

MORE Money, Less Effort. Seven articles of conspicuous merit for your approval. Postal brings details. Harsch, 1137 Fair Ave., Columbus, Ohio.

AGENTS free sample and particulars Delbare's Naptha Washing Tablets. Wash clothes without rubbing. Guaranteed not to injure the finest fabric. No acids, lime nor caustics. Manufactured and sold by Naptha Washing Tablet Co., 718 So. Dearborn, Chicago, Ill.

AGENTS—Brand new specialty Aluminum Triplicate Sauce Pan with detachable handle. Cooks 3 different foods on one burner. Saves gas. Lasts lifetime. \$100 to \$300 per month easy. Send for our catalogue of 400 other specialties. American Aluminum Mfg. Co., Div. J. 10, Lemont, Ill.

READ Good Results—Greatest Mail Dealers—Agents Magazine Published. Two big issues 10c. Good Results, Industry Bldg., Chicago.

\$70.00 TEN Days—Hedrik's profit. Smith sold 24 one house. Rodolph's Patented Curtain Rods. No nails, tacks, screws. Fits any window. Sample 10c. Rodolph, 472 Northwestern Building, Chicago.

AGENTS—Kleanol Sanitary Brushes pay you big profits; fast sellers; big line. Get information from largest wire twisted brush makers. Kleanol Brush Co., Inc., Dept. 1, Springfield, Mass. Branches at Omaha, Nebr., Dallas, Tex.

\$61.50 WEEKLY introducing and selling a new gas light burner for kerosene lamps. Beautiful light. No chimney. No mantle. Perfectly safe. Simple in construction. Nothing to get broken or out of order. Will not burn out. Durable. Will last for years. Low price. Easy to sell. 200 per cent profit. Experience not necessary. Sample free. Why not try one on your lamp? Beware of imitations. No branch offices. Lether Manufacturing Co., Dept. 229, Cincinnati, Ohio.

MAKE and Sell Your Own Goods. Formulas by Expert Chemists. Manufacturing Processes and Trade Secrets. Formula Catalog for Stamp. Blake Mystic Company, Washington, D. C.

\$9.00 DAILY introducing new wonderful invention that keeps cows from kicking or switching tail. Connell Shackie Co., Hoquiam, Wash.

WOULD you like to earn \$120 a month and travel by automobile introducing our guaranteed auto necessities? Answer quick. Secure valuable agency. Fast sellers. Quick repeaters. Remarkable money makers. B. L. Rayburn Co., 181 N. Dearborn, Chicago.

NEWLY patented Gas Saver; cuts gas bill on cooking in half; saves \$20.00 yearly; will fit every gas range; sells at sight. 50c; unusual big profits; write for territory. American Gas Reduction Co., 2171 Transportation Bldg., Chicago.

TELEPHONE Attachment. Holds receiver to your ear, allowing free use of both hands during conversation. Every phone a prospect. Can be attached in one minute. High class agents wanted. Sample \$1.25 post paid. Miner-McClelland Mfg. Co., San Francisco, Cal.

AGENTS write for our new proposition. Berse Mfg. Co., Mt. Pleasant, Pa.

AGENTS—Salary or commission. Greatest seller yet. Every user pen and ink buys on sight. 200 to 500 per cent profit. One agent's sales \$620 in six days; another \$32 in two hours. Monroe Mfg. Co., X6, La Crosse, Wis.

KNIT Hosiery! Easy money. Machines on time. Constant work. We buy and sell your goods. Agents wanted. E. Hussmarkey Co., Inc., 1185 Belmont Ave., Chicago, Ill.

WE manufacture food products. Rapid sellers. Big profits. Exclusive agency. R. Colvin Company, South Bend, Ind.

MAGIC Plate Lifter. Makes other fellow's plate saggle when eating. Sample with proposition, 25c. Box 268M, Waco, Texas.

AGENTS are making big money selling our guaranteed Raincoats. For particulars address Reliance Co., 142 E. 62nd, Chicago.

AGENTS—Every mechanic needs the Speednut Wrench. Great time saver. Rapid seller, large profits. Takes instantly all nuts 1/4 to 1 inch. Sample \$1.00. S. E. Forrest, Far Rockaway, N. Y.

JITNEY-Bus-Game. Very a m a z i n g. Whirlwind seller. Agents, send 10c for sample. John L. Allen, Box 307, Buffalo.

MEN Earn Money, make and sell Universal Clothes-Line Reels. Blue-print drawing 15c coin. W. E. Van Loan, 465 S. Monroe, Streator, Ill.

AGENTS—100 Calling Cards 25c. Samples for stamp. P280 East 87th, N. Y.

CARPENTER agents get new Roof-Framing Gauge Free. Unequaled. Marks seventy pitches. Each in five minutes. John Parkhill, Rochester, Minnesota.

150% PROFIT. "Scientific Gas Lighters." "Self Lighting Mantles." Burners. New fast sellers. Talking unnecessary. Earn \$5 daily. Albert Co., Riverdale, Chicago.

HUSTLERS Only—Just Out. Biggest 25c universal seller. No competition, untouched field. No talking. Sells itself. Be first. Sample free. Runser, Dept. 44, Danville, Ill.

WASH problem solved, economical, practical; bluestone will do it. Representatives wanted. Exclusive territories. Write for particulars. It is a great money earner. K. Neumann Company, 1457 Wayne, Lakewood, O.

AGENTS—get newest, quickest sellers direct from makers—full list free. Nat'l Agents Ass'n, C122 So. Michigan Ave., Chicago.

SELLS Like Hot Cakes; new laundry wax perfumes clothes with lasting violet perfume; woeking outfit 5c; new offer. Perfume Gloss, 12 Water St., New York.

NON-BREAKABLE Lamp Chimneys and Smokeless Burners are sure sellers. F. Finch's, Grand Rapids, Mich.

MAKE your own Extracts and Perfumes. H. Lake Co., Adair, Ill.

OUR new, unusual value Household Specialty makes easy sales and big profits for live agents. Guaranteed goods and an unusual follow-up gets the business. Sales Manager, Dept. H-3, 20 W. Lake, Chicago.

AGENTS Wanted—Agents make 500 per cent profit selling "Novelty Sign Cards." Merchants buy 10 to 100 on sight. 800 varieties. Catalogue free. Sullivan Co., 1234 Van Buren St., Chicago, Ill.

AGENTS—Best proposition out. Preston Co., Dept. 27, Jordan, N. Y.

AGENTS Wanted—\$5.00 profit daily selling our new household articles; \$2.50 premium with each \$1.25 sale. Huse Company, Atlanta, Ga.

YOU are not the man we want if you expect a free suit, but if you have any tailoring experience, we can show you how to make \$25 to \$40 a week. Geo. A. McGregor Co., Chicago.

RE-SILVER Old Mirrors and make \$10 daily; we teach and trust you. Illustrated prospectus; first lesson, 10c. Big money for you. Hallingers Institute (Mec. St.), Francerville, Ind.

\$10.00 EVERY two hours, men and women can get more when using our new selling plan, one sale makes twenty, you cannot afford to miss this. Write Pearl Products, Dept. C1, Hollingsworth Bldg., Los Angeles.

AGENTS—Ho-Ho-Co Skin Soap and Toilet Goods plan beats everything for agents' profits. Bothco, 212 N. 2nd, St. Louis, Mo.

BEST Sellers—Guard, makes safety common razor; Boston Tin Form, for turn-down collars, both 15c; 50% off agents. Barclay Co., 304 Barclay Block, Denver, Colorado.

WANTED, agents in every county in the U. S. to sell revolving light devices for Ford Cars. They will make darkness light before you and crooked roads straight. Rex Revolving Light Co., Vine Grove, Ky.

NONPAREIL Shaving Mirror on cork with calendar. Samples 50 cents. Agents wanted. Frank R. Hewitt Co., 2250 Aqueduct Ave., New York.

AGENTS Novelty Guide contains first-hand supply sources, novelty information, successful plans, etc. 10c postpaid. Satisfaction guaranteed. Rollins, Publisher, Boston.

AMAZING, startling, sensational, stupendous, new guaranteed easy insurance protection plan. Bustling agent 18 to 60 wanted in each locality to represent big sick and accident company. W. G. Critchlow, Dept. 2720, Covington, Ky.

AGENTS, \$69 a week to travel by automobile and introduce our 300 candle power coal-oil lantern. Write for particulars of our auto offer. Thomas Co., 862 North St., Dayton, Ohio.

EARN \$3 each call and get a Reeves \$5 Vacuum Cleaner free by showing it to your neighbors. Reeves, 56 Broad St., Milford, Conn.

FORTUNES in this! If you think all advertised plans impractical or misrepresented, get mine and be undeceived. Make \$40.00 weekly! Easily worked; no canvassing. Complete plan 25c—refunded if dissatisfied. Andrews, 2119 Cornelia Avenue, Chicago.

"THE Life of Booker T. Washington"—a book that has created a wonderful demand—it ought to adorn every library table. Well printed and substantially bound. Retail price \$2.00. Special price to agents; sample purposes \$1.00. Postage prepaid. Well's Publishing Co., 29 S. Second St., Philadelphia, Pa.

HELP-A-PHONE. Makes hearing distinct. Noises don't interfere. Easily attached. Agents wanted. Marts & Co., 321 S. Webster St., Jackson, Mich.

PROSPERITY'S here. Get your share. We show you how. Sample, particulars 50c. Seller Co., 709 Woolworth Bldg., N. Y. City.

OUR line of brushes is a winner. So is our proposition. We want live brush agents everywhere. United Brush Company, 622 W. Lake St., Chicago.

AGENTS sell Mayo Electric Gold and Silver Cleaner. No powders, pastes or acids. Mayo Co., 328 Clinton Ave., Albany, N. Y.

AGENTS make big money selling our Electric Lanterns and Egg Testers to farmers and merchants. Rapid Egg Tester Co., 326 W. Madison St., Chicago.

AGENTS—Send 10c for 25c box Lutz's Herb Tablets and Terms. C. Lutz Manufacturing Co., York, Pa.

**AGENTS—Steady Income.** Large manufacturer of Handkerchiefs and Dress Goods, etc., wishes representative in each locality. Factory to consumer. Big profits, honest goods. Whole or spare time. Credit given. Send for particulars, Prospect Mfg. Co., 59 Main St., Brooklyn, N. Y.

**SUITS \$3.75, Pants \$1.90,** made to measure. For even a better offer than this, if you live in a small town, write and ask for free samples and styles. Knickerbocker Tailoring Co., Dept. 371, Chicago, Ill.

**AGENTS—Average \$5 to \$12 daily** selling astonishing Artec massage machine. New. Just patented. Different. No electricity or water power required. Nothing complicated. Affords exhilarating massage without cent expense. Lowest priced, but best outfit. Retail \$2.50, allowing you big end of the profit. Particulars and "beauty" folder free. Aztec Remedy Co., Dept. 132, Toledo, Ohio.

**JUST show them—The new adjustable** floor and wall mops, dustless dusters and sanitary brushes sell themselves. Big line. Big profits. Agents write Silver-Chamberlain Co., Dept. M, Clayton, N. J.

**STOP Here! Let me start you in a home** business that will bring you money every day. Experience unnecessary. Spare time. No canvassing. I furnish everything. Send for proofs, Voceries, Desk C. R., Omaha, Neb.

**AGENTS! Agents! Quick, easy money.** Send 25c for three samples of quickest selling 25c novelty picture ever published, and coupon scheme worth \$25.00 or more weekly. Something new. Miller Pm. Company, 996 Hartford Bldg., Chicago.

**NEW \$2.50 pocket adder.** Sell 10 daily easy. Excellent profit. Everyone buys. No competition. A. Bassett, 5921 Indiana Ave., Chicago.

**\$2.50 PER DAY salary paid one man or** woman in each town to distribute circulars and take orders for non-alcoholic flavors in tubes. Permanent—easy work. Ziegler Co., TP, E. Harrison St., Chicago.

**RELIGIOUS novelties, quick sellers, big** profits, fine proposition for Agents. Write for particulars immediately. Novelty Altar Co., Dept. P, Stamford, Conn.

**AGENTS to sell our Stationary and Portable** Vacuum Cleaners for residences and buildings. Therman Vacuum Cleaner Co., manufacturers, Dept. R, St. Louis.

**AGENTS—Make real money this year; not** "paper money." Sell our wonderful Luminous articles, "They shine in the dark." Crucifixes, Match Boxes, Pull Chain Bulbs, Switch Plates, Clocks, Startling! Everlasting! Mysterious! Pioneer Portrait Co. (Luminous Specialists), 1259 West 63rd, Chicago.

**AGENTS—Sell rich-looking imported 36x** 48 Rugs, \$1 each. Carter, Tenn., sold 115 in 4 days. Profit, \$37. You can do same. Write for sample offer selling plan; exclusive territory. Sample rug by parcel post prepaid, 16c. H. Condon, Importer, Stonington, Maine.

**LIVE Agents to sell Automatic Fire** Escape. Approved by fire department of New York and other large cities. Used in homes, hotels, factories, institutions, etc. Sells for \$10.00. Fine commission. Sales will bring you from \$7.30 to \$30.00 per day. Address Thomas Mfg. Co., Rockaway, N. J.

**1916's SENSATION! Eleven-Piece Toilet** Article set selling like blazes at \$1, with \$1 carrying set free! Enormous profits! Tremendous hit! Eagle made \$51.60 first week. Write quick! Pierce Co., Dept. P, 906 Lake St., Chicago.

**NOW'S the time to sell Luminous Crucifix** to Catholics for Easter. Old Paducah Co., Paducah, Ky.

**BIG Profits.** New Tartaric Mirror Silvering Process opens enormously profitable business. O. Barstow, 514 23rd Street, Oakland, Calif.

**AGENTS—50 Calling Cards 10c.** F. Shepard, Rome, N. Y.

**LADY or gentleman, fair education, to** travel for old-established firm. No canvassing. Salary, \$936 per year, payable weekly, pursuant to contract. Expenses advanced. Address G. M. Nichols, Philadelphia, Pa., Pepper Bldg.

**FOR quality, prices and service, on Sanitary** brushes, get our proposition. C. Oakes, Zion City, Illinois.

**"GOLDMINE" Sign Letters—1,000% profit.** Sample free. Johnston Co., Quincy, Ill.

**EASY, pleasant work for Mechanics,** Shop Men, Clerks, during spare hours, will add many dollars to their salaries. Also want persons who can give full time. Big wages assured. Novelty Cutlery Co., 47 Bar St., Canton, Ohio.

**AGENTS—Make a big cleanup, selling** our household Specials. Quick sales, \$25 to \$75 weekly a cinch. Write for colored circulars and immediate appointment. E. M. Davis, Pres., 164, Davis Bldg., Chicago.

**MECHANICS: Sell Graduated Beam** Calipers and round Levels. Ernst G. Smith, Tampa, Fla.

**I WILL start you earning \$4 daily at** home, silvering mirrors; free instructive booklet. G. F. Redmond, Dept. 304, Boston, Mass.

**AGENTS make \$100 monthly selling our** 500 handy household articles. Catalogue free. Scheff Company, Des Moines, Ill.

**\$15.00 MADE first day by 13-year-old boy** with Shomescope. Woman made \$8.00 first hour. Particulars free. Shomescope Mfg. Co., 525 W. 13th St., Kansas City, Mo.

**AGENTS—\$5 daily selling our Handy** Tool, 12 articles in one. Lightning seller. Sample free. Thomas Mfg. Company, 762 North St., Dayton, Ohio.

**POURTRAIT Agents: Our goods will** make you big profits. Delivery guaranteed. Refunds credited. Prompt shipments. Low prices. Send for latest catalogue and prices. Adam J. Kroll & Co., 402 Blue Island Ave., Chicago, Ill.

**GENERAL Agents—Sanitary Sugar Bowls.** Greatest 50c article. Sells everywhere. Territory free. Schoenheit & Pease, East End, Pittsburgh, Pa.

**SIGN Letter Agents and Painters; 500%** Profit Gold and Silver Sign Letters for Stores and Office Windows. Anyone can put on. Big demand. Free samples. Metallic Letter Co., 404 N. Clark St., Chicago.

**AGENTS make big money and become** sales managers for our goods. Fast office sellers. Fine profits. Particulars and samples free. One Dip Pen Company, Dept. 2, Baltimore, Md.

**READ the Agents Magazine and make** more money. 2 issues 10c. Agent's Magazine, Chicago.

**ENDLESS Neckties—Something new;** twelve ties in one; costs no more than old style; man made \$70 three days; woman made \$92 week; write for special agents' offer. Endless Necktie Mfg. Co., Dept. 10, Kansas City, Mo.

**AGENTS Wanted Everywhere—To sell our** attractive theatre Brass Poster Frames, Changeable Signs, Building Directories, Brass Signs, Brass Railings, Bank Fixtures, Adjustable Electric Light Brackets. Big demand; easy sales. Established 1887. Newman Manufacturing Company, Cincinnati, Ohio.

**YOU can be your own boss with our Key** Check Outfit. Good for \$5 a day stamping names on pocket key checks, fobs, etc. Sample check with your name and address, 15 cents. Pease Die Works, Dept. M, Winchester, N. H.

**MAIL-ORDER Opportunities: 25 new** Propositions. No competition! Make 85c profit on dollar order; complete outfit 10c. Mail Dealers Wholesale House, 521 Franklin Bldg., Chicago.

**AGENTS, Dealers, wonderful new inven-** tion. Patent necktie presser, removes wrinkles from neckties, makes them look like new. A time and money saver. Not bulky, fits in your grip. A live one. Retail \$50. Send 25c for sample and terms. Burdett Necktie Presser Co., 20 Park Ave., Claremont, N. H.

**HURRY Agents—Act quick; absolutely** new big 100 per cent proposition; everyone buys; repeats sure; big field; particulars free. Windham Specialty Co., 96 Spring St., Willimantic, Conn.

#### AGENCIES WANTED

**WANTED—To represent manufacturers in** Chicago; also goods and articles suitable for sale through mail-order and agents. 708 Hartford Bldg., Chicago.

#### SALESMEN WANTED

**A NEW way to make money—\$10 to \$30** for information only. No selling, soliciting, no real work. We want associates with us—each city—in building and operating "M-S" improved real estate. (Patent construction insures 50 to 100% greater income). Our hardest job is not securing their co-operation, but to find right people. We will pay you \$10 to \$30 or more for information you now possess. Don't delay. Cash in on this; write Sales Director, Merrill System, Monon Building, Chicago.

**SALESMAN to sell the most sanitary and** wasteless drinking fountain made. An excellent side line. Easy to carry. Ingberg Sanitary Supply Co., Mayville, N. D.

**WANTED—Salesmen with ability to sell** Little Giant ice chipping machines; good commissions; write for catalog. B. L. Schmidt Co., Davenport, Ia.

**WANTED—Experienced engine salesman** to sell popular priced, well advertised line of Kerosene and Gasoline engines to dealers. State engine selling and travelling experience. What territory have you been covering. Give age, nationality. All correspondence confidential. E. M., Room 925, 78 E. Madison St., Chicago.

**SALESMEN Traveling—Pocket side-line** offered by responsible concern. Sells on sight to stationers, jewelers, drug, general stores. New proposition. Liberal commission. Exclusive territory. Bond or deposit required for samples. "Corporation," 59 Park Place, N. Y.

**SALESMEN wanted, who are in touch** with responsible buyers of Wall Finishes (mixed hot, used cold) and Wall Size for paper hangers. Liberal commission. Mention experience, territory and references. Schrader, Whittick & Co., Chicago.

**TRAVELING Salesmen—Your clothes** made to measure without cost for placing tailoring lines featuring six special prices, no extra charges, with merchants. Write for particulars. J. W. Jones, 370 Mid City Bank, Chicago.

**WANTED—Representatives everywhere.** Exclusive territory. Gold sign letters for stores and office windows. Any one can put on. Write today for free sample. Metallic Letter Co., 403 N. Clark St., Chicago.

**SALESMEN with Ford cars preferred** secure fast selling line. Big profits selling Fordowners Starters, Stabilizers, Shock Absorbers, and other items. Best Automatic Devices Co., Plymouth Bldg., Minneapolis, Minn.

**SALESMEN—A light, portable Window** Ventilator. Every office and residence a prospect for several. Exclusive territory to competent men. Ask for proposition. Schaefer Ventilator Co., Bloomington, Ill.

**ENERGETIC young men everywhere** as Cigar Salesmen, \$18 weekly and promotion. Ambition more essential than experience. Send stamp. Neway Sales Co., Holyoke, Mass.

**WANTED—500 Salesmen to sell Magic** Motor Gas. One quart, price two dollars, equals 50 gallons gasoline. Greatest product ever discovered. Large profits. Auto Remedy Co., Eighth Ave., Cincinnati.

**SMOKER Wanted—We Want Silent** Salesmen who will smoke a pipe and get paid for it. Send no money, just write for particulars. M. H. Putnam, 607 West 51st St., New York City.

**SALESMEN—For our New Paint Printed** 6-Foot Steel Bulletin Signs. Big demand. Liberal proposition to Hustler. Howard Sign Co., 2110 Patterson, Cincinnati, Ohio.

**WANT Salesmen for latest Automobile** Specialties. Bicknell, Janesville, Wis.

**SALESMEN wanted to sell Shilon** Products to retailers and jobbers. All trades handle. Consumption big. Lowest prices and attractive deals. 18-year quality reputation. Big commissions net handsome income. All or part time. Shilon Co., Rochester, N. Y.

**SALESMEN—Sell Best Ford Steering** Wheel Clock Invented. Exclusive territory. Big profits for you. Send \$1.50 for sample now. B. & B. Sales Co., P. O. Box 37, Dayton, Ohio.

**SALESMAN. Sell beautiful 28x38 Artz-** kraft felt rugs for \$13.50 per doz. Your profit, \$3 per doz. Kelso, Battle Creek, Mich., sold 30 doz. last week. His profit, \$75. Write for exclusive territory and selling plan. Prepaid sample, 75c, refunded on first order. H. Condon, Mgr., Stonington, Maine.

**SALESMEN—Make Big Money on our** Convex Portraits 38c, Frames 35c, Glass 23c. Largest house in America. Est. 15 years. Samples Free. The Culver Co., Box 104, Westerville, O.

**EARN \$5,000 to \$20,000 yearly.** New business necessity. Retail \$5 to \$200. 100-200% profit. Purchaser satisfied or money refunded. No competition. Exclusive territory. Free samples. Sayers, 408 Wainwright, St. Louis.

#### MAILING LISTS

**GUARANTEED lists any classification.** Modern Name Supply Co., Milwaukee, Wis.

**BOHEMIANS, list of five thousand in** Texas—\$10. Albert Fabian, Hallettsville, Texas.

## HELP WANTED

**MEN** to refinish lighting fixtures, brass beds, etc. All or spare time. No capital or canvassing. Experience unnecessary. Information free. Gunmetal Co., Ave. G, Decatur, Ill.

**MEN and Women** wanted for U. S. Government Positions, \$75.00 month. Steady work. Common education sufficient. Pull unnecessary. Write immediately for free list of positions now obtainable. Franklin Institute, Dept. H-21, Rochester, N. Y.

**DISTRIBUTORS**—Wanted of Advertising matter everywhere (good pay); send dime for Contract Magazine (none free). Address Oliver A. Barkley, Mount Pleasant, Pennsylvania.

**BE a detective**, earn \$25 to \$75 weekly, see the world with expenses paid. Write, Lamont, 404 Journal Bldg., Boston, Mass.

**GET Government Jobs**, Spring Examinations. Schedule free. Franklin Institute, Dept. H-21, Rochester, N. Y.

**\$6 COMMISSION** each sale and repeat orders. Traveling salesmen every State. Main or sideline. New, rapid selling automobile accessory used all makes cars. Samples loaned. Weekly settlements. Toledo Cable Co., 118 Davis Bldg., Toledo, O.

**\$20 TO \$35** per month extra money to any employed person without interfering with regular work. No selling, no canvassing. Positively no investment. Unemployed need not apply. Address The Silver Mirror Co., Inc., 119 W. Madison St., Chicago, Ill.

**LEARN** auto trade in most modern school on Coast. Courses practical and complete; expert supervision; time unlimited; reasonable rates. Will help you earn your living while learning. Catalog free. National School of Engineering (Established 1905). Los Angeles.

**GOVERNMENT Wants Clerks**. Examinations everywhere April 12th. Sample questions free. Franklin Institute, Dept. H-21, Rochester, N. Y.

**PROSPECTIVE Chauffeurs, Salesmen, etc.** Learn repairing and driving any car. Small cost. Earn \$20 and up weekly. Modern Auto Co., 1381 Ridge Avenue, Philadelphia, Pa.

**SILVERING** mirrors. Plating tableware, auto-brass. Home booklet plans free. Clarence Sprinkle, Dept. 28, Marion, Ind.

**DETECTIVES** earn from \$25 to \$100 per week and traveling expenses. We show you how. Write National School of Detectives, Room 530, 480 Fifth Avenue, New York.

**U. S. GOVERNMENT Wants Clerks**. \$100 month. Examinations everywhere April 12th. Sample questions free. Franklin Institute, Dept. H-21, Rochester, N. Y.

**GET a Government Job!** See ad on page 40. Write now—today! Patterson Civil Service School, Rochester, N. Y.

**AGGRESSIVE** State Distributing Manager with small capital wanted for \$11.00 Starter and complete line of Ford Car Accessories. Contract should make live man three to eight thousand yearly. Geo. H. Wilson, Manufacturer, 427 Northwestern Bldg., Minneapolis, Minn.

**WANTED, Men-Women**, \$75.00 month. Government Jobs. Vacancies constantly. Write for list positions now obtainable. Franklin Institute, Dept. H-21, Rochester, N. Y.

**BECOME a Detective**—Earn \$150 to \$300 monthly. Extensive traveling, positions open. Particulars free. American School of Criminology, Detroit, Mich., Dept. F.

**"BIG MONEY"** Selling Names to Mail Order Firms; Working Instructions 10c. Vernon Badger, Alburg, Vt.

**YOU Are Wanted**. U. S. Government Jobs. \$100 month. Vacancies. Many appointments coming. Common education sufficient. List of positions obtainable free. Franklin Institute, Dept. H-21, Rochester, N. Y.

**REPRESENTATIVES**—Special Work. Qualified parties can connect with rare proposition. State, county. Give facts about yourself. Address Box 347, Philadelphia, Pa.

**GO on the Stage!** Particulars sent sealed. Enclose stamp. Dramatic Institute, Decatur, Ind.

**YOUNG Men** Wanted in every town and city to look after our interests. Salary starting \$15 weekly with expenses. Rapid advancement. Opportunity to travel. No canvassing. Frontier Mfg. Co., Niagara Falls, N. Y.

**BECOMM Architects**. Draw house and building plans. \$100 to \$500 month. Learn at your home evenings. Sample lessons free. Franklin Institute, Architect 5, Rochester, N. Y.

**BE a Detective**. Earn Big Money. Write John J. Gilles, Licensed and Bonded New York State Detective. Retired member New York Police Department. 24 years' experience. 254 Huguenot St., New Rochelle, N. Y. Investigation solicited.

**CIVIL Service Examinations** open the way to good Government positions. I can coach you by mail at small cost. Full particulars free to any American citizen of eighteen or over. Write today for booklet CE-29. Earl Hopkins, Washington, D. C.

**SPEND** spare time profitably—gathering butterflies, millers. Many wanted for Museums, Artwork. I pay highest prices. Everybody. Send 2c stamp for particulars and 8-page folder. Sinclair, Box 244 D-6, Los Angeles, Cal.

**\$18 WEEK** Paid Chauffeurs. Learn while earning. Sample lessons free. Franklin Institute, Dept. H-202, Rochester, N. Y.

**FIREMEN, Brakemen**, all railroads, everywhere; \$120 monthly; experience unnecessary. Promotion, conductor, engineer, \$150-\$200. Railway Association, Dept. 298, Brooklyn, N. Y.

**PHOTOPLAYS** Wanted. Big prices paid. We show you how. Details free. Rex Publishers, Box 175, A-2, Chicago.

**BE a Detective**—Earn from \$150.00 to \$300.00 per month. Travel over the world. Write C. T. Ludwig, 340 Westover Building, Kansas City, Mo.

**GOVERNMENT Examinations**. Most thorough preparation, \$5; returned if not appointed; particulars free. American Civil Service School, Washington, D. C.

**WANTED**—An Idea! Who can think of some simple thing to patent? Protect your ideas; they may bring you wealth. Write for "Needed Inventions" and "How to Get Your Patent and Your Money." Randolph & Co., Patent Attorneys, Dept. 144, Washington, D. C.

**PLEASANT** spare-time work; mailing circulars. Good pay. No scheme. Details free. Home Pub. Society, 46 N. 12th, Philadelphia.

**INVENT** something; your ideas may bring wealth; our free book tells what to invent and how to obtain a patent, through our new credit system; write today. Waters & Co., 5103 Warder Bldg., Washington, D. C.

**GENERAL Toolmakers and Machinists**, Springfield, Mass. Wanted—Toolmakers, experienced on gauges, jigs, and fixtures; also first-class machinists for setting up and adjusting milling machine fixtures. State references, and wages expected; or call at the New England Westinghouse Company Employment Bureau, Walnut Street, Chicopee Falls, Mass. (Office open week-days, excepting Saturday afternoon, until five o'clock; also Tuesday and Thursday evenings until nine.)

**I WILL** start you earning \$4 daily at home, silvering mirrors; free instructive booklet. G. F. Redmond, Dept. 306, Boston, Mass.

**BECOME** Detectives. Large salaries; easy work. Write Chief Wagner, 1243 Lexington Avenue, New York.

**GO on the Stage**. Vaudeville career offered you. Experience unnecessary. Managers endorse my method. Instructive vaudeville book free. Write today. Frederic LaDelle, Sta. 10, Jackson, Mich.

**STOP** Here! Let me start you in a home business that will bring you money every day. Experience unnecessary. Spare time. No canvassing. I furnish everything. Send for proofs. Voorhies, Desk C. R., Omaha, Neb.

## WANTED

**"UNITED Cigar Store Certificates"** wanted. Will pay 65c per hundred. State quantity. J. Z., Room 925, 78 E. Madison St., Chicago.

## FOR SALE

**VACUUM** cleaner pumps and parts for assembling, save 75%. Vacuum Supply Co., Ann Arbor, Mich.

**FOR Sale**—Model C. Cretors popcorn wagon. Price \$790. Robert Peterson, Harbor Springs, Mich.

**POPCORN**—Peanut Wagon \$150; 1½-H. P. Marine engine \$16; 22-H. P. four-cylinder Auto Engine, overhauled, \$50. Set 4-cyl. 12-H. P. Engine patterns, \$35. Wanted—Ford Engine. Clare W. Webber, Independence, Iowa.

**TYPE and Printing Material** at bargain prices. Now is the time to buy. All sizes rebuilt Job Presses very cheap. Catalogue free. Philadelphia Printers' Supply Co., 14 So. Fifth St., Philadelphia.

**DIETZGEN Engineer's Transit** Complete, cost \$230, for \$125. David Stern Co., 1017 Madison St., Chicago.

**FOR Sale**—Six Mountain Sheep, Deer Heads. Cheap. Reuben Saylor, 497 Broadway, Dayton, Ohio.

**FIELD and Marine, Day and Night** Glasses, with beautiful case. 25-mile adjustment; \$30 value, only \$7.50. Money back if not satisfied. Well's Curiosity Shop, 20 S. Second St., Philadelphia, Pa.

**FOR Sale**—Writerpress, perfect condition. Best Offer. Box 379, New Bedford, Mass.

**REAL** bargains in high-grade Cameras, Lenses, Kodaks, Binoculars, Microscopes, Surveyors' Transits, etc. All goods used, but equal to new. Away below regular prices. Write us today. David Stern Co., 1047 W. Madison St., Chicago.

## SALE OR EXCHANGE

**CONTRACTORS** large traction engine. Exchange for aeroplane or automobile. What have you? Engine in Manitoba. H. M. Pedrick, Columbus, Ind.

**SALE or Exchange**—2-in. by 2-in. gasoline engine. F. Ames, Massena Springs, N. Y.

**NEW** No. 122 Goodell-Pratt geared foot-power machine, \$10. 3-A Kodak with all accessories, cost \$75, want \$30. Like new. Wanted—Small screw-cutting foot-power or engine lathe. Frank C. Lewis, No. 7903 Idlenild St., Pittsburgh, Pa.

**SWAP!** Buy! Sell! What's got? What'd you want? Free advertising. Three months, dime. Swap Bulletin, Detroit.

## GUNS, SPORTING GOODS, ETC.

**DON'T** Be Mushy. Postal will bring catalogue of Famous Home Exercisers, direct from the Manufacturers. Peerless Athletic Supply Co., 383 Pearl St., Brooklyn, N. Y.

**FIREARMS**—Old-time and modern. Buy, sell, exchange all sorts. Stephen Van Rensselaer, 49 Front St., New York City.

## FLOUR &amp; FEED MILLING MACHINERY

**SPECIAL** bargains in second hand Attrition mills, burr mills, crushers, corn shellers, bran dusters, dust collectors, purifiers, reels, double, single, 2 and 3-gear high roller mills, sieve bolters, receiving separators, scourers, etc. Write for description and prices. Sprout, Waldron & Co., P. O. Box 429, Muncy, Pa.

## MACHINERY, TOOLS AND SUPPLIES

**FOR Sale**—Stern's horizontal return tubular type boiler of 100 rated horsepower, with complete set of grates, metal front and back casings, water column and steam gauge. Is in fair condition, except that some tubes will have to be renewed. The boiler is at Cobleskill, N. Y. Courier Electric Company, 65 Pine Street, New York.

**LATHES**—Ten second hand speed lathes, all prices; send for list. Lucas & Son, Bridgeport, Ct.

**OLD** parts made new, new parts made too. Bertschy Kan-Fix It, Omaha, Nebr.

**VACUUM** cleaner pumps, tools, etc., for stationary house or wagon outfit. Vacuum Supply Co., Ann Arbor, Mich.

**"RED Devil"** Mechanic's plier (drop forged steel). Most efficient. 5" size 60c. Style 50. Tool booklet free. Smith & Hemenway Co., 161B Chambers Street, New York City.

**ENGINE** Lathe, swings 9½ in., takes 25 in. between centers. Complete set gears cutting all size threads 3 in. to 49 in., \$45.00. Grammes & Sons, Allentown, Pa.

**WANTED**—Bench lathe; state make, size and price. Barkan, 758 Mitchell St., Milwaukee.

**FOR Sale**: New Power Hack Saw, capacity 4"x4", \$16.75. New 10" Sensitive Bench Drill Press, complete with chuck, capacity ¾", \$15.00. Passman Bros., 30 S. Green St., Chicago, Ill.

**FOR Sale**: All kinds of second-hand woodworking machinery, pullers, belting, fans, etc. Write for prices. Hopeman Bros. Lumber & Mfg. Co., Rochester, N. Y.

**FOR Sale**: Automatic Double Spindle Screw Machine. Will take stock up to ½. Goshen Eyelet Co., Goshen, Ind.

**AIR** Compressor, Ingersoll-Rand No. 12 for any work. Cost \$122.00. My price \$38. Never used. A. Waltenberg, 558 Mott Ave., Bronx, N. Y.

**ONE** Kinsey Rotary Pump, 1½" inlet. Never used. For air, water, oil, or any 10 gravity liquids. Cost \$220.00, my price \$75. Big bargain. H. Liedtke, Bronx, N. Y.

WANT Milling Machine in exchange for welding apparatus. Bertisch, Omaha, Nebr.

PULLEYS, Gears, sprockets, Shafting, Hangers; see display ad this issue. W. A. Jones Foundry & Machine Co., Chicago.

100 NEW Vises \$1.00 per inch width of jaw, all sizes 2½ to 5 inches. Send for circular. Lucas & Son, Fox St., Bridgeport, Conn.

#### ENGINES, MOTORS AND DYNAMOS

GUARANTEED rebuilt alternating and direct current motors, Bargain prices. Reliable makes only. Westinghouse, Wagner, General Electric, Century, Emerson, Sizes from 1/30 H. P. upwards. Satisfaction guaranteed or money refunded. Write today for illustrated price list supplies and motors. Hyre Electric Co., 613 RD. South Dearborn St., Chicago.

TEN second hand engines cheap. Send for description. Lucas & Son, Bridgeport, Conn.

BAIRGAINS, 40-70 Horse Tractors. St. Marys Oil Engine Co., St. Charles, Mo.

FOR Sale—One 75 H. P. gas engine in splendid condition. Can be seen running. The Citizens' Wholesale Supply Co., Columbus, O.

SMALL Auto motors, 4 cylinder, 4 cycle 2-5/8x1, bare or equipped. Bargains. Universal Motor Co., O'Leary, Wis.

WESTINGHOUSE Vertical Gas Engine, 40 H. P. Now running. In best possible condition. Selling because of purchase of a larger unit. Delivery at once. The Acklin Stamping Co., Toledo, O.

FOR Sale—10 H. P. Gasoline Inge Engine—runs with pulley, and also 6½ K. W. Electric Generator. Fine for moving-picture shows. A. Gaebler, 1421 Olive St., St. Louis, Mo.

MARENE type 4-H. P. gasoline engine, little used. Excellent condition, \$35. H. Baither, Sheboygan, Wis.

SALE or Trade—16-H. P. Steam Engine. Address Box 155, Watertown, N. Dak.

BANKRUPTCY Sale: A. C. motors, all new. ¼ h. p., \$15.00; ½ h. p., \$30.00. Small generators, \$8.50. Motor generators and other size motors less than factory cost. Johnston, Evans Ave., Ingram, Pa.

6 H. P. Stationary Gasoline Engine, good as new, cost \$185, sell for \$60. Fred Unser, Jr., Mineola, I. I.

5½ H. P. Gray Marine Engine, brand new, never been used. Make offer. Box 203, Tipton, Iowa.

REBUILT Guaranteed Marine Engines Cheap, state size. Truscott-Pierce, St. Joseph, Mich.

WANTED: Eighteen to twenty-five H. P. two-cycle engines. Howell Bros., Gaylord, Kans.

WANTED: Cash paid for lathes and other small shop equipment. Johnston, Evans Ave., Ingram, Pa.

25 CYCLE, 440 or 220 Volt, 3 Phase, 5-Hp. 150 rpm. Gen Elec. \$140.00, 7½-Hp. 1425 rpm. Richmond \$125. The Elliott Electric Co., Cleveland, Ohio.

1½ HP. Water-Cooled, Two-Cycle Gasoline Engine. Nearly New. \$29. Alvin Sharbondy, Cleveland, Iowa.

ONE 5 H. P. Motor 3 Phase 6 Cycle 220 Volts. Good order. \$65. Fred Unser, Jr., Mineola, I. I.

REBUILT Engines—We have on hand a number of rebuilt "Buffalo" engines, guaranteed, at greatly reduced prices. Write for bargain list. Buffalo Gasoline Motor Co., 1293-1305 Niagara Street, Buffalo, N. Y.

FOR Sale—Engines, new and second-hand. Also Automobile parts. Apply with stamps. B. W. Richardson, Peoria, Ill., R. 56.

NEW Electric Motors Alternating or Direct Current from ½ to ¼ hp. from \$4.50 up. Polishing and grinding motors. Write for Catalogue. Omega Electric Co., 53 W. Jackson Blvd., Chicago.

FOR Sale—Single cylinder, 4"x1½", four cycle Marine gasoline Engine, with coil, pump and carburetor. Price \$30.00. Peter Brothers Mfg. Co., Algonquin, Ill.

#### ENGINE CASTINGS AND BLUE PRINTS

GASOLINE Engine Castings, with drawings. Cheap. Catalog for stamp. Novelty Manufacturing Co., 852 West 6th St., Cincinnati, Ohio.

#### BOATS, LAUNCHES, ETC.

ELECTRIC Portable Propeller for any rowboat. Attached and detached in a moment; are absolutely practical. Selling half price. J. Hopwood, Monomonic, Wis.

FIFTY-FOOT Cruiser, nearly new, fifteen miles, worth twenty-five hundred, sell for half. Truscott, St. Joseph, Mich.

BUILD your own Steel boat from patterns. Material furnished, also finished boats. Catalogue free. Darrow Boat Co., Albion, Mich.

MOTORCRAFT Encyclopedia—A 150-page book that tells 1001 things every motor boatman should know. How to overcome engine troubles. Price \$1, postpaid. Popular Mechanics Book Dept., 6 N. Michigan Ave., Chicago.

#### FOR THE SHOP

JUST Published—Popular Mechanics Shop Notes for 1916—529 Easy Ways to Do Hard Things in every department of mechanics. Over 600 illustrations. 224 pages (size 6½x9½ in.). Price 50 cents, postpaid. Popular Mechanics Book Dept., 6 N. Michigan Ave., Chicago.

FOR That Boy—He will appreciate a copy of the great boy's book "The Boy Mechanic" that tells about 700 different things for boys to do and has 803 pictures. 480 (7x10) pages, cloth, big, handsome book for the price, \$1.50 postpaid. Popular Mechanics Book Dept., 6 N. Michigan Ave., Chicago.

#### BLACKSMITHS

BLACKSMITHS, Listen: Wear the smile that won't come off, by doing hard jobs easy with Toy's Modern Methods on blacksmithing. Making all welds solid, tempering all tools to a standard with colored tempering charts. All for one dollar. Samples free. W. M. Toy, Sidney, Ohio.

#### ELECTRICAL

ELECTRICIANS: Send 50c for 10 Blue Prints of Single, Two, Three-Phase Motor Windings. 50c for 4 D. C. Windings. All for 75c. Winding made easy. Mid-West Electric & Mfg. Co., Box 2, South Denver, Denver, Colo.

ILLUSTRATED wholesale price list supplies and motors. Write today for guaranteed bargains. Hyre Electric Co., 613 BN South Dearborn St., Chicago.

INVENT something; your ideas may bring wealth; our free book tells what to invent and how to obtain a patent, through our new credit system; write today. Waters & Co., 4102 Warler Bldg., Washington, D. C.

ELECTRICIANS, Increase your efficiency, use the Bruly scale of Transformer connections and electric tables. Price 50c. Bruly Co., Orpheum Bldg., Elkhart, Ind.

#### STAMP COLLECTING

FREE—201 Different Foreign Stamps, 100 United States, 60 Japanese, 50 Sweden, 63 British Colonials with Mekeel's Stamp Weekly, Beverly, Mass., six months. Choose one. Remit 25c. Mention magazine.

CANADA—Packet Free. Many varieties, old issues, leaves, etc., postage 2c. Midland Stamp Company, Midland, Ontario.

PACKET "A" 100 varieties foreign, 20c—worth the money! Desirable stamps on approval, to collectors with satisfactory references. F. J. Pope, Box 45, Charlotte, Vermont.

15 DIFFERENT Canada to approval applicants. Postage 2c. Nickels, 122 Florida Ave., Washington, D. C.

FREE—50 different stamps with 60% approvals. Enclose 2c. Seidenberg, Beecher, Illinois.

FREE! 25 different used United States Stamps including Postage, Revenues, Envelopes and Dues, to applicants for our high-grade approval selections. Send 2c for postage. The Edgewood Stamp Co., Dept. H, Midford, Conn.

BORNIA dues complete, 13 varieties, catalogue 2c, net 25. Approvals at net prices; references. Neel, 880 Clarkson Ave., Brooklyn, N. Y.

FREE premiums to approval applicants. Postage 2c. Hawkins, Baton, N. Mex.

\$1.50 PACKET of Stamps for 15c. Packet No. G.56 contains 75 different stamps (cat. about \$1.50), including 6 Chinese (Junk), New Belgium, 9 "Zoological" and 12 beautiful "View" stamps, etc. Bright & Son, 164 Strand, London, England.

COLLECTORS! Fill your stamp books from my approval sheets, 50% discount. Wm. Sprengell, 3643 N. Ardesian Ave., Chicago, Ill.

LOW Priced Stamps on Approval. \$10 Confederate bill free to applicants furnishing satisfactory references. G. V. Lovering, 2715 13th St., N. W., Washington, D. C.

FREE, 200 mixed stamps, postage 2c. Paya Stamp Co., 138 No. Wellington St., Los Angeles, Calif.

STAMPS exchanged for United Profit Sharing coupons. Booklet for stamp. Coin Exchange, New Rochelle, N. Y.

FREE, 8 car. Ceylon, with trial approvals. Provide Co Stamp Co., Providence, R. I.

COLONIAL approvals for collectors who want distinctive stamps. Trial will continue. Hanlon, Box 24, Schenectady, N. Y.

STAMPS—12 different from warring nations, 10c; 10 different foreign coins, 15c; 20 Belgian stamps, 10c. Lists free. Toledo Stamp Co., Toledo, Ohio.

LOW priced approvals. Mention paper and receive unused Department Stamp Free. S. E. Colman, 634 Keefer Place, Washington, D. C.

STAMPS—105 China, etc., stamp dictionary and list, 2c. Bullard, Sta. A, Boston.

STAMPS sent on approval at 70% discount. Precancel, ½c each. Reference required. Emory Renold, Hanover, Pa.

PACKET of 23 stamps; no two countries alike, 500 hinges. Set of \$1 and \$2 U. S. Rev., all for 5c. Mention paper. Miami Stamp Co., Toledo, Ohio.

A STAMP Album. A collection of rare Mexican War stamps, incl. Madero, etc., 180-page catalog. Perf. gauge and mill. scale, coupons, etc., all for 5c. App. sheets 60% to 80% comm. Agents Wanted. We buy stamps. Hussman Stamp Company, St. Louis, Mo.

24 VARIETIES Cuban stamps, 10 cents. List of 6,000 low-priced stamps free. Chambers Stamp Co., 111 P. Nassau St., New York City.

20 UNUSED stamps free. All different. Postage, 2c. Plak Stamps, Toledo, Ohio.

STAMPS, 75, all different, free. Postage 2c. Mention paper. Quaker Stamp Co., Toledo, Ohio.

#### RARE COINS

THREE Large United States Cents, 25c; 5c piece, 10c. Moore Coin Company, Commerce, Texas.

\$1 1798, VERY good, \$2.45. Three broken bank bills and price list, 10c. Norman Shultz, King City, Mo.

BEST offer takes \$5.00 gold piece dated 1834. Reynolds Kriessl, North Branch, Minn.

25c BUFFALO Nickels, original buyer of them and Lincoln pennies at 25c each, certain kinds, and hundreds of other old coins, has catalog quoting high prices. Send 10c for catalog and particulars. National, Dept. 108, Olney, Ill.

10 DIFFERENT Coins from Warring Nations, 25c. Burgess Co., 522-M, Beacon, Toledo, Ohio.

OLD Coins, Spring Catalogue, large list coins for sale (Free). Catalogue quoting prices paid for coins, ten cents. William Hesselin, 191 Tremont St., Boston, Mass.

COINS—Antique Belles, 5 curious rare coins with catalogue, 10c. Ray Chapin, New Berlin, N. Y.

SPECIAL: Splendid set of General Villa Mexican War \$1.00, \$5.00, \$10.00 bills, 25c. Excelsior Exchange, Albuquerque, N. Mexico.

UNITED Profit-Sharing Coupons taken the same as cash for Coins, Notes, Stamps, Indian Relics, Guns, Pistols and curious things. Booklet for stamp. Coin Exchange, New Rochelle, N. Y.

\$4.25 EACH Paid for U. S. Flying Eagle Cents dated 1856. We pay cash premiums on hundreds of Old Coins. Send ten cents at once for New Illustrated Coin Value Book 4x7. It may mean your fortune. Clarke & Co., Coin Dealers, Box 15, Le Roy, N. Y.

Will pay \$750.00 cash for \$3 gold piece dated 1852 (without "In God We Trust"); \$50.00 for 1853 half without arrows; \$3.00 to \$50.00 cash for large cent 1799, etc. We pay cash premium for all large cents, eagle cents, 2c pieces, etc., and all rare U. S. and foreign coins, bills and stamps to 1912. Thousands of rare coins wanted. Many valuable pieces are in circulation. Send 4c. Get our Large Illustrated Coin Circular containing valuable information. It may mean much to you. You certainly have nothing to lose. Send to Numismatic Bank of Texas, Dept. H, Fort Worth, Texas.

## GAMES AND ENTERTAINMENTS

**AMUSEMENT** Goods, largest assortment for immediate shipments. Tricks, puzzles, pocket war novelties, cachoo, itch powder, bombs, 200 others. Send 2c for large illustrated catalog. J. Grandfeld, Mfg., 1233 Theriot Ave., Bronx, New York.

250 **MAGIC** Tricks—8 Big Family Games (Checkers, Dominoes, etc.), Ventriloquist Double Throat. 30c value, all 12c with latest catalog. Northern Supply, Metropolitan Block, Chicago.

**SUPERIOR** magical apparatus for parlor and stage. Clever pocket tricks with cards, coins, handkerchiefs, etc., easily learned by anyone. New and practical magical effects for advanced amateurs and professionals. 50-page catalogue free. Large, illustrated, professional catalogue 10c. Donald Holmes, 3709 Olive St., Kansas City, Mo.

**MAGIC**—Tricks, Books and Supplies. For Amateurs as well as the Great Professionals. Any one can learn through our instructions. Feature Acts in Mind Reading, Spiritualism, Rope Ties, etc. Large illustrated Professional Catalogue, 10c. Chicago Magic Co., Dept. B, 72 West Adams Street, Chicago, Illinois.

**HUMAN** Finger in a box!!! Think of it!!! Show your friends and horrify, mystify, stagger them with this most ghastly sight. You have the laugh! Send 10c and we will send all necessary apparatus. D. Marshall Novelty Co., Manayunk, Phila., Pa.

**FREE!** Illustrated Catalog, Bargain Sheet of over 400 Magic Tricks, Books and Novelties, and copy of "Modern Mystery." Saves you 20% to 50% on everything. Write today. Douglas, Kluwe, Okla.

**MAGIC** Plate Lifter—makes other fellow's plate jiggle when eating—with instructions how to get other tricks free, 25c. Box 308-P, Waco, Texas.

**WIGS**, Makeups, Tricks, Puzzles, Jokes, Magic Goods, Mind-reading Acts, Sensational Escapes, Illusions, and Stage Supplies. Big catalog free. Oaks Magical Co., Dept. 308, Oshkosh, Wis.

"**CHARLEY** Chaplin Puzzle." Interesting and amusing. Fifteen cents. Park Novelty Co., 4233 Lake Park Avenue, Chicago.

"**FORD**" Joke-book, a good one, 10c coin. Mono Pkg. Co., So. Newwalk, Conn.

1916 **MAGIC** Catalog with 350 Illustrations of 800 Tricks and Illusions, including Pocket Trick, free. Send 6c stamps for postage. Hornmann, 249 West 38th Street, New York.

**PATTER-CHATTER**. Our new original comedy magic patter book. 24 pages. Just out. Best ever published. 50c. Gilnovco, Morgan Park, Chicago.

**HIGH** Class Magical Apparatus. Immense stock. Immediate shipments. 50-page Illustrated Catalog, 1916 New List and New Bargain Sheet No. 58, free. Large 223-page Illustrated Professional Catalog, 10c. A. Rotenberg, 152 West Ontario Street, Chicago.

**CARD** Trick and Catalogue 5c. Harvey Arnold, Princeton, N. J.

**TINY** Toy Zeppelin. Mouse propels it. Instructions one dime. Stanley Moran, 5 Church St., Bristol, R. I.

**SECRET** Writing, three codes 25 cents. Box 325, Warren, Ill.

**P-L-A-Y-S**, Speakers, Dialogues, Drills, Joke Books, Wigs and Beards. Catalogue free. Ames Publishing Co., Dept. 49, Clyde, Ohio.

**PLAYS**, Vaudeville Sketches, Monologues, Dialogues, Speakers, Minstrel Material, Jokes, Recitations, Tableaux, Drills, Musical Pieces, Entertainments for all occasions, Make-up Goods. Large Catalog Free. T. S. Denison & Co., Dept. 11, Chicago.

**USED** Magic Goods and Supplies that please. Bargain Catalogue free. Gilnovco, Morgan Park, Chicago.

**FUNABOUT** Fords—The book that contains the funny Ford stories that the whole nation has laughed over. The greatest book novelty of the year. A collection of nearly one hundred of the very latest and best current "Ford stories" in book form. 64 pages, 6 1/2 x 4 1/2 in. Heavy boards. Price 25 cents postpaid. Send for your copy now. Popular Mechanics Book Dept., 6 N. Michigan Ave., Chicago.

## FOR BOYS

"**BOY** Electrician" makes Batteries, Motors, Engines. 75 Illustrations, 10c. Renew Dry Batteries, 3 guaranteed processes, 20c. Both 25c. How to make "Boys Automobile" complete plans, 20c. "Ideal," 3311-D, Belleplaine Ave., Chicago.

**BOYS**: Make a 12 ft. model Zeppelin. Directions and materials complete, 85c. Sure to fly. Cargill-Underhill, 417 Benjamin, Grand Rapids, Mich.

**BIG** New Book for Boys—The Boy Mechanic, Vol. II—Just Out—A sequel to, but containing nothing found in Vol. I. Tells all about 1,000 interesting things to make and do. 480 Pages; 950 Illus. Cloth, Price, \$1.50 Postpaid. Send for descriptive circular. Popular Mechanics Book Dept., 6 N. Michigan Ave., Chicago.

**JUST** Out—Amateur Mechanics No. 7. For everyone that enjoys building home-made contrivances of every description this book will afford a wealth of practical ideas and suggestions of things both ornamental and useful. Over 200 articles. Fully illustrated, 128 pages (size 6 1/2 x 9 1/2 in.). Price 25 cents postpaid. Popular Mechanics Book Dept., 6 N. Michigan Ave., Chicago.

**ENJOY** camp life at Boothbay Camp, Bath, Maine. Complete equipment, ideal conditions. Particulars free. A. R. Webster, 1323 Cypress St., Cincinnati, Ohio.

## FOR MEN

**MR. Cigar** Smoker, do you enjoy the taste and aroma of imported Havana, order a box of White Front Cigars direct from factory, 4 1/2 inch London hand-made Sumatra Wrapper, 50 box, \$2.00; trial box 25 for \$1.00, prepaid anywhere. White Front Cigar Co., 219 West Chestnut St., Lancaster, Pa.

**KENTUCKY'S** Best Natural Leaf Tobacco, chewing or smoking, parcel-post prepaid, 4 lbs., \$1; 10 lbs., \$2. L. Rosenblatt, Hawesville, Ky.

**MR. Man**, do you wear a shirt? Thousands are wearing our patent Kuff Link. Opens like a glove. Send postal for Circular. The Hub Button Co., Attleboro, Mass.

## SAFETY BLADES SHARPENED

**RESHARPENED** by our "New Process" 2c each. Guaranteed better than new. Each blade honed, hair-tested, sterilized, wrapped individually. Jones Keenedge, Dept. A, Jamaica Plain, Mass.

**SAFETY** razors sharpened; two cents each. Guaranteed. Blade box free. Electro Stropping Co., 134 Shelby St., Detroit, Mich.

## FOR THE HOME

**CUP** of delicious tea and handsome souvenir free. A. Palmer, 1017 Locust Street, Philadelphia, Pa.

**ARTISTIC** Lamps and Shades in metal and art glass easily made by the amateur craftsman from instructions given in our book of 18 designs ranging from ordinary reading lamps to pretentious chandeliers. Expense only slight. Price of book 50c postpaid. Popular Mechanics Book Dept., 6 N. Michigan Ave., Chicago.

**BEAUTIFUL** arts-crafts lamps—Anyone can make them out of paper, cardboard and wood. 16 designs. Inexpensive yet artistic. Complete book of instructions. Price, 50c postpaid. Popular Mechanics Book Dept., 6 N. Michigan Ave., Chicago.

## DIAMONDS, WATCHES AND JEWELRY

**GENUINE** perfect cut diamonds at \$97.50 per carat is the lowest price in America. Regular retail value \$150.00 per carat. Send now for your free copy of our beautiful 1916 Deluxe Diamond Book, printed in colors and profusely illustrated. It explains our wonderful and protective, iron-clad money-back contract and also our offer to ship any diamond for your free examination at our expense and without obligating you. Send postcard or letter for this valuable book to L. Basch & Co., Dept. X2400, State & Quincy Streets, Chicago, U. S. A.

**FOR** Sale—Diamond, 3/4 carat, perfect, blue white, \$100.00. Hamilton watches, 21 jewels, \$15.00 and \$20.00. P. O. Box 826, Atlanta, Ga.

## PIANOS AND MUSICAL INSTRUMENTS

**YOU** can tune and keep your own piano or player piano in perfect condition. Van Atta's book on The Piano and Player Piano not only tells you but shows you every movement in their care, repair and tuning. 156 Pages. 51 Illustrations. Cloth. Price \$1.50 postpaid. Popular Mechanics Book Dept., 6 N. Michigan Ave., Chicago.

## MUSIC

**WHAT** will you charge to display an elegant sample Piano in your home and allow us to refer to you as our local representative? Write today for our special agents' display plan. Desk 10, Warren Piano Company, Warren, Pennsylvania.

**NEW** Piano Pieces: "Visions of Hope," meditation, nine pages, 75 cents. "Arrival of the Victors," march, 50 cents. Send 25 cents and receive both. O. Vincent, 569 Park Ave., Woonsocket, R. I.

**FIVE** 75c player-piano music rolls \$1.00, catalogue 2c. Alma Manufacturing Co., Philadelphia, Penna.

**RECORDS** for Victors, Columbia and Edison (disc or cylinder) Talking Machines. Edison Standard, 9c; Blue Amberol, 25c; Victrola, 15c; bought, sold and exchanged. Permanent Jewel Needle, \$1; Jewel point attachment for Victrola or Grafonola to play Edison disc records, \$2. Send for record list. Well's Curiosity Shop, 20 S. 2nd St., Philadelphia, Pa.

"**U. S. NATIONAL** Guard" March, Piano 25c. Title-page picture Mrs. Canfield, only Lady Mayor in America. Gene Swinbank, Warren, Ill.

## FORMULAS AND TRADE SECRETS

1,600 **FORMULAS** 20c. 75 Manufacturing secrets, 10c. Resilvering Mirrors, Renewing Dry Batteries, 20c each. Guaranteed. All 50c. "Ideal," 3311D, Belleplaine Ave., Chicago.

**GET** my fifteen selected flavoring extract formulas, 25 cents coin. Lattime, R78 Dexter St., Medford, Mass.

**STOP** Coughing! Magic Cough Ease. Formula 25c. Wm. Waelder, Hannibal, Mo.

300 **FORMULAS**, Trade Secrets, Manufacturing Recipes, etc., three business plans for home manufacture, all for 25c. Formula, Box 154M, St. Paul, Minn.

**FORMULA** how to lay tile (\$2), including box of tile. With these instructions you will be able to go right out and close contracts for tile floors. Address Tile Dept., 612 Oxford Bldg., Chicago.

**SEND** stamp for new formula list. Wright Co., Brewster, N. Y.

**INDELIBLE** Ink, Leather Renovator, China Cement formulas for dimes. Free sample Antiperspiration Powder. E. Hinz, Elizabethtown, N. Y.

25,000 **FORMULAS**—Price \$1, postpaid; complete list 4c stamps. Edm. Bromley, Watertown, N. Y.

**HIGH** Grade Guaranteed Formulas for almost any occasion. Prices reasonable. Cole Chemical Co., Chicago.

10,000 **SELECTED** scientific, chemical, technological, and practical recipes and processes, including hundreds of so-called trade secrets for every business, alphabetically arranged in one large volume of 808 pages. Price \$3 prepaid. Popular Mechanics Book Dept., 6 N. Michigan Ave., Chicago.

## TYPEWRITERS AND SUPPLIES

**SPECIAL** Note: If you want a real bargain in a dandy, high-class, substantially guaranteed rebuilt typewriter of any make—on time, rental or cash—be sure to write the big house today. Young Typewriter Co., Dept. 227, Chicago.

**SAVE** money. Buy your typewriter ribbons and carbon paper from us. Ribbons 40c each. Carbons 80c per hundred, postpaid. Satisfaction guaranteed. The Herzman Pinkney Co., 6327 S. Greenwood Ave., Chicago.

**ALL** makes typewriters \$5.00 up. Rented \$1.00 per month and up. Write for catalogue No. 50. Machines sent for approval all guaranteed. Beran Typewriter Co., 58 W. Washington St., Chicago.

**GREATEST** clearing out sale in history. Don't fail to get price list Sixty. Typewriter Exchange, Cincinnati.

GOOD, serviceable typewriters \$7.50 and up. Post card brings list. First class ribbons, any machine, 25c. Hub Typewriter Co., 286 Devonshire St., Boston.

LARGEST Stock of Typewriters in America—All makes; Underwoods, Oliviers, Remingtons, etc., one-fourth to one-half manufacturers' prices, \$15 up, rented anywhere applying rent on price; free trial; installment payments if desired. Write for catalogue 70. Typewriter Emporium (Established 1892), 84-96 West Lake Street, Chicago, Illinois.

#### DUPLICATORS AND DEVICES

THE "Brody" Duplicator reproduces 50 or more copies from typewritten or pen original. Letter size \$1.75. Booklet free. Brody Duplicator Co., 1126 S. Halsted St., Chicago.

MULTIGRAPH (rebuilt). Perfect 1/2 cost. Guaranteed. Ship on approval. John Paul, Bourse Bldg., Philadelphia, Pa.

OUR "Modern" Duplicator—Yours for \$2.40. No Ghee or Gelatin. Always ready. All sizes. Free trial, 34,000 users. Standard for 15 years. Booklet free. Sole mfrs., J. E. Durkin & Reeves Co., 339 Fifth Ave., Pittsburgh, Pa.

THE "Universal" reproduces 50 or more from one letter or anything written with pen or typewriter. 50,000 in use everywhere. Letter size, \$3.25. Sample work and booklet free. N. Reeves Duplicator Company, Park Building, Pittsburgh, Pa.

DUPLICATORS, 9x12, price \$1. Make 50 copies from pen or typewritten original. Booklet free. Scientek Laboratories, Dept. 1, Madison, Maine.

#### PRINTING, ENGRAVING AND MULTIGRAPHING

MULTIGRAPH letters, 1,000 complete with letterheads \$3.60. Heads black, letters purple. Quality work second to none. Samples free. Superior Letter Company, Huntington, Indiana.

6x9 PRINTING Press and Outfit. All condition. Will sell cheap. E. C. Smith, Waukegan, Illinois.

QUALITY Printing Prepaid—500 either envelopes, noteheads, cards, statements, \$1.35; 1,000 \$1.85; 1,000 envelope slips, \$1. 1,000 6x9 circulars, \$1.75; 500 lines finish letterheads or envelopes, \$1.75; 1,000, \$3. printing prepaid. Imitation typewritten letters. Stamp brings samples. Model Company, Manchester, Iowa.

GUMMED Labels, 3,000, 60c. 40 pp. catalog, 2c. MacFaggart, 1235 Arch, Philadelphia, Pa.

100 ENVELOPES, printed name and address, delivered, 30c. Samples free. Wris Company, Laceyville, Pa.

EMBOSSER Letterheads on good Bond Paper \$3.75 per 1,000. Send for samples. Commercial Embossing Co., Wilkes-Barre, Pa.

LET us submit your letterhead for approval. Send your copy now. Leach, Box 15, McArthur, Ohio.

ILLUSTRATE your printing; cuts made from photographs, 85c. We print anything. Samples free. Commercial Press, Batavia, Ohio.

1,000 LETTERHEADS or Envelopes on 20 pound Bond Paper, \$2.00. 1,000 Statements or Cards, \$1.75. John D. Mesler, Cobden, Ill.

250 CARDS, 4 lines, 50c prepaid. Autopress, Montclair, N. J.

TWO Color—150 Letterheads, 8 1/2 x 11, and 150 Envelopes, 6 1/2, postpaid, \$1.25. F. Bittenhouse, Belvidere, N. J.

500 FACSIMILE letters, including bond letterheads, printed any way, \$2.25 postpaid. Adams Letter Co., Kansas City, Kan.

CIRCULARS: 1,000 3x6, \$1.00. Samples free. O. Dickey, Baronne, N. J.

PRINTED—500 6 1/2 envelopes \$1.00; 500 cards \$1.00; 500 statements \$1.00; 500 bond letterheads \$1.00; 1,000 3x6 circulars \$1.00. T. B. Dickey, 1170 Stout, Denver, Colo.

100 VISITING Cards, society type, 30c. Samples for stamp. McLaurine, printer, 2117 Fairmount Ave., Baltimore, Md.

GUMMED Labels that stick, 3,000, 75c. up. Send for Catalog No. 102. Royal Label Company, 498 Cherry St., Philadelphia.

HIGH Grade Business Stationery—500 Letterheads, Envelopes, Billheads, Cards, Statements, \$7. Write for Samples, Chas. R. Hartmann, Printer, Box 22 Hudson City Station, Jersey City, N. J.

SPLENDID Quality 250 Bond Letterheads and Envelopes, \$1.35. 1,000 Circulars, 5x8, \$1.25. Hoyt Brothers, Pittsfield, New Hampshire.

QUALITY Printing. Sample order 200 letterheads, 200 envelopes, \$2.00 cash, postpaid. Troy Printing Co., Troy, Ala.

RIBBON Process. Imitation typewritten letters. Send for samples and prices. Tood's Letter Shop, Ottawa, Ill.

"NEARGRAVURE" printed stationery, facsimile embossed. Class. Samples. Solihday's, Knox, Indiana.

1,000 3x6 CIRCULARS, 100 words, 85c. 100 Business Cards 25c. Charles Walter, Lancaster, Ohio.

1,000 COLORED Parchment Circulars, 5 1/2 x 8 1/2, \$1.75; Art. Ad. Slips, 3 1/2 x 5 1/2, \$1.00; both prepaid. Elegant samples printing free. Good's Printery, Harrisonburg, Va.

GUMMED Labels—All kinds. 500 with name and address, 25c. Eastern Label Co., D-1, Clintonville, Conn.

PRINTING Outfits—Presses, type, supplies, type novelties. Send stamp for catalogue. Model Press, York, Penna.

250 BOND Letterheads or Envelopes, white, blue or buff, printed to order, \$1.00 prepaid. Both for \$1.75. Samples free. Commercial Press, Beaver Falls, Pa.

MULTIGRAPH Letters, Letterheads—1,000 complete, \$3. Letters, purple, heads black. Samples for stamp. Perfection Letter Company, Muncie, Indiana.

PRINTING Presses, Type and Supplies. Low Prices. Big Stock. List for Stamp. Popular Bargains, Richmond, Pa.

LETTERHEADS—1,000, \$2.00; 2,000, \$3.50; 5,000, \$7.50; good grade bond paper, 16 pound; others charge more for same quality; samples free. Girard Job Shop, Dept. L-2, Girard, Kansas.

GOOD Printing at low prices. 1,000 good letterheads, envelopes, cards, billheads, labels, circulars, \$2.50. Samples free. Catalogues, booklets, and circulars our specialty. Ernest L. Fantus Co., 527 S. Dearborn St., Chicago.

SEND 4c for portfolio letterheads that give character to your business. White Printing Co., Coudersport, Pa.

GUMMED Labels, 3,000 1x2 1/2; 1,000 Billheads, \$1.50. Samples. Irvin Daniel Wolf, 3124P Jasper Street, Philadelphia.

RELIABLE Printing—Not the cheap kind. Samples and Price List 3c. Evans Press, 27c Main, Concord, New Hampshire.

#### PATENT ATTORNEYS

PATENTS — Manufacturers buy well-known patents worth many hundreds of thousands of dollars, obtained through us and sold or licensed to well-known manufacturers, including some of the largest corporations in the world, are evidence that we obtain for inventors. Particulars, and book of greatest real interest and value to inventors—a book that may prove worth a very large sum of money to you if you read it before you apply for a patent—will be mailed free on request. Lowest fees for best service in the basis of our terms. Submit your invention and we shall promptly and without charge render you reliable opinion as to patentability and quote you cost of patenting. R. S. & A. B. Lacey, Patent Lawyers, Established 1869, 729 Barrister Bldg., Washington, D. C.

H. P. LOWENSTEIN, Patents, Mechanical and Electrical Expert, McGill Building, Washington, D. C. Send sketch and description for advice, statement of total cost and manner of payment. For personal search of Patent Office records with special written report, remit \$5.00.

"PATENTS and Patent Possibilities" is a 72-page treatise which tells all about patents, what to invent and where to sell it. It gives honest advice to inventors and tells about the successes of some of my clients, also explaining what are frequent causes of failure. Manufacturers are constantly writing for protective patents upon all kinds of sound inventions. Can you help supply their wants? The book is free. Write for it today. H. S. Hill, 905 McLachlan Building, Washington, D. C.

PATENTS as low as \$17, total cost including government fee. For full particulars address Patent News, 2, Washington, D. C.

MONEY advanced to secure patents. W. J. Bacon, Columbian Building, Washington, D. C.

PATENTABLE Improvements Wanted. Send preliminary drawing for free opinion concerning patentability and commercial value. Ask for bulletins. Lancaster and Allwine, 221 Ouray Bldg., Washington, D. C.

PATENTS secured. Efficient personal service. W. Wallace Nairn, Jr., Registered Patent Attorney, Washington Loan & Trust Building, Washington, D. C.

\$50 COMPLETE cost of patent through me. Send sketch for free report and search. William C. Linton, Patent Lawyer, 631 F Street, Washington, D. C.

PATENT Secured—Trade Marks registered. Validity and infringement searches made. Patent suits conducted. Instructions sent on request. Wm. N. Roach, Jr., Attorney-At-Law and Solicitor of Patents, 350 McGill Bldg., Wash., D. C.

PATENTS—Send sketch for free search and report. Books on patents and book of reference letters sent free. John S. Duffie & Co., 610 F St., Washington, D. C.

PATENT what you invent. It may be valuable. Write me. No attorney's fee until patent is allowed. Estab. 1882. "Inventor's Guide" free. Franklin H. Hough, 522 Loan & Trust Bldg., Washington, D. C.

PATENTS secured promptly. Personal attention. Edward W. Kibbey, Patent Attorney, 503 Victor Bldg., Washington, D. C.

PATENT Your Ideas—\$9,000 offered for certain inventions. Books, "How to Obtain a Patent" and "What to Invent," sent free. Send rough sketch for free report as to patentability. Manufacturers constantly writing us for patents we have obtained. We advertise your patent for sale at our expense. Established 20 years. Address Chandler & Chandler, patent attorneys, 828 F St., Washington, D. C.

INVENTORS have great opportunities, but a patent is not everything. My free books tell what you should know. H. L. Woodward, Attorney, 902 G, Washington.

PATENTS secured through credit system. Free search. Send sketch. Book and advice free. Waters & Co., 4280 Warder Bldg., Washington, D. C.

C. W. GERARD, formerly Patent Office Examiner, Scarratt Bldg., Kansas City, Mo.

INVENTORS desiring capital to patent inventions, write 101 Western Fiduciary, Denver, Colo.

NO Attorney fees until patent allowed. Send sketch for free report. Books free. Frank Fuller, Washington, D. C.

C. L. PARKER, Ex-member Examining Corps, Patent Office, Patent Attorney, McGill Bldg., Washington, D. C. Inventor's handbook, "Protecting, Exploiting and Selling Inventions," sent free upon request.

PATENTS That Pay. Proof given. Two wonderful guide books free. E. E. Vrooman & Co., 871 F St., Washington, D. C.

DON'T lose your rights to patent protection. Before proceeding further send for our blank form, "Evidence of Conception," to be signed and witnessed. Book, suggestions and advice free. Lancaster and Allwine, 221 Ouray Bldg., Washington, D. C.

PATENTS secured or fee returned. Actual search free. Send sketch. Latest complete patent book free. 1916 Edition. (Ninety pages.) Free sales service. It should never require more than two days to report upon the patentability of your invention; nor longer than six days to prepare your case for filing. Longer delay amounts to gross neglect. For prompt personal service write: George P. Kimmel, 212 Barrister Building, Washington, D. C.

PATENT your invention, \$10,000 offered for inventions wanted. Booklet and opinion free. Milo B. Stevens & Co., Established 1864, 685 F St., Washington, 333 Monadnock Block, Chicago.

PROTECTIVE patents procured promptly. 112 page blue book on patents sent on request. Trade-marks registered. Robb & Robb, 211-215 Southern Bldg., Washington, D. C.

PATENTS: Send model, sketch or drawing. Advice, 103 Mechanical Movements and 50 Perpetual Motions, Free. Fred G. Dieterich & Co., 61 Ouray Bldg., Washington, D. C.

PATENTS obtained through D. Swift being promptly sold to manufacturers. Write today for free books of "Inventions Needed" and surpassing references. D. Swift, 317 Seventh St., Washington, D. C.

WANTED—New Ideas. Write for List of Inventions Wanted. \$1,000,000 in prizes offered for inventions. Our Four Books sent free upon request. Victor J. Evans & Co., 166 Ninth St., Washington, D. C.

**PATENTS** that protect and pay. Advice and books free. Rates reasonable—highest references; best results. Watson E. Coleman, Patent Lawyer, 624 F St., N. W., Washington, D. C.

**PATENTABLE Ideas Wanted**—Send for 3 free books. R. B. Owen, 30 Owen Bldg., Wash., D. C.

**THE Patentome** is free. An education in obtaining patents. Established 1865. Anderson & Son, Attorneys, 147 7th St., Washington, D. C.

**PATENTS**—Herbert Jenner, patent attorney and mechanical expert, 696 F St., Washington, D. C. I report free of charge if a patent can be had and its exact cost. Send for circular.

**PATENTS**—Trade-Marks. Send for my free book, "How To Get Them." It's full of information you should know. Joshua R. H. Potts, 8 Dearborn St., Chicago; 929 Chestnut St., Philadelphia; 805 G St., Washington.

#### FOR INVENTORS

**INVENTORS!** Send 5c for Book and List of Inventions Wanted. Sanders, 7 Webster Building, Chicago.

**PATENTS** and unpatented inventions sold for subscribers or no charge, advertised free. Inventor's Advocate, Washington, D. C. 25c per year.

We are looking for improvements, suggestions and inventions on Player Pianos. What have you? Also inventions, etc., on Player Pianos operated by electricity. Player Piano Patent Purchasers Agency, P. O. Box 178, Madison Square, New York City.

**PATENT Sales Specialists.** Best Location and Facilities. Fuller, 509 5th Avenue, New York.

**HAVE You an Idea?** If so, you should protect it by a patent. Send us a model or sketch for free opinion as to patentability. Write for our Four Books sent free to any address, Victor J. Evans & Co., 157 Ninth St., Washington, D. C.

**PATENTS** without advance attorney's fees. Send sketch for free report. Books free. Frank Fuller, Washington, D. C.

**WANTED**—An Idea! Who can think of some simple thing to patent? Protect your ideas; they may bring you wealth. Write for "Needed Inventions" and "How to Get Your Patent and Your Money." Randolph & Co., Patent Attorneys, 629 F St., Washington, D. C.

**INVENTORS** desiring capital to patent inventions, write 102 Western Fiduciary, Denver, Colorado.

**INVENTORS:** Write us immediately if you have patents for sale. La Croix Tool Co., 214 N. 21st. St. Louis, Mo.

**PATENTS** secured through credit system. Free search. Send sketch. Book and advice free. Waters & Co., 4280 Warder Bldg., Washington, D. C.

"THE Patent Salesman" is saving and making thousands of dollars for inventors. Price 25c. L. R. Schmidt, Box 997, Bakersfield, California.

**GREAT opportunities** exist for inventors, but a patent is not everything. My free books tell what you should know. Horace L. Woodward, 902 G, Washington.

**INVENTIONS**—Patenting and Promoting. A book containing practical advice and directions for inventors and manufacturers. Book, suggestions and advice free. Lancaster and Allwine, 221 Ouray Bldg., Washington, D. C.

**INVENTIONS** commercialized on cash and royalty basis. Two free books. Inventors and manufacturers write, Adam Fisher Mfg. Co., 2061 Ry. Ex., St. Louis, Mo.

**PATENTABLE Ideas Wanted**—Send for 3 free books. R. B. Owen, 30 Owen Bldg., Wash., D. C.

**HAVE you a Patent to sell?** You'll be interested in my proposition. Write now for free particulars, F. W. Johnson, 6 N. Michigan Ave., Chicago.

**PATENTS, Trade-Marks and Copyrights.** Our handbook on patents will be sent free on request. All patents secured through us are described without cost to the patentee in the Scientific American. Munn & Co., Patent Attorneys, 672 Woolworth Bldg., N. Y. Washington, D. C., office, 625 F St.

#### PATENTS FOR SALE

**WANTED**—Communication with successful Patent Salesman, Kirkpatrick, Alexander Street, Rochester, New York.

**PATENTS** 1082433 and 1092073 on a steel re-inforced Cross-tie and rail-fastener, partly developed. Lack means to place on market. Would sell outright, state rights or good royalty proposition. I. A. Miller, Jeannette, Pa.

**HAIR dyeing Comb.** Money maker. Best offer takes it. Holden, 3542 17th St., San Francisco, Calif.

**IF interested** in United States and Foreign patents on Telephone systems, many different types of flying machines, wireless telephone and telegraph systems, amplifier, switches, and other devices, write or see Frank Summers, Memphis, Mo.

**AUTOMATIC Signal Apparatus** for Automobiles. Practical and efficient device for preventing accidents. Outright or royalty. Martin C. Stamm, 292 New York Ave., De Land, Florida.

**FOR Sale**—Patent rights—Billiard and Pool Chalk Holder. A big money maker. G. E. Marshall, 249 So. 13th St., San Jose, California.

**FOR Sale**—The best rail joint ever invented; a fortune for some one. Wm. Orr, 1521a North Spring, St. Louis, Mo.

**FOR Sale**—Patent on a curtain stretcher, superior to anything now on the market. J. Oreson, Boxholm, Iowa.

**PATENT whip lock** for sale. Lewis Neumann, Occidental, Sonoma Co., Calif.

**FOR Sale, with Royalty**—Patented Progressing Hobby Horse, moves forward mechanically by weight of rider. Various weights. Owen W. Badger, 101 Whitehall St., Atlanta, Ga.

**PATENTS** and inventions for sale or on royalty. My clients have valuable inventions for market. No better investment for manufacturers or individuals. Full information without charge. Mention line of invention interesting you and data will be sent. Richard B. Owen, Patent Lawyer, Owen Bldg., Washington, D. C.

**FOR Sale Secret Invention.** Electrically controlled guidable torpedo. C. B. King, Cogar, Okla.

**MOTORIST** cigar and cigaret holder. Attractive, practical, permits smoking in high winds. Excellent for mail order. For sale. Best offer takes it. Patent pending. L. F. Pierson, Fredericksburg, Va.

**PATENT for Sale**—Soap Beater for Kitchen, Pantry and Laundry Use. J. Helstrom, 1339 Third Ave., N. Y.

**MY Rotating Circular Scissors** is a revolution in scissors construction. J. E. Hagberg, 15338 Carondelet Ave., Chicago.

**FOR Sale or Royalty.** New invented emergency coupling. Releasable by highest tension. Write Peham & Gerstner, 1303 Elanor, St. Paul, Minn.

**FOR Sale**—U. S. Patent on Exercising Device. Nothing like it on the market. Write Theodor B. Geisel, Springfield, Mass.

**U. S. & CANADIAN Patents** on Sanitary Fruit and Food Container. Have strong patents on first one of its kind. C. Wrayge, Cass Lake, Minn.

**TWO valuable inventions.** Stock watering device with combined heater. A wonderful and practical invention. Whip socket with lock attached. Absolutely prevents theft of whips. Write B. F. Erwin, Fairfax, Mo.

**FOR Sale or Royalty**—U. S. and Canadian Patent, Automatic Indicating Buoy for locating sunken vessels. Best offer takes them. Alex J. Hebert, 190 E. Grand Ave., Highland Park, Mich.

**FOLDING Chair** with folding arms. Outright or royalty. Can be manufactured cheap. Patent pending. Joe King, Harrodsburg, Ky.

$\frac{1}{2}$  **UNDIVIDED interest** in household necessity for home, restaurant, hotels, etc. Cost  $\frac{1}{2}$  cent to manufacture. E. C. Anderson, Somerset, Wis.

**ATTACHABLE bicycle coasterbrake.** Very simple. U. S. and Canadian patents. Martin Johnson, R. 4, Box 72, Little Falls, Minn.

**PATENT**—"Rope-clamp" instant fasten and release, for all purposes. Simple, inexpensive. Royalty. Louis Erjen, 703 E. 137 St., N. Y. City.

**PATENT Buyers** are invited to address our sales department for information on any class of Patents they wish to purchase or lease on a royalty. We have secured a number of valuable patents in all lines of invention. Mail Order, Department Store and Household Novelties a specialty. Victor J. Evans & Co., 160 Ninth St., Washington, D. C.

**FOR Sale, Window Shade Bracket.** One obviating the spring in the roller. Address, Box 294, Charleston, Illinois.

**STAND release,** fits any Motorcycle. Sheet metal stamping. Y. Little, 309 N. Walnut, Wichita, Kansas.

#### MODELS AND MODEL SUPPLIES

**WE make working models** for inventors; also dies and stamping of specialties, and carry a complete stock of brass gears and model supplies. Send for catalogue. The Pierce Model Works, 3495 Pierce Ave., Chicago, Ill.

**INVENTORS** who have models, dies, tools, metal specialties, special manufacturing and experimental work, don't fail to get our estimates. Our 22 years' experience is at your command. Barker & Gerding Mfg. Co., 121 Opera Place, Cincinnati, Ohio.

**IF you have something** to be made write us. Models, Experimental Work and Manufacturing. Quality is the keynote of success. United Machinery Company, Cincinnati, Ohio.

**NEW Lithographic Model** of a Monster Mallet Compound Locomotive. All parts shown and numbered. Size, 9x19 in. in color. Other models in series are, Atlantic Type Locomotive—Steamship—Automobile—Gas Engine—Steam Engine—Steam Turbine—Dynamo—Wireless Telegraph. Price, 50c each or set of 9 for \$4 postpaid. Popular Mechanics Book Dept., 6 N. Michigan Ave., Chicago.

**PATTERN makers!** A book devoted to the principles of pattern and core making and molding. Written by G. H. Willard, a practical pattern maker of years' experience. This book, just published, treats the subject in a much more simple, direct and effective manner than most books along this line. 224 pages, 312 illustrations. Price, \$1, postpaid. Popular Mechanics Book Dept., 6 N. Michigan Ave., Chicago.

**MODEL making.** Inventions developed. Write for estimate. Stearns, Paxton, Ill.

**FREE catalogue** of model supplies. Castings, metal specialties on contract. North Chicago Tool Works, 15 Grove Ave., North Chicago, Ill.

**PRODUCERS of Results:** Inventions developed. Models, Experimental work, anything special in metal to order, novelties, spinning, forging, castings in any material, electrical devices, patterns of all kinds, plating, general manufacturing, designing, special tools, punches and dies, stampings. Send drawings or sample. Expert information free. The John's Machine & Stamping Works Company, Dept. C, Cleveland, Ohio.

#### MANUFACTURING

**WIRE Goods,** all kinds, made to order. Cooley Mfg. Co., 553 W. Monroe St., Chicago.

**WE can furnish machined castings** of Cast Iron, Brass and Aluminum. Lewis Steel, Iron & Machine Works, North Chicago, Illinois.

**HIGH grade punch and die work.** Send drawings or samples for estimates. Advance Engineering Company, Indianapolis.

**WE can handle small contract** for lathe work. Simonson Iron Works, Sioux Rapids, Iowa.

**WE do Metal Stamping** and forming of all kinds, also make dies. Goshen Eyelet Co., Goshen, Ind.

**LET Our factory be Your factory.** Metal specialties developed and correctly manufactured. L. R. Nelson Mfg. Co., Peoria, Ill.

**WANTED**—Specialties with merit to manufacture and sell, particularly automobile specialties. Well-equipped manufacturing and merchandizing facilities. Hastings Mfg. Co., Hastings, Mich.

**INVENTIONS** perfected and manufactured. Reference: Your Banker. Russell Machine Co., Dallas, Texas.

**LIGHT manufacturing,** tools, models, stampings. Cleveland Specialty & Mfg. Co., Cleveland, S. Brooklyn, Ohio.

Additional Classified Ads Page 34



# Learn the Automobile from A to Z

FOR OWNERS, DRIVERS AND REPAIRMEN

Every Motor Car in use today is fully described and illustrated in every particular in these

## NEW 1916 BOOKS



### Brookes Automobile Handbook

Revised to March 1, 1916. By H. P. Manly. Over 700 pages of practical information on the automobile—over 400 pages on 1916 equipment, with 335 illustrations and diagrams and 12 tables. Every subject is treated in non-technical language—you can understand it. Extensive treatment of Carburetors, Ignition, Starting and Lighting. Subjects are arranged alphabetically and indexed. Special attention is given to adjustments and repairs—what to do and what not to do. Handsomely bound in limp leather, round corners, red edges, gold stamping, pocket size. Price, postpaid, \$2.00.

### Automobile Starting and Lighting

By H. P. Manly, Chief Engineer, American Bureau of Engineers. (Published March 15, 1916.) This book is devoted entirely to 1916 starting and lighting equipment. It is non-technical and is intended for the owner and the repairman. A series of illustrations and diagrams supplement the text. The following divisions of the book show its scope: I. Electric Lighting and Engine Starting Equipment; II. Lighting Dynamos and Starting Motors; III. Storage Batteries; IV. Lamps and Wiring; V. Control Parts; VI. Dynamo and Motor Drives; VII. Current Measuring and Indicating Devices; VIII. Starting and Lighting Troubles. Also words and terms used in electrical work. Index. 200 pages, fully illustrated, pocket size, cloth, postpaid, \$1.60. Full Leather, red edges, gold stamping, postpaid \$1.50.

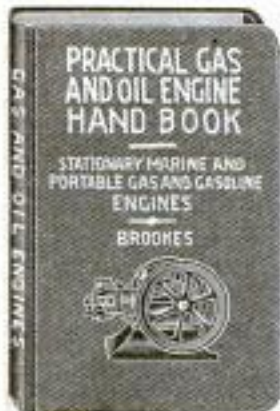
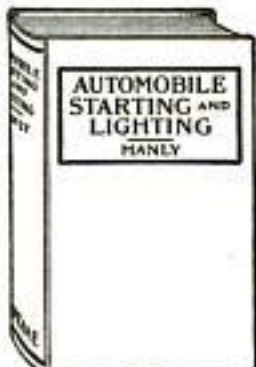

### Automobile Catechism and Repair Manual

By C. F. Swingle and H. A. Tarantous. Pocket size. Full Leather, stamped in gold. Red edges. 165 pages. Fully illustrated with folding charts and line drawings. Price, postpaid, \$1.25. This book comprises over 400 questions and answers on the construction, care and operation of the automobile. Part I comprises the questions and answers. Part II is devoted entirely to automobile repairs. It gives complete instructions for locating troubles and making adjustments and repairs of all kinds. The following subjects are covered in detail from the repair standpoint: Motor knocks, carburetion, ignition, valve troubles, fitting piston rings, and tires. Numerous practical illustrations show just how to follow the directions.

### Practical Gas and Oil Engine Handbook

By L. E. Brookes. 230 pages, 70 illustrations. Pocket Edition. Cloth, postpaid, \$1.00. Full Leather, postpaid, \$1.50. A manual of useful and practical information on the care, maintenance and repairs of gas and oil engines. This book is invaluable as a guide and helper for owners, operators, and all others who may be interested in the construction, operation and management of this type of engine. Stationary, portable and marine gas and oil engines, and the principles governing their action, are fully described and explained, the explanations being accompanied by engravings and line drawings. All the latest oil engines are fully described and illustrated.



## The World's Greatest Practical Electrical Books \$1

By HORSTMANN, TOUSLEY, MORETON, LOWE

Fit You for Any Kind of Electrical Work. Written in non-technical language. You don't need a college education to understand them. They are strictly up-to-date in every respect and uniform in type, illustrations, diagrams and binding. A whole electrical library at \$1.00 per volume, postpaid. These books have never been sold at less than \$1.50 and \$2.00 a volume. All bound in limp cloth, uniform, pocket size, 4 1/2 x 6 3/4 in.

**Electrical Measurements and Meter Testing**  
By PROF. MORETON. All meters carefully described. 328 pages, 191 illustrations and diagrams.

**Modern Electrical Construction**  
By HORSTMANN AND TOUSLEY. 440 pages, 263 illustrations.

**Drake's Telephone Handbook**  
By PROF. MORETON, of Armour Institute. 286 pages, 161 illustrations and diagrams.

**Armature and Magnet Winding**  
By HORSTMANN AND TOUSLEY. 250 pages, 153 diagrams and illustrations.

**Electrical Tables and Engineering Data**  
By HORSTMANN AND TOUSLEY. 300 pages, 150 diagrams, tables and illustrations.

**Drake's Electrical Dictionary**  
By P. E. LOWE. 320 pages of electrical words, terms and phrases, carefully defined and explained.



**Electricians' Operating and Testing Manual**  
By HORSTMANN AND TOUSLEY. 360 pages, 211 illustrations and diagrams.

**Modern Electric Illumination**  
By HORSTMANN AND TOUSLEY. 274 pages, 40 illustrations and diagrams, 21 tables.

**Wiring Diagrams and Descriptions**  
By HORSTMANN AND TOUSLEY. 300 pages, 230 illustrations and diagrams.

**Electric Motors, Direct and Alternating**  
By PROF. MORETON. 250 pages, fully illustrated.

**Motion Picture Operation—Stage Electrics and Illusions.** By HORSTMANN AND TOUSLEY. 303 pages, 216 illustrations.

**Alternating Current, Theory, Practice and Diagrams.** By HORSTMANN AND TOUSLEY. 300 pages, fully illustrated.

**Guarantee:** We will send postpaid one or all of these books upon receipt of price. If after 5 days' examination you are dissatisfied for any reason, return the book or books and we will refund your money.

Send for our large catalogue of practical mechanical books for Electricians, Engineers, Telephone Men, Machinists, Railroad Men, Automobilists, Carpenters, Plumbers, Sign and Card Writers, Scene Painters, etc. It is **FREE**

**FREDERICK J. DRAKE & CO.**  
Dept. 8, 1325 Michigan Ave., CHICAGO

## Continued from Page 32

## REAL ESTATE AND FARM LANDS

**RELIABLE** Information about prosperous, growing regions in Alabama, Florida, Georgia, Kentucky, Mississippi, North Carolina, South Carolina, Tennessee, Virginia, Southern Illinois and Southern Indiana will be sent, on request, to homeseekers, manufacturers and investors. M. V. Richards, Commissioner, Room 64, Southern Railway, Washington, D. C.

**OHIO**, West Virginia and Virginia Farms offer opportunities for you. \$28.00 per acre up. Easy payments. Mild Climate—No long cold or hot spells. Social Life, Fertile soil, good markets, high prices, on railroad, convenient to trains. Write for free magazine and other information. F. H. LaBaume, Agri. Agt., Norfolk & Western Rwy., 250 N. & W. Bldg., Roanoke, Va.

**FLORIDA Opportunity**—During the past year, which has been one of financial depression, panics, hard times and scarce money, we have sold to bankers, doctors, brokers, investment experts, lawyers and the choicest class of business men, about 17,000 acres of first-class orange, grapefruit and Natal hay land in Lake County, Fla.; this in spite of the fact that other companies in Florida have been doing little or nothing in the selling line. There is a reason why we have been able to do this and the reason is—the land. Let us show you as those who have bought have already been shown. Lake County Land Owners' Association, No. 13 Lake Ave., Fruitland Park, Florida.

**FARMS** for Sale or exchange anywhere in the U. S. or Canada, direct from the owners. State where you want to locate. Information free. American Investment Association, 27 Palace Bldg., Minneapolis, Minn.

**CALIFORNIA** little suburban farms for sale. Easy Payments. Write E. B. Waite, Shawnee, Oklahoma.

**FERTILE** Farms, near Philadelphia. Catalog. W. Stevens, Perkasie, Pa.

**TWIN** Park Lots, near Sandusky St., Delaware, Ohio. \$25 down, \$10 per month. No interest, no taxes. H. F. Alkire, Circleville, Ohio.

**"COMING** Apple Section." Round Top Farm, Fruit, truck and chickens. Forced sale, 850 bearing fruit trees, 50 acres cultivated, 70 acres timber, 30 acres pasture. Slight tax. No killing frost. Ideal home place. Four miles to Taylorville, N. C. Alexander County voted \$150,000 road bonds this Spring. \$2,000 takes buildings, implements and farm. G. W. Morrison, Blairsville, Pa.

**80-ACRE** truck and dairy farm. Finely improved, well located, \$2,500. Terms, Box 12, Roseland, La.

**REAL Estate Educator**—Containing inside information not generally known. "Don'ts" in Real Estate, "Pointers," Legal Forms, etc. It gives in condensed form the essential knowledge of the Real Estate Business. New revised edition covers Workmen's Compensation Act, Income Tax Law, Employers' Liability Act, Statute of Frauds, How to Sell Real Estate, etc. What you need to know; ought to know and want to know. 256 pages, cloth, \$1 postpaid. Popular Mechanics Book Dept., 8 N. Michigan Ave., Chicago.

**TWENTY** acres in San Joaquin Valley, California, in fruits, vegetables, alfalfa, with cows, pigs, poultry and bees, will pay you steady, substantial profits. Delightful climate, rich soil, good schools, churches, fine roads. Thrifty, hospitable neighbors. Write for free books. C. L. Seagraves, Gen. Colonization Agent, AT&SF Ry., 1916 Ry. Exch., Chicago.

**SELL** your property quickly for cash, no matter where located. Don't pay big commissions. Particulars free. Real Estate Salesman Co., Desk B, Lincoln, Neb.

**FOR** Improved farms and wild land, write Neitzel, Bloomer, Wis.

**I HAVE** a successful way of selling farms and farm lands. Write me for free particulars. No obligation whatever. E. J. Zimmer, 925 Tower Bldg., Chicago.

**IMPROVED** Farm—141 acres. Grain, fruit, etc. Desirable. A Bargain. H. E. Jackson, Waterloo, Ind.

## GINSENG

**GINSENG** Seeds \$1.00 thousand, planting instructions free. Specialty Farm, Rockford, Minn.

**GINSENG** Culture, 10c. Golden Seal estimate \$0,000 an acre. Booklet giving my experience, 10c. W. N. Long, Florence, Ky.

## DOGS, BIRDS, POULTRY, PETS

**60 VARIETIES** of thoroughbred Poultry. Stock and hatching eggs a specialty. Fine catalog free, describing land and water fowl, Guinea-pigs and Collie dogs. Edwin Souder, Telford, Pa.

**GOLDFISH**—Rare specimens, artistic aquariums, waterplants. Circular free. Pioneer Goldfish Hatchery, Racine, Wis.

**PROFITS**—Pleasure—Possibilities. Raising Cavies. Geo. B. Talbot, Norwood, Mass.

**"BUCKEYE** Egg Dater" \$4.50. Stencils. Catalogue 10c. Buckeye Stamp Works, Dayton, Ohio.

**LLEWELIN** and English Setter Puppies for sale. Oak Hill Kennels, Victor, Iowa.

**RAISE** Guinea Pigs. We furnish stock, show you how and buy all you raise. Big demand. Thousands needed yearly. Easy to raise, very prolific and profitable. Particulars and contract for two-cent stamp. Cavies Distributing Co., 707 West 74th St., Kansas City, Mo.

**FOR** Sale—Coon hounds, trial. Stamp. Nelson Hofstetter, Orrville, Ohio.

**MAKE** money breeding Plymouth Rock squabs, 1914 demand biggest ever. How to sell by parcel post, how to get \$4 to \$8 dozen. Start small, grow big. Small space needed. Write today for big free book. Plymouth Rock Squab Company, 634 Howard St., Melrose Highlands, Massachusetts.

**MONEY-MAKING** Poultry. Our new book for 1916 tells about our leading varieties of land and water fowls, also incubators, brooders and squabs. High quality at low prices. 31st year. 96-page catalogue free. H. M. Jones Co., Box 150, Des Moines, Iowa.

## MISCELLANEOUS

**TATTOOING** Machines. I now manufacture an Electric Tattooing Machine for \$1.00. A machine that runs on four dry cells and gives satisfaction. Best line of tattooist's supplies in the world. Everything for the tattooer. Get my catalog. Prof. J. Barber, 70½ Brush St., Detroit, Mich.

**SPEND** spare time profitably, gathering butterflies, millers. Many wanted for Museums, Artwork. I pay highest prices. Everybody. Send 2c stamp for particulars and 8-page folder. Sinclair, Box 244, D-6, Los Angeles, Calif.

**INFORMATION** regarding any product or formula and my latest guaranteed formula lists for producing newest specialties in all lines. Stamp. Liseombe Miller, Analytical Chemist, Tampa, Florida.

**CRAYON** Portraits—Make them at home. Sample and instructions 20c. L. Dallas, Cambridge, Ohio.

**RUBBER** Stamps ten cents a line. Catalog free. P. O. Box 458, Middletown, N. Y.

**LOCKSMITHS**: My tool and instructions guaranteed to open any door using cylinder lock. Price \$8.50. Particulars for stamp. Chas. E. Williams, Box 1091, Atlanta, Ga.

**CHEAP** simple formula. Will remove white patches from varnished furniture caused by water. Will not mar the finish. Send 25c. Thos. Shea, 405 Pine St., Seattle, Wash.

**DO** you wear Nose glasses? If so send 65 cents for the new "Press the Button" Eye Glass Chain. Satisfaction or money refunded. Vuille, Murphysboro, Ill.

**SEND** 25c in coin for my Wonder Stocking or Hose Heel Protectors. Frisese Novelty Co., 1716 N. Campbell Ave., Chicago.

**CHILDREN'S** play houses for indoor and outdoors. No home complete without a play house. For particulars address F. A. Wood & Son, Hancock, N. H.

**GOLD** Ores, etc., analyzed. Students wanted. E. M. Meyer, Niles, Calif.

**TATTOOING** Supplies. The Werner Co., Dept. 4, 1321 Bremen St., Cincinnati, Ohio.

**IDEAL** Atlas—Just Published—Contains large scale maps, yet is a book of handy size. Has special maps of all war zones in addition to all regular maps found in a good atlas. Is self-revising, that is, contains a certificate entitling the purchaser to a supplement of new maps after the war is over. Genuine flexible leather binding. 512 pages, 256 pages of maps, 256 pages of text. Price \$1.65 postpaid. Popular Mechanics Book Dept., 8 N. Michigan Ave., Chicago.

**BUFFALO** Greenbacks. Finest imitation possible. 5000—\$6.00; 1000—\$1.50; 100—35c. Roll—10c. Samples for stamp. Gilmore, Morgan Park, Chicago.

**FORMULAS**, Schemes, Money Making Plans. 64 Pages Chuck Full. 10c. "Ideal," 3311-D, Belleplaine Ave., Chicago.

**ERADIUM** (Luminous) Pull Chain Bulb for Electric or Gas Light pull chain or key. Shines at night. Locates your chain in a "Jiffy." Sample 35c. Agents wanted. Auburn Supply Co., Dept. 41C, 7817 Peoria St., Chicago.

**3,000 SELECTED** Cartoons for \$3. A Panorama of World Events, Political, Industrial—Social—Humorous—Tragic—all of intense human interest. A wonderful collection of 3,000 cartoons reproduced from the newspapers of the United States, Canada, Mexico, Cuba and the cities of the Old World, has been made by Cartoons Magazine from more than one hundred and fifty thousand published cartoons, and bound in an artistic and durable cover, are now ready for your library table. Vol. I, Jan.-June, 1913—\$1. Vol. II, July-Dec., 1913—\$1. Vol. III, Jan.-May, 1913—\$1. Cartoons, 78 E. Madison St., Chicago.

**INVENT** something; your ideas may bring wealth; our free book tells what to invent and how to obtain a patent, through our new credit system; write today. Waters & Co., 4102 Warder Bldg., Washington, D. C.

**CUTS** anybody can make. Simple Etching Process, \$1. Particulars, specimens, for stamp. M. Day, Windfall, Ind.

**INDIAN** Baskets, Relics. Price free. G. Gilham, Highland Springs, Cal.

**STOP** Using Tobacco. Complete treatment \$1. Sweeney Bros., Des Moines, Iowa.

**GRANDFATHER'S** Clock Works, \$5. Slightly shop-worn, quantity limited, others with chains, all prices; also several nice Grandfather's Clock cases, exceptional bargains. Clock Company, 1673 Ruffner St., Philadelphia, Pa.

**"INK-Powder"** (Blue) Positively acid-proof and water-proof. Excellent for Fountain pens. Enough to make one quart \$1. H. Carr, 114 S. 29th St., Billings, Mont.

**\$2.50** POCKET Adder. Send for circular. Bassett, 3921-K Indiana Ave., Chicago.

## SEEDS, PLANTS, NURSERY STOCK

**ASPARAGUS**, Rhubarb and Horseradish roots. Everbearing and Spring varieties of Strawberry plants. Collection of 107 plants and roots from the above for \$1.98 cash. Zerfass Farm, Danville, N. Y.

## INVENTIONS MARKETED

**INVENTORS** desiring capital to patent inventions, write 103 Western Fiduciary, Denver, Colorado.

## TOO LATE TO CLASSIFY

**SURVEYING** instruments slightly used. Transits, Engineers, Builder and farm levels. Sprengnether Instrument Co., 205 Ozark Bldg., St. Louis, Mo.



## Mental Demons Are They Holding You Back?

Does a host of mental demons bar your path to success? Do you feel yourself incapable to meet important situations? Do you lack the power to make people recognize you—to make others see things *your way*—to compel people to listen to you? Are you weak in a crisis? Most men have the brains and the ambition to do big things—but a weak personality—a lack of self-confidence—timidness—poor vocabulary—unreliable memory—"stage fright"—hazy, unorganized ideas—*ineffective speech*—are holding them back from the success they deserve.

### RESULTS!

"Your Course is a most valuable training to anyone who desires to be able to speak in public without embarrassment."

—G. C. HOFFPAUIR, Att'y, Texas.

"Not only has it enabled me to speak in public in a way that is most gratifying to me, but it has helped me in business as well."

—G. M. COSETT, Banker, Illinois.

"It has given me greater confidence in my own ability, a better memory, a more polished vocabulary, and a stronger personality."

—W. L. WILDER, Mgr., Chicago.

"Your Course is a splendid training for the salesman or sales manager, and I heartily recommend it."

—O. F. BOUGHGESS, Pres., Chicago.

"A fascinating and practical training that overcomes one of the greatest weaknesses of business men—ability to express themselves."

—GUY H. SHEARER, Banker, Idaho.

We have hundreds of similar testimonials in our files from men in every walk of life. Send the Coupon today. You owe it to yourself to find out what this Course will do for you.

Send the coupon below at once and let us tell you how you can drive these mental demons away forever—how you can occupy a place among men who do things—how you can learn to express your ideas forcefully and convincingly—how you can acquire a powerful, magnetic personality—how you can develop a strong dominating will—how you can become a powerful, public speaker. Our new scientific Course in

## Effective Public Speaking and Mental Development

will quickly train you to speak forcefully and convincingly in public

- |                                 |  |  |
|---------------------------------|--|--|
| —talk before your club or lodge | —sell more goods                                   | —become a clear, accurate thinker                                |
| —address board meetings         | —train your memory                                 | —develop your power of concentration, diligence and self-control |
| —propose and respond to toasts  | —enlarge your vocabulary                           | —equip you with power to be the master of any situation.         |
| —tell entertaining stories      | —develop self-confidence and a winning personality |  |
| —make after-dinner speeches     | —strengthen your ambition and will power           |  |
| —converse effectively           |  |  |
| —write better letters           |  |  |

This Course and Service is under the personal supervision and direction of H. E. Pattison Kline, Dean of the Public Speaking Department, Columbia College of Expression, Chicago, one of the foremost authorities in the country on public speaking and mental development. You can now secure the personal instruction of this eminent authority right in your own home, by mail, in spare time. Hundreds have acquired a powerful address and a winning personality through his instruction.

## Special Offer—Now Send the Coupon

Mail the coupon today for full particulars of the Special Limited Offer we are now making. This unusual offer may be withdrawn at any time. We will also send you free, many interesting facts and pointers that you should know about effective public speaking and mental development—information that you can use. Free and no obligations of any kind. Don't delay. Send the coupon now while this offer lasts.

**Public Speaking Department**  
**American Correspondence School of Law**  
 1194 Manhattan Building • Chicago, Illinois

**Public Speaking Department**  
 American Correspondence School of Law — 1194 Manhattan Building, Chicago, Ill.

Gentlemen:—Please send me without obligation full details of your Course in Effective Public Speaking and Mental Development, as well as particulars of your Special Limited Offer.

Name.....

Address.....



"Instruction by correspondence is the cheapest and best way for the poor man"

Thomas Edison

## Edison is Right!!!

You admit the International Correspondence Schools are a good thing. You'd take a course right now "if"—"except"—

"If" what? If you weren't so "overworked," with such "long hours," or had more strength and energy? Wasn't it Edison who stayed up half the night educating himself in spite of every handicap you could ever have?

All big men who have made their mark in the world had the *ambition*—the *determination*—to improve their spare time, to train themselves for big work. You, too, can possess power, money and happiness if you'll only make the effort. The reward is great—it's worth it.

Here's all we ask: Merely mail this coupon. Put it up to us without paying or promising. Let us send you the details of others' success through the I. C. S., and then decide. Mark and mail this coupon now.

### INTERNATIONAL CORRESPONDENCE SCHOOLS

Box 5502, SCRANTON, PA.

Explain, without further obligation on my part, how I can qualify for the position before which I mark X

- |   |   |
|---|---|
| <input type="checkbox"/> ELECTRICAL ENGINEERING | <input type="checkbox"/> ADVERTISING  |
| <input type="checkbox"/> Electric Lighting      | <input type="checkbox"/> Window Trimming                                    |
| <input type="checkbox"/> Electric Railways      | <input type="checkbox"/> Show Card Writing                                  |
| <input type="checkbox"/> Electric Wiring        | <input type="checkbox"/> Lettering and Sign Painting                        |
| <input type="checkbox"/> Telephone Expert       | <input type="checkbox"/> ILLUSTRATING                                       |
| <input type="checkbox"/> MECHANICAL ENGINEERING | <input type="checkbox"/> DESIGNING  |
| <input type="checkbox"/> Mechanical Drafting    | <input type="checkbox"/> BOOKKEEPING  |
| <input type="checkbox"/> Shop Practice          | <input type="checkbox"/> Stenography and Typewriting                        |
| <input type="checkbox"/> Gas Engines            | <input type="checkbox"/> Higher Accounting                                  |
| <input type="checkbox"/> CIVIL ENGINEERING      | <input type="checkbox"/> Railway Accounting                                 |
| <input type="checkbox"/> Surveying and Mapping  | <input type="checkbox"/> Commercial Law                                     |
| <input type="checkbox"/> MINE FOREMAN AND SUPT. | <input type="checkbox"/> GOOD ENGLISH FOR EVERYONE                          |
| <input type="checkbox"/> Metal Mining           | <input type="checkbox"/> Teachers Course                                    |
| <input type="checkbox"/> STATIONARY ENGINEERING | <input type="checkbox"/> English Branches                                   |
| <input type="checkbox"/> Marine Engineering     | <input type="checkbox"/> CIVIL SERVICE                                      |
| <input type="checkbox"/> ARCHITECTURE           | <input type="checkbox"/> Railway Mail Clerk                                 |
| <input type="checkbox"/> Building Contractor    | <input type="checkbox"/> AGRICULTURE  |
| <input type="checkbox"/> Architectural Drafting | <input type="checkbox"/> POULTRY  |
| <input type="checkbox"/> Concrete Engineering   | <input type="checkbox"/> Textile Manufacturing                              |
| <input type="checkbox"/> Structural Engineering | <input type="checkbox"/> Navigation   |
| <input type="checkbox"/> PLUMBING AND HEATING   | <input type="checkbox"/> Chemistry <input type="checkbox"/> Spanish         |
| <input type="checkbox"/> Sheet Metal Worker     | <input type="checkbox"/> AUTO RUNNING <input type="checkbox"/> German       |
| <input type="checkbox"/> SALESMANSHIP           | <input type="checkbox"/> Motor Boat Running <input type="checkbox"/> French |
|   | <input type="checkbox"/> Italian  |

Name \_\_\_\_\_

Present Occupation \_\_\_\_\_

Street and No. \_\_\_\_\_

City \_\_\_\_\_

State \_\_\_\_\_

## "LEARN BY DOING"

Five minutes of Actual Practice properly directed is worth more to a man than years and years of book study. Actual Practice is the only training of value. Graduates of The N. Y. Electrical School have proven themselves to be the only men that are fully qualified to satisfy EVERY demand of the Electrical Profession.

At this "Learn by Doing" School a man acquires the art of Electrical Drafting; the best business methods of Electrical Contracting; together with the skill to install, operate and maintain all systems for producing, transmitting and using electricity.

School open all year. Individual instruction. A school for young and old. Write for information.

44 West 17th St. New York City  
The N. Y. ELECTRICAL SCHOOL

## ESTAB. 1892 BODEE TRADE DENTAL SCHOOL

15-17 W. 44th St.

NEW YORK CITY

LEARN IN 3 MONTHS TO EARN \$1300 TO \$4000 A YEAR

Our valuable book "P" tells how. It's Free—write for it. Anyone from 16 to 60 years old can easily learn Mechanical Dentistry. The Demand is like a gold mine. Unexplored. We are constantly called upon to fill good salaried positions. Why not qualify for one? No book study. All practical work. We guarantee that you can earn before completion of the Course. Tuition payable in instalments.

## The University of Chicago

### HOME STUDY

in addition to resident work, offers also instruction by correspondence.

For detailed information address

24th Year U. of C. (Div. 20) Chicago, Ill.



## EARN TELEGRAPH

Morse and Wireless—R. R. Accounting (Station Agency) taught. Splendid opportunities. Positions secured. Marconi Co. takes our wireless graduates. We own and exclusively occupy two large modern buildings equipped with R. E. and Western Union wires and complete \$1,000 Marconi Wireless Station. Largest School—established 60 years. Investment \$35,000. Endorsed by Railroad, Marconi and Western Union Officials. Expert practical teachers. Low living expenses; easily earned if desired. Tuition low. Easy payments. Correspondence courses also. Catalogs Free.  
Dodge's Telegraph, Ry. & Wireless Institute  
5th Street, Valparaiso, Ind.

## LEARN TO WRITE EARN \$25 to \$100 A WEEK

ADVERTISEMENTS We can positively show you by mail How to increase your salary. BOOK MAILED FREE. PAGE-DAYES CO., 112 Page Building Chicago, Ill., or 159 Nassau St., New York

## Practical Electrical Education

Our practical course in Electrical Science and Engineering trains you to get and keep the big-pay jobs. Enter at any time, no matter what your education. Advance as fast as you can master what we teach. Course combines theory with actual practice in all branches of electrical work. Individual instruction. Positions paying \$1,500 a year up, waiting for graduates. Write for FREE ILLUSTRATED CATALOG. Eleventh year. Spring term now open. School of Engineering of Milwaukee, 246 Third St., Milwaukee, Wis.



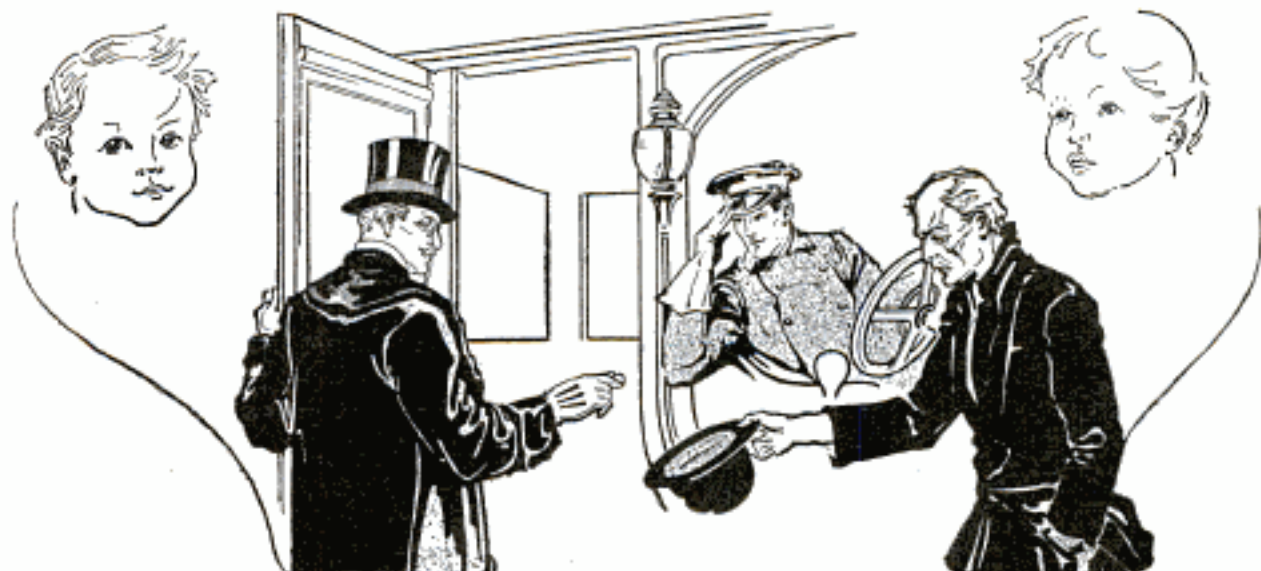

# Both Had an Equal Chance

## Partial Contents

The Law of Great Thinking.  
The Four Factors on which it Depends.  
How to develop analytical power.  
How to think "all around" any subject.  
How to throw the mind into deliberate, controlled, productive thinking.  
Detailed directions for Perfect Mind Concentration.  
How to acquire the Power of Consecutive Thinking, Reasoning, Analysis.  
How to acquire the skill of Creative Writing.  
How to guard against errors in Thought.  
How to drive from the mind all unwelcome thoughts.  
How to follow any line of thought with keen, concentrated Power.  
How to develop Reasoning power.  
How to handle the mind in Creative Thinking.  
The secret of Building Mind Power.  
How the Will is made to act.  
How to test your Will.  
How a Strong Will is Master of Body.  
What creates Human Power.  
The Six Principles of Will Training.  
Definite Methods for developing Will.  
THE NINETY-NINE METHODS for using Will-Power in the Conduct of Life.  
Seven Principles of drill in Mental, Physical, Personal Power.  
FIFTY-ONE MAXIMS for Applied Power of Perception, Memory, Imagination, Self-Analysis, Control.  
How to develop a strong, keen gaze.  
How to concentrate the eye upon what is before you—object, person, printed page, work.  
How to become aware of Nerve Action.  
How to keep the body well poised.  
How to open the Mind and Body for reception of incoming power.  
How to throw off Worry.  
How to overcome the tyranny of the Nervous System.  
*This is only a partial list—a complete list of contents would almost fill this page.*

## —Power of Will Made the Difference—

Why is it that two men with equal opportunities, with equal mental equipment, sometimes end up so differently?

One fights his way to influence, money, and power, overcoming seemingly unsurmountable obstacles, while the other tries one thing after another, gradually losing his grip—never succeeding at anything.

It isn't luck—there's no such thing in the long run—it's a difference of will-power, that's all.

No man has ever achieved success until he has learned to use his will—upon that does success hinge. When the will fails, the battle is lost. The will is the weapon of achievement. Show me a big, successful man, and I'll show you a strong-willed man, every time, whether a business man, a statesman, lawyer, doctor, or fighter.

## Anyone Can Have a Strong Will

It has long been known that the Will can be trained into wonderful power—by intelligent exercise and use.

The trouble with almost everyone is that they do not use their wills. They carry out other people's wills, or drift along with circumstance.

If you held your arm in a sling for two years, the muscles would become powerless to lift a feather. That is exactly what happens, in most people, to the faculty we call "Will Power." Because we never use the Will, we finally become unable to use it.

## "POWER OF WILL"

by Frank Channing Haddock, Ph. D., a scientist whose name ranks with such leaders of thought as James, Bergson and Royce—is the first thorough course in will training ever conceived. It is based on a most profound analysis of the will in human beings. Yet every step in the 28 fascinating lessons is written so simply that anyone can understand them and apply the principles, methods and rules set down with noticeable results almost from the very start.

## A Veritable Godsend

The users of "Power of Will" speak of it as a Bible. It has pulled men out of the gutter and put them on the road to self-respect and success—it has enabled men to overcome drink and other vices, almost overnight—it has helped overcome sickness and nervousness—making thousands of sick people well—it has transformed unhappy, envious, discontented people into dominating personalities suffused with the joy of living—it has enabled people who had sunk deep into the grooves of a rut to pull themselves out and become masters instead of the blind tool of circumstance—it has re-awakened ambition in men and women who had been turned from their life purpose and given them the courage and confidence to build anew—it has converted failures in business into spectacular successes—it has enabled successful men to undertake even bigger projects by showing them how to use the power they already possess with even more telling force.

Young and old alike, men and women in all walks of life, testify to the almost magical changes in their lives once they undertake Dr. Haddock's simple formula for strengthening the will—once they know how to use this God-given faculty recognized the world over as the greatest weapon of achievement.

## Send No Money

"Power of Will" contains 400 pages, half leather, gold-top leaves, and includes more material than many correspondence courses selling at \$25, yet the price is only \$3. Let us send you the book. Look it over. Glance through some of the chapters. Judge for yourself whether you can afford not to own it. Send no money now. Simply send the attached coupon, enclosing your business card or giving a reference. You can keep it five days. If at the end of five days, you do not want it, mail it back. Tear out the coupon now, before you turn the page and forget. This announcement may not appear in this magazine again.



400 pp.  
Half-Leather  
Gold-Top  
Leaves

**PELTON PUB. CO.**  
13-H Wilcox Block, Meriden, Conn.

## Over 75,000 Users

Power of Will has already helped over 75,000 people—a record equaled by no other single course of any kind in the world. Such men as Judge Ben B. Lindsey; Supreme Court Justice Parker; Wu Ting Fang, ex-U. S. Chinese Ambassador; Lieut.-Gov. McKelvie of Nebraska; General Manager Christenson of Wells-Fargo Express Co.; Ernest Knaebel, Asst. Atty.-Gen. of the U. S.; Asst. Postmaster-General Britt; E. St. Elmo Lewis, now Vice-Pres. Art Metal Construction Co., are owners, and literally thousands of other successful men like them have voiced their praise of this great work.

"From what I have already seen I believe I can get \$300 to \$30,000 worth of good out of it."—C. D. Van Vechten, General Agent, No. West Life Ins. Co., Cedar Rapids, Ia.

"Will Power" is a compilation of mighty force. My first week's benefit in dollars is \$900—cost \$3.00; profit \$897."—J. W. Heistand, 926 Tribune Bldg., Chicago, Ill.

"He who reads it and puts forth effort will soon find himself out of the common herd."—F. A. Good, President of Nebraska Lumber Dealers Assn., Cowles, Neb.

"Here is \$3 for you. 'Power of Will' received. It is the book I've wished for for years."—J. L. Seawall, Clerk of Supreme Court, State of N. C., Raleigh, N. C.

**Pelton Pub. Co.,**  
13-H Wilcox Bk.,  
Meriden, Conn.

Gentlemen:—Please send me a copy of "Power of Will" on approval. I agree to remit \$3.00 or return the book in 5 days.

Name.....

Address.....



H. J. RAHE, President  
Automobile Training School  
Kansas City, Mo.

# Big Money For YOU

**Any Ambitious Man Who Wants to Get Out of the Small Wage Class Can Prepare Himself for the Automobile Business in Six Weeks**

Rahe's Automobile Training School of Kansas City—one of the largest institutions of the kind in the world, has trained thousands. Hundreds of our graduates are in business for themselves as garage owners, factory representatives, agents, dealers, etc. Many are holding responsible positions in some of the largest automobile factories in America. Hundreds more are getting fancy wages as managers of garages, repair men, drivers, demonstrators, tractor and power farming experts. These men earn from

## \$75 to \$300 or More Per Month

They earn big money because they are TRAINED MEN in all branches of the automobile business. The same opportunity is before you—you can do as well. The growth of the automobile business is the wonder of the world. Nothing else compares with it. Thousands of Trained Men are Needed—the big jobs are open and they pay big money right from the start. No special education is required to take up our course. Ambition is all you need.

### Only Six Weeks Required to Train You

That is all we ask—six weeks and you will be ready to start in—ready to enjoy bigger money than you

Send for Big  
Free Book Today

Put your foot on the first  
rung of the ladder of  
success Right Now—send  
for our book—“How to  
Make Money in the Au-  
tomobile Business.”



### FREE SCHOLARSHIP AND BOOK COUPON

H. J. Rahe, Pres.  
RAHE'S AUTOMOBILE TRAINING SCHOOL  
1040 Locust St., Kansas City, Mo.  
Send me your 60-page book "How to Make Money in the Automobile Business."

Name.....

Town..... State.....

Street or R. F. D. ....

are now making. Henry J. Rahe, President and Founder of Rahe's Automobile Training School, is the originator of Rahe's System of Practical Automobile Instruction—the acknowledged standard. We claim to have more expert instructors, more equipment, more floor space and more successful graduates than any other similar school in the entire world. All Work is Practical.

**No Charts or Books Used. No Tools to Buy**

Our students work on real cars—not theories. We own and operate two of the largest garages and repair shops in the West. Hundreds of cars and trucks of all makes are at our command. Our students work on these cars—make real repairs.

**FREE—\$50 SCHOLARSHIP—FREE**

For a limited time we are giving away a combination course in Tractor and Stationary Engineering. Enroll now and get one of these free scholarships and receive complete instruction in Power Farming in addition to our regular instruction in all branches of the automobile business. There is tremendous field for men who understand tractors and farm engines. Act promptly and get this added instruction free.

H. J. RAHE, President RAHE'S AUTOMOBILE TRAINING SCHOOL  
(Largest in the World) 1040 Locust St., KANSAS CITY, MO.

## DRAWING

Curricula, Cartoon, Comic, Commercial, Fashion, Newspaper and Magazine Illustrating taught by mail. Illustrated book 6c in stamps. THE BOSTON SCHOOL OF DRAWING, 755M Boylston St., BOSTON, MASS.



### ELECTRICAL

men with training are all-ways in demand. Having trained over 2000 young men in the past 23 years in the fundamentals of Applied Electricity, The Miles Electrical School, with its well-equipped shops and laboratories, is peculiarly well qualified to give a condensed course in Electrical

### ENGINEERING

Including Mathematics, Steam and Gas Engines, Mechanical Drawing, Shop Work, and Theoretical and Practical Electricity, in all branches. Students actually construct dynamos, install wiring and test efficiency of electrical machinery. Course, with diploma, complete

### IN ONE YEAR

For practical young men with limited time. 24th year opens Sept. 27th. Catalogue on request. 104 Takoma Ave., Washington, D. C.



### Learn a Paying Profession

that assures you a good income and position for life. For twenty years we have successfully taught

## PHOTOGRAPHY

Photo-Engraving and Three-Color Work

Our graduates earn \$20 to \$40 a week. We assist them to secure these positions. Learn how you can become successful. Terms easy—living inexpensive. Write for catalogue—NOW!  
ILLINOIS COLLEGE OF PHOTOGRAPHY, 999 Wabash Avenue, Effingham, Ill.



### MEN WANTED

Prepare as Firemen, Brakemen, Electric Motormen, and colored Train Porters. First Class Standard Roads. Hundreds put to work—\$65 to \$150 a month without any experience. 500 more wanted. Uniforms and passes arranged for when necessary. Enclose stamp for Application Blank. Name position you want.

I. RAILWAY C. I., Dept. 35, Indianapolis, Ind.

## MUSIC TAUGHT FREE

IN YOUR OWN HOME

You can read Music like this quickly

Write today for our booklet. It tells how to learn to play Piano, Organ, Violin, Mandolin, Guitar, Banjo, etc. Beginners or advanced pupils. AMERICAN SCHOOL OF MUSIC, 51 Lakeside Bldg., Chicago

## IF YOU STAMMER

Attend no stammering school until you get my big FREE book and special rate. Largest and most successful institution of its kind in the world. Two large modern school buildings fully equipped for treatment of stammering under my advanced natural method. No sing-songing or time-beating Established 14 years. Known everywhere as the best. Personal instruction given each student. Write today for full particulars. Lee Wells Millard, Pres. North-Western School for Stammerers, 2317 Grand Ave., Milwaukee, Wis.

## LEARN WATCH REPAIRING

Be a watchmaker—you can learn this profitable trade by correspondence in a few weeks in your own home by the DeSelms Chart System. After you complete the course you will know a watch from A to Z. You will know just what the matter is and how to repair one. When you graduate you will be a practical watchmaker and repairer and competent to fill any position. Positions for our graduates.

Ask for our Free Book. It explains our system and terms.  
THE DESELMS WATCH SCHOOL  
23 Perry Street ATTICA, INDIANA





# Learn Electricity

## Earn \$2500 to \$4000 a Year

Your CHANCE has come! Your chance for big money. Your chance to do the kind of work you'll be proud of. Your chance to go into business for yourself. Think of it! You can now qualify AT HOME for that most wonderful of all fields open to the ambitious man—the great field of ELECTRICITY! Yes, no matter who you are, where you live or what you do, I will take you in hand and make you an EXPERT ELECTRICIAN so that you should easily earn \$2,500 to \$4,000 a year and more. And I'll do it so quickly and with so little effort on your part that you'll wonder how it was possible.

## LEARN AT HOME

What if you don't know a thing about electricity! What if you've never had a bit of electrical experience. All I ask is that you give me a little of your spare time. I will instruct you personally and make the whole matter so simple for you that you can't help but learn. You don't have to buy a lot of books or equipment. You can master MY personal instructions easily right at home. I've solved this question of teaching electricity. I'll show you I have by giving you 20 personal lessons ABSOLUTELY FREE. Almost from the very first instructions you will have the knowledge and skill to do practical, electrical work—work that you can demand good money for doing. You can earn as you learn—more than pay for your instruction as you go along.

## Be An Electrician

Think! When you have finished my instructions you are an EXPERT ELECTRICIAN! You are right then and there ready to take a big paying job or start in for yourself. I will train you until you consider yourself competent regardless of the time it takes. I not only show you how to do expert electrical work but show you how to estimate on jobs so you can take contracts at big profits. That's what it means to be personally trained by a man of my practical experience in every phase of electricity. Decide today to take advantage of my big free 20 personal lessons offer. Don't let the question of money bother you. I make the cost so small and the payments so easy that you won't miss the money.

**MEN WANTED** Wherever you go there's always urgent demand for Expert Electricians and at big pay. That's because the watchword of the age is, "DO IT ELECTRICALLY." Electricity advances so fast that there's a big shortage of competent electricians. And the demand is constantly increasing every day.

## 20 Complete Lessons FREE!

That's the sensational offer I am making now to a few more ambitious men. I make it for two reasons. 1st. To show you how easy my personal instructions are to master. 2nd. To secure quick action on the part of a few more prospective students. This offer means that you get 20 complete personal lessons ABSOLUTELY FREE! But you must act quick. The offer closes in 23 days. Send coupon or postcard at once. I'll send full particulars immediately. Mail coupon today—sure!

**A. W. WICKS, E. E., Director Wicks Electrical Institute,  
81 West Randolph St., Dept. 118, Chicago, Ill.**

Send this  
Coupon

**A. W. WICKS,  
E. E., Director,  
WICKS ELEC. INSTITUTE,  
81 West Randolph St.,  
Dept. 118, Chicago, Ill.**

Without any obligation on  
me whatever, please send me  
full description of your personal  
instructions in Electricity and  
particulars of your special offer of  
20 of your lessons free.

Name.....

Street and No.....

City.....State.....

Please Mention Popular Mechanics

# STUDY LAW AT HOME

## Become an LL.B.

*Only Law School of  
its Kind in America*

### Special and Exclusive Features

**ONLY** recognized resident law school in the United States conferring Degree of Bachelor of Laws—LL.B.—by correspondence. ONLY law school in U. S. conducting standard resident school and giving same instruction, by mail. ONLY law school giving over 450 class-room lectures to its extension students. ONLY law school giving a full 3-year, University Law Course, by mail, having an actual faculty of over 30 prominent lawyers in active practice. ONLY law school in existence giving Complete Course in Oratory and Public Speaking, in conjunction with its law course.

### Written Bar Guarantee

We give an absolute written guarantee to prepare our students to pass bar examinations.

The Hamilton College of Law is a regular, thoroughly recognized, bona fide College of Law and NOT an "institute," "correspondence school," etc. It occupies the entire third floor of the New Advertising Bldg., where its large and commodious resident class-rooms and executive offices are located.



Our Degree Bachelor of Law, LL.B. NOT a Diploma or Certificate

### Direct From Class-Room to Student



From Lecture Room to Student  
No Other Law School Can Do  
This Illustration

chooses, take part of our course by mail and finish in our resident school where he will receive full credit for all work done by mail. Our resident school is recognized by all standard law schools in the United States.

The Hamilton College of Law is highly endorsed and recommended by Government Officials, Business Men, Noted Lawyers, Graduates, and Students. We have as students a number of practicing lawyers (not graduates of recognized law schools) who are now earning their degree of LL.B. Many other lawyers are using this course as a review. A probate judge, one of our active students says: "I am delighted with the course prescribed and your method of teaching law. It is far in advance of what I expected to receive."

### Our Law Library

consists of 24 volumes of Standard Text Books, two volumes bound together under one cover, making a total of 12 books. These books were prepared at an enormous cost especially for the students of the Hamilton College of Law, by



These 12 Volumes are Free to Students of one of the largest and best law book publishers in America. This is the only set of law text books ever prepared exclusively for student's use. We would be glad to have you submit these books to any lawyer or judge in the country and get his opinion regarding them.

### Mail Coupon Today

and get our Big, Beautifully Illustrated Prospectus and complete information. Please us under no obligations whatever. This may mean the turning point in your career.

Hamilton College of Law, 327 Advertising Bldg., Chicago, Ill.

Gentlemen: Kindly send me your Illustrated Prospectus and full particulars regarding your method of teaching law by mail

Name.....

Address.....

Write plain and in full

Please Mention Popular Mechanics

# Learn Music At Home!

Piano, Organ, Violin, Cornet, Guitar, Banjo  
Mandolin, Harp, 'Cello, Sight Singing

## EASY LESSONS FREE!



No longer need the ability to play be shut out of your life. Just write us a postal today for our new Free Book, fresh from the printer. Let us tell you how you can easily, quickly, thoroughly learn to play your favorite musical instrument by note in your own home, without a teacher, by our New Improved Home Study Method, without paying a cent for lessons! Different, easier than private teacher way—no tiresome, dry exercises—no inconvenience. No trick music, no "numbers," yet simple, wonderful, amazingly easy even for a mere child.

### 200,000 Pupils!

Since 1898 we have successfully taught over 200,000 people from seven to seventy, in all parts of the world! Hundreds write:—"Have learned more in one term in my home with your weekly lessons than in three terms with private teachers." "Everything is so thorough and complete." "The lessons are marvels of simplicity. My 11-year old boy has not had the least trouble to learn."

### Wonderful New Book Free!

We want to have one pupil in each locality at once to help advertise our wonderful easy system of teaching music. For a limited time, we therefore offer our marvelous lessons free. Only charge is for postage and sheet music which averages \$2.40 weekly. Beginners or advanced pupils. We have hundreds of pupils right here in New York, the musical centre of America, who prefer our Home Study method in place of best private teacher. Get all the proof, facts, letters from pupils, amazing free offer and fascinating New Book just issued, all free! Write postal today. Address, U. S. School of Music, Box 4A, 225 Fifth Avenue, New York.



## DON'T TRY TO BE A CHAUFFEUR

or go to ANY SCHOOL to learn, or part with your hard earned dollars until you have read our valuable guide FIRST. It tells what you should PAY and what you should GET. Do not be deceived by schools which claim everything and give you nothing. YOU CAN'T AFFORD TO SPEND ONE CENT TILL YOU GET OUR GUIDE. It costs nothing and may save you many dollars. Write now for this FREE BOOK.

PRACTICAL AUTO SCHOOL, 68 Beaver St., New York

### COPY THIS SKETCH

and let me see what you can do with it. Illustrators and cartoonists earn from \$20 to \$125 a week or more. My practical system of personal individual lessons by mail will develop your talent. Fifteen years' successful work for newspapers and magazines qualifies me to teach you. Send me your sketch of President Wilson with 6c in stamps and I will send you a test lesson plate, also collection of drawings showing possibilities for you.

The Landon School of Illustrating  
and Cartooning  
1438 Schofield Building, CLEVELAND, O.



## A Government Job For YOU

There are many fine openings in the Railway Mail, Post Office and other government branches for American citizens 18 and over. Let us show you how Mr. Patterson, a former U. S. Civil Service Secretary-Examiner, can help you obtain one of these positions. Booklet 16-Y gives full particulars. It's free, without obligation. Write today.

Patterson Civil Service School, Rochester, N. Y.

## Learn Watchmaking At Home



You can learn by our modern and original system of instruction every part of the Watchmaker's Trade at home as good or better than at a shop. You can earn money while learning and secure a well paying position or start in business after completing our course of instruction. Good watchmakers are always in demand and earn from \$20 to \$35 per week. For particulars apply to the Wisconsin School of Watchmaking, 32nd Bldg., Milwaukee, Wis.



# Succeed Through Electricity

This interesting story shows you the way to greater success in the Electrical Field.



### Read These Testimonials

"Any Electrician, Operating Engineer, or Student who wants to do his own construction or further advance himself in the Electrical field should have a set of these books."

JOHN KELLEY  
116 Union St., Newark, O.

"For the man not getting a college training and even in that case, I can sincerely say I do not believe there is a better set of books in the market today."

LLOYD D. HUFFMAN  
Dayton, O.

"We consider Hawkins Electrical Guides the most compact and complete set of electrical references in the market."

NOBLE ELECTRIC WORKS  
Monterey, Cal.

"Hawkins surely knows the art of condensing information."

ELMER F. BALL  
Buckland, Conn.

This is the Electrical age. Electricity now controls more trades, directs more men, offers more opportunities than any other power that man has yet discovered. Through *exact* knowledge of Electricity you will advance in salary and position.

## Hawkins Electrical Guides Will Show You How

These books are the standard works on Electrical Science. They are a complete and up-to-date course in Electrical Engineering, presenting the information in a way you can use it. Only \$1.00 per volume and owners of the set say there are no better electrical books published at any price.

### Specially Arranged for Home Study and Reference

They fit your pocket and your pocket book. Beautifully bound in flexible black leather with gold edges. Easy to read and handle. You can carry each single volume about with you until you have mastered the subject it contains. Written in the form of questions you would ask and the answers to them—in plain, practical, everyday language, complete, concise, authentic and to the point. Over 3200 pages and more than 4,000 illustrations.

10 NUMBERS IN ALL

**1.00**  
A Number  
PAYABLE  
**1.00**  
A Month

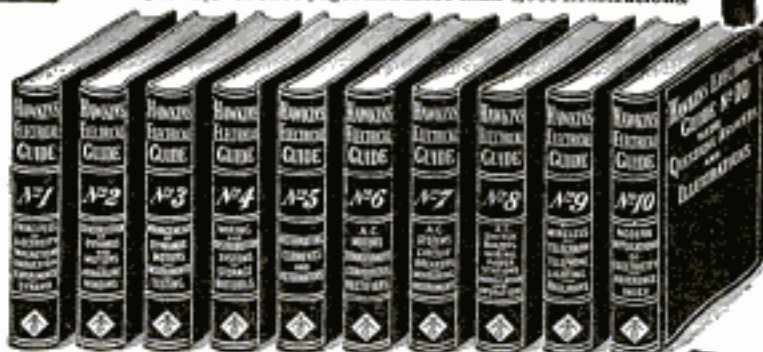

## Shipped to You FREE

Send no money. Examine the books first. Decide for yourself that they are the most complete library of Electricity ever published and that you cannot afford to be without them. Every book is complete in itself, but the complete set is the best bargain. The last volumes are just coming off the press. **Eight numbers now ready.**

### Easy Payments

Accept this unusual offer now—today. Each page—every illustration will convince you of the big value we are offering. See the books first, then decide. If you decide to keep them you can make settlement at only \$1.00 monthly until paid for.

**A FEW OF THE SUBJECTS**  
Magnetism—Induction—Experiments—Dynamoes—Electric Machinery—Motors—Armatures—Armature Windings—Installing of Dynamoes—Electrical Instrument Testing—Practical Management of Dynamoes and Motors—Distribution Systems—Wiring—Wiring Diagrams—Sign Flashers—Storage Batteries—Principles of Alternating Currents and Alternators—Alternating Current Motors—Transformers—Converters—Rectifiers—Alternating Current Systems—Circuit Breakers—Measuring Instruments—Switch Boards—Wiring—Power Stations—Installing—Telephone—Telegraph—Wireless—Halls—Lighting—Railways. Also many Modern Practical Applications of Electricity and Ready Reference Index of the 10 numbers.

**Theo. Audel & Co.**  
72 Fifth Ave.  
NEW YORK

**YOUR FREE COUPON**

Theo. Audel & Co.  
72 Fifth Ave., N. Y.

Please send me for FREE examination Hawkins Electrical Guides (Price \$1.00 each). Ship at once prepaid the first eight numbers. If satisfactory I agree to send you \$1.00 each month until paid.

Signature .....

Occupation .....

Business Address .....

Residence .....

Reference .....

Apr. P. M.

Please Mention Popular Mechanics

# LEARN THE AUTO BUSINESS

## RIGHT NOW IS THE TIME

to get into the Auto Business. Earn a Splendid Salary or start a paying business of your own. Hundreds of positions are ready and waiting. The demand for trained automobile men far exceeds the supply. Over two million cars are now in use; nearly a million more this year. Cleveland is the center of high grade automobile manufacture. Our graduates get jobs quickly; over 3,000 are now "making good" in paying positions. No previous experience is necessary; just the desire to get into congenial, well paid work.

## Cleveland AUTOMOBILE School

12 Years of Success—Oldest and Best Established  
Latest Equipment—Individual Instruction

Practice beats theory. Actual experience is all that counts when you go to get a job. We give you up-to-date training in four weeks; including every point worth knowing—oxy-acetylene welding, machine-shop practice, testing and driving high-powered, late model cars. Silent-Knight and other latest type motors; new 8 and 12 cylinder cars. We claim to have the most completely equipped school in America—the most practical and experienced teachers. Don't waste this opportunity. Come and Join Us Now. Tuition and Board Low, within walking distance of the school. Congenial company and surroundings. We help you get located and make you feel at home. New classes forming. Write today for Catalog and Terms.

**CLEVELAND AUTOMOBILE SCHOOL**  
CLYDE H. PRATT, President  
2338 Euclid Ave. CLEVELAND, OHIO



## BE AN AUTO EXPERT

## Traffic Inspectors WANTED

(BY THE R. R.'s)

\$4 Per Day

Here's a new profession for ambitious men (not rating but new, outdoor work). Positions now open pay \$4 Per Day to start; chances for advancement and travel unlimited. We train you thoroughly, quickly; give you all necessary experience. Find out how men like you—clerks, salesmen, railroad men—are earning real money and advancement. Here's your big chance! Write for Free Booklet A3 now, lest you forget.

Frontier Prep. School, Buffalo, N. Y.

## LEARN JEWELRY ENGRAVING

In your own home. Earn \$20.00 to \$50.00 Weekly. Personal instructions. Write for free booklet. Chicago Engraving School, 612 Athenaeum Bldg., Chicago



**OSCAR A. FORS**  
PRINCIPAL

## Do You Want More Money?

Learn the art of Sign and Showcard Writing. Branch of Advertising. Men and women make big money. Personal instruction and original methods (copyright) make you expert.

**\$6.00 PER DAY OR MORE**

is the union scale in Chicago and other towns. You can make even more on job work. Have a big business of your own. We show you how by mail and help you pay for your course. Mr. O. A. Fors who is the author of this course and who is recognized as an expert will personally instruct you in this money making profession. Particulars and booklet free. Explains everything. Write today.

The School with a METHOD.

**ILLINOIS SCHOOL OF LETTERING & DESIGN**  
Dept. B, 187 N. Clark Street, CHICAGO, ILLINOIS

## DRAWING

Learn by mail in your own home. Cartooning, Newspaper, Magazine and Commercial Illustrating, also

Water-Color and Oil Painting

Learn Drawing or Painting for profit and pleasure. We can develop your talent. This school has taught thousands. Free Scholarship Award—special limited offer. Your name and address brings you full explanation and our handsome illustrated Art Annual by return mail. Don't delay. Write today.

**FINE ARTS INSTITUTE, Studio 214, Omaha, Neb.**



## LANGUAGES

Quickly Learned AT HOME by the Original Phonographic Method

German—French—English—Italian—Spanish or any other language learned quickly and easily by the Cortina Method at home with Disk Cortina-Records. Write for free booklet today; easy payment plan.

**CORTINA ACADEMY OF LANGUAGES**  
1613 Meen Bldg., 1000 Broadway,  
Corner 48th Street, New York



**CORTINA-PHONE**



## VENTRILOQUISM

LEARNED BY ALMOST ANYONE AT HOME SMALL COST

Send today 2c stamp for particulars and proof. O. A. SMITH, Room D 137, 823 Bigelow St., PEORIA, ILL.

## ARITHMETIC SELF-TAUGHT

A plain, easily-understood volume for all who have not had the opportunity of learning this subject thoroughly, or who have forgotten what they once learned. 257 Pages. Requires no teacher. This great little book sent postpaid for 60 CENTS. Stamps accepted.

**GEO. A. ZELLER BOOK CO.**  
Est. 1870, 442 W. Belle Place, ST. LOUIS, MO.

SPANGLER'S  
PRACTICAL  
ARITHMETIC  
Self-Taught

Please Mention Popular Mechanics



**BE A  
TRAFFIC  
MANAGER**

**SALARY  
\$35 to \$100  
WEEKLY**

## Don't Look For the Little Job— Train For a Big One

If you're following the wrong vocation, get out of it. But don't get into another job that almost any man can fill. Train now for a job in a new profession—for a position that will advance you to power and satisfy your desire for a high salary.

# Be a Traffic Manager

## At \$35 to \$100 Per Week

There was never a better opportunity for the competent and well trained traffic man anywhere—or at any time—than there is today. There are over 500,000 shippers in the U. S. Practically every one needs expert traffic men. Recently enacted rate laws and Interstate Commerce Regulations have produced new conditions, thereby increasing the demand for trained traffic specialists.

Business, too, is increasing at a tremendous rate. Our foreign trade balance is now rap-

idly approaching the \$2,000,000,000 mark. American goods are being shipped to all parts of the world. The tonnage forwarded by manufacturers and handled by railroads is the heaviest on record. Lake, railroad and ocean routes are literally choked with goods. As a result, big industries and railroads have urgent need for trained traffic men. It is a field which is constantly expanding. The demand for traffic experts is daily increasing and the positions are permanent.

## We Train You By Mail To Fill These Positions

Hold your present position, keep on drawing your salary while you take up our course, in your own home, in spare time. Study and prepare yourself as quickly as you can. The cost is small and terms are so easy that you will not miss the money. The entire amount of your tuition will be refunded, according to our legally binding Guarantee Bond, if you are dissatisfied. This guarantee is backed by our entire capital and resources of more than a million dollars.

The LaSalle University Home Study Course in Traffic Managership is the work of some of the greatest traffic experts in America. It covers thoroughly every feature of the profession. Teaches you in less time, because it is written in a manner easily understood by any man who can read and write intelligently.

Our graduates are successful because they not only receive training and coaching under direct supervision of practical traffic managers and traffic experts, but the training embraces actual practice in routing shipments to obtain shortest mileage, how to secure quickest deliveries, how to classify goods, how to get lowest rates, etc., which knowledge qualifies you for a traffic position with railroads, lumber concerns, packing houses, steel mills, coal companies, mail-order houses, etc. Or, as Traffic Expert with State R. R. Commissions, Chambers of Commerce, or in business for yourself as Consulting Traffic Expert.

## Send Coupon—This Is Your Opportunity

Don't work hard for small wages when you can so readily and easily equip yourself for a \$35 to \$100 a week salary as a Traffic Manager. Our graduates are holding big jobs—are "making good" on account of their "LaSalle" training. We'll stand by you, help you, direct you, until you make good.

Send in the coupon for Free Book "How to Become a Traffic Manager." Get the interesting letters from our graduates. They'll tell you in their own words how they succeeded. Learn how easy we make it for you to take and complete the course. We'll make the terms to suit you. Accept this chance today. Send in the coupon NOW!

**LaSALLE EXTENSION UNIVERSITY, Dept. 464-C Chicago**

## MAIL COUPON TODAY

**LaSalle Extension University  
Dept. 464-C Chicago, Ill.**

Send me at once free book, "How to Become a Traffic Manager," also proof about opportunities now open, letters from graduates and details of your Easy Payment Plan.

Name.....

Address.....

Please Mention Popular Mechanics

Copyrighted material



## \$125 to \$300 A MONTH

Don't hesitate. Write to us at once and find out about this wonderful opportunity. Hundreds of Signal Men and Signal Engineers are needed right now. Are you able to accept one of these positions? Have you had the training that will enable you to forge ahead and earn big money? All the way from \$125 to \$300 per month. If not, you cannot afford to put off writing us. Send at once for our big book which tells you all about the wonderful new profession of Signal Engineering. After a short time you will be in a position to earn more money. By our plan you can become our Representative immediately. So don't wait. Write us today. Get this special offer NOW.

## More Men Needed

The railroads are constantly looking for competent Signal Men and Signal Engineers. There are not enough men to fill the positions. Thousands and thousands of miles of tracks are to be equipped with automatic signals. More Signal Men are needed to superintend the work. Many new positions will be open and there are not enough men to take them. Besides a profession in which you can make a lot of money, Signal Engineering is the most fascinating work. So don't delay. Write today and find out about this wonderful opportunity.

### FREE BOOK COUPON

Dept. of Signaling  
Room 1194, 1810 Wilson Ave.  
Ravenswood Station, Chicago, Ill.  
GENTLEMEN: Please send me absolutely free and prepaid your big new Signal book. It is distinctly understood that I assume no obligations of any kind.

Name .....

Address .....

Age ..... Occupation .....

## Free Coupon

Just put your name and address on the free coupon and send it to us at once. You are under no obligations of any kind. We will send you the big new Signal Book which tells you all about this wonderful profession absolutely free. This book tells you how you can earn from \$125 to \$300 a month. Don't wait. Write today.

Dept. of Signaling  
Room 1194  
1810 Wilson Ave.  
Ravenswood Sta.  
CHICAGO,  
ILL.

Please Mention Popular Mechanics

## SHORTHAND IN 30 DAYS

We absolutely guarantee to teach shorthand complete in only thirty days. You can learn in spare time in your own home, no matter where you live. No need to spend months as with old systems. Boyd's Syllabic System is easy to learn—easy to write—easy to read. Simple. Practical. Speedy. Sure. No ruled lines—no positions—no shading as in other systems. No long lists of word signs to confuse. Only nine characters to learn and you have the entire English language at your absolute command. The best system for stenographers, private secretaries, newspaper reporters and railroad men. Lawyers, ministers, teachers, physicians, literary folk and business men and women may now learn shorthand for their own use. Does not take continual daily practice as with other systems. Our graduates hold high grade positions everywhere. Send today for booklets, testimonials, etc.

Chicago Correspondence Schools  
969 Unity Bldg., CHICAGO, ILL.

## Be the Boss

Get Into the New Profession  
Thousands of men needed. Meter Engineers in constant demand everywhere. Big money. Learned at home during your spare time.  
A \$3,000 Job For You Electrical Meter Engineering is one of the best paying professions in the industry. Hundreds making \$2,000 and more. You can do the same. Write today.  
Big Book FREE Just your name and address is enough. No obligations of any kind. Big book and details FREE—absolutely free. WRITE TODAY.

Fort Wayne Correspondence School, Department 1194, Fort Wayne, Ind.



## For Artists and Art Students

Publishes Cash Art Assignments, lessons and articles on Cartooning, Illustrating, Lettering, Designing and Chalk-Talking. Criticizes amateurs' work. Interesting, helpful, artistic, UNIQUE. It will please you. Money back if not satisfactory.

Clare Briggs, Ryan Walker, and other noted artists contributors.

STUDENTS ART MAGAZINE  
Dept. 146, Kalamazoo, Mich.

Send Now  
\$1 a Year  
10c a Copy

## LAW STUDY AT HOME BECOME AN LL.B.

Only recognized resident law school in U. S. Conferring Degree of Bachelor of Laws—LL.B.—by correspondence. Only law school in U. S. conducting standard resident school and giving same instruction, by mail. Over 450 class-room lectures. Faculty of over 80 prominent lawyers. Guarantees to prepare graduates to pass bar examination. Only law school giving Complete Course in Oratory and Public Speaking. School highly endorsed and recommended by Gov. Officials, Business Men, Noted Lawyers and Students. Send today for Large Handsomely Illustrated Prospectus. Special Course for Business Men and Bankers.  
HAMILTON COLLEGE OF LAW, 405 Advertising Bldg., CHICAGO, ILL.

## New Jobs

## \$100 Typewriter FREE

Men and women Confidential Secretaries now needed everywhere—new profession.

### Uncrowded Field—\$25 to \$50 Weekly

Big position to start. Learn at home. Qualify through Botsford New Method Touch Typewriting—write 100% faster. Tuition fees refunded if not satisfied. Write for first lesson free. Shorthand Course also. \$100 typewriter free while learning. Amazing method doubling salaries. Address Jas. Patrick Ward, Inc., BOTSFORD Institute, 1102 Botsford Bldg., Chicago.



## Be an Artist

and Draw for  
Magazines,  
Newspapers, Etc.  
Earn Big Money  
(Send sample of your work  
for honest criticism)

All Branches of Art Taught BY MAIL or Local Classes.  
Write for illustrated booklet, terms and list of successful pupils.  
ASSOCIATED ART STUDIOS, 2122 Flatiron Bldg., NEW YORK

## LEARN RAG TIME

Let me teach you Rag-Time Piano Playing by Mail. You learn easily—in just a few lessons, at home. My system is so simple you'll play a real ragtime piece at your 5th lesson. Whether you can play now, or not, I'll teach you to play anything in happy ragtime. "Money Back Guarantee." Write at once for special low terms and testimonials.  
AXEL CHRISTENSEN, "Czar of Ragtime,"  
Room 15 526 So. Western Ave., Chicago, Ill.



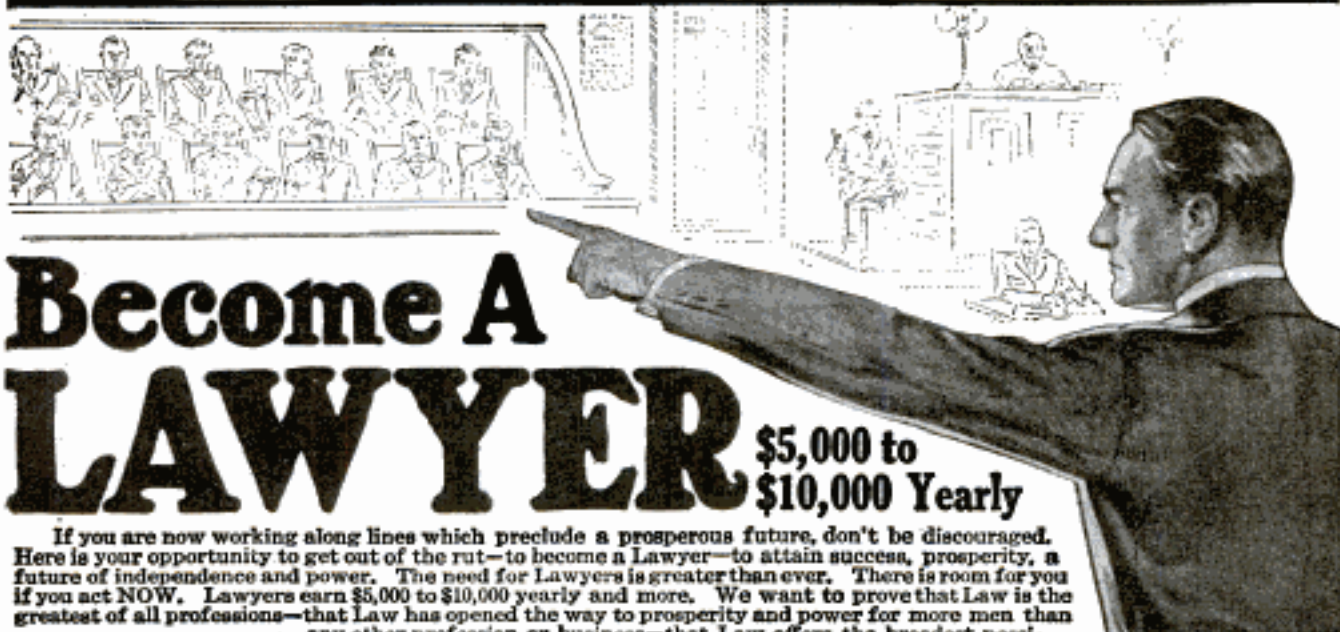

# Become A LAWYER

\$5,000 to \$10,000 Yearly

If you are now working along lines which preclude a prosperous future, don't be discouraged. Here is your opportunity to get out of the rut—to become a Lawyer—to attain success, prosperity, a future of independence and power. The need for Lawyers is greater than ever. There is room for you if you act NOW. Lawyers earn \$5,000 to \$10,000 yearly and more. We want to prove that Law is the greatest of all professions—that Law has opened the way to prosperity and power for more men than any other profession or business—that Law offers the broadest possibilities for YOU no matter what your present vocation or your future plans may be. Think of the wonderful opportunities open to men who know Law. Many of America's most successful men—nearly all of our greatest Statesmen—Abraham Lincoln, James A. Garfield, Woodrow Wilson, Wm. H. Taft, Patrick Henry, John W. Van Meter, E. H. Harriman—were trained in Law. President Wilson and every member of his cabinet, with but one exception, are legally trained men. Do YOU want these same vast opportunities? If so, write immediately.

### Partial List of LaSalle Text Book Authors

The LaSalle text was written by over 30 Law School Deans and Professors of noted Universities, including Harry S. Richards, Ph. D., LL. D., LL. B., Univ. of Wisconsin, Honorary Prof., Ph. D., LL. B., Harvard Univ.; George L. Clark, A. B., LL. D., Univ. of Michigan; Elliott J. Northrup, A. B., LL. B., Tulane Univ.; Charles A. Huston, A. B., J. D., Stanford Univ.; Albert H. Kahn, A. B., LL. B., Northwestern Univ.; Ernest E. Conant, A. B., LL. B., Univ. of Nebraska; James P. Hall, A. B., LL. B., Univ. of Chicago; Walter W. Cox, A. M., LL. B., Univ. of Chicago; Joseph W. Bingham, A. B., J. D., Stanford Univ.; George F. Costigan, Jr., A. M., LL. B., Northwestern Univ.; Harry A. Bevels, A. B., LL. B., Univ. of Chicago; Homer E. Wilgus, B. S., M. A., Univ. of Michigan; Eugene A. Gilmore, A. B., LL. B., Univ. of Wisconsin; Arthur M. Cushman, A. B., Stanford Univ.; Percy Horton, Ph. D., LL. M., Univ. of Iowa; Frank W. Henckesman, A. B., J. D., Univ. of Chicago; William J. DeMarco, A. M., LL. B., Univ. of Wisconsin; Clark B. White, A. B., LL. B., Univ. of Chicago; Arnold B. Hall, A. B., J. D., Univ. of Wis.

The books are ably edited by James Parker Hall, A. B., LL. B., Dean of Law School, University of Chicago, and James DeWitt Andrews, LL. D., formerly of the Law Faculty of the Northwestern University and author of "Andrews' American Law," etc.

### Special Lectures

by Hon. John F. Dillon, America's foremost jurist, Hon. Roger A. Fryer, former Justice, Supreme Court, State of New York; Hon. George W. Wickersham, U. S. Attorney General; Hon. Theodore E. Burton, United States Senator from Ohio; and many others of equal prominence.

## Our Students' Success Is PROOF

Read the letters on the right from a few of our students. Let us send you others to prove that we have helped to success men and women in your very circumstances—to prove that no matter what you work at now, we can qualify you for this wonderful profession of Law. What these men have done, YOU can do, and we make it easy. Law is no longer difficult to learn.

## We Train You By MAIL!

at home, in spare time, no matter what your present occupation, if you can read and write English intelligently. Keep your present position—earn while you learn. We use the same modern methods of instruction used in the biggest resident colleges. Just like having great professors in your home to teach you. The LaSalle text is edited and written in plain language by some of America's foremost legal experts. The greatest authorities recognize the LaSalle Home Study Law Course as the foremost in America. The LaSalle is the largest Home Study Extension Law School in America—enrolls more students than any other.

**Become an LL. B.** The Laws of Illinois authorize us to confer on all graduates the degree of LL. B. (Bachelor of Laws). Our Course prepares you to pass all subjects covered by bar examinations. We guarantee to coach free until successful any graduate failing to pass bar examinations.

### Special Course For Business Men

Many of our students are business men who recognize the necessity of legal knowledge. Write now for facts about business men's course.

### FREE Complete Course in Public Speaking

Most remarkable offer out. Absolutely without cost to you, this wonderful, complete course in Public Speaking, prepared by Dr. Frederick B. Robinson, A. B., A. M., Ph. D., Professor Public Speaking at College of City of N. Y., Editor Public Speaking Review. Most complete, authoritative, efficient course ever written. Will qualify you to become a recognized Public Speaker. No other course like it. Write for facts of how we give it free with Law Course.

### Mail Coupon NOW!

Don't remain in your small job any longer. Mail free coupon for further proof of how we can help you to success. Don't let lack of money interfere—we make terms to suit you. NOW is the time to begin to build a career of prosperity, power and independence. Mail coupon now for wonderful FREE books and facts about how we give without extra cost the wonderful LaSalle Complete, Standard, Authoritative Law Library

### MONEY-BACK GUARANTEE BOND

So thorough is the LaSalle Home Study Course—so exceptional has been the success of LaSalle students—that we issue with the LaSalle Course a legal, binding guarantee to refund the entire tuition fee if after you complete the Course you are not perfectly satisfied. This guarantee is backed by our entire capital and resources of more than two million dollars, which assures your absolute success.

Each student receives a Money-Back Guarantee Bond.

If you enroll at once. No books to buy—everything supplied complete. This is your opportunity for success and we prove it. Mail coupon! LaSalle Extension University, Dept 464-F Chicago, Ill.

### What Some of LaSalle Students Say

Williamfield, Ill.  
I have just finished a campaign for a member of the lower house of the State Legislature. I may state here that I was successful in the election and credit the fact largely to my study of law, though I have been losing your course only since last Spring.

W. H. BARNETT,  
Former Pres., Knox Co. Farmers' Institute, Rep.-Elect to Ill. Legislature.

Seneca, Ark.  
After pursuing your course in law for only two years, I took the examination for admission to the bar, at Huntsville, March 3, inst. I am glad to say that I passed and received the credit of standing the best examination of any candidate the committee had ever examined. I never studied law until I began to take your course.

G. T. SULLINS,  
Waynesville, Okla.

I am now admitted to the bar in this State. I cannot speak too highly of your course of instruction, as I have only been studying about one year and know nothing of the law before I started under your guidance.

WINFIELD SEDORE,  
Llano, Texas.

I was raised on the farm but always had an inclination to become a member of the legal profession. I began studying law under your direction, Feb. 25, 1912, and in April, 1913, I passed the bar examination successfully and you deserve the credit for my success. Your school is unequalled. I haven't lost a day since beginning your course of study.

J. WIGGITT DUNN, Jr.

### This Great LAW Library FREE if You Enroll Now

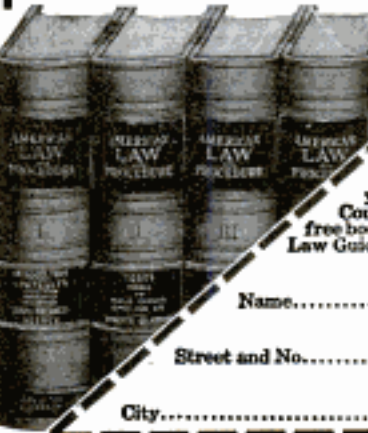

LaSALLE EXTENSION UNIVERSITY,  
Dept. 464-F

Chicago, Illinois

Send at once facts about your free offer of Complete Course in Public Speaking; also free books, "Evidence" and Valuable Law Guide, and Money Refund Bond.

Name.....

Street and No.....

City..... State.....

# Learn to Write

GOOD hand-writing has been truly called the "Bread and butter of a business education." It should be the determination of every body to learn to write at least a good business hand. Good writing is the very foundation of business success.

**Easy to Learn** By my system you can become a good penman at home, in your own room during spare time. Don't be content with the notion that good penmen "are born" such. Because one's ancestors may have been noted for poor penmanship, is no excuse for him to remain an illegible scribbler. My system is original, unique, and highly successful—the result of 25 years' experience.

**Your Spare Time** Just your spare moments—that's all I ask. If you follow my instructions you will soon be able to write a beautiful hand that will be a source of pride to yourself and envy to your friends. Notice the improvement shown in Mr. Campbell's writing below.

*Leland M. Campbell*

"I am astonished at the improvement I've made by means of The Tamblin System in so short time."

LELAND M. CAMPBELL,  
Campbelltown, Ohio.

*Leland M. Campbell*

Mr. Campbell wrote his upper signature July 20, and the lower one November 10—a little less than 4 months apart. Hundreds and hundreds of others in all parts of the world are doing as well with my system.

I have had unbounded success in making poor writers good ones and good writers better penmen than they thought possible.

32  
PAGES  
HIGHLY  
ILLUSTRATED

HOW TO  
BECOME  
A  
GOOD  
PENMAN

FREE  
BOOK  
WRITE  
FOR IT  
TODAY

Penmanship is particularly adapted to correspondence instruction, and I absolutely guarantee satisfactory improvement. Distance no barrier. Ladies taught just as successfully as men.



*F. W. Tamblin*

Don't wait, don't delay, begin now to prepare for that position where good penmanship will be required. Send today for my **Free Book**, "How to Become a Good Penman," which contains copies and beautiful specimens and tells how others have become good penmen by means of the Tamblin System. Your name will be beautifully written on a card with white ink if you enclose stamp.

F. W. TAMBLIN,  
418 Meyer Building,  
Kansas City, Mo., U. S. A.

## FREE BOOK COUPON

F. W. TAMBLIN, 418 Meyer Bldg., Kansas City, Mo., U. S. A.  
I am interested in improving my penmanship. Please send me free your Book "How to Become a Good Penman."

Name.....

Address.....

Sign and mail this today, before you forget it.

Please Mention Popular Mechanics

## SPEAK A FOREIGN LANGUAGE !!!



The War has created unlimited commercial opportunities for those who know Spanish, French, German or Italian. Take advantage of the war situation! Better your position and increase your salary. Extend your business. Establish export trade with South American countries. Equip yourself to read foreign books and papers. Brush up on the language you studied at school or college and make it of practical use. Acquire a new language at home, by the

## LANGUAGE-PHONE METHOD

And Rosenthal's Method of Practical Linguistry  
(Highest Award Panama-Pacific Exposition)

This is the natural way to learn a foreign language. You hear the living voice of a native professor pronounce each word and phrase. He speaks as you desire—slowly or quickly, for minutes or hours at a time. It is a pleasant, fascinating study; no tedious rules or memorizing. It is not expensive—all members of the family can use it. You simply practice during spare moments or at convenient times, and in a surprisingly short time you speak, read and understand a new language.

Write for free "Language Treatise," particulars of Trial Offer, Easy Payments. Our records fit all talking machines.

The Language Phone Method, 961 Putnam Bldg., 2 W. 45th St., N. Y.

## Earn big pay as a tree expert

Through the Davy course of training by mail hundreds of young men have improved their condition in life. You have an equal chance. A few months' study, at home, in your spare time, will fit you for any of the following positions—Tree Surgery, City Forestry, Park Superintendent, Fruit Growing, City Tree Expert, and Forestry. These fields are uncrowded; you will have more demands for your services than you can fill. Write today for book, "Adventures in Success," and tell us which of the professions listed above especially appeals to you. The Davy Institute of Tree Surgery, 303 Oak St., Kent, O.



## BE A TRAVELING SALESMAN

Hundreds of good positions now open. No experience required to get one of them. Write today for list of openings offering opportunities to earn big money while you learn and testimonials from hundreds of our students who are earning \$100 to \$500 a month. Address nearest office, Dept. 507  
NATIONAL SALESMEN'S TRAINING ASSOCIATION  
Chicago, New York, San Francisco

## Voice Thrower 10c

Learn to throw your voice into a TRUNK under the bed, out in the hall or anywhere. Lots of FUN fooling the Teacher, Junitor, Policeman, Parents, Neighbors, or Friends.

## THE VENTRILO

is a little instrument that fits into the mouth out of sight. BOYS or GIRLS can use it. NEVER FAILS! A 32 page book on Ventriloquism sent with the VENTRILO for TEN CENTS.

Royal Novelty Co., Dept. 92, So. Norwalk, Conn.

## A great surprise for your friends Thumb Brander NEW and good Practical JOKE



You may have lots of fun with this Joke. The Brander is attached to a spring ring that fits on the thumb, scarcely noticeable; when you shake hands a slight pressure "brands." Then the fun commences; the victim seldom knows he is "branded" until his attention is called to it. It won't wash off very easily either, as soap and water help for it. Any of these choice epithets: Owl, Fool, Baby, Liar, Grinch, Chicken, Brander, Pad and Bothe of Ink, 15c postage 2c extra, 2 for 20c, or all 6 for 75c. AGENTS WANTED. In print catalogues, novelties, trinkets, etc. 102 and 64 pages furnished. Particulars for stamp. JOHNSON SMITH & CO., 715 S. Dearborn St., CHICAGO

## SELF-CONSCIOUSNESS

Are you timid? Do you lose your nerve and become confused easily? Do you lack confidence, courage, aggressiveness, faith in your own ability? These faults are a big handicap in social or business affairs. My Illustrated Treatise tells you how they may be overcome. It's FREE! Write for it today.

M. DeBETTS, Sta. 89, JACKSON, MICH.

## MEAD RIDE a RANGER



1916 Model bicycle and know you have the best. Buy a machine you can prove by actual test before accepting.

DELIVERED FREE ON APPROVAL and 30 days' trial. No expense to you if you do not wish to keep it. LOW FACTORY COST, great improvements and values never before equalled in our 1916 models.

WRITE TODAY for our big catalog showing our complete line of 1916 bicycles, TIRES, sundries and parts, and learn the wonderful low prices and new offers and terms we will give you. Do not buy until you know what we can do for you. Write a post card now

MEAD CYCLE CO. DEPT. P108 CHICAGO

# YOU Can Earn \$2000 a Year

The demand for trained engineers at \$2000 to \$5000 a year becomes greater every day. Any man with engineering training can practically demand his own price. NOW—as never before—is the time to enter a profession that pays big money—a profession in which the demand for trained workers far exceeds the supply.

The American School will make you an expert engineer in a short time at small expense. Our staff of experienced engineers will give you individual instruction and advice. No previous experience necessary. You can start in immediately to prepare yourself for one of the countless high-salaried positions always open. You run no risk—we guarantee you more pay.

**Gained \$3600 Position**  
"The same day I received my Diploma I secured a position at \$3600 a year. My present success is due to the knowledge gained through your school."—Robert Knight, Chicago, Ill.

**Now Gets \$2000 a Year**  
"I now have a position that pays me \$2000 a year, which I never could have obtained had it not been for your school."—Robert T. Hendrickson, Fremont, Ohio.

**Salary 400 Per Cent Greater**  
"I am now Assistant Chief of the Engineering Department, and my present salary is 400 per cent greater than when I started the course."—Frank C. Krohn, West Allis, Wis.

**Earn While Learning** No need to give up your present occupation. We train you at home—solely by correspondence—as we have successfully trained thousands of others in the past nineteen years. Pocket-size text books enable you to study anywhere—at any time. Papers examined and corrected only by technical experts. Most thorough correspondence instruction in America.

## \$40 Drafting Outfit and Library FREE

First of all we will teach you drafting—the foundation of all engineering professions. We will give you a \$20 drafting outfit and a \$20 drafting library (4 vols.) ABSOLUTELY FREE! Then, after you have mastered drafting and are getting actual working experience as an engineer's draftsman, we will train you in your choice of Civil, Mechanical, Structural or Architectural Engineering. Thus, for a little more than the cost of a course in drafting alone, you get the training that enables you to fill a responsible, well-paying position as engineer. Be sure to investigate this offer if you have been thinking of enrolling in any drafting course.

## Engineering Book FREE

Send the coupon today for your copy of our 248-page Free Book. Tells how easy it is to become an engineer, and gives full particulars regarding the course you are most interested in. Don't hold back because of the money. The cost is small, and you can pay for your instruction as you progress—in small monthly installments.

Mark and mail the coupon today. This is a wonderful opportunity to get into a profession in which the possibilities for advancement are unlimited. No obligation, so mail the coupon now!

AMERICAN SCHOOL OF CORRESPONDENCE, CHICAGO, U. S. A.

## Free Book Coupon

American School of Correspondence, Chicago, U. S. A.

Without any obligation on my part, please send me full particulars of your Engineering Offer and a copy of your 248-page Free Book. I am interested in a course in

Architectural  Structural  Mechanical  Civil Engineering.

Pop. Mech. 4-16

NAME.....

ADDRESS.....

## STAMMERERS

Our Home Treatment will permanently cure you. If others have failed let us show you the way to success. Interesting literature free. CHESHIRE TRAINING SYSTEM, KEENE, N. H.

CHESHIRE TRAINING SYSTEM, KEENE, N. H.

## Learn Watchwork, Jewelrywork and Engraving.

A fine trade commanding a good salary, and your services are always in demand. Address HOBLOGICAL, Dept. P, Bradley Institute, Peoria, Ill., for our latest catalog.



Free Booklet—Send Coupon Today

## Paint Signs and Show Cards EARN \$25 TO \$75 WEEKLY

Get ready for a real job. Command a fine salary. Big opportunities await ambitious men and women. Only short time required to learn. No talent necessary. Course simple, easy—work fascinating. BE SOMEBODY. Aspire to bigger things. CARTOONISTS—learn card and sign writing and lettering. This FREE booklet points the way—shows what YOU can do.

### DEMAND FOR TRAINED ARTISTS

Enormous increase in advertising constantly creating new positions. The field gets bigger every day. Earn money after sixth lesson. I personally guide you—help you get positions when ready. Publishers, printers, engravers, lithographers, advertisers, merchants, manufacturers, calendar makers, box makers must have letterers, designers, show card and sign writers, etc. Send the coupon.

THE ROSING SCHOOL OF LETTERING AND DESIGN  
724 Union Building  
Cleveland, Ohio

Mr. Rosing,  
724 Union Bldg.,  
Cleveland, Ohio

Please send me free booklet and your proof.

Name.....

Address.....



## Think! Think! Think!

This vitalizing message, "Think, Think, Think," faces every executive and employee in the offices and factories of one of the greatest business institutions of the country.

The men at the head of this concern, like many other executives recognize the fact that really notable success is the result of intelligent thought—intelligently applied. Successful men are constructive thinkers, and doers.

Our inspiring 165-page free book will start you thinking along correct and practical lines. It explains in an interesting way the essential requirements which make for success today.

The book tells you of the big opportunities now open in Business and Public Life—and how a law training will help you to grasp these opportunities. It tells you of the great and constantly increasing demand for lawyers—and how you can become one. Send for your copy today. It is free.

### Modern American Law Course and Service of Blackstone Institute

Blackstone Institute (including The Sprague Correspondence School of Law) was founded in 1890, and is by far the oldest and largest law school for non-resident instruction in the world.

We have successfully trained more than thirty thousand men and women in law. Among our graduates are the former Governor of a State, United States Senators and Congressmen, State, County and City Officials, many Judges and thousands of successful Lawyers and business men everywhere. This notable record extending over twenty-five years is the most convincing evidence that we produce results—and it is results that count.

Chief Justice Ladd of the Supreme Court of Iowa, says: "Every person interested in the law will receive from Blackstone Institute an unusually excellent—in fact, the best, non-resident system of instruction."

Our Course and Service has been prepared especially for home study by eighty eminent judges and authorities, including:

Chief Justice John B. Winslow, J. J. D., Sen. Court, Wis.  
Hon. Geo. C. Holt, J. J. D., ex-Judge U. S. Dist. Court, N. Y.  
Hon. Paul S. Reinsch, Ph. D., J. J. D., U. S. Minister to China.  
Judge A. L. Sanborn, U. S. Dist. Court, Western Dist., Wis.  
Dean O. H. Barker, College of Law, University of Ill.  
Dean H. H. Ingraham, College of Law, University of Tenn.

The Course is clearly written in simple non-technical language. It is practical, yet reads like an interesting story. Specific preliminary education is not necessary. You can read in spare time at home, and you will benefit from the day you start. Our Course and Service will prepare you on all subjects required in the bar examinations, as it has already done for so many others. It will equip you to become a leader in business or public life—and to attain positions of honor and profit open only to law trained men.

### Special Offer—Investigate FREE

The recent union of The Sprague Correspondence School of Law with Blackstone Institute and the resulting increase in our facilities enable us to make you a most important Special Offer. Investigate now by sending postcard or letter, or clipping the coupon for our 165-page free book and full particulars. No cost or obligation.

Address Extension Division 1354

**Blackstone Institute**

20 W. Jackson Blvd.  
Chicago, Ill.

**FREE  
BOOK  
COUPON**



Extension Division 1354  
BLACKSTONE INSTITUTE,  
20 W. Jackson Boulevard, Chicago, Ill.

Please send me your 165-page free book, "The Law Trained Man," and full particulars of your Law Course and service and Special Offer. No cost or obligation.

Name \_\_\_\_\_

Address \_\_\_\_\_

Please Mention Popular Mechanics

# 25c BOOKS

List of more than 200 titles

**Sent Free**

**OVER A MILLION COPIES SOLD**

Practical Handbooks for Draftsmen, Engineers, Electricians, Mechanics and Handy Men.

**SPON & CHAMBERLAIN**  
123 P. M. Liberty St. NEW YORK



## Succeed in Life

It's perfectly simple that you can't become a man of achievement and power and influence without

### Health—Strength—Vitality

Then why do you wait? Surely you don't expect to reach the choicest of earthly blessings over THE PILL ROUTE.

A pill pilgrim is one who thinks that he can swallow health and power in tabloid form. He can't—you can't—it can't be done.

### The Strongfort System

is the answer. It is a scientific and authoritative application of scientific methods to Physical Culture. Its creator instructs each pupil personally. Do you want to read the life of the most powerful and symmetrical man ever known? Send for *Intelligence in Physical and Health Culture*, enclosing 4c in stamps for postage. Write now while they are still on hand.

**LIONEL STRONGFORT**

PHYSICAL CULTURE EXPERT

Dept. 846 Havana, Cuba

REVERSIBLE  
**Linene**  
TRADE MARK  
COLLARS

Send 2 Cents  
in U. S. Stamps to pay postage and we will send you free a starch-finished  
**SAMPLE COLLAR**  
State size and which style wanted

REVERSIBLE COLLAR CO., Dept. U, Boston, Mass.

## 150 Parodies on Latest Songs 10c

Neway, Araby, Old Green River, Come Back Darling, Ross-Ross Bay, Doves Home In Tenn., Down Among the Sheltering Palms, Tulip Time In Holland, Dublin Bay, It's a Long Way to Tipperary, I Don't Raise My Boy to be a Soldier, Tokio, Little Spark of Love, When You Were a Tulip, Michigan, Night in Dreamland, Maudslayi, International Rag, In My Haven & Ill others, including Comic Dialects, complete 10c; \$ for 20c.

J. C. DORN, 731 S. Dearborn St., Dept. 180, Chicago, Ill.



## 200 KINDS Iron, Wood, Wire & Steel PUZZLES

Catalog and 2 wire leaders and trick card only 10c.  
**WESTERN PUZZLE WORKS**  
ST. PAUL, MINN.

AT HOME  
**Learn TO SING**

Send 2-cent Stamp for Helpful Booklet, "The Voice Made Beautiful."

**HARVEY SUTHERLAND, 813 President St., Brooklyn, N. Y.**

**AGENTS \$60 WEEKLY**

Robinson Folding Bath Tub. Big seller. Costs little, no plumbing, little water. Weight 15 pounds, folds into small roll. Full length baths far better than tin tubs. Guaranteed 10 years. \$10 a day easily made. Write for free tub offer.

**ROBINSON CABINET MFG. CO. 4108 Factory Bldg., Toledo, Ohio**



# Stop Forgetting!



**Prof. Henry Dickson**

America's foremost Authority on Memory Training, Public Speaking, Self Expression, Lecturer and Principal of the Dickson Memory School, Hearst Building, Chicago.

## The Executive



**Mr. William H. Weeks, District Attorney of Putnam County, N. Y., writes:**

"After a thorough trial of your method of mental and memory training, I find it to be not only first class—simply wonderful. I can truthfully say that I would not be again without the benefits I have received from your study for \$10,000."

## The Salesman



**O. G. Wehmer, of the American Miners' Accident Association, Indianapolis, Ind., writes:**

"I can honestly and truthfully say I am a new person. I have more friends than I really expected I could have. Everyone who has known me says that a wonderful change has come over me in the last six months. It's all due to the Dickson School of Memory."

## Perfect Your Memory and You Can Command What Salary You Will

Your salary—what it is today—what it will be tomorrow—depends very much on your memory. Tricky memories—wandering minds—unable to grasp detail—have thwarted thousands in their battle for success—have held them down to bare living wages—working long hours with slight prospect of advancement—subordinates for life.

## The Ability to Concentrate, to Think and Express Yourself Clearly Means Everything to Your Success

America's men of power—in business, social or public life—are uniformly men of **trained memories**. Train your memory properly and you will find yourself able to concentrate absolutely on matters at hand—to think and speak connectedly—to develop self control, to overcome self consciousness—to make your **PERSONALITY DOMINATE**. Think what this means—a better position—bigger pay—social and business success—the **EFFICIENT LIFE**.

## Give Me 10 Minutes a Day and I Will Give You a "Steel Trap" Memory

That is all I ask—just ten minutes a day for a few weeks and I will train your memory just as I have trained the memories of 50,000 others. I will make your mind an infallible classified index from which you can instantly select facts, figures, faces, arguments. No matter what your age—your education—your vocation—your place of residence—I can make you "forget proof"—can train your memory for **SUCCESS**.

## Special Offer! "How to Speak in Public"—FREE!

For a limited period I am offering "How to Speak in Public," a de luxe edition, handsomely bound book—regularly priced at \$2.00—FREE to every student enrolling in my course. Full particulars of this unusual offer—together with a copy of my famous Memory Test and my remarkable book "How to Remember" will be sent FREE—simply for the mailing of the coupon or a postal. This is **YOUR** opportunity—mail it **NOW**.

## The Public Speaker



**Carl F. Schader, one of California's biggest men, writes:**

"I have been improved physically and mentally beyond my own expectations by the continued study of your course. Every business man, especially those called upon to talk at Chambers of Commerce, realty boards, advertising clubs and other meetings should take your course. I unhesitatingly recommend it to my many friends."

## In Social Life



**Roland Miller, of New York City, writes:**

"What I have gotten from your method has advanced me both socially and financially and I feel it my duty to tell you of these excellent results."



## The Key To Success

## Stop Forgetting

**Prof. Henry Dickson, Prin. Dickson School of Memory 705 Hearst Bldg., Chicago, Ill.**

Please send me free of charge and without obligation your booklet, "How to Remember"; also your remarkable copyrighted "Memory Test." Give me facts on your special offer of a free copy of "How to Speak in Public."

Name.....

Street and No.....

City.....State.....

# ELECTRICAL ENGINEERS

## Earn \$125 to \$250 a Month

The demand for Electrical Engineers at \$125 to \$250 a month far exceeds the supply. Engineering and power companies everywhere are searching for specially trained men. No previous experience necessary to take up this interesting work. Decide to fit yourself for one of these high-salaried positions.

The **American School** will train you to be a well-paid electrical worker in a short time at small expense. Our staff of practical engineers will give you individual instruction and advice. You can start in right now to prepare yourself for a better job and bigger pay.

**Earn While Learning** No need to give up your present occupation. We train you at home—solely by correspondence—as we have successfully trained thousands of others in the past eighteen years. Pocket-size textbooks, prepared by famous electrical experts, enable you to study anywhere—at any time. Papers examined and corrected only by experienced technical graduates.

### \$800 to \$2400 in Three Years

"The work I did with you advanced my salary from \$800 to \$2400 in three years."—**RUDOLPH F. KOORN, Dorchester, Mass.** (Graduate, Electrical Engineering.)

### Made Chief Electrician

"About two months ago I was appointed Chief Electrician of the Schenectady plant of the American Locomotive Co."—**L. A. WARREN, JR., Schenectady, N. Y.** (Graduate, Electrical Engineering.)

## Free Book Coupon

American School of Correspondence, Chicago, U. S. A.

Without any obligation on my part, please send me your Free Book and complete information regarding a course in  Electrical Engineering  Telephone Engineering  Hydroelectrical Engineering  Power House Superintendence  Wireless Telegraphy. Pop. Mech. 4-16

NAME.....

ADDRESS.....

## Electrical Book FREE

Send the coupon for your copy of our 56-page Free Book. Tells how easy it is to master Electricity, and gives full particulars regarding the course you are most interested in. **Don't hold back because of the money. The cost is small, and you can pay for your instruction as you progress—in small monthly installments.**

Mark and mail the coupon today. This is a wonderful opportunity to get into a profession that pays big money. No obligation in sending the coupon. **Mail it now!**

**AMERICAN SCHOOL OF CORRESPONDENCE, CHICAGO, U. S. A.**

Learn to **PAINT STONES and SHOW CARDS**

I'll teach you personally by mail, 17 years' successful teaching. Big field for men and women. You can **Earn \$18.00 to \$45.00 a Week**

Scherer (Chicago) writes: "Your instruction is great. Highly pleased." Full details promptly on request

**DETROIT SCHOOL OF LETTERING**  
Chas. J. Strong, Founder Dept. 204, Detroit, Mich.



## A GOOD POSITION

with **UNCLE SAM** is most desirable. Life positions, pleasant surroundings, good pay, steady work, short hours, promotions on merit. Both sexes. No political pull. Thousands of appointments yearly. Most thorough preparation \$5. Returned if not appointed. Full information and questions used by the Civil Service Commission free.

AMERICAN CIVIL SERVICE SCHOOL

WASHINGTON, D. C.

**BE A BANKER**

Splendid opportunities. Pleasant work, short hours, all holidays off, yearly vacation with pay, good salary. Learn at home. Diploma in six months. Catalog free. **EDGAR G. ALCOORN, Pres.**

AMERICAN SCHOOL OF BANKING, 419 E. State Street, COLUMBUS, OHIO



## JEWELRY ENGRAVING

We teach you, by our new and original method of instruction, this clean, fascinating and profitable business **right at your home**, and furnish you all tools needed absolutely **free**. Write for free book to the

**WISCONSIN SCHOOL OF ENGRAVING, 5th Bldg., MILWAUKEE, WIS.**

**GET ON THE VAUDEVILLE STAGE**

I tell you how! Fascinating profession for either sex. Big salaries. Experience unnecessary. Splendid engagements always waiting. Opportunity for travel. Theatrical agents and authorities endorse my methods. Thirty years' experience as manager and performer. Illustrated book **"All About Vaudeville"** absolutely **FREE**. Send me your name and address **TODAY**.

**FREDERIC LA DELLE, Bldg. 159, JACKSON, MICH.**



# BIG MONEY in the AUTOMOBILE and Tractor Business

Learn it by the

## Sweeney System of Practical Experience in Six Weeks

The only school where you can learn by The Sweeney System. You **DO THE WORK YOURSELF**. The only school equipped with Twin Six Packard, Willys-Knight, Cadillac Eight, fourteen lathes, gear cutting machinery, seven welding plants, two vulcanizers, planers, presses, drills, etc. Full instruction in every department for **ONE PRICE**. No Tools to Buy. No Books Used. Write for **FREE \$50 Traction Engineering course offer** and new 64-page catalog showing boys at work. You can become an **EXPERT**. Earn from \$80 to \$250 a month. Be a demonstrator, motor tester, salesman, garage owner. Write **E. J. Sweeney, President, The Sweeney School, 1162 E. 15th St., Kansas City, Mo.**



## Train for a Job Like This

Don't be content to stay in a job that almost any man can fill. Prepare yourself for a position in a new profession—for a position that needs you—wants you.

There are 500,000 that need the services of Expert Accountants. There are only 2,000 certified public accountants in America. The field is unlimited; the demand many times greater than the supply; the salary far in excess of that earned in other fields.

**We  
Train  
You By  
Mail**

**Be An Expert  
ACCOUNTANT**  
At \$3,000 to \$10,000 a Year

**Your Instruction  
Will Be Under  
Direct  
Supervision of  
William  
Arthur Chase,  
C. P. A.**

—in spare time at home to qualify for one of these positions. You can advance as quickly as your time permits.

The expert accountant is the big man in the office—one of the most important factors in the conduct of any business. His knowledge of the innermost secrets of a business makes him indispensable to the boss. He is one of the first men to be consulted in all matters of management and finance and is confidential adviser in important executive affairs. His salary is anywhere from \$3,000 to \$10,000 a year. That is the kind of a position we can train you for.

Our training is made personal and individual. It takes into consideration your present knowledge or lack of knowledge and is fitted to serve your exact requirements. We prepare you from the ground up; provide complete and comprehensive training according to your individual needs from the simplest bookkeeping principles to the most advanced accounting problems. We will give you whatever training, instruction or review on the subject of bookkeeping you may personally need—and without any extra expense to you.

### Small Cost—Easy Terms

In this course all needless text-book theory has been eliminated. It is practical, directly to the point, giving you such instruction as you need in the shortest possible time. The cost is surprisingly small, and the terms so easy that you will scarcely miss the money. You owe it to yourself to learn all the facts about this course and the truly remarkable opportunities it opens up in the business world today. We have published a book which tells the whole story. Explains state examinations, state regulations, salaries paid expert accountants, etc.—also gives complete information regarding the course. We will be glad to mail you a copy free, without the slightest obligation to you. Write your name and address in the coupon, mail it and learn how quickly you can, if you will, say good bye forever to hard grinding work, long hours, low wages with little or no chance for advancement and enter a field where there is plenty of room, where you can give orders instead of take them, and draw a real man's salary. Take the first step now. Mail the coupon today.

LaSalle Extension University, Dept. 464-H, Chicago

Ex-president of the National Association of C. P. A. Examiners and Ex-Secretary of the Illinois State Board of Examiners in Accountancy, and other experts who rank among the highest. No expense has been spared to make this the easiest-to-understand, simplest to master, and most complete Home Study Accountancy Course ever prepared. It covers thoroughly every phase of Practical Accounting, Theory of Accounts, Auditing, Cost Accounting, Business Organization, Business Management, Business Laws, etc.

Hundreds of accountants, bookkeepers, clerks, cashiers, correspondents and office men in subordinate positions have developed into executives of rare ability and today are commanding handsome salaries—all because of LaSalle training. What we have done for others we can do for you.

### The LaSalle Guarantee

We give you a written agreement signed by our Treasurer that upon your satisfactory completion of the course, should you fail to pass the certified Public Accountant's examination held in any state, we will give you special instruction and help—without additional charge—until you do pass. We further agree to refund entire amount of tuition, according to our Guarantee Bond, if dissatisfied with the course.

### MAIL COUPON TODAY

LaSalle Extension University,  
Dept. 464-H Chicago, Ill.

Send at once without cost or obligation to me, your valuable book of accounting facts and full details of your course in Higher Accountancy; also advise me about Special Reduced Rate and Convenient-Payment Plan.

Name.....

Street and No.....

City.....State.....

Please Mention Popular Mechanics

# Get Into a Business that Pays Big Money

**Driving \$80 to \$125 a Month — Repairmen and Salesmen \$300 and Up!**

Lots of driving and touring jobs now open in all large cities and good chances (if you are ambitious) to start a garage, do repairing, sell cars, etc. 1,000,000 more automobiles this year than last. Every small town in the country needs a Real Expert Auto Repairman. We teach you — and we do it right — the way you would like to learn. We put you to work in overalls, with tools, on all kinds of automobiles, in a real shop and garage. Plenty of actual driving and repairing. Our method is down-in-the-grease — and out-on-the-road. No time limit — you stay till you learn thoroughly and are perfectly satisfied. Here is a chance to "Double Your Pay."

If you are out of work or dissatisfied with your present job, change now — Get into **THE COMING BUSINESS**

**NATIONAL AUTO SCHOOL** 2625 Reading Rd., CINCINNATI, O.



Write your name and address on margin of this page, tear out and mail to us — we'll send you our catalog and full information.

Study at Home

## Make \$25 to \$75.00 A Week

### As A Commercial Artist

Advertisers are in constant need of Men and Women trained in this profession. Commercial drawings often bring \$50 to \$500 each. We train you at home for this work. You learn quickly in spare time by our new easy simple method and **WE GUARANTEE A POSITION \$500 Gold Bond** backs this offer. Hundreds have become successful. We have more positions open now than we can fill. Demand for artists getting bigger. You can't waste your efforts under our \$500 Bond insurance and you are sure of a position.

Write At Once For Free Book and samples of other students work. Students whom we have trained and are now making \$25, \$35, \$50 and over \$100 a week. Perhaps you possess this talent but do not know it. We can develop it. Don't wait. Position is waiting for you. Send postal or letter now.

**SCHOOL OF APPLIED ART, 13 Art Bldg., Battle Creek, Mich.**

## Learn Faster & Better, to Play PIANO

Write today for 64-page free book, "How to Study Music." It explains the pleasures and profits of musical skill, and shows how Dr. Quinn's famous WRITTEN METHOD enables you to learn piano or organ, in your own home, at one-quarter the usual cost. Play chords at once and complete piece, in every key, within 4 lessons. Scientific and systematic, yet practical and simple. Successful in years. Endorsed by leading musicians. For beginners or experienced players, old or young. Diploma granted. 2 special terms this month. Write today. **M. L. Quinn Conservatory, Box 650 KP., Chicago.**

## Book on Law Free

Write today for our new 171-page book on "The Power of Law Training". It carries a vital and inspiring message to every ambitious man. Find out about the opportunities that await the law trained man. Find out how you can learn from masters of the law right in your own home. No obligations. The book is free.

Write today — new while we are making a special reduced price offer.

**AMERICAN CORRESPONDENCE SCHOOL OF LAW**  
9154 Manhattan Bldg., Chicago, Illinois

## Earn More Money

Reproduce Photographs of persons and scenes upon watch caps, dials, etc. Work easily done. Knowledge of photography not necessary. **TRIAL OUTFIT with directions, \$2 postpaid** — Contains enough chemicals to make 15 reproductions (watch cap size) that you should sell from \$1.50 to \$2.50 each. Satisfaction guaranteed. **ORDER TODAY.**

**American Arts & Crafts Company, Dept. D1, Boston, Mass.**

## Drafting will Promote You!

Great demand for trained men. Your spare time is enough to master Architectural, Mechanical, Electrical or Structural Drafting, Plan Reading, Estimating, etc. Send at once for our new book — its free!

This **FREE** **CHICAGO TECHNICAL COLLEGE**  
1050 Lake View Bldg., Chicago, Ill.

## Do You Like to Draw?

**Cartoonists Are Well Paid**

We will not give you any grand prize if you answer this ad. Nor will we claim to make you rich in a week. But if you are anxious to develop your talent with a successful cartoonist, so you can make money, send a copy of this picture, with 5c in stamps for portfolio of cartoons and sample lesson plate, and let us explain.

**The W. L. Evans School of Cartooning**  
821 Leader Bldg., Cleveland, O.



## WIRELESS TELEGRAPHY

Our new practical system of wireless telegraphy will enable you to telegraph to your girl in the next house, or down to the barn, or anywhere that is not too far away. The outfit consists of two complete instruments and directions which include Morse Code. All by mail for **15c**

**ROYAL NOV. CO., Box A, So. Norwalk, Conn.**

## WANTED

**RAILWAY MAIL CLERKS**  
**\$75 to \$150 a month for life**

**OVER 230,000 U. S. GOVERNMENT POSITIONS ARE OPEN TO COMPETITORS**

Many appointments are made each month

**WAR-PROOF — PANIC-PROOF — SURE-PAY JOBS**

Country residents and city residents stand the same chance for immediate appointment. Common-sense education sufficient.

Write immediately for free list of U. S. Government positions now obtainable. Don't delay. Every day you lose means the loss of just so much chance of early appointment.

**FRANKLIN INSTITUTE, Dept. K104, Rochester, N. Y.**



**COUPON**

This coupon, filled out as directed, entitles the sender to free specimen questions; a free copy of our copyrighted book "Government Positions and How to Get Them"; a free list of positions now obtainable; and to consideration for Free Coaching for the examination here checked.

... Railway Mail Clerk (\$900 to \$1800) ... Customs or Int. Rev. Pos. (\$700 to \$1800)  
 ... Bookkeeper - (\$800 to \$1800) ... Stenographer - (\$800 to \$1600)  
 ... City P. O. Clerk - (\$300 to \$1200) ... Clerk in the Departments  
 ... Rural Mail Carrier - (\$500 to \$1200) ... at Washington - (\$800 to \$1600)  
 ... Panama Canal Clerk - (\$1200 to \$1800) ... City Mail Carrier - (\$800 to \$1200)

Name.....Address.....K104

# TRAFFIC



## -Offers Big Jobs To Trained Men

The field of Traffic is the field of Opportunity for trained men today. The unparalleled business expansion resulting from the Great War has had its most direct effect on Commerce. More goods are being shipped and shipped greater distances than ever before in history. And more money is being wasted—more money lost than ever before—simply because there are not enough men—trained in Traffic to classify commodities properly—to figure routings most economically.

### More Experts Needed—Salaries of \$35 to \$100 a Week Paid

A half million shippers—railroads—corporations—manufacturing concerns everywhere are asking for men who know how to figure lowest shipping rates. Such experts can save their employers hundreds and thousands of dollars in lower freight charges. On advice furnished last October by the American Commerce Association, an Ohio manufacturer saved \$3000 on a single shipment to Vladivostok via Vancouver. Study of the A. C. A. Traffic Library Volume on Carload Minimum enabled the Traffic Manager of a Detroit Automobile concern to discover a leak that would enable them to save \$121,650 a year on only four items shipped to four distributing centers. Is it any wonder that Trained Traffic Men can almost dictate their own salaries?

#### Study Traffic!

Why not? Never was the demand greater for Traffic Experts—never has such an unusual opportunity been offered to acquire this expert knowledge. To meet just this need for more men trained in Traffic—to raise the standards of the Traffic profession every year—a group of hard-headed business men—all leaders in the Traffic field have organized the American Commerce Association. Such men as H. G. Wilson, President of the National Industrial Traffic League, J. B. Brown, Manager of the Transportation Department of the Chicago Board of Trade and several hundred other men of like calibre are backing this unusual Association. As a part of the work of the Association, an Educational Department has been formed to train men for the Traffic field. This department—through its correspondence instruction—makes it easy for you—or for any man of ambition to become a Traffic Expert. You share the knowledge of the really big men of the Traffic world—profit by their hard earned experience—benefit by their personal cooperation.

#### Join the American Commerce Association

Study our course in Traffic Efficiency in your spare hours. Our practical method of training gives the required knowledge in the shortest period of time—without sacrificing your present employment—at only a trifling expense.

**Investigate—NOW** Mail the coupon for our new 128-page book, "TRAFFIC MANAGEMENT—A NEW PROFESSION." It tells just what you want to know about the wonderful new Traffic field—a field uncrowded, and a field in which trained men can command almost what salary they will. Mail the coupon—NOW.

American Commerce Association  
The Rookery, Dept. 424 Chicago, Illinois

#### WHAT EXPERTS THINK OF OUR WORK

Mr. H. W. DeWitt, Eastern Traffic Manager of the Western Electric Company, says: "Having personal acquaintance with a few members of the Association, men whom I know to be experts, it seems to me that the American Commerce Association is better equipped with men of experience in the traffic field for the training of traffic men than any other organization, correspondence school or college which has come to my attention."

Mr. C. L. McCain, Chairman of the Traffic Line Committee representing fourteen Eastern railroads, says: "The American Commerce Association has provided a training service which appears to be the broadest, most complete tariff rate and traffic training yet devised."



## Book on Traffic—FREE

#### American Commerce Association

The Rookery, Dept. 424, Chicago, Illinois

Please send me entirely without charge or obligation, your new 128-page book—"TRAFFIC MANAGEMENT—A NEW PROFESSION"—also explain how your course in Traffic Efficiency will train me to become a traffic expert.

Name

Address

Age  Occupation

City  State

## FORGING AHEAD IN BUSINESS

**T**HIS book tells you what successful men are doing to become the leaders in business—it tells you how you can acquire the business training which will make you a leader.

More than 35,000 men in America today are using the Modern Business Course and Service of the Alexander Hamilton Institute. They are equipping themselves to *grasp* and *hold* the opportunities that are bound to come to men who are *prepared*.

Send for this book—"Forging Ahead in Business" which we will send you *free*. No matter what your position may be, it will pay you to read this book and see for yourself what the Modern Business Course and Service has done for hundreds of successful men in business.

Alexander Hamilton Institute  
190 Astor Place New York, N. Y.

## BUSH CAR

Electric Lighting and Starting

28 H. P.

112 Wheelbase



### Special Offer to You

To the readers of Popular Mechanics who apply within 30 days we will make an astounding offer that you cannot afford to let get away.

We are prepared to make you a special low price on a **BUSH CAR** through Popular Mechanics Magazine.

*Give this your immediate attention. It's worth while*

**BUSH MOTOR COLLEGE, Inc.**  
417 Bush Temple CHICAGO, ILL.

## NOW You Need a Really Good ATLAS

Never before in the World's History has an atlas been so constantly necessary to an intelligent understanding of the World's News.

### HERE IS THE IDEAL ATLAS

Hammond's Comprehensive Atlas of the World is a compact, octavo volume, convenient to handle, handsomely bound in genuine flexible leather. It overcomes the objections to large unwieldy atlases and solves the problem of

#### Large Scale Maps in a Book of Handy Size

Each map occupies two, four, six or eight pages as required, thus achieving this long sought ideal. It contains 512 pages, 256 pages of large scale maps of all States, Canadian Provinces, Countries of the World, etc., printed in four colors, showing Cities, Towns, Counties, Railroads, Lakes, Rivers, etc., all thoroughly up-to-date with

#### Special New Maps Showing the Several War Zones

Also 256 pages of text, index and compilations giving population of principal cities of the World, a comprehensive Gazetteer, World statistics, description and history of Panama Canal, latest official population of American towns, cities and counties.

#### Self-Revising After the War

Each copy contains a certificate entitling the purchaser to a supplement of maps showing the new boundaries of the Countries affected as determined by the Peace Treaties, to be mailed free within sixty days after the war is over. This supplement will bring your atlas up-to-date.

Size 9½ x 6¾ x 1¼ inches

**Price \$1.50**

Postage 15 cents extra

Get your atlas now. Use it during the great war when you need it most.

#### Return Privilege

Any purchaser who is not more than satisfied with his atlas in every way may return same and have his money promptly refunded.

POPULAR MECHANICS BOOK DEPT., 6 N. Michigan Ave., Chicago



### What This Book Teaches You

- How to overcome Timidity.
- How to conquer Bashfulness.
- How to have "nerve."
- How to demand "your own."
- How to face people you have always felt inferior to.
- How to develop Self-Confidence.
- How to deal with people on their own level.
- How to successfully face embarrassing situations.
- How to "rise to the occasion."
- How to be Forceful and Dominant.
- How to eliminate Nervousness in dealing with big men.
- How to act calmly and naturally on occasions that usually excite you.
- How to banish Fear, physical as well as mental.
- How to stop Worry.
- How to become a Man among men.
- How to get rid of Superstition.
- How to face old age calmly.
- How to maintain poise in public.
- How to assert yourself in Business as well as in the Home.
- How to develop courage to swing big deals.
- How to dominate Circumstances.
- How to defy old time habits of Hesitation.
- How to insure a healthy, virile, intrepid grade of Brain.
- How to stir into electrical activity, latent leadership qualities, which Nature has tucked into the make-up of every normal man or woman.
- How to mass the myriad cell-forces of your Mind into a strong, tearing, goal-gaining plan of conduct.
- How to break open the door to a new world of Thinking—rare in beauty, practical in application.

A complete list of contents would almost fill this page.

# Stop Letting Fear Hold You Back!

Millions of men and women are being held back from their heart's desires by the demon fear—the arch foe of success, when if they but knew how they could forever shake this devil from their heels and demand the good things of life—the happiness—which is rightfully theirs.

Are you being tied down to an uncongenial, unprofitable job because you haven't the courage to take a chance? Are you unhappy because you are constantly worrying about what is to come? Do you worry about circumstance, about what might happen it—? Or are you full of confidence in yourself—eager to meet new undertakings and conquer new fields—unconcerned—unworried—sure of the future?

## CULTURE OF COURAGE

Send No Money—Only \$3 If You Keep It

This great book is by Frank Channing Haddock, Ph. D.—the famous author of "Power of Will"—a scientist whose name ranks with James, Bergson, and Royce. It is not an inspirational book which merely admonishes you to "Destroy Your Fears" and "Be Courageous." Instead, it is a practical course in how to overcome each particular kind of human fear, physical as well as mental, to which we are all subjected. It contains actual principles, rules, methods and exercises which anyone can easily follow and become ten times bigger—ten times more successful—ten times happier than you have even dared hope.

### WILL HELP YOU

Never, we believe, has a book of more practical help been written. One man tells us how he had been out of a position for months and had absolutely lost confidence in himself until after reading "Culture of Courage" he went out and secured an excellent position the very same day.

That is only one example. Some say that it has made them self-confident and able to demand what they want, instead of whining for it hat in hand. Others say that for the first time are they able to talk to men they had always held in awe—others, that it has given them courage to take risks they dared not and they have won out—others, that they have banished superstition and fear of things formerly beyond their control—some say that they now have courage to say "no," the hardest word in the English language—and hundreds say it has given them a new grip on life. What "Culture of Courage" has done for thousands of users, among them many prominent in all fields of endeavor, it will do for you by forever loosening the hold of fear and putting in its place a brand of courage that will make you well nigh invincible.

### NO MONEY IN ADVANCE

So confident are we that once you examine this great book in your own home, you would never give it up, that we offer to send it on five days' free trial without a cent in advance. Keep it five days—look it over carefully—then if you feel you can afford to be without it, mail it back and you owe us nothing, otherwise remit \$3, the small price of this big 466-page leather bound book. Remember, no money in advance. Merely mail the coupon, enclosing business card or giving a reference today.



466 pp.  
Half Leather  
Gold Top  
Leaves

### What Readers Say:

"In it I found rules, principles and regimes which make it worth its weight in gold to me." — District Attorney Goodwin, Oil City, Penn.

"It is a 'wonder.' The more one reads it, the more forceful ideas he can draw from this storehouse." — J. F. Ellis, Pres. Nat. School of Sales'p, Minneapolis, Minn.

"It is simply magnificent; I shall highly recommend it and wish everybody could read it." — L. I. Hall, Rochester, N. Y.

"It stands absolutely at the head of anything I have ever come across; Mr. Haddock is certainly a Master Mind. As a teacher I can say that no greater good could come than the absorption from superstition this book brings about." — James Straitwell, Reynoldsville, Va.

"'Culture of Courage' is superb. It is clear, forceful, scientific, practical in every form and manner: ALIVE with the rich, the high, the ideal, the sublime. It's an inspiration from beginning to end. IT JUSTIFIES ALL CLAIMS." — F. Stanley Penner, Res. Master, Wesley College, Colombo, Ceylon.

"Enclosed is check for which send me another copy for one of my friends. Dr. Haddock's works are superior to anything I have ever read for the development of the individual. He is entirely in a class by himself." — Chas. E. Ward, D.C., Houlton, Me.

Pelton  
Pub. Co.,  
70-H Wilcox Block  
Meriden, Conn.

Gentlemen: Please send me a copy of "Culture of Courage" on approval. I agree to remit \$3.00 or return the book in 5 days.

## Pelton Publishing Co.

70-H Wilcox Block, Meriden, Conn.

Name .....

Address .....

This Complete Library of  
**LAW**  
 IN 6 HANDY VOLUMES  
 Only \$1 a Month



**"Ignorance of the law excuses no man"**

THAT'S LAW. You can't always "guess" the law. You may not have time to "study" law. Lawyers come high—especially some of them. **BUT YOU MUST KNOW LAW.**

THIS splendid little handy LIBRARY OF LAW is prepared for the average man—the business man—the doctor—the teacher—the minister—the man who works for others—the man who works for himself—the man who writes—the man who has money and the man who has not—EVERY MAN. This Library is a work to read at odd times and a reference work combined. The language is simple, direct, plain, and it covers every subject you need to know about. Here are just a few of them. "Wills"—"Mortgages"—"Deeds"—"Farm Laws"—"Landlord and Tenant"—"Leases"—"Copyrights"—"Trade Marks"—"Partnerships"—"Letters of Credit"—"Trusts"—"Corporations"—"Stockholders"—"Dividends"—"Marriage"—"Parental Relation"—"Employer and Employee"—"Assault"—"Defamation"—"Libel"—"Criticism"—"Self Defense"—"Automobile Laws"—"Patents"—"Contracts"—"Fraud"—"Damages"—"Negotiable Paper"—"Indorsements"—"Promissory Notes"—"Checks"—"Bills of Exchange"—"Bonds"—"Agents"—"Banks"—"Bankruptcy," etc. Also has complete series of "Legal Forms" of all kinds.

**HERE IS OUR SPECIAL OFFER**

14-161  
**Doubleday, Page  
 & Co.**  
 Garden City  
 New York

Send me for examination, one set of your handy LIBRARY OF LAW in six volumes bound in Buckram. If I am satisfied with the books I will send you \$1 as first payment, and \$1 a month thereafter for 5 months. But if you do not wish to keep the books after seeing them, then you may send them back at our expense. That's fair. Isn't it?

WE can't begin to tell you all about this splendid set of books, so we are not going to try. We want to send you the books themselves—the COMPLETE SET of 6 handy volumes, measuring 6 1/4 by 4 1/2 by 1 1/4 inches, so that you can examine all the volumes and decide for yourself if they are just the books you want—and need. If you decide to keep them, just send us \$1 as first payment, and \$1 a month thereafter for 5 months. But if you do not wish to keep the books after seeing them, then you may send them back at our expense. That's fair. Isn't it?

Mail Coupon Below  
 at Once

NAME \_\_\_\_\_

ADDRESS \_\_\_\_\_

**AUTOMOBILE  
 REPAIRING  
 MADE EASY**

(Just Published)

The most needed and useful book on Automobiles ever written.

By VICTOR W. PAGE, M.E.

1056 Pages

1,000 Specially Made Engravings

10 Folding Plates

Price, \$3.00 Postpaid



(Size 5 1/2 x 8 x 2 in.)

A comprehensive, practical exposition of every phase of modern automobile repairing practice. The only book of its kind. It fills a real demand.

The information given is founded on practical experience and covers everything necessary to

**Carry On the Automobile Repairing Business Successfully**

Contains special instructions on Electric Starting, Lighting and Ignition Systems; Tire Repairing and Rebuilding; Autogenous Welding; Brazing and Soldering; Heat Treatment of Steel; Latest Timing Practice; Eight- and Twelve-Cylinder Motors, etc.

A guide to greater mechanical efficiency for all repairmen. You will never "get stuck" on a job if you own this book. Send for Complete Description and Synopsis of Contents.

ADDRESS

POPULAR MECHANICS BOOK DEPT., 6 N. Michigan Ave., Chicago

JUST OUT

**OXY-ACETYLENE  
 WELDING AND CUTTING**

**ELECTRIC AND THERMIT WELDING**

By H. P. MANLY

Chief Engineer

American Bureau of Engineering

215 pages, Fully Illustrated. Cloth, Price \$1.00; Leather, stamped in gold, red edges, Price \$1.50 (each postpaid).

The extensive use of the oxy-acetylene flame in welding and cutting has created an active demand for a practical book explaining this process. In addition to the oxy-acetylene welding are included electric and thermit welding, also a chapter

on hand forging and welding. In order to make a complete book on welding, the following subjects have been included: annealing, tempering, hardening, heat treatment, and the restoration of steel.

Much practical information is given on the uses and characteristics of the various metals. Thus, in this book the manufacturer and the workman will find all necessary information and data required in handling any kind of welding.

Sent postpaid upon receipt of price by

**POPULAR MECHANICS BOOK DEPT.  
 6 N. Michigan Ave., CHICAGO**





Sailors in Winter Camp at Guantanamo, Cuba

## WINTER DRILLS IN THE NAVY

**D**URING the winter months, the U. S. Atlantic Fleet proceeds to Guantanamo Bay, on the South Coast of Cuba, where are conducted the various ship and fleet drills and maneuvers.

The sailors go into camp overlooking the bay, affording plenty of fresh sea breezes at all times. While ashore in divisions the men practice with small arms on the Rifle Range, the largest in the world. They participate in numerous shore drills, such as scaling walls, landing an armed force, artillery maneuvers, etc. Camp life is a pleasant diversion from the routine on shipboard, and adds to the interesting features of the Naval service.

While the fleet is at Guantanamo, athletics of all kinds are encouraged, especially base ball, boxing and boat races. It is at Guantanamo that the annual cup races of the Fleet are held, and the many handsome Navy trophies contested for. Moving pictures are shown nightly, and minstrel shows are of frequent occurrence.

The men return North in the Spring, bronzed and in prime health from their winter spent in the tropics. Upon arrival in home ports, the sailors are granted furloughs to visit their homes.

THE NAVY offers an attractive career to young men of good habits. If you are an American citizen over 17 and under 30, it will pay you to investigate the Navy's opportunities. Call at the nearest Navy recruiting station, and talk it over. Costs nothing to be examined.

*If there's no recruiting station in your vicinity, write to Box 70*

**Bureau of Navigation** NAVY DEPARTMENT  
WASHINGTON, D. C.

**"Just Like New—  
You Can Do It Too"**



Do your motorcycle and side car look so dull and dingy that you contemplate re-enameling? Do you know that you can save this money, and can, yourself, easily and quickly renew the original lustre? All you need is Johnson's Cleaner and Prepared Wax.

## JOHNSON'S CLEANER

really cleans, it entirely removes all stains, discolorations, scum, road-oil, tar and grease. Even those spots that are ground in—mud freckles—and surface scratches that you thought were permanent—will disappear like magic under Johnson's Cleaner. After cleaning thoroughly with Johnson's Cleaner—polish with

## JOHNSON'S PREPARED WAX

It forms a thin, protecting coat over the varnish, adding years to its life. It covers up mars and scratches—prevents checking and sheds water.

S. C. JOHNSON & SON, Racine, Wis. PA4

I enclose 10c for trial-can each of Johnson's Cleaner and Johnson's Prepared Wax—sufficient for a good test on my motorcycle.

Name .....

Address .....

City & State .....

My Dealer is .....

### *A Dust Proof Polish*

Johnson's Prepared Wax imparts a polish so hard, dry and glasslike that dust and dirt cannot adhere to it.

**Use Coupon for Trial Packages.**

*Please Mention Popular Mechanics*

# Popular Mechanics Magazine

REGISTERED IN U. S. PATENT OFFICE

WRITTEN SO YOU CAN UNDERSTAND IT

Vol. 25

APRIL, 1916

No. 4

## 1452 Monoplane Gives Germans Prestige in Air

**B**RITISH airmen operating along the western front were severely harassed by German aerial fighters during the first part of this year. The Royal Flying Corps sustained heavy losses and was out-manuevered time and again by the enemy, although previously it had held supremacy in the air with remarkable consistency. The credit for this spectacular spurt of success by the Germans is given the small high-powered Fokker monoplane. A considerable number of these craft are understood to have been used in Germany's aggressive campaign.

The machine is not of a new type, although it was recently redesigned in some particulars and developed into a

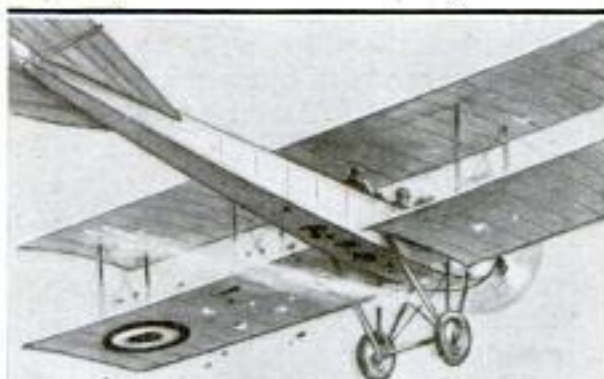

BODY OF ALLIED BIPLANE PREVENTS RETURN FIRE

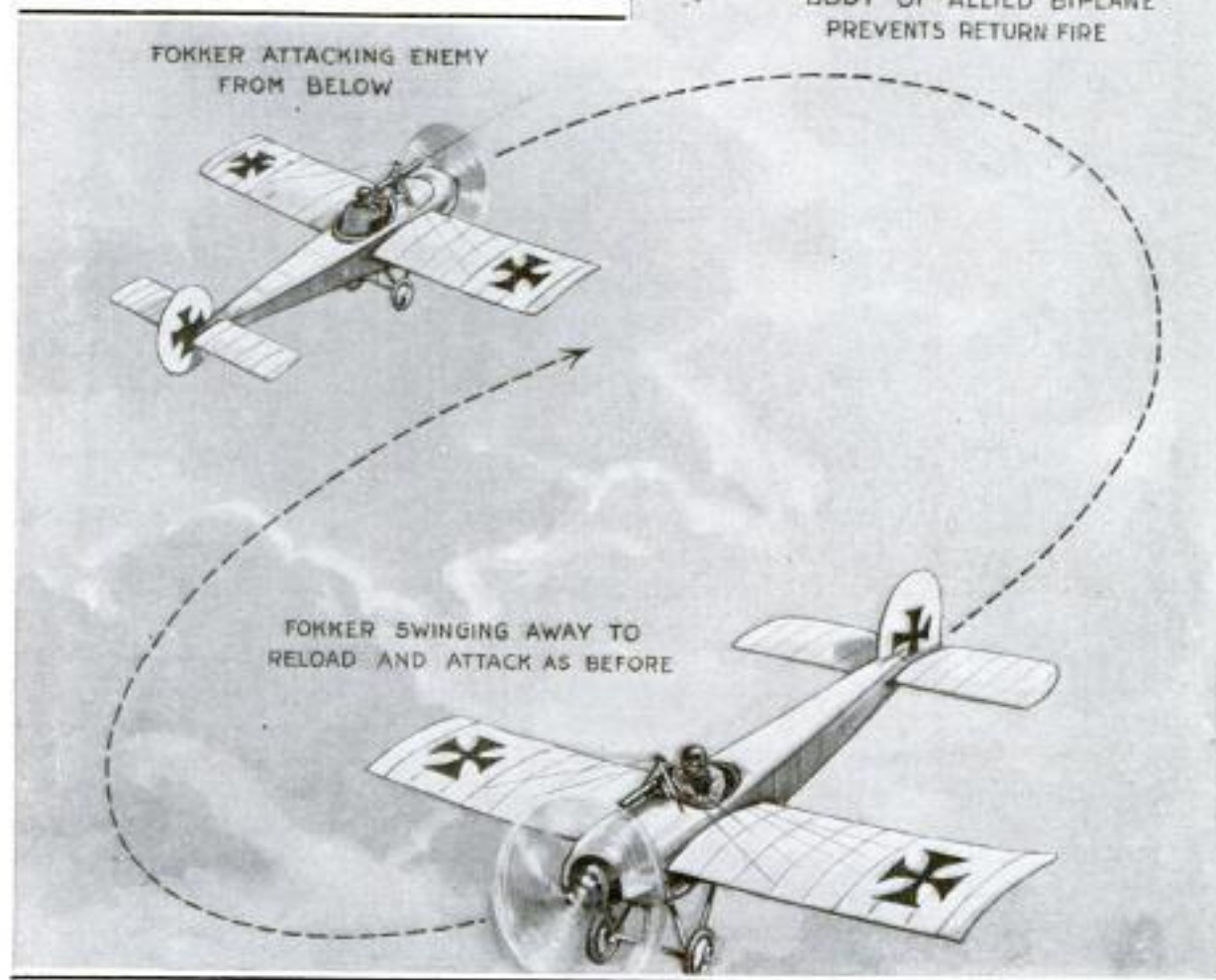

The Artist Shows Here the Method of Attack Used by Pilots of Swift Fokker Monoplanes against the Slower Craft of the Allies on the Western Front

Sphere  
Illus. London News  
Chicago Daily News 1/21/16

formidable, but unstable, craft, the details of which are only partly known. The wing span is small, amounting to about 39 feet. The engine, which is of the rotary type, develops either 150 or 200 hp., the correct figure being a matter of some debate. A speed of over 100 miles an hour and a high degree of climbing ability are given by it. This swiftness of flight, and ability of rapid ascent, for several weeks made it a decidedly serious menace to the slower but sturdier machines operated by the allies.

In appearance the machine is not greatly unlike the latest type of Morane such as was used by Garros. It is armed with a machine gun fixed before the pilot and fired "through" the propeller. Its agility enables its pilots to employ a method of attack which, for a while at least, placed the British at an extreme disadvantage. When an enemy was sighted, a driver of a Fokker climbed to a point a few hun-

dred feet beneath the former. With its machine gun spitting a stream of bullets against the bottom of the fuselage of the slower craft, it usually made a quick, straight dash from behind. In this position the offensive craft was in no danger of being a target for its opponent. By firing at the enemy from below, a German pilot was frequently able to wound or kill his adversary or disable the latter's craft. If unsuccessful in accomplishing this in the first attack, he steered his machine so as to bring it down and around to a similar position again, at the same time reloading the machine gun.

It is understood that the British now have at the front machines, some of American manufacture, which are fully as formidable and swift as the Fokker and more stable by virtue of being greater in wing spread. With these they have apparently overcome the embarrassment, which for a period was serious.

## FISH LIFTED OVER FALLS BY INGENIOUS 1306 ELEVATOR

**T**O enable migratory fish to pass such barriers as waterfalls and dams when ascending a river to spawn, the Canadian commissioner of fisheries has developed an elevator which is apparently practicable. It has been placed in service at a 24-ft. fall in the St. Croix River, N. B., and is operating successfully, according to advices.

In part, the device consists of a vertical shaft erected several feet from the falls. Guides, or walls, radiate from both sides of the structure to the opposite banks of the stream so that fish are led to it. A cage in which the latter are trapped and carried to the top of the shaft, where they are automatically dumped into a sluiceway and discharged into the water on the upstream side of the barrier, is hoisted by means of a counterpoise tank which is periodically filled with water from a supply reservoir surmounting the tower. The cage and tank are secured to the opposite ends of a cable that

passes over pulleys at the top of the shaft.

The fish compartment is provided with two doors, one at each end. When it is at the bottom of the shaft beneath the water one of these gates is raised to permit fish to enter. On the other hand, an auxiliary door on the shaft lets down and prevents fish from swimming around to the back side of the guides or into the space normally occupied by the carrier, when the latter ascends.

The operation of the device is controlled from the supply reservoir rather than by the counterpoise. When the former becomes full of water a rope leading from the lever of a ball valve releases a catch holding the auxiliary gate open at the bottom of the tower. Likewise, the ball valve having been raised by the water in the reservoir causes the counterpoise tank to fill rapidly. As the latter commences to descend and raise the fish compart-

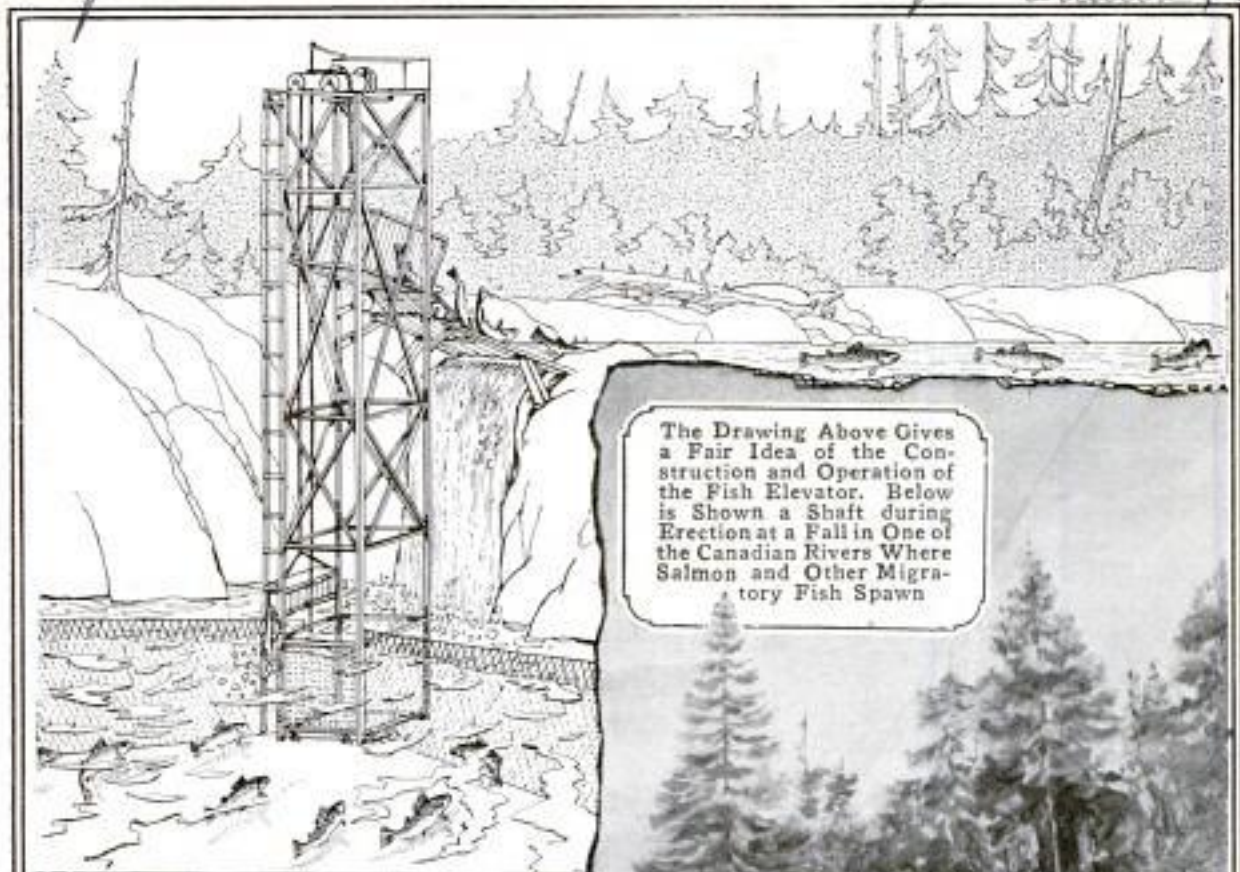

The Drawing Above Gives a Fair Idea of the Construction and Operation of the Fish Elevator. Below is Shown a Shaft during Erection at a Fall in One of the Canadian Rivers Where Salmon and Other Migratory Fish Spawn

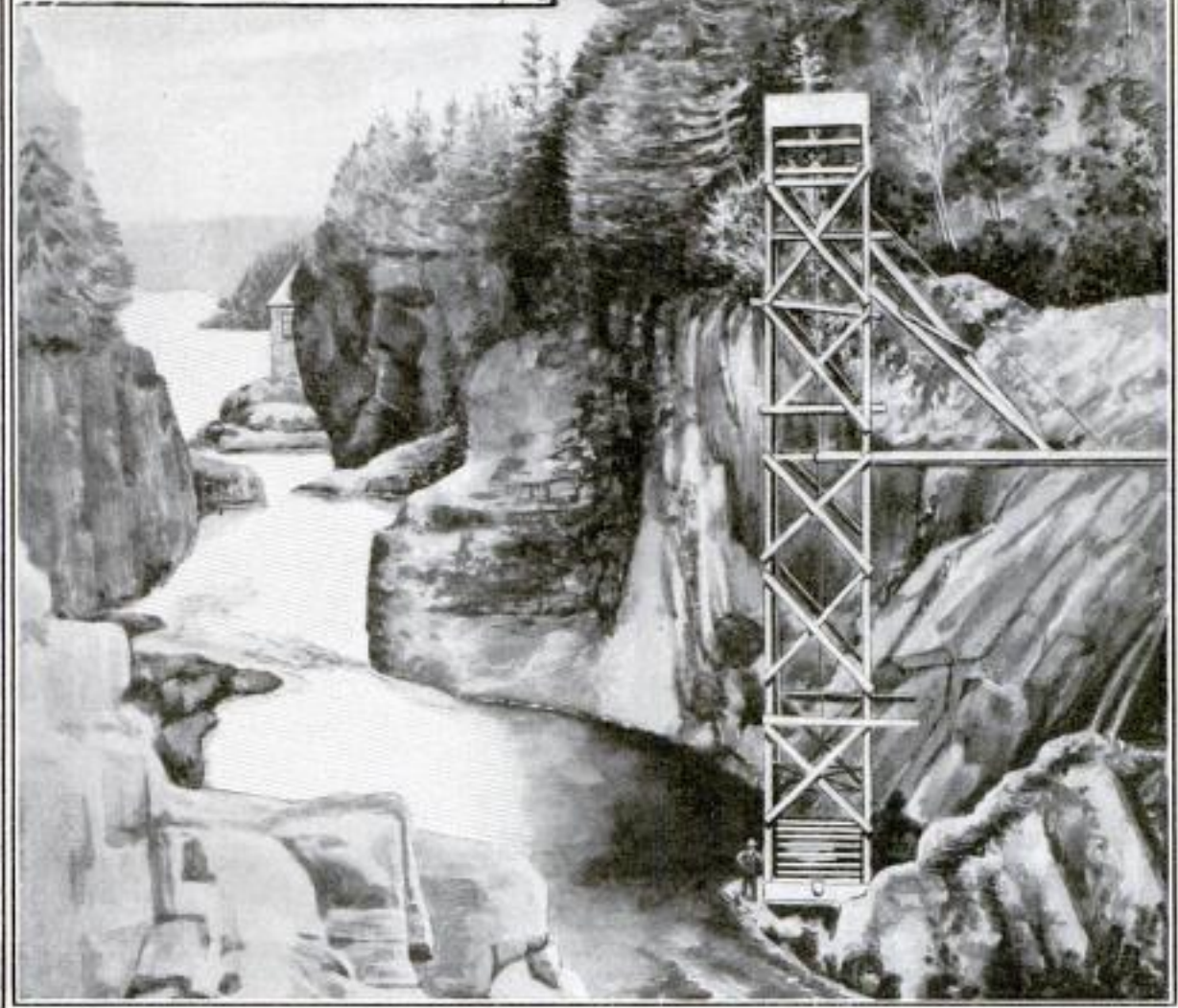

Copyrighted material

ment, the auxiliary gate, which has already been unlocked, drops into place. The door of the cage next closes, and the fish are carried to the sluiceway at the upper part of the shaft, where they are discharged. This is done when the cage is tilted by means of two rollers and a pair of curved guides which it strikes. The front gate is released at the same time and drops open.

As the propelling tank reaches a point near the bottom of the shaft it comes in contact with an arm that actuates a valve and releases the water from it gradually. When the tank is empty, the fish cage, which is heavier

than it, drops back to the river, readjusting the gates and elevating the counterpoise.

The supply tank from which water flows to the counterpoise is filled by means of a hydraulic ram. The elevator can be built to almost any required height and may be placed, if necessary, a considerable distance from a fall. In the latter instance a longer sluiceway would be needed than otherwise, but this would be about the only necessary modification. By regulating the valves the fish cage can be lifted at intervals of from a few minutes to several hours, as desired.

### HANDY SPARK-PLUG TESTER FOR MOTOR-CAR OWNER

For the motorist a convenient and exceedingly simple spark-plug tester has been introduced which is so inexpensive that it is being distributed by different concerns for advertising purposes. It consists of two copper wires and a small piece of wood with a circular hole at one end. The wires are

bent around two corners of the stick and passed through opposite edges into the small aperture, where their ends are separated by only a hair's breadth. Obviously by touching the exposed parts of the wires against the terminal cap and the base of the plug, sparks will jump across the gap between the two wires, providing, of course, that the plug is working. When a cylinder is not working properly the trouble can be located quickly in this manner.

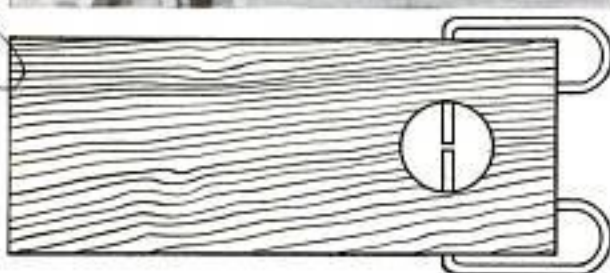
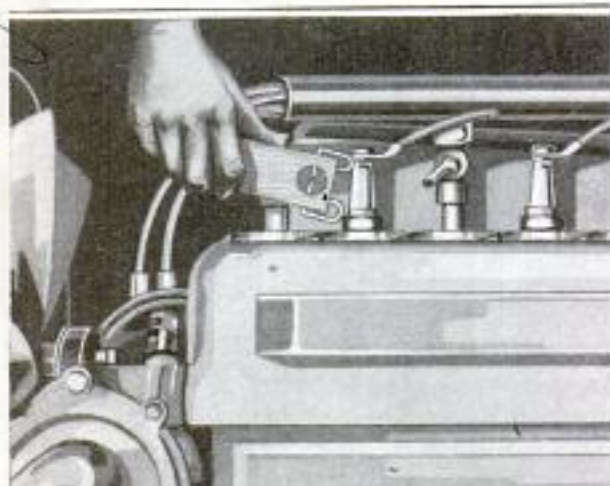

Contact is Made with the Terminal Cap and the Base of a Plug, a Spark Showing in the Gap Providing There Is No Trouble

### EL PASO BUILDING SCHOOL OF UNUSUAL DESIGN

What will be one of the most attractive high-school buildings in the Southwest when completed is now in the course of erection at El Paso, Texas. The structure is being built in the form of a right angle on a mesa situated in the foreground of Mount Franklin, where it can be seen from nearly all parts of the city. It is to be of reinforced concrete faced with pressed brick and terra cotta of a color harmonizing with the gray background formed by the mountain.

The central entrance will be on the inner side of the building at the point from which the two wings project. Broad steps will lead from it down a short terrace to the top of an imposing reinforced-concrete stadium capable of seating 10,000 persons. This will be

Chicago Evening Post advertisement

*Troot + Troot, Architects, El Paso, Texas*

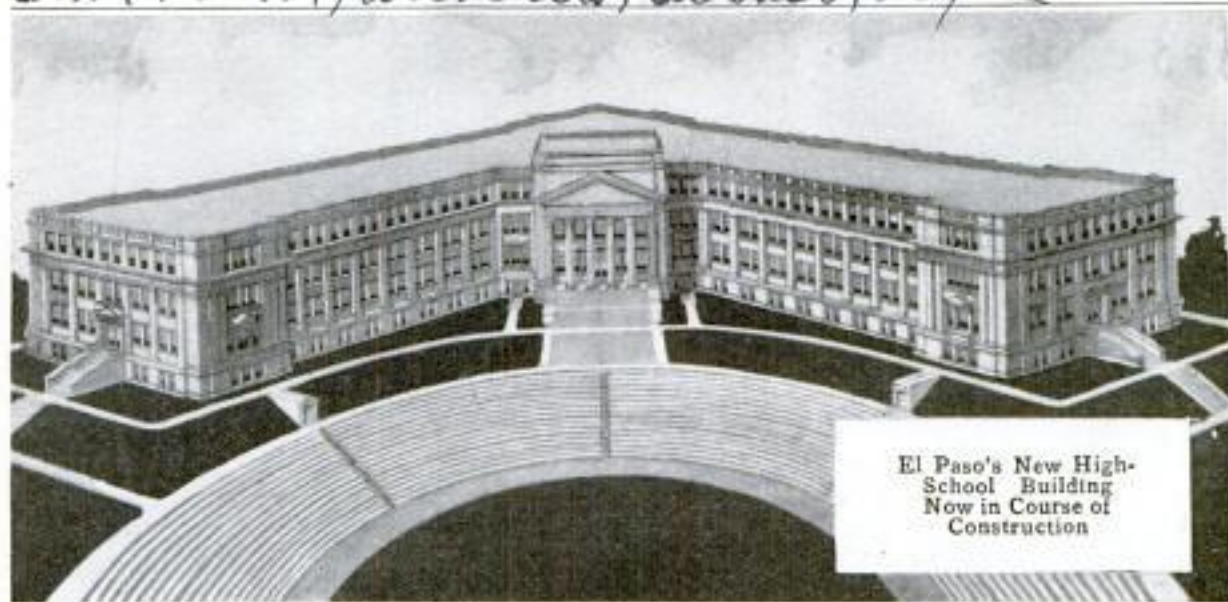

arranged with 17 tiers and be 300 by 390 ft. in size. It will provide space for a baseball diamond, football grid-iron, and a quarter-mile oval. It will be understood that the stadium is to be immediately in front of the building and bordered at one end by the two long wings of the latter. Tunnels will lead to the structure from both the young women's and men's gymnasiums located in the sub-basement.

An auditorium, which with a balcony will be capable of accommodating 1,500 persons, will be provided on the main floor of the school. On this same level there also will be a library and reading room, retiring rooms, and 16 classrooms. The physical, biological, and chemical laboratories are to be on the floor above. The domestic and manual-arts departments with shops, kitchens, and a model bungalow are to be in the sub-basement, where there also will be a swimming pool. The building will be 800 ft. in length, 83 ft. in width at the ends, and will cost \$500,000.

#### CHIFFONIER AND CEDAR CHEST COMBINED

1194 A chiffonier so constructed that what appears to be the two lower drawers is in reality a cedar chest, is now being manufactured. This convenient article of furniture is made in various woods,

the double drawer, or chest, being lined with cedar and faced with the wood of which the rest of the chiffonier is made. The large drawer is made like a cedar chest with lock corners and flush back. The space into which it fits has a dust-proof top and bottom. This chiffonier affords the protection against moths that makes a cedar chest so desirable, and so obviates the necessity of buying a separate piece of furniture which will keep out moths.



The Space for the Two Lower Drawers in This Chiffonier is Occupied by a Cedar-Lined Double Drawer Which Answers the Purpose of a Cedar Chest

Contrib: + Infr: J. D. Freese + Sons Co.  
12501 Homer St. Chicago  
all leading stores

## SMALL MULTIPLYING DEVICE 1383 CLAMPS TO PENCIL

Designed in the form of a cylinder which may be attached to the blunt end of a pencil, a novel little multiplying device which by a simple adjustment

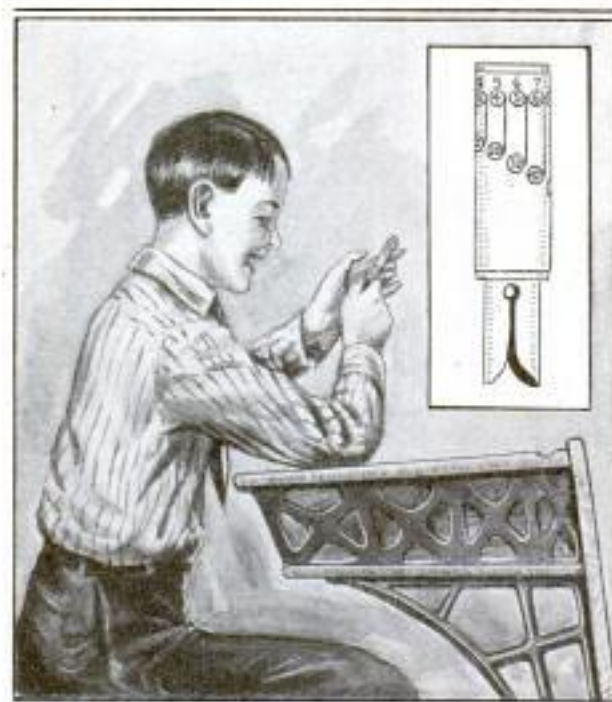

By Turning the Shell so That a Desired Multiplicand and Multiplier Are beneath Each Other, the Product of the Two is Given

will show the product of any two numbers up to 12 times 12, has been invented. Obviously it is intended for those individuals who have not mastered the multiplication table, but who are frequently required to make elementary calculations. The contrivance assists such persons, although it does not necessarily tend to teach them anything. The outer shell, which may be rotated, is provided with 12 numbered holes that extend in a ring about its circumference at the top. In a spiral which reaches once around the cylinder, starting at the top beneath the second hole and extending to the bottom immediately under the twelfth opening, is another series of apertures. Wound about a drum inside of the device is a table. The figures in the top row run consecutively from 1 to 12. The second line multiplies the first by two and reads from 2 to 24. The others

are arranged similarly so that they read from 3 to 36, 4 to 48, 5 to 60, and so on. The numbers stamped in the cylinder above the top ring of holes serve as the possible multiplicands. Correspondingly the figures in the first row on the table, which are those visible through the aforementioned holes, act as the multipliers. The product of any two numbers is found in the hole immediately below the one through which the multiplier is seen, when the cylinder has been turned so that the latter figure appears under the desired multiplicand.

## APPARATUS FOR COMBATING 1051 ENEMY AIR CRAFT

Patent rights have recently been granted to a Peruvian inventor who has developed an aeroplane destroyer so designed as to enable a gunner to determine quickly the elevation and velocity of an enemy craft and fire upon it with accuracy. Briefly it consists of a machine gun combined with a range-finding and sighting mechanism. A large camera obscura constructed of armor plate in the form of a dome, fitted with a ground-glass flooring and provided at the top with a large lens, represents an important part of the device. A pivoted arm, which extends through an opening in the steel housing, holds a machine gun at its upper end and an adjustable pointer at its lower extremity. Delineated on the camera, or image-receiving, surface is a diagram arranged with direct reference to the focal length of the lens. This consists of rectangular coördinates and concentric circles having a point in line with the axis of the lens as a common center. The graduations are made in reference to the lens' focal length so that the coördinates enable an operator to determine instantly the distance of an air craft, the image of which is projected upon the glass. The velocity of a machine is measured by timing the passage of its image across a specific space on the coördinate system. The circular system is graduated so that each division



George C. Denny 4121 New Hampshire Ave. N.W.  
Washington, D.C.

*Lima, Peru*

represents a definite elevation. A gunner knows the trajectory of his rifle for various elevations, and thus may compute mentally what allowance must be made in aiming to hit the flying machine. The gun sights are always in accurate alinement with the pointer. Thus an adjustment of the latter affects the former. In making adjustments, the pointer is placed on the ground glass in the path of the moving image and sufficiently far ahead of it to make the proper allowance for the rifle's trajectory. It is then moved at the same rate as the image of the target which it precedes. This simple operation keeps the gun in proper alinement with the air craft and makes further calculations unnecessary. The housing being constructed of armor plate, the gunner, who works from the interior of it and fires the rifle with an auxiliary trigger which is extended inside of the camera obscura, is afforded effective protection. A modified type of the apparatus is so constructed that it can be mounted aboard a ship without its efficiency being impaired by the rolling motion of the latter, it is claimed.

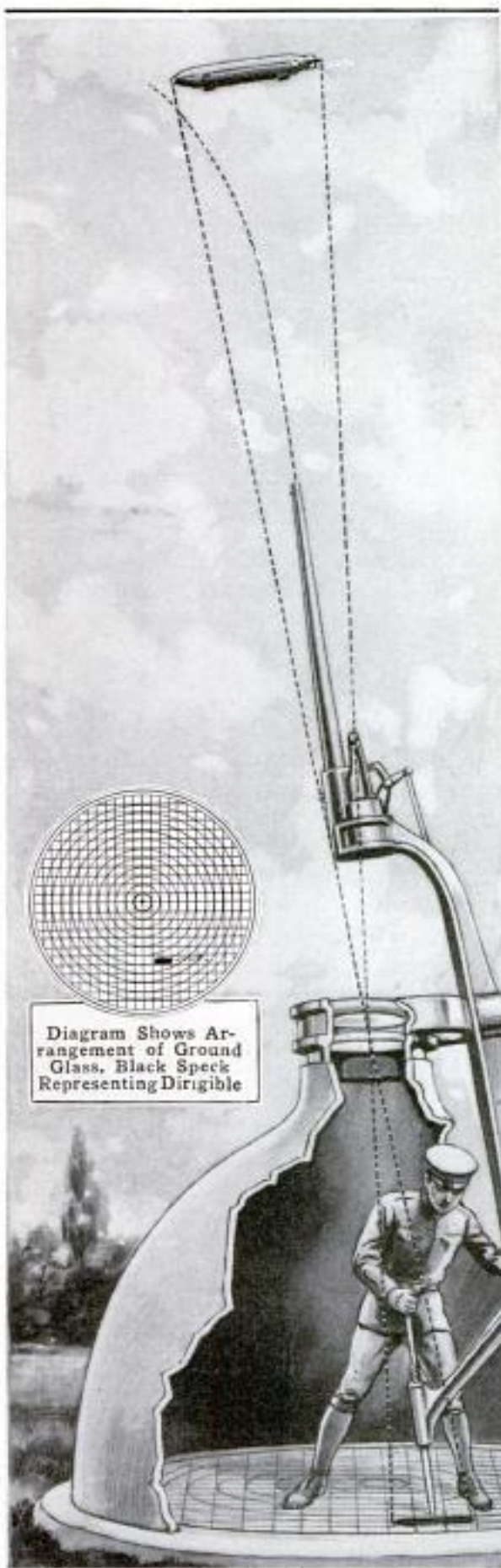

Diagram Shows Arrangement of Ground Glass. Black Speck Representing Dirigible

Below Construction and Operation of Aerial Defense Battery is Illustrated. The Pointer and Sights Are in Alinement, and by Moving the Former in Unison with Reversed Image Appearing on Glass, Gun is Made to Follow Target



*Philadelphia Inquirer*  
*Gutzon Borglum 166 E. 98<sup>th</sup> St. N.Y. City*  
1358

## CHISELED GRANITE MOUNTAIN WILL COMMEMORATE CONFEDERACY

**S**TONE MOUNTAIN, a great naked dome of light-gray granite, an hour by motor from Atlanta, will possibly be transformed into a colossal monument commemorative of the sacrifice and military endeavors made by the South during the Civil War. In the upper portion of the mountain's precipitous face it is expected to chisel a frieze representative of the once formidable army of the Confederacy. When it is completed the project will represent the most stupendous piece of sculpturing ever executed.

The financing of this enterprise is in the hands of the Stone Mountain Confederate Memorial Association, which is headed by the honorary president of the United Daughters of the Confederacy. It is estimated that \$2,000,000 will be sufficient to carry out the undertaking, and this sum is to be raised by subscription in the South. The entire façade of the mountain, enough of its crest to preserve its skyline, and an 80-acre tract at the base which will be developed into a park, have been donated for the memorial. This property will remain under the custodianship of the women, although virtually conveyed to the state.

One of America's foremost sculptors has been chosen to execute the work. His composition represents an army divided in two wings, mounted and afoot, following the contour of the mountain. Pressing over the crest and keeping to its right will be the main body composed of cavalry, infantry, and artillery. At one side of this, rounding the monolith, will appear the other force headed by a brilliant group of horsemen consisting of the figures of Lee, Stonewall Jackson, "Jeb" Stewart, the Johnstons, and probably other great southern leaders of the '60s. This granite army, carved in full relief, will extend across the side of the great rock for roughly 2,000 feet. The horsemen will doubtless average between 45 and 50 feet in height, although these and the former figures are merely approximate estimates. There will be altogether some 1,200 separate portraits,

each uniformed in the gray of the granite. It is possible that nearly all of these figures will represent men who actually fought for the South.

At the base of the mountain immediately beneath the statues of the southern leaders, and hidden from general view by a forest, a chamber 60 ft. deep and 200 ft. long will be excavated. This room will be used as a meeting place and depository by the Daughters of the Confederacy. Extending in front of it will be a colonnade of massive pillars, each typifying one of the Confederate states. Incidentally this raises an interesting point. Eleven states seceded in '60 and '61. Troops, however, were furnished to the South by Kentucky and Maryland, both of which remained in the Union. Because of this service they are now looked upon, at least by those promoting the monument, as Confederate states and will therefore be represented in the memorial.

Briefly this is the sculptor's own conception of the work, certain details of which, it is understood, are yet to be determined. The first step which the artist plans to take in executing the work, which will keep a large force of men busy for eight or ten years, is interesting. It represents the task of locating the frieze on the mountain side. This must be done with consideration for the lighting and structure of the hill. To simplify it, the sculptor plans to construct a studio, 100 ft. in length on the mountain's axis, nearly a mile from the base. This building will be provided with a window on the mountain side of sufficient size to permit him to see from the opposite wall the whole area of the hill which it is purposed to carve. The pane will be cross-lined and the composition drawn upon it to scale. By taking a step to one side or the other, the artist will be able to shift the outlined design to various parts of the mountain, while by moving to and from the window the size of the diagram can be reduced or enlarged, and the location and size of the work determined with little trouble.



The Spirit Manifested by the South and the Sacrifice Made by It during the Rebellion are Planned to be Commemorated by a Memorial Unparalleled in the Sculptural World. The Army of the Confederacy, Represented by the Figures of Some 1,200 Men, Many Mounted, is to be Chiseled in the Façade of Stone Mountain, near Atlanta. An Idea of the Stupendousness of This Undertaking is Given Herewith. The Columns of Soldiers will be Cut in Full Relief, as Pictured Above. At the Base of the Mountain will Be a Colonnade, Each Pillar Symbolic of a Confederate State. In the Middle of the Page is Shown a Cross-Lined Studio Window, Such as will be Used by the Sculptor in "Locating" His Work upon the Mountain Side

*Not Lamp, Works of General Electric Co  
Cleveland, Ohio*

**POWERFUL PHOTOGRAPHIC LAMP WITH BLUE BULB**

*1300*

*Photolite*

A new electric light designed especially for photographers has as its essential feature a 1,000-watt metal-fila-



ment lamp with a bulb of blue glass, which reduces the luminous intensity of the light without affecting its actinic qualities, that is, without affecting the rays which produce the chemical changes essential to photography. These rays are blue-green, blue, violet, and ultraviolet. The result is a slightly bluish light, appearing almost white, having only one-third the luminous

intensity but practically the same actinity as the clear 1,000-watt bulb. The lamp is mounted on a tall metal standard, on which it can be adjusted to the desired height. The frame also supports a diffusing screen. The bulb is set in a reflector.

**WYOMING HILLS FOUND RICH IN POTASH CONTENT**

*1419*

In view of the serious shortage of potash at the present time, it is interesting to learn that an abundant store of this much-needed mineral has been found in the Leucite Hills, a short distance northeast of Superior, Wyo. These hills are composed largely of igneous rocks of a peculiar character, which for some time have been the subject of considerable scientific attention. According to the Geological Survey it has been found that the formation is remarkably rich in potassium salts, holding approximately 197,000,000 tons of the product. While there is little probability of its immediate utilization, it is considered likely that some process can be worked out for extracting it which will be sufficiently cheap to warrant eventually the commercial exploitation of the mine.

*Gen. of Franklin Institute 1-1910*

*1344*



**FIRE RUINS CANADA'S PARLIAMENT BUILDING**

THIS shows the smoldering ruins of the Canadian parliament building at Ottawa, which on the night of February 3d was destroyed by fire of questionable and rather suspicious origin. The magnificent structure was one of a group of government buildings and contained a large collection of splendid paintings as well as valuable documents which were lost. The fire broke out in a room adjacent to the chamber occupied by the house of commons, which was in session at the time. Six lives were lost and several million dollars of damage done.

*Bain News Service  
Tillotson & Terrell 2118 Wablers Bldg. Chicago*

*Inventor:*

*Karl Dougan  
Co. Columbian Feed Governor Co.*

POPULAR MECHANICS

*Minneapolis, Minn.*

491

795 **POCKET-SIZE TYPEWRITER  
OF QUEER DESIGN**

Curious ideas are embodied in a cheap typewriter of pocket size recently patented by a Minneapolis inventor. The machine weighs only about two pounds and can be produced at small cost. Besides performing the ordinary functions of a typewriter it can be used on ledgers and similar record books. It has no platen, keyboard, nor heavy parts, and differs in almost every particular from the usual form of construction.

The machine is so designed that most of it can be stamped from sheet metal. It writes upon paper laid flat on the top of a desk or table. A metal plate, slightly broader than business stationery and held in position by a number of sharp pins fixed in its under surface, comprises the base of the machine. Extending longitudinally across this is a slot through which one line of typed matter is visible to an operator. Flanges turned up at the front and back of the base plate hold the carriage, which moves on four rollers, in proper alinement. In the middle of this carriage is a small, square hole, over and around which is a hopper-shaped piece with inclined walls that guide the type into it and into contact with the paper.

Unlike the usual arrangement, the type are mounted to short bars held

in carrying devices designed to be fitted to the first three fingers of each hand. Several of these type bars are in each of the carriers and geared together in pairs. On the outer face of

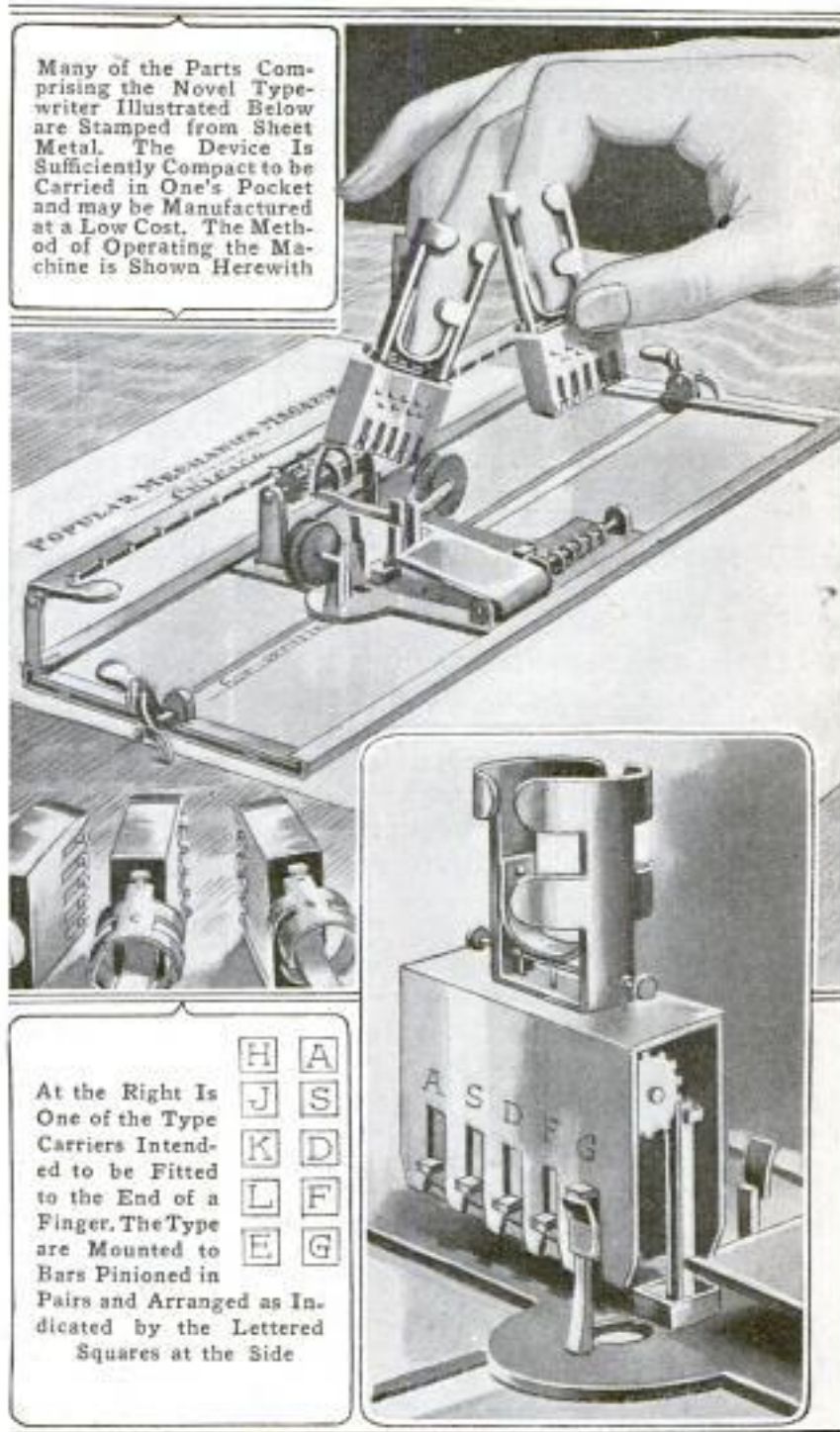

each there is a projecting stud. When one of these is rested on top of a post, provided adjacent to the hopper on the carriage, and pressure is applied by striking down with a finger, the pinion

is rotated and the opposite type bar driven down, impressing its character upon the paper.

The movement of the carriage, like that of other typewriters, is automatic. It is stepped along one space at a time as the carriers are lifted after type has been selected and projected. The depression of a plate will likewise cause the carriage to space. Instead of the ordinary ribbon, an inked pad is used. This is kept at one side of the machine so that an operator can ink the type frequently. Line spacing is accomplished by a lever arrangement which moves the whole device the proper distance down a sheet of paper, instead of sliding the latter upward. It would obviously be impossible to write speedily with the machine.

### ODD MOVING PLAN ADOPTED 1338 BY WHOLESALE HOUSE

In moving its stock to another building a wholesale dry-goods company, at Wheeling, W. Va., recently pursued an unusual scheme in order to expedite the work. The structure which it abandoned is situated immediately across the street from the new loca-

tion. This convenient circumstance prompted the construction of a temporary bridge, to connect the second-story windows of both buildings, over which the goods could be carried on trucks. The plan proved successful, for it saved the time and labor which otherwise would have been consumed in loading and unloading wagons and lowering goods to the first floor in one structure and elevating them to the second story in the other one.

### RICE-LAND CHECKER BUILDS LEVEE IN ONE OPERATION 1318

With the assistance of a caterpillar tractor, 20 miles of levees, averaging about two feet in height, can be thrown up in one day by a grader designed as a rice and alfalfa-land checker by a California agriculturist. A trailer, which forms the carriage of the implement, is triangular in shape and provided in the middle with a windlass which permits the adjustment of two long scrapers. These have a wide spread, and are held by heavy arms hinged to the opposite sides of the vehicle. Each consists of three planks, the lower one tilted inward and faced



The Stock of Goods was Moved across the Street from One Building into the Other on Trucks Operated on the Temporary Bridge

John S. Naylor Co. 14th + Main St. Wheeling, W. Va.



Close View of the Grader, Showing Its Construction. The Machine Throws Up a Two-Foot Levee at One Operation While Traveling Two Miles an Hour

with metal plates, bolted together rigidly. Because of its wide angle, the grader is able to build a good border in one operation. This, of course, is done after the land has been plowed and harrowed. In checking rice land, the acreage is divided into blocks of about 10 acres which are margined by low embankments. This is done to restrict the water to definite areas when the land is periodically flooded. The tractor used with this grader travels about two miles an hour, which is sufficient to check a very large acreage of rice land in a day.

### NOVEL BODY OF MOTOR CAR

#### 282 USED AS DARK ROOM

A motor truck, the body of which is a mammoth reproduction of a newspaper camera, has recently been put into service by a Philadelphia daily both as an advertising feature and as a saver of time for its photographers. The big camera has what appears to be a lens projecting from its rear end; large thumbscrews, such as turn films and adjust the focus, project from the sides; what appears to be a hood is fastened to the top. With the aid of a ladder a photographer in this big camera can mount to the top of the truck through an opening surrounded by the hood. At this elevation of 13½ ft. excellent photographs often can be secured while competing photographers are still searching about for means to

get themselves and their cameras above the crowd. This motor-truck body is light-proof, and is fitted up as a developing room so that films or plates may be developed and prints made during



The Camerallike Body of This Car Is a Fully Equipped Dark Room, Which Frequently Saves Newspaper Photographers Valuable Time by Enabling Them to Develop and Print Exposures While Returning to the Office. The Roof Serves as a Platform from Which to Take Photographs

the return trip to the office, thus effecting a saving of time that means much to a newspaper.

Carnegie Institute, Pittsburgh, is to have a new field house, the basement floor of which will be on a level with a new athletic field; the roof, 60 ft. above, will constitute a bridge connecting the campus and a city street.

1443

## GAY, FESTIVE SPIRIT REIGNS AT ST. PAUL



Thousands of Persons Took Part in Outdoor Sports Inouglud in during the 10-Day Winter Frolic at Minnesota's Capital. Above is Shown the Start of a Whippet Race and at the Left a Carnival Group Engaged in a Game of Pushball



The Festival was Held during the Latter Part of January and the Beginning of February, and Drew Large Crowds of Visitors. Above Appears One of the Decorated Cars Entered in the Winter Parade. At the Right is a Street Scene Which Indicates How the Gala Spirit Gripped the City





## THROUGHOUT CARNIVAL OF WINTER SPORTS



Toboggan Slide, of Which There Were Several in Different Parts of the City, Showing State House in the Background. It was Brilliantly Illuminated at Night



An Ice Wall Surrounded Hockey and Skating Rinks. Established on an Island in the Mississippi, Where International Prize Contests were Held. This Shows the Amateur Champion Fancy Skater of the Northwest Doing a Turn with His Partner. Curling, and Skiing Were Other Sports Observed

1315 TANK AND TOWER ARE BUILT OF REINFORCED CONCRETE

Reinforced concrete was used some time ago in constructing a water tank



and tower at a country place on Galveston Bay, near Seabrook, Texas. The structure rises to a considerable height and has already proved its stanchness by withstanding the hurricane which swept the gulf coast last August and razed all but two dwellings in Seabrook. The tank is perfectly water-tight and

during months of service has given complete satisfaction. The expense of erecting it was only about one-half as much as that necessary to construct a steel structure of approximately the same size. The pipes leading to and from the tank extend through the columns forming the tower.

1320 CAR ENGINE AND RADIATOR KEPT WARM BY HEATER

In an attempt to ameliorate the difficulty experienced by northern motorists who keep their cars in unheated



garages during the winter months, an electric heater has been developed which prevents a radiator from freezing and keeps an engine warm

so that it may be readily started on cold mornings. The device is approx-

imately the size and shape of a small dry cell and weighs less than a pound. It is intended to be placed beneath the hood of a car and its cord attached to any lighting socket. The heat it radiates is sufficient protection, under average conditions, for the pipes and radiator. It burns 100 watts and is provided with a durable heating element housed in a perforated shell.

1426 LOW OPERATING CHARGE AIM OF NEW ELECTRIC ARC

Experiments have been made by illuminating engineers in an attempt to develop an arc lamp which would decrease the operating cost of the present types requiring regular trimming and cleaning. That the work has been rewarded by encouragement at least is indicated by current reports. An experimental lamp has been designed which consists in part of a crystalline chamber, in the middle of which, between a pair of tungsten electrodes, is an arc. The electrodes are slightly more than an eighth of an inch in diameter and partly surrounded by an insulator intended to keep the arc reasonably close to their ends. This refractory member is furthermore meant to help keep the electrodes at a high temperature. A tungsten rod holds the upper of these to an iron core which is safeguarded against corrosion by a glass shell incasing it. The current is carried from this electrode to the upper seal by a spiral of tungsten. The arc is 1/8 in. in diameter, of tubular form, and is said to be very stable. It is surrounded by a vapor of titanium bromochloride which gives a white light of high luminosity.

*Journal of Franklin Institute, Dec. 1916, pp. 107-160*

1256 HOUSEHOLD ARTS TAUGHT IN MODEL HOUSE ON WHEELS

That the fundamentals of domestic science may be more practically and interestingly taught in rural regions, a Kentucky county superintendent of schools has constructed a model house of two rooms which is mounted on a wagon running gear and is transported

*Hughes Electric Heating Co.  
211 W. Schiller St.  
Chgo.*

# K. Davis, Dixon, Ky.  
 Designed by: A. L. Lloyd, Co. Supt. Webster County, Ky.  
 POPULAR MECHANICS  
 Dixon, Ky.



Left:  
 A Model House  
 That is Transported  
 from One Kentucky  
 Rural School to  
 Another to Aid in  
 Teaching  
 Domestic Science.  
 Below: A  
 Drawing Showing  
 the Completeness  
 of the Furnishings  
 of the Dining Room  
 and Kitchen. A  
 Class of Six can  
 be Accommoda-  
 ted in the Struc-  
 ture at One  
 Time

from school to school. The model will accommodate a class of six pupils at a time, which is ample for the needs of the average country school. A demonstrator accompanies the exhibit and in the course of from one to three weeks, which is the average stay at a school, is able to teach a good deal of simple domestic science. Removable steps lead from the ground to the screened door at the end of the structure. The first of the two compartments measures 7 by 9 ft. and is furnished with a dining-room table, chairs, rugs, curtains, etc. The other room, the kitchen, is 6 by 7 ft., and contains a three-burner oil stove with an oven, a kitchen cabinet, a sink with air-pressure water supply from a tank, and a suitable set of kitchen utensils. The floors are of hard wood, and the inside walls of fiber board tastefully painted. An invitation is extended to the residents of each district, particularly the young people, to inspect the model.

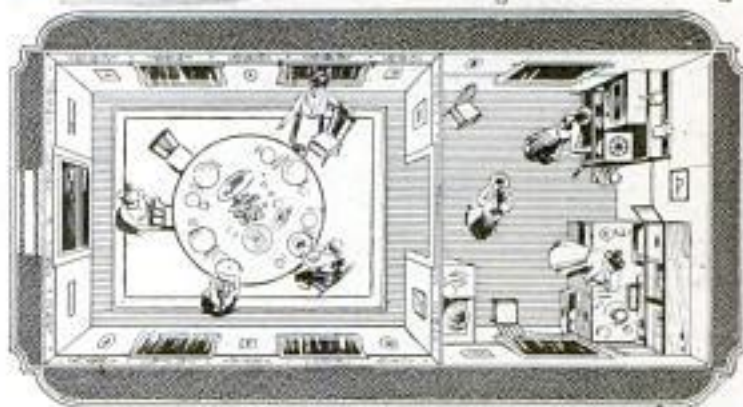

ing hot weather and also shielding them from severe, sand-laden winds which are not at all infrequent. The female angora goat is noted as an indifferent mother, and because of this, raisers as a rule make special provisions for the care of the young, as indicated here. When born, the kid is



Board Shelters for Angora Kids on Goat Ranch in New Mexico

#### INDIVIDUAL SHELTERS USED TO PROTECT ANGORA KIDS

On the angora-goat ranches of the Southwest large numbers of small, tentlike shelters, made of two wide boards nailed together at right angles, are to be seen arranged in rows within the inclosures where the kids are cared for. These low structures form individual shelters for the young animals, shading them from the sun dur-

usually smaller than might be expected. It grows rapidly, however, and reaches maturity within a short time.

ⒸThe body of a new automobile model is orange colored and the covers for the upholstery are vertically striped black and white.

Owner: W. A. Heather, Silver City, Mexico

CEMENT BRICKS ARE MADE  
1230 BY HAND APPARATUS

Cement bricks may be produced easily and at minimum expense by the use of a small, inexpensive hand machine



which has been developed of late. The apparatus turns out five sharp-edged bricks at a time and may be made to produce from 1,500 to 2,500 a day. It is especially serviceable for farmers, and others, who have buildings to erect and who frequently have sand available on their own places. In cases of this kind the bricks are produced at a cost of little more than the cement used in their manufacture. The mold is made of sheet metal, and when desired, may be fitted with special faceplates so that the finished product will have a stone finish. The machine is supported on a metal standard, and after being properly filled with concrete is turned upside down and lifted to a floor. By then drawing up handles provided at either side, the bricks are released.

Tourists motoring through Salt Lake City are invited to camp in one of the city's parks. Gas ranges have been installed there so as to make camp fires unnecessary.

With the aid of an electric illuminating outfit of quite recent invention instantaneous photographs can easily be made at night without employing flash lights. A blue-colored incandescent lamp of 1,000 cp. is mounted in a large bell-shaped, porcelain-lined reflector. This throws the light, increased by reflection to about 3,000 cp., on a circular screen 30 in. in diameter which is held in front of the housing. The cloth used in this device diffuses the rays so that there is good illumination for photographic purposes, but no intense glare projected in the face of a subject. The apparatus may be connected with an ordinary house-lighting circuit and pictures made with a shutter timed at a half second. The lamp house is supported on a tubular stand which may be adjusted to any height between three and nine feet.

MILK SHAKER RESEMBLES  
1273 SHRAPNEL SHELL

A novel reminder of the present war is a milk shaker which is designed closely to resemble a shrapnel shell. The article is of highly polished steel.



This Beverage Mixer, Resembling a Shrapnel Shell, Is of Highly Polished Steel and Brass: The Holder and Glasses Fit into the Lower Half of the Shell

Sold by: Gorham & Co.  
10 So Wab Chicago  
Providence, R. I.

*Vertical handwritten text on the right side of the page:*  
Inventor: Sha Nemick  
50 S. Wab Chicago  
Photographic Studio  
No. 149 No. Lawrence  
Rankings  
Wichita  
Kearney

A. B. Conshans, Director Van Cleven-Browne  
Hospital, 60 Board of Commerce, Detroit, Mich.  
Architects: Malcomson & Higginbotham, 403 Moffat Bldg  
Detroit 199

POPULAR MECHANICS

Detroit Journal 12-3-15

MANY DESIRABLE FEATURES

IN NEW CRIPPLES' HOME 1223

and brass; its upper half fits snugly into the lower half. An attractive metal frame, which holds four small glasses, one above the other, accompanies the mixer. The frame and glasses are designed to fit into the

A crippled children's home and educational colony in which are combined a number of features that will make it one of the most serviceable and up-to-date institutions of its kind in the country is to be erected in Detroit as a result of a recent campaign for \$200,000. The aim of those laying out the plans for this colony has been to foster home atmosphere and to eliminate as much as possible all suggestions of institutionalism without impairing the efficiency of the home.



Above: Near View of One of the Buildings of the Proposed Crippled Children's Home in Detroit. Showing Ramps and Steps

Below: The Children will Live in "Families" in the Cottages. Trades will be Taught in One of the Two Schools

lower section of the shell when not in use. The upper half only is used for mixing beverages. To fill it, the entire cap should be removed. After the ingredients have been shaken, instead of removing the entire cap, the tip may be taken off separately. Immediately below the small opening so formed is a strainer through which the liquid may be poured. If ice has been used it is retained by this strainer. The article is very ornamental for a buffet or side-board.

As a substitute for northern winter coasting, American children in the Panama Canal Zone slide down grassy hillsides on greased barrel staves.

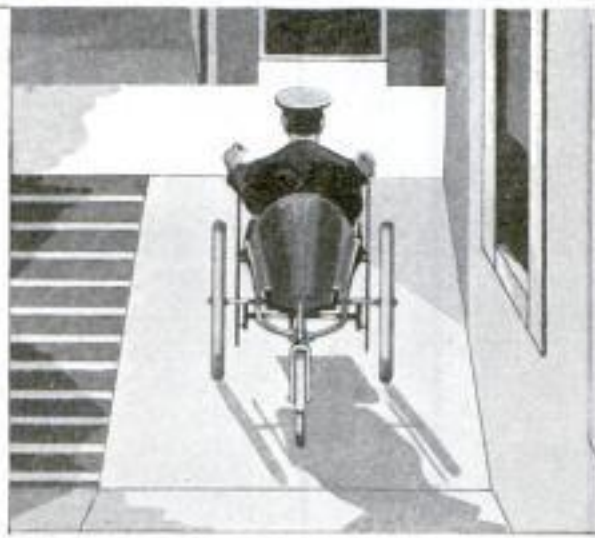

One of the Ramps, Adjoining the Steps, Which will Be a Feature of the Entrances to the Buildings

Instead of erecting one large building, a group of 13 smaller ones will be built in the midst of lawns and gardens comprising a 40-acre plot. This group will include eight cottages, each

of which will accommodate 12 children, a housemother, and a nurse. For the sake of those using wheel chairs all the rooms will be on one floor, and there will be ramps at all the principal entrances. Each of the eight "families" will have its meals served in its own dining room. The food, however, will be cooked in a central kitchen and brought on carriers through subways to the various cottages. A central two-

story building will be used for administration purposes.

It is the aim of the institution to teach each child self-support despite his or her physical handicaps. Two of the buildings will be devoted to school purposes, one for the study of the common branches and the other for manual training, trades, and arts. Set apart from the rest of the plant will be an isolation hospital.

### 1165 CAP FOR TIRE VALVE ACTS AS PRESSURE GAUGE

An automobile tire valve which acts as a safety valve has been patented. The purpose of the invention is to

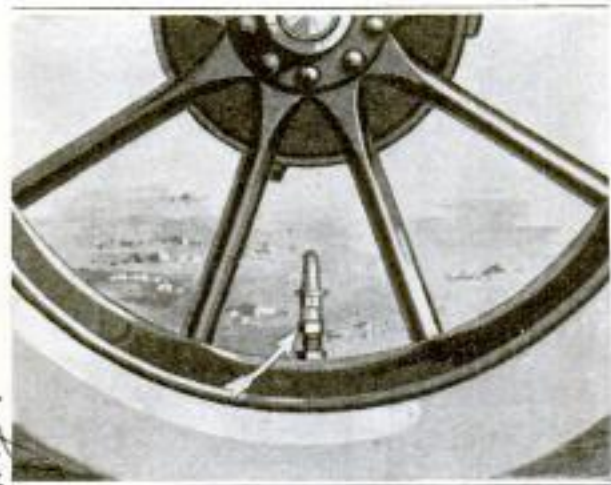

This Tire Valve Automatically Relieves Pressure in a Tire When on Account of Weather or High Speed the Pressure Becomes Too Great

relieve a tire automatically of excessive pressure caused by weather conditions or high speed. This valve is in reality an especially designed cap which fits on any standard tire-valve stem in place of the ordinary dust cap. A rubber gasket is used to make the connection air-tight. The valve can be set for any desired pressure, and when changing conditions increase the tire pressure to the point designated, a sufficient quantity of air will be released automatically to bring the pressure down. The adjustment can take place while the car is running. The device by its operation tends to prolong the life of a tire and to prevent accidents resulting from blow-outs which occur while running at high speed.

### 498 WHERE THE FERNS SOLD BY FLORISTS COME FROM

An answer to the inquiry sometimes made as to where all the ferns sold by the florists of the country come from, is indicated by the business of one company operating in the East, which regularly employs during the season more than 200 men for gathering the ferns, and which handles annually something like 50,000,000 ferns. Ferns, unlike most of the plants handled by florists, grow wild and are seldom cultivated artificially on a large scale. For this reason the work of gathering them from the moist and shaded forest lands forms one of the important features of the business of supplying the market. The actual work of gathering is not so attractive as it would seem in view of this condition. Each picker is equipped with a basket large enough to hold 5,000 ferns, and it is his purpose to fill this basket and turn it in to the packing station twice each day. The basket with its contents weighs about 40 lb., and must be carried on the shoulders of the picker over rough mountain paths, usually for a distance of several miles. In gathering the ferns the picker breaks them off near the ground and counts and ties them into bundles, each containing 100. At the packing station they are packed into boxes holding from 5,000 to 6,000, and then shipped by express to a storage warehouse in which a temperature of 28° is maintained. As needed they are taken from the warehouse, sorted, repacked, and shipped to florists in various cities. About 10 per cent of

One company: The Eastern States Refrigerator Co.  
Springfield, Mass.

POPULAR MECHANICS

501



One of the Packers Checking the Picker's Count and Placing the Ferns in Boxes for Shipment

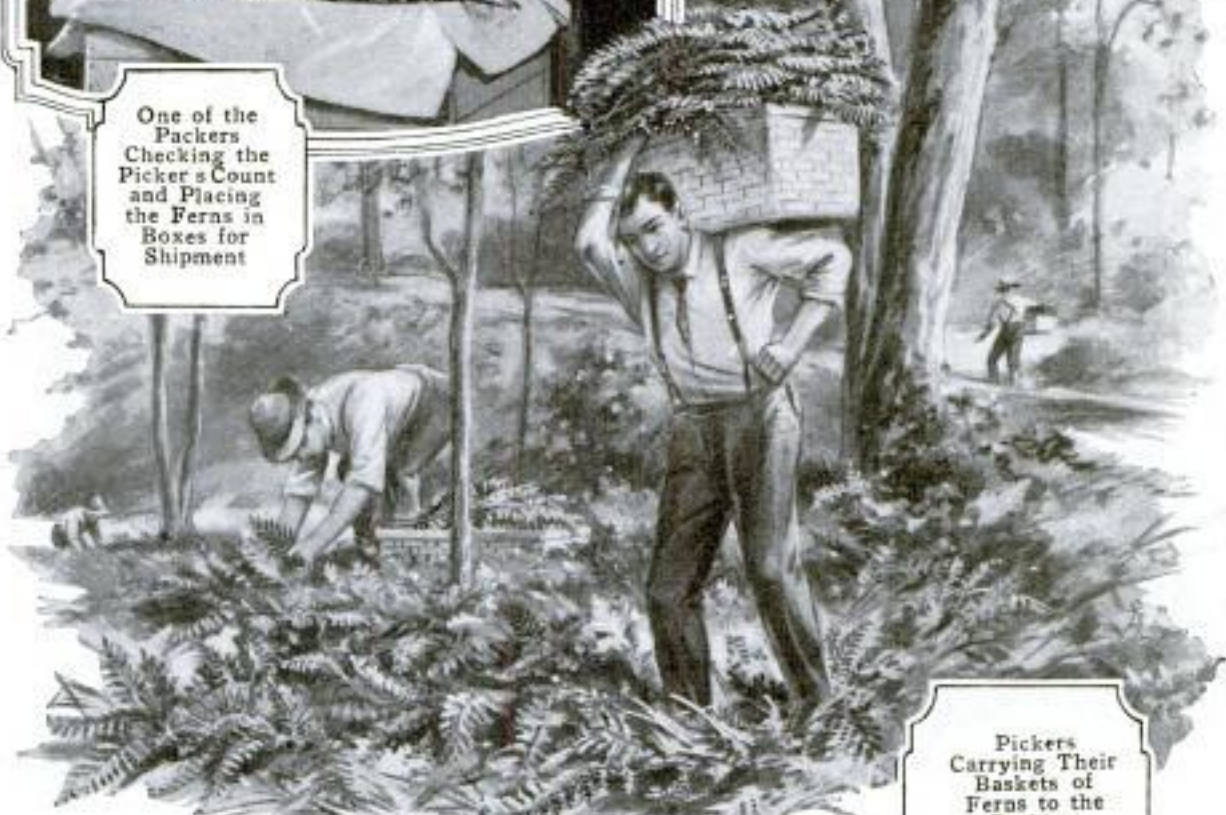

Pickers Carrying Their Baskets of Ferns to the Packing Station: Each Basket Holds About 5,000 Ferns



Scene at the Packing House Where the Ferns are Delivered by the Pickers and Prepared for Market

Located: Carl Minear farm  
Campbell, Iowa.

all the ferns gathered are waste on account of breakage and other defects. The pickers are usually paid 20 cents a thousand for gathering and delivering the ferns to the packing stations.

### WINDMILL SURMOUNTS SILO AND WATER TANK

1380

In constructing a combination silo and water tank on his farm, an Iowa agriculturist in the vicinity of Campbell



made provisions to use the structure as a windmill tower. The economy of making the building serve three functions instead of merely one is quite apparent. Silos which support water reservoirs are not uncommon, but the erection of a windmill at the top carries the scheme a step farther and likewise eliminates the expense of

providing a special elevation for this purpose alone. The structure is 12 ft. in diameter and built of tile. The part reserved for the ensilage extends to a height of 36 ft. and carries the tank, which is 12 ft. in depth and made of concrete. The roof is also of concrete construction and forms a substantial base for the windmill, which rises about 10 feet higher.

### TRADE ROUTE CHANGED BY SURVEY IN SULU SEA

1369

As a result of a survey recently made by the Coast and Geodetic Survey a new route has been charted through the Sulu Sea, which shortens by 200 miles what was formerly considered the safe route. The Sulu Sea lies to the southwest of the Philippine Islands, between the islands of Palawan and

Mindanao on the northwest and east sides, respectively, with the northern end of Borneo bordering it at the southwest. It covers an area of 50,000 square miles and is so filled with uncharted reefs and sand quays that few navigators venture on it, though it lies in a direct path extending from ports in the southern Philippines to the South China Sea and thence to the Suez Canal. Late in 1914 the wreck of two richly laden vessels in this sea proved the wisdom of the underwriters' refusal to assume liability for vessels crossing it.

The European war, however, made a route in this unfrequented region very desirable because its use renders merchantmen of warring nations less open to attack than when they are on busier lanes of travel. The new route answers the demand. A surveying party on the "Pathfinder" took soundings at frequent intervals and a track from 10 to 15 miles wide and 260 miles long was practically completed. The old course used by the Royal Spanish Mail required five changes of course, while the new route has but two. Two large steel towers with flashing acetylene lights which can be seen 14 miles have been placed at the turning points by the Bureau of Lighthouses. These form a link in a chain of lights extending from Iloilo to Balabac Straits.

### WORKING IN COLD MONTHS WITH CONCRETE

1260

Although nearly every one residing in northern cities is accustomed to seeing concrete construction carried on in the coldest part of winter, there are doubtless some in other parts of the country who still consider that such work must be executed during moderate weather. The expense of closing down large plants and suspending building operations for periods of several months each year, as well as other things, has caused many contractors to devise ways of preventing this leakage and taking advantage of the abundant supply of labor available at such a time. It is interesting, there-

Commerce Reports  
1-19-16

Andrews Bldg.  
Minneapolis, Minn.



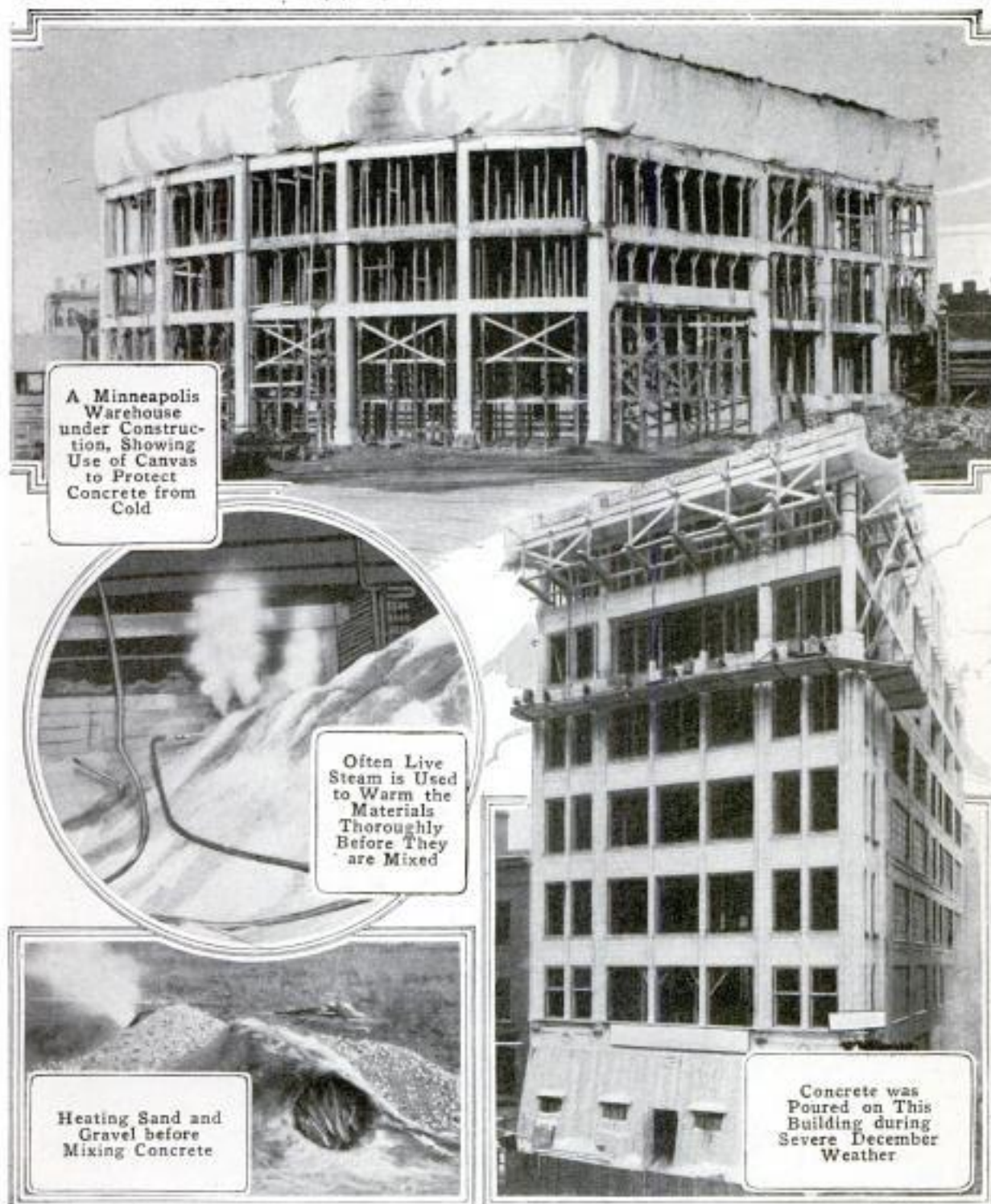

A Minneapolis Warehouse under Construction, Showing Use of Canvas to Protect Concrete from Cold

Often Live Steam is Used to Warm the Materials Thoroughly Before They are Mixed

Heating Sand and Gravel before Mixing Concrete

Concrete was Poured on This Building during Severe December Weather

fore, to notice that during the past two years nearly all of the large reinforced-concrete structures erected at Minneapolis have been put up during the winter. By taking precautionary measures to protect fresh concrete from being injured by low temperatures, a contractor is able to carry on his work in the winter as well as in other seasons, thus keeping his organi-

zation together and lowering his overhead. In mixing concrete when the weather is cold, the water and aggregate are heated, the latter by means of steam pipes or inclosed fires. After the material has been poured into the forms it is protected with straw and canvas coverings and frequently kept from freezing by the additional use of a large number of salamanders.

# Chas. A. Dorgas, Essex  
Bldg., Norfolk, Va.

County of Norfolk County, Norfolk, Va.

Commercial Research  
Bureau

POPULAR MECHANICS.

Engineering News 1/31/16  
DRIFTWOOD CATCHER BUILT  
1374 LIKE A FENCE

CAR CARRIED TO JURY  
1102 IN DAMAGE SUIT

An unusual exhibit produced in a law suit is that of a trolley car mounted



To Disprove Charges in a Damage Suit a Virginia Electric Road Shipped This Car to the Place of Trial so That the Jury might See It

on flat cars and shipped to the place of trial by the defendant, which was a Virginia electric road. The plaintiff alleged that he was injured by the trolley of this car falling on him. To disprove this charge the car in question was brought twice to the county seat where the case was being tried, that the jury might see it and judge the testimony accordingly.

A driftwood catcher has been constructed across the White River, Wash., which consists of a row of 26 concrete rectangular blocks each set diagonally to the line of the stream. From each of the upstream faces of these blocks project nine eyebolts by which as many steel cables are suspended between the blocks. Three spacing rods divide each section of this "fence" into panels. Diagonal wires give them added strength. A total of 18,000 ft. of cable was used in constructing this barrier, which is for the purpose of preventing log jams on the river that cause the water to flood over adjacent farms.

Phonographic records of Emperor Franz Joseph's voice have been made and are being sold for the benefit of a pension fund.

CLAY CASKET PRACTICALLY  
1016 F INDESTRUCTIBLE

A casket, constructed of clay, which, it is said, will withstand the ravages of time indefinitely and is impervious to water, air, and vermin, has been put on the market. The only materials, other than clay, used are metal for the handles, cloth for the lining and covering, and a pane of plate glass set in the cover, through which the interior may be viewed. The handles are molded on when the coffin is shaped. After being molded the clay is burned, polished, and glazed. A flange on the cover fits

closely into a groove in the edge of the lower portion, making it possible to seal the casket hermetically with cement. The handles may be finished with any metal desired, and likewise

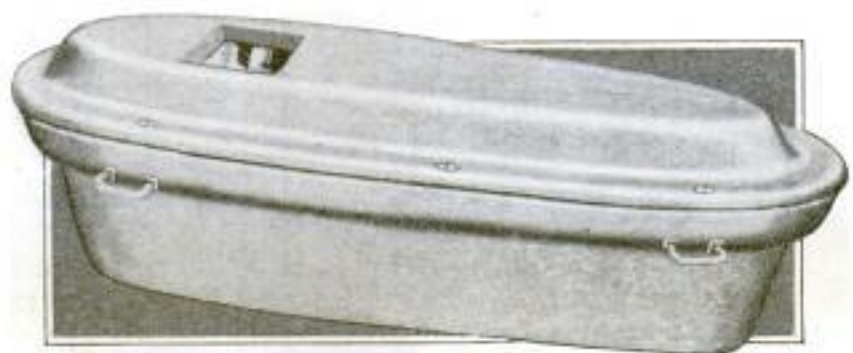

This Casket is Constructed of Clay, Burned, Polished, and Glazed. It is Said That It will Last Indefinitely

the cloth for the trimming may be of any chosen quality. When trimmed this casket resembles the ordinary coffin except that the ends are less angular.

Pat. 1143018 June 15, 1915  
Price Arnold, 928 Travis Dr., Ft Worth, Tex.  
(83 yrs old)

Copyrighted material

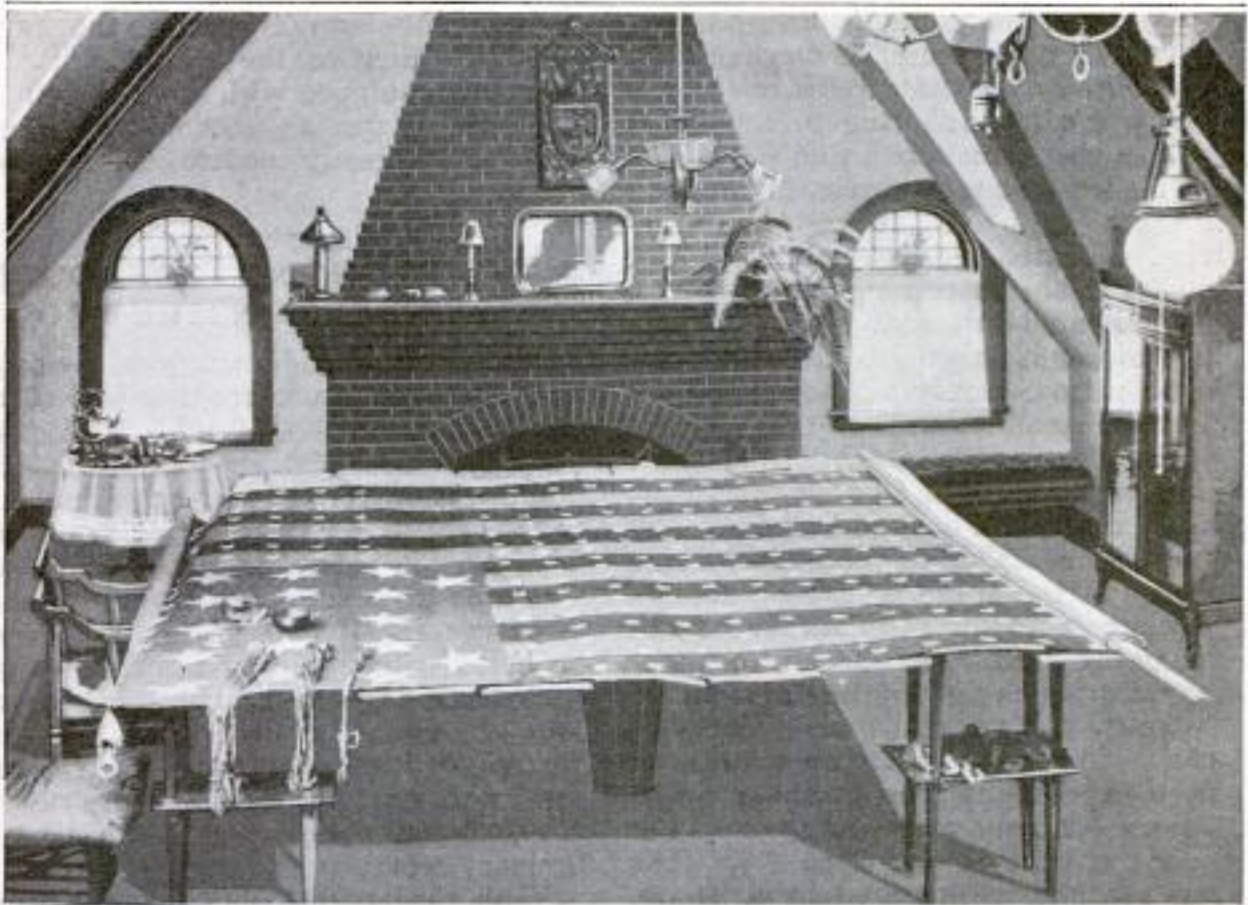

COPYRIGHT, EDYTON PHOTO NEWS CO.

General Grant's Flag Undergoing Repairs: The Small Squares of Paper are Basted at Intervals of Six Inches. As the Work on Different Sections of the Banner is Finished the Respective Squares are Removed. This Shows at a Glance the Progress Which has been Made

## 1379 PRESERVING GRANT'S BANNER AGAINST DISINTEGRATION

In order that it may be preserved for future generations, a flag which waved above General Grant's headquarters during the latter part of the Civil War is being rejuvenated in the same manner as was the original "star-spangled banner" a year and a half ago. When Lee surrendered, the flag was presented by General Grant to one of his staff officers. Some years ago it became the property of the state of Massachusetts, and while reposing in the state house gradually fell into a bad condition. This caused it to be turned over to an eastern woman who has gained a reputation as a restorer of old flags. The process of preserving it consists in backing the banner with Irish linen of a certain weave. Special stitches employed to baste it to the reinforcement give the flag a honeycombed appear-

ance when closely examined. The thread used in doing this work is dyed to match the faded colors of the banner.

## NEW PRINTING PROCESS IMITATES ENGRAVING

A device that produces printing which it is difficult to distinguish from engraving, and at much less cost than engraving, is now on the market. By this method printing is done from ordinary type or cuts with especially prepared ink. While the ink is still moist



By Baking a Powder into Ink After It is Printed and While Still Moist, This Machine Produces Lettering That Closely Resembles Engraving

Wood, Nathan & Verhulst Co.  
30 East 23rd St.  
N. Y. City.

Copyrighted material.

a powdered compound, the formula of which is a trade secret, is mechanically distributed over the surface of the letters, a portion adhering to the moist ink. In that moist condition the sheets are placed on a wire carrier and passed through an oven between two electrically heated asbestos plates, 18 in. long, the sheets coming within  $\frac{3}{4}$  in. of the heated surfaces. By this means the powder is baked into the ink, forming a raised, glossy surface that very closely resembles ordinary engraving.

The heating element used in this machine consists of 12 resistance coils which attain the desired heat in a very short time. The temperature of the oven and the speed of the carrier are regulated according to the thickness of the paper used. Sheets of thin paper can be dried as fast as they are run off the press and are ready for delivery at once. In this respect the process is more expeditious than ordinary printing, for ordinary printed matter has to be given time in which to dry. The new machine is operated by a  $\frac{1}{20}$ -hp. electric motor and may be attached to any power socket.

### MOTORCYCLE ENGINE PRIMED 9756 WITH ACETYLENE

A device recently invented makes it possible to use acetylene gas for priming the engine of a motorcycle as readily as for supplying light. It consists simply of a pipe, leading from the gas generator, which divides into two

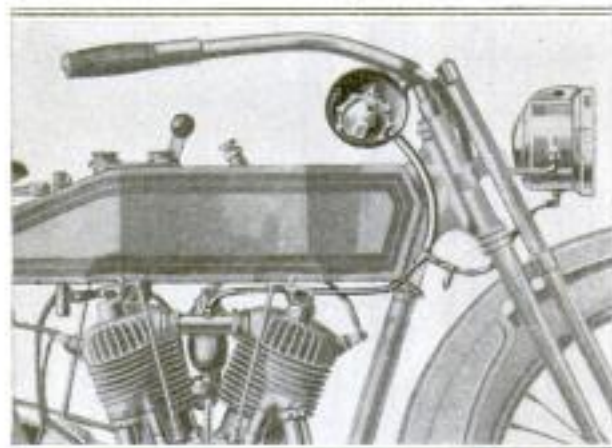

Pipe Connection for Supplying Acetylene Gas to the Lamp or Engine of a Motorcycle.

branches, one branch going to the lamp and the other to the engine. Each branch is equipped with a valve so that the flow of gas as needed for either purpose is easily controlled by the driver.

### BOSTON'S GREAT DRY DOCK NOW UNDER CONSTRUCTION 1292

Work is now under way on Boston's new dry dock, a project that will cost, all told, about \$3,250,000. The dry dock will be 1,200 ft. long over all, making it one of the largest dry docks in the world and surpassing, it is said, any other in North or South America. Previous to beginning work on the structure itself, two years have been occupied with dredging a channel and, with the aid of bulkheads, filling in an area of several hundred acres, a large part of which now becomes available for industrial purposes. More than \$500,000 has been spent in this preliminary work.

With the exception of a few of the very largest liners this dry dock will be able to accommodate any two vessels at one time. For the purpose of dividing it into two sections a special intermediate gate will be constructed 532 ft. from the entrance. The dry-dock closure will be effected by means of a floating gate, or caisson. The width of the entrance at the top will be 133 ft.; the depth over the sill at mean low tide, 35 ft., and at high tide, 45 ft. The width at the coping level in the body of the dry dock will be 149 ft. The capacity of the pumping plant will be such that the structure can be emptied in two or three hours, depending on the tide.

The foundation is of solid rock and the walls and floor are to be of concrete, the inner face of the walls being lined with granite. To prevent lifting by hydrostatic pressure the floor will be underdrained. The contract date for the completion of the work is August, 1918. This undertaking is one of a number of costly water-front improvements which have been added to Boston's shipping facilities.

*De Witt C. Webb, Director of the Port of Boston, Boston, Mass.*

*Boston Acetylene Co. Inc.  
Indianapolis, Ind.*

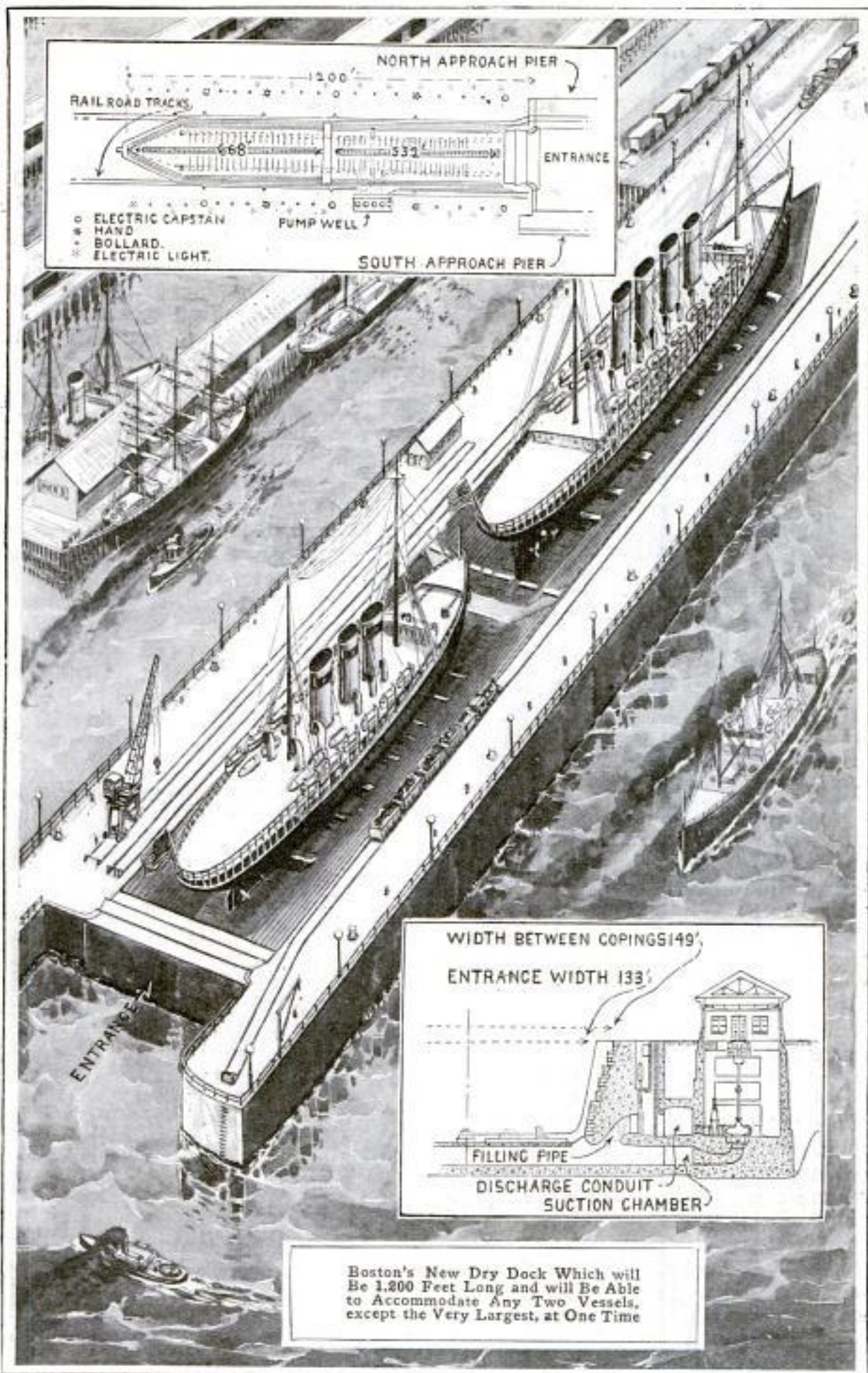

*Brooklyn Eagle*

*Edholm*  
**BASEMENTS OF TWO HOTELS  
 700 BECOME FIRST FLOORS**

When two hotel buildings were erected opposite each other on a hilly Los Angeles street a few years ago,

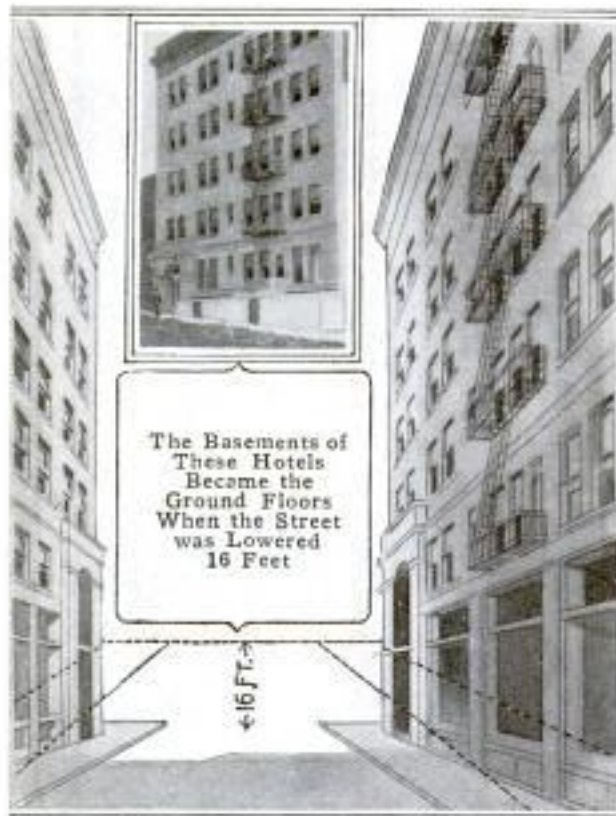

the owner had them designed so that they could be easily remodeled if the thoroughfare were ever graded to a lower level. To do this the foundations were sunk deep and the basements so arranged that they could with slight alterations be converted into ground floors. A short time ago the municipal authorities decided to make the cut and lower the street 16 ft. at this point. No sooner had the grading been commenced than the work of providing an additional story for each of the structures, by building down instead of up, was undertaken. A deep trench was excavated along the front of each hotel and the uncovered foundations faced with brick to match that above. Sections of the walls were torn out and plate-glass windows installed, while the work of changing the basements into lobbies was also begun. The ditches were inclosed as soon as

they were dug, so from the surface there was little indication of the transformation going on beneath.

**ICE-CREAM SODA PROVIDED  
 EASILY IN THE HOME /385**

For use in the home and elsewhere a miniature "soda fountain" has been devised which enables one to prepare carbonated beverages almost as readily as if provided with the facilities of the average soft-drink emporium. It consists of a small nickel-trimmed bronze valve, one end of which is fitted with a sharp-pointed stem. By means of special pliers this tip may be forced through the tin cap sealing an ordinary bottle of flavored soda. By then opening the valve and shaking the flask, the liberated gas forces the soda out with a characteristic fizz. This produces the froth for ice-cream soda and similar refreshments. When sufficient foam has been provided, the cap is lifted and the remainder of the contents of the bottle emptied. If plain soda is used, a sirup flavoring is required, but not otherwise.



The Puncture Tip of the Device is Forged through the Tin Cap of the Soda Bottle with Special Pliers, Permitting the Water to Flow Out

*Sold by Benedict Mfg. Co.  
 East Syracuse, N.Y.*  
 Copyrighted material

...from jaws; means 88  
 jaw for temporarily supporting a bottle, a hollow  
 perforating device carried by the other jaw for perforat-  
 ing the cap and allowing the contents of the bottle to dis-  
 charge through said perforating device, and means for  
 controlling the discharge of the contents of the bottle.  
 A device of the above described class comprising a  
 hinged members terminating in jaws, means car-  
 ried by one jaw for temporarily supporting a bottle and  
 the cap from the bottle neck, and a perforat-  
 ing device carried by the other jaw for perforating the  
 cap during the removal of the cap from  
 a prying movement of the bottle sup-

in Farnesboro, Wash. D. C.  
 men with Headquarters at  
 AR MECHANICS Baltimore, Md. 509

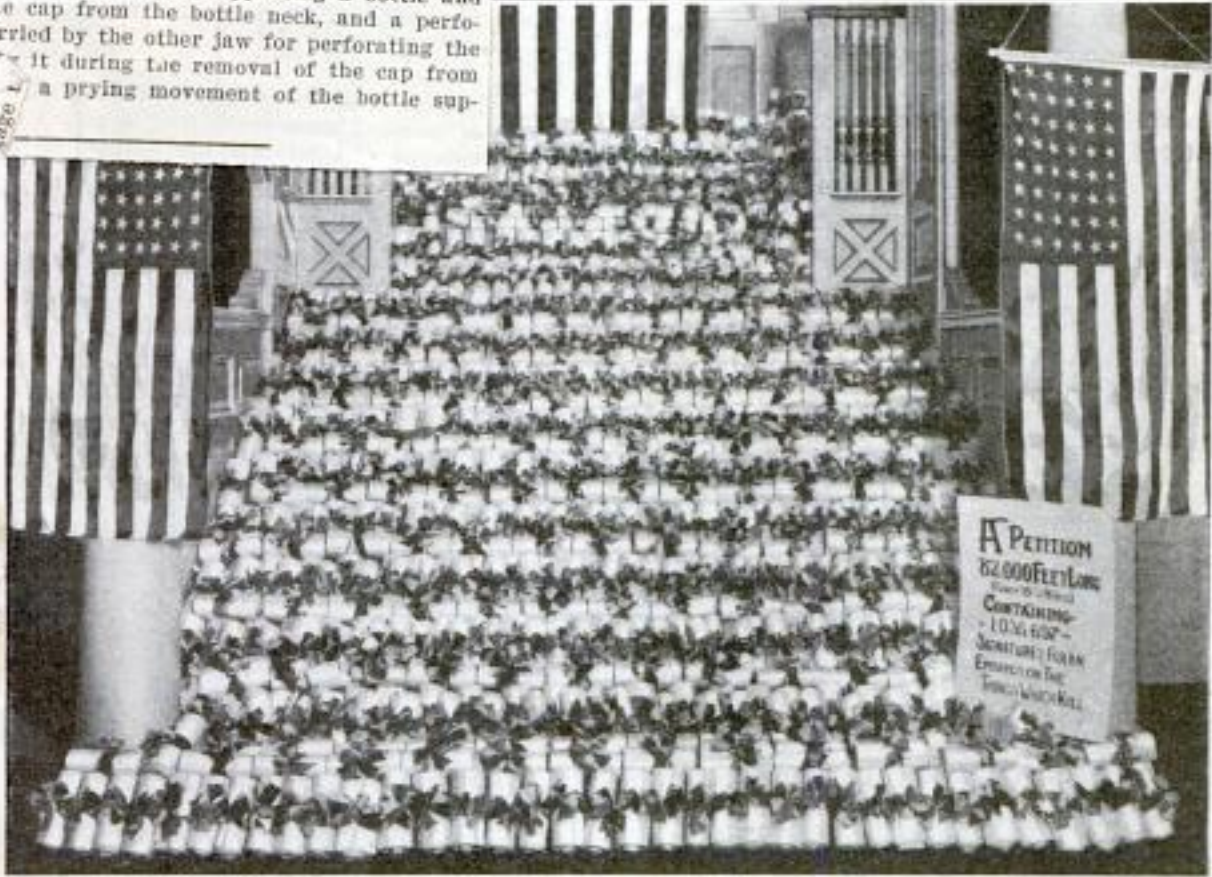

ARMS-EMBARGO PETITION LARGEST ON RECORD

WHEN a petition pleading that an embargo be placed upon all of the "things which kill" was recently sent to Congress, it represented a collection of the most voluminous documents of the kind ever received at Washington, so far as is known. If pasted together, it would have extended approximately 15 1/2 miles in length. In all it bore the signatures of 1,035,897 persons, a very large proportion of whom are of German extraction. The illustration above shows the documents, each tied with red, white, and blue ribbons, arranged on a flight of stairs. The petition was delivered to the Senate and placed before the vice-president's desk.

PARROT OF STAINED GLASS

1232 A NOVEL TRANSPARENCY

A parrot made of pieces of stained glass, leaded together after the manner of stained-glass windows, is a striking window decoration. The brightly colored bird is fastened to a wire loop, by which it may be hung from the center window sash. The bird shown is 27 in. long and the dominating colors are green, orange, and purple. Both as a transparency and with the light shining on it, but not through it, the novelty presents a very artistic appearance.

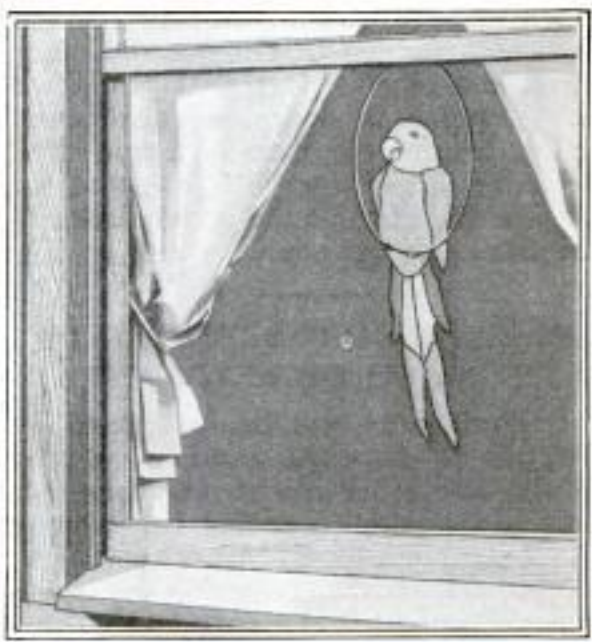

It is reported that the searchlights used at the Panama-Pacific Exposition have been bought by Russia for war use, for which, on account of their great power, they are well fitted.

This Artistic Window Decoration is Made Up of Transparent Pieces of Stained Glass Leaded Together

Owington Bros.  
 314 Fifth Ave.  
 New York

1. A d...  
 2. A de...  
 3. A d...  
 4. A d...

### MILK DISPENSER DESIGNED 1280 FOR SODA FOUNTAIN



At soda fountains, and similar places, milk may be readily dispensed from large containers by the use of a special pump which has been introduced for this purpose of late. The device has a length of  $26\frac{1}{2}$  in. and is designed to extend to the bottom of an ordinary milk can. Near the top of it is a plate which covers the opening usually provided in a cabinet, and this remains in place when the pump is lifted out for one reason or another. The exposed part is made of plated

German silver, the cup and plunger of block tin, and the rods of nickel silver. It is so arranged that it may be taken apart and sterilized regularly. When the plunger is depressed the pump draws from the bottom of a can. The capacity of the cup is 8 oz., and for large users of milk the convenience of the device is apparent.

### 1390 FLOWER-BORDERED ROADS IN REACH OF MOTORISTS

Organizations are being formed by women in different sections of the South, and other places, to promote a movement which has for its purpose the beautification of America's highways. It is the intention of these women to plant flowers of a hardy character along the roadsides in their districts, and convert what are now weed patches into banks of fragrant blooms.

*American Motorist*  
2-8-16

While well-directed organizations can accomplish much, a good suggestion of a somewhat different character is being given publicity. This amounts to an appeal to the individual motorist to do his share by procuring the seeds of plants suited for his respective region and planting them broadcast along country roads at the proper season of the year. If the thousands of car owners of the country would enlist voluntarily in a movement of this character, we could have flower-bordered roads from one end of the nation to the other within a comparatively short time.

### 1087 THERMOSTAT ADJUSTS SELF TWICE DAILY



A thermostat, with which is combined a small eight-day clock, is so constructed that, at night, the thermostat pointer is automatically moved back to the night temperature desired, and again in the morning, at the predetermined hour, is moved forward for day temperature. Attached to the main shaft of the clock is a dial making one revolution per day; it is stamped with time graduations. An adjustable double hand, moving on this dial, is used in setting the automatic apparatus, about as an alarm

clock is set. As the hand at the predetermined hour is brought to the top by the dial, it comes in contact with a small lever, tripping a mechanism that moves the thermostat pointer to the desired reading. In this way a two-fold automatic variation in temperature is secured such as an ordinary thermostat does not provide.

*Domestic Engineering* 11/27/15  
*Minneapolis Heat Regulator Co.*  
*Minneapolis, Minn.*  
Copyrighted material



1450

Women's Clothing

## RECREATION TOGS WITH SNAP FOR THE GIRL

Below: Effective Bathing Costume of Surf Satin Worn with Roomy Bloomers That Button at the Knees. The Tasseled Pompon Hat Adds a Pleasing Touch



Below Is a Comfortable Sport Suit of Light-Weight Wool Jersey Well Adapted for the Girl of Average Stature. The Collar and Cuffs are Trimmed with Leather

PHOTO BY  
UNDERWOOD  
&  
UNDERWOOD



Natty and Serviceable Is the Golf Suit at Top: The Sweater Is Green, Gold, and Brown Plaid with Scarf; the Skirt Is Rough Tweed. Tom-boy Coat of Yellow Guernsey and Swinging Velour Skirt over Bloomers Give Camping Costume at Side Rare Dash of Style. Flannel Shirt, Woolen Skirt over Leather Trousers, and Boots Comprise Fishing Apparel at Right



COPYRIGHT, INTERNATIONAL FILM SERVICE, INC.

Underwood & Underwood, New York City

Copyrighted material

**ELEVATED PLAYHOUSE BUILT  
1324 IN CLUMP OF TREES**

On the grounds of a summer home by Lake Huron beach at Sarnia, Ont., a children's playhouse has been con-



structed several feet from the ground in a cluster of trees. It is very neat in appearance, substantially erected, and a source of almost endless pleasure for the youngsters who make use of it. The house, a small shingled structure with overhanging eaves, is surrounded by a balustraded porch and supported at a height of 12 ft. on a platform firmly secured to the tree trunks. The interior is divided into two tiny rooms which are equipped with an adequate amount of miniature furniture, while small-paned windows on the different sides provide an abundance of sunlight.

**BINDING RARE OLD BOOKS**

**1424 IS INTERESTING ART**

Among the less known arts, some of which are gradually commanding more attention in this country, is that of expert bookbinding. According to an eastern exponent of this profession, the work is not one to choose as a

*Chr. Science Monitor*

2/5/16

profitable means of livelihood. It is better suited as an avocation than as a business, and should be followed for art's sake and pleasure more especially than for pecuniary purposes. The reason for this is found in several things, as for instance the time one must spend in gaining proficiency, and likewise the amount of time that is consumed in working on a single volume. Before a person can attain noteworthy skill he must give, according to this authority, probably 10 years to hard, painstaking study and labor. Furthermore, it is not infrequent that a finely bound book represents two months or more of continuous work. The patrons for the most part are wealthy persons who own old, rare volumes. They wish these to be given rich and historically correct bindings. Also the books must be rejuvenated. Hard work, much time, and true skill are required to accomplish these things. At the outset a book must be taken apart. What are known as hinges are fixed to all of the plates it contains and these are then placed in a press. The book is rounded, backed, laced, edge gilded, and head banded. The leather is pared, washed with vinegar and warm water, polished, and made ready in other ways, for tooling. Altogether there are some 80 different processes involved in executing a fine piece of work. The tools used are all modern and frequently need to be made especially for separate books.

**FIRST CASE OF RABIES IN ENG-**

**1365 LAND IN MANY YEARS**

Through the operation of rigid quarantine regulations and by the muzzling of dogs, England has been able to completely stamp out rabies. What is declared to be the first case since 1902 occurred recently in a dog that was being held in a six months' quarantine which the English law imposes on all canine pets brought into the country. It is said that Australia and New Zealand have never had any cases of rabies. Sweden, Norway, and Denmark are practically free from the disease.

*Scientific American*

1447 *Armandes*  
*sluggish*

# EXPERIENCING A ZEPPELIN RAID

By  
*R. J. Bjurstedt*

ON the night preceding that of the big September raid of Zeppelins on London there was a sort of scouting visit during which bombs were dropped in the vicinity of the Woolwich arsenal, five or six miles from the center of the metropolis. Motoring out with a friend to see the rather inconsiderable damage wrought in this vicinity, the writer was shown by the police a sheet of iron, dropped from the visiting machine, on which was stenciled in white letters about an inch in height, "We are coming back to give you English swine a good blowing up tomorrow night." This "bit of 'strafing,'" as an officer called it, was treated entirely as a joke and a bluff, but it was destined to be made good with a vengeance.

Phone messages calling out volunteer firemen, constables, nurses, and other emergency workers, began to be sent out before 10 o'clock on the following night, but the first the general public knew of the coming of the raiders was through the nearing detonations from the direction of the East End. Instantly, from tenements, hotels, and theaters, garbed in everything from bath robes to evening dress, London's millions began pouring into the streets and squares to "see the fun," and to not over one or two in a thousand of all that multitude did the raid sink home as anything more than a tremendously dramatic and highly diverting spectacle.

From where I watched at my window I saw one searchlight after another swing up and fasten on the Zeppelins, much after the way the reatas of a band of cowboys accumulate on an especially refractory steer. But here there was no entangling, no stumbling, no pause. Swiftly the raiders came on, and presently the eastern heavens were alight with the fires that had sprung up in their wake. At first there was no apparent connection between the sudden bursts of flame from the earth and the explosions, but as the machines came nearer I began to observe that the latter fol-

lowed the former at gradually decreasing intervals. Every flash of light heralded its corresponding detonation, and presently I noted that the least lurid of the flashes were always followed by the loudest explosions, due, I soon decided, to the fact that these were the explosive bombs proper—the ones loaded with the powerful "T. N. T." or trinitrotoluol—and that the brighter bursts, with the dull "knocking" booms, were the incendiaries, filled principally with "thermit" or powdered aluminum. This conjecture was quickly verified when, as the bombs began to drop within half a mile, I was able to identify the incendiaries beyond question by the trail from their lighted fuses.

By this time I was able to see that there were two machines, one following the other, but not quite in line. I was especially astonished at the comparatively low altitude at which they seemed to be flying, and, offhand, at that moment, I should probably have estimated this to have been about 2,500 feet. Later reflection has convinced me that this false impression was traceable to the fact that I had never before seen an airship of over half the size of the average Zeppelin, and that, as a consequence—there being nothing to compare with them as a linear unit—the great length of the raiders made them seem much lower than they really were. It is probable that on this occasion they were flying at about 6,000 feet, considerably lower than in the October raid following. It is revealing no military secret to say that at this time—September—London did not have a single high-powered anti-aircraft gun, such of these as had been manufactured up to that time having been rushed to the fleet, the east coast, or to France and Flanders. This state of things was, undoubtedly, known to the Germans, and they took full advantage of it in venturing nearer the earth than they are ever likely, voluntarily, to come again in the course of an English raid.

The raiders appeared to be almost directly overhead as they passed over

the vicinity of my hotel, but the fact that the nine or ten bombs dropped at that moment fell from 150 to 300 yards away, is the best proof that this structure was not menaced at any time. They were making frequent quick, jerky jumps as they passed over, and one especially strong upward leap I was able to connect with a flight of two or three "fire trails," which told of as many bombs released in quick succession. The trajectory of these lines of light indicated that the bombs traveled first, while still influenced by the impulse of the moving Zeppelin, at an angle of 30 or 40° from the perpendicular, but gradually "rounded" over until they were dropping almost straight at the instant of their impact with the earth. I distinctly felt the sharp "tug" of the air—drawing toward the bomb, be it noted—following all of the explosions within a distance of 300 yards, this being much more in evidence in the case of the T. N. T. missiles than with the "incendiaries." A few fragments of glass came down in neighboring houses, but a block nearer the explosions I could hear it falling in showers.

The fire of the anti-aircraft guns on this occasion did not begin until the Zeppelins, growing bold as a consequence of their unchallenged progress, slowed and started to signal to each other with winking lights, probably orders or queries concerning possible targets. The two big air bags appeared almost stationary when the first shots were fired, and there is little doubt that guns of any great power could have "felt" their way along to hits within a few seconds. Such shells as were fired, however, were plainly away off on length, and, apparently, rather wild on direction. The gunners available at this time were practically all untrained reservists, rating little, if any, better than the entirely inadequate ordnance they served.

As the firing began, people not immediately under the Zeppelins started hurrying to the streets and squares, the better to watch the effect of the shots, and presently, as the flash of bursting

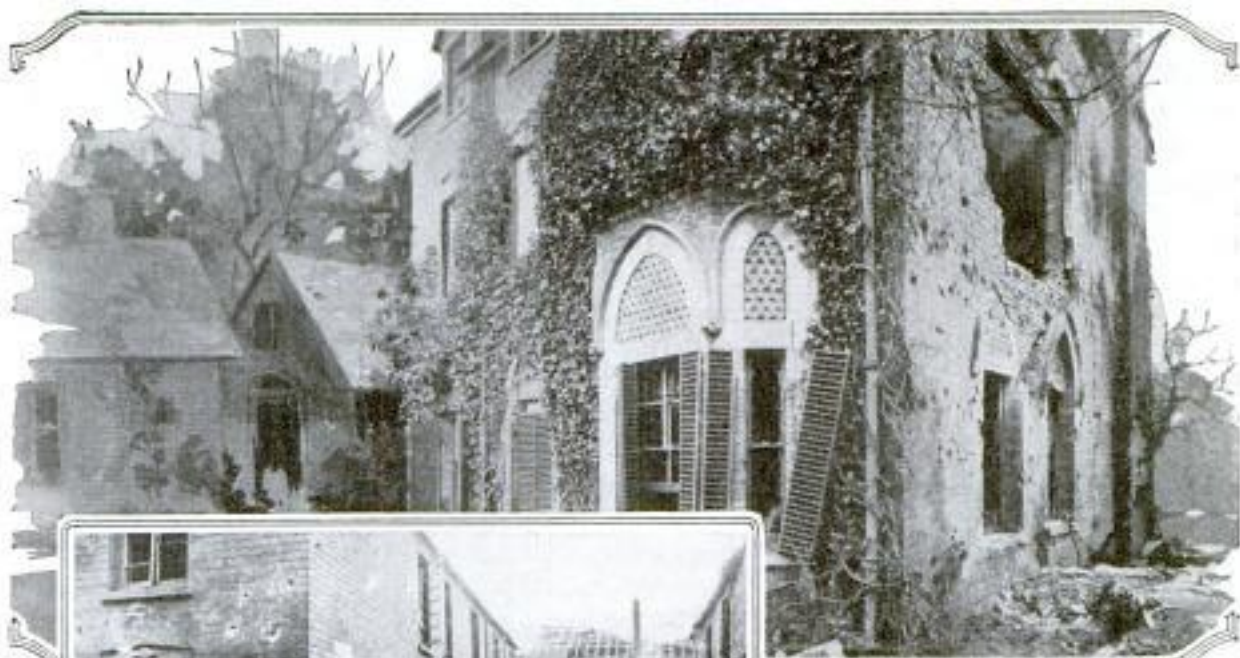

These Photographs, Just Received from Great Britain, Show Some of the Ruin Worked by Zeppelin Bombs Dropped during the Most Recent Assault There by German Aerial Forces. The Bomb Which Damaged the Residence Above and Killed a Woman and Child, Exploded at the Ground but Spent Its Greatest Force against the Upper Part of the Structure

The Roof and Second Floors of the Dwellings Pictured Above and Below were More Badly Injured than the Lower Sections, as Is Clearly Discernible



shrapnel crept upward toward their targets, a generous round of hand-clapping and cheering came from a group on a neighboring roof, much, indeed, as they might have applauded if a batter had hit to "boundary" in a cricket game. No sooner, however, did the gunners appear to be locating their marks than a cloud of white vapor began to issue from both Zeppelins, the clack of their propellers again ground forth, and, with a quick play of shadows among their shifting planes, they headed up at a sharp angle and almost seemed to leap out of sight. Half a minute later the report of a single bomb sounded away to the northeast, and the raid was over. This Parthian shot, I may add, striking between a halted motor bus and a saloon near the King's Cross railway station, killed a dozen people and wounded twice that number.

I have seen it stated that the Germans have a dense harmless chemical gas which is used to obscure a Zeppelin under fire, but I am rather inclined to believe that the white mist I observed was steam from the exhausts, and that this was also forced into the outer envelope to heat and increase the lifting power of the hydrogen in the ballonets.

The firing continued for five or six minutes without anything like a hit appearing to have been scored, and then stopped as suddenly as it began. All of the guns of the central London area were in action, and as a consequence a very lively shower of shrapnel shell and casing shortly began to descend upon several square miles of the most congested sections of the city. This steel hail drove to cover many, including myself, who had "stuck it out" during the Zeppelin bombardment, and that a considerable number of those killed received their injuries from anti-aircraft gun projectiles could be gleaned even from the closely censored account of the inquests. Unmistakable bullet marks on buildings and trees were to be seen the following day at many points remote from the "swath" of the bombs, and

several fragments of shell casing shown me were capable of inflicting far more serious wounds than was the comparatively thin piece of incendiary bomb which I picked up in a later raid. The latest London police instructions, directing those anywhere near the path of the Zeppelins to take cover until the firing is over, were doubtless prompted by a desire to avoid in the future the very considerable loss of life caused by shells fired at the raiders.

The force with which these spent missiles come to earth after their mile or two of fall may be judged from the words of a bank teller with whom I talked the day after this raid. "I live in a villa at Highgate," he said, "and during the firing an unbroken shrapnel case—probably from the big four-inch gun on Parliament Hill—came through the slate roof, the ceiling of my daughter's third-story bedroom, and went on through the floor into a hallway below. My daughter, who was watching the firing from a window, was uninjured. Half an hour later she was asleep in the very bed that had been littered by plaster from the shell case. In fact, sir, none of my family had very much less than our regular nine hours of rest as a consequence of the house being hit."

This is also an illuminative example of the matter-of-fact spirit in which the raids are accepted by the typical Londoner, and it is this spirit, indeed, which is likely to prove the one most important factor in defeating Germany's prime objective, that of forcing Britain to spend millions of money and employ thousands of men in connection with an elaborate defensive establishment.

The way in which the fires were mastered was one of the most remarkable features of this raid. For three or four miles, across the very heart of London, bombs had been dropped on an average of something more than one to the block. There were intervals of three or four blocks here and there that were untouched, but, on the other hand, several bombs often landed close



©INTERNATIONAL FILM SERVICE, INC.  
 The Paris Subway Is Clearly Visible through the Great Cone-Shaped Hole, Shown in the Foreground, Which was Dug by a Zeppelin Bomb Dropped during the Latest Attack upon the French Metropolis by the German Aerial Forces



This Shows a Five-Story Apartment Building Wrecked by a German Bomb. The Occupants, All of Whom Were Asleep at the Time of the Assault, were Killed in Their Bedchambers



A Bomb Cut This Residence Squarely in Two, Blowing One-Half of It into Small Pieces and Leaving the Remainder Standing. At the Time of the Explosion a Baby Was Asleep in the Bed to be Seen Hanging over the Edge of the Second Floor. The Child Escaped Injury

together in a single block. Probably something over half of these were incendiary bombs, and among these—because they were lighted beforehand—there must have been few failures to explode. Indeed, all of the several unexploded bombs which were shown me after each raid were of the nonincendiary type, containing either T. N. T. or picric acid. These rarely, if ever, started fires, even on exploding. From a short distance, the explosion of the T. N. T. bombs was marked by a sudden brilliant flash, while a warm, flickering, red glow always followed the duller detonation of the incendiary. If the latter struck in a street or square, the glow died down in 20 or 30 seconds; if a building, there were usually flames bursting from the roof inside of a minute or two.

At the moment the last bomb was dropped, the glow of countless fires stretched away to the northeast as far as my eye could see. Ten minutes later—when I came up again after the firing had ceased—there were only four or five. One of these was from a broken gas main in an alley, and another from a celluloid factory in the East End, which burned all night. This most creditable work was due entirely to careful previsionary measures. The London fire department was always an efficient one, and care had been taken not to weaken it by enlistments for the army. A large number of volunteer firemen had also been taken on and trained, and these were summoned by telephone as soon as the Zeppelins were reported from the coast. Five minutes before the report of the first bomb, the sound of fire engines dashing through the streets could be heard, and in this way reserves from the unthreatened parts of London were concentrated on the endangered one. It appears, also, that considerable heed had been taken of the police warning to have sand and water handy on the upper floors of all houses, and a volunteer fireman told me that, in many instances, fires were under control before the department arrived. One man, whom I helped

hobble along to a near-by hospital, had put out, unassisted, the fire in his own house, and had later sprained his ankle trying to climb a shattered stairway to help one of his neighbors. Both of these men spoke of the comparative ease with which the fires were extinguished with wet blankets.

Like all high explosives, those used in the bombs dropped on London displayed a characteristic "freakiness." A bomb which struck almost exactly in the center of Queen's Square, shattering the fronts of several hospitals, and breaking every window within two blocks, only made a hole about four feet across and three feet deep in the soft earth of the lawn upon which it dropped. Similarly, in Kingsway in the October raid, a bomb which killed or injured every passenger in a motor bus passing at a distance of a hundred feet, hardly cracked the pavement. Yet a bomb striking the same pavement 200 yards away made a hole almost big enough to drive an omnibus into, at the same time exerting enough force upward to break every pane of glass in India House, London's largest and most imposing office building. The tons and tons of plate-glass fragments falling to the sidewalk at this point literally cut to pieces several men who were passing at the moment of the explosion, their remains having been found half buried in the sharp fragments. I was at the door of a theater on the Strand when this particular explosion occurred, and the sound—half roar, half tinkle—of the plate glass falling from the great office buildings along Kingsway was one of the strangest, weirdest noises I ever heard.

It was in this district that the heaviest loss of life so far inflicted in any of the London raids occurred. The driver of the motor bus I have just spoken of was blown from his seat, across the broad sidewalk, and up against a billboard, leaving a bloody smudge across the smiling features of a popular stage beauty whose poster was affixed there. I was at this point within three minutes of the explosion,



and the dead and injured were being laid in rows along the sidewalk. Several of the trunks were dismembered, and two or three of the bodies were so limp as to suggest that most of the principal bones were shattered. The fact that practically every person on this bus was either killed or badly hurt has led me to believe their injuries resulted from being blown against something by a current of air rather than from fragments of the bomb. The police had thrown up barriers before I could get to the point where the worst damage had been done, in front of a public house or saloon, but even from a distance of 50 yards I was able to see a long row of dead that had been laid out on the sidewalk. In all, I must have seen close to a score of unmistakably dead in this one district, and I am inclined to believe that the popular report that 50 were killed within three blocks is not far wrong; this in spite of the fact that the official bulletins admitted a total of only 56 killed by this raid in all of London.

From my own observations, and from conversations with doctors and volunteer firemen and constables—the "regulars," I might explain, are under strict orders not to talk—I have formed these general conclusions regarding injuries inflicted by Zeppelin bombs: That the very large majority

of these were received on the streets rather than in buildings, and that of those hurt in buildings, nearly all were occupying upper rooms; that of those injured on the street, probably not over five or ten per cent were struck by fragments of bombs, and that in the case of those dying from the latter cause, death usually came several days after the injury as a consequence of the almost inevitable blood poisoning.

I believe that many structures were worse smashed up from bombs which struck close beside them, as on the sidewalk or in an alley, than from bombs on the roofs. In the latter instances the force of the explosion is usually exhausted upward. Even the flimsiest tenements were rarely much shattered below the two upper stories from a bomb on their roofs, and a fairly modern office building in the "City," not far from the American consulate, was damaged only in a single top-floor suite. The worst damage occurred where a bomb went through a roof and into a court or light well without exploding until it was down near the foundations. I saw a three-story brick building that was completely razed from such an explosion, while another—a modern four-story steel-and-stone structure—was so shattered that it will have to be completely rebuilt.

### NEW ARTISTIC DESIGNS

#### 1416 IN WOMEN'S GLOVES

Among the novel features of the newest styles of wearing apparel are ladies' gloves of designs that are not only unusual but also artistic. One of the styles which possesses utilitarian merit is a glove made with a wide, loose frill of ribbon which hangs about the wrist and hand just as a frill on a sleeve. The fact that it can be easily removed makes it especially convenient. In some cases gauntlet gloves are made of pure white chamois and lined with taffeta. Another variation is long mousquetaire gloves that can be drawn well up on the arm and

turned back to show a lining of shiny black kid.



Two New Styles of Women's Gloves: At the Left Is a Pair with Frills of White Ribbon Attached. Right: Gloves Which Draw Well Up on the Arm and Turn Back, Showing a Lining of Shiny Black Kid

*Sphere, London*  
11/29/16

Chicago News 2/21/16  
 " Tribune 2/22/16  
 Editor

1435 **BRITISH SUBMARINE GLAZED WITH ICE AFTER RAID**

Upon returning to its base some time ago, after stealing through the waters of the Baltic and sinking a Ger-

**NATION'S AMATEUR RADIO MEN SHOW PREPAREDNESS** 1504

That the licensed amateur wireless operators of this country, of whom there are 25,000, would be able instantly and efficiently to meet any national emergency which might demand their services, was demonstrated in a spectacular way on the night of February 21, when a message was sent out from a wireless station in Rock Island, Ill., and immediately thereafter was relayed to every part of the country until it reached the east and west coasts, the Gulf of Mexico, and even British Columbia. The range of the Rock Island station enabled it to reach all operators within 300 miles; these men in turn flashed it on until it had reached the whole of the army of amateurs scattered over the country. The greetings, which were appropriate to Washington's birthday,



British Submarine Returning to Its Base after Sinking a German Destroyer in the Baltic Sea

man destroyer, the British submarine "E-9" bore a striking resemblance to an elongated iceberg. Its rounded sides, conning tower, periscope tubes, and cables were heavily incrustated with ice which had formed during the long, perilous voyage the craft had made. As it rode into the harbor, some of its crew, swathed in clothes that made them look like Eskimos, stood on the slippery deck while others grouped themselves on the white-glazed conning tower, eagerly awaiting the chance to get ashore. The incident serves to indicate some of the hardships and perils braved by submarine crews during winter operations, when the difficulties of navigation are materially increased by ice and cold.

were delivered to the governor of each state, to the mayors of the principal cities, and to others, the Boy Scouts assisting in some instances. There were 23 words in the message, which read: "A democracy requires that a people who govern themselves and educate themselves should be so armed and disciplined that they can protect themselves."

**GOOD SPEED SHOWING MADE BY DOMESTIC AEROPLANE** 1206

Ninety-five miles an hour is claimed as the average speed of a late type of the Thomas tractor biplane which is built for military purposes. The craft has the appearance of sturdiness and

Cont. + Mfr: Thomas Bros. Aeroplane Co., Inc., Ithaca, N. Y.

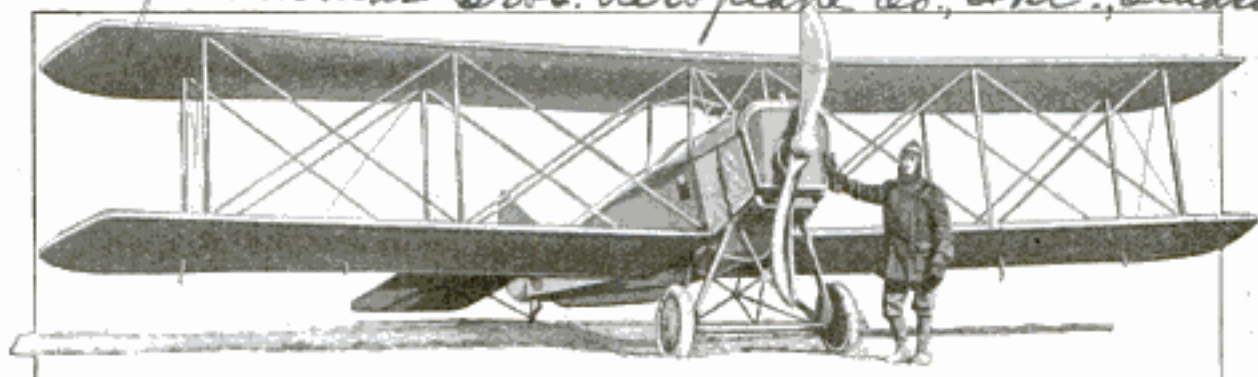

American-Built Biplane of Military Type with Average Speed of 95 Miles an Hour

is equipped with a domestic motor developing 135 hp. Both of its planes are of the same length and the body streamline. Over a measured course at Ithaca, N. Y., the craft recently flew a half mile in  $17\frac{1}{2}$  seconds, and made the same distance against a wind in  $20\frac{1}{2}$  seconds. On another short flight, during which the wind favored the machine, a speed of  $102\frac{1}{2}$  miles an hour was attained.

*Wm. J.*  
-1431 **ELECTRIC INSTRUMENT  
DETECTS FIRE DAMP**

A gas detector for the purpose of determining accurately the presence of fire damp or other inflammable gases in mines has been invented. With it the fact that electric lamps furnish no warning of the presence of gases no longer constitutes an objection to their use. The instrument may also supplement the common safety lamps. It is portable, weighs about 13 lb., and is operated by batteries. By the automatic movement of an index hand over a graduated scale it gives a direct quantitative measurement of the percentage of fire damp in the air tested. It is said that a reading can be made by it in less than 15 seconds, regardless of dust, draft, or pressure. The device is made in two styles; one has a graduated scale to show from 0 to 3 per cent inflammable gas and is intended for use in collieries where safety lamps are employed. The other is for collieries where open lamps are permitted and is designed for accuracy between the limits of 0 and 1 per cent.

*London Times Weekly*

*11/4/16*

**SABER UMBRELLA LATEST  
1912 MILITARY NOVELTY**

A taste for articles of military design which has found expression in such widely differing lines as toys and women's hats, has recently manifested itself in the production of an umbrella for women designed to be carried as a saber. This article is equipped with loops or straps by which it may be hung from the wrist or belt, and its simple decoration is meant to suggest a sword. It can be very appropriately worn with a costume which has features in common with a soldier's uniform.



Experts employed by the Department of Agriculture who have been developing new uses for cranberries have produced candied cranberries which resemble candied cherries and are suitable for many purposes.

**DIRECTION-FINDING RADIO**

**1444 INSTRUMENT INVENTED**

As a result of experiments extending over a period of several years, wireless experts connected with the Bureau of Standards at Washington have developed a remarkable instrument for indicating the source of radio impulses. At the instant signals are received the apparatus registers the direction from which they emanate. Although it is very sensitive, it is less disturbed by unfavorable atmospheric conditions than is an ordinary receiving apparatus. The "finder," as it may be termed, can be used indoors without being grounded or connected with an aerial. Its value for military and naval purposes is obvious. It can be used at sea, as well as on land, to detect the direction of a ship equipped with wireless instruments. It is light enough to be carried in a motor car or other vehicle. The government is also furnished by it a means of determining the locations of radio stations operat-

ing in violation of regulations. It has worked satisfactorily when messages have been received from San Diego, Panama, Key West, Boston, Germany, and other distant points.

**INSTRUMENT DETECTS LEAKS**

**1425 IN WATER PIPES**

A device for detecting leaks in water mains or smaller pipes is being manufactured, which in appearance and size exactly resembles a standard telephone receiver. The instrument is composed entirely of hard rubber and aluminum. Its operation is simple. A metal rod is driven into the ground near a water pipe, or a key is placed in position on a street-surface valve, as the case may be. The point of the instrument is placed on the rod or key. If there is a leak near by, the sound of escaping water can be heard through the receiver. The invention is of particular value in places where there may be wastage of metered water.

*Rubber World 2/1/16*

*Agua-Phoni Co.*

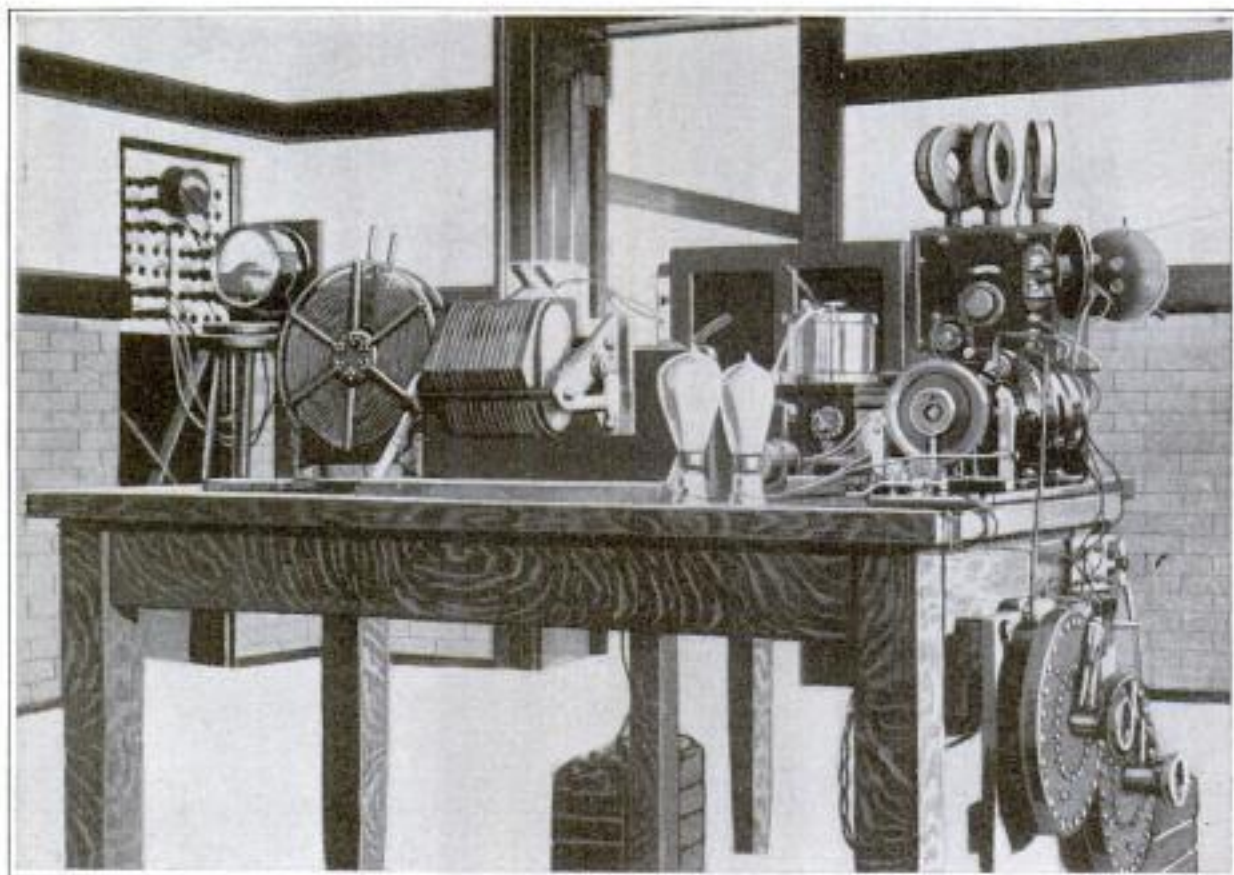

This Apparatus Indicates the Direction from Which Wireless Signals are Emanating

1500

*New York New Haven Rd. Milford Conn.*  
**THREE TRAINS CRASH TOGETHER ON NEW HAVEN**



Except for the Overhead Signal Structure, the Car in Foreground would have Followed Others down 50-Foot Embankment



A Stalled Express near Bridgeport Conn., was Struck in Rear by Local and Knocked in Path of Oncoming Freight, Tragedy Marking Washington's Birthday



Top Photograph Shows Exploded Boiler of Locomotive That Smashed into Rear of Express, Tender, and Car in Which Many were Killed, are Pictured Herewith

COPYRIGHT, INTERNATIONAL FILM SERVICE, INC.

**ELECTROMAGNET COUPLERS**

**1360 EXPEDITE SWITCHING**

Electromagnet couplers have been devised as a feature of switching locomotives used in Berne, Switzerland, thereby dispensing with coupling cars by hand, a practice which costs many lives annually. The Swiss state railway has built a number of storage-battery tractors equipped with these couplers, the batteries furnishing power both for switching and for energizing the magnets. One magnet is located near each of the four corners of the lo-

comotive, like a buffer. The four consist of cylinders with flaring outer ends. Around these iron cores are wound coils of insulated wire. When a current is sent through these circuits the cores become powerfully magnetized. The couplers are directly in line with the car buffers which engage them, after the manner of a ball and socket. This contact permits considerable flexibility. To effect a coupling, after a tractor has drawn up to a car it is only necessary for the motorman in the cab to feed current through the proper coils. By throwing the switch

# Robert G. Skerrett, 15 William St.  
 New York City

Copyrighted material

*Drury**Chr. Science Monitor 1/31/16*  
**GREAT IRRIGATION PROJECT****370 IN INDIA COMPLETED**

What is pronounced the greatest irrigation project so far undertaken in India was recently completed when the upper Jhelum Canal in the Punjab was opened. The canal itself cost nearly \$15,000,000. Because it extends from the border of a rough mountainous region down to the plains it has been one of the most difficult pieces of engineering of its kind ever undertaken in India. The location of the head works was under investigation for four years. The site finally chosen was near Mangla Fort on the Jhelum River, near the border of the mountainous region. The parapet of the retaining wall rises 70 ft. above the canal and its foundations extend 25 ft. below the canal bed to insure stability. The regulation of flow is accomplished by three tiers of floodgates. The canal after crossing a plain terminates at the Chenab River.

For the first mile the canal is in a cutting, about 110 feet deep, through soft limestone and clay. On this excavation the staff and labor gangs worked continuously for three years, in two shifts, day and night. Many labor-saving appliances were used. For 50 miles the canal runs through a tract furrowed by deep and well defined hill torrents, which flow in shifting sand beds having a rapid drop. For some distance beyond this it lies in a flood-swept tract where cross-drainage works are numerous and the construction problems very difficult. The work on the project was in progress for 10 years and there were many discouragements. In 1914 the river rose to an unusual height and burst through the soft-rock wall, dividing the canal from the stream and submerging the regulator, which was then at a low level of construction. The resulting havoc entailed a great amount of additional labor, but, as in other instances, the engineers finally triumphed. With the completion of the project a rich region is made available for farming.

out the car is uncoupled. Each magnet when in perfect contact is good for a drawbar pull of 3,740 lb. Even when there is a slight gap a magnet exerts a pull of nearly 2,000 lb., so that an ordi-

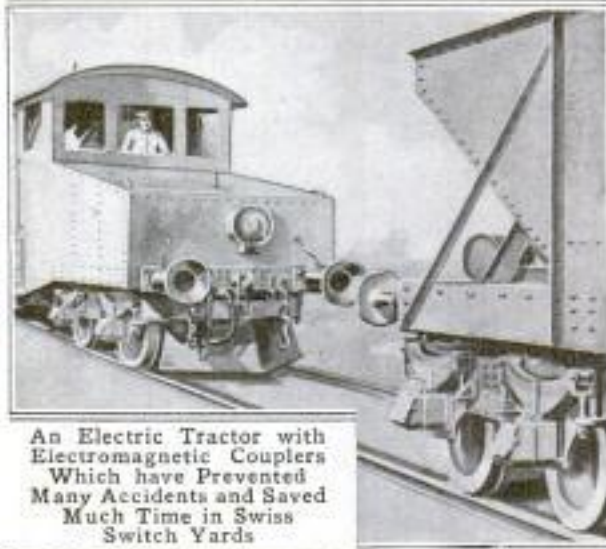

An Electric Tractor with Electromagnetic Couplers Which have Prevented Many Accidents and Saved Much Time in Swiss Switch Yards

nary jar will not break the hold of the tractor. Not only has this improvement prevented many accidents, but it has effected a great saving of time.

*Adolph*
**ARTISTIC REFUSE HOLDERS  
FOR NEW YORK PARK**

1402

An artistic refuse container of unusual design has been adopted for the New York Zoological Park. In appearance it closely resembles a symmetrical tree stump. It stands 26 in. high and is 18 in. in diameter. The exterior is made of special rust-resisting steel, the rough surface being formed by means of dies patterned from real bark. A removable corrugated-iron can fits into this casing; it is 24 in. high, 17 in. in diameter, and has a double-riveted bottom.



removable corrugated-iron can fits into this casing; it is 24 in. high, 17 in. in diameter, and has a double-riveted bottom.

# *L. G. W. Allison*  
170 Roseville Ave.  
Newark, N. J.

*Brown 1/31/16*

# Geo. P. Wright To Bee Sub. Co., Omaha, Neb.

1389

Lakeside Ice Co. Omaha.  
CUTTING ICE FROM SNOW-INCORUSTED FIELD

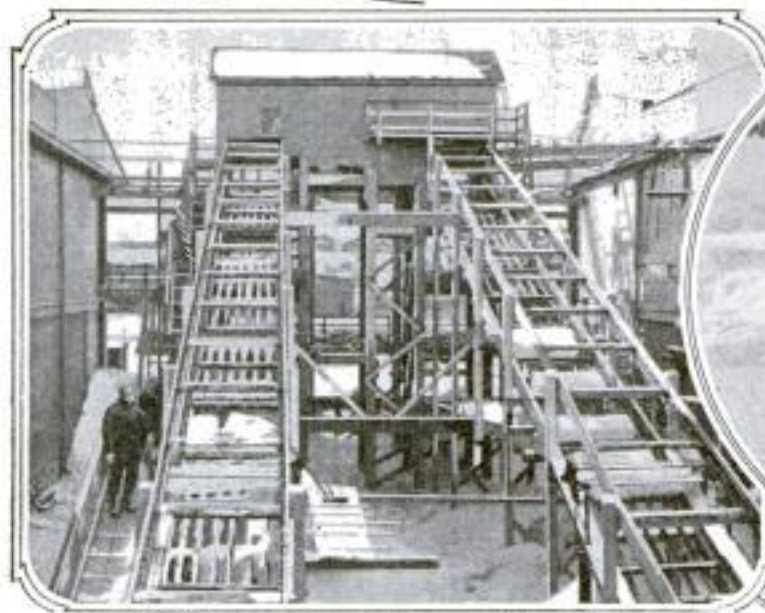

These Pictures Illustrate the Method Employed in Breaking and Removing Snow before Cutting Ice for Commercial Purposes. The Crust is Loosened with Disk Harrows, as Indicated Below, and Then Scraped in the Manner Shown Above

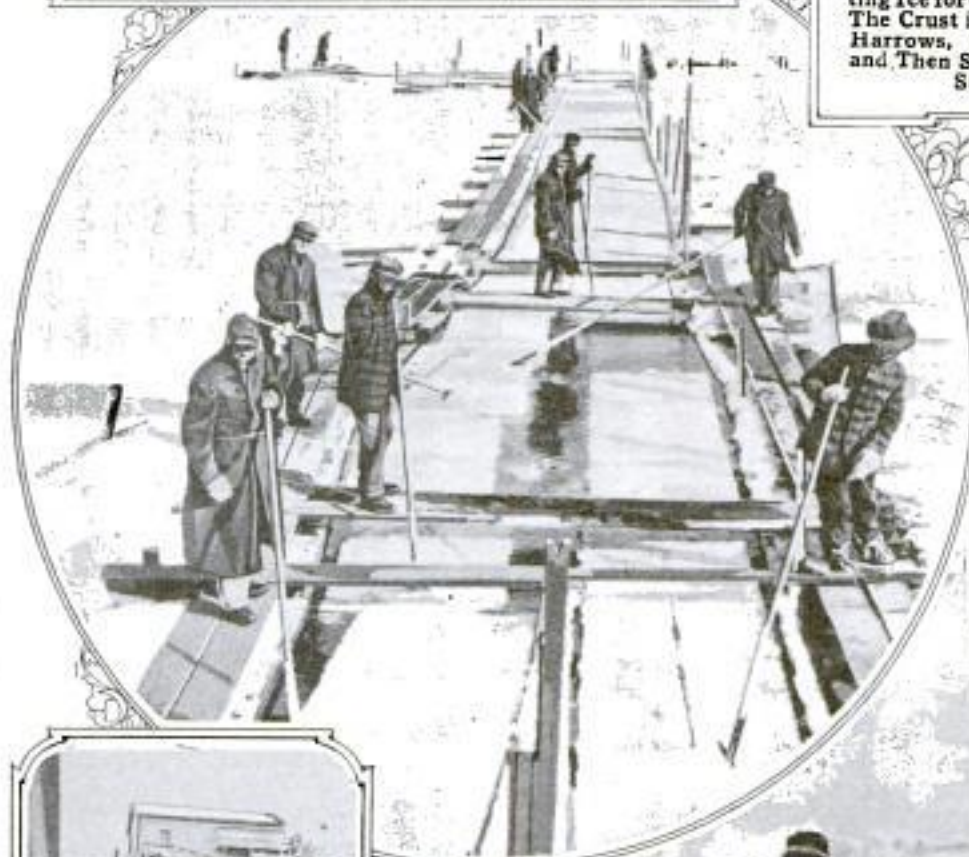

Left: Pushing Large Cakes of Ice through a Runway to Endless-Belt Conveyors Which Lift Them into Storage Houses, as Shown at the Top. As the Cakes Pass up These Inclines, the Remaining Snow is Scraped from Them with Knives Regulated by Men Stationed near the Lower Ends of the Chutes. This is Necessary in Order to Keep Ice in Good Condition



The Photographs were Taken on a Small Lake at Omaha, Where Thousands of Tons of Ice are Cut for Local and State Consumption



**ALASKA MAIL UNDELIVERED  
1427 FOR EIGHT MONTHS**

For slow mail delivery in United States territory it would seem that the mail service for central Alaska sets the record. It often happens that matter started in October on its way to these ice-bound regions of the North does not reach its destination until the following June.



Settlers assert that similarly isolated regions in northern Canada are better served by the Dominion's postal authorities. One Alaskan settler located at Tofty, which is about halfway between Nome and Dawson as the crow flies, near the junction of the Tanana and the Yukon rivers, on going to the post office after the long-

delayed mail arrived, found an accumulation of letters, magazines, and packages for him weighing more than 100 lb. Filling a mail bag with a load of 92 lb., he delivered that to his home and returned for the remainder.

**SNOWPLOW ATTACHMENT  
1474 FOR MOTOR TRUCKS**

Snowplow attachments of a new design that are to be used on the motor trucks of the street-cleaning department for the work of snow removal have been recently adopted by New York City. The apparatus consists of a steel pusher, or blade, 10 ft. long and 14 in. wide. This is hung by a semi-circular steel frame immediately ahead of the front wheels of the truck. The mechanism includes a means of angular adjustment by which an operator sitting at a wheel beside the driver of the truck can turn the snow to the right or left side. An automatic blade release is so constructed that when the edge of the blade strikes an immovable obstruction, such as a manhole frame or car track, the blade passes over the obstacle and returns to its former position. Trucks equipped with these plows can work rapidly. The cost of the device is not great.

*Street Cleaning Dept. N.Y. City*

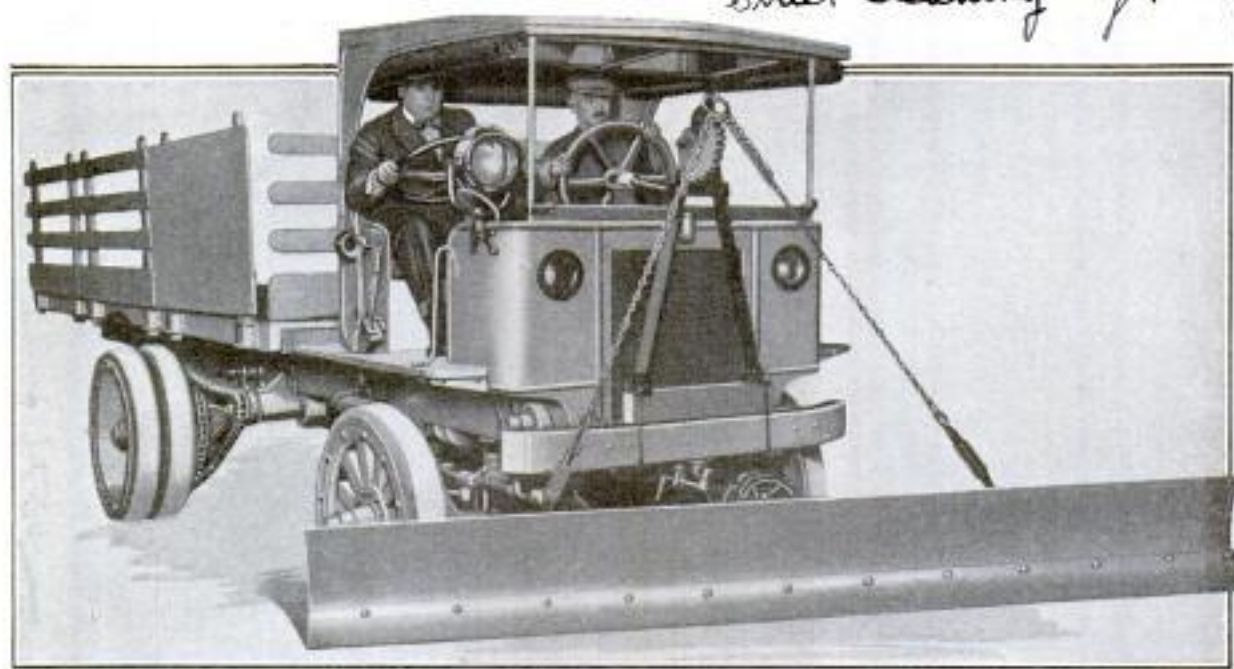

Motor Truck Equipped with One of New York's New Snowplow Attachments

# Stanley W. Todd  
327 Mc Donough St.  
Brooklyn, N.Y.



# H. J. Courtwright, 2016 Chester Ave.  
Bakersfield, Calif.

1591

# WIND AND FLOOD SWEEP SOUTHERN CALIFORNIA

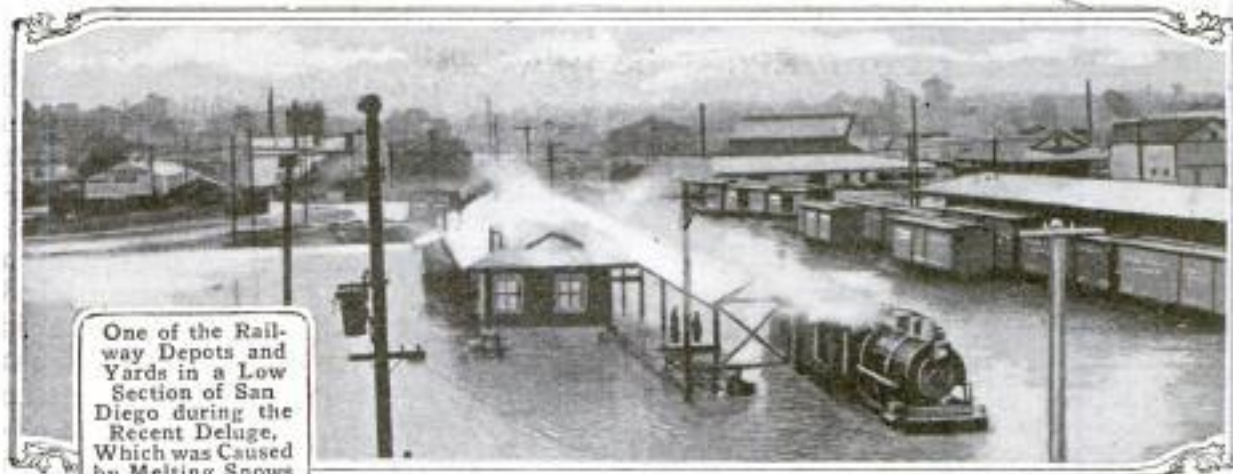

One of the Rail-  
way Depots and  
Yards in a Low  
Section of San  
Diego during the  
Recent Deluge,  
Which was Caused  
by Melting Snows  
and Incessant  
Rains



Venice, One of the Resort  
Places of Southern California,  
was Badly Inundated. This  
Picture Shows One of the  
Marooned Hotels



Some 1,100 Rigs  
were Wrecked by  
Cyclones in Two  
California Oil  
Districts. In the  
Small Area Shown  
Here, Three Der-  
ricks Are Down



Reinforced-  
Concrete Motor  
Bridge over San  
Diego River was  
Undermined and  
the Piers Cut Out  
beneath It



Remains of Lower  
Otay Dam, Which  
Was 565 Feet Long  
and Had a Spillway  
Capacity of One  
and One - Fourth  
Billion Gallons  
a Day

### EFFECTIVE LOOKOUT SHIELD FOR ENGINE DRIVERS

1364

To protect the eyes of a locomotive engineer when he is watching the track ahead, especially during stormy



With This New Shield in Place an Engineer can Watch the Rails without Facing a Sleet or Cinder-Laden Wind. The Diagram Shows the Principle of the Device and the Manner in Which It is Constructed

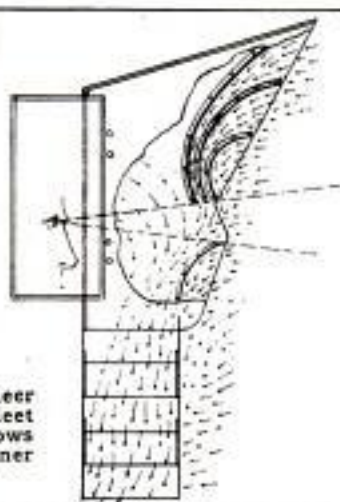

weather, a lookout shield of apparently considerable merit has been developed. The device is a double deflector, and when attached to an engine cab enables the pilot to make observations without facing strong air currents laden with cinders. Furthermore the line of vision is not intercepted by a pane of glass which might become covered with ice or blurred by water. The air upon striking the upper part of the mask at the front is caught by curved

plates and directed in an S-shaped course so that it shoots in front of a peephole provided in the mask, and diverts the intruding air at that open port. It is discharged through ducts in the outer side of the shield with sufficient force to counter-

act the up draft which is often encountered when a locomotive is running with a cross wind striking it on the fireman's side. It is obvious that the air, in rushing through the deflector, produces a suction force. This draws air in from the rear of the shield so that instead of wind cutting back through the unobstructed peephole, a current is

drawn forward through this aperture. The force of this counterdraft is strong enough to lift a piece of cotton waste from one's hands and carry it into the deflector and out at the side. In other words, the line of vision is protected by a strong, down-shooting air blast instead of a pane of glass. The force of this draft is strong enough to carry cinders, dust, insects, rain, sleet, and snow with it and prevent them from being thrown into the engineer's eyes.

### HAND-OPERATED LETTER

#### 12-55 OPENER SAVES TIME

A letter opener, operated by hand, which opens from 85 to 150 letters per minute, is proving to be a profitable timesaver for many business houses

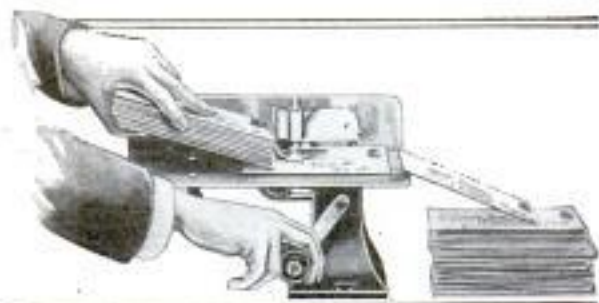

With This Hand-Operated Machine 85 to 150 Letters can be Opened per Minute

Lightning Letter Opener Co.,  
Rochester, N. Y.  
77 Exchange St.

whose mail is not large enough to warrant the use of a power-operated opener. Continuous circular blades, revolved by a crank, cut a thread .01 in. wide from the edge of the envelopes, thus eliminating the danger of cutting inclosures. The letters are placed in a pile against a guide and in front of the knives; the turning of the crank feeds them, one by one, between the blades, regardless of width, thickness, or crumpled condition. All envelopes pass through the machine flat, so that no inclosures fall out. No special skill or instruction is required to operate the device. The blades are protected so that there is little danger of injury for the operator.

## GREAT TEUTONIC HOST PENETRATING SERBIA



In Many Places the Germans Found Serbia's Roads Impassable to Motor Cars. Here a Yoke of Oxen is Helping a Machine Out of a Mudhole, While Dozens of Cars at the Rear Wait for Similar Assistance



The Enemy Making a Noontime Halt in a Valley Outside of Belgrade: The Horses and Pack Mules are being Turned Out to Graze While the Men Arrange Their Trappings and Gather about the Field Kitchen

## KING PETER AND HIS COURT FLEEING SERBIA

As the German Hordes Swept Serbia, the King and His Court Retreated over the Frozen Mountains into Albania to Reach Italy. Much of Their Journey was Made on Foot, the Alpine Roads being Impossible Even to Carts. Insert Shows Royal Entourage Crossing Bridge over the Drin. So Slippery that One of Party Fell into River and Drowned. Beneath, the Aged King in an Ammunition Wagon Which He Finally Had to Abandon

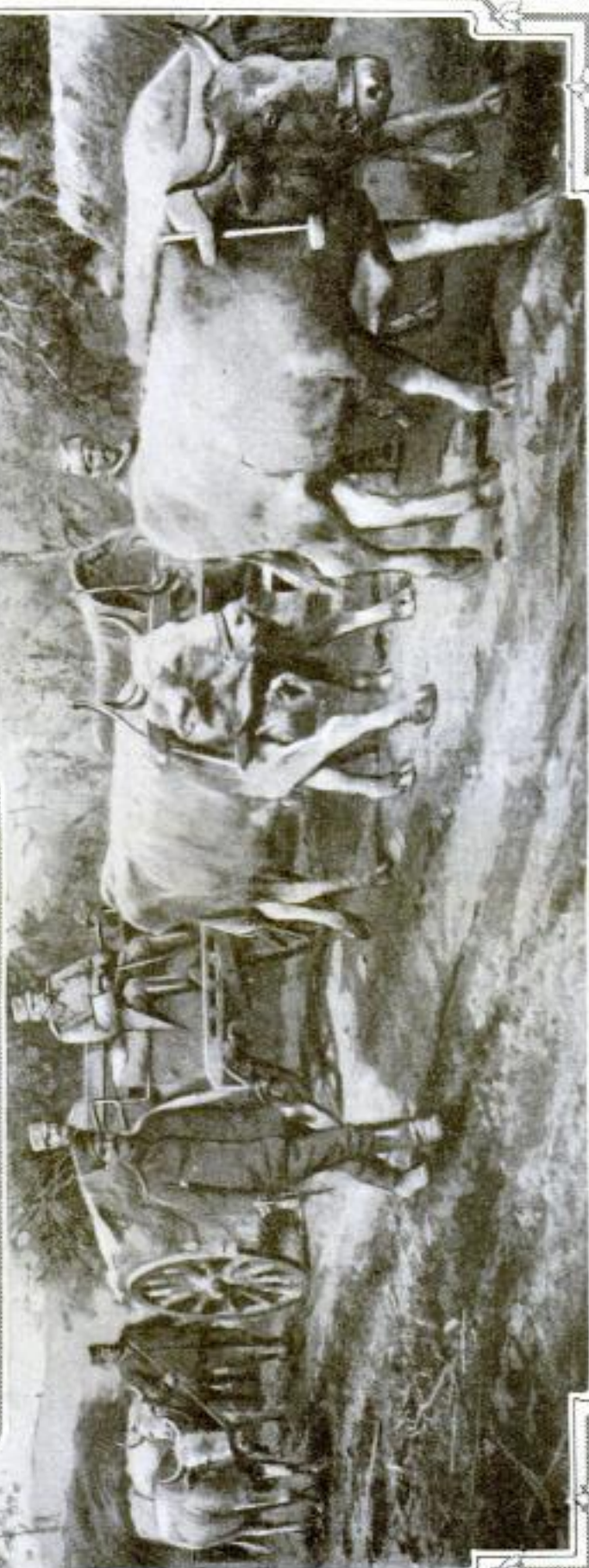

COPYRIGHT, BY L'ILLUSTRATION

## WAR-RAZED SERBIA LAND OF WANT AND DEATH



© UNDER-  
WOODS &  
UNDER-  
WOOD

Serbs Carrying Wounded, during Retreat, over Wrecked Bridge across Morava

Burying Serbian Dead That Littered Battle Field after a Sweeping Attack by the Vastly Superior Forces of the Enemy



Austrian Soldiers Holding Mob of Hungry Civilians Back with Bayonets While Transport Carrying Food for Invading Army Makes Its Way under Guard through Serbian Town. In Many Places the People Are Almost Entirely without Food and Actually Verging upon Starvation

## CHILDREN REFUGEES FROM STRICKEN SERBIA



© INTERNATIONAL  
FILM SERVICE, INC.  
Above: Group of  
Destitute Serbian  
Boys and Girls be-  
ing Cared For at  
a Refugee Camp  
Established at Sa-  
loniki, Dressed in  
Clothing Supplied  
by a Benevolent  
New Yorker



At the Side Is  
a Picture of the  
Youngest Known  
War Prisoner, a  
Six-Year-Old Ser-  
bian Found with  
the Troops: Cap-  
tured by Germans.  
His Homelessness  
Made His Intern-  
ment Necessary



Children Made Homeless by the War and Separated from  
Their Parents during the Austro-German Invasion of Their  
Country, Arriving at Marseille, Where They are being  
Received in Open Arms by the Schoolboys and Girls  
of That City

# CONVEYANCES USED IN TRANSPORTING WOUNDED



Ninety Motor-Car Ambulances, Presented to France by Great Britain, on Display in the Esplanade before the Hotel des Invalides at Paris



Small Car, Carrying Four Stretchers, Operating from French Trenches to Near-By Hospital



Members of Cycle Corps Carrying Wounded Comrade on Wheel Used as Stretcher. Their Own Bicycles are Folded and Strapped upon Their Backs



French Army Ambulance on Road Alongside of Which Screen has been Erected to Hide Timbered Area from View of Germans

## USE OF HEAVY ARTILLERY AGAINST TRENCHES

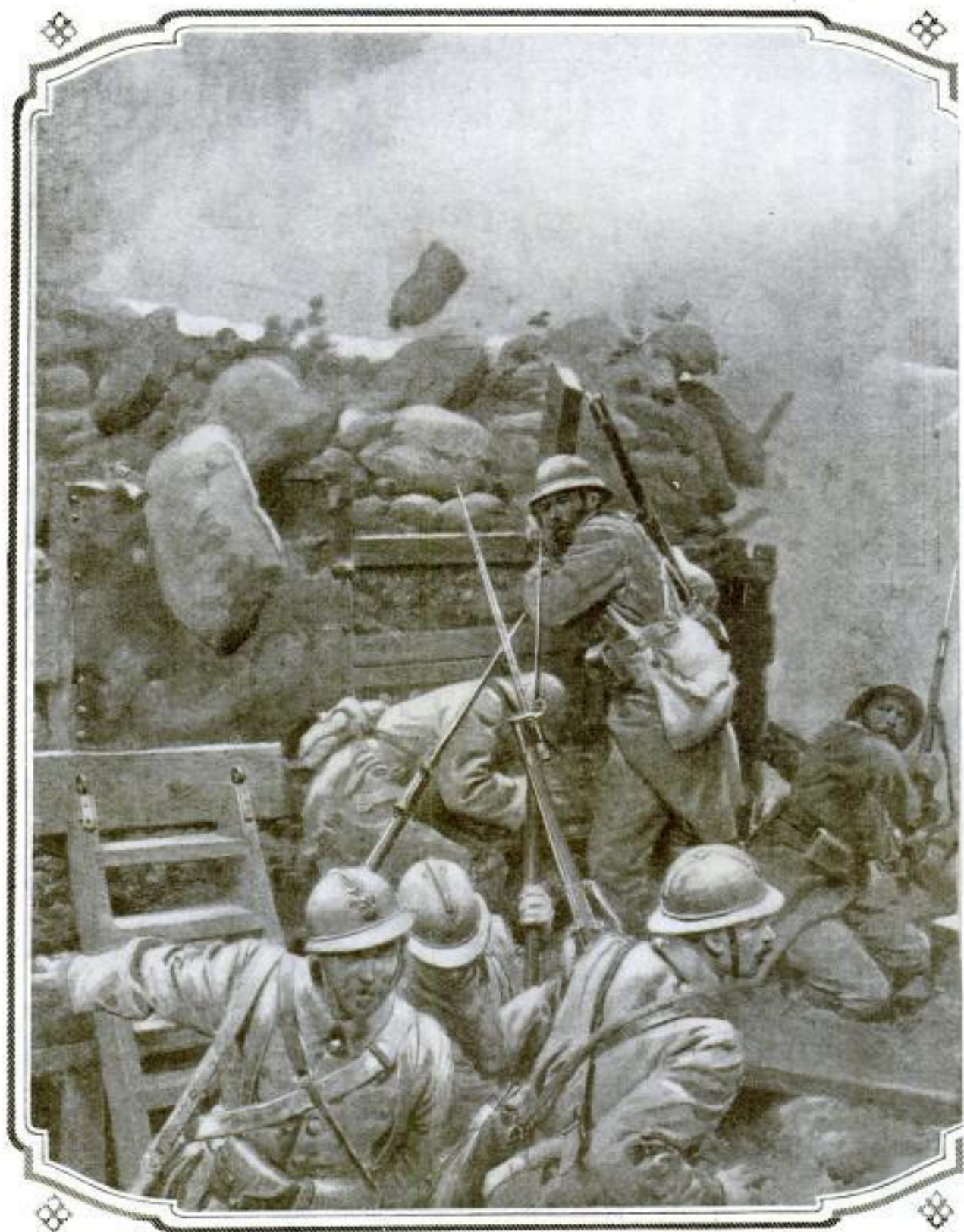

DRAWN BY F. MATANIA FOR THE SPHERE LONDON, AND COPYRIGHTED

**T**HE tremendous part played in modern warfare by artillery is influencing trench building as well as in the past is now needed for the infantrymen, because of the growing use of heavy artillery batteries protected largely by timbers and sandbags, which has been able to hold out consistently against the lighter and by these is meant steel-reinforced redoubts, with sides as well as overhead works protected and has been most intense, steel shields of different types, boiler plate, and other armor, are said to be in use revolving turrets on the firing line, a distinct innovation and one which has apparently proved its worth. The trench during the thick of battle. The cupola in use at one side was captured from a German position



## BRINGING ARMORED REDOUBTS INTO EXISTENCE



IN THE UNITED STATES BY THE NEW YORK HERALD COMPANY

practically everything else connected with the business of fighting. Greater protection than was required against field positions. Large howitzers and mortars are able to break through an earthen trench, proof from ordinary field pieces. A marked tendency is developing in favor of armored trenches, therefore, strengthened by heavy plates. In some of the French trenches along the western front, where the fighting at the present time. Likewise, as previously reported, the Germans in this same theater have been employing The artist's sketch above, which was drawn from photographic material, shows a partly armored French and is here being employed by French machine-gun operators.

# GRIM SIDE OF WAR SEEN IN WESTERN THEATER



French Colonials Giving First Aid to a Wounded German Found on a Field After an Attack had been Repulsed



Removing Harness from Horses Wounded during a Bombardment of Soissons. Picture Taken during Battle



Horses and Soldiers Littering Battle Field "Somewhere on the Western Front" after Spirited Engagement between French and German Forces



Wounded German Soldiers, under Care in a Small French Church at the Front Which has been Turned into a Military Hospital, at Prayer

# ODD SIDELIGHTS ON WAR SNAPPED BY CAMERA



Tubular Device Prevents Glow of Soldier's Cigar being Seen by Enemy



Buttonhole Electric Lamp Worn on Dark Streets at Night



Bottle Window Used in French Dugouts Resists Concussion of Big Shells

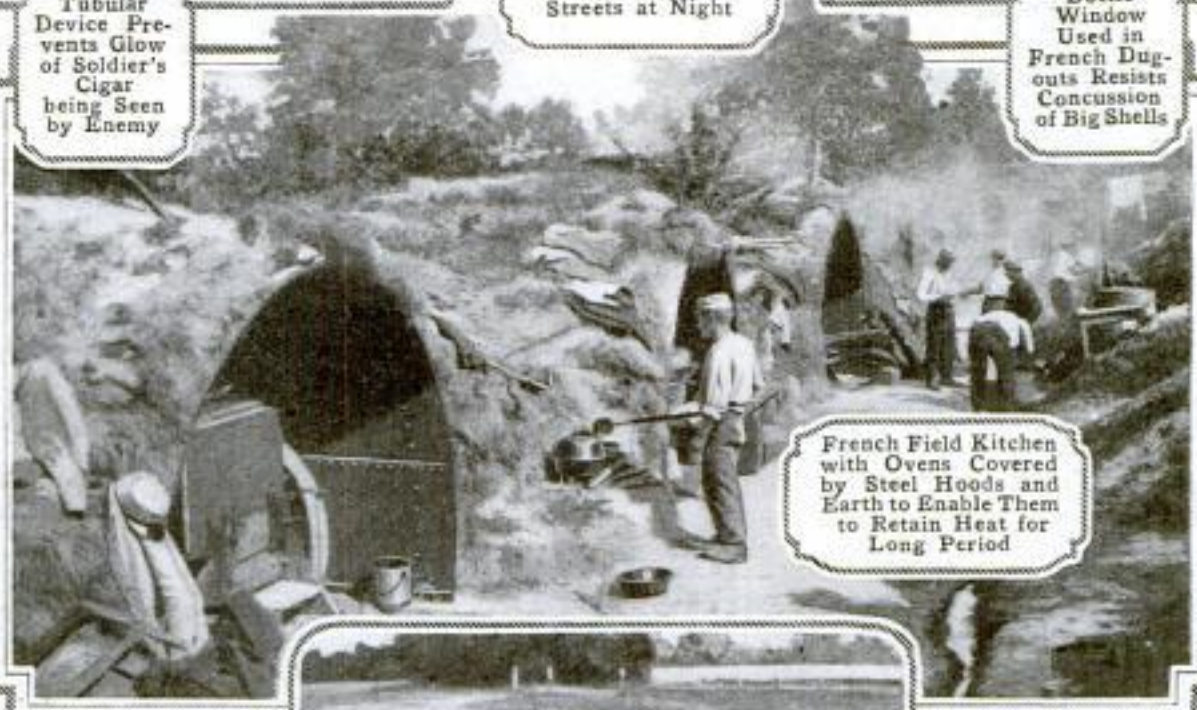

French Field Kitchen with Ovens Covered by Steel Hoods and Earth to Enable Them to Retain Heat for Long Period



Dragging Wounded Man by Teeth; Method Used When under Fire

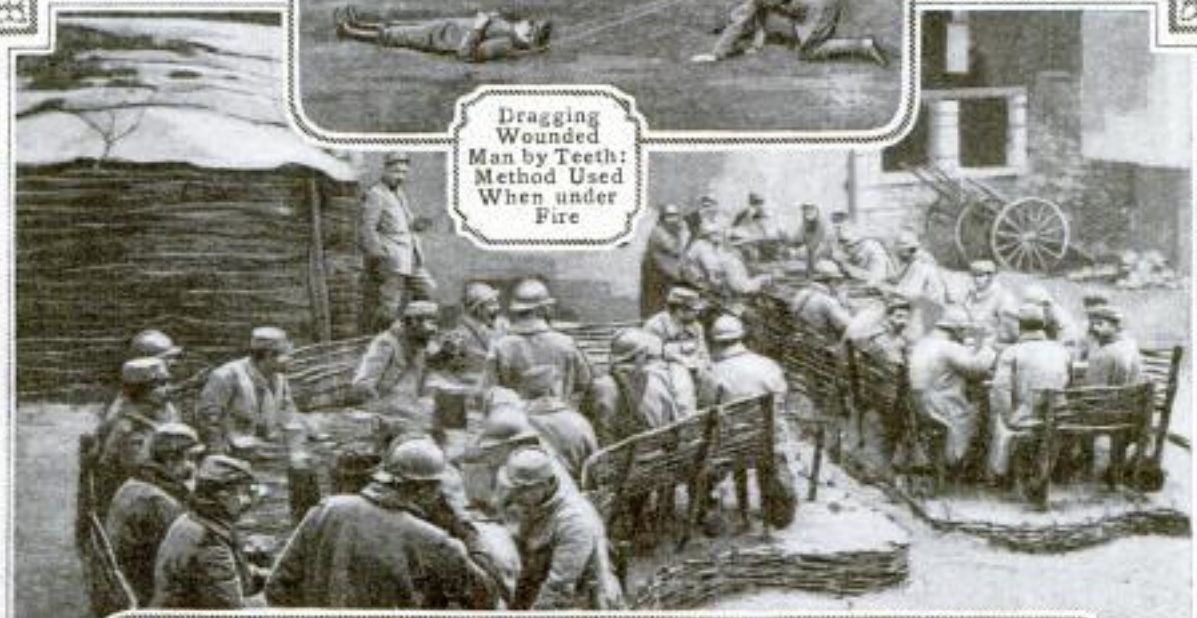

Open-Air Dining Room Constructed by French Soldiers in a Camp "Somewhere at the Front." The Tables and Benches were Skillfully Made from Branches and Reeds by the Men during Their Spare Time When They Were Temporarily off Duty

## THINGS OF INTEREST SEEN IN WAR CAMPS



Austrian Artillery Drawing a Heavy Mountain Battery into Position in the Tyrolean Alps near the Frontier, Where Fighting has Been Intense for Months



Device Indicates Direction of Wind to Austrian Airmen



COPYRIGHT, UNDERWOOD & UNDERWOOD

Network of Entanglements Protecting Austrian Position in Swamp, Where It Was Necessary to Build the Trenches on Top of the Ground



One Type of Mountain Battery Used by Austrians in Combating Italian Advance on the Frontier. When the Revolving Turret is Covered with Sod, as Shown Here, It is Almost Impossible for the Enemy to Locate and Destroy the Gun

## OF AUSTRIAN FORCES ON VARIOUS FRONTS

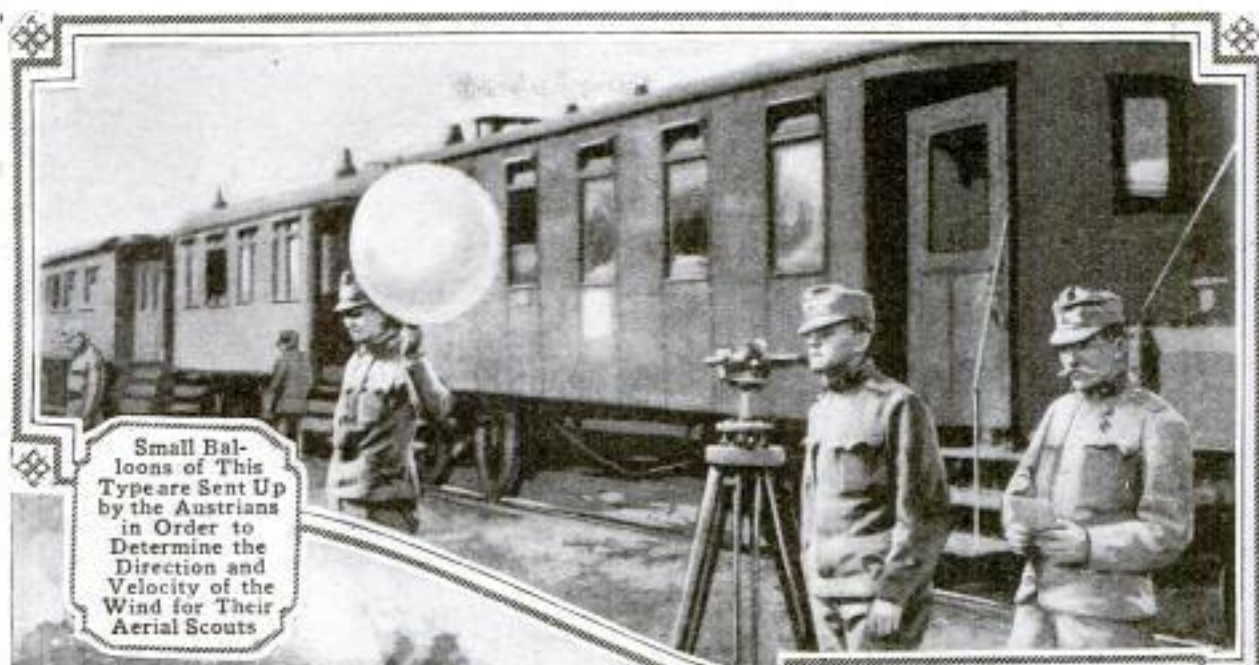

Small Balloons of This Type are Sent Up by the Austrians in Order to Determine the Direction and Velocity of the Wind for Their Aerial Scouts



Conveyor Lifts Munitions to Mountain Position and Brings Back Wounded



This Photograph, Showing Austrian Infantry on Serbian Soil, Gives a Graphic Idea of the Difficulties Encountered by the Invaders in Penetrating the Hill Country Where Mud and Snow have Made Roads Nearly Impassable

## SANITARY PRECAUTIONS OBSERVED BY GERMANS

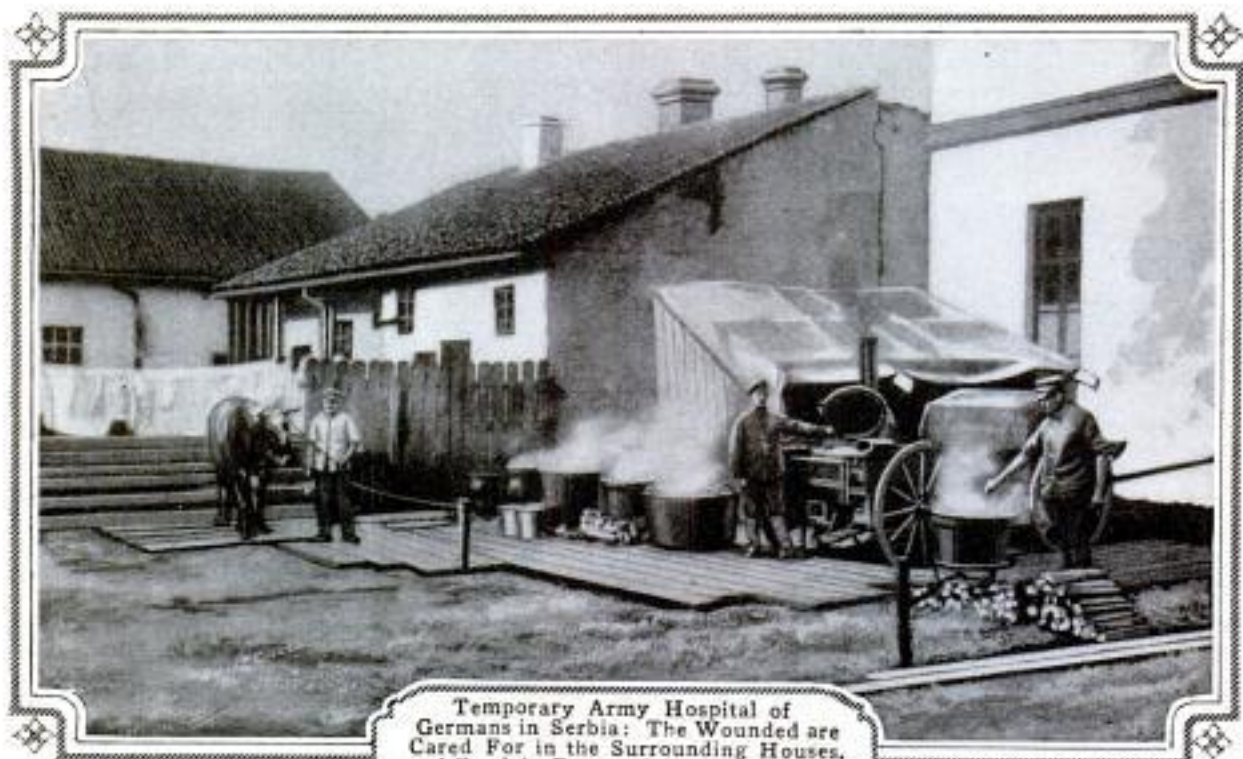

Temporary Army Hospital of Germans in Serbia: The Wounded are Cared For in the Surrounding Houses, and Food is Prepared in the Open-Air Kitchen, the Yard about Which is Kept as Clean as a Parlor Floor



The Sign Stretched above This Street in Slonim, Russia, Warns German Soldiers That the Place is Infested with Cholera. The Men are Commanded Not to Eat Raw Fruit, Drink Unboiled Water, nor Enter Any Uninspected House in the City

## WINTER VIEWS AT FRONT WITHIN GERMAN LINES



Group of Sentries in Eastern Theater Swathed in Full-Length Sheepskin Coats Which Protect Them from Severe Winter Blasts and Snipers as Well. Since in Addition to being Warm They Are Almost Indistinguishable against the White Background of Snow-Covered Fields



Mess Time Becomes an Incident Rather Than an Event When the Fighting is Intense. Here German Soldiers on the Eastern Front are Gathered about a Field Kitchen during a Snowstorm, Hurriedly Taking Their Noonday Meal

Cont. + Infr. Brevards Mfg. Co., Inc.,  
 1520 Arlington Bldg.  
 Rochester, N.Y.

**CONVENIENT HEATER MADE  
 1251 FOR SMALL CAR**

For warming the interior of one of the popular light motor cars, an inexpensive radiator of the type utilizing

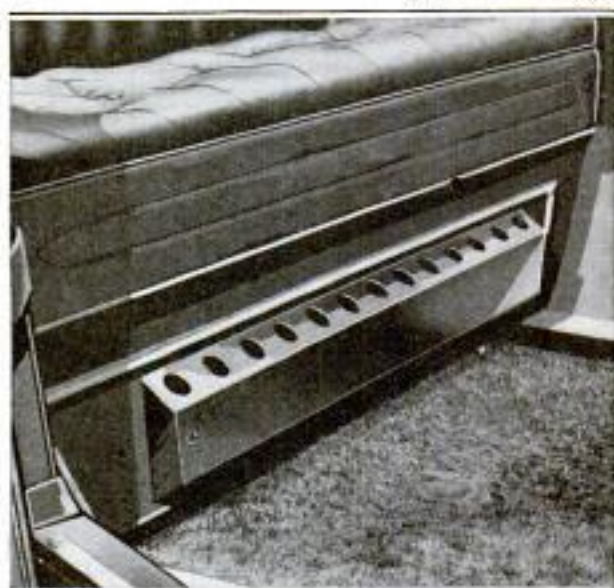

The Heater Makes Use of the Hot Gases Given Off by the Motor and may be Regulated without Leaving the Car

the heated waste gases from an engine has been introduced. It is incased in a neat, enameled housing which fits beneath the front edge of a seat. Its tubing is connected with the exhaust pipe between the motor and muffler, while it is regulated by means of a damper which causes the gases to be

diverted. Warm air is circulated under the rugs and about the feet, and may be turned on or off without leaving the machine. The device weighs about four pounds and may be removed easily and stored during the summer months. It is odorless and clean and costs nothing to operate.

**CONVEYOR BELT EXTENDS  
 USEFULNESS OF WRINGER 9938**

Several innovations of interesting nature are embodied in a washing machine and auxiliary apparatus recently evolved by an Iowa inventor. Of particular note is a conveyor belt attached to one side of the wringer and adapted to carry clothes safely over the working parts of the machine proper. By means of suitable gearing, this conveyor belt is operated by the same electric motor which drives the other parts of the machine. Galvanized tubs carry the hot waters in which clothes are sterilized. An unusual convenience is afforded in a set of gas burners underneath the tubs, which keep the liquids at any desired temperature. Because of the convenience and safety afforded by the conveyor belt, the wringer need not be transferred to the tubs for drying clothes therefrom.

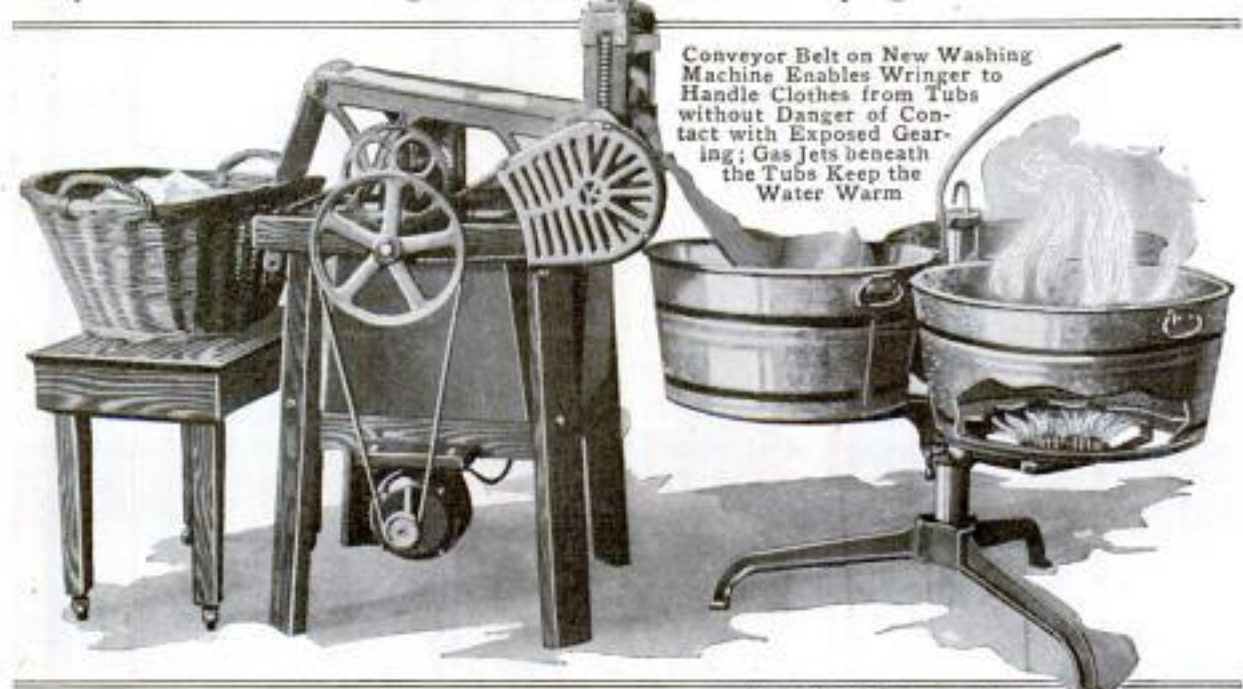

Conveyor Belt on New Washing Machine Enables Wringer to Handle Clothes from Tubs without Danger of Contact with Exposed Gearing; Gas Jets beneath the Tubs Keep the Water Warm

# Lester L. Sargent  
 700 - 9th St  
 Wash. D. C.

Draw. - Sargent & Johnson  
 1136 V. 18 Apr 20, 1915, filed  
 Pat. Aug. 11, 1915, 8938  
 S. 58384



*Canal Record 1-12-16*  
**HOW WASHINGTON SIGNALS**

**1427 TIME TO CANAL ZONE**

Telegraph lines, a sending and a receiving radio station, and a telegraph operator are among the means used in transmitting daily the correct time from Washington, D. C., to the Panama Canal for the purpose of correcting the chronometers in the port captains' offices and on incoming ships. Absolutely correct time cannot be ascertained by this means, there being a variation of about one-tenth of a second. Correct time is highly important for a vessel, because in making observations of heavenly bodies, a variation of one second means an error of about one-fourth of a nautical mile in location. The time signal is sent by wire from Washington to Key West, whence a relay transmits it by wireless. The Darien wireless station in the Canal Zone in turn transmits the signal by ordinary telegraph to the port captains' offices.

The signal is sent from Key West in a series of dots. Five minutes before noon the wireless begins counting off the seconds by dots. After the twenty-eighth second there is a pause, the twenty-ninth dot being omitted; similarly there is a pause from the fifty-fourth to the sixtieth second. The count is resumed exactly on the minute. This procedure is kept up until 10 seconds before 12 o'clock, when there is a pause followed by a long dash at exactly 12 o'clock. The aerial transmission is recorded at Darien by a current too slight to permit ordinary electrical relaying. Consequently an operator with a wireless receiver at his ears sends dots through an ordinary telegraph wire to the port captains. With practice he can strike the dots on his sending key in almost perfect synchronism with the dots received. The principal difficulty is in sending the final dash after a wait of 10 seconds. Here the human brain fails to react instantaneously, the tests showing that the lag is between two-tenths and three-tenths of a second. By making allowance for this lag the chronometers

in the Canal Zone can be adjusted to within about one-tenth of a second of the correct time. Arrangements are being made to install a clock at Darien which will transmit the time exactly as received from Key West.

**COAL DEALER'S FIREPLACE**

**1243 MADE OF HARD COAL** *of Dayton*

A prominent Ohio coal dealer, who has a fondness for things novel, has caused to be built in his new residence

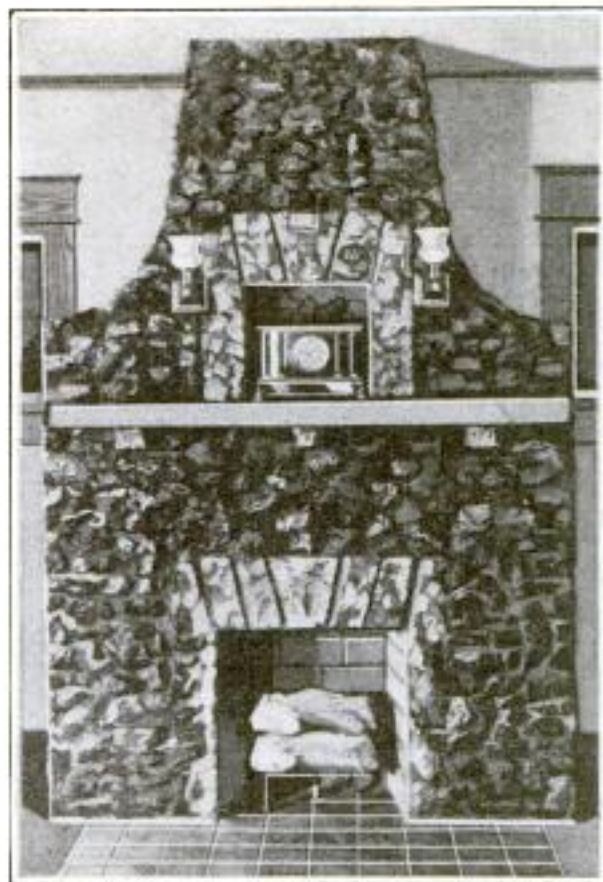

Hard Coal Is the Material Used in Constructing the Outer Surface of This Unusual Fireplace

a fireplace in which pieces of anthracite coal of nearly uniform size were used for constructing its outer surface. The pieces of coal, hard and lustrous, constitute a striking and decorative feature of the new home. In a recess above the mantel a clock is placed. Imbedded in the masonry just above the clock, as may be seen in the illustration, are dark curved objects. These are turnings from a 16-in. gun made in one of the United States government arsenals.

*Harvey D. Meyer*  
 152 1/2 W. Third St.  
 Dayton, Ohio

### SIMPLE FRUIT COLLECTOR

1213 SAVES LABOR

A fruit collector designed for harvesting prunes, but which can be used

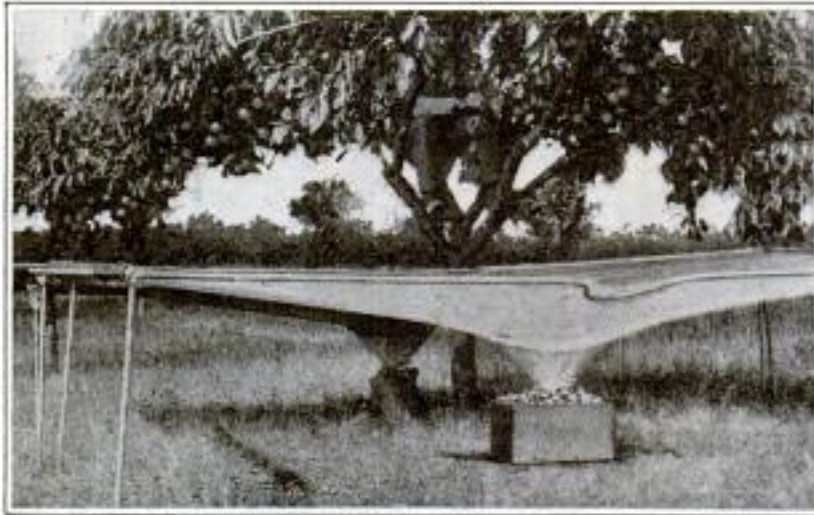

All Fruit Shaken onto This Collector will Roll into the Receptacle Placed beneath the Opening Except the Small, and Hence Undesirable, Fruit Which will Fall through to the Ground

for other fruits also, consists essentially of a netting to be spread under a tree and onto which the fruit is shaken.

The netting is supported above the ground by a frame of  $\frac{1}{2}$ -in. iron pipe, measuring  $7\frac{1}{2}$  by 15 ft. Two such frames, set side by side, are used under one tree. A curve in one side of each permits them to be fitted closely about the trunk. The mesh can be of such size as to allow small fruit to fall to the ground. The netting is so slanted that the larger fruit rolls to an opening in the net's center and thence into boxes or pails. In this way it is kept out of the dirt. The frames can be folded up and moved easily. The device is patented. It is claimed that four persons with two collectors can shake and harvest as many prunes

as 12 persons can by the old method of shaking and gathering from the ground.

### SEWER-CLEANING MACHINE

9614 FLOODS PIPE INTERIORS

A new cleaning machine designed to be pulled through a sewer by means of a cable and windlass recently received several successful try-outs in eastern cities. In one case a tight mass of roots, some of them half an inch through, was easily removed from a 12-in. main. The machine proper consists of an oblong block of metal, terminating at the front end in a rod and eye for the attachment of the cable. Just back of the eye is a group of spiral cutters, operated by a  $3\frac{1}{2}$ -in. hydraulic motor within the block of metal itself. A fire hose attached to the rear fur-

nishes the necessary water for operating the motor and for flushing purposes. Eight small arms project from the side of the machine, keeping it in the center of the sewer. The flow of

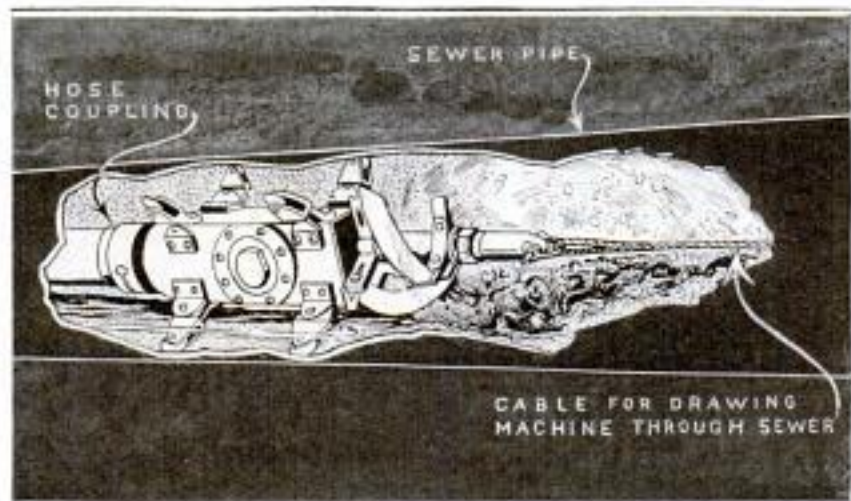

Sewer-Cleaning Machine Uses Water from Fire Hose to Operate the Hydraulic Motor Which Propels the Cutter Blades

water is an aid in cleansing the drain of semifluid matter.

Engineering News 3-25-15 - page 591

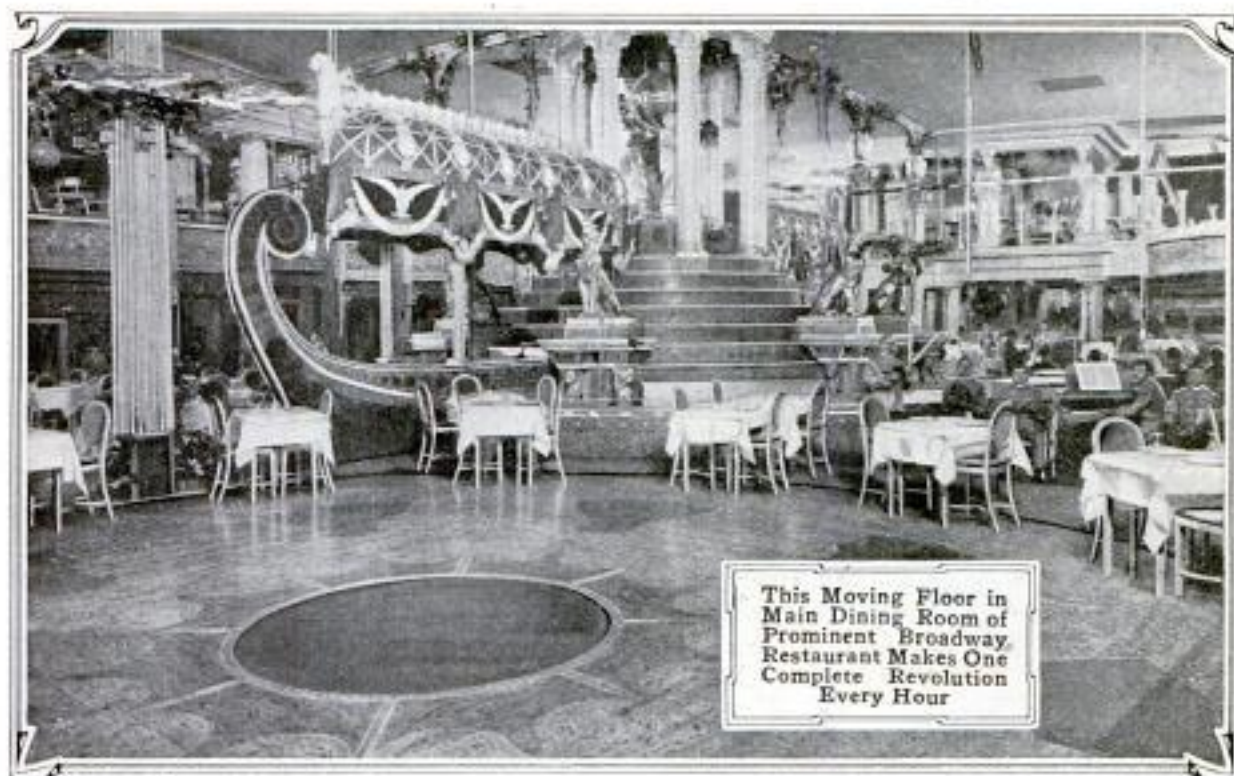

This Moving Floor in Main Dining Room of Prominent Broadway Restaurant Makes One Complete Revolution Every Hour

### MOVING FLOOR INNOVATION

10-59 AT NEW YORK CAFE

In one of the Broadway cafés at New York a merry-go-round dining and dancing space has lately been introduced. This consists of a revolving, circular floor, the outer edge of which is margined with a row of tables, while the middle part is reserved for fox-trotters. As is obvious, the floor is built on a turntable. It is 32 ft. in diameter, and in the center is inlaid with a round piece of plate glass, 6 ft. across, through which different luminous color effects are projected by means of concealed incandescent lamps. The floor surrounding this is stenciled to resemble marble mosaic. The turntable is driven by a 1/4-hp. motor at a normal rate of one revolution an hour. Thus 30 minutes after guests have seated themselves at one of the merry-go-round tables they may be talking with friends around another table at the opposite side of the room. The movement of the floor is slow enough that an unobserving first-nighter might readily be confused upon realizing suddenly that both he and his table were some 15 or 20 ft. from the place they apparently should be.

Hotel + Club News 10-15

### CLEANLINESS OF HOUSE

940 INVITES BIRD TENANTS

Because birds in many cases desire a clean nesting place for each successive brood, ornate and expensive bird houses are often of no value after the first year.

To get around this trouble a Battle Creek inventor has perfected a bird house that can readily be cleaned and thus made available for use each season. The house has a frame and a roof of ordinary sort, but the lower part consists of a cylinder held in place by pegs. When the feathered occupants have flown south for the winter, the pegs are removed, the cylinder drops down, and the nest and debris of the departed tenants are cleared away with the aid of a garden hose. When the birds come back from their winter vacation, they find the old nesting place clean and inviting.



Inventor: J. C. Hubbard  
 Pres. Am. Columbian Co.  
 Battle Creek, Mich.

*Inventa<sup>th</sup>.*

*Crabbe,*

*Paris.*

*Sold: Grand Magasins du Louvre  
Pour les Bros: 6, Impasse Sandrie (3 rue Aubert Paris)*

**POPULAR MECHANICS**  
**Underwood & Underw.**  
**PAPER OUTFITS PROTECT**

### 1177 AIRMEN FROM COLD

Paper suits which are said to be equal if not superior to cloth or fur



garments in keeping out the cold are now being manufactured to be worn beneath outer garments by airmen. Flyers frequently experience great difficulty in keeping warm when ascending to high altitudes, and paper, being a good non-conductor, furnishes excellent protection from the cold. The outfit shown is of very thin, tough paper, which can be washed and dried, and consists of a coat, trousers, loose-fitting socks, and a cap with earlaps.

### 489 OIL-FEED INDICATOR STOPS MOTOR AND LIMITS SPEED

An oil-feed indicator has been invented which automatically stops the



motor car to which it is attached when the lubricating oil ceases to flow and also limits the speed of the motor to any predetermined maximum.

The operation of this device is shown by the movement of a hand which oscillates across the face of a dial, set where it may be viewed by the driver. This

*mfr: The Turner Brass Works,  
Sycamore, Ills.*

hand, or indicating member, is actuated by a piston which is located in a tapered cylinder through which the lubricating oil flows. The pressure of the oil on the piston determines its position in the cylinder and hence the position of the hand. If the oil ceases to flow, because it is used up or clogged, the hand drops back to zero on the dial where is located a "motor-stop" pin. When the hand touches this pin it short-circuits the magneto through a ground wire, thereby stopping the motor. The speed control operates similarly through a pin at the opposite side of the dial which may be set to indicate any desired maximum. When the hand is forced, by excessive flow of oil, against this pin, it short-circuits the motor but does not stop it, as normal electrical connection is immediately resumed with a decreased flow of oil. The invention is adaptable also to motorboats.

### DANGER OF ELECTROCUTION 1350 IN BATHROOMS

Few persons realize the risks which they may run when turning electric-light switches in a bathroom. Several lives are lost annually by accidental electrocutions which take place in bathtubs. In some instances these deaths have been popularly attributed to faulty insulation. But it has been shown that a bather, standing in a tub of water, by turning a switch with his wet hand may cause enough moisture to penetrate the electric socket and establish a circuit, thereby permitting the current to pass from the wires, through his body into the water and thence to the ground. Thus the body acts very much as a lightning rod.

Electrocution may occur if one hand is in a washbowl of water and the other, being wet, is used to turn a switch. If only the key is touched and no moisture penetrates, of course no ill effects will follow. Fatalities are believed to have resulted also when a bather in a tub has accidentally struck his head against a projecting light socket. The hair, if thoroughly

*N. Y. World.*

Ses plus élégants salons de thé — Desserts et glaces pour réceptions

n " **Washington Palace** " 14, Rue Magellan, 14

POUR BALS ET MARIAGES

Tous les Grand'Pères voudront acheter à leurs Petits-Enfants la première partie de

**" L'ALBUM DE LA GUERRE "**

unie en un élégant encartage au prix de 10 frs. Expédition mandat-  
ste M. ROL, 4, rue Richer, Paris.

# Sous-Vêtements en PAPIER CRABBE

Exiger la marque  
" CRABBE "

Médaille par la T. G. F. — Prix de l'A. G. F. (Concours Prince d'Artemberg)

**Contre le Froid — Contre les Douleurs**

GILETS, CALEÇONS, CHAUSSETTES,  
GANTS, SACS DE COUCHAGE, etc., etc.

## Sous-Vêtement pour AVIATEURS

En vente: GRANDS MAGASINS DU LOUVRE et autres  
*Pour le Gros* : 6, Impasse Sandrié (3, rue Auber - PARIS)  
Conditions spéciales pour soldats et aviateurs mobilisés



★★

wet, may supply sufficient moisture in such cases to complete a circuit. Under these circumstances a current that is ordinarily harmless may cause death. This explanation is advanced regarding a fatality which occurred recently in an eastern state. Another accident, somewhat similar, occurred when a bather attempted to use an electric vibrator while sitting in a partly filled bathtub.

### ONE TOOL COMBINES THREE DRAFTING INSTRUMENTS

249 By joining two triangles with a protractor, a combination drafting instrument which may be used for transferring angles, dividing circles, drawing oblique parallels, and doing similar work has been devised. A 90° protractor having an arc with a 4-in. diameter marked in degrees, is fitted between two transparent blades which are adjustable. Any desired angle may be attained by placing a T-square against either of the triangles. A clamping screw, which is used to set the blades firmly, fills the place of a thumb knob.

By setting the instrument at 90°, two 60°, one 90°, two 45°, two 30°, and two 15° angles are obtained, as shown.

This Combination Instrument may be Used for Dividing Circles, Transferring Angles, and Doing Similar Work

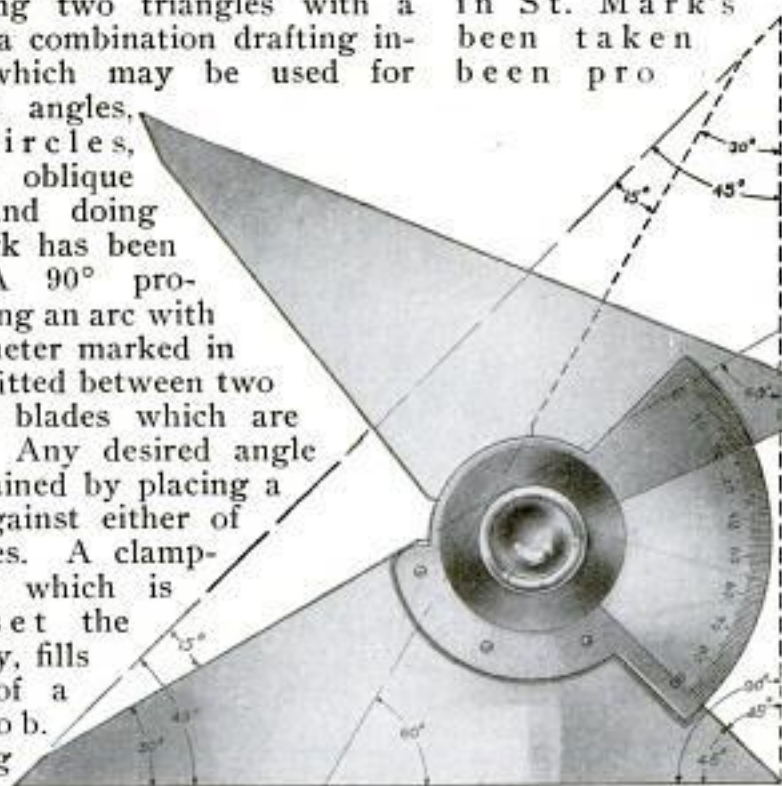

### SAND AND MASONRY SHIELD OLD VENETIAN EDIFICES

Elaborate precautions have been taken by the authorities of Venice to protect their historic buildings and art treasures against aerial attacks. Water pipes have been carried to the roofs of St. Mark's cathedral, the doge's palace, and other famous structures. As additional safeguards against con-

flagration the upper parts of these buildings have been provided with fire extinguishers and sand bags. Small towers have been erected at the corners of the doge's palace for the especial protection of the sculpture. The archways of the palace facing the sea have been strengthened and protected by masonry, and the arches of the loggia have been underpropped with wood. In this way the palace has been formed into a single block, so that if a column or a portico should be shattered the rest of the building would remain intact. All the principal works of art in St. Mark's which have not been taken away have been pro-

tected with bags of sand; some of the outer arches have been walled in. The bronze horses over the entrance have been removed altogether, and the masonry of the cupola has been strengthened. Experts in architecture and military fortification have carefully directed every detail of this work, which has cost \$40,-

000. The additional weight of the sand, masonry, etc., was calculated and distributed so as not to work any possible damage to the foundations or walls. All the protections have been so constructed that after the war they can be removed without damaging the original buildings.

“Merrimack” (not Merrimac) is the spelling approved by the United States Geographic Board for the name of the river that flows through Lowell and other Massachusetts cities.

OLD-WORLD MIRROR DEVICE

124\* ALSO USED IN AMERICA

A quaint old-world device, which in years past has found favor in Philadelphia and may still be seen on many of

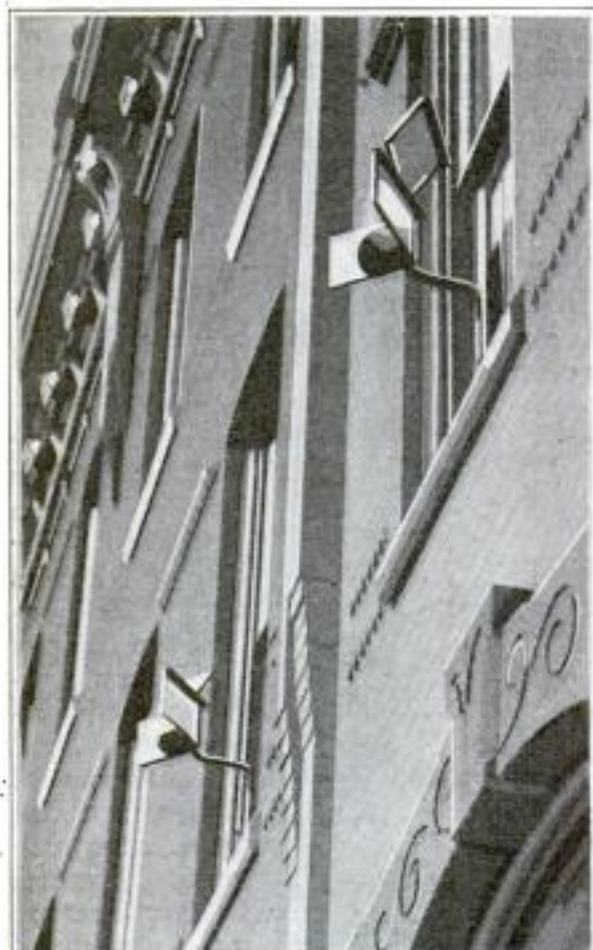

These Quaint Mirrors in Front of the Windows are Patterned after a Device Long Used in Europe, and are Found on Many Old Residences in Philadelphia: They Afford a Person within the House Several Views of the Street Below

its older residences, consists of mirrors fastened on metal frames just outside windows of the second or higher stories, at such angles that they afford a person within the house several views of the street below. These mirrors have been nicknamed "busybodies" and are to be found on houses in many parts of Europe, where they have been employed for generations.

One, two, or three mirrors are used. In case there are three, one is so adjusted that it affords a view of the street in one direction and a second reflects the view in the opposite direction; the third mirror enables one to

see the front doorstep. This frequently is a great convenience and, for example, permits the user to ascertain who may be at the front door, before responding to a ring of the doorbell.

FREIGHT RATES AND RULES

ALTERED BY NEW LAW 1248

Important changes in the rules and rates governing the shipping of live stock have been inaugurated on the various railroads of the country in compliance with the Cummins act pertaining to interstate commerce. In the matter of live stock, the shipper must state the value of his stock, and the rates charged are fixed by a sliding scale according to the valuation given. This valuation governs the limit of the railroad's liability and hence is an important feature of the regulations. Under the new rules the shippers are allowed certain maximum values for various kinds of stock. When the values which the shipper gives do not exceed these maximums, the minimum freight rate is charged. When values given do exceed the specified maximums, the rates are increased a certain percentage. These increases differ in various parts of the country as do the maximum values under which minimum rates can be enjoyed.

MODERN KITCHENETTE MADE

HOUSEHOLD LABORATORY 1283

One of the interesting exhibits at an electric show held some time ago at New York was a model kitchenette which occupied a surprisingly small amount of space. Nearly all of the utensils and appliances with which it was equipped were electrically operated and designed to save labor and simplify kitchen work in particular and housework in general. In a space, 10 ft. long and 26 in. deep, were arranged all the things needed in the culinary department of a small residence or apartment and many things found in but few homes. It represented a combination kitchen and laundry in which every inch of space

N.Y. Edison Co.  
Home Economics Bureau  
124 West 42nd St.  
N.Y. City.

Penna. R.R. Bulletin  
7-31-1915

Designated Mirror since 2 mirrors





COURTESY OF THE NEW YORK EDISON CO.

was utilized, and fire and ice unknown and unneeded. At one end was a well-equipped cabinet, and adjacent to it two wide shelves on which the various utensils were kept. Beneath these were a rack, sink, and washing machine. Space was provided for a portable vacuum cleaner, an electric refrigerator, air purifier, oven, stove, dishwasher and drier, and a sanitary garbage receptacle. An electric roaster, percolator, toaster, chafing dish, tea samovar, and other accessories of a like character were arranged on the shelves, which were finished in white enamel and kept immaculately clean.

### LONDONER ATTACHES KNIFE SHARPENER TO BICYCLE

201

An itinerant knife grinder in London has ingeniously attached his grinding apparatus to his bicycle by mounting a grindstone above the handlebars and connecting it by a chain with a grooved pulley which is fastened to the side of

the back wheel. By means of bracing legs the wheel is lifted slightly above the ground. The grinder seated on his bicycle operates the grindstone by foot

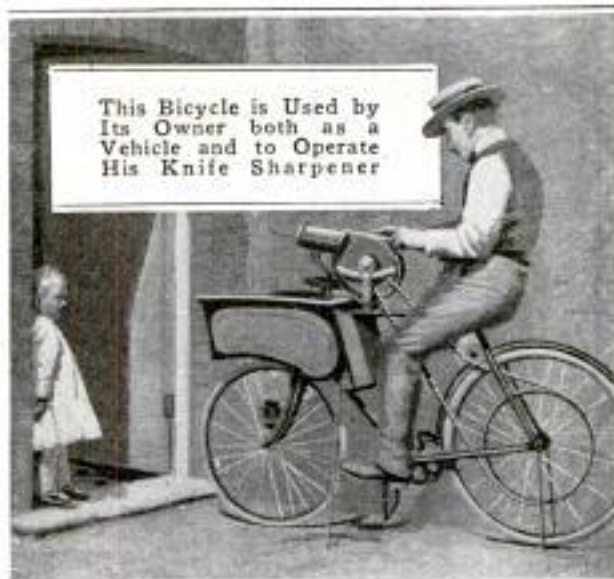

power. A watering can and a table over the front wheel, for cutlery not being sharpened, complete the outfit.

# A. W. Cutler, Rose Hill House, Worcester, England.

Trial at Coicoides in July 1913  
by Engineers of State Roads in  
presence of M. Seghers.

See data card

550

La Nature 7/25/14

### POPULAR MECHANICS

8642

### NEW SLIDING BUFFER FOR RAILROAD CARS

In a test of a sliding buffer that has just been brought out in France, a 200-ton train running at a speed of seven miles an hour was brought to a stop within a distance of 25 ft. without injury to the buffer or the rolling stock.

The weight of the end car of a train, bearing on this section, produces the friction for stopping the train without causing too great a shock. The track rails are secured against sliding and are connected with the ties in such a way as to keep the rails to gauge without preventing the sliding movement. Outside each track rail and running parallel with it is a steel plate to which the ends of the ties are fixed. The two plates are connected by steel I-beams so that the entire section slides as a unit. At the approach to the sliding section are four or five ties connected by articulated plates which are normally folded. When a car strikes the buffer, the unfolding of these plates, with the resulting sliding of the ties to which they are connected, permits the main section to slide

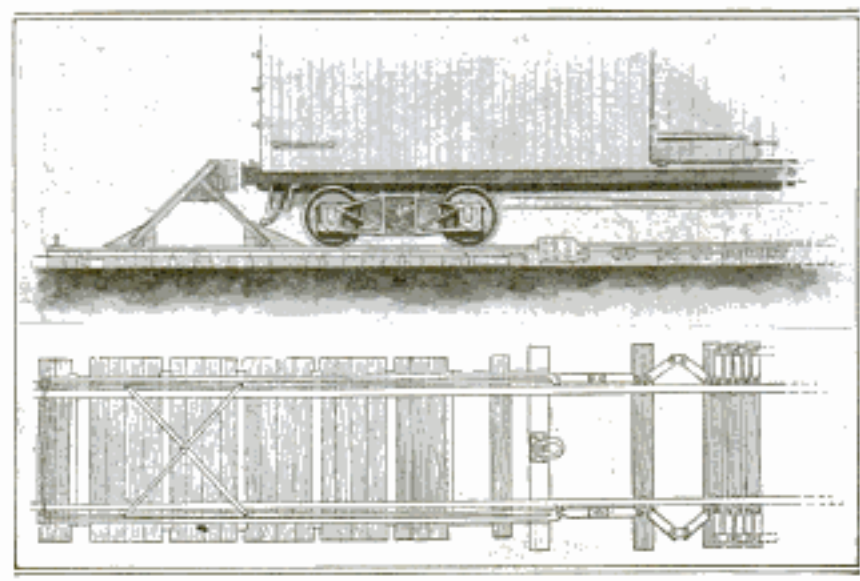

The Buffer and the Ties on Which It is Mounted Slide under the Impact of a Car, Bringing the Car to a Stop Gradually

The essential feature of this apparatus is a section of sliding ties which work in a concrete-lined channel and to which the buffer is attached by means of a triangular steel frame, as shown.

under the impact. The buffer is provided with a hook to which is attached a cable for pulling the apparatus back to its original position after the cars have been removed.

### SUBWAY STATION SUPPORTS LARGE BUILDING

1281

Quite an interesting piece of engineering is being accomplished at Philadelphia, where a four-track subway station is being built beneath the city hall. While the task is a more or less difficult one, as is most subterranean construction in large cities, it is not an unusual undertaking in most respects. The station will lie diagonally under the southwest quarter of the structure, which occupies a square block of ground and is one of the large municipal buildings of the country. When it is completed it will support that part of the weight of the hall which was formerly carried by the walls which have been removed to accommodate

the subway. Likewise it will hold up the present Market Street bore. It is estimated that this load will amount to approximately 200,500 tons.

The underground work is being carried on without interfering in any way with the activities within the building, which is nine stories in height and surmounted by a 548-ft. tower. From the exterior there is also very little evidence of what is going on under the great building and the streets adjacent to it on the south and west sides. During the construction period a section of the building is being carried on underpinnings which have been set beneath the walls to permit the excavat-

Raywell  
M. Seghers  
M. Ad.  
M. Seghers

# John T. McClarren, 18th Floor, No. American Bldg., Philadelphia, Pa.

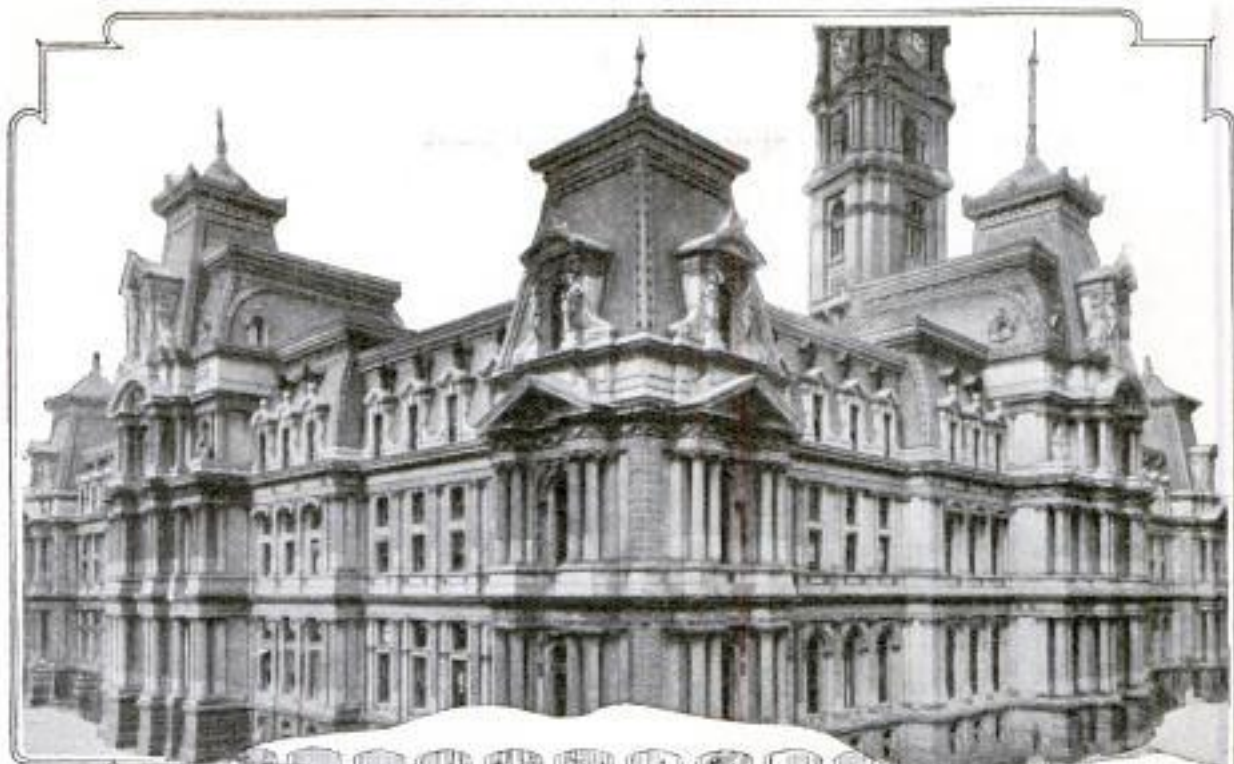
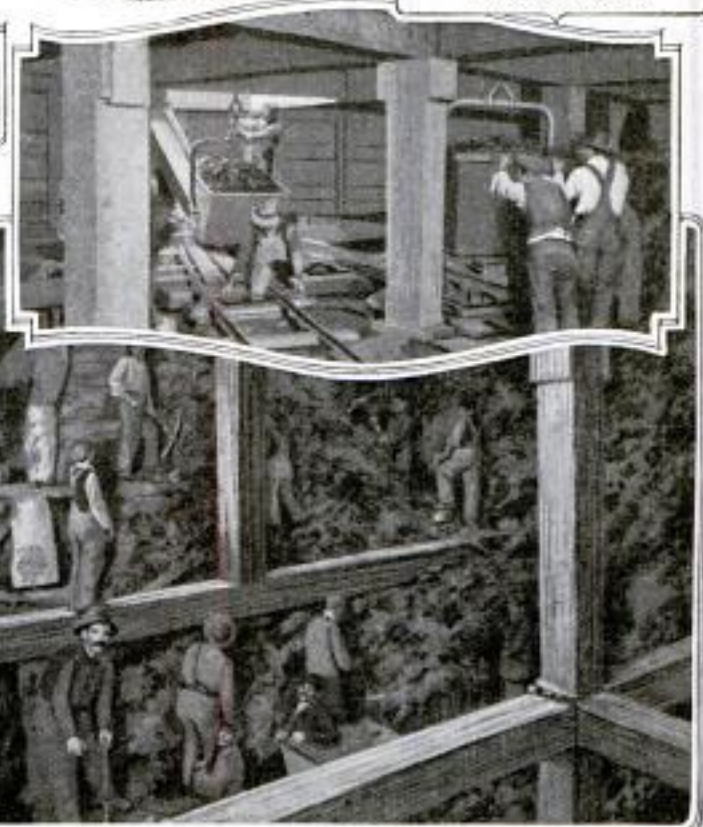
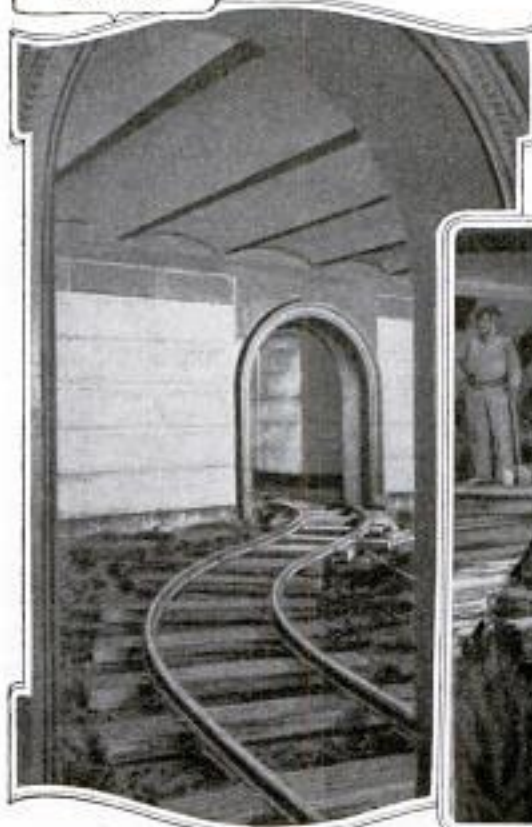

Diagram Shows General Arrangement of Subway Station Now being Built beneath the Philadelphia Municipal Building

Broad Street Tunnel, "B," will Support Part of the Weight of City Hall Shown Above, and Market Street Tunnel, "A," beneath Which It Passes



Left: Dump-Car Track Extending through Basement of Building. Above: Hoisting Dirt to Wagons Waiting at Street Level. Right: Putting the Underpinnings in Place beneath Pavement

ing to be done. As the earth is removed it is scooped into steel buckets mounted on trucks. These are pushed to one of two conveniently located shafts where the containers are lifted to the street level and their contents loaded into waiting wagons and carted away. The cost of the work, which represents the initial step in the new system, will be approximately \$1,300,000. The builders are allowed two and a half years in which to complete the undertaking.

### DISHES WASHED BY MACHINE 1162 IN MINUTE'S TIME

Dishwashing is reduced to a simple, momentary operation by an ingenious machine recently developed for domes-

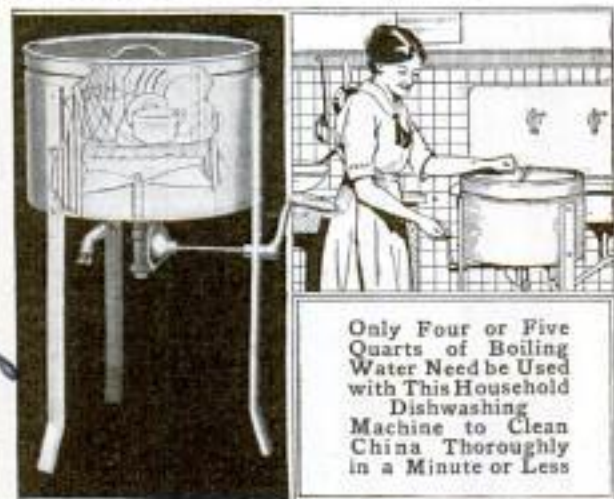

Only Four or Five Quarts of Boiling Water Need be Used with This Household Dishwashing Machine to Clean China Thoroughly in a Minute or Less

tic purposes. Unlike many similar devices, it uses a small amount of water and performs its function quickly and with thoroughness. The device consists of a cylindrical sheet-metal tank, fitted with a series of vertical baffle plates around its inner wall, and supported on legs at a convenient height. The top is tightly covered, while the cone-shaped bottom is provided with a large two-blade propeller driven by a shaft to which a crank is attached. China is set on edge in racks placed in a round wire basket which is suspended in the machine, after about five quarts of boiling, soapy water have been poured into it. When the cover is applied, the crank is turned slowly by hand. The revolving propeller hurls

the hot water with force against the baffle plates and upward among the dishes. Upon striking the vertical strips it is deflected so as to strike the china from every angle. Water is likewise forced against the cover and driven down upon the china. Glasses, bottles, pitchers, and similar articles, are placed upside down so that the water is shot directly into them. Dishes covered with mutton grease have been washed in this way in 35 seconds. A minute's time is almost always sufficient to complete the operation. Dishes in which eggs have been served can be cleaned in the machine, but preferably should be soaked a few minutes beforehand. When the basket is removed from the container the china is sprayed with hot water and set aside to dry. After being drained the machine needs only to be rinsed and dried. Its waste pipe may be permanently connected with a sink drain.

### MUD IN BOILER CAUSES "BAG" 1245 IN ITS SHELL

An excellent example of what boiler men call a "bag" was found in a boiler of an electric-light plant at Carrington, N. D., recently, formed in steel  $\frac{5}{8}$  in. thick. A bag is in reality a blister, or bulge, in the steel, due to high pressure within and occurring in some portion of the shell which has insufficient strength. In this case the bulge was caused by mud which had accumulated inside the boiler because it had not been properly cleaned. The mud and scale at this spot, which was directly over the fire, were really baked to the shell. The boiler pressure was 150 lb. to the square inch. Since there was



Mud Which Accumulated in a Boiler Caused a Portion of Its Shell to Become Red-Hot. The Pressure within Produced This "Bag," Which Projects Eight Inches

Sold by: ~~J. M. Anderson~~  
Minneapolis, Bedding Co.  
5th Ave. S. E. City Division  
Minneapolis, Minn.

# Alfred C. Fox  
Box 933, Fargo, N. Dak.



With This Implement  
Many Loads of Dirt  
were Pushed over the  
Edge of the Bluff into  
a Depression Below

little or no circulation of the boiling water on the shell at this point, the furnace heated the steel red-hot. This of course softened the steel and it began to bulge at the weakened point. The farther the bag extended into the fire box the hotter it became. The distention finally projected 8 in. and burst, the escaping steam and water putting out the fire and shutting down the plant. No one was hurt. The bag was cut out, and a patch riveted in its place.

#### FOUR HORSES AND PUSHER 1266 DO WORK OF MANY MEN

While filling a deep depression near a railway station in LaSalle, Ill., the city authorities had occasion to dump much of the filling dirt at the edge of a steep bluff overlooking the low-lying land. Four horses, two men, and an implement of unusual design were used to push the dirt over the edge of the bluff. This pusher consisted of a wide plank, several feet long, to one face of which was fastened at right angles a section of a telephone pole. This latter member was placed between the two center horses, as shown, the forward end was fastened to a heavy neck yoke, and the rear end to

the axle of two wagon wheels, to which the horses were hitched. A platform fastened to the axle and the pole enabled the drivers to raise the pusher from the dirt when desired by placing their weight at the rear of the platform. By using this implement the city was saved much expense.

#### ORNAMENTAL ASH TRAY AND 1209 MATCH HOLDER

A useful ornament for a smoking room is a match holder and ash tray which stands 3 ft. high—a convenient height for a smoker when seated. It consists of a wooden upright so designed as to represent a liveried house servant holding on his outstretched hands a wooden tray. Fastened to the tray is a match-box holder and sunk in its surface is a metal ash holder. Save for certain bright colors on the figure, the article is finished in a dark stain.



What is believed to be the largest package of motor parts ever sent by parcel post to a foreign country was sent recently from Racine, Wis., to Petrograd. It weighed 201 lb. and \$96.84 was the postage cost.

# Avery E. Granville  
Lock Box 26, Sta. O.,  
Cincinnati, Ohio

# Mrs. Fred Sanford, Western Springs, Ill.

# Geo. Goodwin Jr.  
Jemiskaming Is., P. Q. Canada

CURRENT READINGS TAKEN

9633 UNDER DIFFICULTIES

To sit for hours at a time in a little wooden cage 40 ft. above the wind-swept Ottawa River, the temperature many times 40° or more below zero, is a task regularly endured by a meter reader in eastern Canada during the winter months.



In order to avoid freezing it is necessary to wear a thick woolen cap, a fur overcoat, heavy mittens, four pairs of socks, a pair of moccasins, and sheep-skin boots. Even then it is difficult to remain out more than two or three hours at a time.

A cable stretched across the river supports the cage and rider. Beneath it hangs a current meter which indicates the rate at which the waters are flowing. Data obtained therefrom are useful in determining the availability of the stream for power purposes. Inasmuch as the shiny meter hanging in the water resembles a fisherman's troll, huge pike and pickerel occasionally attempt to swallow it whole.

FLOATING MASS OF PUMICE NEAR FIJI ISLANDS

1373

A mass of floating pumice, some five miles in width and of unknown length, was encountered by a party which was recently cruising in a 10-ton motorboat among the Fiji Islands and other groups. Pumice is lava having a frothy or spongy structure which has been thoroughly permeated by gases. It is often so porous as to float on the water for a considerable time after being ejected from a volcano, but after its pores are filled

with water it sinks to the bottom, its specific gravity being nearly two and one-half times that of water. The edge of the unusually large mass discovered by these voyagers seemed like floating froth and dust, and the boat moved through it easily. But later on there was difficulty in making headway, and at times the craft was brought almost to a standstill. The propeller could be heard striking hard lumps at each revolution and occasionally the pilot steered to one side to avoid solid masses, as much as 4 ft. in diameter. In some places the pumice was so compact that a native was able to stand on a small plank thrown on the top of it. The spongy material clogged the pipes of one of the engines, which had to be taken apart for repairs. It took nearly two hours to pass through this floating mass, which, on the sides, reached as far as the eye could see.

WATER BOTTLE DESIGNED FOR INFANT'S NEEDS

A hot-water bottle with an opening, or passageway, extending through it from side to side has been designed, which admits of a number of uses for which the ordinary water bottle is not suited.



A nursing bottle inserted in this opening can be kept warm for a considerable time, thereby avoiding the inconvenience often experienced in securing warm milk for a baby.

In hot weather the water bottle may be filled with chipped ice or ice water; so filled it will keep milk in a nursing bottle from souring. By running a bandage through the opening the water bottle may be easily and securely bound to any portion of the body.

Shipping Illustrated, 1/22/16

Sold by: Buck & Rayner, Chicago

See white cards:  
Ostrich Farms

## OSTRICH FARMING A PROFITABLE ENTERPRISE

1206

By ROBERT H. MOULTON, Room 1, Bd of Trade  
Chicago

**R**OAST ostrich is the latest dish provided by solicitous chefs to tempt jaded appetites, and it is said by those who have tried it to be quite a delectable morsel. It is safe to predict, however, that this huge, ungainly bird which we are accustomed to associate with zoölogical-gardens and menageries will never become a popular short-order dish. In the first place, it takes an epicurean to appreciate them. And in the next, they are too valuable to be served up in slices and joints. A dead ostrich is worth only about \$100 as an entrée—and once eaten, there is

an end of him. But a live ostrich is worth anywhere from five to twenty times this amount, because he produces each year from \$50 to \$150 worth of feathers, and can keep this up for 50 years or more without any appreciable effort. Some have been known to yield excellent plumage at the age of seventy-five.

Ostrich farming in this country is as yet in its infancy, but its possibilities seem to be attracting the attention of investors. In normal times an average of \$5,000,000 worth of ostrich feathers have been imported into the



Top, Left: Washed and Bleached Ostrich Feathers Drying; Right: Ostrich Eggs, Chicks, Some of Which have Just Hatched, and Full-Grown Birds. In Circular Insert Workers are Shown Packing Feathers for Shipment, and below It is a View of a California Ostrich Farm. Bottom, Left: Washing and Dyeing Feathers; Right: Plucking Ostrich Feathers

United States from Asia and Africa each year, notwithstanding the import duty of 20 per cent on the raw and 60 per cent on the prepared feathers. It has been found that the ostriches raised in this country produce plumage fully equal and in some instances superior to that imported from abroad. There is, therefore, no reason why this large sum should not be diverted to the pockets of American ostrich farmers.

There are a number of states where the climate is ideal for the propagation of these birds. At the present time there are ostrich farms in Arizona, Arkansas, Texas, California, and Florida, with an estimated total of 8,000 birds as against less than fifty, 20 years ago, most of which were in circuses. Certain sections of the Salt River Valley in Arizona, where alfalfa and lucern can be grown on irrigated lands, are especially adapted to ostrich farming, as one farm in that locality has already proved by its great success. Fifty or a hundred acres of this land planted in alfalfa and stocked with ostriches should net the owner a princely income.

Early in the year the best-feathered and finest strain of birds are paired off for breeding purposes in separate corals. The male bird then begins to build the nest, which is merely a hole, about three feet in diameter and a foot deep, hollowed out in the ground. The female deposits her eggs in this nest, one every other day until about 15 have been laid. Each egg weighs about three and one-half pounds or as much as two and one-half dozen hen's eggs.

Contrary to popular belief, the female ostrich does not leave her eggs to be hatched by the rays of the sun. They are simply covered with sand to protect them from the heat. Both male and female take turns in sitting on the eggs, the male bird being in steady attendance during the night and the female during the day. At the end of 40 days the little chick incased in the egg begins to pick at its shell. At this time the farmer removes the eggs to a separate inclosure, where he care-

fully liberates the little ostriches. The mother bird, thus relieved of her first hatching, is ready for another nest of eggs and forthwith takes up the process of reproduction once more.

Each female bird lays an average of 55 eggs per year, from the age of four until she reaches middle life at 35. Thereafter until the end of her life chapter, at the age of about 60, she produces no eggs. Ostrich eggs are valued at about \$5 each.

During the first six months the little chicks grow with amazing rapidity, averaging a foot in growth each month. Between the ages of six and ten months, their feathers are regularly plucked at short intervals. After this period they are examined every two months, and all "ripe" feathers plucked, care being taken that none of the sockets or roots are pulled, for whenever a socket is removed the feather-producing seed is destroyed forever. After two years, three crops of feathers can be gathered each year, the average number of plumes being about 400 for the season. This number of plumes will weigh about one and one-fourth pounds. The glossy black feathers, which are the most valued, come from the male ostrich, while the female yields the drab-colored plumes which go through the various processes of dyeing and bleaching before they become an adjunct of women's fashionable headgear.

The value of ostriches in comparison with cattle shows a large preponderance in favor of the former. A head of cattle, for instance, will eat 60 lb. of alfalfa a day against 10 lb. for an ostrich. At five years of age this head of cattle is worth perhaps \$40, while an ostrich at the same age is worth \$300, or more. There is nothing to the cattle but meat, while at 10 months the ostrich will produce \$10 worth of feathers, and thereafter from \$50 to \$150 worth annually.

---

☞The driving of an 8-in. silver rivet, instead of a cornerstone laying, marked the beginning of the erection of a New York skyscraper recently.





Each Employee is Allowed an Hour's Exercise Each Day the Weather Is Agreeable. An Alert, Efficient Business Organization Is the Result

### 1242 ATHLETIC FIELD ON ROOF OF BUSINESS HOUSE

For the benefit of its employes, a large Philadelphia business concern has established a well-equipped athletic field on the roof of a 12-story building occupied by it in the city's commercial district. A rectangular cinder track extends around the outer edge of the building and is used by long-distance runners, while at one end there is a fast oval, suitable for 220-yd. and 440-yd. sprinters. A 100-yd. straightaway has also been provided by utilizing one side of the oval course. Adjacent to this and entirely inclosed in large cages are two basketball and two tennis courts. A bowling alley and spaces for various mild forms of exercise are also provided. It is appreciated by the company that to have a highly efficient working organization every man in the force must be in physical trim. The athletic field was thus conceived. So that it may be properly used, the company allows its employes one hour in which to exercise every day the weather permits. This gives ample time for the men to put on athletic suits and go through a workout.

Wanamaker Store  
Philadelphia, Pa.

### 1024 AERIAL TOP FLIES AS IT SPINS

A novel top which mounts into the air as it spins is being produced by a Chicago manufacturer. It consists of a handle and parallel shaft, at the upper end of which is a fan wheel, or propeller, with several curved blades. The wheel is fastened solidly to its shaft, which turns easily in two sockets made by curved projections adjoining the handle. By winding a string tightly about the shaft and pulling it as is done in top spinning, the resulting rapid revolutions of the wheel will make the toy rise as high as, or higher than, an ordinary dwelling house. The ring around the fan wheel furnishes protection against cutting the fingers.



Benjamin-Seller Mfg. Co.  
1559 W. Quincy St.,  
Chicago, Ill.

Copyright Chicago

Driver: *Alfred Le Roy, Los Angeles Calif.*

**ONE-ARMED, LEGLESS MAN  
MOTORCYCLE TOURIST**

With a motorcycle that is especially adapted to meet his physical limita-

twice by making an overland trip from California to New York and return. The machine driven by him on this lengthy journey is provided with a sidecar which is used in lieu of the cus-

tomary seat. Instead of depending upon handlebars, a lever arranged on the right side of the auxiliary car enables the cyclist to steer with his one available arm. The motor and clutch are controlled by small levers fastened to the frame at the top of the machine, where they are within easy access. Between the cycle and its sidecar another

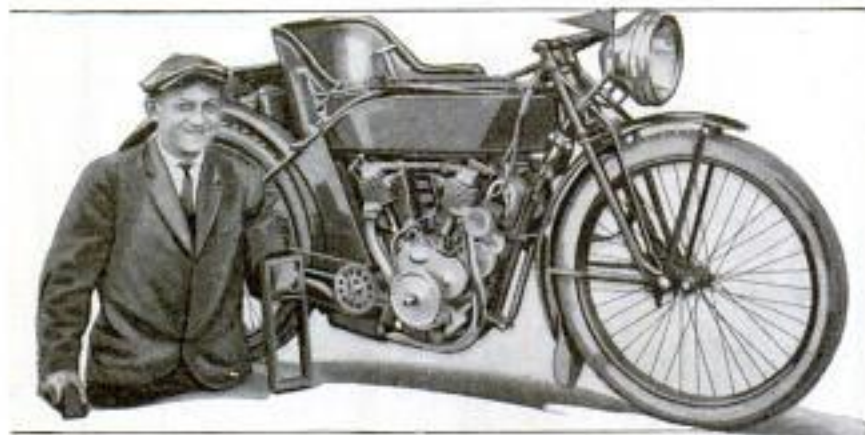

With This Machine the Maimed Rider Makes Overland Trips without Difficulty

tions, a Los Angeles man, who has suffered the loss of both legs and the left forearm, has crossed the continent

lever is arranged so that the engine may be turned over without help. The braking is accomplished similarly.

**LIGHT DIMMING PREVENTED  
BY NEW REGULATOR**

Electric-lighting companies frequently find it difficult to maintain a constant voltage at a consumer's installation, and as a result lamps sometimes grow dim, or flicker perceptibly, every time a motor, or other heavy load, in the vicinity starts up. The reason is that too much current is being drawn from the line, and as a result the pressure, or voltage, falls off. As at present equipped, most power companies cannot at the moment raise the pressure on a particular line, and the consumer must, as a consequence, worry along with the lowered voltage and dimmed lights until the load in his district falls off.

line at all times constant, and consists principally of an induction regulator arranged to be operated automatically by an instrument sensitive to shifts in voltage. An induction regulator is much like the transformer visible on

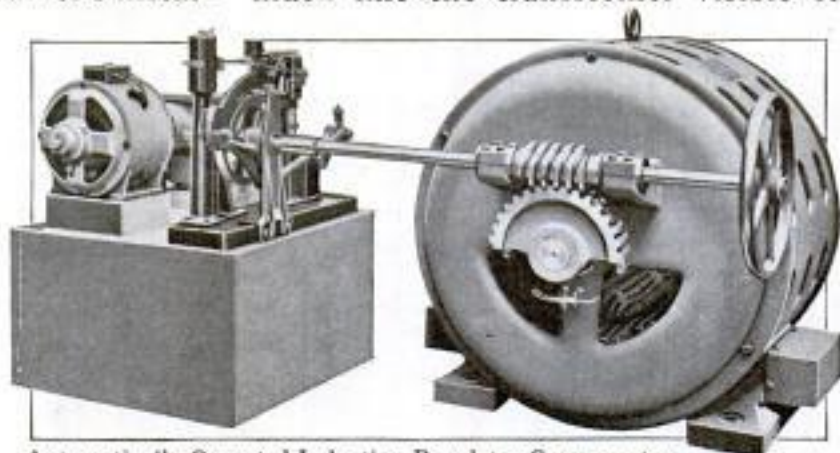

Automatically Operated Induction Regulator Compensates for Voltage Variations in Transmission Lines

most any electric-light pole, except that its primary is mounted on an axis, and is capable of rotation much as the armature of an induction motor. The rotor is, however, kept from revolving by a toothed gear on one side. Shifting the relative positions of stator and rotor by means of this gearing,

*H. Francis P. Mann, Paris, France*

*Heavy automatic driven Oerlikon Regulator*

*Copyrighted material  
Oerlikon, Zurich, Switz., Switzer.*



Above: This Light Hunting Boat can be Carried by Motor Car from One Desirable Lake to Another without Inconvenience



Left: A Roadster Carrying a Complete Hunting Outfit, Including a Boat Strapped to Iron Supports above the Passengers

raises or lowers the voltage impressed across the line beyond the regulator. Thus, with sensitive electromagnets to work pawls operating this gearing, stator and rotor may at any moment be set automatically so as to compensate for any falling off in the line voltage, and by this means current, as delivered to the consumer, comes at a uniform pressure. The contrivance may be connected with any individual lines going out of a plant, or to the main leads coming from the generator. It is most effective, however, when connected only into the local circuit of the troubled district.

### ROADSTER CARRIES BOAT AND HUNTING OUTFIT

A California duck hunter has so altered his cut-down roadster that it carries his boat, tent, bedding, and many other camp necessities, conveniently and compactly. The most striking feature of this utility car is the manner of carrying the boat. Two

iron rods are fastened either side of the machine, just ahead of the windshield. They are connected at the top by a rubber crossbar, bent down slightly to accommodate the curved top of the boat. Two rods, just back of the seat, are similarly placed and also are braced. The boat is placed on these two crossbars and firmly strapped in position as shown. The oars are strapped within the boat. The craft weighs only 80 lb. and can be removed quickly, enabling the hunter to get within range of many ducks that a hunter with high boots could not reach.

To make the skiff as light as possible the seat has been removed, and when one is needed a motor-car seat is used. The craft has proven a satisfactory foundation for a bed, the car seats being placed in the cockpit and used as a mattress, bedding being spread over all. An "A"-tent, blankets, and cooking utensils are carried on a platform at the rear. A spacious trunk has compartments for food, and fishing and hunting materials.

1234

H. Maple

C. W. Clark, Glendale, Calif.

Amer. Artisan + Hardware Dealers  
 Sold by: The Fair, 6th floor, Chicago <sup>12/11/15</sup>

360

POPULAR MECHANICS

*Chr. Science Monitor 1/4/16*  
**DRIFTWOOD - A RICH HARVEST**  
**FOR RIVER LUMBERMAN**

**GLASS MAIL BOX PRESENTS**  
**ARTISTIC APPEARANCE**

A mail box similar to ordinary types except for a glass front and sides, is being offered householders interested



A Mail Box, Chiefly of Plate Glass and Polished Wood, Which It Is Unnecessary to Open to Ascertain Its Contents

in new conveniences for the home. Because of the transparency of the walls, letters deposited in the box may easily be seen from a distance without the trouble of making a special trip to the box. Being made of plate glass and polished wood, the trim appearance of the contrivance is a special feature. The front is made to be tilted outward for the removal of mail. A metal clip at the top holds papers and packages too large to go within.

CA flying boat is a part of the equipment of a party of oil prospectors bound for interior Colombia.

From 150,000 to 300,000 feet of lumber, chiefly cottonwood, is the harvest gathered annually by a sawmill owner on the Missouri River, who makes a special business of sawing up driftwood. Most of the collecting of this stray material is done in the early summer after the freshets have subsided, leaving much good material in their wake. Men go far up and downstream getting out logs and trees, some of which have been uncovered after being imbedded in the sand or under the water for years. This material is sawed into lengths, made into rafts, and floated downstream to the mill where it is cut into lumber, chiefly of a cheaper grade. The logs which have been partly submerged frequently are found to be damaged, but those that have been kept from the air by being wholly under water, even if for decades, generally are in good condition.

**BEAUTY AS WELL AS BIGNESS**  
**A FEATURE OF NEW DAM**

The Kensico dam, which is notable both for its size and for an architectural treatment that possesses individuality and massive beauty, is now being filled with water. Located 13 miles from the northern boundary of New York City, it is already one of the chief objects of interest in that municipality's new water system, which the first of the present year brought water from the Catskills for the first time, though for testing purposes only. Since this public engineering undertaking is situated on many arteries of travel, special consideration has been given to its architectural features, the designs and materials used being selected with a view to conveying a sense of the real vastness of the barrier.

As has been previously noted in Popular Mechanics Magazine, this dam was built to supplement the Ashokan dam, 75 miles farther north, thus establishing a reservoir which can be

*Am. Van Manufacturing Co., Rochester, N.Y.*

*at American River N.Y. State*

*Engineering News, Sept 2, 1915*  
*pp 435 to 436*  
*N.Y. Sun Oct. 10, 1915*

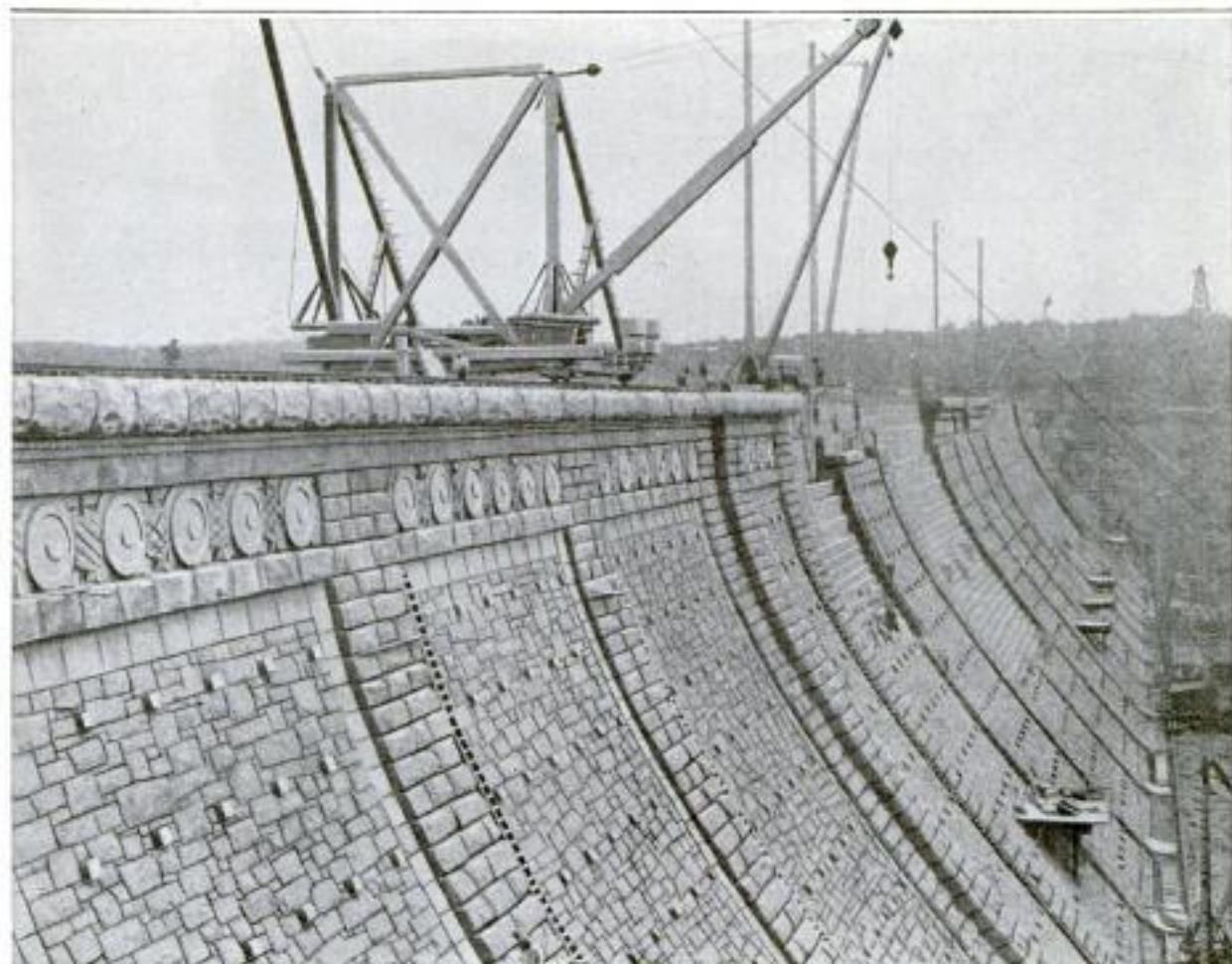

The Downstream Face of the Kensico Dam, Showing the Paneled Granite Facing Partly Finished. The Stones of the Torus Are Four Feet Thick and Weigh from Nine to 14 Tons Each

drawn upon in case repairs are needed in the long Catskills aqueduct.

The Kensico reservoir represents an expenditure of nearly \$8,500,000; its water surface will have an area of 2,218 acres. Excavations for the foundation extended to solid rock, 140 ft. below the original lowest level of the valley. The dam rises 170 ft. above the original level, and is more than 1,800 feet long at its crest. The bulk of the masonry is of cyclopean concrete, that is, irregular masses of stone bound together by concrete. The upstream surface is faced with concrete blocks. Provision for expansion and contraction is made by dividing the dam into sections with expansion joints, supplemented by great strips of copper.

The downstream face of the dam is of local granite, ranging in color from gray to pink and marked with russets and reds. The panels made by the

expansion joints constitute the motif for the decoration on this face, their position being outlined by heavy rows of projecting, rough-faced stone, adjacent to which is a row of smooth-faced stone. The body of each panel is composed of rough stones, a large percentage of which have a face area of more than six square feet. The joints are wide and recessed. At regular intervals square stones project slightly. The stones in the torus are 4 ft. high and weigh from 9 to 14 tons each. The simply designed frieze is 6 ft. 6 in. high, some of the stones weighing from 10 to 14 tons or more.

Terraces, long pools, and playing fountains form the central features of a park extending downstream from the base of the dam and far up the hillsides, which are reached by ramps and driveways that wind amid the forests and offer views of the dam from many angles.

Board of Water Supply, Municipal Bldg., N. Y.  
 J. Waldo Smith, Chief Engineer

COMPACT MOTOR CONTROL

1317 OF INTERESTING TYPE

On the Pacific coast a compact controller of somewhat novel design has

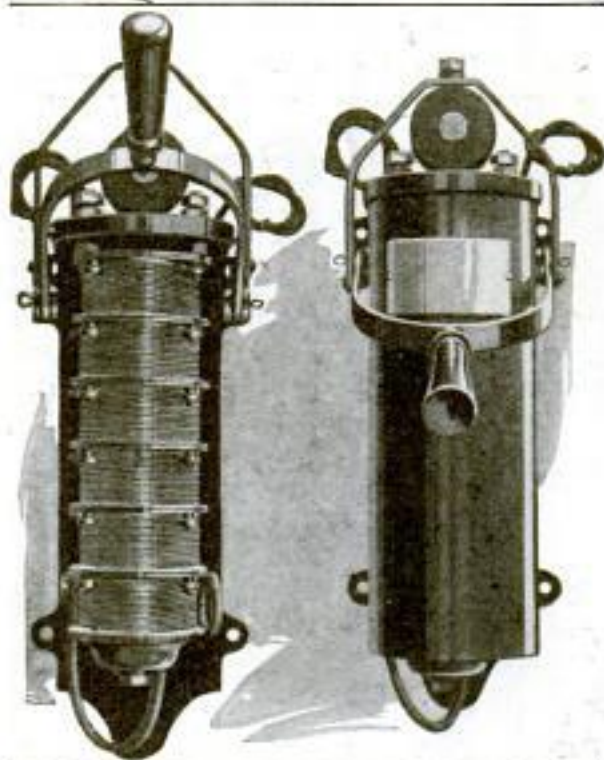

In Addition to being of Compact Size, the Starter Is without Sliding Contacts or Springs

been introduced for use with direct-current electric motors. It differs in a number of points from many of the more commonly known starters, and among other things is without sliding contacts and springs. The wire forming the resistance element is wound about a series of insulated brass spools which are arranged vertically one above the other and suspended on insulating bushings from the cast-iron frame, or back, of the controller. When the manual switch is entirely out of contact the several coils are separated from each other. These members are brought together, however, as the handle is pushed upward. When in final position, all of the spools are connected end to end, the resistance is cut out and the motor runs at full speed. A magnet at the top of the frame holds the hand lever in position. In case of trouble this acts as a "no-voltage release," causing the lever to drop, thus breaking the contact and saving the motor. The operation of the controller can be made automatic by providing a solenoid magnet at the upper part of the frame, substituting it for the handle.

ELECTRICAL CABINETS FOR EXECUTION OF ANIMALS

1264 The Animal Rescue League of Boston has perfected electrical apparatus for killing animals by a method which is humane and in other respects very desirable in that the animals killed endure no suffering, the operator is placed in no danger and engages in no brutalizing practices. Two different execution cabinets have been made, one for dogs and the other for cats. The former, which is the larger of the two, is about 2½ ft. wide and 4½ ft. high, with a door in front. The inside walls of the cabinet are electrically insulated. The apparatus for dogs has a metal floor or pan upon which the animal stands. From a metal bar above the dog's head hangs a strong chain with a snap hook at the lower end. The pan is connected with one pole of a high-tension current and the

bar with the other pole. A metal collar with suitable electrode points is placed about the dog's neck and fastened to the chain. When the door is shut a circuit is formed and the animal is rendered unconscious instantly. The current is kept turned on for half a minute. Experts assert that an animal so executed endures no suffering and its appearance after death seems to confirm that statement.

The cabinet for cats has a door at the top which is opened by a foot lever attached to a cord that runs over a pulley and to a spring latch in the door. This permits the attendant the free use of both hands. Within, at either end of a slate tray, are metal electrodes. The animal is placed with its fore feet on one electrode and its hind feet on the other. Partly because

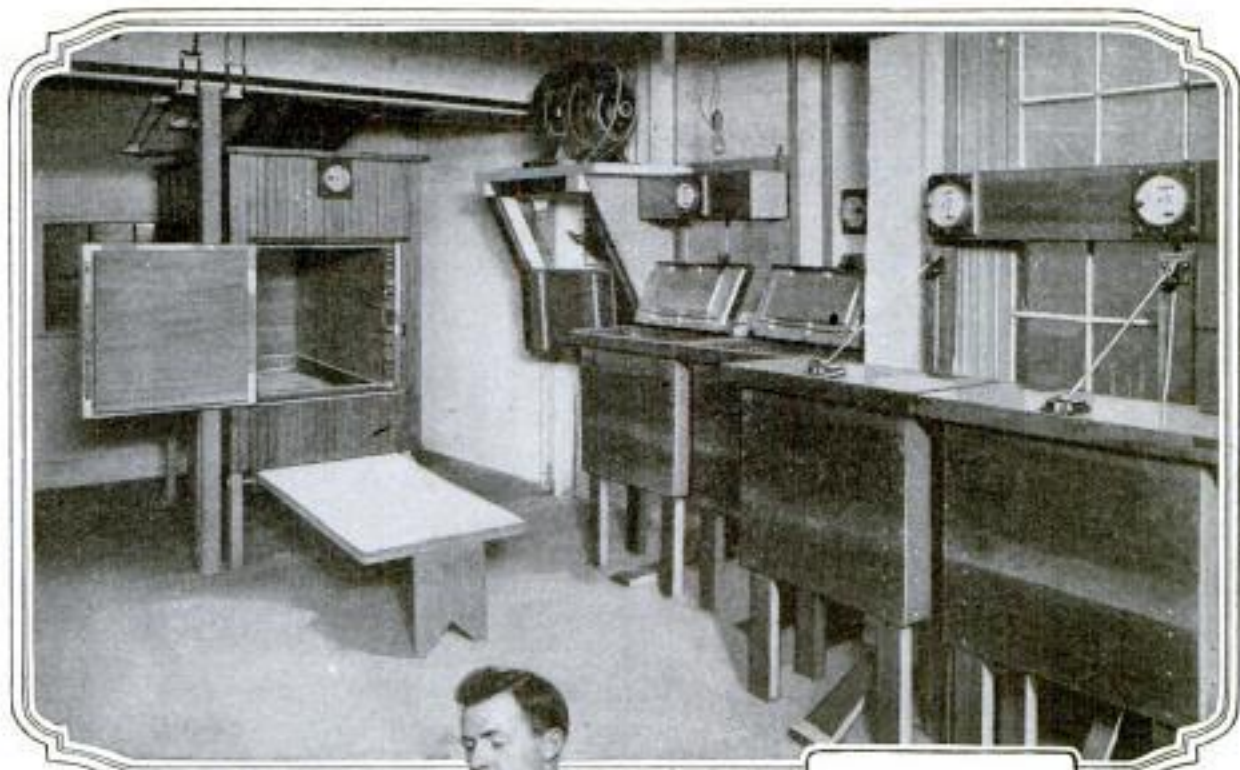

The Large Cabinet is Used for Executing Dogs; the Four Smaller Cabinets Are for Executing Cats



An Executed Cat After the Electrical Current had been Turned on One Minute



Left: A Dog About to be Executed  
Right: Same Dog After the Electrical Current had been Turned on 30 Seconds

of the cat's greater powers of resistance the current is kept on a full minute. Current from an ordinary commercial lighting circuit is sufficient to operate these cabinets, which have already been installed in 20 communities in Canada and the United States.

### SIMPLE LOCK IS DESIGNED FOR LIGHT MOTOR CAR

749

In an attempt to prevent the theft of certain light cars, a rather ingenious lock is being used which is apparently



With the Lock Engaged a Car can Only be Driven or Towed in a Circle

as effective as it is convenient for a motorist. It is made of malleable steel in two parts; a clamp which fits about the steering wheel and over one of its spokes, and a hinged door, containing the lock proper, which is mounted on the steering column. When the device is in use the front wheels of a car are turned slightly to one side and held firmly in that position, making it possible only to drive or tow the machine in a circle. A high-grade lock is employed, and all screws, bolts, and joints are covered. The locking is done automatically from the seat, which forms a convenient feature for the user. When it is not engaged the door lies back against the steering column out of the way of the driver.

*Mudd Auto Lock Co.,*  
*112 So. Clinton St.,*  
*Chicago*

To permit the flagship of a fleet to communicate with the other ships quickly and efficiently, the French are adopting an air siren. Mounted on top of a mast the sounds given out by this device may be heard from one to two miles. By its use signals may be transmitted even in foggy weather at a time when flags or other visual signals are inoperative. The air siren also relieves the wireless of much short-distance work, thus leaving the latter free to communicate with the shore or longer distances.

The machine consists of an electric motor having a vertical shaft on which are three powerful fans. These drive a stream of air at great velocity up through a cylinder at the top of the machine. This is perforated with a large number of holes through which the air escapes, the cylinder at the same time revolving at great speed past several oblong openings in an outer cylinder. This produces rapidly interrupted jets of air, and causes the machine to give forth a shrieking sound after the manner of the usual siren. Interposed between the upper

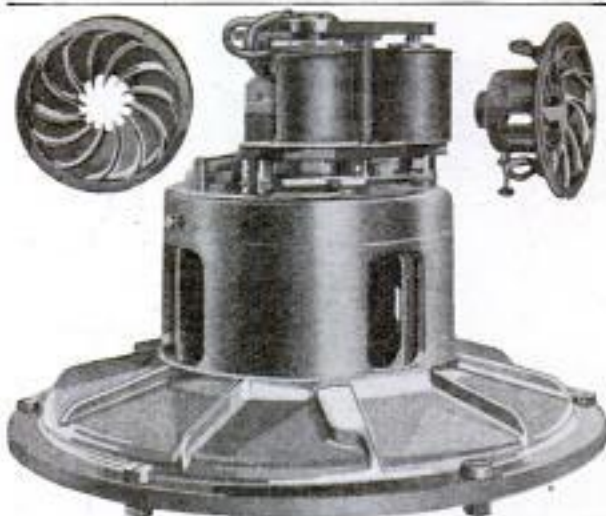

Air Siren Used as Battleship Signal over Short Distances

cylinders is a shutter operated by an electromagnet. Hence, by the simple manipulation of a key, the machine may be made to give off Morse signals as in the ordinary telegraph system.



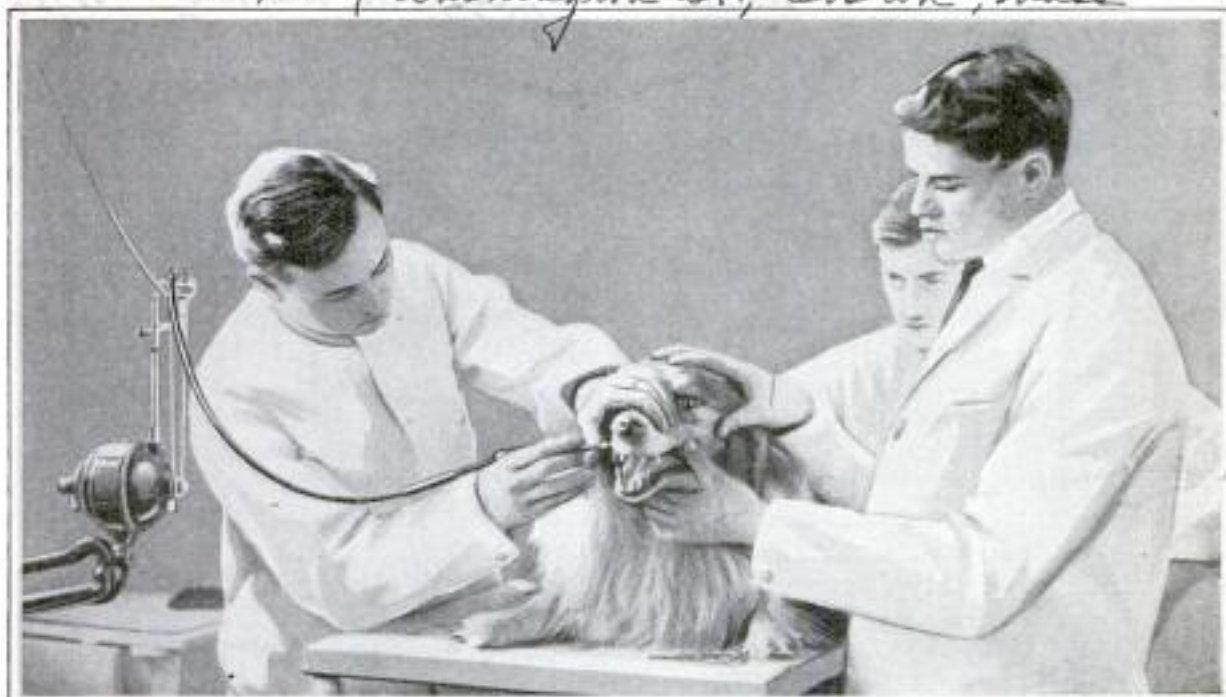

Cleaning the Teeth of a Collie, One of the First Patients Cared For in the New Dental Department of a Boston Hospital for Dumb Animals

## DENTAL ROOM FOR ANIMALS 1252 IN BOSTON INSTITUTION

In order that the teeth of domestic pets may be given proper attention, a dental department has of late been established in the Angell Memorial Hospital, a Boston institution for the medical and surgical treatment of dumb animals. Dogs, cats, and other animals are cared for by experienced practitioners who work upon them with almost as much care as if they were human. Even to many admirers of dogs, the thought of giving attention to an animal's teeth may possibly seem odd. Yet the importance of doing so is very apparent to anyone who realizes the close connection between good teeth and good health. So far the dental work has been confined chiefly to cleaning teeth, treating infected gums, and extracting, now and then, a decayed tooth. The department, however, is well equipped with instruments, and it is understood that other work will also be undertaken.

☐ An American firm is now making the finest quality of photographic raw paper. Formerly this came chiefly from Germany and France.

*Eastman Kodak Co  
Rochester, N. Y.*

## LOW-PRICED SEED TESTER OF 1275 SERVICEABLE TYPE

For the advantage of both the retailer and large consumer, a comparatively inexpensive germinator has been developed for testing the quality of seeds before they are disposed of or planted. It consists of a lamp-heated glass case which accommodates five corrugated trays. The longitudinal depressions in the latter are partly filled with water, while blotters are placed across the top of each. Garden, field, and flower seeds are arranged on these absorbent sheets and the temperature then maintained at from 68° to 86°. After the blotters have once been moistened by sprinkling, the evaporation of the water in the several trays keeps them uniformly dampened. By dividing each tray into



15.00 F.O.B. Chgo  
*the "Subgerminator"*

*Miss Gray (office)  
Seed Trade Reporting Bureau,  
Postal Telegraph Bldg. Chicago*

*Keystone Weekly 1/11/16*  
**AUSTRALIA ALONE PRODUCES  
1366 COSTLY BLACK OPALS**

several sections a number of varieties of seeds may be tested simultaneously. The interior of the cabinet is always visible, and since the seeds are exposed to daylight they germinate rapidly. Usually six days are sufficient to complete tests made with barley, corn, oats, rye, and wheat, while eight days are required for timothy, beets, tomatoes, beans, and cotton.

**WATER-COOLED BREEZES  
1387 EMANATE FROM NEW FAN**

The cooling effect of evaporating water is utilized in an attachment for an electric fan lately invented. Fast-



Air Dampener Attached to Front of Fan Cools the Breezes Given Off

ened to the front guard wires of the fan is a hooplike contrivance having at its bottom edge a small tank containing water. Within the hoop a wheel of windmill type revolves under the influence of the breeze from the fan. The blades of the wheel are made of screen, or light gauze, and dip into the tank at each revolution, getting dampened in the process. The breeze from the fan tends to evaporate the water from these blades as they swing upward, causing a consequent cooling of the air current as delivered into the room. The dampness carried along in the breeze adds to the cool feeling of the air.

What are rather misleadingly called "black" opals, to distinguish them from "light" opals, are regarded as among the costliest of jewels, their price, carat for carat, being in excess of diamonds. These precious stones were almost unknown until recent years; they are much more rare and many regard them as more beautiful than diamonds. These gems possess marvelous, changing colors, ranging from bright, green-glowing fire to gold and lavender. They are found in one region only, a comparatively small tract of land in New South Wales. It is a wild and desolate area about 500 miles from Sydney. There is nothing to guide the miner in selecting a likely spot. The shafts average 40 ft. in depth and all rock has to be brought by bucket to the surface. Water and food are scarce, but the man who finds the gems makes his fortune. The Australian government had an exhibit of these stones at the exposition in San Francisco.

**ICE IS USED IN ORCHARDS  
1387 TO RETARD BUDDING**

Near Luling, Texas, a number of orchardists are trying out a rather interesting plan of retarding the budding of their fruit trees until all danger of damage by late frosts has passed. The experiment consists of burying about 50 lb. of ice around the base of a tree when the weather becomes mild early in the season. This supply is replenished at intervals of two weeks until it is safe to allow the trees to burgeon. Ice is being supplied to several growers by a local producer to encourage the tests with a few trees. Although a considerable expenditure would be represented were the scheme carried out on a really large scale, it might not prove excessive if successful in preventing crop losses. Late frosts are a source of much anxiety to growers of early fruits, not alone in the South, but elsewhere as well.

*Crystal Ice Co., Luling, Texas.*

*294 been not been heat  
# C. L. Edholm  
68 W. 97th St New York 1/28/16*

*# J. H. Barber, 202 E. Wimmera Ave Dallas, Texas*

**GREAT TWO-LEVEL BRIDGE  
ERECTED AT CLEVELAND**

When the river is at its normal stage, the structure gives a clearance of 96

1237

What is undoubtedly the longest double-decked, reinforced-concrete bridge in America is now nearing completion at Cleveland, where it crosses the Cuyahoga River emptying into Lake Erie and connects the east and west sides of the city. It has a length of 2,880 ft. and a width of 80 ft., while



The Massive 591-Foot Center Arch in Course of Construction



From Structure in Foreground It may be Seen That Each Span Is in Reality a Quadruple Arch



Great Steel Arch After It had been Completed and the Two Decks Suspended from It



One of the Concrete Arches Showing the Temporary Steelwork Still in Place

at its highest point it is 200 ft. above the water. The center arch, which is built of structural steel, has a length of 591 ft. and is exceeded in size by only a few single-arch spans in this country. The bridge has been carried to a height sufficiently great to enable the largest ships navigating the Great Lakes to pass beneath it without interference.

ft. The lower deck will be reserved for the use of surface-traction lines and will provide space for six tracks. The upper level will accommodate both vehicular traffic and pedestrians. In

constructing the long series of arches supporting the structure, temporary steel arches were erected to hold the concrete forms in position until the material had set sufficiently to permit their removal.

9149 **TWO-TUB WASHING MACHINE FOR HOUSEHOLD USE**

For domestic use a twin-tub, power-driven washing machine has been brought out which has a number of



The Machine Occupies Only About Eight Square Feet of Floor Space

good features. It is mounted on a movable steel rack provided with a folding shelf, on which a rinsing tub and clothes basket, or bluing container, are intended to be supported. A reversible power wringer so designed that it may be used in different positions by moving it to one side or the other, is held on a swinging frame. All of the gearing is incased and there are no rocker arms, chains, or rack bars exposed. In using the machine it is intended that soiled clothes should first be placed in one tub and subsequently run through the power wringer into the second washer. When this operation has been completed another batch of clothes may be put in the first tub so that both sides are in use. When the

articles in the second container are thoroughly cleaned they are again put through the wringer and dropped into a rinsing tub on the folding shelf, after which the clothing in the first tub is transferred to the second, and a third lot put in the first one. From the rinsing tub the clothing may be wrung into the bluing receptacle and then into a basket. By following this system the machine is almost continuously in operation.

**THIRTEEN WEEKS OF DATES SHOWN ON DESK CALENDAR 1812**

A desk calendar has been designed recently which shows thirteen weeks at one time, and by the turning of projecting rollers upon which the whole year's figures are wound, can be adjusted from week to week. When correctly placed the current week appears as the center line across the face of the calendar, the six past weeks appearing above it and the six weeks in the immediate future, below it. By an ingenious feature of construction the current week stands out more prominently than the others, the background for these figures being made to appear whiter than the others. New calendars can be inserted much as a film camera



This Calendar Shows Three Months' Dates, the Current Week Standing Out from the Rest

is loaded. The front of the frame is of red leather. A patent has been applied for.

Chas. K. Cook Co., Dept. 10.  
Camden, N. J.  
novelty news, Jan. 1916

FINE SPECIMENS OF MOSAIC  
IN MEMORIAL CHAPEL 895

The Effect of This Mosaic on the Façade of the Church is Most Striking

Interior of the Church, Showing Extensive Use of Mosaic



Left: "The Last Supper," One of the Large Mural Decorations



*Calif.* One of the outstanding features of the Stanford Memorial Church, which is now nearing completion at Leland Stanford University, is its wealth of mural decorations in Italian mosaic. More than 1,600 sq. ft. of this, most of it consisting of reproductions of famous paintings and Biblical scenes, cover the interior walls as well as the façade of the edifice, which has been in course of construction since 1906, when it was practically demolished by earthquake. The work has been executed by Venetians brought to this country for the purpose.

Mosaic decorations of this type have never been implanted in America to the same extent that they have in certain European countries, particularly in the South and in Greece, where the art is supposed to have originated. Although marble, mother-of-pearl, and some other materials, have long been used in this work, mosaics in glass predominate. This is because of the superior lasting qualities of the latter substance and the fact that it is impervious to the effects of most acids. Potash-lead and sodium-lime glasses are most commonly employed. The

# Paul H. Dowling, 232 Lytton St. Palo Alto, Calif.

glass is readily colored to correspond to the different shades and tints of the painting to be reproduced, by melting various metal oxides with it. The molten glass is placed upon an iron table and pressed into a plate, several inches square and about a half inch thick. After it has been cooled gradually it is broken into small squares, or tesserae, known as smalts.

Copies of an original painting are cut into sections. Squares of different colors are then fitted together to form

specific portions of the picture and pasted, face down, to strong paper. In this form the mosaic comes to America. Sections of the walls to which it is to be applied are covered with a special kind of slow-drying cement. The numbered sections of mosaic are then put in place carefully, and pounded lightly until the edges are even and the surfaces level. They are then allowed to set. Subsequently the paper covering the face of the mosaic is soaked off and the decoration exposed.

### LIGHTNING RODS PROTECT

#### 1182 STRAW STACKS

For several years an Iowa farmer has protected his straw stacks with lightning rods in the same manner that he protects his farm buildings. The uprights on a stack are supported on a footboard which runs the full length of the stack, along the ridge. The rods are grounded through gas pipes, the lower ends of which are buried deep in

the earth. This apparatus is used from year to year. When a stack is to be removed the cable and rods are rolled up and put aside until a new stack has been built. The device can be quickly and easily installed. Though 12 trees on this farm and three barns on neighboring farms have been struck by lightning in recent years, the barns and stacks on this farm have so far enjoyed complete immunity from damage by lightning.

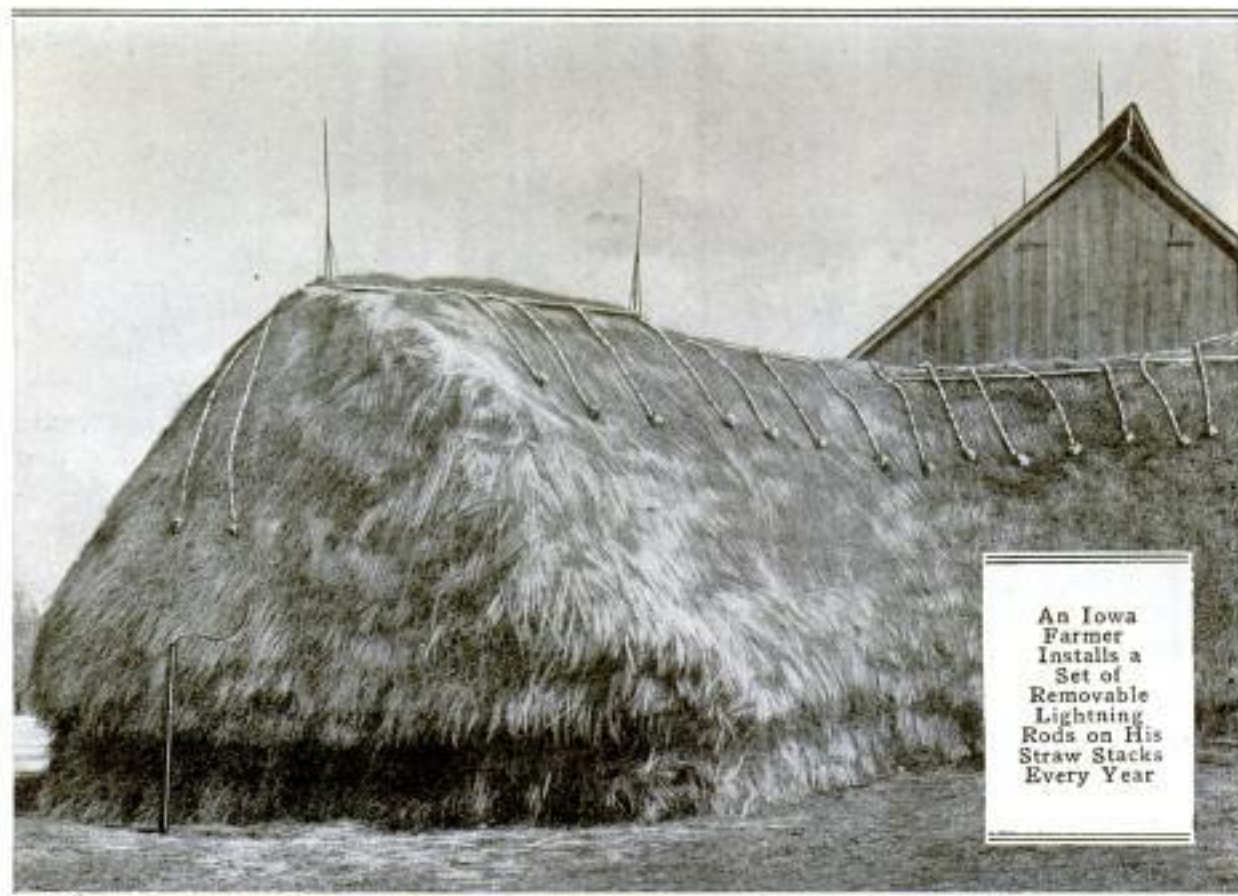

An Iowa Farmer Installs a Set of Removable Lightning Rods on His Straw Stacks Every Year

# O. R. Meyer, 811 S. + L. Bldg. Des Moines, Iowa.  
Chas. Lau, (Scott County, nr.) Davenport, Iowa

## STANDARDIZING A NATION'S PRODUCTS

By J. CROSBY McCARTHY, *The Star, Wash. D.C.*

1307

**B**Y providing better tools with which to work—tools in the form of standards—the national Bureau of Standards, at Washington, is promoting the welfare of the government and is advancing science and industry. It is rendering a service so wide in its scope as to have a more or less direct bearing on almost every line of endeavor, a service that is becoming better understood and more appreciated by men of science and industry alike. Organized on a foundation sufficiently broad to enable it to keep pace with ever-increasing demands, it has grown into one of the most important and valuable government bureaus, dealing, as it does, with problems which have a direct relation to the very prosperity of the country.

The Bureau of Standards is something more than a mere repository for standards of weight and length and for data regarding values of physical and technical constants and mechanical performance; it is a great national physical laboratory, including such branches of chemistry and engineering as are necessary to accomplish standardization in the broad modern sense. It makes research into things as yet unknown and puts things discovered and determined at the service of the people. The bureau deals with standards of measurement, standards of quality, standards of value of constants, and standards of mechanical performance, but this enumeration does not convey an adequate conception of its many activities. There have been added to the list standards of practice where uniformity is needed in scientific and technical matters involved in the enactment of laws, regulations, technical codes, and the like.

The Bureau of Standards confines its activities as far as possible to matters in which an authoritative value or national uniformity is required. It does not enter fields that can be covered effectively by private laboratories. It seeks neither to compete with nor

replace such institutions; on the contrary, it coöperates with them and aids in making the service which they render more accurate and effective.

The bureau is not a money-making institution, for the fees charged for work done are for the most part nominal. No charges are made in the case of tests made for government and state institutions. Anyone may have tests made at the bureau upon furnishing articles to be tested in the form specified and the payment of the scheduled fee.

Some idea of the far-reaching work of the institution may be obtained from an examination of a typical day's mail received at the bureau, which may contain letters from such as iron founders, pipe makers, tanners, makers of optical instruments, textile engineers, well sinkers, photographers, universities, meat packers, concrete contractors, lamp makers, boiler makers, officials of international commissions, engineering firms, dry-goods houses, college professors, students, manufacturers of refrigerators, oleomargarine, watches, and of gas meters, paper manufacturers, public-utility commissions, municipalities, and officials of foreign governments. A morning's mail at the bureau recently contained letters from 85 different professions, institutions, firms, and organizations.

The movement for standards in this country dates back to the early years of the nation when there was obtained from a London instrument maker a standard of length for use by the coast survey and a copy of the British troy pound for use in the coinage of money, and from which the avoirdupois pound was derived. Today the national Bureau of Standards is housed in a group of buildings that stands on one of the many wooded hills fringing the national capital. Its buildings stand in the center of a tract well out from the business center of the city, in order to insure freedom from mechanical, elec-

trical, and other disturbances. Sixteen acres are included in the grounds of the institution. There are four main buildings, 200 ft. in length and about 60 ft. in width, four stories high. A fifth building, one to be devoted exclusively to chemical laboratories, now is in the course of construction. Four smaller buildings for special work are included in the group. The bureau also operates a mechanical testing plant at Pittsburgh, Pa., in temporary quarters, and a cement and clay-products testing plant at Northampton, Pa.

Within the buildings of the Bureau of Standards is to be found a perfect wonderland of science. The institution has been called "the home of precision where the yardsticks and cupfuls of science and industry are refined"; it is here that one may have ocular demonstration that truth oftentimes is stranger than fiction. A liquid-air machine in one building provides extremely low temperatures for one kind of testing; in another building heat is generated of such intensity that rocks and the hardest of metals are melted like snow. Thermometers in the bureau's equipment permit readings as high as 1,000° Fahrenheit and higher, and as low as 300° below zero Fahrenheit. With one instrument the amount of heat given off by any selected star may be ascertained; with another, temperature changes of less than a millionth part of a degree Fahrenheit are recorded. Balances capable of measuring to 1/50,000,000 part of an ounce are in one room; in another section of the bureau is a machine capable of measuring a load of thousands of tons.

The equipment of the bureau includes almost every conceivable kind of testing apparatus, and should a problem necessitating the use of some new device be presented, there is a fully stocked machine shop and a force of skilled instrument makers at hand to construct it. The testing of water-current meters for the Geological Survey, the Reclamation Service, and other branches of the government presented just such a problem; there was

no body of water available in which to make such tests. All difficulties were overcome by constructing a concrete tank several hundred feet in length in the grounds of the bureau. In these tests the tables are reversed; the water remains still and the meter moves through it.

The Bureau of Standards does not lose sight of practicability in its testing work. Precision is demanded in all its work, but not undue precision, for the bureau aims to assign to each case the degree of precision which it deserves. Ten minutes may be spent in testing a clinical thermometer which is perhaps correct to a tenth of a degree. On the other hand, weeks may be spent in determining a standard of length for some manufacturing plant where measuring instruments are made. The preparation, verification, and distribution to the governments of the world of the modern metric standards of length and mass took no less than 15 years.

To no industry is the service rendered by the Bureau of Standards of greater value than that dealing with things electrical, which has, perhaps more than any other industry, adopted scientific methods and precision measurements. The bureau's equipment for the testing of electrical apparatus is complete in every detail. Instruments for testing voltmeters and other electrical measuring devices have been refined to such an extent that maximum accuracy and minimum labor are combined. In one room may be found hundreds of electric lights undergoing a life test in different positions and under different current conditions; in another room the candle-power of such lights is ascertained, and in still another section are the lamps which represent the candle-power standards of the country.

An important work of the bureau in the electrical field has been investigation of the electrolytic effects of stray electrical currents upon underground pipes and other metal construction, with a view of determining some of the data necessary in standardizing elec-



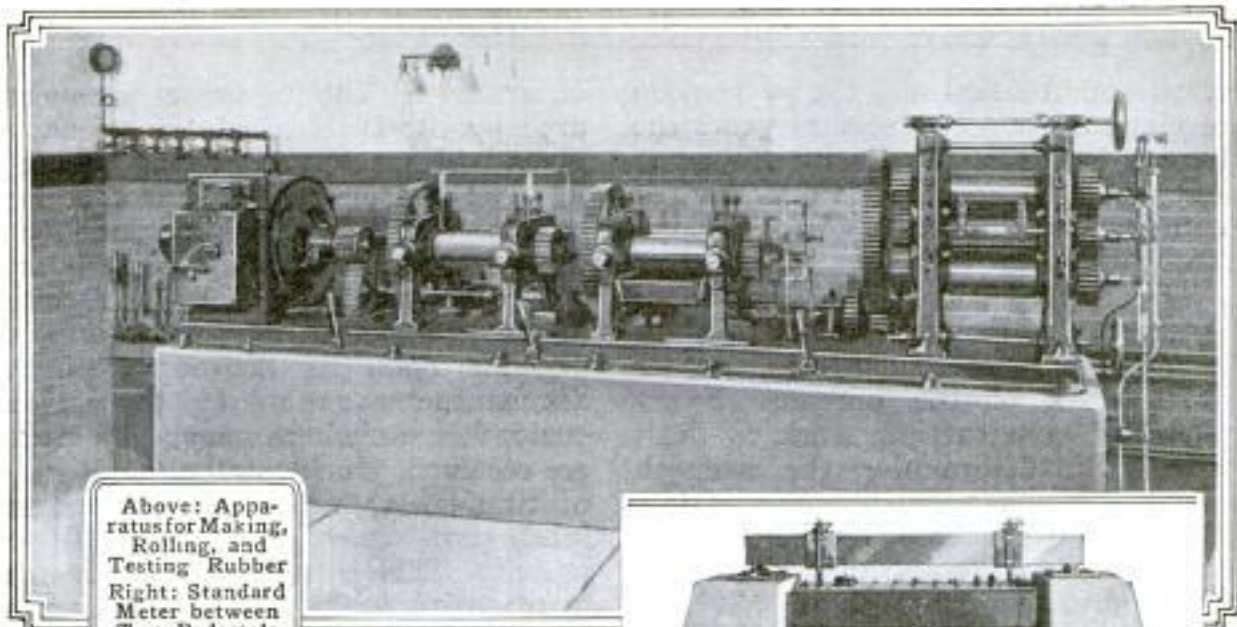

Above: Apparatus for Making, Rolling, and Testing Rubber  
 Right: Standard Meter between Two Pedestals and under a Bar Holding Two Microscopes for Making Readings

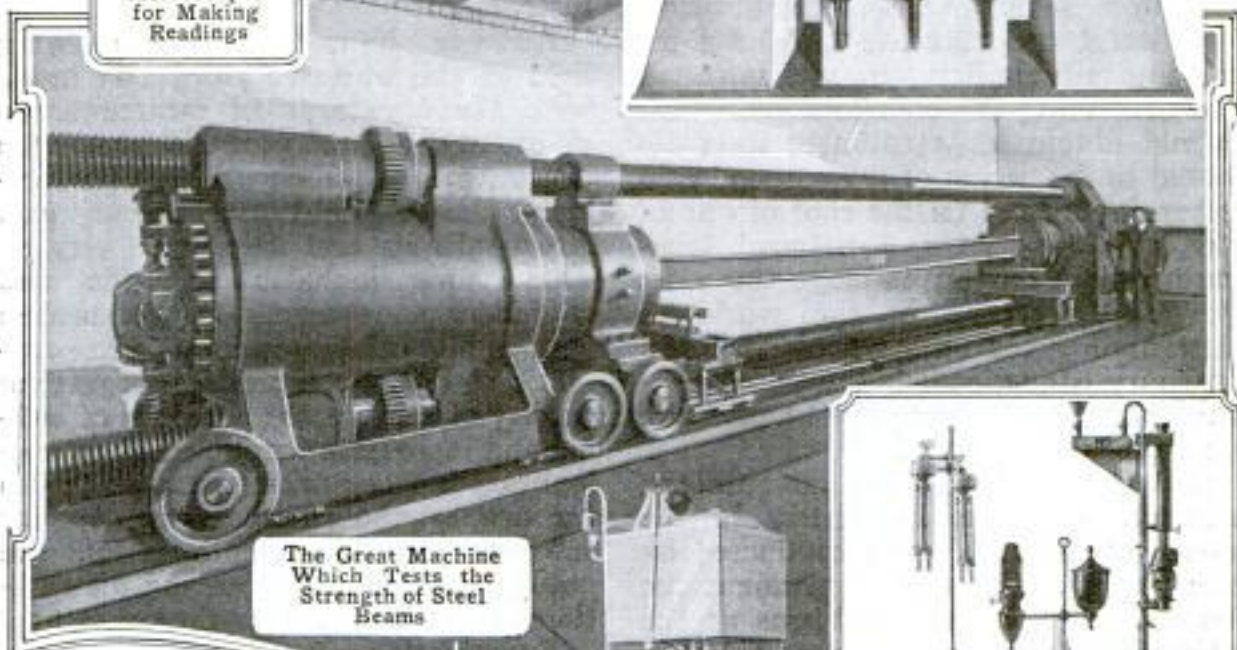
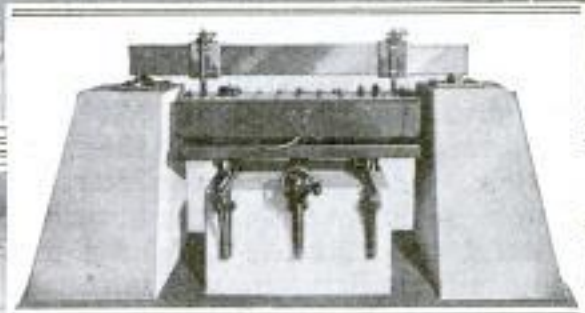

The Great Machine Which Tests the Strength of Steel Beams

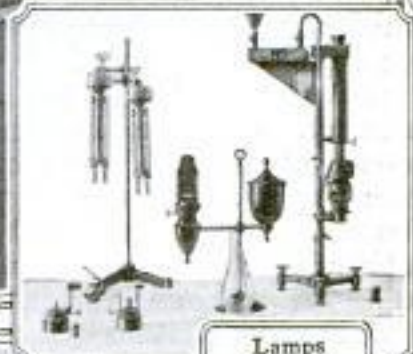

Lamps Which Furnish the Candlepower Standards: At Left German, and at Right, English

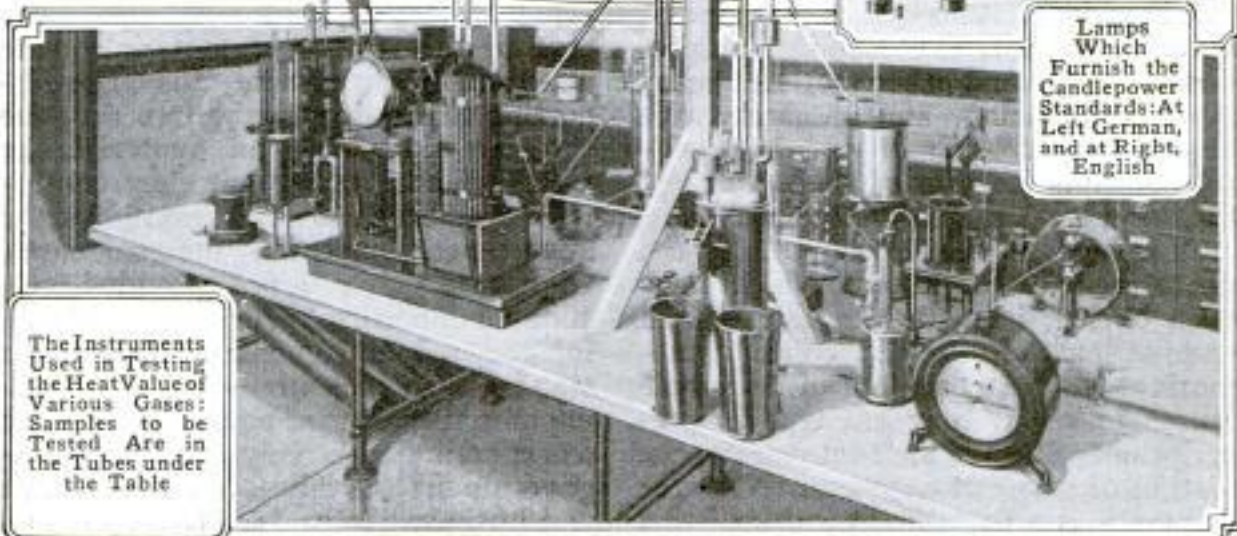

The Instruments Used in Testing the Heat Value of Various Gases: Samples to be Tested Are in the Tubes under the Table

trical construction and the prevention of electrolysis. For several years the bureau has coöperated with the army and navy in research work dealing with various problems of radio communication.

The testing and standardization of structural steel, concrete, and other building materials constitutes another great work of the bureau. Every phase of construction work is dealt with. For determining the strength of steel girders, and like material, a giant testing machine capable of exerting a pulling strength of 1,150,000 lb. and a crushing strength of 2,300,000 lb. is brought into use. To the layman this is perhaps the most interesting piece of apparatus in the bureau's wonderful collection. Metal used for roofing and similar purposes is tested by subjecting it to conditions which would obtain in actual use; it is exposed to the action of the sun and rain on racks erected on the roof of one of the buildings. At its Pittsburgh laboratories the bureau employs the most powerful machine in the world in determining the strength of steel and masonry columns; it is the Olsen testing machine which can exert a pressure of 10,000,000 pounds.

Of great value to the government, science, and the industries, is the chemical research work conducted by the bureau. For the government the bureau handles such problems as the analysis of inks, lubricating and other oils, paints and varnishes, and researches on writing and other papers; determination of the chemical properties of metals and other materials used in manufacturing, and research with regard to corrosion of metals constitute a small portion of the service of this kind rendered to the industries.

A wide field also is covered by the department of the bureau which deals with optics; its activities range from tests of lenses in the periscopes of submarines to examination of spectacle lenses to see if they are true to prescription. Strange as it may seem, the testing of sugar to ascertain its degree of purity is a part of the work of this

department. The impurities are measured by the twist a solution of sugar gives to light waves passing through it. The instrument used for this purpose is called a saccharimeter, and from the governmental standpoint it is one of great importance, for the amount of duty imposed on sugar imports depends upon its degree of purity. Saccharimeters are used at the various customhouses where sugar shipments are received. Incidentally, the Bureau of Standards makes and sells absolutely pure sugar; price, about \$18 per pound. This is used to test instruments with which the heat value of fuels is measured, as well as to fix the 100-per-cent point in sugar-testing instruments.

Another important and growing field of the bureau's work has to do with the standards of measurement, of quality, and of practice concerned in the various public utilities, particularly electric light and power, gas, street-railway and telephone service. This work includes scientific and engineering research in connection with public-utility questions, the preparation of specifications regarding quality of service, the methods of testing and inspection employed by municipalities and commissions, safety rules for use by the utility companies for safeguarding their employes and the public, and the collection and distribution of information on these matters.

Examination of the records of the Bureau of Standards for the past fiscal year shows that approximately 90 per cent of the testing of materials done was for the government, this large proportion being due to the fact that the commercial testing of materials to ascertain whether or not they comply with specifications is done only for the government, except in unusual cases, where the public is not provided with suitable facilities. The actual testing for the public is confined largely to standards of measurement. The testing of materials for Federal institutions has contributed largely toward placing government purchases on a scientific and businesslike basis.

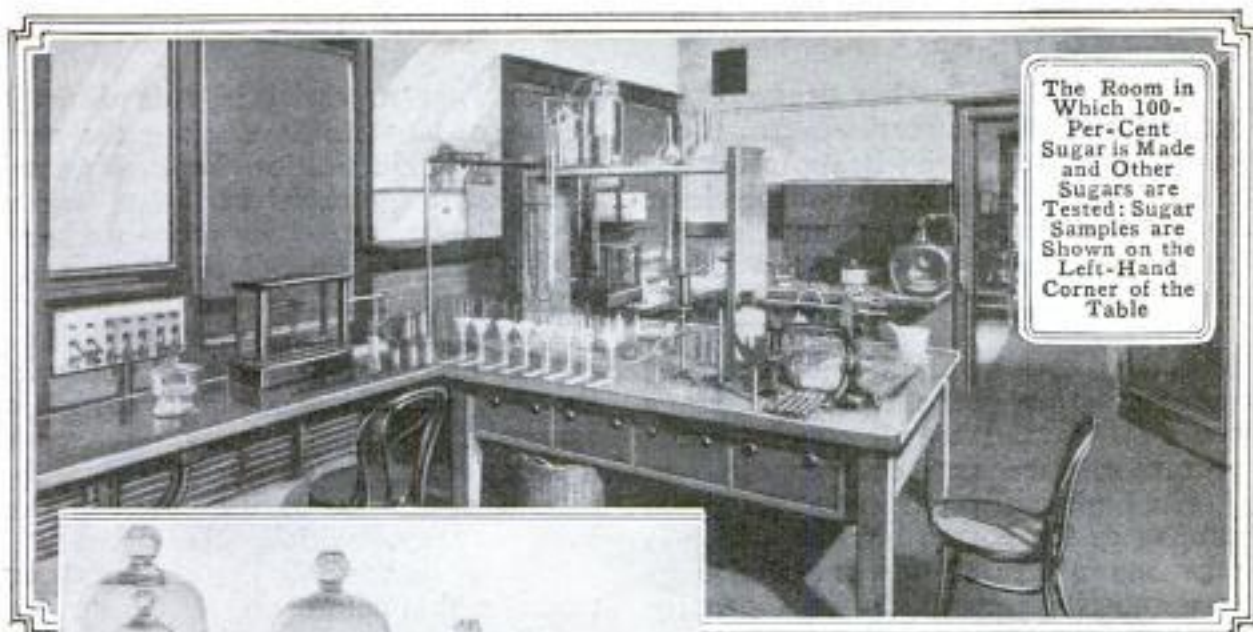

The Room in Which 100-Per-Cent Sugar is Made and Other Sugars are Tested: Sugar Samples are Shown on the Left-Hand Corner of the Table



The Two Standard Kilogram Weights: The One under the Glass Domes is Used Only to Check the Accuracy of Working Standard beside It

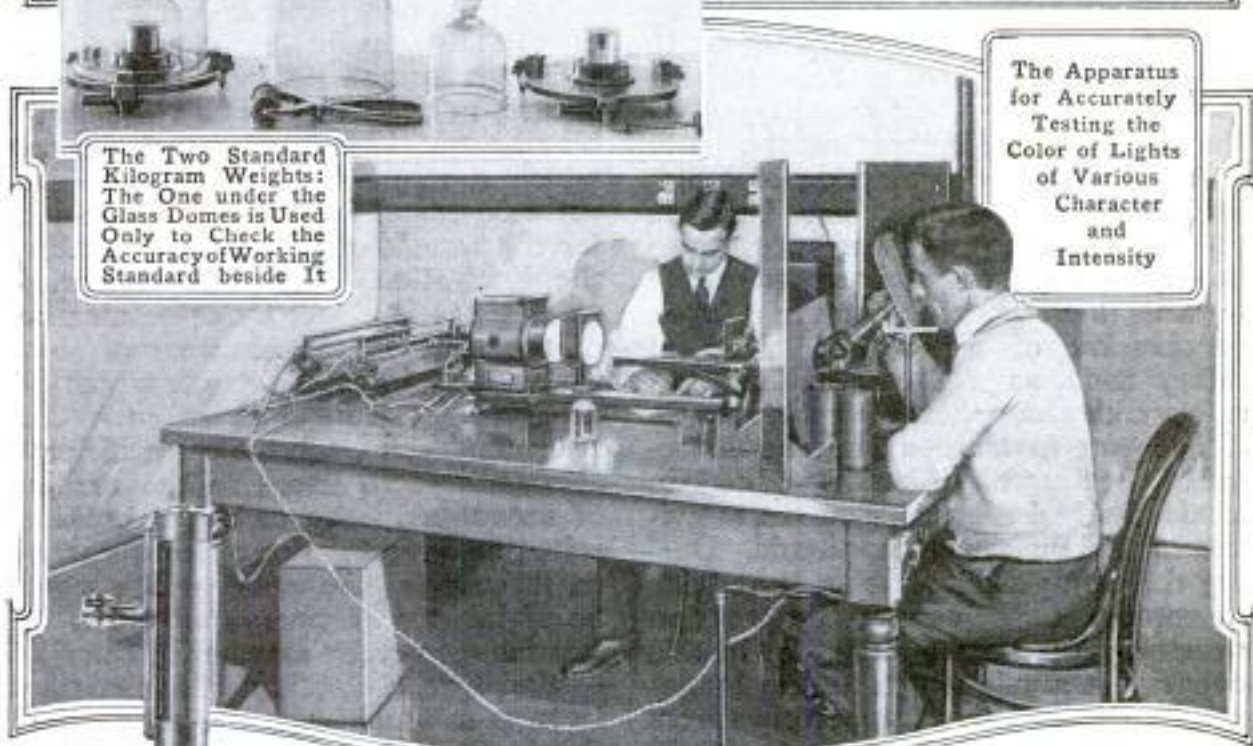

The Apparatus for Accurately Testing the Color of Lights of Various Character and Intensity



The Standard Thermometer Comparator: With This Instrument Temperatures may be Measured to One One-Thousandth of a Degree

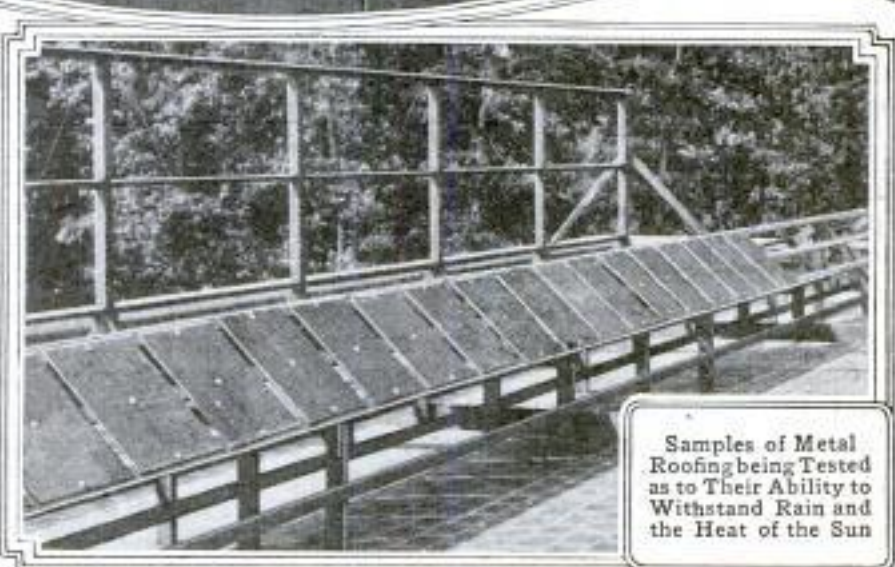

Samples of Metal Roofing being Tested as to Their Ability to Withstand Rain and the Heat of the Sun

Testing of textiles has occupied the attention of the bureau, several thousand tests of this kind being made last year. Many special investigations have been undertaken; for example, on the effect of cotton compression in baling upon the spinning qualities of the fiber. Bales now run 25 lb. to the cubic foot. If cotton can be further compressed without injury to the fiber, savings could be effected in bale covers, transportation, warehouse charges, etc.

The bureau also has investigated the subject of the cotton bunting which is now manufactured for making flags as a substitute for the more expensive wool bunting. The cotton bunting showed up well in the tests made, and as a result large quantities of this material now are being employed by the navy and other departments.

A study of the protection of buildings against lightning has been in progress recently, and the bureau also has been engaged in a study of life hazards in electrical practice and in the preparation of a national electrical safety code, as well as a national gas safety code along the same general lines.

The war in Europe and the subsequent shutting off of imports of certain kinds has had a bearing on the activities of the Bureau of Standards. During the past year researches have been in progress to supply information necessary for the manufacture in this country of goods which are no longer received from abroad. Manufacturers have been compelled to introduce new methods, to use new materials, and to develop new processes, and the bureau

has striven to assist in this difficult period of transition. During the past year the production of chemical porcelain on a commercial basis has begun in this country. The clay-products division of the bureau at Pittsburgh, having worked out the subject fully, presented the results of its labors to manufacturers, and two concerns are now producing chemical porcelain ware of satisfactory quality. The same division also is working on the problem of producing optical glass of the best quality, which, like chemical porcelain, has never heretofore been made in this country.

There is one phase of the activities of the Bureau of Standards which, although somewhat unofficial in its nature, nevertheless has an important bearing on the value of the services which it renders. It consists of lectures on scientific and technical topics for the benefit of the scientific staff of the institution. One afternoon each week there is a talk by some member of the staff on the progress of some particularly interesting task which his department has undertaken. One afternoon each week the scientific staff also gathers to listen to the reading of accounts in the technical press of scientific investigations being carried on throughout the world which would be of interest to bureau workers. In this manner every member of the staff of the Bureau of Standards is enabled to keep in touch with the activities of the institution and to know what is being done by the scientific world in like fields of endeavor.

#### PORTABLE CANOPIES SHIELD WORKERS FROM SUN

Pipe-line construction through the marsh lands and bayous of Louisiana is usually undertaken in the summer months, because of unfavorable working conditions encountered in winter. During the hot season, however, the sun bakes down relentlessly and even the natives require protection from it. The accompanying illustrations show

how suitable protection was provided in projecting a loop line between the Arkansas boundary and an oil-refinery station at Baton Rouge, La. Portable frameworks, supported several feet above the ground and covered with large tarpaulins, were used to shade the workers. These devices were moved along as a line was projected section by section, the men remaining beneath them as much as possible. The method used in laying a pipe

# Paul Wagner, P.O. Box 657, Shreveport, La.



Working beneath One of the Shelters in the Sweltering Sun



Carrying a Shelter across a River to a Point Where the Workers are Concentrated

across shallow streams and bayous in this section is also interesting. Instead of constructing it on a pontoon structure and then sinking it into position, it is built out across the water on temporary supports with the aid of a portable windlass. As frequently it is built with the assistance of merely a windlass, only the open end of the pipe being kept above the water.

#### CHECKER GAMES ARE PLAYED NIGHTLY BY WIRELESS

Members of the Watertown, N. Y., Radio Association who are checker enthusiasts are indulging in nightly long-distance games. This odd diversion has a number of devotees and plans are now being made for a general tournament in which the entire personnel of the organization will participate. In playing checkers by wireless, two boards, instead of only one, are used. The squares on these are numbered, while each set of men is lettered. By this system the various moves are easily designated and the game pursued without delays. Three hours were consumed in playing the first contest some time ago. Now, however, it requires only a little more time to play off a wireless game than one contested in the usual way.

According to standards recently set by the Department of Agriculture, food labeled as "diabetic" must not contain more than half the amount of starches and sugars contained in normal food of the same class.

#### VINE-CANOPIED BENCH IS PLEASING PARK FEATURE

604

A bench for the resting of a tired passer-by, shaded by an arbor of simple construction, is a feature of a small park in a western city. The arbor has but one side, a design which permits its easy installation along a walk or shady path. Chicken netting nailed over the

*marple*



This Vine-Shaded Seat Makes a Pleasing Resting Place along a Park Pathway

# John P. Hoff, 827 State St.  
Watertown, N.Y.

Inventor: Joseph M. Campbell  
Linden, N. J.

framework forms a foundation upon which honeysuckle vines may grow thickly. Though inexpensive, the bench and its canopylike top make a convenience much appreciated by park visitors.

*Wall*

**PAPER-HANGING MACHINE  
DOES WORK OF THREE MEN**

368

A paper-hanging machine that enables a man to put on three times as much wall paper in a day as he can by hand has been invented by a New Jersey man. The machine is of aluminum and contains a roller with an adjustable cutting knife which trims the paper to the desired width; a roller that applies



paste to the paper, and other rollers that guide and hold the material as it is being placed on the wall. The pattern is matched at the baseboard, after which the machine is pressed upward along the wall, laying the paper as it goes. When the ceiling, or border, is reached a shearing device within cuts the paper off at the right length. Paste is applied only as fast as the paper unrolls. The machine may be used on ceilings as well as walls.

**HAT THROWN INTO STREAM  
LOCATES DROWNED MEN**

1384

As a means of locating the bodies of four United States soldiers who were accidentally drowned in the Rio Grande recently an unusual experiment was tried and proved successful. A hat was thrown into the water at the point where the men had last been seen and was followed downstream until, after traveling about five

miles from the scene of the accident, it came to an eddy where it moved about slowly for some time. This gave the searchers what they thought might be a clue and, following a practice frequently used in searching for bodies, a charge of dynamite was exploded at the point where the progress of the hat had ceased. Immediately the bodies came to the surface. The explanation of the experiment is that the Rio Grande in this region is tortuous and has many eddies. The searchers rightly assumed that the bodies would be carried downstream until they came to an eddy, which in this instance was indicated by the retarded progress of the hat.

**ANTISEPTIC MOUTHPIECE**

1044 FOR TELEPHONES *Telephony*

To guard against multitudes of germs such as have been found by microscopic examination of telephone mouthpieces, there has been devised an antiseptic mouthpiece which consists of three shells, one within the other. The inner one is similar in shape to the ordinary telephone mouthpiece. It is perforated and is fastened to the transmitter by threads. An

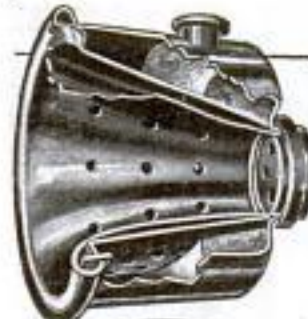

*Sept.*  
*4, 1915*

annular flange, or rim, at its outer end holds the other shells in place, as shown. Between the outer and inner shells is a third shell, also perforated. Disinfectant between the outer and middle shells purifies the mouthpiece by the fumes given off, which pass out through the apertures. Microscopic examination of the new device, after use by many persons, showed an absence of infection.

#J. E. King, 202 S. Winnetka av.  
Dallas, Texas.

Inventor: E. M. Jenkins, M. D.  
Italy, Texas.

1167 SPANS OF LONG BRIDGE FLOATED INTO PLACE

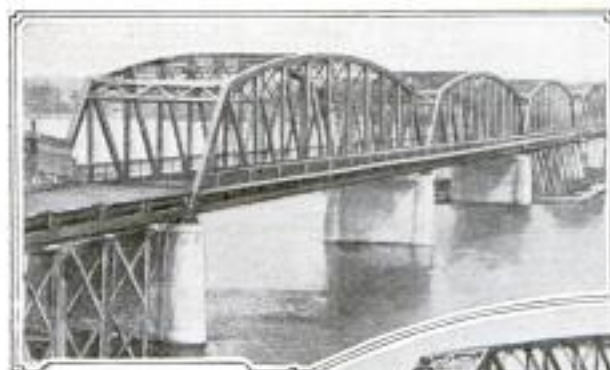

Bridge Spans Which have been Floated into Position: The Supporting Barges are Still under the Third Span



One of the Spans, being Drawn by Two Tugs, Leaving the Special Docks Where Each Span was Constructed



Floating a Section of the Interstate Bridge on the Columbia River

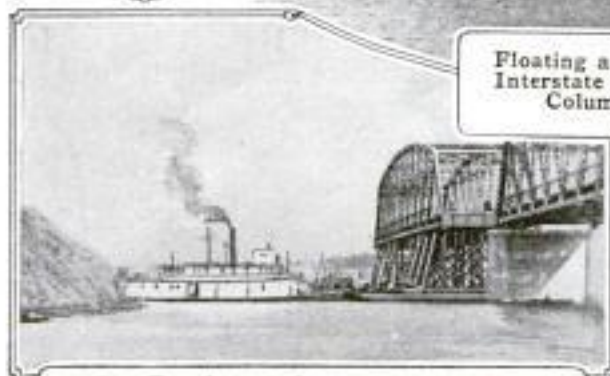

The Trestlework Supporting the Spans Was Just High Enough to Allow Them to Slip into Position Easily



One of the Steel Sections, Weighing More Than 400 Tons, Almost in Its Final Position in the Bridge

The interstate bridge which is being built over the Columbia River to connect Washington and Oregon will consist, when completed, of 13 steel spans, 12 of which were assembled on docks especially made for the purpose and then floated into their final position. One span weighs 468 tons. When a span has been completely assembled, four scows or barges are floated beneath it. These are partly submerged by means of 6-in. centrifugal pumps operated by gasoline engines. Heavy bents are then erected between the barges and the span, and strongly braced, whereupon the pumps are set to work emptying the scows. As these rise they lift the span from the dock. Two tugs attached to the scows convey the steel structure, as-

sisted by a third tug, which helps to turn the other boats and their burden around so that the load may be pushed instead of pulled.

Near the piers the tugs are cut loose and 20 men with lines and capstans shift the span into place. When within half an inch of the final position, horizontally, jacks are put under the span, and it is lowered onto the piers.

### STORM-CURTAIN OPENER IS CONVENIENCE FOR AUTOS

938 Getting in and out of an automobile covered with storm curtains in rainy weather is a task attended with difficulties. Water drips off the flapping protectors onto clothes, and much hunching down is necessary in order to

Dayton Top Improvement Co.  
Dayton, Ohio.  
Copyrighted material

squeeze through the narrow opening usually provided. To eliminate these inconveniences a new type of storm curtain has been devised. It consists of a U-shaped bar of iron or other metal



New Storm Curtain for Automobile Use is Fastened on Brackets to the Door, Allowing Easy Entrance and Exit

which is supported in an inverted position by sockets on the doors of a car. The bar so erected serves as a frame to which the storm curtain may be attached. Opening the door then causes the storm curtain to open with it, leaving a broad opening through which one may enter or alight. When closed, the door curtains fit in snugly with the others on the car, making a storm-proof protection as with the ordinary kind of curtain.

**"SAFETY FIRST" CAR SHOWS MOTION-PICTURE DRAMA**

A dramatic, interest-gripping motion-picture drama is the channel through which the employes of the New York Central Railroad lines are being taught the vital lessons of the

*Marcus A. Dow, Gen. Safety Agt. New York Central N.Y. City.*

"safety first" movement. A railway coach, fitted up for the special purpose of showing this production, is being taken over the lines, stopping at all yards and shops for daily exhibitions before employes and their families. Employes are required to attend. Not only do these reels show the various practices in shops and switch yards which are now universally recognized as unsafe, but all of these practices are skillfully woven into a plot which contains all the thrills of fiction, including a head-end collision, and yet is recognized by railroad men as being tragically real. It will require many months for the car to cover the whole railroad system.

*# R. D. Farmington  
2846 St. Central Terminal  
N.Y. City*

**MANY YEARS REQUIRED TO BUILD STRANGE CLOCK**

*1020*

A mechanical clock which contains 298 moving characters carved from oak with a penknife and depicts at stated intervals scenes from biblical and American history, and others of special interest to a fraternal order, has been completed by a Pennsylvania jeweler after five and a half years of labor. The clock is of oak and is operated by electricity from a dynamo run by a small gasoline engine. It is 8 ft. high, 12 ft. wide, from 3 to 5 ft. thick, and weighs 1,600 lb. The clock is divided

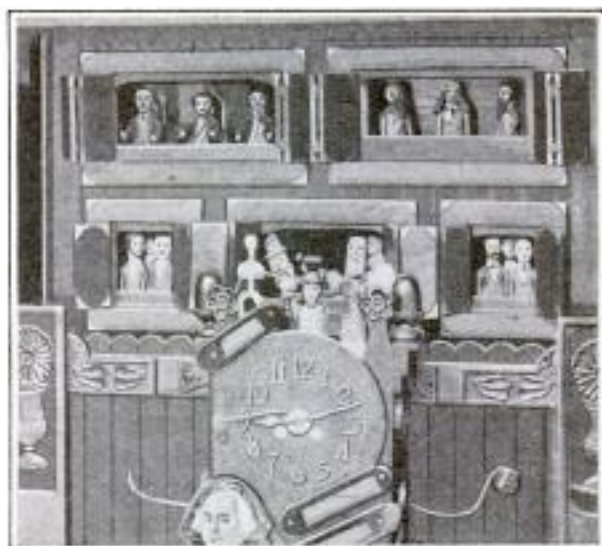

This Mechanical Clock Required Five and One-Half Years to Build and Contains 298 Moving Figures, Carved from Oak with a Penknife

*Keystone Weekly 10/5/15  
Jacob Light, Millersburg, Pa.  
Copyrighted Material*





The Compact Electric Kitchen Range with Double Heat-Retaining Walls, Used in One of the "Electric" Bungalows



Glasgow Bungalows in Which Electricity Is the Only Fuel Used



A Living Room in One of the Glasgow Bungalows, Showing the Electric Grate Used

into three massive towers, the first of which is labeled "the apostolic clock" because it portrays successively many scenes from the New Testament, including the Lord's Supper, Peter denying the Savior, etc. The central and highest portion of the clock is devoted to national figures and events. Here, as if keeping step to the music that accompanies them, appear all the presidents, many Civil War generals of the North and South, Spanish War figures, and many others. The third tower is devoted to scenes portraying the benefits of a fraternal order. Following a death scene the order is honored by the bereaved ones, for kindnesses shown in their distress.

#### HOMES ENTIRELY EQUIPPED WITH ELECTRIC DEVICES

A small suburb composed of attractive, stucco-finished bungalows in which all the heating, cooking, lighting, and cleaning devices are operated by electricity, has been established near Glasgow, Scotland. Chimneys are characterized by the builders of these modern homes as a useless expense, symbols of dirt and mediums of

waste, and since there are no furnaces of the ordinary type in these dwellings, there are no chimneys. An electric grate, 27 in. high, which takes 2.5 kw., is used instead of a drafty fireplace. A very compact electric range, with double heat-retaining walls, takes the place of a coal or gas cook stove. Water for the bathroom is heated by electricity close to delivery, thus saving loss in the use of long pipes. The cleaning of the floors, walls, curtains, and upholstery is done with a vacuum cleaner electrically driven. While admitting that there is a very material increase in the electric bill of the household using such equipment, it is claimed that the housework is made so much lighter that one or more maids can be spared. Added healthfulness of the home, due to absence of soot, dirt and drafts, is also claimed.

¶To pass safely under the electrically charged wire fences erected by the Germans on the Dutch frontier, the Belgians use wooden barrels in which they roll themselves under the "live" barriers without mishap, the iron hoops grounding the electrified wires.

*Electrical World 10/20/10-*

*Carron Company, Carron,  
Falkirk, Scotland.*

630 So Wabash av.

POPULAR MECHANICS

Chicago Dryer Co. Chicago, Ills.

LAUNDRY DRIER UTILIZES HEAT FROM GAS STOVE

# Mrs. Fred Lellord Western Springs, Ills.

978

A drying cabinet so connected with a gas laundry stove that the surplus heat from the latter heats the former is now being manufactured in sizes

a cabinet so joined to the gas stove that the heat passes through the drying chamber and quickly removes the moisture from the articles hung within.

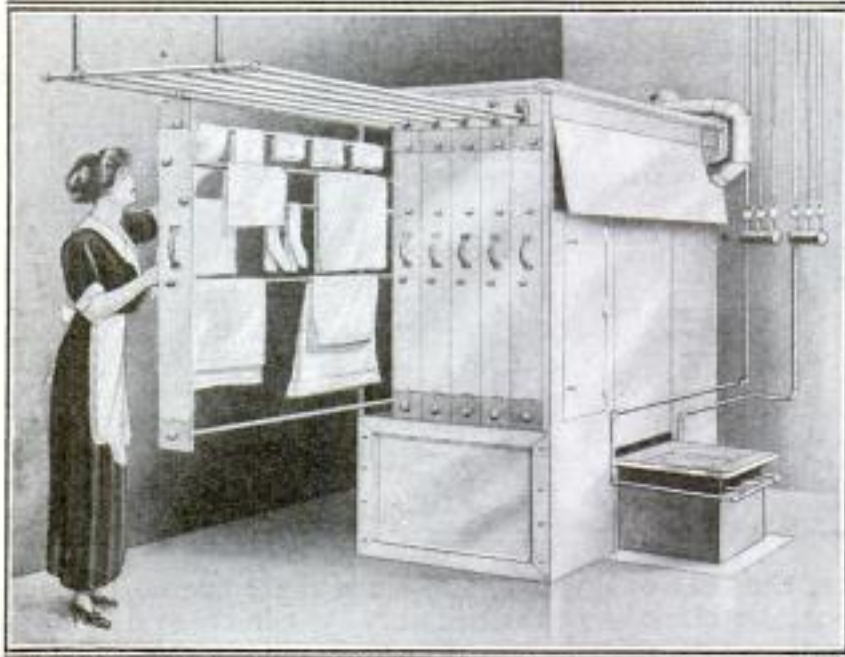

This Drier Utilizes the Surplus Heat from the Gas Laundry Stove with Which It is Connected, and So Is Not Expensive to Operate

On racks which vary in number according to the size of the drier, the clothes or other articles to be dried are hung. These racks are so suspended on frames or tracks which project from the end of the drier that they may be easily withdrawn for the purpose of removing dried articles or hanging wet ones. The capacity of these driers ranges from 78 to 231 linear feet. It is claimed that the drier and laundry stove of family size can be operated at a cost of two to three and one-half cents per hour, where the cost of gas is \$1 per 1,000

suitable for residences, apartments, and small institutions. It consists of

where the cost of gas is \$1 per 1,000 cubic feet.

PIPE LINE BUILT ACROSS RUGGED COUNTRY

1272

Marple

A 200-mile pipe line for carrying oil from the rich oil fields of the San Joaquin Valley to San Pedro, the seaport of Los Angeles, has recently been completed. The time required to construct the line was 15 months, a fast record considering the natural difficulties that confronted the builders. Both the main line, which is 152 miles long, and a branch, 54 miles long, are composed of 8-in. pipe. At Tejon Pass the line rises to an elevation of 4,222 ft., and at another point, 3,716 ft.; a tunnel was utilized in one instance to avoid too great an elevation. The line cost \$3,500,000.

structed and also bridges, one suspension bridge being 500 ft. long. At several stream crossings a row of piles was driven and cut off below the gravel surface. The pipe was laid in a 4-ft. trench on the upstream side of the piles. It was then surrounded by a concrete casing, 22 in. square, and bolted to the piles by long stirrup bolts.

Along portions of the route the line follows highways and railways, utilizing existing bridges and culverts. In other sections trestles had to be con-

There are 16 pumping stations located from six to 21 miles apart along the line, according to the length and steepness of its inclines. Connected with each pumping station are heaters through which the oil is pumped, thereby increasing its fluidity. Eleven of the stations are capable of pumping about 1,000 barrels per hour at 800 lb. per square inch pressure. The other



A Team of 26  
Mules and Horses  
Drawing a Boiler  
to the Site of  
One of the 16  
Pumping Stations



The Pipe Line Projecting  
from a Hillside and Extending  
across the Desert, Supported  
in Part by Framework



A Near View of the Pipe  
Line and a Suspension Bridge  
Which Carries It over a  
River Bed



A Suspension Bridge, 500 Feet Long, Built  
for the Pipe Line in a Region  
Where Bridges Are Few

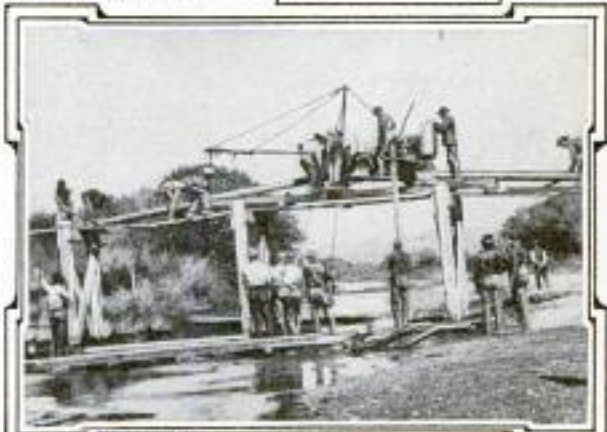

A Pipe-Screwing Machine, Made from an  
Automobile Engine, Capable of Putting  
Together 6,000 Feet of Pipe Daily

stations are fitted for special duties, such as serving refineries, loading tanks, ships, etc. At least one 37,000-bbl. tank is installed at each station, which, when kept full, provides for 18 hours' operation of the pumps in case repairs are necessary farther up the line.

An ingenious pipe-screwing machine

was developed by the contractors, consisting of a frame supporting a 40-hp., four-cylinder automobile engine which rotated a pipe-gripping chuck. The whole machine was mounted on rollers resting on the pipe along which it was moved by power and was capable of screwing daily an average of about 6,000 ft. of 8-in. pipe.

### KANSAS CITY'S STREET CUT 1198 PROVES COSTLY

It cost Kansas City, Mo., \$400,000 to dig what is called the Main Street cañon, 90 ft. wide and from 40 to 80 ft. deep, through three blocks of hills that the traffic from the new union station might have an outlet to the southern residence district of the city. Now slides of earth and boulders have occurred, and engineers have declared that the cut is unsafe for traffic. The street-railway company laid a double track through the cañon to shorten its trackage by four blocks, but the rails were knocked out of alinement by

falling stones before they were used. The city administration asserts that it has no money with which to remedy the difficulty, and the owners of abutting property protest that they should not be made to pay for making the cañon safe.

### PROTECTOR SHIELDS PEACH 192 TREE AGAINST BORER

A Maryland fruit grower has patented a protector which shields peach trees from the insidious peach borer that occasions so much loss in peach orchards. Study of the habits of this insect shows that the parent moth lays

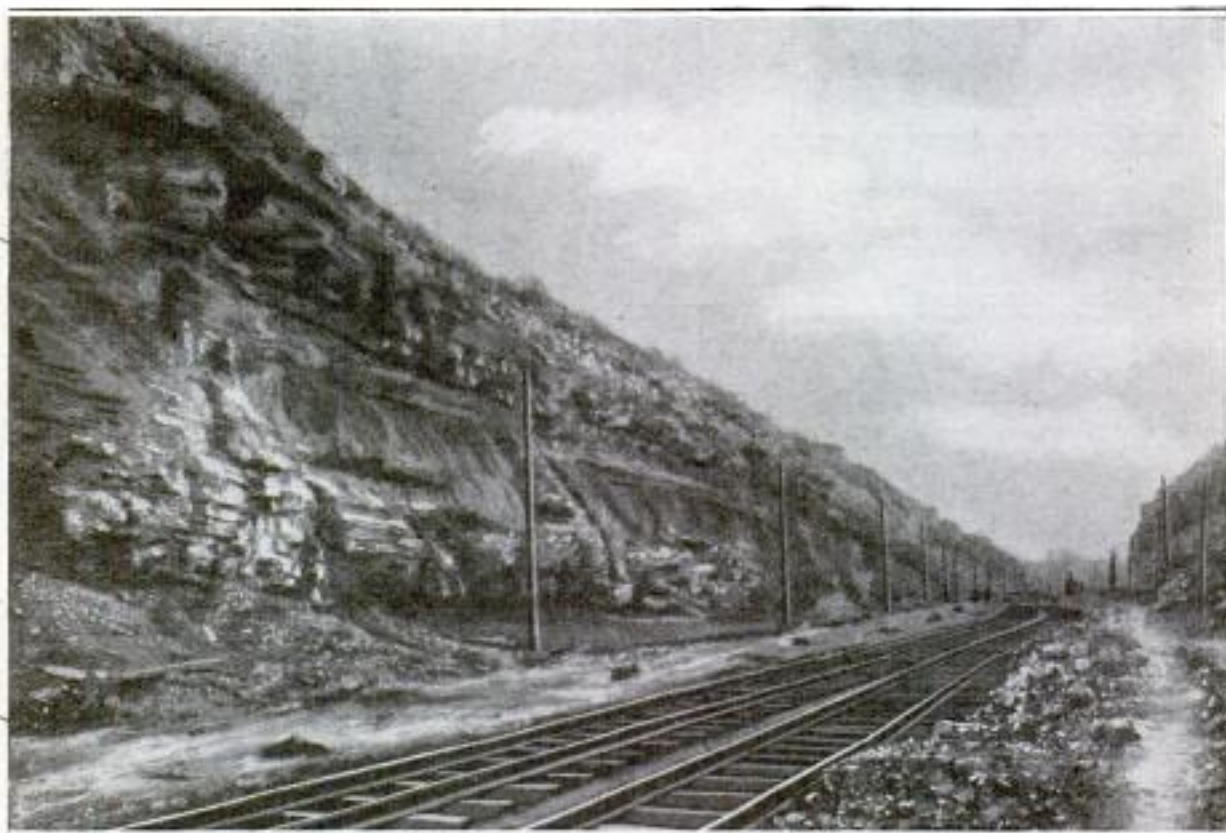

The New \$400,000 Street Improvement in Kansas City Which Falling Boulders Made Unsafe for Traffic

Cont. & Mfg. Scott Tree  
Protector Co., P.O. Box 241,  
Baltimore, Md.

Des. E. Quisenberry, 207 Styene Lane, Kansas City, Mo.  
 Kansas City, Mo. Main St. Cut from New Union Station



This Tree-Encircling Mat, When Properly Fitted and Sealed to the Tree, is Said to Afford Practically Complete Protection against the Peach Borer

its eggs mainly on the tree trunk. The young borer enters the trunk by first crawling down between the soil and the tree where he finds moist, soft bark which he can penetrate easily. To prevent his crawling down, the protector is fastened about the tree just above the ground. It consists of a flexible, tree-encircling mat forming an impenetrable covering for the soil about the base of the trunk. A fringe next to the tree enables the mat to fit any size of trunk. An especially prepared viscous substance is used in sealing the seam where the mat overlaps and in closing the opening between the mat and the tree. Since the young borers are delicate they rarely enter the tough, weathered bark, and so perish when they encounter the protector.

### TRAFFIC SQUAD USES CORK 1315 PLATFORMS IN WINTER

Traffic policemen of Cleveland are now provided with cork platforms on which to stand in the winter time. These consist of a frame about three inches deep filled with granulated pressed cork; a handle is fastened to one side by which it can be moved about easily. In the early years of traffic regulation it was found that the stone pavements became so hot in summer as to cause serious discomfort for the officers who were compelled to stand for several hours in sun-heated areas. Consequently wooden-block paving was laid in these small areas. The cork platforms are a more recent



addition, for winter, and enable an officer to keep his feet out of the snow and slush. Formerly traffic was regulated by a whistle and movements of the arms; now semaphores, each with an iron base,  $\frac{3}{4}$ -in. pipe standard, and revolvable enamel sign are being introduced.



Traffic Policemen in Cleveland Stand on Cork Platforms to Keep Their Feet Out of the Snow and Wet. The Semaphore is Supplanting the Whistle Signal

# C. E. Drayer, 1521 East 93rd St.,  
Cleveland, Ohio

East 9th St. & Superior Ave

## HUMAN EYE ACCOUNTS FOR VANISHING GHOSTS

1322

WHAT is without doubt a sound explanation of certain nocturnal apparitions has been advanced by a German scientist who attributes the responsibility for this phenomenon to the peculiar functions of the eye.

Many persons far removed from superstitious influences have encountered phantom images in the dark. They have awakened in the middle of the night and been startled by the presence of a dim, glowing light at one side of a room. And when they have turned their vision directly toward it in an attempt to determine its source, it has mysteriously vanished, only to reappear weirdly in another spot an instant later. The presence of an unpleasant something is undeniable, yet to tell what it is and to determine its exact location may at the moment be impossible. When such an incident is experienced by one who is only half awake and possessed with a healthy imagination, it is not to be wondered that a sense of fright and bewilderment often creeps into his mind.

Millions of very minute fibers which are branches of the optic nerve constitute the retina of the eye. At the end of each of these tiny members is an organ which converts light into nerve excitation. This organ appears in two forms, one known as a cone and the other as a rod, each different in both structure and purpose. It has been found that the so-called cones are active only in strong light, as during the daytime, while the rods are brought into service at night when there is scant illumination. Thus the functions of the two organisms are opposed so that one rests while the other works. At the point on the retina where an image is focused the sharpest, a depression employed when one centers his vision upon an object to get the clearest possible view of it, only cones are provided. Since these function only in strong light this part of the retina is sightless at night, which explains the reason that the shapes of objects seen in darkness are not well defined nor

distinct. Outside of this focus spot, however, the cones and rods are both distributed over the retina.

Although the cones convey color impressions to us, the rods do not. The latter are literally color-blind and are able to transmit only white, gray, and black. That is why reds appear black to us at night and certain blues and greens seem to be whitish in color, or "rod white," as it is termed; an indistinct, silverish light similar to that of the stars visible on a dark night. Thus it will be understood that, when in an unilluminated room, we are entirely dependent upon the color-blind rods of the retina for sight, and that the sharp focusing point, or central depression, of the latter is off duty.

And here lies the reason that people frequently imagine that ghosts have hovered over them in the darkness, or danced about them in a lonely graveyard at midnight. Suppose, for example, that a pale shaft of light were reflected from some invisible source upon any object in a room, very dimly illuminating a sufficiently small area so that the image of it would barely cover the focus point of the retina. The rays from this, it should be assumed, would not be strong enough to affect the cones, but would excite the rods. Thus if one's vision were directed at one side or another of the light spot, the rays would hit that part of the retina provided with rods. The illuminated image would then be visible. Upon seeing an unnatural glow in a room after being roused from slumber it would be but natural for an observer to attempt to scrutinize it carefully. In other words he would attempt to focus his eyes upon the pale surface. The image in turn would move over the retina. The instant that it covered the rodless spot it would vanish from view, for the cones would be unaffected by it. Realizing that "the thing" had mysteriously disappeared, the observer might shift his glance slightly, and there would be the ghostly spot glaring at him as before. Again it would

melt into nothingness and hide in the folds of darkness at the least provocation.

This explains one of the much hooted-at, feared, and talked-of apparitions. It is one that might readily serve as a glowing, beckoning finger, as an "evil eye," or an evasive will-o'-the-wisp. And it is accounted for by the limitations, or peculiarities, of the human eye.

**MANY DEPEND UPON SUNDIAL AT MIAMI STREET CORNER**

9489

On the south wall of a business building at one of the street intersections in Miami, Fla., there is a large vertical sundial. This has been in use for some time and serves passers-by and the "corner folk" as a town clock. Like any similar indicator, which has been properly made for the latitude in which it is employed, it is a dependable timepiece so long as the sun shines. While its appearance is commonplace to those who reside in sunny regions where such instruments are much used, this sundial rarely fails, because of its position, to attract the attention of the winter tourists from northern cities.



The Sundial Occupies a Conspicuous Position Where It may be Used by Hundreds of Passers - By

H. A. B. Weeks, Warren, Ohio.

Inventor Richard Ashby, 1111 ave A, Miami, Fla.

**NEW SERVING TABLE MADE FOR QUICK-LUNCH ROOM**

1241

For use in quick-lunch restaurants, a combination individual table and chair has been designed which is intended to

Instead of a Chair, a Revolving Stool is Used Which Enables a Person to Seat Himself Easily



replace the more or less awkward arm-chair now commonly in use. It occupies practically no more room than the ordinary type of chair used in such places, and is quite neat and comfortable. A revolving stool is provided so that no difficulty is experienced in seating oneself. The lower part of the article is finished in white enamel, which permits it to be kept in a clean, inviting condition with minimum labor, while the table is fitted with a white top made of a composition material.

**MACHINE CLEANS AND GREASES BREAD PANS**

Using a machine recently brought out, bakers are enabled to grease 2,000 pans with a very small quantity of lard. The object is accomplished through the aid of a set of soft brushes revolved at a speed of 70 or 80 revolutions per minute by an electric motor and intermediate gearing. Projecting

Lottschalk + Co. Reedsville, Pa.

*Commerce Reports 11/11/16*

from the same wooden blocks in which the soft brushes are mounted is a set of stiffer variety. These are provided that all pans may be thoroughly

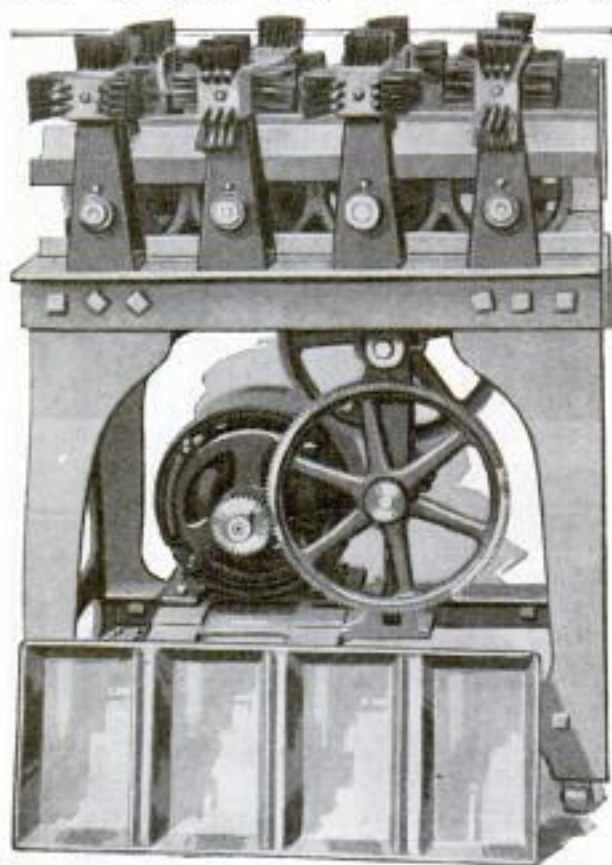

By Using a New Cleaning and Greasing Machine, Bakers are Enabled to Grease 2,000 Bread Pans with Great Saving in Lard

cleaned out before greasing. Otherwise burned crumbs from a previous baking often cling to the tins and make unsightly black specks in loaves turned out later. The machine finds extended use among bakers.

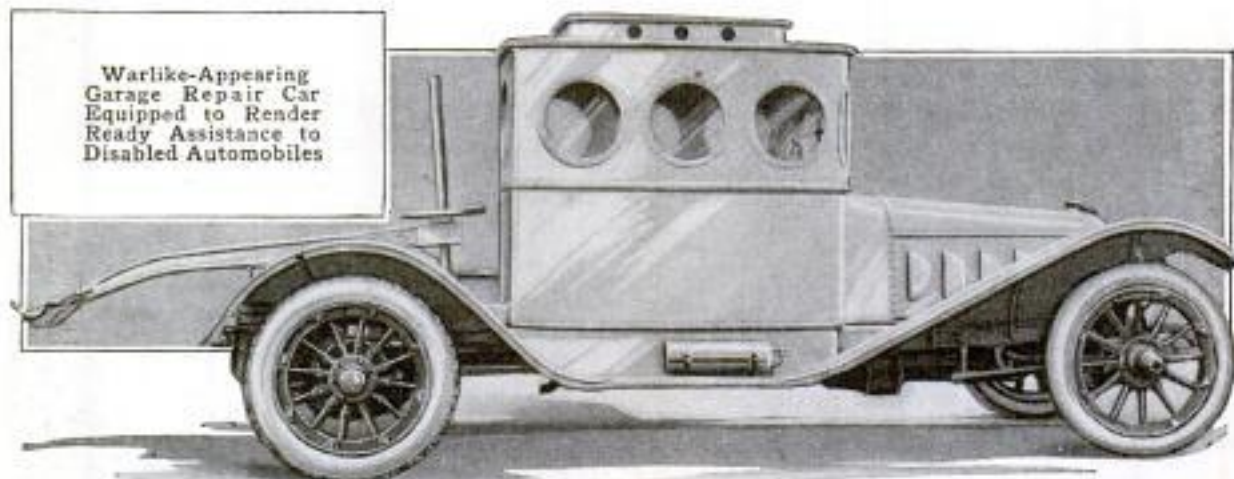

Warlike-Appearing Garage Repair Car Equipped to Render Ready Assistance to Disabled Automobiles

## RECONSTRUCTION IN FRANCE TO BE AIDED BY EXHIBIT

An exposition is to be held in Paris during May, June, and July of this year for the purpose of displaying methods and materials for the reconstruction of houses, factories, farms, highways, villages, etc. Regions devastated by the war, either as means of defense or through assault, will be particularly concerned in this event. The United States apparently is the sole foreign country admitted to participation. The exhibit will be under the patronage of the president of France, leading engineers, hygienists, and business men.

## CAR SPECIALLY EQUIPPED TO AID OTHER MOTORS

A powerful service car which has a distinctly warlike appearance, but which is designed solely to render assistance to disabled motor cars, has recently been added to the equipment of a Utica, N. Y., garage. It is made from a remodeled chassis of a well-known make, surmounted by a box-like body of sheet iron, in the sides of which are several circular and oblong windows. Within are seats for five persons. At the rear, between two mounted tool boxes, is a powerful lifting lever, designed to aid in righting other machines, etc. The lever is actuated by a screw and handwheel, and

*Auto J. J. ...  
E. D. + A. F. ...  
H. William J. ...  
Hotel St. Utica, N.Y.*



# George Paterson  
 46106 Franklin Ave.,  
 Cleveland, Ohio

has a vertical range of  $3\frac{1}{2}$  ft. The car measures about 20 feet over all. It carries spare tires and gas lamps.

**SAFETY-FIRST PLAN WORKED  
 ON LAKE STEAMERS**

1335

One of the steamship companies operating a large fleet of ore vessels on the Great Lakes has inaugurated a rather novel safety-first movement among its seamen. All of its steamers are provided with two white pennants, each having a red spot in the middle, which are carried at the bow and stern. One of these belongs to the deck hands and the other to the engine crew. When afloat they indicate that no member of either personnel has been disabled during the current shipping

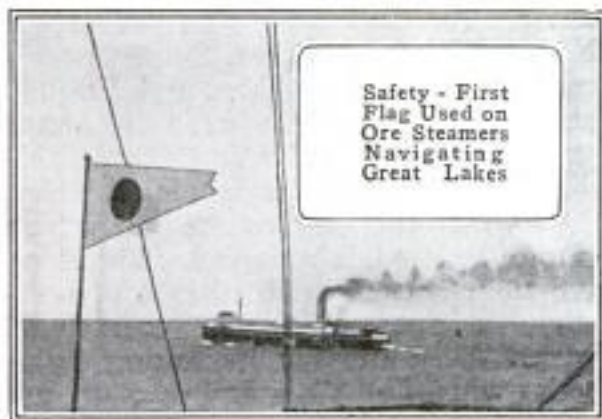

season. In case of an accident incapacitating one of the men, the pennant representing his division of the ship's crew must be lowered for the remainder of the year. If the flags are flown throughout the season, bonuses are paid to the first mate and assistant engineer, who have charge of the welfare of the men.

**ELECTRIC LAMP FOR WAGON  
 OR CARRIAGE**

An electric lamp especially designed to be attached to a carriage or wagon is now on the market. An adjustable iron bracket, which may be screwed to the body of the vehicle, holds the lamp in place. The reflector is of polished nickelplated brass. In it is set a tungsten bulb accurately focused. In the

metal specialties mfg. Co.  
 730 W. DuSable St.  
 Chicago.



This Electric Lamp can be Attached Quickly to Any Carriage or Wagon

side of the reflector is a red lens with many facets which sheds light to the side and rear. The light may be turned on or off by means of a bayonet switch at the back of the lamp. The plug part of the switch can be left in the socket or removed, as desired. Insulated wires connect with the batteries located under the seat, or in some other convenient place.

**FLASH-LIGHT GUN OPERATES  
 CAMERA SHUTTER**

To facilitate night photography, a flash-light gun has been developed which actuates the shutter of a camera simultaneously with the discharge of

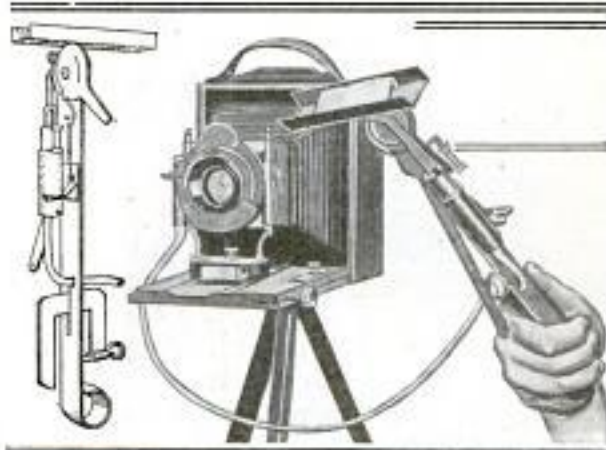

The Shutter is Actuated Simultaneously with the Flash by Pulling the Trigger

Imperial Brass Mfg. Co.  
 Harrison + Racine  
 Chicago

a flash cartridge. The device may be adjusted to respond satisfactorily for both slow and quick shutter speeds, enabling all, or only a part, of the light to be used as occasion may dictate. It may be employed with either an automatic air shutter or one having a flexible-cord release. If a tube is used the bulb is removed and the end of the former connected with a small cylinder provided on the handle of the instrument. The movement of the firing trigger forces air to the shutter, or in the case of a cable presses the plunger. For amateurs who have failed to get good results in flash-light work, the device has desirable features. It is likewise of convenience in certain respects to the press photographer who frequently works under extreme disadvantages. The fact that both the flash and the shutter are operated with one hand, leaving the other entirely free to hold the camera, often means much when fast work has to be done.

### LOCK FOR CAR WHEEL USED IN REMOVING BRASSES

To facilitate the work of removing the brasses from the bearings of a car wheel when a train is on the road, a simple locking device has been invented which will hold a wheel to a rail while

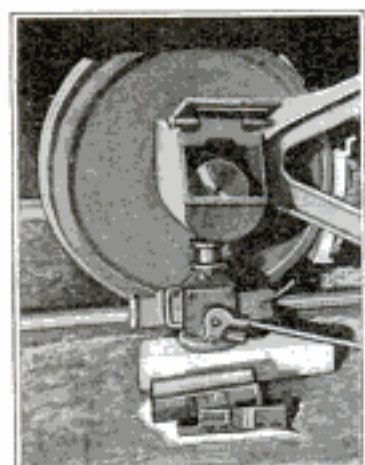

a car is being jacked up. The apparatus may be adjusted in less than a half minute and when once in place grips a wheel and rail tenaciously. While the lock is attached a wheel cannot be raised, turned, or moved, even though the brakes are released. The quickness with which it may be applied saves time for a train crew and thus lessens delays. It is

Cont. + Inventor: J. E. Small,  
1/2 Car Wheel Lock Co.,  
16 Nestor Bldg., Seattle, Wash.

claimed that one man can place the lock in position, jack up a loaded car, and remove the brasses in five minutes or less. Usually a number of men work much longer to accomplish the same thing. The device is made of cast steel and weighs 16 lb. It has lately been introduced in some of the yards at Seattle, where it is said to have proved serviceable. It is made in two sizes, one for the wheels of freight cars and the other for those of passenger and refrigerator cars.

### FUR FROM MANY LANDS USED IN MAKING FELT HATS

A newly installed exhibit in the National Museum at Washington tells, by means of samples and other displays, how felt hats are made. It is not commonly known that fur of the North American beaver, South American nutria, Saxony hare, and English and Scotch cony are used in better grades of hats. Pelts from these animals are washed in whale-oil soap, after which the long, coarse hair, which cannot be used, is removed. The skins are then treated with nitrate of mercury, a process called "carroting," which gives the fur its felting properties when hot water and pressure are applied. Cutting machines are employed to shave off the fur close to the skin. From these the fur, without the skins, is carried on an endless belt, on which it lies apparently intact as if the skin were still beneath it. While passing along on this belt it is sorted according to quality and color by skilled workers, after which it is seasoned. Some manufacturers have from one to two million dollars' worth of fur seasoning in storage. After being seasoned the fur is thoroughly mixed mechanically. By a pneumatic device it is then collected on the surface of a sievelike cone in a fine, thin layer and immersed in boiling water, thereby developing the felting properties of the fur, the particles matting and locking together. These cones of felt, measuring 3 ft. high, are the rough forms which are finally transformed

Smithsonian Institute Bulletin

1/29/16

Cont. + Inventor: C. F. Shelton  
645 Ceres Ave. Los Angeles,  
used at: 11th + Olive Sts.  
Los Angeles, Cal.

Disappearing Metal Shutter &  
Screen Corporation,  
Norfolk, Va.  
591

POPULAR MECHANICS

into hats of various styles. Shrinking and shaping by baths, stretching, and blocking are among the final steps in the transformation.

**MACHINE TESTS QUALITY OF 1154 AUTOMOBILE TIRES**

A machine, set up in a garage window, and propelled by an electric motor, attracted considerable attention in a western city recently as a tester of rubber tires. The method of test consisted in subjecting a sample strip of rubber to the wearing effects of continued expansions and contractions. One end of the strip was affixed to a stationary support and the other oscillated back and forth under the motions of a long lever working on a cam within the machine. In this fashion the machine at one test stretched the rubber of a used tire over one-third of its length upward of 15 times per minute for several weeks in succession, the material showing little deterioration under this most severe treatment.

A set of pulleys and belts reduced the fast speed of the motor to a rate

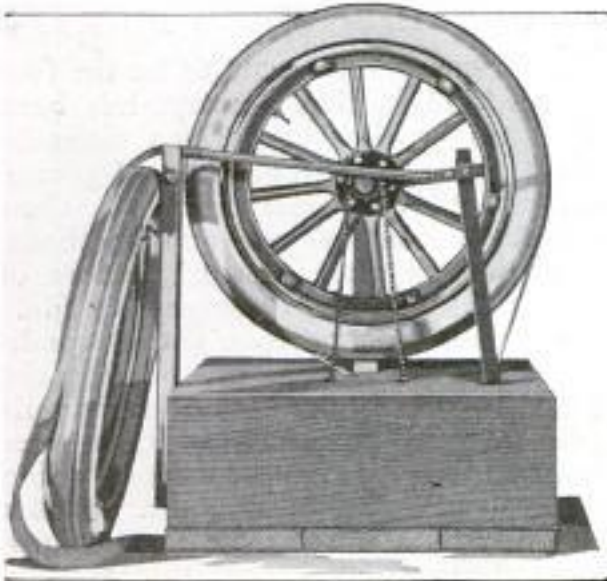

Machine Erected in Show Window Stretches the Rubber of an Automobile Tire 15 Times per Minute for Weeks at a Time in Durability Test

satisfactory for the cam. A feature of this reducing gearing was the use of a fully equipped automobile wheel as one of the revolving members.

**STEEL SHUTTER AND SCREEN FOR RESIDENCE WINDOW**

To replace both awnings and ordinary wooden shutters as protective mediums for the windows of a resi-



When Not in Use the Metal Shutter Is Out of View

dence, a combination steel shutter and screen is being introduced which has a number of pleasing features. The device is made entirely of metal, is very neat, and is not difficult to install. It is made with a metal frame which is hinged in place the same as a casement window, permitting ready access from the outside when it is wished to wash the glass. The screen is attached to the inner side of this, immediately back of the shutter, which is controlled by cords extending down the interior face of the window frame. By using these and a neat locking device, the shutter may be raised to any height and the slats firmly secured. When it is not wished to use it, the shutter is dropped from sight. The advantages of a shuttered window are found in the security and privacy it gives, in its ability to shade a room from intense rays of the sun, and also in the fact that a room may be ventilated during a storm without danger of rain being driven into it.

DEVICE FOR HOLDING HOGS

1207 WHILE RINGING THEM

A device for catching and holding hogs when it is desired to ring them,

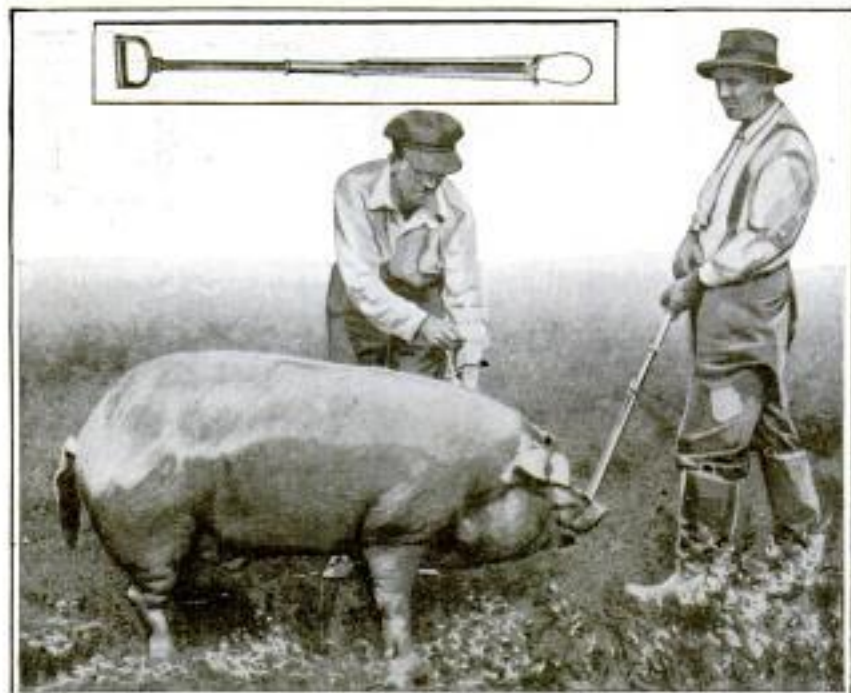

By Placing the Loop over a Hog's Snout and Drawing It Up Tightly the Animal can be Kept under Perfect Control

cut off their tusks, or immunize them from disease, consists of a steel bar, less than three feet long, on which slides a sleeve that carries a thumb release. The release engages a ratchet on the rod, and in this way the sleeve may be fixed firmly in any position desired. An annealed wire, the ends of which are fastened to the sleeve, extends along the rod from the sleeve to the lower end, where it passes through two eyelets, forming a loop at the end of the rod. After placing this loop around the snout, or upper jaw, of a hog it can be drawn up tightly by moving the sleeve. A handle at the upper end of the device gives the user a firm hold so that he can fully control the animal.

MONOGRAMS ON RADIATOR  
892 CAPS IS NEW PRACTICE

A fad of late origin among automobile users consists in the mounting of a monogram on the radiator cap at the front of the machine.



In this position the owner's initials make a neat ornament, as well as serving to identify his machine from a number of others in case of question. Fraternal emblems, mimic policemen, club insignia, and numerous other figures have at one time or another been affixed to the radiator cap, but the use of a monogram is said to be the latest practice.

American Motorist Nov. '15

REAL PRISON LIFE SHOWN  
IN EXHIBITS AND FILMS 1349

A prison exhibit, said to be the first of its kind in this country, has been held this spring in various cities in New York for the purpose of giving the people a clear idea of their state's prison system and methods. Perhaps the most unusual feature of this exhibit is the three sets of films shown. These portray actual conditions and are photographs of real prisoners. One of the sets of reels tells the story of the week which former Warden Thomas Mott Osborn of Sing Sing spent living the life of a prisoner at Auburn. The insanitary and antiquated surroundings which are cited as reasons for the demolition of Sing Sing are shown in another series. As a "happy ending," life in Great Meadow prison, where inmates have a thousand acres in which to work and recuperate physically and mentally, is shown in the third of the series.

Joint Committee on Prison  
Reform Bulletin  
105 West 40th St N.Y. City  
Copyrighted material

*Jack Brooks, Romford, Essex, England*



Sikh Warriors Carry a Ringlike Weapon on Their Heads. In Battle This is Thrown with Terrible Force, the Razor Edge Cutting Deeply

## 9012 RING IS MURDEROUS WEAPON AT SHORT RANGE

A weapon, new to the armies of Europe, is the "chakkar" of the Sikh warriors from India who are fighting with the allies in France. The Indian fighters carry this weapon on their turbans. It looks very much like an ordinary quoit, but has an edge like a razor. The Sikh throws the "chakkar" by twirling it around in his hand and then suddenly releasing it. Whirling through the air and revolving horizontally, it makes a terrible wound on striking. At 12 yd., a "chakkar" will cut a 2-in. bamboo in two.

## 147 NEW TYPE OF TWO-CYCLE GAS ENGINE

In a two-cycle gas engine recently invented the entire control of the gas is accomplished by means of a sliding sleeve that works between the piston and the wall of the cylinder. This sleeve is operated by the crank shaft,

being connected with a crank arm set to one side of the crank arm with which the piston rod connects. The crank arm for the piston has a throw of 4 in., and that for the sleeve a throw of 2 in., making the throw of the piston 2

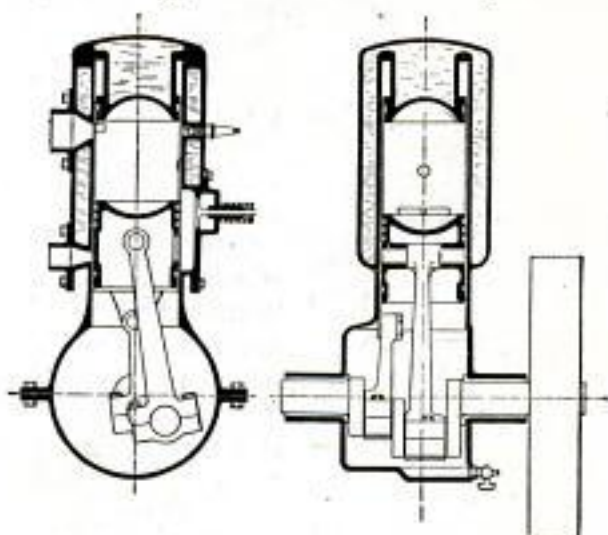

New Two-Cycle Gas Engine in Which the Gas is Entirely Controlled by a Sliding Sleeve

in. greater than that of the sleeve. In addition to this, the short crank arm is set about 20° ahead of the long one,

*Inventor: Howard J. Love, 314 Federal St, Chicago*



educational value of this is considerable, for a child teaches himself something which is of permanent value and unconsciously instills in his make-up that spirit of enterprise which is most necessary for his proper development.

**ALASKAN FISH SHIPPED VIA CANADA TO UNITED STATES**

The rapid development of Prince Rupert, B. C., as a fishing port because it is now a western terminus of two great railway systems, the Grand Trunk and the Northern Pacific, threatens to divert a considerable amount of the fish trade from Ketchikan, a coast town in southern Alaska, whence the fish are shipped to Seattle and thence eastward. The establishment of these new routes results, rather oddly, in the fact that fish caught by Alaskans, in United States waters and destined for United States markets, are being shipped through Canada. One of these new lines has put on a through express service and it is said that they can get fish to cities in the eastern United States two days quicker than can shippers using the Seattle route. Canadian laws now permit American fishermen to land their cargoes at Prince Rupert free of duty and send them in bond through Canada to the United States. Ketchikan, fearing a serious diminution of its fish trade, has petitioned the authorities at Washington for protective legislation.

The bulk of the fish shipped from these northwestern waters is halibut. Parties of fishing boats spend from 10 days to two weeks on a fishing trip; as soon as fish are brought on board they are cleaned and put on ice. When taken to port the fish to be retained in cold storage are kept for 24 hours at 10 to 20 degrees above zero, after which each fish is dipped several times in fresh cold water and so given a coating of ice. Thereafter fish can be kept in cold storage at about four degrees below freezing. When wanted, the fish are wrapped in heavy paper, put in paper-lined boxes holding 375 lb. each, and shipped east in cold-storage trains.

**BURNISHED-METAL MIRRORS**

1191 **FOR SOLDIERS** *Latter Dec 1915*

A pocket mirror of burnished metal that fits into a neat khaki case is one of the handy toilet articles which is



Many European Soldiers in the Trenches are Now Using Pocket Mirrors of Burnished Metal

proving popular with the soldiers in the trenches in Europe. This convenient mirror is scarcely as thick as a looking-glass and cannot be broken as can glass, yet it possesses a reflecting surface quite as brilliant. A metal loop at one end of the mirror serves as a handle.

**STOVEPIPE FOR MOLDING CONCRETE BENCH MARKS 8873**

Sections of ordinary stovepipe are used in Milwaukee for molding the cylindrical concrete bench marks that serve as reference points for establishing elevations in that city. A solid-concrete base is first built with the section of stovepipe set in and projecting from the top. The stovepipe is then filled with concrete and the top is finished with a brass casting that is set

# Warren B. Kenlock  
67 Sentinel Bldg.,  
Milwaukee, Wis.  
Copyright material

184-5  
Pittsburgh Dispatch 11/23/16

at a specified height above mean lake level. The stovepipe eliminates an expensive cast form heretofore used, and

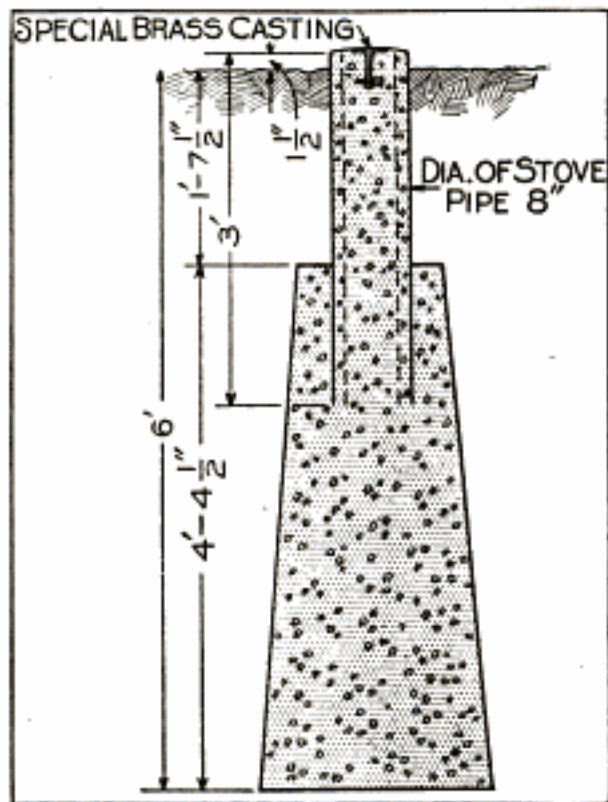

Concrete Bench Mark Adopted as Standard in Milwaukee: A Section of Stovepipe is Used for Molding the Upper Cylindrical Part

is said to have resulted in a reduction of about 75 per cent in the cost of building the bench marks.

### MINOR MOTOR-CAR PATENTS TO BE CROSS-LICENSED

To put a stop to unprofitable and recurring litigation over the infringement of their respective minor patents, 79 motor-car manufacturers, members of the National Automobile Chamber of Commerce, have joined in an agreement whereby these makers may license one another under patents which they control affecting minor forms of improvement, but which are in no way fundamental. Many motor-car producers have long felt that the legitimate profits in their line of business have come from the scientific manufacture and selling of cars and not from the exploitation of minor patents that generally do not represent more than incidental development. It

*National Automobile Chamber  
of Commerce  
7 East 42nd St. New York City*

is believed that this interchange of patents, or cross-licensing, will gradually result in a tendency to standardize many additional features of automobile building and will permit more energy to be devoted to the fundamental problems of construction and questions of design regarding which there remain genuine differences of opinion.

### SPACING BAR SIMPLIFIES CONCRETE REINFORCING 9099

Laying of steel bars for the reinforcement of concrete structures is usually attended with much tying and cross tying of the metal to hold it in proper position before pouring. This is generally done simply by twisting bits of wire around rod intersections, giving them greater or less stability. As a more efficient method of handling the proposition, a spacing bar has lately been invented. This consists of a sheet-iron strip given a channel cross section and having numerous tongues of metal punched out of one side. In use the strips are placed crosswise of the general reinforcing, and the tongues hammered down over the separate rods, thus holding them a fixed distance apart.

The operation is quickly accomplished and is effective in action. The

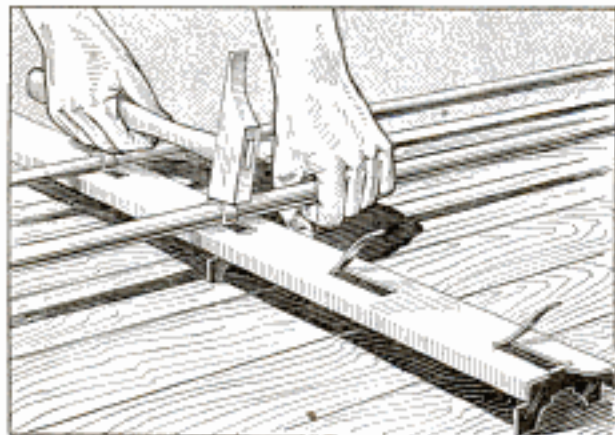

Spacing Bar Holds Concrete Reinforcements Firmly in Position

spacers become molded in the concrete along with the rods, and may thus serve to give some lateral reinforcing.

*Patented 10/22/11  
Infr: Electric Welding Co. Pittsburg, Kans.*

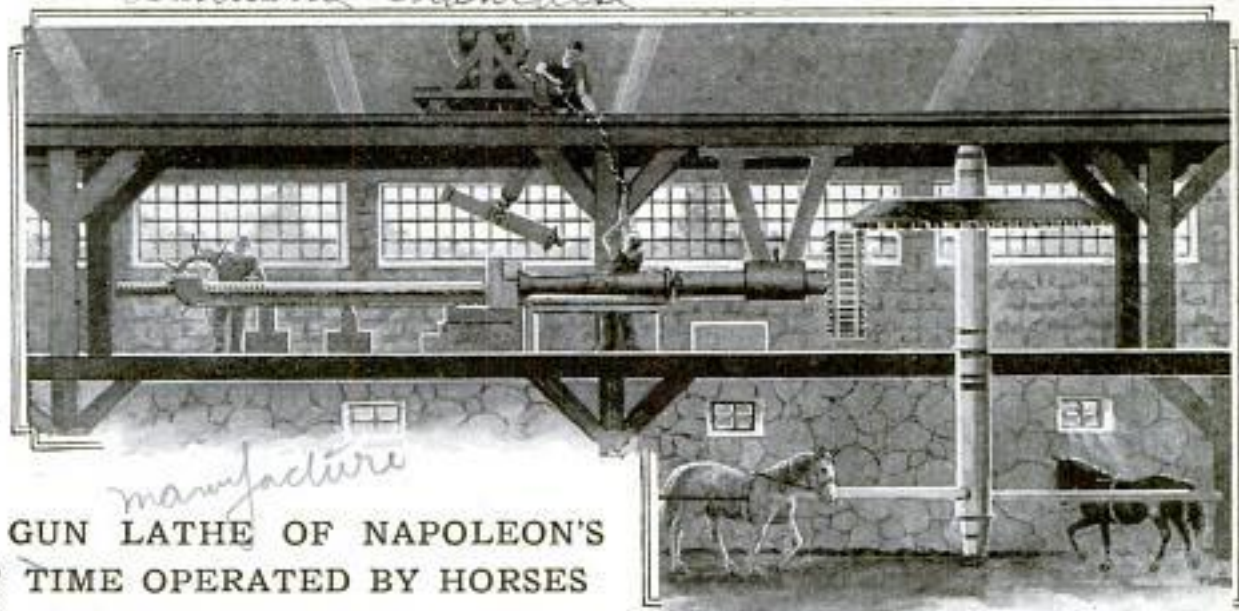

*L'Industrie Française*

*manufacture*  
 9543 GUN LATHE OF NAPOLEON'S  
 TIME OPERATED BY HORSES

Machinists who made war munitions in the time of Napoleon I had no such equipment and tools as those of the present day possess. According to an old-time sketch recently brought to light, cannon were bored by means of a wooden lathe driven by horsepower. The horses traveled in a circle in the lower part of a building, turning a prodigious axle, to the upper end of which a crude but huge gearwheel was attached. This propelled a smaller pinion mounted near its periphery, and the pinion in turn revolved a chuck in which one end of the cannon was attached. The boring tool was advanced by a man operating a handwheel at the far end of the machine. Another handwheel, on a small traveling car above the lathe, lowered the cannon into place, or removed it when machined.

*Portable*  
 1173 GAS STOVES FOR MOTOR AND  
 YACHT PARTIES

Alcohol-gas stoves made with one, two, or three burners, have proven convenient for use in homes where gas is not available and for motor or yachting parties. The stoves have a gravity feed, use denatured alcohol which is transformed into gas, and are always ready for instant use. A popular form of this type of stove is one with two burners, nickelplated and fitted with black-polished handles, by which the

Machinists of Napoleon's Time Bored Cannon in Wooden Lathes Driven by Horsepower

flames are controlled. The alcohol is contained in a receptacle mounted above and back of the stove. Chafing dishes and percolators are also constructed on the same principle. It is



This Portable Gas Stove Burns Denatured Alcohol and Is Suitable for Light Housekeeping as Well as Outings

said that 25 cents worth of denatured alcohol will supply two burners for eight hours.

The two-burner stove has proven particularly popular with picnicking motorists.

CAAn eastern firm, finding laborers scarce, recently advertised for one-legged men for certain tasks that could be performed by laborers so maimed.

*Manning, Bowman & Co - 5 No. Walnut St., Chgo.  
 (Meridan, Conn.)*

## NOVEL AND PRACTICAL THINGS FOR THE HOME

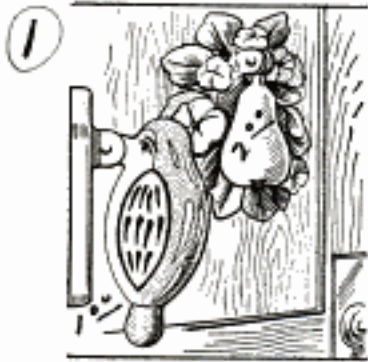

Decorated Knockers for  
Bedchamber Doors

fruits, and similar things, are the subjects of some of the designs, which are finished in bright colors and intended principally for the doors of colonial bedrooms. They are smaller than those customarily used on the exterior.



Scouring Mop Cleans Pots  
and Pans Quickly

For scouring pots and pans a friction swab has been introduced, which is made the same as an ordinary dish mop. It differs from the latter only in that the individual strings composing its cotton tangle are wound with fine copper wire. It enables the most disagreeable part of dishwashing to be done without placing the hands in greasy, hot water.



Mask Enables Person to  
Sleep in Daytime

Designed so that it fits snugly over the eyes, shutting out all light, a black mask has been devised for persons who find it difficult to sleep after dawn. It is especially adapted also for night workers, and others who live according to an inverted schedule and do their sleeping during the daytime. It is made of soft material, is not discomforting, and stays in place.

**H**AND-decorated door knockers for interior purposes are being made in a number of odd patterns. Birds, flowers, fruits, and similar things, are the subjects of some of the designs, which are finished in bright colors and intended principally for the doors of colonial bedrooms. They are smaller than those customarily used on the exterior.

For scouring pots and pans a friction swab has been introduced, which is made the same as an ordinary dish mop. It differs from the latter only in that the individual strings composing its cotton tangle are wound with fine copper wire. It enables the most disagreeable part of dishwashing to be done without placing the hands in greasy, hot water.

Designed so that it fits snugly over the eyes, shutting out all light, a black mask has been devised for persons who find it difficult to sleep after dawn.

It is especially adapted also for night workers, and others who live according to an inverted schedule and do their sleeping during the daytime. It is made of soft material, is not discomforting, and stays in place.

Quite a neat accessory for the medicine case, especially when one spends considerable time traveling, is represented by a teaspoon and tablespoon measuring device.



Medicine Spoon Arranged  
in Neat Form

It is made of silver and consists of two bowls, hinged together so that they may be folded compactly and slipped into a small chamois bag. It serves very nicely as a modest practical gift, for it is both novel and serviceable.

Convenient features for the housewife are embodied in a four-compartment fireless cooker intended to be attached to a kitchen wall at a suitable distance from the floor.

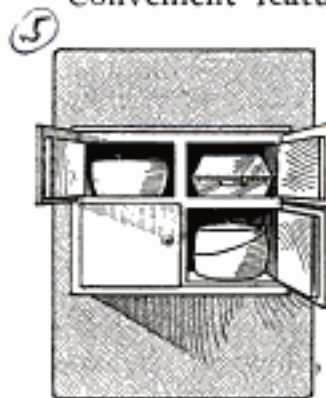

Wall-Cabinet Fireless  
Cooker for Kitchen

its use is somewhat simplified. The outside is made of wood, finished according to the wish of the purchaser.

To permit it to be carried in a small hand bag, a folding paper fan is being made for women.

When opened it is 8 in. in length, but when closed it is only half that size. Its ribs are made



Folding Fan Which may be  
Carried in a Hand Bag

- 1 DOOR KNOCKERS-- Charles Hall, Springfield, Mass.  
*333 4th av. New York - wholesale exhibitor*
- 2 FRICTION TANGLE-Mop-- J. M. Sherwood Co., 154 Chambers St., N. Y.
- 3 BLACK KNIGHT MASK-- P. Paul & Son., 132 N. Pearl St. Buffalo.  
*25¢ extra thick lined with white 55¢*
- 4 MEDICINE SPOON-- ~~Ask Vestal.~~ *Ovington's 314 5th av. New York*  
*4.50 8.50*
- 5 FIRELESS COOKER-- Utilities Mfg. Co., Stamford, Conn., R. R. 29.
- 6 FOLDING FAN-- Fields retail, Chicago.
- 7 SHOES FOR BABIES-- Little Chick Shoe Co., 130 N. 5th. Ave. Chi.
- 8 PENCIL KNIFE-- Peacock, Chicago.  
*C.D. 141 So State St. Gold 17.00 Silver*
- 9 TOASTING FORK-- ~~Ask Telford.~~ *Mrs R. D. Tilney, The Elephant Somers, N.Y.*  
*3.50*
- 10 FOOT WARMER-- ~~Wm.~~ Slaughter ~~& Co.~~, Chicago.  
*1712 S. Mich av.*
- 11 TRAVELING BAG-- H. J. Chilton & Co., Chicago.
- 12 SPIRAL CORER-- Ask Vestal.

JAN 20 1915

in two parts and hinged. When in use it is as rigid as most fans, and bears no noticeable evidence of its difference from ordinary ones.

Shoes for babies who have just learned to walk are being made with small rubber-covered canvas disks set into the soles, to prevent slipping. These contact points remain intact until the shoes become pliable through wear and are properly shaped to a child's feet.

Among the late jewelry novelties now being shown is a combination penknife and pencil, suitable for either a man or woman. It is thin, of neat size, and available in both solid gold and sterling silver. It serves especially well as an anchor piece for a man's watch chain. As an accessory for a woman's hand bag, or desk, its convenience is obvious.

Telescoping toasting forks that may be ex-

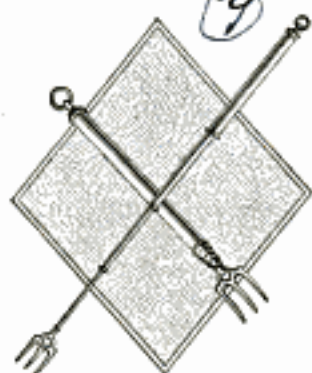

Convenient Toasting Fork Which Telescopes

very useful when cooking is being done over a campfire.



Rubber-Covered Disks Fitted to Child's Shoes



Attractive Combination Penknife and Pencil

tended to various lengths up to 3 ft., are very serviceable when used at an open fireplace. They have four brass segments which slide within each other easily but remain rigid. The prongs are of nickel. The device is also

For invalids, and others who experience difficulty in keeping their feet warm, an electric foot-pad is made with slipper tops attached to it which cover the ankles. Connection may be made with any light socket and the device used when the patient is in bed or supported in an armchair. It may also be used as a bed warmer.

Insurance against the theft of one's personal baggage is given by a new type of traveling bag, the handle of which is hinged to the inside, instead of the outside, of the case. When this grip is turned down and the bag locked, no hold is offered. This absolutely prevents mistakes and gives reasonable security against theft.

To prepare vegetables, such as potatoes, parsnips, and carrots, for stuffing, a handy corer has been devised. It consists of a long bent wire, near to one end of which a small sharp ring is attached. By forcing this into a vegetable and then twisting it, a clean hole is bored. This in turn may be filled with minced meat, and the vegetable baked in the usual manner. The part removed from a vegetable by this operation comes out in a spiral form, and may be made use of if desired.



Foot Warmer of New Type for Invalids



Traveling Bag with Disappearing Handle



Serviceable Vegetable Corer for Housewife

Mr. Ford (alias)  
 Jackson & Semmelmeyer  
 44 S. Wabash Ave.  
 Sold by 600 Chicago

Francis J. Dickie, Suite 1,  
 15 Parkview Bldg., London, Can.

POPULAR MECHANICS

DIRECTORY FOR MUCH USED TELEPHONE NUMBERS

EASTERN CANADA'S INDIANS 1270 CALLED TO COLORS

A device on which may be conveniently listed several scores of much used telephone numbers and corre-

The Indians of eastern Canada have been called to the colors. During the early months of 1916 the Dominion has

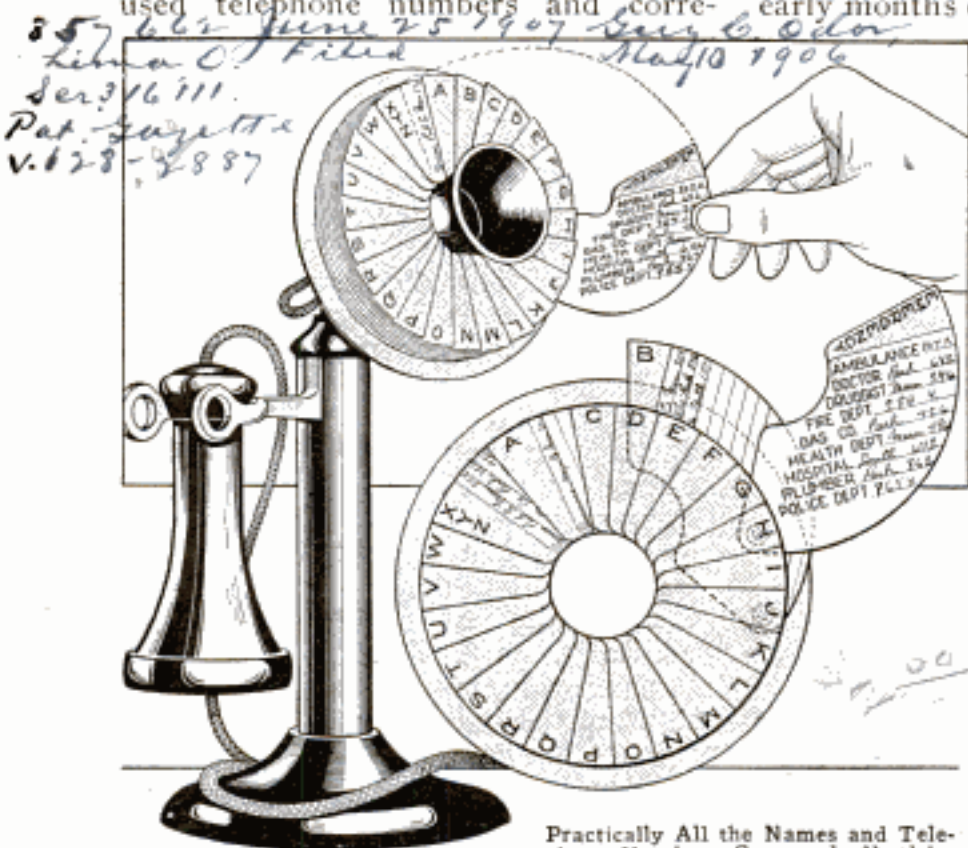

Practically All the Names and Telephone Numbers Commonly Used by One Household can be Made Instantly Available if Entered in This Directory

sponding names, consists of a disk, in the center of which is a circular hole large enough to permit the disk to be fitted over the mouthpiece of a telephone. Fastened to the disk by pivoting rivets are a number of overlapping leaves, semicircular in shape and so arranged as to cover the disk. The exposed edge of each leaf is marked with a letter. Any leaf can be brought fully into view by swinging it outward, in the plane of the disk. Upon each of these leaves may be written telephone numbers and names. Any leaf can be brought into a position where it can be easily read by revolving the whole device.

been engaged in raising its quota of soldiers from a quarter of a million to half a million men and the Canadian minister of militia has sent word to the various tribes in the eastern provinces that men from their number are eligible for service. At the beginning of the war many Indians sought to enlist but were refused on order of the war office at Ottawa. As yet no announcement has been made regarding the tribes in the West, which include perhaps 10,000 men, who might be quickly turned into good soldiers and many of whom are excellent marksmen. Several of

these tribes have already shown their interest by subscribing to various war funds. The vast majority of the Canadian Indians are wards of their government and have been ineligible for military service. The recent invitation for them to enlist has had no parallel since 1812.

MOTOR-CAR DEATHS LESSEN AS MACHINES INCREASE 12 18

Motor cars are increasing much more rapidly than the number of fatalities due to them, according to preliminary mortality figures for 1914 which have recently been given out by the Bureau of Census. During a five-year period ended with 1914, the number of cars increased more than twice as rapidly as did the list of casualties caused by them. There were approximately 200,000 machines in use at the close of

Of the 52,561 men on board vessels of the United States Navy, 47,664 were born in continental United States; of the remainder, 1,900 were born in our oversea possessions.

Commerce Reports Jan. 3, 1916

1909, while at the end of 1913 the number was about 1,270,000. At the finish of the following year automobiles numbered 1,750,000. Fatalities caused by motor-car accidents in the death-registration area, which at that time embraced 56 per cent of the country's population, increased from 632 in 1909 to 2,623 in 1914. On the other hand, the number of casualties due to cars in a greater death-registration area embracing 65 per cent of the population, increased from 2,488 to 2,795 from 1913 to 1914. These figures show that during the five-year period, motor cars increased 775 per cent while the casualties increased 315 per cent. Between 1913 and 1914 machines increased 38 per cent and fatalities 12 per cent. Two possible reasons for this decrease in casualties are advanced in the government's resumé; one being a reduction in the average mileage per machine, and the other that cars are being driven with greater regard for public safety than in the past. In considering the statistics, however, it is not amiss to remember that machines are distributed according to the concentration of wealth in the various parts of the country rather than in relation to the density of its population. Manufacturers have been turning thousands of cars into the West. Also the motor car of today is much more easily controlled and responds more quickly than earlier types, and pedestrians are more careful than heretofore.

### ERASING ATTACHMENT MADE 8793 FOR TYPEWRITERS

Designed so that it is operated by striking an auxiliary key, an erasing attachment that may be attached to a standard typewriter has been patented. The face of the eraser, made of metal and mounted at the end of an arm pivoted to a lever, between which members a spring is fixed, is cut by a number of transverse teeth. The carriage does not move when the erasing key is struck, but remains stationary. The eraser strikes the top of a character, missing the ribbon, and is drawn down-

ward by the action of the spring, cutting into the paper sufficiently to remove the inked impression of a letter.

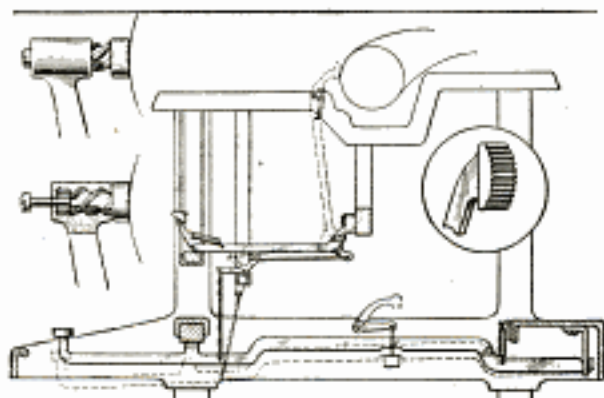

By Striking the Auxiliary Key a Few Times in Quick Succession an Erasure is Made. This Action does Not Cause the Carriage to Move

A modification of the same device has been designed which allows the use of a rubber eraser instead of a metal one. In this instance the head revolves upon striking the platen.

### AIR COOLER FOR SLEEPING

#### 9355 AND SICK ROOMS

An air-cooling apparatus which is intended to be used in place of an electric fan in a sick room or bed-chamber, has been constructed by a German inventor. The advantage which is claimed for the device is that it creates neither a draft nor noise while it is



Ice Packed in the Hollow Walls of the Cylinder Cools the Atmosphere without Creating a Draft

in use. It consists of a hollow-walled cylinder, packed with ice, at the bottom of which is a funnel that gives the descending cool air a tendency to spread out as it strikes the bed over which the apparatus is swung.

Die Export Woche

Inventor & contributor: Harry D. Beddon, L. E. Smith & Bros. Typewriter Co., Pittsburgh, Pa.

Herrn: Otto Stenck, Württemberg, Germany.

**DEVICE PREVENTS RATTLING  
 926 OF WINDOWS**

An attachment to prevent the rattling of windows has been patented by a New Jersey inventor. It consists essentially of a swinging arm, having a notch in the front side near one end into which is fitted the end of a curved spring. The latter curves downward about the arm. Attached to the free end of the arm is a roller. The device is fastened at its pivoted end to the side of a curved

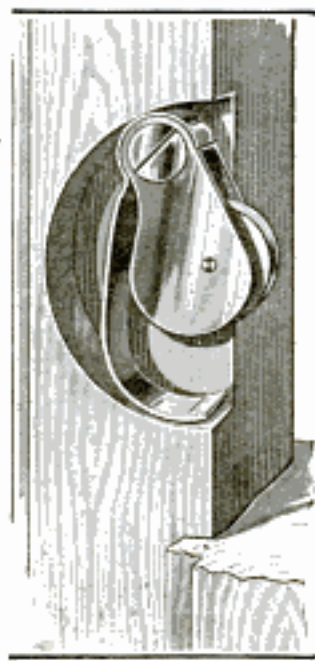

recess cut in a window sash, as shown. When the sash is fitted into the window frame the roller, which has a tendency to press against the latter, prevents play and at the same time permits the window to be moved up and down freely.

**DRAWING PIN HAS MOVABLE  
 928 HANDLE**

A convenient drawing pin, recently patented, consists essentially of a head



formed by an upper cup-shaped disk and a lower circular disk, between which is a smaller head from which projects a sharp point, or pin. The edge of the upper disk is turned over into an annular recess, which thus presents a flat bearing surface. A feature of the pin is a semi-circular handle, the ends of which are turned in to engage holes in the sides

English Patent Gazette  
 Dr. E. E. Stanley, Thornbury  
 Rd. Birchfields, Birmingham.

of the head. One-half of the head may be made of smaller radius than the other half, thus permitting the handle to be turned down flat and thereby completing the circle of the head.

**NEW Y. M. C. A. PLANT COSTS  
 OVER MILLION AND HALF 1169**

The central branch of the Young Men's Christian Association of Brooklyn, N. Y., recently dedicated a new building which cost \$1,600,000 and is said to be by far the largest and most expensive Y. M. C. A. building in the world dedicated entirely to association work. This splendid structure has a frontage on three streets of 111 ft., 126 ft., and 192 ft., respectively. There are 13 floors above ground and two below. On the roof are three four-wall handball courts. It is believed that no other association surpasses this one in its facilities for carrying on its work.

The building contains 510 living rooms, three gymnasiums, two swimming pools, two billiard rooms, 10 bowling alleys, and educational equipment for 2,000 students. The entire eighth floor is devoted to the latter phase of the work; here is found every facility for day and night classes, including chemistry and physics laboratories. A great variety of subjects will be taught, ranging from operation of motion-picture machines to book-keeping.

Unusual attention has been given to the plumbing in connection with the gymnasium baths, swimming pools, and the shower baths on each of the dormitory floors. But there is only one bathtub in the entire plant. This is located in the hospital ward. Bathtubs are regarded as insanitary and agents of infection, hence they have been dispensed with.

About one-fourth of the ground floor is occupied by an auditorium having a full theater equipment and seating 650. The larger of the two swimming pools measures 25 by 75 ft. and, like the smaller one provided for boys, is supplied with water which has been softened and filtered.

Brooklyn Eagle 10/31/15  
 E. A. Hungerford, Publicity Secy  
 55 Hansen Place, Brooklyn, N. Y.





*S. N. 2111(17) 2643*  
**Waterproofing Concrete Work**

For the purpose of waterproofing concrete there is nothing better than the commercial waterglass, which is a solution of sodium silicate. Dilute the waterglass with four parts of soft water. Apply with a flat brush, thoroughly wetting the surface.

Another method is the use of copper sulphate, also known as blue vitriol. One pound, dissolved in 4 gal. of water and applied the same as the waterglass, will give excellent results. The sulphates of aluminum, zinc, or iron can also be used, but the copper solution is by far the cheapest and most efficient.

Waterglass is the best water-resisting agent, for its combination with the calcium of the cement is a chemical one, forming an insoluble silicate of that element. Incidentally the waterglass may be colored by mineral pigments, thus at the same time forming a waterproof color for concrete.—A. E. Soderlund, New York City.

**Wall Paper Window-Display Machine**

A dealer in paints and wall paper devised an ingenious display machine to show his stock of wall papers to his patrons. It is also used in the show window during the dull season, and has proven to be a good advertiser out of season.

The machine is driven by a motor, and the elements are three pairs of cylinders which are mounted in a frame and slowly revolved, one pair for ceiling paper, one pair for borders, and one pair for side walls. A canvas belt, about 200 ft. long, connects each pair of cylinders, and as it unwinds from one it winds up on the other, making a large roll. Each pair of cylinders starts to wind at the same time, and when all

three are unwound, a reverse gear is slipped in, and the belt runs back on the first roller. The mechanism is provided with an ingenious device to keep the surface speed of the belt always the same. Between each pair of cylinders the belt runs on a tangent, or

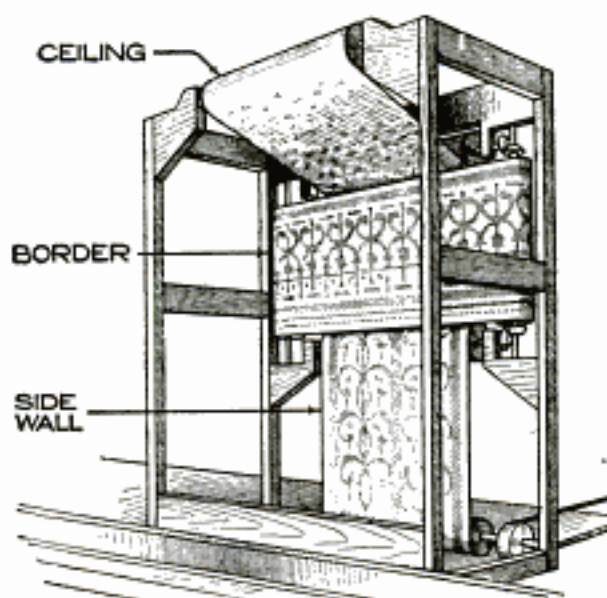

Three Pairs of Rollers with Long Belts of Canvas for Displaying the Combinations of Wall Paper

straightaway, and this part is the part that is visible to the spectators.

On the canvas belt are pasted the wall-paper samples. The machine is so arranged that three harmonizing kinds of paper are visible at a time, thus giving a good idea of how a room would appear with that paper combination. For use in the display room the motor may be disconnected, and each of the three roll systems worked independently by hand. The customer, seated comfortably in a chair, can judge the effect of the different combinations of border, ceiling, and side-wall papers.

⌈The diametral pitch of a gear is the number of teeth to each inch of its pitch diameter.

### Advertising Signboard for Farmers' Products

The farmers in one locality use a novel signboard to advertise their farm products. Instead of the usual painted



The Signboards are Held in Place between Posts Where They are Quickly Inserted

slab, or blackboard, the passing autoist, or summer visitor, finds a neatly painted sign with all of the good things in the farmers' market for that day, for instance, "New Beets," "Shell Beans," "Fresh Killed Chickens." Upon closer examination the sign will be found to be constructed so different panels with the articles for sale may be quickly inserted. A stock of these painted boards is kept to correspond to the different seasons of the year for the things on sale. The boards are usually painted white with black letters, and present a neat appearance.—Contributed by George H. Davis, Jr., Braintree, Mass.

### Transplanting Plants

In changing the location of plants from one place to another they will stand a greater chance for thrifty growing if the earth around the roots remains undisturbed. This can be accomplished by digging a trench around the plant and binding the earth together with a piece of ordinary wire window screen. This screening must reach down as far as the ends of the roots. Cord wrapped around the screen will hold the earth in a compact mass.

The mass can be grasped at the bottom with the fingers, in the earth under the screening, and lifted bodily out, then placed in the new hole, or a spade can be inserted under the screening and the mass lifted. The wire screening need not be removed, as it will rust out in a short time.—Contributed by James A. Hart, Philadelphia, Pa.

### Pulling a Well Casing

When a well casing will not start with the jacks, or when it comes up so slowly that it cannot be seen moving, and is pulling hard, stop pulling, run the bailer two or three times, and the casing will come easily. Always leave the bailer down at the bottom of the hole. Should the casing tighten up again, repeat the bailing, and take out two or three more bailers of water. On one occasion when two jacks, each of 40 tons capacity, failed to start 232 ft. of 8-in. casing, we loosened it up by running the bailer three times. Well diggers should try this, and they will never lose another well, or string of casing, by stripping the threads at the joints.—Contributed by J. J. Coughlin, Versailles, Ohio.

### A Cradle for a Boat

A pair of sawhorses, with pieces of old garden hose tacked on, to prevent marring the surfaces, make a good cradle for a boat. When not in use for

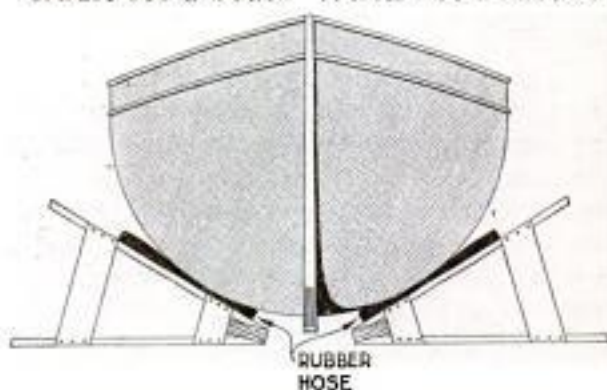

Pieces of Hose Tacked on the Legs Protect the Boat Surfaces

that purpose the horses can be used in the ordinary manner.—Contributed by J. J. O'Brien, Buffalo, N. Y.

# MOTORCYCLE TRAILER AND CAMP OUTFIT

By T. T. STURGEON



**I**NSTEAD of the ordinary sidecar so much used by motorcycle owners I constructed the trailer and camp outfit herein described to take its place. A companion and I made a 600-mile tour with it over some of the worst desert and mountain roads in the western states. The trailer proved its practicability and its advantages over the sidecar. There was no side drag on the motor, and, as the pull was straight backward, the motor was held steady in the sand ruts. Another great advantage over the sidecar is that the trailer can be detached by pulling out a pin when it is desired to make short side trips. Many conveniences may also be incorporated in it that would be impossible with a sidecar permanently attached to a motorcycle.

The complete equipment consists of the following units: trailer car, nested mess kit, tent and sleeping bags, and a complete photographic developing outfit for field work. The total weight of the outfit, with the necessary food-stuffs and motor-repair parts, is slightly under 250 lb. This weight may seem excessive, but it did not prove so, even on bad roads, and upon one occasion 100 miles of good road was covered in five hours.

The first part of the equipment to be taken up in detail is the trailer chassis, which is shown in Fig. 1 ready for the

installation of the body. The illustration shows the axle straight. A 3 or 4-in. dip made in it will lower the center of gravity. The bend in the axle being outside the springs, the tread will be about 6 in. wider, but otherwise the dimensions given are satisfactory.

The measurements for the chassis are as follows: The axle is of steel, 33 in. long and  $\frac{7}{8}$  in. in diameter, turned down at the ends to fit the cones of the ordinary sidecar wheels, and threaded on each end to receive a  $\frac{1}{2}$ -in. castellated nut, which is locked with a cotter. The springs were obtained from the junk pile of a local wagon maker. They consist of the lower halves of ordinary buggy springs, measuring 33 in. long and  $1\frac{1}{4}$  in. wide. As the springs were too stiff, only the three larger leaves were used, these being secured to the axle with strap bolts or axle clips.

One of the rear-corner joints is shown in Fig. 2. The sidepieces are  $38\frac{1}{2}$  in., and the ends 19 in. long, and of  $1\frac{1}{2}$  by  $1\frac{1}{2}$ -in. angle iron. One face of the end pieces is cut 22 in. long, to permit a  $1\frac{1}{2}$ -in. lap for riveting to the side members, as shown at A. The method of mounting the springs is shown at B. A piece of  $\frac{1}{8}$ -in. sheet steel, 3 by  $4\frac{1}{2}$  in., forms the rear bracket, which should be of such quality that it will stand hardening. A slot,

1½ in. long by 5/16 in. wide, is cut through the sides to receive a hardened-steel bolt passing through the spring end in such a manner that it will ride in the slots of the bracket. The front-spring bracket is similar but without a slot, having a hole for the bolts, and does not need to be hardened.

The tongue, drawhead, and automatic brake are shown in Fig. 3. The tongue consists of two pieces of 1 by 1/8-in. angle iron, 52 in. long, and the drawhead is made of a 6-in. length of 3/4-in. pipe, with a pipe cap. The lengths of angle iron are bent slightly, at C, to permit bolting them parallel with the drawhead, and to make a spread of about 10 in. where they connect with the front member of the frame. The drawhead is attached to the tongue pieces with machine screws locked with lock washers. The ends of the screws that project inside of the pipe should be dressed off smoothly, to permit the free action of the drawbar.

The drawbar is made of a machine-steel eyebolt, 6 in. long and 1/2 in. in diameter. The bolt slides through a hole in the cap, against which a spring is placed. It exerts pressure on two nuts on the end of the drawbar, working easily inside of the drawhead. The spring can be adjusted by the nuts on the bar. This arrangement forms a swivel-and-spring drawhead, which is very important, as the safety of the trailer depends greatly upon it. The nuts on the end of the drawbar should be securely locked, to prevent them from coming off and thus releasing the drawbar. A little cup grease should be packed in the spring for lubrication, as the drawbar is constantly working back and forth when on the road.

The automatic brake may appear unnecessary, but it is a great convenience when some of the draft rigging breaks. Also, in an emergency the trailer may be cut off while in motion to prevent a "spill," and the brake will prevent it from running over a bank or into another vehicle. When making camp, it saves searching for something with which to chock the wheels. If

the car is taken down a steep place by hand the brake is needed. It is self-locking and equalizing when set. It took considerable experimenting to find the exact shape and dimensions of the levers.

The working details are shown in Fig. 4. Two brake beams and shoes are required, which are made from metal, 1/2 in. wide and 1/4 in. thick. The beams are bent as shown at D, which is the center of the angle and the point where the tangents of the two legs cross each other, the exact locations of the holes being found from this point. The shoes E are made of steel, 1 in. wide and 1/16 in. thick, riveted to the beams at F. The two beams are pivoted to the frame at G, Fig. 3, 4½ in. from the front end piece, and 1/2 in. from the edge of the side member, inside measurements, the pivot bolts being 3/16-in. stove bolts with lock washers.

The bends, to make the peculiar shape of what may be called the trigger, must be made accurately, to insure the proper adjustment and operation of the mechanism, hence the working details must be observed. The lever is attached, at H, Fig. 5, to the right brake beam, the short piece J being coupled to the trigger, at K, and to the left beam; stove bolts with lock-nuts being used throughout.

The automatic release, Fig. 6, consists of an 8-in. auxiliary wheel supported in a U-shaped bracket, made of 3/4-in. channel iron, 6 in. long on each leg. A 1-in. slot, wide enough to permit the shaft of the small wheel to slide freely in it, is cut in each leg. The bracket is fastened to the cap on the drawhead with a machine screw. The sides of the channel are filed at an angle to fit the cap snugly, when the bracket, drawbar, and braces are joined. They should be joined so that the longer sides of the triangle formed are equal.

The braces are made of 5/16-in. iron rod, having eyes formed in their lower ends to fit the wheel shaft. They are flattened on the opposite ends for bolting to the tongue sections, their length

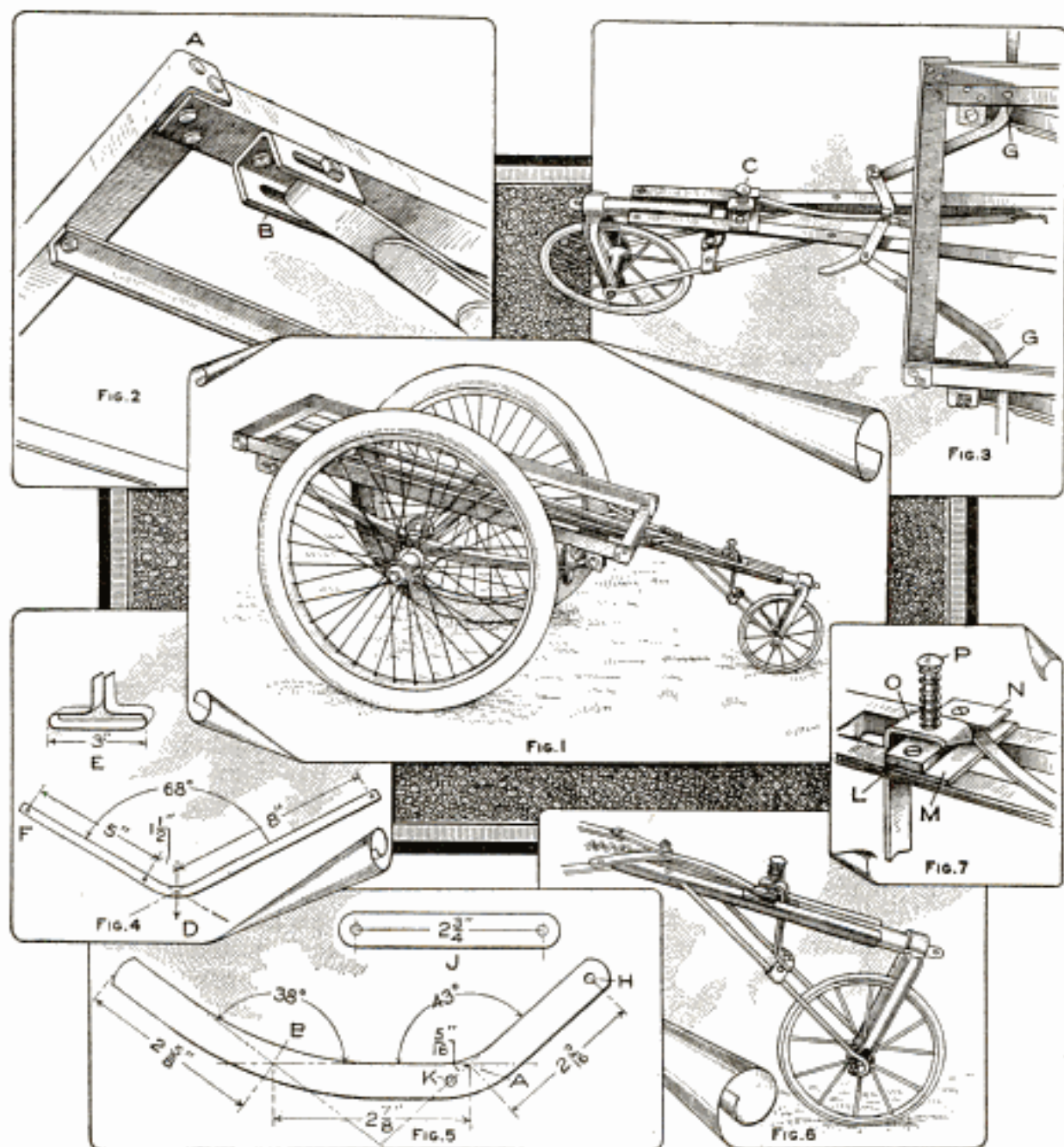

Fig. 1. Chassis Assembled, Showing Auxiliary Wheel and Rigging; Fig. 2. Rear Corner of the Chassis Frame, Showing Corner Joint A, and Spring Fastening B; Fig. 3. The Auxiliary Wheel Frame and the Braking Mechanism; Fig. 4. Brake Beam and Shoe; Fig. 5. Trigger and Trigger Strap; Fig. 6. Auxiliary Wheel, Showing Trigger Device, Braces, and Slotted U-Bar; Fig. 7. The Trigger Device

being such that the center of the shaft will be about 13 in. from the point at which they bolt to the tongue. If the parts are set properly the auxiliary wheel will work freely in the slots, the natural spring in the brace rods tending to hold the wheel at the bottom.

The release-catch feature is simple. At a point  $8\frac{1}{2}$  in. from the front member of the frame, two holes are drilled and tapped for machine screws. Two plates, L and M, Fig. 7, one  $2\frac{3}{4}$  in. long,  $1\frac{1}{2}$  in. wide, and  $\frac{1}{16}$  in. thick, and

the other  $2\frac{3}{4}$  in. long,  $\frac{3}{4}$  in. wide, and  $\frac{1}{4}$  in. thick, are attached to the tongue by the screws, as shown. A small piece of metal, N, is placed on top of the thicker plate, to prevent the trigger from rising out of place when the catch O is pushed up. A carriage bolt, P, is screwed into the plates at their center, with a locknut to hold it on the under side. The catch O is drilled to permit free action on this bolt. A light spring is placed between the catch O and the head of the bolt. The

release is fastened to the braces by means of a strap and stove bolts, as shown in Fig. 6.

The action of the brake is as follows: When the trailer is released from the motor the tongue drops; the auxiliary wheel, coming in contact with the road, rises in its slots, pushing the catch up to clear the trigger, and a coiled spring at the middle draws the brake beams into action. This spring does not hold the brakes in contact with the wheels, but merely starts the action. The braking power is derived from the back pressure on the rod braces, which is communicated to the lever arrangement on the brake beams. The greater the weight pressing down on the auxiliary wheel the greater the braking power.

The design of the body and the arrangement of the covers to form tables are shown in Fig. 8. The dimensions of the box are such that it will fit snugly in the chassis frame. It is made of  $\frac{1}{2}$ -in. lumber with corner and edge strips to reinforce the joints. The inside edges of the strips are beveled to give a neat appearance to the panels. The box is water-tight, 13 in. deep at the center and  $11\frac{1}{2}$  at the ends, the floor resting on the side members of the frame and on the tongue at the center.

A tank, 17 in. long, 10 in. wide, and 4 in. high, of 3-gal. capacity, for a gasoline supply, is set in the rear of the body. It is held in place with cleats, and is made of galvanized iron, with reinforcing plates on the ends.

The front cover is so arranged that it can be attached to the rear of the body for use as a mess table, and for photographic purposes. Folding standards, at the end of the tongue, at the rear of the chassis and under the table, together with the brake make the whole stand firmly. When the table is used for photographic purposes the rear cover, which is hinged to the body, is braced in a vertical position, as in Fig. 9. A collapsible wire frame is attached to the cover by means of screw eyes, on the under side, and a light-proof bag, large enough to inclose the

table and the operator, forms a dark room. As it is used only at night, it is satisfactory for this kind of work.

As the motorcycle was electrically equipped for lighting, a small lamp, not shown in the illustration, was bracketed to the rear of the body. The feed wires were conducted to the end of the tongue, where slip connections were provided to connect with a terminal on the motor draft rigging. A long extension cord was provided, permitting the motor to be set at a distance from the car when in camp. The lamp proved to be convenient, being used as a tail light for night traveling, as a dark-room light, and as a table lamp, when the red lens was removed.

The method of coupling the trailer to the motorcycle is shown in Fig. 10. As slightly differing methods will be necessary with varying types of motorcycles, it is offered as a suggestion only. The motorcycle which was used to tow the trailer was provided with sidecar lugs immediately forward of the rear axle, and with small luggage-carrier lugs on the rear forks. A U-shaped piece of strap iron,  $1\frac{1}{4}$  in. long and  $\frac{1}{4}$  in. thick, was bolted to the sidecar lugs at such an angle that the drawhead of  $\frac{5}{16}$  by 1-in. steel, bolted at the center, would hold the trailer horizontal. The upward thrust of the trailer was prevented by the U-piece resting against the nuts on the rear axle of the motor, the downward thrust being held with  $\frac{1}{2}$ -in. stay rods running from the lugs, on the rear forks, to the outer curve of the U-piece.

A large cotter, slightly spread, forms the coupling pin, and a cord is attached to it so that the man on the rear seat may release the trailer in the event of a skid or fall. All nuts and bolts must be locked either with split washers or cotters. The load should be packed with the heaviest articles in the center in order to balance the car. Several screw eyes should be placed in the sides of the body near the floor, and a lash rope run through them, with which to lash the load solidly in the car. This prevents shifting and protects the contents in the event of a "tip-over."

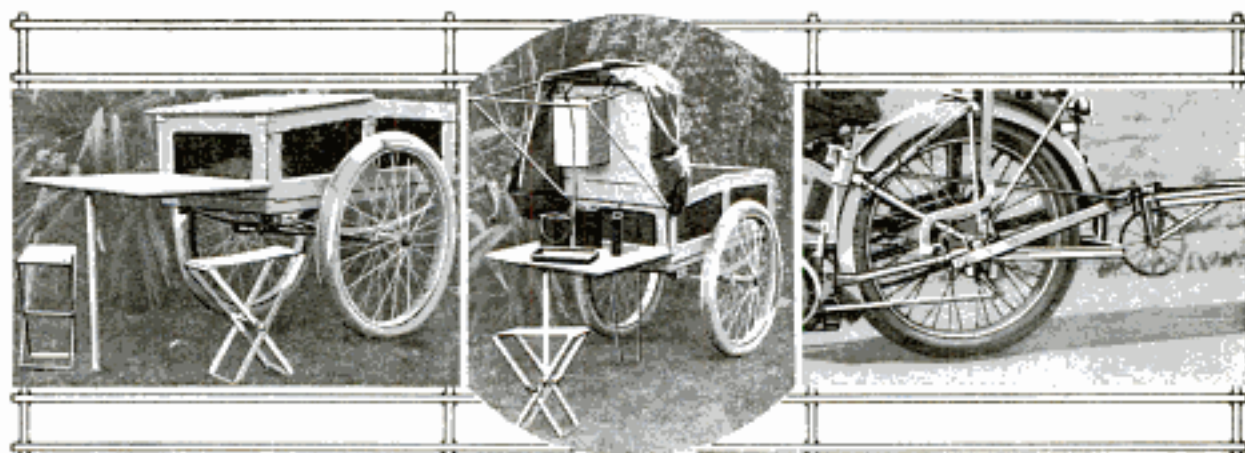

Fig. 8. The Trailer Supported to Make Table Accommodating Two Persons for Meals or Recreation

Fig. 9. Arranged for Photographic Purposes Showing Dark-Room Curtain

Fig. 10. Manner of Attaching the Trailer to Motorcycle for Road Transportation

#### The Mess Outfit

The mess outfit is well adapted for camping, as it provides nearly everything necessary for two persons, and is contained in a small package. While it is designed particularly for motorcycle use, it should prove a serviceable addition to the equipment of the automobile tourist and could easily be made to serve for four or more persons, without enlarging the space occupied by it. Space for extra cups and plates may be obtained by utilizing the space used for food, in the kit for two persons.

An elaborate set of tinnery tools is not necessary in making the outfit; vise, snips, mallet, pliers, hammer, and a soldering iron being the articles required. Short lengths of angle iron, of different sizes, clamped in a vise form the mandrel upon which the bends are made.

The complete outfit nested inside the combination stove ready for transportation is shown in Fig. 11. It occupies a space  $7\frac{1}{4}$  by  $7\frac{1}{4}$  by 12 in., and weighs slightly less than 11 lb. without food-stuffs. It contains the following utensils: coffeepot, two cups, one bowl, stewpan, frying pan, two plates, sugar can, two sets of knives and forks, an extra spoon, and a 2-gal. bucket. There is room also for 3 lb. of bacon,  $\frac{1}{2}$  lb. of butter, cans of pepper and salt,  $\frac{1}{4}$  lb. of tea, and a small dishcloth.

Three sheets of heavy tinplated sheet metal, a piece of light galvanized iron, 12 by 36 in., and a piece of black sheet iron, 15 by 50 in., of medium

thickness, will provide all the necessary pieces with the exception of the gasoline tank for the stove. If it is desired to use the type of stove shown, a small amount of galvanized iron, of medium thickness, will also be required.

The patterns for cutting and forming the different utensils are shown in Fig. 12. The main pattern Q is for one of the sides. The sheet metal is folded on the dotted lines and the joint placed in the center of one side. On each edge

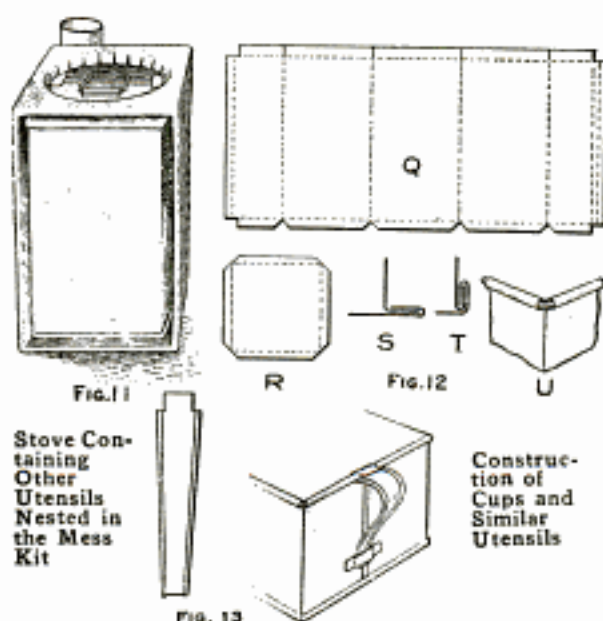

Fig. 11  
Stove Containing Other Utensils Nested in the Mess Kit

Fig. 12  
Construction of Cups and Similar Utensils

Fig. 13  
Layout for Handle and How It is Attached

$\frac{1}{8}$  and  $\frac{1}{4}$  in. are provided to form the clinch seam, and  $\frac{1}{8}$  in. on the bottom edge for the joint. At the top  $\frac{3}{16}$  in. is provided to form a roll around the reinforcing ring.

The bottom pattern is shown at R, the dimensions of which is best determined after the sides have been formed. It is  $\frac{1}{8}$  in. larger than the bottom half

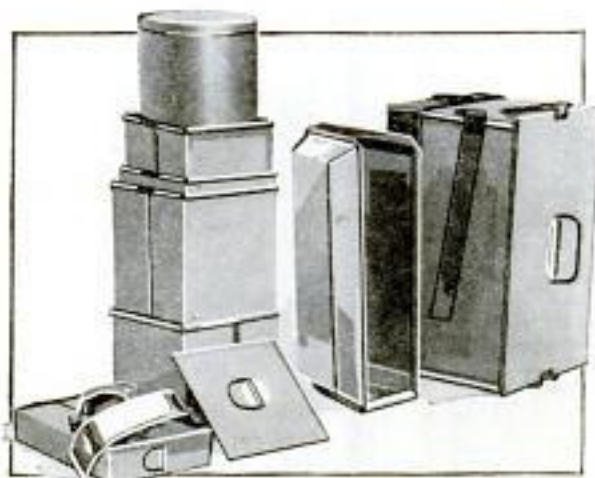

Mess Outfit Partly Nested

of the clinch. The first operation of attaching the bottom plate is shown at S. The lap of the bottom is folded over the side lap, and clinched as shown at T. The top roll around the ring, which consists of ordinary galvanized telephone wire, is formed as shown at U. The side seams are clinched in the same manner. A small piece of steel, similar to a rivet set, with a notch the size of the seams cut in its face, aids in making the clinch properly.

The detachable handle of the cups and the coffeepot are constructed and attached as shown in Fig. 13. The tongue at the top is formed into a hook and hooked under the wire ring, a bit of the metal of the side having been cut out to permit its insertion. A small strap soldered to the side of the utensil permits the handle to slip down under it when squeezed slightly. The handles are reinforced along the edges with a small wire and a roll.

All the utensils are made in the same manner, with the exception of the stewpan, which has the ends clinched in, the sides and the bottom being made of one piece. The handles of the stewpan are not detachable, but form clasps to hold the lid tight, when the equipment for it and other contents are nested inside. The construction of the bucket is similar, except

that larger seams are made. Since a clinch seam is not water-tight, all joints in the bucket must be soldered.

The frying pan is made of the black sheet iron. It is constructed without seams, as shown in Fig. 14, the corners being folded and riveted. A strap is riveted on one end, to receive the detachable handle, which is a short piece of  $\frac{1}{8}$  by  $\frac{3}{4}$ -in. strap iron, with a hook bent upward on the end.

The construction of the plates is shown in Fig. 15. They have a  $\frac{1}{2}$ -in. double, flat brim around the edge.

Beginning with the smallest utensil, shown in the rear row in Fig. 16, the inside measurements are as follows: first cup,  $3\frac{1}{2}$  in. square by 4 in.; second cup,  $3\frac{3}{4}$  in. square; coffeepot, 4 in. square by 8 in.; bowl,  $4\frac{1}{4}$  in. square; sugar can, 1 by  $3\frac{1}{2}$  by 6 in.; plate, including rim,  $\frac{7}{8}$  by  $5\frac{1}{2}$  by  $9\frac{3}{4}$  in.; stewpan,  $5\frac{1}{2}$  by 6 by  $9\frac{3}{4}$  in.; frying pan,  $1\frac{1}{2}$  by  $6\frac{1}{4}$  by 10 in.; bucket,  $6\frac{1}{2}$  in. square by 11 in. The covers of the coffeepot and the stewpan are made to fit. The method of forming the edges of the covers and of attaching the handles is shown in Fig. 17.

The assembling of the mess kit is shown in Figs. 16 and 18. When the articles are nested inside the coffeepot, enough room is left on top for the half pound of butter and the bacon. The lid of the stewpan is shown removed in Fig. 18, and space can be seen at the top for cans to hold salt, pepper, tea, and similar supplies.

The stove was designed so that wood or gasoline could be used for fuel. Double the space is needed when gasoline is used, in order to provide a storage tank for the gasoline.

The stove is constructed of heavy sheet iron. The measurements inside are  $7\frac{1}{4}$  in. square by 12 in. A 3-in. hole is cut in one end, and a 6-in. hole in the other. An old brazing torch was used to make the burner for the gasoline stove.

The gasoline supply was set in a galvanized-iron tank, 4 in. by 7 in. square, in much the same manner as it was in the original torch. The generating pan was removed from the feed



stem and placed on the valve stem, permitting generation of gas in the usual way. The pump was placed in a corner. In order to spread the flame over a larger area, a burner cap, taken from a gasoline stove, was attached to the top of the fire head. A stay bolt was run through the center of the tank to reinforce it to withstand the air pressure. Care must be taken not to have too great a pressure in the tank.

When the stove is used with wood as a fuel, it is placed in a horizontal position, with the open side over a small depression in the ground. A heavy wire screen is hooked over the inside edges, where they are turned in, forming a grate. This gives a draft for the fire.

#### The Photographic Outfit

The photographic equipment need not be detailed completely, as the only point of special interest is the method of washing and drying plates. After taking them from the hypo tank, they were placed in the wash tank. The bucket hanging at the rear lid of the body of the car was filled with water, and a rubber siphon drew the water down to the wash tank, from which it ran to the ground. After the plates had been washed, they were placed in an alcohol tank. The alcohol displaced the water in the emulsion, causing the plates to dry in a few moments, when placed before an electric fan driven by current from the motorcycle storage battery.

#### The Tent and Sleeping Bag

For the making of the small tent, and two sleeping bags, 21 yd. of canvas are necessary, 8-oz. double-twist khaki drill being the most suitable. One or more blankets for each bag are needed, depending on the temperature in which the bags are to be used.

The dimensions of the tent are approximately 6½ ft. long, 5 ft. high, and 5 ft. wide. This is sufficient to cover a motorcycle and two persons. Two bamboo poles support the tent at the front and rear, a rope ridge support being used.

The method of cutting and joining the canvas, which is 36 in. wide, is shown in Fig. 19. Thirteen yards are necessary for the tent. From this four

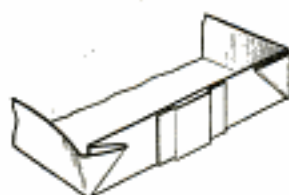

FIG. 14



FIG. 17

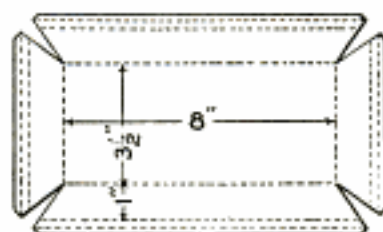

FIG. 15

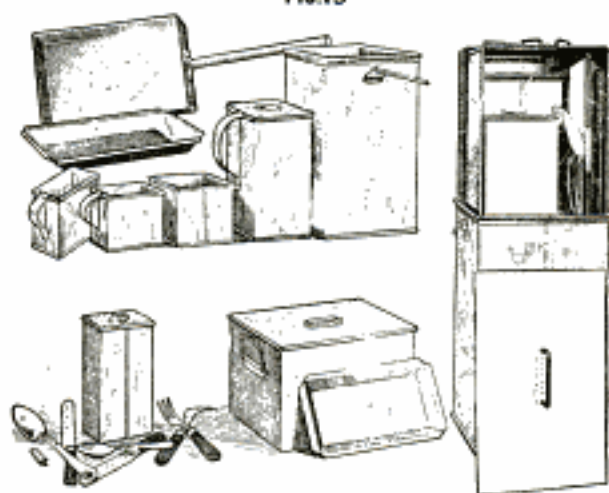

FIG. 16

FIG. 18

Fig. 14, Construction of Frying Pan, Showing Slot for Handle; Fig. 15, Layout for Cutting Metal for Plates; Fig. 16, Mess Outfit Ready for Nesting; Fig. 17, Cover Construction and Fastening of Handles; Fig. 18, Mess Outfit Nested

lengths, 6 ft. 7½ in. long, are cut, thus allowing ¾ in. on each end for the corner seams, stitched together with laps, as shown. One seam is at the ridge and the other in the center of the sides. A ½-in. hem is placed along the bottom edges.

The remainder is now divided and each section equally divided to form the four large gores, A, as shown in Fig. 19. Two of the gores are stitched together their full length, forming the back of the tent, and the other two are stitched about one foot down from the ridge, leaving an opening for an entrance. The front and back are next stitched to the side walls along their

slanting edges. They will be a few inches too long. The part left over is cut off, and the small gores B are made from these scraps. A hem simi-

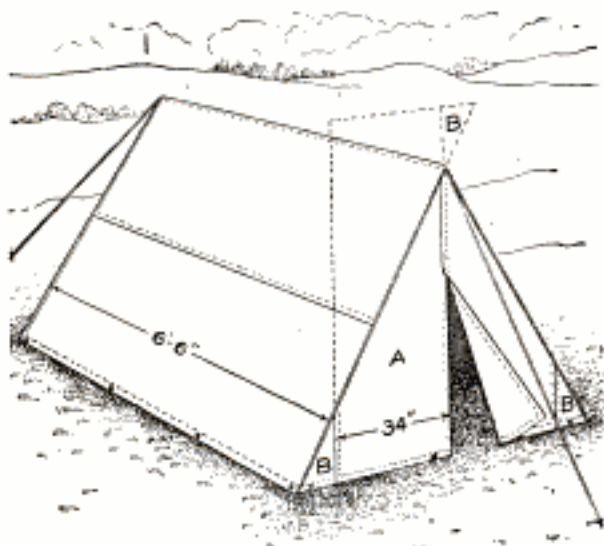

FIG. 19

Tent, Showing Method of Cutting Canvas Economically to Make the Ends

lar to the one upon the sides is next placed on the bottom edge of the end. Eyelets with  $\frac{3}{8}$ -in. holes are fitted along the bottom edges to receive the large spikes used for tent pegs. The ridge rope is then run through the apex of the ends and fastened.

The sleeping bags are each made of 4 yd. of canvas, fashioned like a long envelope. The upper side is  $5\frac{1}{2}$  ft.

long and the bottom  $6\frac{1}{2}$  ft., accommodating a person of medium height. The blankets used inside of the bags should be stitched together with the seam uppermost, and in the middle. The top of the blankets should be left unstitched for about 18 in., as the bag may thus be more readily entered, and the blankets brought closely around the neck of the user. A cord should be run through the bottom seam of the inner bag and through eyelets in the corners of the outer bag, so that the bag may be anchored to a peg, making it easier for one to get out of it.

In connection with the sleeping equipment, a poncho is desirable and can be made from a 48 by 72-in. piece of black oilcloth. A hem should be run around the edges of the oilcloth, and five garment snaps should be sewed on one long edge, in order that the poncho may be thrown around the shoulders and fastened in front.

A poncho of this type protects the upper part of the body when walking or riding in the rain, and may be spread over the sleeping bags to protect them when used in the open. Two ponchos may be snapped together to form an auxiliary roof for the tent. A poncho is the handiest article in camp on a wet day, with the possible exception of a water-tight match safe, and, of course, every camper should have one of these.

### Dresser as a Drafting Table

A dresser, or bureau, may be made to do service as a drawing table and will be found convenient by students and others who make drawings occasionally. The sketch shows how the board is rested on the edge of the open drawer, and held under the dresser top.

For use in a standing position the dresser will be found convenient, whereas a bureau gives better service for the seated position.

The board should be placed at the left-hand edge of the dresser, so that the same edge of the board extends about 1 in. beyond the side. If the

drawer is not firm, small wedges may be inserted between it and the slides

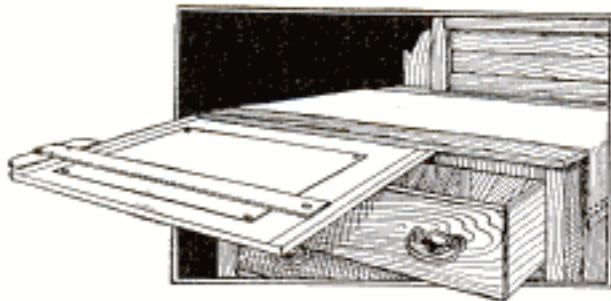

The Board Rests upon the Edge of the Drawer and is Held by the Top

on which it rests.—Contributed by Raymond B. Rogers, Newberg, Ore.

### Substitute for a Slide-Rule Glass

In using the slide rule I have found that one of the chief difficulties is the constant breaking of the glass runner. The glasses being quite expensive, the cost of renewing them every time one drops the rule is no small item. A very good and practically unbreakable substitute for these glasses can be made from an old celluloid, or xylonite, triangle which might otherwise be thrown away. The material can be cut to the required shape with a sharp knife. The hair line can then be scratched on with a needle and colored with India ink. I have found this indicator to be fully as good as glass in work requiring the greatest accuracy.—Contributed by George Caynor Hyde, Hoboken, N. J.

### Repairing a Broken Brake-Lever Handle

The handle on the brake lever of an automobile broke at the point indicated in the illustration, and knowing

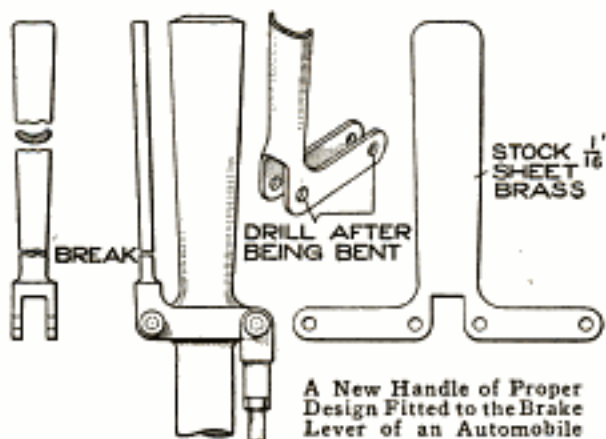

that the break was due to faulty design, I decided to make up a new, entirely different handle.

A piece of sheet brass,  $\frac{1}{16}$  in. thick, was procured and cut to the proper size and shape, the dimensions being taken from the two portions of the broken handle. The four holes shown were not drilled until the piece was bent into shape. After fitting the new handle, it was carefully buffed and polished.—Contributed by Adolph Kline, New York City.

### To Typewrite on Druggists' Labels

A druggist, desiring a neat appearance of labels, found it difficult to typewrite on small sizes, as they could not

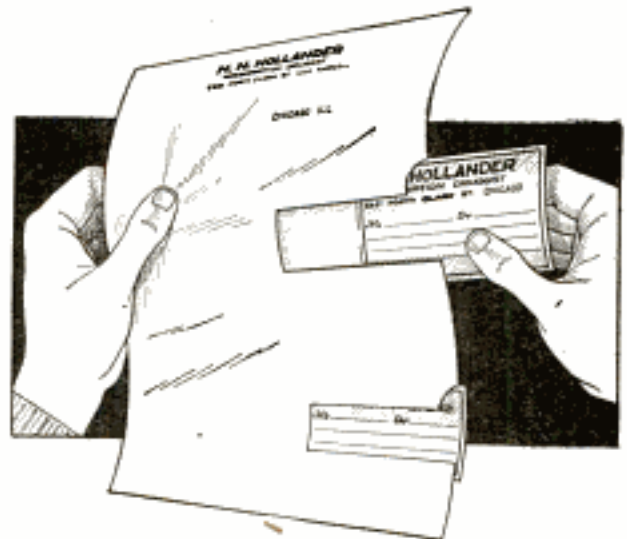

Labels are Inserted into Places Made for Them on a Full-Sized Typewriter Sheet

be kept in the proper place on the typewriter roll. This difficulty was easily overcome by making the holding slip shown in the illustration. An insert was formed for each size of label by pasting a piece of paper on a full-sized typewriter paper, leaving an opening for the insertion of the labels. The opening in front is of such a size as to present the lines on the labels to be filled in.—Contributed by H. N. Hollander, Chicago.

### Forming Tool for Pipe Clamps

The sketch shows a pipe clamp shaped from light steel, and a handy tool used to form it. To use the tool, which is made in the form of a pair of tongs, it is opened and the straight piece of steel to be formed is inserted. The upper part of the forming tool is then struck a blow with a hammer, and the clamp is formed.



### Holder for a Telephone

In order to clear a small desk of a telephone and still have the latter at hand a wall bracket notched to receive the instrument was made and fastened to the wall above the desk. The notch must be made deep enough so that the telephone will not slip out of it easily.—Contributed by Theodore J. Becker, Kansas City, Mo.



### Covering Space on an Automobile Crank Handle

The space between the revolving sleeve and the pinhead on the starting crank of my automobile allowed the flesh of the hand to squeeze in and get pinched, or cut, when starting the engine. This space I covered as follows:

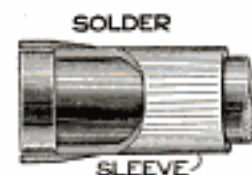

A piece of brass tubing,  $\frac{1}{2}$  in. long and of a size to snugly fit the sleeve on the crank, was placed directly over the space and soldered to the sleeve. The soldered end was then filed down tapering and made smooth.—Contributed by Adolph Kline, New York City.

### Lock for Sliding Doors

The sketch shows a lock for a sliding door. It consists of three pieces, a slotted bolt, A; the plate with the little block on which it rests, and the plate B. The bolt is loosely fastened in place by means of the pin C, and in such a position as to slide snugly into the socket in the

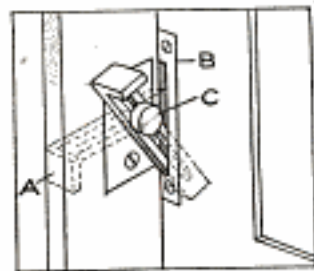

wood, as indicated by the dotted lines. A feature of this lock is that it tends to prevent the door from rattling in the wind. As the door rattles, the wedge point of the bolt works its way downward until the door is held firm.—Contributed by Malcolm E. Moran, Rosario, Wash.

### Removing a Corkscrew Attachment from a Penknife

Having a very good penknife with a corkscrew attachment, which was very much in the way, I opened up the corkscrew and cut the shank off close to the handle on the line AB, then filed the edges of the portion remaining in the handle to the shape of the sides holding it.



As I had previously spoiled a perfectly good knife by removing the corkscrew entirely, and then found I had greatly weakened the spring, I decided this time I would leave a portion of the corkscrew in the handle, which proved a success.—Contributed by James M. Kane, Doylestown, Pa.

### To Prevent Safety Pin from Coming Loose

Most safety pins bend in the center when there is any strain on them, which causes the pin part to slip out of its sheath. If the pin is curved as illustrated, it cannot bend so that the pin part will slip out.—Contributed by J. Cooper Mott, Great Neck Station, Long Island.



### Removing Poppet Valves

The amateur motorist often finds it quite a proposition to get the valves out of an engine without removing the springs. Each valve has a groove in its upper end, and a stick can be quickly cut so that it can be driven into this

groove tightly enough to be used as a handle to pull the valve out. This method has been used with great success in removing the outlet valves of a horizontal force pump for priming, without injuring the rubber facings. A small hole, about  $\frac{1}{4}$  in. deep, was drilled in the top of each valve to receive the stick.—Contributed by P. E. Riggan, Ottawa, Can.

### To Prevent a Flag from Winding around the Pole

A simple and easy way to prevent a flag from becoming entangled, or winding around the pole as the wind changes, is shown in the sketch. A hardwood disk, from 4 to 6 in. in diameter, and from  $1\frac{1}{4}$  to 2 in. thick, depending on the size and height of the pole, is provided with two holes near its outer edge, about 2 in. apart, with a groove cut to connect them on the upper side. A pulley may be used if a means is provided to prevent the rope from running off when it becomes slack. An iron rod is placed in the top of the pole and a washer over the rod, or if the pole end is made smooth enough the washer may be omitted. The disk is then put in place, after greasing the holes as well as the bottom surface of the groove with tallow or paraffin. The ball is placed in position and the rope run through the greased holes and groove of the disk. When the wind changes the flag acts

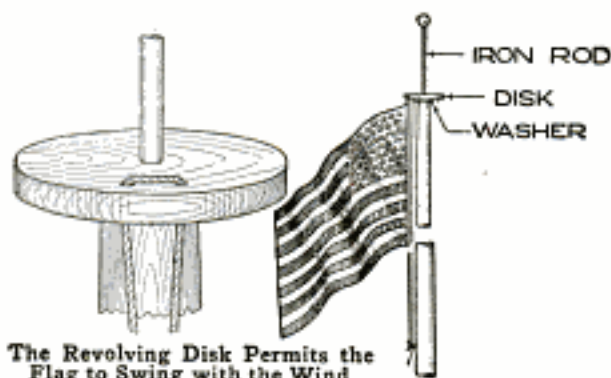

as a weather vane, the disk revolves, and the flag is always on the side of the pole opposite to the wind.—Contributed by W. E. Day, Pittsfield, Mass.

### Weather Vane with Inside Indicator

It is quite convenient to know the direction of the wind, especially in stormy weather, and as the old-fashioned vane is unsightly and altogether

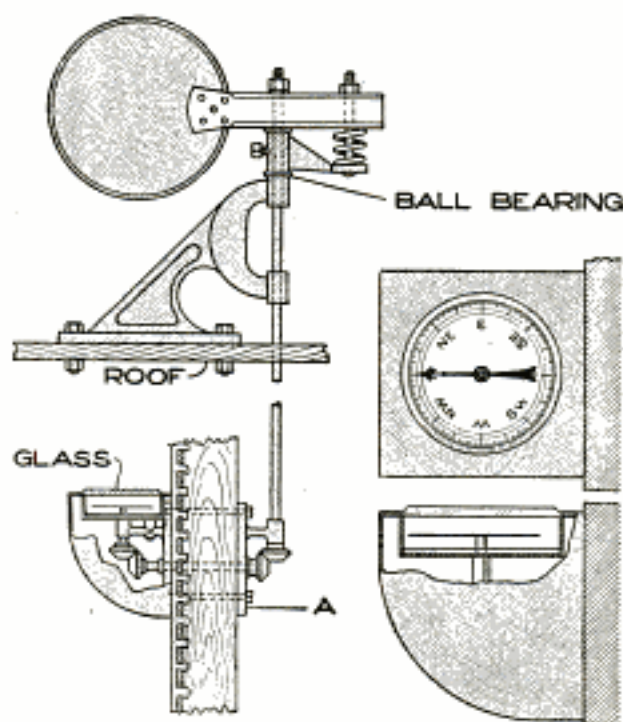

A Neat Weather Vane with a Mechanically Driven Indicator in the House

undesirable, the one shown was designed to make a neat and real ornament for any building. The design makes it easy to build, and as it has so few parts, they are not likely to get out of order.

The vane is set upon the roof by means of a bracket and is securely clamped to the vertical rod. This rod has miter gears at the lower end, where it is connected to a horizontal shaft passing through the wall, and then with another set of gears to the vertical indicator shaft. The indicator and its dial are shown in the projection.

The plate A serves as bearing for the horizontal shaft and for the lower end of the vertical shaft. The indicator should be inclosed in some neat form of a box. The coil spring in the upper part is merely a cushion and the bolt serves to hold the vane bearing horizontal.—Contributed by J. B. Murphy, Plainfield, N. J.

### Twisting Locomotive Link Hangers

After repairing links and their parts, and in assembling them on a locomotive, almost always the jaws of the

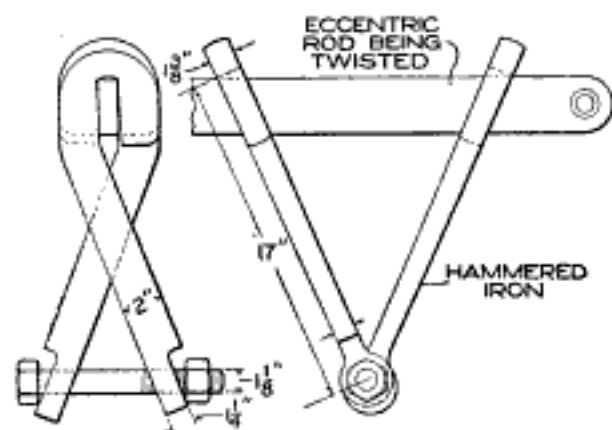

Powerful Twisting Device for Fitting Link Hangers and Eccentric Rods on Locomotives

eccentric rod will be out of line with the link, and the hanger will need a little twisting to make the parts fit properly. The sketch shows plainly a device for twisting the link hangers, and how it is used. The ends are put on the hanger from 12 to 18 in. apart, and the bolt, which is 1 1/2 in. long, is used to draw the lever arms in making the twist.—Contributed by Joseph K. Long, Renovo, Pa.

### A Swinging-Chair Hammock

The illustration shows a hammock that can be used either in an upright position or at any reclining angle by simply adjusting the ropes. The space required is so small that it may be

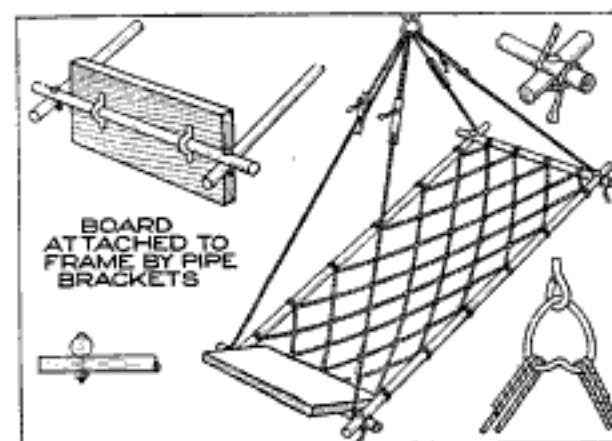

Reclining-Chair Hammock That can be Used Upright or at an Angle by Adjusting the Ropes

used on short porches. It gives greater comfort than the ordinary hammock, which takes up room that is not always available.

The cost of the hammock is very small. The frame can be made of four discarded broom handles. These are joined together in a rectangle with small bolts at the corners. The net is made of awning rope, requiring about 1 lb. of the material. If the fish-net knot cannot be tied the ordinary knot will answer the purpose.

The net soon adjusts itself to the form of the body, making the most comfortable swinging, or reclining, chair that can be had, and far superior for reading to the ordinary hammock, as the body is entirely relaxed without making it necessary for the occupant to strain the eyes in looking upward at the paper or book.—Contributed by T. F. Krey, Detroit, Michigan.

### Banking Material for Pouring Babbitt

When pouring babbitt into bearings, or lead into cable fastenings, it is necessary to bank up the openings in order to confine the molten metal where it is desired. The most common material for the bank is wet clay, which can be molded into the required shape to fit the openings. A better method is to mix asbestos wool with heavy engine oil. This preparation not only serves the purpose better, but is practically indestructible. It is always ready for use, while the clay must be wetted and worked to the proper degree of plasticity each time it is used.

### Waxing a Varnished Floor

A varnished floor may be waxed to save it from scratches, and the wax finish, when defaced, may be easily renovated by rubbing on more wax, or cleaned off with turpentine. Wax finish on a floor has its disadvantages, but it is easily applied and is easily renovated, besides being fit to walk upon as soon as it is applied.

## A Concrete-Block Milk House

By W. E. FRUDDEN

THE use of concrete in the construction of small farm buildings means the substitution of an everlasting, non-decaying type for those constantly in need of painting and repairs. Concrete construction is fire-resisting and has many other points in its

construction, that extends down below the frost line and is flared out at the base, as shown. Mix the concrete with 1 part cement, 3 parts sand, and 5 parts well-graded gravel, and pour into the trenches carefully so that dirt will not fall into the mixture.



A Concrete-Block Milk House for the Farm Is Serviceable and will Add to the Appearance of the Place if Properly Designed

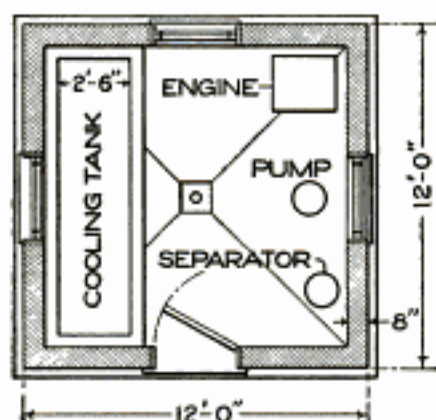
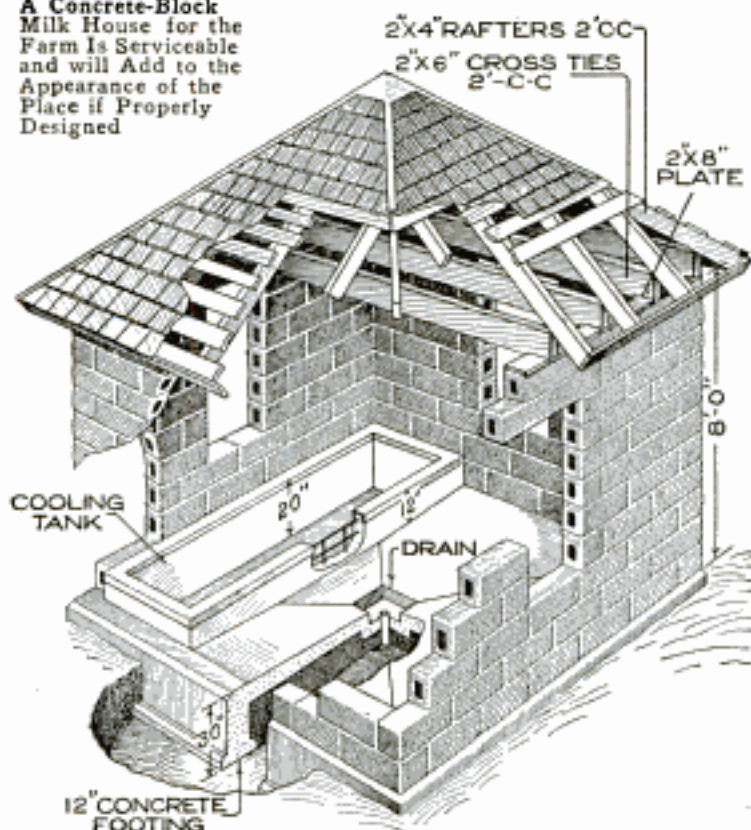

favor, and has become a very popular building material among farm owners. The concrete-block milk house is most ideal. It is permanent and sanitary, and will last indefinitely. Such a structure is shown in the illustration. The one built is 12 ft. square and made entirely out of concrete, except the roof, which is of frame covered with cedar shingles. The materials for the building are as follows:

- 7 bbl. of cement.
- 3 yd. of sand.
- 5 yd. of screened gravel, or stone.
- 4 pieces for plates, 12 ft. long, by 2 by 8 in.
- 12 pieces for rafters, 10 ft. long, by 2 by 4 in.
- 7 pieces for crossies, 12 ft. long, by 2 by 6 in.
- 3 window frames.
- 1 door frame.
- 3 windows, 4 ft. 10 in. by 12 in.
- 1 door, 2 ft. 8 in. by 7 ft.
- 240 ft. of sheathing for the roof.
- 2,000 cedar shingles.
- 275 concrete blocks for the walls.

The building rests on a 12-in. foun-

The rules for the laying of concrete blocks, which are used in the walls, are very simple. Neat and rapid work can be done without much training. The equipment necessary is inexpensive and can be built on any farm. The things needed are a mortar-mixing box, about 3 by 5 ft.; a mortar board, about 30 in. square, made of 1-in. lumber; a trowel, a hand level, a straightedge, and a plumb board. Soak the blocks before laying them, or they will take up the moisture in the mortar and thereby weaken it. Lay the block walls up true and plumb, and in a perfect line, and test frequently to see if they are level. Good cement mortar is made in proportions of 1 part cement and 2 parts sand, mixed with enough water to make it of the required con-

sistency. Cement mortar starts to harden very quickly, and it is best to mix up small batches at a time, or enough to be used in less than one hour's time.

A 2 by 8-in. plate is bolted to the top course of blocks, and the roof rafters are spiked to it in a substantial manner. The rafters are 2 by 4-in. material, spaced 2 ft. from center to center, and covered with sheathing and cedar shingles, laid 4½ in. to the weather, and fastened with galvanized shingle nails.

The milk-cooling tank is made of concrete, 2½ ft. in width. Where the standard 14-in. cans are used, this width will be just right for two rows of cans. The tank used was built to extend a short distance below the floor, which allows the farm hand to lift the cans with ease by obtaining a maximum purchase at the point where the cans are hardest to raise, or just when

they are leaving the water. The floor of the cooling tank is just 8 in. below the grade of the milk-house floor. The tank is 20 in. deep inside. The standard-size milk cans, when resting on the bottom of the tank, will then be surrounded by water up to their necks. The tank is made of concrete in one operation. The floor of the tank is 6 in. and the walls 4 in. thick. The concrete is reinforced with ¼-in. rods, spaced 7 in. the long way, and 12 in. the short way. The rods are bent up into the walls of the tank and are tied securely at all intersections.

Concrete for the cooling tank is mixed to a quaky consistency, using 1 part cement, 2 parts sand, and 3 parts of screened gravel, or stone. The top edge of the tank, over which the cans must be lifted, should be protected with a 4-in. channel iron, which is anchored to the concrete wall every two feet.

### Handy Form for a Screwdriver

Screwdriver points of different widths and thicknesses are a necessity on many classes of work.

The sketch shows how a three-pointed driver can be easily hammered out of a small piece of steel. The two points not in use furnish an excellent leverage for the work the point in use is being applied to. For a very handy little homemade tool of this nature it is hard to beat.

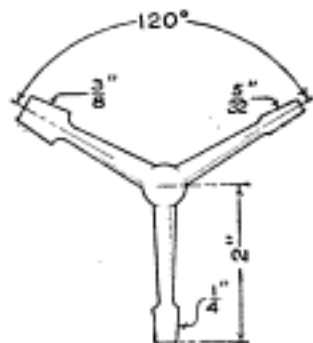

The sketch shows how a three-pointed driver can be easily hammered out of a small piece of steel. The two points not in use furnish an excellent leverage for the work the point in use is being applied to.

### To Locate a Stud in a Partition

When it is desired to hang a heavy picture on the wall, or fasten a new shelf to it, the studs must be located in order to obtain something solid for holding the nails, or screws. The ordinary method is, of course, to sound the wall by tapping it with a hammer until

the stud positions are found. If the ears are not sharp enough for this, small wire brads may be driven in at various places until the studs are located. Not many brads will be required by even the most inexperienced person, and if they are driven in all the way they will never be seen in the wall.

### Spring to Hold Down Latch Bar

Annoyance by the springing open of doors having bar latches may be avoided if the device shown in the illustration is attached to the latch.

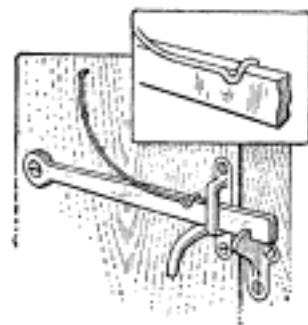

A piece of spring steel, or a strong wire, is bent to exert pressure on the latch bar. The upper end of the spring or wire is fastened to the barn door with staples. The small curve where the spring and the bar connect is important in that it prevents the spring from slipping off of the bar.



### Welding Crank Cases

In accidents, automobile crank cases are often broken or cracked, and the natural desire is to have them fixed if possible. Usually the fixing takes the form of an oxyacetylene weld. Unless new factory parts are very high in price, or the break is only a minor one, or the welder is a real expert, it is a good plan to consider the cost of the welded job. Often the cylinder face has to be replanned, the main bearings rebored, the cam-shaft bearings bored, and special-size odd parts fitted. Considering all this, and the salvage from the old one, a new case is often much cheaper.

### Shade Holder for a Chandelier

The shade holder shown in the sketch obviates the necessity of disfiguring the ceiling with hooks and can be applied to either light fixture. If desired a second holder may be placed on the other side.

The holder can be raised and lowered by lifting the end nearest the shade and sliding the upper loop A along the vertical pipe of the gas fixture. The weight of the shade causes the lower arm of the holder to bind against the

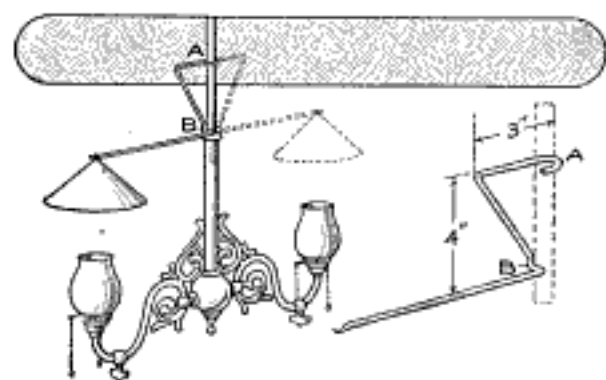

A Shade Holder Made of Heavy Wire to be Attached to the Vertical Pipe of a Gas Fixture

vertical pipe at B and prevents the device from slipping downward.—Contributed by J. A. Fitzpatrick, Altoona, Pennsylvania.

ⒸA cubic foot of water weighs 62.5 pounds.

### An Instantaneous Water Heater

A portable water heater of my own construction and which will heat 25 gal.—enough for a bath—at a cost of

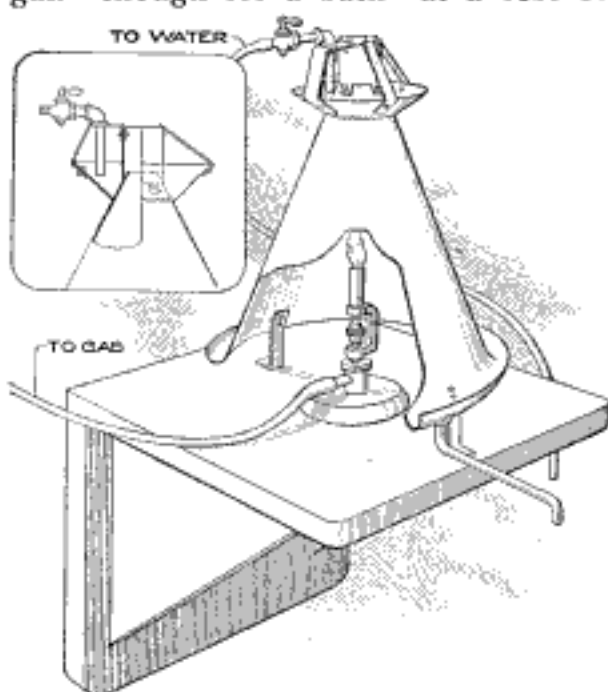

The Water, Running over the Outside Surface of the Funnel, is Heated Quickly

about one cent, is shown in the illustration.

The funnel, which is 11 in. in diameter at the widest point and 12 in. high, is made of sheet metal, riveted at the seam. The chimney at the top is 2 in. in diameter and fits over the top of the funnel, being riveted to it by straps.

Braces support the water reservoir and the water spout from the supply pipe. The view at the left shows the details of the construction at the top.

Instead of the Bunsen burner shown, the fixture from an ordinary mantle gas light may be used, by removing the mantle and adjusting the small collar through which the air supply is received. A steady blue flame will give more heat than a yellow flame.

The heater may be transported to any part of the house where a gas supply is available. If necessary, a water bucket may be set high enough so that water may be supplied through the tube in this manner. Care must be taken that the rubber or other tubes used fit tightly over the nipples, and for purposes of safety, a piece of asbes-

tos or sheet metal should be placed under the heater.

The supply of water should be carefully adjusted in order that only as much as can be heated properly is permitted to flow over the funnel, and the reservoir is not overflowed.—Contributed by James E. Noble, Toronto, Can.

#### Nail Guard for Open Barrels

In stores and factories where material must be scooped by hand from barrels a nail guard saves a great deal

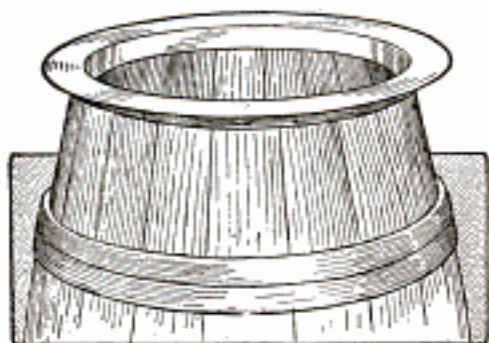

Guard for a Barrel Top to Prevent Injury on the Projecting Nail Points

of time. When the barrels are opened there are so many nails around the upper edge and they are so troublesome to remove that the workman usually allows them to remain. The scooping is then done with such care to avoid injury that an unnecessary amount of time is consumed. A simple guard made of sheet metal, as shown in the sketch, permits the barrel to be emptied quickly.

#### Preparing New Surfaces of Galvanized Iron for Painting

New galvanized iron needs to be treated before painting, otherwise the paint will peel. There are a few ways of doing this, but the simplest, and one of the best, is to apply a coating of iron acetate, which is vinegar that has surrounded iron for a time. A coat of this will do the trick. Another method is to give the surface a coat of equal parts of spar varnish and turpentine. The government specifies sponging the surface with strong vinegar, which is also a sure method.

#### Starting Piston Rings in a Cylinder

In overhauling a four-cylinder motor recently, I had considerable trouble in getting the piston rings back in place. The cylinders, being cast in pairs, were quite heavy and hard to handle, and all the twisting and wriggling possible would not let them enter, and the rings, which were of the leak-proof kind, refused to close in by hand. I hit on the idea of taking a piece of pasteboard, about 2 in. wide and long enough to reach around the piston, and tying it tightly in place with a stout cord. By lifting the cylinders over the pistons and letting them enter, the weight was sufficient to push the pasteboard down, at the same time keeping the rings closed so that they would enter. Considerable time was lost before this idea was tried out, but with its aid the job was completed in 10 minutes.—Contributed by A. Dane, Pottstown, Pa.

#### Protection Hood for Pressure-Ram Indicator Gauges

Pressure gauges on hydraulic rams of almost any make are frequently broken, even though the workmen are careful in handling the material brought into place for the action of the ram. Accidents are not uncommon as a result of the pieces, swung by the cranes into the ram blocks, coming into

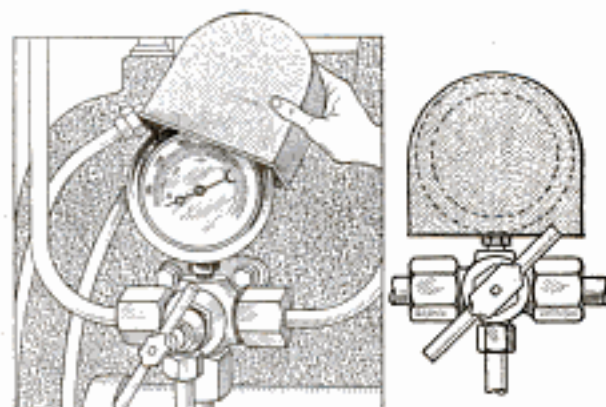

Covering to Protect the Gauge on a Pressure Ram

contact with the glass dial cover of the gauge.

The illustration shows a safety hood of the type adaptable for almost any

kind of gauge located in connection with a pressure of a hydraulic press. The hood is removed only when the gauge is in actual use for controlling the action of the ram, and is replaced when the pressure is removed. In this manner not only are workmen protected against injury from flying splintered glass, but the gauge itself is safeguarded.—Contributed by F. W. Bentley, Missouri Valley, Iowa.

### Air-Cylinder Packing to Prevent Leaks

Hemp, or flax, packing is most generally used in air cylinders in preference to iron rings. The iron rings will rust and cause them to cut the cylinder, which will soon make them leak. The sketch shows the proper way in which to fit hemp packing. Holes are drilled at the base of the packing so that half of their diameters will be in the pack-

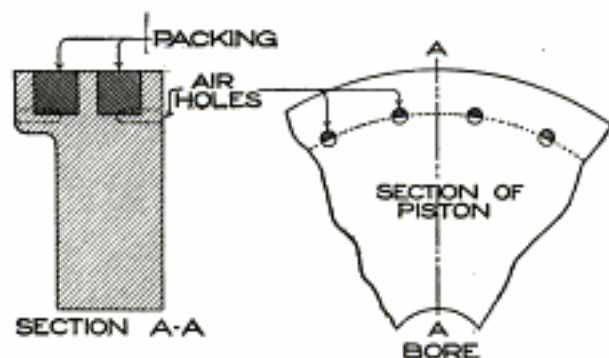

The Drilled Holes Permit the Air to Pass under the Rings and Push Them Out

ing groove. The holes allow the air to get under the packing, which forces them against the cylinder walls. Rings packed in this way will wear longer, make a tight fit, and give no trouble.

### Oiling Inaccessible Bearings

Lubrication of bearings which are ordinarily inaccessible may be accomplished by application of the principle that liquids tend to seek their own level.

The illustration shows a shaft bearing housed in a cast-iron frame into which an oilcan, no matter how long the spout, cannot reach. A hole was drilled in the bottom of the bearing and one of the same size was drilled

in the frame. A tube was fitted into the openings and the outer end of it cut off slightly above the level of the oil in the bearing. This level must be

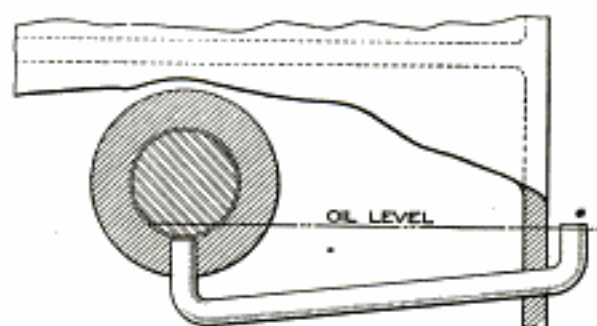

The Oil will Seek Its Level and Lubricate the Bearing

determined in order that a proper quantity of oil may be supplied. By filling the outer portion of the tube to the top, the oil will find its level at the desired point, lubricating the bearing.—Contributed by Frank H. Mayoh, Pawtucket, R. I.

### Replacing a Broken Rung in a Ladder

When a rung breaks in a ladder, do not nail a board across the front edges of the uprights, but make the repair as shown in the illustration. A new rung is made having a length to fit snugly between the side rails or uprights. Two blocks are bored to fit the ends of the rung and they are fastened to the side

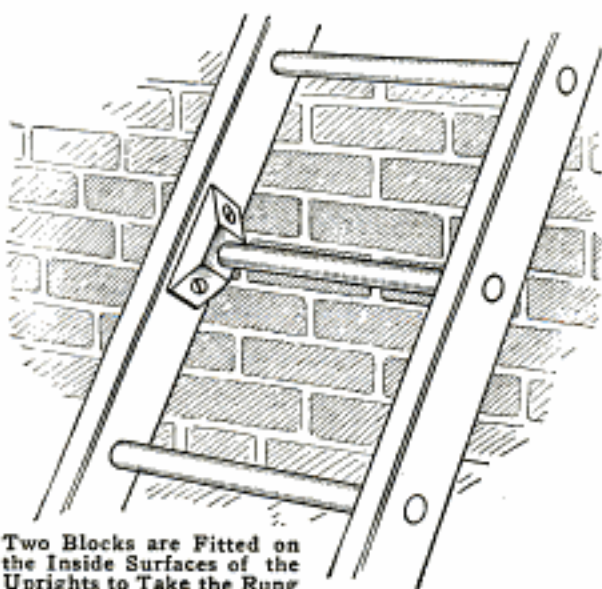

Two Blocks are Fitted on the Inside Surfaces of the Uprights to Take the Rung

rails with screws. This does not make an unsightly repair and the ladder will be as good as new.

### Homemade Flexible-Shaft Hanger

An improvised flexible-shaft hanger is shown in the illustration. The bearing

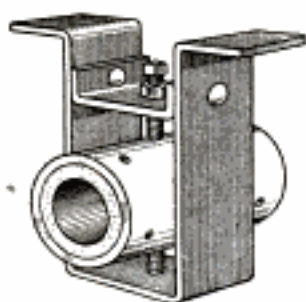

The flexibility is secured by supporting the bearing between the ends of two round-point setscrews. The sockets in the pipe for receiving the setscrew ends are merely shallow holes made with a large drill. The frame is formed from flat bar steel.

is made from a piece of wrought-iron pipe with a babbitt lining. Several small holes are drilled in the pipe previous to the babbitting to serve as anchors for the lining.

### A Temporary Automobile Light

During my vacation I broke the globe on one of my automobile side

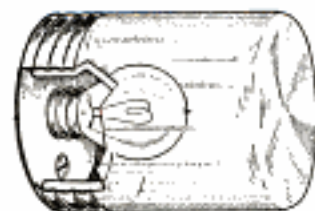

lights. A cold-cream jar and cover, however, was all that was necessary until I reached the city again. A tobacco jar will answer the same purpose.—Contributed by J. F. Southwell, Lynn, Mass.

light. A cold-cream jar and cover, however, was all that was necessary until I reached the city again. A tobacco jar will answer the same purpose.—Contributed by J. F. Southwell, Lynn, Mass.

### Toothed Pawl for Removing Lost Motion

Sometimes when a ratchet wheel is actuated by a pawl it will stop because of the irregularity of its teeth. If the space between any two teeth happens to be longer than the working stroke of the pawl, the reciprocating movement of the

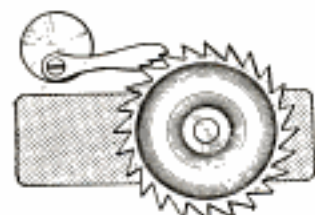

latter will not be sufficient to enable the pawl to pass over the tooth point

where it will engage the next tooth. By filing several small teeth in the working face of the pawl this difficulty is overcome, as there is always one pawl tooth in position to engage a ratchet tooth. Care must be taken in proportioning the pawl teeth in order to insure one full tooth movement on the ratchet for each reciprocation of the pawl.

### An Improved Candle Holder

Not having any connection for gas or electric light in a small, dark room,

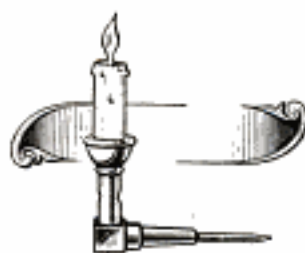

the ingenious owner made a serviceable candle holder of a discarded gas jet cock. The candle was inserted into the threaded socket to which

the gas pipe was connected. A heavy wire was sharpened and formed into a spike by which the holder was stuck firmly to the wall.

### Foundry-Flask Pins

Receiving a rush order for 40 small castings, I was obliged to construct a

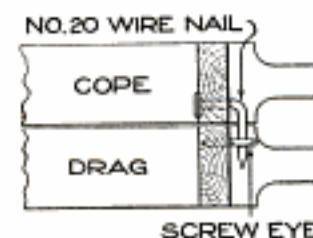

few flasks, the castings being too large for the snap flasks on hand. How the flask pins were made in a hurry is shown in the illustration. A common 20-penny wire nail was driven in the end piece of the flask and bent at right angles to fit in a large screw eye. This made a simple pin that answered the purpose well.—Contributed by M. Johnson, Kenosha, Wisconsin.

☞ In jointing boards for a glue joint, white crayon rubbed on the edge of one of the boards will make impressions on the other, thus fixing the high points.



## Fireside Dissolving Views

BY SUSAN E. W. JOCELYN

TO those interested in amateur theatricals the following method of showing dissolving views in the firelight of pipe dreams and mind pictures will be appreciated.

A frame made of light material, A, Fig. 1, covered with red cloth and chalked to represent brick, is placed in the center of the stage. The central opening, representing the fireplace, must be rather large, about 12 ft. wide and 7 ft. high, because it is at the back of this opening that the pictures are produced. From the chimney back, 21½ ft. behind this opening, the sides, B, of the fireplace slope outward to the imitation brickwork. The walls of the

fireplace are covered with sheet asbestos, for safety, and painted black; then ashes are rubbed on the chimney back and scattered over the hearthstone, to make the appearance more realistic.

The chimney back is removable, in fact it is one of a series of a half dozen screens, the others being behind it, the proper manipulation of which, together with changing lights, gives to the audience the effect of dissolving views of the dreams that are being acted out directly behind the screens.

The screens are carried in a light frame, the top of which is shown in Fig. 2, with position of runs. The runs

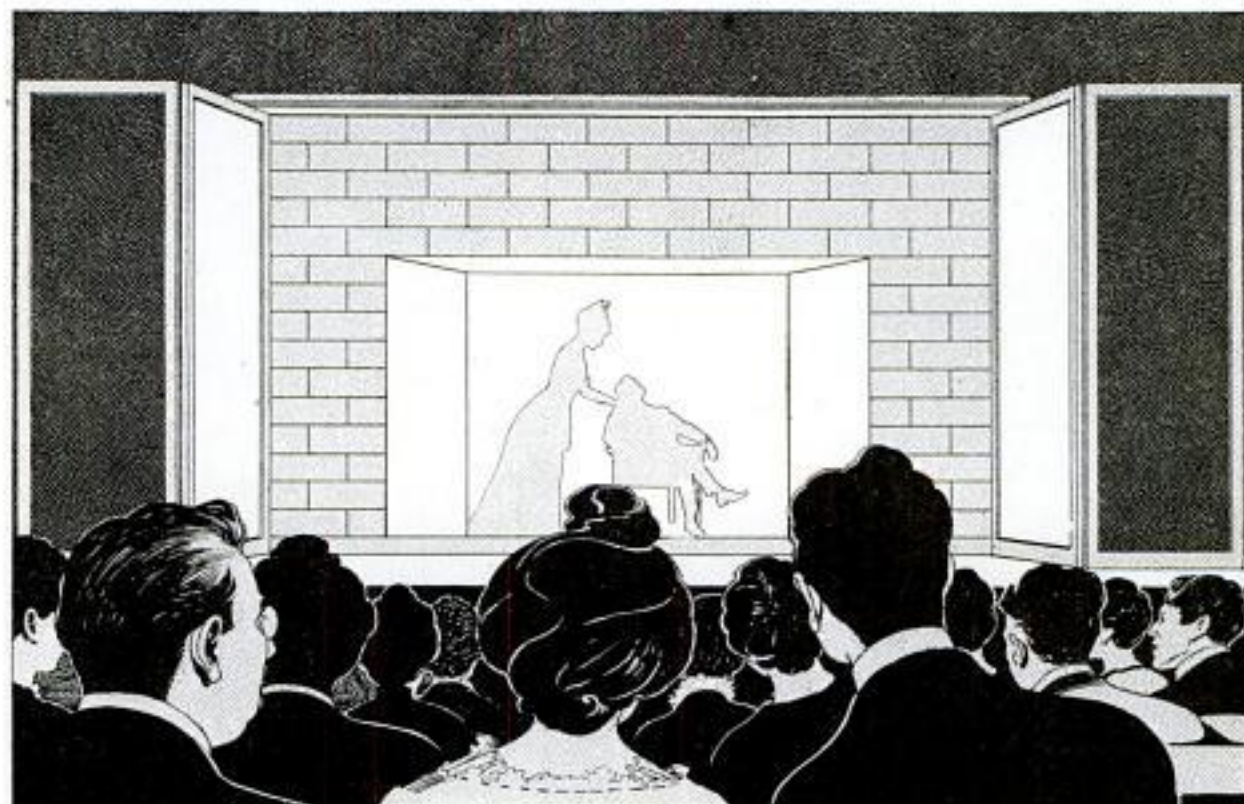

The Tableau is Played Out behind the Screens and is Dimly Seen through the Fireplace Opening When the Lights are Properly Controlled and the Screens Drawn Slowly

are made of narrow strips of wood, fastened to the under side of two end pieces, for the screen frames to slide in. Corresponding strips are placed in a suitable position on the floor, to keep the screens steady in sliding. The frames holding the run pieces are longer than the chimney back is wide, and the upper one is placed as high as the brickwork, the shelf, or mantel, over the fireplace being an extension of the upper part, or frame. The screens are in pairs, as shown in Fig. 3, each one extending to the center of the fireplace. They consist of light frames covered with black mosquito netting. The upper and lower sides of the frames are sandpapered smooth so that they will move easily in the runs. The vertical sides of a pair of screen frames that meet in the center of the fireplace are made of one strand of wire, instead of wood, so that their motion will not be noticeable. To complete the apparatus, andirons and a gas log are needed in the fireplace, and whatever arrangements are necessary for the action of the views to be shown behind the screens.

If gas is available, an asbestos log is used in the fireplace, and it has a connecting pipe to the footlights, where four or five jets are located on the floor just back of the screens. A narrow board, painted black, is placed in front

of the lights, which should be wide enough to conceal the lights from the spectators and reflect the light on the tableau. If the light is thrown above the imitation brickwork, then it should be made higher.

In most halls, and some houses, electric lights are used instead of gas, and in this case ordinary logs are piled in the fireplace on the andirons, and one or more red globes are introduced to produce the effect of glowing embers. The gas is more effective, however, because it is not easy to get a gradual rise and fall in the glow of electric lights. Four or five footlights are sufficient.

The working of the dissolving views can be best explained by an illustration from "Reveries of a Bachelor." The gas log is turned low to make the stage dimly lighted, and the tableau to be shown is all arranged behind the chimney back and the screens. There should be barely sufficient light to reveal the bachelor on the hearthstone smoking in the gloaming. Then the chimney back almost imperceptibly parts, that is, the screens of the first pair are gradually pulled apart, the footlights and gas log are gradually turned on, and the tableau behind the fireplace, being more brightly illuminated, is dimly seen through the series of screens. Slowly the successive pairs

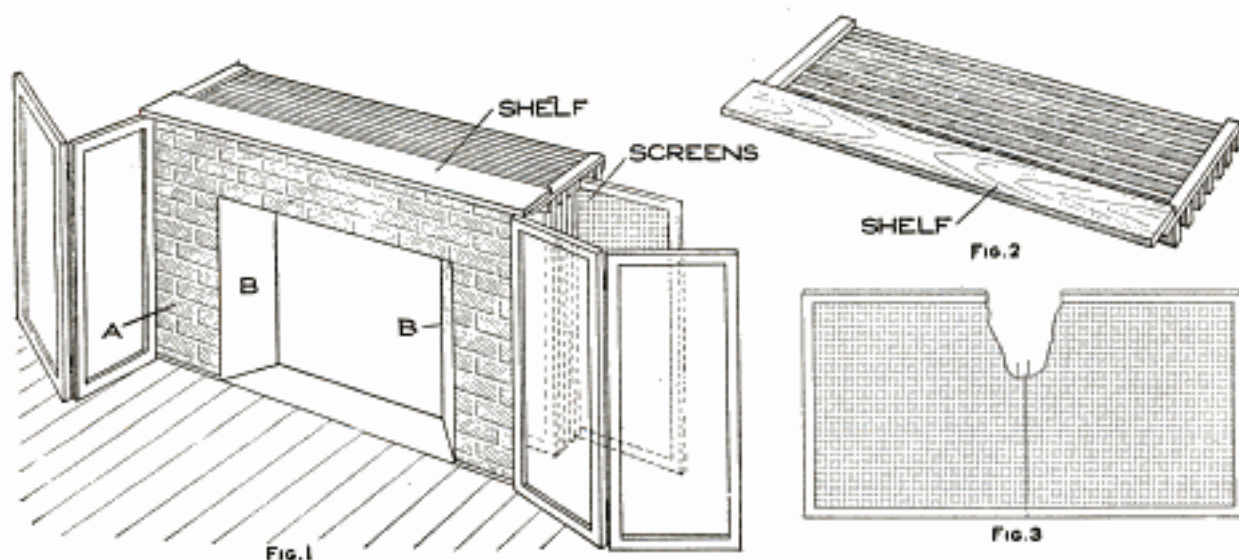

FIG. 1  
Frames Made of Light Material and Covered with Black Mosquito Netting Serve as Screens Which are Operated in Runs Located behind the Fireplace That is Made Up in a Like Manner and Penciled to Represent Brick

of screens are drawn aside, and the tableau becomes quite distinct. Then the process is reversed, the screens are gradually replaced, the lights are lowered and the dream fades away; brightens and fades again; brightens and fades, till gone entirely. The screens are always slowly moving while the tableau is exposed, and this makes the illusory effect. It is evident that the success of this plan depends principally on the coördination with which the screens are operated. "Cinderella," and many other tales based on the vagaries of the mind and having their source in glowing embers, can thus be presented.

### Imitation-Celluloid Scales and Name Plates

Often the amateur turns out a very workmanlike piece of apparatus, which only lacks the addition of a scale or name plate to give it a truly professional appearance. I recently hit upon an excellent method of making these articles in a manner that will stand considerable wear and at the same time present a very good appearance. Simply take a piece of good Bristol board and letter it as desired with waterproof drawing ink, then apply a coat of clear varnish, such as is used on bird's-eye maple furniture. After not less than 24 hours rub lightly with fine steel wool, wipe clean, and revarnish. Usually two coats are sufficient, and the last should be rubbed with a soft oily rag dipped in some abrasive material such as tooth powder, or one of the many powders used for metal polishing. Finally polish with a little oil, and the result will be a perfect imitation of celluloid.—Contributed by John D. Adams, Phoenix, Ariz.

### Direct View Finder for a Box Camera

Disappointment in the taking of pictures with a small camera is often caused by the inability of the photographer to obtain an accurate view of what he is photographing. If, instead of the small view finder on the camera,

the device illustrated is used, a view of the resultant photograph may be obtained, right side up, and of nearly the same size as the finished print.

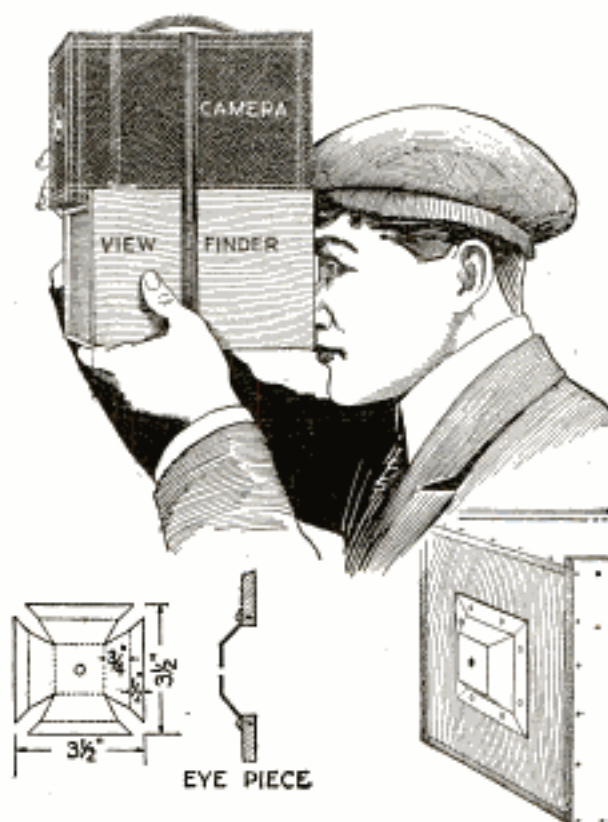

Sight through the Eyepiece for a Direct View of the Object Photographed, Thus Insuring More Nearly the Accuracy of the Result

The distance from the lens of the camera to the front surface of the plate or film must be determined. In the camera shown this was  $4\frac{1}{2}$  in. The distance from the small metal eyepiece, when it is in place on the box, to the inner side of the opposite end of the box must be made  $\frac{1}{2}$  in. shorter than this measurement. This will cause the box to be shorter than the camera.

The box is constructed so that the sides extend above the top and engage the camera. The view-finder eyepiece is made from a flat piece of sheet metal, laid out as shown, and bent into the desired shape. It is fixed over the center of the end of the box. The sight hole must be  $\frac{1}{32}$  in. in diameter. By sighting through the small opening in the eyepiece an unobstructed view of the prospective photograph is obtained.—Contributed by A. S. Thomas, Amherstburg, Ont.

### A Match-Box Trick

All that is required to perform this trick is a box of safety matches. Four matches are removed and three of them arranged as



shown in the sketch. The performer then tells his friends that he will light the fourth match and set the cross match on fire in the center, then asks which match of the

standing ones will light first. Most persons will not stop to think and guess either one or the other. As a matter of fact, after the cross match is set on fire it soon burns the wood away, and the pressure of the two side matches will cause it to spring out so that neither catches fire.—Contributed by Abner B. Shaw, North Dartmouth, Massachusetts.

### Cutting Glass Bottle with Electricity

Performing an experiment in a laboratory, it became necessary to have some apparatus which we did not

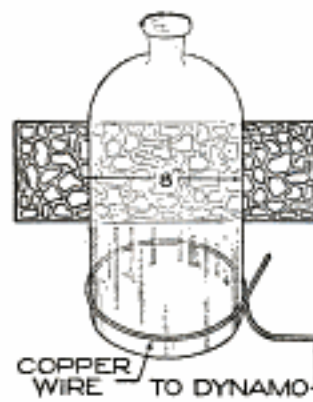

possess at the time. A bell jar could have been used, but this we did not have, and as a substitute we used a large glass bottle, 8 in. in diameter, with the bottom removed. In order to do this, we first made a

mark around the outside of the bottle near the bottom with a glass cutter. A piece of copper wire,  $\frac{1}{32}$  in. in diameter, was then wound around the outside on the mark and connected to the circuit.

As the wire would expand enough to make it slip off the bottle when heated red-hot, pliers were used to keep it

taut about the bottle when the current was turned on. A current of 110 volts and 5 amperes was run through the wire, heating it red-hot, and this cracked the glass exactly on the line marked by the glass cutter.—Contributed by R. E. Hollis, Chicago, Ill.

### Nail Cabinet with Muffin-Pan Trays

Muffin-pan trays used by the housewife in baking make serviceable containers for nails, screws, and other small articles used in a shop. The illustration shows the pans fitted into a box, and sliding in grooves cut into the sides with a saw.

The box is made with the end pieces lapping over the top and the bottom, this being a better construction to

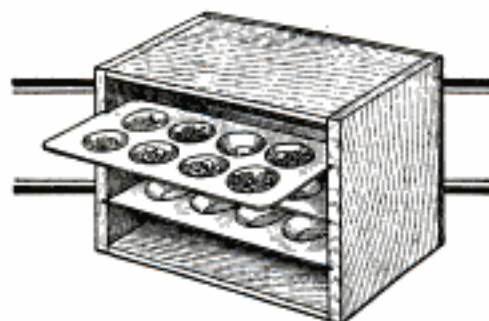

The Metal Trays Are Substantial and may be Removed Readily for Use Elsewhere

carry the weight of the trays. The wood used in the sides is  $\frac{7}{8}$  in. thick, in order that a saw cut may be made to a depth of  $\frac{1}{4}$  in. without weakening the support. Thinner wood may be used if instead of saw cuts small strips of wood are nailed against the side on which the trays may slide.—Contributed by Harry J. Blacklidge, San Rafael, Cal.

### Waterproofing Matches

Dipping ordinary parlor matches into melted paraffin and permitting them to dry thoroughly will enable them to withstand water. The paraffin acts like a wax candle and is unaffected by the moisture. This should be of aid to campers and others who find it hard to keep matches dry.—Contributed by J. W. Lambert, Jr., New York, N. Y.



# Homemade Electric Locomotive Model and Track System

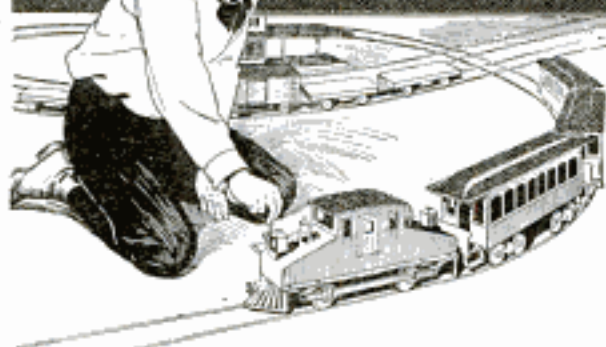

By A. E. ANDREW

## PART I—The Motor

**T**HE electric locomotive described may be constructed by boys having average mechanical ability and the necessary tools. However, in any piece of mechanical construction care must be taken to follow the instructions. The material required is inexpensive, and the pleasure derived from such a toy is well worth the time used in its construction.

The making of the outfit may be divided into three parts, the first of which is the motor; second, the truck, which is to carry the motor and the body of the car, and third, the track system upon which the engine is to operate. A side view of the locomotive is shown in Fig. 1.

The motor is of the series type, having its field and armature terminals connected to the source of electrical energy through a special reversing switch. By this means the rotation of the armature may be reversed to make the locomotive travel forward or backward. The armature and field are constructed of sheet-iron stampings, riveted together.

The detailed construction of the armature and its dimensions are shown in Fig. 2. The shaft upon which the armature core and commutator are to be rigidly mounted is made of a piece of steel rod,  $\frac{7}{32}$  in. in diameter. A portion of this rod,  $2\frac{1}{4}$  in. long, is threaded

with a fine thread, and two small brass, or iron, nuts are provided to fit it. The ends of the rod are turned down to a diameter of  $\frac{1}{8}$  in. for a distance of  $\frac{1}{8}$  in. These are to fit in the bearings that are to be made later.

Cut from thin sheet iron a sufficient number of disks,  $1\frac{1}{8}$  in. in diameter, to make a pile exactly  $\frac{5}{8}$  in. thick when they are securely clamped together. Drill a hole in the center of each of these disks, of such a size that they will slip on the shaft snugly. Remove the rough edges from the disks and see that they are flat. Cut two disks of the same size, from a piece of  $\frac{1}{16}$ -in. spring brass, and drill a hole in the center of each, so that they will slip on the shaft. Place all these disks on the shaft, with the brass ones on the outside, and draw them up tightly with the nuts provided. Be sure to get the laminated core in the proper position on the shaft by observing the dimensions given in the illustration, Fig. 2.

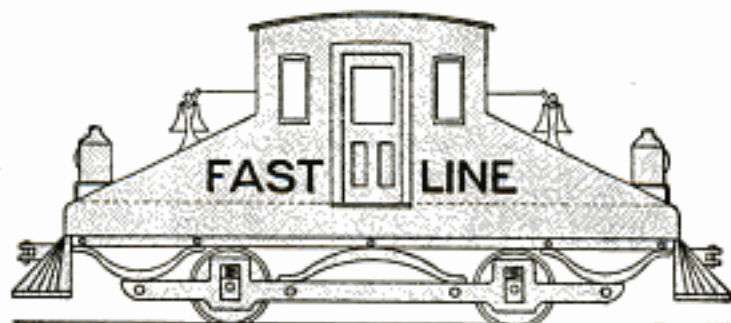

FIG. 1  
Side View of a Locomotive Designed to be Operated  
with Either End Forward

After the disks have been fastened, clamp the shaft in the chuck of a lathe and turn down the edges of all the disks so that they form a smooth

cylinder,  $1\frac{1}{16}$  in. in diameter. Draw a circle on the side of one of the brass disks,  $\frac{3}{32}$  in. from the edge, while the shaft is held in the chuck. Divide this circle into eight equal parts and make a center-punch mark at each division. Drill eight holes through the core lengthwise with a  $\frac{3}{16}$ -in. drill. If the centers of the holes have been properly located, all the metal on the outside will be cut away, as shown in the end view, at the right in Fig. 2. The width of the gaps, F, G, H, etc., thus formed, should be about  $\frac{1}{16}$  in. Smooth off all the edges with a fine file after the holes are drilled.

A cross-sectional view of the commutator is shown at the extreme left, Fig. 2. It is constructed as follows: Take a rod of copper or brass,  $\frac{7}{8}$  in. in diameter, and  $1\frac{1}{4}$  in. long; clamp one end in the chuck of a lathe. Turn the other end down to a diameter of  $\frac{3}{4}$  in., and drill a  $\frac{1}{2}$ -in. hole through it at the center. Cut away the metal from the end to form a disklike recess.

Cut off a disk,  $\frac{5}{16}$  in. thick, measuring from the finished end, from the piece of stock. Place this disk in a chuck, with the unfinished end exposed, and cut away the metal in a dish form, as shown at B. Cut small slots, into which the ends of the wires used in winding are to be soldered, as shown at 1, 2, 3, etc., in the right-hand view of Fig. 2. Obtain two brass nuts, about  $\frac{1}{4}$  in. in thickness, and turn their edges down so that they correspond in form to those shown at C and D. Divide the

points, in the rim of the disk. These cuts should be through the rim. Fill each of the slots with a piece of mica insulation.

Place one of the nuts on the shaft, and then a washer of mica insulation, shown by the heavy lines, near A and B; then the ring, a second piece of mica, and last the nut, C. The latter should be drawn up tightly, so that the insulation in the slots in the disk are opposite the drilled slots in the armature core, as shown in the right-hand view of Fig. 2. After the disk has been fastened securely, test it to learn whether it is insulated from the shaft. This is done by means of a battery and bell, connected in series, one terminal of the circuit being connected to the disk, and the other to the shaft. If the bell rings when these connections are made, the ring and shaft are not insulated. The disk must then be re-mounted, using new washers of mica insulation. Mica is used because of its ability to withstand a higher degree of heat than most other forms of insulation.

Each of the eight segments of the dished disk should be insulated from the others. Make a test to see if the adjacent commutator segments are insulated from each other, and also from the shaft. If the test indicates that any segment is electrically connected to another, or to the shaft, the commutator must be dismantled, and the trouble corrected.

The armature is now ready to be

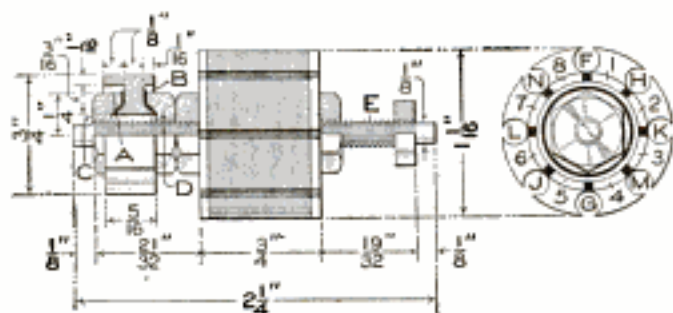

FIG. 2

How the Armature Core is Made of Soft-Iron Disks for the Lamination, at the Left. Diagram for the Winding of the Armature Coils and Their Connection to the Commutator, at the Right

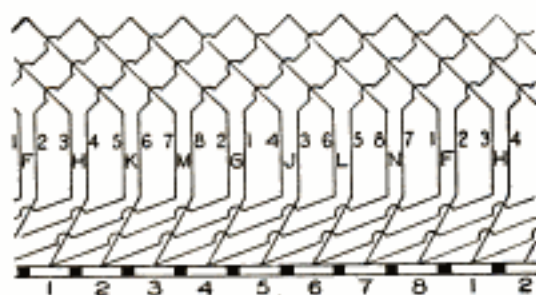

FIG. 3

disk ring, just made, into eight equal parts, by lines drawn across it through the center. Cut eight slots at these

wound. Procure  $\frac{1}{8}$  lb. of No. 26 gauge insulated copper wire. Insulate the shaft, at E, with several turns of thin

cloth insulation, and also insulate similarly the nuts holding the armature core and the inside nut holding the commutator. Cut several pieces from the cloth insulation, wide enough to cover the walls of the slots in the core, and long enough to extend at least  $\frac{1}{16}$  in. beyond the core at the ends. Insulate slots F and G thus, and wind 15 turns of the wire around the core lengthwise, passing the wire back through the slot F, across the back end of the core, then toward the front end through slot G, and back through F, and so on. About 2 in. of free wire should be provided at each end of the coils.

In passing across the ends of the armature, all the turns are placed on one side of the shaft, and so as to pass on the left side, the armature being viewed from the commutator end. The second coil, which is wound in the same grooves, is then passed on the right of the end of the commutator shaft. After this coil is completed test it to see if it is connected to the armature core. If such a condition is found, the coil must be rewound. If the insulation is good, wind the second coil, which is wound in the same slots, F and G, and composed of the same number of turns. Insulate the slots H and J, and wind two coils of 15 turns each in them, observing the same precautions as with the first two coils. The fifth and sixth coils are placed in slots K and L, and the seventh and eighth, in slots M and N.

The arrangement of the half coils, slots, and commutator segments is given in detail in Fig. 3. Each coil is reduced to one turn in the illustration, in order to simplify it. From an inspection of this diagram it may be seen that the outside end of the second coil in the upper row of figures, at the left end, is connected to the inside end of the fourth coil at segment 1, in the lower row of figures, representing the segments of the commutator. The outside end of the fourth coil is connected with the inside end of the sixth coil, at segment 2; the outside end of the sixth coil is connected with the inside

end of the eighth coil at segment 3; the outside end of the eighth coil is connected to the inside end of the coil 1 at segment 4; the outside end of the coil 1 is connected to the inside end of the coil 3 at segment 5; the outside

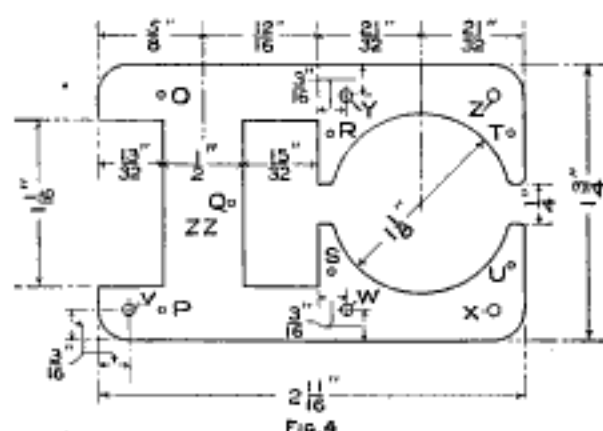

FIG. 4  
Pattern for the Field Stampings, Several Pieces being Used to Make the Desired Thickness

end of the third coil is connected to the inside end of the fifth coil at segment 6; the outside end of the fifth coil is connected to the inside end of the seventh coil at segment 7; the outside end of the seventh coil is connected to the inside end of the second coil at segment 8, and the outside end of the second coil is connected to segment 1, completing the circuit.

In winding the coils on the core, their ends should be terminated close to the commutator segments to which they are to be connected, in order to simplify the end connections. After all the coils are wound and properly tested, their ends may be connected as indicated. They are then soldered into the slots in the ends of the commutator segments. The completed winding is given a coating of shellac.

The dimensions and form of the field stampings are given in Fig. 4. A number of these cut from thin sheet iron to make a pile  $\frac{5}{8}$  in. thick when clamped together is needed. The dimensions of the opening to carry the armature should be a little less than that indicated in the sketch, as it will be necessary to true it up after the stampings are fastened together. Use one of the stampings as a pattern, and drill seven small holes in each, as indicated by the

letters O, P, Q, R, S, T, and U. Fasten them together with small rivets, and true up the opening for the armature to a diameter of  $1\frac{1}{8}$  in. Drill five  $\frac{1}{8}$ -in. holes, as indicated by the letters

Now cut two pieces from  $\frac{1}{16}$ -in. sheet brass, similar to those shown in Fig. 5. Place them on opposite sides of the laminated field structure, shown in Fig. 4, and carefully mark the position

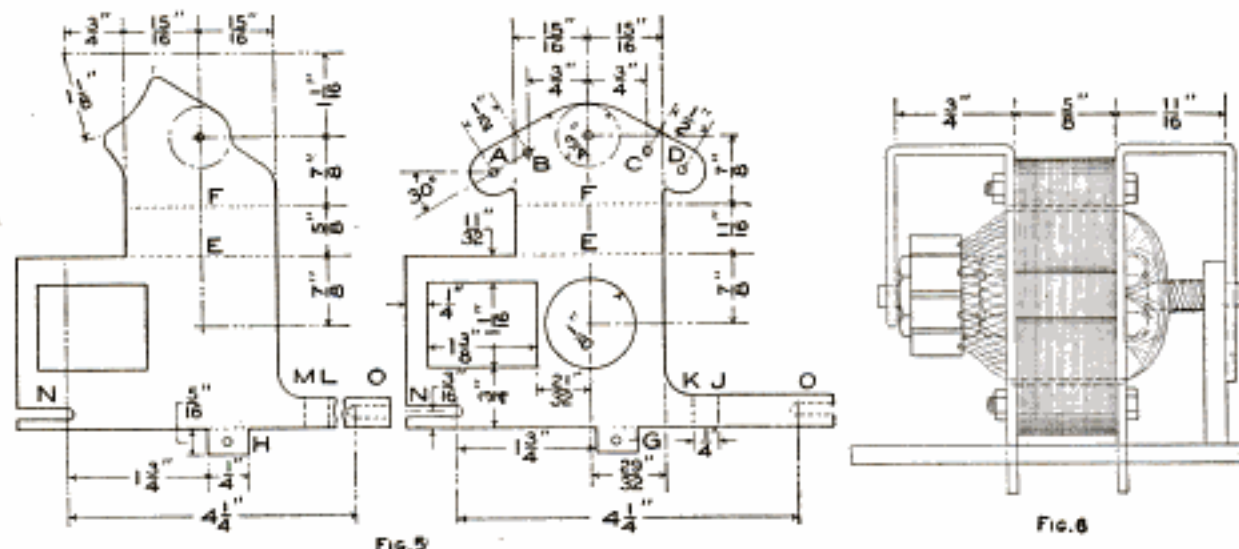

Fig. 5  
Detail of the Field-Structure Supports, One Being for the Left Side and the Other for the Right. The Supports are Shown in Place at the Right

V, W, X, Y, and Z, to be used in mounting the pieces, which are to form the armature bearings, brush supports, and base of the motor.

Cut two rectangular washers from a piece of thin fiber insulation, with outside dimensions of  $1\frac{1}{8}$  in. and  $1\frac{1}{4}$  in., and an inside opening,  $\frac{1}{2}$  in. by  $\frac{5}{8}$  in. Cut open these washers and slip them in position on the portion of the field marked ZZ. Wrap two turns of the cloth insulation about this part, which is to form the field core, and wind the space full of No. 18 gauge enamel-

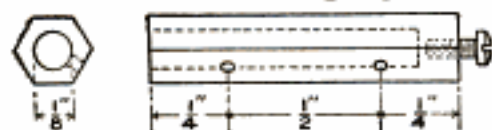

Fig. 7  
Detail of the Brush Holders, One Inch Long, with Holes as Shown

insulated copper wire. Give the completed winding a coat of shellac. The terminals of this winding should be brought out through two holes drilled in one of the fiber washers, one near the core and the other near the outer edge. It is better to have the field terminals at the lower end of the part ZZ than at the upper end.

of the holes; V, W, X, Y, and Z, as indicated in Fig. 4, and drill  $\frac{1}{8}$ -in. holes, where the marks were made. Lay out and drill  $\frac{1}{8}$ -in. holes, A, B, C, and D, Fig. 5. Bend the upper portion of the pieces at right angles to the lower portion, along the dotted lines E, and then bend the end of the horizontal portions down along the dotted lines F, until they are parallel with the main vertical parts of the pieces. The latter should be bent so that one forms the left support and the other the right, as shown in Fig. 6.

Bend the projections G and H at right angles to the vertical main parts. The parts at the bottom are bent, one back along the dotted line J and forward on the line K; the other forward on the line L and back on the line M. The pieces are then mounted, on the side of the field structure, as shown in Fig. 6. The supports are fastened in place with five small bolts. The grooves N and O, in Fig. 5, are used in mounting the motor on the axles of the truck. They will not be cut until after the truck is constructed.

The brush holders are made of two pieces of hexagonal brass, each 1 in. in

length, having a  $\frac{1}{8}$ -in. hole drilled in one end to a depth of  $\frac{7}{8}$  in., and a threaded hole in the other end, for a small machine screw, as shown in Fig. 7. Two holes are drilled and threaded in one side of each of these pieces. These holders are to be mounted, by means of screws, through the holes A, B, C, and D, Fig. 5. Each holder must be insulated from its support. The distance of the holder from its support should be such that the opening in its end is in the center of the commutator. The brushes are made of very fine copper gauze, rolled to form a rod. They

are made long enough to extend about  $\frac{1}{2}$  in. into the holder, when they are resting on the commutator. A small spiral spring is placed in the holder, back of the end of the brush, and which will serve to keep the latter in contact with the commutator.

Temporary connections are made and the motor is tested with a six-volt battery. The construction of the motor may be modified as to the length of shaft, and other minor details, and may be used for other purposes by fitting it with pulleys, a countershaft, or other transmission devices.

### Making String Solder

String solder of a size convenient for electrical work, or other soldering, where only a small quantity is desired, may be made by adapting a ladle for the purpose. Drill a small hole through the ladle near its upper edge. Melt the solder and pour it through the small hole, permitting it to fall on a slab of marble, slate, or stone. The ladle must be moved in zigzag lines in order to prevent the string from crossing and to make it possible to roll up the solder into rings of a convenient size.—Contributed by L. E. Fetter, Portsmouth, N. H.

### To Prevent Wire Coat Hook from Turning

A good way to keep a common wire coat hook in an upright position is to drive a small wire staple over the smaller hook. In public places, such as halls, this will often prevent their removal and save considerable annoyance.—Contributed by Harry L. Dixon, Chicago, Ill.

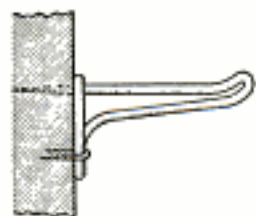

⌘The second coat of varnish should never be put on until the first has been "mossed" (rubbed) off; as, otherwise, it will not stick well.

### Cement Grotto for an Aquarium

To build a small cement grotto for an aquarium, make a clay mold by roughly excavating two right-angled

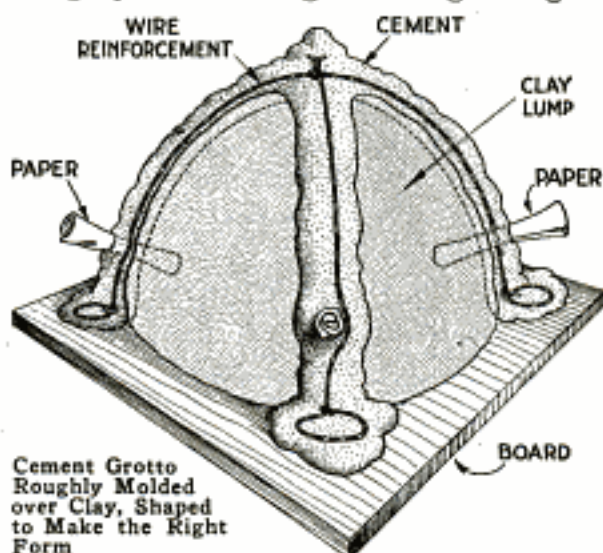

gutters in a lump of clay. Grease, or shellac, the mold after it is dry. Apply cement of about the consistency of putty, or dough, filling the gutters roughly so as to give a rocklike finish. Small shells can be stuck into the cement while it is yet moist. Before entirely shaping the cement, a piece of heavy wire is bent to conform to the shape of the grotto and set in for a reinforcement.

Holes can be made by twisting paper, so that it will extend out at each side, and laying cement over it. After the cement is thoroughly dry, the paper can be removed in sections.

### Focusing Screen for Enlarging Cameras

It is often very difficult when focusing an enlarging camera to determine just when the perfect focus is reached, especially when the negative is dim and without contrasting lights and shades. This difficulty may be overcome and a perfect focus quickly determined by the use of a focusing screen prepared as follows: Take a clear film or plate, one that has been fixed without being exposed, and when dry, rule lines on it with India ink to form small squares. To make the ink adhere to the film, dust the latter with talcum powder.

To use the screen, slide the film to be enlarged in place and set it for the size of enlargement, focusing roughly. Re-

move the film or plate and put the screen in its place. The camera may now be brought to a perfect focus with ease, as the black lines show up sharp and clear on the screen. When the focus has been determined the screen is removed and the film replaced.

The squares may be drawn from  $\frac{1}{4}$ -in. size down to the smallest it is possible to make. For large views it is easier to focus with the smaller squares. If the squares are made to a certain size they can be measured when thrown on the screen and the degree of enlargement determined.—Contributed by R. H. Galbreath, Denver, Colorado.

ⒸThe longitudinal carriage handle should never be held in the hand when cutting threads.

### An Indian Snake Game

Ask any Canadian Indian what a snow snake is, and he will tell you that it is a piece of twisted wood, such as a

end by the other hand, while at the same time the hold in the center is loosened. With a hard bottom and about 1

in., or more, of light snow on top—ideal conditions for playing the game—the Indian snake will travel for a long distance when thrown by an expert, and to a novice seeing the snake traveling along at a rapid speed, raising and lowering

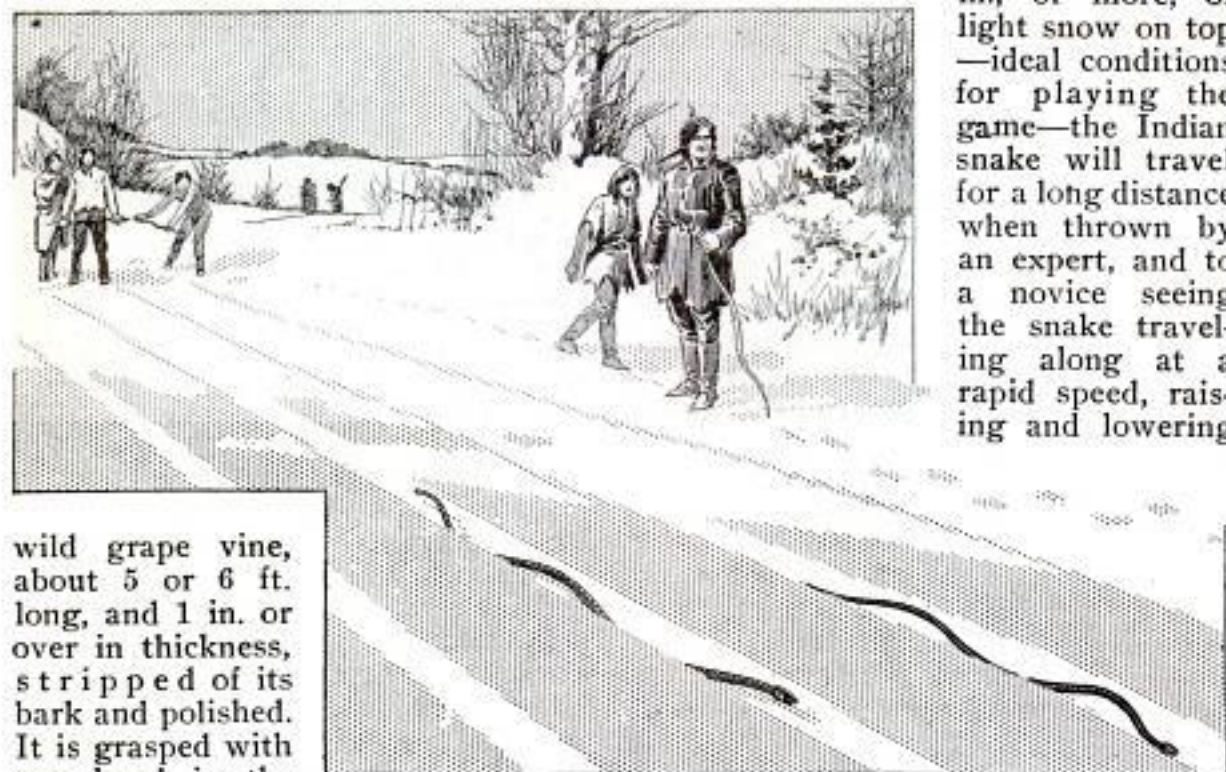

wild grape vine, about 5 or 6 ft. long, and 1 in. or over in thickness, stripped of its bark and polished. It is grasped with one hand in the center and given a strong forward throw at the tail

Throwing the Snow Snake in Tracks Made through the Snow with a Log:  
Each Player Tries to Get His Snake First Out at the End of the  
Track More Times Than His Opponents

its head as the wood vibrates from side to side, its resemblance to the real reptile is perfect.

When the Indians have tests of skill with the snake they make tracks through the snow by drawing a log in it, and sometimes as many as a dozen tracks are made side by side, and a dozen snakes are sent along at once. The one who makes his snake emerge from the end of the track first the most times out of a certain number of throws, takes the prize. The trick of throwing the snake is not at all hard to acquire, and it makes an exciting game.—J. E. Noble, Toronto, Can.

### Storage of Wood for Cabinetwork

When working with wood to be made into furniture, or other constructions of a high grade of workmanship, the ends of the finished pieces should be shellacked in order to prevent moisture from entering the ends. The ends are more susceptible to moisture, as the pores of the wood are exposed. The application of this remedy will often prevent warping or winding of boards, which is particularly distressing after a piece has been shaped to its final size.

The pieces should be stored in a warm, dry room, and in any event care should be taken that they are exposed evenly. If a board is placed on the top of a pile of similar pieces, it will be noted that, if left overnight and the weather becomes rainy, the upper piece will be warped. This is caused by the absorption of moisture on the upper side, the resulting expansion forcing the piece to warp or curve.

Long pieces of wood under process should be set on end while being stored temporarily. The permanent storage should be in racks having supports about 2 ft. apart. If the supports are too far apart, the boards may warp or wind at intervening points. Boards in piles should be separated by strips about 1 in. thick, set about 3 ft. apart, in order that the lumber may be open to the air. This will keep the stock more uniformly dry.

### Hanging Heavy Rug on a Line for Beating

An easy way to put a heavy carpet, or rug, over a clothesline is to fasten two pulleys, one to the house and the

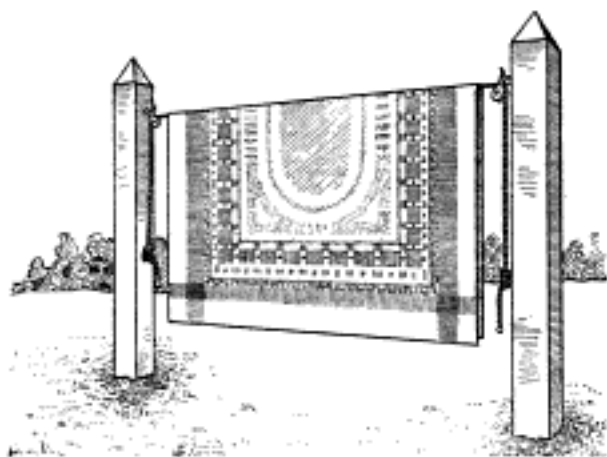

When the Rug is Placed on the Line It is Easily Raised by Pulling the Rope Ends

other to a post or tree, or on two posts, and hang the line between them; then pull the rug over the line and draw up the ends of the line. A very heavy rug can be easily hung in this manner. The line should be long enough to reach over the pulleys and to the ground and have end enough at both supports for fastening.

### Repairing a Broken Metal Cross

A metal cross, the shank of which was imbedded in a plaster ball, broke off level with the top. Not wishing to remove some of the plaster to take out the shank, I soldered a stout brass pin on the back of the cross, allowing the pin to project far enough to fit solidly into a small hole back of the shank. This allowed the cracked edges to fit closely together so that the crack could be entirely concealed with a touch of bronze paint.—Contributed by James M. Kane, Doylestown, Pa.

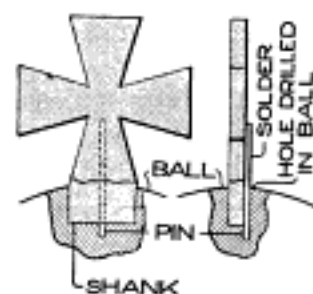

### To Determine the Efficiency of Electrically Heated Devices

The efficiency of any machine is defined as being the ratio of the output to the input expressed as a percentage, and both quantities must be measured

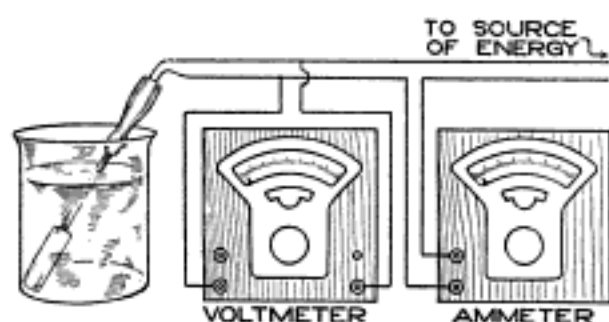

Connections to the Voltmeter and Ammeter for Measuring the Input to an Electric Heater

in the same units. For example, the output of a motor is 10 hp. when the power taken by the motor from the electric circuit to which it is connected is 9,325 watts. What is the efficiency? Since the output must be expressed in the same units it is necessary to change the 10 horsepower to watts or the 9,325 watts to horsepower. There are 746 watts in each horsepower. The 9,325 watts are equivalent to  $9,325 \div 746$  or 12.5 hp. The efficiency is then equal to  $10 \div 12.5$  or .8; that is, the output is .8 of the input or, when multiplied by 100 to change it to percentage, 80 per cent.

By way of an example, consider the efficiency of an electric heater, like the one shown in the illustration, which is immersed in water placed in a suitable vessel. The energy input to this heater in a given time may be easily determined by measuring the current passing through the heater circuit and the difference in pressure between the terminals of the heater. These measurements may be made, in case the heater is operated on a direct circuit, by means of any ammeter and voltmeter of suitable capacity, connected as shown. If the heater is operated on an alternating-current circuit, only alternating-current instruments can be used, as certain types of instruments will not operate when connected to such a circuit. In either case, the

product of the ammeter reading in amperes and the voltmeter reading in volts will give the power taken by the heater in watts, assuming the heater winding to be noninductive. If the heater winding is not noninductive, then the current and the electrical pressure will no longer be in phase when the device is operating on an alternating-current circuit, and a wattmeter must be used. Practically all heating elements are wound noninductively so that the power may be measured by means of an ammeter and voltmeter.

The energy taken by a heater in a given time will be equal to the product of the average power and the time. For example, if the heater takes 300 watts for 30 minutes— $\frac{1}{2}$  hour—then the energy consumed is equal to 300 times  $\frac{1}{2}$  or 150 watt-hours, which is equal to .15 kilowatt-hour.

To determine the output of the heater is a little more difficult, but it may be approximated as follows: Since the object of the device is to convert electrical energy into heat energy the output must be measured in heat units. The unit of heat most commonly employed is the calorie, which is the heat required to raise the temperature of one gram of water one degree centigrade. Hence, if a certain weight of water has its temperature increased a definite number of degrees centigrade by the electric heater, then the total heat imparted to the water in calories will equal the weight of the water in grams multiplied by the change in temperature in degrees centigrade. Of course, the heat generated by the heater exceeds that obtained by the above calculation, due to the fact that some heat is imparted to the vessel containing the water and to the supports for the vessel, but it is only the heat imparted to the water that must be considered, as the other heat is not useful.

When the temperature of the water is raised to the boiling point and a part of the water is evaporated, the foregoing method of calculating the heat imparted to the water no longer holds good, and the following method must be used. Weigh the water before and



immediately after the test to determine the amount of evaporation. For each gram of water evaporated there will be required approximately 536 calories, and the heat in calories imparted to the water to raise its temperature to the boiling point will be equal to the difference between 100 and the initial temperature of the water multiplied by the weight of the water at the start. To determine the efficiency, the input to the heating element in electrical units must be changed to heat units which may be done by multiplying the power in watts by the time in seconds and this product in turn by .24, giving the result in calories. The following example may serve as a help in performing such an experiment or test.

Weight of water at the start.....	500.0	grams.
Weight of water at the end of test.....	474.5	grams.
Temperature of water at the start.....	25	deg. C.
Average current taken by the heater.....	6.5	amperes.
Average pressure at the heater terminals.....	110	volts.
Time heater is connected.....	5½	minutes.
Change in temperature of the water.....	75	deg. C.
Heat developed in heater:		
$6.5 \times 110 \times 5\frac{1}{2} \times 60 \times .24 =$	56,628	calories.
Heat absorbed by water in coming to boiling point: $500 \times 75 =$	37,500	calories.
Heat used in evaporating 25.5 grams of water: $536 \times 25.5 =$	13,668	calories.
Total heat absorbed by water.....	51,168	calories.
Efficiency of heater:		
$\frac{51,168}{56,628} \times 100 =$	90.4	per cent.

This value of efficiency may be increased by insulating the vessel with a nonconductor of heat and providing a covering for it, thus decreasing the losses to the air and surrounding objects.

The efficiency of an electric stove or electric iron, or, in fact, any electrically heated device, may be determined in a manner similar to the water heater. In the case of a stove, place a vessel filled with water on it and measure the heat imparted to the water in a given time, also the input to the heating element in the same time, from which data the efficiency may be calculated. In the case of an electric iron, dampened cloths may be ironed and the actual water evaporated by the iron, determined by weighing the cloths before and after the ironing, together with the increase in weight of the cloth on the ironing board, the time the iron is in use and the temperature of the

cloths. The actual water evaporated is the difference in the weight of the cloths before and after ironing, minus the increase in weight of the cloth on the ironing board, which takes up some of the moisture from the cloths being ironed.

### Earthen Mustard Pots Used as Acid Jars

A small earthen mustard pot of the type shown makes an ideal acid pot

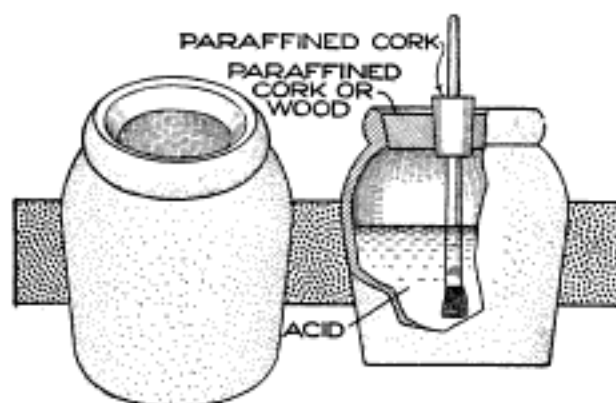

A Bottle Made from an Earthen Mustard Pot to Contain Acid

for the bench, as it is not only acid-proof but will not upset so easily as the ordinary acid bottle. The large cork, or stopper of soft wood, thoroughly boiled in hot paraffin, is bored for the insertion of another paraffined cork holding the acid-brush handle. If a coat of paraffin is given the handle, it will easily resist the action of the acid and last much longer.

### Squeezing Paste from Tubes

Tubes of paste, glue, etc., may be more easily handled by applying an ordinary key, such as found on most cans containing fish put up in oil. The end of the tube is inserted in the slot of the key and then turned.



—Contributed by J. H. Priestly, Lawrence, Mass.

## Kitchen for Hikers

By PRESTON HELLER

WITH a view to provide all the needs of a commissary department for 36 boys for a period of four days, either on a hike or in a permanent camp, the kitchen illustrated was constructed. As it is placed on two wheels, which are removed when the kitchen is in use, it can be moved from one day's camp to another by attaching it to the rear of a horse-drawn wagon by means of a shaft. When the wheels are removed the entire outfit rests on legs, which are swung down from the bottom. The sides and one end are opened by swinging one half up and resting it on the top, while the other half swings down to a horizontal position where it is used as a work board, making all parts easily accessible.

The outside dimensions of the kitchen, when closed and in the form of a large box on wheels, are 5 ft. 3 in. long, 3 ft. wide, and 2½ ft. high. The main feature of this entire kitchen is its compactness. At the front, and extending about 1 ft. back, is a kitchen cabinet where the plates, sugar, salt, flour, etc., are kept in separate compartments. Here also are found the necessary cooking utensils, such as bread knives, butcher knives, cleaver, cooking spoons, pancake turner, sieves, large forks, lemon squeezer, etc.; and on the shelves of galvanized iron small boxes and packages of baking powder, cocoa, etc., are placed. This entire compartment, as well as all others where food is handled and prepared, is lined with No. 28 gauge galvanized iron which makes sanitation a feature also.

Upon passing around to one side there can be seen a large three-shelved oven, 21 in. wide, which is heated by a gasoline burner. Between the burner and the bottom of the oven are located coils of pipe for heating water, and these coils are connected with a tank of 7-gal. capacity, located just above the oven. An air valve and glass gauge are attached to the tank.

The next compartment to the rear is a large storage space, extending all

the way through the kitchen, and a 2½-gal. forged-copper gasoline tank occupies a shelf in the upper portion of this space. At the rear end along this side are located nickelplated faucets which are connected with the hot-water tank mentioned; a 7-gal., white-enamelled milk tank above; an 18-gal. cold-water tank, and an ice-water tank, used when distilled-water ice can be secured. These faucets all drain into a small sink, which, in turn, drains off through an ordinary sink drain to a hole dug in the ground beneath it. Practically the entire rear end of the kitchen is occupied by the large water tanks, ice box, and milk tanks, with the exception of a small space at the bottom where the silverware is kept in a drawer.

On the other side, and to the rear, two compartments above and below the large water tank form excellent storage space for ham, bacon, sausage, preserves, butter, etc., which need to be kept in a cool place. Next in line is the other end of the large storage place which extends through from the other side. Pans, pails, canned goods, larger packages, etc., are kept in this space.

Immediately to the rear of the kitchen cabinet, on this side, are located compartment shelves where the tin cups are kept, and adjoining this is found a three-compartment steam cooker. By having the cups and plates near this steam cooker, which is also heated by a gas burner, there is less danger from rust, as they are kept thoroughly dried. Wherever there is a gasoline burner the compartment in which it is located is not only lined with galvanized iron, but asbestos in sheets is placed on the inner side, so that the heat will not ignite the interior packing or the woodwork. The tanks are accessible from the top of the kitchen for filling and cleaning, and are packed with ground cork.

The kitchen has shown its efficiency by giving satisfactory service in camps of many members.



Hungry Campers Quickly Provided For from the Compact, Easily Transported Kitchen, Shown with Supply Cabinets on Left and Utensil Cupboards on Right

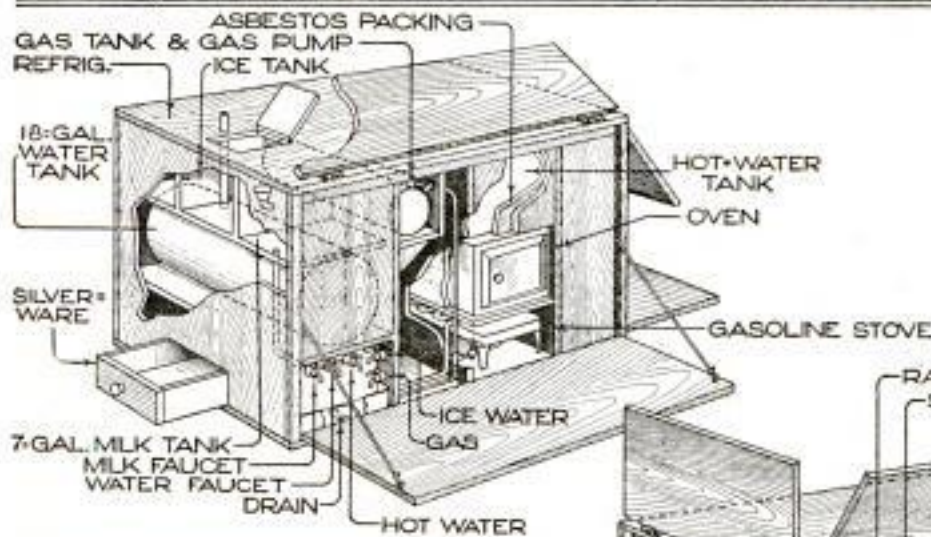

The Kitchen Outfit Compacted into Its Cabinet, Mounted on Wheels and under Transport

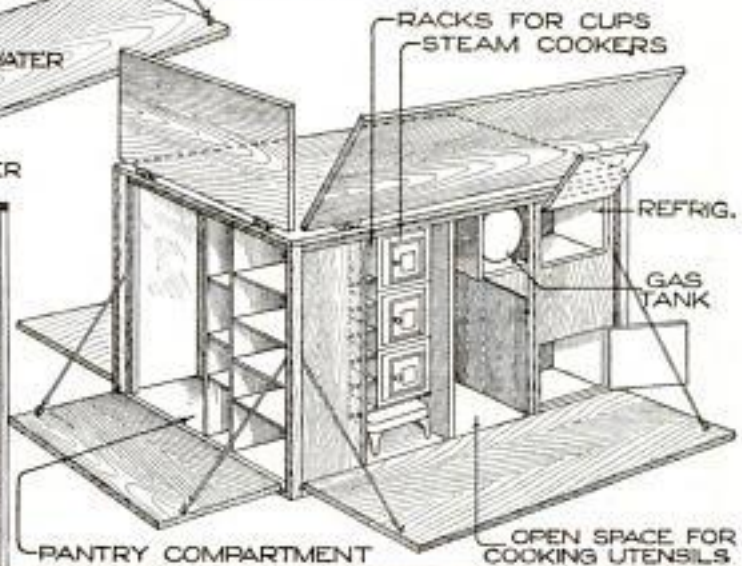

The Portable Kitchen Outfit Opened, Exposing the Various Compartments Arranged So as to Be Convenient: Above, Stove and Cooking Compartments; Below, Pantry Compartment and Space for Utensils

### Seeing an Alternating Current in a Mirror

It will almost appear impossible to those unfamiliar with laboratory methods that one may watch the vibrations

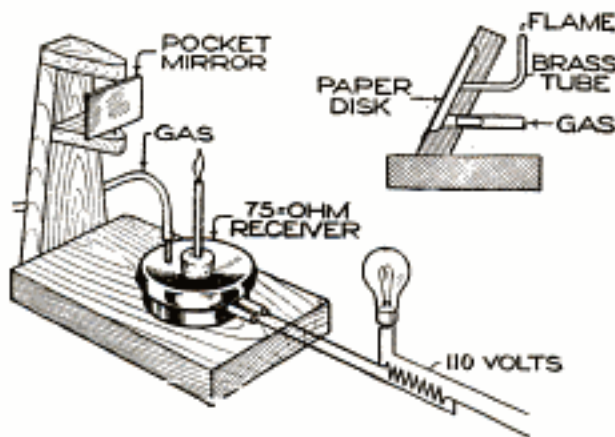

The Alternations of the Current may be Seen by Looking in the Mirror

—3,600 per minute—of an alternating current in a little pocket mirror without the use of any apparatus other than a telephone receiver. The experiment is very interesting and instructive, one that may be performed at practically no expense.

Take an ordinary inexpensive watch-case receiver, drill a hole in the cover for a short piece of brass tubing, to make a gas connection, and then plug up the center opening with a cork, into which is tightly fitted a piece of  $\frac{1}{8}$ -in. tubing. The upper end of this should be closed with a plug having a central opening about the size of a pin. Procure a small rectangular pocket mirror and remove the celluloid covering, and then, across the back, solder a piece of straight wire to form a vertical spindle, about which the mirror may be rotated. Connect any resistance, such as a magnet coil of 10 or 20 ohms, in series with an incandescent lamp, and then connect the receiver terminals to the ends of this resistance. In this manner an ideal alternating-current supply of a few volts to operate the receiver safely is secured. Turn on the gas only sufficient to produce a narrow pencil of flame, not over 1 in. long. Mount the mirror as shown, or hold the spindle between the thumb

and forefinger of the left hand while rocking it back and forth with the right. Ordinarily only a streak of light will appear, but immediately upon turning on the current this streak will be broken up into a series of regular waves, flatter or sharper according to the speed with which the mirror is rocked. After carefully noting the wave form, connect the receiver with the primary of an ordinary medical coil, across the make-and-break, and note the marked difference in the waves.

By replacing the receiver with a block of wood having a circular depression, about 2 in. in diameter and  $\frac{1}{8}$  in. deep, over which is pasted a disk of smooth paper, the waves set up by the human voice may be observed if the talking is done loudly and close to the disk. The gas connection in this case is made from the back of the block, as shown. As the several vowels are sounded, the characteristic wave from each will be seen in the mirror. It is also interesting to increase the pitch of the voice and note how much finer the waves become.

### Homemade Screen-Door Check

An outside screen door causes considerable annoyance by slamming when exposed to the wind, even if it is equipped with a bumper. Nothing

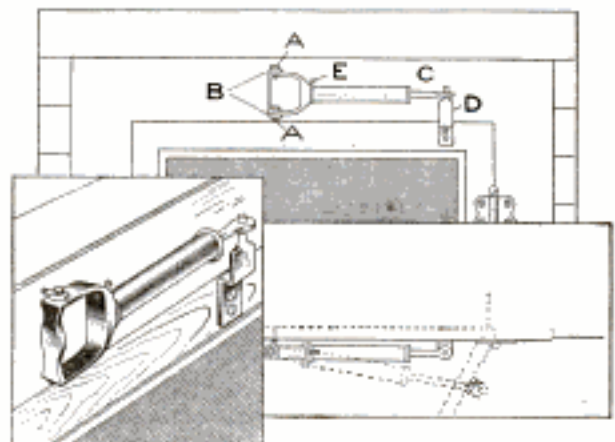

Air-Cushion Check Made of a Bicycle Foot Pump for a Screen Door

short of a door check will prevent this slamming, so I made a very simple

pneumatic check for our door, which works entirely satisfactorily.

A discarded bicycle foot pump was procured and hinged to the casing over the door, as shown in the illustration. The hinge was made as follows: Two holes, A, were drilled through the stirrup, as near the foot plate as possible; two ordinary screw eyes were turned into the door casing at B, and two pins were passed through the holes in the screw eyes and the holes in the stirrup. This allows the pump to swing when the door is opened. The end of the plunger rod C is flattened and a hole drilled through it to receive the pin at the top of the bracket D, which is screwed firmly to the door.

The action of the pump when the door is opened can be readily understood. The check is adjusted very easily by the machine screw E, which controls the exhaust of the air when the door closes. The screw is turned into the hole in the base of the pump where the pipe was originally connected. One side of the end of the screw is slightly flattened to allow a better adjustment. The pump can be quickly removed by pulling out the upper pin in the hinge part.—Contributed by M. C. Woodward, San Diego, California.

#### Bushing Made of Brass Tip on Cartridge Fuse

In order to fasten a short piece of tubing in a socket which had become worn to a funnel shape, without having to tap the socket and put in a threaded bushing, it was fixed as follows: One of the brass tips on a spent cartridge fuse was cut off and one of its ends filed tapering. After trimming the fiber lining so that it would fit snugly over the tube, it was driven home. The combination of brass and fiber adjusted itself nicely to the shape of the worn socket and made a tight fit.

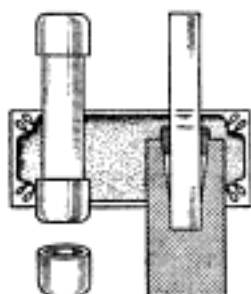

#### Opening Springs for a Tennis-Racket Clamp

When putting a tennis racket in a press, it is difficult to keep the press open to let the racket slip in. This can be easily remedied by simply putting a small coil spring around each of the four bolts, as shown. This will always open the press when the bolts are loosened.—Contributed by W. X. Brodnax, Jr., Bethlehem, Pa.

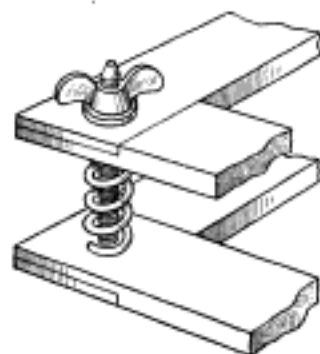

#### Magic-Paper Fortune Telling

At outdoor carnivals and fairs there is usually a fortune teller who uses a glass wand to cause one's fortune to appear on a pad of paper. Anyone may perform this trick by observing the following directions.

Instead of a glass wand use a long, narrow bottle of glass. Dip a new pen into copper sulphate, diluted with six parts of water, and write out the "fortune" on a piece of paper. The writing, when dry, will not be visible. Next procure two corks to fit the bottle. An unprepared cork is placed in the bottle and the other is pocketed, after hollowing it out and inserting a small sponge soaked in pure ammonia.

The bottle with the cork is passed out for examination. The cork is casually placed into the pocket after it is returned by a bystander. A pad of paper is then proffered and an initial is placed on the pad of paper by the person whose "fortune" is to be told. The paper is rolled up, with the prepared side on the inside, and inserted into the glass bottle. The fumes of ammonia will develop the mysterious message. The trick can be repeated if several prepared sheets of paper are on hand, and always proves of interest in a party of young persons.

## PLEASING BRICK BUNGALOW OF MODERATE COST



C. C. CATER, ARCHITECT, DALLAS, TEXAS

1309 1/2 Main St.

THAT rare combination, attractiveness and economy, are to be found in this modest but pleasing brick bungalow, which is of a design adaptable to almost any climate. While its broad, low roof, exposed rafters, and pergola give it a touch which suggests the land of perpetual sunshine, its heavy brick columns, stanch walls, and substantial-looking balustrade make it well-fitted in appearance for the North.

The structure has effective lines which command attention. Its front and approach are attractive, while the sides, although very plain, harmonize architecturally with the rest of the structure and contribute to the appearance instead of detracting from it, as is too often the case in small, low-priced houses. Shrubbery and flowers deserve a large proportion of credit for the homelike atmosphere of the structure. Without the exterior decorations it would be only a house. With small expense and little work a prim, appealing tone has been developed which no architect nor builder alone could supply.

A glance at the floor plan shows clearly the interior scheme. Plenty of windows, two large closets, and a roomy back porch, which may be inclosed if desired, are provided. The front door gives direct access to the living room, immediately back of which are the dining room and kitchen. The latter has an ample pantry, which if necessary could be used as a storage place, adjacent to a swinging door leading to the dining room. On the opposite side of the house are two bedchambers separated by a bathroom and a couple of closets. Entrance to the front bedroom is gained by way of the living room, while the rear one has doors leading into the dining room and onto the back porch. While the rooms are not large, none of them are cramped and all are adequate for the needs of the average family of two or three members. The cost of building the structure will obviously vary in different localities, and this also brings up the heating question, but the architect's estimate is \$1,700. Where labor and building materials are available at reasonable figures, there should be no difficulty in erecting the bungalow at the estimated price.

IN accordance with the editorial policy of this magazine never to accept compensation in any form for what appears in our reading pages, and also to avoid all appearance of doing so, we are obliged to omit the name of the maker or the seller of any article described. This information, however, is kept on file and will be furnished free, by addressing Bureau of Information, Popular Mechanics Magazine, Chicago. [Editor.]

**\$638** for this Bungalow  
**ALADDIN**



**This Home Contains Living Room, Dining Room, Three Bedrooms, Bath and Kitchen**

Highest  
AWARDS  
WORLD'S  
FAIR

The Aladdin Catalog gives you full information on this attractive Bungalow home. Tells you of the high quality material that is furnished for it. Every part of this home and 100 other Aladdin Beauty homes is carefully explained in detail—in a most interesting style—in the Aladdin catalog. Get a copy of it today. It has helped thousands to own a better home at a saving—it will help you, too.

**Save \$200 to \$800 Building This Year**

Do you want to save big money building this year? Do you want to get a better quality of lumber and dodge high lumber prices? Aladdin Houses will save you from \$200 to \$800. Aladdin Houses are being sold for last year's prices—other lumber manufacturers have raised their prices from \$4 to \$10 per thousand feet this year. And probably never again will Aladdin prices be as low as the present. Send for your copy of the catalog. Decide to build this year. You'll save big money over lumber market prices by building an Aladdin home in 1916.

**Aladdin Dwellings, Bungalows, Garages, Summer Cottages, \$138 to \$8000**

**\$1355**

for this  
Aladdin

Aladdin Houses save you four profits on lumber, millwork, hardware and labor. Prices from \$298 for a five-room home, to \$10,000. Aladdin Read-Cut houses are complete. No extras. One hundred beautiful modern homes and bungalows, summer cottages, garages, farm buildings and barns in the new 1916 catalog. Send stamps today for your copy of Catalog No. 180.

**Remember—Aladdin prices are the same in 1916 as in 1915.**

**North American Construction Co.**

**296 Aladdin Ave., Bay City, Mich.**

Canadian Branch, C. P. R. Bldg., Toronto, Ont.



**NORTH AMERICAN CONSTRUCTION CO., 296 Aladdin Ave., BAY CITY, MICH.**  
I am enclosing stamps for your catalog No. 180.

Name .....  
Street .....  
City .....  
State .....

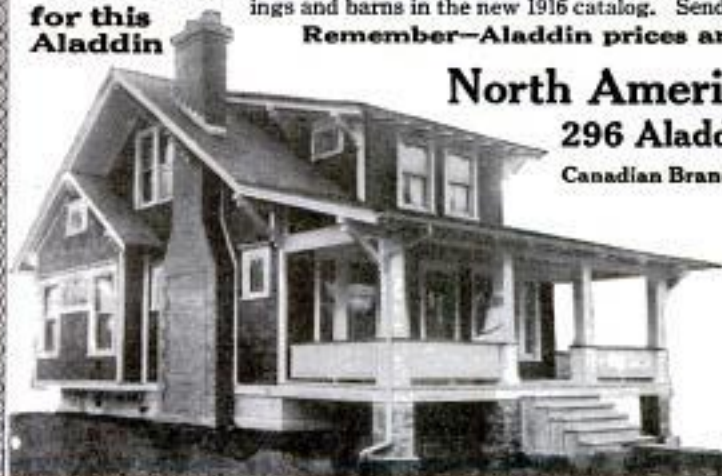

# SAXON ROADSTER

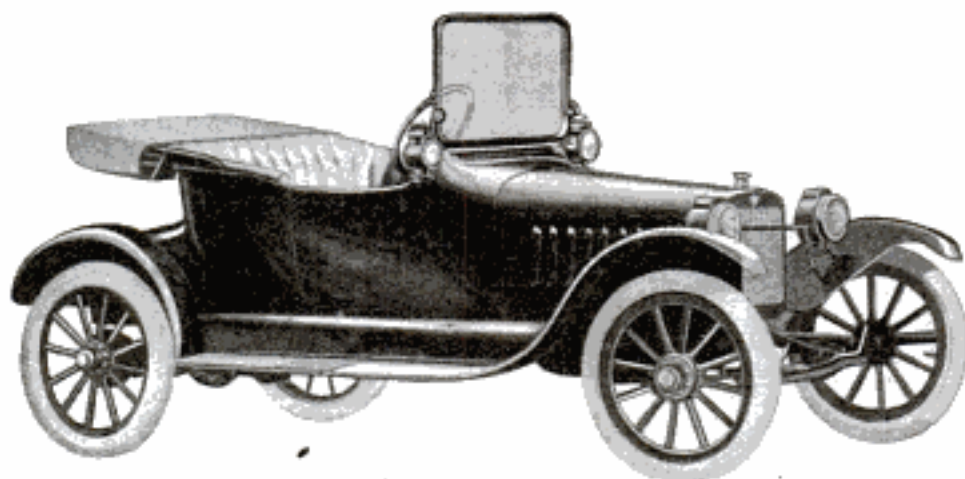

## This car rules the roadster field

Roadster buyers last year paid \$4,250,000 for Saxon "Fours." You men and women who seek the truth about motor car values should bear this in mind.

For if the verdict of buyers is to be accepted, then the Saxon "Four" must be given top place in the field of high-grade two-passenger cars.

No other roadster—of like price—can measure quality with this Saxon "Four" at \$395. Feature for feature, it clearly outclasses all price-rivals.

### Note these refinements:

Three-speed sliding gear transmission—a feature on all high-priced automobiles. Insures marked flexibility. Only Saxon "Four"—among standard roadsters under \$400—has three-speed transmission.

Modern high-speed motor—of noteworthy power, smoothness, quietness, flexibility, operative economy and ability to cool under all conditions.

Timken axles. No better can be had on any car.

Honeycomb radiator—admittedly the best type of radiator made. Assures perfect cooling.

Streamline body. Among low-priced roadsters—no one, we believe, doubts the supremacy of the Saxon "Four" in the matter of distinctive beauty.

Dry-plate clutch—same type as used on \$2000 cars. Vanadium steel cantilever springs—unquestionably the easiest riding type of spring suspension.

Ventilating windshield, Signal lamps at side, Adjustable pedals, and fifteen further improvements. Saxon "Four" costs one-half cent per mile to run. Before you buy any roadster—see this Saxon "Four."

### "Sixes"

Touring Car	.	.	.	\$785
Roadster	.	.	.	785

### "Fours"

Roadster	.	.	.	\$395
Delivery Car	.	.	.	395

*Canadian Prices f. o. b. Windsor, Ont.*  
Standard equipped six-cylinder car, \$1075;  
detachable top, \$200; standard equipped four-cylinder roadster, \$530; electric equipment \$70 additional; detachable top, \$75 additional.

Write for interesting booklet *Saxon Days*. Address Dept. J

## Saxon Motor Car Co., Detroit

*The Saxon Motor Car Company does not announce yearly models*

(355)



# BLUE STREAKS



## Quit Experiments: Use These Tires

**W**HAT is the use of spending your own money to find the best tire when motorcycle manufacturers have done it for you?

The manufacturers of all leading makes unite on Goodyear Blue Streak Motorcycle Tires.

They have not arrived at this unanimous conclusion hastily, or without due test of all tires.

They have compared Blue Streak records and Blue Streak performances with the records and performances of other tires.

And Blue Streak—the tire that holds every important world's record for speed and endurance on track and road, the tire that motorcycle owners prefer, is the manufacturers' choice as standard equipment.

Can you hope to find a tire better fitted for your own use; or one more highly recommended than the Goodyear Blue Streak?

Get Goodyear Blue Streak from your motorcycle dealer.

Buy them for your old machine. Accept no other tires when you buy a new one.

The Goodyear Tire and Rubber Company  
Akron, Ohio

**GOODYEAR**  
AKRON  
Motorcycle Tires

Please Mention Popular Mechanics

I have an offer to make  
you if you will be one of  
the 300 who are going  
to profit by being my  
partners in my new plan



\$ **695<sup>00</sup>**

COMMONWEALTH  
**PARTIN-PALMER**

34 H.P. — 110 Inch Wheelbase  
Five Pass. Touring Car



Demountable Rims Full-Floating Rear Axle  
32x3½ Wheels and Tires Yacht-Line Body

Only 34 H. P. car selling as low as \$695  
with so many quality selling features

**You can be one of 300 who save money**

I want 300 Owner-Boosters in 300 different towns where we have not yet established agencies, to help me advertise this wonderful family touring car. I have a special proposition to make to you and if you will write me quick you can be one of the 300 who are going to profit by being partners with me in my new plan for creating a big market for Partin-Palmer cars in every locality.

**Largest, most powerful car for \$695**

Our regularly established connections would gladly take all the cars we can manufacture this year but I have induced my company to reserve 300 cars in order to make this special proposition to 300 Owner-Boosters in 300 different towns and help me pave the way for a much larger output next season. I have promised my company that each of these 300 cars will sell ten more.

Partin-Palmer cars have made good for four seasons in all parts of the world. Thousands of owners testify today to the value and dependability of Partin-Palmer cars.

The new 1916 Partin-Palmer "32" is a luxurious, comfortable, easy-riding five-passenger touring car of beautiful lines.

In low up-keep cost, in quality of material and workmanship, in all that makes for dependable service, it is the biggest value ever offered.

**Dealers:** My attractive exclusive agency proposition will be a money maker for you.

**Wire or Write Quick**

I will send you by return mail the PROOF that the Partin-Palmer "32" is the greatest buy on earth, and send full details of my money-saving offer to you. So address me personally today.

W. H. CONKLIN, Sales Manager.

**COMMONWEALTH MOTORS CO.** Dept. "H," Hearst Bldg.  
CHICAGO, ILLINOIS

# WINS!

A new motor oil—a patented invention—a compound of pine castor with other vegetable and mineral oils that sets an absolutely new record in efficient lubrication. Every user of motor oil—whether he motors on land, water, or in the air—will find it tremendously to his advantage and to the advantage of his motor to learn immediately of this wonderful new lubricating agent.

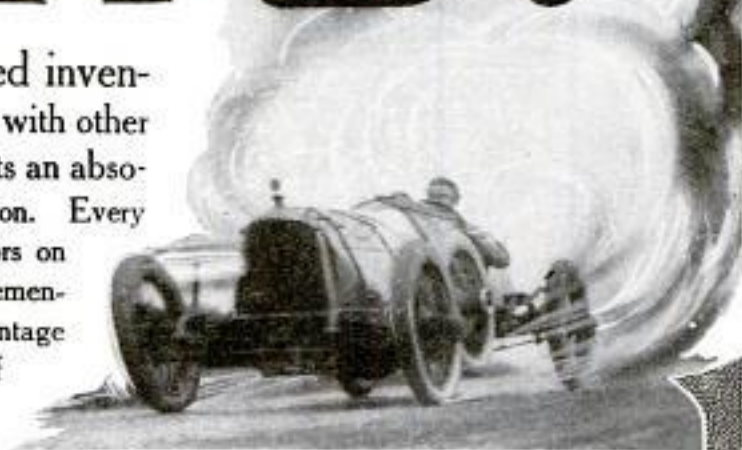

TRADE MARK

## SEXTON'S

### CASTOR

## MOTOR OIL

**"THE BEST FRIEND YOUR MOTOR EVER HAD"**

Don't confuse Sexton's with pure castor oil—it is a patented mixture—entirely different, infinitely better than anything heretofore offered the motoring public, yet it costs but a fraction of pure castor.

A truly wonderful oil—offers a perfect resistance to the damaging effects of gasoline vapor—keeps every part of the motor covered with a thin film of oil under all conditions. Prolongs the life of your motor—gives it added power—pick-up and acceleration.



#### Dealers Wanted Everywhere

There are also many places in our organization open to high-grade salesmen.

**"Take My Advice And Send Coupon Today"**  
*C. O. Bean*

Under the severest conditions on motor speedings—in motor-boat contests—in aeroplane trials—it has been clearly demonstrated that Sexton's will safeguard motors by perfect lubrication where other oils fail.

You certainly owe it to yourself to give your motor the best lubricant that can be had, and that means Sexton's. Mail coupon today for interesting lubricating facts and name of nearest dealer where Sexton's can be obtained.

#### Salesmen, Dealers Wanted

#### SEXTON OIL CO.

General Office, 11th Fl., Peoples Gas Bldg., CHICAGO

Gentlemen: Please send full particulars of your Sexton's Castor Motor Oil, and grade best adapted for my motor, which is.....

Name.....

Address.....

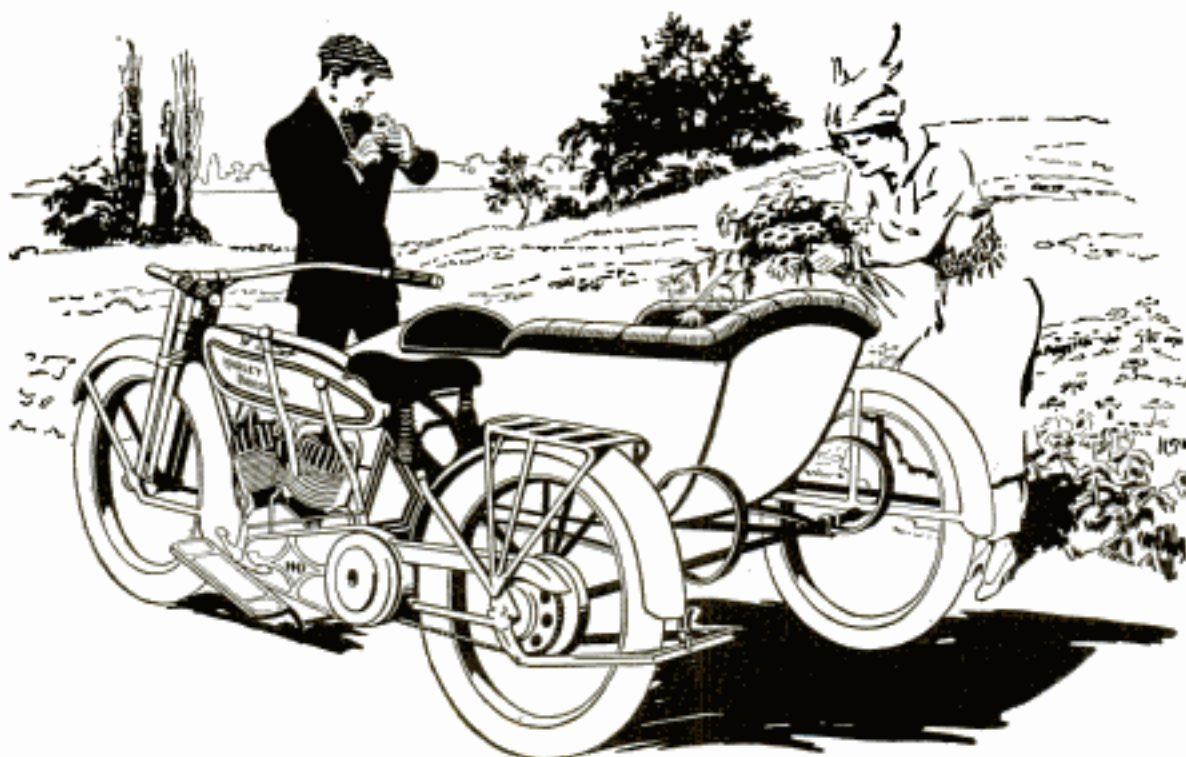

## When Your Travel Dreams Come True

When you stand beside your Harley-Davidson motorcycle, ready for the first trip, every travel dream you ever had will begin to come true. Then you can laugh at the miles that separate you from the lakes, woods and mountains—or the place you want to be. With your

# Harley-Davidson

you can go anywhere, any time, at a loitering pace or with the speed of the wind, as you choose, in safety, dignity and comfort. You will like it for its beauty, simplicity and reliability, but most of all you will like it for its everlasting convenience. If you have sidecar equipment for your Harley-Davidson, intimate companionship on your trips will double your pleasure in the big outdoors.

Every day in the year you will enjoy your Harley-Davidson, but most of all in these glorious spring days and evenings when the woods are waking up. Those who "know" will appreciate the mechanical excellence of the Harley-Davidson, while the uninitiated will learn through use to appreciate how "worry-proof" a motorcycle can be. When you buy a Harley-Davidson, you buy a perpetual vacation.

*Telephone your local Harley-Davidson dealer for a demonstration.  
He will probably be glad to arrange terms to suit your convenience.*

## HARLEY-DAVIDSON MOTOR COMPANY

*Producers of High-Grade Motorcycles for More Than Fourteen Years*

460 B STREET

MILWAUKEE, WISCONSIN



## The best tire is none too good for your bicycle

The biggest rubber factory in the world *knows* this is the best bicycle tire, for it is a smaller size of the Goodrich Black Safety Tread Automobile Tire, and is made of the same rubber as the famous Silvertown Auto Tire that broke the *world's* record at 105 miles per hour. The

# Goodrich "GIANT"

*With the Black Safety Tread*

"Giant" is the strongest Bicycle Tire ever made, with actually heavier, stronger fabric than many small sized auto tires. This fabric is loosely woven—different from any other bicycle fabric—allowing the rubber layers to sink through its mesh so that when cured they are welded together into a single piece of solid rubber from tread to lining.

Like the best of everything it is really cheaper in the end for it is guaranteed for a year and will outlast several ordinary tires.

**Boys all over the United States are getting these two gifts free with "Giants"**

*First*—A Goodrich "Boys' Guide Book." How to make a boomerang, how to make a camping tent, semaphore signaling, and many other "pointers."

*Second*—A rich Maroon or Blue Felt Pennant with sparkling frosted letters.

If the tire dealer near you does not sell Goodrich Tires, write us and we will tell you where you can get them.

*Address*

**The B. F. Goodrich  
Company**

*Advertising Dept., AKRON, OHIO*

*Makers of the Celebrated Goodrich Automobile Tires—"Best in the Long Run"*



# IVER JOHNSON

## Everybody Is Riding This Year

Bicycling has suddenly returned to a nation-wide popularity as a sport. Everyone rode this winter at the fashionable resorts of Florida and California.

Fortunately, you know the bicycle to buy. For thirty years the Iver Johnson has ranked in your opinion as the best made, strongest, fastest and finest bicycle. It is made of seamless steel tubing, has finest bearings ever used in a bicycle, and is finished with four coats of baked and hand-rubbed enamel.

The model above costs \$30. Other models from \$20 to \$55. Our big, 84-page catalog describes the line and explains the mechanical superiority of the Iver Johnson. This catalog is free.



### FREE BOOK

Send for our big, 84-page book on Iver Johnson Bicycles, Motorcycles, Revolvers and Shot Guns in single and double barrels. This valuable book will tell you how to get full value in service and satisfaction. It is free.

### True Preparedness

means that each individual is ready to defend himself, his home and his country. Learn how to use firearms. Buy a good revolver and get used to the smell of gun-powder. A safer, harder or straighter shooting revolver cannot be made than the Iver Johnson. It is so safe that you can drop it, or hit it; throw it against a wall or Hammer the Hammer without danger of accidental discharge. The regular model costs \$6. With a large grip as shown below, it costs \$6.75. Other models cost \$6, \$7 and \$8. Send for free 84-page book.

#### IVER JOHNSON'S ARMS & CYCLE WORKS

307 River Street, Fitchburg, Mass.

99 Chambers Street, New York

717 Market Street, San Francisco

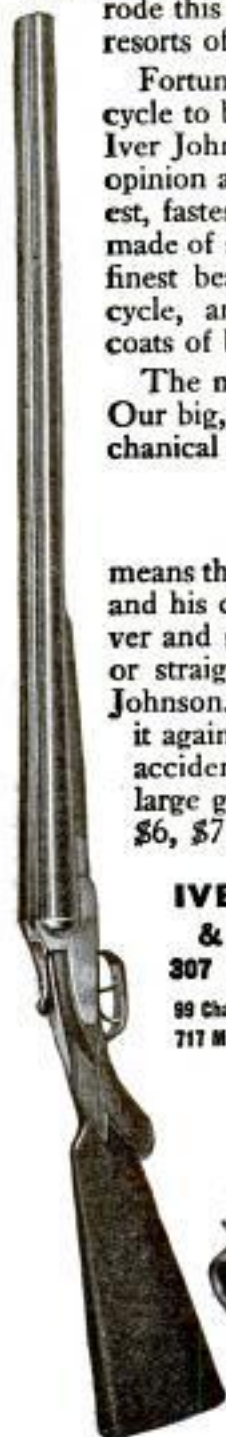

Regular Model with Perfect Grip \$6.75



Please Mention Popular Mechanics



## Mennen's Shaving Cream Takes the Sulk Off the Face

Efficient work is a mental and physical impossibility if your tooth aches, feet suffer, or face smarts.

The face smarts and sulks for hours after a difficult, unpleasant shave.

Mennen's Shaving Cream brings science to the rescue of the old laborious torture of the daily shave.

It grooms the face and soothes the nerves—gets you ready for the most proficient performance of each day's job.

A 25-cent tube of Mennen's Shaving Cream, if used according to directions, means daily face insurance for seven months.

It has put the *save* into *shave*—and taken the *H*—everlastingly out of it.

Mennen's means no free caustic, hence serene and soothing freedom from sting and smart.

It means economy plus, and labor minus. It means, with most beards, no need of re-lathering or "rubbing in." One-half inch of Mennen's absorbs a mighty

lot of water, and makes a rich, copious lather that stays put for about ten minutes. Its response is instant, whether the water is hot or cold, hard or soft.

Use only Mennen's already famous Talcum for Men at the finish, the latest product of the world's first and greatest makers of talcum powder, whose natural or neutral color overcomes the objectionable pallor left by pure white talcum powders.

Gerhard Mennen Chemical Co.  
Newark, N. J.



This Coupon brings you two samples for 10 cents

Enclosed is 10c for which please send me a medium-sized tube of Mennen's Shaving cream and, free, a trial can of Mennen's Talcum for Men.

GERHARD MENNEN CHEMICAL CO.  
Laboratories:  
2014 Orange Street,  
Newark, N. J.

Name .....

Address .....

City..... State.....



**One Dollar**  
at your dealer's  
or direct by mail to you

# Benjamin 92

The Double Duty Electric Plug

*"In Yours for  
Double Duty"*



**F**OR every imaginable electric service that requires or lends itself to "two-ways at once," Benjamin 92 is indispensable.

Take careful notice of the photographs surrounding this ad. Then mentally make use of this handy device in your own home or office. We warrant there are situations already occurring to you where Benjamin 92 would provide a deal more comfort than you are now getting from the ordinary "one-way" socket.

Benjamin 92 requires no extra wiring—nor does it cause the slightest fuss or bother. It is simple and screws into any ordinary socket with as little effort and work as can be.

## Benjamin Electric Mfg. Company

126 So. Sangamon Street, Chicago 11-17 Charlotte Street, Toronto, Canada  
114 Liberty Street, New York 590 Howard Street, San Francisco



*Please Mention Popular Mechanics*



*"Not the name of a thing, but the mark of a service"*

# MAZDA

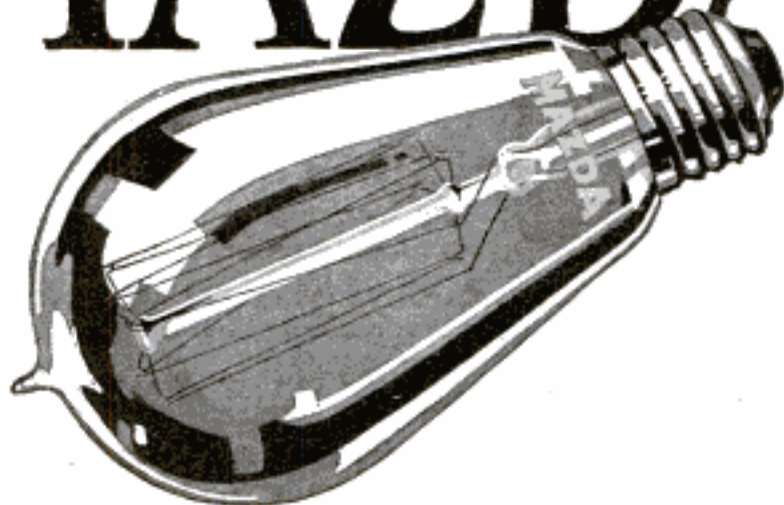

## Depend on any lamp marked MAZDA

**THE MEANING OF MAZDA**—MAZDA is the trademark of a world-wide service to certain lamp manufacturers. Its purpose is to collect and select scientific and practical information concerning progress and developments in the art of incandescent lamp manufacturing and to distribute this information to the companies entitled to receive this Service. MAZDA Service is centered in the Research Laboratories of the General Electric Company at Schenectady. The mark MAZDA can appear only on lamps which meet the standards of MAZDA Service. It is thus an assurance of quality. This trademark is the property of the General Electric Company.



**RESEARCH LABORATORIES OF GENERAL ELECTRIC COMPANY**

4625

*Please Mention Popular Mechanics*

Copyrighted material

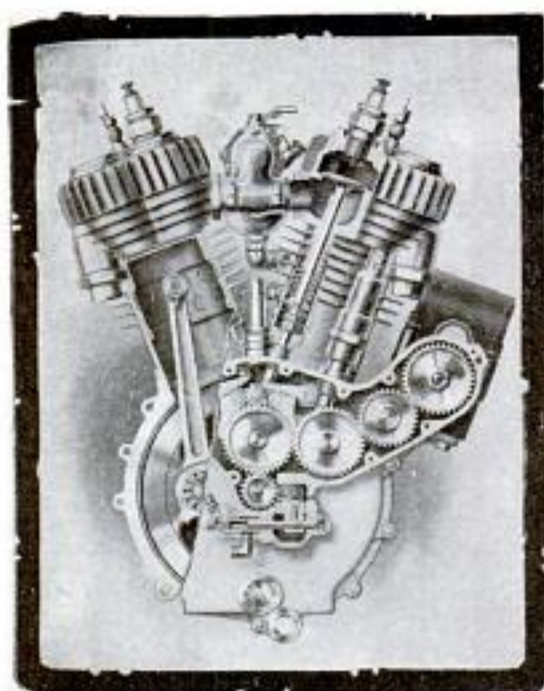

# POWERPLUS

## *Indian with New Powerplus Motor*

The far-ahead standard of quietness, cleanliness, accessibility, simplicity, speed, power! The most wonderful advancement and example of mechanical completeness in motorcycle history.

A machine that has, almost daily since its introduction, astonished the world by feats of power, speed, hill-climbing and general endurance. The 1916 Indian, with new Powerplus motor, is an acknowledged masterpiece—a created whole.

Right out of the crate any *stock* Powerplus, cleanly, silently, easily, hits the trail at approximately 70 miles an hour.

It is the all-drop-forge machine. 81 steel drop forgings embodied in the 1916 model. No other motorcycle made has this great number of drop forgings.

These Samson pieces make the 1916 Indian a machine which withstands, with smallest wear and operating cost, the hardest tests to which a motorcycle can be subjected.

The expensiveness and fineness of Indian construction are comparable with those of a high grade motor car.

For these excellent reasons, we assert our earned right to call the 1916 Indian wonderful in all the word means.

**2800 Dealers Everywhere**

*Send for your copy of the beautiful 1916 Indian Catalog.*

**HENDEE MANUFACTURING CO.** 711 State Street  
Springfield, Mass.  
*(Largest Motorcycle Manufacturers in the World)*

# Indian

Please Mention Popular Mechanics

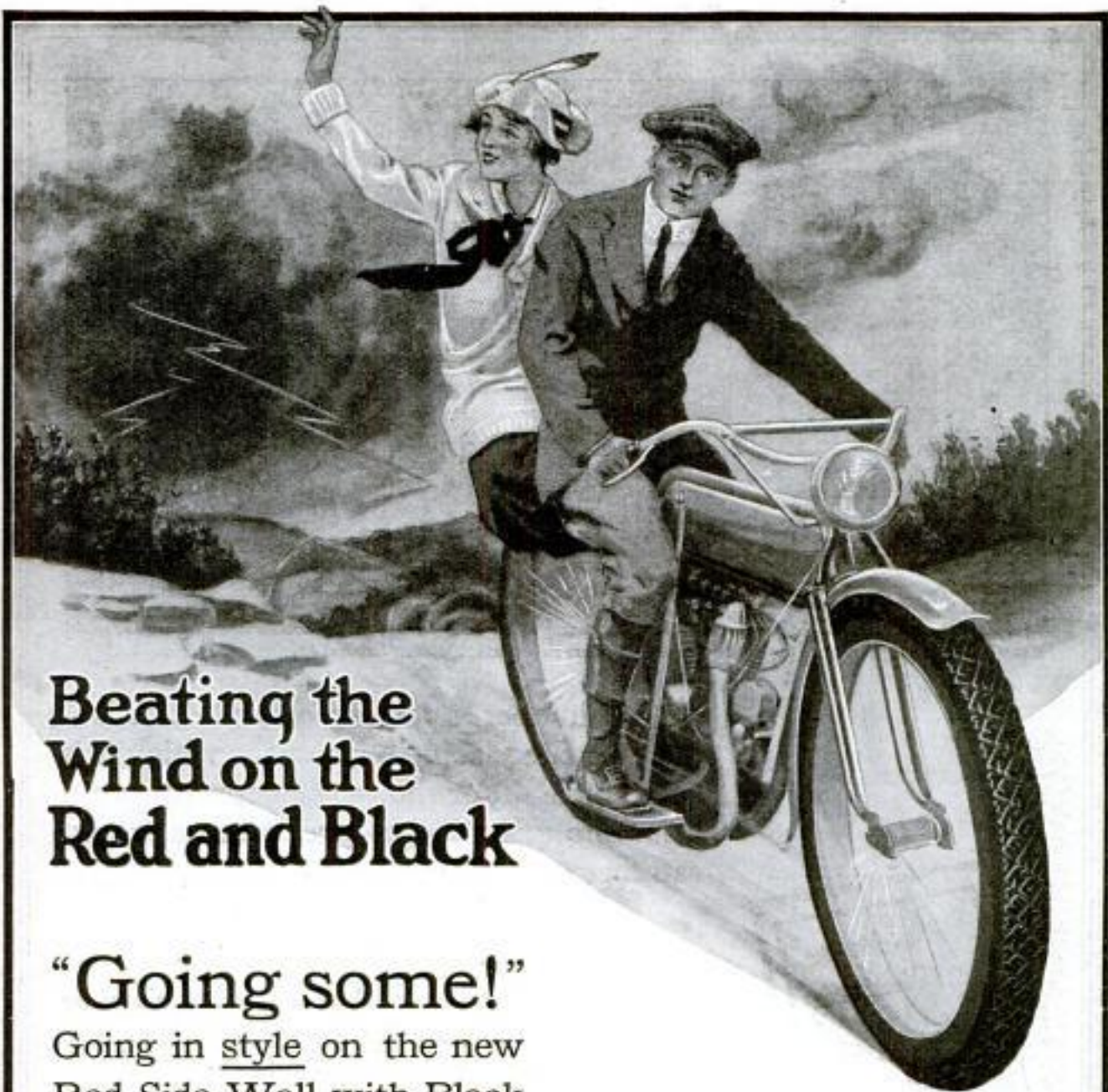

## Beating the Wind on the Red and Black

“Going some!”

Going in style on the new Red Side Wall with Black Tread, now the trade-mark of Firestone Tires. Going in safety—30% more angles against skid in the Firestone Non-Skid Tread.

Going in comfort—ease of mind because the tough, strong tread grips the road and makes sure riding. Ease of body because the tread is not only strong but of Firestone resiliency.

*Your Dealer Has Firestones for His Most Experienced Trade*

Firestone Tire and Rubber Co., *“America's Largest Exclusive Tire and Rim Makers”* Akron, Ohio

BRANCHES AND DEALERS EVERYWHERE

# Firestone Motorcycle Tires



House of George McBride, Esq., Highland Park, Ill. Robert F. Seyfarth, Architect, Chicago, Ill.

**B**UY lumber as you buy other materials—  
for the specific purpose for which it is  
to be used. For the outside covering of a  
house no other wood gives such long and  
satisfactory service as

## WHITE PINE

It does not shrink, swell, crack, twist, warp or rot; and once in place it "stays put," after years of exposure, even in the closest fitting mitres and in delicate mouldings and carvings. It takes paints and stains perfectly.

Investigation of the merits of White Pine will well repay anyone seeking a wise choice of building materials.

If your lumber dealer is unable to supply White Pine, we should appreciate the opportunity of being helpful to you in securing it.

Address, **WHITE PINE BUREAU,**  
1426 Merchants Bank Building, St. Paul, Minn.



"White Pine in Home-Building" is beautifully illustrated and full of valuable information and suggestions on home-building. Send today for this booklet—free to all prospective home-builders.

"The Helen Speer Book of Children's White Pine Toys and Furniture"—a fascinating children's plan book, from which a child may build its own toys and toy furniture. Prepared by Helen Speer, the toy expert. If there are children in your home, sent free on request.

Representing  
The Northern Pine Manufacturers'  
Association of Minnesota, Wisconsin  
and Michigan, and The Associated  
White Pine Manufacturers of Idaho

# Money Grows if rightly planted



## A Yearly Income For Every Man and Woman

Would you save \$10.00 monthly for a few years if you felt assured it would earn for you an income of \$1,500 to \$2,000 yearly? This without a stroke of work on your part. You do not have to leave your present business or employment unless you choose.

That is what a Dixie Estate planted to fancy grapefruit, oranges, and avocados should earn after it begins bearing. Past and present prices for these fruits prove this an EXTREMELY CONSERVATIVE ESTIMATE.

Picture for yourself a cozy home in balmy Florida, beneath beautiful skies, among flowering shrubs and luxuriant money-producing fruit trees. SUCH IS A DIXIE ESTATE, which awaits you whenever your inclination draws you to it.

### SAVE NOW—SMILE LATER

We expect to plant at least 1,000 of these Dixie Estates this year and bring them into bearing for their fortunate owners. Will you be one? Think of this great and unparalleled opportunity!!!

## \$10.00 Monthly Is All You Have to Invest

You are not paying out or spending this money, but saving and investing it in a safe, money-making property—a highly developed fruit grove, which according to statistics should within a few years bring you a substantial income. Think what this really means to you—figure it out for yourself.

## A Dixie Estate Will Insure Your Future

**HERE IS THE ONE INVESTMENT** which must appeal to every man and woman. Whether you are drudging along for a mere living wage—whether you are a merchant or farmer—or whether you have an independent income, you cannot afford to miss this chance to own a Dixie Estate.

Citrus fruit and avocado trees are long lived. This is not a temporary investment, but one which will bring a permanent income and continue to increase in value yearly. Compare this with any investment you have ever heard of—you will have to admit a similar offer has never before been made.

### You Are Planting Money Rightly When You Invest in Dixie Estates

**LOCATION**—the best in all Florida, in the vicinity of Tampa—population, including suburbs, 70,000; growing so rapidly that it is destined to become the Los Angeles of the South. Dixie Estates will be near paved boulevards, railroad stations, schools and churches.

**THE SOIL** is as good as any of the best fruit land in all Florida. You could not buy better land for fruit growing no matter how much you paid for it.

**THE CLIMATIC CONDITIONS** are ideal for fruit growing. A more health giving, charming climate could not be desired.

**THE TREES** are the very finest obtainable—budded, pedigreed stock, grown by experts. Owning extensive nurseries and having years of experience developing Florida lands enables us to develop these Dixie Estates in the most approved, up to date manner.

Fancy oranges and grapefruit are well known money producers, when brought into bearing by expert, scientific methods.

The Avocado (commonly called alligator pear) is known as the aristocrat of fruits. The supply is so limited that in Northern Cities only the rich can afford to pay the extravagant prices it sells for. In December, 1915, Avocados sold in Chicago at the almost unbelievable price of \$3.00 to \$4.00 each. It is no doubt the highest priced fruit known.

**NORTH TAMPA LAND CO.**  
8th Floor Marquette Bldg. CHICAGO, ILL.

**ONE SINGLE AVOCADO TREE HAS PRODUCED \$1,500 IN FRUIT ANNUALLY.** When you realize what a wonderful fruit the avocado is you will understand why we claim that in Dixie Estates (which will contain 20% avocado, 40% grapefruit and 40% orange trees) you are offered a heretofore unheard of opportunity to derive a splendid YEARLY INCOME FOR A SMALL INVESTMENT. The proof is what you want!!! We have it and will gladly send it to you FREE.

**YOUR DIXIE ESTATE** receives expert and scientific care and attention for three years. A grove manager then takes charge if you do not wish to look after it personally. He will care for your Dixie Estate—its development and marketing of fruit indefinitely—for a percentage of the profits. You can receive the benefits of this truly marvelous proposition even if you never intend to live in Florida.

Every one of the several hundred thousand readers of this paper who mail us the coupon below will want a Dixie Estate after reading our illustrated booklet giving detailed information—therefore act at once and be certain of obtaining one of the first locations.

**MAIL THE ATTACHED COUPON TODAY.** We will mail you FREE full information showing you how easily you can become owner of a splendid money making Dixie Estate in the most attractive, most healthful, and delightful district to be found anywhere in America.

**FILL IN AND MAIL COUPON NOW**

**NORTH TAMPA LAND CO.,** P. M. 4-16  
8th Floor Marquette Bldg., Chicago

Please mail me detailed information and free Booklet on Dixie Estates. This does not obligate me in any way.

Name .....

Street No. ....

City.....State.....

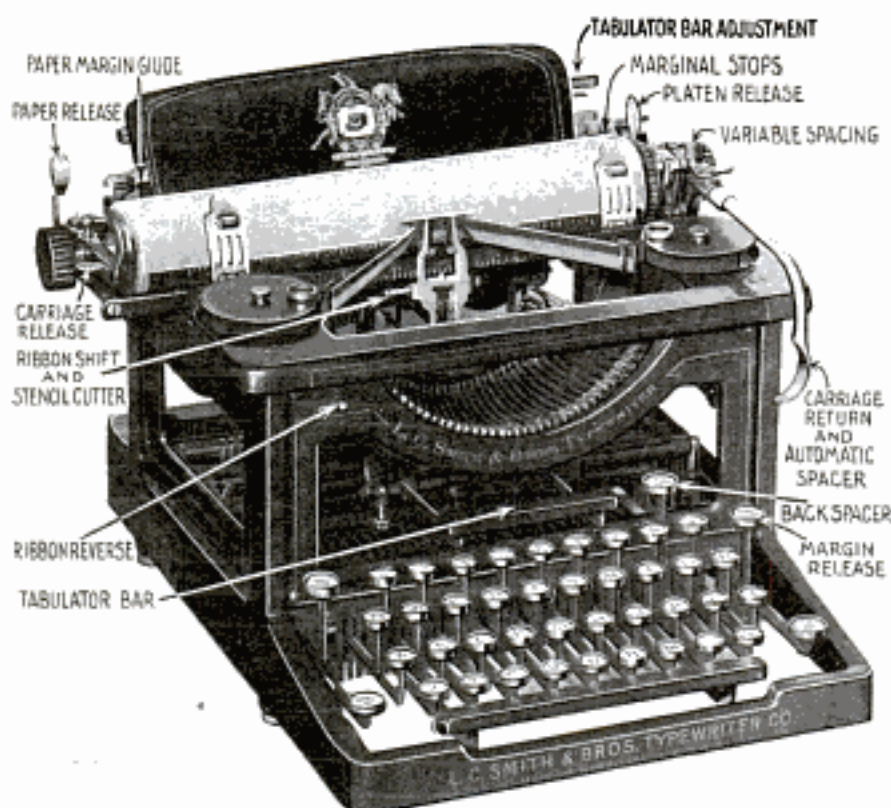

I want, through this advertisement, to establish as friendly business relations with you as I possibly can. I want you to realize also, that it is my earnest effort and intention to give you full honest value for every dollar that you spend with me. This is the only way I can succeed. The publisher of this magazine will vouch for my square dealings during the four years and more my advertising has appeared.

I am building up my business on the foundation of good value and square dealings. I am saving thousands of satisfied customers thousands of dollars, by supplying, perfect—late style—visible writing—typewriters, at remarkably low prices.

All my transactions are handled throughout by personal correspondence. I assure you every courtesy and consideration, in your dealings with me. Your order will have my prompt, careful, personal attention. I will be glad to do business with you.

*Harry A. Smith*

# TYPEWRITER SENSATION

## Free TRIAL—Use As You Pay

Send me only \$2.50 a month until the low total price of \$48.80 is paid, and the machine is yours

This is absolutely the most generous typewriter offer ever made. Do not rent a machine when you can pay \$2.50 a month and own one. Think of it—Buying a \$100.00 machine for \$48.80. Cash price, \$45.45. Never before has anything like this been attempted.

Standard Visible **L. C. Smith** Model Number 2

Perfect machines, Standard Size, Keyboard of Standard Universal arrangement writing 84 characters—universally used in teaching the touch system. The entire line of writing completely visible at all times, has the tabulator, the two color ribbon, with automatic reverse, the back spacer, ball bearing type bars, ball bearing carriage action, ball bearing shift action, in fact every late style feature and modern operating convenience. Comes to you with everything complete, tools, cover, operating book and instructions, ribbon, practice paper—nothing extra to buy.

You cannot imagine the perfection of this beautiful reconstructed typewriter until you have seen it. I have sold several thousand of these perfect latest style Model No. 2 machines at this bargain price and every one of these thousands of satisfied customers had this beautiful, strictly up-to-date machine on five days' free trial before deciding to buy it. I will send it to you I. O. U. Chicago for five days' free trial. It will sell itself, but if you are not satisfied that this is the greatest typewriter you ever saw, you can return it at my expense. You won't want to return it after you try it—you cannot equal this wonderful value anywhere.

**H. A. SMITH**  
Room 510-231 N. Fifth Ave.  
CHICAGO, ILL.

Ship me a No. 2 L. C. Smith F. O. B. Chicago, as described in this advertisement. I will pay you the \$40.00 balance of the SPECIAL \$48.80 purchase price, at the rate of \$2.50 per month. The title to remain in you until fully paid for. It is understood that I have five days in which to examine and try the typewriter. If I choose not to keep it I will carefully repack it and return it to the express agent. It is understood that you give the standard guarantee for one year.

## You Take No Risk—Put In Your Order Now

When the typewriter arrives deposit with the express agent \$8.80 and take the machine for five days' trial. If you are convinced that it is the best typewriter you ever saw, keep it and send me \$2.50 a month until my bargain price of \$48.80 is paid. If you don't want it, return it to the express agent, receive your \$8.80 and return the machine to me. I will pay the return express charges. This machine is guaranteed just as if you paid \$100.00 for it. It is standard. Over one hundred thousand people own and use these typewriters and think them the best ever manufactured.

The supply at this price is very limited, the price will probably be raised when my next advertisement appears, so don't delay. Fill in the coupon today—mail to me—the typewriter will be shipped promptly. There is no red tape. I employ no solicitors—no collectors—no chattel mortgage. It is simply understood that I retain title to the machine until the full \$48.80 is paid. You cannot lose. It is the greatest typewriter opportunity you will ever have. Do not send me one cent. Get the coupon in the mails today—sure.

**HARRY A. SMITH, 510-231 N. Fifth Ave., Chicago**

Name .....

Address .....



# Genuine Imported English Serge

Made - **\$14.50**  
to-Order  
For Only

**G**LENN Urquart Plaids—Tartan Plaids, Shepherd Plaids, Fancy and Pencil Stripes, Two tone stripes. Your choice of any cloth, plain or fancy weaves, rough mill finish or smooth finish—tailored to your own measure at prices that will astound you.

Send the coupon for our new Style Book and read of the remarkable bargains in tailored-to-measure clothing. Newest fabrics—at prices never before equaled by any other high-grade house.

The Imported English Serge is but one of the bargains we offer. Just think of it! A genuine Imported English Serge—made to your measure for only \$14.50.

Pay \$4.50 first and the balance in small monthly payments. Your credit is good.

## On Credit!

You do not pay a cent unless you are delighted with the suit—after it has been tailored to your own measure. See for yourself before you decide to buy. Note the perfect fit—note how carefully it is made in the latest style—compare it with any other suit you ever bought—then, if you are not satisfied, send it back.

If you decide to buy—you may pay the bargain price—a little each month. Your credit is good

## New Style Book

and Samples of the Latest Fabrics—FREE

Send the coupon for our Style Book and samples at once. See for yourself the astounding bargains

we are making. Examine carefully the newest fabrics. See handsome illustrations of the latest New York styles. The Style Book is free—write for it today. You will be under no obligations—and your name will be recorded so that you can take advantage of these great price reductions made for introductory purpose.

## Send the Coupon

For free colored Style Book and samples of the newest fabrics for suits and overcoats. We can have your suit ready in 10 days. Send for booklet and free imported samples.

**Babson Bros.** Dept. 1194  
19th Street Chicago

**Babson Bros.**  
Dept. 1194 Chicago

Gentlemen:—Please send me your free colored Style Book and samples of fabrics for suits and overcoats. Also explain your easy credit terms.

Name .....

Address .....



**Goodness, man! I hardly recognized you  
—I never saw you looking so well—been away?**

"No sirree! I've been as hard at it as ever, but I take what I call my concentrated vacation, golf, rest cure and exercise with every meal and before I go to bed." "Give me the recipe—or is it a prescription?" "No—it's a liquid-food- tonic. As you know, my Doctor ordered a complete rest—when I showed him *that* was impossible he said

**ANHEUSER-BUSCH'S**  
*Malt-Nutrine*

REG. U. S. PAT. OFF. TRADE MARK

**Liquid-Food-Tonic**

An aid to digestion—a nourishing, strengthening tonic. Taken before retiring, an aid to sound sleep. Recommended for the overworked, the anaemic and the under-nourished."

Don't let anyone tell you there's something as good. There are some cheaper preparations—calling themselves malt preparations—they are beverages, not tonics. Malt-Nutrine is rich in malt—that's what makes it cost more than imitations and what gives it its value to you. Insist.

**All Druggists—Most Grocers**

Malt-Nutrine declared by U. S. Internal Revenue Department to be a pure malt product, not an alcoholic beverage. Contains 14.50 per cent malt solids—1.9 per cent alcohol.

*Interesting Booklet on Request.*

**Anheuser-Busch St. Louis, U. S. A.**





**MEN!****Big Money  
For YOU**

**In the Tire  
Repair Business  
\$250 A Month  
AND UP  
With This New Machine**

**No Guess-Work About It** There are nothing but facts to prove that you will make a success—**Big Money, Yearly, Repairing and Retreading Automobile Tires.** No matter where you go, where you live—on the farm, in a town, in the city—everywhere there are automobiles—millions of them and all with tires to repair. **Get into this business** at the beginning of its most prosperous period. **Fifteen Million Tires** will be made this year and every one will need repairing. More tires than in all time before. **Success, Wealth, Power and Independence—\$3,000 a year** and up, from the start, awaits any man with ambition, nerve and energy—the man who is tired of working for others—who is seeking to break all bonds of low wages—who strives for something better in life and **who can see this opportunity before him.** Write today for big book of facts on the tire repair business. **Investigate** by mailing the coupon below.

## Haywood's 1916 Tire Repair Plants

Complete machines that do all the work—**Vulcanize** and mend tires from the smallest puncture to Retreading. Every plant is the last word in efficient and economical tire repairing. Business comes easy as soon as people find out that you repair tires with Haywood Equipment. It means work that satisfies—work that brings back the customers—all at big profits to you.

### Punctures & Blow-outs Common

Autoists clamor for tire repair work. Not a day passes but thousands of tires blow up. Thousands of punctures are made. Repairing is a necessity. The work has to be done. It will come to your shop and pay you **big profits** if you make a bid for it.

### A Year Round Business

Autos are used both summer and winter. No dull seasons. Keep busy day in and day out. One

## Get All the Facts From Big FREE CATALOG

Learn all the secrets of this proposition. A big **FREE CATALOG** gives all details. Tells all about tires and how to repair them. Shows outfits in use. Gives actual proof of successes—Letters from men who have already started and are well on their way to success and fortune. What these men have done, **you can do**, and maybe better. There is really an important message for every ambitious man in this valuable book. Send your name and address at once. Use the coupon—a letter or post card.

**Haywood Tire & Equipment Co.**  
609 Capitol Ave. Indianapolis, Ind.

machine will give you a start—a small investment—\$50 and up, trifling for such a big proposition. You build a big business from there. You are soon a manufacturer—your own boss and making the big end of the profits instead of the small.

### No Experience Necessary

Not even a knowledge of tires. We teach you the work when you get a machine. **You learn in a week to handle all kinds of jobs.** Just follow directions is all that is necessary. Do the work yourself at the start. **Open a small shop.** You don't need a store. You can start in your home if you prefer. It's well worth your while to investigate this opportunity. **Be the first in your town.** Fortunes are to be made while the business is yet young. This coupon or post card brings complete information. Send it today.

## FREE CATALOG COUPON

**M. E. HAYWOOD, Pres.**  
Haywood Tire & Equipment Co.  
609 Capitol Ave.  
Indianapolis, Ind.

Dear Sir: You can send me your book and full particulars about your tire repairing device. This, of course, without any obligation on my part.

Name .....

Address .....



## You Take No Risk

This Razor is  
**GUARANTEED FOR LIFE**

This Shumate "Barber" razor is so good that we dare guarantee it to you for *life*. Here's the reason—the blade is made from Tungsten Alloy Steel, which takes a keener edge than any ordinary steel can—and it holds it. You can use it for years without honing. The secret of this wonderful steel is *ONE* alone, and we guard it jealously.

Here's our *unqualified guarantee*: Buy a Shumate "Barber" razor and use it—not once, but as long as you like. If you say after an exacting trial that you don't like it, we'll exchange it *without a word*.

Sent postpaid, **\$2.00**

In remittance, mention your dealer's name, and a chamois lined, rust-proof case will be included with your razor.

State whether you want light, medium or heavy blade. Heavy blade for very strong beards.

Established 1884  
Output 6,000 razors daily

**Shumate Razor Co., 682 Locust St., St. Louis, U. S. A.**



### 300 Candle Power of Light at a Cost of 1-8c Per Hour

Burns Kerosene or Gasoline

This lamp generates and burns its own gas from ordinary kerosene. "QUICKLIT" gasoline lamps can be lit with an ordinary match like city gas.

Write today for illustrated catalog of our complete line of kerosene and gasoline lamps, lanterns and lighting systems. **Agents Wanted**

**The Nagel-Chase Mfg. Co.**  
176 East Erie St., Chicago

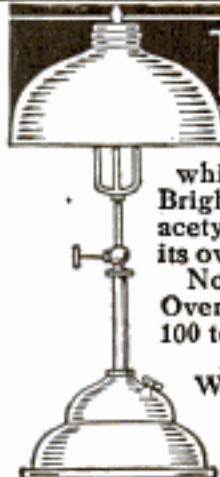

### The "BEST" LIGHT

A soft, luminous light, which casts no shadow. Brighter than electricity or acetylene. Makes and burns its own gas. Costs 2c a week.

No dirt, smoke nor odor. Over 200 styles, ranging from 100 to 2000 candle power.

Absolutely guaranteed. Write for illustrated catalog.

**AGENTS WANTED EVERYWHERE**  
**THE BEST LIGHT CO.**  
324 E. 5th St., Canton, O.

SUPERIOR SINCE 1903

A limited number of slightly Trial-Worn and agents' demonstrating samples, will be sold, while they last, for **\$5 CASH WITH ORDER** subject to refund after 10-day trial. Guaranteed to be in perfect operating condition for at least 1 year.

E. Gaecher A.A.M. Co., 140 Duane St., New York



**Golden Gem**  
PORTABLE  
Adding Machine

Multiplicates - Subtracts



**HERE YOU ARE, BOYS** A medalion pin of Foxy Grandpa. Everyone will notice it on the lapel of your coat and try to get a closer look at it. All you have to do is press the bulb.—Foxy Grandpa will finish the job by squirting a fine stream of water over the inquisitive one. Will squirt 20 feet. Greatest joke out. Order one today and fool your friends. Price 35c. Foxy Grandpa and Hoodlum both for 25c. 5 for 50c or 1 doz. for \$1.00. A beautiful fountain pen free with every \$1.00 order.  
**AMERICAN SUPPLY CO., 918 Union St., St. Paul, Minn.**

**NEW PAROLE METHOD USED IN OHIO**—A novel parole system for workhouse prisoners is being tried in Dayton, Ohio. If a prisoner behaves himself properly when he enters the institution, he is turned over to the municipal parole board. That body finds out what sort of work he can do best, and proceeds to get him a job somewhere in the city. The prisoner



### BEACON BURNER FREE

FITS YOUR OLD LAMP

100 Candle Power Incandescent pure white light from (kerosene) coal oil. Beats either gas or electricity.

**COSTS ONLY 1 CENT FOR 6 HOURS**

We want one person in each locality to whom we can refer new customers. Take advantage of our Special Offer to secure a Beacon Burner **FREE**. Write today. **AGENTS WANTED.**

**HOME SUPPLY CO., 111 Home Bldg., Kansas City, Mo.**

### START A MOVING PICTURE SHOW

#### MAKE MONEY FAST

COMPLETE OUTFIT, MACHINE, FILM AND EVERYTHING FURNISHED. EASY PAYMENT PLAN. NO EXPERIENCE NEEDED. WRITE FOR FREE CATALOG

**NATIONAL MOVING PICTURE CO.** Dept. P., Ellsworth Bldg., CHICAGO

### TYPEWRITERS ALL MAKES ALL PRICES

Look at these bargains! Typewriters Rebuilt in our own Factories and guaranteed for one year.

Remingtons \$15 to \$65 Smiths \$18 to \$50

Underwoods \$25 to \$65 Royals \$30 to \$45

L. C. Smiths \$28 to \$60 Oliverts \$23 to \$45

Brand new No. 2 Smith-Premiers \$45

We have others, of course. Send for catalog describing them. Branch offices in principal cities.

**American Writing Machine Co., Inc., 345 Broadway, N. Y.**



# DIAMONDS

ON CREDIT

20% DOWN

10% A MONTH

The most beautiful Diamonds are the Blue-white, especially if absolutely perfect. **THE MOST BEAUTIFUL DIAMONDS ARE 1st Quality, Blue-white.** A certificate furnished with every Diamond guaranteeing its value and providing for exchange at full purchase price. Goods sent prepaid for examination and approval. Write for Catalog No. 3.

**J. M. LYON & CO.,** 10 per cent DISCOUNT FOR CASH  
(Est'd 1842) 71-73 Nassau St., NEW YORK.





## The Smoke of the U. S. A.

That snappy, spirited taste of "Bull" Durham in a cigarette gives you the quick-stepping, head-up-and-chest-out feeling of the live, virile Man in Khaki. *He* smokes "Bull" Durham for the sparkle that's in it and the crisp, youthful vigor he gets out of it.

GENUINE  
**"BULL" DURHAM**  
 SMOKING TOBACCO

"Roll your own" with "Bull" Durham and you have a distinctive, satisfying smoke that can't be equalled by any other tobacco in the world.

In its perfect mildness, its smooth, rich mel-

low-sweetness and its aromatic fragrance, "Bull"

Durham is unique. For the last word in wholesome, healthful smoking enjoyment "roll your own" with "Bull" Durham.

THE AMERICAN TOBACCO COMPANY

Ask for FREE  
 package of  
 "papers" with  
 each 5c sack.



Please Mention Popular Mechanics



"Wire Your Home"  
Month  
March 15—April 15



## Wash With Electricity Without Muss or Fatigue

Right in your own laundry—in the electric light socket—is all the power necessary to do your washing. Why go on with the old-fashioned washboard or hand-washer way? Why not take advantage of the help so close at hand and which costs so little?

The newest, most useful, most convenient laundry appliance is the

# Western Electric Washer and Wringer

No paddles, agitators or other contrivances to mash, twist or tear the clothes. No injury to most delicate laces. The wringer is reversible. All mechanism is enclosed.

You can arrange for a *Two Weeks' Trial* in your own home. Take advantage of this opportunity. Write to us for particulars. Drop a post card to our nearest house, and ask for Booklet No. 91-AW.

**WESTERN ELECTRIC COMPANY**  
INCORPORATED  
463 West Street, New York      500 South Clinton Street, Chicago  
Houses in All Principal Cities



Get this  
Free Book  
Write  
Today!



### Learn How to Make Home Ironing Easy!

Housewives everywhere are now doing their entire ironings—except dresses and shirt-waists—on the labor-saving Simplex Ironer. All work beautifully done in  $\frac{1}{4}$  the time, and at fraction of usual cost.

**SIMPLEX IRONER**  
THE BEST IRONER

#### 30 Days' Free Trial. Easy Terms

Iron Tablecloths, Napkins, Dollies, Centerpieces, Dresser Scarfs, Curtains, Sheets, Bedspreads, Pillow Cases, Blankets, Towels, Handkerchiefs, Underwear, Kitchen Aprons, Night Dresses, Pajamas, Hosiery, Children's Play Suits—and many other things.

Illustrated Free Book shows beautiful work done. Write for it.

**AMERICAN IRONING MACHINE CO.**  
505, 168 N. Michigan Avenue, CHICAGO  
(24721)



Please Mention Popular Mechanics

then goes to work every day, as if he were a free man, except that in the evening he returns to the work-house and is locked up for the night.

When the prisoner gets his pay, he is required to bring the envelope sealed to the superintendent. It is



### 3 YEARS TO PAY

**Meister Piano** 30 days free trial  
in your own home

\$1 A WEEK or Price \$175.00  
\$5 A MONTH

No cash payment down. No interest—no extras. Piano stool and scarf free

**ROTHSCHILD & COMPANY**  
Dept. 16T CHICAGO, ILL.

**Fenestra** On  
the  
Ground  
When  
Needed  
SOLID STEEL WINDOWS  
"REG. U.S. PAT. OFF."

In Standard Units Shipped in 10 Days.  
Write for Table of Dimensions.  
DETROIT STEEL PRODUCTS CO., Dept. D6, Detroit

## WE PAY CASH

For Diamonds, Jewelry, Watches, Old Gold, Silver, Platinum, Emeralds and Pearls. Send any old jewelry and turn it into cash.

### WE PAY HIGHEST PRICES

Send by Registered Mail or Express. We guarantee to pay highest prices. We remit cash the same day goods are received. If our offer is not satisfactory, we return goods at our expense. All business strictly confidential. References: Colorado National Bank, Denver, Colo. Capital and Surplus \$2,000,000.00.

**COLORADO JEWELRY MANUFACTURING CO.**  
1524 1/2 Champa St. Established Diamond Importers DENVER, COLO.

# Three Cents a Day



**THAT'S ALL**  
—just three cents. Too little to think about. Too important to neglect.

**Yet it will enable you to Aetna-ize yourself and your family so as to provide as much as \$3,250 insurance if you should be accidentally killed, to furnish an income if you are disabled by accident, to supply at once \$250 cash if you should die a natural death. (\$50 added to above payments, for death, if you insure while under 40 years of age.)**

**Just three cents a day, if you are in "Preferred" occupations, will stand between you and yours and the want which often follows upon the unexpected loss or injury to the bread-winner. Don't think that just because you have never had an accident you are safe.**

**One of every seven men is accidentally killed or injured each year. You can't be careful enough to prevent all possibility of accident, but you can be careful enough to protect yourself and those dependent upon you.**



## AETNA-IZE



Send in the coupon today and let us tell you all about the **AETNA Ten Dollar Combination Policy**, which gives a wide range of protection at such low cost. Let us tell you how it pays \$2,000 for death or loss of limbs or sight from a travel, elevator or burning building accident; \$1,000 for death or loss of limbs or sight from an ordinary accident; how it pays half of the above amounts for loss of one limb or sight of one eye; how these amounts increase 10 per cent. each year without extra cost; how weekly indemnity

is paid for total and partial disability from accident; how \$250 life insurance is paid for death from any cause, natural or accidental.

If you already have accident insurance, you need this policy too. If you have none, you need this all the more.

**Send in the coupon and let us tell you what you can get for three cents a day.**

### AETNA LIFE INSURANCE COMPANY

Drawer 1341

HARTFORD, CONN.

*The largest company in the world writing Life, Accident, Health and Liability Insurance*

**Agency opportunities for all Casualty and Bonding lines.**

An Aetna Agent has a national advertising campaign working for him all the time.

Name..... P. M. 4-10  
Occupation.....  
Bus. Address.....  
AETNA LIFE INSURANCE COMPANY  
Drawer 1341 HARTFORD, CONN.  
I have marked the kinds of insurance  
Health  Disability  \$250  
Life Certificate  My  
Age is..... years. I  
am in good health.

Please Mention Popular Mechanics

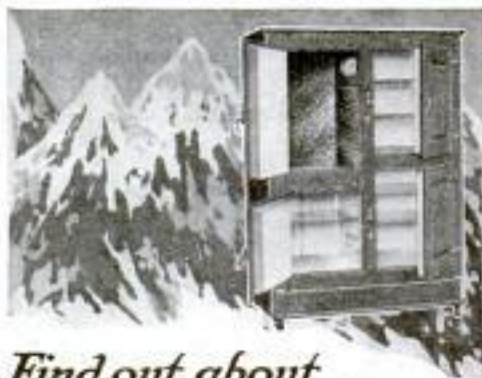

Find out about  
the **GLACIER** before  
You Spend Your Refrigerator Money

Send for the wonderful free Glacier Book — a Nature-story of the frozen North and greatest presentation of refrigerator facts ever written. Learn why the Glacier Refrigerator keeps food cold, clean, sanitary. Why the solid one-piece white porcelain lining, and ten walls keep out heat and keep in cold. See how easily cleaned. Approved by Good Housekeeping Institute. 100 styles. We pay freight.

### GET THE BOOK

The Glacier Book tells how to protect health by storing food in circulating fresh air. Get it BEFORE you spend that refrigerator money. The Glacier Book tells you why the Glacier is YOUR kind of a refrigerator — full of hard-fact truths. Write today. It will PAY you WELL.

**NORTHERN REFRIGERATOR CO.**  
776 Crofton Ave., Grand Rapids, Mich.

Try My **Rapid** Fireless Cooker  
30 Days—FREE



Cook every meal on it. If you are not satisfied and delighted I will refund every cent. Get my **SPECIAL LOW FACTORY PRICE**

direct to you. Cooker is aluminum lined throughout. Full set of famous "Wear Ever" aluminum cooking utensils comes with it. Ask for free book of valuable recipes.  
**WILLIAM CAMPBELL CO.**  
Dept. 64, DETROIT, MICH.



**Print Your Own**

Cards, circulars, book, paper. Press \$5. Larger \$15. Rotary \$30. Save money. Print for others, big profit. All easy, rules sent. Write factory today for catalogue of presses, TYPE, cards, paper, samples. It will pay you well.  
**THE PRESS CO.** Meriden, Connecticut

Write for the Wholesale Price

**A Kalamazoo**  
Trade Mark Registered  
Direct to You

## Get This All Metal, Snowy White KITCHEN KABINET

direct from Kalamazoo factory. Unlike any other kitchen cabinet—sanitary, easy to keep clean as a china bowl; sweet smelling; cannot warp; easy sliding doors; good for lifetime use.

Write today for offer on **Free Trial, Cash or Credit**

Now is the time—save work when housecleaning. We pay freight—ship within 24 hours—30 days' trial, 90 days' approval test, \$100,000 guaranty.

**FREE** 8-piece crystal set, white glass rolling pin, patented bread board with each cabinet. Write today for prices and beautiful art catalog No. 15.

**KALAMAZOO STOVE COMPANY**  
Manufacturers—Kalamazoo, Michigan

We also make gas ranges, furnaces, and 500 styles of stoves and ranges. We have four catalogs—state which you want.



## Cut Cost of Your Furniture In Two

Any Piece Assembled in Ten Minutes

Shipped in sections, knock-down—saves factory space—packing costs and freight charges. Direct from factory to you saves dealer's expenses and profits.

"Period Furniture"—over 100 designs—everything for the home, office or club. Every piece from selected quarter sawed oak.

Hundreds of dealers are assembling Brooks "Master-Built" Furniture in their stores and selling it from forty to fifty per cent above our prices.

### Home Exhibitors Wanted

Exchange spare time for furniture or cash commissions. A new business for men or women. We ship from a single piece to en-load lots. Free Catalog with full particulars.

**Brooks Mfg. Co.**  
2704 Rut Ave., Saginaw, Mich.  
Largest Plant of Its Kind in the World



\$40 Value at  
**\$19.75**

Extension 48 to 84 in.

**\$9.75**

Worth \$17



Rocker No. 10  
Height, 35 in.  
Width, 21 in.; Depth, 21 in.



50x63x15 in.  
Desk and Bookcase  
Value \$60 Price \$29.75

then opened in the presence of the man's family, and the money is apportioned as the superintendent sees fit. The system seems to work admirably in the case of men committed for failure to support their families, says the Jacksonville Metropolis. One prisoner, it is reported,



## Amazing Profits In Mushrooms

Anybody can add \$10 to \$40 per week to their income, in spare time, entire year growing mushrooms in cellars, sheds, barns, boxes, etc. I tell you where to sell, at highest prices.

Free Illustrated Instruction Booklet

**HIRAM BARTON**  
Desk 2, 329 W. 48th St., New York

IF IT ISN'T  
**AN EASTMAN**  
IT ISN'T A KODAK

# Our \$10,000 Plan Books Have at Least One Plan That Will Exactly Suit You!

**Send For Them Today—Free!**

The houses illustrated in this advertisement are but three out of over 300 shown in our two big \$10,000 Plan Books. Full details—photographs—floor plans—color schemes—wholesale prices. Despite the cost, we will send these books Free to home builders. Get your copies. Contain hundreds of ideas, space saving plans, new wrinkles, home suggestions that a woman will appreciate, and all facts about our famous "factory-direct-to-you" selling plans.

**Buy Your Home at Factory Prices  
Save \$200 to \$800 or More**

You take no risk; 100,000 customers vouch for us. Ask your Bank about us. Each house built hundreds of times—in every state. Every house bought by mail. Highest quality. Wholesale prices. Guaranteed figures—no "extras"—no "come-backs." Either

**Ready-cut Homes or Standard  
Material!**

Buy on the method you prefer. Ready-Cut Homes—all material cut to fit—"we saw them; you nail them!" Standard Homes—material in the standard way. All at factory prices! Save enough to buy your lot.

**Shipped Anywhere—Satisfaction  
or Money Back**

Safe, prompt delivery guaranteed no matter where you live. Freight paid both ways if you are not satisfied. Send coupon now for 2 big books of 300 plans, photos, color schemes, exact prices! Houses \$425 up. Also 156 page illustrated catalog of 5000 Building Material Bargains. All Wholesale. See all these books before building. Write today!

**Gordon-Van Tine Co.**

805 Federal Street, Davenport, Iowa

*Established Half a Century*

**3 BIG BOOKS FREE!**

GORDON-VAN TINE COMPANY, 805 Federal St., Davenport, Iowa

Please send me Free the books checked.

- |  |   |   |
|--|---|---|
| <input type="checkbox"/> Standard Home Plan Book       | <input type="checkbox"/> Ready-Cut Plan Book                          | <input type="checkbox"/> 5000 Building Material Bargain Catalog |
| <input type="checkbox"/> Garages—Portable or Ready-Cut | <input type="checkbox"/> Hot Beds and Greenhouses for the Home Grower | <input type="checkbox"/> Summer Cottages                        |

Name.....

Street No.....

City..... State.....



Please Mention Popular Mechanics

Copyrighted material



## Boston Garter

*Velvet Grip*

The maximum of worth is found in the "Boston"

Silk 50c Lisle 25c

GEORGE FROST CO. BOSTON

Countless generations of American marksmen bred your boy's natural craving for the new

# DAISY

## Pump Gun

50-Shot Repeater \$3.00  
Other Daisy Air Rifles 50c to \$2.50

*At all Dealers or direct from Factory*  
DAISY MANUFACTURING COMPANY  
PLYMOUTH, MASSACHUSETTS

"The Happy Daisy Boy"

## BOYS!

### Automatic-Repeating Pistol

SHOOTS a hole in a paper tape—fifteen hundred loud reports from one charge. Made of blued gun-metal—8 inches long—easy action—absolutely harmless—no powder or projectile—permitted in any community.

**FIVE EXTRA ROLLS FREE**

# \$1.00

THE AIRMATIC PISTOL CO.  
370 Citizens Building CLEVELAND, OHIO

Postage prepaid anywhere U. S. or Can.

12, 16 or 18 size **\$2.50 a Month**



Here's your chance to own a world standard Masterpiece at the lowest price on the Easiest Terms ever offered. We'll send you your choice of a fine \$30.00 Factory New 17-Jewel Illinois, Elgin or Waltham, exactly timed; regulated to the second, guaranteed accurate and durable, in a Superfine 20-year Gold-filled Case, for only \$2.50 down and \$2.50 a month for 7 months. You save \$10. Send now for your choice of these fine watches for Free Inspection before you pay a penny. Satisfaction or money back.

SUTTON WATCH CO., 202 Keller Bldg., Louisville, Ky.

## THE BEST AMERICAN MAKE ARROW COLLARS

2 for 25 cents



### 3 CUSTOM SHIRTS FOR \$5.00

I make shirts that fit you, because I make your shirts from your measurements and guarantee to take them back if they do not satisfy you.

I send you 100 samples to select from.

I send you measurement blank with rules. I send you the finished shirts express prepaid. No ready-made shirts in my shop, but facilities for quick delivery of the highest grade of custom work. Write for my samples. (Higher-priced fabrics, too.) Spring and Summer samples now ready. No agents.

CLARENCE E. HEAD (Master of Shirtecraft), 110 Cayuga Street, ITHACA, N. Y.

A Baseball Jersey



### Be the First in Your Club

School, City or Town, to wear this pure, all wool sweater, double collar and cuffs. Your choice in colors. This jersey was selected by 10,000 of my customers for last season. Your club will recommend it. My 1915-1916 catalogue is now ready. Write me and learn my offer for your club's order. Popular Prices. Best Grade Sporting Goods—Baseball, Basketball, Tennis, Golf, etc.

WRITE ME NOW.

JACK SHANNON CO., Dept. 46, 54 E. Monroe St., Chicago

OVER 70 YEARS' EXPERIENCE

# PATENTS

TRADE MARKS  
DESIGNS  
COPYRIGHTS, &c.

Anyone sending a sketch and description may quickly ascertain our opinion free whether an invention is probably patentable. Communications strictly confidential. HANDBOOK on Patents sent free. Oldest agency for securing patents. Patents taken through Munn & Co. receive special notice, without charge, in the

## Scientific American.

A handsomely illustrated weekly. Largest circulation of any scientific journal. Terms, \$3 a year; four months, \$1. Sold by all newsdealers.

**MUNN & CO.** 672 Woolworth Bldg., NEW YORK

Washington Office, 625 F St., Washington, D. C.





Heats Big House  
for only \$35.

**Coal Bills GUARANTEED**  
Reduced  $\frac{1}{2}$  to  $\frac{2}{3}$  the  
**Williamson UNDERFEED Way**

They have cold winters in Wisconsin. Zero and the mercury are on friendly terms all winter long. So that when you read of an eight room house being heated for \$35, and the coal bill reduced 45% the UNDERFEED Way, you owe it to yourself and your pocketbook to consider carefully what is said.

Let the letter speak for itself: "The UNDERFEED was installed in my house about two years ago, and will say that I am perfectly satisfied. House has 8 rooms and bath, and not small rooms at that. The first year I used about \$37 worth of coal, and this last year about \$35 worth. The entire house was kept warm. In the last two years I saved not less than forty-five per cent of my fuel bill with every room warm."

(Signed) SAMUEL ISELY, Monroe, Wis.

We can show you thousands of such letters that indicate how you can save  $\frac{1}{2}$  to  $\frac{2}{3}$  of your coal cost the New-Feed UNDERFEED Way, GUARANTEED, mind you, and have your home heated comfortably from top to bottom all winter long as well.

**WILLIAMSON CUT**  
**NEW-FEED COAL**  
**UNDERFEED BILLS**  
Furnaces and Boilers  $\frac{1}{2}$  to  $\frac{2}{3}$

The New-Feed UNDERFEED burns coal on the "candle" principle. The fuel supply is always below the fire. No heat is wasted because the fire does not have to fight its way up.

### Save Before You Spend

Because of its scientific feeding principle, the New-feed UNDERFEED burns the cheaper grades of coal as effectively as others burn the expensive grades. Thus you are sure of a great saving of real money before you order your coal. In the UNDERFEED, coal is fed from below, so that the clean live fire is always on top, where it will do the most good. Fire is never smothered by fresh coal being dumped on. It is never chilled by opening of top-feed doors. There is no smoke, soot, or gas, because these valuable heat elements must pass up through the fire, and thus be transformed into heat and every particle of coal is burned to a clean white ash. No clinkers. No partly burned coals.

### A Boy Can Run It

There is no tiresome stooping with the New-Feed UNDERFEED. A few easy strokes of the handy lever and the firepot is full. The operation throughout is simplicity itself.

Mail the attached coupon today and we will send you, free, the interesting book, "From Overfed to Underfed," which pictures and describes it all. You will be glad to own this book. It solves many a heating problem. Some day it will save you real money. No obligation in asking for it. Send the coupon today—NOW.

The Williamson Heater Co.

175 West Fifth Avenue Cincinnati, Ohio

The Williamson Heater Co. 175 West Fifth Ave. Cincinnati, O.

Tell me how to cut my coal bills from  $\frac{1}{2}$  to  $\frac{2}{3}$  with a Williamson New-Feed. Warm Air.... Steam or Hot Water.... (Mark X after system interested in)

Name..... Address.....

My Dealer's Name is.....

DEALERS: Let us tell you about the New-Feed UNDERFEED and our new proposition. Both are winners.



## AGENTS—Make \$100 to \$300



per month easy selling our new Triplicate Sauce Pan. Cooking utensil for 3 different foods on one burner. 400 Specialties — all Whirlwind sellers. Write quick for exclusive territory and large catalogue. AMERICAN ALUMINUM MFG. CO. Div. 5 61 LEMONT, ILL.



## FREE BIG BOOKLET TELLING HOW TO GROW MUSHROOMS

at home all the year. Big profits. Take advantage of this wonderful opportunity to become independent. Write Nat'l Spawn Co., Dep. 12, Boston, Mass.

Hand Forged  
Razor Steel  
Blades. No. 57

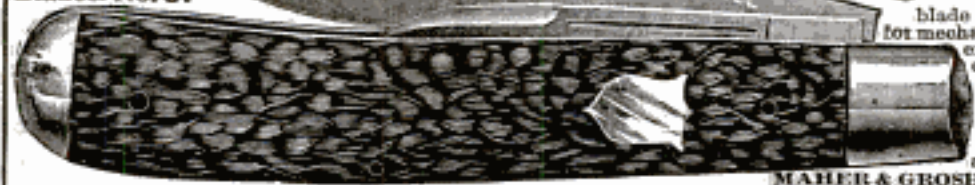

This \$2 KNIFE 83¢  
DIRECT AT FACTORY PRICE

Handy shaped blade makes this knife best for mechanics, sportsmen and farmers; light but strong; resharpened easily. Stag handle, German silver finish; blades file tested, hand forged from razor steel and warranted. Sample 83¢, 3 for \$2 postpaid. Cheapest post \$2 each. Send for our 80 Page List and "How to use a Razor" FREE

MAHER & GROSH CO., 106 A. St., Toledo, Ohio.

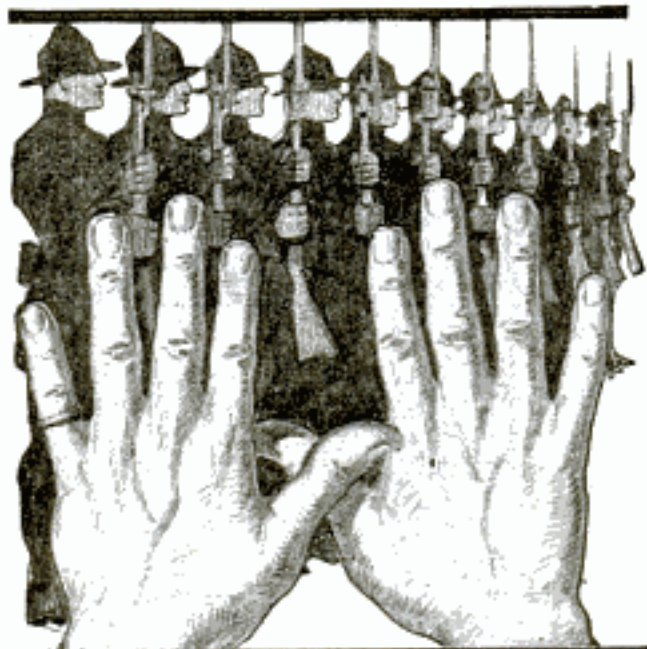

## Your Ten Soldiers

**BEN FRANKLIN** said that everybody owned ten good fighting men—five on each hand.

You can't afford to risk their usefulness with clumsy, makeshift gloves. Efficiency demands the help in the flexible, protecting

# HANSEN GLOVES

Whatever work you do your hands are world-factors. It's good business to keep them in condition. Write for definite information on your special glove.

Our free book shows many of the 500 styles—a glove for all—motoring and driving; work or "dress-up." If your dealer is not supplied, write us. Be sure to get the book. No obligation.

**O. C. Hansen Manufacturing Co.**  
291 AN Milwaukee St. Milwaukee, Wisconsin

## Hatch by Electricity

Newest, most up-to-the-minute incubator. **OAKES WONDERFUL "Electric Hen"** Gives steadiest, most exact heat. Does not dry out eggs. All metal, double walls and insulation, large glass top. Oakes famous appliances. Egg tester free. Works from ordinary light socket. Safe, clean, sure. Costs so little to run you can't afford to bother with greasy "smelly" oil lamps. Write quick for book of "Facts."

**Oakes Mfg. Co., Dept. 10, Tipton, Ind.**  
Eastern Branch, Dept. 10, 64 Cliff St., New York City, N. Y.



## SMALL ENGINES

Perfected Gasoline Engines— $\frac{1}{4}$ , 1 and  $1\frac{1}{2}$  h. p.—for Farm and Shop use. Price \$19.50 and up. Also

## INCUBATORS

We ship on trial. Send for Booklet and Special Offer.  
**SIEVERKROPP ENGINE CO.**  
1224 18th St. RACINE, WIS.

## STARTER for FORD CARS

Please Mention Popular Mechanics

Furnish Your Home Out of the New

## "COME-PACKT" Catalog

Send for it today. See what it saves you on beautiful furniture. See the wonderful choice it gives you at low cost. Then begin to make your home a Come-Packt home, as thousands are doing.



Come-Packt Furniture, designed by famous furniture craftsmen, is sent to you in sections direct from the factory, saving intermediate profits and much freight. Write today.

ADDRESS

**COME-PACKT FURNITURE CO.**  
401 Dorr St., Toledo, Ohio

## BIG CHANCE FOR AGENTS



### You can earn BIG MONEY

selling the most complete line of guaranteed transparent handle Knives and Razors with Photo, Name and Lodge Emblem—also full line of cutlery. Write today for catalogue and terms, **Golden Rule Cutlery Co., 554 W. Lake St., Dept. 327, Chicago, Ill.**

## POULTRY PAPER

44-124 PAGE periodical, up-to-date; tells all you want to know about care and management of poultry for pleasure or profit. Four months for 10 cents. **POULTRY ADVOCATE, Dept. 98, SYRACUSE, N. Y.**



### GREIDER'S FINE CATALOGUE

of pure bred poultry; 70 breeds illustrated and described, many in color. Perfect poultry guide—all facts. Low prices on stock and hatching eggs. Incubators and brooders. 21 years in business. You need this book. Send 10c for it—today.

**B. H. GREIDER Box 19 RHEEMS, PA.**

**CALIFORNIA'S GOLD NOT EXHAUSTED**—The general impression both in the United States and abroad is that the gold mines of California are practically all worked out. Nothing could be farther from the truth. From 1849 to the end of 1914, this state has produced the stupendous amount of \$1,608,741,400 in

GET IT

### AMERICAN POULTRY JOURNAL

Tells everything about the fascinating and profitable poultry industry. Issued monthly; 10 cents. We want you to know how good it is and will send it 6 months for 25c. Order now.

**A. P. J., 1345-542 S. Dearborn, CHICAGO, ILL.**

25 CTS

**AUTOMATIC MAILED POSTPAID WEEDERS FOR ONE DOLLAR SIMPLEX CO. HOGE BLDG SEATTLE WASH. U.S.A.**  
OVER 5000 GUARANTEE WEEDLESS LAWN SALES MEN WANTED

## MAKING POULTRY PAY

depends more on the knowledge you have of Poultry Culture than on expensive equipment or extensive space.

Let Director Quisenberry teach you how to raise poultry successfully and make a good living and a nice profit from a flock of thrifty hens.

If you want to save money and make money in the poultry business write us today for our large illustrated **Free Book, "Dollars and Sense in the Poultry Business."** It points the way to success.

**American School of Poultry Husbandry Box 75 Mountain Grove, Missouri**



## PRICES SMASHED!

Write for the Greatest Incubator Bargain ever offered, on the most successful incubator ever built.

### OLD RELIABLE INCUBATOR

34 years the standard—holds over 1200

First Premiums, awarded an superior merit.

Guaranteed successful in your hands or your money back. Get Free

Poultry Book and my low price before you buy.

**J. W. Myers, Pres. Reliable Incubator & Brooder Co. QUINCY, ILL.**



# Again, Down Go Engine Prices

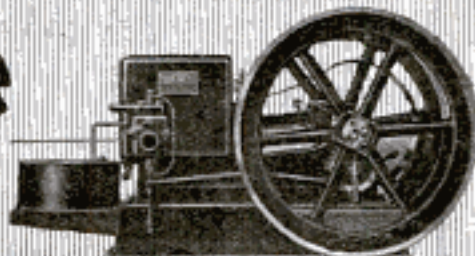

## Easy to own a good Engine Now for cash or on Easy Terms

ALL my business life I have done nothing but make engines. My factory is the only one which, starting in the engine business 29 years ago, has come through successfully under the same management with which it started. Only engine quality has made this possible. I have never had any trouble in keeping in the lead in engine quality. I had only to make the best engine I knew how, and to be honest and hold the respect and confidence of my customers. And I have done it. I take special pride in the fact that such a large part of my orders come through the recommendation of my old user-customers. This, together with the fact that I have for years had manufacturing advantages—including free natural gas from my own well for power, light and heat—explains why I am again able to reduce WITTE Engine prices another notch.

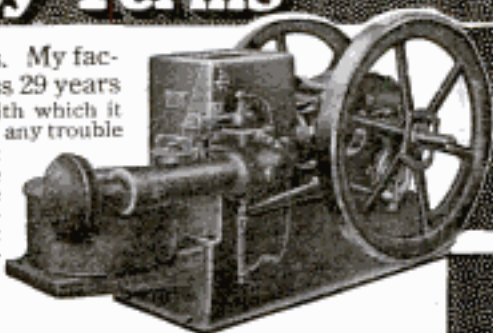

## WITTE ENGINES 5-Year Guarantee

**Kerosene, Distillate, Gasoline & Gas  
Stationary, Portable, Skidded and Sawrig Styles**

The rapid growth of my business has made it necessary to enlarge my already immense plant, more than doubling its former capacity. My entire factory is now better equipped than ever for economical engine production.

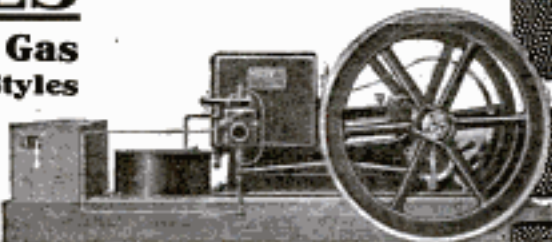

### Look at These Latest WITTE Prices:

**2 H-P \$34.95 4 H-P \$69.75 6 H-P \$97.75 8 H-P \$139.65 12 H-P \$197.00  
16 H-P 279.70 22 H-P 359.80 Portable and Sawrig Outfits proportionately low**

Engine quality is determined by the cost of operation, not alone by the price you pay to get it. The lowest cost of operation—the highest quality—comes from the smallest possible amount of fuel needed per horse-power hour—the certainty of steady power all day, as long as needed, with the least amount of watching and the least need of any repairs during the whole life of the engine. In this kind of quality, WITTE engines are known the world over, wherever they are used.

Write me today, so I can send you my new and liberal selling plan, under which a WITTE engine may earn its own cost while you pay for it.

### ED. H. WITTE, WITTE ENGINE WORKS

1747 Oakland Ave., Kansas City, Mo.  
1747 Empire Bldg., Pittsburgh, Pa.

### Most Understandable Engine Book FREE

Be sure to get my Great New Book before you arrange to try any engine. With my book you will know how to judge an engine—how to pick out the engine that is best for your work—and what are the secrets of the old time high double prices in the engine business. If you don't say my book is worth

dollars to you in finding out about engine quality and value, I'll pay the

postage to get it back.



ED. H. WITTE  
WITTE ENGINE  
WORKS

1747 Oakland Ave.,  
Kansas City, Mo.  
1747 Empire Bldg.,  
Pittsburgh, Pa.

With no obligation on my part, I should like to receive your latest and finest Engine Book, with your new Liberal Selling Plan.

Name.....

Address.....

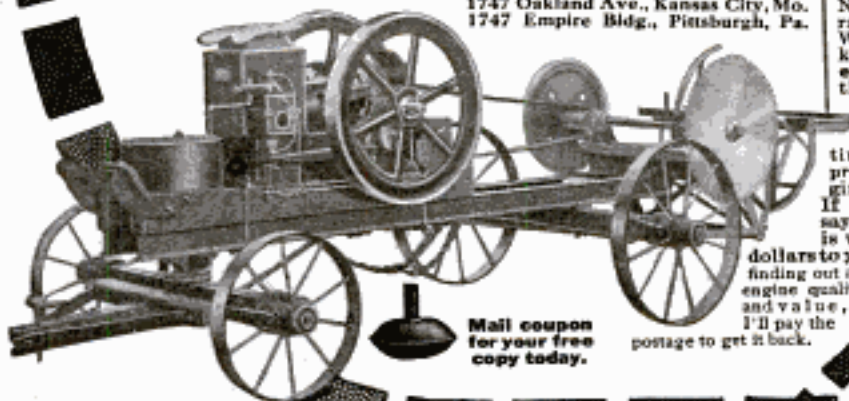

Mail coupon  
for your free  
copy today.

Please Mention Popular Mechanics

**GENUINE PERFECT CUT \$97.50 Per Carat**  
**DIAMONDS**

**No. A20**  
 14K solid gold, iridium tipped pen. Perfect coin and clip self-filler. **NAME INLAID WITH GOLD FREE.** We guarantee free repairs for one year. \$4.00 retail value. Actual length of pen 7 inches.

**Money-Back Guarantee!** Nothing equal to this iron-clad contract in the whole diamond business. Permits you to return diamond anytime within a year and we refund in cash full price less 10 per cent. Also allows full price in exchange at any time. It further certifies exact carat weight, quality and value of the diamond.

**You Save 35% by buying from Basch — the direct importer of diamonds.** All middlemen's profits eliminated. At \$97.50 per carat we give you beautiful, brilliant, genuine perfect-cut diamonds that retailers sell for \$150.00 per carat.

14K, mtr. complete with  
 1/4 Carat.....\$12.00  
 1/2 Carat.....\$21.25  
 3/4 Carat.....\$35.00  
 1 Carat.....\$48.75  
 1 1/4 Carat.....\$71.25  
 1 Carat.....\$101.25

**You Can Examine Any Diamond FREE At Our Expense**  
 And this will not obligate you in any way and it won't cost you one cent. We send any diamond to you to examine thoroughly and if you don't think it's the greatest value you have ever seen simply return it at our expense.

**Beautiful 1916 De Luxe Diamond Book FREE!**  
 Send for your copy NOW! Contains thousands of illustrations of diamonds and jewelry priced at remarkable saving of money. Contains expert facts about diamonds needed to buy safely. Just send post-card or letter for your free copy NOW!

**L. BASCH & CO.**  
 Dept. X2470 State & Quincy Sts.  
**CHICAGO, U. S. A.**

Our Special Price  
**\$1.00**



**Your Washing Done for 2c a Week**  
 Electric or Water Power Will Do the Work

I have built a new "1900" power washing machine. I consider this machine the most wonderful washer ever put on the market. Tub built entirely of high quality sheet copper, it is the strongest and most durable machine made. It is constructed on a brand new principle and I will guarantee that this machine will not tear clothes, break buttons or fray the edges of the most delicate fabric. It will wash everything from heavy blankets to the finest lace without damage to the goods.

This new "1900" washing machine can be connected with any electric socket instantly and is started and stopped by a little "twist of the wrist" and it will do your washing for 2 cents a week.

I also make a lighter power machine which can be run by water or electric power. On most of these machines the motor will run the wringer too. Just feed in the clothes and this power wringer will squeeze the water out so quickly and easily you will be astonished. It will save 50% time, money and labor every week. The outfit consists of washer and wringer and either electric or water motor, as you prefer, and I guarantee the perfect working of each.

I will send my machine on 30 days' free trial. You do not need to pay a penny until you are satisfied this wringer will do what I say it will. Write today for illustrated catalog. Address: H. L. Barker, 6239 Cozart St., Washington, N. Y., or, if you live in Canada, write to the Canadian "1900" Washer Co., 305 Yonge St., Toronto, Canada.

**Every Boy His Own Toymaker**  
 Greatest boys' book ever written. Tells how to make a Steam Engine, Telephone, Magic Lantern, Boats, kites, balloons, electrical and mechanical toys, traps, fishing tackle, 200 illustrations, also catalog of 150 puzzles, puzzle picture card and "DOUBLE THREAT" warbler and bird call all for only 10c. WESTERN PUZZLE CO., ST. PAUL, MINN.

**Mammoth Jubilee Book Free**

Picturing 5152 Home Things  
 Make your own Credit Terms — 1 to 3 years' time.  
**SPiegel, MAY, STERN CO., 1409 W. 35th St., Chicago**

**Big \$2 Offer—KEITH'S**



The magazine for home builders, the recognized authority on planning, building and decorating Artistic Homes.

Each number contains 7 to 10 PLANS by leading architects. Subscription \$2. Newsstands, 20c copy. Twelve big house building numbers and your choice of

**KEITH'S BOOKS for the HOME BUILDER**

140 Bungalows and Cottages 170 Plans costing below \$6000  
 140 Plans of Cottages 125 " " over \$6000  
 125 " " costing below \$4000 100 " " Cement and Brick  
 170 " " \$3000 50 Garages, 40 Duplex and Flats

Any one of these \$1.00 Plan Books Free with a year's subscription, \$2.00  
**KEITH'S, 874 McKnight Bldg., Minneapolis, Minn.**

**THIS BUNGALOW \$900 CAN BE BUILT FOR**

This and many others in my new book, Building Plans for Modern Homes, will save you hundreds of dollars. One of the most complete and comprehensive books of plans ever published by any architect. Fifth edition just off the press. Two hundred and fifty floor plans and photographs of bungalows, etc., costing from \$200 up to 2 gives sizes and cost to build. Sent postpaid for \$1.00



**FREDERICK H. GOWING ARCHITECT**  
 18 Tremont St., BOSTON, MASS.

**On Four Weeks' Trial**

Yes, we'll ship to you—on 4 weeks' absolutely free trial—a genuine highest grade Wing Piano direct from our own factory—all freight prepaid by us. The most amazing piano offer ever made. Your choice of 35 new styles in any shade of mahogany, walnut or oak for four full weeks in your own home—at our expense.

**No Money Down—Freight Prepaid**

We ask no money down—no C.O.D.—no deposit—no security—no guarantee. Use and enjoy any Wing 4 weeks free then, if you wish, ship it back at our expense. You will be amazed at our Rock-bottom direct-from-our-factory price on the famous Wing guaranteed for 49 years. Easy monthly payments if you prefer not to pay cash, but first 4 weeks free trial.

**VALUABLE BOOK on PIANOS—FREE**

"The Book of Complete Information About Pianos"

The New York World says: "A book of educational interest everyone should own." Mailed free to those who write at once. This magnificent 136-page book tells all the secrets of the piano making and selling. Write for it today. We will also send free our beautiful catalog showing new art styles, and our amazing Rock-bottom offer. **Act NOW!**

**WING & SON (Est. 1868) Wing Bldg., 13th St. & 9th Ave., Dept. 1194 NEW YORK, N.Y.**



One of Our 35 New Styles



## Chew It Over With "PIPER"

and you'll find the right solution to your problems. "PIPER" gives you real tobacco satisfaction and helpful, cheerful comfort that a man needs to bring his efficiency up to top-notch. That's the reason famous architects, lawyers, judges and scientists chew

# PIPER Heidsieck

CHEWING TOBACCO—Champagne Flavor

Only the ripest, finest leaves of selected white Burley are used for "PIPER". The richness and mellowness of this superb tobacco are blended with a wonderful wine-like flavor that distinguishes "PIPER" from all other tobaccos.

This "Champagne Flavor" affords a degree of satisfying, healthful pleasure and lasting, substantial enjoyment not obtainable from the use of tobacco in any other form. A week's trial will prove this, and make you a lifelong friend of "PIPER".

5c and 10c cuts, foil-wrapped, in slide boxes. Also 10c cuts, foil-wrapped, in metal boxes. Sold everywhere.

THE AMERICAN TOBACCO COMPANY

*Please Mention Popular Mechanics*

## "IDEAL" Lawn Mower Grinder



Grinds all makes of Mowers perfectly in 15 minutes without removing wheels, ratchets or reel-knife. Ball-bearing; operated by either hand or power. Skate Sharpener Attachment for sharpening skates.

"You Grind It As You Find It"

**Write Today** for full information of this great labor-saver and money-maker. Will do the work so much better, quicker and easier you cannot afford to do without it. The only practical machine for sharpening Lawn Mowers on the market. Over 7000 in use. Fully warranted. Write today. Don't delay.

**THE ROOT-HEATH MFG. CO., Plymouth, O.**

**DO YOU HAVE KNIVES TO GRIND, SILVER TO POLISH, SMALL TOOLS TO OPERATE, WASHING MACHINES OR WRINGERS TO RUN? LET THE RED DEVIL DO YOUR WORK**

Attached to any water faucet will develop up to 3 Horse Power according to size of pipe and water pressure. Only perfect small motor made. Improved bucket wheel construction.

6 in. Motor for Mechanics and Tradesmen, Washing Machine, 1/2 H. P. on 1/2 in. pipe, 80 lbs. water pressure; 1 H. P. on 3/4 in. pipe, 80 lbs. pressure, 2 in. pipe, Net price \$5, cash with order.

No. 1492—4 in. Motor for grinding, polishing, fans, sewing machines; for Doctors, Dentists, Druggists, etc., with emery, buffing wheel, silver polish and pulley, \$3.

No. 1425—4 in. Motor and pulley only \$2.50, cash with order. Motor back for any reason. Order your motor from dealer or from us. Send your water pressure and size of supply pipe. Active Agents wanted. Catalog free.

Only Motor to do this work

**DIVINE WATER MOTOR CO  
DEPT P, UTICA, N.Y.**

## Every Machine Shop

no matter how small, should have a grinder on hand, ready at all times for keeping your tools in proper condition. You do not need to buy a Grinder for every special job. You can grind your lathe centers, cutters, reamers, dies, tools, jigs, fixtures and a hundred other different jobs with the

## TEMCO Tool Post Grinder

And when the Grinder is not working on a machine, bolt it to a bench and you have a very practical little bench grinder. It is the handiest tool known for a machine shop. Has reversible switch for running motor either forward or backward — an offset head that is adjustable — lever feed, very sensitive but positive — vertical adjustment and many other convenient features. Use it in any part of the shop by simply connecting it to a drop cord, either A. C. or D. C.

One of the many needs for a Temco Tool Post Grinder



It keeps your tools in first class condition for getting out most efficient work. Often it does special kinds of work that ordinarily would take a machine costing several hundred dollars.

**Ask for One on Trial**

Your dealer will order one for you and let you have it on trial. Our catalog shows a number of different ways of using the machine and gives full specifications.

**DON'T DELAY FINDING OUT ABOUT IT AT ONCE.**

**THE TEMCO ELECTRIC MOTOR COMPANY  
122 Sugar Street LEIPSIK, OHIO**

Manufacturers of the famous Temco line of Electric Portable Drills

**The Name CRESCENT** is synonymous of high quality in wood working machinery. You will get the best always when you buy CRESCENT machines.

Send today for catalog of jointers, saw tables, band saws, planers, planers and matchers, disk grinders, swing cut off saws, shapers, borers, hollow chisel mortisers, variety wood workers, universal wood workers.

**THE CRESCENT MACHINE CO.  
93 Columbia St. LEETONIA, OHIO**

**South Bend Lathes**  
For the Machine and Repair Shop

**How to Run a Lathe**  
A 50 cent book for 10 cents. Postpaid, stamps accepted.

Straight or Gap Beds. Send for free catalog giving prices on entire line.

**SOUTH BEND LATHE WORKS  
423 Madison St., South Bend, Ind.**

## SEBASTIAN LATHES HIGH QUALITY LOW PRICES

If you delight in good tools you will delight in Sebastian Lathes. For 25 years we have built lathes, and lathes only, employing skilled labor always, and improving equipment and machinery every year. Sebastian Lathes are **STANDARD FOR QUALITY—LOW IN PRICE**

They are accurate, economical, simple and durable. Many re-orders and voluntary letters from users of Sebastian Lathes prove this. The Sebastian reputation is back of every Sebastian Lathe. You are judge and jury when you buy a lathe. We are not satisfied until you are. Look over the complete line in our new catalog. It shows Lathes for general repair work, garage and automobile work, etc.

**When you buy a lathe, say "Sebastian"**

ADDRESS (FOR THE CATALOG)

**THE SEBASTIAN LATHE COMPANY, 107 Culvert St., Cincinnati, Ohio**

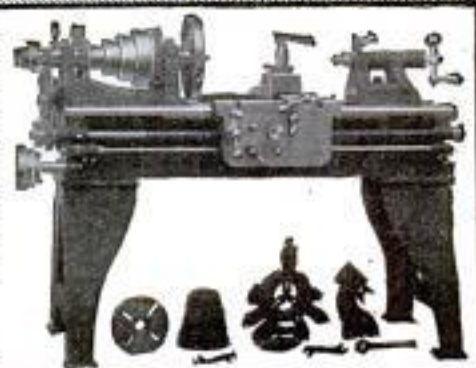

## BUY YOUR FURNACE \$10 DOWN \$10 A MONTH



Our monthly payment plan of selling direct saves you the dealer's profits, and charges for installation. The

### JAHANT FURNACE

with the patented "Down Draft System" is best for residences, schools, hotels, churches, etc., because it delivers plenty of heat wherever and whenever desired at a saving of  $\frac{1}{3}$  to  $\frac{1}{2}$  in fuel bills. Install the JAHANT yourself. We send complete outfit, freight prepaid with special plans, detailed instructions and all necessary tools for installation. Satisfaction guaranteed or money refunded.

WRITE FOR FREE ILLUSTRATED BOOK

THE JAHANT HEATING CO.

225 Steiner Avenue

AKRON, OHIO

## Save $\frac{1}{3}$ to $\frac{1}{2}$ on Fuel Bills

### Runs on Alcohol



anywhere. No electricity, wires or springs. Convenient. Much cheaper to operate than other fans. 12-inch blades. Roller bearing. Reliable. Brings genuine comfort and satisfaction. Ideal for the sick room. Third season. A proved success. The WONDER FAN. Price, \$16.50 cash with order only, delivery prepaid in the continental U.S.A.

LAKE BREEZE MOTOR, 122 N. Jefferson St., Chicago



## CLASS PINS

FACTORY TO YOU



Made to your special order, any style or material.

Write to-day for free catalog of 1915 designs. Special offer, either style of pins here illustrated with any equal number of letters and figures, with one or two colors of best hard enamel. SILVER PLATE, \$1.15 each, \$11.50 per dozen; STERLING SILVER, \$1.30 each, \$13.00 per dozen; GOLD PLATE, \$1.35 each, \$13.50 per dozen; SOLID GOLD, \$1.50 each, \$15.00 per dozen.

BASTIAN BROS. CO. 295 BASTIAN BLDG., ROCHESTER, N. Y.

**NOVEL MEANS OF ATTRACTING FISH**—A novel means of attracting fish has been reported by the chief hydrographer as in vogue along the lower reaches of the Trinidad River, near the hydrographic station at Las Raices, says the Panama Canal Record. The Trinidad

### Bohner's Self-Cleansing Filter



Agents Make \$25 to \$40 PER WEEK

Easy Money. Takes less than 5 minutes to attach, demonstrate and sell. Protects health against danger of disease germs in unfiltered and impure water. Every Home needs one.

Bohner Manufacturing Co.  
1009X So. Wabash Ave., Chicago, Ill.

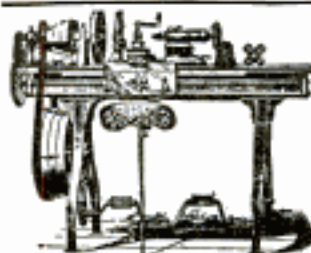

## LATHES

9 to 18-inch Swing

List price \$75 and up according to size. When ready to buy send for Lathe Catalog and prices.

W. F. & John Barnes Co.

100 Ruby Street, ROCKFORD, ILL.



Playable  
Without  
Previous  
Experience

Everyone  
Can Play  
The  
Symphonic

## Symphonic Pianos and Player Pianos

No Interest to Pay—4 Years' Time

Your longings to own a Symphonic Piano made by Knabe Bros., former makers of the William Knabe piano, may now be gratified. Symphonics are always sold the factory-to-family way on easy payments, at prices that save you much money.

### Five Daughters Taking Lessons

Our piano, without parallel in piano merchandising history, enable home after home to welcome these agreeably built, charming toned pianos. Witness Mrs. Genevieve's Terre Haute, Indiana home, where five daughters take their music lessons on the Symphonic. Think of this home before the Symphonic came, its lack of opportunity to study music, the unsatisfied longings. Then consider the changes wrought since factory-to-family dealing brought their piano. Will you let the Symphonic do as much for your home?

### Symphonolas Play

All Victor and Columbia Records Schumann-Hotik, Gluck, Kreisler, Caruso, McCormack, Farrar, Scotti, Blipham and other master musicians will abide permanently in your home with the coming of the Symphonola. Their records are all playable on this full sized cabinet instrument. Let us now send all details of the Symphonic or Symphonola.

MAIL THIS TODAY

Larkitt Co. Dept. P. M. 416  
Buffalo, N. Y.

Tell me about offers on instrument checked and send the Musical Instrument Catalog.

Piano  Player  Symphonola

Name.....

P. O.....

State.....

St. or R. D.....

Address.....

Go into **MOVING PICTURE BUSINESS**  
**Small Capital Starts You**  
 on our easy payment plan. Begin now and get your share. We sell everything. Write TODAY.  
**Atlas Moving Picture Co.**  
 Dept. 40 5255 Dearborn St., Chicago

## Water Pumps Water

with a Rife Ram. Plenty of it for every purpose about your farm and country home—day and night, winter and summer, without fuel, labor, freezing or repairs. The

### RIFE RAM

is operated by any small stream having a fall of three feet or more and a supply of three or more gallons per minute. Fills high elevated tanks or operates air pressure system.

Easy to install. First cost the only cost. Always on the job; over 11,000 in daily use. Tell us your water supply conditions. Ask for free estimate and catalog. Now is the time to install. Write today.

RIFE ENGINE CO., 3131 Trinity Building, NEW YORK

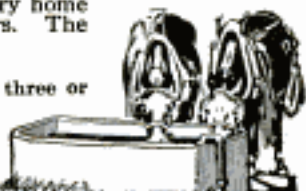

## They Stay on the Job for Years

One of the good things about all Brown & Sharpe Tools, especially these Non-Precision Tools

Take tools like these, which are not Precision Tools, and you know that they get pretty rough use. That's why it is worth while to look up the B. & S. line. After they have been in your kit a while you appreciate that these tools are made right.

You are sure of the best kinds of steel, drop forged and case hardened parts where the wear comes, clean cut threads and knurling, parts that fit together, with smooth corners. These are the things that count in the kit you use every day. Catalog No. 26 shows the entire line of many hundred tools for mechanics, tool makers, draughtsmen and others.

ASK THE HARDWARE MAN FOR A FREE COPY OR DROP A POSTAL TO

**Brown & Sharpe Mfg. Co.**  
PROVIDENCE, R. I.

BS

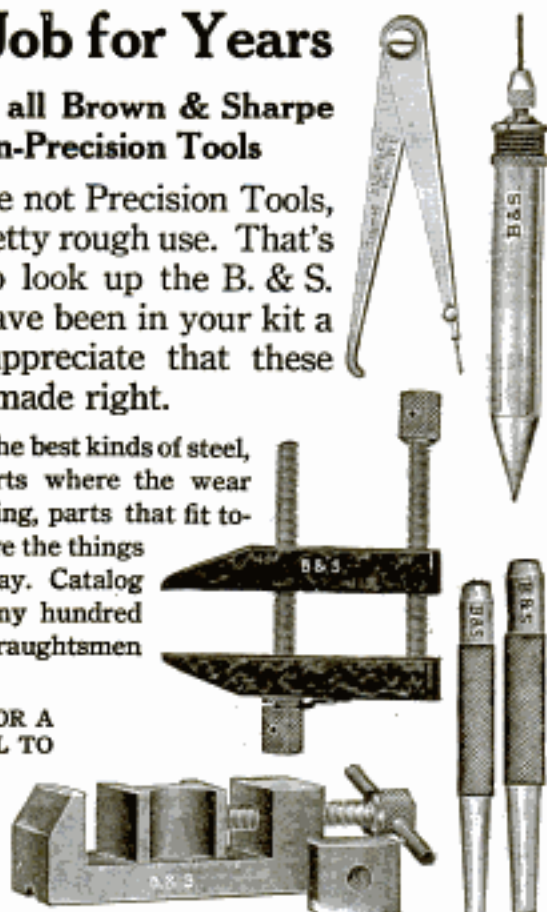

### Safe—The Gears Are Guarded

This ensures protection both for you and the gears. No chance for fingers or clothing getting caught. This Bench Grinder carries a 4x1 inch aluminum wheel. Fine for sharpening knives, drills, chisels, etc. It clamps easily to any bench or table. Order by this name

**GOODELL  
PRATT**  
1500 GOOD TOOLS

and then you'll be sure of getting a grinder with turned and cut gears, reamed bearings, carefully fitted and hand-somely finished with the best quality steel grinding wheel. We have a big mechanic trade—most mechanics can judge a good tool.

Goodell-Pratt Company  
Toolsmiths  
Greenfield, Mass.

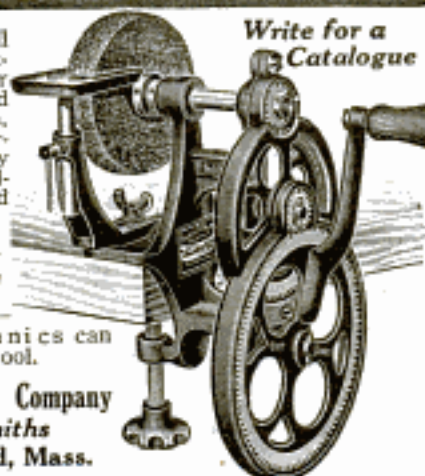

Write for a  
Catalogue

Please Mention Popular Mechanics

is one of the important tributaries of Gatun Lake, and the lake has backed up the valley beyond Las Raices, submerging wide areas of vegetation. In its rise the water marooned numbers of ants and other crawling insects on the trees which were partly submerged. Many of these trees have rotted at the roots and fallen down. Each falling tree has meant insects for the fish in the vicinity, and the natives have discovered that the fall of a tree attracts them. Accordingly, when they wish

LET US SEND YOU

### "The Professor and the Saw"

an illustrated booklet which besides an interesting story tells how to build useful things and gives valuable information about tools, especially

### SIMONDS SAWS

which are unsurpassed for all uses in fast and sharp-cutting and edge-holding qualities. WRITE FOR BOOKLET 11.

SIMONDS MANUFACTURING CO., "The Saw Makers"  
5 Factories FITCHBURG, MASS. 11 Branches

PATENTED  
OCT. 19, 1915

### THE GILSON POCKET SLIDE RULE

This new slide rule surpasses any other pocket slide rule for accuracy in solving mathematical problems. It has four sets of graduations, each set being 70" long, and the results of computations can be read to four, and sometimes five figures with remarkable accuracy. This instrument will solve any problem involving multiplication, division, proportion, even and uneven roots and powers, Logarithms of numbers and the Sines and Tangents of angles. Its operation is very simple and anyone can learn to use this slide rule in a few minutes, and can quickly obtain the result of any calculation, for example—Find the cube root of 817.49; answer 9.351; time required, using a Gilson Pocket Slide Rule, 15 seconds. It is made of heavy, waterproof Bristol, size 4"x7" and just fits the pocket. Price, with complete instructions, 50c. Imitation leather carrying case, 25c. extra. Send for free facts, circular.

GILSON SLIDE RULE COMPANY, NILES, MICH.

### Portable Cases

FOR TOOL MAKERS  
AND MACHINISTS

Twelve styles, felt lined drawers, solid brass trimmings, best of material, beautiful finish, low prices, satisfaction guaranteed. Ask for booklet of cases built for service.

The Pilliod Lumber Co.  
SWANTON, OHIO





# The CALDWELL AUGER BIT

IS AN  
**EFFICIENT TOOL**

To the ordinary user, all bits are much alike until they are put into use. When this is done, the superiority of The CALDWELL is evident.

*This is because of the exclusive mechanical features in its construction.*

Regular Prices	4	5	6	7	8	9	10	11-12	13-14	15-16-16ths
	30	32	35	38	40	45	50	55	60	65

**COMPLETE SET OF 13 BITS \$5.50.**

Until your dealer is supplied, remit direct to us. We will deliver without further cost to you.

Send for Catalog  
**THE CALDWELL AUGER BIT CO.**  
LEBANON - N. H.

(Fourth in Factory to Financier Series)



The construction, as shown in detail above, enables The Caldwell to work several times faster and with less friction than any other known bit.

to bring the fish, they either push over a rotting tree or throw in a limb or log to make a splash. According to the chief hydrographer, this method, though calculated in ordinary circumstances to frighten fish away, attracts the lake fish in great numbers.

## YOU NEED THIS TOOL

**GASOLINE  
SOLDERING IRON  
BLOW-TORCH**

Address Dept. 1, Emmelmann Bros. Mfg. Co., Indianapolis, Ind., U.S.A.

**BILLINGS & SPENCER**  
**TOOLS**

When you "need them bad," you need them (good)

**Wrenches  
Pliers  
Sc. Drivers  
Hammers  
Ratchets  
Wrench Kits  
Tool Kits**

**HARTFORD, CT.**

## THE AWL YOU WANT



Is the genuine MYERS \$1.00 "Lock Stitch" Sewing Awl with the exclusive feature. See thread reel in front of handle under the finger tips. Natural tension. Sews heavy or light material, diamond point, full grooved needles used to protect the thread when sewing.  
**C. A. MYERS COMPANY, 6339 University Ave., Chicago, Illinois**

**TOOL CASES**  
For Up-to-Date TOOLMAKERS and MACHINISTS

We carry the finest and most complete line of mechanics' toolcases and tools in the country. We guarantee to please you or refund money. Write for free catalogue.

**J. M. WATERSTON**  
177 Jefferson Ave., E. Detroit, Mich.

## CRESCENT TOOLS

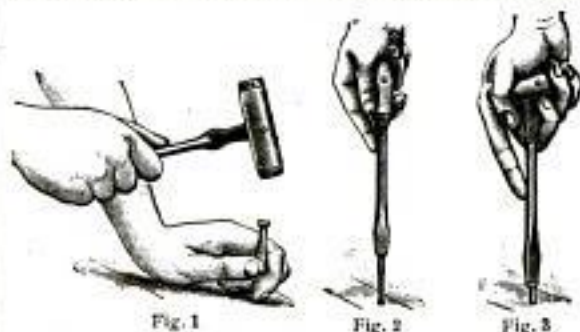

## CRESCENT HAMM-HANDL SCREW DRIVER

YOU start the screw by using the handle as a hammer (Fig. 1). Then use as an ordinary screw driver (Fig. 2). When the screw is nearly set and difficult to turn, spring the handle into position and finish easily (Fig. 3).

MADE IN THREE SIZES—

Style	Length of Blade	Width of Point	Price
K-24	4 inch	$\frac{1}{8}$ inch	\$0.65 each
K-25	5 inch	$\frac{3}{8}$ inch	.70 each
K-26	6 inch	$\frac{1}{2}$ inch	.75 each

Drop Forged, Hardened and Oil Tempered

At your Dealers or sent prepaid upon receipt of price.

**CRESCENT TOOL CO.**

Manufacturers of Famous Crescent Wrench

JAMESTOWN, N. Y.

Please Mention Popular Mechanics



# Starrett Efficiency

This tool is a Starrett Test Indicator. It shows the slightest variation to the thousandth of an inch in testing inside, outside or surface work.

This means *accuracy* and *time saving* and the sum of these is *efficiency*.

Manufacturers, Engineers, Superintendents and expert Machinists all recognize Starrett Tools as absolutely Standard.

Other Starrett Tools are:

Micrometers Protractors Hack Saws  
Vernier Calipers Speed Indicators  
Expansion Pliers Combination Squares  
Steel Rules Wrench Sets

To aid in selection send for free Catalogue No. 20-A.P.



The  
**L. S. Starrett Co.**  
*The World's Greatest Tool Makers*  
Athol, Mass.  
New York London Chicago



## Your Choice of These— Steel Guide Vise **FREE** Fine Post Drill

To pay you for making a thorough test of the famous Luther Hummer Tool Grinder, we will give you either one of these two articles absolutely free. You merely agree to use one of our Hummer Grinders for thirty days. You don't have to buy anything at all. We're willing to give you the premium outright, simply for the opportunity of showing you what a wonderful tool sharpener the Luther Hummer Grinder is.

## LUTHER HUMMER Tool Grinder

Handiest, lightest running, most accurate of foot-power tool sharpeners. Steel-shaft drive, dust-proof bearings, perfect lubrication. Puts keen edge on your dulled tools quick and easy. No water needed—can't draw temper—Dime-Grit (artificial diamond) wheels. Patent tool rests give each tool proper bevel. Many special attachments.



Now Only  
**\$12.35**  
F.O.B. Milwaukee

**Write for Free Premium Today**

Send us your dealer's name—and we will send to him for you the premium you choose and the Hummer Grinder. If not satisfied, return the Hummer Grinder after 30 days—or if you want to keep it, pay \$12.35 (special introductory price). The premium belongs to you—it's free for simply making the trial.

**LUTHER GRINDER MFG. CO. 925 Point Street Milwaukee, Wis.**

Beaching a vessel at high tide for repairs to the hull is very common practice in the case of small vessels, and has been resorted to at the Pacific end of the Panama Canal for even such large vessels as the seagoing

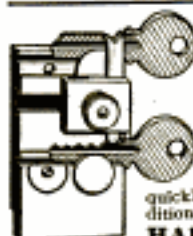

### THE HARRISON M. I. P. KEY FILING MACHINE

Makes duplicate Pin Tumbler Keys with absolute accuracy, and without injuring the original key. Price \$3.00. Special diamond shaped files 35¢ each or 4 for \$1.00. Net Cash. \$4.00 for the outfit complete.

**THE HARRISON C. K. KEY CLAMP** will make duplicate Common Keys of all kinds for Doors, Padlocks, Trunks, Cabinets, Lockers, etc., quickly and accurately. Price \$1.00. Both machines unconditionally guaranteed. Parcel Post Prepaid.

**HARRISON & CO., 81 New St., New York**



### Tool Cases for Toolmakers and Machinists

Keep your tools orderly arranged in a Gerstner Portable Tool Case. There's a place for every tool in one of the felt lined drawers. Every up-to-date mechanic needs one and you'll find our Cases the best built, neatest and most practical on the market. We guarantee to please or refund all money. Write for our free booklet.

*Gerstner & Sons*

Mfrs. of Mechanic's High Grade Tool Cases  
808 Columbia St., DAYTON, OHIO

## The Neverip and the Speedy Stitcher

SAMPLE



50c

The two greatest inventions with which the unskilled man can repair leather goods or any heavy material. Needles and thread are inside the handle. **FAST SELLERS.**

**Agents Wanted** Foreign trade solicited. Advertiser's circulars in different languages.  
**Stewart-Skinner Co., 29 Hermon St., Worcester, Mass., U. S. A.**

Please Mention Popular Mechanics

**Stanley  
Tools**



## Edge Trimming Block Plane No. 95

For trimming or smoothing the ends of boards for a square or close fit. It has a right-angle rest or guide from the cutter edge, and the cutter works on a skew giving an easy shaving cut. In the rest or guide are two screw holes to which wood blocks of various bevels may be attached enabling the user to make a slanting cut.

**6 inches long — 7/8 inch Cutter**

One can hardly think of a wood working job where this tool will not come in handy.

**Price Each, \$1.15**

If you cannot procure same from your hardware dealer, we will be pleased to forward you one, postage prepaid, upon receipt of price.

— ADDRESS —

**STANLEY RULE & LEVEL CO.  
NEW BRITAIN, CONN. U.S.A.**

suction dredge "Culebra," says Engineering News. As the range of tidal levels at the Pacific end is 20 to 21 ft. a vessel beached at high tide on the broad, sloping, sandy beach will be left high and dry at low tide. This method has been so successful with large-size vessels that, although a dry dock is now available at Panama, the "Culebra" was recently beached for minor exterior repairs to her hull because the work could be done in that way more cheaply and quickly than by dry-docking.

## Interlox™ SAVES TIME, TEMPER AND TROUBLE

**MASTER SLIDE RULE**

The Only Interlocking Rule made — and the Only one whereby inside measurements of doors, windows, etc., can be taken rapidly and accurately. Also superior to all others for outside measurements of walls, ceilings, etc.

If your hardware dealer hasn't this Rule, send us his name and 15c per foot (in any length from 2 to 8 ft.) and it will be sent prepaid.

Liberal Proposition for Dealers and Agents

DAHL MFG. CO., 51P E. 42nd St., NEW YORK

**50 Mends for 50 Cents** **Price 50c**

WHEN YOU SOLDER SOLDER WITH SOLDERALL  
**SOLDERALL**  
TRADE MARK  
PATENT APPLIED FOR

## Genuine Solder

With an ordinary match it easily mends and solders metals permanently. Used by the housewife, farmer, electrician, automobilist, moving picture operator, jeweler, merchant and mechanic.

### AGENTS WANTED

Show what it will do and it sells itself. Everybody wants SOLDERALL. Send 50c for large tube. Your money back if dissatisfied.

**EMENAR CO., 53 E. 23rd St., New York City**



## Good Work Implies Good Tools

And the difference in cost between the best tool and an ordinary tool is mighty little when you figure the greater service the good tool will give you.

## MILLERS FALLS HAND DRILL No. 306

is the last word in small hand drill design. Ratchet shifts instantly by turning a knurled knob. Gear and idler gear both of cut steel and enclosed.

Solid wheel. Three jaw chuck of Star pattern with protected springs.

Removable hollow handle with mushroom head.

Send for pocket catalog which shows our complete line of tools.

**Millers Falls Co.**

"Toolmaker to the  
Master Mechanic"

**Millers Falls, Mass.**

N.Y. Office, 28 Warren St.



# TIFNITE GEMS

## Brilliant as Diamonds

A Tifnite Gem and a diamond are as near alike as two peas. Nothing else in the world so near a diamond in looks, brilliancy and every diamond test. Tifnite Gems cut glass like diamonds, won't tile, won't melt. Guaranteed to last forever. Not one particle of glass in them. To quickly introduce them to 10,000 men and women, we make a test never before heard of. We have made up four exquisite items, latest style designs, guaranteed solid gold mountings and each set with a genuine Tifnite Perfect Diamond Cut Gem. We will send you

## YOUR CHOICE FREE Without Deposit

Send no money whatever. Just state which item you prefer—Ring, Pin or La Valliere—and we will send it to you promptly. If ring, send string showing size around your finger. State lady's or gent's. If you think it's worth all we ask, simply send us \$1.25 within 10 days after arrival and pay the balance, \$2.00 per month, until these Special Limited Bargain Offers are paid in full, otherwise return to us. Send no reference—no money—simply your request. You be the judge of this wonderful gem. These pictures show the mountings and rock-bottom prices. Send for yours today—while supply lasts.

**THE TIFNITE GEM CO.,**  
1015 Jackson Blvd., Dept. 9 Chicago

**LA VALLIERE—Solid Gold, 15 in. Chain, one-half carat Tifnite Gem, black stone mounting, \$14.25, Nothing down, \$2 Per Mo.**

**Ladies' Ring**  
Tiffany Mounting  
Solid Gold, One  
Carat Tifnite Gem  
\$11.25 Nothing  
Down, \$2 Per  
Month

**Gent's Ring**  
Claw Mounting  
Solid Gold, One  
Carat Tifnite Gem  
\$12.25 Nothing  
Down, \$2 Per  
Month

Scarf  
Pin, Solid  
Gold,  
open  
circle  
mounting  
Half  
Carat  
Tifnite  
Gem  
\$12.25  
Nothing  
down,  
\$2.00  
Per Mo.

# Every Builder and Contractor Needs this Level

## 10 Days' Free Trial

We have been makers of transits and levels since 1863 and our instruments are the standard of the world. Prove the superior quality of the Aloe Convertible Level by giving it a 10 days' free trial. Use it on your every-day work laying out buildings, leveling up foundations, walls and floors, aligning, shafting, piers, etc., for getting angles or levels anywhere.

## Easy Monthly Payments

If you decide to keep it, the instrument will earn its way while you make monthly payments so small that you hardly feel them. Costs no more than to pay all cash. No red tape about it, no embarrassing questions, everything confidential.

## Aloe Convertible Level

is the finest instrument ever offered at anywhere near its price. Permits taking of sights both above and below the horizontal. For taking vertical sights it is provided with a special convertible bracket rigidly and permanently attached to cross bar; telescope, fitted with permanent axis, rests in bracket bearings and held by special clips which can be easily and quickly released.

Aside from being a level, it is a modified transit that permits a much wider range of work than is possible with the ordinary architect's level. With it the man without technical training can obtain the same absolutely accurate results as the expert. Write today for descriptive circular.

**A. S. ALOE CO.**  
512 OLIVE ST., ST. LOUIS, MO.

Showing  
Sunshade  
Attachment



# A Wonderful Combined Tool

is this **STEWART HANDY WORKER**



It combines: A strong and powerful vise, steel faced; a steel pipe vise for up to 1½-inch pipe; big, sturdy anvil; cutting hardie; corundum grinding wheel 5" x 1", 2 speed drill press; 3 speeds, direct, 4 to 1 and 16 to 1.

Weights, boxed, 90 pounds; price f. o. b. Chicago, \$12.50. Send \$2.00 and pay balance when outfit arrives. All money back if not highly pleased. It's a marvelously valuable outfit. Write for circular.

**Chicago Flexible Shaft Co.**  
A617 N. La Salle St. CHICAGO

## MECHANIC'S POCKET SECRETARY

Constructed of finest steel. Just push the button and out comes the article you require. Worth \$1.00. Postpaid

15c

Get One Today



15c

10 in 1—

Adjustable Pencil, pen, paper knife, ink eraser, pencil sharpener, nail file and cleaner, mechanic's marking point, fine compass with screw attachment, foot rule.

**ARDEE CO., Dept. 750, STAMFORD, CONN.**

# LE PAGE'S GLUE 10c

WILL MEND THAT VASE

# Shanhouse MOTOR SUIT \$2.00

## Saves Clothes



A one-piece garment for every use. Keeps off dust, dirt and grease. Especially handy for motorists in changing tires or working around the machine. Covers you thoroughly from head to foot over all your clothes.

Made of olive khaki. Strong, roomy, washable—on in a minute—off in a second.

If your dealer cannot supply you, send \$2.00, giving chest measure and dealer's name. We will send you one direct, prepaid. Money back if not satisfied.

**W. SHANHOUSE & SONS, Dept. 101 Rockford, Ill.**



## The Results You Are After

can only be accomplished by using good tools. Poor tools were never meant for results. Whether you are performing practical or experimental work of the most exacting character, there is a plier that will meet your need.

## "RED DEVIL" Dependable Tools

—tools scientifically designed for practical work to give you results. Diagonal side cutting plier, style No. 942—4 in. shown here, tested to cut the finest silk insulation, sent for 65c. **TOOL BOOKLET FREE.**

**Smith & Hemenway Co., Inc., 161 Chambers St. NEW YORK CITY**

# Get Into the Flour Milling Business Quick

The best paying thing you can get into in a small town or rural community now is the flour milling business. Wallace & Wynns, Sturgis, Ky., say they cleared \$4,628 in seven months with a 25 barrel

## "Midget" Marvel Self-Contained Roller Flour Mill

Bennett & Sons, Valley City, O., cleared \$3,210 with theirs last year. Write for our free book, "The Story of a Wonderful Flour Mill," telling you all about this money-making mill wonder that is making others so much money and will make it for you from very start. Solves community mill problem. In 12 1/2, 25 and 50 bbl. capacities a day, finest roller patent flour.



ANGLO-AMERICAN MILL CO., Inc.  
1563 Fourth Street, OWENSBORO, KY.

**\$22.00 for \$3.36**



**AGENTS** 10 Piece Aluminum Set makes 15 Combinations enough for a whole Kitchen Outfit. Worth \$22.00; retails \$3.36. Biggest value ever offered. \$100 a week easy. Be first in your territory. Write quick. Address AMERICAN ALUMINUM MFG. CO., Div. RP., LEMONT, ILL.

**Make Music Rolls**  
30 each. Inexpensive Leharjan Perforator makes player-piano rolls from any piece of music written. Music knowledge unnecessary. Pleasure or profit. Details free. LEHARJAN MANUFACTURING CO., DEPT B, HAMILTON, OHIO

**10 Cents a Day**  
Pays for This Cornet An astounding offer! Only 10¢ a day buys this superb Triple Silver Plated Lyric Cornet. **FREE TRIAL** before you decide to buy. Write for our big offer.

**WURLITZER** 44 years of instrument making  
Carrying Case Free with this superb triple silver plated Lyric Cornet.  
Write for our big new 256-page Band Catalog. Back bottom, direct from the manufacturer's prices on all kinds of instruments. Pay for them at the rate of only a few cents a day. Generous allowance for old instruments. Free Trial. We supply the U.S. Govt. Write now THE WURLITZER CO., Dept. 1194, 4th St., Cincinnati, Ohio 5. Wabash Ave., Chicago

**1/3 SAVED** Buy Direct From MANUFACTURER  
FREE BOOK  
Do Your Own Plumbing and Heating NEW HARDIN EASY WAY  
Get our "Handy-Man" Free Book. Every home needs it. Shows new home improvements and everything in plumbing and heating supplies EXCLUSIVELY at wholesale prices—complete heating plants, bathroom outfits, sinks, pipe, fittings, water systems, lighting plants, etc. Any handy man can install our goods with this free book and free easy installing plans. \$100,000 plants behind our guarantee. Write today.  
40 years at 4540-50 Cottage Grove Ave. Chicago

# GENUINE DIAMONDS BLUE WHITE PERFECT CUT



Special 1 1/8 C. Blue White Diamond. See full size at right. 14k. solitaire. Complete. \$8.00



Special 1 1/4 C. Blue White Diamond. See full size at right. 14k. solitaire. Complete. \$17.25



Special 1 3/4 C. Blue White Diamond. See full size at right. 14k. solitaire. Complete. \$42.75



Special 1 5/8 C. Blue White Diamond. See full size at right. 14k. solitaire. Complete. \$67.13



Special 1 3/4 C. Blue White Diamond. See full size at right. 14k. solitaire. Complete. \$71.13



Special 1 1 carat Blue White Diamond See full size at right. 14k. solitaire. Complete. \$92.50

These illustrations are 1/2 size



Small Sizes as low as \$6.25

By direct importing from the European cutters to you—by nation-wide selling at smallest profits, we have smashed down the price for Genuine Blue White Perfect Cut Diamonds to only \$88 per Carat; small sizes as low as \$6.25! Same quality by expert comparison that the old middleman-to-jeweler method demands \$150 per carat for! Our sensational import prices actually lower by far than others ask for orange-white and other off-color stones!

**\$88**

PER CARAT



1 Carat \$88



3/4 C. \$64.25



1/2 C. \$40.25



3/8 C. \$29



1/4 C. \$15



1/8 C. \$6.25

## NO MONEY IN ADVANCE

Send no deposit, even. Our simple plan the safest way to buy your diamond. We actually show you the diamond and mounting. FREE EXAMINATION allowed. Absolutely no obligation to buy. Return or accept as you wish. Not one penny of expense to you; not the slightest risk at any time!

## Bankable, Legal, MONEY-BACK GUARANTEE

The only bankable cash refund contract in the entire diamond business. Issued in writing with every diamond we sell, permits its return direct, or through any bank in America for instant cash refund! No delay or red tape. Full price guaranteed in exchange at any time! Color, carat weight and value legally guaranteed, too.

**References** Rogers Park National Bank, Chicago; your own banker, any Commercial Agency, your favorite magazine Publisher,—will all certify our high standing and absolute reliability.

## Expert Personal Service

By confining our business exclusively to DIAMONDS, Mr. Barnard can personally serve every Barnard customer. Years of experience have qualified him to satisfy every taste. This is a unique feature of our business you will highly appreciate.

## THIS DIAMOND BOOK FREE

A real gold-titled bound book, profusely illustrated, full of facts that enable you to judge and buy diamonds intelligently and like an expert. First to show the latest 1916 styles. Comes to you FREE and of course without obligation. Mail handy coupon or write; a postal will do. Do it NOW and be sure of getting this valuable book.



## BARNARD & CO.

Dept. 488C S. W. Cor. Wabash & Monroe, Chicago



## FREE BOOK COUPON

BARNARD & CO., Dept. 488C S.W. Cor. Wabash & Monroe, Chicago  
Without obligation on my part, please send me free and postage paid by you, DeLuxe Book of Diamonds, new 1916 edition.

Name .....  
Address .....

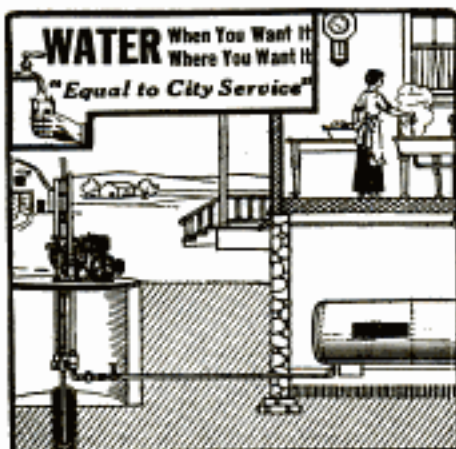

**WATER** When You Want It  
Where You Want It  
"Equal to City Service"

Water under pressure in your home will make housework easier, add to comfort, and increase the property value.

All water requirements of farm homes are met at moderate cost with our pneumatic pressure outfits.

*May we give you details?*

**Fairbanks, Morse & Co.**

New York CHICAGO San Francisco  
and other principal cities

(649-G.L.)



**2 H.P. \$35** Auto Throttle Governed  
not hit and miss governed. One of the many exclusive features found in no other low priced engine.

Auto Throttle Governor means smooth, even, economical power for every work. Wonderful engine valve. Will operate electric light plant, run machinery, pump water, etc. Hopper cooled. Price complete with gasoline tank, electrical equipment, etc., ready to run, only \$35. Further details and catalog free. Write today.

C. BENNINGHOFFEN & SONS, Dept. 125, Hamilton, Ohio

**9c A DAY Is All It Costs**  
For 1 1/2 H.P.



**A REAL Kerosene Engine**

Biggest value ever offered in a 1 1/2 H.P. engine. Same cylinder capacity as many 2 1/2 H.P. engines. Throttling governor adjustable while running; crank shaft extends both sides. Runs either way. Starts without cranking. Patent Fuel Device guarantees successful operation on cheap oils.

Just the engine for pumping, separating, churning, corn shelling, sawing shop work, lighting and dozens of other light jobs. Easy to operate and move.

**Sold on 30 Days' Trial** Guaranteed 10 Yrs. Freight Prepaid

Also other sizes 3 to 18 H.P., vertical and horizontal, single or double cylinders.

Write today for valuable Engine Book telling how to judge and buy an engine and special prices.

**ELLIS ENGINE COMPANY**  
2925 E. Grand Boul., DETROIT, MICH.

**Meco ENGINES**  
Gasoline, Kerosene & Gas

**Prove Their Quality**

Write us, giving dealer's name and we will tell you how to get a high-grade Meco Engine for trial, and send you our Engine Catalog to select the kind of engine you want.

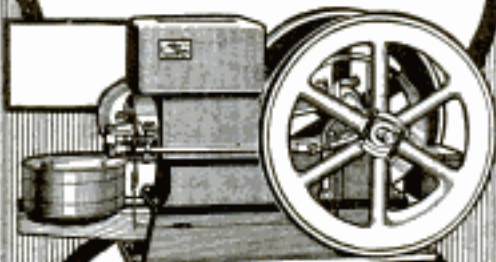

**COSTS YOU LESS**

2 H.P., \$35.10; 3 H.P., \$52.65; 4 H.P., \$70.20;  
6 H.P., \$100; 8 H.P., \$140.40; 12 H.P., \$210.90.  
Built for hard, heavy work, compact, easy to run; few parts, and save their cost in fuel first year.

**Guaranteed 5 Years**

Don't pay more than our prices for any high-grade engine until you have tried the Meco. Write for Catalog today.

**Manufacturers Engine Company**

1821 Crystal Avenue, Kansas City, Missouri.

Of the raw material used in American manufactures, one-half per cent is derived from the sea; five per cent from the forests, 13 per cent from the mines, and 81 per cent from the farm.

**FARM VIM MARINE ENGINES**

Get a VIM Engine and save money. VIM Midget 1 1/2 H.P. Farm Motor shown below does all the chores—churning, washing, pumping, separating, spraying, etc. Women operate easily. No complicated parts. Weighs only 70 lbs. Water cooled, automatic lubrication. Comes ready to run. Guaranteed. Full line marine engines 5 to 27 H.P.; 1, 2 and 3-cyl.; Speed, pleasure and heavy duty types, Gasoline or kerosene.

Double lubrication. Non-backfiring. Strong, simple, accessible—absolutely dependable. Built for a lifetime. The best—handy, a standard, the best—owner's pride. When writing for catalogs, please mention whether interested in stationary or marine engines, or both. Ask for attractive agency offer. The Vim Motor Company, 104 Water St., Sandusky, Ohio



**WEBER THROTTLE-GOVERNED KEROSENE ENGINES**

**4-Cycle Lowest Priced Throttle-Governed Engine on the Market—Cash or Payments**

Save Half In Fuel. The 1916 model Weber solves the problem of low cost power for all time. Power and speed controlled by throttle, same as steam. No waste of fuel—no violent explosions. Throttle regulates amount of fuel to size of load.

Sold on a Five-Year Guarantee—Two Months' Trial in shop or on farm. Shipped direct from factory at a big saving.

**FREE BOOK**—"How to Use Kerosene" and Engine Folder, sent post-paid. Address



**WEBER ENGINE CO.**  
Dept. 1774  
Kansas City, Mo.

## A Real Kerosene Engine

We dwell particularly on low fuel cost, because we have perfected our engine to run on coal oil (kerosene), alcohol, distillate, etc.

LOWEST FUEL COST



# BESSEMER

## NON-KEROSENE CRANKING ENGINE

Built by the largest makers of two cycle engines in the world, every engine has a million dollar company back of it. This is your guarantee that the Bessemer must give you satisfaction. Sizes 2 to 10 H. P., and also direct connected to many kinds of machinery. Get our prices and terms.

### Bessemer Oil Engine

recommended where power from 15 to 200 H. P. is required. Burns crude and fuel oil and runs at about  $\frac{1}{2}$  to  $\frac{1}{4}$  cost of gasoline. Now being used in irrigation, flour mills, factories, lighting plants. This engine is revolutionizing the power question. Get the facts by writing for Catalog "O."

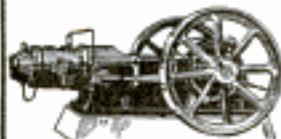

THE BESSEMER GAS ENGINE CO.  
121 Lincoln Ave., GROVE CITY, PA.

## Bausch and Lomb BALOPTICON

THE PERFECT STEREOPTICON

Bausch & Lomb Optical Co., 576 St. Paul St., Rochester, N. Y.

## BUY PLUMBING and HEATING SUPPLIES

at WHOLESALE Will Save You 30%

Don't pay retail prices. Full stock on hand for prompt shipment. Send for free catalog.

B. P. KAROL, 800-802 South Kedzie Ave., CHICAGO

## POWER

for farm, ranch, shop, to pump, saw, excavate, hoist, irrigate, can be had in Galloway engines from  $1\frac{1}{2}$  to 16 h.p. All styles. 200,000 customers testify to quality. Prices from  $\frac{1}{2}$  to  $\frac{1}{3}$  what's usually asked. Low freight.

WM. GALLOWAY COMPANY

Box 865

WATERLOO, IOWA.



4 H.P. Cushman Weighs Only 190 lbs.  
8 H.P. 2 Cylinder Only 320 lbs.

Discussing light-weight motors recently, the Scientific American said: "Efficiency means light weight, reduced friction, and above everything else, lowered operating cost." Cushman Light-weight engines are today recognized as the leading American

light-weight, high efficiency, all-purpose motors, challenging comparison in minimum weight per horsepower, reduced friction, quality of material and Sizes 4 to 20

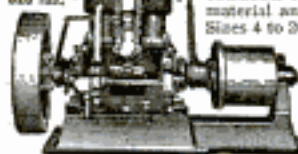

workmanship and cost of operation. H. P. Throttle Governor. Schellor Carburetor. Forced Water Cooling System. Moving parts enclosed and run in both oil. Not cheap engines, but cheap in the long run. ENGINE BOOK FREE.

Cushman Motor Works  
882 N. 21st St., LINCOLN, NEB.



# Have Your Suit Made To Order and Take

# 6 MONTHS TO PAY.



Here it is—the biggest sensation in the history of high class tailoring! Think of getting a suit tailor made strictly according to your own individual measurements and having six whole months to pay for it! Yes, no matter who you are, where you live, or what you do, we will make you the finest, the richest, the snappiest suit you ever saw and give you an entire half year to pay for it! Don't miss this amazing opportunity.

## Save Half

You actually and positively get the suit at about half of what it would ordinarily cost you! Our tremendous woolen buying gives us the pick of the world's greatest mills at lowest prices known. Therefore we can cut the price in half and still give you six months to pay. Don't buy cheap "ready made" and pay double our price. Don't pay other tailors two or three times as much as we charge.

## Only \$2.50 Per Month

You wear the suit while paying for it. Payments so marvelously easy you won't miss the money. We trust you absolutely. Your word is all the security we ask. No reference, no red tape, no delay, no collectors. No strings attached to this credit whatever. It's yours to use as freely as you wish. Don't class us with ordinary tailoring houses. We are "different!" You'll be delighted.

## Get This Free Sample Book

The most sumptuous style book ever published—our 1916 Spring and Summer Style Book! See the actual cloth samples of most beautiful weaves and patterns—the newest and latest. Also illustrations of choicest designs from world's greatest style centers. You'll marvel

## \$1,000 REWARD

To anyone who proves that we do not make all garments to individual measurements of each customer. Beware of houses that try to palm off altered "ready made" claiming them to be made-to-order.

at this wonderful book.

## Send Coupon

or postal or letter if you wish—but do it NOW! Get the magnificent free style book and full particulars of our startling offer. Don't delay! Write today.

Stanley Rogers Company,  
544 S. Clark St.  
Chicago, Ill.

BIG FREE BOOK OF SAMPLES

FREE BOOK COUPON

STANLEY ROGERS CO.,  
544 S. Clark St., Chicago, Ill.  
Please send me, FREE, your new DeLuxe Style Book and full particulars of your great offer.

Name.....

Address.....

City.....State.....

Please Mention Popular Mechanics

This Year We Are Making Twice as Many

1916  
Fourteen Million  
Dependable Spark Plugs  
1915

## What Our Big Production Means to You

Year after year for many years, we have made more spark plugs than all the others combined.

Year after year we have greatly enlarged our output.

This year we will double last year's production.

Year after year we have made Champions more and more dependable.

As our production has grown we have been able to adopt extreme and still more extreme measures to insure dependability—

Because—as our production increases we can distribute the expense of these extremes of engineering, of testing and of processing, over a vastly larger number of spark plugs.

That's why Champions are so much more dependable.

Your dealer will supply you with the Champion designed to serve your car more dependably than any other.

Look on the porcelain (not merely on the box) for the name Champion.



**Champion Spark Plug Co.**  
405 Avondale Ave. TOLEDO, O.

## Free Motorcycle Book

A book you ought to have, whether you are a motorcycle enthusiast or merely considering the purchase of a machine. Full from cover to cover of interesting and instructive information about the buying and care of a machine. Describes in detail the construction of every discriminating rider from Maine to California.

### EMBLEM

Motorcycles are built for the red blooded, outdoor man who appreciates the throb of a powerful motor; the unhesitating sweep up and over the worst sort of hills; the unfailing, faithful drive that sends the Emblem without faltering through sandy and treacherous roads. The Emblem has a stout heart—it will take you where no other machine will attempt to go, and will bring you back. It is the motorcycle for you. Your name on a postal NOW will bring our Motorcycle Book and a full description of the Emblem by return mail.

EMBLEM BICYCLES are made by the same organization that builds the Emblem Motorcycle. They embody the same sturdiness of construction; the same ability to stand up and perform under every sort of hard work and abuse. Bicycles are once more coming into their own—and the Emblem is leading the way. We have an Emblem Bicycle Book here for you and will send it as soon as we get your name—a postal will do.

**Emblem Manufacturing Company**

Station A  
ANGOLA, Erie County, N.Y., U.S.A.  
Pack of EMBLEM 500 Playing Cards sent on receipt of 10c in stamps.



## \$40 Motorcycles and Bicycles at Cut Prices



Second-hand and rebuilt motorcycles, singles and twins, \$25 to \$100. Motorcycle tires, \$5; Automobile tires, \$3. Second-hand bicycles, \$5; tandems, \$10. New bicycles and motorcycles at Factory prices. Buy direct, save dealer's profits.

SEND FOR CATALOGUE  
DENINGER CYCLE CO., Rochester, N. Y.

## We Save You \$\$\$\$

Buy Motorcycle Accessories from the largest and cheapest supply house in the United States.

Our 1916 catalog listing 3015 accessories sent **FREE**

You can't be an up-to-date rider without it. It is the one others try to copy. You need it, so send us your name and address today.

MOTORCYCLE EQUIPMENT CO., Hanzelshopt, N. Y., or Los Angeles, Cal.

## Don't Throw Away Your Worn Tires



For over three years European motorists have been getting from 10,000 to 15,000 miles out of their tires by "half-soling" them with Steel Studded Treads. In eight months 20,000 American motorists have followed their example and are saving \$50 to \$100 a year in tire expense.

**We ship on Approval** without a cent deposit, and allow you to be the judge.

**Durable Treads** double the life of your tires and are sold under a signed guarantee for 5,000 miles without puncture. Applied in your own garage in thirty minutes.

**Special Discount** offered to motorists in new territory on first shipment direct from factory. A postal will get full information and sample within a week. State size of tires. Don't wait—write today. Address nearest factory office.

**THE COLORADO TIRE & LEATHER CO.**  
444 Tread Bldg., Denver, Colo. Dept. D 44, Transportation Bldg., Chicago, Ill.  
547 20-444 Woolworth Bldg., New York, N. Y.



The 1916  
←ARROW←



### Electric Light

Motocycle type frame, saddle, handlebars, pedals, mud-guard, stand and luggage carrier. Push thru-proof Non-Skid tires. New coaster brake, tool kit and tire pump. Other new features. Write today—now.

## Great Bicycle Offer

Write for catalog. Wonderful 1916 Arrow—new motorcycle type—shipped **no money down**. Pay small amount each month while you ride. Write for our special, rock-bottom offer while it lasts. **Write Today** Biggest bicycle value ever built. Read above the many new features. Write for free catalog now. Arrow Cycle Co., Dept. 1194, 19th St. & California Av., Chicago

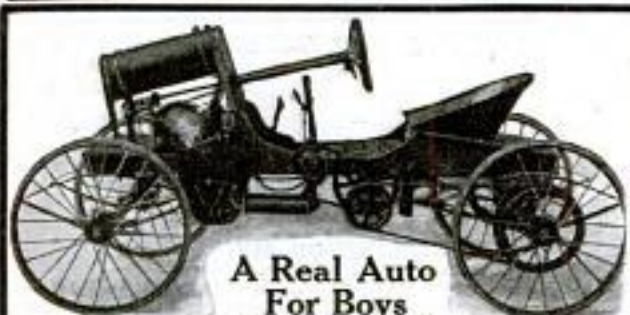

### A Real Auto For Boys

You Can Build It

Send a quarter for drawing, description, instructions and price list of parts. They make it easy. THE MOTOR BOB, Dept. 1, BUFFALO, N. Y.

## Used Indian Motorcycles

We specialize in 'em. Don't handle anything else. Nothing but the best, at rock bottom prices. If you want a guaranteed second-hand machine that will give the service that you have every right to expect, write for our big, descriptive list. Reference, State Street Trust Co., Boston.

George N. Holden, Indian Motorcycle Agent  
186 Massachusetts Ave. BOSTON, MASS.

### 5-16 H. P. 1916 Peerless Motorcycles



with Free Engine, Bosch Magneto, together with the best there is in Motorcycle construction. Power, Speed, Silence, Endurance, and those wearing qualities so essential for low cost of maintenance. 5 MILES FOR ONE CENT  
Agents Wanted—Liberal Discount

PEERLESS MOTORCYCLE CO., 179 Huntington Ave., Boston, Mass.

### The Litt Sho-Fur for FORD CARS

This flat spring does the trick.



Price \$3

Prepaid

Safety assured. No more tired wrists. Simplest, lightest, safest, and cheapest, perfect steering device on the market. Every Ford owner must have one. Write for full description. This is a gold mine for you. Ford Owners buy at sight. Dollar an hour profit. Sales guaranteed. Full details free.

Agents White Mfg. Co., Dept. P, Cincinnati, O.

## Garage \$69.50

10x12feet "Steelcote" Edwards ready-to-use garage, \$69.50 complete. Factory price. Fireproof. Portable. Quickly set up. All styles and sizes of garages and portable buildings. Send postal for illustrated catalog.

THE EDWARDS MFG. CO.  
320-370 Eggleston Ave., Cincinnati, O.



## Net

Prices Direct to You

**A**BSOLUTELY net terms on any diamond you choose. You can now buy direct. No jobbers, no retailers to pay.

Write for our net price catalog listing an exquisite collection of pure, blue-white

## Diamonds

Tiffany and Belcher rings, La Vallieres, brooches and other diamond jewelry. Every diamond a perfect gem. Selected by a famous expert. Perfectly cut to give maximum brilliancy. Richly mounted in solid gold settings.

**Free Examination** Not a cent down—you see the diamond before you accept it. We want you to compare these diamonds with others at twice their price.

**\$2<sup>50</sup> Monthly** Only \$2.50 a month will make you the wearer of a

beautiful diamond ring. Other terms, \$3.50 \$4.50 and up—and middle-men's profits cut out.

## Write

For Net Price List and Diamond Book

Shows the different gems, styles of mountings and gives our importer's net prices with terms of payment. Do it now.

BURLINGTON WATCH CO.  
Dept. 1194  
Chicago, Ill.

Burlington Watch Co.  
Dept. 1194  
Chicago, Ill.

Without obligations send me your net price offer on diamonds; also send Diamond Book.

Name.....

Address.....

## Save 20% Buy the Famous Riverside Tires

Guaranteed  
5000 MILES

Ford Size

4000

All

Others



GET our 1916 prices before you buy tires. We save you one dollar out of every five, of others prices. And we unconditionally guarantee the mileage. Famous racers have broken all records on Riverside Tires.

### SEND FOR AUTO BOOK

Showing Riverside construction—wrapped tread—one cure—toughest fabric, with pure Upper River Para Rubber, extra thick tread. Book shows similar saving on all automobile accessories. Sent free on request. Write today.

Montgomery Ward Co. Dept. C133 NEW YORK CHICAGO KANSAS CITY  
FT. WORTH PORTLAND

Write to the house most convenient to you



# REFLEX

## The Spark Plug with The Gold Bond Guarantee

### REFLEX GOLD BOND GUARANTEE

Reflex Spark Plugs are fully guaranteed against defects in material and workmanship. Any plug proving defective within one year from date of purchase will be repaired or replaced free of charge if returned with this tag to your dealer or direct to our factory. Reflex plugs are sold on thirty days trial. Your money back if not satisfactory. THE REFLEX IGNITION COMPANY, CLEVELAND, O.

Packed with every Reflex Spark Plug.

Factory equipment on Henderson Motorcycles, White, Winton and other high grade cars—Reflex Spark Plugs will give the most efficient service—the greatest freedom from spark plug troubles in any motor.

### OUR OFFER

Buy a Reflex—use it 30 days. If not satisfactory, return it and get your money back.

Reflex No. 1—Conical Reflex  
\$1.00 Postpaid, or at your dealers.

State make of car when ordering.

Dealers and Local Representatives wanted everywhere.

The Reflex Ignition Co.  
1713 Payne Ave., Cleveland, Ohio



SOME CAR!

BOYS!

Send for Booklet Today



The Lad's Car

Send 20c today for Booklet, telling how to build this automobile. Complete instructions and descriptions of parts and sizes, illustrated with diagrams, blue print, cuts made from photographs, and price list of parts.

SPECIAL INDUCEMENT to first boy in your town  
Niagara Motor Car Corp'n, Dept. A, Niagara Falls, N. Y.



### Convert Your Bicycle into a Motor-Cycle

Motor fits any wheel. BEST, MOST RELIABLE. Best hill climber. More STEFFEYS in use than all others. Stamp for circular. STEFFEY MFG. CO., 5007 Brown Street, PHILA., PA.

**COST OF ARTILLERY HARNESS**—A six-horse artillery harness costs \$365, and thousands of them are being destroyed in the present war. American manufacturers have already sent over \$15,000,000 worth of them to Europe. They are made of the best bark-tanned, hand-curried leather.



### Build a WAR Aeroplane

"Ideal" accurate Scale Drawings enable you to EASILY build 3 Ft. Flying Models of Aeroplanes now used in the European War. Students of Aeronautics, everyone with an inquiring turn of mind, should construct one of these fascinating Models.

Prices of 3 Ft. Scale Drawings  
Curtiss Flying Boat 25c Blériot Monoplane 15c  
Curtiss Military Trainer 25c Taube Manplane 25c  
Hydroaeroplane 25c Wright Biplane 25c  
Nieuport M' n' plane 25c C. e. il Peoli Racer 25c

Complete Set of Eight, \$1.50 postpaid. Get 50 page Aeroplane Book, containing full information about models, parts, etc., be postpaid. Ideal Aeroplane & Supply Co., 87-88 West Broadway, New York



Taube

# THIS MOTORCYCLE GIVEN AWAY AS A PRIZE GIFT

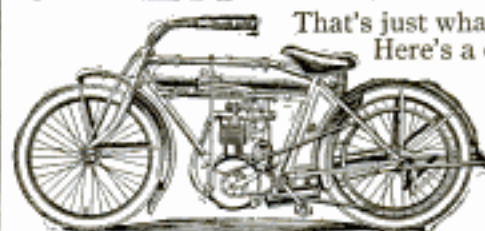

That's just what we mean—given away as a prize. Our plan is easy and simple. Here's a chance to get a motorcycle with the least possible effort. Send us

your name for our free plan. You'll scarcely believe us when we tell you how easy it is to get this machine. An easy plan. No fake puzzles to work. If you will give us just a little of your spare time, you can have this machine; but be sure and

### Send Your Name Today

This is a genuine, latest model "Pope" machine, the latest and last word in motorcycle making. The machine is a brand new 1916 model and will be shipped direct from the factory so as to insure that you get only the latest and best. Don't fail to send us your name. Our plan is to advertise our business, and if you will help us you can have the machine. It will not require a solid week of your time to get this machine. Isn't that worth a try? Where else can you earn a \$200.00 motorcycle in a week? Be quick—that's the main thing. Don't lose a minute. Do it now.

D. BRYDON, MANAGER

202 S. WITTENBERG AVE.

SPRINGFIELD, OHIO



## 5000 MILES From Hawaii to Richmond, Va. with CRYSTALOI

"On Dec. 23 I made what I believe to be a new record for the Crystaloi Detector. About 11 P.M. I heard the station at Lahaina, Hawaiian Islands, a distance of 5,000 miles. Heard the station four different times."  
(Signed) RALPH J. ROBEY,  
3314 Floyd Ave., Richmond, Va."

### We Guarantee Every Claim Made for CRYSTALOI The Highly Sensitive, Permanent WIRELESS DETECTOR

Crystaloi offers a large surface of highly sensitive mineral, which is brought into contact with a finely divided alloy—thus giving innumerable contact points. Crystaloi works under the heaviest static conditions—will not burn out—and with proper use will last a lifetime. With it every message will come in strong and clear.

#### THREE TYPES

TYPE O—\$ 3.50—Mailing Wt., 1 lb.  
TYPE AA— 5.00—Mailing Wt., 2 lbs.  
TYPE BB— 12.00—Mailing Wt., 4 lbs.

All Live Dealers carry Crystaloi. If your dealer cannot supply you, write us. Catalog "G" sent on receipt of 5c in stamps.

Eugene T. Turney Co.  
INCORPORATED  
2595 3rd Ave., New York



## MURDOCK Wireless Receivers

2000 ohm complete double set \$4.00  
3000 ohm complete double set 5.00

We guarantee that these 'phones are real wireless receivers of standard double pole construction, wound with genuine copper wire, and fitted with best quality headband and cord.

**Fourteen Days'** trial allowed and money refunded immediately on return of 'phones, if you are dissatisfied in any way.

OUR CATALOG IS FREE

Wm. J. Murdock Co. 10 Carter St.  
CHELSEA, MASS.

## MECCANO Toy Engineering for Boys

Have piles of sport building working models of towers, bridges, cranes, derricks and anything you want to; build models of real things and learn how they work. Fine fun, too. MECCANO builds more models, better ones; builds easier and quicker. Every part is interchangeable; girders are ready to use, strong and rigid. It's the most practical, instructive and amusing construction toy for boys.

### 10,000 Models

were entered in our last prize contest. MECCANO builds real models of actual machinery, structural works and all kinds of other things. Boys—get MECCANO-wise!

MECCANO outfits cost \$1.00 to \$35.00. Some, costing \$3.00, \$5.00 and \$7.50, have the MECCANO Electric Motor. See them at your dealer's. Get one and build models! Send the names and addresses of five boys and get the 144-page story-book catalogue free. Send the names today!

MECCANO  
COMPANY, Inc.  
Room 15  
71 West 23rd Street  
New York City



## The Electrical Experimenter

VOICE-OPERATED TYPEWRITER



THE big electrical Magazine for those who dabble in electricity and Wireless. The "How-to-Make-It" magazine, chuck full of experiments and the latest electrical progress. Foremost authority on WIRELESS in the United States. Official organ of the Radio League of America. Over 200 wonderful illustrations with over 100 articles in each number. You are not keeping abreast with the times unless you read the Electrical Experimenter. One copy will convince you. Every issue also contains the snappiest and most up-to-date scientific stories that will delight you.

\$1.00 a Year. 10c at Newsstands

Send 10c for three numbers

THE ELECTRICAL  
EXPERIMENTER

234 Fulton St., NEW YORK CITY

## Send 10c for Copy of Our New Wireless Manual No. 2

YOU GET YOUR MONEY BACK ON AN ORDER OF \$1.00

It contains 120 pages and tells how to erect and maintain wireless telegraph stations. Shows a number of diagrams. Has the Morse and Continental Telegraph Codes. Illustrates the best instruments to use; tells what they are for and how to use them. Has many new diagrams and other valuable information not contained in any other book. Do not wait. Send your request now. Get the best 10c value you will ever buy.

## Send for Our Pocket Catalog P28

It contains 212 pages, with over 1,000 illustrations, and describes in plain, clear language all about Bells, Push Buttons, Batteries, Telephone and Telegraph Material, Electric Toys, Burglar and Fire Alarm Contrivances, Electric Call Bells, Electric Alarm Clocks, Medical Batteries, Motor Boat Horns, Electrically Heated Apparatus, Battery Connectors, Switches, Battery Gauges, Wireless Telegraph Instruments, Ignition Supplies, Etc.

### MANHATTAN ELECTRICAL SUPPLY COMPANY

NEW YORK, 17 Park Place

CHICAGO, 114 So. 5th Ave.

ST. LOUIS, 1106 Pine St.

San Francisco, 604 Mission St.

## WE ARE HEADQUARTERS FOR ELECTRICAL GOODS and WIRELESS APPARATUS

OUR NEW 224 pp. No. 7 CATALOG IS THE BEST ONE PUBLISHED



### EXPERIMENTERS THIS IS THE Experimenter's Reference Book

It's the latest edition of the famous **Amos Catalogue**, contains over 200 pages and is fully illustrated. Complete description and prices of the latest electrical and experimental apparatus—Storage Batteries, Rectifiers, Transformers, Induction Coils, Wireless Apparatus, Lamps, Flash Lights, Motors, X-Rays, Books, Tools, Electric Railways, Steam Engines, Water Motors, Dynamos, Motors, Telegraphs, Telephones, Electrical Sirens, Model Aeroplanes and Parts for building your own apparatus. 6c in stamps will bring you this wonderful book. Contains a complete list of Wireless Calls, Morse Codes, Wiring Diagrams, tells how to put up an aerial and install apparatus, etc. **Best catalog of Wireless and Electrical Apparatus, etc., published. Send for this catalog right away. Our prices will save you money. 6c in stamps brings it by return mail.**



### FUN WITH ELECTRICITY

Here is a rare chance to get started right in your study of electricity. This wonderful outfit contains 55 page book of instructions and all the apparatus for performing 40 interesting and spectacular experiments which will give any boy a practical knowledge of electricity.

Price Only 50c. Postage 10c Extra



**LOTS OF FUN FOR BOYS!**  
3 1/2 volt, 2 C. P. TUNGSTEN lamp, switch, socket 20 ft. insulated wire and 3 cells of dry battery all ready to install. May be used to light a dark closet or hall.  
Price only 50c. Postage extra 15c



### LITTLE GIANT MOTOR

Is nearly 3 in. high. Runs at high speed on a single cell of battery. Very powerful and may be used to run small toys, etc. Just the motor every boy has been looking for. **Send postpaid for only 50c**

### THE SIMPLEX TELEGRAPH OUTFIT

An opportunity for every boy to learn to telegraph and to put up a line with his class. This is a full sized telegraph set, consisting of a fine key and receiver, mounted on a polished base. Will work any distance. An excellent Field Telegraph for Boy Scouts. **Price, 95c. Postage Extra. Wt. 2 lbs.**



### UPRIGHT STEAM ENGINE

A fine engine of the best materials. 9 in. high. The Right Engine for Any Boy. Runs at high speed. Each engine tested at factory and fully warranted. **Send postpaid for only 50c.**



Send 6 cents for our mammoth catalog

**ADAMS - MORGAN COMPANY** "The Experimenter's Supply House"  
25 Alvin Place UPPER MONTCLAIR, N. J.

# WIRELESS

OUR TRADE MOTTO:

## "Everything for the Experimenter"

Send for our big 275 page Electrical Cyclopedic containing 658 illustrations. Treatise on Wireless Telegraphy, complete code chart of Morse, Continental and Navy Codes besides list of call letters



**Interstate Wireless Receiving Outfit** has tuner, detector, fixed condenser, receiver and coil, top and base of hard rubber construction. Will receive 200 miles. Size 3x3x3.5 in. Wt. 4 lbs. Price **\$3.75**

of all the U. S. Ship and Shore wireless stations. This wonderful book sent for 4c in stamps or coin to cover postage only.

It's the "Livest Catalog in America," and one book you simply must have.

**The Electro Importing Co., Mfrs.**  
233A Fulton St., New York City

Retail Stores: 317H Livingston St., Brooklyn, N. Y.  
69H W. Broadway, New York City

# ELECTRICITY

**ELECTRIC LIGHT PLANTS** Complete gasoline engine, dynamo, switchboard and storage battery \$240.  
Agents wanted. American Battery Co., 1139 Fulton St., Chicago (Estab. 1898.)

## Complete Wireless Sending and Receiving Station \$10<sup>10</sup>

Receives hundreds of miles. Sends 8 to 20 miles.

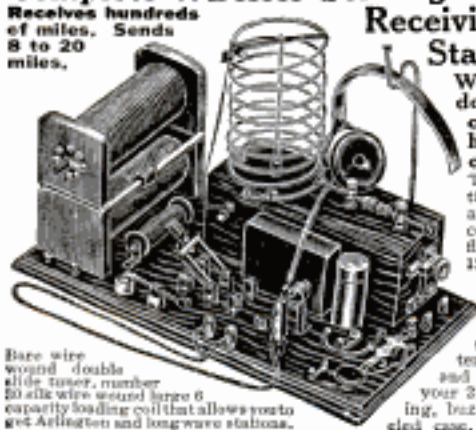

With 1000 ohm, double pole, receiver, nicked head-band and cord.

This remarkable station consists of a guaranteed 1 1/2 in. spark coil, machine turned fluted spark gap, our 1501 key, a flat plate condenser, assembled in an oak case, a large capacity helix, DPDT switch, 500 ohm potentiometer, buzzer and switch to tell if your 2 detectors are working, buzzer battery in nickel case, tubular condenser.

Base wire wound double slide tuner, number 20 silk wire wound large capacity loading coil that allows you to get Arlington and long wave stations.

Send stamp for our large catalog "P" of remarkable values. If possible call and see our stock.  
**Wireless Stations from \$1.95 Up**  
**THE HANDEL ELECTRIC CO., 59 & 61 Park Pl., NEW YORK**  
Please note our new address

One-eighth of the population of the United States, but only 1/136 of its area are included within a circle of 100 miles' radius, drawn around New York City.

**GACHOO!** Make the whole family and all your friends "just sneeze their heads off" without knowing why, with Gachoo, the new long distance harmless snuff. Sent anywhere for 10c. 3 for 25c. 1 doz. and special premium for 90c. **AMERICAN SUPPLY CO., St. Paul, Minn.**



**ELECTRIC HOME, FARM, THEATRE, STORE and TOWN LIGHTING PLANTS.** \$18.00 Rectifier Charge Storage Batteries from Lamp Socket Lighting Your Auto Electrically for ONE CENT an hour. Lamps; Dynamos; Engines; Belts; Medical and Storage Batteries; Belts; Books; Sewing Machine and Power Motors; Railways; Bikes; Carriage, Fish, Hunting, Auto and Xmas Lights; Massage and Ozon Machines; Telephones. Picture Theatre Traveling and Permanent Equipments. Big Profits. Ten Cents an Hour lights Theatre and M. P. Machine. Catalog 3 cts.  
**OHIO ELECTRIC WORKS, CLEVELAND, OHIO**



# DUCK'S No. 9—320 pp. Electrical and Wireless Catalog

JUST OFF THE PRESS

40 new pages of wireless instruments at startling prices. Many new items in the electrical line. This unrivaled catalog mailed upon receipt of 8c in stamps or coin, which may be deducted from first dollar purchase. Great cost of catalog and low prices prohibit distribution otherwise. This catalog contains anything and everything in the field of wireless and electrical supplies.

YOU CANNOT AFFORD TO BE WITHOUT IT

**The Wm. B. Duck Co., 223-227 Superior Street, Toledo, Ohio**

# WANTED IDEAS



Inquiries from Manufacturers and Other Buyers of Patents  
Who Are Looking for Good Ideas

## Protected by Owen Patents

Are constantly being received. Hundreds of ideas are wanted—a market exists for them to-day. YOURS may be one of them. Send for my free books and see for yourself—read the requests for inventions protected by me. Many are simple. You can help supply this demand.

As soon as my clients' rights are protected I aid in every practicable way, without charge, to sell. Their applications are advertised free—their patents are called to the attention of the proper prospective buyers—every necessary thing is done. Get my booklets and see.

## THESE ARE FREE

You will incur no obligation by writing me. A simple request will bring them to you—the finest, most reliable and instructive patent books published. A postal will do.

**“Successful Patents”**—a 72 page guide book, tells how to proceed; describes my advantageous business methods; gives references, testimonials, etc.

**“Stepping Stones”**—gives hundreds of hints of inventions wanted; articles from interviews of noted authorities; tells the truth about prizes for inventions.

**“Patent Promotion”**—tells you how to sell; why some inventors fail; discusses the value of your idea; how I aid my clients; manufacturing aids furnished you; recent successful patents, etc.

You will also be sent from time to time, as new inventions are wanted, full information concerning them. Only in this way can you keep up to date.

### Write for These To-day

Advice costs nothing. All communications confidential. Your work will receive my personal supervision—but my fees are no higher than others.

### Results Speak Loudest—But Here Are Some References

Columbia National Bank,  
Washington, D. C.  
National Locktile Co.,  
Washington, D. C.  
The Carnahan Press,  
Washington, D. C.  
Lightning Gun & Cycle Works,  
Oklahoma City, Okla.  
Antholene Mfg. Co.,  
Hutchinson, Kans.

National Rack Co.,  
61 Hannover St.,  
Boston, Mass.  
The C. J. Loftus Co.,  
13 Spring Common,  
Youngstown, Ohio  
Whitehead Hosiery Mills,  
Burlington, N. C.  
Dickinson Mfg. Co.,  
Des Moines, Iowa.

A LARGE NUMBER OF OTHERS IN MY BOOKLETS.

**RICHARD B. OWEN** 9-303 OWEN BLDG.  
WASHINGTON, D. C.

Inventors submitting their inventions to me are protected in a tangible manner until their applications are filed.



### SPECIAL FREE REPORT

Send sketch or model of your invention for free report on patentability, practicability, etc.

# Manufacturers Calling for Over Two Hundred Inventions

## Money Is Waiting to Back the Good Idea

(By a Washington Patent Attorney)

Never was there so good an opportunity for the inventor of something — anything — of merit as right now.

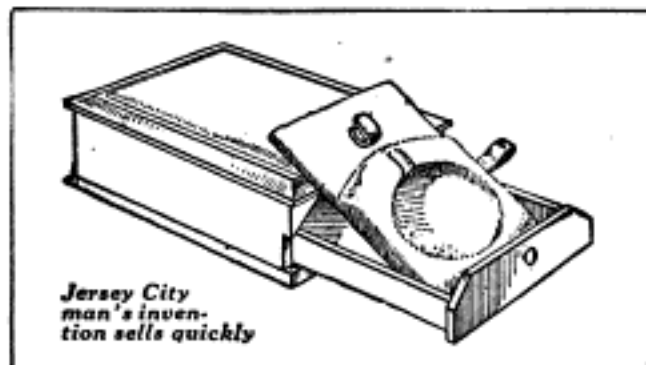

Jersey City man's invention sells quickly

Manufacturers with money and facilities are asking for ideas—calling for them. The supply is not nearly equal to demand. Over 200 inventions are asked for in a list just given in a little book "What to Invent." The demand is not for anything extraordinary—just the common everyday things that make work easier or life more pleasant in the household, the shop or the field.

You might think the possibilities of the window screen had been exhausted, but I know of 28 concerns that are looking for a new screen, duly covered by patent, which they can manufacture. I know of 46 manufacturers and others who are ready to manufacture any good, patented household article such as can openers, baking pans, coffee pots, washing machines, carpet sweepers and other devices.

Within the last few weeks I have received forty special requests for a dishwasher and drainer; seventeen others request an improvement in scissors. Manufacturers know that everyone must have a pair of scissors in the house, and they realize that a novelty in them would always sell in place of the old kind, and hence the demand. Among my letters are sixteen requests for a device to turn sheet music on a music stand or piano, and seventeen people are interested in the purchase of a patent on a device for holding an electric light in any position. Besides these there are hundreds of manufacturers who do not specify any particular device but state that they would be interested in anything of merit.



Coupling hook adopted by Pennsylvania R. R.

A Chicago man says: "I want something that can be sold to farmers by mail. There is practically no limit to the investment my associates would make in a good proposition." A man in Woodhaven, N. Y., says he is in the market for a small household article, light in weight, which can be sold somewhere around ten cents.

A prominent manufacturing company is interested in something to sell to hardware stores, but would also be interested in other things promising to be money-makers.

A man in Revere, Mass., says: "I am looking for something that can be manufactured, plant equipped, etc., and marketed for an outlay of not over twenty-five thousand dollars."

A big textile machinery company says they are interested in newly patented devices that can be either bought outright or manufactured on royalty. They do not require machinery inventions alone, but anything of merit.

A company in Belvidere, Illinois, wants patents on small tools or metal novelties.

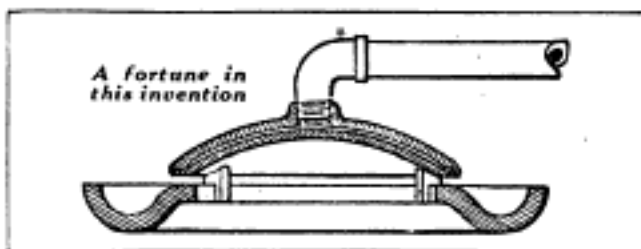

A fortune in this invention

A Dayton, Ohio, concern writes for some machine or device that would have a general sale throughout the land.

The names and addresses of these prospective purchasers are supplied absolutely without charge by Messrs. Chandlee & Chandlee to those who obtain patents through their firm. This firm has been in practice before the Patent Office for over twenty years, and its members are, consequently, familiar with every detail of patent work. They also issue a booklet entitled "How to Obtain a Patent," which tells in simple words just how to go about protecting an invention. The two books, "What to Invent" and "How to Obtain a Patent," are both free. Why don't you write for them and learn what manufacturers are looking for and how to protect your ideas? If you have an invention, send a sketch or model and description of it to Chandlee & Chandlee, 969 F Street, Washington, D. C. They will give you a free opinion as to whether or not it can be patented.

# Wanted—Ideas

Inventors! Send for these Remarkable FREE BOOKS, Today



## "Inventions Needed"

This book lays before you a description of the active and profitable field of invention. It tells you the inventions the world needs today, the devices manufacturers are seeking for their business, the ideas for which the public will pay big money.

## "How to Get Your Patent"

This book is a guide to the inventor. If you have invented something and desire to learn what it will cost you to get your patent and what you must do to find your market, read this book.

## "Special Bulletin of Patent Buyers"

This bulletin contains letters from men who are seeking to purchase patents. We act as intermediary without one cent of charge, between the man who invents and the man who invests.

Send Model or Sketch and description of your invention for Free Opinion as to patentability

*Rejected and Difficult Cases are Our Specialty*

**RANDOLPH & CO.**

600 F St., N.W., Washington, D.C.

**RANDOLPH & CO.**  
600 F St., N. W., Washington, D. C.

Gentlemen: Please send me without obligation on my part, the books indicated on margin of this coupon. (Write on margin of coupon, names of books desired.)

NAME .....

STREET .....

CITY.....STATE.....

Freight rates within a 50-mile zone about New York are said to be the lowest in America, in some cases being only one-half of those in similar zones surrounding many cities.

### Models and Gears

### Experimenters—Inventors

Developing inventions and making working models our specialty. Well equipped shop and staff of experts at your service. Carry complete stock of gears. Shipments same day order received. Send 4c stamps for booklet of Inventors' Supplies.

UNION MODEL WORKS, Est. 1882, 121 S. Clark St., CHICAGO



MECHANICAL SUPPLIES AND MATERIAL of all kinds. EXPERIMENTAL AND LIGHT MACHINE WORK to order. 132 MILK STREET. BOSTON



### MODELS BUILT FOR INVENTORS

Practical, economical and modern methods of Model and Machine construction. Scientific Experimental Work. Expert designing and building of special Models, Tools and Machinery. Our staff of Skilled Mechanics assist customers to develop and perfect ideas, Patents and Inventions, etc. Let us take care of your mechanical requirements.

Regal Model & Tool Works, 122 S. Clark St., Chicago



### BRASS GEARS

Cut by an entirely new process. The most accurate made and at prices that cannot be equalled by others. Every gear has a hub, center painted ebony black, edges turned true, highest grade red brass, and much heavier than others. We carry the largest stock in the world and every gear listed is always shipped on date of order.

SEND FOR CATALOGUE  
CHICAGO STOCK GEAR WORKS  
16 S. Fifth Av. Chicago



### INVENTORS Our Brain Belongs to You. Our Ideas

Are Free of Charge.

All we want in return is to build your model, special machinery, dies, tools and jigs to manufacture sheet metal goods, etc. We are expert mechanics, over thirty years' experience and have one of the best equipped shops in the country. Ask for Booklet No. 17. Consultation free. Experimental work strictly confidential.

A. Macke & Son, J. Urmann, A. Haldrich, Prop's  
236-242 S. 9th St., Philadelphia, Pa.

## U.S. PATENTS

**FREE** →  
**BOOK-BULLETINS & ADVICE**

REGISTERED ATTORNEYS

**LANCASTER & ALLWINE**

204 OURAY BLDG. WASHINGTON, D. C.

## Don't Lose Your Rights

We publish forms called "Evidence of Conception" by which you can establish your rights before sending the invention to anyone. It is your best protection. We issue up-to-date bulletins of improvements wanted; aid inventors to promote their rights; render reliable opinions free of charge and secure valuable patents and trade marks on reasonable terms. Personal service assured by our Service Guarantee Contract. References: 2nd National Bank, Washington, J. P. Roth Packing Co., Cincinnati.

### SIMPLY MAIL COUPON

LANCASTER & ALLWINE, 204 Ouray Bldg., Washington, D. C.  
Send me free, book "Invention—Patenting and Protecting," Bulletin of Improvements Wanted and blank form, "Evidence of Conception."

Name .....

Address .....

Please Mention Popular Mechanics

# PATENTS

## THAT PROTECT AND PAY

### SEND FOR FREE BOOKS

Advice free. Terms reasonable. Highest references. Best results. Send sketch or model for FREE examination and opinion.

BONDED and recommended Patent Lawyer in the Rand-McNally Directory of Bankers and Attorneys Published by Rand-McNally & Co., Chicago, Ill. Recommended Patent Attorney in the Bankers Register and special list of selected lawyers published by the Credit Company, Pontiac Building, Chicago, Sharp & Alleman's Directory of Lawyers and Bankers published in Philadelphia, Martindale's American Legal Directory published in New York City, and the Con. P. Curran Directory of Bankers and Lawyers published in St. Louis.

**ALL BUSINESS GIVEN PROMPT AND PROPER ATTENTION**

*A large list of strong recommendations furnished free*

**Read the following Testimonials** **THEY SPEAK FOR THEMSELVES**  
**SEE WHAT OTHERS SAY**

Tacoma, Wash., May 25, 1914.

I received my Letters Patent and was much pleased and wish to thank you once more for the way you handled my business. It shows you lost no time, and if anyone is looking for information in this locality I would be glad to recommend or to favor you in any way.

H. J. BURCHETT, 1727 So. E. St.

Los Angeles, Calif., May 25, 1914.

I wish to thank you for the valuable work which you have done for me.

A. C. BATES, 231 So. Grand Ave.

Indian Springs, Indiana, May 29, 1914.

I am pleased to thank you for your excellent work in securing patent, as every movement by you has been to my entire satisfaction.

JESSE E. GOSSMAN.

Anamoose, N. Dak., May 29, 1914.

Please accept my thanks for successfully securing this patent for me. Will recommend your prompt services to all my friends who endeavor to get patents upon inventions.

MAX TURECK.

Moline, Kansas, May 30, 1914.

I want to assure you that your promptness and painstaking in what little business we have had has insured you any further business I may have.

JAMES H. FONTS, Box 157.

Passaic, N. J., June 1, 1914.

I am very much pleased with the way you handled my patent and will heartily recommend you to any friend that has any idea of employing an expert attorney.

BUANAFEDE MONTERASTELLI,  
474 Highland Ave.

De Leon, Tex., June 3, 1914.

I am in receipt of your letter today, of the official notice of allowance of my application, and I want to thank you for your prompt and honorable service. I was not expecting the allowance so soon. You can rest assured if I have any more inventions, you will get them, and I will recommend you to others, as I have done a number of times. If all inventors know you as I do, other patent attorneys would have to quit business.

W. P. HAMMERS.

Buffalo, N. Y., June 8, 1914.

I am very much pleased with your work. You can refer your clients to me and I will always have high words of praise for your work.

WALTER MICHALSKI, 66 St. Louis Ave.

Wrights, Ill., June 9, 1914.

I received my patent all O. K. June 5th, and am more than pleased with your work, and cannot recommend your work too highly.

CLARENCE ELMER GRIFFITH, Box No. 90.

Trenton, Ky., June 9, 1914.

The reason why we picked you was we heard that you were the best patent lawyer in the world.

W. and F. BURRUS, R. 3, Box 25.

Chattanooga, Tenn., June 12, 1914.

I received my patent yesterday. I was greatly surprised to get it so soon, filed February 26, issued June 9. It must be a record in its way.

REGINALD PURSE, 502 Georgia Ave.

Lancaster, Ohio, June 12, 1914.

I must congratulate you for getting the patent through so quickly. Many thanks for the work you have done.

CHARLES HATTER, R. R. No. 2.

**WATSON E. COLEMAN, Patent Lawyer, 624 F St., Washington, D. C.**





## IDEAS = MONEY PATENTS THAT PAY

Over \$600,812.00 made by clients. Proof given. Send data for free advice.

### 2 WONDERFUL GUIDE BOOKS FREE

Don't miss these books. Mail postal today.

E. E. VROOMAN & CO., 871 F St., WASHINGTON, D. C.

## SAFE METHODS

No catches resulting in useless patents. Large lists of manufacturers and inquirers. Nearest patents and report in each case to be filed: no extra charge. **Easy payment plan.**

To be sure of honest guidance before, and a good attorney after, filing application, is more important than stories of fortune.

Send for **FREE BOOK** { **WHAT TO INVENT**  
**WHAT NOT TO INVENT**  
**HOW TO SELL YOUR PATENT**  
H. L. WOODWARD, Att'y, 9th and G, Washington

## PATENTS

**C. L. PARKER**  
Formerly Member Examining  
Corps, U. S. Patent Office  
**PATENT LAWYER**  
MCGILL BLDG.  
WASHINGTON, D. C.

Patents, Trade Marks, Copyrights, Patent Litigation

Handbook for Inventors, "Protecting, Exploiting and Selling Inventions" sent free upon request.

## Protective Patents

Procured Promptly. No fee refund, no guarantee certificate, no so-called prize or free search schemes used in our business. Inventors 104 page Blue Book sent on request.

Robb & Robb, 211-215A Southern Bldg., Washington, D. C.

The Empire of Japan includes about 4,000 islands.

## PATENTS

procured for electrical, chemical, automobile, engineering and other inventions. Booklet free. Best references.

**MASON, FENWICK & LAWRENCE**  
Established 1861. Washington, D. C., New York and Chicago

## INVENTION

\$1.00 A YEAR

### Special Offer

Invention will be sent 5 months if you send \$1.00 now.

**DO IT NOW!**

Helps inventors to save and make money in patenting, developing and selling inventions. A friend and teacher. It is "The Inventors' Aid." Publishes the news of recent patents, and Articles on successful inventing, patenting and promoting. **Before Spending Money on Patents Consult Invention.**

**INVENTION** 915 G St., N. W.  
WASHINGTON, D. C.

# DIAMONDS

ON CREDIT - \$  
TERMS AS LOW AS

# 2.50

A MONTH



### Diamond Rings

Wonderfully brilliant Genuine Diamonds, any style solid gold mountings; also Diamond La Vallieres, Ear Screws, Brooches, Scarf Pins, Studs, etc., on credit terms as low as \$2.50 a month.

Send for **Jewelry Catalog No. 57**

containing over 2,000 beautiful illustrations of Diamonds, Watches, Artistic Jewelry, Silverware, Cut Glass, etc. Select anything desired, either for personal wear, or for a gift to friend or loved one, then ask us to send the selection for your examination. It will be sent, all charges prepaid by us.

**YOU PAY NOTHING—NOT ONE CENT** until you see and examine the article right in your own hands. If you like it, pay one-fifth of the purchase price and keep it, balance divided into eight equal amounts, payable monthly. If not entirely satisfactory, return at our expense. You assume no risk; you are under no obligation. Our Catalog tells all about our Easy Credit Plan. Send for it Today. It is FREE.

**LOFTIS BROS. & CO., The National Credit Jewelers**  
Dept. M894, 100 to 108 N. State Street, Chicago, Illinois  
(Established 1858) Stores in: Chicago : Pittsburgh : St. Louis : Omaha

Well-known patents worth many hundreds of thousands of dollars, obtained through us and sold or licensed to well-known manufacturers, including some of the largest corporations in the world, are evidence that we obtain for Inventors

## PATENTS BUY MANUFACTURERS

Particulars, and book of greatest real interest and value to Inventors—a book that may prove worth a very large sum of money to you if you read it before you apply for a patent—will be mailed free on request.

Lowest fees for best service is the basis of our terms. Submit your invention and we shall promptly and without charge render you reliable opinion as to patentability and quote you cost of patenting.

**R. S. & A. B. LACEY, Patent Lawyers**  
Established 1869 724 Barrister Bldg., Washington, D. C.

# PATENTS SECURED OR FEE RETURNED

Compare My SERVICE and TERMS with Those of Any First Class Attorney

Send Sketch, Photograph, or Model of your invention for an ACTUAL SEARCH of the Records of the Patent Office and report as to patentability — FREE. I give every detail of every case my closest personal attention and do not entrust your interests to assistants. Impartial advice on your ideas. I help you sell your patent. Terms moderate. My 90-page book tells what inventors should know before they apply for a patent.

**GEORGE P. KIMMEL, Patent Lawyer**  
200 Barrister Bldg. Washington, D. C.

Latest and Most Complete Patent Book Ever Published for Free Distribution

WRITE FOR IT

# Patents Trade Marks and Copyrights Secured

## SPECIAL OFFER — Free Opinion as to Patentability

Send us a model or sketch and description of your invention, and we will give a free opinion as to the patentability of the invention. If we report the invention patentable, we will furnish a certificate of patentability.

**This Certificate of Patentability will protect the inventor and serve as proof of the invention until the case can be filed in the U. S. Patent Office.**

### Obtaining Assistance for Inventors

Our certificate is of great assistance to inventors who require financial aid to obtain patents.

### Our Five Books Mailed Free

(SEE COUPON BELOW)

to any address. Send for these books—the finest publications ever issued for free distribution.

#### How to Obtain a Patent

Our illustrated eighty-page Guide Book is a book of reference for inventors, and contains 100 mechanical movements illustrated and described.

#### Money in Patents

Tells how to invent for profit, and gives history of successful inventions.

#### What to Invent

Contains a valuable **LIST OF INVENTIONS WANTED** and suggestions concerning profitable fields of invention; also information regarding prizes offered for inventions, among which is

#### Prize of One Million Dollars

offered for one invention, and \$10,000 for others.

#### Patents That Pay

Contains letters from our clients who have built up profitable enterprises founded upon patents procured by us; also endorsements from prominent inventors, manufacturers, Senators, Congressmen, Governors, etc.

#### We Advertise Our Clients'

#### Inventions Free

In a list of Sunday newspapers with two million circulation, in manufacturers' journals and in the World's Progress. Sample Copy Free. We save you time and money in securing patents. After the patent is granted we assist you **TO SELL YOUR PATENT.**

#### Foreign Patents

**WE HAVE DIRECT AGENCIES IN ALL THE PRINCIPAL FOREIGN COUNTRIES** and secure **FOREIGN PATENTS** in the shortest possible **TIME** and at the **LOWEST COST.** Write for our Illustrated Guide Book on Foreign Patents, sent free to any address.



**VICTOR BUILDING**

Our new \$200,000 building opposite U. S. Patent Office  
SPECIALLY ERECTED by us for OUR own use

## WANTED NEW IDEAS

Send for **LIST OF PATENT BUYERS** who consult us when purchasing patents. Contains requests from **MANUFACTURERS, MAIL ORDER HOUSES** and **PROMOTERS** for patents secured by us, and suggestions as to New Ideas they wish to purchase. We invite manufacturers and promoters to address our Sales Department regarding the purchase or leasing of a number of meritorious patents secured by us.

### REFERENCES

Second National Bank, Washington, D. C.; Union Savings Bank, Washington, D. C.; Chamber of Commerce, Washington, D. C.; Pinner Gasoline Lighting Co., Chicago, Ill.; R. G. Dun & Co., Washington, D. C.; Smethport Glass Co., Smethport, Pa.; The Melvin Gauge and Signal Co., Scranton, Pa.; M. Winter Lumber Co., Sheboygan, Wis.; National Savings and Trust Co., Washington, D. C.

### FREE COUPON!

## VICTOR J. EVANS & CO., Patent Attorneys

NEW YORK OFFICES: 189-191 Broadway

PHILADELPHIA OFFICES: 1429 Chestnut St.

Main Offices: 765 Ninth St., N. W., WASHINGTON, D. C.

GENTLEMEN: Please send me FREE OF CHARGE your FIVE Books as described above.

NAME..... ADDRESS.....

You  
May  
Rent an  
Underwood  
Applying  
Rent on  
Purchase  
Price



10  
Days'  
Free  
Trial

# Rent or Buy an UNDERWOOD Standard Typewriter at Less than Half Price

Rent an Underwood—Buy it at half regular price on easy terms later, if you decide to keep it. Rent you have paid will be applied on purchase price. Don't neglect this splendid opportunity. Let us send you a Standard Underwood Typewriter on

## 10 Days' Free Trial

If you are not thoroughly pleased with it, send it back at our expense—in no way will you be obligated. Should you decide to keep it, you may rent, then—remember this—should you finally decide that you want to own it, every cent of the rental you have paid for six months will be applied on the purchase price.

### Make Extra Money—Many Uses

You won't know until you try an Underwood how many uses you will have for it. In addition to doing your own work, you can type manuscript for others—usual price 20c a page—write photo plays—\$25 to \$100 paid by producers. Short stories for newspapers and magazines—\$100 is not an unusual price for a good story.

**Typewriter Emporium**  
Established 1892 CHICAGO

**SEND COUPON TODAY** and let us tell you how we can sell Standard Underwood Typewriters at less than half regular price. We are the

**Largest Independent Typewriter Dealers in the World** and, remember, we do not ask you to buy an Underwood at once; you may rent them; if you decide to buy, the rental you have paid will be applied on purchase price. Send for special Bargain Offer No. 152.

#### Typewriter Emporium, Chicago

Without expense or obligation to me you may tell me all about your Underwood Offer No. 152.

Name.....

Address.....

Town..... State.....

Please Mention Popular Mechanics



## EXCELSIOR Series 17



### The Ultimate of Motorcycle Quality

*Brim Full of Big New Features  
of Real Superiority*

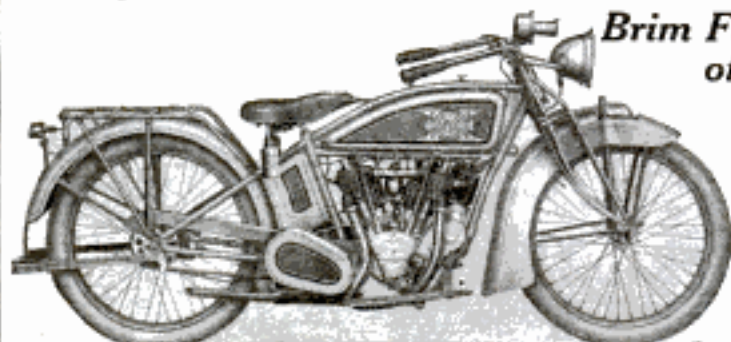

Note these details—

*Ultra Power Big Valve Motor  
The Most Powerful Motorcycle  
Engine Ever Built*

*Foot Motor Starter with Auto-  
matic Compression Release  
insures a start every time*

Automobile Type Three Speed Transmission made of nickel steel throughout with big oversize annular ball bearings. Nickel Steel Frame, made of seamless steel tubing and drop forgings throughout, no castings or stampings in any part of the structure. Motor chain and clutch completely encased in oil and dirt proof drawn steel housing.

*Write today for Catalogue 17, describing this machine and the wonderful Excelsior Lightweight, a machine that will put thousands of people on motorcycles who have never ridden one before.*

**Excelsior Motor Manufacturing & Supply Co.**  
3702 Cortland St., CHICAGO

### 10 NEW FEATURES in the 1916 Waterman Porto

Our new catalog describes in detail all the latest features of the 1916 Waterman Porto, including built-in high tension fly-wheel magneto, unlimited speed control, automobile type carburetor, double capacity fuel tank, larger bearings, newly designed pump, etc., etc.

The Waterman Porto has the perfect speed control of an automobile. Simply shift lever to get any speed desired, forward or reverse. Wonderful flexibility. You can stop your boat in half its length—dock without stopping your engine. Trolly at any speed with any type or size of boat.

Send for this Book today.



Demand these essentials or you will not be getting full value for your money.  
Waterman Motor Company  
230 Mt. Elliott Ave., Detroit, Mich.



### CORONA

FOLDING TYPEWRITER  
CORONA TYPEWRITER CO., Inc., GROTON, N. Y.

Weights 6 lbs. Occupies little space. Durable, efficient. Costs but \$50. Write for booklet No. 13. New York: 141 West 42nd Street

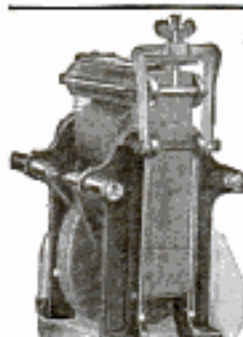

MAKE YOUR  
**WIRELESS**  
100% EFFICIENT  
You can always get a powerful spark when you own a  
**THORDARSON**  
Wireless Transformer

Scientific design and construction—ideal for amateurs. Connects to light circuit; no batteries needed. Equipped with flexible impedances, 5,000, 10,000 and 20,000 volt standard types—special windings to order. Write NOW for our interesting booklet.

Thordarson Electric Mfg. Co., 518 S. Jefferson St., Chicago

## Get Into the Tire Repair Business!

It's the  
Big End  
of the  
Auto  
Business

Write a  
postal now

Easiest to start—biggest opportunities of any business on earth. A broad claim, but easy to prove. Only stop and think!—you know it's true. Listen! Not one auto factory can build cars fast enough. Everybody is car crazy and the craze is growing. 2,000,000 autos now in use. Four tires to each car. That means 8,000,000 tires to repair. Just think of it—8,000,000 tires! Each car wears out its cost in tires alone.

**DETROIT** is the PLACE to Learn and the **RELIABLE** IS THE SCHOOL

Begin now. In every city, town, village, and hamlet there is a fine chance to start—down town or in a good residence district. Soon you will be on easy street. Sounds too good to be true? Couldn't happen to you? Why couldn't it? Why can't you get the big money? There's no corner on the business. You can start and make good too, same as other Reliable men have. Money is no respecter of persons. Of course, you've got to work—you've got to hustle, but hustling where the hustling is good fun. Slaving where the picking is thin is what hurts. Is that what you're doing? At least investigate. Find out what there is in this proposition for you.

Earn  
**\$3000**  
to  
**\$8000**  
a Year

**THE RELIABLE TIRE REPAIR COMPANY, 104 Reliable Building, DETROIT, MICH.**

## Free Camp Guide

Send just your name and address (No money) for **Free Camp Guide**. Gives you exactly the information that all campers need. Big Boy Scout section. Also catalog of tent and camp supplies of all kinds.

### Wall Tents



Serviceable, durable wall tents, with fly. Waterproof. Well made of 8 oz. single-filling duck, first quality. Light and easy to erect. First-class for camping trips. Made in many sizes.

7 x 7 foot - \$5.50

T	X	9 foot	\$
7	7		7.15
9	9		8.50
9	1-2 x 12		9.50
9	1-2 x 14		10.00
12	12		11.15
12	14		12.40
12	16		14.00
14	14		15.60
14	16		17.00
14	18		18.25
14	20		19.50
16	16		20.80
16	18		22.75
16	20		24.50
16	22		26.00
16	24		27.50
18	18		29.75
18	20		31.50
18	22		33.00
18	24		34.50
18	26		36.00
18	28		37.50
18	30		39.00
18	32		40.50
18	34		42.00
18	36		43.50
18	38		45.00
18	40		46.50

Every Boy Scout should have a copy of the Free Camp Guide.

H. Channon Company, Dept. Chicago

Write at once for FREE Camp Guide

### Indian Wigwams

No better lawn tent made for the use of children. Set with tripod. All clear space inside. No center pole. Decorated in handsome designs. Two sizes: 4 styles. Large size 7 ft. 6 in. high and 7 ft. 6 in. diam. Special size for boys or children; height 4 ft. diam., 5 ft. \$1.50.



No. 1 extra heavy white drill, \$4.00

No. 2, made of 8 oz. duck, \$5.00

No. 3, made of standard khaki drill, \$5.00.

No. 4, as above described, \$1.50

### Scout Tents



No. 1 - \$2.50

Also called shelter tents. Fine for camping or fishing. Similar to those used by U. S. soldiers on active duty. Easy to carry, take down, or put up. 5 ft. 3 in. x 3 ft. 6 in. wide and 3 ft. 9 in. high.

No. 1, spec. white cloth, \$2.50

No. 2, spec. khaki cloth, 3.00

No. 3, yacht drill, 3.75

No. 4, khaki drill, 4.75

## APPLIED ELECTRICITY FAMOUS \$35 SET



NOW \$19.80—50c A WEEK

Greatest reference work on electrical subjects ever published. Most exhaustive electrical cyclopedia of modern times. 7 big books written by 32 famous experts; 3500 pages, 3000 illustrations, full page plates, diagrams, simple explanations, etc., with hundreds of valuable facts and figures. Bound in half red morocco.

Earn \$150 to \$250 Monthly

Electrical Engineers earn from \$150 to \$250 a month. The work is pleasant—the hours short. These great books will fit you—in your spare time—to enter this fascinating, well-paid work. No previous experience necessary.

**SENT FREE** To prove what these books will do for you, we will trust you seven days before you spend one penny. They must make good with you or we take them back at our expense without question or annoyance. On receipt of coupon below we ship the entire set to you—express prepaid—at our risk for absolutely free examination.

### Read These Subjects Carefully

Elements of Electricity—Electrical Measurements—Underwriter's Requirements—Theory, Calculation, Design and Construction of Direct Current Generators and Motors—Types of Generators and Motors—Management of Dynamo-Electric Machinery—Electric Lighting—Alternating Current Machinery—Power Transmission—Electric Railways—Self-Propelled Railway Cars—Power Stations—Switchboards and Switching—Storage Batteries—Applied Electrochemistry—Electric Elevators—Electric Welding and Heating—Wire and Wireless Telegraphy.

Free \$12.00 Consulting Membership

Our 32 electrical experts answer every question you want to ask on electrical subjects absolutely free for a full year to every holder of a set of these books. This privilege has always cost \$12.00 and men tell us it is worth twice that amount in settling one problem alone. You get this service free if you buy the books after examination.

This means \$12.00 saved if you act now. Read the coupon carefully. Then fill it out and mail today. The books will reach you promptly—express paid by us. After seven days send us \$2.00; otherwise, notify us for their return.

Don't wait. You take no chances whatever. It costs nothing to inspect and you are nothing out if you do not care to buy. Mail the coupon today.

### FREE COUPON

Worth \$15.20 to You

### American Technical Society:

Please send me Cyclopaedia of Applied Electricity for seven days' free examination. If I keep the books will send \$2.00 within seven days and \$2.00 a month until \$19.80 has been paid, when \$35 books and \$12 consulting membership will be mine. Otherwise will notify you and hold books subject to your order. Title not to pass until fully paid.

Pop. Mech. 4-16

AMERICAN TECHNICAL SOCIETY

Chicago, U. S. A.

NAME .....

ADDRESS .....

As I have had no previous dealings with you, I refer you to

## Unusual Trial Offer for 10c

Best Kodak Developing. Any size roll, 10c. Six prints free with first roll. Or, send six negatives, any size, and 10c (stamps) for six prints. 8x10 Enlargements, 25c each. Roanoke Cycle Company, 2006 W. Campbell Ave., Roanoke, Va.

## TOOTH-ACHE STOP Stops the Pain & Stops the Tooth

Agents Wanted **TOOTH-ACHE STOP** PRICE Postpaid 25 CENTS 3 for 50 CENTS ENOUGH TO STOP 30 TOOTHACHES Easy to use. Insert a little of this paste into hollow in the tooth and the **ACHE STOPS INSTANTLY**, then the paste hardens, forming an antiseptic stopping for the tooth, excluding the air and preventing a recurrence of the agony. **Guaranteed Absolutely Harmless**—will not spread and burn mouth. Does not decay the tooth. **Get it ready for the next bad attack.** A perfect godsend at two in the morning. NATIONAL CHEMICAL CO., 7133 N. Clark Street, CHICAGO

## Comfort Indoor Closet Odorless Sanitary Germ-Proof

Every home without sewerage needs one. Most convenient, meritorious home necessity in a century. A boon to sick people. Can be placed anywhere in house. **Outdoor Privy Unnecessary** Put a warm Comfort Toilet in your home; a guarantee of healthy, sanitary conditions. Germ-life killed by chemicals in retort. Emptied once a month—no more trouble than throwing out coffee grounds. Needs no other attention. Boards of Health endorse it. **WRITE NOW for literature, prices, etc.**

AGENTS CAN EARN \$10 to \$25 DAILY **Send us FREE TRIAL 30 Days**

Here's something going like a prairie fire. Best thing that ever headed your way—big chance to clean up \$25 a day if you will hustle. Sale sure in every home without a toilet. Hardly any limit to your earnings. Don't sleep over this. Send postpaid by next mail. Biggest money-making, easiest selling proposition ever put up to an agent. Exclusive territory. **WRITE NOW FOR AGENT'S PROPOSITION.** COMFORT CHEMICAL CLOSET CO., 384 Factoria Bldg., TOLEDO, O.

## Evinruding - Is Rowboat Motoring



## Just "Exploring"

'WAY up among the weedy, snaggy shallows, where motor boats and launches never penetrate—too far from home to row—there's where you can "explore" to your heart's content, if there's an Evinrude on the stern of that old rowboat of yours. Your expeditions are no longer restricted by the dread of miles of pulling at the oars. Any rowboat, Evinrude-equipped, will take you where you will and when you will, on ocean, lake or river, with no thought of a long row home again.

## EVINRUDE

DETACHABLE ROWBOAT &amp; CANOE MOTORS

The new Evinrude Four-Cycle Twin has more speed, more power, than the Single Cylinder models, and the opposed-cylinder design eliminates vibration.

Write for the new 1916 Evinrude catalog—just off the press

## Evinrude Motor Company

335 Evinrude Block, Milwaukee, Wis., U. S. A.

DISTRIBUTING BRANCHES

69 Cortlandt Street . . . . . New York, N. Y.  
214 State Street . . . . . Boston, Mass.  
436 Market Street . . . . . San Francisco, Cal.  
Front and Morrison Streets . . . . . Portland, Ore.

Over 60,000 Sold

ROWBOAT MOTOR  
**FERRO**

## Make Your Own Motorboat—It's Easy

You can equip it with a complete power plant, Bosch high-tension magneto, full-boat feed carburetor, noiseless muffler, wood-proof propeller, rudder and tiller at small expense. Simply clamp the Ferro on your rowboat. Speedy, reliable, easy to operate. Selling Ferro Motors is pleasant, profitable work. You only need buy one motor for demonstration. Some fine territories open for the best corners. Ask for agency proposition No. 21b.

\$85 with Bosch high-tension magneto.  
\$65 with water-proof batteries.

The Ferro Machine & Foundry Company  
442 Hubbard Avenue Cleveland, Ohio



DON'T GO ROWING - GO FERROWING

## Hildebrandt Baits Hook &amp; Land 'Em



Made in 3 shapes, 11 sizes and 6 finishes. Reversible blades, interchangeable flies, providing outfits for any kind of game fishing.

Send for Tackle Catalogue with color sheet, Logansport, Ind.  
John J. Hildebrandt Co. 1334 High St

## BOATS &amp; GRAY

120 Leading Boat Builders have united with the Gray Motor Co., world's largest engine builders, and issued a 1916 Boat Catalogue for your convenience. It tells about four times as many specialized Motor Boats as you could see at any Motor Boat Show. Every size from 16 foot Work and Pleasure Launch to the high class Express Cabin Cruisers, also Marine engine catalog of 2 and 4 cycle motor and a Book of Boats. Each is full of boating information. All yours for the asking. Write today.

**GRAY MOTOR CO.,** Detroit, Michigan  
498 Gray Motor Bldg.



"Old Town Canoes" were awarded the Gold Medal at the Panama-Pacific Exposition.

## Off for the Week-End

You are never at a loss to "know what to do" when you own an "Old Town Canoe." There is never-ending pleasure in paddling around cool, shady stream or lake. "Old Town Canoes" are staunch and serviceable—the favorite of woodsmen. Price \$30 up. 4000 canoes ready to ship.

Easy to buy from dealer or factory. Write for catalog and get ready for the first days of summer.



OLD TOWN CANOE CO., 1564 Middle Street, Old Town, Maine, U. S. A.

**"Old Town Canoes"**

## Power for Forty Litchfielders

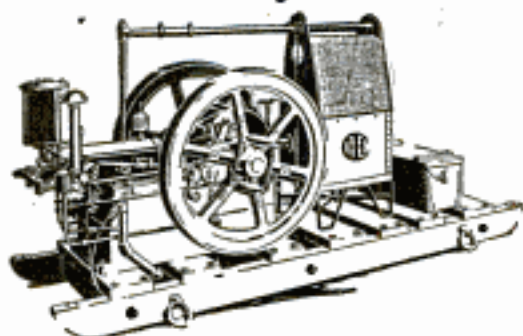

**T**WENTY Titan engines of all sizes — all kerosene burners—were lined up in front of a dealer's store at Litchfield, Minn., one day last summer. That day their new owners took them out to supply good reliable power in twenty locations. A few months later Litchfield saw the same thing happen again.

Two big Titan engine delivery days in that town last year. In many hundreds of towns you will find this same popularity of International Harvester Titan engines—the proven best power—Grand Prize winner at San Francisco. This is the same popularity that has sold over a quarter million Titans, for every conceivable power use.

Buy a Titan and save fuel and repair bills and save trouble. Titan engines are made in all approved styles, sizes from 1 to 50 horse-power, operating on low as well as high-grade fuels. Drop us a line. We'll send you full information, and make it easy for you to get the most reliable engine made.

**International Harvester Company of America**  
(Incorporated)  
16 Harvester Building Chicago U S A

**Toledo MARINE MOTORS** NONE BETTER

Special Cash Prices for this month only—

3 H. P. 1 cyl. complete	\$ 55.00
6 H. P. 1 " "	72.00
7 H. P. 2 " "	100.00
12 H. P. 2 " "	140.00
18 H. P. 3 " "	210.00

Fully guaranteed by a responsible concern. 2 cycle, 2 port, 3 1/2x3 1/2 and 4 1/2x4 1/2. Send for free catalog "C."  
**THE UNIVERSAL MACHINE CO., 104 Pike Ave., Bowling Green, O.**

**GET THIS CATALOG**

FULL OF VALUABLE INFORMATION TO EVERY BOAT OWNER ON

**RACING PROPELLER WHEELS, REVERSE GEARS AND MARINE ACCESSORIES**

LARGE CATALOG FREE. SEND TODAY

**MICHIGAN WHEEL CO.**  
1129 MONROE AVE., GRAND RAPIDS, MICH.

**Motor Perfection**

is what you get in Watkins Class "B" all iron motors. Especially fine for canoes and light boats. Constant and efficient.

3 H. P. single cylinder	45 lbs.
6 H. P. double cylinder	85 lbs.
12 H. P. four cylinder	155 lbs.

Are light, at the same time strong, accomplished by using semi-steel castings, high carbon steel shaft, bronze bearings, high class workmanship.

**THE WATKINS MOTOR CO.**  
837-839 W. 6th Street Cincinnati, Ohio

**UNIVERSAL MOTORS**

4-cylinder 4-cycle, \$125 to \$160,  
9 to 12 H. P., 600 to 1800 R.P.M.  
Fits all boats from 14 to 26 ft.  
Magneto, ignition, rear starter, automatic pump and lubrication.

**UNIVERSAL MOTOR CO., Dept. P, OSHKOSH, WIS.**

# 10¢ a Day

now buys this superb  
**Baader Violin**

**A**N exquisite instrument—perfect in tone and superbly finished. Made by the great violin maker, J. A. Baader, and now offered direct to you at the rock-bottom price. You may pay this rock-bottom price at the rate of only 10 cents a day, 10 days' free trial. Write for special circular—send coupon at once.

## Your Choice of Instruments

This Baader violin is only one of the bargains we have to offer. Write today for our new Violin catalog. There you will find illustrated products of the leading violin makers of the world—Farny, Baader, Gler, Heberlein, Fiedler, Wurlitzer and many others. Violins of the highest grade, as well as those of moderate prices—all special values. Priced from \$2.70 to \$50.00, and from \$60.00 to \$250.00. Write now.

**Rare Old Violins**

Our collection of rare old violins is one of the largest in America. Write today for Special Art Catalog.

# WURLITZER

200 years of instrument making

Get the benefit of our mammoth facilities for buying in large quantities. The house that supplies the United States Government now makes a startling money-saving offer direct to you. Write for circular.

## 10 Days' Free Trial

You cannot judge a violin by seeing it in a store or by playing upon it once. Play on one of these instruments in your own home, in your own way for ten full days. Then you will be able to decide.

If you are not satisfied send it back at our expense. If you wish to buy, pay only the rock-bottom price—at the rate of only a few cents a day.

**10c a Day**

now buys this superb Lyric Cornet. Exquisite triple silver-plated long model Lyric Cornet direct to you on a startling offer. Ten days free trial before you decide to buy. Liberal allowance for old instruments. Write today for 225-page Catalog—showing 2500 instruments that you have to choose from.

## Send the Coupon

Put your name and address on the coupon now and indicate catalogue matter you wish us to send you. Absolutely no obligation in sending the coupon. Do it now. Find out about the startling money-saving offer we are making. Write today—send Coupon or a Letter or a Post-card.

**The Rudolph Wurlitzer Co.**  
Dept. 9194  
East 4th Street, Cincinnati, O.  
So. Wabash Avenue, Chicago

Address \_\_\_\_\_

Name \_\_\_\_\_

Gentlemen—Please send me without obligation, free and prepaid the catalog matter checked below:

- The special violin circular.
- Special low priced violins under \$15.00
- Your 225 page illustrated catalog of musical instruments.
- Catalog of music stands, cases and other stringed instrument accessories.
- Art catalog of rare old violins.

Please Mention Popular Mechanics

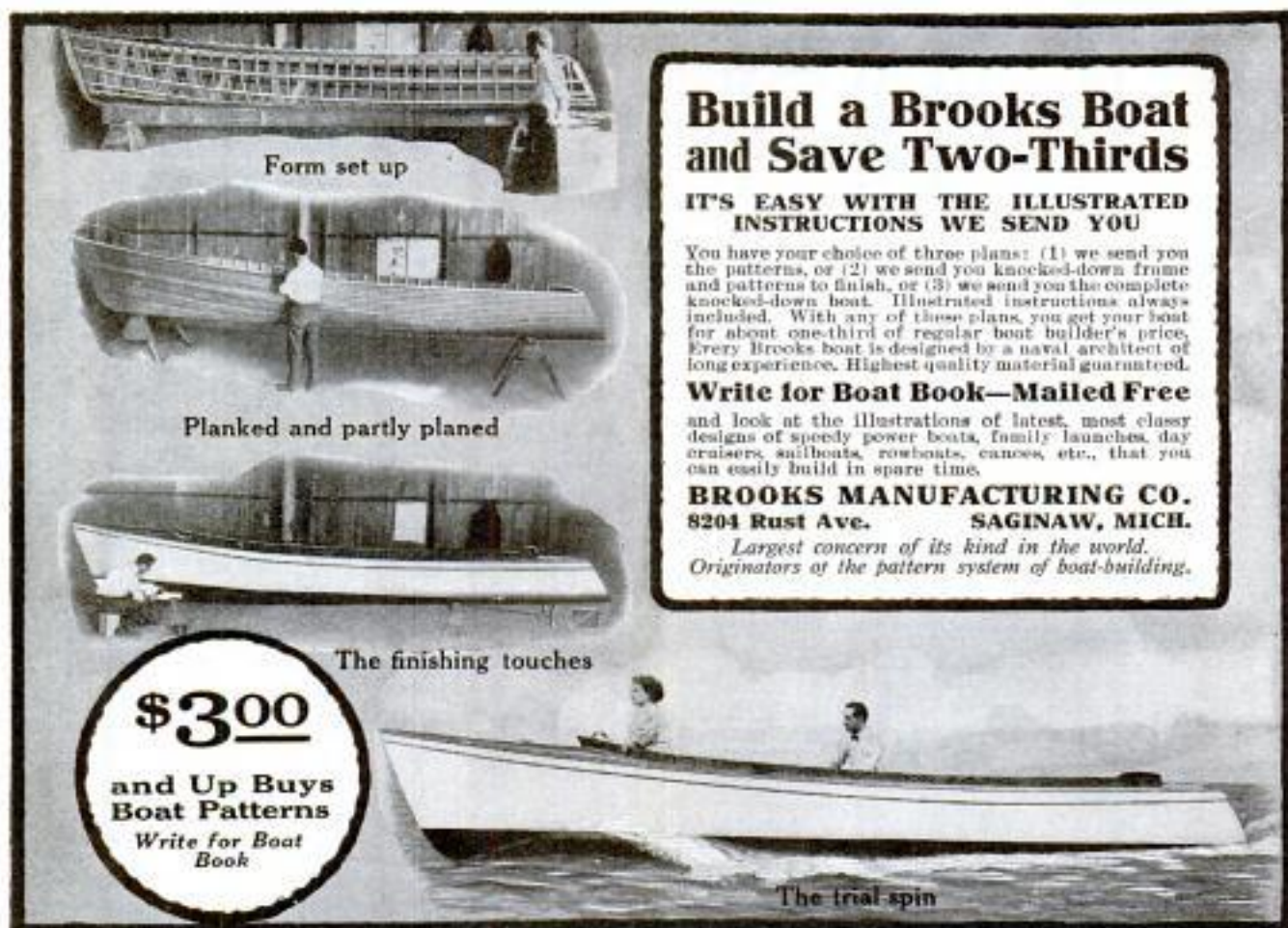

## Build a Brooks Boat and Save Two-Thirds

**IT'S EASY WITH THE ILLUSTRATED  
INSTRUCTIONS WE SEND YOU**

You have your choice of three plans: (1) we send you the patterns, or (2) we send you knocked-down frame and patterns to finish, or (3) we send you the complete knocked-down boat. Illustrated instructions always included. With any of these plans, you get your boat for about one-third of regular boat builder's price. Every Brooks boat is designed by a naval architect of long experience. Highest quality material guaranteed.

**Write for Boat Book—Mailed Free**  
and look at the illustrations of latest, most classy designs of speedy power boats, family launches, day cruisers, sailboats, rowboats, canoes, etc., that you can easily build in spare time.

**BROOKS MANUFACTURING CO.**  
8204 Rust Ave. SAGINAW, MICH.  
*Largest concern of its kind in the world.  
Originators of the pattern system of boat-building.*

\$300

and Up Buys  
Boat Patterns

Write for Boat  
Book

## SPEEDY, POWERFUL

### No Vibration

Absolutely dependable. Easy to start—Easy to manage. Without question the finest rowboat motor made.

### The Great

## 2-CYLINDER KOBAN ROWBOAT MOTOR

**The original 2-cylinder  
Rowboat Motor**

New 1916 features include tilting device, multiple speeds, tiller at right hand side, waterproof timer, fool-proof carburetor, thrust adjusting gear case, Aeroplane Type magneto and many others.

**Doesn't Shake the Boat** Has 3 full  
Horse power

**VIBRATION** is entirely removed by opposed cylinders that fire at the same time. Reverses by simply pressing the button. Runs perfectly at trolling speed or can skin nine out of ten launches at high speed. Interesting facts fully explained in illustrated 32-page catalog. "For Goodness Sake" don't think of making a selection until you have sent for the catalog. It's free.

**AGENTS AND DEALERS WANTED**

**Koban Mfg. Co., 291 So. Water St., Milwaukee, Wis.**  
*Our line also includes a 2-cylinder, 3 H. P., vibrationless, inboard marine engine for small launches, canoes, etc.*



Send for  
big  
catalog  
of  
inter-  
esting  
and  
valuable  
infor-  
mation

**Light—  
Speedy—Durable—  
Powerful—Economical**

## ROBERTS MOTOR

2 cyl. rated 6 H.P., guaranteed to develop 8. **NEW 1916 MODEL 2-0  
MORE SPEED!**

Roberts Motors have always been good; this year's line is 50% better than ever before. This new engine is right up to the top mark of power and speed. Will make higher speed and run at lower speed than any other 6 H. P. engine we know of. Lightest in weight for the power developed. Few moving parts. Horizontal float-feed carburetor. Standard aluminum intake and water-jacketed manifold. \$110 complete. Order yours. If interested in a good seller get agent's proposition.

Known the world over as "The Motors That Never Backfire"—the most dependable motor that money can buy. Get a Roberts and you avoid all engine troubles.

**THE ROBERTS  
Motor Mfg. Co.**

**304 Roberts Building  
Sandusky, Ohio**

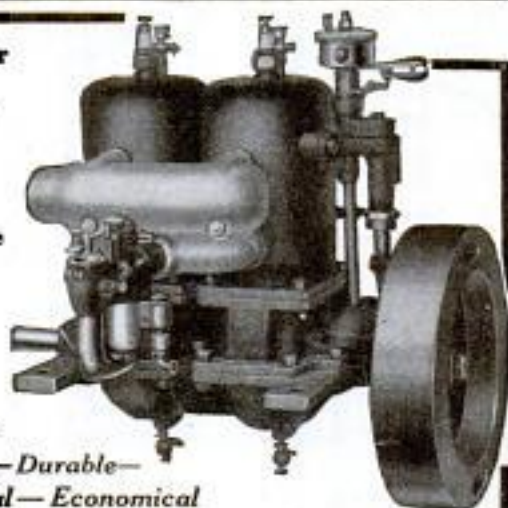

Please Mention Popular Mechanics



## "On A Summer Sea—"

or lake or river—with your Mullins boat you will find miles and miles—hours and hours of invigorating, healthful business-forgetting pleasure. Sweet, cool air, fresh from fields and mountains—nature's laboratory—will make your heart beat faster from the sheer joy of living.

Sixty thousand owners of Mullins Boats are now planning a glorious summer to be spent, for the most part on the water. Mullins boats of either wood or steel, are designed

by America's foremost naval architects, built in the largest boat factory in the world—powered with 2 and 4-cycle motors. Speedy—beautiful—distinctive.

Send for interesting, free catalog and learn where you can see a Mullins Boat

**The W. H. Mullins Company, 707 Franklin Street  
SALEM, OHIO**  
World's largest builders of pleasure boats



**MULLINS**  
STEEL BOATS CAN'T SINK

**HORSE POPULATION OF SOME WARRING NATIONS**—France has, normally, 3,000,000 horses, some 600,000 of which are available for army purposes; Russia has 30,000,000 horses, and about 7,000,000 are convertible for use in warfare. The German allies have over 8,000,000 together, of which 33 per cent can be used in war.

**PALMER MOTORS AND LAUNCHES**  
2 AND 4 CYCLE

Catalogue M Free of Motors.  
Catalogue B Free of Boats.

ENGINES FROM 2 TO 40 H.P. PALMER BROS.  
IN STOCK. COS. COS. CONN.

## PLAY GOLF WITH CARDS

"Golf Bug"—the only game of golf with cards! Real golf—slicing, ditching, lobbing, etc. Lots of fun for everyone. Teaches the outdoor game. Complete outfit only \$1. At your dealer's or send direct to us. Money back if not delighted. CON P. CURRAN PTG. CO., Walnut St., ST. LOUIS, MO.

## Superior Small Engines



Our Stewart small engines, made only in 1/2, 2 and 3 h. p. are marvelously perfect. Design, materials, workmanship and finish of a high order. Use a minimum of fuel for a maximum of work; gasoline only. Write for special engine booklet.

**Chicago Flexible Shaft Co.**

4617 N. La Salle St., Chicago

## Get the Newest LA Engine Book

AN LA ENGINE  
FOR EVERY PURSE  
AND PURPOSE

The question of selecting the right engine for that boat of yours is an important one. It will pay you well to get all the information possible before making your final decision, as the satisfaction you get from your outfit will depend largely upon the care you take in choosing your motor. You will find the new LA engine book brim full of valuable hints and interesting engine information. It describes the complete line of LA inboard and outboard motors for canoes, rowboats, pleasure boats, work boats, etc., and gives complete details of our liberal

### 30 DAYS' TRIAL PLAN

whereby you can have the privilege of proving out the quality of LA Motors before making your final decision. Write for YOUR copy to-day. **Lockwood-Ash Motor Co.**

1120 Borton Av. Jackson, Mich.



## Sharp Tools Pay Big

80% of all edged tools used in America are sharpened by the makers on "Cleveland Grindstones"—the natural abrasive stone that best preserves the temper of the steel.



Profit by their experience. Keep your own tools at their best with the recognized standard—"Cleveland Grindstones."

### Our Little Giant

is built for all ordinary grindstone work in the shop or on the farm. Fitted for hand, treadle or power; 24" by 3½" to 4" stone; ball bearing; latest improvements.

### \$1 Special Introductory Offer

To prove the superior grit and toughness of "Cleveland Grindstones," we will send this handy "Harvest King, Jr." for kitchen or tool box, charges prepaid as far west as the Dakotas, Nebraska, Kansas, Oklahoma and Louisiana, on receipt of one dollar.



Send \$1 today. Get Free Catalog on Complete Line.

THE CLEVELAND STONE CO.

1111A Leader-News Bldg. Cleveland, Ohio

"Cleveland Grindstones" Save Tool Temper

TWO-STROKE

**Cyclemotor**

HIGH-SPEED

### NEW MARVEL MOTOR FOR BIKES

Attaches to any bike without altering the frame; weighs 21 pounds complete including magneto, and develops 1 h. p.



A push on the pedal starts the power and away you coast. Equip your bicycle now and be ready for spring riding. A fast seller for live dealers. Ask for Booklet "S"

CYCLEMOTOR CORPORATION  
Arlington Bldg.  
ROCHESTER, N. Y.

## RUNATIRE REPAIR SHOP

### BIG MONEY—FROM THE START Model F

Every auto owner needs frequent tire repairs. Badger Equipment makes the work quick and easy. Small investment puts you into a business of your own—paying up to \$200—\$300 a month.

### WE TEACH YOU FREE

No experience needed. We teach you at factory or by mail. Show you how to get the business and handle your shop. Best system, best machines and money-making FREE AID SERVICE.

Write for full description of Badger outfit. It's free—write. TIRE REPAIR EQUIPMENT CO.  
601 Johnson St. Appleton, Wisconsin



## For a Better SHAVE

The cutting edge of either a "safety" or "ordinary" razor, when seen under the microscope, looks just like a saw.

These tiny teeth become rust coated and that's why a razor pulls.

### 3-in-One Oil

stops this formation of rust. You simply put a little 3-in-One on your razor blade before stropping and after shaving. Try it. Send for free 3-in-One Oil and our little scientific booklet, the "Razor Saver."

3-in-One is sold by all good stores in three size bottles: 1 oz., 10c; 3 oz., 25c; 8 oz., (½ pint) 50c. Also in Handy Oil Cans, 3 ½ oz., 25c.

If your dealer hasn't these cans, we'll send one by parcel post, full of 3-in-One, for 30c in stamps.

3-in-One Oil Co.

42 CNR. Broadway  
NEW YORK



WEAR

Trade Mark Registered

**B.V.D.** U. S. Patent Office and Foreign Countries

UNDERWEAR

American vines occupy many thousands of acres of Spanish vineyards, having found especial favor since the native vines were ravaged by the phylloxera.

A dining table for schools in the form of a ring, children being seated both inside and outside to save room, has been invented by a New York woman.



## START YOUR FORD FROM THE SEAT

Throw away your crank. Start from the seat with the famous never-fail

**Sandbo Two-Compression Starter**

92,000 sold. Differs from all others. Sold on 30 days trial—positively guaranteed. New improved 1916 model—Price \$14

SANDBO STARTER COMPANY, 28 Sandbo Building, Rock Island, Ill.

## SEXOLOGY

by William H. Walling, A. M., M. D.

imparts in a clear wholesome way, in one volume:

Knowledge a Young Man Should Have.  
Knowledge a Young Husband Should Have.  
Knowledge a Father Should Have.  
Knowledge a Father Should Impart to His Son.  
Medical Knowledge a Husband Should Have.

Knowledge a Young Woman Should Have.  
Knowledge a Young Wife Should Have.  
Knowledge a Mother Should Have.  
Knowledge a Mother Should Impart to Her Daughter.  
Medical Knowledge a Wife Should Have.

All in one volume. Illustrated \$3.00 postpaid

Write for "Other People's Opinions" and Table of Contents.  
PURITAN PUB. CO., 744 Perry Building, PHILA., PA.

## This Used Piano

Splendid bargains—all standard makes—Steinway, Knabe, Emerson, Kimball and others—\$45 to \$195. Also second-hand player-pianos \$195 to \$325. No money down. 30 days' free trial. Lowest payments. 50 free music lessons with every piano.

### Big Piano Book Free

containing beautiful illustrations of new Starck Pianos and a vast amount of piano information. Write today for latest bargain list.  
P. A. Starck Piano Co., 94 Starck Bldg., Chicago



## Free Book on WASHING

Tells how to get a good-sized washing done in an hour with the **Thor Electric Washing Machine**. Also tells how the Thor pays for itself by saving wear on clothes and cost of help. Write for this big 48-page book, fully illustrated. Sent absolutely free. And we will also tell you about the special offer we are making. Write Today  
Get this book and information now.  
**HURLEY MACHINE CO., Dept. 1194, Chicago, Ill.**



## QUICK MONEY

### Growing Mushrooms

How to really make big money in mushrooms, is fully explained in the wonderful book, "The Truth About Mushrooms." Everything explained from A to Z, at first hand, from the greatest practical authority in America. Add \$10 to \$10 a week to your income. Demand exceeds supply. Grow in cellars, sheds, boxes, etc. Small capital to start. Profits bigger and quicker. Anyone can do it. Women and children, too. Now is the best time. Send for FREE book of information.

**Bureau of Mushroom Industry, Dept. 761, 1342 N. Clark St., Chicago**

American automobiles were sold last year to about 80 different countries.

In the suburbs of London, milkmen are almost entirely displaced by milkmaids.



## BEAUTIFUL PINS

For any school or class. No. 46, any letters or date, hard enameled, two colors, silver plated 15c each, \$1.50 doz. Sterling silver, 30c each, \$3.00 doz. CATALOG FREE.

**Metal Arts Co., Inc., 91 South Ave., Rochester, N. Y.**

## Health? Take Turkish Bath at Home—Only 2 Cents



Physicians are abandoning drugs for this new treatment. If your mind or body is tired, open your pores and feel the rapid change in your condition, at cost of 2c a bath. The Robinson Bath Cabinet is the only scientifically constructed bath cabinet ever made for the home. Great \$2 Book Sent Free—"The Philosophy of Health and Beauty." With hints. Agents Wanted.  
**ROBINSON MFG. CO.**  
862 No. 12th St. TOLEDO, O.

## AGENTS—A BIG SELLER

### SCREEN DOOR CHECK



Splendid summer seller. Stops the bang and saves the door. Big demand. A sale in every home. Dozen can be carried in pocket. Demonstrating sample free to workers.  
**THOMAS MFG. CO., 4448 East St., DAYTON, OHIO**

## HOME MADE Concrete Mixer PLANS FREE

Send me your name and I'll send you, absolutely free, blue-print plans and complete instructions for building a practical, thoroughly-proven, home-made concrete mixer. Hundreds have used my plans successfully. So can you.

**S. M. CO., Box 7378, NEHAWKA, NEB.**



## THIS BIG NEW SET SENT FREE TO YOU

We will send this big Civil Engineering library—1916 edition—to you, EXPRESS PREPAID, for seven days' free examination; returnable at our expense. If you decide to keep the books, you can buy them at about two-thirds the regular price, payable in small monthly installments. Whether student, worker, or expert, you can gain from these nine volumes an intimate knowledge of Civil Engineering—knowledge that will mean greater success and higher pay. The work of twenty-seven experts, this library is recognized as a standard reference work by technical schools, libraries and practical men throughout the country. Remember, this is a brand new edition—just off the press—and contains important subjects included in no other work on Civil Engineering.

**Earn \$150 to \$250 Monthly** Civil Engineers earn from \$150 to \$250 a month. The work is pleasant—the hours short. These great books will fit you—in your spare time—to enter this fascinating, well-paid work. No previous experience necessary.

## The 1916 Edition Cyclopaedia of Civil Engineering

contains 3,900 pages, 7x10 inches, 3,000 illustrations, full page plates, diagrams, etc.; hundreds of valuable tables and formulas; carefully cross-indexed for quick, easy reference. The books are substantially bound in half red morocco, gold stamped, and are printed in large, clear type on special quality paper.

### Important Subjects Covered

Plane Surveying—Plotting and Topography—Highway Construction—Railroad Engineering—Earthwork—Steel Construction—Estimating for Steel Buildings—Stairs—Roof Trusses—Civil Specifications and Contracts—Bridge Engineering—Strength of Materials—Masonry and Reinforced Concrete—Water Supply—Sewers and Drains—Hydraulics—Water Power Development—River Improvement—Harbor Improvement—Cost Analysis Engineering—Dams and Weirs—Irrigation Engineering.

### Sent Absolutely Free—Express Prepaid

The complete nine volumes, not a sample volume, will be sent, express prepaid, for seven days' free examination; returnable at our expense if they do not contain the information you want. If you keep the books, pay \$2.00 seven days after receipt and then \$2.00 a month until you have paid the special introductory price of \$29.80. The regular price of this great Cyclopaedia is \$45.00.

### Another Great Free Offer

With every set is included a year's Consulting Membership, regular value \$12.00, entitling you to the free advice of a staff of expert Civil Engineers. This will give you practical help in handling working problems which are too specific to be taken up in detail in the cyclopaedia. There will be no limit to this service. A single problem solved for you might be worth more than the first cost of the books.

**AMERICAN TECHNICAL SOCIETY, CHICAGO, U. S. A.**

## FREE EXAMINATION COUPON

American Technical Society, Chicago, U. S. A.

Please send set Cyclopaedia of Civil Engineering for 7 days' free examination. I will send \$2.00 within 7 days and \$2.00 a month until I have paid \$29.80, or notify you and hold the books subject to your order. Title not to pass until fully paid.

Pop. Mech. 4-16

NAME .....

ADDRESS.....

As I have had no previous dealings with you, I refer you to

Please Mention Popular Mechanics

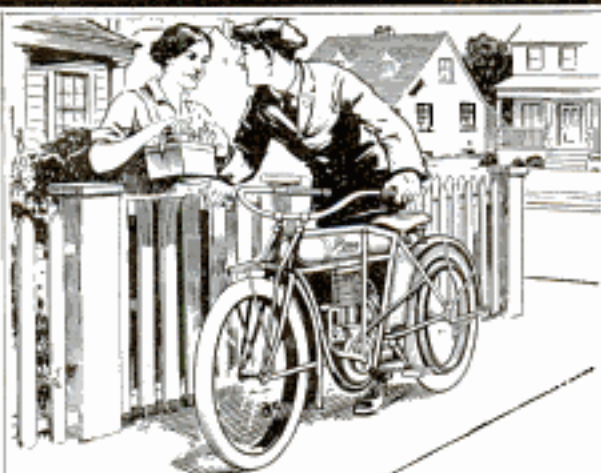

## "You Bet I'll Beat the Whistle"

"No more car-schedules for yours truly. Since I got a regular motorcycle, I'm hep to what real travelling means. This Pope of mine just eats up the miles. It gets me to the shop in half the time the car would take."

On-the-job men, the country over, are getting wise to the chances they've overlooked. They're hitting the trail to work and away from it on the comfortable, speedy

**Pope** Lightweight Motorcycles  
Cost only \$150.00

They're saving car-fares, keeping in better health and having the best sport in the world; with a cost of upkeep that is ridiculously low.

You get yours today and find out why the Pope lightweight—now in its seventh year of manufacture—is "America's Most Popular Lightweight." Write for our new catalog—crammed full of interest for you.

### Specifications

Single cylinder, 4 h. p.	Spartan V belt transmission
Single speed	United States motorcycle tires
Schebler carburetor	
Eclipse clutch	

## Westfield Manufacturing Company

Successors to the Pope Mfg. Co.

15 Lozier Ave. WESTFIELD, MASS.

Largest Manufacturers of High-Grade Bicycles in the World.  
Makers of Columbia, Tribune, Crescent, Rambler, Cleveland and Pope Bicycles.

## The Brake You Select

for your bicycle this year should be a reliable brake, at all times ready for good, hard service, and such a brake is

## ORBIN Duplex Coaster Brake

With your foot on the pedal and the famous Corbin Duplex Coaster Brake on the hub you are prepared to tackle any proposition the roads and crowded streets have to offer—to tackle them with safety, assurance and absolute ease.

Just rest your feet on the pedals and take the long, down grade—that's the way to enjoy the spin and get the most out of riding. And remember, there is no brake sold which enables you to do this as well as the Corbin Duplex. If you've never used this brake there are happier days ahead; if you have, you know the satisfaction to expect.



### "Corbin Control Means Safety Assured"

For the old or new bicycle specify the Corbin Duplex. Sold and equipped by all dealers. Send for a free 1916 catalogue and Liberty Pin.

## The Corbin Screw Corporation

The American Hardware Corporation, Successor  
201 High St. NEW BRITAIN, CONN.

BRANCHES: New York Chicago Philadelphia  
Makers of Corbin-Brown Speedometers



### "LITTLE TALKS WITH SPORTSMEN FROM COAST TO COAST"

—shooting and hunting experiences by prominent sportsmen in 48 states, sent FREE on request.  
THE REMINGTON ARMS UNION METALLIC CARTRIDGE COMPANY, N. Y.

## \$8<sup>00</sup> All Wool Suit Made to Order

LININGS AND TRIMMINGS  
Guaranteed for Two Years

Amazing low price for a suit made to your individual measure from your choice of cloth in latest fashionable style, guaranteed to fit you perfectly. We send big selections of cloth samples Free and save you half. Don't buy a suit or overcoat anywhere at any price until you see our samples and wonderful offer. Everything guaranteed.

THE OLD WOOLEN MILLS CO., Dept. 88, CHICAGO



## The Proper Card for You

Your business is vastly too important to be represented by anything less than a

## Wiggins Peerless Patent Book Form Card

Many of America's largest card users compliment the skill and care exercised in engraving a Wiggins Plate by using Wiggins Cards exclusively. Ask for tab of specimens; detach them one by one and observe their clean cut edges and general excellence.

THE JOHN B. WIGGINS CO.  
Established 1857

Engravers Plate Makers  
Die Embossers  
62-64 East Adams Street, CHICAGO



# Veeder <sup>CLUTCH</sup> <sup>SPEED</sup> Counter

No. 21



Two-Third Size

This is the best instrument for finding revolutions per minute of a shaft or any revolving part. Will measure high or low speeds. No stop-watch required. Perfectly accurate. Cut is two-thirds size. Price **\$3**

This counter like all Veeder counters is known by engineers to be

most accurate      best in material  
best in design      best in finish

We make a counter your machine should have. Let us give you valuable counter advice about your individual problem. Drop us a line.

Cyclometers, Odometers, Tachometers and all kinds of counters. Fine Die Castings.

**Veeder Mfg. Co.** 4 Sargeant Street HARTFORD, CONN.



NOTE REAR VIEW ABOVE. BACK WHEEL OF MOTORCYCLE IN CENTER.

**"On or Off in 30 Seconds"**

**Safe Practical Economical**



Fits Any Standard Motorcycle

You can go to work on your motorcycle—and in the evening hitch on your Rear Car and take two adults and a child for a joy ride.

## One For Pleasure One For Business

You can, with same low upkeep for motorcycle, attach our Rear Car for Delivery Work.

P. M. Cygnet Rear Car Company Buffalo, N. Y.

Panel or Open Body Types.

Gentlemen: Without obligation to me send full particulars about Rear Car for Pleasure or Business

Cygnet Rear Cars can not tip over or skid.

Be sure to send name of motorcycle and name of dealer.

Name.....

Address.....

Cycle Make.....

Use This Coupon Dealer.....



### Typewriters

All Makes, Factory Rebuilt by the famous "Young Process"; look like new, guaranteed like new. Our big business insurance "Square Deal" and permits lowest cash prices — \$10 and up; also machines rented — or sold on time. No matter what your requirements are, we can best serve you. Write and see — NOW, YOUNG TYPEWRITER CO., Dept. 353 CHICAGO

### MODEL AEROPLANES

Send 2c postage for Complete handbook of Models and Supplies. **WADING RIVER MFG. CO.** WADING RIVER, N. Y.

Our set contains this and 9 other drawings, with instructions for building.....\$1.00

# BIG BICYCLES

## \$15<sup>98</sup>

High-grade, guaranteed Bicycle. Worth 1/3 to 1/2 more. Seamless steel tubing frame, triple truss forks, arch crown design.

### NEW SERVICE MODEL

Motorcycle type anti-skid, puncture-resisting tires. Superior enamel finish. Send for Free Bicycle Book today.

**Montgomery Ward & Co. Dept. G 133**  
New York Chicago Kansas City  
Fl. Worth Portland

Write home most convenient

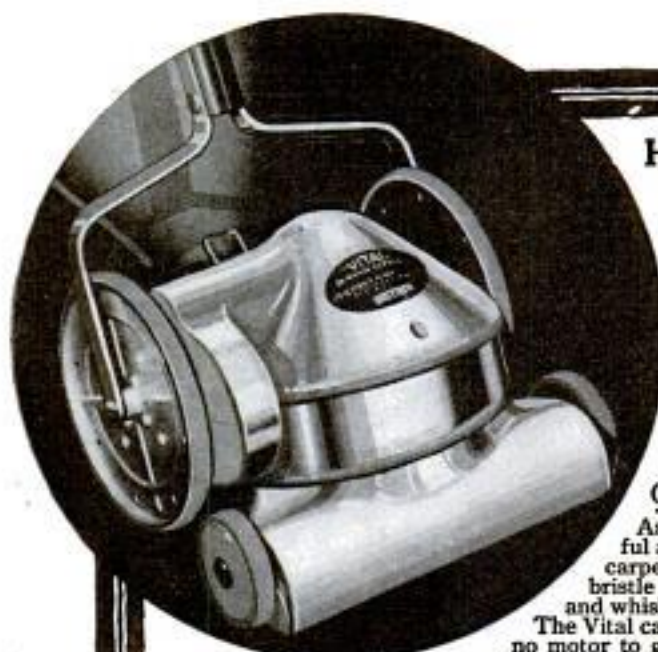

## Here is the Suction Cleaner You Have Demanded! Let the Vital do Your Spring Cleaning!

Housewives have for years wished for a portable and efficient cleaner that could be operated without Electric current! Here it is—the

# VITAL SUCTION CLEANER

Operated by hand—Generates its own power.

As you lightly glide the "Vital" across the floor, a powerful and continuous suction is set up. It gives your rugs and carpets a cleansing bath, of pure fresh air. The revolving bristle brush in the nozzle picks up all the dirt, dust, and lint—and whisks it into the sanitary dust proof bag.

The Vital can be used in every home. There are no wires to attach, no motor to get out of order. The Vital will enable you to Spring-Clean from cellar to garret without fatigue. It does not consume expensive current—therefore there is no cost of operation.

Easy to operate—light in weight—efficient in cleaning power—and simple in construction.

These features enable you to use the Vital every day—just as you now use a carpet sweeper. So compact that it searches out the dirt under the chairs, davenport, etc., with the greatest ease. Extremely reasonable in price, thoroughly guaranteed, and will last for years. Ask your dealer—or write us—now—and have a Vital take the burden of Spring cleaning from your shoulders.

The Bigsby-Rotary Manufacturing Co., Cleveland, U. S. A.  
San Francisco, 428 Sutter St. Los Angeles, 721 S. Olive St.

# \$17.50

Attractive opportunity for  
Dealers and Agents.

Write today for details!



A complete line of appliances for the transmission of Power. Anything from a bolt to a complete mill or factory outfit. Send for catalogue. Largest Manufacturers of Pulleys in the country.

W.A. Jones Foundry & Machine Co. 1400 W. North Ave. CHICAGO

## You Lose Your Fish

because your rod is not quick enough to catch them. Use a "Bristol" Steel Fishing Rod and you can hook the quickest, wariest, bunter, nibbler or striker. CATALOG FREE.

# "Bristol"

## The Prize Winning Rods

have the durability, the tested reliability and the never-say-die "hang on" lasting strength to hold the fish until he is tired out and ready to net.

THE HORTON MFG. CO.  
196 Horton St. Bristol, Conn.

We offer prizes for the best fishing pictures. Send your fishing photos.



ATALOG FREE showing 38 styles of "Bristol" Rods at \$3.50 to \$25. Sold by 19,000 dealers.

Please Mention Popular Mechanics

## BARODA DIAMONDS

FLASH LIKE THE GENUINE—AT 1-50 THE COST  
SOLID GOLD MOUNTINGS Stand acid test and expert examination. See them first, then pay. Catalog FREE. Patent Ring Gauge included for 5 two-cent stamps. The Baroda Co., Dept. 35, 1458 Latent Ave., Chicago



## Rider Agents Wanted

in each town to ride and show a new 1916 model "RANGER" bicycle. Write for our liberal terms. DELIVERED FREE on approval and 30 days' trial. Send for big free catalog and particulars of most marvelous offer ever made on a bicycle. You will be astonished at our low prices and remarkable terms. FACTORY CLEARING SALE—a limited number of old models of various makes, \$7 to \$12. A few good second-hand wheels \$3 to \$5. Write if you want a bargain. Tires, lamps, wheels, sandries, parts, motorcycle supplies of all kinds at half usual prices. Write us before buying. MEAD CYCLE CO., DEPT. P108, CHICAGO

## BUY DIRECT—SAVE 1/2 USUAL PRICE

Auto Tops—without frame, \$7.25, \$9.25, \$10.25 up. Ford Regular Tops complete, \$14.25, \$16.50 up. Ford "One Man" Tops complete, \$19.25 up.

Seat Covers—For Fords, \$3.45, \$5.60, \$7.00 up. For Buicks, \$5.00, \$7.00, \$10.50 up. For Overlands, \$4.65, \$5.60, \$7.00 up. Catalogue and samples free. Write today.

Special Exclusive Agency—Limited territory still open. You can outsell all competitors and control business in your territory. Don't delay—Send for full particulars today.

AUTO SPECIALTY FACTORY, Dept. A, Cincinnati, Ohio



## POWERLIGHT

Highest Award World's Exp. 335 C. P.—20 Hrs. 1 qt. Kerosene or Gasoline. Read and sew without spectacles.

Daylight's GREATEST COMPETITOR  
5 yr. Guarantee—20 styles—5 finishes. Everybody buys—Sure sale when seen.

RETAILS \$5 AND UP

AGENTS—Contract exclusive territory. Big Profit—Samples Loaned. POWERLIGHT CO., 543 Broadway, NEW YORK



# 5¢ A DAY BUYS A GIBSON

Terms as low as \$1.00 down—\$1.50 per month. Mandolin or Guitar sent on approval. The wonderful new Gibson violin construction has set the whole Mandolin and Guitar world talking. Get our new **Free Book**—112 pages—111 illustrations, a valuable fund of information for player and teacher. Also **Free** treatise on "How to Practice."

**Exclusive Features that Make Every Gibson Matchless:**  
 Stradivarius arching—scientific graduation from thickness at center to thinness at rim, securing strength—sensitiveness—free vibration of entire sounding board. Tilted neck, high bridge with extension string-holder, securing increased string pressure that vibrates a larger sounding board, producing a richness of tone never before realized. Reinforced, non-warpable neck—elevated guard plate or finger rest—easy action—adjustable string-bearing at bridge overcoming sharpening of heavier strings in upper positions.

**Make \$1800 to \$5000 or More a Year Teaching and Selling the Gibson**

Become a teacher. Splendid opportunities for either sex in every locality for private and class instruction and the sale of Gibson instruments have "made" many a teacher, professionally and financially. C. V. Ruttelman, Jackson, Mich., Teacher and Director, writes: "A \$7000 Gibson business for mine this year." C. A. Templeman, Teacher, Sioux City, Ia., writes: "\$4500 gross business for the year." WM. PLACE, JR., AMERICA'S GREATEST MANDOLIN VIRTUOSO, Star Soloist for Victor Talking Machine Co., UNQUALIFIEDLY ENDORSES THE GIBSON.

**Do Business on Our Capital** If a teacher, become our agent. Stock territory protected. You make the profits. We pay the advertising. You pay for goods when sold; return goods not sold. Try our "Still Hunt." Catalog and thematic list free. Fill in coupon now.

**GIBSON MANDOLIN GUITAR CO.** 164 Harrison Court **KALAMAZOO, MICH.**

Address: \_\_\_\_\_  
 Be sure you have checked instrument.

Mandolin  Mando-bass  
 Mandola  Guitar  
 Mando-cello  Harp-guitar

Name: \_\_\_\_\_  
 Address: \_\_\_\_\_



"Everyone A 'Gibson'ite"  
 The Acolian - The Hazard  
 Mandolin Quartet



"Everyone A 'Gibson'ite"  
 Thompson's Mandolin Orchestra

**GIBSON MANDOLIN GUITAR CO.**  
 164 Harrison Ct., Kalamazoo, Mich.  
 Gentlemen:—Without obligation send me free book complete Catalog, free treatise, also information about instrument checked below.

Mandolin  Mando-bass  
 Mandola  Guitar  
 Mando-cello  Harp-guitar

Name: \_\_\_\_\_

Address: \_\_\_\_\_  
 Be sure you have checked instrument.

## LEARN TO PITCH

Lessons by "MATTY," ED. WALSH, "DOC" WHITE, WALTER JOHNSON, "NAP" RUCKER, "SMOKY JOE" WOOD.

### PITCH THE FADEAWAY, SPITTER, KNUCKLER, SMOKE BALL, etc.

Clearly described and ILLUSTRATED by 66 Pictures. Entire COURSE OF LESSONS SENT POSTPAID for 80 cents.

**J. C. DORN, 721 S. DEARBORN ST., DEP. 270, CHICAGO, ILL.**

## A 14-Inch Dancing Skeleton

It dances, bows, rises or falls at your command. Also 1 Roll of Stage Money, 1 Imitation Diamond Ring, 1 Opera Glass Charm, 1 Gold Tooth, 1 Checker Board, New Puzzles; also Postage Stamp Flirtation, Parlor Pastimes and Card Tricks, and the great Gypsy Fortune Teller. All with a large Catalog of Novelties for 14 cents. 2 cents postage.

**ED. STRAUS, Dept. 9, 306 Water Street, BROOKLYN, N. Y.**

## Invisible INK Love Letter INK

The most confidential messages can be written with this ink, for the writing **MAKES NO MARK**. Cannot be seen unless you know the secret. Invaluable for many reasons. Keeps your postals and other private memoranda away from prying eyes. Great fun for playing practical jokes. Only 15c Bottle

Most people are "a bit off" when in love, and they often write the most ardent letters yet their affection soon cools. This remarkable ink is just the thing to record such flaming love, for in a couple of weeks the writing has **vanished completely**, leaving the paper quite blank. Price 15c Postpaid.

**JOHNSON SMITH & CO., 715 South Dearborn Street, CHICAGO**

## DOMELRE

The Electric Ice Man will soon be standard equipment in all good American homes. Men of ability and capital who want a real monopoly in their territory are obtaining our exclusive perpetual sales contracts. Get started on the ground floor of "The Next Great Business" by writing for our proposition today.

**Domestic - Electric - Refrigerator** The Mechanical Refrigerator Company  
 718 Fisher Building, Chicago  
 Factory: Clybourn Avenue and Wilcox Street, Chicago, Ill.

## DO YOU INTEND TO BUILD?

### BUNGALOW PLAN BOOK FREE

Fifty practical California Bungalow and House designs, suited for any climate, exterior photos and floor plans complete in **1916 Art Plan Book**. Sent postpaid upon deposit of 50c. Deposit refunded upon purchase of working specifications. Don't build until you get this book—its valuable suggestions will save many times its cost. Address **BUILDING DEPARTMENT**  
**AURELIUS SWANSON COMPANY, Inc.**  
 1001 State Nat'l Bank Bldg. OKLAHOMA CITY, OKLA.

# Get This! Feel Like a Prince Every Day!

Here is something you need—to put more vim, more pep, more go into your daily life right from the very minute you get up in the morning. Spend just five minutes a day with Prof. Anthony Barker's Muscle Builder Outfit and you won't tire so easily, you will breathe deeper, you will get more fun out of life, you will expand your chest, you will strengthen your muscles and you will beautify your body as well as lengthen your life. With your Muscle Builder Outfit I will include a complete body-building course of instruction containing twenty-four selected exercises, thoroughly illustrated, so that you can see exactly what and how to do the things that make you strong, healthy, happy and contented. Every man, woman and child requires a few minutes' exercise daily. The Muscle Builder Outfit rejuvenates every muscle of the body, hands and feet, legs, neck, chest—makes the blood tingle through all parts of the body. This means health, with a capital H.

## SPECIAL PRICE CUT from \$3<sup>00</sup> to \$1<sup>00</sup> NOW

I will send to every reader of Popular Mechanics the complete Muscle Builder Outfit for one dollar—the regular price is \$3.00. Send today—and if you are not more than pleased I'll trade back—give you your dollar the minute you return the Muscle Builder. Send the coupon now to Prof. Anthony Barker, Studio 6A, 110 W. 42nd St., New York.

**COUPON—Save \$2**

Prof. Anthony Barker, Studio 6A

110 West 42nd Street, New York

Dear Prof.: Enclosed find \$1.00, for which

send me one Muscle Builder Outfit on 5 Days'

approval. Money to be refunded if I am not

satisfied.

Name: \_\_\_\_\_

Address: \_\_\_\_\_

## Oxy-Acetylene Welding and Cutting



Welding two pieces of angle iron by oxy-acetylene process. Final work has neat finish and great strength.

## Let This Process Help You

Wherever two pieces of metal are to be joined, oxy-acetylene provides a simple, low-cost method—sometimes the only one—generally the best one and always a possible one.

It opens the way to metal manufacturing, construction and repair operations which cannot be performed by any other process. Far-seeing designers and production experts are taking advantage of its possibilities in simplifying hundreds of operations without any radical changes in established systems of production.

In many cases oxy-acetylene welding equipment pays for itself many times over on one repair to stationary machinery by effecting repairs "on the spot" without necessitating dismantling and subsequent tie-ups during the replacement of expensive damaged parts.

It will pay you to investigate the

**Prest-O-Lite**  
PROCESS

Employs both gases (acetylene and oxygen) in portable cylinders. Prest-O-Lite Dissolved Acetylene (ready-made carbide gas) is backed by Prest-O-Lite Service, which provides dry, purified gas, insuring better welds, quicker work, and lower cost, and also avoids the large initial outlay and heavy depreciation incurred in making crude acetylene in a carbide generator.

The necessary equipment is not expensive. We furnish high-grade welding apparatus for \$60 (Canada, \$75); acetylene service at additional cost. Also adaptable for oxy-acetylene cutting by the purchase of a special cutting blow-pipe. Thorough instructions are furnished free to every user—any average workman can learn the process quickly. We will train your operators at our shops if you desire.

## Job Welding Offers Splendid Opening

If you've been looking for a profitable business of your own, investigate oxy-acetylene welding. The earnings are substantial and necessary equipment is not expensive. Send for details.

The results obtained by this process in many different lines of work, together with specific information of decided value to you, will be mailed on request. It will pay you to let us send you this interesting data now.

## The Prest-O-Lite Co., Inc.

The World's Largest Makers  
of Dissolved Acetylene

Main Offices and Factory  
816 Speedway, Indianapolis, Ind.  
Canadian Office and Factory  
Merriton, Ontario

53 Branches and Charging Plants



Please Mention Popular Mechanics

## Quicker Results— Doubled Efficiency

When you work  
with electricity.

First cost  
and operat-  
ing expense  
are both  
low.

Attaches to  
any light plug.

## Garageman's Machine Shop

Hundreds of auto-  
mobile repair men  
declare that the  
Temco Model B Drill is the best  
part of their shop equipment. Built  
to use emery wheel and reseater  
attachments. Has multitude of uses.  
Does away with tiring hand work.

## TEMCO Garage Outfit

Drilling, tapping, valve grinding, sharpening tools, etc., all performed quickly and cheaply with these wonderful tools. Weighs only 12 pounds. Connect to any lamp socket (AC or DC). Cheap to operate. Reverses instantly on full speed. Guaranteed not to burn out. Doubles working capacity of your shop.

Ask your jobber for one today, or write us. The sooner installed, the quicker your profits will increase.

The Temco Electric Motor Company  
Main Office and Factory, 125 Sugar St., Leipsic, Ohio

Measures 15 inches  
over all including  
chuck. Drilling ca-  
pacity 3/8 inch.  
Equipment includes  
standard chuck, cord  
and attachment plug.

Thirty-one languages and dialects are spoken by the various races in the Philippine Islands.

Pressing the button that turns on the current in a new cigar lighter also operates a cigar cutter.

## Make Your Bike A MOTORCYCLE

with the Kopp Light Weight Magneto Model Motor Attachment—fits any bicycle—powerful motor—good hill climber. Catalog free. KOPP MOTOR WORKS, Dept. 5, AKRON, O.



## ALORRA DIAMONDS SPARKLE LIKE THE GENUINE—AT 1-40 THE COST SOLID GOLD RINGS

—stand acid, fire and expert examination. See them before paying. Any style ring, pin or earring. Catalog FREE. The Alorra Co., Dept. A7, 140 S. Dearborn St., Chicago



## AGENTS \$60 WEEKLY

Robinson Folding Bath Tub, Big seller. Costs little, no plumbing, little water. Weight 25 pounds, folds into small roll. Full length bath, far better than tin tubs. Guaranteed 10 years. \$10 a day easily made. Write for free tub offer. ROBINSON CABINET MFG. CO., 4103 Factory Bldg., Toledo, Ohio

## U. S. "Chain Tread" Motorcycle Tire

All the Strength of the "Chain Tread" Automobile Tire.  
UNITED STATES TIRE CO., New York City



## TURN SPARE TIME TO DOLLARS

You can be sole agent for the  
REX VISIBLE STANDARD TYPEWRITER

A brand new \$100 machine that you sell for \$17.50 and make \$80 MONEY, without investment or experience. Unsurpassed merit, low price. Easy payments, 10-day free trial and 10-year guarantee will sell the REX for you. WRITE TODAY FOR PARTICULARS.

REX TYPEWRITER CO., Dept. 31, 28 E. Jackson Blvd., CHICAGO



## DIAMONDS- AND WATCHES ON CREDIT

### GREAT DIAMOND SALE

The most astounding sale of perfect cut diamonds ever offered.

**TERMS LOW AS \$1.50 PER MONTH**

This is your opportunity to get that long wanted diamond at a bargain. This is an extraordinary saving.

**SPECIAL \$39.50 GENUINE DIAMOND RING**

A wonderful value \$4.50 per month. A written guarantee with every purchase you make from **ALFRED WARE**.

**SENSATIONAL ELGIN WATCH SALE.**

**\$12.50 Elgin Watch 17 Ruby Jewels 25 year guaranteed double gold strata case.** Factory tested and adjusted.

Payments \$2.00 Per Month.

### 30 Days Trial

**No Money Down Express Paid**

Any watch you want on easy payments. Be sure to send for our 96 page catalogue. Over 300 suggestions, Watches, Jewelry, Diamonds. This book describes our big bargains in all lines. All sold on Easy Payments and Free Trial. Send for it this minute. A postal will bring it.

**ALFRED WARE COMPANY, Dept. 538 St. Louis, Mo.**

## Big Free Catalog

## PIGEONS PAY

Better Than Chickens  
Young pigeons/squabs bring 40 to 50c each when 2 to 4 weeks old. Big demand in city markets. Each pair of pigeons easily clear \$5 per year. Always penned up. Very little space and money needed to start. Free Book explains all. **MAJESTIC SQUAB CO., Dept. 55, Anson, Iowa.**



During times of peace, a scheduled ocean-going vessel leaves New York every two hours and 40 minutes.

With an annual rainfall of about 600 in., the southern part of Assam, British India, is the world's wettest region.

## PROTECT YOUR EYES

**MECHANICS, AUTOISTS, EXPERIMENTERS, GRINDERS AND SAWYERS**



Wear the Dixie Double Peak Shop Cap. The latest invention for guarding your eyes from flying chips, dust and emery. Prevention is better than injury. Your eyes are good; keep them so. Simple and quickly adjusted; once used, will always be in use. The Dixie Shop Cap has no rival. When ordering give size. Price postpaid, **25c**. Transparent Peak with instructions for attaching to other cap or hat, **15c**.

Address: **O'B. BROS., Box 444, MIDDLETOWN, NEW YORK**

## WHEEL CHAIRS AND TRICYCLES



A Wheel Chair is often an invalid's greatest comfort. We offer over 75 styles of invalid's rolling chairs and tricycles with latest improvements. Ship direct from factory to you and sell on **THIRTY DAYS' TRIAL**. Liberal discounts to all sending for **FREE Catalog** now.

**GORDON MFG. CO.**  
353 Madison Ave. Toledo, Ohio

## WOULD YOU



show this standard high grade 42 key fully visible typewriter to your friends and let them see wherein it excels any other \$100 typewriter, if by doing this and rendering other small assistance, you could easily have one to keep as your own? Then by post card or letter to us simply say, "Mail Particulars."

**GIVEN YOU**

**WOODSTOCK TYPEWRITER CO., Dept. A 204, Chicago, Ill.**



## THE TRAINED MAN HAS MOVED UP

"Yes," he says to himself, "Bill has moved up and here I'm still at the same old job. Why they promoted him over my head gets me. I guess he must have a 'stand-in' with the boss."

It doesn't occur to him that Bill's rise to a responsible, well-paying position was due solely to preparation. He doesn't realize, like a great many others, that promotion comes only to those who prepare for it. Don't lay it to a "pull" if some other man gets the job you expect. If you don't train for it you'll have no one to blame but yourself.

### Prepare for Promotion

If you are dissatisfied with your progress toward a better job and bigger pay, the **American School** will give you advice that may change your whole future. We will, by a careful analysis of your answers to the questions we will send you, show you how you can advance in your present occupation, or, if we find that you are following the wrong line of work, we will help you to determine the occupation for which you are best fitted by nature and experience. This personal service is absolutely free whether you enroll or not.

No matter where you live or what you do, the **American School** can easily prepare you for success in **Engineering, Business or Law**. No need to give up your work. We train you at home, in your spare time, as we have successfully trained thousands in the past nineteen years.

## American School of Correspondence, Chicago, U.S.A.

### Your Opportunity Coupon

Check the course you want and mail the coupon now

**American School of Correspondence, Chicago, U.S.A.**

Without any obligation on my part please send me your Bulletin and advise me how I can qualify for the position marked "X." Pop. Mech. 6-16

- |                                |                            |
|--------------------------------|----------------------------|
| .... Electrical Engineer       | .... Lawyer                |
| .... Elec. Light & Power Supt. | .... Business Law          |
| .... Hydroelectric Engineer    | .... Business Manager      |
| .... Telephone Engineer        | .... Auditor               |
| .... Architect                 | .... Accountant            |
| .... Architectural Draftsman   | .... Cert'f'd Public Acc't |
| .... Building Contractor       | .... Private Secretary     |
| .... Building Superintendent   | .... Stenographer          |
| .... Structural Engineer       | .... Bookkeeper            |
| .... Structural Draftsman      | .... Fire Ins. Inspector   |
| .... Mechanical Engineer       | .... Fire Ins. Adjuster    |
| .... Mechanical Draftsman      | .... Fire Ins. Expert      |
| .... Civil Engineer            | .... Sanitary Engineer     |
| .... Steam Engineer            | .... Plumber               |
| .... Shop Foreman              | .... Reclamation Eng.      |
| .... Shop Superintendent       | .... Textile Boss          |
| .... Sheet Metal Draftsman     | .... College Preparatory   |

We also prepare for civil service examinations in all engineering subjects

NAME .....

ADDRESS .....

Please Mention Popular Mechanics

**Indigo**—the only fast blue color. All goods dyed with substitute dyes fade miserably when washed or even exposed to the light

## HEADLIGHT OVERALLS

(Union Made)

"A smile of satisfaction with every pair"

**\$1<sup>25</sup>** per pair

(In Canada \$1.35)

Genuine Indigo Fast Blue Dye



**SAVE MONEY!**

Buy your year's supply now

If the war continues they will go to \$1.50 per pair soon



Larned, Carter & Co., Detroit

World's Greatest Overall Makers

Factories: Detroit and Port Huron, Mich. St. Louis, Mo.

San Francisco, Cal.

Canadian Factory - Sarnia, Ont. [13]

Please Mention Popular Mechanics

**Extra money for you now**



You need more money this summer—and here's a dignified, easy way to get it. Take orders for the

### Wisconsin Detachable Motor Row Boat

Equip your boat with a guaranteed Wisconsin—enjoy yourself while demonstrating and making money. Thousands in use. Everyone interested. Has many exclusive features including self-locking tiller and patented top adjustment, which make the Wisconsin the best row boat or canoe motor to use, and the easiest to sell. Ask for our agents' plan. Ask for catalog Q.

WISCONSIN MACHINERY & MANUFACTURING COMPANY  
11 Minor St., Milwaukee, Wisconsin

Highest Award Panama-Pacific Exposition. Purchased by U. S. Government, after competitive tests.



**\$575<sup>00</sup>** Buys This Beautiful 26 ft. RUNABOUT

Equipped with high grade, 4 cylinder, 4 cycle motor, high tension Dual magneto, bulkhead starter and controls, nickel trimmings, life preserving cushions and linoleum floor covering.

**\$48<sup>00</sup>** BUYS THE COMPLETE FINISHED K. D. FRAME ready for planking. Carefully prepared scale drawings and all necessary patterns and instructions for assembling and completing the boat. Every piece is fitted, marked and numbered. A few hours' work with hammer and screw driver and you have frame ready for planking.

**WRITE FOR OUR 1916 CATALOG**

Row Boats, \$19.50 to \$40.00. Outboard Motor Boats, \$45.00 to \$85.00. Cedar Canoes, \$25.00 to \$48.00.

DUNPHY BOAT MFG. CO., Box 19, Eau Claire, Wis.

More small towns in Norway are supplied with electricity than in any other country, due to the abundance of water power.



**Save Your Trophies**

of the chase, such as coon, fox, wolf, coyote, bear, and get a beautiful rug made. We put them up with the open mouth or closed mouth. We tan all kinds of furs for ladies' furs.

SEND FOR CATALOG

W. W. WEAVER Custom Tannery Reading, Mich.

**IF \$10 to \$20 a Day Profits LOOKS GOOD TO YOU**

Let us send you a Free Booklet of our Automatic Card Printing Press

Printing is ever-lastingly a big money-making enterprise anywhere. Don't delay. Write today.

S. B. FEUERSTEIN & CO.

Photocolors and Manufacturers

542 West Jackson Boulevard CHICAGO



## INVENTORS!



**"Let Us Be Your Factory"**

We manufacture Special Machinery, Patented Metal Specialties of all kinds, Electric Articles, Hardware, Contract Manufacturing, Development, Sample Work. You get the advantage of our splendid equipment, up-to-date methods and wide experience. We Do It All. Tools, Dies, Stampings, Lathe, Screw Machine Work, Milling Machine Work, Metal Spinnings, Metal Drawings, Castings, Finishing of all kinds, Enameling, Japanning, Tinning, Galvanizing, Wood and Metal Patterns, Drafting, De-signing, Blue-print Work. Send sample for expert advice. Our 25c Book Free, containing tables and valuable information. **WRITE FOR IT TODAY.** Address THE EAGLE MFG. CO., 1605 Blue Rock St., CINCINNATI, O.

# BUTLER ROUND RUF METAL GARAGE

PORTABLE FIRE PROOF



## Portable, Fire-Proof, Low in Price

Economical, easily and quickly erected, yet permanent and durable. Made entirely of sheet steel, which locks together, making a structure neat in appearance. Very strong, rigid, fire-proof (being all metal), and absolutely weather tight. Useful as a garage, work shop, tool house and storage building. Additional sections to increase length furnished at any time. Made in sizes to fit all standard cars or in large sizes for trucks, or for two or more cars. If your dealer does not handle, write us for full information and price of size to fit your car.

**BUTLER MANUFACTURING CO.**  
204 Butler Bldg. KANSAS CITY, MO.

911 6th Ave., S. E., MINNEAPOLIS, MINN.

**BUTLER**  
PRODUCTS

A few agencies in good towns still open.  
Write at once for information.



## Spend Spare Time, Profitably

gathering butterflies, millers. Many wanted for Museums, Artwork. I pay highest prices. Everybody. Send 2c stamp for particulars and 8 page folder. SINCLAIR, Box 244 D-4, LOS ANGELES, CAL.



**At the Traps or in the Field**  
shoot shells loaded with Smokeless Shotgun Powder made by the **HERCULES POWDER CO.**



## Delivered to You Free

A sample 1916 model "Ranger" bicycle, on approval and 30 DAYS TRIAL and free riding test.

Write at once for large illustrated catalog showing complete line of bicycles, tires and supplies, and the most marvelous offer ever made on a bicycle. You will be astonished at our low prices and remarkable terms.

**RIDER AGENTS Wanted**—Boys, make money taking orders for Bicycles, Tires and Sundries from our big catalog. Do Business direct with the leading bicycle house in America. Do not buy until you know what we can do for you. WRITE TO US.

**MEAD CYCLE CO., DEPT. P108, CHICAGO**

# The Acetylene Blow Torch

## Prest-O-Torch

Costs less to buy than a good gasoline blow torch and costs less to use

In all soldering and brazing, the Prest-O-Torch avoids the delays and uncertainties of gasoline torches. Provides a concentrated, intense flame that doesn't blow out even in a high wind. Needs no attention whatever. Used with handy sizes of Prest-O-Lite cylinders—ready-made gas. Style "A" sells for 75c (Canada 85c). Used with the small MC size Prest-O-Lite. Will braze up to 1/4 inch round rod. Can be fitted with handle and hook for added convenience in bench and overhead work. Style "C" Prest-O-Torch, for use with the larger sizes of Prest-O-Lite, is recommended for large work. Will braze up to 1/2 inch round rod. Sells for \$2.25/Canada \$2.75.

Write for special literature and learn where you can see the Prest-O-Torch in operation.  
**THE PREST-O-LITE CO., Inc., 816 Speedway, Indianapolis, Ind.**  
Canadian Factory, Morrison, Ont. Exchange Agencies Everywhere



# Wake Up!

**D**RIVE out that tired feeling. Enter into the day's activities with a keen, wideawake brain. Enjoy to the utmost every minute you live. When your brain is fagged and when you are only half awake your senses are dull.

Try vibration just once. Let it "tune up" every nerve and fibre in your body. Then you will declare with thousands of men and women in all walks of life the White Cross Electric Vibrator is one of the greatest aids to health and happiness ever invented.

## Vital Strength

The virile force of robust manhood—the dynamic energy that gives man the power to do things may be yours through vibration. Write today for our new book that tells you what this great force has done for others.



This remarkable invention has accomplished wonderful results. Physicians the world over endorse it. So simple is it constructed and so easy to operate that anyone can give himself vibratory treatments right in his own home. The fact that over 80% of the vibrators now in use bear the name White Cross is conclusive evidence of their excellence.

## Send the Coupon for New Book

Send your name and address in the coupon or on a letter or post card and get our new book "Health and Beauty" absolutely free. No obligations. Find out about this marvelous force that has been such a help to thousands. Also find out about our special reduced price and free trial offer. Write today.

### SPECIAL!

Special free trial and reduced price offer now being made. Send the Coupon.

**Lindstrom-Smith Co.**  
Dept. 1194  
1100-10 S. Wabash Ave.  
CHICAGO, ILL.

We also manufacture White Cross Electric Blowers, Irons, Hair Dryers, Electric Lamps, Electric Fans, Electric Automobile Horns, Electric Curling Irons, Heating Pads, Small Motors, etc., etc.

Name .....

Address .....

My Electrical Dealer's Name is .....

**Dealers Write**

Lindstrom-Smith Co.  
1100-10 S. Wabash Ave.  
Dept. 1194, Chicago, Ill.

Without any obligations on my part, please send me free and prepaid detailed description of the White Cross Electric Vibrator and full particulars of your free trial offer. Also your FREE book, "Health and Beauty."

.....

.....

.....

.....

.....

.....

.....

.....

.....

.....

.....

.....

.....

.....

.....

.....

.....

.....

.....

.....

.....

.....

.....

.....

.....

.....

.....

.....

.....

.....

.....

.....

.....

.....

.....

.....

.....

.....

.....

.....

.....

.....

.....

.....

.....

.....

.....

.....

.....

.....

.....

.....

.....

.....

.....

.....

.....

.....

.....

.....

.....

.....

.....

.....

.....

.....

.....

.....

.....

.....

.....

.....

.....

.....

.....

.....

.....

.....

.....

# The Drill That Fits the Job

You needn't take work apart to adjust the job to the drill when you use a "Yankee" Ratchet Breast Drill No. 555. It works in tight corners and out-of-the-way places where other breast drills are useless.

With Double Ratchet Adjustment, drill cuts continuously with every movement of the crank, forward and backward, and you can change from fast to slow speed without taking drill from work.

## "YANKEE" Ratchet Breast Drill No. 555 Price, \$5.25

Adjustable ball bearings. Cut gears. Chuck jaws of drop forged steel.  
No. 555, 2-jaw chuck for round or square shanks to 1/2 in. diam.  
No. 1555, 3-jaw chuck for round shanks only, to 1/2 in. diam.

Your dealer can supply you

Write for "'Yankee' Tool Book" showing all the "Yankee" wood-and-metal-boring and screw-driving tools.

**NORTH BROS. MFG. CO., PHILADELPHIA, U. S. A.**

**"YANKEE" TOOLS** *Make Better Mechanics*

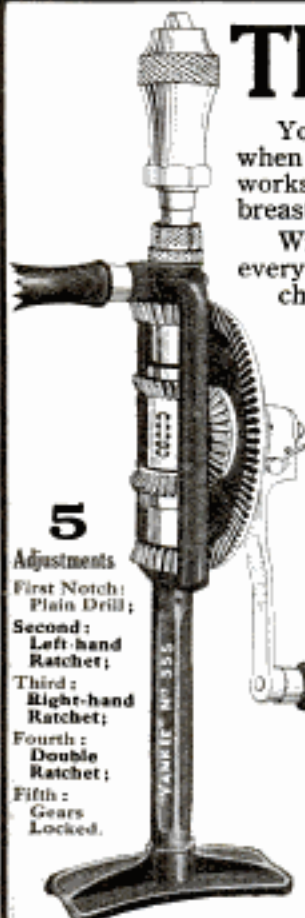

**5**

Adjustments

First Notch:  
Plain Drill;

Second:  
Left-hand  
Ratchet;

Third:  
Right-hand  
Ratchet;

Fourth:  
Double  
Ratchet;

Fifth:  
Gears  
Locked.

## KENNEBEC

WRITE FOR  
CATALOG  
FREE!

Send for it at once and insure a fine summer and a healthful one.

This new booklet is of vital interest to you. Tells all about our paddling, sailing, motor and sponson models; tells you just what a canoe should be for a given purpose.

Kennebec models are the result of years of experience in canoe building, and an intimate knowledge of canoeing. The materials used are the best that can be obtained.

Write now for booklet. Address

Kennebec Canoe Company, 49 R. R. Sq., Waterville, Me.

## Sell 3—Get One Free



The **ACORN** Self-Heating **FLAT IRON** is something entirely new—takes women by storm—saves miles of walk—carry it anywhere—iron anywhere—on the porch, under the shade trees—costs one cent for week's ironing—no stove needed—everybody interested. Every home a prospect. Use one in your own home, then sell your neighbors. Send for liberal offer.

Acorn Brass Mfg. Co., Dept. 606, Chicago, Ill.

## Who Hears Most News?

Do you hear as much news as the other fellows? A Brandes Head Set will greatly increase your range—no matter how modest your apparatus. Get ahead of the others. Send 4c for our Catalog P. It will tell you how.

C. BRANDES, Inc., Room 117, 32 Union Sq., New York

**BRANDES WIRELESS RECEIVERS**

## AGENTS—The Million Dollar Hit!

New, wonderful home invention, just introduced, yet million sales already recorded. Tremendous, rapid sales stagger country. Agents happy—banking enormous profits daily. Mighty opportunity for you to get the mighty dollar. Failure impossible. Experience unnecessary. Money rolls in first hour—\$10 to \$30 daily. Amazing cash records made. Walters received

**\$50.00 FOR 7 HOURS' WORK**

Never sold goods before. Arnold sold 160 in 2 days; Hagen 100 same time; Webb 10 per hour; O'Connell 25 first day. Hundreds like these. You, too, can have money in abundance. Grab's Scientific Shoe Cleaner sells itself—you take orders—that's all. Every family wants one on their doorstep. Replaces unsightly, unsanitary, crude door mat. **Automatically removes mud, dirt, snow from shoe in one operation.** Cleans sole, sides, heel. Works like magic—sells like sixty. Saves drudgery, time, money, shoes—saves carpets, floors. Mechanical wonder. Has 7 new patented features not found in any other scraper—10 steel blades—10 dirt outlets—twin adjustable and removable brushes—compound springs. Rotates for sweeping. Can't clog—practically self-cleaning. Handsomely embossed. Nothing else like it. Nothing so popular—so easy to sell. Selling price only \$1.00. You make big profits. Satisfaction guaranteed. Write quick for free catalog—exclusive agency. Investigate without fail.

**SECURITY MFG. CO., Dept. 251, TOLEDO, OHIO**

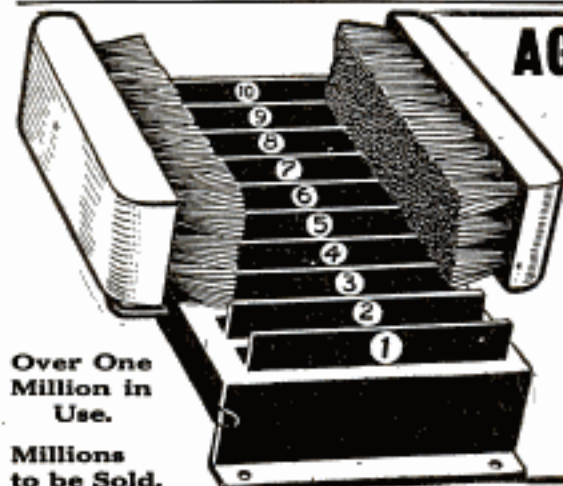

Over One  
Million in  
Use.

Millions  
to be Sold.

# Prest-O-Lite

For  
Motorcycles

Get this brilliant  
dependable light  
on your motorcycle

It will add to your pleasure and safety. Good lighting is no less important than fuel.

Prest-O-Lite gives you perfect service and satisfaction at all times—is unaffected by bumps or jolts. It furnishes mellow, penetrative light, will not wink out suddenly or fail you in emergencies. Its operation is thoroughly simple. Any rider can easily give it all the attention it needs.

Because of its reliability, efficiency and freedom from trouble, Prest-O-Lite is used on more motorcycles than any other system of lighting. It costs little to buy and little to use.

## Of Proven Value on All Makes of Motorcycles

Your dealer can supply you Prest-O-Lite on any motorcycle you buy. One of the most popular combinations of complete equipment, offered by many dealers, is a Prest-O-Lite, a lamp and a good mechanical horn. You save money both on purchase price and upkeep cost by *insisting* on this kind of equipment.

**The Prest-O-Lite Co., Inc.**  
The World's Largest Makers of Dissolved Acetylene  
265 Speedway Indianapolis, Ind.  
Canadian Offices and Factory  
Merrinton, Ontario  
Prest-O-Lite Exchange Agencies Everywhere



# Rock Bottom on the Very Best Steel Roofing Ever Made

This is positively the greatest roofing proposition ever made. Before you invest in new roof covering, siding or ceiling, first learn about the one best—by far the best from every viewpoint, and cheapest. Take no chances. Get Edwards' Freight Prepaid offers and note the big saving.



Reo Steel Cluster Shingles

## EDWARDS TIGHTCOTE REO STEEL SHINGLES

actually cost less—outlast three ordinary roofs—no painting or repairs. Rot-proof, fire-proof, rust-proof, and guaranteed lightning-proof. Any one can lay it, right over old shingles if you like.



Spanish Metal Tile

## Impossible To Rust Edges and Nail Holes

Every sheet of Edwards' Galvanized Steel Shingles, Roofing, Siding, Ceiling or finish is extra heavy galvanized, piece at a time, by our exclusive Tightcote patented process after sheet has been stamped and resquared. Side and edges are as heavily galvanized as body of sheet. Means no weak spots to rust or corrode. By means of Edwards' Patent Interlocking Device (see illustration) all nails are driven through underlayer of metal only—no exposure—no leaks.



Edwards Patent "Grip-Lock"



Corrugated

## Garage \$69.50 Up

Wide variety, many styles, all sizes of Portable, Fireproof Metal Garages, \$69.50 and up. Lowest prices ever made. Postal brings FREE 64-page Garage Catalog.



Garage

## FREE Roofing Book

Edwards' Reo Steel Cluster Shingles, V-Crimped, Corrugated, Standing Seam, Painted or Galvanized Roofing direct to you at "rock bottom" factory prices. Write today for FREIGHT PREPAID OFFER on the lowest prices ever made for World's Best Roofing. Free Samples and Roofing Book No. 450.

## THE EDWARDS MFG. CO.

400-450 Pike Street  
Cincinnati, Ohio

**WORLD'S  
GREATEST  
ROOFING  
BOOK**

Note construction of Patent Interlocking Device, protecting nail heads from weather—making roof absolutely water-tight.

**SPECIAL OFFER COUPON**  
THE EDWARDS MFG. CO.,  
400-450 Pike St., Cincinnati, O.  
Please send FREE samples  
Freight-Paid prices and World's  
Greatest Roofing Book No. 450.

Name.....

Address.....

Largest Makers of Sheet Metal Products in the World

# STOP USING A TRUSS

Do Away With Steel And Rubber Bands

## FREE TRIAL



PAT'D  
APRIL 6  
1909

Inner surface is made adhesive to secure the PLAPAO-PAD firmly to the body, keeping the PLAPAO continually applied and the pad from slipping. No straps, buckles or springs attached. Soft as velvet—easy to apply.

It's the Non-Slipping, yet Non-Rigid Pad and What is Within It That Counts

### FREE to 5,000 Truss Sufferers

To the first 5,000 Sufferers who write, I will send, ABSOLUTELY FREE, a sufficient quantity of the Plapao to positively convince them that this is the only logical, common-sense way of treating rupture. Plapao is a highly astringent medication placed within the Plapao-Pad and being absorbed through the skin, creates a wonderful feeling of relief and at the same time tends to strengthen the weakened muscles and thus permanently close the rupture opening. The process of recovery is natural, so you'll have no use for a truss—you can throw it away forever! Old and young have testified under oath that the Plapao-Pads cured their rupture—many of them long-standing, aggravated cases—without delay from work. Patent allowed in U. S. and foreign countries. Awarded Gold Medal at Rome and Grand Prix at Paris.

**Send No Money**—for a sufficient quantity of the Plapao is sent without charge to enable you to give it a thorough test; you pay nothing for this trial now or ever. Write for it and full information today. Address: Plapao Laboratories, Block 1427 St. Louis, Mo.

# Deafness



Perfect hearing is now being restored in every condition of deafness or defective hearing from causes such as

Relaxed or Sunken Drums, Roaring or Hissing Sounds, Perforated, Partially Destroyed Drums, etc.

### Wilson Common-Sense Ear Drums

"Little Wireless Phones for the Ears"—require no medicine but effectively replace what is lacking or defective in the natural drums. They are simple devices, which the wearer easily fits into the ears where they are invisible. Soft, safe and comfortable to wear at all times.

Write today for our 168 page FREE book on DEAFNESS, giving you full particulars and plenty of testimonials.

WILSON EAR DRUM CO., Incorporated  
734 Inter-Southern Building LOUISVILLE, KY.

## Don't Wear a Truss

Brooks' Appliance, the modern scientific invention, the wonderful new discovery that relieves rupture will be sent on trial. No obnoxious springs or pads.

### Brooks' Rupture Appliance

Has automatic Air Cushions. Binds and draws the broken parts together as you would a broken limb. No salves. No lies. Durable, cheap. Sent on trial to prove it. Protected by U. S. patents. Catalogue and measure blanks mailed free. Send name and address today.

C. E. BROOKS, 1817A State Street, Marshall, Mich.

## "I Would Not Part with It for \$10,000"

So writes an enthusiastic, grateful customer. "Worth its weight in gold," says another. In like manner testify over 100,000 people who have worn it.

## The Natural Body Brace

For MEN and WOMEN.

Develops erect, graceful figure, overcomes WEAKNESS and AILMENTS of Women & Men.

Brings womanly beauty and manly strength, restful relief, ability to work and enjoy life.

### Banishes All These Troubles

Does away with the strain and pain of standing and walking; replaces and supports misplaced internal organs; reduces enlarged abdomen; straightens and strengthens the back; corrects stooping shoulders; develops lungs, chest and bust; relieves backache and nervousness. Comfortable and easy to wear.

### Wear It 30 Days Free at Our Expense

Write today for illustrated booklet, measurement blank, etc., and read our very liberal proposition.

HOWARD C. RASH, Pres. Natural Body Brace Co.  
223 Rash Building SALINA, KANSAS



## "Bow Legs and Knock-Knees" Unsightly

Send for booklet showing photos of men with and without

### The PERFECT LEG FORMS

Perfect Sales Co., 143 N. Mayfield Ave., Dept. 5  
Austin Station, CHICAGO, ILL.



Erickson Artificial Limb Co., 38 Wash. Av. No., Minneapolis, Minn.  
Light Double Does Not Chafe Overheat or Drive End of Stump  
Patented

We are Under Govt. Bond

Feathers, worth over \$200,000, are exported annually from Ireland as a by-product of its extensive poultry industry.

## RELIEF TO TRUSS USERS

Any appliance is a truss. Ruptured people must wear some kind of support. Our New Sponge Rubber Pad (pat'd) is velvet, soft to the skin, pliable, cannot slip, extremely comfortable, adapts itself to ruptured parts with less pressure, is sanitary, long lived. Massages and strengthens muscles, allows blood circulation and produces many cures.

### New Scrotal Pad Needs No Leg Strap

Our new scrotal pad (pat'd) holds hernia perfectly without strap between legs in 8 out of 10 cases.

**FREE SAMPLE PAD** A Sample Akron Sponge Rubber Truss Pad (pat'd) will be sent absolutely FREE upon request, also booklet "Help to Truss Wearers," if it's full of help. Ask your dealer, or write us. THE AKRON TRUSS CO., Dept. 104, AKRON, OHIO

## NO MORE BALD HEADS



WHEN our VACUUM CAP is used a few minutes daily. We accept no pay until you have tried the Cap 60 days and are satisfied. The Vacuum Cap is an appliance that draws the blood to the Hair Roots and starts a new healthy crop of hair. It stops dandruff, stops the hair from falling out.

Bought by Doctors and men who know that it is the only reasonable HAIR GROWER known to science. No Drugs Used. Write for application blank, testimonials, and booklet on "HAIR," sent sealed in plain envelope. FREE.

THE MODERN VACUUM CAP CO.  
C. 559 BARCLAY, DENVER, COLO.



## Immediate Results

Trying to quit the tobacco habit unaided is a losing fight against heavy odds, and means a serious shock to your nervous system. So don't try it! Make the tobacco habit quit you. It will quit you if you will just take Tobacco Redeemer according to directions.

It doesn't make a particle of difference whether you've been a user of tobacco for a single month or for 50 years, or how much you use, or in what form you use it. Whether you smoke cigars, cigarettes, pipe, chew plug or fine cut or use snuff Tobacco Redeemer will positively remove all craving for tobacco in any form in from 48 to 72 hours. Your tobacco craving will begin to decrease after the very first dose—there's no long waiting for results.

Tobacco Redeemer contains no habit-forming drugs of any kind and is the most marvelously quick, absolutely scientific and thoroughly reliable remedy for the tobacco habit.

## Not a Substitute

Tobacco Redeemer is in no sense a substitute for tobacco, but is a radical, efficient treatment. After finishing the treatment you have absolutely no desire to use tobacco again or to continue the use of the remedy. It quiets the nerves, and will make you feel better in every way. If you really want to quit the tobacco habit—get rid of it so completely that when you see others using it, it will not awaken the slightest desire in you—you should at once begin a course of Tobacco Redeemer treatment for the habit.

## Results Absolutely Guaranteed

A single trial will convince the most skeptical. Our legal, binding, money-back guarantee goes with each full treatment. If Tobacco Redeemer fails to banish the tobacco habit when taken according to the plain and easy directions, your money will be cheerfully refunded upon demand.

## Let Us Send You Convincing Proof

If you're a slave of the tobacco habit and want to find a sure, quick way of quitting "for keeps" you owe it to yourself and to your family to mail the coupon below or send your name and address on a postal and receive our free booklet on the deadly effect of tobacco on the human system, and positive proof that Tobacco Redeemer will quickly free you from the habit.

Newell Pharmaceutical Company  
Dept. 300, St. Louis, Mo.



**Mail Coupon NOW  
for FREE Booklet**

NEWELL PHARMACAL CO.,  
Dept. 300, St. Louis, Mo.

Please send, without obligating me in any way, your free booklet regarding the tobacco habit and proof that Tobacco Redeemer will positively free me from the tobacco habit.

Name .....

Street and No. ....

Town..... State.....

Please Mention Popular Mechanics



## Be An Early Bird This Year

Practice up now for the season's trophies. Start early. Be among the first out to pepper the speedy clay targets. Get an edge on the other fellow while the season is still young. There's no game can surpass

## TRAPSHOOTING

for all 'round sport, health and pleasure. Gun "bugs" are the best of good fellows and there's a hearty welcome ready and waiting for you at the nearest gun club. Have you seen the

### DU PONT HAND TRAP

Throws all kinds of targets. Folds up. Goes in a bag and makes trapshooting possible at any time or place. Get one now. \$4.00 at your sporting goods dealer's or sent prepaid on receipt of price anywhere in the U. S.

Write for booklet "The Sport Alluring" No. 386

**E. I. DU PONT DE NEMOURS & COMPANY, Wilmington, Delaware**

When in Atlantic City visit the "Du Pont Store" Pennsylvania Avenue & Boardwalk—see the big Du Pont Night Sign and try your skill at the Trapshooting School at the end of Young's Million Dollar Pier.

## Andrews Hot Water Heating

VAPOR & STEAM

For New or Old Houses

Andrews Engineers design each Andrews System to fit its requirements and the whole plant is built in our modern shop, tagged and shipped ready to screw together. Complete Estimate Free.

Andrews Steel Boilers are different. They heat quicker and require less fuel than others. More durable. Easily operated. Big Heating Book Free.

**ANDREWS HEATING COMPANY**  
1493 Heating Bldg. MINNEAPOLIS, MINN.



### AGENTS GOOD INCOME

Wide Awake Men and Women to sell our Gasoline Table Lamps, Lanterns and Self Heating, Quick Lighting, Stay Hot Bed Irons. Positively the simplest and most practical iron on the market. We challenge competition. **Your Chance.** Territory is being rapidly taken. If you want a good, steady income, write to us TODAY.

**International Light, Novelty & Specialty Co.**  
426 So. Clinton St. Dept. 81 Chicago, Ill.

### 30 Days FREE TRIAL

and freight prepaid on the new 1916 "RANGER" bicycle. Write at once and get our big catalog and special offers before buying.

Marvelous improvements. Extraordinary values in our 1916 price offers. You cannot afford to buy without getting our latest propositions. **WRITE TODAY.**

Boys, be a "Rider Agent" and make big money taking orders for bicycles and supplies. Get our liberal terms on a sample to introduce the new "RANGER."

Tires, equipment, sundries and everything in the bicycle line half usual prices.

**MEAD CYCLE CO., DEPT. P108 CHICAGO**



## An Easy Way to Make Money

Don't be content to plod along on a small salary. Be independent. Go in the tire repairing business and make \$60 or more a week. One man made \$45 the first day he received his outfit. Others are making \$25 a day and hundreds of wide-awake men are making \$200 to \$500 a month.

No experience needed. We teach you how. Very little capital required. But slight risk, as every car owner in your town is a possible customer. Jobs are plentiful because tires blow out and puncture every day.

## SHALER Tire Repair Outfit, \$60

will do as much and as perfect work as the big \$250 to \$500 vulcanizing outfits. A boy can vulcanize perfectly with this simple machine. It's the only vulcanizer that has **Automatic Heat Control.** It must vulcanize just right. It can't undercure or overcure a tire. Requires no watching or regulating. You can learn to do expert tire vulcanizing in half an hour with the Shaler.

**WRITE FOR FREE BOOK "HOW TO OPEN A TIRE REPAIR SHOP"** and complete catalog which gives full information. **WRITE QUICK BEFORE SOME HUSTLER GETS AHEAD OF YOU.**

**C. A. SHALER CO., 202 Fourth Street, WAUPUN, WIS.**





## TO MAKE MONEY

To any woman who has no special training and wants to earn money, I would recommend nothing better than selling World's Star goods. When I started in this work I had never done any soliciting of any kind. The commission on my first day's orders came to \$7.00. What other work is there that a woman can do to earn that amount? One cannot help but succeed with World's Star goods and enthusiasm. Both will lead to success. So writes Mrs. G. H. Littlefield, of Oregon.

From Mill to Home

## World's Star Hosiery and Klean-Knit Underwear

Lower Prices Higher Values

In more than 9000 cases we have helped ambitious, deserving women. You can do the same as they have done. Sell World's Star Hosiery and Klean-Knit Underwear in your home town. No previous experience is necessary—we show you how to make money in an easy, congenial and profitable way. World's Star Hosiery and Klean-Knit Underwear are known everywhere. Our advertising makes sales easy—the quality holds the trade.

Prompt Deliveries and Protected Territory  
Our free catalog tells whole story. Write today.



We have been in business here for twenty-one years!

## Machinists and Tool Makers

Save money buying **Kwality Tool Cases** direct from the factory. Write for **SPECIAL PRICE LIST**.  
Detroit Leather Goods Co., 341 Woodward Ave., Detroit, Mich.



## Put Perrin "No Glare" On Your Car's Headlights

Avoid all danger from light-dazzled motorists. Enjoy long, low, powerful light on both streets and country roads, with complete safety. Recommended by Police officials. Placed on lamp bulb permanently—always working—no buttons or levers. Over 100,000 in use.

**\$1 per set of two.** At your Dealer's or Garage or sent postpaid. Patented. Reject imitations. Insist on the Perrin "No Glare."  
**PERRIN MFG. CO., Detroit, Mich.**

## Pay as You Wish

We'll send you a genuine Lachnite for you to wear for 10 full days. If you can tell it from a real diamond send it back at our expense. Costs but 1/10th as much. If you decide to keep it pay only a few cents a month. Write for catalog.

### Genuine Lachnite Gems

Keep their dazzling fire forever. Set in solid gold. Cut by world renowned diamond cutters. Will stand fire and acid tests. All kinds of jewelry at astonishing low prices. Low tournaments. **WRITE TODAY.**  
H. Lachnite Co., 12 N. Michigan Ave., Chicago Dept 1194



## JAPANESE ROSE BUSHES

### The Wonder of the World

Japanese Rose Bushes bloom all the year round. Just think of it. Six weeks after planting the seed, the plants will be in full bloom. It may not seem possible, but we positively guarantee it to be so. They will bloom every ten weeks, Summer or Winter, and when three years old the bush will be a mass of roses, bearing from five hundred to a thousand roses on each bush. The flowers are in three shades—white, pink, and crimson. The plants will do well both in and out doors. We guarantee at least three bushes to grow from each packet of seed. Price, including our big catalog (300 pages) of other novelties and curiosities, only 10c packet, 3 pcks. for 25c postpaid.

**Live Agents Wanted** We have the finest stock of exclusive, fast selling novelties in America. Many of our lines unobtainable elsewhere. We supply you with most attractive catalogs (32 or 64 pages) bearing your own imprint on. Orders mailed direct to your customers if desired. Our proposition is a winner. Let's get acquainted.

**JOHNSON SMITH & CO., 7123 N. Clark St., CHICAGO**

# Look For This Drug Store



The Sign of the Nurse points out the SAN • TOX Druggist

Only a druggist with an established reputation for honesty, integrity and fair dealing is permitted to handle the SAN • TOX Line of Toilet Articles and Household Preparations.

Before any SAN • TOX Druggist placed SAN • TOX on his shelves he was required to rigidly investigate the entire line of more than 125 items and by so doing thoroughly satisfy himself that each one will substantiate his personal guarantee.

# SanTox

## The Public Service Line

You will know the one "best" drug store in your locality by the sign of the Nurse on the window. Go there for all your toilet requisites and household preparations. The SAN • TOX Druggist unhesitatingly recommends SAN • TOX because he knows that you will be delighted—that you will come back for more. He will cheerfully and without argument refund the price of any SAN • TOX item which does not satisfy you in every particular.

**THE DEPREE CHEMICAL CO.**

CHICAGO, ILLINOIS



Please Mention Popular Mechanics



## GET ACQUAINTED WITH US ON THE NEWS-STANDS

**I**F you are a Man of Affairs, and would like to know what the world is thinking—if your time is limited, and you want a "Cook's Tour" through the realm of world thought—if a Monthly Review in Cartoon and Comment of Current Events appeals to you—if you want the viewpoint of other nations—if you would like to read history in the making in its most attractive form

GET A COPY OF

# CARTOONS MAGAZINE

(Published by H. H. WINDSOR, Publisher of Popular Mechanics Magazine)

It is the only magazine in the field mobilizing the pen-and-ink satirists from the four corners of the world, men who are fighting silent battles on their drawing boards.

So great has been the demand for back numbers of this periodical that several issues published early in the war have been exhausted. The file of *Cartoons Magazine* will be almost priceless a few years hence. It is a magazine for your library and reading table.

25c A COPY

\$3.00 A YEAR

This Coupon and \$3 brings it to you for a Year

CARTOONS MAGAZINE  
6 N. Michigan Avenue, Chicago

Enclosed please find \$3.00, for which enter me for a year's subscription to your magazine.

Name .....

Street .....

City .....

# LAW BOOK FREE



Do you know that the incomes of many lawyers exceed that of the President of the United States? Are you aware that the President himself, as well as practically every other man prominent in public life, is a lawyer? Then you owe it to yourself to get and read this interesting 80-page law book. Doing so may change your whole future! It shows that the demand for legally-trained men in business and public life was never greater than today, and points out the importance of a thorough knowledge of law in many lines of work. It compares resident and correspondence instruction, and explains just what a law course should contain to give you the training absolutely necessary to success. It enables you to weigh and judge the claims of correspondence schools; shows you how to choose the best school in which to take up the study of law, and describes thoroughly the American School's new and efficient method of acquiring a legal education at home—in your spare time.

## FREE 13 Volume Law Library and 60 Text Books

With each course we furnish 60 new pocket size text books, 36 Case Books, and instruction for five years if necessary. Our big 13-volume Law Library—the most splendid reference work of its kind ever published covering the entire field of American law and practice—included absolutely free. Course contains 28 more subjects and 30 more authors than any other correspondence law course. Written in plain, simple, easily understood language—the easiest, best, most complete and practical correspondence law course ever devised. Only law course ever written especially for correspondence instruction. Send for "How To Acquire a Legal Training" today. It is absolutely free—just mail the coupon.



This 13-vol. Law Library and 60 Text Books Free with every Course

**American School of Correspondence**  
Chicago U.S.A.

**FREE BOOK COUPON**

NAME .....

ADDRESS .....

Copy Recd. 4-16 A. S. of C.  
Gentlemen: Please send me your FREE Law Book, "How To Acquire a Legal Training," and full particulars regarding your wonderful new system of correspondence law instruction.

**Know a man by his writing**

*Whatever your style of writing,*  
(honest, straightforward, reliable, also generous)

*there is a Spencerian Make*  
(independent, blunt, artistic, a bit selfish)

*especially for your hand.*  
(ambitious, persevering, somewhat sentimental)

**WOULD** you like to know what the handwriting of your friends signifies? Here's a booklet of thirty-two pages that will tell you—"What Your Handwriting Reveals." It is written by William Leslie French, the celebrated Graphologist. It is illustrated with fifty specimens of handwriting.

*A new edition is being printed to supply the great demand. A copy of this book with twelve different patterns of Spencerian Steel Pens will be sent on receipt of ten cents.*

**SPENCERIAN PEN COMPANY**  
349 Broadway, New York

**SPENCERIAN PEN COMPANY**  
349 Broadway, New York PM

I enclose ten cents for samples of Spencerian Steel Pens and a copy of the book, "What Your Handwriting Reveals."

Name \_\_\_\_\_

Street No. \_\_\_\_\_

City \_\_\_\_\_

State \_\_\_\_\_



DENBY **ID** FOR TRAIL OR PAVEMENT **ID** DENBY

## DENBY

If you are as thorough in your investigation as we are in our construction your truck will be a Denby.

### Denby Frame—For Instance

Sturdier, more generously dimensioned, wider flanges, deeper channel face—made to carry the load with confidence—inspiring ease and permanence.

Just one of a hundred points of superiority in Denby construction.

### Denby Trucks

have become noted for a **super-service**—a remarkable freedom from expensive replacements or exasperating breakdowns.

That is because Denby construction is **thorough**. The factor of safety in the smallest bolt or rivet is as great in proportion as in the wonderful Denby internal-gear axle itself.

It is when you look beyond mere specifications or "talking points" that the reasons for Denby dominance becomes clearly apparent.

The  $\frac{3}{4}$ -ton Denby, for example, is the first **real** light-delivery truck, designed and built from the ground up for the work which it is intended to perform.

Four models, with body and chassis modifications to fit any business.

$\frac{3}{4}$ ton (with open express body)	\$ 890
1 ton (chassis only)	1475
$1\frac{1}{2}$ tons (chassis only)	1685
2 tons (chassis only)	1985

Your local Denbyman has some data that will interest you.

**Denby Motor Truck Company**  
403 Holbrook Ave., Detroit, Mich.

DENBY **ID** FOR TRAIL OR PAVEMENT **ID** DENBY

**No More Plastering**

That alone is argument enough for Beaver Board—no more plastering.

The distressing muss and litter of plastering is done away with. More than that, the additional litter and annoyance of paper-hanging is likewise unnecessary.

The Beaver Board way is so much easier—just nail the ready-made walls to the timbers, paint according to your taste, apply decorative strips over joints and the crack-proof wall is done.

Our Design and Decoration Department will gladly help you get exactly the effect you want—no charge.

Use Beaver Board for new work or remodeling, large jobs or small. It gives handsome, permanent, serviceable walls and ceilings. Write for free sample.

## BEAVER BOARD

The BEAVER BOARD COMPANIES  
631 Beaver Road, Buffalo, N. Y. Branches in 16 Cities

### "E-Z" Coin Safety Self-Filler Pen



A new safety self-filler for every man at any man's price. To fill merely insert coin or other article in slot and press once. Safety Cap prevents leakage if carried point down. Holder of Diamond Chased Vulcanized Rubber. 14 Kt. Gold Pen. Every part guaranteed. No. 315 Vest-Pocket size \$1.75. No. 316 Regular size \$2.00. Free Catalogue. Agents Wanted.

**J. C. ULLRICH & CO., 27 Thames St., NEW YORK**

**\$25.00 a Day Easy!**

That's what you can make every day in the year "snapping the crowds" at Bathing Beaches, Ball Parks, Fairs, etc., with a **DIAMOND POST CARD GUN**—marvelous all-metal camera that takes, develops, finishes sizes of Post Cards, including Official size photo buttons at the rate of 5 to 8 a minute. No experience needed, no plates, film or dark room required. Write for free booklet to Dept. M12 International Metal & Ferry Co., Chicago.

Spells Go on Every Dime

### NEW WIRELESS WONDER THE INSTANT RADIOGRAPH

Greatest Invention of the Age. The Result of Years of Experimentation. **ABOLISHES DETECTOR TROUBLES and Adjustments. NO MORE DELAYS—NO MORE LOST TIME AND MESSAGES. NO COST TO OPERATE.** Pick up your receivers any time, Summer or Winter, in any atmospheric conditions.

You can receive instantly without any adjusting

Introductory Price for April **\$3.00**

3000 Miles is latest record. Send for Instant Radiograph folder C. 2. Here's a book you need. A complete list of call signals of all public wireless stations. Price only 50 cents.

Send 4c for 154 p. Catalog

**Universal Wireless Co.**  
19 East 32nd St. New York



Please Mention Popular Mechanics

"Little Guard"  
the new **Torrey**

gives a quick, smooth,  
clean shave

Here's a real safety  
guard razor, shaves  
in the only correct  
way, cuts close,  
doesn't rough  
the skin.

\$2

Like all  
**Torrey**

razors, this  
new safety has  
the perfect shaving  
edge. Hold like  
any other real razor—  
it's two-thirds size. Has  
reversible safety guard.

If your dealer hasn't Torrey  
razors, write us; we'll tell you  
where to get them. Ask for Free  
Booklet, "How to Shave."

The new Torrey Hon-  
ing Strap has no equal

THE J. R. TORREY RAZOR COMPANY  
Dept. P, Worcester, Mass.



Ten million of the United States inhabitants are  
savings-bank depositors.

IT WRITES WITH WATER! **THE INKLESS PEN**

Only  
10 Cents  
3 for 25c

Complete with Hand-  
some Nickel-plated Re-  
versible Holder. Points  
only. 50 each, 3 for 25c posted.  
AGENTS Wanted. Full line of ex-  
clusive, fast selling novelties, trunks &  
puzzles. 32 & 64 p. imprint catalogs furnished.

JOHNSON SMITH & CO., 7125 North Clark Street, CHICAGO

Writes 500 words with one dip in water. It is a real  
pleasure to write with the Inkless Pen, as you have  
simply to dip it in plain water. The point is of  
special construction and of a peculiar metal.

It resists corrosion and lasts very much  
longer than ordinary pens. NO  
MESS, NO TROUBLE. Writes  
a rich violet color, which  
may be copied. It is  
much better than  
a fountain pen, for  
you can write a long  
letter with simply  
one dip in water.

**MAKE YOUR BIKE A  
MOTORCYCLE**

at a small cost, by using our  
attachable outfit. Fits any  
Bicycle. Easily attached. No  
special tools required.

**"Used His Four Years"**

Harry A. Hyatt, of Boreas River, New  
York, writes: "About four years ago I  
received my motor attachment, and wish  
to say that I am satisfied with it in every  
way, for it has certainly given me good  
service. Anyone wanting a motorcycle or  
attachment, I would recommend them to  
the Shaw Manufacturing Co."

**FREE BOOK** Write today for bargain list and  
free booklet, fully describing the  
SHAW Bicycle Motor Attachment. Motor-  
cycles all makes, new and second-hand, \$35.00 up.

**SHAW MANUFACTURING CO.**  
Dept. 6 GALESBURG, KANSAS



**What Paint**  
shall I buy, is sometimes asked,  
to be sure that it contains  
**Dutch Boy White Lead**  
It can't be done. You buy Dutch Boy  
White Lead in a steel keg (as shown here).  
The painter makes paint of it by adding  
linseed oil and color.  
That is the paint which wears.  
Ask us for Paint Tips No. 31.

**NATIONAL LEAD COMPANY**  
New York Cleveland Boston Buffalo  
Chicago Cincinnati  
St. Louis Philadelphia  
John T. Lewis  
& Bros. Co.  
(National Lead  
& Oil Co.,  
Pittsburgh)

**UNCLE SAM  
WANTS YOU**



**Get a U.S. Government Job  
\$75 to \$150 a Month**

Rapid advancement to higher Government Positions.  
No "Layoffs" because of STRIKES, WARS, FINANCIAL  
FLURRIES or THE WHIMS of SOME PETTY BOSS.  
THE POSITION IS YOURS FOR LIFE.

Country residents and city residents stand the same chance for  
immediate appointment.

Common sense education sufficient.  
Political influence NOT REQUIRED.

**We Will Coach 25 Candidates Free of Charge**  
Write immediately for full list of many positions now obtainable.  
Don't delay. Every day you lose means the loss of just so much  
chance of early appointment.

**FREE COACHING COUPON**

**FRANKLIN INSTITUTE, Dept. K 97, Rochester, N. Y.**

This coupon, properly filled out, entitles the sender to full list of posi-  
tions now obtainable, a free copy of our valuable copyrighted book,  
"Government Positions and How to Get Them," and to considera-  
tion for FREE COACHING for the Civil Service position here checked.

... Railway Mail Clerk (\$900 to \$1800) ... Customs Positions (\$600 to \$1500)  
... Postoffice Clerk (\$800 to \$1350) ... Internal Revenue (\$700 to \$1500)  
... Postoffice Carrier (\$800 to \$1350) ... Stenographer (\$600 to \$1500)  
... Rural Mail Carrier (\$600 to \$1200) ... Panama Canal C's (\$1200 to \$1800)

Name.....

Address.....

Use this before you lose it. Write plainly.

# Prosperity in Canada

## \$900,000,000

### in New Wealth Added in 1915

**ENORMOUS CROPS and LOW  
TAXATION Make Farmers Rich**

**C**ANADA, enjoying wonderful prosperity from the products of the farm, the orchard, and the centers of industry—Canada has come into her own. No country wrote a brighter page of history in agricultural and industrial development during 1915 than Canada. All industrial plants working overtime. Wheat average, 36.16 bushels per acre in Alberta; 28.75 bushels per acre in Saskatchewan; 28.50 bushels per acre in Manitoba. All other grains showed similar large yields per acre. Taxes average \$24 and will not exceed \$35 per quarter section. This includes all taxes. No taxes on improvements.

### Come and Get Your Share of This Prosperity

—the greatest wealth-producing era the Dominion has ever known. Free schools and full religious liberty. Good climate. World-renowned livestock. Prizes won at International Fairs prove this. Here is your opportunity! What chance have you to provide a farm for your children in your present location, where land prices are so high?

### Get Your Farm Home from the Canadian Pacific Ry.—20 Years to Pay

Good land from \$11 to \$30 per acre. Irrigated lands from \$35, and the Government guarantees your land and water titles. Balance after first payment extended over nineteen years with interest at 6%. Privilege of paying in full at any time. Long before final payment becomes due your farm should have paid for itself.

**\$2000 Loan in Improvements.** We will lend you up to \$2000 in improvements in certain districts with no security other than the land itself. Particulars on request. Twenty years for repayment of loan with interest at 6%.

**Ready-Made Farms for Sale.** Farms which we have developed by providing house, barn, well and fencing and in some cases cultivation for sale. Special easy terms.

**\$1000 Loan for Livestock.** In defined districts after one year's occupation under certain conditions, we advance cattle, sheep and hogs to farmers up to a value of \$1000.

**We Want You, We Can Afford to Help You.** We own the land. We want the land cultivated. Our interests are mutual. Buy direct and get your farm home from the Canadian Pacific Railway. Send for free book.



**J. S. DENNIS, Assistant to the President**  
**Canadian Pacific Ry.**  
39 Ninth Avenue  
CALGARY, Alberta, Can.



### Magic Match Box

Open this ingeniously constructed Match Box in the ordinary way, and it is full of matches. Pass it to a friend, and behold! It is **EMPTY**. There is a secret way of doing it, which you must know when you want to make the matches appear. You should get one, for, besides being useful and an endless source of amusement, it is a great conjuring trick. Any small article will disappear or reappear in the most mystifying manner. **BEST NOW!** simple, striking for "satisfaction." **PRICE 25c** (postage 2c extra, 4 for \$1 postpaid). Agents, send for quantity prices. Mail order dealers and beginners furnished with circulars and novelty catalogs (32 or 54 p.)

**JOHNSON SMITH & CO., 7127 N. Clark St., CHICAGO**

## YOUNG MAN! LEARN DRAFTING



**ONE** of the most practical subjects of study today; an essential in most lines of engineering; indispensable in many occupations and often the secret of successful advancement; of no less importance to the farmer than the mechanic. There is bound to come a time when you will feel the need of the ability to "lay out" something in accordance with the rules and conventions used in the drafting profession.

### Individual Study

may be successfully engaged in with the aid of our new enlarged edition of the book

## A Practical Course in Mechanical Drawing

By **WM. F. WILLARD**

(For several years instructor in Mechanical Drawing at Armour Institute of Technology, Chicago)

**160 PAGES — SIZE 5x7 — 157 DRAWINGS — CLOTH COVER**

**Price 50 Cents, Postpaid**

There has been a real need for a book of this kind, as it clinches each problem in the mind of the student by giving the practical application of that problem to every day practice in some phase of the world's work. It meets every modern requirement and is in advance of any other work on the subject. Excellent for use in shop classes, trade or high schools. *A complete detailed description of the contents of this book sent free upon request.*

Order of your Book Dealer or direct from the publishers

**POPULAR MECHANICS BOOK DEPT.**  
6 N. Michigan Ave., CHICAGO

Just Out

## Amateur Mechanics No. 7

**200 Articles**  
**211 Illustrations**  
**128 Pages**  
**Price 25c Postpd.**



(Actual Size 6½ x 9½ in.)

**A few of the many practical things described:**

Mile-O-View Camera — Houses Made of Poles — Houseboat — Pushmobile — Ice Glider — Electric Chime Clock — Basket Ball Game — Musical Doorbell — Snowshoes — Child's Playhouse — Ice Boat and Catamaran — Poultry Coop — Coasting Bobbed — Candy Press Machine — Snowball Maker — Lantern for Spot and Colored Lights — Skating Merry-Go-Round — Skiff — Steering Sled — Photographic Work Table — Skates Made of Wood — Water Meter — Foot Boats — Graining Tools — Roller Skates, etc.

The other numbers of Amateur Mechanics are equally interesting and will be sent postpaid at 25 cents each.

**POPULAR MECHANICS BOOK DEPT.**  
6 N. Michigan Ave., CHICAGO

*image  
not  
available*

# Profitable Repair Work

**A SPLENDID OPPORTUNITY:** Oxy-Acetylene Welding, Cutting and Decarbonizing offers a splendid opportunity to mechanical men for either establishing their own profitable repair business or earning big money working as an operator at this fascinating occupation. Automobile Factories, Garages, Repair Shops, in fact every metal or machinery using industry has need of Imperial Oxy-Acetylene Welding and Cutting Equipment. Any intelligent mechanic can soon become a proficient operator and good welders make big pay and are in constant demand. Why not identify yourself with this process which bids fair to revolutionize manufacturing methods as well as repair work.



## IMPERIAL Oxy-Acetylene Welding and Cutting EQUIPMENT

**An Unlimited Field** The marvelous increase in the use of this process in practically every manufacturing and metal working industry presents an unlimited field for employment at big wages for skilled operators. Master mechanics can save their employers hundreds of dollars every year by repairing costly broken castings and engine and machinery parts or correcting errors made in machining at very slight expense.

**Easy to Operate** Imperial Equipment is easy to operate; any mechanic who carefully follows our simple directions can quickly master the art of welding and cutting by the oxy-acetylene process. Our engineers assist beginners in every possible way. The outfit is portable and can be taken anywhere—always ready to use.

**A Common Error** Do not make the mistake of thinking that "any old make" of equipment is good enough. Remember that you are handling gases at extremely high pressures and that cheap equipment is dangerous and short lived.

No other torch has a mixing principle like the Imperial—scientific, practical, years ahead. No other regular possesses our automatic safety features or so accurately and uniformly controls the delivery of gas. No other torch affords as great a working range with one unit.

Our No. 4 Combination makes it possible to do all kinds of welding, cutting of wrought iron and steel and to remove carbon from gas engine cylinders, all with one compact outfit.

Write today for full data, prices, etc.

Imperial Brass Mfg. Co., 1212 W. Harrison St., Chicago

## Big Money for Live Agents

Marvelous, new Radiosene Lamp—valveless, wickless, smokeless. Burns vaporized kerosene by means of mantle—newly invented process. First of its kind on the market. Gives more light than Tungsten electric bulb from cheapest, safest of fuels—10 cents worth of oil lasts average week.

### RADIOSENE

Simple and reliable to use. Perfectly safe, lighted or extinguished. Gives 100 candle power of white brilliant light—steady and restful to the eye. Splendid money making proposition for agents. Write at once for terms and exclusive territory.

**SUPERIOR MANUFACTURING CO.**  
294 Second St. Ann Arbor, Mich.



\$7.50  
Canadian Price \$9.50



## REDEMOTORS

### 1-2 and 1 H. P. GAS ENGINES

Redemotors are light weight, portable Gas Engines that can be easily carried in one hand from place to place. Develops strong power and used by the thousand for such purposes as running wash machines, sprayers, pumps, electric dynamos, railway speeders, lathes, grain graders, separators, churns. Does all the tiresome chores. Simple carburetor, automatic governor. Send stamp for catalogue J.

ELGIN WHEEL & ENGINE CO., ELGIN, ILLINOIS

## OLD AGE CAUSE AND CURE

Are you feeling the signs of old age—stiffening joints, weak eyes, rheumatic pains, poor memory, loss of mental force, weak digestion, lessening bodily powers? A man, young at 75, has a message of untold value for you! Write for our free booklet—or we will send you instructions, book and magazine. Keep the book five days. If you like it, send us your check for \$2.00 for book and a year's subscription to **Physical Culture Magazine**. If not, return the book only and owe us nothing. Address

**PHYSICAL CULTURE PUB. CO., 2614 Fifth Bldg., New York**



Blitzzen Detector Stand. Holds any crystal, universal adjustment, High grade throughout. Price . . . \$1.00

**CLAPP-EASTHAM CO.** Manufacturers and Distributors  
147 Main Street, Cambridge, Mass.

## DEAL DIRECT WITH THE MANUFACTURER

We will save you time and money. Our new catalog "W" is filled with "up to the minute" wireless apparatus. Our new 112 page "Book of Electrical Apparatus" contains motors, dynamos, parts and materials, meters, lighting plants, storage batteries, phonographs, motion picture cameras, etc., at prices that will positively save you dollars. Both books sent for 6c stamps to cover mailing.



The best made, small Variable Condenser in the world. Glass case, Aluminum plates and base. Price . . . \$4.00





**23 Jewel Movement**

**20 Year Guarantee**

**This Superb Watch SENT FREE**

Get full particulars of our smashing direct price offer. Buy direct—save all middlemen's profits. This masterpiece of watch manufacturing—23 jewels, adjusted to the second, temperature and isochronism. Thin model, guaranteed 20 year gold filled case sent Free on request.

**NO MONEY IN ADVANCE** If you decide to keep it, pay only \$1.80 a month on our confidential inside price. You can easily afford to own a perfect timepiece on our easy payment plan. Get our amazing low direct price to you.

Watches, Diamonds, Jewelry, etc., on the easiest Monthly payments as illustrated in our Catalog De Luxe No. 6.

**A REMARKABLE OFFER** OUR DIAMONDS are absolutely guaranteed and can be returned if not satisfactory. A binding guarantee furnished with each diamond. Exchangeable at any time at an increase of 1% per cent more than you paid.

A postal will bring full details of this great offer. Don't let an opportunity like this slip through your fingers. Write today—NOW.

**L.W. SWEET & COMPANY** Dept. 5, 3 & 4 Maiden Lane NEW YORK CITY  
The World's Greatest Diamond Merchants



**Sharpens Safety Blades Perfectly \$1**

At last the perfect sharpener—the **STAG SHARPENER**

The only sharpener that both hones and stropps all makes of safety blades. Keeps blades in perfect shaving condition. Makes old blades better than new. Surprisingly simple. **Roller** in holder automatically sets blade always at correct honing and stropping angle. **Thumb lock** makes it easy to insert and remove blades. Heavily nickeled holder, barber's hone and stropp in neat box, complete, postpaid \$1.00. Try it 20 days, money back if not satisfactory. Dealers Write for Special Introductory Offer.



**STAG CO.** 30 No. State St. CHICAGO



**INDOOR CLOSET**

**More Comfortable, Healthful and Convenient than the Out-Door Privy**

Eliminates the out-door privy, open vault and cesspool. They are breeding places for germs. Have a warm, sanitary, odorless toilet right in your house. No going out in cold weather. A boon to invalids. Endorsed by State Boards of Health.

W. M. Davis writes: "Your indoor closet is giving absolute satisfaction. It is certainly the thing for a home without sewerage."

**Absolutely Odorless Put It Anywhere in the House**

The germs are killed by a chemical process in water in the container, which you empty once a month. **Absolutely no odor.** No more trouble to empty than dishwater. Closet absolutely guaranteed. Write for full description and price.

**Agents Wanted — Big Profits** Wonderful opportunities in every town, village and in the country. Best season just at hand. Every home is a good prospect. Sell eight out of every ten you call on. Ernest Badnell writes, "Have ten orders." G. A. Dismann says: "Sold at once twenty closets and fifteen washstands. Sold them all in one community." Sell it yourself. Everybody hates the outdoor privy. Everybody wants a Ro-San Indoor Closet. Write quick for territory and full particulars.

**ROWE SANITARY MFG. CO., 412P Sixth St., Detroit, Mich.**  
Ask about the Ro-San Washstand — Hot and Cold Running Water Without Plumbing

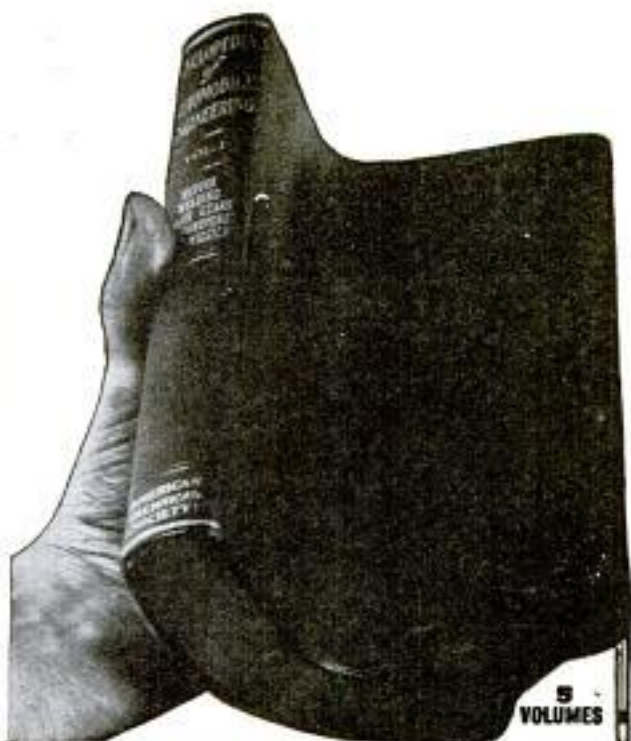

**NEW 1916 EDITION AUTOMOBILE ENGINEERING**

Here is your opportunity to get, at an inside price, a brand new library covering every conceivable motor subject. Here is your chance to secure the most practical, most authoritative set of books ever written on the construction, operation and repairing of motor cars, motorcycles and motor boats. Contains 290 pages alone on ignition, starting and lighting systems.

This five volume auto library, one volume of which is shown above, contains 2,200 pages (15 1/2 by 8 1/2 inches), together with 2,000 illustrations that make technical points as simple as A-B-C; full page plates that literally pick the mechanism to pieces before your very eyes; drawings and diagrams that show the principles employed in various types of motors. Flexibly bound in solid morocco leather, gold stamped. These five volumes are a remarkable value at the regular price of \$25.00, yet we offer a limited number of sets at a special introductory price of \$14.80—payable \$2.00 a month.

**SHIPPED FREE** Test these books before you buy. You don't buy a motor until you have tried it out. Buy books the same way. We send the full 5 volumes to you, express prepaid, for 7 days' free examination. Use them a whole week free. See if they don't help you work out the problems that come up in your garage or repair shop. If the books are what you want, send us \$2. Otherwise we'll take them back, paying the express both ways ourselves.

**Subjects Covered**

- Explosion Motors — Welding Repairs — Gasoline Car Features — Ignition Systems — Lighting Systems — Electric Starters — Electric Pleasure Cars — Storage Cells — Electric Motors — Care and Operation of Electric — Automobile Driving — Road Troubles — Private Garages — Repairs — Electric Delivery Wagons — Electric Trucks — Gasoline Delivery Wagons — Trucks — Taxicabs — Tractors — Trailers — Road Trains — Traction Engines — Maintenance and Costs — Steam Cars — Motorcycles — Motor Boats — Glossary of Automobile Terms.

**FREE !! \$12.00 Consulting Membership**

We give you absolutely free our \$12 consulting membership. This privilege puts our whole staff of experts at your service for a whole year without cost to you. Ask them any motor question you want. They will give you practical help. The solution of a single problem might easily be worth more than what you pay for the books—you get this service free.

The moment you see the books you will realize that you need them. There is no limit to the good they can do you every day. It costs you nothing to look them over, to use them for a whole week. You run no risk, you incur no obligation. The books come back at our expense if you say so. Send in the coupon now—today.

**FREE COUPON**

**Worth \$10.20 to You**  
**American Technical Society**  
Chicago, U. S. A.

Please send me the Cyclopaedia of Automobile Engineering for 7 days' free examination. If I decide to buy, will send \$3 in 7 days and balance \$2 a month until \$14.80 has been paid, when \$25 books and \$12 consulting membership will be mine free. Otherwise will notify you and hold books subject to your order. Title not to pass until fully paid. Pop. Mech. 4-16

**AMERICAN TECHNICAL SOCIETY**  
Chicago, U. S. A.

NAME .....

ADDRESS .....

As I have had no previous dealings with you, I refer you to .....



**SENT ON APPROVAL ANYWHERE**

Diamond Cutter at work

**WRITE FOR BIG CATALOG-FREE**

14KT SOLID GOLD MOUNTINGS FREE.

# GENUINE DIAMONDS

**DIRECT FROM THE DIAMOND CUTTERS TO YOU BY MAIL**

For the first time in the history of the diamond business, it is now possible for the public to buy diamonds direct from the importers and cutters at rock bottom wholesale prices. By dealing with this noted house of diamond cutters, established 25 years, you save fully 40 per cent. Don't be skeptical because our prices are so amazingly low. Realize that dissatisfaction is an impossibility, because we guarantee to refund the full purchase price any time within a year—no deduction for mountings or anything—you get back every penny you paid. The values we offer in our magnificent 176-page catalog are creating a profound sensation all over the United States. Write for it today.

14 kt. Solid Gold 23 Jewel Adjusted \$11.75

17 Jewel \$9.75

7 Jewel \$7.75

**THIS MONTH'S SPECIALS: WATCHES**

14 kt. Solid Gold 23 Jewel Adjusted \$11.75	GOLD Filled 21 Jewel \$4.75	15 Jewel \$3.98	7 Jewel \$2.75
---	-----------------------------	-----------------	----------------

If you were in the jewelry business yourself, you could not buy watches at lower prices than those listed in our catalog. All standard makes at enormous savings. Write for it NOW.

<b>\$39.00</b> <sup>00</sup> CARAT	<b>\$50.00</b> <sup>00</sup> CARAT	<b>\$70.00</b> <sup>00</sup> CARAT	<b>\$85.00</b> <sup>00</sup> CARAT
1/4 carat Rings—\$ 4.88	1/4 car. Rings \$12.50	3/4 car. Rings \$52.00	1 car. Rings \$ 85.00
3/8 carat Rings— 9.75	1/2 car. Rings 25.00	1 1/4 car. Rings 87.50	1 3/4 car. Rings 148.75
1/2 carat Rings— 14.63	3/4 car. Rings 37.50	1 3/4 car. Rings 122.00	2 1/2 car. Rings 212.50

**MONEY BACK IN FULL ANY TIME WITHIN ONE YEAR-NO DEDUCTIONS**



These prices include any two engraved letters you wish. These rings are for ladies and gentlemen. State ring size.

STERLING Silver 48c

10 Karat Solid Gold \$1.98

14 Karat Solid Gold \$2.75

**I-PRESS & SONS**  
IMPORTERS & CUTTERS OF DIAMONDS  
WHOLESALE JEWELERS  
825 CHESTNUT ST., PHILADELPHIA, PA.

## Hartman Will Trust You

### Rock Bottom Prices

Furniture, Carpets, Rugs, Etc.

**Easiest Terms** Hartman's credit terms easiest, most liberal ever offered. No security—no notes—no mortgage. Free from all obligations. At the end of a month you may return anything unsatisfactory. Hartman refunds your money including freight.

**30 Days Approval** Over 5,000 bargains. Write today for FREE copy.

**FREE-Big Bargain Book**

**HARTMAN FURNITURE AND CARPET CO.**  
3945-47 Wentworth Av., Chicago



## Stop Making Mistakes

### Ropp's Calculator

Figures out, in the twinkling of an eye, every conceivable problem that occurs in the Office, Store, Shop, Bank, Farm or Factory. Greatest time and labor-saving work on figures in the world. Edition of 1912 vastly improved. Three different sizes.

Prices \$1.25, \$1.00, and 50c.

Popular Mechanics Book Dept., CHICAGO

## Home Builders

Write quick for Wonderful Building Book of Expert Architect's Plans. Shows how to save 1-3 labor bill, eliminate material waste and buy building materials at amazingly low prices. Explains wonderful two-years-to-pay credit plan. Send 10c for postage.

International Mill & Timber Co., Dept. P. M. 4, Bay City, Mich.

## FREE Glove Book

Send for free copy of "Glove Styles" showing the very latest Grinnell Gloves.

Morrison-Ricker Mfg. Co., 141 Broad St., Grinnell, Ia.



## GREEN AUTOMATIC MACHINE

### LARGE PROFITS FROM SMALL CAPITAL

Start a business of your own bringing an income of \$5 to \$10 a day with practically no experience or overhead expense.

## The GREEN AUTOMATIC MACHINE

Sharpens, Honors, and Strops all kinds of safety razor blades, in one operation, from four to six blades per minute. For both Quality and Quantity this machine is in a class by itself. There is nothing like it on the market. Let us send you our free booklet explaining everything, including the "AMERICAN" Key Cutter—cuts square, angular or round slots.

AMERICAN SHARPENING MACHINE CO. (Inc.), Dept. 4, 184 W. Washington St., CHICAGO



# Germany Wanted 100,000

## For Use in the Trenches

### This \$2.25 Flashlight, Postpaid for \$1

We made them, but as you know, could not make delivery. Now we are commissioned to sell this special \$2.25 gun metal case Flashlight fitted with Mazda Lamp and battery that can't short-circuit, postpaid for \$1. They will not last long at this price. Send your dollar today.

**DETROIT FLASHLIGHT CO., Dept. B, DETROIT, MICH.**



# 7 Cents a Day Buys This Standard Visible Oliver Typewriter



## Sensational Reduction

Our enormous purchasing power, tremendous output and the simplicity of our methods make this truly remarkable saving to you possible. Such an offer needs no high-priced salesman; no collectors. We are willing to let the typewriter do the talking and sell itself. We know from experience that a satisfied customer will pay. The simple coupon tells the story. Sign it and we will ship you one of the splendid machines—perfect in every detail. If it is not what you expected, if it fails to please you in any way, if you are not satisfied that it is the greatest bargain you were ever offered, get your money back. Read the coupon.

## Much Less Than Half Price FREE Trial—10 Year Guarantee

This is positively the best typewriter offer ever made. The typewriter is the genuine Model No. 5 Standard Visible Oliver, with complete and brand new equipment. Perfect machines only. Not shop worn, not damaged, inferior in no way. Back Spacer, Tabulator, Disappearing Indicator, not a feature lacking. Equal in quality in every respect to the \$100 article.

This amazing offer is not on some ancient style of blind typewriter, but on the wonderful Model 5 Oliver, the kind thousands of the world's best business firms are using today.

## Trial Order Coupon

UNITED STATES TYPEWRITER EXCHANGE  
Dept. 348, All-Light Building, Chicago, Ill.

Send me by express a No. 5 Oliver Typewriter on approval. I will leave \$3.80 with the express agent when I get the machine, the same to be returned to me in full if I return the typewriter within 10 days. If I keep it, the \$3.80 will apply on the purchase price of \$39.80, and I will pay the balance of \$36 in 18 consecutive monthly payments of \$2 each, commencing 1 month from delivery, title to the typewriter to remain in you until it is totally paid for. (342)

Name..... Address.....

Two References.....

Twenty-five thousand women are now regularly employed on the railroads of France.

## KEROSENE Gas Lamps

**Make Your Business Prosperous and Your Home Cheerful**

by using our "Safety" Kerosene and Gasoline Gas Lamps. If we are not represented in your town we want an agent.

**BRILLIANT GAS LAMP CO.**  
1009X So. Wabash Ave., CHICAGO, ILL.

## FREE TRIAL

Use the **FAMOUS KARNAK RAZOR** for 30 days FREE; then pay us \$1.85, or return the razor. Send your name and this ad. (no money) and get razor by return mail. **MORE COMPANY, 182 More Bldg., ST. LOUIS, MO.**

# Deaf?



The day of imperfect hearing is past. Science rivals nature in the marvelous new 1916 Mears Ear Phone, "Intensitone" model—the world's greatest hearing device. It transmits sound without blur. Write today for our 15 days' free trial offer.

### Perfect Aid to Hearing

The Mears is the only scientific instrument for the deaf. It marvelously covers 26 degrees of sound, every range of tone of the human ear.

**Write for Free Book** Our free book is a highly valuable treatise on deafness, trial offer and low direct laboratory prices. If convenient to New York call for demonstration.

**FREE Book**

**MEARS EAR PHONE CO., Inc.**  
Desk 1191, 45 W. 34th St., New York



## True, Tight Pipe-Joints WITH

### OSTER-CUT THREADS

WHATEVER sort of pipe-threading you do, one of the 47 tools in the Oster line will do it quickly, easily and accurately. In over 40 trades men are making bigger profits through the use of Oster Die-Stocks and Power Machines. Find out how they fit *your* needs. If you haven't the Oster catalog, the coupon will bring it to you free by return mail. It is complete with illustrations, descriptions and prices.

**THE OSTER MFG. CO.** 2100 E. 61st St. Cleveland, Ohio

47 distinct hand, tripod, belt and motor tools

Please send me by return mail the free Oster Catalog.



NAME.....  
COMPANY.....  
ADDRESS.....  
CITY.....  
STATE..... (2100)

Please Mention Popular Mechanics



To Test the Toughness of

# VITALIC TRADE MARK TIRES

For Bicycles

Hold a Vitalic sample section in one hand, squeezing the sides part way together so you can press heavily against the tread with the point of a knife. See how long it takes to work your knife blade through the tire. Some job! Notice what a stubborn fight the live rubber puts up against it.

That's because it's real rubber of high quality, instead of the heavily compounded lower grade rubber that goes into cheaper tires. And there are two plies of genuine motorcycle fabric instead of the fabric that is put in ordinary tires.

A tire like that costs a little more but it outwears cheaper tires more than two to one.

Write for folder "From Boston to San Francisco on one set of Tires." Told by the man who rode the bicycle.

Continental Rubber Works  
1964 Liberty St., Erie, Pa.



Starter

Starts It

Pulling this Strap Starts It.

Simply pull a handle. The coil starter on the flywheel does the rest. No more cranking. Eliminates blistered hands, aching arms and back. The

**CAILLE 5 Speed Motor**

Attaches to any rowboat in a jiffy. Runs 7 to 10 miles an hour. Has five speed adjustments—high speed, trolling speed, neutral, slow and fast reverse. Speed changes made without stopping, reversing or altering motor speed.

Details in Catalog No. 10

Dealers wanted. Catalog No. 24 covers Inboard Motors to 30 h. p.

The Caille Perfection Motor Co.  
1523 Caille St., Detroit, Mich.

## SOLID GOLD MIDGET BUTTONS

50c 50c

All societies, also Pins, Buttons, Rings, Charms. Agents wanted.  
P. M. STANLEY, 45 CORNHILL, BOSTON, MASS.

## 10-Second Balihone

Sharpen your razor in 10 seconds with a Balihone—ordinary or safety blade. Special offer. Balihone sent prepaid on 30 days' free trial, only \$1. Money back if not pleased. Safety blade holder 25c. Send today.

BALIHONE CO., Dept. 5248, Wilmette, Ill.

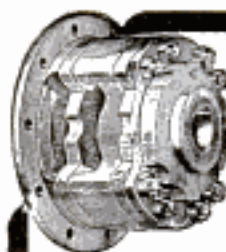

## Pull Easily Through the Bad Spring Roads

You get the maximum of power; you abolish skidding, slipping and sideways; you save money on fuel, oil and tires—when you equip your car with the

### BAILEY Gearless Differential

Thousands in use—every one sold on a 30-day money-back offer. You'd hardly know it was the same car—try it and see. See dealer, or write for circular.

Ford, Overland and Chevrolet 490 Replacements Now Ready.

Gearless Differential Co., 892 Woodward Ave., Detroit, Mich.

## Private Weather Bureau

IN EVERY HOME  
A Reliable Barometer  
An Accurate Thermometer

Actual Size 13 Inches High

Indispensable to the farmer, business man, professional man, automobilist, in fact, to everybody who should know in advance what the weather will be. Will save you money and time.

FORECASTS WEATHER

## WEATHEROMETER

HOURS IN ADVANCE

\$1.00 ONLY — Reduced from \$3.00

Send us no money. Mail your order today and Weatherometer will be sent to you C. O. D. (10c extra). If you prefer you may enclose \$1.00 bill or money order with order. Satisfaction guaranteed.

This Instrument Inspired Makes an Excellent Advertising Article  
WITHINGTON INSTRUMENT CO.  
5 South Wabash Avenue, Dept. 24, CHICAGO



## DIAMONDS ON CREDIT

EIGHT MONTHS TO PAY  
Wear a Fine Diamond while paying for it on our easy terms of 20% DOWN — 10% A MONTH

Sent on approval, all charges prepaid. No Obligation to Buy. No Security Required. Transactions Strictly Confidential. Guarantee Certificate with each Diamond and full credit allowed on exchange. 10 per cent Discount for all cash. Write today for BIG FREE CATALOGUE No. 5. It shows 4,000 illustrations—Diamonds, Watches, Jewelry, Gems, Silverware and countless fascinating articles. Dept. A, 37-39 MAIDEN LANE, ESTAB. 1896 NEW YORK CITY

## WATCHES ON CREDIT

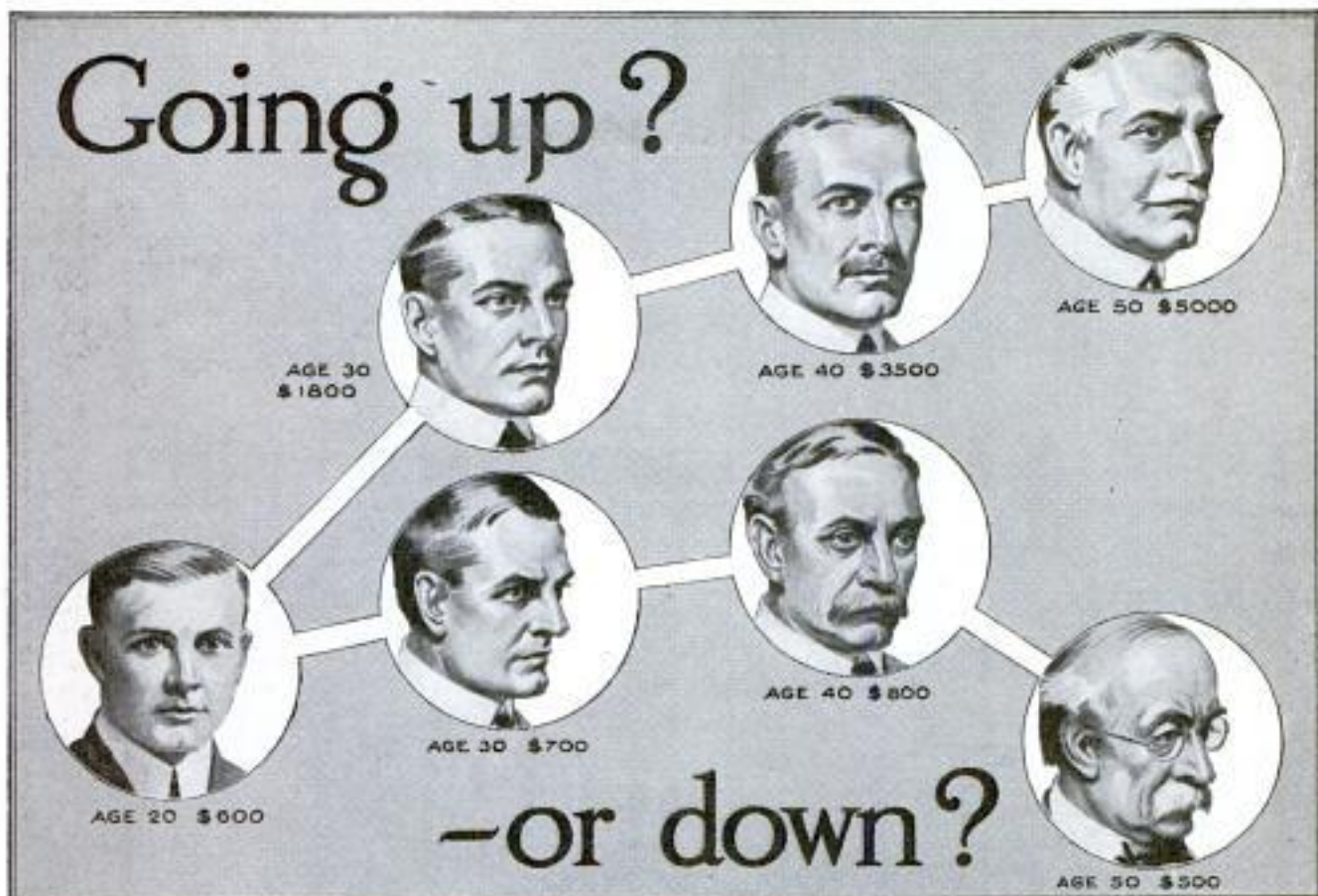

**H**ERE is your future charted for you, based on the actual average earnings of trained and untrained men.

Which way will you go? You'll either go *up*, through *training*, to a position that means good money and more comforts as the years go by, or you'll go *down*, through *lack* of training, into the ranks of the poorly paid.

It rests entirely with you which way you go. You can make or break your own future. And *now* is the time to decide. Not next year, not next month, but *now*. You can go up if you want to. You can get the training that will command a trained man's salary. The International Correspondence Schools have helped hundreds of thousands of men to qualify for advancement. Let them show you how you can prepare yourself, in your own home, for the position you want in the work you like best.

At least, *find out* what the I. C. S. can do for you, by marking and mailing this coupon. It will be the first step upward. Choose your future from this list, then get this coupon into the mail today.

INTERNATIONAL CORRESPONDENCE SCHOOLS  
Box 5501, Scranton, Pa.

OUT OUT HERE  
**INTERNATIONAL CORRESPONDENCE SCHOOLS**  
Box 5501, SCRANTON, PA.

Explain, without obligating me, how I can qualify for the position, or in the subject, before which I mark X.

- |   |  |
|---|--|
| <input type="checkbox"/> ELECTRICAL ENGINEER        | <input type="checkbox"/> ADVERTISING MAN           |
| <input type="checkbox"/> Electric Lighting          | <input type="checkbox"/> Window Trimmer            |
| <input type="checkbox"/> Electric Car Running       | <input type="checkbox"/> Show Card Writer          |
| <input type="checkbox"/> Electric Wiring            | <input type="checkbox"/> Outdoor Sign Painter      |
| <input type="checkbox"/> Telephone Expert           | <input type="checkbox"/> ILLUSTRATOR               |
| <input type="checkbox"/> MECHANICAL ENGINEER        | <input type="checkbox"/> DESIGNER                  |
| <input type="checkbox"/> Mechanical Draftsman       | <input type="checkbox"/> BOOKKEEPER                |
| <input type="checkbox"/> Machine Shop Practice      | <input type="checkbox"/> Stenographer and Typist   |
| <input type="checkbox"/> Gas Engineer               | <input type="checkbox"/> Cert. Public Accountant   |
| <input type="checkbox"/> CIVIL ENGINEER             | <input type="checkbox"/> Railway Accountant        |
| <input type="checkbox"/> Surveying and Mapping      | <input type="checkbox"/> Commercial Law            |
| <input type="checkbox"/> MINE FOREMAN OR ENGINEER   | <input type="checkbox"/> GOOD ENGLISH              |
| <input type="checkbox"/> Metallurgist or Prospector | <input type="checkbox"/> Teacher                   |
| <input type="checkbox"/> STATIONARY ENGINEER        | <input type="checkbox"/> Common School Subjects    |
| <input type="checkbox"/> Marine Engineer            | <input type="checkbox"/> CIVIL SERVICE             |
| <input type="checkbox"/> ARCHITECT                  | <input type="checkbox"/> Railway Mail Clerk        |
| <input type="checkbox"/> Contractor and Builder     | <input type="checkbox"/> AGRICULTURE               |
| <input type="checkbox"/> Architectural Draftsman    | <input type="checkbox"/> POULTRY RAISING           |
| <input type="checkbox"/> Concrete Builder           | <input type="checkbox"/> Textile Overseer or Supt. |
| <input type="checkbox"/> Structural Engineer        | <input type="checkbox"/> Navigator                 |
| <input type="checkbox"/> PLUMBING AND HEATING       | <input type="checkbox"/> Chemist                   |
| <input type="checkbox"/> Sheet Metal Worker         | <input type="checkbox"/> AUTO RUNNING              |
| <input type="checkbox"/> SALESMANSHIP               | <input type="checkbox"/> Auto Repairing            |
|   | <input type="checkbox"/> Spanish                   |
|   | <input type="checkbox"/> German                    |
|   | <input type="checkbox"/> French                    |
|   | <input type="checkbox"/> Italian                   |

Name \_\_\_\_\_  
Occupation  
& Employer \_\_\_\_\_  
Street  
and No. \_\_\_\_\_  
City \_\_\_\_\_ State \_\_\_\_\_

Please Mention Popular Mechanics



4-38

**\$750**

f. o. b. factory

**Briscoe**

114-inch wheelbase;  
Briscoe-line body;  
powerful, economical,  
long-stroke motor;  
cantilever rear springs;  
full equipment.

## You'll Like the Briscoe, Too

The Briscoe is today the best-liked car in the country. Three things have combined to make it so.

**The Man** Benjamin Briscoe is recognized as one of the foremost designers in the industry, and one of the few who combine mechanical and artistic training. That means an **efficient** car, and a **beautiful** car as well.

**The Factory** The Briscoe factory is today second to none in equipment. The six great plants at Jackson contain over a million dollars' worth of special machinery. That means **economy**.

**The Company** A \$6,000,000 company, with practically unlimited financial resources, is straining every nerve to make the automobile value of a dollar greater under the Briscoe name than anywhere else. That means **value**.

Briscoe Eight 38—same body and specifications as Four 38, but with Briscoe special Eight-cylinder power-plant—\$950.

**Briscoe "The Latest Briscoe Beauty" \$585**  
Twenty-four Electric starting and lighting; full equipment. f. o. b. factory

Here's a hundred percent car for the average citizen. Beautiful, as all Briscoe models are. Fully equipped—one-man top, electric starting and lighting, electric horn, speedometer, demountable rims. Comfortable—four full elliptic springs, sofa-type seat springs, extra leg and body-room. Power—the same economical long-stroke  $3\frac{1}{8} \times 5\frac{1}{2}$  motor that was famous in the 1915 Briscoe at \$785.

**Write today** and we'll tell you where you can see the car—and at the same time send you your free copy of an interesting folder.

**Briscoe Motor Corporation**  
117 Wildwood Ave., Jackson, Mich.  
The Canadian Briscoe Motor Company, Limited  
Brockville, Ontario



*Unless you've "money to burn," you'll find your car in the Briscoe line.*

Please Mention Popular Mechanics

# A New Bicycle Thrill

**A**WAY at the touch of your thumb-lever! Safe, care-free, clean! No pedal work! Over boulevards or country lanes—anywhere your bicycle would take you!

That's Motor Wheeling—the new route to pleasure and business—and the cost is trifling.

The Smith Motor Wheel attaches in five minutes to any bicycle and two easy pedal turns

*Smith* Motor Wheel  
DETACHABLE

summon the power. Then your thumb-lever controls. The hardy

motor will urge you on at any speed from four miles to twenty, and one gallon of gasoline yields up to 125 miles.

You go when and where you wish and you dress as you will, for there is no grease or dirt. Your first short ride reveals the pleasure secret which more than 10,000 already know and you will make that pleasure your own.

See your dealer today or write for book "Motor-Wheeling"

MOTOR WHEEL DIVISION

A. O. SMITH COMPANY,  
Milwaukee, Wisconsin

*World's Largest Manufacturers of Automobile Parts*

Dealers: A few exclusive territories are still open. Write for particulars.

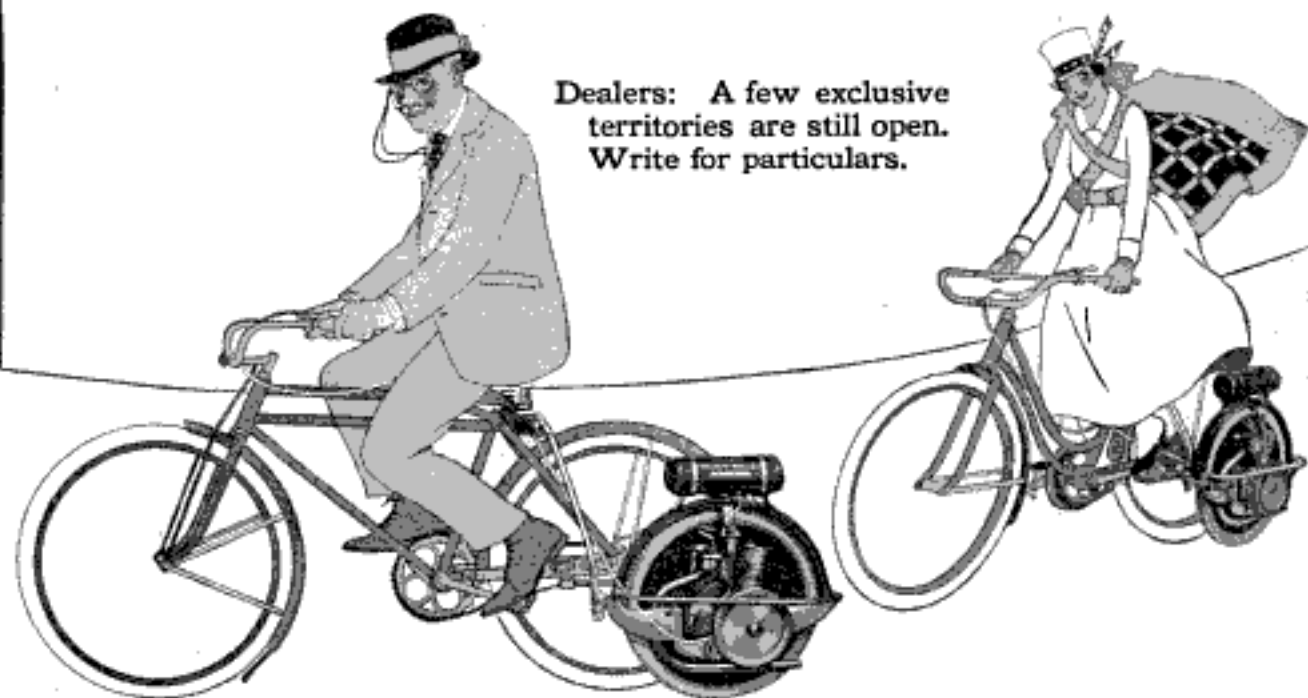

Please Mention Popular Mechanics

# Easy to own this good engine now

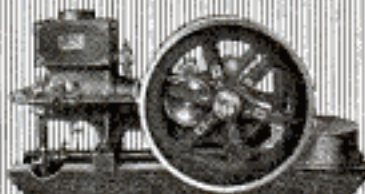

Send for my new, money-saving offer, before you arrange to try any engine, for any price. Compare my engine with any other, consider my low prices — (easy terms, if you wish), and you will see your advantage in having one of my

## BAUER ENGINES

### Kerosene, Gasoline, Distillate, Gas

Sizes, 2, 3, 5, 7, 9, 12, 15, and 18 horsepower. Now sold only direct from my own factory at prices averaging under \$16.50 per H. P. All sizes are of the up-to-date, long-stroke, valves-in-head, even speed type of engine. You can more intelligently select your engine after you have studied my engine book and my newest offer.

### Guaranteed 5 Years Sold Direct from Factory to User

Over 21 years ago I made my first engine with my own hands, and the many thousands I have since made by their record of easy usefulness and great durability, prove that you take no risk when you get a BAUER engine.

### Write for My Free Book

Send me your full address, now, so I can send you by return mail, my free book, which fully explains my engines, and shows how easy you can own a good engine, for a live-and-let-live price. Send the coupon or write me today.

**A. F. BAUER  
ENGINE CO.**

476 Bauer Block  
KANSAS CITY, MO.

Gentlemen:— Please send me without obligation on my part, your Free book and latest offer.

**A. F. Bauer  
Engine Co.**

476 Bauer Block  
Kansas City, Mo.

Name.....  
Address.....  
City..... State.....

Please Mention Popular Mechanics



## The Right Delivery Body for your Ford

Highland standard bodies are built by men who have been studying delivery problems for years. They give you the maximum of load space with the minimum of strain. They are sturdy, durable, stylish. There are no better bodies — and thousands of owners tell us that, judged by the test of service, there are no cheaper ones.

### Larger Bodies, Too

For larger trucks there is also a full line of standard Highland bodies — each the best that experience can build for its particular work. Many leading truck-makers prefer to sell Highland bodies — they know that the quality's there.

It will pay you to insist on a Highland body when buying any truck.

### "Body Blows"—Sent Free

Write for it—it's full of meat about body-building, good and bad.

Tell us the body you're interested in and we'll be glad to send photographs of the standard Highland that fills the bill.

### The Highland Body Mfg. Company

402 Elmwood Place Cincinnati, Ohio

DEALERS—The demand for Highland standard advertised commercial bodies is country-wide, and increasing. Write for our dealer proposition.



# DEAF? "I Now Hear Clearly"

## You, Too, Can Hear!

Inasmuch as 200,000 users of the "ACOUSTICON" have had the same results from it as Mr. Garrett Brown, whose photo appears above, we feel perfectly safe in urging every deaf person, without a penny of expense, solely and entirely at our risk, to accept a thorough trial of the

# 1916 Acousticon

No Deposit **FREE** No Expense

All you need do is to write saying that you are deaf and will try the "ACOUSTICON." The trial will not cost you one cent, for we even pay delivery charges.

**WARNING!** There is no good reason why everyone should not make as liberal a trial offer as we do, so do not send money for any instrument for the deaf until you have tried it.

The "ACOUSTICON" has improvements and patented features which cannot be duplicated, so no matter what you have tried in the past, send for your free trial of the "ACOUSTICON" today and convince yourself — you alone to decide. Address

**GENERAL ACOUSTIC CO., 1307 Candler Bldg., NEW YORK**  
Toronto, Ont., Office, Royal Bank Bldg.





# 5 DAYS' FREE TRIAL

That's all there is to the proposition we make you on the **SPLENDID, GENUINE**

**Underwood** Latest Style **\$58<sup>50</sup>**  
Standard Back Spacer  
**Visible Typewriter**

Don't send a cent, just write us if you want to take advantage of our five days' free trial offer. No deposit is required. All we want is your permission to send you one of these machines on approval. The machine must then sell itself. The decision rests entirely with you.

You have never seen such typewriter value as we are offering in these Underwood machines. If we were to tell you how good they are you would say we were exaggerating. So we want you to see and use one right in your own office. That's the reason we are making, and can make, this five days' free trial offer.

If you like it send us only four dollars a month. But you pay not one cent till you have seen and used the machine for five days!

This machine we are offering is not the old style Model No. 4, but the latest style Underwood typewriter with the **Back Spacer** (the greatest improvement in typewriting since visible writing was introduced); this machine also has the two-color ribbon, the automatic ribbon movement, in fact every late style feature and improvement of this famous and most popular typewriter. Over one million of them have been manufactured and sold.

Every machine is complete with waterproof cover, tools, instruction book, etc. Remember, these machines are guaranteed to be absolutely perfect. They are guaranteed for one year, which is as long as any guarantee. And they are shipped anywhere on approval, without deposit, subject to five days' free trial and examination in your own home or office.

If you find the slightest thing to criticize, if you think you can get better value elsewhere for your money—return the machine at our expense. Surely no fairer offer could be made. And, bear in mind, this liberal proposition is made on the Underwood, the acknowledged leader of visible writers, of which over 10,000 are sold every month. And if you are renting a typewriter you can, by paying us a little more each month, own one of these high-grade, standard visible writers in a short time. Just think of it! A few cents a day for ten months and one of these typewriters is yours!

**SPECIAL!** No. 3 Model Underwood with 14-inch carriage, the regular way-bill machine with standard pica type, at a special low price of \$65.00—\$5.00 down, and \$5.00 a month, or less 6% for cash.

Fill out the coupon and mail it today. You take no chances. If the machine is not the greatest value you ever saw, just send it back at our expense. **ACT NOW**, as we have only a limited number of machines, and they will go like hot cakes on this wonderful offer. When you write, just give us the names of two or three people who know you, merely as an evidence of good faith, etc.

**TYPEWRITER INST. COMPANY, 229 No. Wells St., CHICAGO**

### FREE TRIAL ORDER BLANK

Typewriter Inst. Co., 229 No. Wells St., Chicago

Gentlemen—Please ship me a No. 4 Underwood Typewriter, P. O. B. Chicago, per your Ad. in Popular Mechanics Magazine. I will either accept the typewriter within five days of its receipt, or I will return same to you at your expense. If I accept the typewriter I will remit \$8.50 within the five days and pay the balance in monthly installments of four dollars each until the price \$58.50 has been paid. Title of machine to remain in your name until machine is fully paid for. **Cash price, 6% off, or \$55.00 cash.**

Name..... Address.....

References Required.....

## Take Lunch in the Woods

The greatest chef in the world could not furnish you a more appetizing luncheon than you can enjoy at will on your outing trips if you carry your lunch and drinkables in a

# HAWKEYE

## Basket Refrigerator

Three quarters of the non-rusting, nickel plated interior of the basket is for the storing of food and drink with a compartment to accommodate a small lump of ice that will keep the basket's contents fresh, clean and cool for 36 hours. Add to the joy of motoring by adding a Hawkeye Basket to your summer equipment. Handsome—cleanly—durable—light-weight—ultra-useful. Priced as low as \$4.00. 30 days' free trial.

Write for Booklet 21 and name of nearest dealer

**Burlington Basket Company**  
Burlington, Iowa

We Want More Dealers



## A BOOK OF NEW MISSION FURNITURE DESIGNS



### Part 3—Mission Furniture HOW TO MAKE IT

A 128 page collection of 36 excellent new designs that have never before been published and that are entirely different from those in the books Parts One and Two previously issued.

Handsome Cloth Binding

Price 50c Postpaid

This new number has just been published and those already in possession of Parts One and Two will find this an even greater value in variety and excellence of the plans.

A feature of the New Book is a

### Complete Set of Dining-Room Furniture

Designed to Harmonize Perfectly

If you are at all handy with tools, you will find that the plainly written directions, dimension drawings and half-tone illustrations will enable you to

### Make Your Own Furniture and Save Two-Thirds

The many who use tools for pleasure will find this book a working guide which will furnish many moments of delightful and profitable occupation while several of our readers have been able to devote their entire time to this work by disposing of what they have made at a nice profit. One man made and sold \$400 worth of one piece alone.

Parts One and Two in this series are also 50 cents each postpaid

Ask Your Book Dealer or Address the Publishers

**POPULAR MECHANICS BOOK DEPT.**  
6 N. Michigan Ave. CHICAGO

# NOW a \$10 Vacuum Cleaner that Really Cleans

Here is a real suction Vacuum Cleaner. Works on the same principle as an electric machine, but needs no electric current—cleans with the same thoroughness and efficiency. Can be used anywhere at any time. No heavy weight to carry—aluminum construction. No awkward electric cord to attach or to become tangled in furniture or fixtures.

## Whirlwind Vacuum Cleaner

An absolutely new idea in vacuum cleaners. No effort required. Sliding handle converts natural operating movement of arms into power which whirls suction fan at 2500 r.p.m. A child can operate it with ease. Cleans rugs, carpets, floors, overstuffed furniture, curtains, draperies. Our liberal trial offer enables you to use the Whirlwind 30 days in your own home—with your order remit \$2.00—test the Whirlwind thoroughly for 10 days; if not entirely satisfied return it to us express collect and your money will be refunded immediately. If you are pleased in every way send the additional \$5.00 and the Whirlwind is yours. Remember—we pay express both ways, so you run no risk whatever. Give us an order today.

Agents & Dealers  
Write for Prices

A. E. JENNINGS CO.  
425 Detroit Street  
ANN ARBOR, MICH.

**\$10**

First cost  
is the  
only cost

## LITHOGRAPHIC MODELS

SIZE  
10 x 14  
INCHES

IN  
COLORS

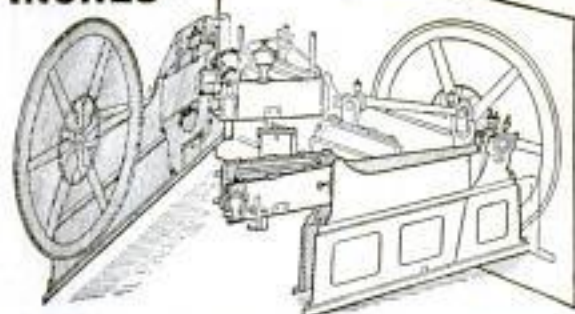

of the following: Mallet Compound Locomotive—Atlantic Type Locomotive—Automobile—Steamship—Steam Engine—Steam Turbine—Dynamo—Gas Engine—Wireless Telegraph.

As shown in the illustration these models are like a dissected chart of the human body, and open by means of a series of flaps which show every part of the machine for purposes of study. Each part is numbered and the name given. They are ingeniously made, accurate and show every detail; educational and worth many times their cost.

Price 50 Cents Each

or \$4.00 for complete set of nine subjects, prepaid

**Popular Mechanics Book Dept.**  
6 N. Michigan Ave., CHICAGO

# No Money In Advance

## This Marvelous CAMERA ON FREE TRIAL

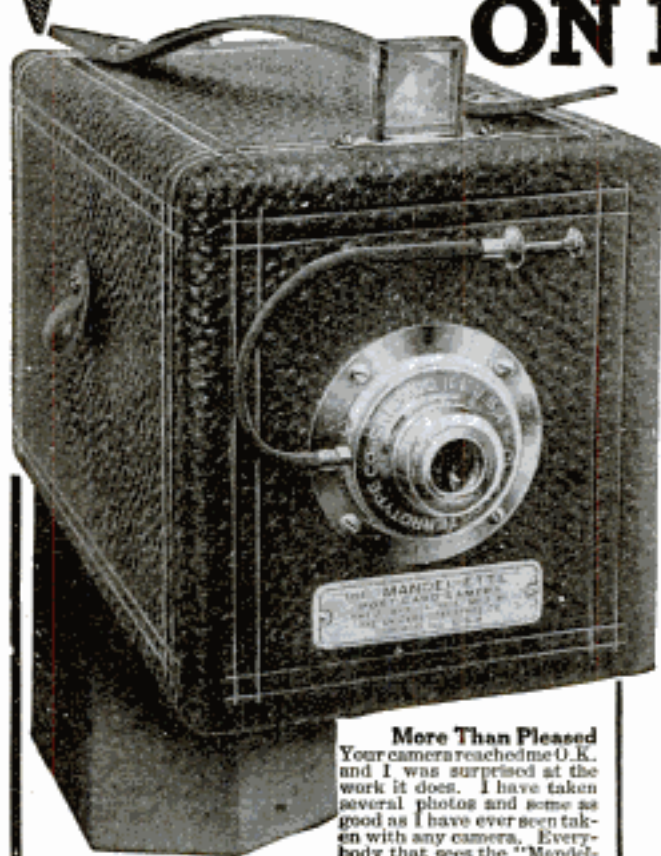

Only 10,000 of these marvelous instantaneous picture-taking and making cameras to be sent out absolutely on approval without a penny in advance just to prove that it is the most wonderful invention—the camera sensation of the age. So you must send for it quick! Just think of it—the new Mandel-ette

### Takes and Makes Finished Pictures INSTANTLY!

You press the button, drop card in developer and in one minute take out a perfect, finished post card photo  $2\frac{1}{2} \times 3\frac{1}{2}$  inches in size. Camera is about  $4\frac{1}{2} \times 5 \times 7$  inches. Loads in daylight 16 to 50 post-cards at one time.

### No Films—No Plates—No Dark Room

Not a bit of the muss and bother of the ordinary kodak or camera. It is instantaneous photography! Universal focus lens produces sharp pictures at all distances. Pictures develop and print automatically. Can't over-develop. Results positively amazing.

## We Trust You

No difference who you are, where you live or what your age, we will send you the complete "Mandel-ette" outfit absolutely on approval and give you 10 days to test it. But when you see what elegant pictures it takes—so quick, so easy, with no trouble at all—if you wish to keep it you simply send us \$1.00 per month until our special price of only \$5.00 is paid.

### Easy Payments—No References

No red tape of anykind. Monthly payments so small you'll not notice them. Simply fill out and mail coupon today. Send no money. No references required. Lots of fun—big profits.

**Chicago Ferrottype Co.,**  
Desk 252 Ferrottype Building,  
Chicago, Illinois

Send me at once one complete model Mandel-ette Camera outfit including supply of postcards and instructions. I agree to examine and test it thoroughly and if satisfied keep it and pay you \$1.00 a month until your special price of \$5.00 is paid. Otherwise I will return it at the end of 10 days.

Name.....

Address.....

Town.....State.....

### Anyone Can Use Them

Received the "Mandel-ette" and supplies Saturday evening. Sunday morning we began to take pictures and had very good luck. It is sure simple enough. Anyone can use them. We couldn't get along without ours.

MRS. R. U. IDINGS,  
Mapleton, Ia.

### Amazed At Minute Camera

I am enclosing pictures taken with my "Mandel-ette" to show you gentlemen what I am making. Nobody taught me but your instructions. I am making pictures with great pleasure and my friends are amazed at your very high grade minute camera.

C. SATURM,  
Santa Ana, Alaska

### More Than Pleased

Your camera reached me U.K. and I was surprised at the work it does. I have taken several photos and some as good as I have ever seen taken with any camera. Everybody that sees the "Mandel-ette" says it is fine and I am more than pleased with it.

VERNIE BOYLE,  
Northome, Minn.

### Beats All Things Yet

The "Mandel-ette" received and opened and in 20 minutes I took a splendid picture of my wife, fully developed and ready to look at. My, this beats all things yet.

T. J. HOUTS, Pastor,  
Methodist Episcopal Church,  
South, Welch, West Va.

### Takes Pictures On Dark Day

I am perfectly delighted with the "Mandel-ette." I have had very good success never before to have handled a camera at all. I can say it will do all you claim. I have taken a picture which shows a Mt. more than 4,000 feet away and on a very dark day.

JAS. H. HUBBARD,  
Penhook, Va.

## No Experience Required

Plain instructions and everything complete with outfit so you can begin taking pictures the moment it arrives. We guarantee that even a child can operate it. Mail coupon now. No risk or obligation to keep camera.

**Chicago Ferrottype Co.,** Desk 252 Ferrottype Bldg.,  
Chicago, Illinois

Please Mention Popular Mechanics

# The Burlington SMASHES ALL WATCH PRICES



## Look!

- ☞ 19 Ruby and Sapphire Jewels—
- ☞ Adjusted to the second—
- ☞ Adjusted to temperature—
- ☞ Adjusted to isochronism—
- ☞ Adjusted to positions—
- ☞ 25-year gold strata case—
- ☞ Genuine Montgomery Railroad Dial—
- ☞ New Ideas in Thin Cases.

# Only \$2.50 A Month

And all of this for \$2.50—only \$2.50 per month—a great reduction in watch prices—direct to you—positively the exact prices the wholesale dealer would have to pay. We do not care to quote these prices here, but write—write before you buy. Think of the high grade, guaranteed watch we offer here at such a remarkable price. Indeed, the days of exorbitant watch prices have passed.

## See It First

You don't pay a cent to anybody until you see the watch. We won't let you buy a Burlington Watch without seeing it. Look at the splendid beauty of the watch itself. Thin model, handsomely shaped—aristocratic in every line. Then look at the works. There you see the pinnacle of watch making. You understand how this wonder timepiece is adjusted to the very second.

Every fighting vessel in the U. S. Navy has the Burlington Watch aboard. This includes every torpedo boat—every submarine as well as the big Dreadnaughts.

**Burlington Watch Co.**  
19th Street and Marshall Blvd.  
Dept. 1194 Chicago, Ill.

Please send me (without obligation and prepaid) your free book on watches with full explanation of your cash or \$2.00 a month offer on the Burlington Watch.

Name.....

Address.....

## Send Your Name on This Free Coupon

Get the Burlington Watch Book by sending this coupon now. You will know a lot more about watch buying when you read it. You will be able to "steer clear" of the double-priced watches which are no better. Send the coupon today for the watch book and our offer.

**Burlington Watch Co.**  
19th St. & Marshall Blvd., Dept. 1194, Chicago, Ill.

Please Mention Popular Mechanics



## How Dad Broke Up the Corner Gang

Carom or Pocket Billiards played at home gives boys a manly way to let loose their 40-horse energy. *It keeps them off the street.*

In homes that have the "Baby Grand," the parents write us it's **solved** the boy problem.

Why don't you learn to be a robust boy or girl again? One Brunswick Home Table brings 33 royal games—and each one makes grown-ups feel a year younger.

# Brunswick "Baby Grand"

"Grand," "Convertible" and "Quick Demountable" Billiard Tables

This family of Brunswick Tables lead the world because they are scientifically built.

Fast, ever-level billiard beds, famous Monarch cushions—life, speed and accuracy of angle. *Sizes and styles to fit all homes, regardless of room.*

**\$27 Up—Pay 10c a Day**

"Grand" and "Baby Grand" Brunswicks are made of genuine San Domingo mahogany, with rich inlaid design.

We can use these beautiful woods because we are building for thousands yearly, and quantity output cuts our factory cost way down.

"Quick Demountable" Brunswicks can be set up anywhere in a jiffy and easily taken down after play.



"Baby Grand"  
Combination Carom and Pocket Table  
with Accessory Drawer that holds full  
playing outfit.

"Convertible" Brunswicks are handsome library and dining tables that give you grown-up carom and pocket billiards, too.

**30-Day Trial—Balls, Etc., FREE!**

Yes, complete High-Class Playing Outfit included without extra cost—Balls, Cues, Rack, Markers, Expert Book of 33 Games, etc.

Accept our home trial offer and let the table win every member of the family. Color-photos, low prices, and easy terms all shown in our handsome book—"Billiards—The Home Magnet." *It's FREE.* Lest you forget, **mail the coupon now.**

### **This Brings Billiard Book FREE**

The Brunswick-Balke-Collender Co.  
Dept. 31R 623-633 S. Wabash Ave., Chicago  
Send free postpaid your color photo book  
**"Billiards—The Home Magnet"**  
and tell about your home trial offer.

Name.....

Address..... [518]

Please Mention Popular Mechanics



## Cave Life or Civilization

Civilized man is distinguished from the cave man by his habit of co-operation.

The cave man lived for and by himself; independent of others, but always in danger from natural laws.

To the extent that we assist one another, dividing up the tasks, we increase our capacity for production, and attain the advantages of civilization.

We may sometimes disregard our dependence on others. But suppose the farmer, for example, undertook to live strictly by his own efforts. He might eke out an existence, but it would not be a civilized existence nor would it satisfy him.

He needs better food and clothes and shelter and implements than he could provide unassisted. He requires a market for his surplus products, and the means of transportation and exchange.

He should not forget who makes his

clothes, his shoes, his tools, his vehicles and his tableware, or who mines his metals, or who provides his pepper and salt, his books and papers, or who furnishes the ready means of transportation and exchange whereby his myriad wants are supplied.

Neither should he forget that the more he assists others the more they can assist him.

Take the telephone specialists of the Bell System: the more efficient they are, the more effectively the farmer and every other human factor of civilization can provide for their own needs and comforts.

Or take our government, entrusted with the task of regulating, controlling and protecting a hundred million people. It is to the advantage of everyone that the government shall be so efficient in its special task that all of us may perform our duties under the most favorable conditions. Interdependence means civilized existence.



**AMERICAN TELEPHONE AND TELEGRAPH COMPANY  
AND ASSOCIATED COMPANIES**

*One Policy*

*One System*

*Universal Service*

*Please Mention Popular Mechanics*

## Nature Baffles Science!

*The Dumbest Oyster  
can make a better pearl  
than the brightest man.  
The oyster uses Nature's  
methods.*

*Velvet Joe.*

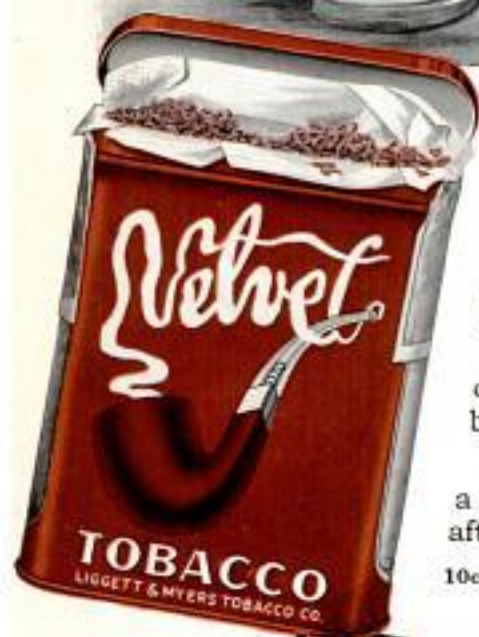

**N**ATURE says smoking tobacco is at its best after two years' curing.

There may be *quicker* ways and cheaper ways to cure tobacco. But we believe in Nature's way—the **VELVET** way—two years' mellowing in big wooden hogsheads.

Just fill a pipe with **VELVET**, and draw in the cool, mild smoke that's so fragrant and rich that—but what is the use of trying to describe a *taste*?

Take our word for **VELVET** long enough to try a pipeful, and you won't need to take *anybody's* word after that.

10c Tins

5c Metal lined Bags

One Pound Glass Humidors

*Liggett & Myers Tobacco Co.*

# Williams' Shaving Cream

## Shaving Cream

Wet your brush, squeeze a small bit between the bristles and go to it. Or apply the cream directly to your face if you prefer.

Pretty smooth stuff, this Williams' Cream—smooth looking, smooth feeling, quick acting. It's almost lather when you start; it's all lather an instant later—the same moistening, lasting lather that you always get in Williams' Shaving Soap no matter what the form.

If you are a cream devotee, remember that Williams made shaving soap before cream was thought of and that the soothing, refreshing, enduring lather that has made Williams' Shaving Soaps famous for 75 years is in Williams' Shaving Cream.

Try it; compare it; in the tube; on your face; throughout the shave and after the shave. Your nearest dealer can supply you.



Stick, Powder, Cream, Liquid

Send 10 cents in stamps for a trial size of all four forms, and then decide which you prefer. Or send 4 cents in stamps for any one.

The J. B. WILLIAMS COMPANY, Dept. A, Glastonbury, Conn.

*Add the finishing touch to your shave with Williams' Luxurious Talc Powder*