

THIS ISSUE 450,000 COPIES

# POPULAR MECHANICS MAGAZINE

WRITTEN SO YOU CAN UNDERSTAND

TRADE MARK



PHOTOGRAPHING  
WINTER SPORTS FROM A  
WHIZZING BOBSLED

PAGE 171

Copyrighted material



# \$727 buys the material to Build This Home

Clear, KNOTLESS Cypress siding, No. 1 Dimension lumber, Guaranteed Roofing, Creosoted wall plates, Clear Modern Craftsman style interior finish. Clear Millwork, Doors and Windows. Satin finish hardware. All guaranteed and backed by our \$10,000,000.00 capital.

This elegant substantial bungalow (No. 183—five rooms and bath) shipped direct-to-you—No money in advance. You risk nothing. Pay according to our liberal terms.



**\$473** No. 109. Five Rooms and bath, closets, etc.



## FREE Book of 100 Harris Homes

Over 100 actual designs of Harris homes, barns, garages, etc., illustrated by beautiful photographic engravings. Complete floor plans, material list and prices shown for each one. Book explains the Sensibly Cut-To-Fit Harris Way, gives our liberal terms, and much valuable information. Your copy mailed to you free of any cost or obligation.

## Sensibly Cut-to-Fit The Harris Way

The most economical and practical of all cut-to-fit methods. The Harris Way—the result of 23 years of practical building experience reduces building expenses to the minimum. First you save from 20 to 50% on material, and then cut your expense bills way down by building our guaranteed no shortage Sensibly Cut-To-Fit Harris Way.



**\$583** No. 61. Six rooms and bath, closets, etc.

## Saved \$510.00

Greensburg, Pa.

Harris Brothers Co.  
As to quality and quantity of material furnished me for my home, (No. 131), I am highly pleased. I have made a saving of \$510.00 and have had sufficient material for the smallest detail. I could not have duplicated this design for twice the amount paid your firm. Also might state further that Plans and working sheets for this design worked out to the letter. I am always your friend for your fair and courteous treatment.  
Yours respectfully,  
H. H. HENRY.



## FREE Plan Offer & Specifications

Complete building Blue Prints, exact material lists and specifications for any Design on this page at the special price of \$1.00 with the coupon below. Our regular price \$2.00. Material illustrated and described. Our blue prints set would cost \$50.00 to \$100.00. We send them to you for \$1.00. 50¢ refunded, if plans do not suit. If you purchase materials from us, plans are free.

### MAIL COUPON NOW!

HARRIS BROS. CO., Dept. AL-7.  
Send me Free Books marked X.

- |  |                                   |
|--|-----------------------------------|
| <input type="checkbox"/> Book 100 Harris Homes | <input type="checkbox"/> Plumbing |
| <input type="checkbox"/> Building Material     | <input type="checkbox"/> Roofing  |

Name .....

Address .....

### Plumbing Our Plumbing

smashes all prices on high grade materials. Install your own plumbing with the aid of our free expert engineering service. Complete porcelain roll rim bath tubs, at \$11.00. Bath-room outfits at \$29.75. Send for free Plumbing Book to-day.

### Roofing We offer the

century's greatest bargains in high grade roofing, wall board, ornamental steel plates, etc. Our Ajax brand, rubber surface, 3-ply at 96¢ per roll of 108 sq. ft. Galvanized steel at \$1.95 per 100 sq. ft. Write for our big FREE Roofing Book to-day.

### Greatest Bargains of the Century

in Lumber, Millwork and other building materials. We ship direct-to-you from our great manufacturing plant. Get our free Building Material Catalog

**HARRIS BROS. CO.**  
35th & IRON STS. CHICAGO



**\$960** No. 131. Eight rooms and bath, closets, etc.

The Victor Talking Machine Company

announces an important discovery

## The Victor Tungs-tone Stylus

An improved, semi-permanent, changeable, reproducing stylus of tungsten combining all the desirable features of the Victor system of changeable needles with the added advantage of playing 50 to 200 records without changing.



After searching the earth for better stylus material, a Victor expert discovered the miraculous reproducing and wearing qualities of tungsten. The Tungs-tone Stylus will play from fifty to two hundred records or even more. The life of the Tungs-tone Stylus depends on the character and volume of the records played.

**YOU DON'T HAVE TO CHANGE THE TUNGS-TONE STYLUS**

until it wears out. When this takes place the stylus simply stops reproducing as a signal for a new one. There is no danger of spoiling the record, because, strange to say, tungsten is softer than the record, although its wearing quality is one to two hundred per cent. better than the hardest steel. We cannot explain why—it is one of nature's secrets—a phenomenon. We only know it is true and recommend the Tungs-tone Stylus to all Victor users.

**NO NEEDLES TO CHANGE** is the chief nostrum of manufacturers of machines operated with a permanent jewel point, but the Victor Company knows what others will learn

in time, namely: that no permanent point can be made to last forever on hard disc records. The jewel stylus was a success on the old wax cylinder records, but jewels do wear rough in time, and, if not instantly detected and changed, will quickly spoil a valuable collection of records—a most insidious danger; hence the Victor Steel Needle, to be used but once, was the only practical needle for the new gramophone type of hard record until the discovery of the miraculous properties of tungsten for reproducing styli.

**TUNGS-TONE** is a trade-name and was coined for the occasion. The new Tungs-tone Stylus is made in **SOFT TONE AS WELL AS IN FULL TONE** and can be changed instantly, just the same as a steel needle. The virtue of the Tungs-tone Stylus lies in a small cylinder of tungsten projecting from the end of a steel holder in which it is rigidly set.

The tiny cylinders of tungsten reproduce Victor Records better than any other known material. Smooth, strong and full as to tone. The Victor Tungs-tone Stylus fits all Victor sound boxes.



Full  
Tone



Soft  
Tone

Made in Full Tone  
and Soft Tone  
Boxes of ten, 25c  
Packages of four, 10c



Manufactured  
exclusively by  
Victor Talking Machine  
Company, Camden, N. J.

**Important warning.** Victor Records can be safely and satisfactorily played only with *Victor Needles or Tungs-tone Stylus* on Victors or Victrolas. Victor Records cannot be safely played on machines with jeweled or other reproducing points.

New Victor Records demonstrated at all dealers on the 28th of each month

This One



YSWQ-4NZ-GFFQ

Copyrighted material

**"Oh, you mustn't go down cellar, Mamma!"**

"Father's down there making Cypress Furniture—it's going to be a grand surprise for *you*—so you mustn't know!"

*These are the days of thrift as well as days of sentiment.*

**Vol. 38** of the famous Cypress Pocket Library (a real departure) contains detail sketches (on sheet 2+x36,) specifications and complete directions how to easily make correctly-designed, artistic, "craftsy" furniture of "the wood eternal" in your spare hours. *"Furniture that you make yourself you love as well as use."*

Write for **Vol. 38.**



*CYPRESS IS "EASY ON EDGED TOOLS"—THE FAVORITE IN MANUAL TRAINING SCHOOLS.*

When planning a Peego'n, Mansion, Bungalow, pasture-fence or sleeping porch, remember—"With CYPRESS you BUILD BUT ONCE."

Let our "ALL-ROUND HELPS DEPARTMENT" help YOU.

Our entire resources are at your service with Reliable Personal Counsel.

**SOUTHERN CYPRESS MANUFACTURERS' ASSOCIATION**

1219 Hibernia Bank Bldg., NEW ORLEANS, LA., and 1219 Heard Nat'l Bank Bldg., JACKSONVILLE, FLA.

INSIST ON CYPRESS AT YOUR LOCAL DEALER'S.

IF HE HASN'T IT, LET US KNOW IMMEDIATELY.

*Please Mention Popular Mechanics*

# Popular Mechanics Magazine

6 N. Michigan Avenue, Chicago, U. S. A.

EDITED BY H. H. WINDSOR

England: The International News Co.,  
5 Beams Bldg., Chancery Lane, London, E. C.

Australia:  
The Australasian News Co.

ISSUED MONTHLY

SUBSCRIPTION:

SINGLE COPY, 15 CENTS

In United States, and its possessions, Cuba and Mexico, per year, postpaid - - - \$1.50  
To Canada - - - - - 1.75  
To all other countries in the Postal Union - - - - - 2.50

All subscriptions are discontinued at expiration. Please examine the date printed on your wrapper.

Entered as Second Class Matter Sept. 15, 1903, at the Post Office at Chicago, Illinois, under Act of March 3rd, 1879.

Entered as Second Class Matter at the Post Office Department, Canada.

Published monthly by POPULAR MECHANICS CO.

Copyright, 1916, by H. H. Windsor.  
Copyright, in France.

Z V V A R M E T A L

185

## Contents for February, 1916

Addressing Machine Made for Small Offices.....	246	Crochet Cotton, Holder for.....	279
Aeroplane Is Feature of Lord Mayor's Parade... 180		Dam Holds Water until Warmed for Bathing... 174	
Aeroplanes, Two War, Land in Queer Fashion... 234		Dam, Roller, Water Level Controlled by..... 234	
Air Cooling Apparatus of Simple Design..... 232		Deaf and Dumb Students Play Football..... 257	
Aluminum, Flexible Coating Is New Insulator for 274		Deaths Due to Aerial Accidents, Summary of Year's..... 203	
Ambulance, New Military, is Loaded Quickly... 180		Defense—Air Coast Patrol, First Step is Undertaken for..... 168	
Ammeter, Pocket, is Made in Substantial Form... 224		Desk, Louis XVI, Costs Four Years' Labor.... 263	
Arch, Cobblestone, Moves Several Feet Intact... 241		Digger, New Post Hole Has Jointed Shank.... 231	
Asphalt Beds, Extensive, in Honduras..... 222		Dish Pan, Convenient, for Kitchen Sink..... 279	
Automobile, Cone Clutch of Runs in Oil Bath... 220		Dish Rinser Fits over Hot Water Faucet..... 279	
Automobile Racer is Guided by Armless Driver.. 264		Dogs Carry Diseases to Live Stock..... 255	
Automobile Top, Shield Stops Draft under..... 276		Drill, Gang, for Working Structural Steel.... 270	
Automobile, Touring, Unusual Record is Made by 282		Drying Form for Children's Garments..... 279	
Automobile Tubes, Inner, Hindus Use for Water Spouts..... 240		Dust Arrester Purifies Factory Air..... 264	
Automobile, Warlike, Pipe Fittings Assembled into..... 253		Electric Cross Revolves above Church..... 191	
Bags Formed and Filled in One Operation..... 281		Electricity, Idaho Towns are Lighted and Heated by..... 254	
Balance, New, Uses Chains instead of Weights. 257		Embossing, Electricity Supplies Heat for..... 260	
Bank, Savings, Is Automatic Receiving Teller... 185		Enamels, Hued, for Heating and Cooking Stoves. 266	
Barometer is Illuminated by Groove in Mounting 270		Fire Escape, Rope, Pulley Used as Brake in... 281	
Basket Holds Clothes While in Boiler..... 278		Fire Escape, Rope, Used by Germans..... 232	
Beans in Large Quantities Sorted by Machinery. 269		Fish are Kept in Streams by Revolving Screen... 230	
Beaver Dams Work Trouble along Railway Line. 162		Flagstaff, Rhode Island, Felled by Gale..... 192	
Bed Springs Prevent Mattress from Spreading... 278		Flash Light, Pocket, Made in Form of Watch... 270	
Belt, Monster, is Used in Sugar Refinery..... 258		Flood Control Methods, Engineers Experiment on Footmat, Squeegee, Made for Motor Runboard. 172	
Benzol Output Increased by War Conditions.... 224		Forest, Chugach National, Reduced One-Half... 170	
Bicycle Attachment May Carry Rider or Luggage 280		Fort, Old, Now Serves as Water Tower..... 251	
Bird Houses, Telephone Cabinets Made into..... 282		Fountain, Public, Built of Cobblestones..... 232	
Blasting Machine, Pocket, Electric Caps Fired with..... 265		Fruit, Use Ice Box to Preserve in Transit.... 233	
Blind Boys are Trained to Shine Shoes..... 162		Furnace, Compact Crucible, for Brass Foundry.. 242	
Boat, Trailer, Folding Masts Used on..... 176		Garage Doors, Electric Device Controls..... 225	
Bouquet, Novel, Tin Kitchen Utensils Form.... 178		Gasoline Supply Station Handles Orders Quickly "Gibraltar," American, in Pacific Ocean..... 246	
Bridge, Concrete, is Built along New Lines.... 238		Gold is Mined from River Bottom by Diver.... 171	
Building—Brick Dwelling Modeled After Indian Wigwam..... 180		Guns, Dispersed, Better than Big Coast Forts... 202	
Building, Clinical, Solely for Study of Disease... 200		Gunstock, Special, Taking the Measurements for. 192	
Bulb, Frosted, Eliminates Headlight Glare.... 273		Headlight is Improvised for Use on Baby Cab.. 235	
Burial Lots, Contrasting, Used for Advertising.. 250		Heat, Hot Water, Supplied by Kitchen Range... 246	
Burner, New, Converts Fuel Oil into Gas..... 226		Heater, Convenient Kitchen, with Gas Kindler.. 275	
Buttons, New Attaching Device for..... 251		Heater, Simple Electric, for Small Rooms..... 276	
Cages, Brightly Hued, Aquariums, and Bric-a-Brac, Striking Designs in..... 166		Heating System, Electric, Economizes Current... 202	
Calendar Stand, Space for Notation Slips in... 268		Hitching Posts, Concrete, Part of Street Curbing 261	
Card, Visiting, with Map on Its Reverse Side... 277		Hoist Elevates Ashes from Cellar..... 228	
Check Raising Prevented by Pocket Instrument.. 280		Home, Model, is Carried on Auto Truck..... 179	
Clothes Drier, Multiple Line..... 274		Horses, Standing, Automatic Anchor for..... 271	
Concrete Pile Driven Like Wooden One..... 274		House Plan—Farmhouse, Cement-Stucco, with Garage..... 320	
Coronation, Japanese, Scenes from..... 201		Houses, Steel, Allies Plan for Devastated Area.. 247	
Cotton, Absorbent, Europe Using Substitutes for. 244			

[Continued on Page 6]

Popular Mechanics offers no premiums; does not join in "clubbing offers," and employs no solicitors to secure subscriptions. It is for sale by nearly every newsdealer in the United States and Canada.

## [Contents—Continued]

Hydro-Motor Car Designed for Land and Water.	165
Ice Cream Machine Is Refrigerating Plant.	232
Induction Balance, Buried Shells Found by.	205
Ink, Colored, Scarcity of Embarrasses Publishers	272
Knitting Hoops are Made in Novel Form.	242
Ladder, Driftwood, Soldiers Scale Sea Wall with	262
Lamp, Dashboard, Assists in Locating Trouble.	182
Lamp for Eye, Ear, and Nose Operations.	289
Law, Full Crew, Odd Dispute about.	248
Lifeboat, New Collapsible, Has Wooden Bulwarks	227
Lion, Cub, at Zoo, Trained Nurse Cares for.	156
"Maine" Memorial, Cuba Wants Designs for.	240
Map of Harvard Yard, Historical, Made in Concrete	266
Measuring and Computing Device for Measuring Dry Goods	246
Metal Cutting, High Speed, New System of.	266
Metal Spraying Process is Used in New Fields.	268
Master Lumber, Checks Work of Machine.	267
Meters are Affected by Neighboring Currents.	190
Microscopic Particles, New Process for Studying.	280
Milk Can Cover is Held in Place by Grips.	287
Mine Blast is Followed by Unexpected Results.	189
Mine, To Deepen Despite High Temperature.	224
Minerals, Light Sensitive, Open New Door to Science	184
Mohair of Unusual Length Sheared from Goat.	184
Motorcycle and Sidecar Fitted for Winter.	209
Moving Picture and Story Plots Built by Machine	164
Moving Picture Screen, Large Shade Serves as.	241
Moving Pictures, Bobbed Used in Taking.	171
Music from the Audion Lamp, by Lee de Forest, Ph. D.	193
Music Indian, Recorded by Phonograph.	263
Novel and Practical Things for the Home.	278
Oil Waste, Receives Scientific Study.	252
Omnibus Top, Collapsible Hood Covers.	275
Oxyacetylene Welds Huge Transformer Cover.	239
Panama-Pacific Exposition, Two Emblems of Liberty Associate at.	269
Pencil and Pen, Giant, Serve as Pillars.	251
Photographing Machine, Skyrocket, Wagon Carries	181
Plants, Young, Protecting from Injury by Frost.	184
Platforms, Waiting, Street Railway Erects.	250
Post Offices to Display Coast Survey Charts.	170
Printing Office Has Odd Environment.	231
Rabies among Coyotes, Forest Service to Fight.	186
Railroad Line across Canada, New, Opening of.	182
Railroad, New Siberian, Taps Rich Region.	186
Railroad Station, New Los Angeles, Is Attractive	172
Railroad Track, Project at Night under Electric Lamps	179
Reindeer Supplant Goats in Clearing Forest Area	281
Respirator, Light Weight, for Factory Workers.	253
Restaurant Rail, "Love," Causes Death.	262
Rifles, Army, Sight for Set for Too Long Range	200
Roads, Hard, Made from Hot Asphalt and Pea Stone	260
Roller, Cookie, Stamps Figures in Dough.	276
Root, Hatched, Sugar King's Palace Has.	265
Rubber Stamps Save Draughtsman's Time.	236
Rule Case Is Aid in Make-Up Work.	174
Russia's Door, The Key to, by LeRoy Kenneth.	233
Saw, Teeth on End of Hold It Upright.	195
Scale Truck Weighs Goods without Unloading.	271
Schools of California, High, New Courses In.	236
Searchlight, Ship's Under Water, Sights Hidden Mines	161
Shingles, Cypress, Resist Storm Better than Slate	261
Ship Bound for Alaska Hits Hidden Rock.	204
Ship—Schooner Has Propeller Mounted Off Center	259
Ships Beached during Gull Storm, Recovering.	174
Ships—Warships, Making Invisible to Hostile Fleet	276
Sidecar, New, is Adapted for Land and Water.	189
Sign, Large, Used by Boy Scouts in Campaign.	169
Skating, Ice, for Guests, Hotel's New Pastime.	268
Sleeping Chamber, Outdoor, Elevated above Ground	168
Snow Quickly Removed with Steam Heat.	199
Status, Maid of Orleans, Erected in New York.	199
Stereoscopic Substitute for Bulky Samples.	273
Stone, Odd Semiprecious, Is Asteriated Quartz.	261
Stove, New, No Outlet for Gas Fumes Needed with	176
Street Cleaner Collects Dirt as It Sweeps.	294
Submarine, Navy's Latest, Put through Trials.	188
Submarines, Fleet, Present Difficult Design Problem	251
Sulphuric Acid Made by New Method.	222
Sweepers, Hand and Power, for Industrial Plants	248
Swing, Californian Builds for Boys and Girls.	224
Tank House, Farmer Uses as Temporary Residence	252
Telephone Carries Songs of Birds into Home.	177
Telephone, Desk, Convenient Stand is Made for.	256
Telephone, Loud Speaking, for Use in Mine.	273
Telescopes, More Gifts of Asked by British.	271
Thermometers, Efficiency, Employed in Office.	274
Tile, Metal, Shelter Station Has Roof of.	230
Tire Repair Washers Grip Rubber Like Vise.	262
Tire Shoe, Steel, Prevents Slipping and Skidding.	280
Tongs, Attractive Olive	278
Tongs, Wooden, Permit Safe Handling of Fuses.	239
Train, Armored, New York National Guard Given	180
Transfer Problems, Machine Offers Solution of.	240
Trenches, Digging, Is to Supplant "Bag Rush".	277
Tripod Carried beneath Coat in Handy Fashion.	256
T-Square, Aluminum, to Supplant Wood.	245
Tunnel 11,088 Feet Long for Japanese Tramway.	260
Tunnel, Engineers Erect Bridge within.	277
Vulcanizer, New Electric, for Automobile Tires.	247
War, European:	
Airship, Night Battle with over London.	209
Alps, Snow Packed, Winter Campaign in.	211
Armenian and Pole Victims of.	219
Artillery, Heavy, Landing at Dardanelles.	213
Austrian Forces Seen on Two Battle Fronts.	210
Bridges Razed by Russians, Germans Rebuild.	216
French Lines in Western Theater, Behind.	214
Houses, Cozy, Erected at Front by Germans.	218
Mines, Naval, and Trench Turrets of Germans.	217
Munitions, Consigning to Warring Nations.	221
Russia and the War as Seen by Camera.	212
Serbia, War Stricken, Where Winter Finds Thousands Homeless	206
Women and Red Cross in War, Activities of.	220
Winter Warfare, White Clad Soldiers Wage.	208
Wars, Future, Economic Forces may Join against	272
Washing Machine and Boiler, Combined.	279
Water Faucet, Combination Device for.	268
Water, Simple Machine Purifies for Home Use.	235
Water Tank, Railroad Commandeers Car for.	258
Water, Warm, is Supplied by Novel Heater.	277
Wedding, Indian, Marked by Pomp and Display.	223
Whale Oil Production Increased by War.	182
Window Curtains Operated by Electric Motors.	245
Window, Merchant Covers Crack in with Sale Sign	190
Wool Drier, Efficient, California Sun Proves.	249
Wool, Long, More Uses for through New Process	256
Wreck of Missouri Freight Train, Fallen Boulder Causes	202

## SHOP NOTES

Acetylene Gas Tanks, Carrying Handle for.	288
Automobile Engine, Cold, To Start.	292
Automobile Engine Fan Bracket, Making Rigid.	288
Automobile, Light, and Weight, Power, and Speed.	290
Automobile Radiator, Supply Water Tank for.	287
Bushings, Small, Removing.	288
Chuck Jaws, Holding Thin Disk or Ring in.	287
Clamp, Special Cabinetmaker's.	301
Cutters, Milling, Clearance of.	284
Electric Switch in Hall Operating from Outside.	286
Electricity, Marking Tools by.	292
Fish Line in the Ice, Protecting.	290
Floor of Small Shop, Heating.	285
Gas Bag, Controlling the Inflation of.	282
Glass as a Substitute for Tracing Cloth.	283
Hammer for Handling Cotters.	301
Home, Building a:	
Part XI—Roofings	293
Hose, Rubber, Reinforcing.	289
Ice House, Hollow Tile.	283
Lathe Dog, Quickly Applied.	292
Liquid in a Funnel, To Prevent Whirling Motion of	301
Lubricator Glasses, To Prevent Oil Sticking to.	288
Oil Cup, Homemade.	282
Pail, Hot Dinner.	280
Paint, Storing without Waste.	285

[Contents Continued on Page 8]

# The Grand Prize and Medal of Honor

## The Two Highest Awards

Both Won by The

# Encyclopaedia Britannica

### At the Panama-Pacific Exposition

The Encyclopaedia Britannica was awarded at the Panama-Pacific International Exposition *the Grand Prize and Medal of Honor*—the two highest prizes. The Committee of Awards decided that the Britannica, both as a book and as a means of education, was supreme.

This award gives official sanction to what has always been recognized as beyond dispute; namely, that The Encyclopaedia Britannica was the best work of general information, the highest authority. It confirms the popular verdict, which has been expressed by the sale within a short time of 75,000 sets of the Cambridge University issue, for which the public paid over \$14,000,000.

The Encyclopaedia Britannica, Cambridge University issue, is printed on India paper from large type, with large pages and wide margins, this being the form that

has heretofore been associated with The Encyclopaedia Britannica since the first edition—1768.

We sell this issue in the several bindings at the following cash prices:

Cloth Binding . . . . .	\$166.75	Limp Suede Full Leather . . . . .	\$255.25
Green Sheepskin Full Leather . . . . .	203.25	Genuine Red Morocco Full Leather . . . . .	267.50

Subscribers may, if they wish, pay only \$5.00 down and \$5.00 a month at slightly more than the above cash prices, the complete set of 29 volumes being sent on receipt of the first payment.

It is only fair to state that we have arranged with Sears, Roebuck and Co., of Chicago, for the distribution by them of the Encyclopaedia Britannica—guaranteed complete and unabridged—in a "Handy Volume" issue, the 29 volumes being smaller in size, and therefore produced at a lower manufacturing cost. These sets will be sold for cash at \$58.88 (Cloth); \$68.54 (Full Sheep Morocco); \$81.88 (Three-Quarter Levant Morocco); and \$92.00 (Full Levant Morocco); or, at slightly higher prices for \$1.00 down and monthly payments of \$3.00, \$3.50, \$4.00, or \$4.50, according to binding.

Anyone interested in this new form of The Encyclopaedia Britannica should apply directly to Sears, Roebuck and Co., Chicago.

You can get full information about The Cambridge University issue of the Encyclopaedia Britannica if you cut out and mail to us the inquiry form; we will then send you a large pamphlet, together with specimen pages, illustrations, maps, reproductions of bookcases, an order form, etc.

#### Cut Out and Mail

*I am interested in the Cambridge issue of the new Encyclopaedia Britannica. Please send me your Illustrated Pamphlet with specimen pages, and particulars of prices, bindings, monthly payments, etc.*

\_\_\_\_\_

\_\_\_\_\_

\_\_\_\_\_

45

The Encyclopaedia Britannica Corporation, 120 W. 32nd St., New York

Please Mention Popular Mechanics

# Send



**NOW for DYKE'S  
Free 32 PAGE Booklet**

EXPLAINING:

**HOW TO GET INTO  
THE AUTOMOBILE  
BUSINESS & ITS OPPORTUNITIES  
HOW TO LEARN DURING SPARE  
TIME BY MAIL AT HOME WITH  
DYKE'S NEW IDEA  
Working Model Method**

This system is endorsed by Barney Oldfield, Elwood Haynes, Chas. Duryea and other motor authorities.

If we prove to you that we have started hundreds of others into the repair business and as chauffeurs—who had no previous experience and who knew no more about an auto than you do right now—you must admit we can do the same for you. Write me today—now—and let me prove it.

**The AUTOMOBILE BUSINESS is Growing**

**We Assist Students Getting Actual Driving Experience**

More help needed and big pay. No other business offers such opportunities. It's easy to learn. An Auto Repairman is not a machinist—his work consists of adjustments and re-fitting worn parts, "knowing the principle," that's the thing. One of our students writes: "Before I started with your course I was a clerk at \$50 per month. After finishing I followed your instructions, started a repair shop and cleared \$122 the first month—pretty good for the first month." Let us show you this and many other letters. You can learn the same as this young man by

**DYKE'S NEW IDEA OF TEACHING BY MAIL WITH WORKING MODELS**

On these models you get actual practice, see the actual operation and learn more than you could from the auto itself—it's easy and quick. You don't have to study hard with this system—we teach through the eye—a new idea. Mr. Dyke is the originator of the system of teaching by mail with models—therefore beware of imitators.

**Our Employment Plan for Students**

represents years of work to provide something that no other school had, namely, a way for the student to get started in the practical line of work.

Mr. Dyke has been identified as a pioneer inventor, supply man, etc., with the auto industry since its beginning. He originated the first auto supply co. and published the first book on autos in America. No other man with such experience is today teaching others.

**Mail This Free Coupon Now**

(a postal card will do)  
for Mr. Dyke's 32-Page Booklet. Write for it—now! It is interesting and instructive in itself. Learn how you can get all this training for only \$15. Fill out below or write a postal—but do it now.

**Dyke's Correspondence School of Motoring**  
Box 196, Roe Bldg.  
St. Louis, Mo.

Send me your free 32-page booklet about your New Idea Working Model Course and testimonials and proofs. It is understood I am under no obligations in sending for this.

Name .....

Address .....

This school is a department of the firm:

**A. L. DYKE**  
Pub. & Importer  
St. Louis, Mo.

Deal with the originators. Beware of imitators.

(Contents—Continued from page 6)

Post, Making Dir the Post Hole.....	290
Push Button for the Door Latch, Extra.....	302
Rubber Stamp Used on Tracings, Guide for.....	288
Sheave Wheels, Large, Turning without a Lathe.....	291
Soil Basin, Cracked, Repairing.....	300
Stovepipe, To Keep Connected.....	291
Tank, Expansion, Connections for.....	285
Tap, Automatic, for High Speed Work.....	286
Varnish on Pianos, Filling Pits in.....	285
Wagon Racks for Hauling Pipe.....	284
Water, Heating with Exhaust Steam.....	300
Window Opener, Multiple.....	302
Window Sash, Large Glazed, How to Carry.....	286

## AMATEUR MECHANICS

Cabinet, Magic.....	319
Calendar, Perpetual.....	305
Clock Hand, Magic.....	307
Clocks for the Craftsman.....	303
Countersinking a Hole Smoothly.....	318
Electric Motor, Quickly Made Toy.....	310
Enamel for Steel Fishing Rods.....	309
Galvanometer, Compact.....	304
Gas Furnace, Small.....	306
Gauge for Woodwork.....	310
Heater for the Experimenter.....	305
Knife, Fork, and Spoon Holder.....	318
Ladder for Hatchway, Hanging.....	309
Oilcan Stopper.....	309
Rods, Long Wood, Turning.....	309
Rods, Round, Making for Fishpoles.....	318
Shellac Varnish, Receptacle for.....	306
Skis and Ski Running: Part II—Running, Jumping, and Climbing.....	311
Sled, Ski.....	308
Steel Wool, Uses for.....	308
Tooth Powder Used on Tracing Cloth.....	306
Vaporizer, Homemade.....	306



## Every Boy His Own Toymaker

Greatest boys' book ever written. Tells how to make a Steam Engine, Telephone, Magic Lantern, Bats, kites, balloons, electrical and mechanical toys, trams, sailor tanks, 200 illustrations; also catalog of 150 puzzles, puzzle picture card and "Doubt Threat" warbler and bird call all for only 10c. WESTERN PUZZLE CO., ST. PAUL, MINN.

REVERSIBLE  
**Linene**  
TRADE MARK  
COLLARS

Send 2 Cents  
in U. S. Stamps to pay postage and  
we will send you free a starch-finished

**SAMPLE COLLAR**  
State size and which style wanted

REVERSIBLE COLLAR CO., Dept. U, Boston, Mass.

**If It Leaks! —  
SOLDER IT Yourself**

—and Save Money!

Send 55c for book of instructions

**"Simple Soldering"**

(Illustrated)

SPON & CHAMBERLAIN  
123 P. M. Liberty St., N. Y.

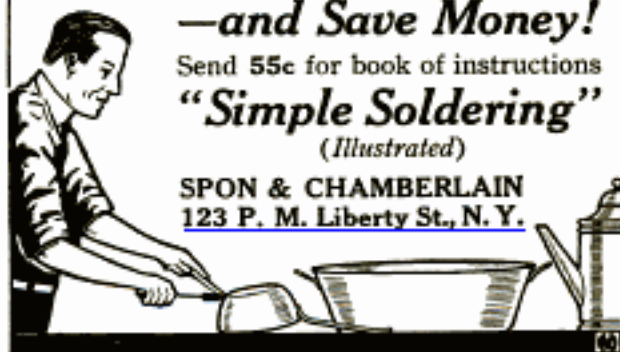

Please Mention Popular Mechanics





MARK ANTONY DELIVERING THE ORATION OVER THE BODY OF CAESAR

**C**ÆSAR'S name has stood through all the ages as the embodiment of imperial power. His untimely end after reaching the pinnacle of earthly glory is one of the great tragedies of history. The greatest tragedy in all human history is now being enacted on the battle fields of Europe. All the underlying causes of this conflict, the racial antipathies, the commercial rivalries, the sting of past defeats, the vaulting ambitions for world Empire may be discerned from the pages of history. The one great history of every Empire, Kingdom, Principality and Power from the beginning of civilization to the present, is the world-famed publication,

## Ridpath's History of the World

We will mail free a beautiful 46-page booklet of Sample Pages to all Popular Mechanics Readers interested in our great offer. A coupon for your convenience is printed in the corner of this advertisement. We offer the remaining sets of the last edition, brand new, down to date, beautifully bound in half morocco,

### At a Great Sacrifice in Price and on Easy Terms

We will name our special low price and easy terms to all readers who mail us the coupon below. Tear off coupon, write name and address plainly, and mail now before you forget. We employ no agents as our low price does not permit an agent's commission. The beautiful sample pages will give you some idea of the splendid illustrations and wonderfully beautiful style in which the History is written.

#### President McKinley

said: "I am familiar with Ridpath's History, and cordially recommend it to the scholar as well as to the people generally."

#### James Whitcomb Riley

said: "I stand in wonderment at the accomplishment of this vast work. It is thorough, symmetrical, masterful and complete."

#### Bishop Vincent

says: "Ridpath's History is a permanent college chair of general history in one's own house."



**THE REASON** for Dr. Ridpath's enviable position as an historian is his wonderfully beautiful style, a style no other historian in any generation has ever equalled. He pictures the great historical events as though they were happening before your eyes; he carries you with him to see the battles of old; to meet kings and queens and warriors; to sit in the Roman Senate; to march against Saladin and his dark-skinned followers; to sail the Southern Seas with Drake; to circumnavigate the globe with Magellan; to watch that thin line of Greek spearmen work havoc with the Persian hordes on the field of Marathon. He combines absorbing interest with supreme reliability and makes the heroes of history real living men and women, and about them he weaves the rise and fall of empires in such a fascinating style that history becomes as absorbingly interesting as the greatest of fiction. Hundreds who read this have decided to buy Ridpath some day; now is the time. Mail coupon for free sample pages.

**WESTERN NEWSPAPER ASSOCIATION  
CHICAGO**

**2000 PICTURES  
4000 PAGES**

**2 18 FREE COUPON**

**FOLD HERE, TEAR OUT, SIGN AND MAIL**

Name .....

Address .....

Western  
Newspaper  
Association  
**H. E. SEVER**  
President  
140 So. Dearborn St.  
CHICAGO, ILL.

Please mail, free, 46 page sample booklet of Ridpath's History of the World, containing photogravures of Napoleon, Socrates and Caesar, diagram of Panama Canal, etc., and write me full particulars of your special offer to Popular Mechanics readers.

# How Foods Affect Your Health and Efficiency

**Noted Scientist Shows How Certain Combinations of Good Foods Are Responsible for Over 90% of All Sickness, While Other Combinations Produce Sparkling Health, Greatly Increased Efficiency and Surprisingly Long Life. 23,000 Cases Recorded**

Twenty years ago Eugene Christian was at death's door. For years he had suffered the agonies of acute stomach and intestinal trouble. His doctors—among them the most noted specialists in this country—gave him up to die. He was educated for a doctor, but got no relief from his brother physicians, so as a last resort he commenced to study the food question, especially its relation to the human system, and as a result of what he learned he succeeded in *literally eating his way back to perfect health* without drugs or medicines of any kind—and in a remarkably short space of time.

To-day Eugene Christian is a man 55 years young. He has more pep, more ginger, vitality, and physical endurance than most youngsters in their teens. He literally radiates energy and power.

## A Great Truth

So remarkable was his recovery that Christian knew he had discovered a great truth which fully developed would result in a new science—the *science of Correct Eating*.

From that day to this he has devoted his life to corrective and curative feeding, and the results of his efforts have bordered on the miraculous.

Without *special* foods, drugs or medicines of any kind, he has successfully treated over 23,000 people for almost every kind of non-organic ailment known, and he has brought a new kind of health and vitality—a new type of personal efficiency, and a greater capacity for pleasure and increased longevity to thousands—many of whom came to him as a last resort.

## Most Sickness Caused by Wrong Eating

After his twenty years of study and practice, Eugene Christian has come to the definite conclusion that the reason most people are below par physically and mentally most of the time—the reason that business men break down at middle age, and the reason that the average life of man is only 39 years, is simply because we don't know how to properly select and combine our foods.

Very often good foods, when eaten in combina-

tion with other good foods, create a chemical action in the digestive tract and are converted into dangerous toxic poisons, which, according to Eugene Christian, are responsible for over 90% of all sickness. In other words, good foods wrongly combined will cause acidity, fermentation, gas, constipation and numerous sympathetic ills leading to most serious consequences.

The evils of toxic-poisoning have been brought out by Professor Metchnikoff in his treatise on the "Prolongation of Life" and by many other modern scientists. But most efforts in the past have been designed solely to remove the effect, wholly disregarding the cause, by cleansing out the system and removing the poisons after they had formed.

## Removes the Cause

Christian, however, has gone a step further. He has discovered a scientific method of both preventing and removing the cause of toxic poisoning instead of waiting until the poisons accumulate. He has proved that just as some combinations of ordinary food produce slow consuming poisons that wreck the system, other combinations of food taken in the right proportions become the greatest tonics for health, efficiency and long life ever discovered. And a wonderful feature of his method is that results come practically with the very first meal.

## Your Food is Your Fuel

Food is the fuel of the human system. And just as certain fuels will produce definite results when consumed in a furnace, so will certain foods produce the desired results when put into the human furnace. Yet not one person in a thousand has any knowledge of food as fuel. Some of the combinations we eat every day are as inefficient and dangerous as soggy wood, wet leaves, mud, sawdust and a little coal would be for a furnace. No wonder man is only 50% efficient—no wonder the average life is only 39 years—no wonder diseases of the human liver and kidneys have increased 103% within the past 30 years.

(Continued on next page)



Eugene Christian

### What People Say

"I am feeling fine again, thanks to you and your course of lessons on Scientific Eating. There ought to be 100,000 men practicing Scientific Eating in America."—F. A. Fully, Niagara Falls, South Ont., Canada.

"I am delighted beyond expression with the lessons. They have proved invaluable to me and have revolutionized both my diet and my health."—Olive M. Sees, 725 East Tipton St., Huntington, Ind.

"Your work on Scientific Eating is invaluable. It is with much pleasure that I recommend your course to prospective students everywhere."—Chas. A. Intel, 1212 Tremont Avenue, North Side, Pittsburgh, Pa.

"Your Course in Scientific Eating is wonderful because it has simplified both the chemistry of the body and the chemistry of the food and teaches one how to unite these two branches of science so as to make our food prevent and cure disease."—Eugene A. Ayers, Harrington Park, N. J.

"I think the Almighty sends men on the earth at different periods with independent and fearless minds to rectify the wrongs that have been taught, and reveal the truth in all its simplicity."—Edward Brook, 10 No. 10th W. Sts., Salt Lake City, Utah.

"I have read of you for years, and I have recently looked over some of your work. You are doing much for humanity. I congratulate you on your latest contribution to the health and happiness of man."—Dr. V. M. George, 235 N. High St., Columbus, Ohio.

(Continued from preceding page)

# Little Lessons in Correct Eating

(24 Pocket-Size Booklets in Leatherette Case)

By EUGENE CHRISTIAN

Send No Money—Only \$3 if You Keep Them

Christian's 24-Lesson Course in Scientific Eating is written expressly for the layman. There is an almost entire absence of technical terms, and every point is explained so clearly that there can be no possible misunderstanding. Reasons are given for every recommendation, and every statement is based not upon theory, but upon actual results secured in the author's many years of practice.

But the course doesn't merely tell you why you should practice Scientific Eating and what the results will be, it also gives actual menus for breakfast, luncheon and dinner, curative as well as corrective, covering every condition of health and sickness for all ages from infancy to old age and covering all occupations, climates and seasons.

Each and every one of these menus has been employed for its purpose of increasing efficiency and restoring health not merely once but many times—with almost invariable success before finding a place in the Course, so that every vestige of experiment has been removed.

## No Special Foods Required

In no case are patented or proprietary foods prescribed. You can get all of the foods out of your garden, at your local stores or in any restaurant. It is not necessary to upset your table to follow Christian's suggestions—neither is it necessary to eat things you don't enjoy or to which you are not accustomed. You will marvel at the simplicity of the methods as much as you will at the results which come after the very first meal. The lessons are indexed and you can turn to any subject and apply the suggestions the day you get the course. Each lesson is in a separate bound booklet which you can slip in your pocket, and the 24 booklets come in an attractive leatherette container for your library or for permanent preservation.

## Well or Sick Young or Old

Every thinking man or woman—young or old—well or sick—should know the science of correct eating. The saying that most people dig their graves with their teeth is as true as gospel. Yet Christian shows in his 24 lessons how easy and simple it is to eat your way back to perfect health and up to a new type of physical and mental power. Most people who are healthy today are so *not because* but *in spite of* the way they eat, and even the strongest of us must some day pay the penalty for the abuse we inflict unconsciously on our digestive organs, simply because we don't know how to select and combine our foods.

It is the almost invariable experience with those who follow the simple suggestions and menus contained in Christian's Course that they enjoy a new type of health—a health so perfect that it can only be described as a sort of super-health as compared to what most of us call health. Christian's ideal of health is to be literally champing at the bit with vital physical energy and mental power—not once in a while—but every moment of the day and every day of the year from youth to deferred old age.

## Health and Success

The relationship of health to material success is so close that the result of Christian's teaching is a form of personal efficiency which puts his pupils head and shoulders above their less fortunate brothers. Every one knows that the best ideas, plans

and methods are worked out when you are brim full of vitality—when you feel full of "ginger." The better you feel—the better work you can do. The Christian Course has almost times without number been the means of bringing great material prosperity to its students by endowing them with health so perfect that work seems like play.

## No Money in Advance

The price of the Christian Course of 24 lessons—containing rules, methods and actual menus which are literally priceless—is only \$3.00. We will gladly send you the course without deposit for five days' free inspection. Merely mail the coupon or write a letter and the complete course will be mailed you at once all charges prepaid. Then if you decide to keep the course, you can send the money. If not, you can mail the books back to us; no obligation will have been incurred. If the more than 300 pages contained in Christian's Course yield but one single suggestion that will bring you greater health, you will get many times the cost of the Course back in personal benefit—yet hun-

dreds write us that they find vital help on every page. Tear out and mail the coupon **now**, before you forget, as this announcement may not appear here again.

**CORRECTIVE EATING  
SOCIETY, Inc.**

52 Hunter Ave., Maywood, N.J.

Name.....  
Address.....  
City..... State.....

Partial Contents	
Three great laws that govern life.	
What food is and its true purpose.	
Digestion, assimilation, and metabolism.	
Chemistry of the body and the chemistry of food.	
How wrong eating causes disease.	
How foods establish health by removing causes of disease.	
Scientific eating explained, sample menus.	
Harmonious combinations of food tables.	
How to select, combine and proportion your food according to age, sample menus.	
Obesity, cause and cure, sample menus.	
Emaciation, cause and cure, sample menus.	
The business man—right and wrong ways of living, sample menus.	
Superacidity, fermentation, gastric catarrh and intestinal gas and auto-intoxication. Causes, sample menus.	
What to eat and omit for all stomach and intestinal disorders.	
Intestinal congestion (constipation), cause and cure, sample menus for the four seasons of year.	
Appendicitis—cause and cure, sample menus.	
Nervousness—cause and cure, sample menus.	
Curative menus; for each season of year for manual laborer and sedentary worker.	
Diagnosis simplified and made practical.	



24 Pocket-Size Booklets in Leatherette Container

Corrective Eating Society, Inc.  
52 Hunter Ave.,  
Maywood, N. J.

Send me the "Christian Course in Scientific Eating." I will either remit it within 5 days or send you \$3.00.

Please Mention Popular Mechanics

# Stop Forgetting!



Prof.  
Henry  
Dickson

America's foremost  
Authority on Mem-  
ory Training, Public  
Speaking, Self Ex-  
pression, Lecturer and  
Principal of the Dickson  
Memory School, Hearst  
Building, Chicago.

## The Executive



Mr. William H. Weeks, District  
Attorney of Putnam County, N.  
Y., writes:

"After a thorough trial of your method  
of mental and memory training, I find it  
to be not only first class—simply wonder-  
ful. I can truthfully say that I would not  
be again without the benefits I have  
received from your study for \$10,000."



The Key To Success

## Stop Forgetting

Prof. Henry Dickson, Prin. Dickson School of Memory,  
705 Hearst Bldg., Chicago, Ill.

Please send me free of charge and without obligation  
your booklet "How to Remember"; also your remarkable  
copyrighted "Memory Test." Give me facts on your  
special offer of a free copy of "How to Speak in Public."

Name.....

Street and No.....

City.....State.....

## Perfect Your Memory and You Can Command What Salary You Will

Your salary—what it is today—what it will be tomorrow—depends very much on your memory. Tricky memories—wandering minds—unable to grasp detail—have thwarted thousands in their battle for success—have held them down to bare living wages—working long hours with slight prospect of advancement—subordinates for life.

## The Ability to Concentrate, to Think and Express Your- self Clearly Means Every- thing to Your Success

America's men of power—in business, social or public life—are uniformly men of **trained memories**. Train your memory properly and you will find yourself able to concentrate absolutely on matters at hand—to think and speak connectedly—to develop self control, to overcome self consciousness—to make your **PERSONALITY DOMINATE**. Think what this means—a better position—bigger pay—social and business success—the **EFFICIENT LIFE**.

## Give Me 10 Minutes a Day and I Will Give You a "Steel Trap" Memory

That is all I ask—just ten minutes a day for a few weeks and I will train your memory just as I have trained the memories of 50,000 others. I will make your mind an infallible classified index from which you can instantly select facts, figures, faces, arguments. No matter what your age—your education—your vocation—your place of residence—I can make you "forget proof"—can train your memory for **SUCCESS**.

## SPECIAL OFFER!

"How to Speak in Public"—FREE!

For a limited period I am offering "How to Speak in Public," a de luxe edition, handsomely bound book—regularly priced at \$2.00—FREE to every student enrolling in my course. Full particulars of this unusual offer—together with a copy of my famous Memory Test and my remarkable book "How to Remember" will be sent FREE—simply for the mailing of the coupon or a postal. This is **YOUR** opportunity—mail it NOW.

Please Mention Popular Mechanics

## The Public Speaker



Carl F. Schader, one of Cali-  
fornia's biggest men, writes:

"I have been impressed physically and mentally beyond my own expectations by the continued study of your course. Every business man, especially those called upon to talk at Chambers of Commerce, realty boards, advertising clubs and other meetings should take your course. I unhesitatingly recommend it to my many friends."

## In Social Life



Roland Miller, of New York  
City, writes:

"What I have gotten from your method has advanced me both socially and finan-  
cially and I feel it my duty to tell you of  
these excellent results."

## The Salesman



O. G. Wehmeter, of the Amer-  
ican Miners' Accident Associa-  
tion, Indianapolis, Ind., writes:

"I can honestly and truthfully say I am  
a new person. I have more friends than  
I really expected I could have. Everyone  
who has known me says that a wonderful  
change has come over me in the last six  
months. It is all due to the Dickson  
School of Memory."

# Succeed Through Electricity

**This interesting story shows you the way to greater success in the Electrical Field.**



This is the Electrical age. Electricity now controls more trades, directs more men, offers more opportunities than any other power that man has yet discovered. Through *exact* knowledge of Electricity you will advance in salary and position.

**Read These Testimonials**

"Any Electrician, Operating Engineer, or Student who wants to do his own construction or further advance himself in the Electrical Field should have a set of these books."

JOHN KELLER  
116 Union St., Newark, O.

"For the man not getting a college training and even in that case, I can sincerely say I do not believe there is a better set of books in the market today."

LLOYD D. HUFFMAN  
Dayton, O.

"We consider Hawkins Electrical Guides the most compact and complete set of electrical references in the market."

MOOGLE ELECTRIC WORKS  
Monterey, Cal.

"Hawkins surely knows the art of condensing information."

ELMER F. HALL  
Buckland, Conn.

## Hawkins Electrical Guides Will Show You How

These books are the standard works on Electrical Science. They are a complete and up-to-date course in Electrical Engineering, presenting the information in a way you can use it. Only \$1.00 per volume and owners of the set say there are no better electrical books published at *any* price.

**Specially Arranged for Home Study and Reference** They fit your pocket and your pocket book. Beautifully bound in flexible black leather with gold edges. Easy to read and handle. You can carry each single volume about with you until you have mastered the subject it contains. Written in the form of questions you would ask and the answers to them—in plain, practical, everyday language, complete, concise, authentic and to the point. Over 3200 pages and more than 4,000 illustrations.

**10 NUMBERS IN ALL**

**100**  
A Number  
**PAYABLE**

**100**  
A Month



## Shipped to You FREE

Send no money. Examine the books first. Decide for yourself that they are the most complete library of Electricity ever published and that you cannot afford to be without them. Every book is complete in itself, but the complete set is the best bargain. The last volumes are just coming off the press. **Eight numbers now ready.**

### Easy Payments

Accept this unusual offer now—today. Each page—every illustration will convince you of the big value we are offering. See the books first, then decide. If you decide to keep them you can make settlement at only \$1.00 monthly until paid for.

**A FEW OF THE SUBJECTS**  
Magnetism—Induction—Experiments—Dynamoes—Electric Machinery—Motors—Armatures—Armature Windings—Installing of Dynamoes—Electrical Instrument Testing—Practical Management of Dynamoes and Motors—Distribution Systems—Wiring—Wiring Diagrams—Sign Flashing—Storage Batteries—Principles of Alternating Currents and Alternators—Alternating Current Motors—Transformers—Converters—Rectifiers—Alternating Current Systems—Circuit Breakers—Measuring Instruments—Switch Boards—Wiring—Power Stations—Installing—Telephones—Telegraph—Wireless—Bells—Lighting—Railways. Also many Modern Practical Applications of Electricity and Handy Reference Index of the 10 numbers.

**Theo. Audel & Co.**  
72 Fifth Ave.  
NEW YORK

### YOUR FREE COUPON

Theo. Audel & Co.  
72 Fifth Ave., N. Y.

Please send me for FREE examination Hawkins Electrical Guides (Price \$1.00 each). Ship at once prepaid the first eight numbers. If satisfactory I agree to send you \$1.00 each month until paid.

Signature .....

Occupation .....

Business Address .....

Residence .....

Reference ..... Feb. P. M.

Please Mention Popular Mechanics

# Learn to Write

GOOD hand-writing has been truly called the "Bread and butter of a business education." It should be the determination of every body to learn to write at least a good business hand. Good writing is the very foundation of business success.

**Easy to Learn** By my system you can become a good penman at home, in your own room during spare time. Don't be content with the notion that good penmen "are born" such. Because one's ancestors may have been noted for poor penmanship, is no excuse for him to remain an illegible scribbler. My system is original, unique, and highly successful—the result of 25 years' experience.

**Your Spare Time** Just your spare moments—that's all I ask. If you follow my instructions you will soon be able to write a beautiful hand that will be a source of pride to yourself and envy to your friends. Notice the improvement shown in Mr. Campbell's writing below.

*Leland M. Campbell*

"I am astonished at the improvement I've made by means of The Tamblin System in so short time."

LELAND M. CAMPBELL,  
Campbelltown, Ohio.

*Leland M. Campbell*

Mr. Campbell wrote his upper signature July 20, and the lower one November 10—a little less than 4 months apart. Hundreds and hundreds of others in all parts of the world are doing as well with my system.

I have had unbounded success in making poor writers good ones and good writers better penmen than they thought possible.

32  
PAGES  
HIGHLY  
ILLUSTRATED

HOW TO  
BECOME  
A  
PENMAN

FREE  
BOOK  
WRITE  
FOR IT  
TODAY

Penmanship is particularly adapted to correspondence instruction, and I absolutely guarantee satisfactory improvement. Distance no barrier. Ladies taught just as successfully as men.

Don't wait, don't delay, begin now to prepare for that position where good penmanship will be required. Send today for my Free Book, "How to Become a Good Penman," which contains copies and beautiful specimens and tells how others have become good penmen by means of the Tamblin System. Your name will be beautifully written on a card with white ink if you enclose stamp.

F. W. TAMBLYN,  
418 Meyer Building,  
Kansas City, Mo., U.S.A.

## FREE BOOK COUPON

F. W. TAMBLYN, 418 Meyer Bldg., Kansas City, Mo., U. S. A.  
I am interested in improving my penmanship. Please send me free your Book "How to Become a Good Penman."

Name .....

Address .....

Sign and mail this today, before you forget it.

# LEARN TO PAINT SIGNS and SHOW CARDS

THERE'S MONEY IN IT



I'll teach you personally by mail. 16 years' successful teaching. Five courses: (1) Complete Lettering, Sign and Card Writing; (2) Show Card and Ticket Writing; (3) Lettering; (4) Advanced Show Card and Ticket Writing; (5) Advanced complete Course. You can succeed—big. No limit to the window cards, sale cards, banners, and signs used. Gold lettering on glass and wood valuable feature of course. Teaches everything you need. Pay good, work fascinating, hours short.

## EARN \$18.00 to \$45.00 a WEEK

Schwartz, Del., writes: "Yours is the only school that really teaches." Weaver, Canada, writes: "Your course has increased my income 50%." Get in on this big thing, too. Your name and address brings full particulars.

THE DETROIT SCHOOL OF LETTERING  
Chas. J. Strong, Founder, Dept. 2020, Detroit, Mich.

## Guarantee—

I guarantee to place my graduates in positions paying \$85.00 to \$175.00 when they have graduated and are competent. We have constantly more requests for men at good salaries than we can supply.

## Traffic Inspectors WANTED

(BY THE R. R.'s)

\$4 Per Day

Here's a new profession—for 15,000 men ambitious to better themselves by special training. Positions now open pay \$4 Per Day to start; chances for advancement and travel unlimited. We train you thoroughly, quickly; give all necessary experience. Find out how men like you—clerks, salesmen, railroad men—are earning real money and advancement. Here's your big chance! Write for Free Booklet A2 now, lest you forget!

Frontier Prep. School, Buffalo, N. Y.

New Jobs

## \$100 Typewriter FREE

Men and women Confidential Secretaries now needed everywhere—new profession. Uncrowded Field—\$25 to \$50 Weekly. Six position to start. Learn at home. Quality through limited New Method Touch Typewriting—write 150% faster. Tuition fees refunded if not satisfied. Write for first lesson free. Shorthand Course also. \$100 typewriter free while learning. Amazing method doubling salaries. Address Jas. Patrick Ward, Pres. BOTSFORD Institute, 1102 Botsford Bldg., Chicago.



## MEN WANTED

Prepare as Firemen, Brakemen, Electric Motormen, and colored Train Porters. First Class Standard Roads. Hundreds put to work—\$65 to \$150 a month without any experience. 500 more wanted. Uniforms and passes arranged for when necessary. Enclose stamp for Application Blank. Name position you want.

I. RAILWAY C. I., Dept. 35, Indianapolis, Ind.

## JEWELRY ENGRAVING

We teach you, by our new and original method of instruction, this clean, fascinating and profitable business right at your home, and furnish you all tools needed absolutely free. Write for free book to the WISCONSIN SCHOOL OF ENGRAVING, 508 Bldg., MILWAUKEE, WIS.



## VENTRILOQUISM AT HOME

LEARNED BY ALMOST ANYONE SMALL COST  
Send today 2c stamp for particulars and proof.  
O. A. SMITH, Room D 135, 823 Bigelow St., PEORIA, ILL.

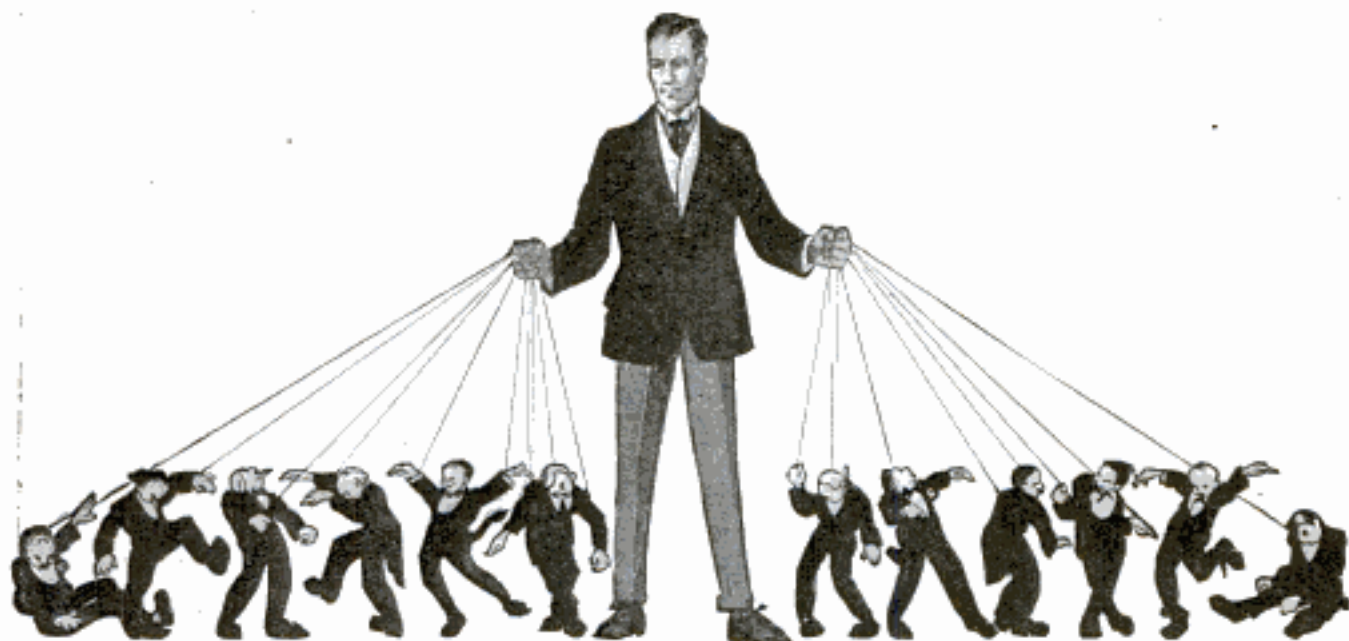

**Partial Contents**

- The Law of Great Thinking.
- The Four Factors on which it Depends.
- How to develop analytical power.
- How to think "all around" any subject.
- How to throw the mind into deliberate, controlled, productive thinking.
- Detailed directions for Perfect Mind Concentration.
- How to acquire the power of Consecutive Thinking, Reasoning, Analysis.
- How to acquire the skill of Creative Writing.
- How to guard against errors in Thought.
- How to drive from the mind all unwelcome thoughts.
- How to follow any line of thought with keen concentrated Power.
- How to develop Reasoning Power.
- How to handle the mind in Creative Thinking.
- The secret of Building Mind Power.
- How the Will is made to act.
- How to test your Will.
- How a strong Will is Master of Body.
- What creates Human Power.
- The Six Principles of Will Training.
- Definite Methods for developing Will.
- The NINETY-NINE METHODS for using Will-Power in the Conduct of Life.
- Seven Principles of drill in Mental, Physical, Personal Power.
- FIFTY-ONE MAXIMS for Applied power of Perception, Memory, Imagination, Self-Analysis, Control.
- How to develop a strong, keen gaze.
- How to concentrate the eye upon what is before you—object, person, printed page, work.
- How to become aware of Nerve Action.
- How to keep the body well poised.
- How to open the Mind and Body for reception of incoming power.
- How to throw off worry.
- How to overcome the tyranny of the Nervous system.
- How to maintain the Central Factors of Body Health.
- Difficulties in Mastering Harmful Habits.

**Power of Will Makes You the Master**

Yours can be the master mind controlling the actions, the thoughts, the very destinies of your fellow men. You can learn to overcome seemingly insurmountable handicaps that have hitherto effectively barred your way. You can rise to heights undreamed of, through the Power of your Will if you but know how. For Power of Will is the driving force wherein lies the secret of every world achievement—of every man's really great success.

**The Power Behind the Brain**

Thousands of men are thinkers and planners. Thousands are able to create really good ideas—while but few have the will power to carry them out—to overcome the obstacles blocking the path to success. This is because from earliest childhood the mind is trained, while the Will—which is the motive power of the brain—is wholly neglected. Yet the Will is even more susceptible to training than the brain—and by the same methods—by intelligent exercise and use.

**"Power of Will"**

by Frank Channing Haddock, Ph.D., a scientist whose name ranks with such leaders of thought as James, Bergson and Royce—is the first thorough course in will training ever conceived. It is based on a most profound analysis of the will in human beings. Yet every step in the 28 fascinating lessons is written so simply that anyone can understand them and apply the principles, methods and rules set down with noticeable results almost from the very start.

**May Transform Your Life**

The users of "Power of Will" have experienced results through its study which border on the miraculous—it has enabled thousands to carry to a conclusion plans which they had worked on unsuccessfully for years—it has made active men of affairs out of pitiable down and outers—it has transformed those who had always been the pawn of others into self-confident powerful leaders—it has enabled men and women held down by petty fears—by trivial daily incidents, to brush them aside as though made of paper maché—it teaches self-mastery—control of appetites and desires—it has cured drunkards of long standing—it has made innumerable sick people well—it has brought peace and happiness to nervous, discontented envious natures, and it has enabled strong successful men by the thousand to accomplish bigger things by giving them even greater power to use in their dealings with others.



400 pp. Half-Leather Gold Top Leaves

No matter what your occupation in life—no matter what your age—"Power of Will" can help you by giving you the power to say "I will," by giving you unwavering determination to carry out your purpose in spite of all—for showing you how to succeed where others fail—as over 75,000 men and women owners of "Power of Will" can tell you.

**Send No Money—Examine Book First**

Although "Power of Will" is a 400-page, leather bound book containing more material than many \$25 correspondence courses, the price is only \$3. The publishers will gladly send a copy free, for five days' inspection. Send no money now. Merely mail the coupon on the right, enclosing your business card, or giving a reference. If you decide to keep the book, send the money. If not, mail the book back. Tear out and fill in the coupon, or write a letter NOW, before you turn this page.

**Over 75,000 Users**

Power of Will has already helped over 75,000 people—a record equalled by no other single course of any kind in the world. Such men as Judge Hon. B. Lindsey; Supreme Court Justice Parker; Wu Ting Fang, Chinese Ambassador to U. S.; Lieut.-Gov. McKelvie, of Nebraska; General Manager Christeson of Wells-Fargo Express Co.; Ernest Knaebel, Asst. Atty.-Gen. of the U. S.; Asst. Postmaster-General Britt; E. St. Elmo Lewis, now Vice-Pres. Art Metal Construction Co., and literally thousands of other successful men like them are amongst the users of this great work.

"From what I have already seen I believe I can get \$300 to \$30,000 worth of good out of it."

—C. D. Van Vechten, General Agent, No. West. Life In. Co., Cedar Rapids, Ia.

"'Will Power' is a compilation of mighty force. My first week's benefit in dollars is \$100—cost \$3; profit \$97."—J. W. Heistand, 916 Tebbune Bldg., Chicago, Ill.

"Send 15 copies to our New York Office"—W. M. Taylor, Efficiency Expert, the Overland Auto Co., Toledo.

"He who reads it and puts forth effort will soon find himself out of the common herd."

—P. A. Good, President of Nebraska Lumber Dealers Assn., Cowles, Neb.

"Here is \$3 for you. 'Power of Will' received, it is the book I've wished for, for years." J. L. Seawall, Clerk of Supreme Court, State of N. Carolina, Raleigh, N. C.

**Pelton Pub. Co., 138 Pelton Bldg., Meriden, Conn.**

Gentlemen: Please send me a copy of "Power of Will" on approval. I agree to remit \$3, or return the book in 5 days.

Name.....

Address.....

**Pelton Pub. Co., 138 Pelton Bldg., Meriden, Conn.**

Please Mention Popular Mechanics

TEAR OR CUT ALONG THIS LINE



## \$125 to \$300 A MONTH

Don't hesitate. Write to us at once and find out about this wonderful opportunity. Hundreds of Signal Men and Signal Engineers are needed right now. Are you able to accept one of these positions? Have you had the training that will enable you to forge ahead and earn big money? All the way from \$125 to \$300 per month. If not, you cannot afford to put off writing us. Send at once for our big book which tells you all about the wonderful new profession of Signal Engineering. After a short time you will be in a position to earn more money. By our plan you can become our Representative immediately. So don't wait. Write us today. Get this special offer NOW.

## More Men Needed

The railroads are constantly looking for competent Signal Men and Signal Engineers. There are not enough men to fill the positions. Thousands and thousands of miles of tracks are to be equipped with automatic signals. More Signal Men are needed to superintend the work. Many new positions will be open and there are not enough men to take them. Besides a profession in which you can make a lot of money, Signal Engineering is the most fascinating work. So don't delay. Write today and find out about this wonderful opportunity.

### FREE BOOK COUPON

Dept. of Signaling  
Room 1192, 1810 Wilson Ave.  
Ravenswood Station, Chicago, Ill.

GENTLEMEN: Please send me absolutely free and prepaid your big new Signal book. It is distinctly understood that I assume no obligations of any kind.

Name .....

Address .....

Age.....Occupation.....

## Free Coupon

Just put your name and address on the free coupon and send it to us at once. You are under no obligations of any kind. We will send you the big new Signal Book which tells you all about this wonderful profession absolutely free. This book tells you how you can earn from \$125 to \$300 a month. Don't wait. Write today.

Dept. of Signaling  
Room 1192  
1810 Wilson Ave.  
Ravenswood Sta.  
CHICAGO,  
ILL.

Please Mention Popular Mechanics

## SPEAK A FOREIGN LANGUAGE !!!



The War has created unlimited commercial opportunities for those who know Spanish, French, German or Italian. Take advantage of the war situation! Better your position and increase your salary. Extend your business. Establish export trade with South American countries. Equip yourself to read foreign books and papers. Brush up on the language you studied at school or college and make it of practical use. Acquire a new language at home, by the

## LANGUAGE-PHONE METHOD

And Rosenthal's Method of Practical Linguistics  
(Highest Award Panama-Pacific Exposition)

This is the natural way to learn a foreign language. You hear the living voice of a native or professor pronounce each word and phrase. He speaks as you desire—slowly or quickly, for minutes or hours at a time. It is a pleasant, fascinating study; no tedious rules or memorizing. It is not expensive—all members of the family can use it. You simply practice during spare moments or at convenient times, and in a surprisingly short time you speak, read and understand a new language.

Write for free "Language Treatise," particulars of Trial Offer, Easy Payments. Our records fit all talking machines.

The Language Phone Method, 961 Putnam Bldg., 2 W. 45th St., N.Y.

## A Civil Service Job For YOU—

A job with Uncle Sam under Civil Service protection means employment for life with good pay, short hours, pleasant work, annual vacations and the assurance that you will get your pay regularly in spite of panics or hard times.

Post Office, Railway Mail, Rural Carrier, Custom - Internal Revenue and other examinations are coming soon.

If you're an American citizen, 18 or over, we can help you secure one of these good jobs. Our 64-page booklet tells how you can prepare for "exams" under personal supervision of a former U. S. Civil Service Secretary-Examiner—a man who knows and whose knowledge is at your disposal.

Write today for booklet. It's free, without obligation.

PATTERSON CIVIL SERVICE SCHOOL  
116 Irving Place ROCHESTER, N. Y.



## COPY THIS SKETCH

and let me see what you can do with it. Illustrators and cartoonists earn from \$20 to \$125 a week or more. My practical system of personal individual lessons by mail will develop your talent. Fifteen years' successful work for newspapers and magazines qualifies me to teach you. Send me your sketch of President Wilson with \$6 in stamps and I will send you a test lesson plate, also collection of drawings showing possibilities for you.

The Landon School of Illustrating  
and Cartooning  
1438 Schottfield Building, CLEVELAND, O.



## VIOLIN, MANDOLIN, GUITAR or CORNET FREE FINE TONE

To introduce our wonderful new system of teaching

note music by mail, Violin, Guitar, Mandolin, Piano, Organ or Cornet, will give you a dandy instrument absolutely FREE and guarantee to make you a player or no charge. Complete outfit FREE. Write at once. Special offer to first pupil. No obligation. SLINGERLAND'S CORRESPONDENCE SCHOOL of MUSIC, Dept. 9, Chicago, Ill.



## SELF-CONSCIOUSNESS

Are you timid? Do you lose your nerve and become confused easily? Do you lack confidence, courage, aggressiveness, faith in your own ability? These faults are a big handicap in social or business affairs. My Illustrated Treatise tells you how they may be overcome. It's FREE! Write for it today.

M. DeBETTS, Sta. 89, JACKSON, MICH.

BE AN ILLUSTRATOR  
by mail how to draw for magazines and newspapers  
Send for Catalog

Learn to draw. We will teach you  
School of Illustration  
112 Page Bldg.  
Chicago, Ill.



## BE A BANKER

Splendid opportunities. Pleasant work, short hours, all holidays off, yearly vacation with pay, good salary. Learn at home. Diploma in six months. Catalog free. EDGAR G. ALCORN, Pres.  
AMERICAN SCHOOL OF BANKING, 419 E. State Street, COLUMBUS, OHIO



# An Old Man at Fifty —A Young Man at Seventy

The Remarkable Story of Sanford Bennett, a San Francisco Business Man, Who Has Solved the Problem of Prolonging Youth

**T**HERE is no longer any occasion to go hunting for the Spring of Eternal Youth. What Ponce de Leon failed to discover in his world-famous mission, ages ago, has been brought to light right here in staid, prosaic America by Sanford Bennett, a San Francisco business man. He can prove it, too, right in his own person. At 50 he was partially bald. Today he has a thick head of hair, although it is white. At 50 his eyes were weak. Today they are as strong as when he was a child. At 50 he was a worn-out, broken-down, decrepit old man. Today he is in perfect health, a good deal of an athlete, and as young as the average man of 35.

All this he has accomplished by some very simple and gentle exercises which he practices for about ten minutes before arising in the morning. Yes, the exercises are taken in bed, peculiar as this may seem.

As Mr. Bennett explains, his case was not one of preserving health, but one of rejuvenating a weak middle-aged body into a robust old one, and he says what he has accomplished, anyone can accomplish by the application of the same methods, and so it would seem. All of which puts the Dr. Osler theory to shame.

There isn't room in this article to go into a lengthy description of Mr. Bennett's methods for the restoration of youth and the prevention of old age. All of this he tells himself in a book which he has written, entitled "Old Age—Its Cause and Prevention." This book is a complete history of himself and his experiences, and contains complete instructions for those who wish to put his health and youth-building methods to their own use. It is a wonderful book. It is a book that every man and woman who is desirous of remaining young after passing the fiftieth, sixtieth, seventieth, and, as Mr. Bennett firmly believes, the one hundredth milestone of life, should read.

### Partial Contents

Some idea of the field covered by the author may be gained by the following topics: Old Age, Its Cause; How to Prevent It; The Will in Exercising; Exercising in Bed—shown by fifteen pages of illustration. Sun, Fresh Air and Deep Breathing for Lung Development; The Secret of Good Digestion; Dyspepsia; How I Strengthened

My Eyes; The Liver; Internal Cleanliness; External Cleanliness; Rheumatism; Varicose Veins in the Legs; The Hair; The Obese Abdomen; The Rejuvenation of the Face, Throat and Neck; The Skin, and many other experience chapters of vital interest.



Sanford Bennett at 50



Sanford Bennett at 74

### How You Can Get This Book

"Old Age—Its Cause and Prevention" with its 400 pages, profusely illustrated and handsomely bound in cloth, contains as much material as many books selling for \$3.00 or more. By special arrangement with the publishers of *Physical Culture*, the leading and most practical health magazine of the day, it is now possible for you to secure a year's subscription to *Physical Culture*—12 big numbers—each copy containing over 100 pages of interesting and instructive information akin to the development of health, strength and vitality, together with Sanford Bennett's big book, for only \$2.00. The subscription price of *Physical Culture* alone is \$1.50. So you are getting a rare bargain.

### Don't Send Any Money

Before committing yourself in any way, however, the publishers will send you "Old Age—Its Cause and Prevention," together with the current issue of *Physical Culture*, on approval without deposit. Then, if after examination in your own home you feel you can afford to be without this library of vital practical youth and health-achieving knowledge, send the book back within five days after its receipt and you will owe nothing. If you decide to keep the book and become a subscriber to *Physical Culture*, send your check for \$2.00 and you will receive the magazine regularly for a year. There are no strings to this offer. No money is required in advance. Merely fill out and mail the coupon and by return post "Old Age—Its Cause and Prevention," and the current issue of *Physical Culture* will reach you.

For having solved the problem of perpetual youth during life, the world owes Sanford Bennett a vote of thanks. Of course there are those who will scoff at the idea, but the real wise men and women among those who hear of Sanford Bennett and his return to youth, will most cer-



tainly investigate further and at least acquire a knowledge of his methods. This the publishers allow you to do without cost or obligation through their "send no money" offer. But it is advisable to mail the coupon today because this unusual no-risk offer is liable to be withdrawn any moment.

**Mail This Today—No Money Required**

Send me Sanford Bennett's book—"Old Age—Its Cause and Prevention," and the current number of *Physical Culture* prepaid. I will either return the book within five days after receipt and owe you nothing, or will send \$2.00 in payment for the book and a full year's subscription to *Physical Culture*.

Name.....  
Address.....  
City..... State.....

Mail to: **Physical Culture Publishing Co.**  
2612 Flatiron Bldg., New York City

# FREE!

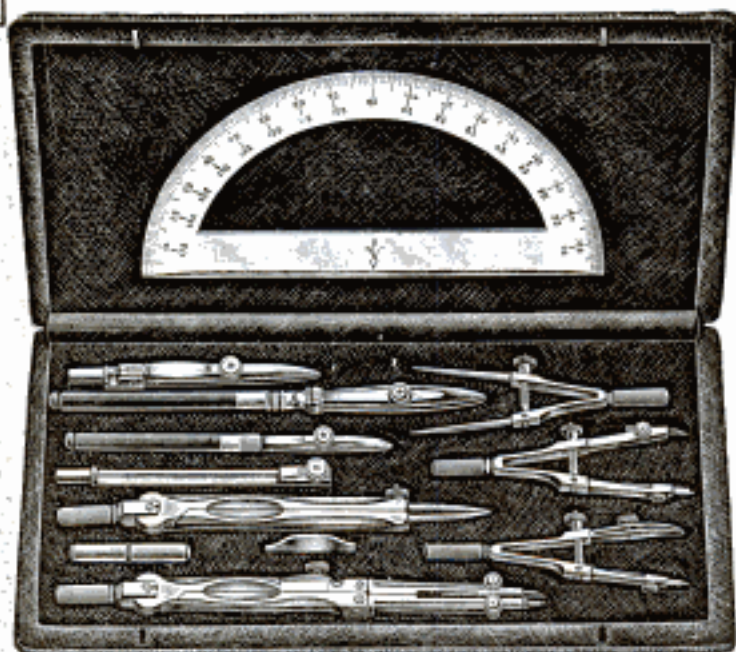

## I Will Train You By Mail

I am Chief Engineer of a large firm. Draftsmanship brought me to my position. I know just the kind of training you need to get a big salary. I will give you personal instruction by mail—instruction based on my own every day practical experience. You need no special talent or requirements. You do not have to take a minute from your regular work. No matter who you are or where you live, if you can read and write and are ambitious I will take you in hand and make a real draftsman out of you. Write for my free book and see what I have done for others. Send the coupon or postcard.

### MAIL COUPON TODAY

**CHIEF ENGINEER COOKE**  
Dept. 12, 455 Cass St., Chicago, Ill.

Without obligation or cost to me send prepaid your free book "The Road to Success" and particulars of your very extra special offer.

NAME .....

ADDRESS .....

Yes, I mean just exactly what I say—that I will give you this magnificent set of Imported German Silver Draftsman's Drawing Instruments positively and absolutely free. And besides the instruments in this beautiful plush lined leather case, I will also give you absolutely free a 20x25 inch drawing board, a 24 inch T square, a 12 inch rule, two triangles, a French curve, two bottles of drawing ink, a supply of paper, pencils, erasers, thumb tacks, etc.—a complete draftsman's working outfit, the very same kind that I use myself.

This superb set is valued at \$17.50. It goes absolutely free to those who get my personal instructions in Draftsmanship.

## Become A Draftsman

The need now is for draftsmen! Companies everywhere are looking for skilled draftsmen to fill positions paying from \$125.00 to \$175.00 per month. The work is light, pleasant and profitable. Look at the want ads of our metropolitan newspapers and see for yourself what an urgent demand there is for draftsmen. This is the "Construction Age"—the epoch of a new pace in every field of industrial endeavor. The services of the draftsman are needed more than ever before. Give me a few minutes of your spare time for a few months and I will qualify you for a big salary and a real future.

## Take Your Time To Pay Me

Let me count on you as an earnest student and you won't have to bother about the money question. I'll help you take care of that. To secure the quick enrollment of a few more ambitious men I'll cut my tuition price to an extremely small figure and give the privilege of paying this small cost on terms so easy that you'll scarcely miss the money. Remember you get the draftsman's outfit free, so that you can start in right away. Send the coupon for my amazing free book and full particulars of my special offer.

**CHIEF ENGINEER COOKE**  
Chicago Engineering Works, Dept. 12, 455 Cass St., CHICAGO, ILL.

Please Mention Popular Mechanics

THE  
NEW

# Encyclopaedia Britannica

[IN A COMPACT AND  
CONVENIENT FORM]

saving 64% of the lowest price today of the Cambridge University Press issue. THE ENTIRE 29 VOLUMES—30,000 pages; 41,000 articles; 44,000,000 words; 15,000 maps and illustrations; 500,000 index-entries—SENT FOR

only \$1.00 down, and 21 monthly instalments of \$3.00 each pay for the set

WE announce the sale of the new Encyclopaedia Britannica, 11th edition, in a "Handy Volume" issue. Printed on genuine Britannica India paper, it sells for \$1.00 with the order—securing delivery of the complete set—and 21 monthly payments of \$3.00 each; or for \$58.88 cash. The lowest price at which the larger-paged form published by Cambridge University, on India paper, can now be bought is \$166.75 cash. This is a saving of \$107.87, or 64%.

**How This Offer Became Possible** This remarkable offer, saving you 64%, is the result of our arrangement with the publishers of the new Encyclopaedia Britannica. They own the copyright. Without their permission no copies of the new Britannica can be sold.

**The Reason Why We Make This Offer** Though our business is now over \$100,000,000 annually and reaches more than one-quarter of all the families in the United States, we constantly strive to make it bigger and better.

Our growth during the past twenty-five years has been achieved by selling things of better value than could be obtained elsewhere—equal or better quality for less money. A nation-wide business such as ours could have been built up only by service and enduring satisfaction.

**Our Search for a Real Bargain** We are always seeking real bargains to offer our customers, something of superlative quality; something that everyone needs; something that lends itself to economical manufacture

### We Guarantee

your complete and entire satisfaction with the contents of The Encyclopaedia Britannica and with the form of the "HANDY VOLUME" issue. To anyone who is not satisfied for any reason and returns the set within three weeks, we guarantee to return all he has paid (including shipping charges).

Sears, Roebuck and Co.  
Chicago

Another guarantee on next right-hand page.

(See next page)





save 64% save 64% save 64% save 64% save 64% save 64% save 64% save 64% save 64% save 64% save 64% save 64% save 64% save 64% save 64%

save 64%

## We want you to see for yourselves what the "Handy Volume" Britannica is like

save 64%

save 64%

save 64%

save 64%

save 64%

save 64%

save 64%

save 64%

save 64%

save 64%

save 64%

save 64%

save 64%

save 64%

save 64%

save 64%

save 64%

save 64%

save 64%

save 64%

save 64%

save 64%

save 64%

save 64%

save 64%

save 64%

save 64%

Sign the coupon on this page and we will send you a pamphlet that gives you all you can know about the books without actually seeing them. It contains color reproductions of different bindings, sample pages of text and illustrations, information about the price—cash or instalment—of sets in each binding, etc. Send \$1.00 with the coupon now to reserve a set.

If it is convenient for you to go to any of the places listed below, you can see for yourself the actual "Handy Volumes" in the different bindings, look at print and illustrations, satisfy yourself on every point, and hand in your order. There is a full exhibit of the "Handy Volume" Britannica at each of the following places:

**NEW YORK**  
GIMBEL BROTHERS  
CHARLES SCRIBNER'S SONS  
HENRY MALKAN

**WASHINGTON**  
S. KANN SONS & Co.

**PHILADELPHIA**  
GIMBEL BROTHERS

**NEWARK**  
HAHNE & Co.

**BALTIMORE**  
THE NORMAN, REMINGTON Co.

**BOSTON**  
W. B. CLARKE Co.

**PITTSBURGH**  
JOSEPH HORNE Co.

**BUFFALO**  
THE WM. HENGERER Co.

**NEW ORLEANS**  
MAISON BLANCHE Co.

**MILWAUKEE**  
GIMBEL BROTHERS

**CHICAGO**  
THE FAIR

**ST. LOUIS**  
FAMOUS AND BARR Co.

**CLEVELAND**  
THE BURROWS BROS. Co.

**CINCINNATI**  
STEWART & KIDD Co.

**ST. PAUL**  
ST. PAUL BOOK &  
STATIONERY Co.

**INDIANAPOLIS**  
W. K. STEWART Co.

**LOUISVILLE**  
DEARING'S, INCORPORATED

**SAN FRANCISCO**  
"THE WHITE HOUSE"  
RAPHAEL WEILL & Co., INC.

**LOS ANGELES**  
A. HAMBURGER & SONS,  
INC.

**PORTLAND**  
THE J. K. GILL Co.

**SEATTLE**  
LOWMAN & HANFORD Co.

**SALT LAKE CITY**  
KEITH-O'BRIEN Co.

**DENVER**  
A. T. LEWIS & SON DRY  
GOODS Co.

**KANSAS CITY**  
BRYANT & DOUGLAS BOOK  
AND STATIONERY Co.

**OMAHA**  
J. L. BRANDEIS & SONS

**DETROIT**  
JOHN V. SHEEHAN & Co.

For more information or to reserve a set  
immediately mail the coupon to

**Sears, Roebuck and Co.**  
Chicago

Sole Distributors

SEARS, ROEBUCK AND Co.  
CHICAGO

Please send me

- The booklet with full information about the "HANDY VOLUME" issue of the new Encyclopaedia Britannica, sample pages, bindings, prices, terms, etc.
- The booklet called "The Part the Encyclopaedia Britannica Plays in the Affairs of Ambitious Women," with sample pages and full information.
- Order form, which I will sign on receipt.  
 Reserve one set for me. \$1 enclosed as first payment.

Name \_\_\_\_\_

Address \_\_\_\_\_

save 64% save 64% save 64% save 64% save 64% save 64% save 64% save 64% save 64% save 64%

# CLASSIFIED ADVERTISEMENTS

WORLD'S BEST WANT AD MEDIUM

We have records to prove that a classified ad in these columns will find a buyer for almost anything which can be sold. Doubtless you have some article of value to some one else which you no longer need. Why not turn it into money?

Advertisements in this section, 15 cents per word, each insertion, minimum 10 words, payable in advance. To insure ads being inserted under proper classified head in the March issue, copy must reach this office not later than February 1st.

Chicago, Ill., Oct. 7, 1915.

Popular Mechanics Magazine, Chicago.

Gentlemen: We wish to express our appreciation of your splendid advertising medium, Popular Mechanics. Our records show an expenditure of \$19.35 for advertising with you the past season. We have profited to date from these ads, \$52.51. Our average number of answers per issue has been thirty-two. Again assuring you of our appreciation, we are,

Yours very truly,

MOTORCYCLE PARTS MFG. WORKS.

## AUTOMOBILES

1914 OAKLAND six touring Car, Model No. 48, \$650. Complete equipment including electric lights, starter, and power pump. Fine condition. L. M. Aspinwall, 6816 McPherson St., Pittsburgh, Pa.

GET into the Automobile business, as salesman, chauffeur, garage manager, mechanic. Automobile instruction in four weeks' residence course. Send for booklet P. M., West side Y. M. C. A. Auto School, 318 West 57th St. New York.

MARATHON torpedo runabout. Late 1913, handsomely equipped, including electric lights, cost over \$1,200, must sell immediately, \$775. Edwards, 142 Brown Place, New York.

"FORD" model R motor, "International" 4-cyl. roadster, "Spilldorf" 4-magneto, "Pepe-Toledo" truck. Write for list; can use power hack-saw, small miller. Tom Beckinton, Belvidere, Ill.

COULD You Sell Gasoline at 2½ cents a gallon? If so, sell Carbonvoid to automobilists for \$1.39; costs \$1.09 dozen. \$1.09 tube equivalent of 40 gallons of gasoline. Ricmore's carbon. Sample 50c. Gasoline going up. Carbonvoid Chemical Works, Asbury Park, N. J.

AUTOMOBILE Repairs—Automobile owners, Garages and Repairmen should subscribe for the Automobile Dealer and Repairer; 150-page illustrated monthly devoted exclusively to the care and repair of the car. The only magazine in the world devoted to the practical side of motoring. The "Trouble Department" contains five pages of numbered questions each month from car owners and repairmen which are answered by experts on gasoline repairs. \$1 per year; 15 cents per copy. Canadian subscription, \$1.50. Postals not answered. Charles D. Sherman, 50 Windsor Road, Hartford, Conn.

CYLINDERS reground, new pistons and rings fitted. Restores lost power. Prompt and efficient service given. Write for prices, giving make and model. The Everts Machine Company, No. 20 Hicks St., Hartford, Conn.

DOUBLE Tread your old tires; it's easy; 50¢ per tire. Just the thing for winter wear. Particulars free. Tire Trading Co., Newark, N. J.

BUICK foredoor touring, five passenger, 20 horsepower, has complete equipment and many extras; big bargain, \$225. Doctor Thomas, Bergen Ave., 149th. N. Y.

AUTOMOBILE Troubles made easy. Address Lamont Co., Beacon, New York.

MOTORS, trucks, and used autos, \$50 up. Auto Supply Co., Burlington, Wis.

CYLINDER grinding of the finest quality; accurately made light pistons and perfect rings inserted. Prompt service assured. New Haven Machine Corp., New Haven, Conn.

CYLINDER Grinding. Pistons. Wristpins; first-class equipment. Sixteen years' experience and specializing in this work enables us to do high grade work at lowest prices. We manufacture the individually cast, heat-treated piston rings. Bridgeport Piston Ring Co., Bridgeport, Conn.

PAINT Your Car Yourself—Save \$25 to \$75 by doing the work at home with the Arsenal system. Our big free booklet "The Car Beautiful" tells how. Send for it today. Arsenal Varnish Co., Dept. P, Rock Island, Ill.

"AUTOMOBILE Repairing Made Easy"—The most needed and useful book on automobiles ever written. Only book of its kind—just out—Covers every phase of automobile repairing practice. 1056 pages (5½x8 in.) 1000 Engravings—Cloth, Price \$3.00 Postpaid. Popular Mechanics Book Dept., 6 N. Michigan Ave., Chicago.

## AUTOMOBILE SUPPLIES

THE Latz Gasolene Hydrometer—The motorist's necessity. It tells what grade gasoline you are using in your automobile. It shows whether the gasoline you use is good high test gasoline or low test gasoline that is but a little better than kerosene. Test the gasoline you use, and use the highest test gasoline you can secure, for the higher the gasoline tests, the more mileage, speed and power you will obtain, the easier your car will start, the smoother it will run, and the less carbon, carburetor and engine trouble you will have. Send sixty cents today for a Latz Gasolene Hydrometer and know that the gasoline you use is best by test. H. W. Latz & Co., Atlantic City, N. J.

OUR Double-Tread Tires are Guaranteed (written) for 3,500 miles. Two tires in one. Big, strong, extra heavy, 30x3½, \$7.00; 34x4, \$9.25; 36x4½, \$12.00; 37x5, \$13.00. Big saving on other sizes also. Send for list now! State size and type rim. Max Liben & Company, 205B West 48th, New York.

EXPLOSION Whistle. Fits priming cup. Most powerful signal made. Must be heard to be appreciated. Sent on 30 days' trial upon receipt of \$4.25. Buell Manufacturing Co., 1141 East 46th St., Chicago.

MOUNT power vacuum cleaner on your auto. Buy parts, assemble, \$50 cost—earns \$15 daily. Vacuum Supply Co., Ann Arbor, Mich.

ENGINES: 6-cyl. Thomas \$175, 4-cyl. Metz \$85, 25-hp. Buick engine \$109. Bosch Magn. \$30 each, 3-speed trans. \$35, suitable Ford or Buick \$10. Winton 6 rear axle \$35. Overland rear axle and trans. \$50, 1911 Chalmers Axle \$50. All kinds of used parts. Auto Salvage Co., 1436 Wabash Ave., Chicago.

IMPERIAL Angle Wrench, \$1.50; drop-forged steel, reaches difficult places; Marvel Socket Wrench, \$3.00, for Ford cars; sent prepaid upon receipt of price; agents wanted. Circular, Thomas Mfg. Co., Kennett Square, Pa.

REPAIR Parts for Ford Cars, quality guaranteed; axles, propeller shafts, hubs, bearing assemblies, connecting rods and gears. Grossman Auto Parts Company, White Plains, N. Y.

GASOLINE reduced 25%. Motor Efficiency increased every way. Guaranteed with Parker Vaporizer. Highly successful in the North 3 yrs. 15 days' Free Trial. Postal. C. Parkop Mfg. Co., Philadelphia, Pa.

ALL makes engines, magnetos, cylinders, pistons, carburetors, wheels, bearings, etc., and all auto supplies at very lowest prices. Atlantic Supply Co., Long Branch, N. J.

STORAGE Battery Chargers earn big profits. Operate from city current or engine. Sold on small monthly payments. Hobart Brothers, Troy, Ohio.

AUTOMOBILE Wind Shield Cleaner; neat, durable and simple, cleans both sides at once, now ready for the market. Agents wanted for all territories. Standard Accessories Co., 81 New Street, New York.

SPARK Plug trouble? Pronto Spark gaps will fire any plug, in any condition, every time. Inexpensive—the most gladly accepted motor accessory ever invented. Salesman, you've hit it. Ask us. Pronto Manufacturing Co., Omaha, Neb.

HYDRAULIC Tufting Machine with motor, used 6 months, will sacrifice. Also Streamline Automobile Bodies Painted, Trimmed with Top, complete, \$75. Carriage Auto Painting & Trimming Co., Carthage, Ohio.

ATTENTION! A perfect substitute for welding Aluminum, in one-fourth time and cost. So-Luminum guaranteed the newest, strongest, cheapest and best great discovery in aluminum solders. No oxidation. No flux. Only thing needed is a gasoline torch. Used by the U. S. Navy, Vickers Ltd. of England, largest automobile manufacturing and welding companies. Write for Booklet 5 Sample bar \$1.50; one lb. \$3.50. So-Luminum Mfg. & Eng. Co., Inc., U. S. Rubber Co. Building, 1790 Broadway, N. Y. Sole manufacturers and distributors.

BUILD your own auto top and save money. We furnish complete knocked down frames for any make of car with roof and back curtain ready to put together. You save half. A. A. Top Mfg. Co., 1449 Washington Blvd., Chicago, Ill.

"MOR-LITE" cleans the celluloid in Automobile Curtains quickly and thoroughly. Agents wanted. Sample mailed for 25 cents. Mor-Lite Chemical Co., 421 West Grand Boulevard, Detroit, Mich.

CARBON troubles vanish by use of "Gids" the Modern Auto Fuel. More power, speed and mileage per gallon, guaranteed non-injurious. Highly endorsed. Exclusive county sale rights, \$1 prepaid. Fred M. Giddings, Manufacturer, 65 Simmons St., Galesburg, Ill.

FINISH and Preservative for Autos, etc. "Auto-Lustre" makes a new car over night. Durable, beautiful, economical, enamel effect and a beautiful lustre. Not affected by weather conditions. No rubbing, no wiping, no polishing. Quart can sufficient for five-passenger car, including the seats, top, etc. \$1.50. Agents wanted. General Sales Agent, 1121 Van Ness Ave., San Francisco, Cal.

RAISE and lower your "auto top" (not one man) same as buggy top. Nickel plated. Weighs one-half pound. Can be carried in the pocket. Price \$1.00. Agents wanted. The Mirp Co., Lincoln, Ill.

4x4½ SIX cylinder motor, carburetor, magneto, clutch, \$125. Heavy front, rear axles, wheels, springs, frame, \$75. Transmission, \$50. Front, rear, axles, wheels, \$40. Butts, Oxford, N. Y.

COMPOUND keeps windshields clear in stormy weather. Bottle 50c. Formula \$1.00. Main Photo, Grove Hall Sta., Boston.

AUTOMOBILE Parts of all descriptions bought and sold. Prices right. Motor Parts Listing Co., Parts Dept., Detroit, Mich.

ATTACH a Vacuum Cleaner on your Auto, go into the Carpet Cleaning Business, and earn an income of \$15.00 a day upwards. Write quick. Thurman Vacuum Cleaner Co., Dept. A, St. Louis, Mo.

ACT quick! Automobile gasoline going up. Sell "Gaso-Tonic." Equals gasoline at 3c a gallon, eliminates Carbon, Deterioration, an hour profit. Sales guaranteed. White Mfg. Co., Dept. M, Cincinnati, O.

VULCANIZER for shop, bargain. Vanderpool's, Springfield, Ohio.

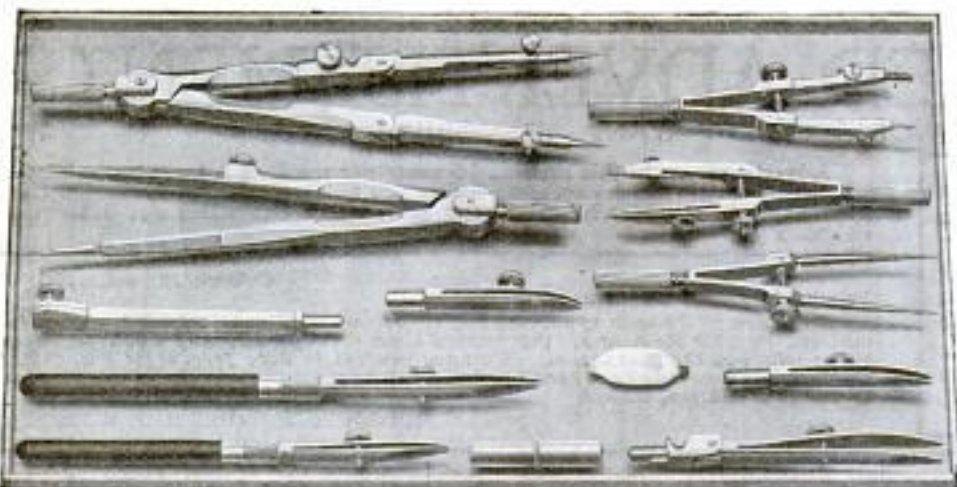

## Because

*I want ambitious men to become high salaried Draftsmen through my practical working training—therefore:*

# I Will Give You This Set of Drawing Instruments

The Chief Draftsman of a large and well-known company will give you this complete draftsman's outfit absolutely free. It does not cost you a penny. Besides these Imported regular draftsman's instruments shown here, I also give you absolutely free a 20x25 inch drawing board, a 24-inch T-square, a draftsman's triangle rule, supply of drawing paper, 2 triangles and French curve, pencils and erasers, drawing thumb tacks, etc., in fact a complete and first-class regular Draftsman's Working Outfit as soon as you enroll. This is just the same kind of an outfit I use myself. Genuine working instruments. You could not get this outfit for less than \$15. But now on this special offer, I will give it to you absolutely free.

## And Train You For a \$200 Position

I am Chief Draftsman of an old and well known company. There is a constant demand for trained draftsmen all over the country and I will give you just the kind of training that will qualify you to hold one of these big paying positions. \$125 to \$200 a month straight salary is an ordinary pay for a good draftsman. I will give you just the kind of training that you need to hold one of these fine jobs, right in your own home during your spare time. I know the kind of training that you must have in order to get the highest salary—and that is just exactly the kind of training that I will give to you. During the last twenty years I have trained some of the highest paid men. Their success in the profession is well known. You can do as well—or better than they.

### SPECIAL!

For a limited time I am making a special price offer in order to complete a new class ready to start. Send for free book at once, today.

## Send Me the Coupon For FREE New Book

Put your name and address in the coupon or on a letter or postcard now and send to me at once for my new book "Successful Draftsmanship." Find out about the golden opportunities that await you in our profession. Find out how you can get just exactly the kind of training that you need to hold a position paying from \$125 to \$200 a month at once. Absolutely no obligations in getting the book. Just put your name and address on the coupon. But send it now—immediately while I am making this special offer.

### Chief Draftsman Dobe

Engineer's Equipment Co.  
Division 1192, CHICAGO, ILL.

Without any obligation to me whatsoever, please mail your book "Successful Draftsmanship," and full particulars of your liberal "Personal Instruction" offer to a few students. It is understood that I am obligated in no way whatever.



Name.....

Address.....

**CHIEF DRAFTSMAN DOBE**  
Div. 1192, Engineer's Equipment Co., Chicago

Please Mention Popular Mechanics



"THE How and Why of the Automobile"  
—A 200-page book of practical information for seekers after the fundamental facts regarding the gasoline engine and its application to the motor car. Interesting and instructive to both the beginner and the expert. Bound in full cloth—250 illustrations. Price \$1 postpaid. Popular Mechanics Book Dept., 6 N. Michigan Ave., Chicago.

RECTIFIERS for garages. All sizes. Charge one to eight batteries, \$12 upwards. American Battery Company, 1129 Fulton St., Chicago.

#### FORD ACCESSORIES

MAKE your Ford ride like a Cadillac. Ford's shock absorbers, the strongest and best shock absorbers on the market, shipped anywhere C. O. D., subject to examination. Price \$7.50 for a set of two; \$14 for a set of four. Dallas Specialty Co., P. O. Box 1442, Dallas, Texas.

FORD Owners, owing to greatly increased sales, we have decided to reduce the wholesale price of our celebrated Safety Ford Starter; our price complete \$4.50. Send nine dollars for two starters. Safety Ford Starter Corp., 701 Seventh Ave., N. Y.

"STEER Relief" for Fords. Guaranteed Best Made. Want Agents. Sample \$3.00; prepaid. C. B. Post, New London, Ohio.

COMMUTATOR complete with roller mailed to any address for one dollar prepaid. Grossman Auto Parts Company, White Plains, N. Y.

NEW 300-page book on the Ford car for every Ford owner, dealer and repairman. Deals fully with construction, operation and repair. 100 engravings. Best and most complete Ford book ever published. Price, \$1 postpaid. Also Ford Engine Chart—25x28 in. Location of engine troubles made easy. Price, 25c postpaid. Your money back if not satisfied. Popular Mechanics Book Dept., 6 N. Michigan Ave., Chicago.

TO salesmen capable earning \$200.00 month we offer attractive 1918 proposition selling Ford owners "Best" line popular priced Shock Absorbers—Safety Drivers—\$10.00 Starters—Engine Driven Pumps, etc. Men with Ford cars preferred. Jackels Campbell Co., Dept. 20, Minneapolis, Minn.

ALUMINUM Pistons for Fords give Speed, Snap, Power, Less Vibration, Fuel, Carbon, Repairs. Set weighs four instead of twelve pounds. With rings and pins, \$15 set. Four sizes. Featherweight Piston Co., Guyman Way, Pittsburgh.

#### CYCLECARS AND MATERIAL

CYCLECAR Friction Transmissions and parts. Cogswell Manufacturing Co., Hall St., Springfield, Mass.

#### MOTORCYCLES, BICYCLES & SUPPLIES

A REAL bargain in second-hand motorcycles. We have an overstock of all makes, such as Indians, Harley-Davidsons, Excelsiors, Pops, Reading-Standards, Merckles and 4 cylinder Hendersons. All are in A-1 condition and fully equipped. If interested in buying a motorcycle, write for our complete list giving description and prices, which is about 1/2 of their real value. \$225 new 1915 twin cylinder Flanders motorcycles, \$138.50. Catalogue upon request. Gotham Sporting Goods Co., 57 Warren St., N. Y. City.

INDIAN Motorcycle. Must sell or trade. Bargain. S. J. Griffin, Ogden, Utah.

BRAND new motorcycles, standard makes, on easy terms—descriptive circular free. Smith, 610 Center St., Brockton, Mass.

MOTORCYCLES, accessories, repair parts for all makes. Thousands of dollars given away by our special profit sharing plan. Write for it. Motorcycle Parts Mfg. Wks., 2127 Michigan Avenue, Chicago.

\$50 TO \$150 buys the best motorcycles; every make and model in our large stock must be cleared. Half price. Send for list today. Brown Music Co., 3018 E. 91st St., Chicago, Ill.

FOR Sale—Second-hand Indian, Excelsior and Reading Standard Motorcycles. John G. Nuebling, Reading, Pa.

EASY terms on rebuilt motorcycles—get new list P. 1, \$25 up. Rebuilt Motorcycle Co., Brockton, Mass.

FOR Sale—1914 2-speed twin Pope. Chas. Grindrod, Belleville, Ill.

1915 HARLEY-DAVIDSON Three-speed Twin. Fully equipped. Harley sidecar. Thoroughly overhauled. Enamel like new. \$250. H. E. Seward, Jr., 23 Wales St., Rutland, Vt.

NEW motorcycles \$115—\$265. Used \$25—\$125. Knights, 3324 Locust, St. Louis, Mo.

\$225 NEW Twin 9 H. P. 1915 Flanders Motorcycles. Equipped with F. N. Tandem. A few left at \$138.50. Catalogue on request. Gotham Sporting Goods Co., 57 Warren St., N. Y.

ONE three-speed Harley-Davidson; one three-speed Excelsior; both fine shape. A. E. Bakeman, St. Cloud, Minn.

TWO-speed Thor 9, half price. \$80 Phonograph \$25. Records 10c. Box 248, Ottumwa, Iowa.

BARGAIN—1914 Harley-Davidson 5-hp. in fine running order; electric horn, good tires. \$700 if taken now. John C. Baker, R. P. D. 1, Volga, S. Dak.

SAVE one half on repairs and accessories for all makes. Get circular. Jones "The Parts Man," Brockton, Mass.

MOTORCYCLES and Accessories—Henderson four-cylinder fully equipped enamel, tires and motor just like new, \$85.00; 1915 Flying Merkel, two-speed, 9-horsepower, speedometer, light, Horn and Tandem Seat. Enamel and tires like new, run less than 300 miles, snap \$110.00; Harley-Davidson 1913 5 H. P., speedometer, light, Horn and Tandem Seat. Enamel, tires and motor in good condition, \$40.00; Indian 1915 Electric Twin 3-speed Demonstrator run less than three hundred miles, like new; Speedometer, Horn, Light and Tandem seat, snap, \$75.00; Spark plugs 25c; Grips 25c; Pedals 65c; Saddles \$2.00; Stewart-Warning Signals, regular \$5.00, for \$2.98; Pully Hims 50c; Crank Hangers \$1.75; Heigter Carbureter \$2.00. Ask for February Bargain Bulletin. 100 Motorcycles to select from. All Bargains. Largest Motorcycle store in the United States. Exchange any goods not satisfactory or money refunded. W. E. Wandersee Company, 129 Gratiot Ave., Branch Store, 2996 Woodward Ave., Detroit, Mich.

REAL Bargains—1912 Excelsior single magneto, \$50. 1912 Indian single magneto, \$50. 1910 Thor single battery, \$35. Thor belt drive, \$30. 1912 Thor 7 twin, \$80. Overhauled this winter and ready to use. Send \$10 with order. Anderson's Motorcycle Store, Batavia, Ill.

MOTORCYCLES \$25 to \$175. All makes, singles, twins, two speeds and three speeds. 200 to pick from. Write today for complete list. Free. Save \$50 by buying now. The Largest Motorcycle Store, The Lister Motorcycle Co., Cleveland, Ohio.

ALL used motorcycles at lowest prices. Buy now and save money. List Free. Steeber and Hofheins, Buffalo, N. Y.

INDIAN Motorcycles. Rebuilt machines. Written Guarantee. Write for details and price list. John Steele, 91 Broadway, Paterson, N. J.

WANTED: We pay cash for used motorcycles or take them in on exchange for new machines. Write with complete description. State condition of tires, frame, motor, make and model. Shaw Manufacturing Co., Galesburg, Kans.

USED Motorcycles from \$25 to \$200. Small deposit required. Money refunded if machine not satisfactory. Write for list today. C. H. Lang, 1704 Michigan Avenue, Chicago.

MOTORCYCLE Prestolite outfit complete, never used; cost \$19.00, sell \$14.00. Rolfe, Dorchester Centre, Mass.

MOTORCYCLE cylinders ground, fitted with new piston and rings \$5.00, guaranteed. Muncie Piston Co., Muncie, Ind.

UNUSED Flexible Sidecar with rigid attachment fittings, \$45.00. Thomas Dunham, Aurora, Ill.

BARGAINS—We have one of the largest lines of used motorcycles in the East. Get our latest list. All machines guaranteed. Lowell Cycle Shop, Lowell, Mass.

FOR Sale: Twin Indian almost new, will sell at bargain. Write Walter Powell, Fowler, Indiana.

FOR Sale: 1912 Twin Excelsior, Belt Drive Motorcycle, parts. Edward Brebis, 740 E. Hurbit Ave., Belvidere, Ill.

1914 TWIN Thor, A-1 condition, Tandem and Prest-o-Lite. Cost \$350, will sell \$140. Orle Steele, Midland Park, N. J.

DON'T buy a Bicycle Motor Attachment until you get our catalogue and prices. Shaw Mfg. Co., Dept. 27, Galesburg, Kansas.

\$40.00 TAKES 1915 Shaw Bicycle Attachment. Wm. Lawson, Deming, Wash.

SEND for list of guaranteed used motorcycles. \$40 up. Driscoll & Jeanroy, 209 West 126th St., New York City.

FOUR Cylinder Pierce Engine. Excellent bargains in motorcycles. Get list. Erwin L. Miles, Box 622, Red Lodge, Mont.

EXCELSIOR 1915 — 3-speed, electric equipped, with Pullman sidecar. \$235. Locke Cycle Store, Ravenna, Ohio.

TWIN Excelsior used one season. Asked \$125. Need money. Make offer. Claude Line, Jasper, Ind.

SEND for latest Bulletin of real Motorcycle Bargains, used and slightly used, all makes, models and prices; if you have \$25 and really want a powerful Motorcycle, send for this Bulletin; hundreds of machines at all prices, new ones on easy payments; tell us what you want and how much you can pay; we can fix you up. Peerless Motorcycle Co., Dorchester, Mass.

USED and rebuilt motorcycles—all makes. Yales \$50.00 up; Harley-Davidsons \$35.00 up; Indians \$25.00 up; Reading-Standards \$25.00 up. Get our Bulletin No. 2. W. J. Walker, 178-182 Columbus Ave., Boston, Mass.

SEND for list of used Indian motorcycles. Every one overhauled by expert workmen, and guaranteed right. Geo. H. Bachelder, P. O. Sq., Lowell, Mass.

NEW Motorcycle Book—Just Published—Motorcycles, Side Cars and Cyclecars, Their Construction, Management and Repair—550 pages, cloth, 350 illustrations. The Dealer, Mechanic and Rider will find this treatise a work of reference without an equal. Price \$1.50 postpaid. Popular Mechanics Book Dept., 6 N. Michigan Ave., Chicago.

MOTORCYCLES and bicycles at cut prices: singles and twins \$25 to \$50. Motorcycle tires \$3; automobile tires \$3. Second-hand bicycles \$5; tandems \$19. New bicycles and motorcycles at factory prices. Buy direct, save dealer's profits. Send for catalog. Deninger Cycle Co., Rochester, N. Y.

BIG bargains in second-hand motorcycles, \$25 up, Indians, Harleys, Thors, Excelsiors and Merckles. Write for description. Howard A. French & Co., Baltimore, Md.

SUPPLIES—Our big catalogue with prices lower than usual sent free to motorcycle owners. Meeco, Hammondsport, N. Y.

I HAVE two motorcycles I will sell for \$150. They are 1913 Indian and Excelsior, both in good running condition. First check for same will get bargain. Emil J. Krinsky, 1424-26 So. Michigan Ave., Chicago.

BIG bargains in good motorcycles we have taken in exchange on new ones. Send for special bargain list. Shaw Mfg. Co., Galesburg, Kansas.

WANT to sell your motorcycle? I have a method which has sold many. Write me today for free information. F. W. Johnson, Room 909, 78 E. Madison St., Chicago.

1914 EXCELSIOR, two-speed, fine condition. \$150 with mechanical horn. Run about 500 miles. Raymond Tegansaw, R. F. D. Utica, Ill.

#### WELDING

ATTENTION, Manufacturing concerns, Automobile Manufacturers, Garage, Repair men and Welding Shops. Why weld, when So-Luminum, the newest, strongest great discovery in aluminum solder, does the work in quarter the time and expense of welding broken crank cases, manifold pipes, etc. Runs low temperature, used with gasoline torch. No flux. Tested and used by U. S. Navy, Vickers Ltd., International Motor, Locomobile, Packard, Pierce-Arrow, Simplex and other leading Automobile, Aeroplane and Manufacturing companies and Welders. \$3.50 per lb.; sample bar, \$1.50. Write for Booklet S, So-Luminum Mfg. & Eng. Co., Inc., United States Rubber Co., Bldg., 1790 Broadway, New York. Sole Manufacturers and Distributors.

BRAZING Torches forty cents each. Welding Torches ten dollars each, postpaid, guaranteed. Auto Welding Company, Omaha, Neb.

COMPLETE Acetylene Welding Equipment, including gas, \$58.50. Tanks loaned in Central West. Write for printed matter. S. Campbell, 819 Cass Ave., St. Louis, Mo.

OXY-ACETYLENE Welding and Cutting is the title of a brand new practical instruction book on the methods of doing this work. It includes the operation and care of Acetylene Generating Plants and the Oxygen Process for removal of carbon. 200 pages, 76 illustrations, pocket size, cloth, \$1.00; leather, \$1.50 postpaid. Popular Mechanics Book Dept., 6 N. Michigan Ave., Chicago.

WELDING Plants, \$25 to \$250. Liberal terms. Write Berno Co., Omaha, Neb., U. S. A.

## AERONAUTICS

**BARGAIN** Sales in New and Slightly Used Aeroplanes, Motors and Accessories. The Aero Mart, Department G, 327 South LaSalle Street, Chicago.

**YOUR** Ideas may bring you wealth, if patented through credit system. Send sketch. Free search. Book free. Waters & Co., 5103 Warder Bldg., Washington, D. C.

**WRITE** for our special flight course; we furnish machines and dates for our students. Spruce Ash finished parts and metal fittings to order. Northern Aircraft Co., 311 Center Ave., Bay City, Mich.

**GET** our 1916 Aeroplane Book containing full information about "Ideal" Model Aeroplanes, parts, plans, etc. 5c postpaid. Ideal Aeroplane Co., 82½ West Broadway, N. Y.

**THE** Benedict School of Aviation announces a new Correspondence Course. A thorough training in Aeronautical Construction and Engineering. For particulars write The Benedict School of Aviation, Correspondence Department, 1201 Webster Building, Chicago, Ill.

**BICYCLE** monoplane plans 25c, frame work \$10. Elmer Hamann, Raspsburg, Md.

**NEW** and used Balloons and Parachutes. Walter Raub, Danville, Ill.

**BEST** and lowest priced aeroplanes, motors and propellers. Bates, 104 Oak, Chicago.

**TURNBUCKLES:** all sizes, immediate delivery. National Aeroplane Co., Machinery Hall, Chicago, Ill.

**EVERYTHING** aeronautical, bought, overhauled, sold. Oxyacetylene welding. Elmer D. Pendleton, North Fond Du Lac, Wis.

**FOR** Sale—Used Aero Motor, 60 H. P. L. B. 473, Harlan, Ia.

**AEROPLANE** Models, Supplies, Motors, and parts. Send stamp for catalogue. McCutchen Aero Co., 2043 West Tioga Street, Philadelphia, Pa.

**BLERIOT** Type Monoplane. Fine Shape. Hawley, Box 161, Oronogo, Mo.

**LIGHT** Weight Gasoline Engines, 2½ lbs. Guaranteed ½ H. P. The Weiss Co., Torrington, Conn.

**AVIATION** Motors, all makes, up to 150 H.P., \$250 up. Complete aeroplanes, all types, \$500 up. State your needs. Aero Exchange, 33 Park Row, N. Y. C.

**CATALOG "H"** off the press, most complete aeronautical catalog ever published, sent for 6 red stamps. Motor Catalog, 8c; propeller catalog, 6c. Heath Aerial Vehicle Co., Chicago.

**BUILDING** and Flying an Aeroplane—160-page handbook covering the building of small models and full sized gliders and machines. In both biplane and monoplane models the well-known Curtiss and Blériot types are followed. Fully illustrated with detail drawings. Price, \$1 postpaid. Popular Mechanics Book Dept., 6 N. Michigan Ave., Chicago.

**HOW** to Make a Biplane Glider—Our book "Amateur Mechanics No. 2" contains a complete detailed description of how to make one. Price of book 25c postpaid. Popular Mechanics Book Dept., 6 N. Michigan Ave., Chicago.

## BOOKS AND PERIODICALS

**"URIBE'S** Master Key," recognized as the most successful self teacher of Spanish ever offered to the public. It contains the three model conjugations of the 9,000 regular verbs printed in two colors with complete list of the irregular verbs fully conjugated and translated, being the only book by which one can learn to pronounce correctly without aid. The convenient size of the book permits it to be carried in one's pocket and may be consulted at all times. Any one interested in learning Spanish should not miss this opportunity. Mailed to any address upon receipt of one dollar. The Geo. F. Garfield Co., 315 Washington Bldg., Los Angeles, Cal.

**DRAFTSMEN** and Engineers—Send stamp for sample copy of "The Compass," devoted to topics of interest to the Drafting and Engineering professions. Room 304, McLachlen Building, Washington, D. C.

**BUILD** Yourself a Boat, a Racing Cat or Speed Launch. Send for catalog, Yacht and Boatbuilding Books. Read "The Builder," the Magazine for Yachtsmen. The Rudder Publishing Co., 256 West 34th Street, New York, N. Y.

**BOYS**—16c brings large 9x12 Boys' magazine, one year. Canada 20c. Dandy stories, mechanics, stamp electros. Country-boy Magazine, 2122 Mailers Bldg., Chicago.

**INTERESTING** Book revealing Character Reading, Palmistry, Astrology, Indian Secrets, etc., 10c. G. Elser, Owosso, Mich.

**SHOE** Repairing Self Taught. It's easy, interesting, profitable. Price, fifty cents. W. J. Shuman, North Second Street, Chambersburg, Pa. Write for contents.

**ROPE** Splicing—knots—hitches—rigging—complete handbook 100 illustrations 10c coin. G. Brady, 764 Jackson, Chicago.

**PRACTICAL** Hand Books. Automobile Troubles—Gas Engine Troubles—Electric Starters—Ignition and Valve Setting tables. Send for complete catalog. Charles C. Thompson Co., 509 Plymouth Court, Chicago.

**USED BOOKS**—Extraordinary Bargains. Catalog. Higene's, A-2441 Post, San Francisco.

**METAL** Work and Etching—A 20-page hand book for art metal workers telling how to make a great variety of useful and ornamental objects, such as desk sets, artifacts, jewelry, etc. Price, 50c postpaid. Popular Mechanics Book Dept., 6 N. Michigan Ave., Chicago.

**ENGINEERS'** questions and answers for license, by Hobson, for twenty-five cents, postpaid. Send stamps. Reilly's Book Store, Philadelphia, Pa.

**BINDER** for Popular Mechanics magazines. Best adjustable magazine binder on the market made especially to hold any number from one to six copies of this magazine with name "Popular Mechanics" in gold letters on front cover. No laces or cutting or perforating of pages necessary. Simple, unique adjustment; handsome, durable and neat. We buy in quantities and can offer our readers this regular \$1.50 binder for \$1.25, all shipping charges prepaid. Address Popular Mechanics Book Dept., 6 N. Michigan Avenue, Chicago.

**READ** these great books about the War: 1. Germany and the Next War, by Gen. F. Von Bernhardi (discloses Germany's war plans for crushing England and France. Price 85 cents). 2. Secrets of the German War Office (by A. K. Graves, for twelve years a spy in the Kaiser's service. Price \$1.50). 3. Germany's Fighting Machine (by E. P. Henderson. Divided into three parts. The War, The Army and The Navy. Price \$1.35). 4. Men Around the Kaiser (by F. W. Wile. Tells about those men who figure most prominently in the affairs of Germany at the present time. Price \$1.35). 5. The Germans (by I. A. R. Wylie. A graphic picture of the German people on the eve of the great conflict. Price \$2.15). 6. The War and America (by Hugo Munsterberg, the great German-American. Price \$1.10). 7. War's Aftermath (a study of the deterioration of the quality of stock occasioned by the lamentable waste of war. Price 85 cents). Popular Mechanics Book Dept., 6 N. Michigan Ave., Chicago.

## EDUCATIONAL AND INSTRUCTION

**FREE** Slide Rule. Will give absolutely free Slide Rule to every purchaser of my book, "The Slide Rule Simplified," 64 pages, 100 actual illustrations showing just how to set the slide rule (with explanation) for the solution of any problem, written so you can understand it; price \$1 while they last. This offer is for 30 days only, to introduce my book. Our slide rules are the only ones that will add and subtract numbers as well as multiply or divide them, besides performing all the other calculations of ordinary slide rules. Send postal for descriptive literature. Richardson Metal Slide Rule Co., Established 1908 (Made in U. S. A.), 4210 W. 24th Place, Chicago.

**YALE** Drafting School. Post Office Drawer 143, New Haven, Connecticut. New, up-to-date method of correspondence instruction in Drafting and Machine Design. No money down. No money in advance. Full particulars upon request.

**DETROIT** Technical Institute offers courses university grade in Automobile, Chemical, Electrical, and Mechanical Engineering, Law, Accountancy, Business Administration, Pharmacy, Salesmanship, Advertising, Real Estate, Credits, and Watchmaking. Bulletin free. Address Director of Education, Room 311, Y. M. C. A., Detroit, Mich.

**MOULDS** and models for ornamental casting of novelties, statuary, garden furniture, in cement, plaster, Italian marble, etc. Free illustrated catalogue displaying large assortment. Roth, A-45 Frost St., Brooklyn, N. Y.

**LEARN** to Draw! Big demand for illustrators, cartoonists, designers. Many of our students secure positions before completing course. Personal instruction, correspondence or local. Artist's outfit free. Send 6c for illustrated book. Washington School of Art, 971 F St., Washington, D. C.

**STUDY** Bacteriology, Public Health, Hygiene and Sanitation. Positions pay \$3,000 to \$5,000. Interesting home study course. Previous experience unnecessary. Degree granted. We help secure positions. Write for prospectus, American College of Bacteriology, Dept. 200, Chicago.

**CLIMBERS'** Correspondence Course in English. Individual attention by experienced teacher. All written work corrected and returned. No books to buy, 30 lessons \$10.00. First exercise corrected free. M. George Wright, Box 535, Chicago.

**SHORTHAND**—If you are honest, ambitious, have a grammar school education, you can secure a thorough knowledge of shorthand without expense for board or tuition. Mosher Shorthand Publishing Company, 2167 Sherman Ave., Omaha, Nebr.

**GERMAN** Magazine for Americans. Vocabulary. Well illustrated, fascinating, extremely simple. Send 50c for trial subscription. Two years 75c. "Nah & Fern," 330-332 Webster Ave., Chicago.

**SCIENTIFIC** Laws of Memory, Health and Personal Attractiveness—Simple—Practical. Send 20 cents. Trimount Supply Co., 56 Bromfield St., Boston, Mass.

**TINNERS!** Send 3c cent coin for Elbow Chart, Cloth 15x18, Protractor, Circumference table, complete instruction. Will make 30 patterns in 90 degrees and 65 separate elbows; in all diameters, any sweep in throat. Two, Three, Four and Five pieces. The Osborne School, Box 371-H, Springfield, Mass.

**BE** a Proofreader. Big demand. Salaries \$18 to \$35 weekly. Send \$1 for First Lesson, Charts, and Key. Capital Correspondence Course, 720 Ninth St., Washington, D. C.

**POOR** handwriting easily and quickly changed to good. Particulars free. Address D. R. Jones, Paducah, Ky., Route 3.

**WE** publish "past examinations" in twenty subjects—any state—with answers; send for catalogue. U. S. Bureau Examination, E. A. S., Box 80-3, Rochester, N. Y.

**CARRY** a Gilson Pocket Slide Rule (Patented). It will solve any mathematical problem rapidly and accurately. Price with complete instructions, 50c. Circulars free. Gilson Slide Rule Company, Niles, Michigan.

**\$10.00 PER** day made laying Tile. Mosaic Tile laying taught in one lesson. For particulars address Tile Dept., 609-10-11 Oxford Bldg., Chicago.

**ARTIFICIAL** Marble, Sanitary flooring, ornamental casting, concrete, plaster, papier-mache, interior decorations, garden furniture, statuary, life casting, elastic moulds, electro bronze depositing (immensely profitable work), complete instructions \$1; particulars. 200 illustrations free. Mahler, D-117 Russell St., Brooklyn, N. Y.

**STAMMERERS!**—Let me cure you at home. New, sure method. Expense small. Results permanent. Write immediately. My terms will please you. R. Arnaud, Keene, N. H.

**EXPERIMENTS.** A new 256 page book that gives practical information for building simple, efficient apparatus at small cost, conducting tests and experiments, establishing a laboratory and applying the best experimental methods. Shows you what you can do with your own brains and hands. Both amateur and commercial work is covered. Send for complete description free or book itself sent postpaid upon receipt of price, \$1.50. Popular Mechanics Book Dept., 6 N. Michigan Ave., Chicago, Ill.

**WANT** to secure a marine or steam engineers' license? For that great class of ambitious and hard working men, the oilers, coal-passers, watertenders, firemen or anyone who wants real practical and useful information regarding the every-day operation of a steam plant, Chief McAllister of the U. S. Revenue Cutter Service has written an engineering story called "McAndrew's Floating School," that makes it possible for those who have not had previous training to absorb the necessary information. Cloth, 250 pages and 37 diagrams. Price, \$2. Popular Mechanics Book Dept., 6 N. Michigan Ave., Chicago.

**PREPARE** for commission in Organized Militia or Continental Army. Kilburn's Military Quiz-Compend. One dollar. Dale Kilburn, Quincy, Ill.

## TRADE SCHOOLS

**THE Benoit School of Aviation** announces a new Correspondence Course, A thorough training in Aeronautical construction and Engineering. For particulars write The Benoit School of Aviation, Correspondence Department, 1201 Webster Building, Chicago, Ill.

**PLUMBING, Heating, Brick and Tile** laying taught from practical work on jobs; only school where you can get a thorough training. Litchfield Trade School, Area, Ill. Write for particulars.

**ELECTRICITY, Plumbing, Bricklaying, Mechanical, Architectural and other Drafting Courses.** Motion Picture Operating taught by practical work. Largest, best equipped practical trades school in America. Short time to learn. Small cost, easy payments. Write for big illustrated book; it's free. Coyne National Trade Schools, Dept. 8192, Chicago, Ills.

**COME to Seattle**, the gateway to Alaska and Orient. Learn practical electrical, gas, steam engineering, mechanical drawing, machine-shop practice, automobile construction. Splendid openings for ambitious students when competent. Seattle Engineering School, Seattle, Washington.

**NEW Handy Manual on Plumbing, Heating, Ventilating and Mechanical Refrigeration.** A practical book for practical men. 380 pages fully illustrated with cuts and diagrams. Pocket size. Cloth. Price, \$1.15, postpaid. Popular Mechanics Book Dept., 6 N. Michigan Ave., Chicago.

## TELEGRAPHY

**TELEGRAPHY—Morse and Wireless—**taught at home in half usual time. The Omnigraph Automatic Transmitter combined with sounder or buzzer sends you messages, any speed, just as expert operator would. Used by U. S. Gov't to examine all applicants for licenses. Trifling cost. Catalog free. Omnigraph Mfg. Co., 41-G Cortlandt St., New York.

**TELEGRAPHY—Morse and Wireless—**also Station Agency taught. R. R. and Western Union wires and complete Marconi Wireless Station in school. Graduates assisted. Marconi Co. employs our wireless graduates. Low living expense—easily earned. Largest school—established 40 years. Investment \$25.000. Correspondence courses also. Catalog Free. Dodge's Institute, 15th St., Valparaiso, Ind.

## PICTURES, POSTCARDS, PENNANTS

**JOIN biggest Exchange in existence.** Exchange cards, letters. Results guaranteed. Join now. Membership 15c. Popular Exchange, Box L, Windsor, N. C.

**MEMBERSHIP printed immediately 10c.** Pacific Card Exchange, Bryn Mawr, Wash.

**OIL field views of oil gushers, gas blow-outs, 16 views on postcard 10c.** T. A. Mullen, Lenzburg, Ia.

**EXCHANGE pretty postcards with our members far and near.** Best card club. Membership, 10c. Jolly Card Exchange, Eighth St., Decatur, Indiana.

**If you really want to exchange postcards, try our splendid club.** Lists circulate in many countries. Membership, 10c. Halcyon Club, Box 133, Erie, Pa.

**POSTCARDS from everywhere.** Join our Jolly Club. Send 10c. H. J. Teeple, Decatur, Indiana.

**200 ILLUSTRATIONS Free.** Beautiful art cards. Mahler, K-117 Russell St., Brooklyn, N. Y.

**3,000 SELECTED Cartoons for \$2.** A Panorama of World Events, Political, Industrial—Social—Humorous—Tragic—all of intense human interest. A wonderful collection of 3,000 cartoons reproduced from the newspapers of the United States, Canada, Mexico, Cuba and the cities of the Old World, has been made by Cartoons Magazine from more than one hundred and fifty thousand published cartoons, and bound in an artistic and durable cover, are now ready for your library table. Vol. I, Jan.-June, 1912—\$1. Vol. II, July-Dec., 1912—\$1. Vol. III, Jan.-May, 1913—\$1. Cartoons, 78 E. Madison St., Chicago.

**CROSS-SECTIONAL view of ocean liner "Britannic,"** showing interior arrangement of ship in colors, size, 14x20 inches, on heavy plate paper for framing or hanging. Very interesting. Reproduced from front cover design of July issue Popular Mechanics. Will be sent postpaid to any address in the world on receipt of 4 cents in stamps to cover packing and mailing. Popular Mechanics Magazine, 6 N. Michigan Ave., Chicago.

## CAMERAS AND PHOTO SUPPLIES

**DON'T Cry Over Spilled Milk.** Send your next batch of films to us. We'll develop and print them in an expert manner and charge you no more, maybe less, than you've been paying. Why not ask us for samples and prices? Barbeau's, 27 East Bridge St., Oswego, N. Y.

**FILMS developed 10c.** all sizes. Prints 2 1/4-3 1/4, 3c; 2 1/2-4 1/4, 3 1/2-3 3/4, 3 1/4-4 1/4, 4c; Post Cards, 50c doz. Work guaranteed and returned 24 hours after receiving. Postpaid. Send negatives for samples. Girard's Commercial Photo Shop, Hobbroke, Mass.

**FILMS developed—Roll and 6 prints 25c.** 10c per Roll. Kodak Studio, 4039 Easton Ave., St. Louis, Mo.

**If you have a High-grade Camera, Lens, Kodak, or Motion-Picture Camera,** and want to turn it into cash, write us today. State particulars, price, etc. We buy and trade, sell or exchange everything in Cameras from Vest Pocket to Graflex. Prompt, satisfactory service and a square deal to all. David Stern Co., 1047 M W. Madison St., Chicago, Ill. In business since 1885.

**FILMS developed, 10c; prints, 3c to 5c.** A reputable Incorporated Company conducting largest existing plant. Price list and special offer. Enlargements our specialty. Chicago Photo Finishing Co., 51 W. Lake St., Dept. A, Chicago.

**HIGH Grade, artistic developing and printing.** Prompt service. Guaranteed work. Price list. Robbins Studio Shop, Harwich, Mass.

**CUT Rate Bargain List for January** just out. Send stamp. Willoughby, 810 Broadway, New York City.

**LEARN "Opaque" Photography,** the new plateless process, worked with focusing cameras without special apparatus. Stamp brings sample and particulars. Leroy Parker, Box 164, Telluride, Colo.

**FREE.** Sample print from your negative. Films developed 10c. Prints, 3 and 4c. Price list. Hall Photo Finishing Co., Dept. C, Chapman, Kansas.

**SUBSCRIBE to Photo-Era Magazine.** Best of all. \$1.50 year. Copy with club-offers, five cents. 383 Boylston St., Boston, Mass.

**I GET One to Six Dollars each** for coloring photos. New Russian Oil process easily learned. Beautiful results like professional work. Complete instructions, list of materials, \$1.00. Pierce Studio, Ottumwa, Iowa.

**WE buy, sell and exchange.** Bargains in Microscopes, Telescopes, Binoculars, Cameras, etc. Bargain list sent. Kahn & Son, Opticians, No. 54 John St., New York. Established 62 years.

**A POSTAL** will bring you our Free Kodak Finishing Coupon. Send for it Now. Kodak Finishing Company, 3157 Indiana Avenue, Chicago.

**"RAYDIUM Photolights"** make winter photography dead easy. This month—a "Simplex" Flashlight Free on Dollar orders for Photolights. Money-back Guarantee. Photo Chemical Co., Lincoln Park, Chicago.

**ENLARGEMENTS: 8x10, 19 cents; six, \$1.** Ashton Photo Works, Ashton, Ill.

**GET my tanks, make big money** developing films. Cost 1/2c per roll. Particulars free. S. H. Gilbert, Roscoke, Wis.

**ROLLS developed, 10c.** prints 3c. All sizes. Ideal Photograph Co., Winston-Salem, N. C.

**FIRST Film developed, with prints, 10c.** Crown Photo Supply, Box 216, Ottumwa, Iowa.

**REMARKABLE Process** enables you to make exquisitely colored photo prints with ease. Complete outfit \$1.50. Large size \$2.00. Money-back basis. Photokrome Company, Box 113, Scranton, Pa.

**ROLL Film developed free.** Prints, 2c to 3c. Post cards, 5c. 8x10 Negative Enlargements, 20c; 6, \$1.00. Get Price List. Sprauer, Stahlheber Road, Hamilton, Ohio.

**LET me finish your next roll of Kodak Films.** Send 10c for trial order. Slocum, 466 Main, Peoria, Ill.

**SEND us six of your favorite negatives,** any size, and 10c (stamps) for 6 prints. Or send any size roll of film for development and 6 prints for 10c. 10-inch mounted enlargements 25c. Mention this ad. Rosnoke Cycle Company, Rosnoke, Va.

**KODAK Films Developed, 10c per roll,** any size. Prompt attention given mail orders. Prints, 2 1/4x3 1/4 to 3 1/4x4 1/4, 3c. 4x5 to 3 1/4x5 1/4, 4c. J. M. Manning, Box B, 1062 Third Ave., New York City.

**BIG Money Saved on Photographic Lenses and Apparatus—goods exchanged; repairing done.** Ralph J. Golsen, 5123 Kenmore Ave., Chicago, Department P.

**HAVE you a Camera? Send a quarter,** just half price, for latest issues of my three helpful magazines, American Photography, Popular Photography, Practical Photography. F. R. Praprie, 702 Pope Bldg., Boston, Mass.

## MOTION PICTURES

**SPOT cash paid for second-hand high-grade Motion-picture Cameras, Lenses, etc.** Write us today. David Stern Co., 1047 W. Madison St., Chicago, Ill.

**MOTION Picture equipment at bargain prices.** Box 417, Montpelier, Vermont.

**MAKE big money writing moving picture plays.** Previous experience, literary talent or correspondence course unnecessary. Free details and special offer. E-Z Scenario Co., 609 West 127th St., New York.

**WRITE Photo-Plays, Instructions, Markets, 25c.** Write Plays, Sketches, Instructions, Markets, 25c. Both 40c. E. L. Gamble, Playwright, East Liverpool, Ohio.

**BIG Money Writing Moving-Picture Plays.** Constant demand. Correspondence course; literary ability unnecessary. Write for free booklet, "How to Write Moving-Picture Plays." Universal Publishing Co., 204 Fergus Falls, Minnesota.

**ELECTRIC Arc Generator.** Anyone can operate from engine. Reduces your lighting bills. Sold on easy terms. Hobart Brothers, Troy, Ohio.

**LOS Angeles World's Picture Producing Centre.** Thousands Photo Plays Needed. Complete course now sent for 25c prepaid. Particulars free. Emel Co., Box 1608, Los Angeles, Calif.

**BE a Motion Picture Operator and earn big money for short hours, easy, pleasant work.** We teach by practical work on the finest equipment. Write for free catalog. Coyne Trade Schools, Dept. 7192, Chicago, Ill.

**BIG money writing Photo-plays; details free to beginners.** No correspondence course. Producers League, 230 Wainwright, St. Louis.

**MAKE \$50.00 clear nightly.** We start you in the moving-picture business on the installment plan. No experience necessary. Write for free catalog. Monarch Film Service, Dept. P, Memphis, Tenn.

**WRITE Photoplays, Short Stories, Poems.** Big demand. No correspondence course. Start writing and selling at once. Details free. Atlas Publishing Co., 304, Cincinnati.

**MOTION Picture Films for sale, \$2 reel up.** Box 417, Montpelier, Vermont.

**MAKE a complete Motion Picture Camera and Projector from instructions given in our book Amateur Mechanics No. 4.** Full details given. Not hard to construct. Worlds of enjoyment taking and exhibiting subjects dear to the heart. Price of book only 25c, postpaid. Popular Mechanics Book Dept., 6 N. Michigan Ave., Chicago.

**WRITE Photoplays—Earn a big income.** Our book tells how. Details free. Enterprise Co., PM-3348 Lowe Ave., Chicago.

**MOTION Picture Work—A large 618-page book** covering every phase of the moving picture, its production and its theatre. Indispensable for reference and instruction to the thousands of workers in the motion picture field. Price, \$3, postpaid. Popular Mechanics Book Dept., 6 N. Michigan Ave., Chicago.

**HOW to Write Photoplays is a brand-new volume** devoted to motion-picture playwriting. Contains model scenario, a list of 35 scenario buyers, and all information necessary. Price 35c. Photoplay Pub. Co., PM-3348 Lowe Ave., Chicago.

**\$25 PROFIT Nightly—Moving Picture Business—small capital starts you, no experience needed.** Teach you—furnish everything. Ralph J. Golsen, 5123 Kenmore Ave., Chicago, Dept. M.

## BUSINESS OPPORTUNITIES

**LEARN** a business that will pay from \$3,000 to \$5,000 yearly; taught in a few weeks at your home, small expense; no further capital required, no job hunting, goods to buy, soliciting or agency, but a fee-earning, professional business for yourself, easily learned by anyone, openings everywhere with all the trade you can attend to. Apply by letter to Stephenson Laboratory, 5 Irvington St., Boston, Mass.

**HOW** would you like to sell a formula to a certain class of merchants throughout the United States for one dollar each? This is your opportunity to get a start in the Mail-Order business. Formula and full instructions 25c. The Itaska Company, Box 64, Norwich, N. Y.

**READ** Good Results—Greatest Mail Dealers—Agents' Magazine published. Two big issues 13c. Good Results, 156P, Washington, Chicago.

**MAKE** Big Money. Start your own Metal Weather Stripping Business. We will show you how and furnish everything. Write today. Morgan, 2218 Pine St., St. Louis, Mo.

**MARKET** Your Spare Moments intelligently; profitably; commercial information wanted; exceptional opportunity without canvassing. "Cico," PMC, Evansville, Indiana.

**OWN** your business. My plan successful. Big profits. Permanent business. Kightlinger, Wayne Ave., East Orange, N. J.

**\$6.50 STARTS** Premium Toilet Goods Business similar to Crofts and Reed. For 10c I'll send sample circulars with source of supply. "Expert," 2511 N. Klidare, Chicago.

**ESTABLISH** a permanent Mail Order Manufacturing Business of your own. "Chemical Service" tells how. Personal guidance of experts available in confidential way. Particulars free. Chemical Service, 1681 East 86th Street, Cleveland, Ohio.

**I MADE** \$50,000 in five years with a small mail-order business; began with \$5 in my own home. I will show you how to do the work; no canvassing. Send for free booklet; tells how. Hancock, Box 867, Lockport, N. Y.

**ANYONE**—Make money—renew old dry batteries. Guaranteed formula, 24 other valuable money makers 25c. Northern, 154 Randolph, Chicago.

**SILVERING** mirror formula and 150 other money-making formulas and Digest, one year, 25c. Digest, Grand Rapids, Mich.

**\$25 TO \$100** a week to reliable representative in every city. Address Dept. M, 108 Security Bldg., Davenport, Iowa.

**TWO** years ago I was \$400 in debt; starting with one advertisement in a Cincinnati newspaper, I have transacted a business of \$53,000. I can prove it. Ambitious men write for my valuable free book; it will start you on the road to success. Perry Gosley, M114, Frankfort, Indiana.

**I PUBLISH** a wonderful magazine of money-making plans, ideas, suggestions and inspiration! It will show you how to make more money. Sample copy, 10c. Editor, Booster Magazine, Northwestern Bldg., Chicago.

**OPERATE** success-proven mail business under guarantee by reputable corporation—established eleven years. Everything furnished—no stock to carry. Save money—avoid mistakes. Merford Company, Incorporated, Dept. 156, Chicago.

**CANDY** making a profitable and pleasing trade. Be your own employer. Our Candy Book tells how, 25c. Auburn Supply Co., Dept. 2C, 1817 Peoria St., Chicago.

**BIG** Kansas Company will start ambitious people in fast-growing mail-order business; any locality; make \$3,000 yearly; spare time; no canvassing; no experience; we furnish everything. New, unique selling methods free. Eveson, Pres., 621 W. 7th, Pittsburg, Kansas.

**EARN** \$100 weekly managing clean, legitimate mail-order business. We furnish everything. Right party need not worry about capital. Splendid chance for intelligent, employed person to control independent business on profit-sharing basis, beginning in spare time, evenings at home. Particulars free. Opportunities Exchange, Buffalo, N. Y.

**WITH** a mould of Pres. Wilson or Lincoln and Plastography instructions, you can produce beautiful plastic medallions 5/8x 5/8 inch ovals framed. Remit \$1.00. P. B. Spahr, York, Pa.

**START** a legitimate business of your own, look after it evenings. A small or large amount invested in our proposition will net you from two hundred to five hundred per cent. Write for particulars and territory. We can easily substantiate our claims to parties who are interested, and also give ample proof of our business and financial standing. National Novelty Company, Minneapolis, Minn.

**EARN** five dollars a day coloring photographs and prints. Any person can easily learn this beautiful art. Fascinating, pleasant, money-making home work. Regular or spare time. Complete, practical instructions and materials furnished. Send today for free booklets giving full particulars. The National Arts Company, 1223 State Street, Alpena, Michigan.

**SPLENDID** business opportunity; manufacture advertising signs, paint them by machinery—on metal, wood or cloth. Machine for sale. Bargain. Investigate. H. A. P., 222 Wall St., Shreveport, La.

**361 SUCCESSFUL** Business Men want to tell you how to "Build Your Business by Mail." B. Newham, Waukegan, Ill.

**SPOT** cash paid for second-hand, high-grade cameras, lenses, Kodaks, Motion-Picture Cameras, Microscopes, Binoculars, Surveyors' Levels, Transits, etc. David Stern Co., 1047B W. Madison St., Chicago, Ill.

**WANTED**—Men of good character, aged 20 to 60, for my special realty representatives. Experience unnecessary. (We teach you the Real Estate business.) Digitized work. No canvassing. Part or whole time. Make money while learning. McDonnell, Dept. 161-Y, 1426 You St., Washington, D. C.

**INVENT** something; your ideas may bring wealth; our free book tells what to invent and how to obtain a patent, through our new credit system; write today. Waters & Co., 4102 Warder Bldg., Washington, D. C.

**START** a mirror factory at home. We teach and trust you; 10c brings sample lesson; Prospectus; your choice of 30 distinctive and exclusive lines of profitable business \$10 to \$25 daily, easily. Hallinger's Institute Mec., Francesville, Ind.

**CONDUCT** a "Candy Kitchen"—Clear \$10 daily; practically no capital required; booklet free. The Kennon School, 142 W. Ontario St., Dept. A, Chicago.

**NEW** Way to Paint Signs—Our patterns do the work. Complete alphabet 50c. Butts Advertising Co., 15 W. 10th St., Kansas City, Mo.

**START** Profitable Mail-Order Book Business. Catalogue and further information sent for stamp. Sheridan Company, 417 E. 151st St., New York.

**MAKE** Jumbo Salted Peanuts, complete plan FIFTY Cents. Reynolds, State College, Pa.

**BIG** Profit Growing Ginseng and Golden Seal. Reliable information and book on culture 10 cents. Rising Sun Ginseng Nursery, Box 225, Narrows, Ky.

**START** a Profitable Contracting Business on \$1.00 capital. Earn \$5.00 daily. Experience unnecessary. Write immediately for special try on approval offer. Greenhalgh, Contractor Brightwood, Indianapolis.

**WE** will start you in the cleaning and dyeing business. Little capital needed, big profits. Write for booklet. Ben-Vonde System, Dept. C, Charlotte, N. C.

**RESILVERING** Mirrors, Renewing Dry Batteries, and book chock full of formulas, 25c. "Ideal," 3311-B, Belleplaine Ave., Chicago.

**WE** start you in business, furnishing everything; men and women, \$30.00 to \$200.00 weekly operating our "New System Specialty Candy Factories" home or small room anywhere; no canvassing. Opportunity lifetime; booklet free. W. Ragsdale Co., East Orange, N. J.

**LARGE** Profits operating Mail Order Book business. Small outlay required. For particulars write Rollins, Box 5272, Boston.

**555 MONEY-MAKING** Formulas, 10c. Process Company, 415 Ft. Dearborn Building, Chicago.

**"HIRE** Yourself as Boss." Big corporation will back you in Money-Making Mail-Order Business selling guaranteed Goods. Start spare time. Small capital. No canvassing. Wm. J. Dick, Mgr., Dept. F-10, 20 W. Lake St., Chicago.

**"DOLLARS"** yearly in your back yard. No ginseng, mushrooms dope. New ideas never before published, particulars free. Metz, 313 East 89th St., New York.

**MAIL** order leader of the season—" \$1,500 Yearly Average Wage," fastest selling booklet ever written. Every copy sold sells several more. Like an "endless chain," it brings you thousands of live names and addresses, accompanied by coin. Helps your sales of other goods. Sample and complete proposition, 10c. Jack Pansy, Author, Box M-307, Grand Rapids, Mich.

**500 MONEYMAKING** formulas, trade-secrets, 10c. "Ideal" 3311-B, Belleplaine Ave., Chicago.

**PATENTABLE** ideas wanted—Send for 3 free books. R. B. Owen, 30 Owen Bldg., Washington, D. C.

**WRITE** Photographs, Short Stories, Poems. Big demand. No correspondence course. Start writing and selling at once. Details free. Atlas Publishing Co., 3046, Cincinnati.

**LEARN** to collect money. Good income; quick results. Send for free booklet, "Skillful Collecting." Collectors' Association, Long Street, Newark, Ohio.

**I WANT** to send you proof of the wonderful pulling power of Popular Mechanics classified pages. What's your proposition? Write me today. F. W. Johnson, Classified Dept., Popular Mechanics Magazine, 6 N. Michigan Ave., Chicago.

**START** a second-hand store. We will help you. Free particulars. E. O. Worth, Mgr., Owosso, Mich.

**PENDLETON'S** Mail Order System for beginners; stationary free. Pendleton, 104, Box 1005, Atlantic City, N. J.

**\$25,000—I MADE** it in mail order business. Had \$3 to start. No canvassing. Free Booklet tells how. Send 2c postage. Alb. Scott, Coboes, N. Y.

**START** in the carpet or clothes cleaning business now. Thurman Vacuum Process unequalled for commercial cleaning. We show you how. Easily learned. Only \$125 capital needed to earn good income in towns of 2,000 and over. Write today. Thurman Vacuum Cleaner Co., manufacturers of all types Vacuum Cleaners. Dept. H, St. Louis, U. S. A.

**IF** you work in a shop find out if the company has any lathes, turret lathes, screw machines or milling machines for sale and write me full particulars and price asked. I will pay you \$5 for each machine I buy. Pinner, 122 Water St., New York, N. Y.

**WOULD** you like to own a good-paying Mail-Order Business? We have a line that gets repeat orders all the time. You can start in spare time; invest a dollar or two a week and soon own a nice business of your own. Particulars free. Nadico, 4315 Lincoln Ave., Chicago.

**HOW** to Operate a Mail Order Business. 30 Big Profit Plans and year's Mailing service sent for 10c. Mail Dealers' Wholesale House, 521 Franklin Bldg., Chicago.

**WANT** Big Profits? Learn Tartaric Mirror Silvering. New process opens enormously profitable business. Particulars free. H. Barstow, 514 23rd Street, Oakland, Calif.

**INDEPENDENCE** and fortune quickly attained in the Manufacturing Mail Order business. I furnish Formulas, Manufacturing Processes and Trade Secrets in all lines. Sold under positive guarantee; 18 years' practical experience. Revision and improvement of Formulas and Processes—reduction of manufacturing cost—utilization of waste materials, etc., a specialty. Booklet, Formula List, and Valuable Information Free. W. L. Cummings, Ph. D., 127 Standard St., Syracuse, N. Y.

**STOP** Here! Let me start you in a home business that will bring you money every day. Experience unnecessary. Spare time. No canvassing. I furnish everything. Send for proofs. Voorhies, Desk C. R., Omaha, Neb.

**LET** the parcels post help you. Add (\$15 to \$25 weekly) to your present salary or income. Start during spare time and build up a permanent mail-order business of your own. We show you how and help you make good. No canvassing. Experience unnecessary. The Parcels Post makes success doubly sure. Our new ideas and up-to-date plans bring the money. No so-called "Course of Instruction" to sell. We give that free. Write today. Address Pease Mfg. Co., Inc., Dept. A, 79 Broadway, Buffalo, N. Y.

**ADVERTISERS,** Mail Dealers. Our 1915 Rate Book lists 2,000 Principal Publications, rates, circulation. Includes 50 Mail-Order Plans. Price 10c. Dearborn Advertising Agency, 210 Franklin Bldg., Chicago.

**MANUFACTURERS, Promoters and Patent Buyers** are invited to write us stating the line of invention in which they are interested, as we can supply their wants in any class of patents. Victor J. Evans & Co., 162 Ninth St., Washington, D. C.

I WILL start you earning \$4 daily at home, silvering mirrors; free instructive booklet. G. F. Redmond, Dept. 396, Boston, Mass.

**INVENTORS:** We develop and perfect inventions, make models, dies, tools. Metal stamping and special manufacturing. Garding Bros., Lion Bldg., Cincinnati, O.

**PERMANENT Income** operating Ball Gum Vending Machines. Particulars Free. Gum samples 10c. Rice, 7122 Normal Blvd., Chicago.

**FORTUNES** in patents do not come by chance. Learn systematic inventing. Particulars 2c stamp. Simpson, Union Building, Cleveland.

5c **ESTABLISHES** new, clean, permanent business, men or women. Alert Ideas, Drawer B, Omak, Washington.

#### BUSINESS FOR SALE

**FOR Sale**—Well established plumbing and heating business in good locality. Box 269, Bloomington, Ill.

#### TO MANUFACTURERS

**WANTED**—To hear from electrical manufacturers who are equipped for making small medical induction coils. A. G. Johnston, Sturgis, Mich.

**WANTED**—Mail-order goods, direct from manufacturers. E. H. Coultas Company, New Bedford, Mass.

**SEND** us a list of your line and we will handle it through our mail-order department, first and largest in Hawaiian Islands. Goods bought for cash, sold on commission or consignment. We issue our own catalogue printed in Japanese and English. Send terms, samples and cuts. Hawaii Hochi Shu, Publisher of Hawaii Hochi, Daily Japanese Newspaper, Honolulu, T. H.

#### MAIL ORDER SUPPLIES

**SELL** Joker's Novelties! 16 samples, 10c. Chambers Works, Plainwell, Mich.

**INCREASE** your sales. Place your proposition before the readers of "Cartoons Magazine," 20,000 copies guaranteed every month. Classified rate 2c per word. Mail in a trial ad today. Cartoons Classified Dept., 78 E. Madison St., Chicago.

#### FOR ADVERTISERS

**ADVERTISE!** 25 words in 100 months, \$1.00; in 65 weeks, \$1.50; 18 words in Ten Leading Sunday Papers (\$2,100,000), \$4.00. Advertising placed anywhere—lowest rates. Stanford Advertising Agency, Sebring, Ohio.

**REACH** 3,000 live buyers. 40 words 25c. Stamps accepted. American Youth, Box 731-E, Joplin, Mo.

**YOUR** thirteen word ad, in our 9x12 magazine reaching 20,000 boys for 25c. Extra words 2c. Country Boy Magazine, 2180 Mallers Bldg., Chicago.

**YOUR** advertisements placed in 36 different magazines for 3c per word; displayed, \$1.80 per inch; three times for price of two. List, particulars free. King's Magazine, Box 13-P, Little Silver, N. J.

**YOUR** Thirty-Word Ad, in our big post-card magazine, 25c. Inch display, 50c. Elite Exchange, 3694 Milwaukee Ave., Chicago.

**ADVERTISE** 50 magazines—\$1.00 per inch—whole list. L. M. Clark, Thomaston, Me.

**BARGAIN** Advertising rate, 20 words, one insertion, 40,000 circulation and one year's subscription 25c. Digest, Grand Rapids, Mich.

**ADVERTISERS**—Here's your opportunity. Your proposition placed before the readers of "Cartoons Magazine" for only 2c per word. Circulation 20,000 copies guaranteed. Send a trial ad for our next issue. Cartoons Classified Dept., 6 N. Michigan Ave., Chicago, Ill.

#### ADVERTISING SERVICE

**ADS,** sales-letters, descriptive circulars composed for \$1.00 up. Send particulars. Jones, Mackinaw, Michigan.

#### BUSINESS SERVICE

**CORPORATION Service System,** Clarksburg, West Virginia; Incorporates, organizes, represents companies throughout America. Expert service guaranteed.

**INCORPORATE.** Our lawyers do the work, saving you time, annoyance and money in incorporating under the most liberal laws of Arizona. Laws and forms free. Southwestern Securities & Investment Co., Box D488, Phoenix, Ariz.

**COLLECT** your own accounts. Our Automatic Self-Collection Service is guaranteed to "get" the money—without offending the Debtor—otherwise money refunded. Interesting particulars upon request. Direct-Adjustment Service, Brooklyn, New York.

**NEVADA** Charters cost less; greatest combination advantages. Operate everywhere. Charterguide free. Corporation Charter Trust Company, PM-38, Reno, Nevada.

#### AGENTS WANTED

**MEN** and Women Agents: Money talks—how much are you making? If you are earning less than \$200 a month, no matter what your locality, you will positively be delighted with our Sentinel Burglar Alarm proposition. Many agents easily earn \$15.00 daily. Brand new invention. Sells quickly on sight to homes, offices. Patented. No competition. Free exclusive territory. Instantly attached any door knob. Impossible turn knob without ringing bell. No batteries, screws, nails. Handsomely nickel-plated. Retail \$1.00. Provides cheap burglar insurance. It's a big money maker. Let us prove why. If you mean business write today for liberal terms to agents. Marshall Dobbins & Co., Manufacturers, 1422 Marquette Bldg., Chicago.

**AGENTS!** New Big-Money Winner. Something unexpected; high class; 100 years coming; here at last; wonderful scientific discovery; great household problem solved; clothes-washing ideas revolutionized; Kalamite Laundry Marvel abolishes rubbing, washboards, washing machines; Kalamite is supreme; it's a marvel; simple, sure, scientific and safe; \$1,000 guarantee; protected by trade-mark registration, etc.; valuable territory concessions; all or spare time; \$200 weekly repeat order profits. Bettens, Idaho, writes: "Rush 5,000 packages more." Women astounded, satisfied. Reputable \$50,000 manufacturing corporation. No experience necessary; credit granted; big money; whirlwind repeater; hurry; write today; get overwhelming proof; all free. Equitable Corporation, Dept. 349, 217 W. Superior St., Chicago.

**WONDERFUL** Lord's Prayer Pins. Agents, Demonstrators, Church Workers, investigate this new whirlwind seller. The Lord's Prayer, embracing 65 words or 254 letters, is accurately engraved on the tiny heads of ordinary sized small pins. They sell like wildfire. Send 25c for sample pin and be convinced. Particulars free. Fine Arts Engraving Co., Peyton Bldg., Spokane, Wash.

**AGENTS** Wanted—Man or woman for each town to sell labor-saving, heavily-bought household necessity. Sell either house to house or to dealers. Liberal commissions and other selling helps. Instantaneous seller. Season now on. A great proposition for all or spare time. Exclusive territory to earnest hustlers. Write at once. V. H. Jepson, Woolworth Bldg., New York.

**AGENTS:** Get an easy seller. Sanitary All-Metal Bread and Pastry Board and Rolling Pin is making big hit. Make \$25 to \$40 every week. Smith, Ohio, sold 38 one day. Profit \$19.00. Sells at sight. No talking necessary. Territory and general agency given. Free sample to agents. Write quick for appointment. Union Mfg. Co., 167 Main St., Cambridge, O.

\$61.50 **WEEKLY** introducing and selling a new gas light burner for kerosene lamps. Beautiful light. No chimney. No mantle. Perfectly safe. Simple in construction. Nothing to get broken or out of order. Will not burn out. Durable. Will last for years. Low price. Easy to sell. 200 per cent profit. Experience not necessary. Sample free. Why not try one on your lamp? Beware of imitations. No branch offices. Lather Manufacturing Co., Dept. 192, Cincinnati, Ohio.

**AGENTS** Wanted—Agents make 500 per cent profit selling "Novelty Sign Cards." Merchants buy 10 to 100 on sight, 800 varieties. Catalogue free. Sullivan Co., 1234 Van Buren St., Chicago, Ill.

**AGENTS**—Men and women: make \$30 to \$50 weekly selling the New Improved Monitor Self-Heating Iron—the "World's Best." Over 750,000 in use. Positively the easiest, fastest selling, lowest priced, best known iron made. Binding Guarantee. Big profits for all or part time. Evans, N. Car., sold two dozen on Saturday. Mrs. Nixon, Vt., sold eight first half day. New low terms. Exclusive territory. Sample free to workers. Write today. The Monitor Sled Iron Co., 749 Wayne St., Big Prairie, Ohio.

\$1,000.00 **FOR** your next 100 days. Spot cash. New money-making invention for agents, general agents, managers. Recently invented. 1,000,000 already sold; 200 more salesmen wanted at once. Washes tub of clothes in 6 minutes. No cranks to turn or levers to push—no rubbing. Works like magic. Price only \$1.50—makes sale at every house—200% profit. L. Palmer, Glen Allen, Ala., put out on trial 108 machines, sold 107. Profit \$107.90. Write today. Wendell Co., 292 Oak St., Leipsic, O.

**GASTINE** eliminates carbon, purifies gasoline, 30 per cent more mileage. Use one tablet each gallon gasoline, 100 tablets \$1.00. Good agents wanted. Liberal commission. Gastine Company, Bridgeton, New Jersey.

**AGENTS**—Make \$30 to \$60 weekly selling our 300 candle power gasoline table and hanging lamp for homes, stores, halls, churches; no wick, no chimney, no mantel trouble; costs 1c per night; exclusive territory; we loan you sample. Sunshine Safety Lamp Company, 926 Factory Bldg., Kansas City, Mo.

**AGENTS**—Make a big cleanup, selling our household Specials. Quick sales, \$25 to \$75 weekly a cinch. Write for colored circulars and immediate appointment. E. M. Davis, Pres., M64, Davis Bldg., Chicago.

**EASY,** pleasant work for Mechanics, Shop Men, Clerks, during spare hours, will add many dollars to their salaries. Also want persons who can give full time. Big wages assured. Novelty Cutlery Co., 67 Bar St., Canton, Ohio.

I WILL start you earning \$4 daily at home, silvering mirrors; free instructive booklet. G. F. Redmond, Dept. 396, Boston, Mass.

**AGENTS** make \$100 monthly selling our 500 handy household articles. Catalogue free. Scheff Company, Desplaines, Ill.

\$15.00 **MADE** first day by 13-year-old boy with Shomescope. Woman made \$3.00 first hour. Particulars free. Shomescope Mfg. Co., 523 W. 13th St., Kansas City, Mo.

**JUST** show them—The new adjustable floor and wall mops, dustless dusters and sanitary brushes sell themselves. Big line. Big profits. Agents write Silver-Chamberlin Co., Dept. M, Clarton, N. J.

**AGENTS**—\$5 daily selling our Handy Tool, 12 articles in one, Lightning seller. Sample free. Thomas Mfg. Company, 762 North St., Dayton, Ohio.

**MEN** and Women with spare time can earn big weekly profits by our new advertising plan. No investment. No selling. No soliciting. Write today for details for this new money maker. Crown Mfg. Co., Dept. F1, 20 W. Lake St., Chicago.

**STOP!** \$30 weekly easy. Four new articles. Fastest sellers out. Talking unnecessary. Simply demonstrate. 150% profit. Albert Co., Riverdale, Chicago.

**MANUFACTURER'S** Agents for well-known popular Home Exerciser. Furnish experience, territory desired and references. Peerless Athletic Supply Co., 383 Pearl St., Brooklyn, N. Y.

**PORTRAIT** Agents: Our goods will make you big profits. Delivery guaranteed. Rejects credited. Prompt shipments. Low prices. Send for latest catalogue and prices. Adam J. Kroll & Co., 602 Blue Island Ave., Chicago, Ill.

**AGENTS**—To handle remarkable money-makers. Many repeat orders. Particulars. Dorsa Novelty Co., 560 2nd Ave., New York City.

\$10 **DAILY** refinishing chandeliers, brass beds, etc., by new method; producing amazing results; no capital or experience necessary. Information free. Gunmetal Co., Ave. H, Decatur, Ill.

**SUBSTANTIAL** Moneymaker. Two-edged safety razor, 6 blades, \$25 per 100. Retail \$50c. Sample 25c returned. Herpa, 1626 Hancock, Chicago.

**AGENTS! 500% Profit.** \$25.00 to \$50.00 a week; that's what our agents are making selling our new metallic sign letters for office windows, store windows and glass signs. For a quick, easy money making proposition for agents, salesmen and sign painters, there is nothing to equal the selling and putting up of our new metallic letters and numbers. There is no experience necessary to put up these signs. Anyone can succeed and make money right from the start. We will send you full particulars and you will see how easy it is to make money in this business. One agent says: "Have already put up 14 signs in this little burg and more in sight. Your letters are the best thing I have seen in years. Will soon be in a position to buy in 5,000 lots." Another says: "I am getting all the work I can do and the letters have given entire satisfaction everywhere." We are daily receiving such letters from agents who have started in the sign letter business. This is the only field that is not overcrowded. There is a big demand for window and glass signs in every town. You can sell to nearby trade or travel from town to town all over the country as you please. We would be pleased to send you a free sample and full particulars. Write today. Address The Metallic Sign Letter Co., 497 N. Clark Street, Chicago, U. S. A.

**AGENTS—Send for sample "Fretnot"—**the wash day wonder. Be convinced you can do a whirlwind business. You can clear at least \$20 to \$100 weekly, according to spare or whole time. You don't have to talk, if she doesn't buy at sight, leave sample, she will be looking for you long before you are able to make the rounds again. Samples furnished free. Premiums for your customers. Exclusive territory granted to agents who can produce. Credit given. Don't call. F. M. Motter & Sons, 3215 Warren Ave., Chicago.

**AGENTS: Manufacture your own goods.** 500 Genuine money-making formulas 10c. "Ideal" 3311-J Belleplaine Ave., Chicago.

**CUT your own hair.** Most remarkable invention. Brand new. Get busy while territory is clean. Send 25c for sample and make big money. Everybody a prospect. Sommerfeld, 152 Traders Bldg., Chicago.

**NONPAREIL Shaving Mirror** on cork with calendar. Samples 5c cents. Agents wanted. Frank R. Hewett Co., 2250 Aqueduct Ave., New York.

**AGENTS—Handle an article that keeps cows from kicking or switching tail.** 100% profit. Connell Shackle Co., Hoquim, Wash.

**SOMETHING every man needs.** Write Chas. Milton Co., Hermosa Beach, Calif.

**MAKE and Sell Your Own Goods.** Formulas by Expert Chemists, Manufacturing Processes and Trade Secrets. Formula Catalogue for Stamp, B Mystic Company, Washington, D. C.

**AGENTS—Kleanol Sanitary Brushes** pay you big profits; fast sellers; big line. Get information from largest wire-twisted brush makers, Kleanol Brush Co., Inc., Dept. 1, Springfield, Mass. Branches at Omaha, Nebr.; Dallas, Tex.

**BIG Profits—New Gold and Silver Store** and Office Window Sign Letters. Will not tarnish. Anyone can put on. Free samples. Flexible Letter Co., 1642 Division, Chicago, U. S. A.

**THE "Show-Me" is the most unique, scientific, dependable low-priced clothes washer** ever produced. Large demand easily developed your territory. Large profit to you. Establish thriving business of your own. Address H-A Manufacturing Co., 4960 Wornall Road, Kansas City, Mo.

**AGENTS Wanted to sell the Metropolitan Talking Machines.** Earn from \$50 to \$100 per week easily. Write quick for particulars and territory. Metropolitan Talking Machine Co., 111 Second Avenue, Dept. 31, New York.

**BIG Textile Mills want ambitious men** and women everywhere to show latest dress fabrics, neckwear, hosiery and underwear, 400 styles. Easy sales. Values best stores. Many making over \$30.00 weekly. All or spare time. Complete sample outfit starts you. Steadfast Mills, 50 Bessens St., Cohoes, N. Y.

**MAKE Your Own Rope.** Agents wanted everywhere for New Era Rope Machine. Twenty-two thousand sold. If you are not making ten dollars per day write New Era Manufacturing Co., Plymouth Bldg., Minneapolis.

**NEW \$2.50 pocket adder.** Sell 10 daily easy. Excellent profit. Everyone buys. No competition. R. Bassett, 5921 Indiana Ave., Chicago.

**SPLENDID 30% Commission to Aggressive agent** on new liberal \$2,000 accident policy. \$5 yearly pays for injuries and sickness. Double benefits. \$10. Photo-identification (in leather case) free with each policy. Underwriters, 1345 D, Ins. Exchange, Chicago.

**GENERAL Agents—Sanitary Sugar Bowls.** Greatest 50c article. Sells everywhere. Territory free. Schoenheit & Pease, East End, Pittsburgh, Pa.

**AGENTS—Something New—Fastest sellers** and quickest repeaters on earth. Permanent, profitable business. Good for \$50 to \$75 a week. Address American Products Co., 3292 Third St., Cincinnati, Ohio.

**SIGN Letter Agents and Painters; 500% Profit** Gold and Silver Sign Letters for Stores and Office Windows. Anyone can put on. Big demand. Free samples. Metallic Letter Co., 494 N. Clark St., Chicago.

**ARE you making less than \$3 per day** and expenses? We pay every week and furnish supplies free; nothing for you to buy; no cash deposit; experience unnecessary; write today. The Hawks Nursery Co., Wauwatosa, Wis.

**AGENTS—Use our capital, jump into big permanent business; New Automatic Fuel Saver;** fits any stove or furnace; saves 25% fuel; exclusive territory. States Mfg. Co., 273 Consolidated Bldg., Chicago.

**AGENTS—\$60.00 a week.** Travel by automobile introducing 300 candle-power coal-oil lantern. Write for particulars how to earn auto. Thomas Co., 862 North St., Dayton, Ohio.

**\$7.50 COMMISSION** each sale and repeat orders; traveling salesmen among general mercantile trade; every state; weekly settlement; no competition; pocket sample. Toledo Cable Co., 44 Davis Bldg., Toledo, Ohio.

**PHOTO Pillow Tops, Portraits, Frames, Sheet Pictures, Photo Plates, Pennants, Rejects, credited.** Prompt shipments; samples and catalogues free to agents; 30 days' credit. Jas. C. Bailey Co., Desk A2, Chicago.

**WRITE for good paying position as salesman,** Albert Gloede, Suffern, N. Y.

**SOLICITORS: Make \$50 weekly;** each merchant and physician a prospect; free outfit. One man made \$145 first ten days; that was last June; he is still working. Address Secretary, 343 Wells Bldg., Quincy, Illinois.

**ROBE Ball Lock (New) Unlimited Territory.** Bonanza for Agents. Write for particulars, Inventors Sales Company, 101 Main St., Smethport, Pa.

**AGENTS—Why not make and sell your own Products?** Send 10c for six wonderful formulas and make manufacturer's and agent's Profits. Enzel Co., Box 1606, Los Angeles.

**AGENTS—50 Calling Cards** 10c. F. Shepard, Rome, N. Y.

**AGENTS: Make big money** by selling our new Auto Accessory to owners, garages and repair shops. Write for proposition. H. H. Colson, 3225 Dickens Ave., Chicago, Ill.

**STARTLING big offer for live agents:** hurry, grab now, absolutely new, big profits, free particulars, write, Lancelot Co., 6815 Anthony Ave., Chicago, Ill.

**AGENTS \$800 Line.** Double your income, 150% profit. Whiting Specialty Co., P. O. Box 21, Station B, Brooklyn, N. Y.

**AGENTS to sell "Eureka Steel Ranges"** from wagons, on notes or for cash. Big money maker for live men. Catalogue Free, Eureka Steel Range Co., O'Fallon, Ill.

**PASSED by U. S. Bureau of Standards** Official Tests, Richmond Chemical Fire Extinguishers, 3 kinds, 4 sizes. District Managers make 500% profit. Auto prize. Richmond Chemical Co., Desk A, Wheeling, W. Va.

**AGENTS wanted to sell Schlickers** Practical sewing vice, price 30c. Schlicker Mfg. Co., 12 Bloomingdale St., Rochester, N. Y.

**AGENTS: Here's a live one,** newly patented, self-wrapping mop. Easy to sell. Offers splendid profit. Every customer satisfied. Experience not necessary. Don't wait—write us at once for our attractive proposition. O. K. Mfg. Co., 1519 Sedgwick St., Chicago.

**DIRECT to Consumer Salesman.** Were you satisfied with your earnings for 1915? There is more money in circulation now than for many years. If you are not getting your share, write us for choice territory. Our consumer and dealer sales plan establishes you in a permanent business, unlike ordinary canvassing propositions. Our Superlatings and Superlat-gravures are the most exquisite art reproductions of the age, and excite the wonder and admiration of all who see them. Send for liberal commission proposition at once. The Cincinnati Fine Arts Company, 28 Beech St., Cincinnati, Ohio.

**EVERY man needs Expanding Cuff Buttons!** Presto slip your cuffs over elbows without unbuttoning, they positively stay where placed upon forearm; slip them down they close automatically; your cuffs always tidy; combines utility with convenience; invisible, durable and strong. Good-by old style once you wear these fastest selling patented specialty in United States. Large profits. Wanted agents, salesmen with some available means, to sell direct to wearer; enclose red stamp for full particulars. Flexo Mfg. Co., Sheboygan, Wis.

**DRUNK, Sick or Crazy—not us, but we** let you collect the money and keep it all. Small capital needed to start. U. S. Mfg. Co., Dept. P3, Columbus, Ohio.

**SELL up-to-date household specialties.** Particulars free. S. V. Phillips, Box 17, Minneapolis, Minn.

**Men and Women Make \$30.00 to \$45.00** Weekly Selling our 300 candle power gas-line incandescent lamp; burns 98% air; costs one cent a night; Absolutely Safe; guaranteed five years. Sample on Free Trial. Exclusive territory. Write today. J. B. Hall & Co., 813 Church Building, Chicago, Illinois.

**SUN Ray-Diator room heater.** No fuel cost. New tremendous seller; every home buys on sight at 50c. Big profits. Act quick. Details free. White Mfg. Co., Dept. 8-11, Cincinnati.

**\$2,100.00 PROFIT for Faucet 1915 Selling** Feeny Vacuum Cleaners—the Gold Medal Winner San Francisco Exposition. More live agents wanted. We also manufacture Star and Handy Clothes Line Reels. Write for special proposition. Feeny Mfg. Co., A-75, Muncie, Indiana.

**AGENTS to establish and manage a permanent** box cigar trade. Quick results. Sample 25 for 65c. R. Reynolds Co., Washington, D. C.

**CURIOSITY Seekers do not apply; if \$50** a week looks good to you, send \$1.25 for agent's sample outfit of high-grade household specialties; no talking needed. Leonard Supply Co., Dept. M, Warren, Pa.

**EARN \$100 monthly** demonstrating Dixie Cream. Cleans and restores whiteness to gloves, including those previously cleaned in gasoline. Chamberlen Co. Commonwealth, Portland, Oregon.

**AGENTS—Salary or commission.** Greatest seller yet. Every user pen and ink buys on sight. 200 to 500 per cent profit. One agent's sales \$620 in six days; another \$32 in two hours. Monroe Mfg. Co., X6, La Crosse, Wis.

**WE want capable, live wire General Agents** and Crew Managers to sell an absolutely new Household Specialty guaranteed by \$200,000 Corporation. It's a big value household necessity that no woman can resist. Easy sales mean big profits. Our follow-up is unusual, and we give you exclusive territory, and advertise the business for you. Wm. J. Dick, Dept. F-21, 20 W. Lake, Chicago.

**DON'T risk your money.** Not a cent needed as capital to act as our salesman for high-grade household goods. We furnish samples and merchandise without a penny in advance. Write immediately for particulars. Mumford & Larson, 339 Walker Building, Salt Lake City, Utah.

**AGENTS wanted to sell hornless talking machines.** Demonstrating machine at reduced price. Superior Sales Co., Dept. M, 1135 E. 43rd St., Chicago, Ill.

**AGENTS Wanted—Out of town live men** can make 15 to 25 dollars weekly evenings or on the side selling my "made to order" men's \$15 and \$20 suits and overcoats. We are delivering quality, fit and work, so you can build up a future business. Tom Murray Clothing, 411 S. Sangamon, Chicago.

**MORE selling brains needed.** More help wanted. This means you, Mr. and Mrs. Agent. Carma Non-alcoholic Food Flavors in tubes plus other lines. Our plan gets the cash. Mather-Carroll Co., 5235 Kimbark Ave., Chicago.

**AGENTS**—Fast selling automobile necessity; large profits; exclusive territory; write for particulars. Ahrshold Co., 6251-53 Dorchester Ave., Chicago.

**AGENTS**—Something entirely new, take orders for medallion pictures; sells \$1.98, \$1.79 profit. Lemen & Perlman Company, Bloomington, Ind.

**SELL** Simplex Furnace Controllers, very useful, cheap, easily sold; every heater owner needs one; send for booklet. Simplex, 706 South St., Indiana, Pa.

**OUR** Spring Line is Now Ready; we are lining up our salesmen now; big money made selling shirts direct to wearer. Write now for \$8 a day proposition with protected territory. Wright Shirt Works, Asbury Park, N. J.

**LUMINO** changeable signs—a metal sign with embossed letters. Something new. Every merchant buys. Fastest dollar seller ever invented. 250% profit. Write today. Changeable Sign Co., 381 East 102nd St., Cleveland.

**DISTRIBUTORS** for Sterling Baby Violet Ray Generator complete with 3 applicators and case—\$15—and other exclusive electrical specialties. Liberal discounts. Sterling Corporation, 1279 West 3rd St., Cleveland, Ohio.

**READ** Good Results—Greatest Mail Dealers—Agents Magazine published. Two big issues 10c. Good Results, 154P Washington, Chicago.

**AGENTS**—If you want to "Clean Up" on most wonderful invention of age, send 10c for samples. Sells everybody—Stores, Offices, Houses, No Fake. The Edson Company, Dept. 55, 1709 Michigan Ave., Chicago.

**AGENTS** for automatic damper guaranteed to save 1/3 the fuel. 100% profit. 518 Commonwealth, Portland, Ore.

**\$70.00 TEN** days—Hedrik's profit. Smith writes, "Sold 21 one house." Rodolph's Patented Curtain Rods. No nails, tacks, screws. Fits any window. Sample 10c. Rodolph, 472 Northwestern Building, Chicago.

**BIG** Kansas Company will start ambitious people in fast-growing mail-order business; any locality; make \$3,000 yearly; spare time; no canvassing; no experience; we furnish everything. New, unique selling methods free. Eyestone, Pres., 600 W. 11th, Pittsburg, Kansas.

**OUR** new, unusual value Household Specialty makes easy sales and big profits for live agents. Guaranteed goods, and an unusual follow-up gets the business. Sales Manager, Dept. F-3, 29 W. Lake, Chicago.

**WONDERFUL** Needle Threader. Big seller. Sample, 10c. Stovers, Millersburg, Pa.

**OUR** line of brushes is a winner. So is our proposition. We want live brush agents everywhere. United Brush Company, 622 W. Lake St., Chicago.

**AGENTS:** Get propositions of all kinds; registration 10c. Ziska, 1279 Mack, Detroit, Mich.

**AGENTS**—Get newest, quickest sellers direct from makers—full list free. Nat'l Agents Assn., C122 Michigan Ave., Chicago.

**MAKE** more money in 1916, with less effort. It's our business to start, also to increase your business. Particulars free. Harsh Mfg. Co., Indianapolis, Ind.

**AGENTS:** Neatest Safety Key Ring Hook; sells everywhere. Sample 10 cents. Fats Novelty Shop, St. Louis.

**AGENTS** are coining money selling our big 10c Packages of 20 Assorted Postal Cards, "5,000 Varieties." "Big Profits." Sell everywhere at sight. Sample Packages 10c. Particulars Free. Sullivan Card Co., 1224 Van Buren St., Chicago, Ill.

**AGENT'S** free sample and particulars Delbare's Naptha Washing Tablets. Wash clothes without rubbing. Guaranteed not to injure the finest fabric. No acids, lime nor caustics. Manufactured and sold by Naptha Washing Tablet Co., 718 So. Dearborn, Chicago, Ill.

**AGENTS,** either sex. The greatest 50c proposition on earth. Sells itself. No attention paid to inquiries unless 20c remitted for sample particulars. Ideal Specialty Co., Duluth, Minn.

**AGENTS,** make 400% profit handling new changeable signs, novelty signs, postcards, etc. Catalog Free. Hinton Co., 6142 49th Ct., Chicago.

**MEN** and women earn up to \$3,000.00 yearly distributing Guaranteed Hosiery from mill to wearer. All or part time. Repeat orders insure permanent increasing business. No capital or experience needed. D. Parker Mills, 2733 No. 12th St., Phila., Pa.

**GET** into your own business. Cut loose from lay-offs, short hours, and wage slavery. Our catchy soap and toilet combinations have put thousands on Prosperity Road. Tremendous saving to consumer—200% profit for you. Send postal quick for details. E. M. Davis Co., K64 Davis Bldg., Chicago.

**AGENTS** make big money and become sales managers for our goods. Fast office sellers. Fine profits. Particulars and samples free. One Dip Pen Company, Dept. 2, Baltimore, Md.

**EVERY** household on farm, in small town or suburbs, where oil lamps are used, needs and will buy the wonderful Aladdin Mantle Lamp. Burns common coal oil (Kerosene); gives a light five times as bright as electric. Awarded gold medal at San Francisco Exposition. One farmer cleared over \$500.00 in six weeks; hundreds with rigs earning \$100.00 to \$300.00 per month. No cash required. We furnish capital to reliable men. Write quick for wholesale prices, territory and sample lamp for free trial. Address nearest office. Mantle Lamp Co., 517 Aladdin Bldg., Chicago, Ill. Mantle Lamp Co., 517 Thermos Bldg., New York City.

**AGENTS**—Sell the Primus, genuine Swedish wickless, coal-oil stove. Smokeless, odorless. Twice the heat of gasoline at one-eighth the cost. No danger of explosion. Big profits. James Anderson & Sons, Sidney, Ohio, American distributors.

**READ** the Agents Magazine and make more money. 2 issues 10c. Agent's Magazine, Chicago.

**KEROSENE** Gas Burners in Cook Stoves or Ranges stop use of wood or coal. Recently patented. Money-Maker for Agents. The Vapor-Gas Burner Co., Desk 8, Columbus, Ohio.

**ENDLESS** Neckties—Something new; twelve ties in one; costs no more than old style; man made \$70 three days; woman made \$92 week; write for special agents' offer. Endless Necktie Mfg. Co., Dept. 10, Kansas City, Mo.

**\$1,000 PER** Man per County. Strange invention startles world—agents amazed. Ten inexperienced men divide \$40,000. Korstad, a farmer, did \$2,200 in 14 days. Schleichner, a minister, \$135 first 12 hours. \$1,200 cold cash made, paid, banked by Stoenman in 30 days; \$15,000 to date. A hot or cold running water bath equipment for any home at only \$6.50. Self-heating. No plumbing or waterworks required. Investigate. Exclusive sale. Credit given. Send no money. Write letter or postal to-day. Allen Mfg. Co., 121 Allen Bldg., Toledo, Ohio.

**AGENTS**—Large Manufacturer wants reliable Men, Women, to sell guaranteed Hosiery, Underwear, Shirts, direct to homes. Write for free samples. Madison Mills, 588 Broadway, New York.

**WE** pay \$80 a month salary and furnish rig and all expenses to introduce our guaranteed poultry and stock powders. Bigler Company, X368, Springfield, Illinois.

**AGENTS!** Earn big commissions selling \$20 value all-wool made-to-measure suits for \$10.75 retail. No experience necessary. Chicago Woolen Mills, Dept. 100, 833 Jackson Blvd., Chicago.

**"DECALCO"** gold sign letters letter everything. New. Sensational. Enormous profits. Sample free. Wadhams, 90 Broadway, Brooklyn, N. Y.

**STOVINK**—Agents! Big money! Extraordinary stove backing; will not burn off; sells to every home; repeats; rich opportunity; permanent business. Experience unnecessary. Season on. Hayden Griffin Co., Toledo, Ohio.

**AGENTS** Wanted Everywhere—To sell our attractive theatre Brass Poster Frames, Changeable Signs, Building Directories, Brass Signs, Brass Railings, Bank Fixtures, Adjustable Electric Light Brackets. Big demand; easy sales. Established 1882. Newman Manufacturing Company, Cincinnati, Ohio.

**YOU** can do it. What? Make only 2 sales a day, \$3.60 net profit. More sales, more dollars. No limit to opportunity selling latest Aluminum Combination Set at a price the women go wild over. Write today and let me show you how to make at least \$3.60 a day. Sales Manager, 1423 Westmoreland St., Philadelphia.

**\$6.60 A DAY** profit selling our products. 25c box and terms 10c. C. Lutz Manufacturing Co., York, Pa.

**MAKE** your own Extracts and Perfumes. H. Lake Co., Adair, Ill.

**"PEACE** Calendars," quick sellers. Mulowney, Paxtang, Pa.

**ACT** Quick! Automobile Gasoline going up. Sell Gaso-Tonic. Equals gasoline at 3c a gallon. Eliminates Carbon. Dollar an hour profit. Sales Guaranteed. White Mfg. Co., Dept. M, Cincinnati, Ohio.

**AGENTS** make \$5 to \$10 a day on the spot. Atkinson writes: "The best proposition I have found in my forty years' canvassing." Permanent work. Household necessity. Saving 80%. Write today for General or Local Agents terms. Free sample. C. H. Stuart & Co., 16 Union St., Newark, New York.

**YOU** can be your own boss with our Key Check Outfit. Good for \$5 a day stamping names on pocket key checks, fobs, etc. Sample check with your name and address, 15 cents. Pease Die Works, Dept. M, Winchester, N. H.

**AGENTS** of ability and high character wanted on a new household article. Over 100 per cent profit. Special selling plan that pulls results. Address Merritt & Brock, 59 to 69 Temple Place, Boston, Mass.

**WE** are the largest manufacturers of twisted Wire Brushes in America. Highest grade goods, best service, largest profits. Our new Auto Specials are winners. Send for catalog. Fuller Brush Company, Hartford, Conn.; Rock Island, Ill.

**AGENTS**—Stamping names on Pocket Key Protectors; sample Check with your name and address, 12c. Stamping Outfits, Emblem Checks, Check Fobs, Name Plates. Hart Mfg. Co., Desk 2, 363 Degraw St., Brooklyn, N. Y.

**BIG** Profits for You! Manufacture Barley Crisp. New Confection. 5c package costs you 1c. Machine instructions complete \$7.50 prepaid. Send 10c for samples. Barley Crisp Co., 1205 Broadway, San Francisco.

**YOUNG** Man, would you accept a tailor-made suit just for showing it to your friends? If you live in a town smaller than 10,000, write Banner Tailoring Co., Dept. 214, Chicago, and get beautiful samples, styles and a wonderful offer.

**MAIL-ORDER** Opportunities: 25 new Propositions. No competition! Make 95c profit on dollar order; complete outfit 10c. Mail Dealers Wholesale House, 521 Franklin Bldg., Chicago.

**WONDERFUL** Opportunity—Start as our agent, become manufacturer. Everyday necessities. Fastest repeat sellers. Marvellous profits. Proposition worth at least \$40 weekly. Samples free. Frederick Lobd Company, 525 Warren St., Boston, Mass.

**YOU** can make \$\$\$\$ as our general or local agent. Household necessity; saves 80 per cent; permanent business; exclusive territory; salary or commission; free sample; credit. J. Pitkin, 113 Redd St., Newark, N. Y.

**MEDALLIONS**—300% profit. Make up your own goods and be independent. Catalogue free. Resag Co., 1205 Randolph St., Chicago.

**50% PROFIT** selling our wonderful sign letters for office windows, store fronts and glass signs; resembles finest gold leaf; easily applied; samples free. Metallic Letter Co., 406 N. Clark St., Chicago.

**SELL** Dry Goods Remnants. Greatest bargains on earth. Remnant Store Co., Cincinnati, Ohio.

**STOP** Here! Let me start you in a home business that will bring you money every day. Experience unnecessary. Spare time. No canvassing. I furnish everything. Send for proofs. Voorhies, Desk C. R., Omaha, Neb.

**AGENTS**—Average \$5 to \$12 daily selling astonishing Artec massage machine. New. Just patented. Different. No electricity or water power required. Nothing complicated. Affords exhilarating massage without cent expense. Lowest priced, but best outfit. Retail \$2.50 allowing you big end of the profit. Particulars and "beauty" folder free. Artec Remedy Co., Dept. 132, Toledo, Ohio.

**"STEAM-NO-MORE"** for eye glasses. Everyone who wears glasses buys. Live agents 200% profit. Send 10 cents for 25c sample. Gray's Sales Agency, Port Huron, Mich.

**AGENTS**—Here's a brand new article, just ready for market. Make over 100% profit, with satisfied customers. Every mechanic needs one, sells quickly on sight; no competition. Our proposition is a winner. Don't wait. Write for it now. The Security Aluminum Rule Pocket Co., Ivanpah, Calif.

**ACCEPT** no agency until getting offer on Ho-Ro-Co Skin and Scalp Soap and Toilet Articles. Our plan new and different. Territory limited; write today. Rotheo, 209 N. 2nd, St. Louis.

**AGENTS**—Steady Income. Large manufacturer of Handkerchiefs and Dress Goods, etc., wishes representative in each locality. Factory to consumer. Big profits, honest goods. Whole or spare time. Credit given. Send for particulars, Freeport Mfg. Co., 59 Main St., Brooklyn, N. Y.

**AGENTS**—Brand new specialty Aluminum Triplicate Sauce Pan with detachable handle. Cooks 3 different foods on one burner. Saves gas. Lasts lifetime. \$100 to \$300 per month easy. Send for our catalogue of 400 other specialties. American Aluminum Mfg. Co., Div. 3, 10, Lemont, Ill.

**"GOLDLINE"** Sign Letters—1,000% profit. Sample free. Johnston Co., Quincy, Ill.

**AGENTS**—Biggest hit ever! Eleven-piece Toilet Article Set, selling like blazes at \$1; with \$1 Carving Set Free! Enormous profits! Tremendous sensation! Experience unnecessary. Engle made \$51.00 first week. Write quick! Pierce Co., Dept. P, 908 Lake St., Chicago.

**AGENTS**—Sell rich-looking imported 36x 68 Rugs, \$1 each. Carter, Tenn., sold 115 in 4 days. Profit, \$37. You can do same. Write for sample offer selling plan; exclusive territory. Sample rug by parcel post prepaid, 98c. Condon, Importer, Stonington, Maine.

**AGENTS**—150 per cent profit selling new, easy wringer mop; every home buys; Martin sold 131 in 2 days; Handel sells 18 in 4 hours; Baker made \$9 in 2 hours; one man's orders \$2,653 in one month; get details. U. S. Mop Co., 363 Main St., Toledo, O.

#### AGENCIES WANTED

**USEFUL**, first-class articles wanted from manufacturers only. Samples, particulars: catalogs required. Chas. Gutierrez, Box 1213, Havana, Cuba.

**WE** can sell your goods. Northwestern Sales Agency, Tigard, Oregon.

#### SALESMEN WANTED

**SALESMEN** — Make Big Money on our Convex Portraits 38c. Frames 35c. Glass 29c. Largest house in America. Est. 15 years. Samples Free. The Culver Co., Box 194, Westerville, O.

**SALESMEN WANTED**—Salesmen and Manufacturers' Agents to represent us everywhere among the Superintendents, Engineers and Purchasing Agents of manufacturing plants. Federal Graphite Mills, Cleveland, Ohio.

**ENERGETIC** Young men everywhere as outside salesmen on Cigars. \$18 weekly and promotion. Ambition more essential than experience. Send stamp. Neway Sales Co., Holyoke, Mass.

**SALESMEN**—Country. Universally used Indoor Golf specialties—side line small samples—liberal commission. The Golf Shop, Chicago.

**SALESMEN WANTED** to handle Skat Soap and other products as a side line, or full time. Will allow exclusive right for several counties, to right man. Give full particulars as to present occupation, territory wanted, time you can give, and references. The Skat Co., 793 Park St., Hartford, Conn.

**SALESMEN**—To sell direct to consumer, tailored suits to measure, \$12.50 and \$16.50, greatest values ever offered. To hustlers with selling and organizing ability will give exclusive territory, and appoint as branch manager. Capable men answer at once. Midland Tailors, Suite 1001, 19 S. 5 Av., Chicago.

**WANTED**—Traveling Salesmen who will accept clothes made to their measure in payment for placing with merchants "The Line That's Different," an all-wool tailoring line, quoting six special prices; no extra charges. Write for particulars, J. W. Jones & Sons, 100 Mid-City Bank Building, Chicago.

**SALESMEN**, with ability, to sell Little Giant Ice Chipping machines. Get our proposition. R. J. Schmidt Co., 417 W. 4th St., Davenport, Ia., U. S. A.

**SALESMEN WANTED**—For Toy and Bell ringing transformers, Magneto charging machines, etc. Write for proposition, Midwest Electric and Mfg. Co., Box 2, South Denver, Denver, Colo.

**WANTED**—Hustlers to take orders for made-to-measure high-grade men's tailored suits from \$9.50 to \$22.00. Make \$25.00 to \$50.00 weekly. Elegant large book outfit free. Experience unnecessary. No pocket folder affair. Splendid opportunity to make money. Handy Dandy Line, Dept. 8, 411 Sangamon St., Chicago.

**UNUSUAL** opportunity for "Idea wires" to handle the greatest electrical wonder of the age—High Frequency Violet Ray Machines. Sells to Doctors, Dentists, Massage Parlors, Electrical stores, Homes, etc. Widely advertised—big profits. Exclusive agency. International Electric Co., Cleveland, Ohio.

**SALESMEN** to sell Paint and Paint Specialties, Roof Paint and Roof Specialties. Regular or sideline proposition. Commission paid each week. Standard Paint and Lead Works, Cleveland, Ohio.

**EARN \$5,000 to \$20,000** yearly. New business necessity. Retail \$5 to \$200. 100—200% profit. Purchaser satisfied or money refunded. No competition. Exclusive territory. Free samples. Sayers, 408 Wainwright, St. Louis.

**SALESMAN** can secure exclusive territory for two of the greatest sellers and repeaters of the age, "Auto-Lustre" and "Motor Vigor." General Sales Agent, 1421 Van Ness Ave., San Francisco, Cal.

**SIDELINE**—Sells to stationers or consumers. Unusual proposition—including commission on repeat orders—offered by old established house. Pocket sample case. We help you every way. Experience in this or similar line desirable, but not necessary. Write today. The National Ribbon & Carbon Co., Cleveland, Ohio.

**SALESMEN**—Wanted everywhere by a responsible, established house. If you average sales of one or two machines a week, you make from \$2,000 to \$4,000 a year. Sell Chemical Fire Engines on Wheels to factories, stores, Fire Depts., etc. No capital required; exclusive territory; goods well advertised. Ajax Fire Engine Works, 95 Liberty St., N. Y. City.

**EXCLUSIVE** county rights. Sell Tankik; new auto fuel. Profitable. Tankik Chemical Co., Cleveland, Ohio.

**HELP-A-PHONE**; the profitable side line for Salesmen. Write Ebnard, 415 Belden Ave., Chicago.

**WANTED**, Salesmen—To represent manufacturer. Must be wide-awake, energetic and able to produce. Excellent opportunity. Exclusive territory to right man. Box 190, Station C, Cleveland, Ohio.

**SALESMEN**: Acquainted with merchants. Large demand. Lib. comm. Pocket samples. Wirth Salesbook Co., Chicago.

**WANTED**—Representatives everywhere. Exclusive territory. Gold sign letters for stores and office windows. Any one can put on. Write today for free sample. Metallic Letter Co., 403 N. Clark St., Chicago.

**SALESMAN**, Sell beautiful 28x58 Artz-kraft felt rugs for \$13.50 per doz. Your profit, \$3 per doz. Kelso, Battle Creek, Mich., sold 30 doz. last week. His profit, \$90. Write for exclusive territory and selling plan. Prepaid sample, \$1.50, refunded on first order. H. Condon, Mgr., Stonington, Maine.

**SALESMEN**—Get our plan for Monogramming Automobiles and Motorcycles by transfer method. Very large profits. Motorists' Accessories Co., Ashland, O.

#### HELP WANTED

**FOR** Positions between \$2,500 and \$15,000 per year. If actually qualified for technical position, or executive, administrative or manufacturing position above \$2,500, communicate with undersigned counsel, who will negotiate strictly confidential preliminaries for such positions. Not an employment agency; undersigned acts in direct confidential capacity. Send name and address only for prefatory details. R. W. Bixby, 3 Niagara Square, Buffalo, N. Y.

**YOUNG** men as District Representatives to look after our interests in every state. No canvassing. Salary starting, \$15 weekly. Frontier Mfg. Company, Niagara Falls, N. Y.

**\$7.50 COMMISSION** each sale and repeat orders; traveling salesmen among general mercantile trade; every state; weekly settlement; no competition; pocket sample. Toledo Cable Co., 45 Davis Bldg., Toledo, Ohio.

**DRAFTSMEN**—Become proficient in lettering, and demand best salary. Our course in Topographic Drafting prepares for Government service where demand is great. Request particulars. No obligation. Columbia School of Drafting, 10th and G, Washington, D. C.

**MEN**—Women, 18 or over, wanted, \$75 month. Government jobs. Thousands positions obtainable. Write for list. Franklin Institute, Dep't F-21, Rochester, N. Y.

**BE** a Detective—Earn \$150 to \$300 a month; extensive traveling; positions open, particulars free. American School of Criminology, Detroit, Mich., Dept. F.

**I WILL** start you earning \$1 daily at home, silvering mirrors; free instructive booklet. G. F. Redmond, Dept. 306, Boston, Mass.

**MEN** to refinish lighting fixtures, brass beds, etc. All or spare time. No capital or canvassing. Experience unnecessary. Information free. Gunmetal Co., Ave. G, Decatur, Ill.

**YOUR** Ideas may bring you wealth, if patented through credit system. Send sketch. Free search. Book free. Waters & Co., 5103 Warder Bldg., Washington, D. C.

**PLEASANT** spare-time work; mailing circulars. Good pay. No scheme. Details free. Home Pub. Society, 46 N. 12th, Philadelphia.

**DO** you want a sure job with big pay, easy hours, and rapid advance? Write for my big Free Book DW-29, which tells you how you can get a good government position. Earl Hopkins, Washington, D. C.

**LEARN** Auto Trade in most practical school on Coast. Course includes everything worth knowing about auto business. No time limit. Positions secured. Board and room while learning. Catalog free. National School of Engineering, Los Angeles. Est. 1905.

**BECOME** Detectives. Large salaries; easy work. Write Chief Wagner, 1243 Lexington Avenue, New York.

**MEN**, become chauffeurs. \$18.00 week. Learn while earning. Sample lessons free. Franklin Institute, Dep't F-802, Rochester, N. Y.

**CORPORATIONS** employ thousands of detectives. Interesting, profitable. Rubber City Secret Service, Akron, O., trains men for detective work. Write today.

**GET** a Government Job! See ad on page 10. Write now—today! Patterson Civil Service School, Rochester, N. Y.

**U. S. GOVERNMENT** Wants Clerks, Men—Women, 18 or over, \$75.00 month. List of positions now obtainable free. Write immediately. Franklin Institute, Dep't F-21, Rochester, N. Y.

**BE** a Detective. Earn Big Money. Write John J. Gilles, Licensed and Bonded New York State Detective, Retired member New York Police Department, 24 years' experience, 254 Huguenot St., New Rochelle, N. Y. Investigation solicited.

**WANTED**—Aggressive party to handle local office for leading manufacturer. State salary expected. The Schilling Manufacturing Co., Dept. 98, 928-930 Pacific Avenue, Long Beach, California.

**COLLECTORS** everywhere. Permanent employment. Steadily increasing income. No canvassing, no outlay. Sales Manager, Box 8272, Boston.

**DO** you want \$75.00 a month? Thousands U. S. Government jobs now obtainable. Steady work. Common education sufficient. Write immediately for free list of positions. Franklin Institute, Dep't F-21, Rochester, N. Y.

**SILVERING** mirrors, Plating tableware, auto-brass. Home booklet plans free. Clarence Sprinkle, Dept. 28, Marlon, Ind.

**MEN** wanted to make Toy Soldiers; profitable homework. Big business on larger scale. Germany's great industry. War stopped importation; greatest demand. We buy soldiers all year. Tools, experience unnecessary. Casting-form outfits complete \$2.50. Booklet, pay-list, free. Toy Soldier Manufacturing, 32 Union Square, New York.

**I BUY** hundreds of insects, butterflies each summer at 5c to \$7.00 each, for museums, artwork, if properly fixed. Men, women, send 2c stamp for details telling all. Stelclair, Box 244, D-6, Los Angeles, Calif.

**RAILWAY** Mail Clerks Wanted. Commence \$75.00 month. Sample examination questions free. Franklin Institute, Dep't F-21, Rochester, N. Y.

**MARKET** your spare moments intelligently; profitably; commercial information wanted; exceptional opportunity without canvassing. "Cleo," PMC, Evansville, Ind.



**FIREMEN**, brakemen, all railroads, everywhere; \$120 monthly; experience unnecessary. Promotion, conductor, engineer, \$150-\$200. Railway Association, Dept. 298, Brooklyn, N. Y.

**CIRCULAR Distributors Wanted**. Send dime for Contract Magazine. Oliver A. Barkley, Mount Pleasant, Pennsylvania.

**\$75 MONTH**. Get Government Jobs—Men and Women Wanted. List of positions open—free. Franklin Institute, Dep't F-21, Rochester, N. Y.

**"BIG Money"** Collecting and Selling Names to Mail Order Firms during spare time. Working Instructions 10c. Vernon Badger, Alburgh, Vt.

**CONTRACT San-o-tex**, modern, sanitary, fireproof floors. Put on like Plaster, 1/2 inch over any wood or cement floor. Complete formula and instructions \$3. San-o-tex Company, Mechanic Street, Washington, Indiana.

**BIG Kansas Company** will start ambitious people in fast-growing mail-order business; any locality; make \$3,000 yearly; spare time; no canvassing; no experience; we furnish everything. New, unique selling methods free. Egerton, Pres., 602 W. 11th, Pittsburg, Kansas.

**EARN \$100 weekly** managing clean, legitimate mail-order business. We furnish everything. Right party need not worry about capital. Splendid chance for intelligent, employed person to control independent business on profit-sharing basis, beginning in spare time, evenings at home. Particulars free. Opportunities Exchange, Buffalo, N. Y.

**THOUSANDS Government Jobs** Now Obtainable. \$75 Month. List free. Franklin Institute, Dep't F-21, Rochester, N. Y.

**WRITE Photographs**. Short Stories, Poems, Big demand. No correspondence course. Start writing and selling at once. Details free. Atlas Publishing Co., 3045, Cincinnati.

**TREE Experts** Coin Money. Free booklet tells how. Wilmette School of Tree Dentistry, Los Angeles, Calif.

**GO on the Stage**. Vaudeville career offered you. Experience unnecessary. Managers endorse my method. Instructive vaudeville book free. Write today. Frederic LaDelle, Sta. 19, Jackson, Mich.

**BE a Detective**—Earn from \$150.00 to \$300.00 per month. Travel over the world. Write C. T. Ludwig, 340 Westover Building, Kansas City, Mo.

**GOVERNMENT Examinations**. Most thorough preparation, \$5; returned if not appointed; particulars free. American Civil Service School, Washington, D. C.

**STOP Here!** Let me start you in a home business that will bring you money every day. Experience unnecessary. Spare time. No canvassing. I furnish everything. Send for proofs. Voorhis, Desk C. R., Omaha, Neb.

**WANTED—An Ideal** Who can think of some simple thing to patent? Protect your ideas; they may bring you wealth. Write for "Needed Inventions" and "How to Get Your Patent and Your Money." Randolph & Co., Patent Attorneys, Dept. 144, Washington, D. C.

**WANTED—at once**: Young men for automobile business. Big pay. We make you expert in ten weeks by mail. Pay us after we secure you position. Century Automobile Institute (141), Los Angeles, Cal.

#### PARTNERS WANTED

I HAVE a new invention on "Motor-skates," an attachment for motorcycles—when taking the wheels of any motorcycle make and place this new device on for traveling over ice and snow; it's well tested and guaranteed merit; can be manufactured cheap and no competition. Was going to have it manufactured on contract and needed some capital for necessary expense. I don't wish to sell outright. Will give 45% interest to the one who brings the necessary fund. Adolph W. Olson, McIntosh, Minn.

**PARTNER** Wanted with money and business experience to back inventions. P. O. Box 497, Greensburg, Pa.

#### WANTED

**WANT a Screw-cutting Lathe** suitable for garage; also Corona Typewriter. Give full details, price. Box 381, Hesperia, Ontario.

**WANTED—United Cigar Stores** Coupons. State quantity and lowest price, or exchange for what. J. Z., Room 325, 78 E. Madison St., Chicago.

#### FOR SALE

**REAL bargains** in high-grade Cameras, Lenses, Kodaks, Binoculars, Microscopes, Surveyors' Transits, etc. All goods slightly used, but equal to new. Away below regular prices. Write us today. David Stern Co., 1047F W. Madison St., Chicago.

**VACUUM** cleaner pumps and parts for assembling, save 15%. Vacuum Supply Co., Ann Arbor, Mich.

**FOR Sale**: Rifle, Steam and Electrical Books. Henry Priebe, Kent, Ohio.

**FIELD** and Marine, Day and Night Glasses, with beautiful case. 25-mile adjustment; \$30 value, only \$7.50. Money back if not satisfied. Well's Curiosity Shop, 29 S. Second St., Philadelphia, Pa.

**500 NICKEL** Flashlights, \$1.50 value with battery, 88c postpaid. Pulver's Sporting Goods Store, Hudson, N. Y.

**EDISON** Moving Picture Machine, Stereopticon, Films, Motorcycle, Tandem Bicycle, Cheap. Box 171, Norfolk, Va.

**ROWBOAT** Motor. I accepted a new Jewel Electric Rowboat motor for a debt and having no use for it will sell for \$50. Regular price \$75. The motor was never used and is in original case, just as it left the factory. W. J. Kuecker, 6 N. Michigan Ave., Chicago.

**TYPE** and Printing Material at bargain prices. Now is the time to buy. All sizes rebuilt Job Presses very cheap. Catalogue free. Philadelphia Printers' Supply Co., 14 So. Fifth St., Philadelphia.

#### SALE OR EXCHANGE

We have prospects for anything you have to sell or trade. Guaranteed service. Write M. R. P. 391 Mailers Bldg., Chicago.

**10x15 JOB** press, for late motorcycle. 304 Ave. G, Miami, Fla.

**FOR Sale** or Trade—Upright mahogany piano with automatic player and electric battery enclosed so no pedaling necessary. Plays master rolls. List price \$1,400. Entirely new. Will accept second-hand Ford five-passenger part payment. Owner must sell on account of moving. Best make on the market. Address T. W. J., care Popular Mechanics, Chicago.

**YOU** can sell or exchange almost anything through these classified pages. Tell me what you have and I'll send you some interesting information. No obligation whatever. Write me today. F. W. Johnson, Manager of classified advertising, 6 N. Michigan Ave., Chicago.

**SWAP! What's Got? What'dye Want?** Free Advertising, Swap Bulletin, Detroit.

#### GUNS, SPORTING GOODS, ETC.

**SUREGETUM**, bait and trail scent, for Fox, Mink, Skunks, etc., with full directions postpaid 50c; satisfactory or money returned. O. Twitchell, West Milan, N. H.

**DON'T Be Mushy**. Postal will bring catalogue of Famous Home Exercisers, direct from the Manufacturers. Peerless Athletic Supply Co., 383 Pearl St., Brooklyn, N. Y.

**FIREARMS**—Old-time and modern. Buy, sell, exchange all sorts. Stephen Van Rensselaer, 49 Front St., New York City.

#### FLOUR & FEED MILLING MACHINERY

**SPECIAL bargains** in second hand Attrition mills, burr mills, crushers, corn shellers, bran dusters, dust collectors, purifiers, reels, double, single, 2 and 3-pair high roller mills, sieve bolters, receiving separators, scourers, etc. Write for description and prices. Sprout, Waldron & Co., P. O. Box 429, Muncy, Pa.

#### MACHINERY, TOOLS AND SUPPLIES

**ONE** Sturtevant heater, consisting of 40-inch fan, six sections of steam coil, steam trap and steam connections, all in good condition. Suitable for heating or dry kiln. One 48x12 H.P. steam boiler (forty-two 3-inch tubes, furnace front injector, safety water column, steam gauge, etc., all complete) in good condition. One 40-inch steel planing mill, single exhaust fan, left-hand up discharge. Sellers have no further use for above and same will be sold at exceptionally low price to any one interested. Jno. H. Swisher & Son, Cigar Manufacturers, Newark, O.

**VACUUM** cleaner pumps, tools, etc., for stationary house or wagon outfit. Vacuum Supply Co., Ann Arbor, Mich.

**FOR Sale**—25 new engine lathes; prompt delivery. Gurley, 4211 Cedar, Cleveland, O.

**"RED Devil"** Mechanic's plier (drop forged steel). Most efficient. 5" size 63c. Style 50. Tool booklet free. Smith & Hemenway Co., 181B Chambers Street, New York City.

**PULLEYS**, Gears, Sprockets, Shafting, Hangers; see page 128. W. A. Jones Foundry & Machine Co., Chicago.

**FOR Sale**: New Power Hack Saw, capacity 4"x4", \$15.00. New 10" Sensitive Bench Drill Press, complete with chuck, capacity 3/8", \$15.00. Passman Bros., 30 S. Green St., Chicago, Ill.

**NEW eleven-inch** lathes and attachments. Bargain. A. E. Bakeman, St. Cloud, Minn.

**ENGINE** Lathes, swings 9 1/2 in., takes 25 in. between centers. Complete set gears cutting all size threads 3 in. to 40 in., \$43.50. Grammes & Sons, Allentown, Pa.

#### ENGINES, MOTORS AND DYNAMOS

**SMALL** Dynamos and Motors, bought from Sheriff Sale—all new—guaranteed. A. C. motors, 110-220 volts, 1/2 hp., \$10.50. 3/4 hp., \$12.50. 1 hp., \$15.00. 8-light dynamos—110 volts—\$8.50. Other sizes, all voltages, less than factory cost. Johnston, 99 Evans Ave., Ingram, Pa.

**GUARANTEED** rebuilt alternating and direct current motors. Bargain prices. Reliable makes only. Westinghouse, Wagner, Fort Wayne, General Electric. Sizes from 1/2 H. P. upwards. Satisfaction guaranteed or money refunded. Write for illustrated list supplies and motors. Hyre Electric Co., 618 FK South Dearborn St., Chicago.

**FOR Sale**—4-Cylinder Locomobile gasoline engine complete, \$50. 4 1/2 H. P. Locomobile steam engine, \$10. 6-H. P. Single cylinder gasoline engine suitable for stationary use, \$25. 1423 North Ave., Bridgeport, Conn.

**FOR Sale**—New 40-hp. Knox, 4-cylinder, unit engine and transmission, Bosch Magneto. Price, \$250. J. L. Lucas & Son, Bridgeport, Conn.

**FORTY** Horse Roberts gasoline engine. C. A. Mittel, Savannah, Ga.

**TWELVE** horse, two-cylinder gasoline engine. Sale or trade. Earle Gray, Guthrie, Okla.

**ELECTRIC** Motors, from 1/4 to 3 horsepower, new and second-hand, for sale; standard makes. United Mfg. Co., 508 Nelson Bldg., Kansas City, Mo.

**A 25-HP.** "Porter-Allen" Steam Engine; also shafting, pullers, hangers and an office safe. Bargain. Box 302, Hammonston, N. J.

**ELECTRIC** Motors, Special prices. 1/2 hp., \$18; 3/4 hp., \$16; 1 hp., \$12.50. Zenith Electric Motor Co., 28 W. Lake St., Chicago.

**CLOSING** out entire line of 8-hp. engines, 4 1/2" bore, 6" stroke, hopper-cooled. While they last \$50, with complete equipment. Colborne Manufacturing Co., 153 W. Division St., Chicago.

**WANTED**: Small engines—gasoline or steam—model engines preferred. Johnston, West End, Pittsburgh, Pa.

**EIGHT** hp. two-cylinder four-cycle opposed gasoline engine, \$25. Mayer, 183 Sheridan Ave., Brooklyn, N. Y.

**GASOLINE** Engines, 1/2 horsepower, upright, water-cooled, \$29 complete, \$12 bare. Mustin Mfg. Co., Newport, Kentucky.

**12-HORSE** Olds Gasoline engine \$150. Edgar Kyle, Pleasant Plain, Iowa.

**ELECTRIC** Motors Alternating or Direct Current from \$4.50 up. Write for Catalogue. Omega Electric Co., 53 W. Jackson Blvd., Chicago.

**REBUILT** Engines—We have on hand a number of rebuilt "Buffalo" engines, guaranteed, at greatly reduced prices. Write for bargain list. Buffalo Gasoline Motor Co., 1293-1305 Niagara Street, Buffalo, N. Y.

#### ENGINE CASTINGS AND BLUE PRINTS

**FIVE** Horse Stationary-Marine gasoline engine castings \$15 set. Wills, Dover, Ohio.

**GASOLINE** Engine Castings, with drawings. Cheap. Catalog for stamp. Norelty Manufacturing Co., 853 West 6th St., Cincinnati, Ohio.

**SMALL** Gasoline Engines and Castings with drawings. Crown Motor Works, Elgin, Ill.

## BOATS, LAUNCHES, ETC.

**MOTORCRAFT Encyclopedia**—A 150-page book that tells 1401 things every motor boatman should know. How to overcome engine troubles. Price \$1, postpaid. Popular Mechanics Book Dept., 6 N. Michigan Ave., Chicago.

**BUILD your own Steel boat** from patterns. Material furnished, also finished boats. Catalogue free. Darrow Boat Co., Albion, Mich.

## FOR THE SHOP

A NEW glue that is better than the ordinary glue in every way. Guaranteed twice as strong and waterproof. Just the thing for pattern-maker, furniture factory, repair man and household. Send 25c coin for large sample. Warren Specialty Co., Warren, Ohio.

**JUST Published**—Popular Mechanics Shop Notes for 1916—529 Easy Ways to Do Hard Things in every department of mechanics. Over 600 illustrations. 224 pages (size 6½x9½ in.). Price 50 cents, postpaid. Popular Mechanics Book Dept., 6 N. Michigan Ave., Chicago.

**FOR That Boy**—He will appreciate a copy of the great boy's book "The Boy Mechanic" that tells about 700 different things for boys to do and has 800 pictures. 480 (7x10) pages, cloth, big, handsome book for the price. \$1.50 postpaid. Popular Mechanics Book Dept., 6 N. Michigan Ave., Chicago.

## BLACKSMITHS

**BLACKSMITHS**, Listen! Wear the smile that won't come off, by doing hard jobs easy with Toy's Modern Methods on blacksmithing. Making all welds solid, tempering all tools to a standard with colored tempering charts. All for one dollar. Samples free. W. M. Toy, Sidney, Ohio.

## CEMENT

**CONCRETE Building Block Machines** and moulds. Free catalogue. 5 Market St., St. Louis, Mo.

## ELECTRICAL

**ILLUSTRATED** wholesale bargain list supplies and motors. Write now for your copy. Hyve Electric Co., 613 GT South Dearborn St., Chicago.

**ELECTRICIANS**—Send 50c for 10 Blue Prints of 3-phase, 2-phase, and single-phase motor windings. Winding made easy. Midwest Electric and Mfg. Co., Box 2, South Denver, Denver, Colo.

"**BOY Electrician**" makes Batteries, Motors, Engines. 75 illustrations, 10c. Renew Dry Batteries, 3 guaranteed processes, 20c. Both 25c. "Ideal," 3311-B Belleplaine Ave., Chicago.

**YOUR Ideas** may bring you wealth, if patented through credit system. Send sketch. Free search. Book free. Waters & Co., 5193 Warder Bldg., Washington, D. C.

**TEST your batteries** with an "Ever-Ready" ammeter. Sent postpaid for \$1.00. C. C. Loomis, 332 Washington St., Providence, R. I.

## STAMP COLLECTING

**STAMPS**—12 different from warring nations, 10c; 10 different foreign coins, 15c; 20 Belgium stamps, 13c. Lists free. Toledo Stamp Co., Toledo, Ohio.

**POSTER Stamps**, Art Stamps for collectors. New, instructive, artistic. 25 all different, 10 cents. Ask for circulars. Stone City Poster Stamp Co., 192 Mound St., Joliet, Ill.

**PACKET** of 23 stamps; no two countries alike, 500 hinges. Set of \$1 and \$2 U. S. Rev., all for 5c. Mention paper, Miami Stamp Co., Toledo, Ohio.

19 VAR. Egypt free with approvals; postage 2c; lists, wholesale and retail, free. Providence Stamp Co., Providence, R. I.

**FREE**, Choose one. 20 Persia; 60 Japanese; 50 Asiatic; 101 United States; 201 foreign; 50 Sweden; 50 Norway-Denmark; with six months' subscription McKee's Stamp Weekly, Boston, Mass. Remit 25c.

**BOYS**, all approvals 60% discount and premiums. M. Place, Wrentham, Mass.

**SODAN 1902**, 5 mt. 1 and 2 piastres, set 14 cents. Quality approvals sent against references. M. Neel, 880 Clarkson Ave., Brooklyn, N. Y.

**FREE**, 25 different used United States Stamps including Postage, Revenues, Envelopes and Dues, to applicants for our high-grade approval selections. The Edgewood Stamp Co., Dept. H, Milford, Conn.

**WAR** stamp free with approvals. C. A. Ploch, Reid Place, Indianapolis, Ind.

A **STAMP Album**. A Collection of rare Mexican War stamps, incl. Madero, etc., 100-page catalog. Perf. gauge and mill, scale, coupons, etc., all for 5c. App. sheets 60% to 80% comm. Agents Wanted. We buy stamps. Hussman Stamp Company, St. Louis, Mo.

**ROYAL Approvals**—Choice stamps at big discounts. Reference. Belmont Stamp Co., 551 North 52nd St., Philadelphia.

20 **UNUSED** stamps free. All different. Postage, 2c. Flak Stamps, Toledo, Ohio.

**STAMPS** on approval at 60% discount. 50 different free. Seidenberg, Beecher, Ill.

**APPROVALS** 60% discount. Lang, 1433B 59th Ave., Cicero, Ill.

7 **VAR.** China free with trial approval selections. Graves, Box 858, Providence, R. I.

200 **STAMPS** 3c. Net approvals. Grant Paul, Napanee, Ont.

1,000 **MIXED** Stamps 12c. 150 Varieties 11c. Charles Peugh, Elma, Wash.

24 **VARIETIES** Cuban stamps, 10 cents. List of 5,000 low-priced stamps free. Chambers Stamp Co., 111 P. Nassau St., New York City.

**STAMPS**, 75, all different, free. Postage 2c. Mention paper. Quaker Stamp Co., Toledo, Ohio.

25 **DIFFERENT** British Colonials to applicants for stamps on approval who send 2c postage. Nickles, 122 Florida Ave., Washington, D. C.

**LOW Priced Stamps** on Approval. \$10 Confederate bill free to applicants furnishing satisfactory references. G. V. Lovering, 2715 13th St., N. W., Washington, D. C.

**PACKET "A"** 100 varieties foreign, 20c—worth the money! Desirable stamps on approval, to collectors with satisfactory references. F. J. Pope, Box 45, Charlotte, Vermont.

**STAMPS**—195 China, etc., stamp dictionary and list, 2c. Bullard, Sta. A, Boston.

**STAMPS** sent on approval at 70% discount. Precanceled, ½c each. Reference required. Emory Renoll, Hanover, Pa.

**LOW priced approvals**. Mention paper and receive unused Department Stamp Free. S. E. Colman, 634 Keefer Place, Washington, D. C.

## RARE COINS

**OLD Coins**, Spring Catalogue, large list coins for sale. Catalogue quoting prices paid for coins, ten cents. William Hesselin, 101 Tremont St., Boston, Mass.

**COINS**—Antique Belles, 5 curious rare coins with catalogue, 10c. Ray Chapin, New Berlin, N. Y.

10 **DIFFERENT** coins from Warring Nations, 25c. Burgess Co., 522M Beacon, Toledo, Ohio.

**UNITED Profit-Sharing Coupons** taken the same as cash for Coins, Notes, Stamps, Indian Relics, Guns, Pistols and curious things. Booklet for stamp, Coin Exchange, New Rochelle, N. Y.

**THREE** large United States Cents 25c. 3c Pieces 10c. Moore Coin Company, Commerce, Texas.

\$4.25 **EACH** Paid for U. S. Flying Eagle Cents dated 1856. We pay cash premiums on hundreds of Old Coins. Send ten cents at once for New Illustrated Coin Value Book 4x7. It may mean your fortune. Clarke & Co., Coin Dealers, Box 15, Le Roy, N. Y.

**ALL** for 60c. A 25c, 50c, \$1.00, \$5.00, \$10.00, \$20.00. New uncirculated Mexican Notes. Coin Exchange, New Rochelle, N. Y.

**WILL** pay \$750.00 cash for \$5 gold piece dated 1822 (without "In God We Trust"); \$50.00 for 1853 half without arrows; \$5.00 to \$50.00 cash for large cent 1799, etc. We pay cash premium for all large cents, eagle cents, 2c pieces, etc., and all rare U. S. and foreign coins, bills and stamps to 1912. Thousands of rare coins wanted. Many valuable pieces are in circulation. Send 4c. Get our Large Illustrated Coin Circular containing valuable information. It may mean much to you. You certainly have nothing to lose. Send to Numismatic Bank of Texas, Dept. H, Fort Worth, Texas.

## GAMES AND ENTERTAINMENTS

**MAGIC** below Cost! Complete line closing out at 40% discount. Largest assortment in South. Orders filled from any Catalog at this rate as long as stock lasts. Orders under 25c not accepted. Catalogs free on request. Write or order today—never will such opportunity be presented again! Douglas, Klows, Okla.

**GREENBACKS**—Big bunch 10c; 4—25c. Downey, 3337 Union Ave., Chicago.

**TRICKS**—jokes—magic—puzzles—cracker-jack 25c sample 5c. Catalogue free. McDaniel, 9 "A" Griffith, New Bern, N. C.

"**CHARLIE** Chaplin Comic Camera," 10c. Sullivan, 109 Abbott Ave., Fitchburg, Mass.

250 **TRICKS** and 300 Toasts with our catalog 15c. Brown Mfg. Co., Ft. Atkinson, Wis.

**MIDGET** Croquet. Clover, fascinating! postpaid, 25c. E. D. Smith, 72 Woodlawn, Crafton, Pa.

**BE** a handcuff king. We teach you. Escape from handcuffs, boxes, ropes, etc. Secrets of 20 sensational escapes, \$1. Particulars free. The Magicraft Co., Dept. A, Box 251, Detroit, Mich.

**WIGS**, Makeups, Tricks, Puzzles, Jokes, Magic Goods, Mind-reading Acts, Sensational Escapes, Illusions, and Stage Supplies. Big catalog free. Oaks Magical Co., Dept. 288, Oshkosh, Wis.

**FUN!** Beauty Squirt Ring, 10c. Surprise Squirtier, 15c. Pocket Shower Bath, 25c. Stowers, Millersburg, Pa.

**PLAYS**, Vaudeville Sketches, Monologues, Dialogues, Speakers, Minstrel Material, Jokes, Recitations, Tableaux, Drills, Musical Pieces, Entertainments for all occasions. Make-up Goods. Large Catalog Free. T. S. Denison & Co., Dept. 11, Chicago.

**USED** Magic Goods and Supplies that please. Bargain Catalogue free. Gilnovos, Morgan Park, Chicago.

**FUNABOUT** Fords—The book that contains the funny Ford stories that the whole nation has laughed over. The greatest book novelty of the year. A collection of nearly one hundred of the very latest and best current "Ford stories" in book form. 64 pages, 6½x4½ in. Heavy boards. Price 25 cents postpaid. Send for your copy now. Popular Mechanics Book Dept., 6 N. Michigan Ave., Chicago.

**MAGIC** Pocket Trick, including professional catalog, 6c. Magic Co., Sta. 10, 249 West 38th St., New York.

**MAGIC!** We teach you to perform Tricks at home as good as the great professionals. Feature Acts in Mind Reading, Spiritualistic Work, Rope Ties, Escape Acts. Send for New Thumb Ties for stage work—7 illustrations; complete directions, 50c. Catalogue 100 pages, greatest on earth, 10c. Chicago Magic Co., Dept. B, 72 W. Adams St., Chicago, Ill.

**MAGICIANS'** tricks, escapes, Ventriloquist and Punch Figures. All the latest. Prices low. Big catalog free. Magic Partners, 192 Clifford, Providence, R. I.

## FOR BOYS

**HERE'S** Your Chance, Boys, to earn good money, for that rifle or camping trip. Write us today and learn about a household necessity that sells on sight in every home. We pay you well and teach you how to sell. Don't miss this big opportunity to make a man's wages and show Dad and your pals that you have the right stuff in you. Write to V. P. Jepson, Woolworth Bldg., New York.

**BOYS**, make a Gomobile, Gobob. Complete instructions free. Write for them. A postal will do. Detroit Wood Products Co., 954 Field, Detroit, Mich.

**BIG** New Book for Boys—The Boy Mechanic, Vol. II—Just Out—A sequel to, but containing nothing found in Vol. I. Tells all about 1,000 interesting things to make and do. 480 Pages; 295 Illus. Cloth. Price, \$1.50 Postpaid. Send for descriptive circular. Popular Mechanics Book Dept., 6 N. Michigan Ave., Chicago.

**JUST** Out—Amateur Mechanics No. 7. For everyone that enjoys building homemade contrivances of every description this book will afford a wealth of practical ideas and suggestions of things both ornamental and useful. Over 200 articles. Fully illustrated, 128 pages (size 6½x9½ in.). Price 25 cents postpaid. Popular Mechanics Book Dept., 6 N. Michigan Ave., Chicago.

## FOR MEN

**WAVECURL** Hair-Curling Fluid will make your hair beautifully curly. Send 15c for a sample. Wavecure Co., 10A, Saint Paul, Minn.

THE "Dash Cigar Cutter," also "Combination Pocket Tool," 3 Puzzles and big catalog sent complete for 10c. Dash Co., 3341 Herndon, Chicago.

## SAFETY BLADES SHARPENED

**RESHARPENED** by our "New Process" 2c each. Guaranteed better than new. Each blade honed, hair-tested, sterilized, wrapped individually. Jones Keenedge, Dept. A, Jamaica Plain, Mass.

**SAFETY** razors sharpened; two cents each. Guaranteed. Blade box free. Electro Stropping Co., 131 Shelby St., Detroit, Mich.

## FOR THE HOME

**FISH**—Smoked Whitefish in 20-pound baskets direct to you. Guaranteed Stock. J. L. Stuller, Wooster, Ohio.

**ARTISTIC** Lamps and Shades in metal and art glass easily made by the amateur craftsman from instructions given in our book of 18 designs ranging from ordinary reading lamps to pretentious chandeliers. Expense only slight. Price of book 50c postpaid. Popular Mechanics Book Dept., 6 N. Michigan Ave., Chicago.

**BEAUTIFUL** arts-crafts lamps—Anyone can make them out of paper, cardboard and wood. 16 designs. Inexpensive yet artistic. Complete book of instructions. Price, 50c postpaid. Popular Mechanics Book Dept., 6 N. Michigan Ave., Chicago.

## DIAMONDS, WATCHES AND JEWELRY

**GEMS** that look and wear like diamonds. \$1. Robert Bleckford (gem cutter) and dealer in all kinds of gems. 5 Main, Norway, Maine.

## PIANOS AND MUSICAL INSTRUMENTS

**TALKING** Machine Records at cut prices. 120,000 10" records for Victrolas, 20c each; 50,000 indestructible two and four minute records for Edison phonographs, 25c and 20c. Send for catalog. Deminger, The Price Cutter, Rochester, N. Y.

## MUSIC

**RECORDS** for Victrolas, Columbia and Edison (disc or cylinder) Talking Machines. Edison Standard, 7c; Blue Amberol, 25c; Victrolas, 15c; bought, sold and exchanged. Permanent Jewel Needle, \$1; Jewel point attachment for Victrola or Grafonola to play Edison disc records, \$2. Send for record list. Well's Curiosity Shop, 29 S. 2nd St., Philadelphia, Pa.

**MAKE** money mailing music circulars. Plan free. Write Needham Music Co., Del. St. Louis, Mo.

"**MIDSUMMER** Memories"—the beautiful popular new waifs mailed postpaid for 10c. You will like it. Published by Ernest Hand, Williamsport, Pa.

## FORMULAS AND TRADE SECRETS

1,000 **FORMULAS** 20c. 75 Manufacturing secrets, 13c. Resilvering Mirrors, Renewing Dry Batteries, 20c each. Guaranteed. All 50c. Catalogue free. "Ideal," 3211-B, Belleplaine Ave., Chicago.

**LEARN** how to make wine from oranges. You can make 100 to 200 per cent profit on a quart bottle selling to your friends. No alcohol used. It has the same sparkling qualities as champagne. The flavor is excellent. Can be made dry or sweet. Send 50 cents by registered mail for recipe, to the Formula Co., Box 1031, Bridgeport, Conn.

**RESILVER** Mirrors, guaranteed formula, 25c (coin). H. E. Aten, Garden Grove, Iowa.

**FORMULAS** for making Baking Powder, Tobacco Habit Cure and Gray Hair Restorer, \$1.00. Send for them today. Potter Mfg. Co., Box 82, Muncie, Ind.

**HIGH** Grade Guaranteed Formulas for almost any occasion. Prices reasonable. Cole Chemical Co., Chicago.

**FALLING** hair mastered by my wonderful tonic treatment. Formula with complete personal instructions for use and general care of the hair, \$1 money order. Don't delay. Give details with order. Browne Tonic Treatment Co., Box 157, Beloit, Wis.

20,000 **FORMULAS**—Price \$1, postpaid; complete list 4c stamps. Edm. Bromley, Watervliet, N. Y.

10,000 **SELECTED** scientific, chemical, technological, and practical recipes and processes, including hundreds of so-called trade secrets for every business, alphabetically arranged in one large volume of 800 pages. Price \$3 prepaid. Popular Mechanics Book Dept., 6 N. Michigan Ave., Chicago.

## TYPEWRITERS AND SUPPLIES

**OLIVER** Typewriters—Guaranteed Factory Rebuilt Machines—look, write and wear like new. Small cash payment and \$2 monthly. Ship anywhere. Write for descriptive circular. Galveston Typewriter Exchange, Galveston, Texas.

**TYPEWRITERS**, all makes, rebuilt, \$10 up. Guaranteed, 15 days' free trial. Catalogue free. References: Dun's or Bradstreet's. Office Equipment Company, Michigan City, Indiana.

**TYPEWRITERS**, all makes factory-rebuilt by famous "Young Process." Look like new, wear like new, guaranteed like new. Our big business insures "Square Deal" and permits lowest cash prices—\$10 and up. Also, machines rented or sold on time. No matter what your needs are, we can best serve you. Write and see—now. Young Typewriter Company, Dept. 225, Chicago.

**EXCEPTIONAL** Bargains. Selling Out. \$150.00 typewriters from \$12.00 up. All in first-class order. Write quickly. Atlantic Supply Co., Long Branch, N. J.

**TYPEWRITER** Ribbons, any color, any machine, 25c each. Petersens, Cando, N. D.

**TYPEWRITERS**. All makes. All guaranteed. Free trial allowed. Remingtons, Hammonds, Oliviers, Underwoods, etc., \$5.00 to \$35.00. Send for our list. Fordham Typewriter Exchange, Fordham, N. Y.

**LARGEST** stock of Typewriters in America—All makes; Underwoods, Oliviers, Remingtons, etc., one-fourth to one-half manufacturers' prices, \$15 up, rented anywhere applying rent on price; free trial; installment payments if desired. Write for catalogue 70. Typewriter Emporium (Established 1892), 84-38 West Lake Street, Chicago, Illinois.

**GOOD**, serviceable typewriters \$7.50 and up. Post card brings list. First class ribbons, any machine, 25c. Hub Typewriter Co., 285 Devonshire St., Boston.

## DUPLICATORS AND DEVICES

**TYPEWRITTEN** Letters, perfect ribbon process, 500 hourly produced on simple Multipress anyone can make for 50c. Complete drawings, instructions, 25c. Stamps preferred. Bona fide guarantee. Carl McFranklin, Diamond, Ohio.

A **NEW** self-inking stencil duplicator, hand or typewriting, made in England; United States selling price \$25.00; liberal discount to agents. National Typewriter Company, 78 Victoria Street, Toronto, Canada.

THE "Universal" reproduces 50 or more from one letter or anything written with pen or typewriter. 50,000 in use everywhere. Letter size, \$3.25. Sample work and booklet free. N. Reeves Duplicator Company, Park Building, Pittsburgh, Pa.

OUR "Modern" Duplicator—Yours for \$2.40. No Glue or Gelatin. Always ready. All sizes. Free trial. 34,000 users. Standard for 15 years. Booklet free. Sole mfrs., J. E. Durkin & Reeves Co., 339 Fifth Ave., Pittsburgh, Pa.

**DUPLICATORS**, \$x12, price \$1. Make 50 copies from pen or typewritten original. Booklet free. Scintek Laboratories, Dept. 1, Madison, Maine.

THE B. & R. Duplicator will print 150 copies in ten minutes, pen, pencil or typewritten original. Letter size, \$1.75. Booklet free. Brody & Rutenberg Duplicator Co., Desk P, 1126 S. Halsted St., Chicago, Ill.

## MAILING LISTS

**MAILING** List 35,000 Ford auto owners, Iowa, \$15.00, 1915 registration. Guaranteed. Other lists lowest prices. Byrd Multigraphing Co., Box 89, Durham, N. C.

**GUARANTEED** Wisconsin Rural names. \$1.50 per 1,000, 5,000 for \$6.00, 10,000 for \$10.00. Other states and classifications on request. Modern Name Supply Co., Milwaukee, Wis.

**FREE** to business men, copy of our comprehensive "Silent Salesman." Contains over 2,000 different classifications of Mailing lists with number and price of each list, and information every business man needs. Accept this free offer. Trade Circular Addressing Co., G. 164½ W. Adams, Chicago.

## PRINTING, ENGRAVING AND MULTIGRAPHING

**HIGH** Grade Business Stationery. A complete outfit consisting of 500 each letterheads, envelopes, cards, billheads and statements, white or colored, for \$7.00. Money with order. Charles R. Hartmann, Printer, Box 22 Hudson City Station, Jersey City, N. J.

**MULTIGRAPH** Letters, Letterheads—1,000 complete, \$3. Letters, purple, heads black. Samples for stamp. Perfection Letter Company, Muncie, Indiana.

**TWO** Color—200 Letterheads and 200 Envelopes—\$1.25 postpaid. F. Rittenhouse, Belvidere, N. J.

**MULTIGRAPH** Letters and Letterheads, \$3.00 complete, two colors; second to none. Samples free. Superior Letter Co., Huntington, Indiana.

**POSTPAID**—500 Bond letterheads, \$1.40; 100, 40c; 500 either envelopes, noteheads, statements, cards, tags, \$1.00; 100, 35c. Great bargain on large lots. A. J. Sturm, Stratford, Wis.

25 **BUSINESS** cards or envelopes, 10c postpaid. Chas. Walter, Lancaster, Ohio.

**PRINTED**—530 6x envelopes, 95c; 500 cards, 95c; 500 statements, 95c; 1,000 3x3 circulars, 95c; 500 bond letterheads, \$1.50. T. R. Diekey, 1174 Stout, Denver, Colo.

1,000 **IMITATION** Typewritten Letters, heading black, body purple, bond paper, \$3.00. 6x9 circulars, Letterheads, Envelopes, \$1.50. Elegant samples free. Good's Printery, Harrisonburg, Va.

**CIRCULARS**: 4½x6, \$1.00; 6x9, \$1.50 1,000 delivered. The Owl Press, Malden, Mass.

**GOOD** Printing—2,000 20-lb. Bond Letterheads, \$1. Stock's Press, Odell, Illinois.

**NOTEHEADS**, billheads, envelopes, statements, tags, \$1.50 per 1,000. Samples free. Wris Company, Lacerville, Pa.

**GOOD** Printing; Low Prices—Letterheads; envelopes; \$2 thousand, 3,000, \$7.50. Samples sent. Frankfort Sun, Frankfort, Ohio.

**SNAPPY**, up-to-date Printing. Sample order, 200 Letterheads and Envelopes, \$2.00 postpaid. Earl Engraving Co., 111 South Sixth Street, Minneapolis, Minn.

1,000 3x6 **HAMMERMILL** Bond Circulars, \$1 postpaid. Daniel Webster, Printer, Washington, D. C.

**GOOD** Printing. Reasonable prices. Mack, 1073-P, East Main, Columbus Ohio.

**PRINTING** Presses, Type and Supplies. Low Prices. Big Stock. List for Stamp. Popular Bargains, Richland, Pa.

**PRINTING** Press, paper cutter, type; complete outfit. Bargain. Whills, Dover, Ohio.

**SPLENDID** Quality 250 Bond Letterheads and Envelopes, \$1.50. 1,000 Circulars, 5x8, \$1.25. Hoyt Brothers, Pittsfield, N. H.

**GUMMED** Labels, 3,000, 60c; 40 p. catalogue, 2c. MacTaggart, 1235 Arch, Philadelphia, Pennsylvania.

**BILLHEADS** Noteheads, Envelopes; 1,000, \$1.50. Samples free. Winfield Juces, Philadelphia.

100 **GOOD** Letterheads and 100 Envelopes, 50c postpaid; 1,000 6x9 Circulars, \$1.50 postpaid. Osc. Hanson, Mentor, Minn.

50 **CARDS**, Name, Address (Business), 20c. Prompt, stylish. Will please. Royal Print, Mount Carmel, Pa.

**EMBOSS** your own letterheads, envelopes and circulars. Particulars free. Hutton Co., Box 435, Springfield, Mass.

**GUMMED** Labels—All kinds. Write for prices. Eastern Label Co., Clintonville, Conn.

1,000 **LETTERHEADS**, Envelopes, Billheads, \$2.50. The National Print Shop, 59 L Street, Northeast, Washington, D. C.

**GUMMED** Labels, 3,000 1x2 \$1; 1,000 Billheads, \$1.50. Samples. Irvin Daniel Wolf, 3136P Jasper Street, Philadelphia.

**LETTERHEADS**—1,000, \$2.00; 2,000, \$3.50; 5,000, \$7.50; good grade bond paper, 16 pound; others charge more for same quality; samples free. Girard Job Shop, Dept. L-2, Girard, Kansas.

**QUALITY Printing Prepaid**—500 either envelopes, noteheads, cards, statements, \$1.25; 1,000 \$1.85; 1,000 envelope slips, \$1.1,000 6x9 circulars, \$1.75. 500 linen finish letterheads or envelopes, \$1.75; 1,000, \$3. Printing prepaid. Imitation typewritten letters. Stamp brings samples. Model Company, Manchester, Iowa.

100 **BOND Envelopes** printed, 50c post-paid. Samples. Francis Bauer, 477 N. Goodman, Rochester, N. Y.

**GOOD Printing** at low prices. 1,000 good letterheads, envelopes, cards, billheads, labels, circulars, \$1.50. Samples free. Catalogues, booklets, and circulars our specialty. Ernest L. Fantus Co., 523 S. Dearborn St., Chicago.

**REMARKABLE Bargains** in Printing. Samples free. Excelsior Printery, Manchester, Maryland.

**PROPER Printing**. Not cheaper but better. 1,000 envelopes, letterheads, bill-heads circulars, \$2.50 per 1,000. Samples. Robinson Printery, Curwensville, Pa.

**PRINTING Outfits**—Presses, type, supplies, type novelties. Send stamp for catalogue. Model Press, York, Penna.

250 **BOND Letterheads** or Envelopes, white, blue or buff, printed to order, \$1.00 prepaid. Both for \$1.75. Samples free. Commercial Press, Beaver Falls, Pa.

**GOOD Printing**—1,000 Bond Letterheads, Envelopes, Bill Heads, or Cards, \$1.75. Circulars, \$2.00. Samples free. Wolverine Press, 37 Harrison Ave., Detroit, Mich., Printing Dept.

1,000 **GUMMED Labels**, 50c. Samples Free! G. F. Edward Harrison, Printing, Baltimore, Md.

**GUMMED Labels**—3,000, \$1.40; catalogue, 2c. Standard Label Co., Mutual Life Bldg., Phila., Pa.

501 **PLAIN Sheets** Finest Chauncy Bond Paper, 8 1/2 x 11. Suits every purpose. \$1.50. Sample Free. Frank R. Mike, Omaha, Neb.

**SEND 4c** for portfolio letterheads that give character to your business. White Printing Co., Coudersport, Pa.

#### PATENT ATTORNEYS

**PATENTS** secured or fee returned. Actual search free. Send sketch. Latest complete patent book free. 1916 Edition. (Ninety pages.) Free sales service. It should never require more than two days to report upon the patentability of your invention; nor longer than six days to prepare your case for filing. Longer delay amounts to gross neglect. For prompt personal service write: George P. Kimmel, 212 Barrister Building, Washington, D. C.

C. L. PARKER, Ex-member Examining Corps. Patent Office, Patent Attorney, McGill Bldg., Washington, D. C. Inventor's handbook, "Protecting, Exploiting and Selling Inventions," sent free upon request.

**PATENT** your invention, \$10.000 offered for inventions wanted. Booklet and opinion free. Milo B. Stevens & Co., Established 1864, 683 F St., Washington, 355 Monadnock Block, Chicago.

**NORMAN T. WHITAKER**, Patent Lawyer, Attorney at Law and Mechanical Engineer—Former Ass't Examiner United States Patent Office, Suite 22, Legal Building, Washington, D. C.

**PATENTS** secured through credit system. Free search. Send sketch. Book and advice free. Waters & Co., 4280 Warder Bldg., Washington, D. C.

**PATENTS** That Pay. Proof given. Two wonderful guide books free. E. E. Yrooman & Co., 871 F St., Washington, D. C.

**PROTECTIVE** patents procured promptly. 112 page blue book on patents sent on request. Trade-marks registered. Roth & Hobbs, 211-215 Southern Bldg., Washington, D. C.

**SEARCH** and report \$5. A careful, personal search of the Patent Office records and special written report as to patentability is included in this service. Send sketch and description of invention. H. F. Lowenstein, McGill Building, Washington, D. C.

**PATENTS**. Book and information free. Prompt and efficient service. References. Fifteen years' experience. Edgar B. McBeth, 208 G St., Washington, D. C.

**PATENTS** bring riches; protect your invention. Attorney's fee payable when patent allowed. Correspondence solicited; valuable patent advice free. Trade-marks registered. Jaynes & Jaynes, 655 Kellogg, Washington, D. C.

**DON'T** lose your rights to patent protection. Before proceeding further send for our blank form, "Evidence of Conception," to be signed and witnessed. Book, suggestions and advice free. Lancaster and Allwine, 221 Ouray Bldg., Washington, D. C.

**PATENTS**: Send model, sketch or drawing. Advice. 100 Mechanical Movements and 50 Perpetual Motions, Free. Fred G. Dieterich & Co., 61 Ouray Bldg., Washington, D. C.

**INVENTORS** will receive prompt attention and advice from Edwin S. Clarkson, Patent Lawyer, 595 Victor Building, Washington, D. C. Established 1890.

**PATENTS** obtained through D. Swift being promptly sold to manufacturers. Write today for free books of "Inventions Needed" and surpassing references. D. Swift, 317 Seventh St., Washington, D. C.

**WANTED**—New Ideas. Write for List of Inventions Wanted. \$1,000,000 in prizes offered for inventions. Our Four Books sent free upon request. Victor J. Evans & Co., 166 Ninth St., Washington, D. C.

"**PATENTS** and Patent Possibilities" is a 72-page treatise which tells all about patents, what to invent and where to sell it. It gives honest advice to inventors and tells about the successes of some of my clients, also explaining what are frequent causes of failure. Manufacturers are constantly writing for protective patents upon all kinds of sound inventions. Can you help supply their wants? The book is free. Write for it today. H. S. Hill, 965 McLachlan Building, Washington, D. C.

**INVENTORS**: Do Not Sacrifice Your Inventions. Get full money value. Reliable Book Free. Write B. S. & A. B. Lacey, 629 Barrister Bldg., Washington, D. C.

**PATENTS** that protect and pay. Advice and books free. Rates reasonable—highest references; best results. Watson E. Coleman, Patent Lawyer, 624 F St., N. W., Washington, D. C.

**PATENTS** explained in my free books, telling what you should know—what to invent—what not to invent—how to sell your patent, etc. Write today. H. L. Woodward, 992 G St., Washington, D. C.

**PATENTABLE** Ideas Wanted—Send for 3 free books. R. B. Owen, 30 Owen Bldg., Wash., D. C.

**THE Patentome** is free. An education in obtaining patents. Established 1865. Anderson & Son, Attorneys, 707 7th St., Washington, D. C.

**PATENTS**—Herbert Jenner, patent attorney and mechanical expert, 606 F St., Washington, D. C. I report free of charge if a patent can be had and its exact cost. Send for circular.

**PATENTS**—Trade-Marks. Send for my free book, "How To Get Them." It's full of information you should know. Joshua R. H. Potts, 8 Dearborn St., Chicago; 929 Chestnut St., Philadelphia; 805 G St., Washington.

**PATENTS**—Send sketch for free search and report. Books on patents and book of reference letters sent free. John S. Duffie & Co., 610 F St., Washington, D. C.

**PATENT** What You Invent. It may be valuable. Write me. No attorney's fee until patent is allowed. Estab. 1882. "Inventor's Guide" free. Franklin H. Hough, 522 Loan & Trust Bldg., Washington, D. C.

**PATENTS** secured promptly. Personal attention. Edward W. Kibbey, Patent Attorney, 563 Victor Bldg., Washington, D. C.

**NO** Attorney fees until patent allowed. Send sketch for free report. Books free. Frank Fuller, Washington, D. C.

#### FOR INVENTORS

**WE** want patented mechanical toys to manufacture and market on royalty. Northern Electric Co., 25 E. 26th St., New York.

**INVENTIONS**—Patenting and Promoting. A book containing practical advice and directions for inventors and manufacturers. Book, suggestions and advice free. Lancaster and Allwine, 221 Ouray Bldg., Washington, D. C.

**PATENTS** secured through credit system. Free search. Send sketch. Book and advice free. Waters & Co., 4280 Warder Bldg., Washington, D. C.

**WILL** furnish capital, factory space and established organization for manufacturing and marketing good light article (patented or unpatented) in Canada. Twelve travelers on road covering entire Canada. A. Morin, Box 690, Montreal, Canada.

**THE Magazine** of Invention helps inventors to profit. It will help you to save money, obtain strong patent protection and promote your invention. One-half year, 25c. Washington, D. C.

**PATENTS** and Patentable Ideas sold. Best location and facilities. Fuller Co., 500 Fifth Ave., New York.

**WANTED**—New ideas of quick-selling attachments for automobiles, or labor-saving devices for the farm. Will assist inventor to patent and manufacture on royalty. Address, H. L., 313 North Fifth St., Springfield, Illinois.

**INVENTIONS** commercialized on cash and royalty basis. Two free books. Inventors and manufacturers write. Adam Fisher Mfg. Co., 2051 Ry. Ex., St. Louis, Mo.

**INVENTORS**: Let us help you. Inventors' Syndicate, Desk PM, St. Louis, Mo.

**SELL** your patent through the Patent Publicity Company, Browning Building, New York City. Particulars free.

**CANADIAN** Patents sold and secured. Best selling facilities. Quick results. The Law Company, 2 Wood St., Toronto, Canada.

**INVENTORS**: Patent your inventions through me and I will negotiate the sale of the patent free. Book on patents with List of Needed Inventions 5c. Sanders, 7 Webster Building, Chicago.

**WIRE** goods all kinds made to order. Cooley, 553 W. Monroe, Chicago.

**PATENTABLE** Ideas Wanted—Send for 3 free books. R. B. Owen, 30 Owen Bldg., Wash., D. C.

**HAVE** you a Patent to sell? You'll be interested in my proposition. Write now for free particulars. F. W. Johnson, 6 N. Michigan Ave., Chicago.

**PATENTS, Trade-Marks** and Copyrights. Our handbook on patents will be sent free on request. All patents secured through us are described without cost to the patentee in the Scientific American. Munn & Co., Patent Attorneys, 672 Woolworth Bldg., N. Y. Washington, D. C., office, 625 F St.

**PATENTS** without advance attorney's fees. Send sketch for free report. Books free. Frank Fuller, Washington, D. C.

**MECHANICAL** Engineers. Specialist in designing and perfecting inventions. 15 years experience. Send details for free estimate of cost. Albert S. Kux, 105 W. Monroe St., Chicago.

**WANTED**—An Idea! Who can think of some simple thing to patent? Protect your ideas; they may bring you wealth. Write for "Needed Inventions" and "How to Get Your Patent and Your Money." Randolph & Co., Patent Attorneys, 620 F St., Washington, D. C.

**HAVE** You an Idea? If so, you should protect it by a patent. Send us a model or sketch for free opinion as to patentability. Write for our Four Books sent free to any address. Victor J. Evans & Co., 157 Ninth St., Washington, D. C.

**MONEY** advanced to develop, patent, commercialize good inventions. Repay when sold. Simpson, Union Building, Cleveland.

#### INVENTIONS MARKETING

**YOUR** Invention may come within the limits of our Laboratories' work. If so our Business Department will consider it. Copy of patent with stamps for return will receive prompt attention. McCormick Laboratories, Dayton, Ohio.

#### PATENTS FOR SALE

**FOLDING** Garment hanger for entire wardrobe. Contains rods for coat and trousers; rings for collar, tie, hat. Can be carried in suit case. Fannie L. Reed, 413 N. Armstrong, Kokomo, Ind.

**PATENT**—Something New: Fruit, Vegetable Cutter and Grater Combined. Every Kitchen Needs One. Jno. Denis, 2037 Ursulines Avenue, New Orleans.

**NEW** game puzzle; outright or royalty. H. B. Hill, Rumford, B. I.

**SALE** or Royalty—Patent combined shovel and brush for cleaning streets. Caleb Crisman, 5730 W. Madison St., Chicago, Ill.

**2 PATENTED Fasteners** easy to put on awnings, canopies, tents, curtains, similar devices. Does away with rings, staples, gromets, snap hooks, straps, buckles, laces, lings, binding bands, etc. One patent now in successful use today. A. F. Nugent, 231 W. 21st, New York City.

**RATCHET Wrench** for sale. Vern Seiver, Elkton, South Dakota.

**"McLERAN'S Safety Bull Lead"** Endorsed by five hundred users in forty-three states. Poor health forces sale. Patent—completely established business. McLeran, Wrenshall, Minn.

**FOR Sale—Automatic Wrench**, a dandy; for full particulars, write G. M. Capter, Mattoon, Ill.

**PATENT** allowed; will offer good proposition; utilize scrap upper leather for attractive novelty, belts, watch fobs, coat chains, etc. Paul Agrillo, San Jose, Calif.

**UNITED STATES, British, French and German patents** on Bird-wing Safety Aeroplane, for sale, royalty, lease. 324 Jenkins, Columbus, Ohio.

**PATENT for Sale**, Sixteen-size S Wrench for Farm Machinery, and a Cutlery Cleaner. J. Helstrom, 1390 Third Ave., New York.

**FOR Sale**: Patented Thermo Electric Circuit Closer. Simple and accurate. W. B. Neely, Chapel Hill, Tenn.

**SELF-LOCKING Hinge**. Patent recently allowed. For sale or royalty. Dieter, 1422 Myrtle Avenue, Brooklyn, N. Y.

**PATENTED One Cycle Gas Engine**, simple and noiseless and cheap to manufacture. Address A. Anderson, Barre, Mass.

**NEW "Toy"** outright or royalty. F. J. Boyle, 1614 Ave. K, Galveston, Tex.

**MANUFACTURERS, Attention!** Automatic Wrench, three tools in one. Cheap to manufacture. Postoffice Box 742, South Manchester, Conn.

**PATENT Buyers** are invited to address our sales department for information on any class of Patents they wish to purchase or lease on a royalty. We have secured a number of valuable patents in all lines of invention. Mail Order, Department Store and Household Novelties a specialty. Victor J. Evans & Co., 160 Ninth St., Washington, D. C.

**FOR Sale—American and Canadian Patents** on combined Broiling and Baking Oven for Gas Ranges. Reasonable price for quick sale. Splendid chance for some one. Box 783 La Crosse, Wisconsin.

#### MODELS AND MODEL SUPPLIES

**PRODUCERS of Results**: Inventions developed, Models, Experimental Work, anything special in metal to order, novelties, spinning, forging, castings in any material, electrical devices, patterns of all kinds, plating, general manufacturing, designing, special tools, punches and dies, stampings. Send drawings or sample. Expert information free. John's Machine & Stamping Works, Dept. C, Cleveland, Ohio.

**MODEL** making. Inventions developed. Write for estimate. Stearns, Paxton, Ill.

**MODELS, Dies** for inventors, by builders of "Tools That Work" manufacturing. La Croix Tool Co., 214 N. 21st St., St. Louis, Mo.

**MODELS** made for inventors; general machine work; designing and perfecting; developing automatic devices and machinery. In a position to do all kinds of light tool and machine work. Prices reasonable; estimates cheerfully given. Ideal Machine Works, 62 Ann Street, New York City.

**PATTERN makers!** A book devoted to the principles of pattern and core making and molding. Written by G. H. Willard, a practical pattern maker of years' experience. This book, just published, treats the subject in a much more simple, direct and effective manner than most books along this line. 224 pages, 312 illustrations. Price, \$1, postpaid. Popular Mechanics Book Dept., 6 N. Michigan Ave., Chicago.

**NEW Lithographic Model of a Monster Mallet Compound Locomotive**. All parts shown and numbered. Size 9x19 in. in colors. Other models in series are: Atlantic Type Locomotive—Steamship—Automobile—Gas Engine—Steam Engine—Steam Turbine—Dynamo—Wireless Telegraph. Price, 50c each or set of 9 for \$4 postpaid. Popular Mechanics Book Dept., 6 N. Michigan Ave., Chicago.

**WE** make working models for inventors; also dies and stamping of specialties, and carry a complete stock of brass gears and model supplies. Send for catalogue. The Pierce Model Works, 3165 Pierce Ave., Chicago, Ill.

**INVENTORS**: We manufacture metal articles of all kinds to order. Also, special machinery, tools and dies, punchings, lathe and screw machine work, metal spinings, castings, plating, wood and metal patterns, etc. Send sample for estimate and expert advice, free. The Eagle Mfg. Co., Dept. B., Cincinnati, O.

**SPECIAL Electrical and Mechanical devices** built to order. Models, Tools, Dies. Bend. Levi, 357 West Broadway, N. Y. City.

**FREE catalogue** of model supplies, Castings, metal specialties on contract. North Chicago Tool Works, 15 Grove Ave., North Chicago, Ill.

#### MANUFACTURING

**WE** can roll metal in any conceivable shape with our Roller Die Process. Groover Engine Company, 2218 Pine St., St. Louis, Mo.

**WE** are prepared to furnish machined castings of Cast Iron, Brass or Aluminum. Practical Iron & Machine Works, North Chicago, Ill.

**NOVELTIES or Specialties** to manufacture or market. O. D. Johnson, Stamping Wks., Batavia, N. Y.

**WE** manufacture all kinds of metal specialties, make dies, tools, patterns, models, etc. Write for particulars. Cincinnati Specialty Mfg. Co., Cincinnati, Ohio.

**WANTED—Specialties** with merit to manufacture and sell, particularly automobile specialties. Well-equipped manufacturing and merchandising facilities. Hastings Mfg. Co., Hastings, Mich.

**LET** our factory be Your factory. Metal specialties developed and correctly manufactured. L. R. Nelson Mfg. Co., Peoria, Ill.

**INVENTIONS** perfected and manufactured. Reference: Your Banker. Russell Machine Co., Dallas, Texas.

**WIRE Goods**, all kinds, made to order. Cooley Mfg. Co., 533 W. Monroe St., Chicago.

#### REAL ESTATE AND FARM LANDS

**FREE** Book of Florida Facts. If interested in Florida, before visiting or settling in this wonderful state of fragrant flowers and sunshine, write Lake County Land Owners' Association, No. 93 Lloyd St., Fruitland Park, Florida, for free book of actual photographs and real conservative facts concerning this State. There is poor, good, better and best land in Florida. This book will teach you what is best and why. The members of the Association are not land agents; they simply wish to tell actual facts to those really interested in the State. They have no time to waste on curiosity seekers, children or people who expect to grow rich without effort, but to those of character, energy, some capital, with a desire to learn more of the opportunities in this most prosperous State we would be glad to give fullest information.

**YOUR Opportunity—Eleven-acre** bearing Satsuma Orange and Grape-fruit grove, small bungalow, garage, two miles from Gulf, shell roads, stone's throw from Golf Links. \$7,000 value for \$5,000, \$3,000 cash, balance one and two years. M. R. Hicks & Co., Ocean Springs, Miss.

**WANTED** to hear from owner of good farm for sale. State cash price and description. D. F. Bush, Minneapolis, Minn.

**TWENTY acres** in San Joaquin Valley, California, in fruits, vegetables, alfalfa, with cows, pigs, poultry and bees, will pay you steady, substantial profits. Delightful climate, rich soil, good schools, churches, fine roads. Thrifty, hospitable neighbors. Write for free books. C. L. Songraves, Gen. Colonization Agent, AT&SF Ry., 1016 Ry. Exch., Chicago.

**VIRGINIA Farms**, small and large, \$15 an acre and up. Easy payments, mild climate, fertile soil. Ideal for fruit, stock or general farming. On railroad with big markets near-by. Write for list, maps, etc. F. La Baume, Agri. Agt., N. & W. Ry., 250 N. & W. Bldg., Roanoke, Va.

**LANDOLOGY**, a magazine giving the facts in regard to the land situation. Three months' trial subscription Free. If for a home, or as an investment, you are thinking of buying good farm lands, simply write me a letter marking it personal and say, "Mail me Landology and all particulars Free." Address Lloyd M. Skinner, Gen'l Mgr., Skidmore Land Co., 49 Skidmore Bldg., Marinette, Wis.

**17,000 ACRES** improved, easy terms, for colony, several small farms. Levi Paul, El Campo, Texas.

**FOR Sale**: Improved 120 dairy farm, near creamery, \$85 per acre, half cash, balance 5 years, 6%. J. E. Armstrong, Claremont, Richland Co., Ill.

**SOUTHERN lands** are low in price but high in productive value, make two to four crops a year and give largest profits in grain, vegetables, fruits, live stock and dairying. Unsurpassed climate, good markets. Southern Progress is on the Southern Railway. Publications on request. M. V. Richards, Commissioner, Room 64, Southern Railway, Washington, D. C.

**PEETLE Farms**, near Philadelphia, Catalog, W. Stevens, Perkasie, Pa.

**ARKANSAS—Write** today for free literature about Southwest Arkansas farms. L. E. Smith, Locksburg, Arkansas.

**OPENING of a New Town**, and 10,000 acres of choice land, on the Tampa & Gulf Coast R. R., 36 miles from Tampa; situated on a beautiful river; near the Gulf of Mexico; rail and water transportation; hard roads; good drinking water; fine fishing, hunting and boating; delightful climate; best health conditions; high, rolling, well drained land; center of citrus growing and winter resort district; splendid opportunities for homeseekers, investors and business men; town and surrounding country developing rapidly; low prices; easy terms. Send for particulars. R. L. Smith, Industrial Agent, 157 Main St., New Port Richey, Fla.

**BEST and cheapest hardwood timber**, farms and homes in America—easy terms—write. Jones, Pettigrew, Ark.

**NATIONAL Realty Exchange Bulletin**, Milford, Ind. 3 months, 10c. Ads, 1c word; 1,000 bargains.

**TEXAS school land**, for sale by the state, at \$2 per acre; 5 cents per acre cash and no more, for 40 years, but 3%. Send 6 cents postage for further information. Investor Pub. Co., Dept. 47, San Antonio, Tex.

**DAIRY Farm**, Modern, Near Peoria, Ill. Bargain. Phillips & Greaves, 502 Princess Bldg., St. Louis, Mo.

**CALIFORNIA** improved farms for sale. Write E. R. Waite, Shawnee, Okla.

**FARMS for Sale or exchange** anywhere in the U. S. or Canada, direct from the owners. State where you want to locate. Information free. American Investment Association, 37 Palace Bldg., Minneapolis, Minn.

**WANTED—To hear** from owner of good farm or unimproved land for sale. H. L. Downing, 180 Palace Bldg., Minneapolis, Minn.

**REAL Estate Educator—Containing** inside information not generally known. "Don'ts" in Real Estate, "Pointers," Legal Forms, etc. It gives in condensed form the essential knowledge of the Real Estate Business. New revised edition covers Workmen's Compensation Act, Income Tax Law, Employers' Liability Act, Statute of Frauds, How to Sell Real Estate, etc. What you need to know; ought to know and want to know. 256 pages, cloth, \$1 postpaid. Popular Mechanics Book Dept., 6 N. Michigan Ave., Chicago.

**MONEY-MAKING Farms** throughout 15 Eastern States; 1 acre to 1,000 acres, \$15 per acre up; several with livestock, tools, and crops included, to settle estates; big illustrated catalogue free. E. A. Strout Farm Agency, Dept. 3343, 47 W. 34th St., New York.

**SELL** your property quickly for cash, no matter where located. Don't pay big commissions. Particulars free. Real Estate Salesman Co., Desk B, Lincoln, Nebr.

**I HAVE** a successful way of selling farms and farm lands. Write me for free particulars. No obligation whatever. E. J. Zimmer, 925 Tower Bldg., Chicago.

**CALIFORNIA—Improved** ten acre ranch in city. House, furniture, wonderful Grape-fruit Valley. Bargain and terms. Mrs. J. Musser, Imperial, Calif.

**FARMS—All Kinds—All Sizes Located** throughout U. S. Bargains. Deal direct. Tell us your requirements. Ayres Real, 2164 Gas Bldg., Chicago, Ill.

## GINSENG

**GINSENG Culture**, 10c. Golden Seal estimate \$6,000 an acre. Booklet giving my experience, 10c. W. N. Long, Florence, Ky.

## DOGS, BIRDS, POULTRY, PETS

**POULTRY Book Free**—Contains condensed experience of twenty-five years with poultry. Houses, Yards, Incubator Operation, Care of Chicks and Poultry, Diagnosis and Treatment of Disease, Poultry Secrets, Pointers for the Amateur, Mandy's Poultry School, The \$1,000 Egg, Hatch Record, Egg Record, etc. All free. Geo. H. Lee Co., 400 Lee Bldg., Omaha, Nebr., Mfrs. Lee's Lice Killer, Germozone, Lee's Egg Maker, etc.

**THE Best in Pointers, Puppies, Broken Dogs and Brood Bitches**, by Champion Comanche Frank, Fishel's Frank and Champion Nicholas R. Write me your wants please. U. B. Fishel, Box P, Hope, Ind.

**HOUNDS** trained on fox, rabbit, deer, wolf, bear; bloodhounds; 50-page catalog, 5c stamp, Rockwood Kennels, Lexington, Ky.

**BOOK on Training Performing Dogs**—Postpaid, 25c money order. Address McFall Pub. Co., North Baltimore, O.

**COON, Fox and Rabbit Hounds** sold on trial. Good as lives. Illustrated catalog 10 cents. Homestead Kennels, Plainfield, Ind.

**RAISE Guinea Pigs**. We furnish stock, show you how and buy all you raise. Big demand. Thousands needed yearly. Easy to raise, very prolific and profitable. Particulars and contract for two-cent stamp. Cavies Distributing Co., 707 West 74th St., Kansas City, Mo.

**GOLDFISH**—Rare specimens, artistic aquariums, waterplants. Circular free. Pioneer Goldfish Hatchery, Racine, Wis.

## PERSONAL

**STOP Tobacco**, without harmful drugging, quickly, secretly, inexpensively. Free booklet tells how. Hexex Remedy Company, Dept. B., Houston, Texas.

**BROTHER!**—Accidentally discovered root cures tobacco habit. Gladly send particulars. F. Stokes, Mohawk, Florida.

**FREE**—Stop using Tobacco. Free. We will give free information how to conquer the habit easily and permanently. Results Guaranteed. Anti-Tobacco League, 618 Paxton Block, Omaha, Nebr.

## MISCELLANEOUS

**GRANDFATHER'S Clock Works**, \$5. Slightly shop-worn, quantity limited, others with chimes, all prices; also several nice Grandfather's Clock cases, exceptional bargains. Clock Company, 1673 Ruffner St., Philadelphia, Pa.

**HOW to make Printing Cuts cheaply**, 150 selected formulas, 20c. "Ideal," 3311-B, Belleplaine Ave., Chicago.

**\$2.50 POCKET Adder**. Send for circular. Bassett, 3921-N, Indiana Ave., Chicago.

**ADDING device** mailed for a dime. Unlimited scope, accurate. School children prove addition. Korrekt Counting Co., Athens, Texas.

"**HOMES** made happy, and sad hearts glad. Drunkenness cured without effort. Pleasant and harmless. The appetite leaves you. Send \$2.30 to The People's Friend, Trujillo, Honduras, and be convinced." Foreign postage five cents.

**INVENT Something**: Your ideas may bring wealth; our free book tells what to invent and how to obtain a patent, through our new credit system; write today. Waters & Co., 4103 Warder Bldg., Washington, D. C.

**HIGHEST Grade, Rare, Exclusive Formulas** supplied for any product. Mail-Order, Agent's Latest Specialties. Write me your wants. Latest Formula Lists, How to Start a Pleasant Profitable Permanent Manufacturing Business for stamp. Liscombe Miller, Analytical Chemist, Tampa, Florida.

**I BUY** hundreds of insects, butterflies each summer at 5c to \$7.00 each, for museums, artwork, if properly fixed. Men, women send 2c stamp for details telling all. Sinclair, Box 244, D-6, Los Angeles, Calif.

**CRAYON Portraits**—Make them at home. Sample and instructions 20c. L. Dallas, Cambridge, Ohio.

**BUILD Home for yourself**—Save architects' cost. Practical. Perfect Building Sketches—One Hundred Perspective Views and Floor Plans \$1.00. Free Illustrated Catalogue Home Study Books. Drift, 69 Washington, Chicago.

**BARGAIN!**—Reliable self-filling fountain pen, 25c in cash. V. N. Gingrich, Box 245, Hearshey, Pa.

**RUBBER Stamps, Stencils**. Catalogue 10c. Florida papershell pecan nuts \$1.25 lb.; samples 10c. Buckeye Stamp Works, Market, Dayton, Ohio.

**STOP Using Tobacco**. Complete treatment \$1. Sweeney Bros., Des Moines, Iowa.

**LOCKSMITHS**: My tool and instructions guaranteed to open any door using cylinder lock. Price \$6.50. Particulars for stamp. Chas. E. Williams, Box 1091, Atlanta, Ga.

**BUFFALO Greenbacks**. Finest imitation possible. 5000—\$6.00; 1000—\$1.50; 100—35c. Roll—10c. Samples for stamp. Gil-noveo, Morgan Park, Chicago.

**3,000 SELECTED Cartoons for \$3**. A Panorama of World Events, Political, Industrial—Social—Humorous—Tragic—all of intense human interest. A wonderful collection of 3,000 cartoons reproduced from the newspapers of the United States, Canada, Mexico, Cuba and the cities of the Old World, has been made by Cartoons Magazine from more than one hundred and fifty thousand published cartoons, and bound in an artistic and durable cover, are now ready for your library table. Vol. I, Jan.-June, 1912—\$1. Vol. II, July-Dec., 1912—\$1. Vol. III, Jan.-May, 1913—\$1. Cartoons, 78 E. Madison St., Chicago.

**WAR Atlas**—Large 20-page (11x15 in.) Atlas of the War in Europe, containing large colored scale maps of the battleground, showing Europe, Austria, Servia, Germany, England, Belgium, France, Russia, Italy, Greece, The World, etc. Special data showing comparison of armies and navies involved, pictures of rulers, etc. Price, 25 cents. Postage and packing, 5 cents additional. Address Popular Mechanics Book Dept., 6 N. Michigan Ave., Chicago.

**TATTOOING Machines, Colors and Supplies** for all interested in the Art. Get My Catalogue Now and be ready for the coming season. Prof. J. Barber, 70½ Brush St., Detroit, Mich.

**CUTS** anybody can make. Simple, cheap process. Numerous specimens, convincing particulars, for stamp. M. Day, Windfall, Ind.

**MOTOR-SLEIGHS**, ice-boats, 2-4 and more passengers, from \$100 up. Safe and speedy. Send for particulars. U. S. Aero, 38 Park Row, N. Y. C.

**GENUINE Sioux Indian Headwork and Curios**, also Elk Teeth, Moccasins, Fobs, Belts, Hatbands, Pouches, Warclubs, Indian Costumes. Send 10c for price list. Strong Curio Co., Gordon, Neb.

**INDIAN Baskets, Relics**. Price free. G. Gilham, Highland Springs, Cal.

**AGENTS \$60 WEEKLY**  
 Robinson Folding Bath Tub, Big seller. Costs little, no plumbing, little water. Weight 15 pounds, folds into small roll. Full length baths, far better than tin tubs. Guaranteed 10 years. \$10 a day easily made. Write for free tub offer.  
 ROBINSON CABINET MFG. CO. 4227 Factory Bldg., Toledo, Ohio

**AGENTS! A CYCLONE SELLER! LOOK!!**  
**Make \$10 a Day**  
 Write for biggest offer ever made. A FORTUNE IN IT! Stark made \$148 first week. Bell cleaned up \$85 in four days. All our agents making loads of money.  
**\$3.45 Value to Sell for \$1.00 With \$1.00 Carving Set FREE**  
 "BIG DANDY," our leader 11 piece Toilet Article Set to sell for \$1 or more and give every customer a beautiful \$1 Carving Set FREE. Many getting \$1.25 to \$1.50 for the combination. Biggest hit on record. Costs only 90c complete or 45c without carving set! This is just one item of our enormous line. Get our big circulars.  
**Special Offer**  
 Write quick, or send \$1.50 for complete sample in plush lined case! FREE case with first order 10 sets \$8. Get in the swim NOW!  
 E. J. WHITE, Pres.  
**PIERCE COMPANY**  
 600 Pierce Bldg., Chicago, U.S.A.

**1916 MEAD** **RIDE a RANGER**  
 bicycle and know you have the best. Buy a machine you can prove by actual test before accepting.  
**DELIVERED FREE ON APPROVAL and 30 days' trial.** No expense to you if you do not wish to keep it.  
**LOW FACTORY COST**, great improvements and values never before equalled in our 1916 models.  
**WRITE TODAY** for our big catalog showing our complete line of 1916 bicycles, TIRES, sundries and parts, and learn the wonderful low prices and new offers and terms we will give you. Do not buy until you know what we can do for you. Write a post card now.  
**MEAD CYCLE CO. DEPT. N108 CHICAGO**

**Be an Artist.** and Draw for Magazines, Newspapers, Etc. Earn Big Money (Send sample of your work for honest criticism)  
 All Branches of Art Taught BY MAIL or Local Classes. Write for illustrated booklet, terms and list of successful pupils.  
**ASSOCIATED ART STUDIOS, 2122 Flatiron Bldg., NEW YORK**

**Public Speaking Taught at Home**  
 Write now for special offer. We train you, in spare time by mail. Be a powerful, convincing speaker. Overcome "stage fright"—enlarge your vocabulary—train your memory—gain self-confidence—become more popular. Learn to use your voice effectively—to enunciate your words—how and when to use gestures—what style of speech to use on different occasions, etc.  
**Special Offer—Write Now** Special discount offer open to a limited number of new students. So write for particulars now while this offer lasts. No obligation or expense to you.  
**Public Speaking Dept.** American Correspondence School of Law, 1192 Manhattan Bldg., Chicago, Ill.



# Learn Electricity

## Earn \$2500 to \$4000 a Year

Your CHANCE has come! Your chance for big money. Your chance to do the kind of work you'll be proud of. Your chance to go into business for yourself. Think of it! You can now qualify AT HOME for that most wonderful of all fields open to the ambitious man—the great field of ELECTRICITY! Yes, no matter who you are, where you live or what you do, I will take you in hand and make you an EXPERT ELECTRICIAN so that you should easily earn \$2,500 to \$4,000 a year and more. And I'll do it so quickly and with so little effort on your part that you'll wonder how it was possible.

**A. W. Wicks,  
E. E.**

Formerly with the General Electric Company; former General Manager of company manufacturing Jenney Electric Motors; also formerly with Fairbanks, Morse & Co.; now Consulting Engineer and Director of the Wicks Electrical Institute.

## AMAZING OPPORTUNITY

What if you don't know a thing about electricity! What if you've never had a bit of electrical experience. All I ask is that you give me a little of your spare time. I will instruct you personally and make the whole matter so simple for you that you can't help but learn. You don't have to buy a lot of books or equipment. You can master MY personal instructions easily right at home. I've solved this question of teaching electricity. I'll show you I have by giving you 20 personal lessons ABSOLUTELY FREE. Almost from the very first instructions you will have the knowledge and skill to do practical, electrical work—work that you can demand good money for doing. You can earn as you learn—more than pay for your instruction as you go along.

## Be An Electrician

Think! When you have finished my instructions you are an EXPERT ELECTRICIAN! You are right then and there ready to take a big paying job or start in for yourself. I will train you until you consider yourself competent regardless of the time it takes. I not only show you how to do expert electrical work but show you how to estimate on jobs so you can take contracts at big profits. That's what it means to be personally trained by a man of my practical experience in every phase of electricity. Decide today to take advantage of my big free 20 personal lessons offer. Don't let the question of money bother you. I make the cost so small and the payments so easy that you won't miss the money.

**MEN WANTED** Wherever you go there's always urgent demand for Expert Electricians and at big pay. That's because the watchword of the age is, "DO IT ELECTRICALLY." Electricity advances so fast that there's a big shortage of competent electricians. And the demand is constantly increasing every day.

# 20 Complete Lessons FREE!

That's the sensational offer I am making now to a few more ambitious men. I make it for two reasons. 1st. To show you how easy my personal instructions are to master. 2nd. To secure quick action on the part of a few more prospective students. This offer means that you get 20 complete personal lessons ABSOLUTELY FREE! But you must act quick. The offer closes in 23 days. Send coupon or postcard at once. I'll send full particulars immediately. Mail coupon today—sure!

**A. W. WICKS, E. E., Director Wicks Electrical Institute,  
81 West Randolph St., Dept. 64 Chicago, Ill.**

Send this  
Coupon

**A. W. WICKS,  
E. E., Director,  
WICKS ELEC. INSTITUTE,  
81 West Randolph St.,  
Dept. 64 Chicago, Ill.**

Without any obligation on me whatever, please send me full description of your personal instructions in Electricity and particulars of your special offer of 20 of your lessons free.

Name.....

Street and No.....

City.....State.....

Please Mention Popular Mechanics

# Alois P. Swoboda

## A Remarkable Personality

By Donald Richardson

**T**HE simple fact that the human body is built up of billions of cells, all resulting from the evolution of one original cell, is in itself interesting, but little more to the average person. The further declaration that health, life and pleasures of the body depend upon the condition of each individual cell compels notice.

When, however, along comes an individual who combines intimate scientific knowledge of the human cell with the discovery of the means to insure its health and develop unusual energy and potency—who by reason of study, experience and a certain genius, shows us how without inconvenience, apparatus, drugs, study or loss of time, we can put unusual health and uncommon life into every one of our vast multitude of cells, thus giving the human body and mind the maximum of health, pleasure and power, and do this in a perfectly natural, easy and practical way—then we are all attention.

### A Great Secret of Life

This is the marvelous secret uncovered in a wonderful little book by Swoboda, a great pioneer in the realm of physiological science. Some day the complete history of Conscious Evolution and its discoverer will be recorded, with all its immense significance and far-reaching ramifications. This brief article can only sketch the rough outlines.

The story of Alois P. Swoboda is one of the romances of human history. As the discoverer of the origin and nature of the laws governing "conscious energy" and of a scien-

tific system for applying those laws in a manner that has operated successfully in over two hundred thousand cases, Swoboda occupies a peculiar niche in earth's hall of fame. He did not merely write a great book, paint a great picture, invent some useful device, or win some particular battle. His fame is built on a far more substantial foundation. He is the

wizard of the human body. He is the apostle of the greater, the successful life. Swoboda not only makes men and women unusually well, unusually energetic, unusually alive and unusually keen; but he, virtually, by exchanging the elements of the cells of the body, recreates human beings.

He makes them more powerful, capable, and happy than they were before. He advances them a tremendous way along the line of human development. The man himself—as well as his hosts of enthusiastic clients—is a most convincing example of the effectiveness of his methods. He has revolutionized the methods of energizing the body and mind.

### The Swoboda System of Conscious Evolution Based on a Knowledge of All Sciences

Swoboda fairly radiates vitality, his whole being pulsating with unusual life and energy. And his mind is even more alert and active than his body; he is tireless. He discourses with learned fluency on the science of "Conscious Evolution," which embraces all other sciences, entering with equal ease and facility on any phase of this all-important subject.



*Swoboda*  
Originator of  
Conscious Evolution

Please Mention Popular Mechanics



Start him on his particular specialty—the development of human powers—and he pours out a veritable flood of illuminating exposition. Earnest and vehement, he rises to eloquence as he unfolds in his masterful manner the magnificent possibilities of man under the guidance of “conscious energy.” You are impressed with the fact that you are in the presence of a remarkable personality, a superior product of the Swoboda system of body and personality building. Swoboda embodies in his own super-developed person the best proof of the correctness of his theories and of the success of his “Conscious Evolution.”

### **The Aim of Conscious Evolution Is Better Minds, Better Bodies, Better Health and More Intense Pleasures**

Mr. Swoboda must not be classed with ordinary physiologists, physicians, faddists or with those whose aim is merely the development of muscle. Neither his philosophy nor his science is confined to such narrow limits. Swoboda's plan comprehends the complete development of the human being—increase of internal force, more body power, more brain power, mind power and, in fact, greater capacity to live and enjoy in every way. He is primarily interested in those influences which make for a fuller and more potent life.

One cannot remain long in the presence of Swoboda without realizing that he is mentally and physically a superman. He makes you feel that you are only partially well and vigorous and ambitious, only partially developed, that, in short, you are only half as alive as you must be if you wish to enjoy to the full the benefits of living—that you are leading an inferior life. No one can read his book without becoming conscious of his wonderful power and personality.

***Ponce de Leon's fountain of youth died with him. Your fountain of youth will die with you. Each man's fountain of youth is within himself. Through Conscious Evolution only can you drink to the full of the fountain of youth.***

***The address of Alois P. Swoboda is 1381 Aeolian Building, New York, N. Y.***

Swoboda demonstrates that no matter how old we may be we can, through the conscious use of the principles of evolution make ourselves full-powered dynamos, with every part and wheel and power-belt thoroughly in trim, working smoothly and at maximum capacity—100 per cent efficient.

If you believe you have developed to the highest degree your vitality, energy and powers of living and enjoying, you are, according to the Swoboda Standard, indeed, mistaken. Conscious Evolution can lead you to a new and greater realization of health, energy and pleasure.

More power, energy and life are the needs and will be the salvation of the present generation. The problem has always been how to get them. Eagerly we try each solution offered, swarming like the Athenians after every new thing. And yet the means lie right within us, as Swoboda clearly demonstrates.

Conscious Evolution is an antidote to old age in its every form and variety of conditions. It scientifically reduces excessive blood pressure, restores elasticity to arteries and turns the dial of physiological time in the direction of youth, efficiency, vitality and greater pleasure.

No one who is energized through Conscious Evolution will be subject to indigestion, bowel sluggishness, nervous exhaustion, brain fag, sleeplessness, nervousness, or any functional difficulty of any character.

### **Swoboda Has Written a Wonderful Little Book**

This book explains the Swoboda System of Conscious Evolution and the human body as it has never been explained before. It makes clear Swoboda's new theory of the mind and body. It startles, educates and enlightens. It tells how the cells build the body and how to organize them beyond the point where nature left off, for each one of us. It will give you a better understanding of yourself than you could obtain from a college course; the information which it imparts cannot be duplicated elsewhere at any price. It shows the unlimited possibilities through conscious evolution of the cells; it explains Swoboda's discoveries and what they are doing for thousands of men and women of every age and condition. It tells of the Dangers and after-effects of Exercise, and Conscious Deep-Breathing. Swoboda's book shows how anyone may possess unusual health and vitality.

You will cherish this book for having given you the first real understanding of your body and mind and for showing you how you may be able to attain greater pleasure and in every way a superior life.

Thousands have advanced themselves in every way through a better realization and conscious use of the principles of evolution which Swoboda discovered. It will open new avenues through which you may become successful in satisfying your most intense desires. It is not a dry treatise on physiology; on the contrary, it tells in a highly interesting and simple manner just what you need to know about the body and mind and the laws of their evolution.

It is futile to try to describe by words the Swoboda kind of health and vitality and energy. You must experience it for yourself to appreciate it and to learn that you are missing the cream of existence or that you are living, in reality, an inferior life to what you may easily acquire or live.

*Please Mention Popular Mechanics*

**You Can Make This Jump Easy!**



# Become an EXPERT ACCOUNTANT

**\$3,000 to \$10,000 Yearly** Right now railroads, corporations and other big firms need Expert Accountants at salaries of \$3,000 to \$10,000 yearly. The need for experts is greater than the supply, and possibilities for advancement into big, powerful executive positions of prosperity are excellent everywhere. Become an Expert Accountant and name your own salary—be your own boss—build a future of prosperity and independence. Be a big man—an important factor.

## We Train You By MAIL!

You can become an Expert Accountant—we make it easy, no matter what you work at now, your wages or education. If you can read and write English, the LaSalle Extension University can qualify you for this remarkable vocation at home, in spare time. It is not necessary that you already understand bookkeeping. For those who need elementary training, we have devised a general Course in Bookkeeping that prepares you from the ground up for more advanced work in Higher Accountancy. The LaSalle Course is thorough, advanced, comprehensive. Prepared by some of the world's most noted Expert Accountants and covers Theory of Accounts, Practical Accounting, Cost Accounting, Auditing, Business Organization and Management, Business Law, etc. Administered under the supervision of William Arthur Chase, a nationally recognized leader, Ex-President American Association C. P. A. Examiners and Ex-Sec'y Ill. State Board Examiners in Accountancy. Prepares you for C. P. A. examinations in any state.

**Remarkable Book FREE** What Every Bookkeeper Should Know — tells information you need—studies, kind of examinations, State regulations, salaries, positions to be had, etc. Send coupon now for free copy.

**Special Reduced Rate**

**LIMITED OFFER!** Let us tell you how, for a limited time only, to secure Special Extra Reduced Rate Scholarship. This offer is limited and might be withdrawn any day, so do not delay. Send NOW for facts.

# ACT

Let us tell you about the success of LaSalle students and the success possible now for Expert Accountants with LaSalle training. Let us prove that we can qualify you for one of these opportunities. Don't let money worry you—we make terms to suit you. Mail coupon now. Send no money—all free.

**LaSalle Extension University**  
Dept. 264. H, Chicago, Ill.

**MONEY-BACK GUARANTEE BOND**

So thorough is the LaSalle Home Study Course—so exceptional has been the success of LaSalle students—that we issue with each LaSalle Course a legal, binding guarantee to refund the entire tuition fee if after you complete the course you are not perfectly satisfied. This guarantee is backed by our entire capital and resources of more than one million dollars, which assures your absolute success.

LaSalle Extension University  
Dept. 264. H Chicago, Ill.

Send free book, How to Become an Expert Accountant, and details of your Course in Higher Accountancy; also facts about Reduced Rate. I am obligated in no way.

NAME.....

ADDRESS.....

**A New Instrument TEACHES ANYONE TO TUNE PIANOS**

No Musical Ear or Training Necessary. An amazing invention—a marvel of science. Teaches anyone to tune pianos, The New (Tune-a-Phone) method is absolutely accurate. Eliminates guess-work. Positively unfailing. Guaranteed. Endorsed by authorities. Turn your spare time to profit. Learn this well-paying, independent profession at home.

**\$5 TO \$15 A DAY—NOW EASY**

Opportunity for you in your town to make BIG MONEY. Daniels, Koss (mechanist) MADE \$38 FIRST WEEK. Chances equal for MEN and WOMEN, country over. Work is all profit. INVESTIGATE. Get FREE booklet of interesting facts and records. Send name and address.

MILES BRYANT SCHOOL OF PIANO TUNING, 500 Institute Bldg. Berke Creek, Mich.

**LEARN JEWELRY ENGRAVING**

In your own home. Earn \$20.00 to \$50.00 Weekly. Personal instructions. Write for free booklet. Chicago Engraving School, 612 Athenaeum Bldg., Chicago

**SHORTHAND IN 30 DAYS**

We absolutely guarantee to teach shorthand complete in only thirty days. You can learn in spare time in your own home, no matter where you live. No need to spend months as with old systems. Boyd's Syllabic System is easy to learn—easy to write—easy to read. Simple, Practical, Speedy, Sure. No ruled lines—no positions—no shading as in other systems. No long lists of word signs to confuse. Only nine characters to learn and you have the entire English language at your absolute command. The best system for stenographers, private secretaries, newspaper reporters and railroad men. Lawyers, ministers, teachers, physicians, literary folk and business men and women may now learn shorthand for their own use. Does not take continual daily practice as with other systems. Our graduates hold high grade positions everywhere. Send today for booklets, testimonials, etc.

**Chicago Correspondence Schools**  
969 Unity Bldg., CHICAGO, ILL.

**PAINT SIGNS and SHOW CARDS**

I'll teach you personally by mail. 16 years' successful teaching. Big field for men and women. You can Earn \$18.00 to \$45.00 a Week

Scherer (Chicago) writes: "Your instruction is great. Highly pleased." Fall details promptly on request

**DETROIT SCHOOL OF LETTERING**  
Class. J. Strong, Founder Dept. 202, Detroit, Mich.

**BE A DETECTIVE**

Earn from \$150.00 to \$300.00 per month; travel over the world. Write

**C. T. LUDWIG, 133 Westover Bldg., Kansas City, Mo.**

**LEARN TO WRITE ADVERTISEMENTS** **EARN \$25 to \$100 A WEEK**

We can positively show you by mail How to increase your salary. BOOK MAILED FREE

PAGE-DAVIS CO., 112 Page Building Chicago, Ill., or 150 Nassau St., New York

**Given Given Given**

**A 6-Pass. 32 H. P. Bush Touring Car** and the Agency for your Territory. Qualify to make from \$3,000 to \$5,000 selling Bush cars in 1916. Write for my 40-page book giving all details of this wonderful offer. Address

**J. H. BUSH, Pres., Dept. 217**  
Bush Bldg., No. Clark St. and Chicago Ave., CHICAGO, ILL.

**ARITHMETIC SELF-TAUGHT**

A plain, easily-understood volume for all who have not had the opportunity of learning this subject thoroughly, or who have forgotten what they once learned. 257 Pages. Requires no teacher. This great little book sent postpaid for **60 CENTS**. Stamps accepted.

**GEO. A. ZELLER BOOK CO.**  
Est. 1876, 4472 W. Belle Place., ST. LOUIS, MO.

SPANENBERG'S PRACTICAL ARITHMETIC Self-Taught



## Here's YOUR Chance to Learn **DRAFTING**

This Complete \$15 Drawing Outfit and Full Instructions in Mechanical Drawing **FREE**

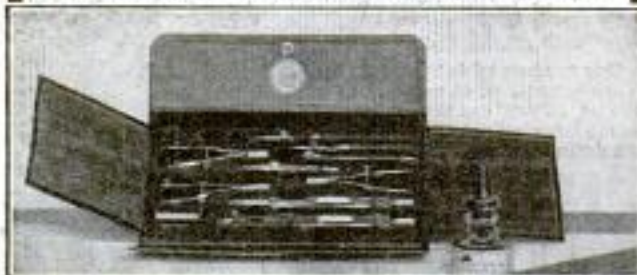

There's a good job waiting for you. The country is facing greater prosperity than it has ever before experienced. Far-seeing men are getting ready for boom times. Get this training now and share in the coming prosperity.



**CHARLES W. MOREY**  
President of the College  
and Head of a Large Chicago  
Firm of Civil, Mechanical and  
Electrical Engineers and  
Contractors.

## Men Wanted AT BIG SALARIES

This is a rare chance for a few wide-awake young men

On account of the rapidly increasing demand for trained draftsmen Pres. Morey has issued orders that instruction be furnished to a limited number of young men who are inclined along engineering or architectural lines. Read about this great offer below—then mark and mail the coupon.

### STUDY AT HOME

Devote your spare hours for a profitable and pleasant profession, and get in the class drawing the big pay envelope. Hundreds of men are in daily attendance at this old established college. In your own home you can do the same work these men are doing, and the same experts that teach them will guide you toward the big job. These well known engineers prepare your instruction matter. Your work is examined and approved by them. They know exactly the practical training you need and they train you. No books to sell. Live, up-to-date blue prints of work in actual construction. In your own home you work with plans of machinery, buildings, steel work, etc., actually being constructed in Chicago, New York and other large cities.

### ELECTRICAL DRAFTING AND DESIGN

No other similar correspondence course in America has a resident college of National reputation back of it, nor a faculty of active experts actually engaged in municipal and cooperation engineering work. These men know exactly the kind of training you need because they are in constant charge of big work.

## \$45 COURSE FREE IN MECHANICAL DRAFTING

This College has set aside a limited number of Free Scholarships and will give the regular \$45 Course in Mechanical Drafting Free with any one of the Home Study Courses named in the coupon below—this is in addition to the complete \$15 Drawing Outfit which is also furnished to students free. Take advantage of this unusually liberal offer today, as it will be withdrawn when the allotted number of Free Scholarships has been awarded. It costs you nothing to get full information. No obligation on you.

### ACT NOW—FILL OUT COUPON TODAY

- |                           |                       |
|---------------------------|-----------------------|
| —Electrical Drafting      | —Builders' Course     |
| —Machine Drafting         | —Plan Reading         |
| —Architectural Drafting   | —Estimating           |
| —Structural Drafting      | —Sheet Metal Drafting |
| —Civil Engineering (1050) | —Surveying            |

Name.....

Address.....

Town.....State.....

College or Home Study Course.....

**CHICAGO TECHNICAL COLLEGE**  
1050 Lake View Building, Chicago, Illinois

Please Mention Popular Mechanics

# Learn Music At Home!



New Method  
Learn To Play By Note

Piano, Organ, Violin, Banjo, Mandolin, Guitar, Cornet, Harp, Cello or to sing. Special Limited Offer of free weekly lessons. You pay only for music and postage, which is small. No extras. Beginners or advanced pupils. Everything illustrated, plain, simple, systematic. Free lectures each course, 16 years' success. Start at once. Write for Free Booklet Today—NOW.

U. S. SCHOOL OF MUSIC  
Box 4, 225 Fifth Ave. NEW YORK CITY

## LEARN TELEGRAPH

Morse and Wireless—R. R. Accounting (Station Agency) taught. Splendid opportunities. Positions secured. Marconi Co. takes our wireless graduates. We own and exclusively occupy two large modern buildings equipped with R. R. and Western Union wires and complete \$5,000 Marconi Wireless Station. Largest School—established 43 years. Investment \$25,000. Endorsed by Railroad, Marconi and Western Union Officials. Expert practical teachers. Low living expenses; easily earned if desired. Tuition low. Easy payments. Correspondence courses also. Catalogs Free.  
Dodge's Telegraph, Ry. & Wireless Institute  
8th Street, Valparaiso, Ind.

## Chicago Correspondence School of Law

Prepares Students at Home for the Bar. Four Courses of Study: College, Post-Graduate, Business Law and Bar Examination Review. Actual Daily Lessons by a recognized School that is approved by Bench and Bar.

Write today for FREE Catalog and Rules for Admission to the Bar.

520 Reaper Block, Chicago



# CIVIL SERVICE

positions are in all parts of the country. Good pay, steady work, life positions, congenial surroundings, promotions on merit, short hours, annual vacation and sick leave with pay. Many thousands appointed yearly. Both sexes. No political pull. Nearly 300,000 classified positions. Common school education sufficient. Full information and questions used by the Civil Service Commission free.

COLUMBIAN CORRESP. COLLEGE, Washington, D. C.

Send Now  
\$1.00 the Year  
Sample 10c

A CHANCE TO MAKE \$100 at



**ART WORK** For \$1 you will get 12 issues of the **Students Art Magazine**. It publishes

Cash Art Assignments, amateurs' work, articles on Cartooning, Designing, Illustrating, Lettering and Chalk-Talking. CLARE BRIGGS, RYAN WALKER, and other noted artists, contributors. You will like it, artistic, helpful, UNIQUE. Send NOW, \$1, stamps or bill, to the Editor—C. H. LOCKWOOD, Dept. 81, KALAMAZOO, MICH.

# MUSIC TAUGHT FREE

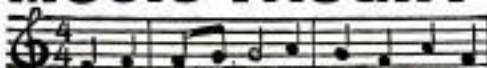

You can read Music like this quickly

IN YOUR  
OWN  
HOME

Write today for our booklet. It tells how to learn to play Piano, Organ, Violin, Mandolin, Guitar, Banjo, etc. Beginners or advanced pupils. AMERICAN SCHOOL OF MUSIC, 51 Lakeside Bldg., Chicago

## SHOW CARD WRITERS

EARN \$80 TO \$200 A MONTH  
**LEARN FREE!**



We will furnish a thorough course in Show Card Writing and Lettering absolutely free to introduce our colors if you will purchase an assortment of Alpha Colors to use while practicing. Particulars for stamp.

ALPHA COLOR COMPANY, Inc., Dept. K, 81 East 125th St., N. Y. City

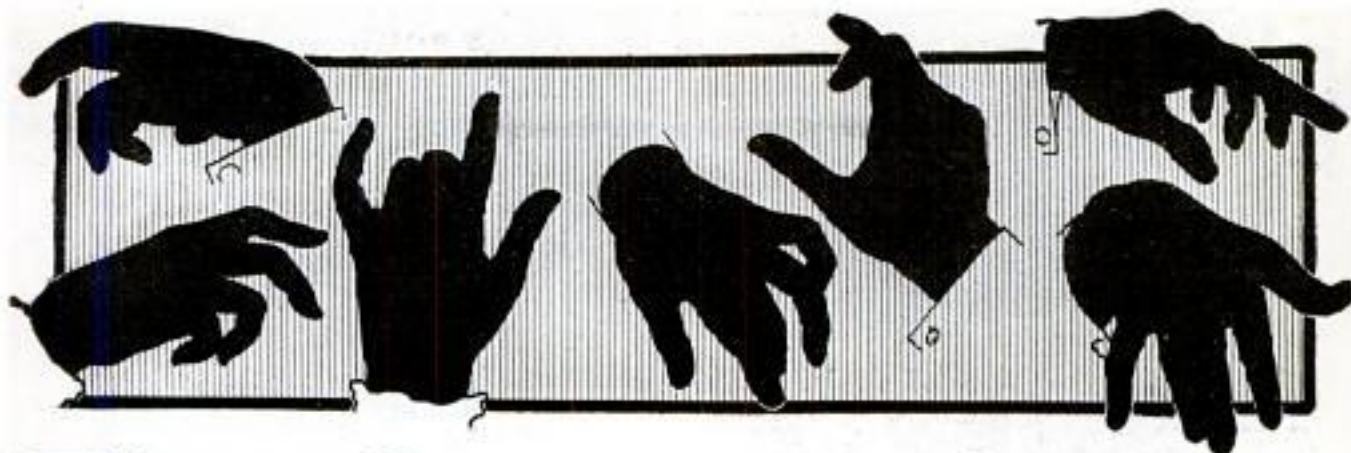

# The Secret of Fast Typewriting

New method enables anyone to write 80 to 100 words a minute without mistakes. It's all in the fingers!

## Doubles and Trebles Salaries

Now, for the first time, has an idea been discovered which puts speed—great speed and accuracy—within the reach of every typewriter user. Almost overnight it has revolutionized the whole typewriting situation. Stenographers who formerly never exceeded 30 to 40 words a minute are writing 80 to 100 words with less effort and with infinitely greater accuracy than ever before. And their salaries have jumped from a meagre \$8 to \$15 per week to \$30, \$40 and even \$50.

### Easy for Anyone

No matter how low your present speed, no matter how labored your efforts, no matter how weak or clumsy your fingers now seem to be, no matter how little or how much experience you have had, no matter what other courses you have taken, this new method will positively bring you the desired results, as thousands of stenographers—and ministers, lawyers, reporters and writers as well—have already proven. A few short weeks of spare time study is all that is required and the work is simply fascinating.

### Trained Fingers— The New Way

European music teachers when training their pupils for the piano, invariably give special gymnastic finger exercises. This is because untrained fingers are not skilful fingers. The best results cannot be obtained—the fingers simply cannot be used correctly—unless the student develops and strengthens the proper muscles.

This training is even more essential to expert typewriting. The reason that so few people can write more than 30 to 40 words a minute is because their fingers are not flexible or nimble enough. This new easy method overcomes this at once—develops finger strength and flexibility by exercises away from the machine—trains the fingers beforehand for their work on the machine—and the results border on the miraculous.

## Valuable Book Free

We have prepared a book which tells all about the wonderful gymnastic finger exercises and explains the course in complete detail, which is free to those interested. It is a big 48-page book, brimful of eye-opening ideas and valuable information. It explains how this unique new method will quickly make your fingers *strong and dextrous*, bring them under *perfect control*, make them extremely rapid in their movements—how in a few short weeks you can transform your typewriting and make it *easy, accurate*

and *amazingly speedy*—all this and much more is told in detail. No instruction book ever written, no matter what its cost, ever told so plainly the real **WHY** and **HOW** of expert typewriting.

If you are ambitious to get ahead—if you want to make your work easier—if you want to get more money in your pay envelope—don't wait a single moment before sending for this book of information and proof.

This new method is bringing such marvelous results to others—is proving itself to be so sure a means of quickly increasing salaries—that you will be doing yourself a big injustice if you fail to write for it *at once*.

It will be a revelation to you as to how to get more money in your pay envelope—don't wait a single moment before sending for this book of information and proof.

the speed and salary that is possible to typists.

Tear off the coupon now, before you turn the page.



**USE THIS TODAY FOR BIGGER PAY**

Name.....  
Address.....  
City..... State.....  
Occupation.....  
Mail to **THE TULLOSS SCHOOL**  
102 College Hill SPRINGFIELD, OHIO

## Why Aren't Stenographers Better Paid?

Why are most stenographers getting only \$8 to \$15 a week—while others get \$25, \$30, \$40, and even \$50? Eight words tell the story. It's nothing in the world but *lack of speed and accuracy on the typewriter* that is keeping salaries down—that is robbing most stenographers of the pay they ought to get. Think a minute. What is a stenographer paid for? Isn't it for your *finished product*—for the quantity and quality of letters or other typewritten matter you can turn out in a day?

No matter how good you are at shorthand, you can never expect much increase in pay until you get *speed—real speed—and accuracy on the typewriter*.

Here are a few examples of how the New Way in Typewriting has already resulted in increased pay. Letters from these students and from scores of others will be found in the free book. What it has done for them it will do for you.

Raise First Year		Raise First Year	
J. H. Krull	\$ 836	Richard Clarke	\$ 900
O. B. Hunter	780	R. L. Rankin	420
S. Shainin	1,800	Carlos C. Guerre	2,000
Marie Parker	240	C. C. Dorsey	300
A. H. Gardiner	900	J. P. Jones	900
E. Stoneman	780	H. K. Temme	540

Please Mention Popular Mechanics

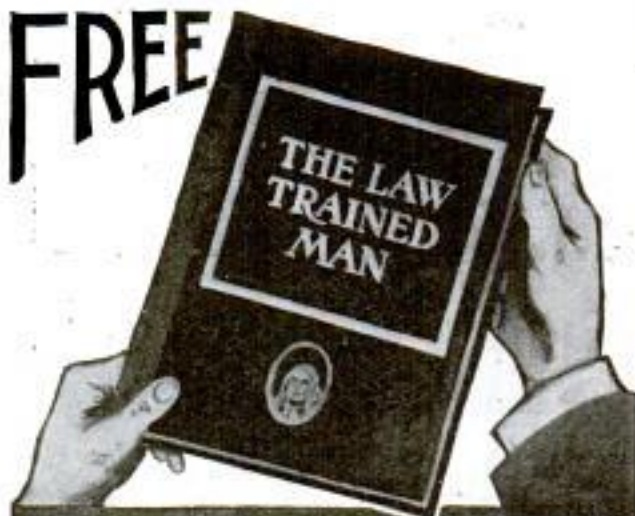

## This Inspiring Book Free To Ambitious Men

This intensely interesting and instructive 165-page book tells you how a knowledge of law will develop your natural ability and increase your earning capacity; how it has proved to be the stepping stone for thousands of men to power and achievement.

It tells you of the great and increasing demand for lawyers and how you can become one. It tells you why law trained men are now selected for most positions of responsibility in business, public life and social work—and how you can grasp these opportunities.

It shows you how you can become law trained without leaving your home or business by a method which includes the comprehensive features of the best resident law schools and is endorsed by distinguished men throughout the country in whose opinion you have the utmost confidence. Send for your copy of "The Law Trained Man," today.

### Modern American Law Course and Service of Blackstone Institute

Blackstone Institute (including the Sprague Correspondence School of Law) was founded in 1890, and is by far the oldest and largest law school for non-resident instruction in the world.

We have successfully trained more than thirty thousand men and women in law. Among our graduates are the Governor of a State, United States Senators and Congressmen, State, County and City Officials, many Judges and thousands of successful Lawyers and business men everywhere. This notable record extending over twenty-five years is the most convincing evidence that we produce results—and it is results that count.

Chief Justice Ladd of the Supreme Court of Iowa, says: "Every person interested in the law will receive from Blackstone Institute an unusually excellent—in fact, the best, non-resident system of instruction."

Our Course and Service has been prepared especially for same study by sixty eminent judges and authorities, including: Chief Justice John B. Winslow, LL. D., Sup. Court, Wis.; Hon. Geo. C. Hoar, LL. D., ex-Judge U. S. Dist. Court, N. Y.; Hon. Paul S. Heinach, Ph. D., LL. B., U. S. Minister to China; Judge A. L. Ranbom, U. S. Dist. Court, Western Dist., Wis.; Dean G. H. Barker, College of Law, University of Ill.; Dean H. H. Ingalls, College of Law, University of Tenn.

The Course is clearly written in simple non-technical language. It is practical, yet reads like an interesting story. Preliminary education is not necessary. You can read in spare time at home, and you will benefit from the day you start. Our Course and Service will prepare you on all subjects required in the bar examinations, as it has already done for thousands of others in your own state, and every other state in the Union. It will equip you to become a leader in business or public life—and to attain positions of honor and profit open only to law trained men.

### Special Offer—Investigate FREE

The recent union of the Sprague Correspondence School of Law with Blackstone Institute and the resulting increase in our facilities enable us to make you a most important Special Offer. Investigate now by sending postcard or letter, or clipping the coupon for our 165-page free book and full particulars. No cost or obligation.

Address, Extension Division 1352

Blackstone Institute  
20 W. Jackson Blvd.  
Chicago, Ill.



Extension Division 1352  
BLACKSTONE INSTITUTE,  
20 W. Jackson Boulevard, Chicago, Ill.

Please send me your 165-page free book, "The Law Trained Man," and full particulars of your Law Course and service and Special Offer. No cost or obligation.

Name \_\_\_\_\_

Address \_\_\_\_\_

**FREE BOOK COUPON**

## Young Man! Your greatest opportunity



Write for Book Today It's FREE



To the man who wants to improve his condition in life—to increase his earning capacity—to get away from the monotony, grind, and low wages of ordinary occupations—to elevate his social standing, the new profession of Tree Surgery, which is not overcrowded, offers the young man of today his greatest opportunity. The Extension Course given by The Davey Institute of Tree Surgery will fit you to practice this profitable profession.

### LEARN TREE SURGERY AND FRUIT GROWING BY MAIL

You can become proficient in this work without interfering with your present occupation. An hour or so a day will give you a training that will make your future bright and prosperous. The work of a Tree Surgeon is healthful, fascinating and remunerative. The call for men in this profession is far greater than the supply, and the demand is growing. There are positions open at good salary and opportunities everywhere to establish a paying business of your own. Why work for others at small pay when you can be your own boss? Write today for our book, "Adventures in Success." Read what others have done, and learn how easily and quickly you can improve your condition in life.

THE DAVEY INSTITUTE  
OF TREE SURGERY  
383 Oak St., Kent, Ohio

## LEARN WATCHMAKING

and become independent. Good-paying positions secured.

Easy to learn. Send for FREE CATALOG.

ST. LOUIS WATCHMAKING SCHOOL, Dept. 5, ST. LOUIS, MO.

## LETTERING AND DESIGN

Invest your spare time. Learn Card Writing, Sign Painting or Commercial Lettering and Design. Earn a steadily increasing income or start in business. Rossing's personal instruction makes Course self-paying. P. Wenzel writes "Your lessons are great." Constant demand for graduates. Assistance in obtaining positions. Investigate now. FREE BOOK.

THE ROSSING SCHOOL OF LETTERING & DESIGN  
722 Union Bldg. Cleveland, Ohio

## Personal Influence



That force of personality variously termed "Will Power," "Personal Magnetism," "Stamina," etc.—the thing that more than anything else spells the difference between success and failure—is inborn in every individual and needs but little cultivation to be brought forth in all its strength. In the race for money, position, power, love and all that makes for complete happiness, you are sadly handicapped without an understanding of this power. My system equips you in a practical way to influence—yes, control others. Years of success and thousands of delighted students vouch for its quick results. Write today for my

### ILLUSTRATED TREATISE FREE & FULL PARTICULARS

It tells about this wonderful influence and how you may yourself master it in your own home with the assurance of guaranteed success. Don't send any money, but send name and address at once for this Free Treatise.

M. D. BETTS, Sta. 610, Jackson, Mich.

# Learn Electricity

## Earn \$100 to \$300 a Month

Electricity, now but in its infancy, is destined to become the greatest factor in human existence during the present generation.

The opportunities for thoroughly trained men in this wonderful field are absolutely unlimited—the demand for such men, enormous. Big jobs, \$100 to \$300 a month, opening up all the time—our Free Employment Bureau unable to supply the demand at times.

## We Train You For a Big Job In Short Time— At Small Expense

You get your training under actual working conditions in our big shops—under the personal guidance of expert instructors who will fit you, in a remarkably short time, to take one of the big jobs opening up every day. Day and Evening classes, open all the year. Enter any time.

Our course of instruction is simple, clear and concise—no correspondence or text books to tangle you—you get real, every day shop work and master all its problems with the tools right in your own hands. All Tools and Materials furnished FREE.

**Tuition Met By Easy Payments** Don't pass up this opportunity for lack of ready money. Our easy payment plan is for you if you need it and is strictly confidential. Because of the enormous demand, we are making a very special offer to new students. Mail the Coupon below—ask us to tell you all about it.

## Coyne National Trade Schools

### Men Wanted

**FOR THESE TRADES**  
Plumbing, Bricklaying, Drafting  
Courses, Motion Picture Operating

**CHOOSE YOUR OWN FUTURE TODAY.** There are unlimited possibilities in any one of these trades. It's up to you—up to you to drift along at some job yielding mighty small pay—liable to a "let-out" every time times are tight—or you can sign the coupon below as the first step toward a big future—a big job at big pay. We train men by actual shop work in all of the above trades. Our graduates are qualified to demand from \$5 to \$8 a day right from the start or go into business for themselves—to the growth of which there is absolutely no limit.

**FREE TOOLS**  
We furnish all material and tools you use in taking any course **ABSOLUTELY FREE.** All we charge is a very small amount for tuition. Many of our students earn their expenses while taking their course.

**No Experience Needed** Don't allow yourself to be misled by a notion that you need previous experience—because you don't. Don't think you are either too young or too old—our successful students range from 15 to 50. We train you from the ground up—train you by the most fascinating actual shop work possible. All fully explained in our catalog.

**Send the Coupon Today For Our New Big FREE Book**  
Send no money—you don't obligate yourself in any way. Just allow us to send our big FREE Book fully explaining the work of the Coyne National Trade Schools and the remarkable opportunities constantly opening for their trained men.

Don't be satisfied to work for mere living wages—don't be at the mercy of every adverse wind that blows. Get into a good trade—become an expert by our training, command a big future—mail coupon today.

B. W. COOKE, Director  
COYNE NATIONAL TRADE SCHOOLS  
39-51 E. Illinois St., Dept. 1192, Chicago, Ill.

WE OCCUPY  
ENTIRE BUILDING

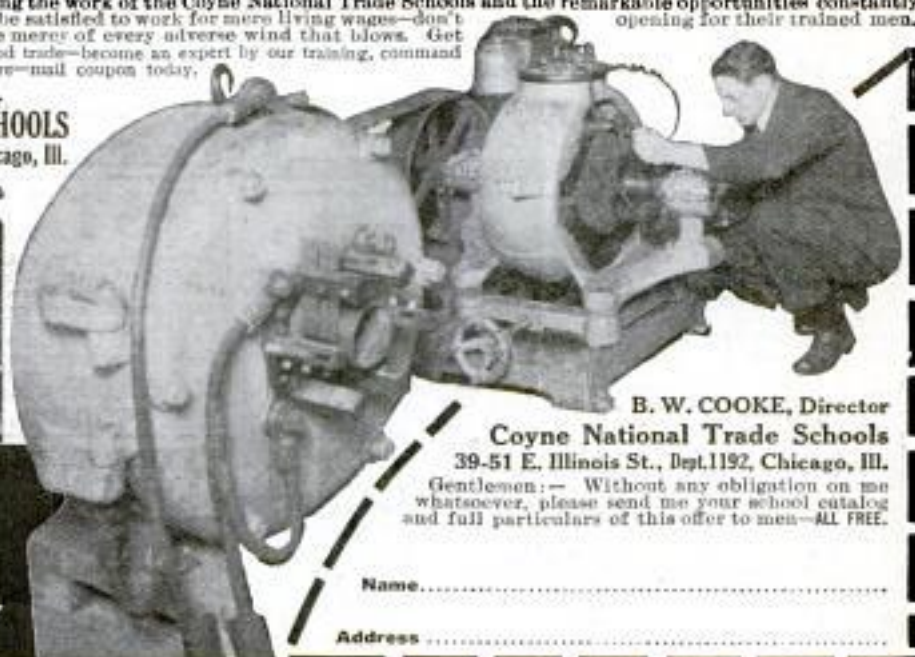

B. W. COOKE, Director  
Coyne National Trade Schools  
39-51 E. Illinois St., Dept. 1192, Chicago, Ill.

Gentlemen:— Without any obligation on me whatsoever, please send me your school catalog and full particulars of this offer to men—**ALL FREE.**

Name.....

Address.....

Mail This  
Coupon  
NOW →

# Big Money For TRAINED MEN!



**Only Six Weeks is Required** to prepare you for a position that will enable you to earn \$75.00 to \$300 monthly. Do you know that the demand for **trained men** far exceeds the supply? **The motor car is today as large a factor in everyday life and business as are the railroads.** Do you realize what this means?

**The Automobile Training School of Kansas City Claims to be the Largest Institution of Its Kind in the Entire World.** Graduates of this school are in demand. Many of our graduates are now holding high salaried positions in some of the largest automobile factories in America. Many are in business for themselves and are making big money.



## ALL PRACTICAL WORK—NO BOOKS USED—NO TOOLS TO BUY



Thousands of graduates and every one of them possessing a thoroughly practical education in the various branches of the automobile business. We use no books—no charts. Our students are real workers—working hand in hand with the very best trained instructors—men who have given the best years of their lives to this work. The Automobile Training School owns and operates two of the largest garages and repair shops in Kansas City, the metropolis of the great Southwest, and claims to have

**MORE FLOOR SPACE: MORE INSTRUCTORS: MORE EQUIPMENT** than any other automobile training school in the United States. Three big buildings are required to take care of the various departments of The Automobile Training School. You get a real practical education here—there is no theory—nothing but real work and real instruction, that will enable you to master the technical and mechanical side of the most remarkable business the world has ever known.

## FREE — \$50 SCHOLARSHIP — FREE

In order to bring our enrollment up to capacity without delay, we are giving away a combination course in **TRACTOR AND STATIONARY ENGINEERING.** Only a limited number of these **Free Scholarships** will be given in addition to our regular automobile course. The development of Power Farming is the wonder of the age.

**WRITE TODAY** for full information regarding this special Free Scholarship offer and big Sixty Page Book, "How to Make Money in The Automobile Business." Sure success awaits you—Use the coupon.

**HENRY J. RAHE, President**

**AUTOMOBILE TRAINING SCHOOL**  
1055 Locust St., KANSAS CITY, MO.

## FREE SCHOLARSHIP AND BOOK COUPON

Henry J. Rahe, Pres., AUTOMOBILE TRAINING SCHOOL, 1055 Locust St., Kansas City, Mo. Send me, free and postpaid, your big, 60-page illustrated book, also the Free \$50 Scholarship Certificate covering Course in Tractor and Stationary Gas Engineering and Electric Starting and Lighting, as offered in your advertisement. This request does not obligate me in any way.

Name..... R. F. D.....  
Postoffice.....County.....State.....

## "LEARN BY DOING"

Get a complete training by actual practice. Get the knack of "HOW" together with the theory of "WHY" and the best business methods used in the World of Electrical Activity.

The N.Y. Electrical School is the pioneer and premier school of the "Learn by Doing" method. When you have completed this Course you shall be fully qualified to handle ALL branches of Electrical industry.

The equipment of this School is unequalled and up-to-the-minute. No preparation needed to become a "learner" in this School. You can start to learn on any day of any week throughout the whole year.

Visitors heartily welcomed. Send for catalogue.

44 West 17th St. New York City

**N. Y. ELECTRICAL SCHOOL**

## Learn Drafting

Good draftsmen always in big demand. Positions pay \$75 to \$200 per month. Practical, experienced draftsman (employed by large corporation) will teach Mechanical Drafting and Machine Design to a few students by mail. Draftsman's complete outfit free to students. Terms very reasonable. Particulars upon request. **HAYNER, 3742 Elmwood, Chicago**

## AT HOME Learn TO SING

Send 2-cent Stamp for Helpful Booklet, "The Voice Made Beautiful."

**HARVEY SUTHERLAND, 813 President St., Brooklyn, N. Y.**



## LEARN RIGHT AT HOME BY MAIL Drawing—Painting

Be a Cartoonist, Newspaper, Magazine, or Commercial Illustrator; paint in Water Colors or Oil. Let us develop your talent. Free Scholarship Award. Your name and address brings you free particulars by return mail and our illustrated Art Annual Free. **FINE ARTS INSTITUTE, Studio 212, OMAHA, NEB.**

## Learn How to WRESTLE



In Your Own Home  
By Mail

Yes, learn to become an expert wrestler right in your own home, by mail, from the greatest wrestlers the world has ever known. Be an athlete, be strong, be healthy. Learn how to throw and handle big men with ease. Learn to defend yourself. All taught in our course of lessons, and illustrated with hundreds of charts and actual photographs by

## Farmer Burns and Frank Gotch

Farmer Burns, "the grand old man of the mat," taught Frank Gotch the present World's Champion, all he knows about wrestling, so Gotch says. He will now teach you Scientific Wrestling—Physical Culture—Jiu-Jitsu—Self Defense. Every man and boy in America, no difference what age, needs this wonderful course of lessons. Write today—your name, age and address on a postcard or letter brings you our fine book absolutely free—no obligations of any kind. A splendid book on wrestling and physical culture. Write today stating your age.

Farmer Burns School of Wrestling 1192 Range Bldg., Omaha

This Wrestling Book FREE

## FEAR STAMMERERS!

Consult Foote, the trained expert Psychologist. If you have tried many other methods and failed know that you cannot fail if you place yourself in my hands—either for personal treatment or by correspondence. I have studied psychology in the greatest Universities in the World. It is now recognized that the trained Psychologist is the only one who can successfully treat stammering. Mine is the only scientific method of treatment which will permanently eradicate your "FEAR." Write for booklet, "The Cure of Stammering."

**Prof. F. B. Foote, Michigan Boulevard Building, Chicago, Illinois**

## Learn Watchmaking At Home



You can learn by our modern and original system of instruction every part of the Watchmaker's Trade at home as good or better than at a shop. You can earn money while learning and secure a well paying position or start in business after completing our course of instruction. Good watchmakers are always in demand and earn from \$20 to \$35 per week. For particulars apply to the Wisconsin School of Watchmaking, Sixth Bldg., Milwaukee, Wis.



# LAW BOOK FREE



**Be Sure to Get This Wonderful Free Book Before You Enroll for Any Law Course**  
 No matter which school or which course you may be considering—no matter which method of instruction you may favor—be sure to read "How to Acquire a Legal Training" before you enroll. The greatest free book on law ever offered. Tells how to weigh and judge the claims of a correspondence school. Tells just what a law course should contain to give you the training absolutely necessary to succeed in the legal profession. Points out how you can save both time and money in acquiring your legal education. Tells the easiest and best way to become a lawyer by studying at home. Also explains all about our

**WONDERFUL NEW SYSTEM OF CORRESPONDENCE INSTRUCTION**

## FREE 13 Volume Law Library and 60 Text Books

With each course we furnish 60 new pocket-size Text Books, 36 Case Books, and our big 13 volume Law Library prepared by 56 of America's greatest legal authorities—26 more subjects and 30 more authors than any other correspondence law course. Written in plain, simple, easily understood language. The easiest, best, most complete and practical correspondence course ever devised. Only law course written especially for correspondence instruction. Send for free book today. Just drop us a postal—there is no obligation—it is absolutely free for the coupon.



This 13-vol. Law Library and 60 Text Books Free with every Course

**American School of Correspondence**  
 Chicago U.S.A.

**FREE BOOK COUPON**

Gentlemen: Please send me your FREE Law Book, "How to Acquire a Legal Training," and full particulars regarding your wonderful new system of correspondence law instruction.

P.M. 2-16, A. S. of C.

NAME.....

ADDRESS.....



## THE MAN WHO KNOWS TRAFFIC

Easily Earns \$50 to \$100 Weekly  
*The Traffic Field Is Calling for Trained Men. The Demand Is Increasing Each Year*

The railroads are the arteries of commerce. Modern commerce is absolutely dependent on Transportation—TRAFFIC. It makes or breaks. Ignorance of classifications and correct routings permits profits to slip away. Shippers are realizing this more each day. They are eager for trained traffic men who can prevent such losses. Right now many thousands of high-salaried, efficient traffic men are needed. And there is no fixed salary limit. YOU will be paid what you are worth. Thousands of Traffic Managers receive \$50 to \$100 weekly. Many a great deal more. It is no longer difficult to gain Traffic Knowledge. You can have the active cooperation of many of America's noted Traffic Experts. They will help you, guide you—TEACH YOU.

**Endorsed by Traffic Authorities**

Mr. A. T. Waterfall, Traffic Commissioner, Detroit, Mich.: "You are to be congratulated on this splendid and important work." Mr. C. C. McCain, Chairman of the Trunk Line Committee, representing fourteen Eastern railroads, says: "The American Commerce Association has provided a training service which appears to be the broadest, most complete tariff rate, and traffic training yet devised." Mr. H. G. Wilson, President of The National Industrial Traffic League, writes: "Your Association is better equipped to advance the efficiency of traffic men than any other."

### American Commerce Association

This is an organization of Traffic Men by Traffic Men for Traffic Men to promote American Commerce, Export and Import Trade. Our methods are thorough and practical. The work is fascinating. It is really easy to learn—easy to become an efficient traffic man. **And You Can Study During Your Spare Hours in The Evenings.** In a short time you can acquire the same valuable knowledge gained by numerous traffic experts only after a life-time of hard work and tedious study. Traffic Knowledge, so easily gained in so short a time, will become your permanent asset—YOU can always "cash" it. It is Your Big Opportunity. Investigate! Let us tell you all the facts.

**American Commerce Association**  
 Dept. 504, The Rookery, Chicago, Illinois

**Ask Us for a FREE Copy** of one of these valuable books, "Opportunities Along the Trails of Traffic" by H. G. Wilson, Straightforward and Informative. "Traffic Efficiency," 80 pages. Tells the need of high-salaried efficient Traffic Men. "Millions Wasted in Traffic." Gives actual cases. Intensely interesting. Tells of Traffic Savings Opportunities.

**MAIL THIS TODAY**  
**AMERICAN COMMERCE ASS'N.**  
 Dept. No. 504, "The Rookery," Chicago.  
 Please send me, entirely without charge or obligations, book as checked . . . "Opportunities Along the Trails of Traffic" . . . "Traffic Efficiency" . . . "Millions Wasted." Also explain how your course in Traffic Efficiency will train me to become a traffic expert.

Name.....

Address.....

# SENT FREE



## LAW

### COURSE SENT FREE ON APPROVAL

Not one penny down. Get this greatest home-study course in law—consisting of a magnificent 14-volume law library, the most complete library of its kind and the first individual lessons; clear, comprehensive discussions of the law—in your hands positively free of charge, without any obligation whatever. We want you to see this course, examine and compare it with other courses before you even decide.

### Law Offers You Success

Become a lawyer and success awaits you—power, dignity and independence—\$5,000 to \$10,000 yearly. Hundreds of big salaried positions for legally trained men now open with large firms. With our simplified method you can easily master Law at home in your spare time. Course written in plain language by legal experts who are law professors in big Universities; endorsed by bench, bar and colleges. Our method like that used in big Universities and the course is of University grade.

### Get Your Degree By Mail

We are authorized by the laws of Illinois to confer on our graduates the degree of Bachelor of Laws (LL. B.). Course prepares you to pass bar examinations in any state. Should you fail to pass we guarantee to coach you without charge until you are successful.

In a recent bar examination at Lansing, Michigan, only six out of fourteen applicants for admission were successful and two of those who passed were LaSalle Students. Not one of the LaSalle Students who entered the examination failed. Among the eight rejected, four were graduates of leading resident University Law Schools. These are some of the reasons why it pays us to send out our course on approval, without obligation.

**Free Complete Course in Public Speaking** prepared by Dr. Frederick B. Robinson, Professor of Public Speaking, College of City of N. Y., etc. No other course like it—Write Today for Special Limited Free Offer.

**Mail Coupon—Offer Limited** Send no money. Just your name and address on the coupon

below, and we will forward by return mail full particulars of our remarkable free on approval offer and our wonderful free book "Guide to the Law" showing how to study law at home. This is the first time in history that a University Home-Study Law Course has been offered on approval; our course is the only one that will stand this acid test. Moreover, if you act promptly we will save you more than half your tuition. We are doing it for advertising purposes only and the offer is subject to withdrawal in a short time without notice. So act now. Get all the facts in your hands—NOW. Simply sign and mail coupon.

**LaSALLE EXTENSION UNIVERSITY, Dept. 264-G Chicago, Ill.**

**Coupon Brings Details—Tear Off and Mail**

**LaSALLE EXTENSION UNIVERSITY, Dept. 264-G Chicago, Ill.**

Please send me full particulars of your free on approval, without obligation offer, showing also how I can secure Public Speaking Course free, and a copy of your free book "Guide to the Law."

Name \_\_\_\_\_

Address \_\_\_\_\_

Kitchener



Wilson



Von Hindenburg



Edison



Joffre



# Courage—the Secret of Leadership

## What This Book Teaches You

- How to overcome Timidity.
- How to conquer Bashfulness.
- How to have "nerve."
- How to demand "your own."
- How to face people you have always felt inferior to.
- How to develop Self-Confidence.
- How to deal with people on their own level.
- How to successfully face embarrassing situations.
- How to "rise to the occasion."
- How to be Forceful and Dominant.
- How to eliminate Nervousness in dealing with big men.
- How to act calmly and naturally on occasions that usually excited you.
- How to banish Fear, physical as well as mental.
- How to stop Worry.
- How to become a Man among men.
- How to get rid of Superstition.
- How to face old age calmly.
- How to maintain poise in public.
- How to assert yourself in Business as well as in the Home.
- How to develop courage to swing big deals.
- How to dominate Circumstances.
- How to defy old time habits of Hesitation.
- How to insure a healthy, virile, intrepid grade of Brain.
- How to stir into electrical activity, latent leadership qualities, which Nature has tucked into the make-up of every normal man or woman.
- How to mass the myriad cell-forces of your Mind into a strong, daring, goal-gaining plan of conduct.
- How to break open the door to a new world of Thinking—rare in beauty, practical in application.
- How to blaze the way to unthought-of fields of self-expression.
- How to add to your physical lissamancy a single and zest hitherto missing.
- How to impress others with your poise, purpose and power.

A complete list of contents would almost fill this page.

## "Culture of Courage" a Complete Course in Courage-Building Sent Free for Inspection

The leaders in business, politics, law, medicine or any field are invariably courageous men.

Look around you. Do you know any successful man who hasn't courage? The world's leaders in every line of endeavor since the world began have been men of nerve. To the man without courage success is absolutely barred.

### Fear is a Tyrant

Fear of self—fear of people—fear of the future—fear of things—fear for others (worry)—are what keep men and women down when they should and could be on top.

But not until the shackles are broken—not until fear is eliminated—not until courage is properly cultivated, can man come into his own.

No matter what your occupation—no matter what you seek in life, whether it be health, happiness, money or power, it can never be yours until you have conquered man's bitterest, most subtle enemy—the poisonous dragon of fear. Yet once conquered and the world is at your feet—for courage rules the world.

## "Culture of Courage"

by Frank Channing Haddock, Ph.D.

This great work by the famous author of "Power of Will"—a scientist whose name ranks with James, Royce, and Bergson, is not an inspirational book which merely admonishes you to "Destroy Your Fears" and "Be Courageous." Instead, it is a practical course in how to overcome each particular kind of human fear, physical as well as mental, to which we are all subjected. It contains actual principles, rules, methods and exercises which anyone can easily follow and become ten times bigger—ten times more successful—ten times happier than you have ever dared hope.

### Are You Timid or Afraid?

Do you lack confidence in meeting other people? Are you conscious of another's personality and your own lack of it? Do you feel inferior to others? Are you superstitious about anything? Do you worry about your loved ones or about conditions? Are you afraid of approaching old age? Do you seem to be blinded by petty fears? Are you frightened in public? Are you afraid of your ability to "put things over?" Are you afraid to assert yourself in your home or in business? Do you fear the opinion of others? Have you the courage of your convictions? Do things that other men and women are doing seem impossible of accomplishment by you? Are you afraid to go in business for yourself or afraid to take the risks you need to? Are you able to brush aside all obstacles in order to arrive at your destination? Are you conscious of your power, self confident and eager, demanding what you want, or do you stand cringing, hat in hand, and whine for it? If any of these subjects even touch on your condition, "Culture of Courage" will prove a godsend.

### A Ghost-Scattering Searchlight

In "Culture of Courage" the author opens up into some of the most important problems of existence: he throws a ghost-scattering searchlight into the straw-and-gossamer entanglement which has held men and women in subjection; he pulls off the imagination-created masks of various fears, superstitions and bugaboos which in all ages have paralyzed the brain's energies and constantly dinned into eager ears the failure slogans: "I'm afraid," "I dare not try," "I haven't the ability," etc.

As you study this new system, you will learn definitely how Reason, Thought, Analysis, and Sanity can scatter to the high heavens the senseless visions of fear that are causing unutterable losses, embarrassments, and failures.

This book will startle you, will awaken strains of thought that may easily change the entire course of your career, just as it has that of thousands of other men and women in all walks of life who have learned its wonderful back-bone-building secrets.

### NO MONEY IN ADVANCE

So confident are we that once you examine this great book in your own home, you would never give it up, that we offer to send it on five days' free trial without a cent in advance. Keep it five days—look it over carefully—then if you feel you can afford to be without it, mail it back and you owe us nothing, otherwise remit \$3.00, the small price of this big 466 page leather bound book. Remember, no money in advance. Merely mail the coupon enclosing business card or giving a reference today.



466 pp.  
Half Leather  
Gold Top  
Leaves

**Pelton Pub. Co.** 70-B Wilcox Block  
Meriden, Conn.

## What Readers Say:

"In it I found rules, principles and regimens which make it worth its weight in gold to me." — District Attorney Goodwin, Oil City, Penn.

"It is a 'wonder.' The more one reads it, the more powerful ideas he can draw from this storehouse." — J. F. 103a, Pres. Nat. School of Sales'p, Minneapolis, Minn.

"It is simply magnificent; I shall highly recommend it and wish everybody could read it." — L. I. Hall, Rochester, N. Y.

"It stands absolutely at the head of anything I have ever come across; Mr. Haddock is certainly a Master Mind. As a teacher I can say that no greater good could come than the absorption from superstitious this book brings about." — James Straitwell, Reynoldsville, Pa.

"These books are a gold mine of 'energizing material' for the progressive mind." — A. A. Martin, M. D., Pierce, Neb.

"Enclosed is my check; send another copy." — W. H. Smith, Pres., Herring-Hall, Marvin Safe Corp., New York.

"'Culture of Courage' is superb. It is clear, forceful, scientific, practical in every form and manner; ALIVE with the rich, the high, the ideal, the sublime. It's an inspiration from beginning to end. IT JUSTIFIES ALL CLAIMS." — F. Stanley Perera, Res. Master, Wesley College, Colombo, Ceylon.

"Enclosed is check for which send me another copy for one of my friends. Dr. Haddock's works are superior to anything I have ever read for the development of the individual. He is entirely in a class by himself." — Chas. E. Ward, D.C., Houlton, Me.

**Pelton Pub. Co.**  
70-B Wilcox Block  
Meriden, Conn.

Gentlemen: Please send me a copy of "Culture of Courage" on approval. I agree to remit \$3.00 or return the book in 5 days.

Name.....

Address.....

# MEN WANTED

## To Drive and Repair Automobiles and Tractors

### Tear Off and Mail the Coupon Herewith Today—Right Now

It may mean to you all the difference between success and failure. Will you, by training yourself in a few short weeks, become a competent, expert automobile man? **Cash in on your time.** How would you like to have an earning capacity of \$5 a day and up? How would you like to have a trade that will always insure you good wages, independence, opportunity to see the world? How would you like to be in demand? Have employers looking for you—have big opportunities for a successful career spread out before you? Now young man, you can't do this simply by wishing. You have to take action. This Automobile School has over 3000 successful graduates. Practically all came here without the slightest experience. But all had ambition and resolution. If you have these qualities you can be sure of success. The first step is to send the coupon and get the big free book. It obligates you in no manner—binds you to nothing. But it gives you without cost or trouble all the facts you should know. Learn how others have made good. A post card or coupon brings this book today.



### 551 Students From 38 States Enrolled in the Last 60 Days From Nov. 1st to Dec. 29th 1915

Iowa . . . . . 79	Michigan . . . . . 14	New York . . . . . 4
Kansas . . . . . 66	Nebraska . . . . . 11	New Mexico . . . . . 4
Oklahoma . . . . . 60	Colorado . . . . . 11	Arizona . . . . . 4
Illinois . . . . . 49	Arkansas . . . . . 10	Virginia . . . . . 4
Missouri . . . . . 34	Corada . . . . . 7	Maine . . . . . 4
Minnesota . . . . . 32	Ohio . . . . . 7	New Hampshire . . . . . 4
Texas . . . . . 30	Kentucky . . . . . 5	Massachusetts . . . . . 4
Montana . . . . . 27	Wyoming . . . . . 4	Oregon . . . . . 4
South Dakota . . . . . 27	Louisiana . . . . . 4	Pennsylvania . . . . . 4
North Dakota . . . . . 27	Tennessee . . . . . 4	Utah . . . . . 4
Wisconsin . . . . . 19	Alabama . . . . . 4	North Carolina . . . . . 4
Indiana . . . . . 15	Washington . . . . . 4	California . . . . . 4
Idaho . . . . . 14	Mississippi . . . . . 4	Total . . . . . 551

## By the Sweeney System You Can Learn in 6 Weeks

There's only one place in the world to learn by the Sweeney System; and that is at the School of practical experience where you learn without text books and by doing the work with your own hands; and that's the Sweeney Automobile School of Kansas City, Mo. I want every young man mechanically inclined to send today for my big catalog. It costs me 50 cents, and is a complete encyclopedia on the subject. It is like a moving picture as the 123 actual photographs show men at work in every department, at every job. It explains the wonderful Sweeney System. I will send it free, to those who answer this announcement, together with a special advantageous offer. A \$50 Tractor Scholarship Free. Use Coupon Today—NOW.

### Earn Big Money in the Automobile Business

The Sweeney School can give you the names and addresses of over 3,000 graduates who are now chauffeurs, repair men, factory experts, garage owners, salesmen, etc. These men came to us untrained. They got interested by reading our advertising, just as you are reading now. They acted on the same impulse that moves you now to investigate. And then after a few weeks' instruction they went out of this school completely equipped, got employment, and today are **Prosperous, Happy and Respected.** You can do likewise. I will teach you so that you have a chance to qualify yourself for a **Business Success** handling or repairing automobiles. It will **cost you nothing** to investigate, and let me tell you the actual experiences of my graduates.

### Make \$5 Per Day and Up

21,000 tractors were sold this year. Over half a million automobiles. Who's going to drive and repair them? Men are in big demand. Our school is doing double the business it did last year. Nothing succeeds like success. Don't you want to make \$5 a day and up? There's money in the automobile business for you.

### \$50 Course in Gas Traction Engineering Free to Men

#### Who Answer This Advertisement

You know right in your neighborhood of the demand for traction engineers and mechanics. Factories want workmen and demonstrators. We teach you on five different types of tractors in actual work. Men are wanted right now for good jobs. Here is a wonderful opportunity for young men. You can learn in a few weeks. We want to start out a few graduates right away and so although the regular price of the course is \$50 you GET THE COURSE FREE if you enroll in Automobile School now. Sign and return the scholarship coupon today. No previous experience required.

#### FREE COUPON

E. J. SWEENEY, President  
SWEENEY AUTO SCHOOL  
1169 E. 15th St., Kansas City, Mo.

Send free tractor scholarship offer and catalog.  
Also magazine.

Name .....

Address .....

### MY BIG BOOK COSTS ME 50 CENTS, BUT I SEND IT FREE

If you are interested in planning your future and mean to investigate the opportunities before you, I will gladly send you my automobile book. This book is almost like a visit as it has 123 illustrations showing men at work in every department. It pictures the wonderful equipment of the Sweeney School. It shows how you are taught, shows the class of men you will associate with, portrays various phases of the automobile industry, explains how, when and where you begin to earn money, in a word is a complete encyclopedia of the subject. Simply send name and address today.

E. J. SWEENEY

SWEENEY AUTOMOBILE SCHOOL  
1169 E. 15th Street KANSAS CITY, MO.

# Trained Traffic Men Direct The World's Commerce

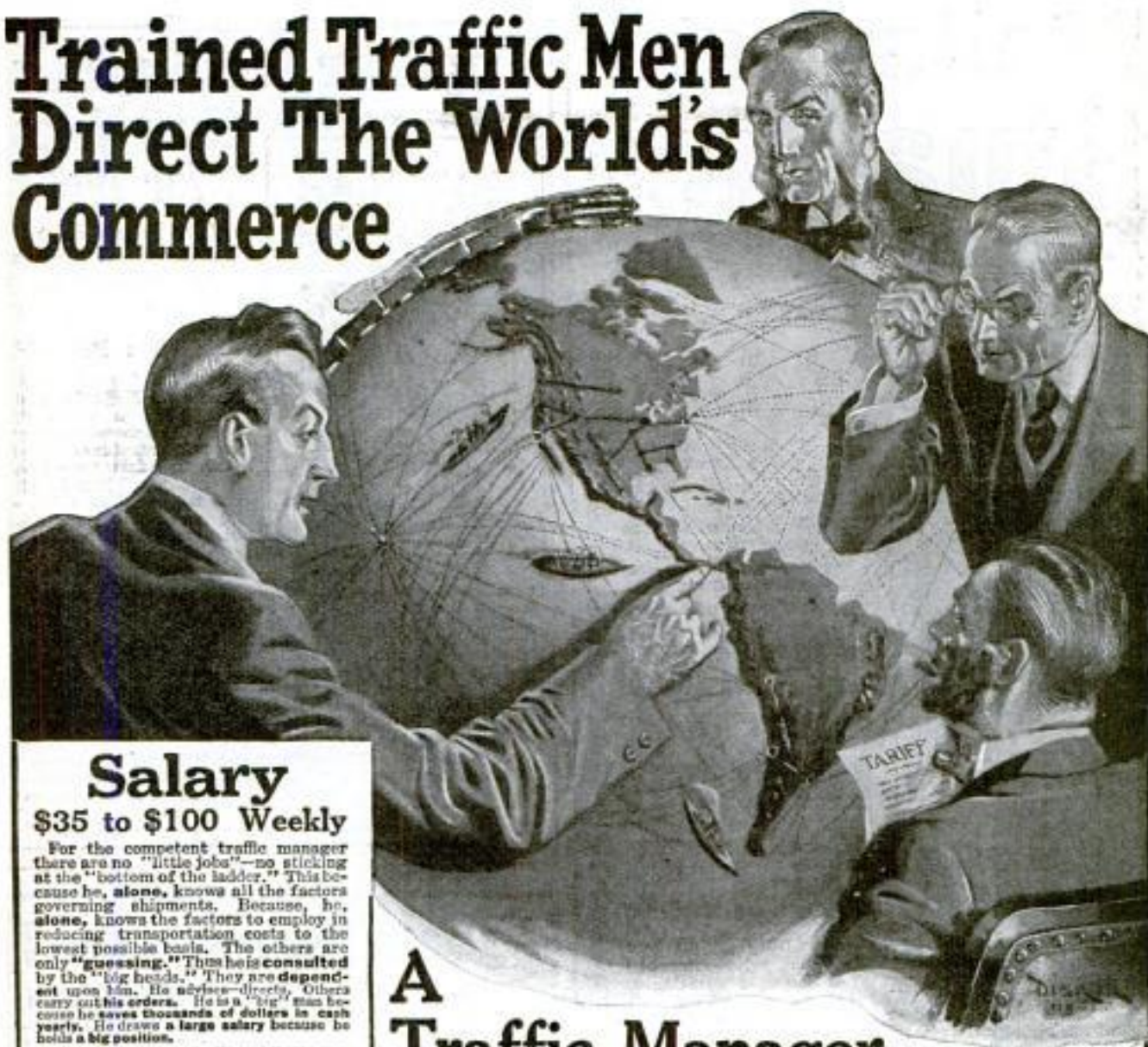

## Salary

**\$35 to \$100 Weekly**

For the competent traffic manager there are no "little jobs"—no sticking at the "bottom of the ladder." This because he, **alone**, knows all the factors governing shipments. Because, he, **alone**, knows the factors to employ in reducing transportation costs to the lowest possible basis. The others are only "guessing." Thus he is consulted by the "big heads." They are dependent upon him. He advises—directly. Others carry out his orders. He is a "big" man because he saves thousands of dollars in each year. He draws a large salary because he holds a big position.

You can be the man who "knows." You can advise and direct. You can be a big man in an important position and draw a large salary—if you will only gain this training. We will teach you—advise you—direct you. If you make an honest effort you cannot help but succeed.

## A Traffic Manager

**Can Get a Position any Place in the World at Good Salary. Be One. Train by Mail Under Expert Guidance**

Without trained traffic men, commerce—in its present efficient state of development could not possibly be carried on. For the efficient traffic manager—no matter where he may be, north or south, east or west—there is work and at high salary. The profession is permanent. It grows better and pays more money each year because commerce is a huge giant, still growing. In America, alone, is a vast field. Recently enacted railroad and interstate commerce regulations and laws have created thousands of new positions. Hundred of these positions cannot now be filled because there is a great scarcity of really competent traffic men. Think of this—at the close of the present great European war, the commerce of a greater part of the world will require re-establishment. This great task will require thousands of highly trained traffic men. America will be greatly affected by these changes. Now is the time to enter this profession.

**Simple—"Progressive" Lessons You Can't Help but Learn**

Our lessons were prepared by practical traffic managers and traffic experts who do the things they write about. Thus the lessons contain just the things that a traffic manager **must know**—and our experts will **train you** in doing them. Our students get **actual practice**—are qualified to obtain a position and **to hold it**. By the La Salle System there is nothing beyond your capacity to learn. With our help your progress will be easy and rapid; your success, certain.

**An Unusual Book FREE—"Ten Years' Promotion in One"—also copies**

of students' letters and full information concerning the course—just mail the coupon. This unusual book was written especially to give you facts concerning conditions in the business world—facts that are known only to those few men who have learned them through bitter experience. Written by a man who has "been through the mill." Don't go "up against a stone wall"—get this book—it will "open your eyes." Determine how to become a traffic manager—to take the La Salle Course—to be a man among men—and draw a "man's" salary. Don't complain about the low pay of your present position—prepare to get out of it. We will help you. Send the Coupon and receive the Book and full information by return mail.

**LA SALLE EXTENSION UNIVERSITY**  
Dept. 264C Chicago, Ill.

## La Salle Graduates Hold Big Positions

Our graduates are successful because the instruction is complete and thorough. They are taught just those things they need in their daily work either as railroad or industrial traffic expert manager. Because our experts coach and direct them in making practical application of things they learn. We want to send you copies of letters they have written us—let them tell you—in their own words—of the progress they have made, of the positions obtained, of promotions and raises in salary.

## You Will Like To Read These Letters

One from a La Salle graduate, Alex. Denholm, wherein he explains how he saved his firm \$3,988.00 on a single shipment of steel rails and cross-ties—a letter from a traffic manager of a big wholesale house, who received a one-third increase in salary through study of the La Salle Course—one from the manager of a brick company who says that one of our students saved his firm \$1,848 on the shipment of brick covering a single contract—these and many others, testifying with "human interest," that tell of success coming to our students and graduates as the result of La Salle training.

The La Salle is a long-established, powerful institution—financially strong, and reliable. We prove all our claims—fulfill all our promises. We will show you the way to good salary—stand behind you—help you to "make good."

**LaSalle  
Extension  
University,  
Dept. 264C  
Chicago, Ill.**

Send Free proof about opportunities now open to TRAFFIC EXPERTS with LaSalle training; also Free copy of "10 Years' Promotion in One."

Name.....

Occupation.....

Address.....

City.....State.....

Please Mention Popular Mechanics

# The Burlington Smashes

Mail the  
Coupon  
TODAY  
for Free  
WatchBook



All Watch  
Competition  
**Look!**

19 Ruby and Saphire Jewels—  
Adjusted to the second—

Adjusted to temperature—  
Adjusted to isochronism—

25-year gold strata case—

Genuine Montgomery Railroad Dial—  
New Ideas in Thin Cases.

Every fighting vessel in the U. S. Navy has the Burlington Watch aboard. This includes every torpedo boat—every submarine as well as the big Dreadnoughts.

**\$2.50**

**Only 2 A Month**

And all of this for \$2.50—only \$2.50 per month—a great reduction in watch price—direct to you—positively the exact prices the wholesale dealer would have to pay. We do not care to quote these prices here, but write—write before you buy. Think of the high-grade, guaranteed watch we offer here at such a remarkable price. Indeed, the days of exorbitant watch prices have passed.

## See It First!

You don't pay a cent to anybody until you see the watch. We won't let you buy a Burlington watch without seeing it. Look at the splendid beauty of the watch itself. Thin model, handsomely shaped—aristocratic in every line. Then look at the works! There you see the pinnacle of watch-making. You understand how this wonder timepiece is adjusted to the very second!

Free Watch  
Book Coupon

Burlington Watch Co.  
19th St. and Marshall Blvd.  
Dept. 1192 Chicago, Ill.

Please send me (without obligations and prepaid) your free book on watches with full explanation of your cash or \$2.50 a month offer on the Burlington Watch.

## Free Watch Book

Get the Burlington Watch Book by sending this coupon now. You will know a lot more about watch buying when you read it. You will be able to "steer clear" of the double-priced watches which are no better. Send coupon today for the book and our offer.

**Burlington Watch Co.**

19th Street & Marshall Blvd.  
Dept. 1192  
Chicago

Name.....

Address.....

JUST PUBLISHED

## Popular Mechanics

### Shop Notes for 1916

529 Easy Ways  
To Do Hard Things

469 Illustrations

224 Pages

Price 50c Postpaid

Reprinted from Popular Mechanics Magazine and comprising a series of 529 articles covering every department of mechanics with useful time and labor-saving kinks for all the trades. The following partial list of contents gives an indication of the wealth of material one will find in this book:

POPULAR  
MECHANICS  
SHOP NOTES



529 EASY WAYS  
TO DO HARD THINGS  
POPULAR MECHANICS CHICAGO

(Actual Size 6½ x 9½ in.)

Boat Dump—Automatic Siphon—Electric Door Lock—Gardener's Weeding Cart—Installation of Water-Heating Plant—Handy Jack—Spark Plug Tester—Steam Water Heater—How to Make a Log Canoe—Chute for Fish to Pass Over Dam—Decarbonizer—Tire-Fluid Gun—Home Made Folding Bed—Portable Oxyacetylene Welding Outfit—Lining Up Shafting—Proper Fireplace Construction—Outdoor Fireplace—Small Crane for Wagon—Home Made Engine-Driven Tire Pump—Lift Pump—Concrete Mixer—Inexpensive Wood Pulleys—Iceless Refrigerator.

Complete series of Shop Notes consisting of 12 volumes \$6.00 prepaid or any single volume 50 cents postpaid.

POPULAR MECHANICS BOOK DEPT.  
6 N. Michigan Ave., CHICAGO

Just Out

## Amateur Mechanics No. 7

200 Articles

211 Illustrations

128 Pages

Price 25c Postpd.

Those who take delight in building their own homemade contrivances will find in this new book a wealth of suggestions of interesting things to make. Each of its 200 articles tells completely how to construct some one thing. Everything described is either useful or ornamental. This book contains nothing found in any of the other numbers of the Amateur Mechanics series.



(Actual Size 6½ x 9½ in.)

A few of the many practical things described:

Mile-O-View Camera—Houses Made of Poles—Houseboat—Pushmobile—Ice Glider—Electric Chime Clock—Bucket Ball Game—Musical Doorbell—Snowshoes—Child's Playhouse—Ice Boat and Catamaran—Poultry Coop—Coasting Bobbed—Candy Floss Machine—Snowball Maker—Lantern for Spot and Colored Lights—Skating Merry-Go-Round—Skiff—Steering Sled—Photographic Work Table—Skates Made of Wood—Water Meter—Foot Bots—Graining Tools—Roller Skates, etc.

The other numbers of Amateur Mechanics are equally interesting and will be sent postpaid at 25 cents each.

POPULAR MECHANICS BOOK DEPT.  
6 N. Michigan Ave., CHICAGO



## Learn a Paying Profession

that assures you a good income and position for life.  
For twenty years we have successfully taught

## PHOTOGRAPHY

Photo-Engraving and Three-Color Work

Our graduates earn \$20 to \$50 a week. We assist them to secure these positions. Learn how you can become successful. Terms easy—living inexpensive. Write for catalogue—NOW!

ILLINOIS COLLEGE OF PHOTOGRAPHY, 999 Wabash Avenue, Effingham, Ill.

## ELECTRICITY

CONDENSED COURSE IN  
ELECTRICAL ENGINEERING

Complete in One Year  
Bliss Electrical School

Studies restricted to theoretical and practical electricity, mechanical drawing and necessary engineering work. Teaches simplicity, concentration, hard work. For young men of energy and character. 23 years of greatest success. Graduates hold first-class positions.

Opens Sept. 27th. Write for new catalog.  
104 Takoma Avenue, WASHINGTON, D. C.

ESTAB. 1892

## BODEE TRADE DENTAL SCHOOL

15-17 W. 44th St. NEW YORK CITY

LEARN IN 3 MONTHS TO EARN \$1300 TO \$4000 A YEAR

Our valuable book "P" tells how. It's Free—write for it. Anyone from 16 to 60 years old can easily learn Mechanical Dentistry. The Demand is like a gold mine. Unexplored. We are constantly called upon to fill good salaried positions. Why not qualify for one? No book study. All practical work. We guarantee that you can earn before completion of the Course. Tuition payable in installments.

## Do You Like to Draw? Cartoonists Are Well Paid

We will not give you any grand prize if you answer this ad. Nor will we claim to make you rich in a week. But if you are anxious to develop your talent with a successful cartoonist, so you can make money, send a copy of this picture, with \$2 in stamps for portfolio of cartoons and sample lesson plate, and let us explain.

The W. L. Evans School of Cartooning  
821 Leader Bldg., Cleveland, O.



## Learn Watchwork, Jewelrywork and Engraving.

A fine trade commanding a good salary, and your services are always in demand. Address HOROLOGICAL, Dept. P, Bradley Institute, Peoria, Ill., for our latest catalog.

## DRAWING

Cartooning, Cartoon, Comic, Commercial, Fashion, Newspaper and Magazine illustrating taught by mail. Illustrated book 6c in stamps. THE BOSTON SCHOOL OF DRAWING, 755M Boylston St. BOSTON, MASS.



## The University of Chicago

### HOME STUDY

in addition to resident work, offers also instruction by correspondence.

For detailed information address

24th Year U. of C. (Div. 20) Chicago, Ill.



## NEW 1916 EDITION AUTOMOBILE ENGINEERING

No matter what type of motor vehicle you are interested in. No matter what standard make of auto, motor car, motorcycle or motor boat you want to know about.

Here is your opportunity to get a brand new library covering every motor subject. Here is your chance to secure the latest, most practical, most authoritative set of books ever written on automobile and motor engineering at an extremely low, inside price.

If you want help in solving the knotty points you bump up against every day, this set of books is just what you are looking for. If you want to become a Gas Engine expert, this great 5 volume cyclopedia, written by the biggest men in the business, is the standard text book for you.

**\$25.00 Set Now \$14.80—\$2.00 a Month**

This auto library contains 2,000 pages, with 1,800 illustrations that make technical points as simple as A-B-C; full page plates that liberally pick the mechanism to pieces before your very eyes; drawings and diagrams that show the working of all the principles employed in the various types of motors. Bound in half red morocco, gold stamped. These five volumes are a most remarkable value at the regular price. Yet we offer a limited number of sets at a special introductory price of \$14.80—payable \$2 a month.

**SHIPPED FREE** Test these books before you buy. You don't buy a motor until you have tried it out. Buy books the same way. We send the full 5 volumes to you, express prepaid, for 7 days' free examination. Use them a whole week free. See if they don't help you work out the problems that come up in your garage or repair shop. If the books are what you want, send us \$2. Otherwise we'll take them back, paying the express both ways ourselves.

### Subjects Covered

Explosion Motors—Gasoline Car Features—Ignition Systems—Lighting Systems—Electric Starters—Types of Automobiles—Electric Pleasure Cars—Storage Cells—Electric Motors—Care and Operation of Electrics—Automobile Driving—Road Troubles—Private Garages—Repairs—Electric Delivery Wagons—Electric Trucks—Gasoline Delivery Wagons—Trucks—Tractors—Trailers—Road Trains—Traction Engines—Maintenance and Costs—Steam Cars—Motorcycles—Cyclecars—Light Cars—Motor Boats—Glossary.

## FREE !! \$12.00 Consulting Membership

We give you absolutely free our \$12 consulting membership. This privilege puts our whole staff of experts at your service for a whole year without cost to you. Ask them any motor question you want. They will give you practical help.

The solution of a single problem might easily be worth more than what you pay for the books—you get this service free.

The moment you see the books you will realize that you need them. There is no limit to the good they can do you every day. It costs you nothing to look them over, to use them for a whole week. You run no risk, you incur no obligation. The books come back at our expense if you say so.

Send in the coupon now—today.

AMERICAN TECHNICAL SOCIETY  
Chicago, U. S. A.

## FREE COUPON

Worth \$10.20 to You

American Technical Society  
Chicago, U. S. A.

Please send me Cyclopedia of Automobile Engineering for 7 days' free examination. If I decide to buy, will send \$2 in 7 days and balance \$2 a month until \$14.80 has been paid, when \$25 books and \$12 consulting membership will be mine free. Otherwise will notify you and hold books subject to your order. Title not to pass until fully paid.

Pop. Mec. 2-16

NAME .....

ADDRESS .....

As I have had no previous dealings with you, I refer you to

Please Mention Popular Mechanics

# FREE BOOK



## How To Study Music

### This Interesting Book

shows the keen delight and personal satisfaction which a musical training will bring you; and how you can obtain this training easily and thoroughly in your own home at one-quarter the usual cost.

It tells how this most prized of social accomplishments greatly increases your own enjoyment of life and the enjoyment of others. It tells of the concert career which may be open to you, and how you can increase your earning power by giving musical instruction in your spare time. Send for your copy of this valuable book today; it is free.

**Dr. Quinn's Famous WRITTEN METHOD** has revolutionized the study of music. By the use of Dr. Quinn's remarkable device, the **COLOROTONE** (patented), you save three-quarters of the time and effort usually required for learning piano or organ. You play chords immediately and a complete piece within a few lessons. The method is scientific and systematic, yet practical and simple. It is endorsed by leading musicians and heads of state universities. Equally effective for children or adults, beginners or experienced players. Practice in spare time, whenever convenient. Successful graduates everywhere. Lessons granted. Special reduced terms this month. Acquire without cost or obligation by writing today for free book, "How to Study Music."

Marcus Lucius Quinn Conservatory, Box 650KN, Chicago

# FREE!

Best Offer Ever Made!

A superior course in **SHOW CARD** and **SIGN WRITING**, in leading correspondence school (not a book) and high grade **Air Brush**, given free! to purchasers of assorted "NOBEMA" ready-to-use **COLARS**. An HONEST OFFER, to INTRODUCE our **COLARS**. Show Card Writing is a fascinating, profitable trade, easy to learn. Get better pay, or have own business. WRITE FOR ILLUSTRATED BOOK, CIRCULARS AND INFORMATION.

**NOBEMA Pm. CO., 8 S. DEARBORN ST., CHICAGO, ILL.**

You should have it

The **Earl J. Early Company**  
307 Arch St., Philadelphia, U.S.A.

Your dealer should have it

**The Drawing Attraction of the Drawing World**

**Line-O-graph**  
Patented Dec. 15 '04. *Keeps an equal*

Use 75¢ per sheet. Draftsman. Standard.

## Learn to Operate Motion Picture Machines

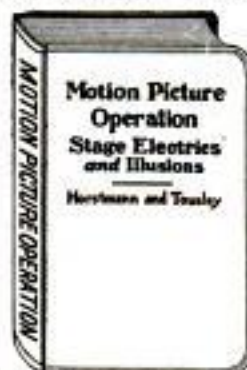

Every detail is taught in plain language in our new book

### Motion Picture Operation

A practical guide for theater electricians. 393 pages. Full leather. Pocket size, \$2.00 sent postpd.

Send for our large catalogue of **Practical Mechanical Books** for HOME STUDY. It is

# FREE

Best Books for Electricians, Telephone Men, Engineers, Railroad Men, Motormen, Draftsmen, Automobile Mechanics, Plumbers, Carpenters, Builders, Sign and Card Writers, also Bookkeepers and Civil Service Applicants.

**THE DRAKE COMPANY**  
Dept. 8, 1325 Michigan Ave., Chicago

## STUDY AT HOME LAW

We give our resident law course by correspondence. Course prepares for Bar of any state. LL.B. Degree conferred. Endorsed by Bench and Bar. Faculty of 45 distinguished jurists and lawyers.

CATALOG FREE

Oklahoma City University, 906 Colcord, Oklahoma City, Okla.

## DON'T TAKE MACHINE DRAFTING

until you've read my proposition. Practical, experienced Draftsman, regularly employed in large modern works, will teach a few men by mail. Best way to become a well-paid Draftsman. Special courses in Mathematics also. Instruments furnished. Rates very reasonable. Draftsman, 252 S. Corona St., Denver, Colo. Pay a part after in position.



## MAGIC

### Tricks, Books and Supplies

Learn magic at home. We teach you to do these tricks as good as the great professionals. Send for the new Thumb Tie for stage work, seven illustrations, complete directions, 50c. Large Professional Catalogue, 160 pages, 10c.

**CHICAGO MAGIC CO.**  
Dept. A, 72 W. Adams St. CHICAGO, ILL.

# SELF MASTERY

## BRINGS HEALTH AND HAPPINESS



Make yourself the strong, healthy, happy person you should be and can be. Train your mind and body together to resist and repel the negative and dispiriting forces to which you succumb so easily. Be master instead of slave. Decide and act now instead of putting it off until some other time. Without placing yourself under the slightest obligation—without committing yourself in any way—without even exerting yourself, you can find out all about

and the many wonderful things it has done in placing men and women on the sunny side of life and putting them in complete possession of their natural rights

of mental and physical ease and power. What Leavitt-Science has done for others, most of them skeptics at first, but believers at last, it can and will do for you. For 12 2c-stamps, to cover postage and packing, I will send you *The Story of Leavitt-Science* to read and consider, and with it the names of many men and women it has benefited and to whom you can write, if you wish? Send for this great book today.

**C. FRANKLIN LEAVITT, M. D.**  
Suite 946 14 West Washington Street  
CHICAGO ILLINOIS



Come to Detroit  
the automobile center  
and

**LEARN THE AUTOMOBILE BUSINESS**

Detroit trained men get preference over all others, get jobs quick as soon as ready. *The reason*—study the heart in the center. Realize its tremendous power.

No other city, no other school can give you what Detroit offers. Factories shown are not all. Think what it means to learn at Detroit. Every factory knows us, endorses our school, glad to get our graduates. You're right in the middle of great auto activity. Men are needed everywhere as testers, repairmen, chauffeurs. Splendid chance to start in business. Hundreds of our graduates are doing it.

**Earn \$75 to \$300 a Month**

We teach you to handle any auto proposition. Our equipment is complete. Students actually build cars from start to finish, getting regular factory training in assembling, block-testing, road-testing, etc. That's the Detroit Way. All leading types of starting, lighting and ignition systems in operation. Learn to time motors, adjust carburetors, magnetos, valves, bearings, etc. Six-cylinder Lozier and 8-cylinder King are used for road instruction. We have a new Chalmers "6" chassis with overhead camshaft motor, the latest thing out.

**Detroit is the Place to Learn—Start Any Time**

There are 44 auto factories in Detroit. Our students have the privilege of going through any or all of them, including Detroit electric service department, while taking our course. You can't get these advantages and opportunities anywhere else. Detroit is the automobile center. You make faster time here and you get practical instruction. Come to Detroit and learn the business right. Enter classes any time.

### Great Demand for Detroit Trained Men

Garages throughout the country write us for men. Why not fit yourself for one of these good paying positions?

**Demand Greater Than Supply for Competent Men. Following Clipped from Daily Papers—All Parts of U.S.**

Experienced motor mechanics, bearing scrapers, assemblers, repairmen; good wages. Henderson Motorcycle Co., 1158 Cass.

Chauffeur—Must be good driver, steady and reliable; one with knowledge of Pierce-Arrow cars preferred; no other but good mechanic need apply. Address Box B, No. 100 Free Press.

10 road testers, 20 garage repair men, final assemblers. Maxwell Motor Co., Inc., Oakland Ave. Plant.

40 Drivers—Come ready to work. Maxwell Motor Co., Inc., Oakland Avenue Plant.

Block Testers—Apply Continental Motor Mfg. Co.

Wanted—High-grade retail automobile sales manager. Box E, No. 52.

Automobile Repair Men wanted; must be experienced; none other need apply. Come ready for work. Auto-Kraft & Garage Co., rear 76-86 Forest Avenue, East.



### GUARANTEE

We guarantee to qualify you for a position as chauffeur, repairman, tester, salesman, demonstrator or garage man paying from \$75.00 to \$300.00 in a short time or refund your money. We have constantly more requests for men, at good salaries than we can supply.

Write for full particulars. Ask for "Auto School News" and new Pictorial catalog—just out. Both free. Or, better still, jump on train and come to Detroit.

**Michigan State Auto School Students are Competent to Fill Every Position and Make Good**

Has Studebaker and Maxwell Agency La Farge, Wis., February 6, 1915.

Prof. C. G. Arthur, Michigan State Auto School, Detroit, Mich. Dear Sir—I am getting along just fine. A friend of mine, Mr. Shoulin, and myself, have opened a garage in our home town, and we have been having all we could do. We have been doing overhauling this winter and have got enough work ahead waiting to keep us going until spring opens up. Thanks to what you have pointed into that old nut of mine, I have never been stuck yet. We have the agency for the Studebaker and Maxwell.

Yours truly, (Signed) O. C. HILL.

**Starting Garage of His Own, Couldn't Accept Position We Offered**

Elma, Iowa, May 1st, 1915.

Michigan State Auto School, Detroit, Mich. Gentlemen:—I thank you very much for the information sent me and am very sorry because I cannot accept the position as I am busy at the present time, putting up a garage. I am going into the business for myself and was compelled to turn down the position offered me. I am thankful that I went to Detroit to learn the auto business and wish the School the best of success. Sincerely yours, (Signed) CARL WEBER, Box No. 304, Elma, Iowa.

W. C. Garden, Tenn., is Chauffeur at \$25 a week and expenses. E. Livingston is head of government garage at Toronto. Hundreds of others in good paying positions.

**READ OUR GUARANTEE**



**SEND THIS COUPON TODAY**

**Michigan State Auto School**

.....I expect to leave here about..... for Detroit.

.....I would like to see your new pictorial catalog. (just out) and the Auto School News and will let you know later what I expect to do.

Name.....

Street.....

Post Office.....State.....

**Michigan State Auto School** Dept. 302, 11-19 Selden Ave. Detroit, Mich., U. S. A.



# Don't Be a Draftsman!

Learn these facts before you enroll for any Drafting Course

Are you planning to learn Drafting? Have promises of light, pleasant work at a big salary tempted you to become a Draftsman? THEN YOU OWE IT TO YOURSELF TO KNOW THE FACTS BEFORE ENROLLING FOR ANY DRAFTING COURSE!

**Drafting alone** will never get you anywhere! You can't earn more than a decent living as a mere Draftsman. The big money goes to the man who tells you what to draw—the Architectural, Structural, Mechanical or Civil Engineer.

**Drafting Only a Beginning** All Engineers are expert Draftsmen. Drafting was the first thing they learned. But they weren't satisfied to spend their lives drawing other men's plans. They didn't stop when they learned Drafting—they went right ahead and got the special training that enables them to hold down big jobs and draw big pay. YOU, TOO, CAN GET THIS TRAINING, and it will cost you only a little more than a course in Drafting alone

**Be an Engineer—Earn \$2500 to \$5000 a Year!** We will train you—in your spare time—to earn \$2500 to \$5000 a year as an expert Engineer. First of all we will teach you Drafting, furnishing a \$20 Drafting Outfit and a \$20 Drafting Library (4 Vols.) ABSOLUTELY FREE! Then, after you have mastered Drafting and are getting actual working experience in an Engineer's office, we will train you in your choice in Architectural, Structural, Mechanical and Civil Engineering. Why stop at a Draftsman's pay when a little more study will make you an Engineer, competent to fill a responsible, well-paying position?

This is the big advantage which the American School offers. A staff of highly-trained instructors—men who have been graduated from the country's greatest technical schools—enables us to prepare you in any branch of Engineering you select. Remember, we train you—in your spare time—to become a high-salaried Engineer, not an ordinary Draftsman. It will cost you only a trifle more than a course in Drafting alone, and you can pay for your instructions as you progress—in small monthly installments.

**Don't enroll for any Drafting Course until you have thoroughly investigated this remarkable offer.** The coupon will bring you full particulars and a copy of our 248-page Free Book. Mail it today—NOW! You have no time to lose if you are to get the free set of Drafting Instruments and the free four-volume Drafting Library.

**AMERICAN SCHOOL OF CORRESPONDENCE, CHICAGO, U.S.A.**

## Free Book Coupon

American School of Correspondence, Chicago, U. S. A.

Without any obligation on my part, please send me full particulars of your Engineering Offer and a copy of your 248-page Free Book. I am interested in a course in  
 Architectural  Structural  Mechanical  Civil  
 Engineering. Pop. Mech. 2-16

NAME .....

ADDRESS .....



## IF YOU STAMMER

Attend no stammering school until you get my big FREE book and special rate. Largest and most successful institution of its kind in the world. Two large modern school buildings fully equipped for treatment of stammering under my advanced natural method. No sing-songing or time-beating.

Established 14 years. Known everywhere as the best. Personal instruction given each student. Write today for full particulars. Lee Wells Millard, Pres. North-Western School for Stammerers, 2317 Grand Ave., Milwaukee, Wis.

## A GOOD POSITION

with UNCLE SAM is most desirable. Life positions, pleasant surroundings, good pay, steady work, short hours, promotions on merit. Both sexes. No political pull. Thousands of appointments yearly. Most thorough preparation \$5. Returned if not appointed. Full information and questions used by the Civil Service Commission free.

AMERICAN CIVIL SERVICE SCHOOL

WASHINGTON, D. C.

## DON'T TRY TO BE A CHAUFFEUR

or go to ANY SCHOOL to learn, or part with your hard earned dollars until you have read our valuable guide FIRST. It tells what you should PAY and what you should GET. Do not be deceived by schools which claim everything and give you nothing. YOU CAN'T AFFORD TO SPEND ONE CENT TILL YOU GET OUR GUIDE. It costs nothing and may save you many dollars. Write now for this FREE BOOK.

PRACTICAL AUTO SCHOOL, 68 Beaver St., New York

## LEARN WATCH REPAIRING

Be a watchmaker—you can learn this profitable trade by correspondence in a few weeks in your own home by the DeSelms Chart System. After you complete the course you will know a watch from A to Z. You will know just what the matter is and how to repair one. When you graduate you will be a practical watchmaker and repairer and competent to fill any position. Positions for our graduates.

Ask for our Free Book. It explains our system and terms.

THE DESELMS WATCH SCHOOL  
 23 Perry Street ATTICA, INDIANA



## WANTED

**Railway Mail Clerks**  
**\$900 to \$1800 a Year**  
**(\$75 to \$150 a Month)**

Rapid advancement to higher Government Positions. "No lay offs" because of STRIKES, WARS, FINANCIAL FLURRIES or the WHIMS OF SOME PETTY BOSS. THE POSITION IS YOURS FOR LIFE.

Country residents and city residents stand the same chance for immediate appointment. Common-sense education sufficient. Political influence NOT REQUIRED.

**We will coach 25 candidates free of charge**  
**If you want to be one, send coupon immediately**

FRANKLIN INSTITUTE, Dept. H104, Rochester, N. Y.



Business Boom means hundreds of appointments

FRANKLIN INSTITUTE (The Pathway to Plenty), Dept. H104, ROCHESTER, N. Y. This coupon, filled out as directed, entitles the reader to free specimen questions, a free copy of our book, "Government Positions and How to Get Them," a list of Government positions now obtainable and to consideration for Free Coaching for the examination here checked.

### COUPON

Railway Mail Clerk. (\$900 to \$1800) ..Customs Positions.. (\$800 to \$1500)  
 Bookkeeper .. (\$900 to \$1800) ..Stenographer .. (\$800 to \$1500)  
 Postoffice Clerk .. (\$900 to \$1200) ..Internal Revenue.. (\$700 to \$1800)  
 Postoffice Carrier .. (\$800 to \$1200) ..Clerk in the Departments  
 Rural Mail Carrier.. (\$500 to \$1200) ..at Washington... (\$800 to \$1500)  
 Auto Chauffeur..... ..Canadian Gov't Positions.....

Name.....Address.....H104

Use this before you lose it. Write plainly.



## Music Lessons Sent Free

You too, can now quickly satisfy your musical ambitions — learn to play your favorite instrument, whether for pleasure, social prestige or to teach music, by our wonderful home study lessons under great American and European teachers. The lessons are a marvel of simplicity and completeness, endorsed by Paderewski and other great authorities.

### Any Instrument

Write today, telling us your musical ambitions, course you are interested in, age, how long you have taken lessons if at all, etc., and we will at once send you six lessons, free and prepaid, of any of the following Complete Courses: Lessons in PIANO (students' or teachers' courses) by the great Wm. H. Sherwood, HARMONY by Dr. Protheroe and Rosenbecker, PIPE ORGAN by Clarence Eddy, VIOLIN, CORNET, MANDOLIN, GUITAR, BANJO, REED ORGAN, PUBLIC SCHOOL MUSIC, by eminent teachers.

This offer is absolutely Free — we do not ask you to pay one cent for the six lessons, either now or later. We want to prove in this remarkable way what grand lessons they really are — seeing is believing. This offer is limited, so write today. A few Special Introductory Scholarships are now being awarded by our Faculty. Full particulars sent free along with the free lessons. Write today. Send no money.

**Siegel-Myers Correspondence School of Music**  
Clarence Eddy, Dean 1366 Siegel-Myers Bldg., CHICAGO, ILL.

CORRESPONDENCE COURSE ON	<b>Freehand Lettering</b>	FOR DRAFTSMEN AND STUDENTS
Don't you want to draw a larger salary each week?	You certainly do. I offer you an absolutely sure way.	
Become an <i>Expert</i> on above subject through my <i>Standard System</i> of instruction by mail. Personal criticism by <i>recognized authority</i> . 25 yrs. experience.		
C. W. REINHARDT, ARLINGTON, N. J.		

**WHENEVER** you need a book on any mechanical subject and do not know where to obtain it, write **POPULAR MECHANICS BOOK DEPARTMENT, 6 North Michigan Ave., Chicago**

**LEARN WATCHMAKING AND ENGRAVING**

Earn while learning. Most practical watch school. Individual instructions. Graduates in great demand. Book free. Chicago School of Watchmaking, 63 E. Van Buren St., Chicago



## Oh, You Skinny!

Why stay **thin** as a rail? You *don't* have to! And you *don't* have to go through life with a chest that the tailor gives you; with arms of childish strength; with legs you can hardly stand on. And what about that *stomach* that flinches every time you try a square meal? Are you a *pill-popper*?

Do you expect **Health and Strength** in tabloid form — through pills, potions and other exploited piffle?

**You can't do it; it can't be done.**

The only way to be well is to build up your body — all of it — through nature's methods — *not* by pampering the stomach. It is *not* fair that is making you a failure; it's that poor, emaciated body of yours; your half-sickness shows plain in your face and the world loves healthy people. So be *healthy* — *strong* — *vital*. That's *living*. Don't think too long; send 4 cents in stamps to cover mailing of my book, "INTELLIGENCE IN PHYSICAL CULTURE," written by the *strongest physical culture instructor in the world*.

**LIONEL STRONGFORT**  
Health and Strength Institute  
Dept. S26 Atlantic City, N. J.

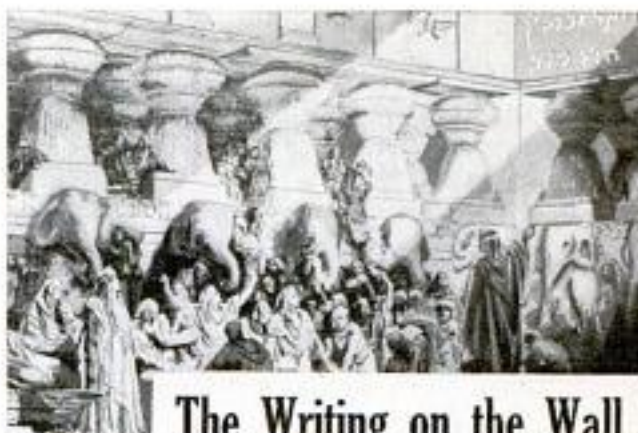

## The Writing on the Wall

It was at the famous feast of Belshazzar, King of Babylon, that the prophet Daniel read the awful dictum — "Mene, Mene, Tekel Upharsin." That night Cyrus and his army captured the city, but not until thousands of years later was unearthed the inscribed cylinder that told the **real** story of the "Fall of Babylon." This curious account, which is very different from the popular version, is but one of many thousand "original documents" contained in

## The Library of Original Sources

now for the first time available to the general public. This remarkable Library had previously been sold by subscription, but by purchasing the *entire unsold edition* from the publishers we secured it at an *absolutely unheard of reduction*. We offer a few sets to Popular Mechanics readers at an

### EXTRAORDINARY BARGAIN

Send us the attached coupon **AT ONCE**, and we will tell you how to get the Library on **EASY MONTHLY PAYMENTS**, and mail you **FREE** a book of rare documents showing curious inscriptions of the Ancients. There are only a limited number of sets, so act quickly. Mail the coupon **NOW**. You assume no obligation. No salesman will call. The book is **FREE**.

**THIS MARVELOUS WORK** gives the authoritative, rock-bottom sources of our knowledge on **ALL SUBJECTS OF HUMAN INTEREST** from the earliest civilization *down to today* — the inside facts which the average person has never even heard of.

**OVER 100 RESEARCH SPECIALISTS** spent 10 years gathering the contents of this great work. Ancient and remote civilizations in all parts of the globe, age-buried hieroglyphics on monuments, tablets and sun-baked bricks yielded their secrets; untiring workers ransacked the hidden literature of every age, to find these "original documents." Nothing like it has ever been attempted or thought of before. You'll be amazed at the wealth of information this unique library contains.

■ **MAIL THIS COUPON FOR FREE BOOK** ■

■ UNIVERSITY RESEARCH, Dept. G, P. M. 2-16 ■  
■ Milwaukee, Wis. ■

■ Send me the **FREE** book of rare documents showing inscriptions of the Ancients and tell me of your easy payment offer. I assume no obligation, the book and all you send me is to be **free**, and no salesman is to call. ■

■ Name ..... ■

■ Address ..... ■

Please Mention Popular Mechanics

# STOP USING A TRUSS

Do Away With Steel And Rubber Bands

## FREE TRIAL



PAT'D  
APRIL 6  
1909

Inner surface is made adhesive to secure the PLAPAO-PAD firmly to the body, keeping the PLAPAO continually applied and the pad from slipping. No straps, buckles or springs attached. Soft as velvet—easy to apply.

It's the Non-Slip- ping, yet Non-Rigid Pad and What is Within It That Counts

### FREE to 5,000 Truss Sufferers

To the first 5,000 Sufferers who write, I will send, ABSOLUTELY FREE, a sufficient quantity of the Plapao to positively convince them that this is the only logical, common-sense way of treating rupture. Plapao is a highly astringent medication placed within the Plapao-Pad and being absorbed through the skin, creates a wonderful feeling of relief and at the same time tends to strengthen the weakened muscles and thus permanently close the rupture opening. The process of recovery is natural, so you'll have no use for a truss—you can throw it away forever! Old and young have testified under oath that the Plapao-Pads cured their rupture—many of them long-standing, aggravated cases—without delay from work. Patent allowed in U. S. and foreign countries. Awarded Gold Medal at Rome and Grand Prix at Paris.

**Send No Money**—for a sufficient quantity of the Plapao is sent without charge to enable you to give it a thorough test; you pay nothing for this trial now or ever. Write for it and full information today. Address: Plapao Laboratories, Block 1427 St. Louis, Mo.

# Deafness



Perfect hearing is now being restored in every condition of deafness or defective hearing from causes such as

Relaxed or Sunken Drums, Roaring or Hissing Sounds, Perforated, Partially Destroyed Drums, etc.

### Wilson Common-Sense Ear Drums

"Little Wireless Phones for the Ears"—

require no medicine but effectively replace what is lacking or defective in the natural drums. They are simple devices, which the wearer easily fits into the ears where they are invisible. Soft, safe and comfortable to wear at all times.

Write today for our 168 page FREE book on DEAFNESS, giving you full particulars and plenty of testimonials.

WILSON EAR DRUM CO., Incorporated  
459 Inter-Southern Building LOUISVILLE, KY.

## Don't Wear a Truss

Brooks' Appliance, the modern scientific invention, the wonderful new discovery that relieves rupture will be sent on trial. No obnoxious springs or pads.

### Brooks' Rupture Appliance

Has automatic Air Cushions. Binds and draws the broken parts together as you would a broken limb. No salves. No lies. Durable, cheap. Sent on trial to prove it. Protected by U. S. patents. Catalogue and measure blanks mailed free. Send name and address today.

C. E. BROOKS, 1817A State Street, Marshall, Mich.

Please Mention Popular Mechanics

## "I Would Not Part with It for \$10,000"

So writes an enthusiastic, grateful customer. "Worth its weight in gold," says another. In like manner testify over 100,000 people who have worn it.

## The Natural Body Brace

For MEN and WOMEN.

Develops erect, graceful figure, overcomes WEAKNESS and AILMENTS of Women & Men.

Brings womanly beauty and manly strength, restful relief, ability to work and enjoy life.



For Children Also

### Banishes All These Troubles

Does away with the strain and pain of standing and walking; replaces and supports misplaced internal organs; reduces enlarged abdomen; straightens and strengthens the back; corrects stooping shoulders; develops lungs, chest and bust; relieves backache and nervousness. Comfortable and easy to wear.

### Wear It 30 Days Free at Our Expense

Write today for illustrated booklet, measurement blank, etc., and read our very liberal proposition.

HOWARD C. RASH, Pres. Natural Body Brace Co.  
223 Rash Building SALINA, KANSAS

## Deafness Mastered



The day of imperfect hearing is past. Science rivals nature in the marvelous new 1916 Mears Ear Phone, "Intensitone" model—the world's greatest hearing device. It transmits sound without blur. Write today for our 15 days' free trial offer.

### Perfect Aid to Hearing

The Mears is the only scientific instrument for the deaf. It marvelously covers 96 degrees of sound, every range of tone of the human ear.

**Write for Free Book** Our free book is a highly valuable treatise on deafness.



Write for it today—learn all about our 15 days' free trial offer and low direct laboratory price. If convenient to New York call for demonstration.

MEARS EAR PHONE CO., Inc.  
Desk 1192 45 W. 34th St., New York

## J-M ASBESTOS ROOFINGS

Sometimes called "The Everlasting Roof." Investigate J-M Roof Registration always mindful of J-M Roofing Responsibility.

H. W. JOHNS-MANVILLE COMPANY  
3186 New York and Every Large City

Ericsson Artificial Limb Co., 38 Wash. Av. No., Minneapolis, Minn.  
Does Not Chafe or Overheat or Draw End of Stump



We are Under Govt. Bond

## NO MORE BALD HEADS



WHEN our VACUUM CAP is used a few minutes daily. We accept no pay until you have tried the Cap 60 days and are satisfied. The Vacuum Cap is an appliance that draws the blood to the Hair Roots and starts a new healthy crop of hair. It stops Dandruff, stops the hair from falling out.

Bought by Doctors and men who know that it is the only reasonable HAIR GROWER known to science. No Drugs Used. Write for application blank, testimonials, and booklet on "HAIR," sent sealed in plain envelope, FREE.

THE MODERN VACUUM CAP CO.

A. 559 BARCLAY, DENVER, COLO.



# Tobacco Habit BANISHED

## in 48 to 72 Hours

### Immediate Results

Trying to quit the tobacco habit unaided is a losing fight against heavy odds, and means a serious shock to your nervous system. So don't try it! Make the tobacco habit quit you. It will quit you if you will just take Tobacco Redeemer according to directions.

It doesn't make a particle of difference whether you've been a user of tobacco for a single month or for 50 years, or how much you use, or in what form you use it. Whether you smoke cigars, cigarettes, pipe, chew plug or fine cut or use snuff Tobacco Redeemer will positively remove all craving for tobacco in any form in from 48 to 72 hours. Your tobacco craving will begin to decrease after the very first dose—there's no long waiting for results.

Tobacco Redeemer contains no habit-forming drugs of any kind and is the most marvelously quick, absolutely scientific and thoroughly reliable remedy for the tobacco habit.

### Not a Substitute

Tobacco Redeemer is in no sense a substitute for tobacco, but is a radical, efficient treatment. After finishing the treatment you have absolutely no desire to use tobacco again or to continue the use of the remedy. It quiets the nerves, and will make you feel better in every way. If you really want to quit the tobacco habit—get rid of it so completely that when you see others using it, it will not awaken the slightest desire in you—you should at once begin a course of Tobacco Redeemer treatment for the habit.

### Results Absolutely Guaranteed

A single trial will convince the most skeptical. Our legal, binding, money-back guarantee goes with each full treatment. If Tobacco Redeemer fails to banish the tobacco habit when taken according to the plain and easy directions, your money will be cheerfully refunded upon demand.

### Let Us Send You Convincing Proof

If you're a slave of the tobacco habit and want to find a sure, quick way of quitting "for keeps" you owe it to yourself and to your family to mail the coupon below or send your name and address on a postal and receive our free booklet on the deadly effect of tobacco on the human system, and positive proof that Tobacco Redeemer will quickly free you from the habit.

Newell Pharmaceutical Company  
Dept. 300, St. Louis, Mo.



## Mail Coupon NOW for FREE Booklet

NEWELL PHARMACAL CO.,  
Dept. 300, St. Louis, Mo.

Please send, without obligating me in any way, your free booklet regarding the tobacco habit and proof that Tobacco Redeemer will positively free me from the tobacco habit.

Name .....

Street and No. ....

Town ..... State .....

Please Mention Popular Mechanics



# LEARN THE AUTO BUSINESS

## RIGHT NOW IS THE TIME

to get into the Auto Business. Earn a Splendid Salary or start a paying business of your own. Hundreds of positions are ready and waiting. The demand for trained automobile men far exceeds the supply. Over two million cars are now in use; nearly a million more this year. Cleveland is the center of *high grade* automobile manufacture. Our graduates get jobs quickly. No previous experience is necessary; just the desire to get into congenial, well paid work.

## Cleveland AUTOMOBILE School

12 Years of Success—Oldest and Best Established  
Latest Equipment—Individual Instruction

Practice beats theory. Actual experience is all that counts when you go to get a job. We give you *up-to-date training* in four weeks; including every point worth knowing—oxy-acetylene welding, machine-shop practice, testing and driving high-powered, late model cars. Silent-Knight and other latest type motors; new 8 and 12 cylinder cars. We claim to have the most completely equipped school in America—the most practical and experienced teachers. Don't waste this opportunity. **Come and Join Us Now. Tuition and Board Low**, within walking distance of the school. Congenial company and surroundings. We help you get located and make you feel at home.

New classes forming. Write today for Catalog and Terms.

**CLEVELAND AUTOMOBILE SCHOOL**  
CLYDE H. PRATT, President  
2338 Euclid Ave. CLEVELAND, OHIO

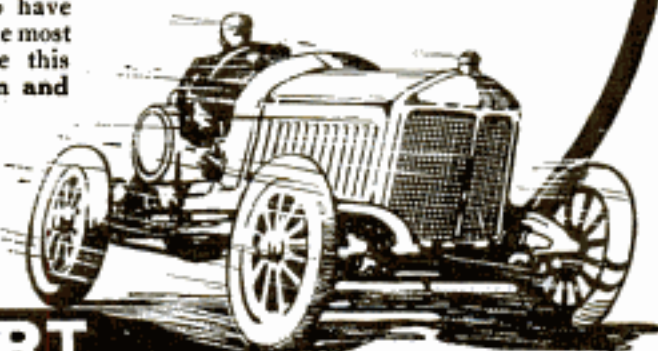

## BE AN AUTO EXPERT

## AUTO GIVEN AWAY

We want representatives in every locality. No experience or capital necessary. Send us your name and address and by return mail we shall tell you how you can secure one of our new 1916 model 5-passenger touring cars free for demonstrating. Write today—do not delay—a postal card will do. Address

**ECLIPSE MOTOR CAR CO.** 851D Buhl Block  
DETROIT, MICH.

## STUDY LAW AT HOME



Investigate the New, Modern Method of personal instruction in law; the easiest, shortest, and most thorough method ever devised, and at about half the cost of any other course. Very little trouble to become a first class lawyer through interesting Home Study. Law is the best stepping-stone to every kind of success, professional or otherwise. Every business man should be a lawyer. Most of the "Big Men" are law-trained. Twenty-three Presidents of the U. S. were lawyers. Law develops the mind—teaches logical reasoning, and assists in arriving at correct conclusions. Attendance at a resident college is too expensive and unnecessary. A former President of Chicago University states that correspondence instruction has been proven more valuable than resident schools. Among our faculty are three former Presidents of Law Schools. Our course, while most thorough, is simplicity itself—no frills. The cost is remarkably low because there is no expense of maintaining an unnecessary "Resident College." A postal will bring you a FREE COPY of "LAW FOR EVERYMAN." Write for it today—Now

**ILLINOIS CORRESPONDENCE SCHOOL OF LAW**

Dept. 238, Rookery, CHICAGO, ILL.

## Voice Thrower 10 cts

Learn to throw your voice into a TRUNK under the bed, out in the hall or anywhere. Lots of FUN fooling the Teacher, Janitor, Policeman, Parents, Neighbors, or Friends



## The Ventrilo

is a little instrument that fits into the mouth out of sight BOYS or Girls can use it. NEVER FAILS! A 32 page book on **Ventriloquism** sent with the **VENTRILO** for **TEN Cents**.

Royal Novelty Co., Dept. 92 SO. NORWALK, CONN

## FORD JOKE BOOK

All the latest and best funny jokes and stories on the FORD automobile. Hundreds of them and all good ones. Also JITNEY jokes, Moving Picture, and Stage jokes. Laugh till you shake. A neat colored covered book by mail for only **TEN CENTS**.



## PIKE PUBLISHING COMPANY

Box 77, So. Norwalk, Conn.



## Minstrel Show Guide

350 End-men's Jokes, 26 Songs, 9 Complete Sketches, 8 Monologues, 4 Stump Speeches, besides **Complete** instructions on stage and program arrangements, rehearsals and "make-up," from beginning to end. Price **10c** postpaid.

J. C. DORN, 701 S. Dearborn Street, Dept. 120, CHICAGO, ILL.



## Taxidermy Book FREE

## Mount Birds

We teach you by mail to stuff and mount all kinds of **Birds, Animals, Game Heads**. Also to tax skins and make rugs. Be your own taxidermist. Decorate your home with your beautiful trophies or increase your income selling specimens and mounting for others. Easily, quickly learned in spare time by men and women. Highest endorsements by thousands of students. Write today for our great free book "How to Mount Birds and Animals" Free—write today.

**N. W. School of Taxidermy**, 1192 Elwood Bldg., OMAHA, NEB.



## \$100.00 EARNED BY YOUNG ARTIST IN 2 DAYS

He was trained by members of our Faculty. About his drawing he says,—“I spent a little less than two days’ time in its preparation and received \$100.00 for it.”

You too, if you like to draw, should make a success of Commercial Designing and Illustrating—with the right training.

### Opportunities Unlimited

Salaries \$25.00 to \$75.00 a week and more. Thousands of advertisers, periodicals, publishers and others use millions of dollars’ worth of designs and illustrations every year. The field is uncrowded. The prices paid for good work and ideas will surprise you. With our intensely practical and original home study course, personally conducted by well known and successful commercial artists and advertising experts, you can master this dignified, pleasant and profitable profession in your spare time. Easy to learn, easy to apply, endorsed by eminent authorities.

### Send For Free Book “Your Future”

A book every young man and woman should read before deciding on their future—a book parents should read with the future of their children in mind. Tells of wonderful opportunities open to those with training—cites instances of success won by our students in all parts of the country—describes the ease with which you can become expert through our home-study method. With the book we will send a handsome portfolio of Commercial Illustrations all without charge or obligation. Opens the way to greater success in life for you. Mail the coupon—NOW.

**FEDERAL SCHOOL OF  
COMMERCIAL DESIGNING, INC.**  
609 Warner Bldg., Minneapolis, Minn.



P.M.  
**Free  
Book  
Coupon**

Federal School of  
Commercial Designing  
609 Warner Bldg.  
Minneapolis, Minn.

Please send me your free book “Your Future,” also your portfolio of commercial illustrations.

Name.....

Address .....

# ELECTRICAL ENGINEERS

## Earn \$125 to \$250 a Month

The demand for Electrical Engineers at \$125 to \$250 a month far exceeds the supply. Engineering and power companies everywhere are searching for specially trained men. No previous experience necessary to take up this interesting work. Decide to fit yourself for one of these high-salaried positions.

The **American School** will train you to be a well-paid electrical worker in a short time at small expense. Our staff of practical engineers will give you individual instruction and advice. You can start in right now to prepare yourself for a better job and bigger pay.

**Earn While Learning** No need to give up your present occupation. We train you at home—solely by correspondence—as we have successfully trained thousands of others in the past eighteen years. Pocket-size textbooks, prepared by famous electrical experts, enable you to study anywhere—at any time. Papers examined and corrected only by experienced technical graduates.

### Free Book Coupon

American School of Correspondence, Chicago, U. S. A.

Without any obligation on my part, please send me your Free Book and complete information regarding a course in  Electrical Engineering  Telephone Engineering  Hydroelectrical Engineering  Power House Superintendence  Wireless Telegraphy. Pop. Mech. 2-16

NAME.....

ADDRESS.....

#### \$800 to \$2400 in Three Years

"The week I did with you advanced my salary from \$800 to \$2400 in three years." —RUDOLPH F. KOORS, *Graduate, Electrical Engineering.*

#### Made Chief Electrician

"About two months ago I was appointed Chief Electrician of the Scheepstady plant of the American Locomotive Co." —L. W. WARREN, JR., *Scheepstady, N. Y. Graduate, Electrical Engineering.*

### Electrical Book FREE

Send the coupon for your copy of our 56-page Free Book. Tells how easy it is to master Electricity, and gives full particulars regarding the course you are most interested in. **Don't hold back because of the money. The cost is small, and you can pay for your instruction as you progress—in small monthly installments.**

Mark and mail the coupon today. This is a wonderful opportunity to get into a profession that pays big money. No obligation in sending the coupon. **Mail it now!**

**AMERICAN SCHOOL OF CORRESPONDENCE, CHICAGO, U. S. A.**

\$800  
to  
\$1800

A Year  
for  
Life



### YOU, — GET A GOVERNMENT JOB

Candidates Coached Free

No "layoffs" without pay, because of strikes, financial panics or the whims of some petty boss. If you want immediate appointment, send **TODAY** for free list of positions now obtainable. Any delay means the loss of just so much time in preparing yourself for examination.

We Will Prepare  
25 Candidates  
Free

Send  
Coupon Below  
FRANKLIN INSTITUTE  
(The pathway to plenty)  
Dept. H106, Rochester, N. Y.

This coupon, filled out as directed, entitles the sender to free specimen questions; a free copy of our book, "Government Positions and How to Get Them," a full list of positions now obtainable and to consideration for Free Coaching for the examination here checked.

#### COUPON

— Railway Mail Clerk	(\$900 to \$1800)	— Stenographer	(\$800 to \$1500)
— Bookkeeper	(\$800 to \$1800)	— Internal Revenue	(\$700 to \$1800)
— Postoffice Clerk	(\$800 to \$1200)	— Clerk in the Departments at	Washington
— Postoffice Carrier	(\$800 to \$1200)	— Washington	(\$800 to \$1500)
— Rural Mail Carrier	(\$800 to \$1200)	— Canadian Govern-	ment Positions
— Customs Positions	(\$800 to \$1200)		

Name.....

Address..... H106

Use this before you lose it. Write plainly.

Please Mention Popular Mechanics

### Practical Electrical Education

Our practical course in Electrical Science and Engineering trains you to get and keep the big-pay jobs. Enter at any time, no matter what your education. Advance as fast as you can master what we teach. Course combines theory with actual practice in all branches of electrical work. Individual instruction. Positions paying \$1,500 a year up, waiting for graduates. Write for Disk Illustrations CATALOG. Eleventh year. Spring term opens Jan. 31st, 1916.

School of Engineering of Milwaukee, 236 Stroß Bldg., Milwaukee, Wis.



### LANGUAGES

Quickly Learned AT HOME by the Original Photographic Method

German—French—English—Italian—Spanish or any other language learned quickly and easily by the Cortina Method at home with Disk Cortina-Records. Write for free booklet today; easy payment plan.

CORTINA ACADEMY OF LANGUAGES  
1612 Necca Bldg., 1000 Broadway,  
Corner 48th Street, New York

CORTINA-PHONE



### TRAVELING MEN

EARN \$2,000 TO \$10,000 A YEAR

We will teach you to be a high grade salesman, in eight weeks at home and assure you definite proposition from a large number of reliable firms who offer our students opportunity to earn Big Pay while they are learning. No former experience required. Write today for particulars, list of hundreds of good openings and testimonials from hundreds of our students now earning \$100 to \$500 a month. Address nearest Office, Dept. 507, NATIONAL SALESMEN'S TRAINING ASSN., Chicago New York San Francisco



The FARMER'S CYCLOPEDIA Vol. I The FARMER'S CYCLOPEDIA Vol. II The FARMER'S CYCLOPEDIA Vol. III The FARMER'S CYCLOPEDIA Vol. IV The FARMER'S CYCLOPEDIA Vol. V The FARMER'S CYCLOPEDIA Vol. VI The FARMER'S CYCLOPEDIA Vol. VII

Hon. F. D. Coburn

**\$4,000,000<sup>00</sup>**  
**Farming Facts Yours**

**INFORMATION** about practical farming that cost the U. S. Government \$4,000,000 and more than ten years to collect—every fact worth knowing about agriculture—positive U. S. Dept. of Agriculture facts—yours on a wonderful offer.

Read our free shipment offer. Learn how we put these facts right into your hands. Yes, and more besides. A book written by America's greatest agriculturist, Hon. F. D. Coburn. This mailed to you, also, to help you study the Cyclopedic to the best advantage. Just send the coupon today.

FARM ANIMALS BREEDING FEEDING CARE DAIRY FARMING

DOUBLEDAY PAGE & CO.

FARMING METHODS SOILS FERTILIZERS IRRIGATION ROTATION BUILDINGS FARMER'S HOME AND EDUCATION INDEX

DOUBLEDAY PAGE & CO.

# The Farmer's Cyclopedic

(Authentic Records, U. S. Dept. of Agriculture)

These 7 big volumes, containing over 5000 pages, 3,000,000 words and hundreds of pictures, give you in condensed but complete form the most valuable data which the government has gathered at an enormous expense.

Verified facts about every branch of farming are given with all theories cut out. Just the methods which have proved best in actual practice are explained. Minutely indexed so that every fact is accessible in an instant.

## Free Shipment Offer NOW

Sign and mail the coupon below. It will bring you this great library of farming facts absolutely free for 10 days. Not a penny to send. No express charges to pay. The whole 7 big volumes delivered prepaid. Read them at your leisure. Then, if you decide to keep them, send only 50 cents. The balance in \$2 monthly payments for twelve months, \$24.50 in all. Otherwise return the books at our expense. Send for the Farmer's Cyclopedic on our free shipment offer and see how this great library answers practically every farming question you may ask. If you have had puzzling failures it will show you how to trace the causes. If you are dissatisfied with your yield of crops, or the results from your dairy, your hogs, your sheep, your poultry or your orchard, it will explain the scientific methods for securing a larger production. One fact may save you from a mistake which might cost 10 times the price of the book. Another may show you how to cut out waste. Still another may tell how to add 25 per cent or more to your profits in some direction you have not thought of. The experience of thousands of successful farmers—gathered and tested by the government—is now yours at a trifling cost. And free examination first.

### Partial List of Contents:

**Feed and Care of Dairy Cows** — This alone worth the price.  
**Feed and Feeding for Beef** — A wonderful work.  
**Diseases and Insect Pests** — How to protect cattle and crops against them.  
**Profitable Hog Raising** — A complete library on the hog.  
**Success with Sheep** — Every question answered.  
**Poultry Problems Solved** — No other books on poultry ever need be read.  
**Fruit** — How to get a larger yield. How to avoid insect pests.  
**Latest Facts and Investigation on every Farm**

**Protect** — Insures bigger, better crops with less labor.  
**Every Phase on Farm Management** — From government experiments and researches.  
**Soils and Fertilization** — Make your land yield more.  
**Farm Buildings** — How to plan and build on the farm.  
**Domestic Science** — Comfortable, economical farm housekeeping. Lightens the work of the housekeeper.  
 And thousands of other subjects of vital interest and value.

## Save \$10.50

You save \$10.50 on our former price, \$35.00, because the sales of the first edition have absorbed the cost of type-setting and plates.

## Send Coupon Without Money

Clip the coupon and mail it now. Keep the books for 10 days—then decide. No obligation to buy. Only 50c down, \$2 monthly until \$24.50 is paid. Otherwise return books at our expense. Send the coupon today.

Doubleday, Page & Co., Dept. 1192, Garden City, N. Y.

## Valuable Book Free

With the Cyclopedic you get absolutely free this important Manual written especially as an aid to systematic study by America's famous authority on tanning, Hon. F. W. Coburn, who says of the Cyclopedic: "It contains the most valuable agricultural information ever gathered together. With this Manual at hand you practically have Mr. Coburn's direction in your reading. He points out important facts and suggests how to get the most out of your reading. This help costs you nothing."



### Pres. Wilson says:

"The methods of our farmers must feed upon the scientific information in the State Departments of Agriculture and in the U. S. Dept. of Agriculture." This is the information you get from the Cyclopedic.

Doubleday, Page & Co.  
 Dept. 1192 Garden City, N. Y.

Send me, all charges prepaid, the complete set of Farmer's Cyclopedic (Authentic Records of U. S. Dept. of Agriculture) in 7 big, thick volumes. If not satisfactory I will tell you so in 10 days and you will tell me where to return the books at your expense; otherwise I will send you 50c down and \$2.00 monthly for 12 months for the Cyclopedic. I am to have the Coburn Manual free if I keep the books.

Name.....

Address.....

# This Machine Helps Sick People

It gives new vitality to tired nerves, it makes the blood circulate more freely, it tones up flabby muscles, it brings refreshing sleep, it gives the whole body strength, through vibration. It helps to make weak people strong—it helps well people to stay well. This interesting machine is the

## White Cross Electric Vibrator

a very ingenious device, invented by a wizard of mechanics—the result of years of patient work. If you are interested in mechanics you ought to know about it. You ought to send today for our free book and free explanatory chart of this vibrator. Everything described—how it is made—how it works—how it relieves. Send the coupon and get all this information.

Lindstrom-Smith Co.  
Dept. 1192  
1100-10 S. Wabash Ave.  
Chicago, Ill.

Please send without obligation on my part your free book and chart explaining the mechanism of the White Cross Electric Vibrator.

**FREE GREAT BOOK** Our book "Health and Beauty" should be in every family. It shows

the way to manly strength and womanly beauty. It gives the secret of keeping young. It tells how you can have any kind of vibratory electric treatments without cost in your own home. It is free. Send the coupon for it today. Your request implies no obligation.

### Get Our Special Offer

Learn also about our very special offer by which you can get this ingenious machine at an amazingly low price. You do not need electricity in your home to use the White Cross Electric Vibrator. No matter where you are, you can use this health and strength giving device. Send for the free book now. The coupon or a postal will bring it. But act quickly to get this special offer.

**LINDSTROM-SMITH CO.** Dept. 1192  
1100-10 S. Wabash Ave., Chicago, Ill.

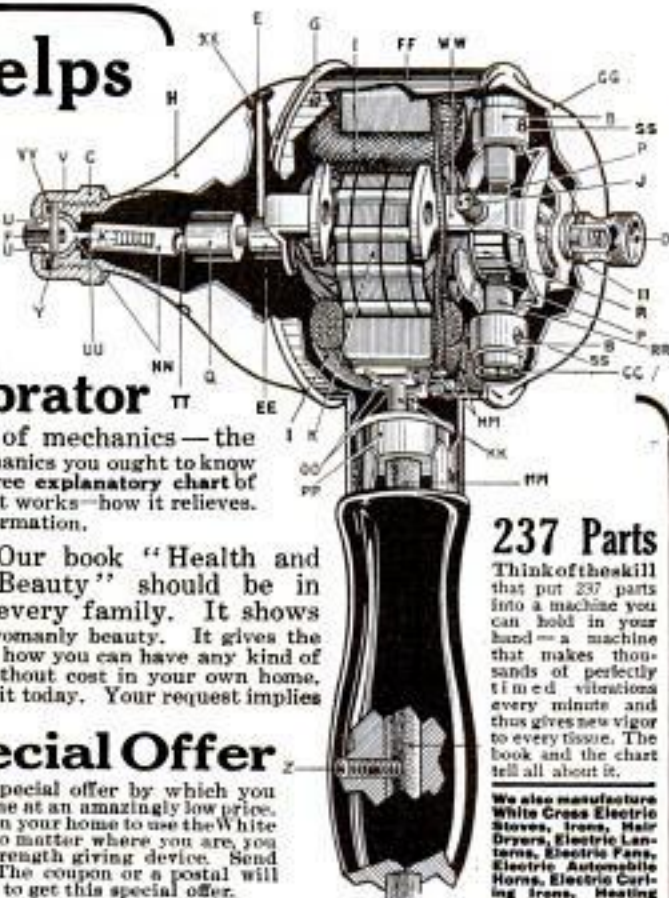

### 237 Parts

Think of the skill that put 237 parts into a machine you can hold in your hand—a machine that makes thousands of perfectly timed vibrations every minute and thus gives new vigor to every tissue. The book and the chart tell all about it.

We also manufacture White Cross Electric Stoves, Irons, Hair Dryers, Electric Lamps, Electric Fans, Electric Automobile Horns, Electric Curling Irons, Heating Pads, Small Motors, etc., etc.

Dealers Write

Name.....

Address.....



## You Be The Boss!

Earn \$1200 To \$3000 a Year  
As Electrical Meter Engineer

Become a master of men in this wonderful new profession. Get the big job—climb to the top in the great electrical industry. Electric Lighting Plants must have Meter Engineers. Nearly eight million electric meters now in use need constant attention. Half million more being installed yearly.

### Big Demand For Trained Men

The supply of trained men does not begin to meet the demand. The field is tremendous—growing greater and greater. Work is interesting, fascinating, profitable. The marvels of electricity interest and hold you captivated, as you study our simple, concise and complete course. Experience unnecessary. Just common school education. Earn while you learn. We help you to a position when ready. Our graduates command respect everywhere. Only school teaching Meter Engineering. Get into this new profession—get the high-salaried job. YOU be the boss.

#### FREE—New Literature

Tells all—explains all—proves all; terms, outline of course, faculty, money-back guarantee and the story of King's rise from Newsboy to Meter Engineer. Mail the coupon today.

**FORT WAYNE  
CORRESPONDENCE SCHOOL**  
Dept. 442 Ft. Wayne, Ind.

Fort Wayne Correspondence  
School

Ft. Wayne, Ind. Dept. 442

Gentlemen:—Send me absolutely free and prepaid your new literature on Meter Engineering.

Name.....  
Address.....



## Learn How to Talk

New idea. Easy method. Send for our special opportunity. Scientific, simple, easy Calhoun course in speaking. Teaches you how to convince people. Makes you earn more. Send for particulars.

### At Home

Learn at home in your idle moments. Become a public speaker. Learn how to talk in business. For salesmen, lawyers, merchants, mechanics, farmers and all business men, young men and women. The good talker succeeds in all walks of life. Post yourself. Send for all particulars of special opportunity. Write today.

CALHOUN CORPORATION, Dept. 5246 Old Colony Bldg., Chicago

## Get This Car!



And the Agency  
FOR  
Your Territory

You can do it. I will show you how. Write at once for full details of my amazing offer. Biggest and best opportunity to enter the most fascinating and profitable business in the world today—the automobile business. I train you for success and give you the agency for the wonderful BIRCH MOTOR CAR—"The Car That Everybody Wants." You can get it—if your name reaches me soon enough.

**\$3,000 to \$10,000 A Year** Earned by men trained to succeed in this great new industry. Let me show you how to make big money. You can learn quickly—in spare time—right at home—without giving up your present work.

**Write Quick!** The offer is strictly limited—may be withdrawn at any time. I want an agent in every county. Hurry—or you may be too late. Write now. A postal will do. Address the personally. Ralph Birchard, President.

**Birch Motor College, Inc., 219 Tower Bldg., Chicago, Ill.**

Please Mention Popular Mechanics



## "Your Report has saved the Company \$37,000 a year—from now on you are to be my assistant"

"Your plan has enabled us to eliminate certain costly parts of the business which we did not know were unprofitable—I wish the other young men in the company would get down to the *fundamentals* of this business."

This young man tells us that it was by applying to his own business the suggestions given in the Modern Business Course and Service, that he was able to work out one plan that saved his company \$37,000.

### Helps Men Succeed in a Big Way

This case is typical of thousands. Every day men are doubling their earnings by having looked ahead and fitted themselves for the opportunities that come to the men who are *equipped*. These men are preparing themselves with all the business knowledge available through our Modern Business Course and Service. A billing clerk wins a position as head accountant in his concern. A general manager saves his firm from impending bankruptcy. A young bank clerk gains a position paying \$9,500 a year.

Such remarkable cases are cited by the score in "Forging Ahead in Business"—a 128-page book which will be sent free to you.

### This Course and Service is Based Upon the Actual Experience of Thousands of Successful Business Men

The Institute collects, classifies and transmits to you through the Modern Business Course and Service the best thought and practice in modern business. It will give you a

thorough and sound training in the fundamental principles underlying all departments of business—it will give you a knowledge that could be otherwise obtained *only* by years of bitter experience—if at all.

### Advisory Council

The Advisory Council are Judge E. H. Gary, Chairman of the U. S. Steel Corporation; Frank A. Vanderlip, President of the National City Bank; John Hays Hammond, the great engineer; Joseph French Johnson, Dean of New York University School of Commerce; and Jeremiah W. Jenks, the statistician and economist.

### "Forging Ahead in Business"

A careful reading of this 128-page book, "Forging Ahead in Business," which we will send you free, will repay you many times over. It will help measure what you know—what you don't know, and what you should know—to make success *sure*. Every business man with either a business or a career to guide to bigger, surer success, should read this book. You need send no money for it—simply send the coupon below.

ALEXANDER HAMILTON INSTITUTE  
188 Astor Place New York, N. Y.

Send me "Forging Ahead in Business" FREE

Name.....

Business Address.....

Business Position.....



## Power Plant Engineering



**\$1**  
Per  
Month  
No  
Money  
Down

**The Most Used** Among engineers, and those who are studying steam and electrical engineering, the Power Plant Library is now the most used library in existence. Why? Because it was written by practical men who are recognized authorities. Because it is free from higher mathematics and technical descriptions, and covers the whole field, including steam, electricity, turbines, refrigeration and mathematics.

### Practical Men Wrote These Books

Its present rate of sale, about 800 sets per month, is convincing evidence that the practical man requires and demands records of actual performances in the engine room, facts without theory, as contained in the Power Plant Library. The fact that this Library is known and used in nearly every power plant in the United States proves conclusively that the so-called technical writer lacking in actual experience cannot possibly supply the thousands of details of operation necessary to be known by the engineer.

**Systematic Instruction** The learner of steam and electrical engineering, in order to advance rapidly towards the higher positions, must have his instruction course arranged systematically and in order. The text arrangement of the Power Plant Library enables him to commence with the simplest principles of operation, say proper firing or oiling, and then to proceed without interruption through every branch of power plant work, until he is able to take charge of the largest plant.

**Nothing Omitted** To the chief engineer or superintendent earning \$150 to \$400 per month these books are just as valuable as to the learner, because they contain nothing but practice and there is no detail omitted.

### Pay Nothing Until You See the Books

The eight volumes contain nearly 3,000 pages, 1,500 illustrations and weigh 14 pounds. They are beautifully and durably bound, and with reasonable care will last a lifetime. They will be sent to you by parcel post prepaid upon receipt of the coupon below. No money in advance is required. If for any reason whatever you do not wish to keep them we will send you return charges. If you are satisfied send us \$1 per month for twelve months.

**Contents** Mathematics—Engine Running—Valve Setting—Boilers—Electricity—Piping—Pumps—Shutting—Belting—Governors—Steam Turbines—Refrigeration—Ice Making.

### FREE EXAMINATION COUPON

McGraw-Hill Book Co., Inc., 239 W. 39th St., New York  
Gentlemen:—Ship the Power Plant Library, eight volumes, for my inspection. If satisfactory after examination, I will send you \$1 in ten days and the balance at the rate of \$1 per month until I have paid the price of the books, \$12. If not satisfactory I will write for shipping instructions.

SIGNATURE.....

RESIDENCE ADDRESS.....

CITY AND STATE.....

NAME OF EMPLOYER.....

REFERENCE.....

ADDRESS..... P.M. Feb.

## Popular Mechanics Magazine

desires the services of a capable and experienced man as editor of its Shop Notes Department. The position requires not only a general mechanical education but initiative and ability to write.

### ADDRESS

H. H. WINDSOR, Editor,  
Popular Mechanics Magazine,  
CHICAGO

## NOW YOU NEED A GOOD ATLAS

Never before in the World's History has an atlas been so constantly necessary to an intelligent understanding of the World's News.

### HERE IS THE IDEAL ATLAS

Hammond's Comprehensive Atlas is a compact octavo volume, 9½ x 6¼ x 1¼ in. in size, bound in flexible leather. Solves the problem of

### Large Scale Maps in a Book of Handy Size

Contains 512 pages, 256 pages of large scale maps of all States, Canadian Provinces, Countries of the World, etc., also 256 pages of text, index; compilations, gazetteer, statistics as to population, etc.

### Self-Revising After the War

Each copy contains a certificate entitling the purchaser to a supplement of maps showing the new boundaries after the war is over, making this atlas self-revising.

### Special New Maps Show the Several War Zones

Get your atlas now. Use it during the great war when you need it most and rest assured it will be up-to-date after the war is over.

Price \$1.50. Postage 15c Extra

**Return Privilege** Any purchaser who is not more than satisfied with this atlas may return same and have his money promptly refunded.

**POPULAR MECHANICS BOOK DEPT.**  
6 N. Michigan Ave., Chicago

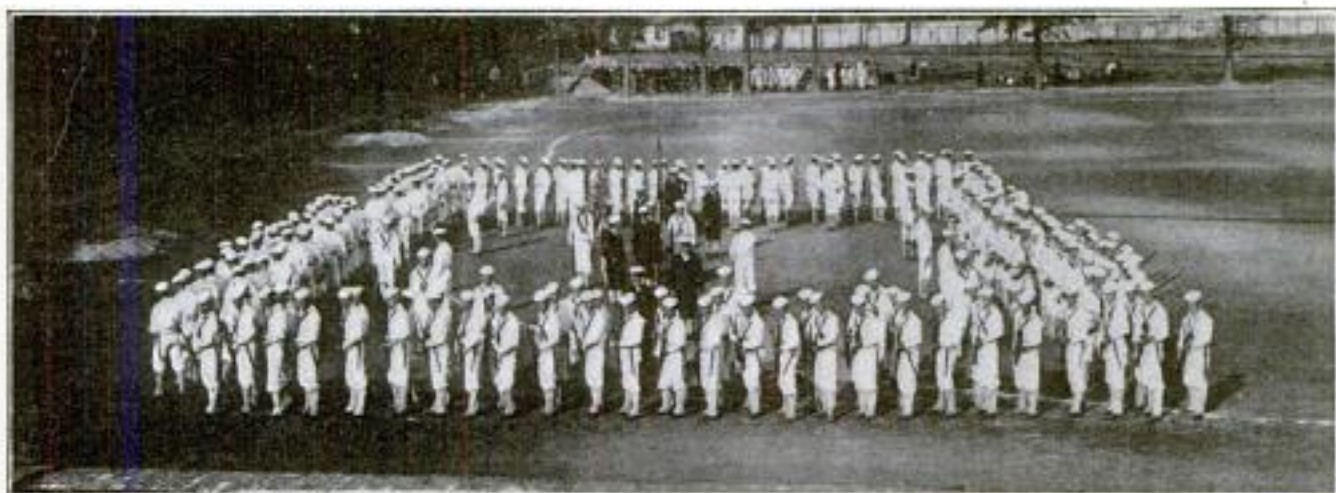

Recruits at Naval Training Station, Company Square

# An Attractive Career

**T**HE U. S. NAVY offers many attractions as a career for young men. The instruction which apprentice seamen receive at the Training Stations is full of interest, consisting as it does of boat drill, infantry and artillery practice, sham battles, signalling, swimming and the like.

☐ Plenty of time is allowed for sports, baseball, football, gymnasium exercises, "movies," etc.; and the recruits usually find their time too much taken up to get into mischief. They associate with healthy, clean-minded young men, and every incentive is offered them to strive for advancement.

☐ After six months at the Training Station, the apprentice seamen are promoted to a sea-going rating, and they are assigned to a ship, where they put into practice the instruction they have gained ashore. They find their superiors willing to aid them in mastering their profession, and if they apply themselves to their duties they are certain to win promotion.

☐ The Navy has many opportunities for bright young men, and these opportunities are increasing year by year. Promotion is open through the various petty officer ratings to warrant officer and eventually *for the exceptional men*, to Commission.

Write for full particulars and for address of Navy recruiting station nearest you. You'll be interested in the Navy's offer. Address Box 67.

## BUREAU OF NAVIGATION

NAVY DEPARTMENT

WASHINGTON, D. C.

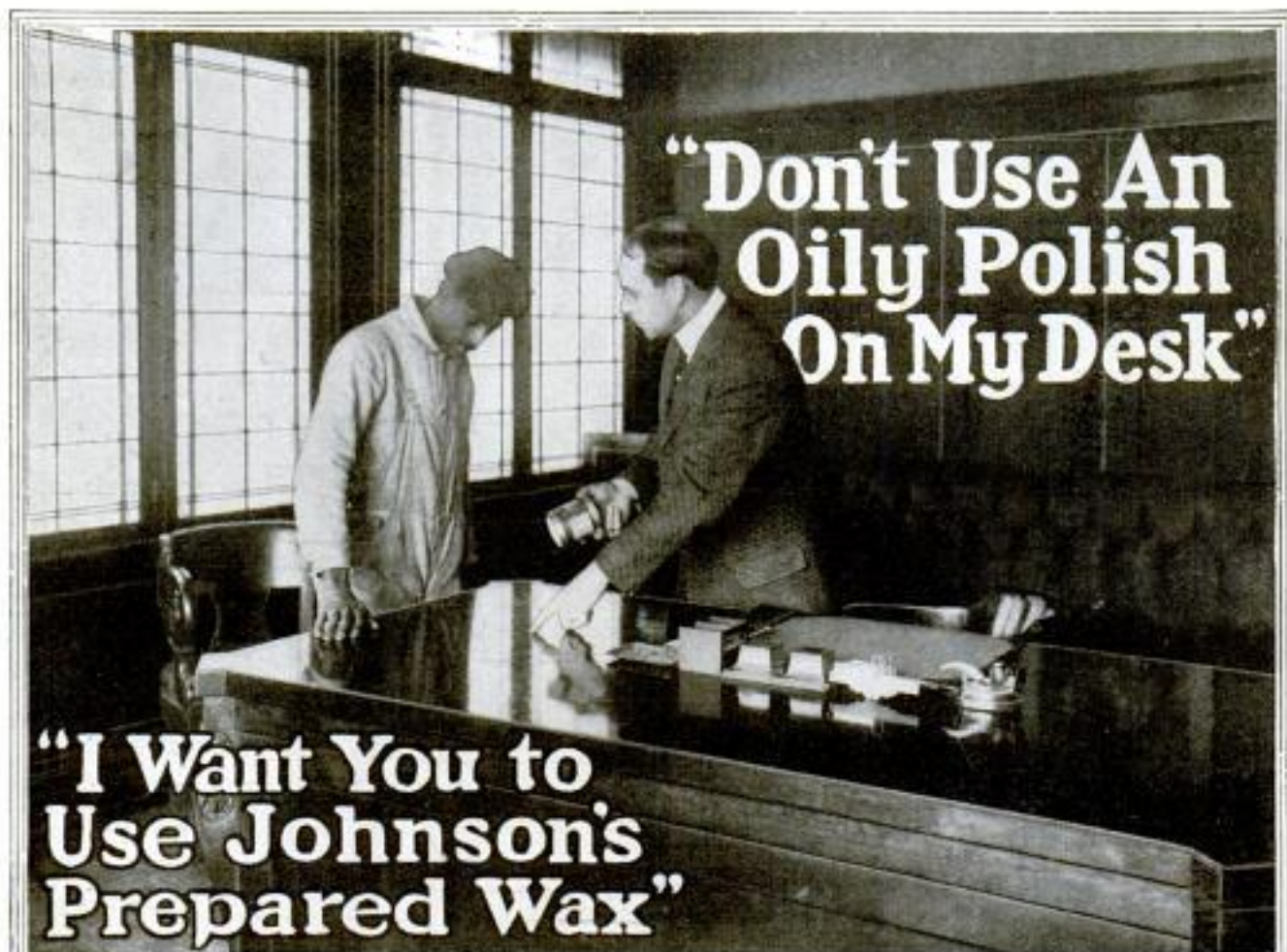

**O**ILY polishes gather and hold dust, soiling the clothes and papers. Johnson's Prepared Wax makes a glossy, glasslike surface—smooth, hard and dry. The dust does not stick to it, for it is not oily.

It imparts a beautiful finish to the desk, covering marks and scratches, and does not show finger prints.

A single coat of Johnson's Wax rubbed to a polish will last a long time, and preserves the varnish from wear and the drying effects

of steam heat and sunlight.

It cleans, finishes and polishes in one operation.

One application on your desk or any furniture will convince you that it is the only polish that

## Will Not Collect Dust

For floors Johnson's Prepared Wax is the only proper finish. It saves wear, adding to the life of the finish. It is easily kept clean, and does not show heel marks.

As an automobile polish it is wonderful. Easily applied and long lasting. The dust does not stick and mud leaves no stains.

Send 10c and the coupon for a small tin.

**S. C. Johnson & Son**

*"The Wood Finishing Authorities"*

**Racine, Wis.**

S. C. Johnson & Son, Racine, Wis.

I enclose 10c for a can of Johnson's Prepared Wax—enough for polishing a small floor, an automobile, a piano or several pieces of furniture, also Instruction Book on Home Beautifying. P.A-2

Name .....

Address .....

City and State .....



*...y, 246 West 25th St., N.Y. City*  
*S. Parker, Equitable Bldg. 120 Broadway - N.Y. City*

# Popular Mechanics Magazine

REGISTERED IN U. S. PATENT OFFICE

WRITTEN SO YOU CAN UNDERSTAND IT

Vol. 25

FEBRUARY, 1916

No. 2

## 1014 Ship's Under-Water Eye Sights Hidden Mines

**T**O assist battleships and destroyers in locating submerged mines, an American has developed an under-sea searchlight equipment which, when used in conjunction with a special water glass, makes it possible to distinguish objects at a distance of 2,000 ft. A powerful electric lamp is mounted on one side of a vessel below the water line, at its bow. This may be turned to different angles by an operator on deck. Immediately forward of this is the glass, similar to a modified periscope, forming the ship's under-sea eye and used to follow the illuminated path. When a mine is located in a vessel's course a torpedo is launched which may be discharged electrically. This is watched and at the proper instant detonated, thus exploding the mine.

It is believed that the device could also be used on mine sweepers to advantage.

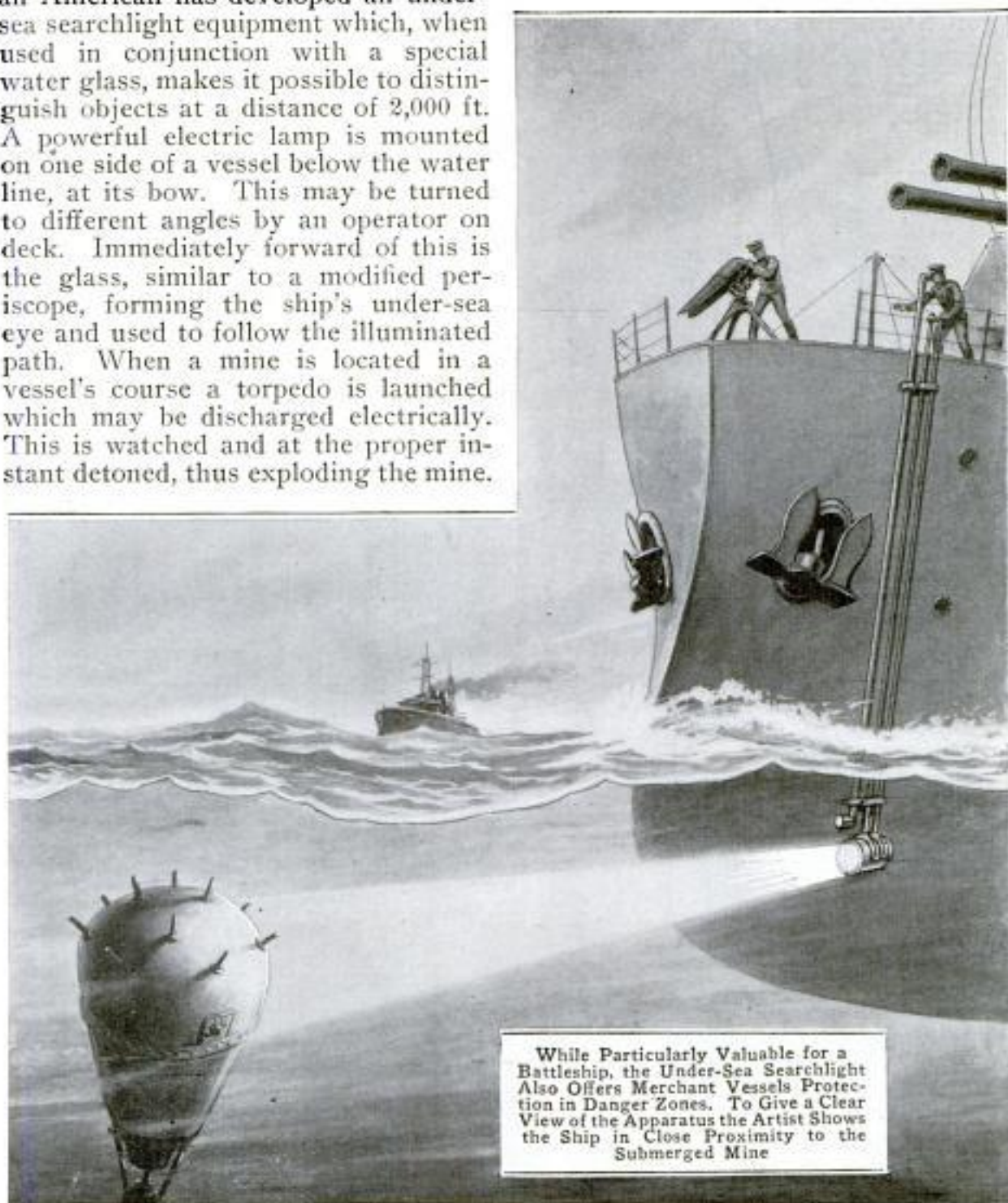

While Particularly Valuable for a Battleship, the Under-Sea Searchlight Also Offers Merchant Vessels Protection in Danger Zones. To Give a Clear View of the Apparatus the Artist Shows the Ship in Close Proximity to the Submerged Mine

### BLIND BOYS ARE TRAINED 813 TO SHINE SHOES

In an attempt to assist blind persons to make themselves self-supporting, a westerner has designed a bootblack stand and made working paraphernalia

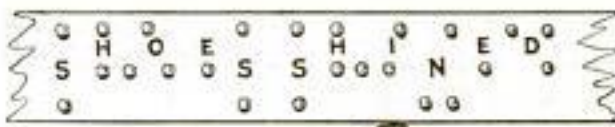

SHINE 5¢

TELL  
OPERATOR  
WHETHER  
BLACK OR  
TAN



Bootblack Stand Arranged to Enable Blind Boys to Shine Shoes and Make Themselves Self-Supporting

which enable a boy, or man, deprived of sight to polish shoes after a short apprenticeship. The chief difference between this stand and others is that separate compartments are provided between the chairs for the polish, brushes, and cloths used on shoes of different colors. Ankle shields made of waterproof material fixed to trouser guards are used to protect a patron's hose from being soiled when work is done on low shoes. In order that the blind operators may be able to handle the liquid with which boots are first treated, soap dispensers have been modified and are used in place of the usual type of dauber. For advertising purposes an illuminated sign in Braille characters as well as English is employed. The man has trained a few

blind boys to do this kind of work, for these he has prepared badges which indicate whether a worker is totally, or merely partially, blind. It is only necessary for a patron to take a seat and inform an operator whether his shoes are tan or black.

### BEAVER DAMS WORK TROUBLE 1083 ALONG RAILWAY LINE

In certain parts of Wisconsin beavers have increased rapidly during the last few years, owing to the enforcement of rigid laws for their protection. As a result a serious as well as an amusing situation has arisen in Oneida County, along Bear Skin and Rucky Run creeks, where great numbers of the industrious little animals have built a series of large dams that have backed up the stream and caused the tracks of the Chicago, Milwaukee and St. Paul Railway to be flooded and damaged.

Following heavy rains some time ago Bear Skin Creek rose at several points west of Goodnow, covering the railroad's right of way. When the water failed to recede, an investigation showed that a beaver dam, and not the rain, was responsible for the trouble. Since it is contrary to the statutes to destroy these works, the assistance of the conservation commission had to be enlisted before the condition could be rectified. The state game warden subsequently superintended the destruction of the dam, which had backed up a 6-ft. head of water. Owing to the substantial construction of this blockade, ten separate blasts of dynamite were required to clear it away.

Two or three weeks after this was accomplished it again became necessary to destroy a dam at the same place, for during the interim the beavers had reconstructed it. The same condition prevails at the present writing, and it is a matter of but a very short time until this obstruction will need to be eliminated. Since the animals apparently refuse to be discouraged in building at this particular point it is considered possible that



Chi. Daily News Sept 29, 1915  
Geo. E. Waugh, Asst. Ed. Employee Mag. 1242 Ry. Exchange Bldg.

POPULAR MECHANICS

163

Geo. B. Haynes, V.P.A. E.M. & St. P.R.R. Chicago Ill.



Above is Shown One of the Beavers' Chopping Grounds, While at the Right is a Typical House Constructed by These Industrious Little Animals



A Sluiceway through Which Beavers Floated Logs to One of the Dams. Above, in the Middle, a Beaver is to be Seen in One of the Chopping Grounds



An Impression of How the Water was Backed over the Tracks is Given Above, and Below is Shown a Section of the Longest Dam on Rucky Run Creek



steps will have to be taken to trap them and remove them to another place so that their work will not menace the railroad. The population of this specific colony is not accurately known, but the extent of the work suggests that there may be 500 or more of the animals in that immediate locality.

The largest dam on the Bear Skin is 75 ft. in length and is now built to a height of about two feet above the

water. On Rucky Run there are several dams, the largest of which is 310 ft. long. This is of water-tight construction and is provided at either end with small sluiceways. Between this structure and the railway company's right of way, a distance of a mile and a half, are eight other dams which will eventually have to be removed to protect the trackage from being inundated at different points.

## MOVIE AND STORY PLOTS

### 986 BUILT BY MACHINE

By the invention of an "idea box," a Cambridge, Mass., writer has developed a mechanical device which creates

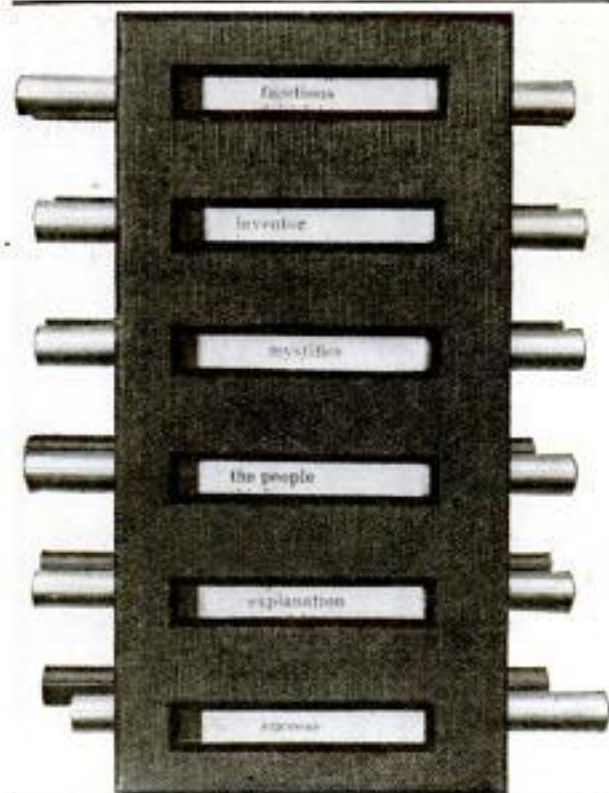

The "Idea Box" Which Turns Out an Endless Number of Situations and Plots for Movie and Story Purposes

plots for movie scenarios, plays, and short stories; originates comic, melodramatic, and tragedy situations, and serves as an efficient substitute for an overworked or underdeveloped imagination. Although few things would seem more ludicrous than the thought of building the skeleton of a literary production by turning a crank, this is

the very function performed, and surprisingly well, by this latest brain-replacing machine. It permits a staid clerk or an inspirationless schoolgirl to turn out fiction or moving-picture plots galore.

It is not a toy. Apparently it is meritorious. It consists of a paste-board box, 3 in. wide, 6 in. long, and 2 in. thick, fitted with a half-dozen pairs of spindles on each of which a roll of paper carrying a long, printed list of words is wound. In the cover of the box are six slots through which one word on each roll may be read. Altogether about 1,200 different words are listed. These are classified into six separate groups, such as nouns, verbs, adjectives, and so on. The ends of the spindles extend through the sides of the box, and by turning any one of them different words appear one after another in one of the cover openings.

The machine is operated by turning the spindles in the order they come until words which make sense when read from top to bottom are grouped. By a few turns of each roll combinations such as these are given: Beautiful-Widow-Marries-President-Inspiration-Election; Brilliant-Atheist-Corrupts - Clergyman - Change - Outcast; Eccentric - Spinster - Adopts - Burglar-Excitement-Marriage. Each of these furnishes a central idea, or skeleton, for a scenario or story. The basic theory of the device is thus shown to be that actions and thoughts can be dissolved into a word formula, and the words rearranged mechanically to the formation of other, and original, thoughts and actions.

*Inventor: Arthur Blanchard  
Cambridge, Mass.*

*Hydro-motor Car Mfg. Co.  
235 Montgomery St*

*Letter rec'd  
11/30/22*

*San Francisco*



The Amphibious Car Under Way Making a Speed of About 10 Miles an Hour.



Stern View of the Hydro-Motor Showing Rudder and Propeller

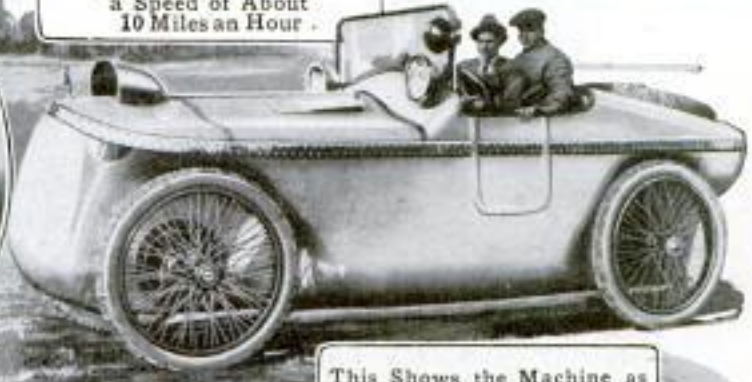

This Shows the Machine as It Appears When Spinning along a City Street

*Auto Amphibious*

**HYDRO-MOTOR CAR DESIGNED FOR LAND AND WATER**

994

Tests which resulted very satisfactorily were recently conducted at San Francisco with an amphibious motor car constructed by a local concern. At its debut it was driven off the beach into the bay, where it navigated nicely at a speed of about 10 miles an hour for a time and then climbed ashore without hesitation. The machine is a high-power roadster fitted with a boat-shaped aluminum body and provided at the stern with a screw propeller and rudder. The gears are shifted to drive the marine propulsion shaft and the rudder controlled by the steering wheel when the car slips into the water and its driving wheels lose their purchase on the earth. The car sits well in the water and looks much like a blunt-nosed motorboat. This appearance is only somewhat modified when it is propelled over land. The machine travels easily along average roads.

# *San Francisco Chronicle 11/30/22*  
*International Film Ser. Inc.*  
*278 William N.Y. City*

**TEETH ON END OF SAW**

970 HOLD IT UPRIGHT

Handsaws have a way of slipping and falling to the floor when temporarily leaned against the wall or saw horse, making it necessary for the carpenter to stoop and pick them up many times a day. To prevent this inconvenience a saw with two small teeth on the end of the blade has been invented. The latter catch in the floor when the saw is standing upright, and prevent the tool from slipping. Even a very small support is sufficient to keep the saw erect, if the points on the end of the blade are pushed into the wood. Except for the extra teeth, the saw is like any other.

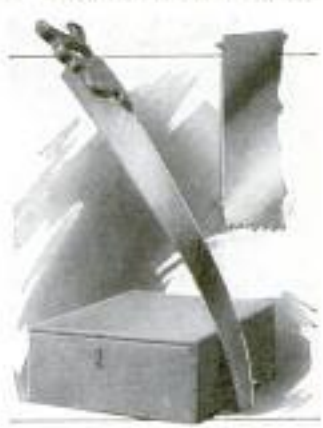

*Inventor: Howard N. Weddle  
Dinuba, Cal.*

## STRIKING DESIGNS IN BRIGHTLY HUED CAGES,

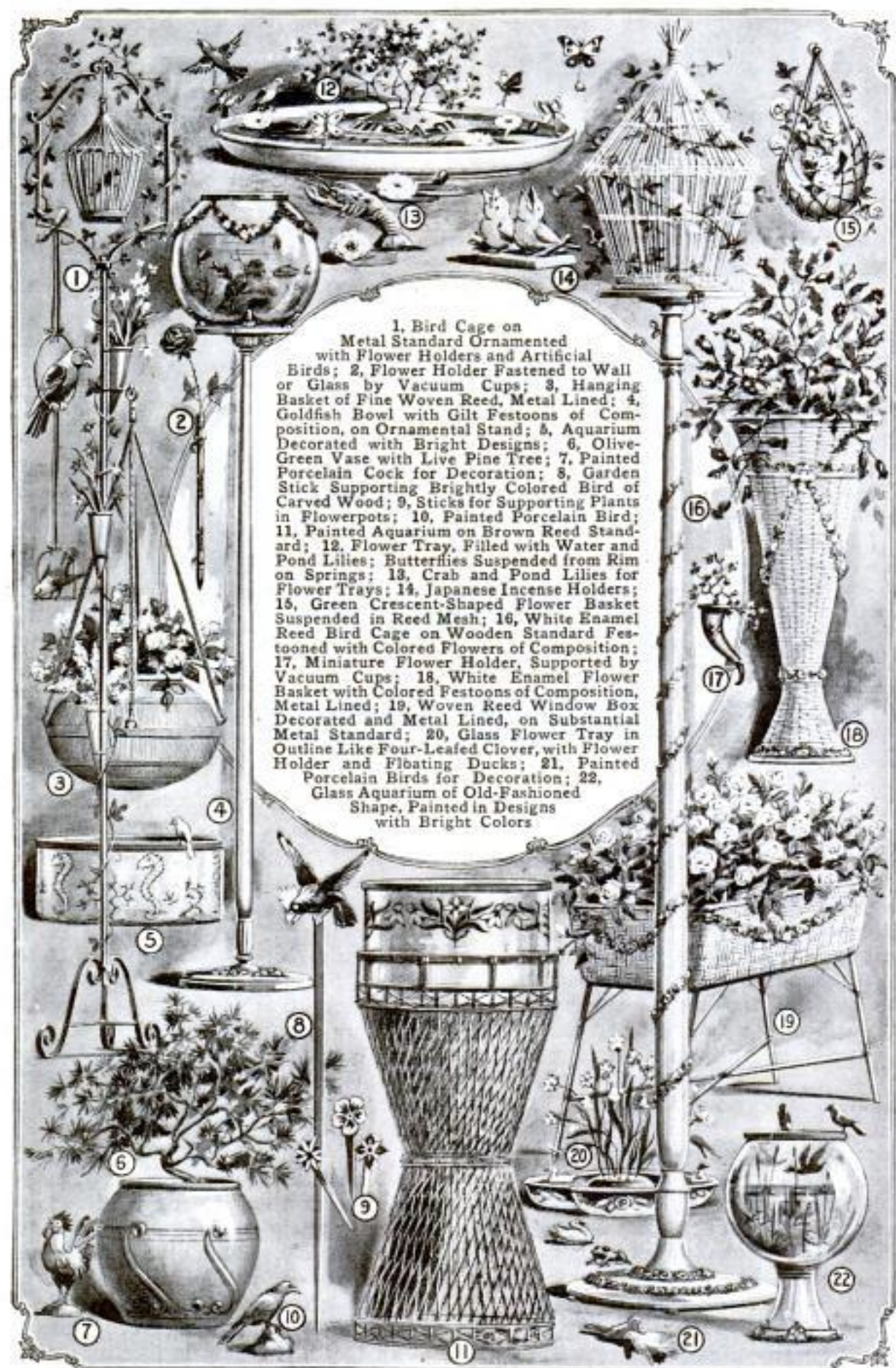

# PAINTED AQUARIUMS AND USEFUL BRIC-A-BRAC



23. Flower Vase in Cubist Design; 24. Bird Cage on Bamboo Standard Decorated in Gilt; 25. Aquarium with Metal Support, Festooned with Artificial Flowers; 26. White Enameled Wicker Basket, Metal Lined, with Decorations of Colored Flowers of Composition; 27. Colored Wooden Parrot to Balance on Edge of Vase or Shelf; 28. Metal Doorstop Painted in Bright Colors; 29. Japanese Flower Basket; 30. White Enameled Wicker Serving Tray Ornamented with Colored Flowers of Composition; 31. Bird Sticks with Carved Wooden Birds, for Flowerpots; 32. Porcelain Flower Holder for Small Bouquets; 33. Curtain Holders, Rosettes of Artificial Flowers; 34. Tin Tub and Lattice Painted in Bright Hues, to Hold Potted Vine; 35. Hanging Flower Box, Metal Lined, Painted in Contrasting Bright Colors; 36. Enameled Wicker Fern Holder Festooned with Garlands of Composition, Supported by Tall Enameled Standard; 37. Large, Brightly Hued Porcelain Beetle to be Hung on Wall as Flower Holder; 38. Miniature Flowerpot; 39. Garlanded Parrot Cage, Containing Porcelain Parrot, Supported by Metal Standard Decorated to Match Cage; 40. Small Porcelain Vase with Wax Flowers; 41. Highly Decorated Japanese Vase with Artificial Cherries; 42. Painted Flowerpot, Decorated with Old-Fashioned Designs; 43. Plain Painted Flowerpot; 44. Fan with Border of Painted Flowers

OUTDOOR SLEEPING CHAMBER  
ELEVATED ABOVE GROUND

990

At first sight the appearance of an elevated sleeping porch constructed by the city engineer of a small California municipality might reasonably be mistaken for a private water-supply reservoir. The chamber is supported about 40 feet above the ground on an iron framework and is reached by means of a box-like elevator that resembles a large dumb-waiter. This is operated by a small electric motor and enters the room through an opening in the floor. The compartment is sufficiently high to avoid being cut off from the breeze by the surrounding houses, and cool, fresh air is almost always assured. Screens inclose two sides of it, while a substantial roof and canvas curtains provide protection against rains. The supporting structure is made of piping and is braced to withstand severe windstorms. It is erected at the rear of the owner's residence.

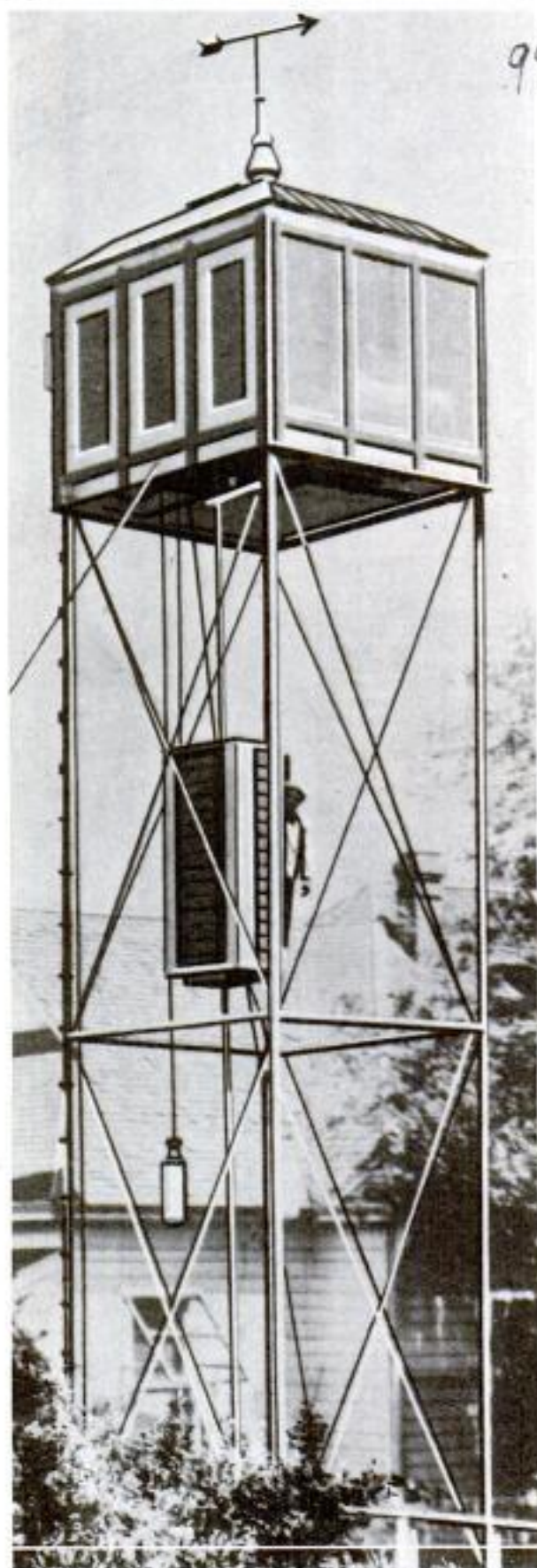

The Apartment is Reached by Means of an Odd Electric Elevator Which Resembles a Dumb-Waiter

FIRST STEP IS UNDERTAKEN  
FOR AIR COAST PATROL

1099

By employing a comparatively small number of flying boats and creating a series of zones from Maine to Puget Sound, our entire coast could be adequately patrolled and surprise attacks by a hostile fleet thwarted, according to exponents of an aerial-defense plan which is being promoted. The initial move in carrying out this proposed undertaking is now being made on Casco Bay, near Portland, Me., by the establishment of an aerial-patrol base. This station has been promoted by Rear Admiral Robert E. Peary, who urges the coöperation of the various seaboard states of the country in building the complete system of bases advocated.

The financing of the plan would devolve upon the several communities affected. Following its establishment, each unit would be turned over to the naval militia of its state, the officers of which would direct the activities of the airmen. The zones, which would rep-

Rear Admiral Robert E. Peary  
Army + Navy Club,  
Wash. D.C. Copyrighted material

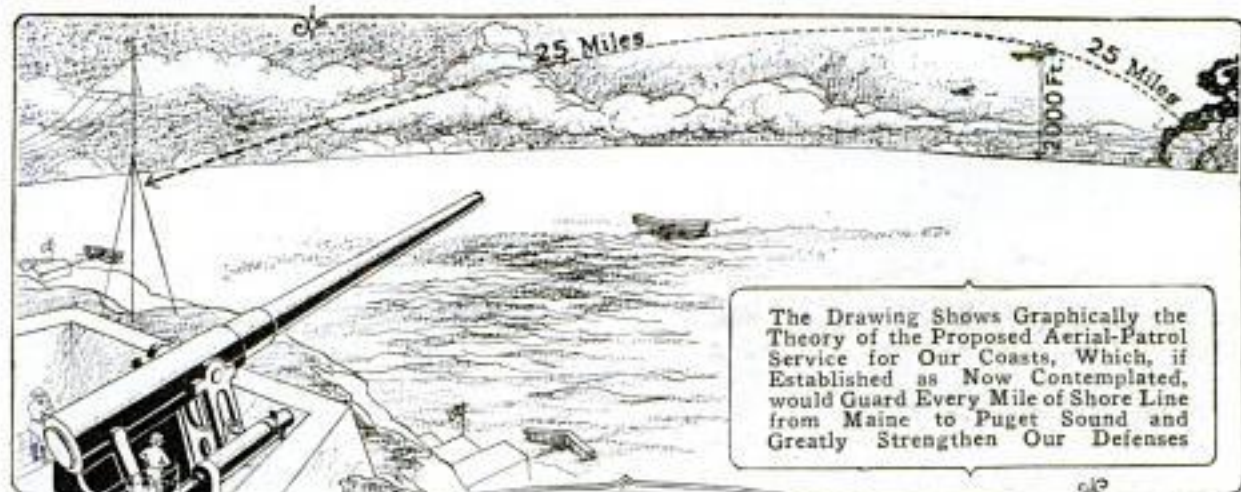

The Drawing Shows Graphically the Theory of the Proposed Aerial-Patrol Service for Our Coasts, Which, if Established as Now Contemplated, would Guard Every Mile of Shore Line from Maine to Puget Sound and Greatly Strengthen Our Defenses

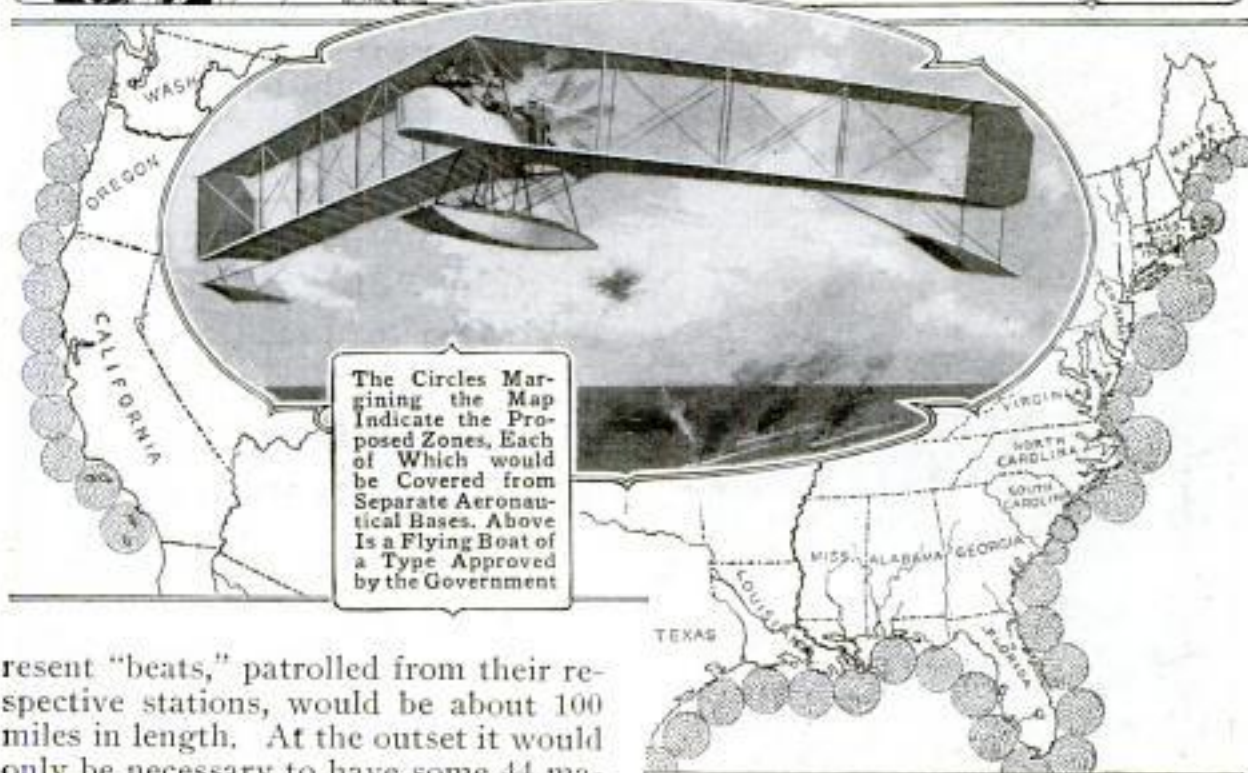

The Circles Margining the Map Indicate the Proposed Zones, Each of Which would be Covered from Separate Aeronautical Bases. Above Is a Flying Boat of a Type Approved by the Government

resent "beats," patrolled from their respective stations, would be about 100 miles in length. At the outset it would only be necessary to have some 44 machines; 132 airmen, who would work in three shifts; radio installations, and about 40 telegraphers. The cost would be approximately \$400,000.

A number of times each day, in an event of war, an airman carrying an observer would make the flight over his course, driving far enough from land to be able to see enemy war vessels 50 miles or more off the coast. Each flying boat would be equipped with wireless and the scouts kept in constant communication with the shore.

This plan has received very strong backing. Providing interest is manifested by the coast states, it is thought that it can be worked out so as to be of

inestimable service to the country. Eventually each station would have an extra flying boat in reserve and the whole system be strengthened.

#### LARGE SIGN USED BY BOY 1042 SCOUTS IN CAMPAIGN

At their headquarters overlooking City Hall Park at New York, boy scouts recently employed a large sign to advertise a vigorous campaign to raise \$200,000 during a four-day period. In the middle of the large board, which was more than 50 feet in height, was a picture of a boy in the uniform of a scout. This was provided with a

movable arm which served as an indicator of the funds in hand as the sub-



COPYRIGHT, INTERNATIONAL FILM SERVICE, INC.  
Sign Used by Boy Scouts during New York Campaign to Raise Funds for Extending Their Activities

scriptions grew. When the arm was pointed at the \$200,000 mark it was in a saluting position.

### CHUGACH NATIONAL FOREST 1098 REDUCED ONE-HALF

The area of the Chugach National Forest, Alaska, which the new government railway will traverse, has been reduced to almost one-half its former size by a proclamation by President Wilson, which has returned to the public domain more than 5,800,000 acres. This is said to be the largest elimination of

national-forest land ever made by a single presidential proclamation. The forest as now constituted contains approximately 5,818,000 acres supporting some eight billion feet of merchantable timber. In the area which has recently been excluded there are large quantities of timber also, but it is so sparse and scattered that its commercial value is small. The restricted Chugach forest is the region in which the Alaskan Engineering Commission has been authorized to cut 85,000,000 ft. of timber for the new government railroad. According to the Forest Service there is small opportunity for locating homesteads in the lands recently returned to public domain, since so little of it is available for agriculture.

### POST OFFICES TO DISPLAY COAST-SURVEY CHARTS

1072 That the Coast and Geodetic Survey at Washington, D. C., may render more available to the public the results of its many activities, it has been decided to display charts of local interest in the post offices of the principal seaport cities on the Atlantic and Pacific coasts, and in some cities in the interior. Accompanying the chart, which will be suitably framed, will be a placard bearing information as to how charts and publications may be obtained. The published results obtained by the survey include sailing charts; general charts of the coasts; tide tables issued annually in advance showing the time and height of the tide at all principal ports in the United States and at some foreign ports; notices to mariners, issued weekly; special publications on geodesy, terrestrial magnetism, and other subjects pertaining to the work of the survey.

11/13/11  
Commerce Reports  
CWhat is said to be a record in radio transmission was made a few weeks ago when a wireless operator in Honolulu picked up war dispatches being transmitted from Nauen, Prussia, to Tuckerton, N. J., a distance of approximately 9,000 miles.



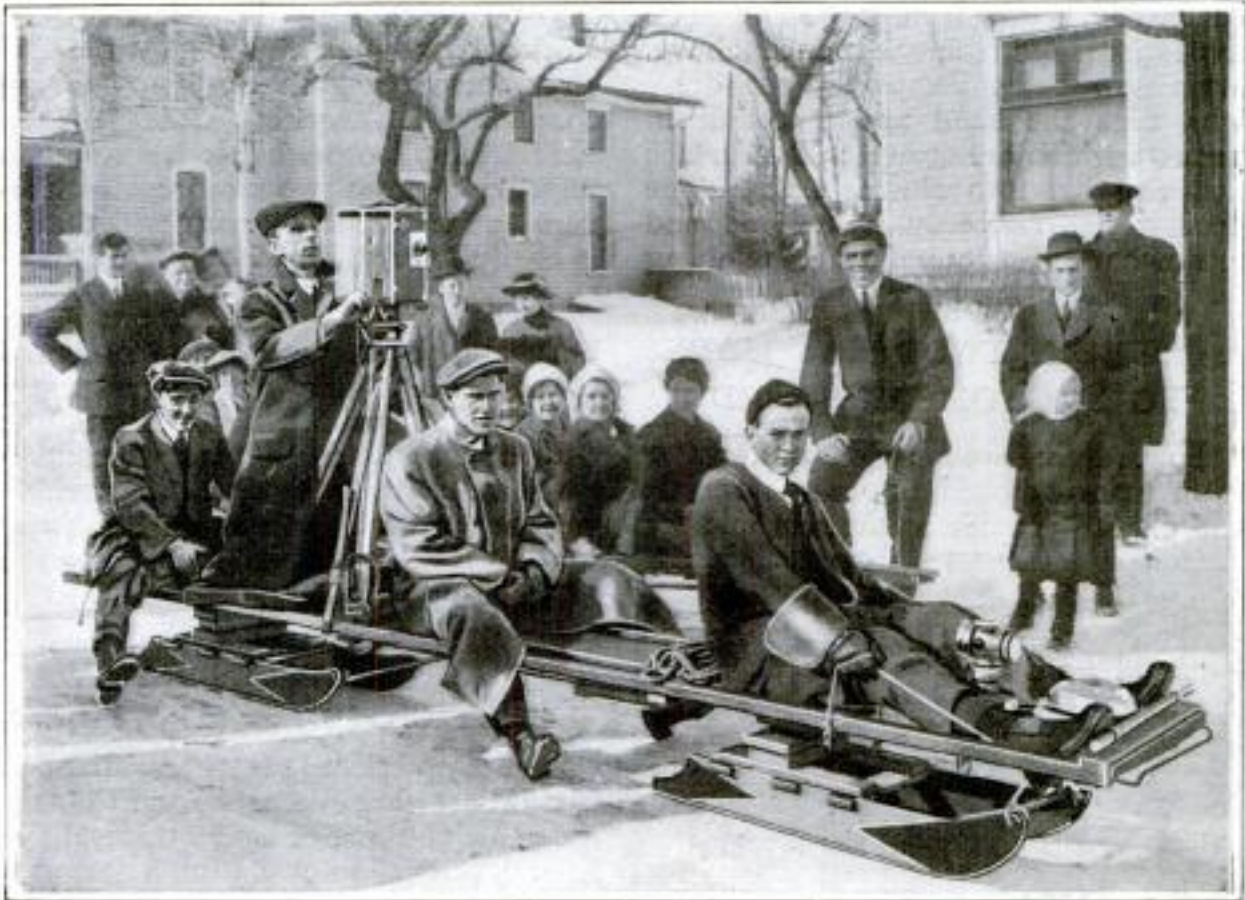

To Reproduce the Visual Sensations of a Person Skiing, a Photographer Took Motion Pictures While Coasting on This Bobsled

**BOBSLED USED IN TAKING  
9473 MOTION PICTURES**

The problem of how to reproduce vividly and accurately for motion pictures the sensations of a person coasting swiftly down a hillside on skis was solved recently by a Michigan photographer who placed his camera at the rear of a long bobsled such as is used for coasting. Kneeling on the sled behind the camera, while an assistant steered the rapidly moving vehicle down the course, the operator turned the crank of his camera, which was pointed straight ahead. The pictures secured in this way graphically reproduced all the sensations experienced by a person coasting on skis. A few feet after the ski "jump" was reached the sled was swerved to one side and the camera shut off.

Ⓒ In six weeks the National Guard of Hawaii increased from 700 to 3,693, exclusive of the naval militia.

**GOLD IS MINED FROM RIVER  
934 BOTTOM BY DIVER**

Gold is being mined from the American River, near Colfax, Cal., in a very curious manner. At the point where the operations are being carried out the bottom of the stream is rich in mineral. This has been carried down by the



Diver Who is Mining Gold from the Bottom of the American River in California

# Hanton Salmore  
Battle Creek, Mich.

O. J. Eiley, Colfax, Placer County, Cal.  
By stage through Searsville, American Placer

current for years from large hydraulic mines situated some distance above. It is now being removed by a diver who digs the sand and places it in buckets which are drawn to the surface and emptied into sluice boxes. The process is obviously a tedious and somewhat difficult one, but it is netting

a good revenue to the miners. The worker who digs the sand from the river bottom wears an ordinary diving costume when working in deep water. He is supplied with air by a pump improvised from two motorcycle cylinders and mounted on a raft so that it is easily moved from point to point.

**SQUEEGEE FOOT MAT MADE FOR MOTOR RUNBOARD**

992

To prevent mud, snow, and water from being tracked into a motor car, and also to provide a safe foothold for "Stanwood" Safety Step.



Besides Cleaning the Soles of the Shoes, the Mat Provides an Excellent Foothold Which Lessens the Danger of a Person Slipping When Stepping on the Runboard

Those entering and leaving it, a serviceable mat has been introduced which is intended to be secured to the runboard of a machine. It consists of an enameled metal plate having a series of long slits through which strips of rubber protrude for about an eighth of an inch. These are semipliant and, when the sole of a shoe is scraped across them, act similarly to squeegees, removing water and slush. The device is 1 ft. in length, 8½ in. wide, and extends ¾

in. above the surface of the runboard to which it is screwed. It is neatly finished, is durable, and lessens the danger of a person slipping when stepping from a car during disagreeable weather. When it becomes necessary to do so, the rubber strips may be replaced by new ones.

**NEW LOS ANGELES RAILWAY STATION IS ATTRACTIVE** 982

Several interesting features, intended to be of comfort to patrons and to facilitate the handling of heavy traffic, have been developed in designing a new passenger station on the Southern Pacific Railway at Los Angeles. The building itself, which is an example of modern Renaissance architecture and is finished in plaster over brick, is a large, light, airy, and attractive structure. In the ticket office there is an absence of grille. The counter is designed for free business intercourse and in this respect represents somewhat of a departure from the established plan. The ticket cases are not in evidence, for instead of being kept in plain sight, the coupon racks are in drawers beneath the counter. A grip shelf extends in front of the ticket windows, permitting bags to be rested at a convenient height without cluttering the floor. The check-room and baggage-room counters are likewise low, so that bundles and grips may be passed across them at a normal carrying height.

Another attractive point of the station arrangement is found in the reinforced-concrete train sheds which have been erected. These are of the butterfly type. They were built according to the unit system; the posts and two longitudinal roof sections of each 20-ft.

Mfr. & Contrb: Automatic Appliances Co.  
 172 Columbus Ave. Boston, Mass.  
 Gray 3 50  
 Plate 2 50  
 Rubber on feet. steel 1 50

L. Giamboni, News Bureau, So. Pacific Co.  
 San Francisco, Cal. (refer to file #932230/351)  
 POPULAR MECHANICS 173

panel being poured and seasoned some distance from the place of their erection. The canopies dip to the center and at alternate pillars are provided

neat, and substantial. A 35-ft. space between the station and the first track is covered by a cantilever marquise which forms a sheltered baggage way.

Arrangement of Ticket Office is Shown at Right: The Grip Shelf Is Especially Convenient for Women Patrons, While the Absence of Grille Adds to the Appearance of the Counter

The Train Sheds Are of Reinforced Concrete with Eaves that Slope toward the Center, Eliminating the Use of Marginal Drain Troughs. The Various Platforms Are Connected by a Subway

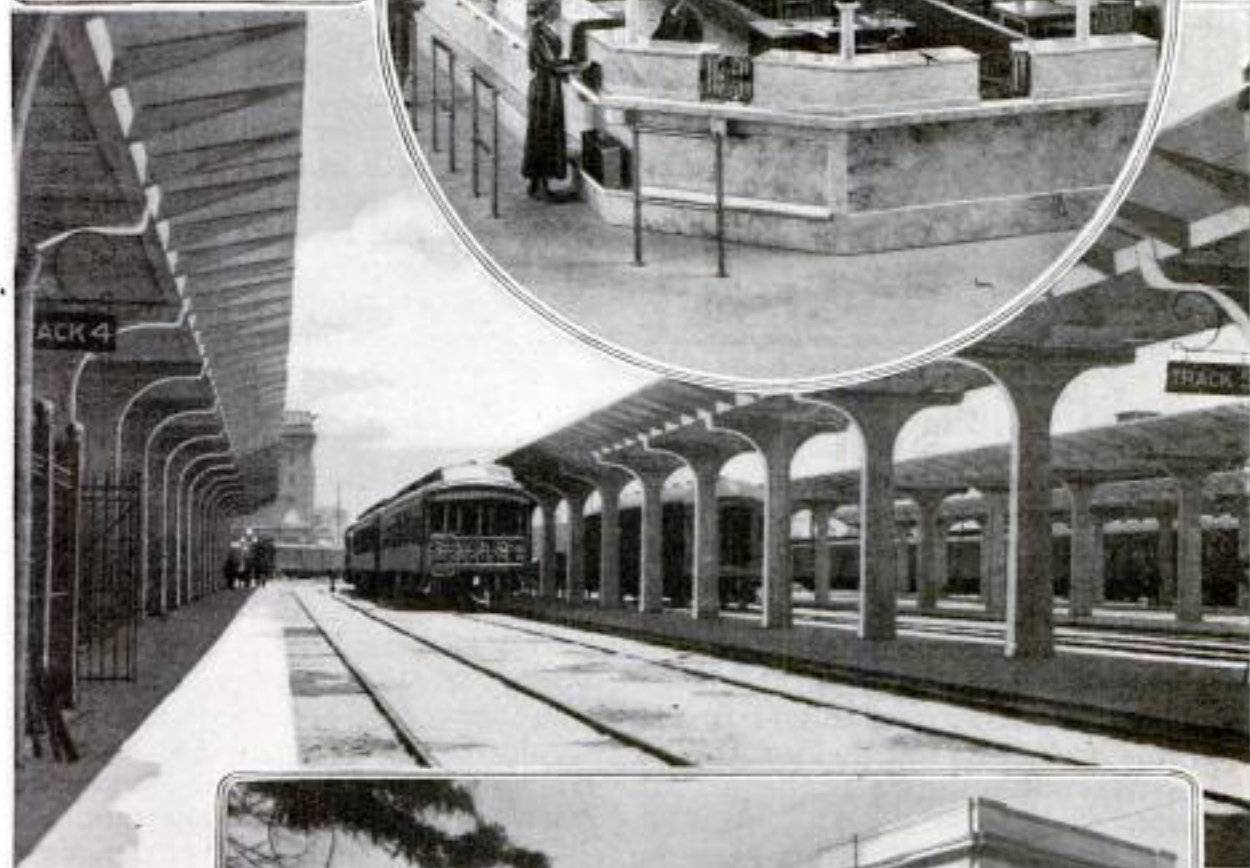
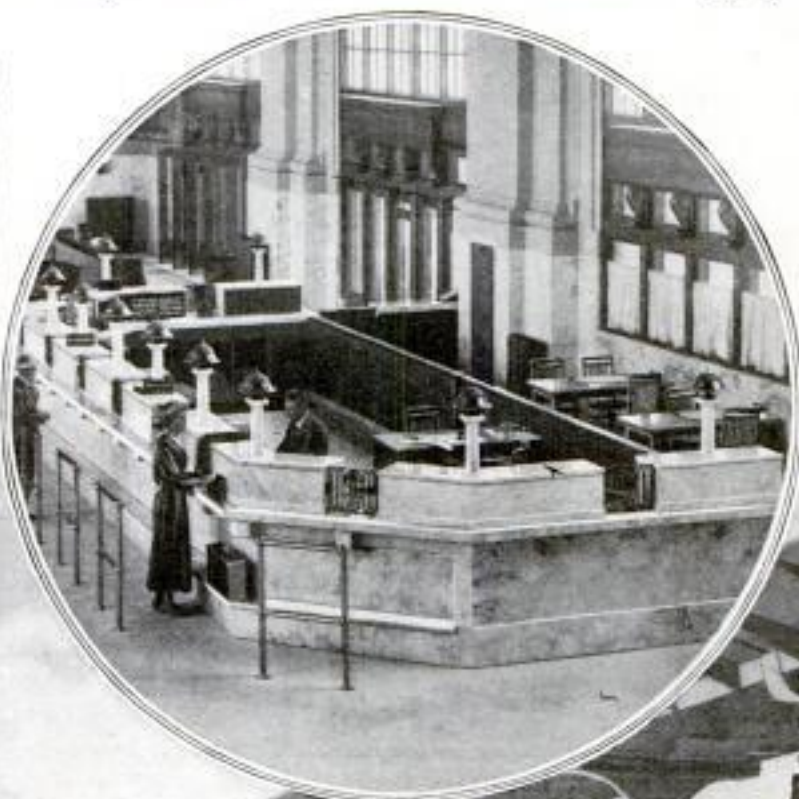

View of Station Which Presents a Pleasing Example of Modern Renaissance Architecture: Its Walls Are of Brick Finished in Plaster



with drain pipes. This plan eliminates the necessity of erecting several thousand feet of troughs along the eaves and thus lessens the maintenance charge. The sheds are quite plain, very

Extending beneath the platforms separating the various tracks is a passenger subway. This is 32 ft. in width and divided into two passages, one each for incoming and outgoing traffic.

### RULE CASE IS AID IN 777 MAKE-UP WORK

A contrivance lately out is designed to aid in the make-up of a newspaper, or to help in most any sort of job-print-

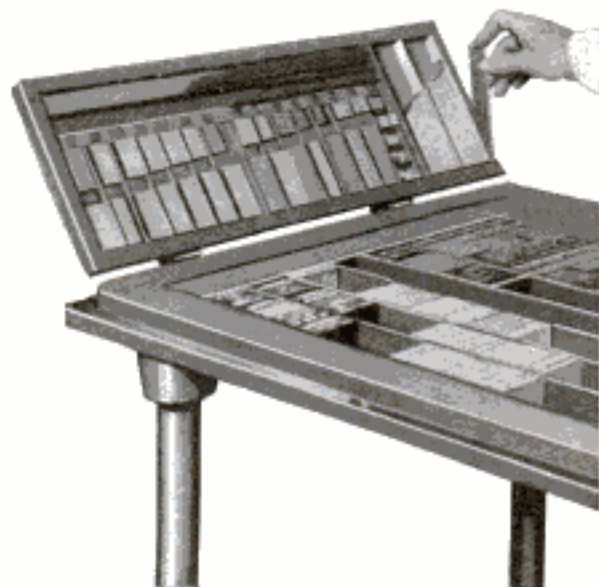

Rule Case Clamps onto End of Chase, Conveniently at Hand during Make-Up Work

ing work. It consists of a case for holding different sizes of column rules, and is arranged to clamp onto the end of the chase. This latter being the metal frame in which the columns of type are put during make-up processes, the presence of the rule case so conveniently at hand is a great aid to rapid work. After one form is made up, the case may be moved to the next, where it can give further useful service.

### 1049 DAM HOLDS WATER UNTIL WARMED FOR BATHING

Warm salt water for beach bathing, such as is seldom enjoyed by dwellers along the northwest coast of the United States, has been made available for campers on Puget Sound by the construction of a dam at the mouth of a lagoon which projects into one of the islands in the sound. This dam is of cement and has cement floodgates operated by ordinary windlasses. At

high tide the gates are closed, thus enabling a large quantity of water to be held for several hours while the sun warms it. When desired, the water can be changed. If the sun is shining when the lagoon is emptied, the bed of the lagoon soon warms and aids materially in raising the temperature of the new volume of water let in by the rising tide. The lagoon is not over five feet deep except near the floodgates. The cost of this improvement was comparatively small.

### 1013 RECOVERING SHIPS BEACHED DURING GULF STORM

During the severe storm which swept the Gulf coast last fall, four British steamers and a schooner in Galveston Harbor and Bolivar Roads were swept far from deep water. Two of the vessels were left high and dry, while two others were carried nearly five miles from water sufficiently deep to float them. None of the ships, however, was badly injured.

The task of getting the merchantmen back to deep water was the largest salvaging operation ever attempted in the South. To accomplish it five dredges and some 300 men were employed day and night for a period of six weeks. In recovering two of the vessels a channel  $4\frac{1}{2}$  miles long, 200 ft. wide, and 15 ft. deep was cut through the bay. In each instance it was necessary to cut a slip to the stranded vessel, dig entirely around it and then remove the sand and earth beneath it by hydraulic pressure.

One of the ships was carried down the channel by the hundred-mile-an-hour wind and lifted out of the water into a railroad yard. A large steamer and a three-masted schooner were grounded on Pelican Spit, while the other two ships were carried out into a prairie at Swan Lake. The machinery in the four steamers was capable of being operated, so when it came time to make the final efforts to float the vessels, basins were dredged under their propellers and power from their own engines used to assist the tugs.

The Engineer 11/19/10

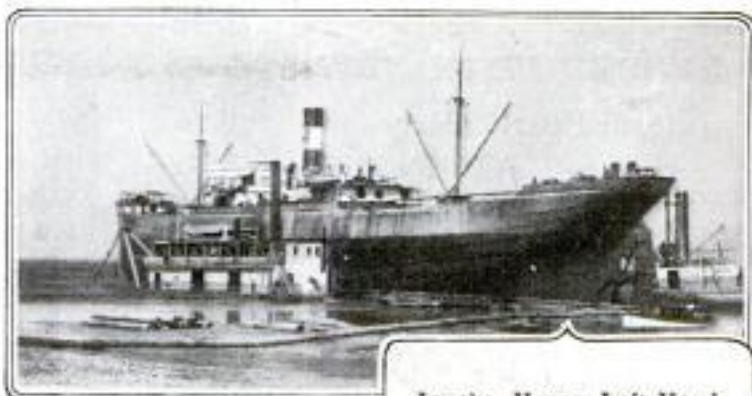
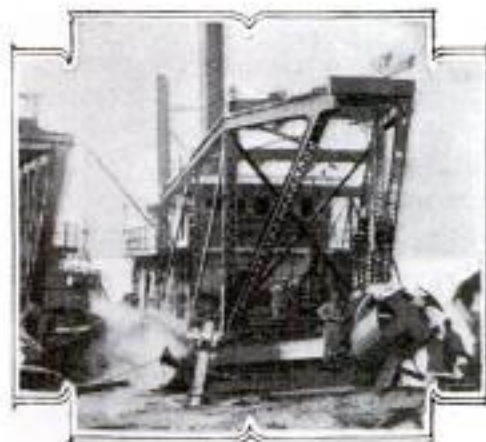

In the Upper Left-Hand Corner is Shown the Type of Dredge Which was Used in Cutting Channels to the Five British Vessels Which were Beached at Galveston during the Terrific Gulf Coast Storm Some Months Ago. The Steamer Immediately Above was Driven Far from Deep Water by the Gale, but was Not Materially Injured

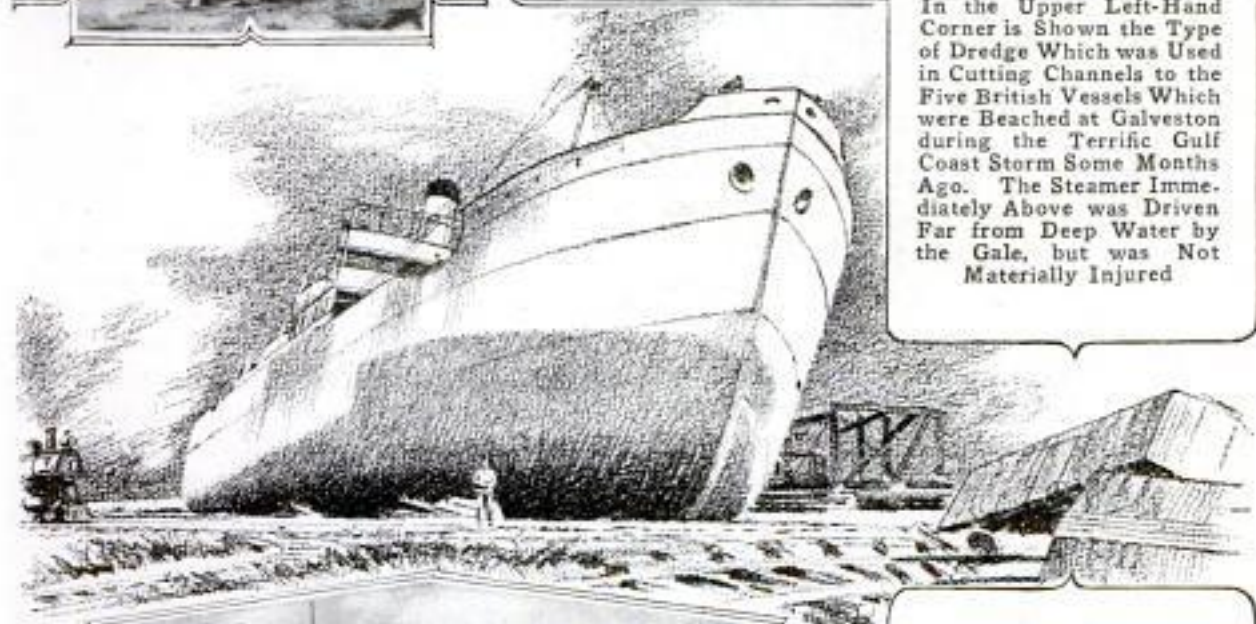

The Artist's Sketch Above Pictures Another of the Merchant Vessels Caught by the Storm: This One was Swept Down a Channel and Lifted Bodily into a Railway Yard, Where It Rested across the Tracks and on a Turntable until Salvaged. At the Left are a Schooner and Steamer Which were Driven from Deep Water and Left High and Dry



By an Odd Coincidence the Two Vessels Below at the Right Stayed Together during Their Wanderings and were Finally Grounded in a Prairie at Swan Lake, Several Miles from Water of Any Depth. This Photograph was Taken When the Dredging Operations were at Their Height. The Picture Above Shows a Dredge Cutting a Channel around One of the Boats



Wm. Tiffhard & Sons  
Wheeling, W. Va.

**NO OUTLET FOR GAS FUMES  
NEEDED WITH NEW STOVE**

93x

Intended particularly for installation in rooms not provided with chimneys, a gas heater has been designed which

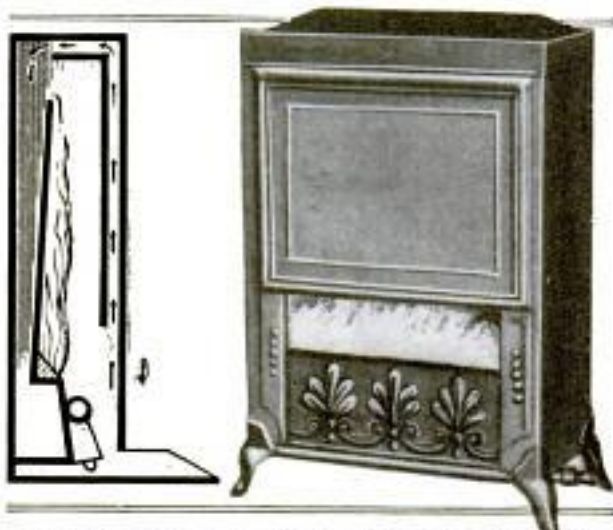

An Authority on Gas Analysis Asserts That This Stove Produces Complete Combustion

is claimed to insure complete combustion of the fuel it uses. In outward appearance it is quite like many similar stoves used in the natural-gas belts. Its internal construction, however, differs considerably from that of the ordinary stove of this type. Furthermore, it has no outlet for fumes. It is provided with a series of deflecting plates forming channels in which the gas is burned and through which superheated air is circulated. The arrangement is such that the heated air produces a suction that draws the products of combustion

—or unburned gases—upward with it and into a return channel. Here the products are mixed with fresh air drawn in at the front of the stove, carried to the top through a passage and forced around into the return duct. Finally the gases are driven across the burner from the back of the stove and reheated. This cycle continues as long as the stove is burning. Tests recently made by an eastern authority showed that no carbon monoxide was present after combustion.

**FOLDING MASTS USED ON  
1003 TRAILER BOAT**

To permit the masts of a small sailing boat to be folded back out of the way, an Illinois sportsman, who frequently transports his craft on a motorcycle trailer, has secured a short substantial post aft of the cockpit and at the bow. When erected, each mast is leashed at the top of one of these permanent uprights and held in place at the bottom by a fork which is fastened to one end of the boom. It is a matter of but a moment's time to raise them for sailing, and when they are lowered, cross-country runs may be made easily and without danger of the masts striking the lower limbs of trees or other overhead obstructions which might snap them off. The arrangement also permits the craft to be used for paddling without serious inconvenience.



By Providing Permanent Posts to Which They may be Leashed, the Masts may be Taken Down Quickly for Portages, as is Shown in the Photograph at the Left. Below, the Sails are Raised to Show the Manner in Which the Masts are Held by the Uprights



Rogers Inf. Co.  
326 W. Madison St.,  
Chicago

*Prometheus 7/24/15*  
**ENGINEERS ERECT BRIDGE**

*949* **WITHIN TUNNEL**

Engineering problems in ordinary tunnel construction are many and difficult enough, but in the recent building of a subway in Berlin a new proposition was encountered. Deep underground two unexpected beds of peat halted progress, it being obvious that the material was too spongy to support the weight of the tunnel structure, let alone that of passing trains. To get over the obstruction the novel idea of building two steel bridges within the narrow confines of the tunnel was proposed and carried out. One of the structures so built had a span about 200 feet long and the other nearly 140 feet, the first time probably that bridges of such length were ever erected underground. It would have been simpler, perhaps, to have sunk concrete piles in the peat and erected the tunnel upon these as a foundation, but the idea was rejected because of the probability that acids in the peat would attack and seriously injure concrete supports in the course of time.

**TELEPHONE CARRIES SONGS**  
*896* **OF BIRDS INTO HOME**

Quite an interesting as well as ingenious use is being made of a telephone by the keeper of a lighthouse on the Island of Guernsey, off the coast of France, for the entertainment of his four-year-old son. The boy is fond of birds, but the presence of a cat in his home keeps them on their guard and restrains them from venturing near.

*Telephony 6-1915*

*E. O. Catford, Flatte Songere  
 Lighthouse, Guernsey, Eng.*

This difficulty has been overcome to an extent by erecting a feeding tray at the top of a pole some distance from the dwelling. There the birds congregate and chatter away without fear. A telephone transmitter, sheltered from

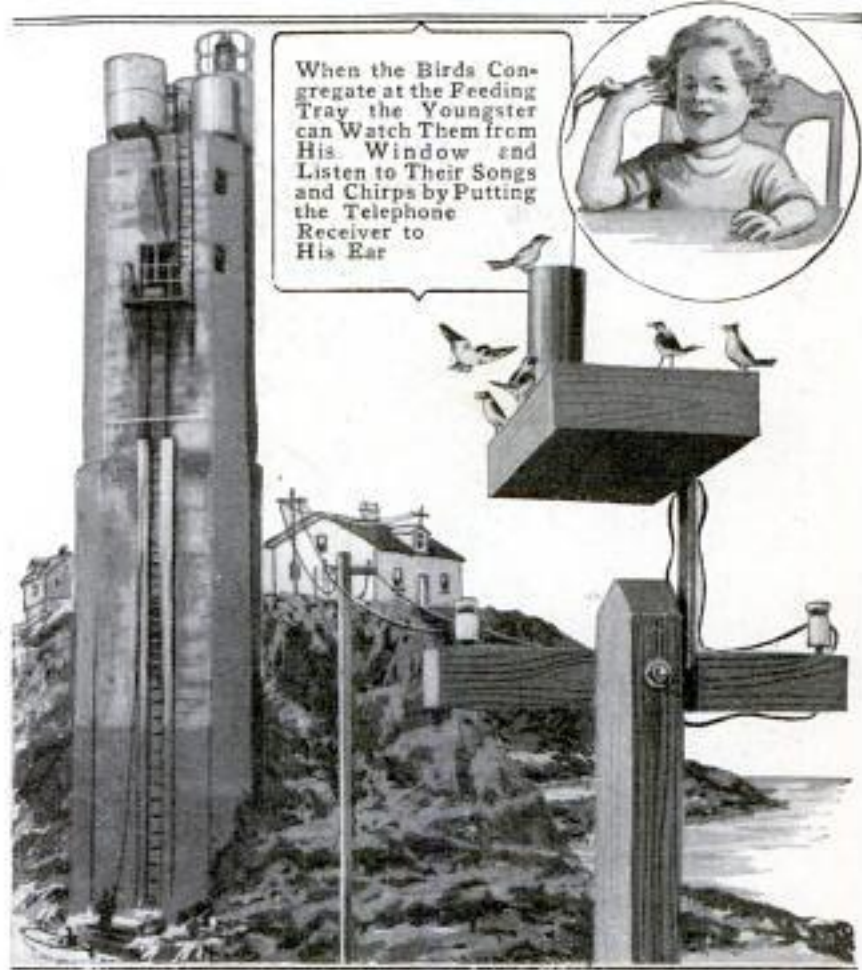

rain and snow by an inverted cocoa can, is mounted on the platform, while wires connect it with a receiver installed in the near-by house. By standing at a window the youngster can watch the robins, finches, and other birds feeding, and at the same time listen to their chirps and songs. The novel system has been in use for a number of months, has worked admirably well, and has been the means of affording the boy an almost endless round of pleasure day after day.

☞ Fire caused by the friction of a rear wheel of the wagon against a piece of misplaced board resulted in the loss of a load of hay that was being driven to market by a Pennsylvania farmer.

Sent to: Mrs. E. B. Gloue, City-Carlton,  
New York

TIN KITCHEN UTENSILS FORM  
1041 NOVEL BOUQUET

Among the many remembrances received by a wealthy New York woman on the occasion of her tenth



COPYRIGHT, UNDERWOOD & UNDERWOOD

Curious Bouquet Presented to a New York Woman in Honor of Her Tenth Wedding Anniversary

wedding anniversary, which was recently celebrated at one of the downtown hotels, was a tin bouquet. It was composed of divers kitchen utensils interspersed with a small

amount of greenery and tied with flowing white ribbons. Tea strainers, egg beaters, cake turners, soap baskets, funnels, large spoons and small spoons, with many other things, were represented in the collection. The idea was so well carried out that the assorted bouquet proved to be one of the most-talked-of gifts of the evening.

MODEL HOME IS CARRIED  
1010 ABOUT ON AUTO TRUCK

A western compressed-fuel concern recently devised a neat plan for advertising its product. On the broad platform of an auto truck a model house was erected, complete as to detail and well furnished. Across a rear corner a fireplace blazed forth a welcome to visitors, while in the front end, a full-sized kitchen range and full complement of cooking utensils stood ready to cook any sort of luncheon desired. With this novel outfit the streets of the city and vicinity were toured, the odd appearance of the house attracting attention and the conveniences within calling forth favorable comment. Of course the fuel used in fireplace and range was the briquettes made by the company. These consist of a compound of coal dust and asphaltum.

#Frank E. Ring, 7341 - 9th Ave. S.W. Seattle, Wash.

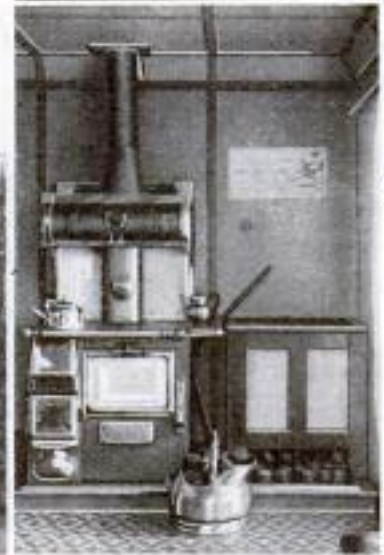

Interior and Exterior of Model Home Carried about the Streets of a City in an Advertising Plan. Interior is Neatly Finished and is Furnished with Tables, Chairs, a Kitchen Range, and a Fireplace

Used by Pacific Coast Coal Co. Seattle, Wash.



1012

## PROJECT TRACK AT NIGHT UNDER ELECTRIC LAMPS

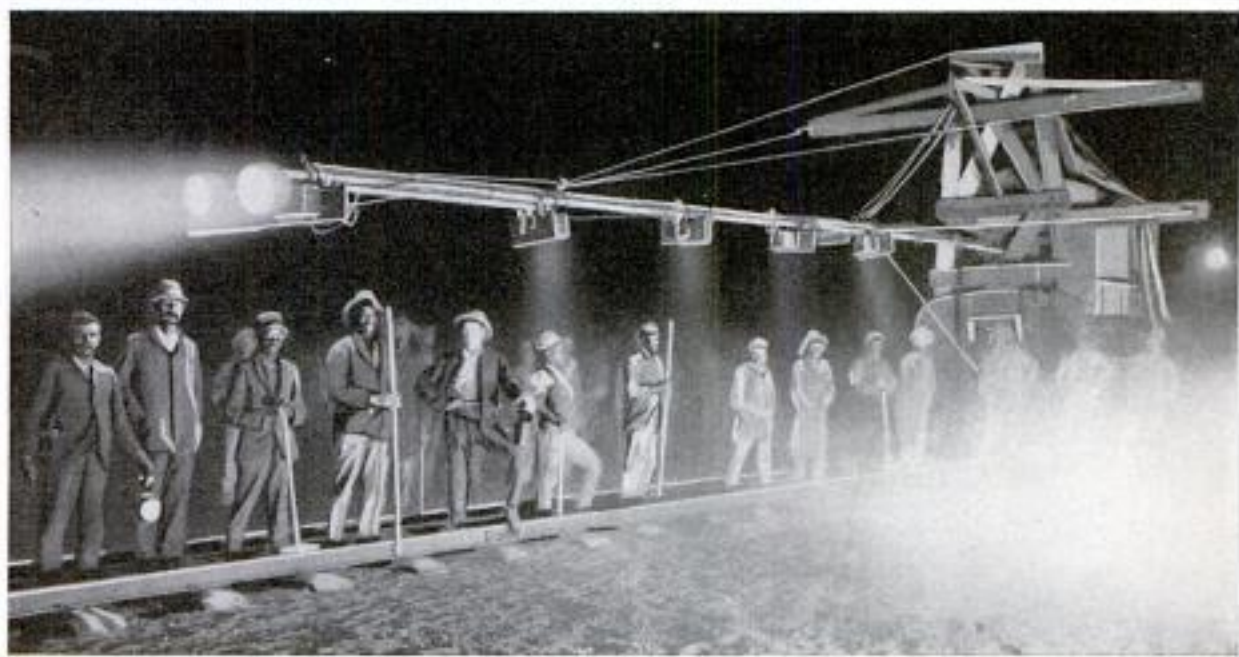
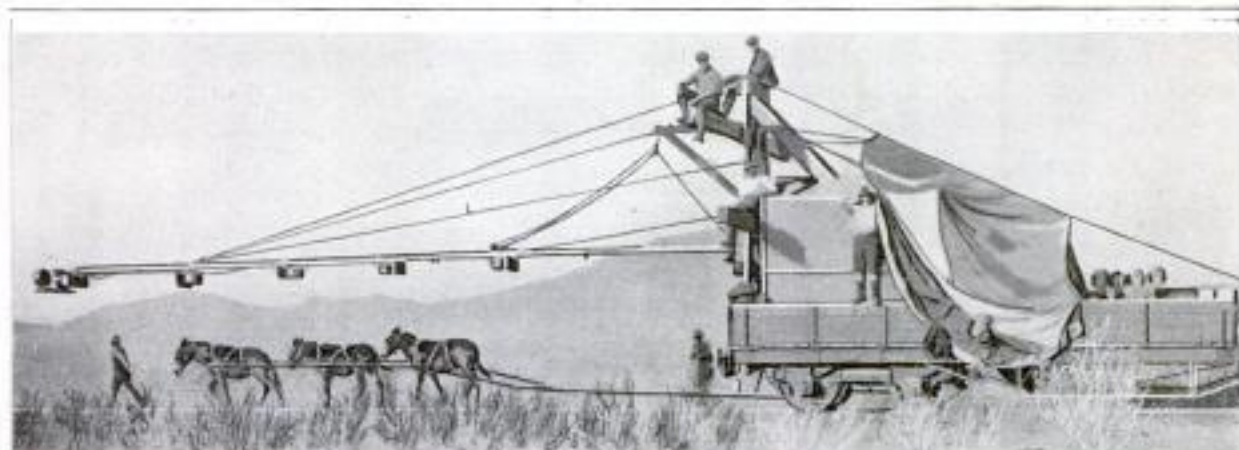

COURTESY RAILWAY REVIEW

This Shows at Close Hand the Arrangement of the Lamps and the Strong Light Cast along the Track by Them

In building a strategical railway in South Africa to connect Prieska, Upington, and Kalkfontein, an interesting system of illumination has been employed to expedite tracklaying at night. A 50-ft. boom, made of 2-in. pipe fastened to a plank, was extended from a trestle erected at one end of an open work car. This was supported by a cable attached 10 ft. aft of the forward end and passed over the top of the trestle to the rear of the car where it was secured to a winch. Five 100-wp. incandescent lamps mounted in reflectors were arranged, face down, along the under side of the boom at intervals of about 10 ft., while at the

extreme end of the cantilever a pair of similar lamps were placed horizontally so as to throw a strong light for a distance of about 120 ft. ahead. The light was diffused along the track beneath the boom and in advance of it so that workmen could lay rails, tighten joints, and do all other work without difficulty. Power for these lamps, and for portable ones used along the sides of the material train when unloading was to be done, was supplied by a dynamo driven by a 5-hp. oil engine. With this arrangement it was possible to carry the work on at night without interruption, which was considered at the time to be highly necessary.

### AEROPLANE IS FEATURE OF 1006 LORD MAYOR'S PARADE

A feature of an enormous parade held recently at the inauguration of

### NEW YORK-NATIONAL GUARD 1092 GIVEN ARMORED TRAIN

An armored train and an armored

aeroplane soon will be added to the equipment of the New York National Guard through the generosity of certain public-spirited citizens. The governor of the state has approved of a request for a \$10,000 appropriation to be used in maintaining the train; a similar amount is asked for the aeroplane. It is said that this will be the first armored train in this country. One of its units will be a battle car carrying nine or ten men and resting on especially constructed trucks equipped with motor apparatus and steering gear at either end so that it can be run in either direction without reversing control. There will be seven lightly armored fast motor cars for carrying machine guns and suitable for scout work or bringing up ammunition. Twelve motorcycles also will be equipped with machine guns. The train,



Aeroplane Hauled through Streets of London as One of the Spectacular Floats in Lord Mayor's Parade: Pageant Is Outgrowth of Old-Time Custom of Honoring Newly Elected Mayor While En Route to Inauguration. The First Such Parade was Held in 1215

COPYRIGHT, INTERNATIONAL FILM SERVICE, INC.

the newly elected lord mayor of London was an aeroplane attached to the rear of an automobile and pulled through the streets as one of the spectacular floats. The use of a flying machine in such connection was unusual, especially in such an old-time pageant as the lord mayor's parade. The first of such affairs was held in 1215 and grew out of a requirement in a charter granted by King John that the citizen chosen to be mayor should be presented to the king or his justice for approval. The mayor rides in an elaborate coach in such parades.

if bought in the open market, would cost approximately \$150,000. It will need the services of fully 100 men. The armored air craft is the gift of several prominent citizens who are especially interested in military aviation.

### WAGON CARRIES SKYROCKET PICTURE-TAKING MACHINE

950 Skyrocket photographing outfits have been considerably developed by the Germans for taking pictures of enemy country, a similar device having been described in this magazine a few

*Spake*

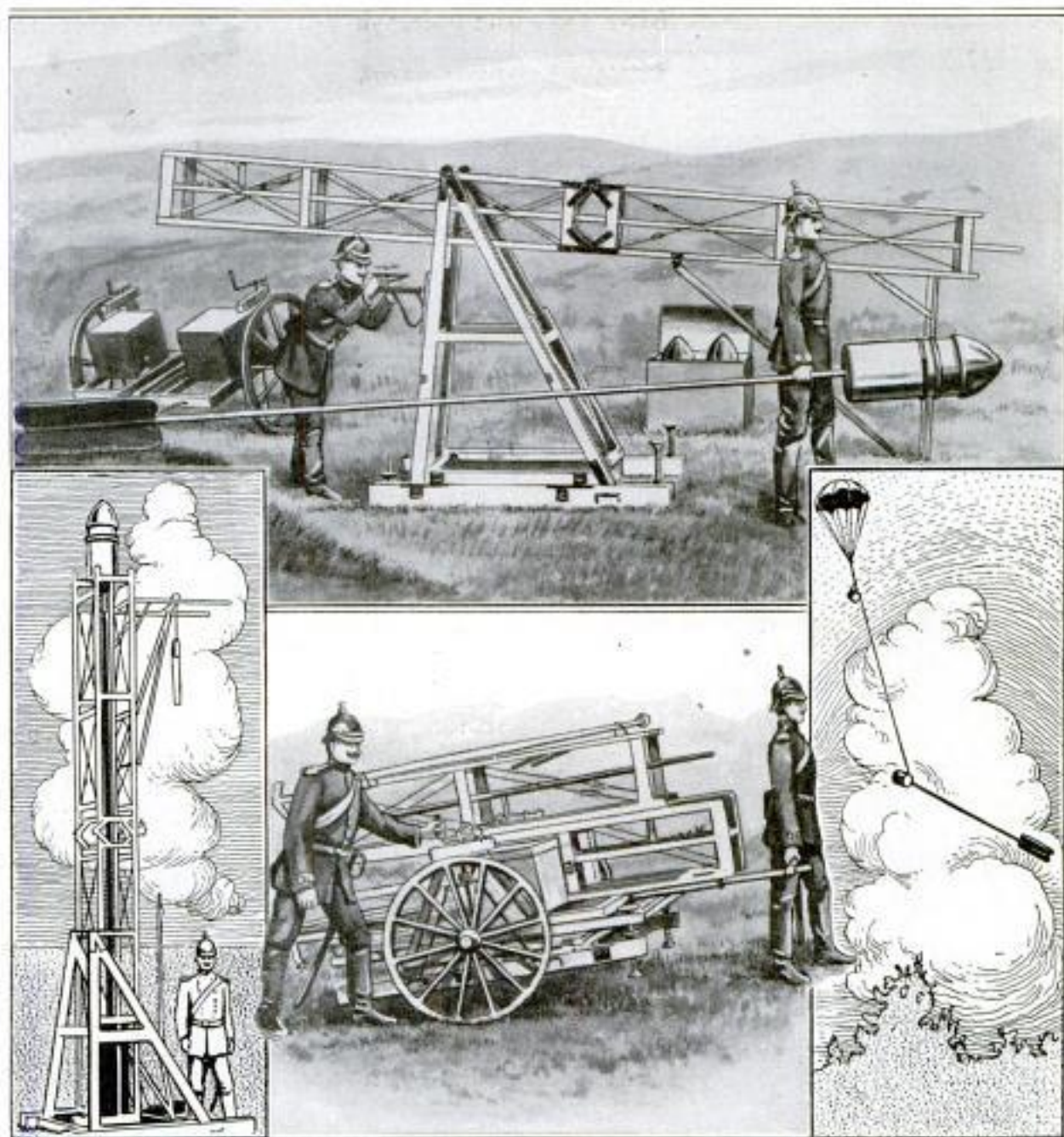

Apparatus for Taking Pictures of Enemy Country with a Camera Carried on a Skyrocket: The Equipment may be Packed Compactly on a Wagon and Easily Transported

years ago. A new outfit was recently brought out, the various parts of which fold compactly, allowing easy transport in the field.

The rocket used is about  $19\frac{1}{2}$  ft. long, and carries a camera in the conical nose, and a parachute in the cylindrical part. A tall tower is provided for guiding it at starting. The structure which serves in this connection is made in two sections, and forms the bulkiest part of the apparatus. Interlocking joints hold it together when erected, and near the middle an A-

shaped support is provided. In shooting a rocket, the missile is placed within the tower, the latter rotated to an upright position, and the powder charge touched off. The long projectile mounts high in the air, a gyroscope in its upper end keeping the camera pointed in the right direction, until a picture is taken. Coming down, the parachute unfolds from the upper barrel and conveys the various pieces safely to the ground. Afterward the film is taken from the camera and developed.

The Car 9/22/15  
"Euno" Lamp

Records  
All

Euno Engineering Corporation,  
Meriden, Conn.

### DASHBOARD LAMP ASSISTS IN LOCATING TROUBLE

929

An electric dashboard lamp recently put on the market is intended for use in locating troubles around an auto-

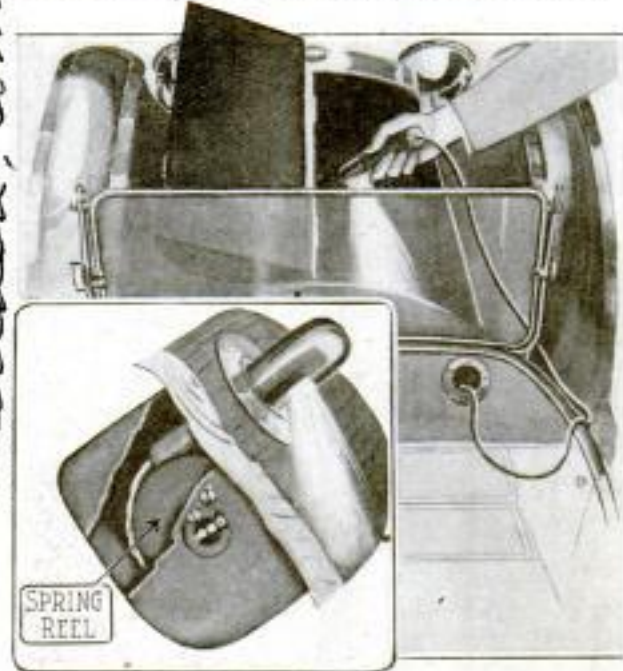

Dashboard Lamp Provided with Extension Cord: Automatic Reel Takes Up Surplus Length

mobile at times when darkness would make the finding difficult. An interesting feature about the device is its especial convenience. The trouble lamp is fastened to the end of a long lamp cord. Back of the dashboard an automatic reel takes up all of this cord except the part necessary to reach a given locality, thus making it unnecessary to coil up the wire by hand every time the device is used. When not in use as a trouble hunter, the lamp and its holder fit into a socket on the dashboard next to the reel. A metal cap fitting down over the end of the light converts it into the ordinary dashboard type.

### WHALE-OIL PRODUCTION INCREASED BY WAR

1077

The fact that large quantities of whale oil are used in the composition of glycerin, thus making it a factor in the manufacture of high explosives used in such vast quantities in the war, is regarded as one of the reasons for

Engineering 11/26/15

the increasing volume of the whale-oil business. In 1914 the world's production amounted to 750,000 bbl. The uses of whale oil are more numerous at the present time than ever before. Among the many ways in which it is employed are: In treating leather; in the iron and steel industries for hardening processes; for lubricating, often mixed with mineral oils; in the manufacture of artificial rubber, and in the soap industry.

### OPENING OF NEW RAILWAY LINE ACROSS CANADA

958

The running of a special train over the Canadian Northern Railway from tidewater on the Atlantic seaboard to tidewater on the Pacific marked the completion of a railway project that is in many ways one of the most interesting pieces of railway construction ever carried out on the American continent. Although this line traverses hundreds of miles of country that is exceedingly difficult for railway construction, the grade at no point exceeds .6 ft. in 100 ft. Every curve is "compensated," this being a term used by railway engineers to indicate that on curves the grade is reduced sufficiently to make the total resistance that an up-bound train has to meet just equal to that caused by the full grade on straight track. Because of this low grade it was possible to haul the special train, carrying 150 passengers and made up of 15 of the heaviest standard passenger cars, from Quebec to Vancouver with a single engine. An idea of the kind of country through which the line was built is given in the accompanying illustrations. Fully as remarkable as the construction of the road was that of financing it. A large percentage of the line is made up of short railroads that were bought and connected to make a continuous line. This, as well as the new construction, was financed by means of bonds which in every case were guaranteed either by the Dominion government or by the individual provinces through which the line passes.

Foreing

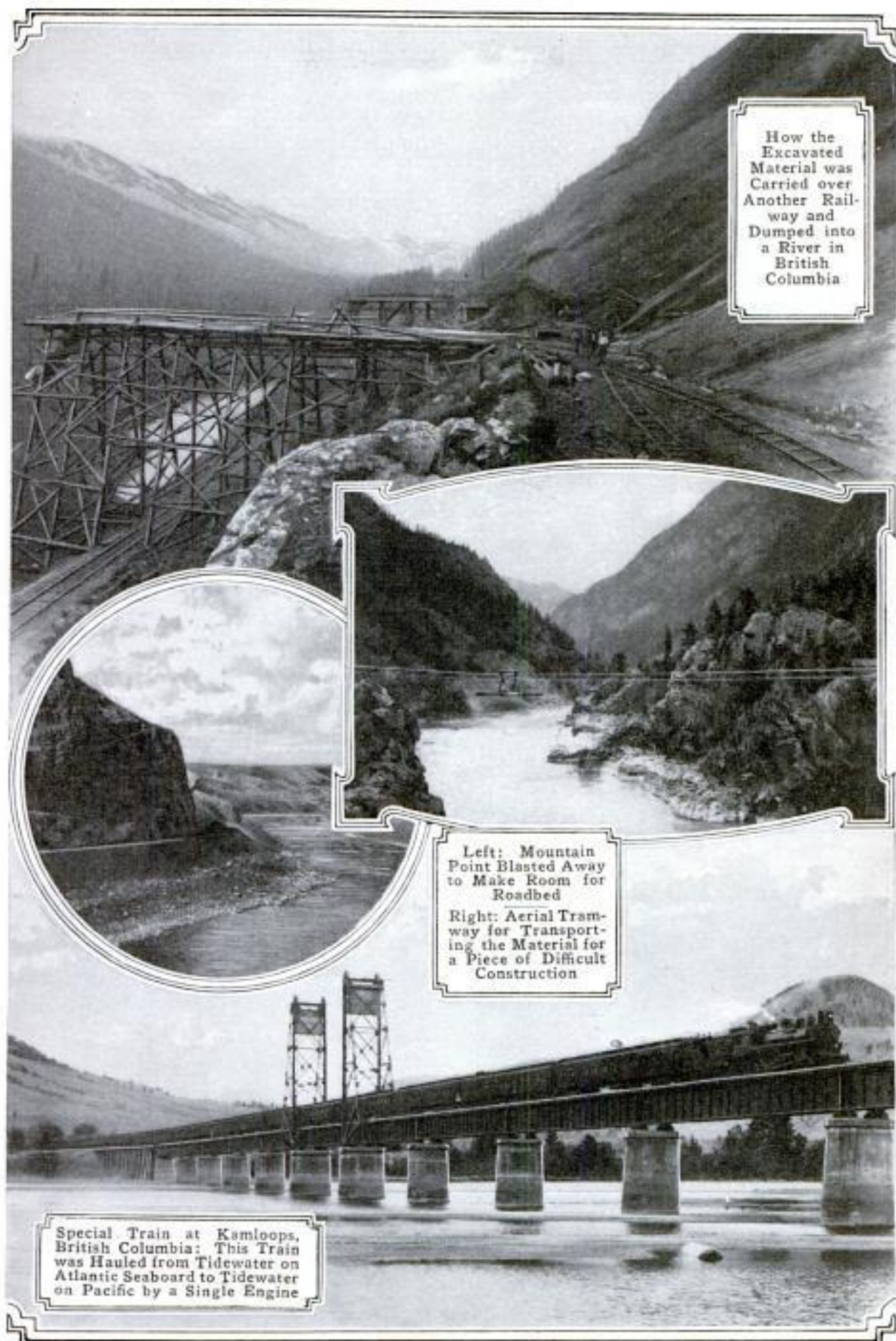

How the  
Excavated  
Material was  
Carried over  
Another Rail-  
way and  
Dumped into  
a River in  
British  
Columbia

Left: Mountain  
Point Blasted Away  
to Make Room for  
Roadbed

Right: Aerial Tram-  
way for Transport-  
ing the Material for  
a Piece of Difficult  
Construction

Special Train at Kamloops,  
British Columbia: This Train  
was Hauled from Tidewater on  
Atlantic Seaboard to Tidewater  
on Pacific by a Single Engine

# W. R. Schindler - saw. & 1/2 yr. B 7/8/16  
 Brawley, Calif.

**PROTECTING YOUNG PLANTS  
 FROM INJURY BY FROST**

939

For shielding delicate young plants from spring frosts and freshets, ingenious covers are being used in the



In One Section of Southwestern California Thousands of Acres of Plants are Covered by Using a Hand Implement to Set Cone-Shaped Shields in Place

fields of southwestern California by truck gardeners, and others. The individual covers are pressed into shape

from blank disks made of a light, flexible material which is waterproof. The operation of setting them in place is a simple procedure which requires but little labor. They are first laid over the plants and their bottom edges then pressed into the loose earth, by means of a hand implement, and held securely. Two men working together, it is said, can distribute and anchor several thousand in a day's time. Since they are made of an opalescent material, they care for the young plants nearly as well in mild weather as if the plants were set in greenhouses. By employing them, growth is hastened, losses guarded against, and the chances for early crops increased.

**MOHAIR OF UNUSUAL LENGTH  
 SHEARED FROM GOAT**

1005

Certain breeds of Angora goats furnish a very long and silky grade of mohair which is extensively used for different commercial purposes. Before being sheared, as is shown in the accompanying illustration, the fleece of these animals is combed and carefully braided. In this instance the mohair is of a remarkable length and even in its heavy braids sweeps the ground. The fleece yielded at this clipping weighed approximately 30 pounds.



The Pile of Wool Shown in the Middle was All Taken from the Goat Shown While being Sheared at the Right

Wool at R.P. Expo. Mar/1915

Owned by F. A. Pieren Days Creek Oregon

International Film Service, Inc. 238 William St. N. Y. City

Motorcycling 10-5-15

Sidecar Co. 895 Fulham Road S.W. London Eng.

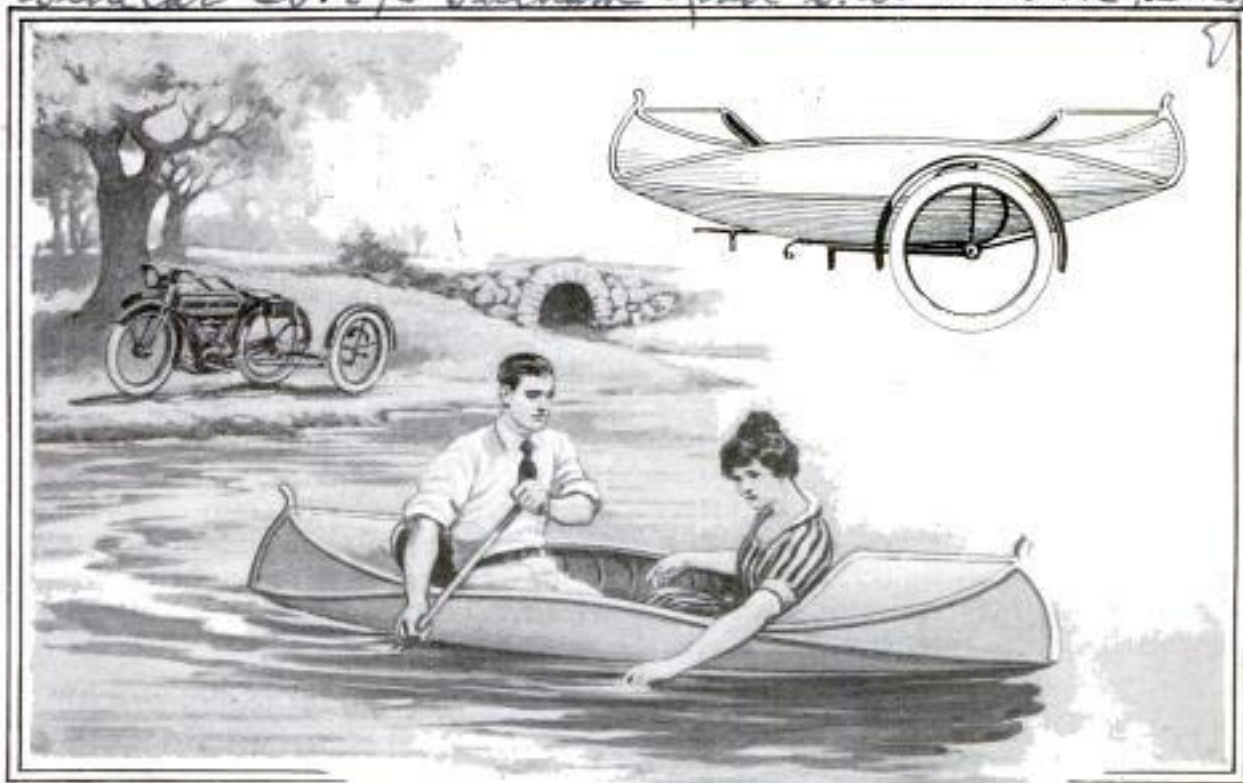

The Body of the Sidecar Forms a Very Comfortable Canoe, Serviceable for Both Hunting and Pleasure Purposes

NEW SIDECAR IS ADAPTED FOR LAND AND WATER

1064

While some of the latest amphibious motor cars are attracting considerable attention both here and abroad, a British company has developed a land-and-water sidecar attachment for the motorcycle which is also a curious innovation. The body of this is built along the same lines as a canoe, is secured to a very low chassis by means of four winged nuts, and may be quickly detached and used in the water. The framework is constructed of wood and provided with metal shields at each end, while the exterior is covered with stanch, waterproof canvas. It has sufficient room for two persons and when used as a canoe may be paddled with ease. While it is particularly convenient for the cyclist who uses his machine on shooting trips, it is equally well adapted for pleasure purposes.

Invar metal, which has a very low coefficient of expansion, is now being manufactured in the United States.

MACHINE IS AUTOMATIC RECEIVING TELLER

980

A contrivance which automatically receives, registers, and receipts for coins deposited is now being manufactured and sold as a supplement to the regular savings service offered by banks. It is intended that the machines shall be placed in schools, fac-

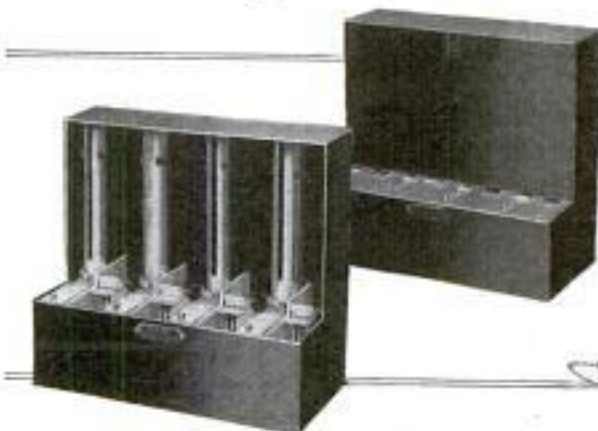

Interior and Exterior Views of New Automatic Savings Bank

tories, hotels, department stores, and the like, to pick up spare change a passer-by might want to save. Stamps are issued as receipts, and when

Ans: P. V. Hocking, Engineer, Mich. State Training School Saginaw, Mich.

"Invar" - Alloy - 64.3% steel, 35.7% nickel - Co. eff. expansion .0000008 for 1° C. Similar made by Midvale Steel Co. See white card, "Invar" Victrola, Phila.

Army + Navy Journal 12/12  
NEW SIBERIAN RAILWAY

amounting to a dollar, or more, they may be deposited in the usual way as a savings account in the bank. The coins placed in the machine are filed compactly in metal tubes until collected by an emissary from the savings institution.

1004 TRAINED NURSE CARES FOR CUB LION AT ZOO

One of the youngest members of the animal colony at the Grant Park Zoo in Atlanta is a tousy, awkward little cub lion which dines at regular intervals on warm milk given to him in a bottle. His meal hours are events which break the monotony of his keeper's daily routine, because of the



Feeding the Cub Lion to the Wonderment of His Small Playmate, the Fox Terrier

eagerness he displays in getting the last drop from the vial. The cub has several distinctions, one of them being that he is attended by a trained nurse who is especially employed to look after his wants. As a companion he has a fox-terrier pup, as lively as himself, that helps him while away the hours. Neither of the animals seems to hold any prejudice against the other and they play almost as contentedly as if they were of the same family. At feeding times, however, the dog manifests much curiosity at the nursing, which he apparently cannot understand.

1097 TAPS RICH REGION

A new railway line, 501 miles in length, has recently been put in operation in Siberia, connecting with the Trans-Siberian Railway. It opens a section rich in minerals and in agricultural possibilities. In this Altai region, as it is called, are deposits of gold, silver, zinc, lead, and copper, which were worked in the eighteenth and nineteenth centuries, but owing to poor transportation and other causes were abandoned. A valuable coal basin, 6,000 square miles in extent, is a part of the region now brought in touch with the outside world.

1088 FOREST SERVICE TO FIGHT RABIES AMONG COYOTES

Because of a very serious outbreak of rabies infection among wild and domestic animals in the West, a special fund has been set aside for use of the Biological Survey and the Forest Service in fighting this dread disease. The malady has been prevalent among coyotes in eastern Oregon and Washington and has spread into California and Nevada. Alarm has been manifested by residents of the infected districts, many of whom feared for the safety of their children on the roads to and from school. Efforts several months ago to eradicate the disease were unsuccessful because they did not cover wide enough areas. With the government funds recently allotted to this work of fighting the disease, additional men will be hired and traps and poison purchased.

Dept. of Agriculture, Forestry Service

991 NEW MILITARY AMBULANCE IS LOADED QUICKLY

In an attempt to improve the arrangement of military and emergency ambulances so as to facilitate the work of loading and unloading them, a new type of body has been developed which has a number of apparently good points. It is similar to certain Eu-

Contrib + Builder: C. C. Blackmore  
The Dayton Top Improvement Co  
Dayton, Ohio



The Sketch Below Shows Both Tiers of the New Ambulance in Use, with an Aisle Left in the Middle for the Convenience of an Attendant. When It Is Necessary This Arrangement Permits Wounded to be Given Attention While the Machine Is in Motion.



Below, the Body is Shown Closed. The Lower Portion of the Side Consists of Canvas and may be Buttoned Back Quickly, While the Top Half is Opened Out and Supported Like an Awning. Food and Fuel Storage Compartments are Provided at the Rear End.



From the Drawing Above It may be Seen That Wounded may be Loaded into the Car from Both Sides at the Same Time, While Access to the Interior is Given from Both the Front and Rear of Machine. The Method of Raising Stretchers to the Upper Tier is Illustrated Below.

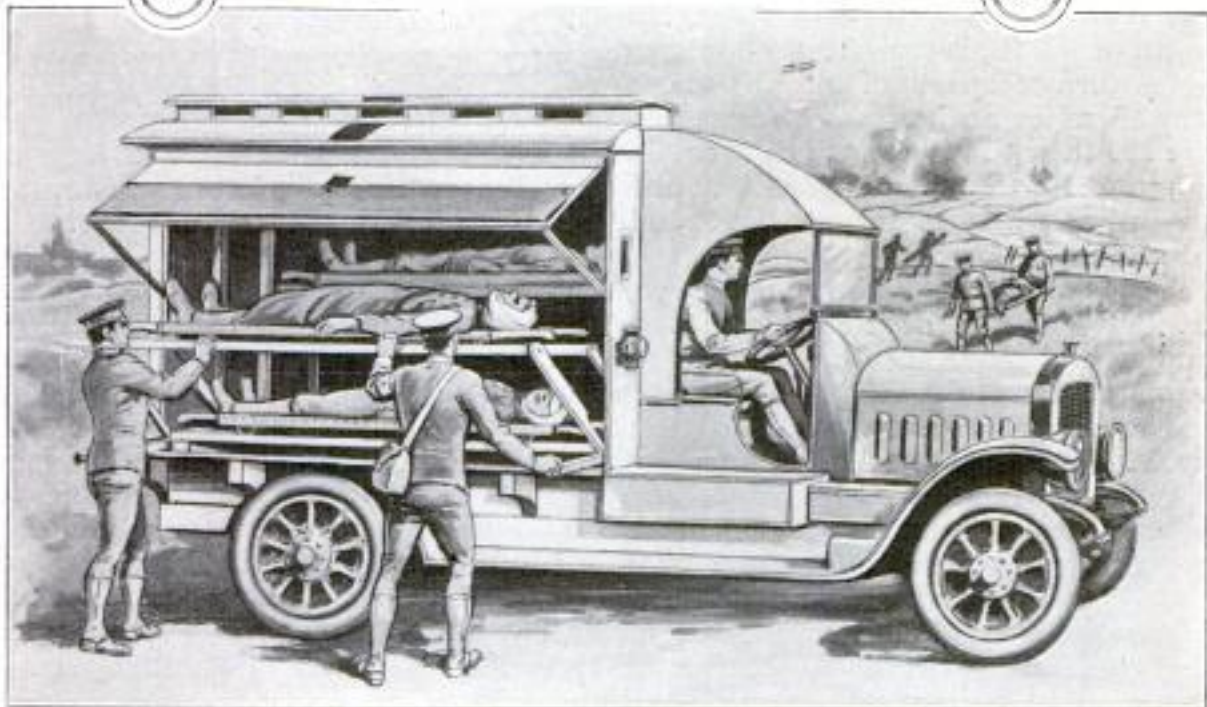

ropean ambulances in that access to the interior is given at either side of the car. It is designed with two decks. The upper of these is built in two sections, each supported on folding arms that enable it to be let down level with the lower tier. In loading, this permits a stretcher to be placed in the upper frame, while the latter is at a convenient height, and then pushed into position with comparative ease. Obviously this is much easier for both the patients and ambulance attendants. Doors are placed fore and aft, per-

mitting an attendant to enter the ambulance compartment from his seat beside the chauffeur while the car is in motion, as well as from the rear at other times. The roof is built similar to that of a street, or railroad, car and is fitted with a series of ventilators. Storage compartments are provided at the rear and also near the front on each side for food, medical and surgical equipment, and an auxiliary supply of fuel. The arrangement permits wounded to be loaded into the ambulance from both sides at once.

### NAVY'S LATEST SUBMARINE PUT THROUGH TRIALS

Tests which apparently proved very satisfactory were recently made in Cape Cod Bay, off Provincetown, Mass., with the "M-1," the latest and largest ocean-going submarine so far completed for the United States Navy. The boat has a guaranteed cruising radius of 3,500 miles and is said to be capable of covering a 5,000-mile course without stopping to replenish either its fuel or supply stores. After one of its early trials, during which it spent four hours in a choppy sea, it was declared by its commander to be the best submersible flying the American flag.

The "M-1" represents the first of a new type of craft. It has an over-all length of 185 ft., is capable of maintaining a surface speed of slightly more than 18 miles an hour, is designed to dive 150 ft. with safety, and can remain submerged for a period of 72 hours. It is armed with four torpedo tubes and a deck gun.

The engines are of the Diesel type, but have been developed in this country and modified in an attempt to overcome the faults found in those of similar design used in the European navies. The two engines together develop approximately 900 horsepower, while the electric motors which drive the craft when it is submerged give about 700 horsepower. The arrangement of the boat differs somewhat from the "Holland" boats and embodies a new form of hull construction.

*Underwood & U. H. 17,*

The cruising radius and high surface speed of the "M-1" will enable it to be used more effectively than former models. In this connection the recent tests were watched with particular interest, because the "M-1" closely resembles the fleet submarine "Schley" which is now under construction. The latter craft is of a still more formidable pattern, for when completed it will have a length of about 265 feet, a displacement of approximately 1,000 tons, and will represent an expenditure of nearly \$1,350,000. It will have a surface speed of about 23 miles an hour, which will enable it to operate in conjunction with a fleet and possibly even take the place of a torpedo-boat destroyer.

*1056*

### LIGHT-SENSITIVE MINERALS OPEN NEW DOOR TO SCIENCE

The element selenium has long attracted considerable attention because of the peculiar effect light exerts on its electrical conductivity. Scientists have now discovered that copper oxide has properties similar to selenium. Another mineral recently put in the same class is stibnite, an antimony mineral. Other materials, such as sulphur, shellac, paraffin, and anthracene, a coal-tar product, will also exhibit odd conductivity effects under the influence of light, but to a lesser degree. Keen research in this class of substances is being carried on in a great many scientific laboratories throughout the world.

*5th av., New York*

*A. H. Stephens  
Scientific Laboratory  
137 3/4 St. Louis  
St. Louis, Mo.  
St. Louis, Mo.  
St. Louis, Mo.*



The "M-1" under way: The latest and largest under-water fighter of the United States Navy

It is capable of making a surface speed of 18 miles an hour and dives 150 feet safely

BRICK DWELLING MODELED AFTER INDIAN WIGWAM

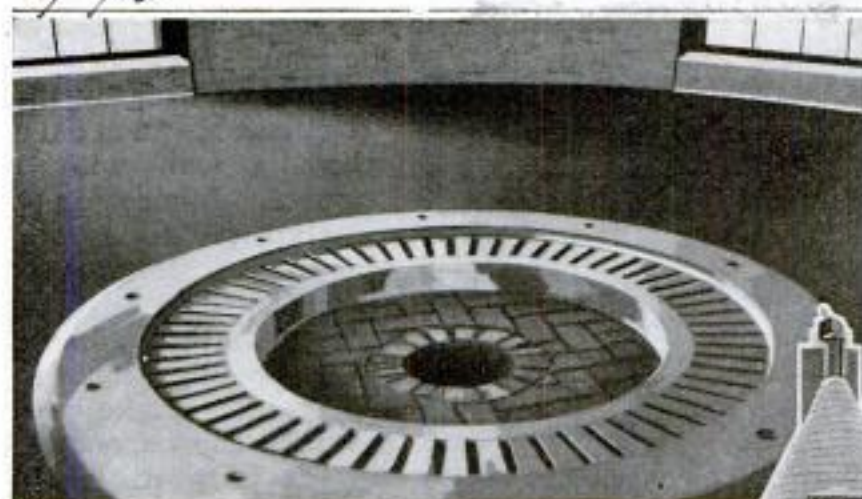

The Circular Fireplace in the Middle of the Teepee House at Dover, Massachusetts, is Shown at the Left. The Smoke Rises in a Slender Column to the Top of the Cone-Shaped Ceiling, Where It Passes Out through a Flue. The Appearance of the Brick Dwelling from the Rear is Presented in the Photograph in the Lower Corner at the Left, While Immediately Below is Shown the Front Entrance of the Place

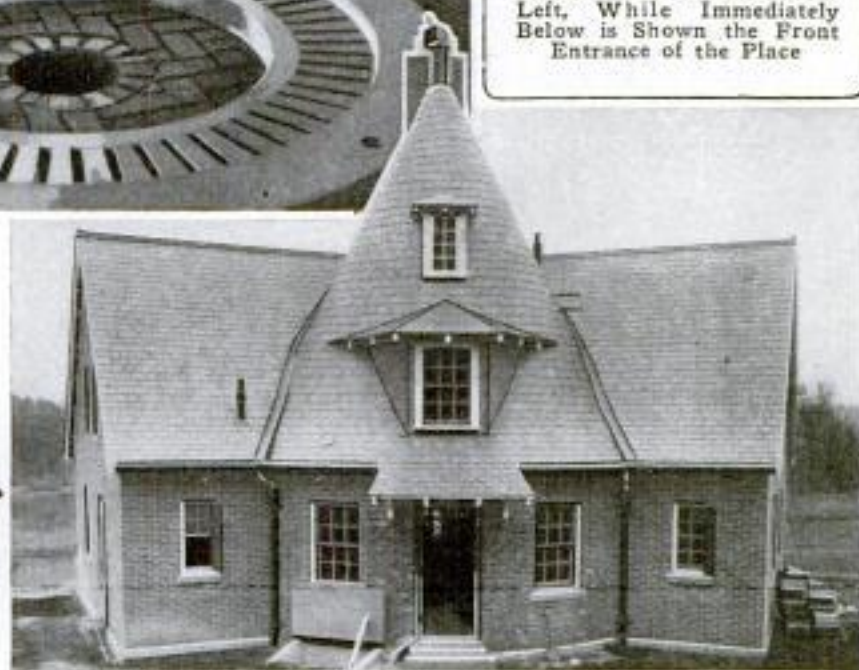

"The Minor Teepee"

One of the queerest-looking houses in Massachusetts is a brick residence at Dover, now nearing completion, which architecturally represents a modern adaptation of an Indian teepee. It has been designed according to the rather fantastic ideas of a Bostonian who has embodied in it several odd features.

The central part of the building is conical in shape and flanked on either side by wings which are a story and a half in height. The circular section forms two-thirds of the residence, and the interior consists of one large room, 24 ft. in diameter. In the middle of its red-tile floor is a circular fireplace which might easily be mistaken for the base of a gun turret or a mounting for a heavy turbine. Air forced up from the basement passes through a grating, margining the inner circumference of this, and creates a draft which carries the smoke to the

peak of the room, 32 ft. above the floor, where it passes out through a flue. The tapering ceiling is finished in very dark blue to represent the sky. This is bedecked with tiny stars, showing the various constellations as they appear at night on March 18.

The rest of the building is heated electrically. This system is controlled by a master switch in a bedchamber, enabling the rooms to be thoroughly warmed, the kitchen range heated ready to prepare breakfast, and plenty of hot water stored before the occupants arise. When the house is to be left for an indefinite period during cold weather, the closing of the front door directs current to an electric apparatus which keeps the water in all of the pipes lukewarm while the owner is absent, thus preventing the plumbing from being injured by freezing temperatures. The house has attracted much attention because of its architecture.

1019  
**MINE BLAST IS FOLLOWED  
BY UNEXPECTED RESULTS**

Events of unusual nature followed an attempt at blasting in a Kansas



Volumes of Smoke and Dust Issue from Shaft When Dust Unexpectedly Explodes in Kansas Mine

mine recently. Electrical means had been employed to fire off a minor charge, or two, when suddenly a reverberating explosion occurred, much

greater than that caused by an ordinary small stick of dynamite, and affecting all the main passageways and shafts of the mine. Persons near the mouth were knocked over by the concussion, among them a man with a camera. Quickly jumping up, he seized the instrument and trained it on the sheds over the mine shaft. Almost instantly huge volumes of black smoke appeared, the aftermath of a dust explosion which had caused the unexpected concussion. The man's quick action resulted in his securing an excellent picture, out of the ordinary both in its subject matter and in the quick thinking necessary to

secure it. Fortunately no one was killed in the accident. The miners were off for the afternoon, celebrating the recent arrival of pay checks.

818  
**MERCHANT COVERS CRACK IN  
WINDOW WITH SALE SIGN**

A large plate-glass window in a Chicago department store was accidentally cracked down its whole length recently. The beauty of displays within the window was seriously marred by the disfigurement, and another window of like size could not at

once be obtained. What to do in the matter was something of a puzzle. Finally a solution was reached by planting a long sale sign directly over the crack. Being of stiff material, the sign securely hid the fracture, and made the window appear whole. In this manner interest of a passer-by was centered on the display within rather than on the fractured glass.

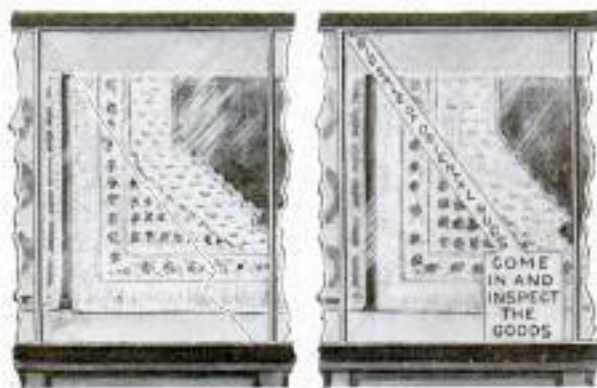

Disfiguring Crack in Window Covered with Sale Sign, Thereby Diverting Attention to Display Within

1054  
**METERS ARE AFFECTED BY  
NEIGHBORING CURRENTS**

In an effort to settle definitely just what effect the proximity of heavy electric currents has on the registration of electric meters, an eastern power company recently made extended tests. As a result it was determined that meters on a control panel, or other switchboard, should be set at least 15 in. apart, kept away from iron

*Alexander H. Revell Esq.  
Adamo & Wabash*

*Metropolitan  
Electric Co.,  
Reading, Penna.*  
Copyrighted material

girders, or the like, and the leads run in horizontally from the left side. In the tests conducted, it was found that a cable carrying 600 amperes at a 12-in. distance from a direct-current meter, affected its accuracy 50 per cent on light load. The same cable and current, only two inches away but tilted at a different angle, had no effect. Again, a 300-ampere, direct-current meter would not register on less than 50 amperes, due to an interfering field offered by an adjacent current. A meter's own leads would seriously affect its readings if placed in certain positions. The tests were illuminating as to why certain meters in the company's service had been reading high or low.

### ELECTRIC CROSS REVOLVES

#### 1060 ABOVE CHURCH

A very striking variation of the usual types of electric signs which are now quite generally used by churches to call attention to their location, is a revolving illuminated cross erected above a church in San Francisco. This cross is lighted by electricity and

makes two revolutions a minute. At night it attracts attention for long distances and presents a very beautiful appearance. It was the invention of one of the members of the church which it adorns.

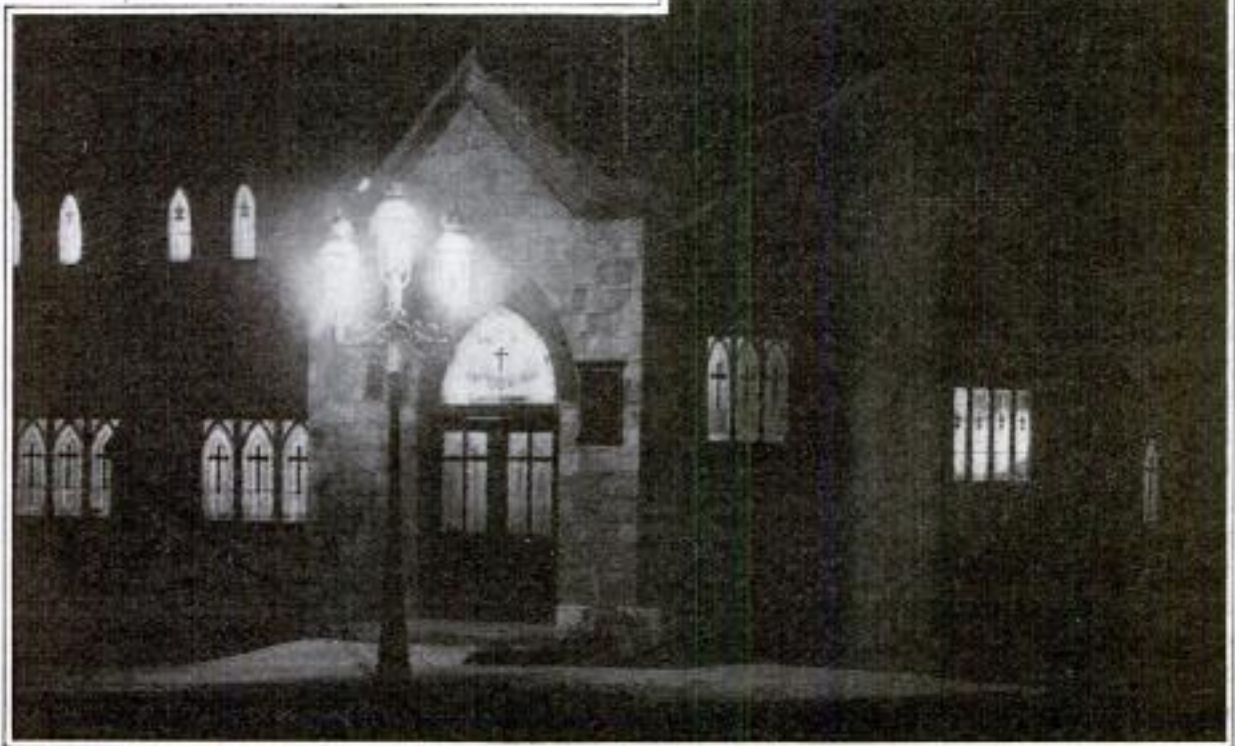

This Electrically Lighted Cross above a San Francisco Church Revolves Twice Every Minute

*Calvary Methodist Church*



High Wind Overthrew This Flagpole, from the Top of Which, in Winter, a Signal was Displayed to Show the Condition of the Skating

### RHODE ISLAND FLAGSTAFF 1030 FELLED BY GALE

A high gale recently blew over and broke a 150-ft. flagpole which had long been a landmark in Providence, R. I. The site from which the broken staff has now been removed was the second occupied by the pole. Formerly a large red globe on the top of the staff was lighted, in winter, when the skating was good, thus furnishing welcome information to thousands of Providence young people. A careful examination of the photograph shows that the top of the pole struck the billboard on a building across the street. The red globe, which was 1 ft. in diameter, crashed through the roof below.

Hot water from a hose was employed recently to release a wheelsman from a pilot house of a lake boat in which he was imprisoned by a coating of ice which had accumulated during a storm.

### TAKING THE MEASUREMENTS 97' FOR SPECIAL GUNSTOCK

In making guns to order for individual sportsmen, an adjustable form is being employed which permits the proper measurements for a special stock to be readily determined. Men of different statures require various lengths and types of stocks, and this device enables a pattern to be tried before an order is rendered to a factory. It consists of a stock quite of the usual shape, but so arranged that the top edge may be raised or lowered and the butt extended and tilted to different angles by turning a series of screws sunk in the body of it. After the desired pattern has

been obtained in this manner, its dimensions are taken with a special steel measure which resembles an adjustable square. In this way the finished stock meets the requirements

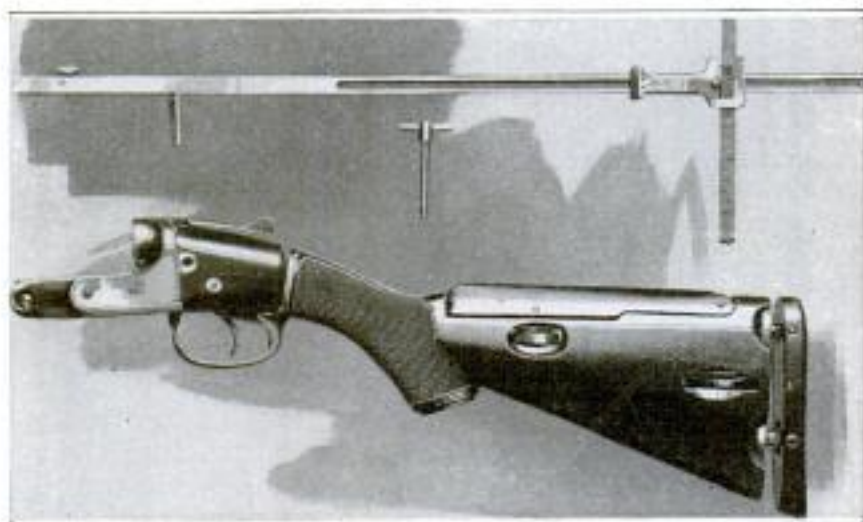

By Making a Few Adjustments the Proper Pattern for a Stock may be Determined

of the man for whom it has been made, just as a tailor-made suit fits a person better than stock garments.

*Parker Gun Co.  
Meriden, Conn.*

# MUSIC FROM THE AUDION LAMP

By LEE DE FOREST, Ph. D.

*"In all my work with the audion—and I can imagine no device in the whole realm of practical physics of greater fascination than this little instrument—I have never found any phase of its unlimited possibilities quite so interesting as this, the production of musical tones. The idea of producing beautiful tone effects by an entirely new method, unknown to all our great composers and perhaps offering to future musicians new fields for their genius, is alluring. I hope ere long to produce an instrument along these lines, sufficiently developed so that it can be turned over to musicians to work out the thousand and one details of perfection which such men alone are capable of achieving."—Page 198.*

IT may be, I believe, a matter of general interest to understand in brief the development of a vague idea from the most rudimentary form up to the various applications which already have revolutionized our methods of communication, and which still holds possibilities beyond our imagination to limit.

In the year 1900, in Chicago, when I first began experimenting with wireless-telegraphy receivers, I worked at night underneath a Welsbach burner in my room. I was experimenting then with an electrolytic type of receiver which I believed would have some advantages over the coherer. One night I noticed that whenever I operated the little spark coil, which I was using as the transmitter in my experiments, the gas light over my head dimmed, and brightened again when the spark stopped.

By frequent recurrence this phenomenon forced itself on my attention. I thought that here accidentally, without any premeditation, I had come across a most astonishing discovery; that the electric waves radiating from that spark were actually affecting the light of the lamp above me, and this to a surprising degree. For a day or two I believed that I had discovered something very startling. However, I soon realized that the effect was an acoustic phenomenon, dealing with sound waves entirely, and had nothing to do with the electric qualities of the spark. It was merely the effect of the sound waves of that spark on the gas in the mantle. I found later that I could obtain the same effect on the mantle by clapping my hands or jingling a bunch of keys!

Though disappointed to find that this "discovery" was not such, it had nevertheless set me thinking. I was determined now, that there was, hidden in that incandescent mantle or flame, a principle or phenomenon whereby the electric waves did produce some change—if not in the light of the lamp, then perhaps in the ability of the flame to conduct electric currents. I thought and studied with that idea tucked away in my mind for two years.

In 1902 I was first able to secure actually the effect I had been looking for, in a Bunsen gas burner, which I used for the first time then as a detector for wireless-telegraph signals. It was a very crude detector at first, but it proved that the principle existed. I applied for a patent at that early date. In 1903 I recommenced these experiments, and obtained a fairly sensitive receiver with a gas flame. In 1904 I had developed the idea to a point where the sensitive gas should derive its heat not from a gas flame but from an incandescent filament, where one would at once get away from all the troubles attendant on gas lamps and flames. When the first incandescent lamp "responder" was tried out it was found that, in addition to its convenience, its sensitiveness was also very much increased. In 1905 I obtained a device that showed much greater sensitiveness than that of any detector of that period. My assistant, Mr. C. D. Babcock, who was my constant and indefatigable helper through all this early work, suggested the beautiful and very appropriate title of "audion" for the incandescent-lamp detector. The word "audion" is made up of two derivatives: "audio," to hear, and "ion";

ions being the carriers of the electric charges traveling inside the exhausted vessel, by whose agency the electric current traverses the gap between the hot and cold electrodes. That word "audion" has been widely used ever since, as applied to this type of detector. These ions, or electrons, migrating all the time from the hot filament to the cold plate sealed within the lamp, impelled by the potential of the battery in the external circuit, carry the current through the telephone receiver, which is also in the circuit with that battery.

The current-carrying properties of these ions—their electric activity—depended, I found, to a remarkable degree on the electric stresses set up in any way whatever within the bulb. It occurred to me, therefore, that if I should insert another electric conductor near or between the filament and the plate, and then lead the exceedingly weak electric impulses from the received wireless signals to that third electrode, I might obtain an increased effect in the telephone receivers connected to the cold-plate electrode. Here then was the beginning of the audion as we know it today, the use of that intermediate electrode. This third electrode was originally put outside, then built in the form of a grid bent back and forth in zigzag fashion, and put in the lamp between the filament and the plate. Immediately I obtained an enormous increase in the sensitiveness in the bulb; the "grid" electrode is the secret of the extraordinary sensitiveness of the audion. And that grid electrode has ever since been used in all forms of the audion or "gas relay." A little later, when I began my experiments with the wireless telephone, the audion, having proven itself to be far more sensitive than the other types of detector which had been employed in wireless telegraphy, was exclusively used; adopted, in fact, by almost all experimenters in that new field, because the wireless-telephone signals are at best very faint, and one needs the most sensitive detector possible for that purpose.

But to resume; in 1908 I discovered that in addition to being a detector and relay of high-frequency wireless waves, this little audion was also an amplifier of telephone currents. I took an ordinary telephone line and by putting in resistance cut down the strength of the current until the voice was below audibility—too faint to be understood. Then, leading that weak current to the grid and the filament of the audion amplifier, and connecting my telephone receiver as before between the plate and the filament of the amplifier, I found an increase (at first very slight) in the current in the telephone receiver. This telephone repeater was crude at first, but later developments, carried on particularly in California, showed that it could increase the volume of the voice currents 10 and even 20 times; so that we could get loud telephonic speech through the audion from voice currents which were originally too faint to be detected, or at least to be understood.

In 1912 this audion amplifier was brought to the attention of the engineers of the American Telephone and Telegraph Company, who had been for many years searching for an adequate amplifier, or repeater relay, for their long-distance telephone lines. The telephone repeater was a problem on which telephone engineers had been working for 10 or 15 years, without obtaining satisfactory results. Many mechanical amplifiers, or telephone repeaters, had been built, involving the utmost mechanical ingenuity, but they all used the same principle, that of a telephone receiver talking into a telephone microphone.

In order to make that device sensitive it was necessary to use the most careful adjustments, and those adjustments, it was found, would not remain constant any length of time. Changes of temperature in the room, or changes of atmospheric pressure, would cause that delicate adjustment to fail so that the device required constant attention, or "nursing," by expert assistants or operators. Thus, as a practical wire-



telephone amplifier, this electric-mechanical repeater had proven itself a most costly failure. Various engineers of the telephone companies had spent very many thousands of dollars in attempting to develop the telephone amplifier.

When I brought the audion amplifier to the attention of a well-known electric manufacturing company's engineers in 1912 I was really amused at the skepticism with which they received the device. They had heard about the audion amplifier, but apparently had never succeeded with it in an experimental way.

I took to them a device which was very much like this instrument, which is illustrated here, not in such a finished form, but with one, two, and three audion lamps. I showed them how, with a telephone receiver—an ordinary Bell telephone receiver—as our transmitter (which everyone knows

is a very deaf kind of a transmitter) in connection with one audion bulb only, one could hear in another high-resistance telephone receiver the faintest whisper. If I whispered in the phone very faintly one could hear perfectly clearly a whisper in the other telephone receivers—sounds which, if one merely connected a cell in circuit between the two telephone receivers, one used as transmitter, the other as receiver, could not be heard at all. Then I connected in a second audion bulb, so that the amplified currents of the first audion went in the second, and then had the telephone engineers listen to the telephone connected to that second bulb. They

now found that this receiver used as a telephone transmitter, became actually "microphonic," so that by hanging it a few inches above the floor they were able to hear the sounds of a typewriter in an adjoining room, 30 feet away, where without the audion amplifier the telephone receiver was absolutely deaf to such sounds. Then by going one step farther and putting in a third bulb, they found an amplification of sound from several hundred to a thousand times in magnitude.

We have then at last a practical telephone repeater,

without moving parts, and one which possesses a sensitiveness unlike anything possible with moving mechanical parts. You can readily understand that. Here inside this bulb we have an exhausted atmosphere containing "ions," which are pieces of fragments of molecules of gas, or electrons, which are, if you

like the term, "atoms of electricity." You can't conceive anything finer, or smaller, or more intangible than those ions or electrons—those little invisible things which are flying back and forth and being affected in their excursions by the slightest electric charge which comes in on the grid. They are the little things that do the work. Comparing that little lamp with an ordinary telephone microphone and receiver is like comparing a soap bubble with a load of coal! When you are dealing with matter of this intangible character you will easily understand how a scientist might obtain results which are absolutely impossible



to secure with any mechanical arrangement.

The American Telephone and Telegraph Company experimented with the audions which I turned over to them for a year, and then finally approached the owners of the patents for licenses for wire-telegraph and telephone purposes. They secured those exclusive licenses for wire purposes; and within eight months after they had secured the licenses they achieved what they had been vainly striving for for 10 years, a transcontinental wire telephone from New York to San Francisco.

The sound of the unamplified voice from New York is very faint at Denver—Denver was the limit to which it was possible to transmit the voice until the advent of the amplifier. With it, however, there is no limit for overhead-wire line communication. If it were commercially feasible, you could string wires from here to the southern end of South America, putting in a small number of audion amplifiers at various points along the line.

Throughout all the years that the audion, first as wireless detector, then as telephone amplifier, was being developed, new and interesting facts were discovered. I will cite one or two instances:

In my early attempts to use the audion amplifier as a telephone repeater for standard circuits, where it was necessary to amplify the currents coming from both directions on the line, it was observed that the audion would set up alternating currents in these lines. These alternating currents became in fact very troublesome at times, setting up loud and persistent singing in the telephone receivers. The impulse of the original transmitter currents in the "grid" circuit of the audion would of course cause similar but intensified currents in the "plate circuit." But in a "two-way" telephone line it is essential to associate the incoming and the outgoing circuits through the two windings of a transformer. Then I found the impulse in the "plate" circuit would react through the trans-

former on the "grid" circuit, and this secondary impulse on the grid would again cause another amplified impulse in the "plate" circuit. Thus the audion and its two circuits, inductively associated, became the seat of persistent alternating currents which were in my telephone experiments a nuisance until special means were employed to suppress them, or prevent the system from "oscillating."

As an alternator, or source of undamped electric currents, however, this audion system offered most interesting possibilities. First of all, for low-frequency work, it was observed that the pitch of the note in the telephone receiver could be easily and simply varied by changing the capacity of the inductance in the circuits. This can be done very easily by a sliding contact, or simply by turning the knob of the condenser. In fact the pitch of the note can be changed by merely putting the finger on certain parts of the circuit, or even by holding the hand close to parts of the circuit. In this way very weird and beautiful effects can be easily obtained.

At the earlier stage of these investigations I found that the pitch of the note could also be varied by a simple resistance arrangement, such as a graphite-pencil mark on a piece of paper connected between parts of the circuit, and that this afforded the most ready means of altering the pitch and quality of the notes. I found it would be a comparatively simple matter to arrange a crude scale similar to that of an organ, with switches in place of the ordinary keys, so that by pressing certain keys I could cut out, or in, more or less inductance, or capacity, or resistance, thus changing the notes emitted from the telephone receiver, at will.

In order to bring the volume of sound out large and full in the room it was necessary to connect a number of loud-speaking "reproducers," similar to telephone receivers provided with horns. With these distributed in different parts of the laboratory, or grouped together in one place, the

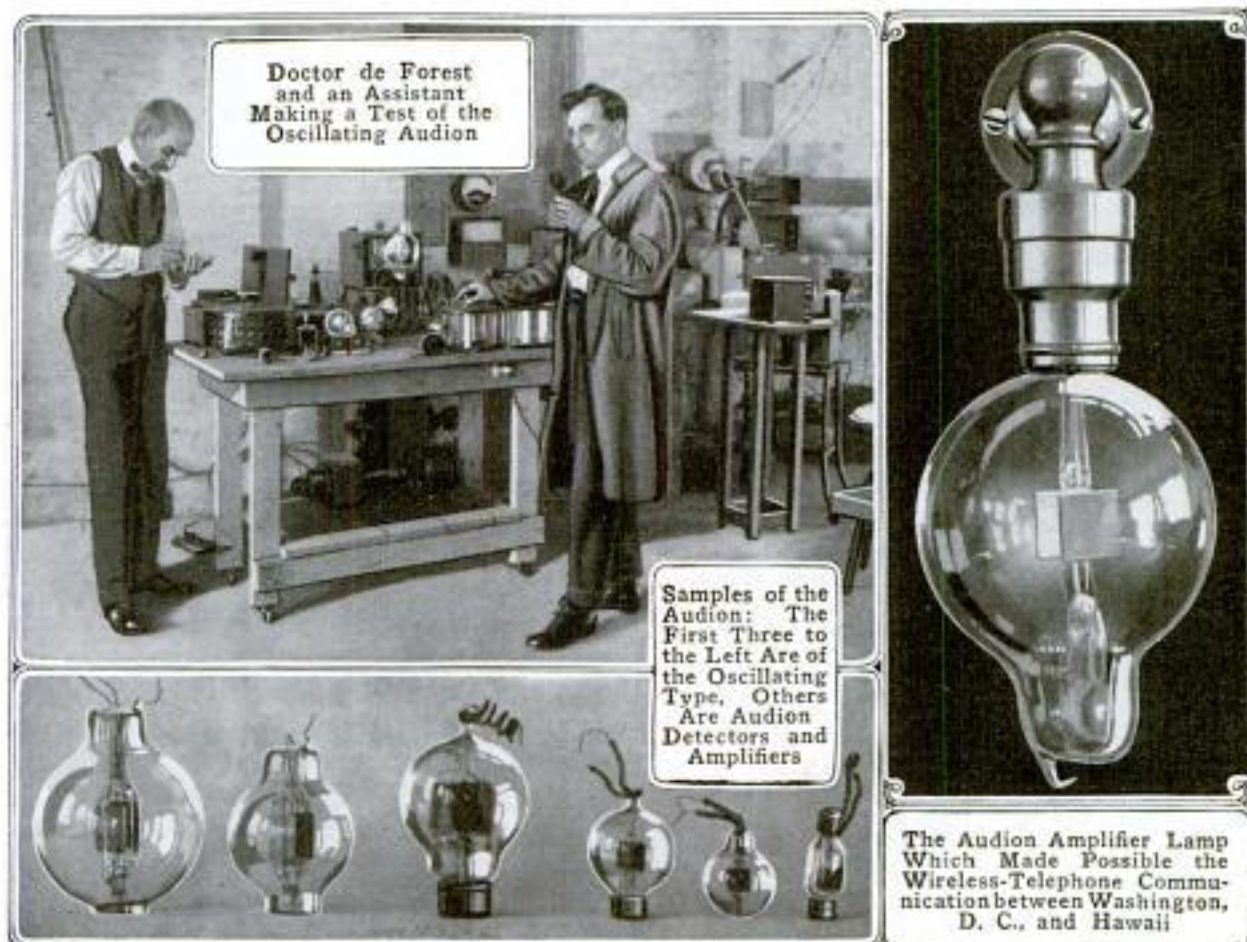

sound was made to emanate from all quarters of the room or from one corner, as desired.

Under certain conditions I found that the quality of the notes obtained from the telephone receivers connected to the "self-impelling" audion, as just described, could be made very pleasing to the ear, or weird and raucous—in fact, that the sound produced could take on an endless variety of qualities, imitating, say, that of a flute, reed-wind, or stringed instruments. With audion bulbs as large as three inches in diameter very intense sounds can be produced—ample to fill a large auditorium.

Several years ago, it will be remembered, an elaborate undertaking was launched for producing music from a large number of electric alternators, "mixing" the "tone currents" from the hundred or more machines in accordance with the wishes of the skilled performer, who in that way produced musical tones of large volume from telephone reproducers, and which sim-

ulated those of almost every instrument in an orchestra. The idea was to generate this music at a central station where highly trained organists were constantly at the keyboard, and distribute it through telephone wires throughout the city to hotels, restaurants, lobbies, concert halls, and private residences. The plan was most meritorious and deserved success. But the heavy cost of the original plant, the maintenance of the telephone cables, etc., rendered it commercially a failure.

Now with the audion or incandescent lamp as a generator of musical tones we have on a small scale all of the possibilities of the large telharmonium. Each audion bulb with its associated oscillating circuits becomes the equivalent of such an alternator, as a source of sustained pulsating currents, but at a tithe of the cost, bulk, and weight of the alternator machine. Moreover, whereas a given alternator could produce but one note of definite pitch and quality, the audion circuits can be readily changed so as to alter the pitch and

quality of the note emitted by the telephone reproducer. Graduations in sound volume can be easily controlled simply by increasing or decreasing the resistance in the circuit which lights the filament.

Where chords are to be sounded—several notes emitted simultaneously—it is preferable to use one audion for each separate note struck. Ten separate bulbs then could produce any ten notes which can be simultaneously struck by the hands of a player. Imagine each key of a piano then controlling, not a separate oscillating circuit, but a certain predetermined amount of resistance or capacity in such a circuit. If these resistances are correctly proportioned, all the various notes of the musical scale can be in this manner produced.

The alternating currents from all the bulbs are made, through the medium of the transformers, to act upon one set of telephone reproducers, so that the total energy in the form of sound is that of all the bulbs which are operated at one time.

You have doubtless all heard the peculiar plaintive notes of the Hawaiian ukulele—or mandolin—produced by the players sliding their fingers along the strings after they have been set in vibration. Those notes have not a definite pitch, but their pitch is made to vary through several notes while sounding. Now this same effect, which can be weirdly pleasing when skillfully made, can be obtained with the musical audion. It is simply necessary to vary slightly and continuously the capacity of a small "variable" condenser in one of the circuits associated with the audion while the note is sounding.

That is just one instance of the many possibilities in the use of the oscillating audion as a musical instrument. My experiments in this field, although but cursory thus far, convince me that in this new method lie developments and resources which will require the richest imagination of musical composers to picture.

In all my work with the audion—and I can imagine no device in the

whole realm of practical physics of greater fascination than this little instrument—I have never found any phase of its unlimited possibilities quite so interesting as this, the production of musical tones. The idea of producing beautiful tone effects by an entirely new method, unknown to all our great composers and perhaps offering to future musicians new fields for their genius, is alluring. I hope ere long to produce an instrument along these lines, sufficiently developed so that it can be turned over to musicians to work out the thousand and one details of perfection which such men alone are capable of achieving.

It was discovered years ago, then, that in addition to being a detector and relay of high-frequency oscillations from the incoming wireless signals, the audion became under certain conditions a generator of electrical oscillations. Why then could it not be used, not merely as a detector, a receiver or amplifier, but as a generator or transmitter? It was recognized that if the audion generator could be made larger and could generate larger power, we would have a substitute for the spark—the noisy, clumsy, irregular spark—or for the very costly high-frequency alternator for wireless-telegraph, or telephone, transmission.

During the last two years the audion as a generator has been increased in size and power until, a few weeks ago, by its aid the voice was sent by wireless from Arlington to Honolulu—a distance of over 4,000 miles. Here we have the latest, and almost unbelievable, triumph of the audion, a bulb containing those three elements always, the hot filament, and the two cold electrodes, the plate and the grid.

Let me briefly describe the method used in the Arlington tests. First, we have a small oscillating audion or oscillion, with a microphone transmitter associated with its "grid" circuit. In its "plate," or output circuit, we have sustained high-frequency oscillations, the amplitude, or magnitude, of which is modulated in accordance with the voice currents controlled by the small

"master" microphone which is associated with the "grid" circuit. This high-frequency telephone current is led to the grids of several other larger oscillating audions, connected in parallel, and thereby amplified and sent out from the "plate," or output, circuits of those larger bulbs. Then the amplified oscillating energy from this second group of bulbs is again led to the "grid" electrodes of another, still larger, group of oscillating amplifier audions, and so on; until after three

or four successive amplifications, we have sufficient oscillating energy, all controlled by that first small bulb and small microphone, to put 50 amperes into the big antenna at Arlington, and to be heard a quarter way around the globe. It is, you see, merely a gigantic audion-amplifier system.

But think of the expense of this method. Six hundred bulbs, costing some \$15 each—\$9,000 to \$10,000 worth of lamps, to be renewed every month! It is a wonderful "stunt."

### SNOW QUICKLY REMOVED WITH STEAM HEAT

A convenient and efficient means for quickly disposing of piles of snow which frequently obstruct city streets following a heavy snowfall, has been employed by an eastern hotel. A long narrow box made of rough lumber and mounted on low wheels is fitted with a steam pipe which extends along the bottom of the box. This pipe is connected with a steam plant in a near-by building. Workmen then shovel the snow into this box instead of into a wagon. The steam-heated pipe rapidly

melts the snow, the water running off into the sewer through holes in the bottom of the device.

### MAID OF ORLEANS STATUE ERECTED IN NEW YORK

With an appropriate ceremony which was attended by a number of prominent persons, among whom was the French ambassador to Washington, a large bronze statue representing Joan of Arc was unveiled recently at Riverside Drive and Ninety-Third Street, New York. The work shows the armored figure of the Maid of Orleans,



Snow Shoveled into This Steam-Heated Box Melts Quickly, and So is More Easily Disposed Of Than by Use of Wagons and Teams

COPYRIGHT, UNDERWOOD & UNDERWOOD

417

5th Av. New York

mounted astride a powerful charger, swinging aloft a heavy sword. Aside from its artistic qualities, the statue holds interest in the fact that the mas-

*Sculptor*

*Anna Vaughan Hyatt*



Figure of Joan of Arc Which was Recently Unveiled on Riverside Drive at New York

sive pedestal supporting it was chiseled from stone taken from the prison walls at Rouen. It will be remembered that it was at that place that the girl champion of France was imprisoned and subsequently burned at the stake as a heretic, after being captured at Compiègne and sold to the English by the Duke of Burgundy. Another significant thing is that a section of a shell-scarred pilaster from the Rheims cathedral was incorporated in the base. It was through Joan of Arc's successes at Orleans and Patay that the coronation of Charles VII at Rheims was made possible at a time when the French nation was passing through a great crisis.

### CLINICAL BUILDING SOLELY FOR STUDY OF DISEASE

A new clinical building which will perform many functions of a hospital, but which will be maintained primarily for the scientific study of human diseases in patients themselves, is to be erected by the University of Illinois for its College of Medicine. Only such patients will be admitted to this institution as in the judgment of the faculty will furnish data for interesting and profitable first-hand study. Granting, of course, that the interests of patients shall be fully safeguarded, inmates will be permitted to stay only so long as their cases supply material for scientific study. Thus some will soon be turned over to regular hospitals and others will remain indefinitely. A difficulty which nearly all medical schools in this country labor under is that they have no hospitals absolutely under their control where diseases may be studied under such regulations as those proposed for this establishment.

### SIGHT FOR ARMY RIFLE SET FOR TOO LONG RANGE

*A. N. Journal 10/16/15*

One of the fruits of the brief but practical experience which United States soldiers have had in connection with recent Mexican affairs is the discovery that apparently the battle sight of the Springfield rifle is gauged for fighting at too long range. The rear sight is so arranged that when the leaf lies flat the weapon is sighted at 530 yd. This is called the battle sight. Using this sight on an object 200 yd. distant, the trajectory, or curve, of the bullet carries it 28 in. above the object aimed at. The idea of the rifle designers seems to have been that most of the fighting would take place at about 500 yd. But in Texas and Mexico the distance to the enemy is more often likely to be from 50 yd. to 300 yd. Instinctively a soldier aims at an object, not above or below it, hence considerable ammunition is wasted when rifles are improperly adjusted.

# ENTHRONEMENT OF JAPAN'S EMPEROR AT KYOTO



INTERNATIONAL FILM SERVICE, INC.

Out of Respect for Their Age, the Oldest Inhabitants of Kyoto were Provided a Special Inclosure from Which to View the Arrival of the Imperial Cortège at the Sacred City, Where for More Than a Thousand Years the Rulers of Japan have been Enthroned

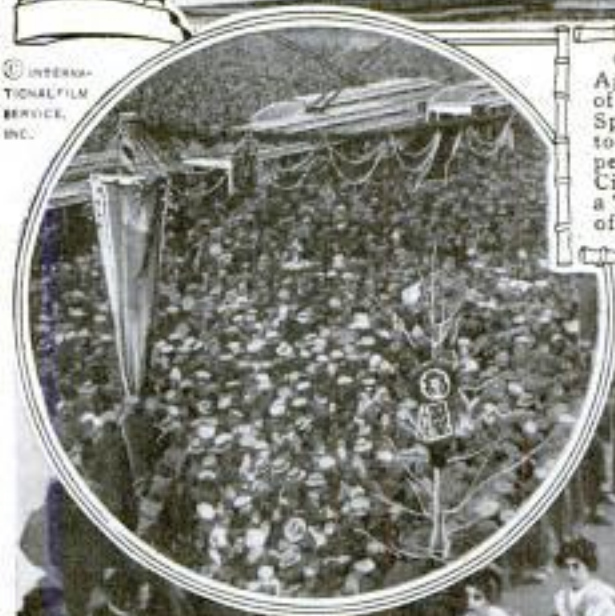

The Ancient Forms are Observed in the Enthronement Ceremonies. This Shows the Shrine, Containing the Imperial Treasures, the Sword, Mirror, and Jewel, Which was Escorted to Kyoto by the Emperor



In the Land of Cherry Blossoms the Geisha Girl Always Fills a Charming and Picturesque Place. This Group of Young Misses, Wrapped in Gay-Colored Little Costumes, is Shown in a Brilliant Ceremonial Procession. The Insert Above Gives a Glimpse of the Great Throng Gathered before the Palace at Tokyo before the Departure of the Emperor for Kyoto



COPYRIGHT, INTERNATIONAL FILM SERVICE, INC.

## FALLEN BOULDER WRECKS

1068 MISSOURI FREIGHT

While traveling at a high rate of speed around the side of a steep bluff,



The Engine, Tender, a Flat Car Loaded with Heavy Lumber, and an Oil Car were Hurlled over the Side of This Steep Bluff

a fast freight of a Missouri railroad was wrecked near Bronson, Mo., when it crashed into a boulder that had fallen onto the track a short time before. The engine, tender, a flat car loaded with heavy lumber, and an oil car plunged over the side of the bluff, the engine almost reaching the bed of the river below. The engineer and fireman, who stuck to their posts, were found alive in the engine cab, but died shortly after. The head brakeman and a tramp were killed. The accident occurred at four o'clock in the morning.

1150

## ELECTRIC-HEATING SYSTEM

### ECONOMIZES CURRENT

*Htg. & Vent. Mag. Dec '15*

What is pronounced one of the most complete electrical installations which has ever been made in a private residence has been placed in a 10-room frame dwelling in Spokane, Wash., for the purpose of comparing the cost of electric heating with wood and coal heat. It is recognized that with ordinary methods electricity would cost much more than these fuels, and also that the heaviest light load and heat load would occur at about the same

*see Apr 1915*



An Oil Car was Completely Overturned on the Side of the Embankment and Rested Precariously above the Other Wreckage





An Eastern Hotel has Added an Ice Rink to Its Equipment, Which Promises to Make Skating as Popular as Dancing

COPYRIGHT, UNDERWOOD & UNDERWOOD

time of the day. Hence this system now being tried stores reserve heat so that the current can be shut off from 5 P. M. to 9 P. M. It consists of an auxiliary plant attached to the hot-water system already in use. A transformer in a fireproof vault reduces the line voltage so that it can be taken by the switches, heaters, etc. The hot-water heaters have a capacity of 32 kw., and are divided into units of 1 kw. each. Two thermostats control the system. One is centrally located on the main floor and controls the water supply to the radiators. The other is attached to the boiler and governs the heat of the water in the boiler in order to store heat when the full heat is not required by the radiators. A clock mechanism cuts off the heaters when the station is carrying the heaviest load.

#### ICE SKATING FOR GUESTS HOTEL'S NEW PASTIME

A wholesome novelty in indoor sport which promises to become very popular is skating on ice rinks which form a part of the equipment of high-class hotels. A fashionable eastern hotel

*Hotel Biltmore  
New York*

which made an ice rink for its guests early in the winter is believed to have started a movement which will extend to many other cities. Roofs or ball-rooms can be transformed for the winter pastime; by the use of artificial lighting such rinks are made available at night as well as in the day. The popularity of this new departure in skating may equal that of the tango.

#### 1119 — SUMMARY OF YEAR'S DEATHS DUE TO AERIAL ACCIDENTS

*C. Palmblad*  
According to what are unquestionably incomplete statistics, 107 airmen and passengers met death as the result of aeroplane accidents during 1915. This number includes a few fatalities that occurred in the previous year but were not reported until after the first of January a year ago. While many of those embraced in the casualty list were military fliers, their deaths were due to accidents and not to conditions directly attributable to the war. Army airmen killed in action at the front are not considered as among those who died because of aeronautic mishaps.

The toll of American lives reached 14, three of whom were passengers;

one, a newspaper correspondent, who was killed during a flight with Lieutenant Warneford in England. The most prominent of the group was Lincoln Beachey, who was killed at San Francisco while attempting to make a spectacular dive in a very light and poorly braced monoplane.

The deaths reported in other countries were: Argentina, 3; Belgium, 5; Bulgaria, 2; Chile, 1; Denmark, 2; England, 28; France, 29; Germany, 8; Italy, 6; Sweden, 3; Japan, 5, and one in Spain.

Germany's fatalities, as shown here, are undoubtedly only a part of those that actually occurred. Aeronautical papers of that country reaching America have contained no mention of accidental deaths among airmen, and the only figure available is compiled from casualties reported by French, British, and American correspondents. No data whatever has been received from Russia, Turkey or the British possessions, where some accidents surely must have happened. It is useless even to guess at the number of fliers who were

killed in the war zones. For some time French aeronautical journals attempted to publish lists of fallen airmen, but were finally forced to give up the idea. British aviation papers have enumerated some of that country's losses, but the figures have been too uncertain to be used as a basis for an estimate.

Adolphe Pégoud, the Frenchman, was one of the most famous fliers known to have been killed in action during the year. In addition to other distinctions, he was the first airman to loop the loop. Bruno Langer, the German who during the early part of 1914 made two record duration flights, one of 14 hours and the other of 16 hours, also met death in the war. Reports have been circulated from Vienna that the Russian designer, Sikorsky, was killed in action in Galicia. This rumor is probably unauthentic, as it has been repeatedly contradicted in dispatches from other places. Prominent in the German list of accidental deaths is also the name of Anton Klubel, the inventor of a material used in rendering the wings of air craft transparent.



BOAT BOUND FOR ALASKA HITS HIDDEN ROCK

WHILE steaming up what is called the "inside passage" on its regular run to Alaskan ports, the steamship "Mariposa" struck a hidden rock near McLaughlin Bay, B. C., and became badly damaged. All the passengers were safely transferred to other steamers. The accompanying illustration is from a photograph taken shortly after the accident. A salvaging crew succeeded in floating the boat off the rock, after which it was repaired. The inside passage is used daily by many boats plying between Seattle and Alaska.

BURIED SHELLS FOUND BY INDUCTION BALANCE

1040



This Instrument Detects the Presence of Shells or Other Metal Buried in the Soil, Thereby Enabling the Farmer to Remove Them before Tilling a Field

*faculté de Nancy.*

The tilling of French fields, recently the scenes of battles, has proven so dangerous a task because of numerous unexploded shells found in the soil, that a French professor has devised an instrument by means of which shells or fragments may be detected even though imbedded in the soil as deep as 16 in. This instrument is an adaptation of the induction balance and consists essentially of a bamboo rod at the end of which is a wooden cross arm which supports at either end a coil having a primary and secondary winding. These coils are carried over the battle field by an attendant who holds them close to the earth. He is followed by an observer wearing a head receiver, similar to those worn by telephone operators. This is connected with the coils by wires. Other parts of the observer's apparatus are a dry-cell battery, condenser and interrupter, etc. When the coils come close to an

iron or steel object a buzzing sound is produced in the receiver. Experienced men can differentiate between sounds produced by shells and by fragments; their depth also can be calculated. It takes a little over an hour to explore an acre.

1144  
**DISPERSED GUNS BETTER THAN BIG COAST FORTS**

*Int. U. S. Art. Nov-Dec '15*

Experience in the present war, notably at Liège and Antwerp, has led many military experts to the conclusion that coast-defense guns should not be concentrated in forts, but dispersed and concealed. Howitzers of 12 in. and over are pronounced preferable to other guns. Money spent on ordnance is more effective than money spent for armor; light shrapnel-proof, splinter-proof shields for such ordnance being regarded as sufficient.

## IN WAR-STRICKEN SERBIA, A LAND OF RUIN



Many Refugees Returned to Their Homes upon being Assured of Protection by Teutons



In the Retreat before the Austrian and German Armies, Trains and Every Other Available Means of Transportation were Crowded to Capacity



Fugitives Consisting of Peasants, Mostly Old Men and Young Boys, Taken in Custody by German Military Police. When Captured They were Armed



An Army of War Prisoners Concentrated in Serbian Village Street by Invading Austrian Forces



# WHERE WINTER FINDS THOUSANDS HOMELESS



Native Soldiers, Carrying All of Their Equipment, Fleeing into the Mountains to Escape the Enemy's Superior Force



INTERNATIONAL FILM SERVICE  
Serbian Prisoners, Including Women Captured While Fighting in Trenches, in the Hands of the Enemy

Peasants Who Fled before Invading Germanic Armies Returning to Place Where Their Homes Formerly Stood. They Are without Shelter and Food



One of a Chain of Forts Commanding the Danube Levelled by Austrian Shells after Long Siege

# WHITE-CLAD SOLDIERS WAGE WINTER WARFARE



German Ski Patrol Operating in Vosges: The Men are Taking Aim at the Enemy While Resting Their Rifles in Forks Formed by Crossing Their Skiing Sticks. The White Uniforms Worn by These Soldiers are Almost Indistinguishable against the Expansive White Background



Montenegro Soldiers Swathed in Hooded Cloaks Making Their Way along an Alpine Pass. The Winter in These Parts is Intensely Severe



Members of an Austrian Alpine Patrol at an Observation Post on a Snow-Bound Peak: This is One of the Highest Points to Which the War has been Carried, and Represents an Altitude of 10,500 Feet. Ability to Use Skis Adeptly is a Requisite for Military Service in This Zone

## THRILLING NIGHT BATTLE IN SKY OVER LONDON

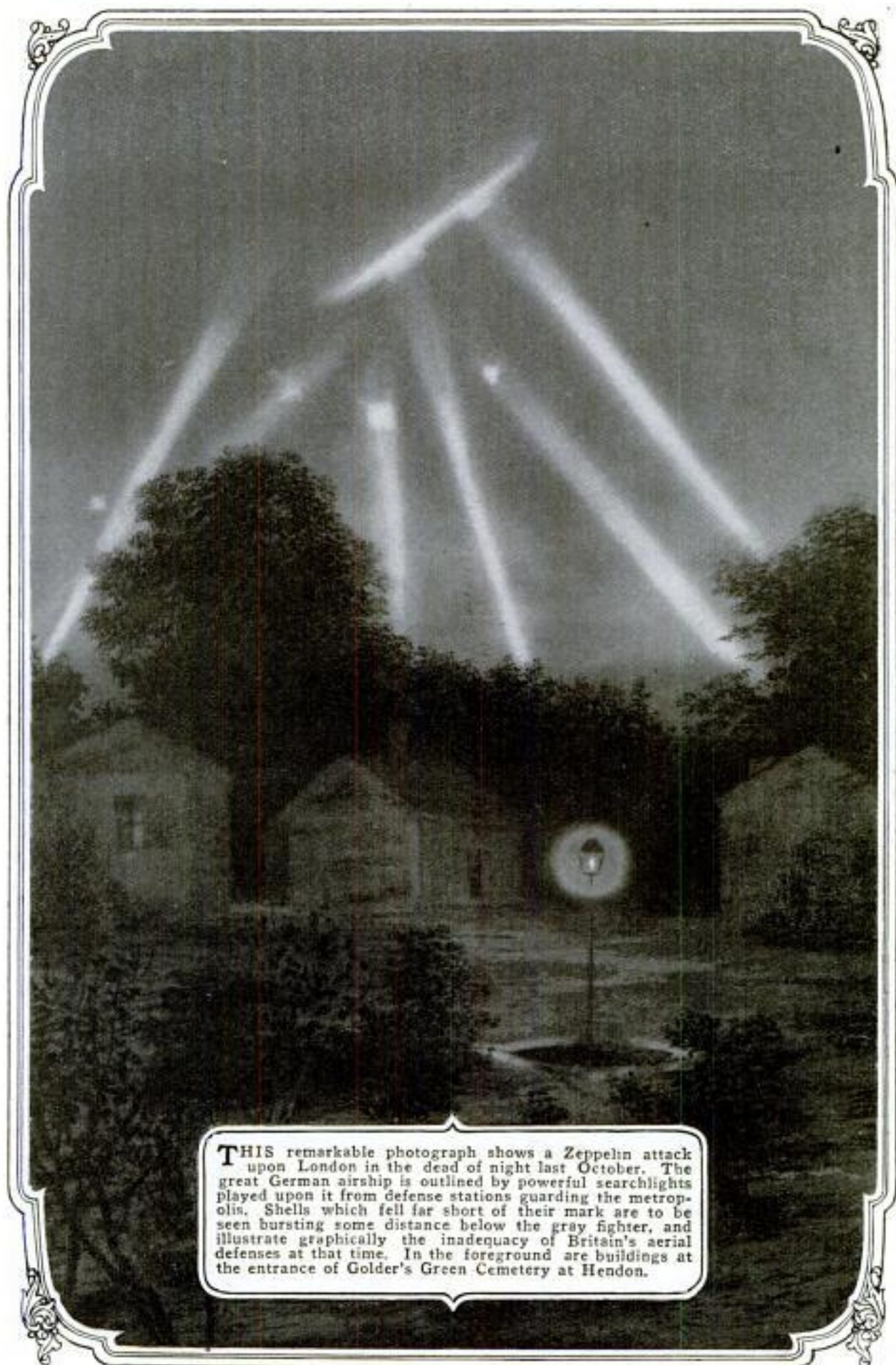

**T**HIS remarkable photograph shows a Zeppelin attack upon London in the dead of night last October. The great German airship is outlined by powerful searchlights played upon it from defense stations guarding the metropolis. Shells which fell far short of their mark are to be seen bursting some distance below the gray fighter, and illustrate graphically the inadequacy of Britain's aerial defenses at that time. In the foreground are buildings at the entrance of Golder's Green Cemetery at Hendon.

## AUSTRIAN FORCES SEEN ON TWO BATTLE FRONTS



COPYRIGHT BROWN & DAWSON

Commodious and Attractive Quarters are Usually Unknown Even to Officers When an Army Is on a March. This Shows an Improvised Shelter Occupied by a Couple of Austrian Commanders during the Drive into Russia.



This Mountain Pass within the Austrian Lines Presents Strikingly the Character of Some of the Alpine Battle Grounds.



Clear, Fresh Water is Frequently Little Less than a Luxury to a Soldier in Time of War. This Shows a Group of Austrian Troops Filling Their Empty Canteens While Passing a Trough on the Isonzo Front.



## WINTER CAMPAIGN IN THE SNOW-PACKED ALPS



One of the Numerous Heavy Mountain Batteries Relied Upon by Italy to Protect the Flanks of Its Army in the Terrific Fighting Which is being Done against the Strongly Fortified Austrian Forces in the Alps



The Thin, Staggered, Black Line Extending Down This Snow-Banked Slope Is a Column of King Emmanuel's Troops Making a Desperate Effort to Reach the Crest of the Mountain, Rout the Intrenched Enemy, and Capture Its Defenses. The Photograph Gives a Vivid Idea of the Character of the Isonzo Front, Where Some of the Most Sanguinary Battles of the War are being Waged

## RUSSIA AND THE WAR AS SEEN BY THE CAMERA



One of Many Large Rafts Which are Now being Used on a Russian River for Transporting Troops and Supplies: It is Made of Heavy Timbers and is Capable of Carrying a Very Heavy Cargo



COURTESY OF L'ILLUSTRATION  
Approximately 300 Church Bells have been Sent from Invaded Parts of Russia to the Nikolsky Monastery near Moscow to Save Them from the Enemy. Each is Labeled with the Name of Its Church



One of the Czar's Motorcycle Squads at Rest beside a Large Old Windmill Somewhere in Russia at the Front. On the Landing at the Top of the Stairs is a Lookout

## LANDING HEAVY ARTILLERY AT DARDANELLES



**T**HE artist shows in this sketch one of the ways in which the allies some time ago carried their artillery pieces and field equipment ashore for operations against the Turks on the Peninsula of Gallipoli. The big guns were lifted from vessels held in deep water off shore, leashed to rafts, which had been especially constructed for this purpose and heavily ballasted with bags of sand, and towed in by tugs. When only one gun was taken aboard a raft the rest of the available space was used for carrying one or two large army wagons. The ballasting was done primarily to safeguard against the guns rolling and breaking loose.

# INTIMATE GLIMPSES BEHIND FRENCH LINES



French Machine-Gun Battery at the Front: When the War Began France's Army was Inadequately Provided with These Important Instruments, but of Late This Condition has been Materially Ameliorated



After the French have Taken a German Trench, Troops Rush Ahead with These Entanglements and Quickly Provide a Temporary Defense against Counterattacks



Allied Trench in the Champagne District within a Stone's Throw of the German Positions. Large Quantities of Hand Grenades are Lined along Wall of Excavation



The Value of France's New Helmets is Indicated by These Headgears Which, Although Battered by Shrapnel, Saved the Lives of Their Wearers

## SHOWING CONDITIONS IN WESTERN THEATER



First Line of Belgian Trenches in the Western Theater, Where the Enemy has been Held for Months. Graves of Some of the Fallen Line the Ditch at the Left



A Very Good Idea of the Strength of Some of the Important French Positions is Shown by This Broad, Heavily Reinforced Trench Somewhere along the Extended Firing Line



Badly Wounded German being Carried by a Fellow Prisoner into a French Camp under Guard. Many of the Captives of Both the Teutons and Allies are Wounded When Taken in Charge

## GERMANS REBUILD BRIDGES RAZED BY RUSSIANS

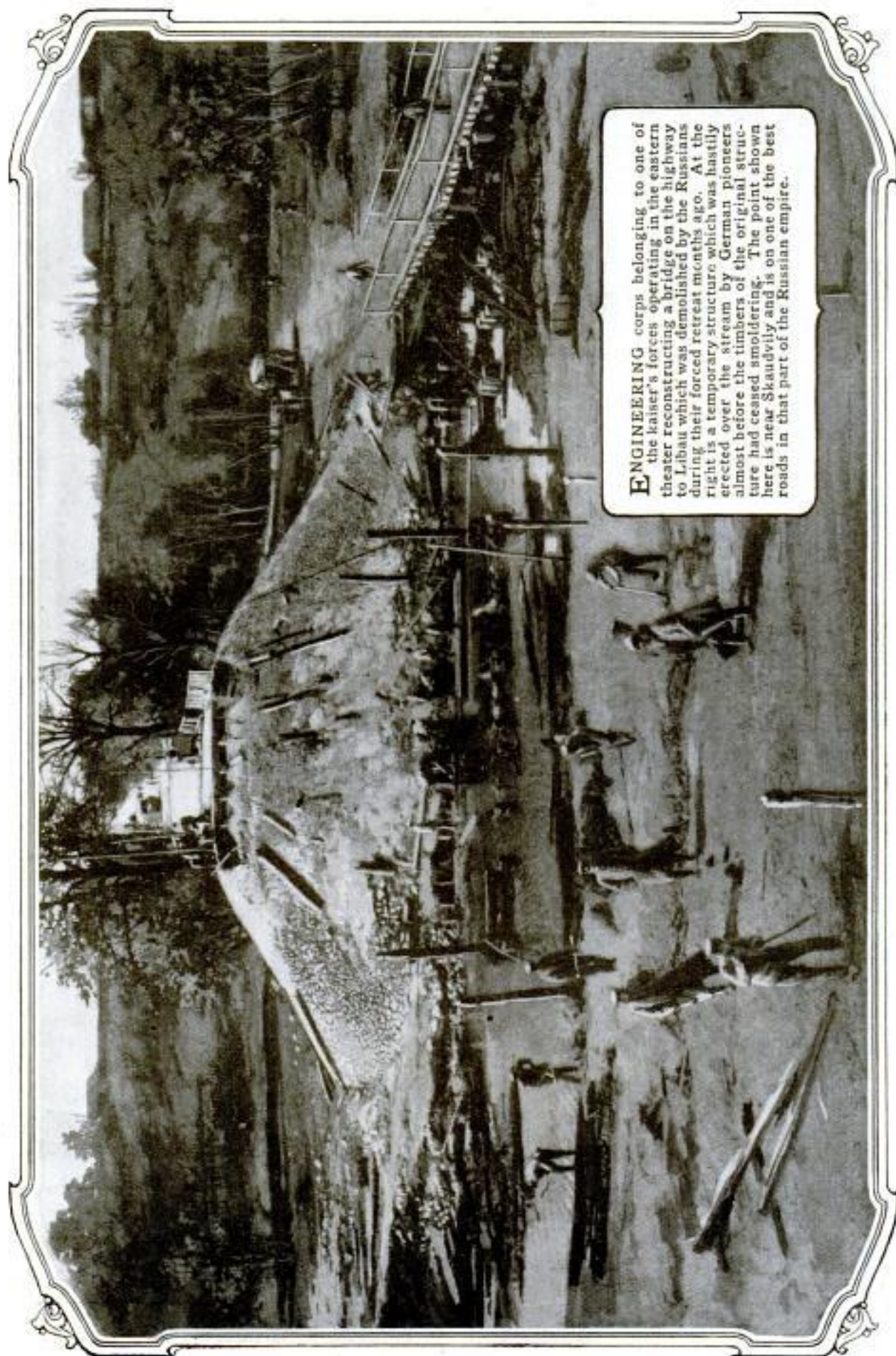

**E**NGINEERING corps belonging to one of the kaiser's forces operating in the eastern theater reconstructing a bridge on the highway to Libau which was demolished by the Russians during their forced retreat months ago. At the right is a temporary structure which was hastily erected over the stream by German pioneers almost before the timbers of the original structure had ceased smoldering. The point shown here is near Skaudvily and is on one of the best roads in that part of the Russian empire.

# NAVAL MINES AND TRENCH TURRETS OF GERMANS

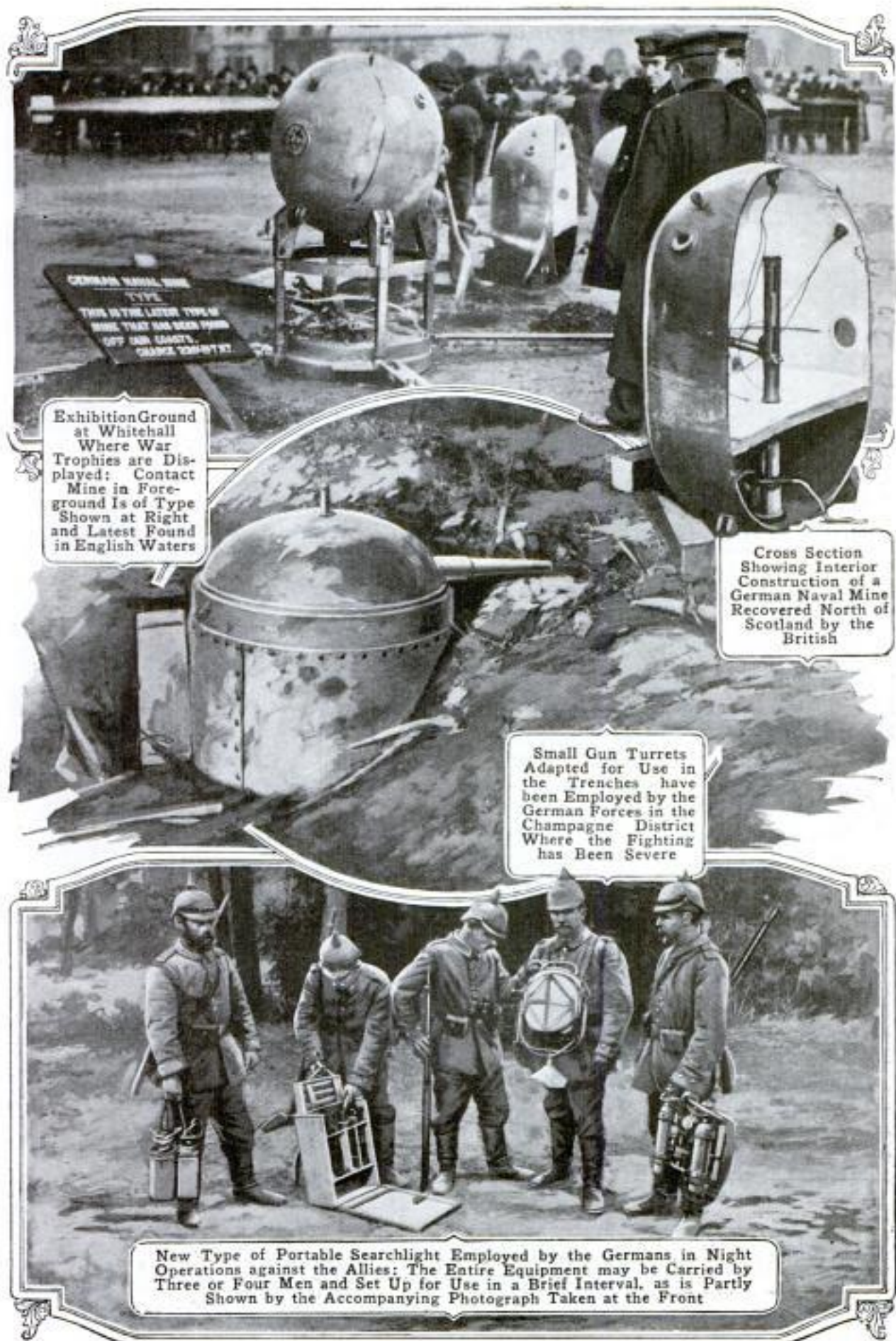

Exhibition Ground at Whitehall Where War Trophies are Displayed; Contact Mine in Fore-ground is of Type Shown at Right and Latest Found in English Waters

Cross Section Showing Interior Construction of a German Naval Mine Recovered North of Scotland by the British

Small Gun Turrets Adapted for Use in the Trenches have been Employed by the German Forces in the Champagne District Where the Fighting has been Severe

New Type of Portable Searchlight Employed by the Germans in Night Operations against the Allies; The Entire Equipment may be Carried by Three or Four Men and Set Up for Use in a Brief Interval, as is Partly Shown by the Accompanying Photograph Taken at the Front

## COZY HOUSES ERECTED AT FRONT BY GERMANS



Attractive War-Zone Residence Built by Soldiers for German Officers near Laon in Western Theater. The Roof is Protected against Bombs by an Earth Covering

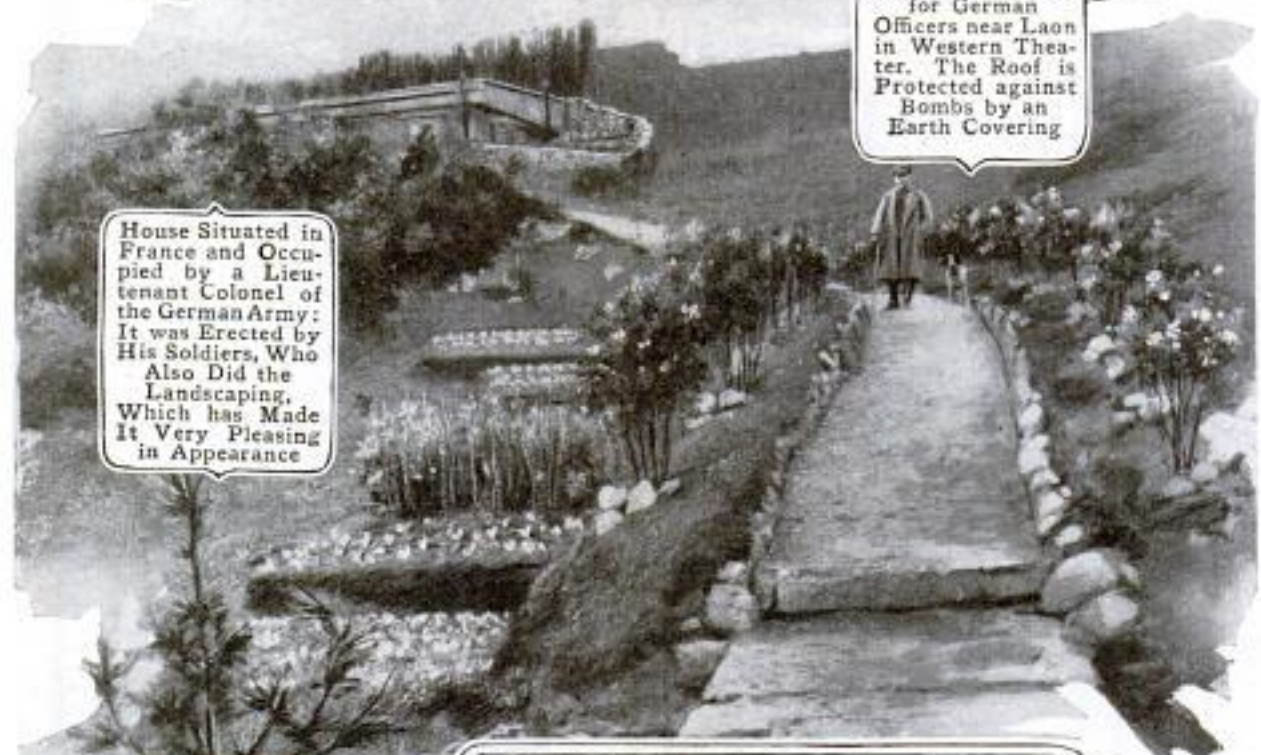

House Situated in France and Occupied by a Lieutenant Colonel of the German Army: It was Erected by His Soldiers, Who Also Did the Landscaping, Which has Made It Very Pleasing in Appearance

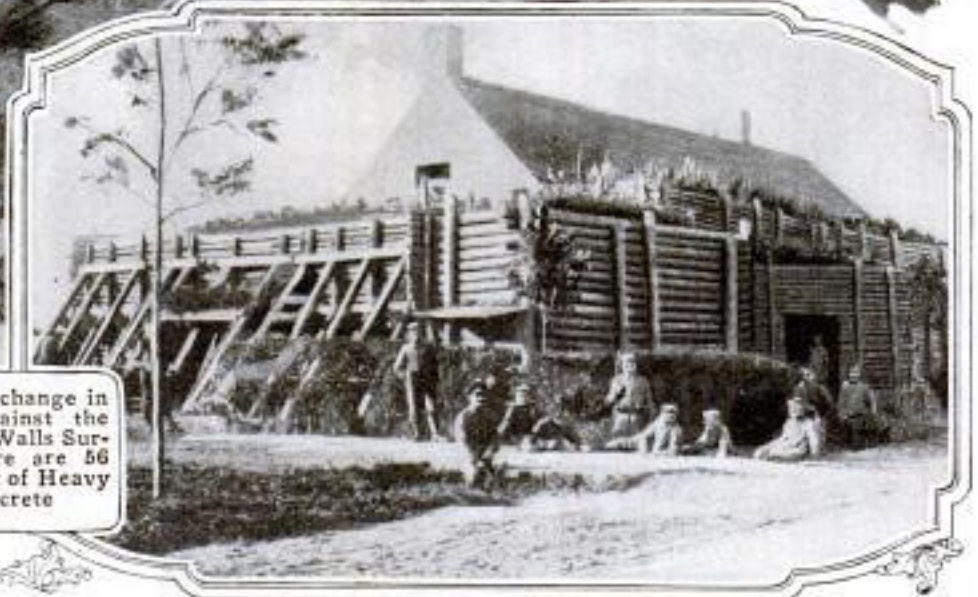

Military Telephone Exchange in Flanders Fortified against the Enemy's Shells. The Walls Surrounding the Structure are 56 Inches Thick and Built of Heavy Timbers and Concrete



## ARMENIAN AND POLE VICTIMS OF EUROPE'S WAR



COPYRIGHT, INTERNATIONAL FILM SERVICE, INC.  
Group of Armenian Women and Girls,  
the Survivors of a Race Which has Met Hideous  
Torture and Slaughter at the Hands of the Turks.  
Although Penniless and without Homes, These  
Refugees Are Free from the Grip of the Moslems



The Name, Birth Date, Residence, and Occupation  
of Every Individual in the Conquered Districts of  
Poland are Being Gathered by the Germans, Who  
are Also Making Tens of Thousands of Group  
Photographs Like the One Shown Here

# ACTIVITIES OF WOMEN AND RED CROSS IN WAR



COPYRIGHT, INTERNATIONAL  
FILM SERVICE, INC.  
Open-Air Garden  
and Comfortable  
Little Huts for  
Wounded Soldiers  
Provided on a  
Roof



Uniforms of  
This Type are  
Worn by  
Several  
Thousand  
French Women  
Who are Assist-  
ing the Army



Light Vehicles Such as This,  
Drawn by One or Two Dogs and  
Carrying a Single Stretcher, are  
Used in Field by French Red Cross



Women and Girls Bearing Portrait  
of Edith Cavell during Public  
Demonstration in London to Raise  
Memorial Fund in Honor of  
Martyred Nurse

## CONSIGNING MUNITIONS TO WARRING NATIONS



Norwegian Merchant Vessel Bearing Its Flag Painted Amidship to Identify It at Sea. The Steamer is Shown Tied Up in an American Port



Guarding One of a Number of Armored Motor Trucks Crated and Awaiting Shipment to Italy



Hundreds of Tons of Copper, Destined for the Use of the French Government, being Loaded for Transportation across Atlantic



Goods Shipped from Holland Bearing Stars and Stripes to Show American Ownership



American-Built Locomotive Boilers Billed for Russia and being Transferred from Lighters to a Freighter Docked at New York

**ROPE LIFE-SAVER USED BY  
9096 GERMANS AT FIRES**

The fire department in a German city has made use of a simple contrivance for lowering people from  
*Fireman's Herald 10/24/14*



Women and Children in Burning Buildings are Safely Lowered to the Ground with This Simple Rope Contrivance

burning buildings, particularly women and children. A portable hoisting apparatus which has a long steel arm that reaches far out over the casing is quickly clamped to a window sill. A rope from the hoisting drum runs through a pulley at the outer end of this arm, and is attached to two straps which are to hold the person being lowered. One of these straps goes around the waist of the person, while the other is fastened just above the knees. In this manner a woman may comfortably be lowered, the lower

strap preventing her skirts from flaring into flames issuing from lower windows.

**SULPHURIC ACID MADE BY  
1094 NEW METHOD**

*Science 12/1/15*  
A new method of manufacturing sulphuric acid, an important advantage of which is a decrease in the cost of constructing the plant in which the acid is produced, has been successfully tried in laboratory experiments, and it is believed that the method will prove desirable for commercial purposes. An essential feature of the new process is that the gases employed are drawn downward through a spiral flue in place of being drawn through the usual lead chambers where certain necessary chemical reactions take place. In this flue the gases are mixed intimately. Its walls may be cooled by water or air, thereby making it practical to maintain the gases at the temperature most favorable for an efficient yield of sulphuric acid. The lead chambers which are displaced by this spiral, which likewise must be of lead, are vast in extent. Since a plant equipped with a spiral flue would occupy much less ground space and would not need as large buildings, nor require quite as much lead, the initial cost of construction would be materially decreased.

**EXTENSIVE ASPHALT BEDS  
1078 IN HONDURAS**

*Chemical Engineer 11/19*  
Extensive deposits of remarkably pure bitumen, or asphalt, have been discovered recently in Honduras, Central America. Preliminary prospects reveal beds of great richness, and there are outcroppings for several miles. Since the region where these deposits have been found is considerably distant both from railroad transportation and an ocean port, it is hoped to employ motor trucks on a model highway which the Honduras government is preparing to construct in this region. If sufficient capital can be interested, it is planned to make connection with the nearest railroad also.

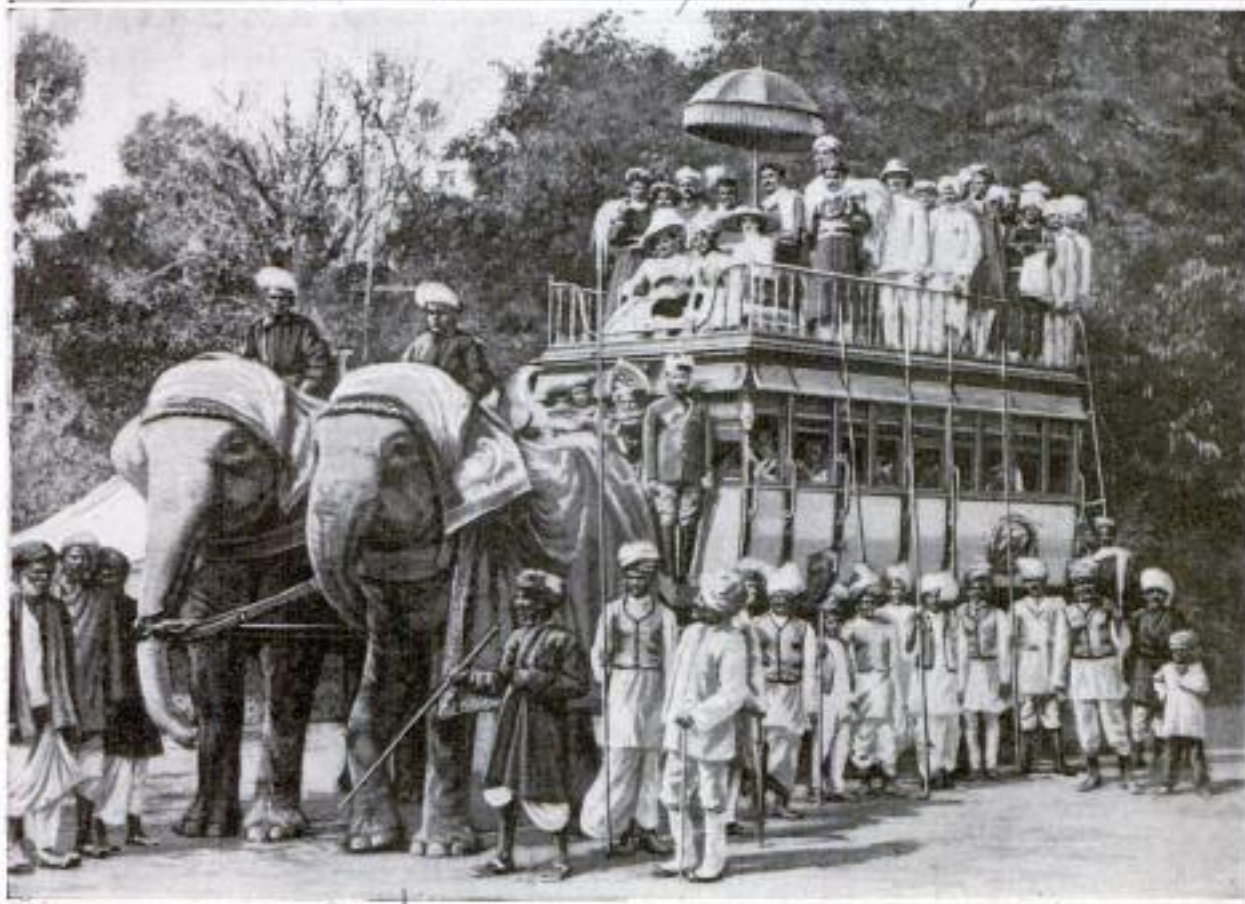

INDIAN WEDDING MARKED BY POMP AND DISPLAY

**T**HE chief of Akalkot, a native state in the Deccan division of Bombay, and his guests at an Indian wedding: The party, consisting of various native and foreign dignitaries and friends, is carried in a large, ornate omnibus drawn by two elephants and attended by the host's personal guard and functionaries. The chief, who is a Mahratta of the Bhonsla family, resides at Poona and derives a pension from the state, which is now under British management.

### USE ICE BOX TO PRESERVE FRUIT IN TRANSIT

Shipping of fruit from the Pacific coast by "pony refrigerator" methods is increasing, according to recent reports. Through the use of refrigerator contrivances, early crops can be transported to eastern markets with little delay, and the high prices current at the beginning of a season obtained. The refrigerators are but substantial ice boxes, with a central pan for ice, and compartments for fruit at the side. They are of such size as to be readily handled in express cars, and because of the rapidity of express service it takes but five days to cross the continent with this method. In addition to fruit, experiments have been made on transporting flowers in the new ice boxes. Early California violets

shipped by this plan a short time ago, arrived in New York in excellent condition. In the fruit line first boxes of spring cherries have sometimes brought as much as \$25.



Fruit Shipped across Continent in "Pony Refrigerator": Boxes of Fruit Bring High Prices at the Beginning of a Season

## CALIFORNIAN BUILDS SWING FOR BOYS AND GIRLS

For the enjoyment of neighborhood children, a Los Angeles mechanic has constructed a large swing with a boat-shaped carriage which is capable of holding eight or ten youngsters at one time. The framework of the contrivance consists of two 40-ft. masts, thoroughly guyed, which support a heavy cross beam. From this, wire cables are suspended to carry the load. By pulling a line attached to the top



of the structure the operator of the swing is able to make it oscillate back and forth, and to a considerable height, with ease.

## TO DEEPEN MINE DESPITE HIGH TEMPERATURE

Conducting mining operations at a level below the earth's surface at which the temperature would be 126.5° F. when the rock was first opened to the air, is contemplated by a mining company in Brazil. Seldom, if ever, have mining operations been attempted in higher temperatures. The depth of the proposed level would be 7,626 ft., but it is estimated that operations could be conducted profitably at that depth and even greater, providing the temperature could be artificially reduced. It is believed that under present arrangements not much more can be done in the matter of increasing the volume of ventilating air. But it has been proposed to pass down into the mine air artificially cooled. Already an air-cooling and drying plant has been

designed, which, it is stated, will effectually remove this one serious obstacle to working the mine at great depth.

## BENZOL OUTPUT INCREASED BY WAR CONDITIONS

Estimates by representatives of the United States Bureau of Mines indicate that in recent months the rate of production of American by-product coke ovens has been raised to approximately 25,000,000 gal. of crude benzol, or light oil, annually—an increase of 150 per cent in about a year. War conditions are given as the reason. It is said that the amount of this product necessary to make all the dyes and refined coal-tar chemicals, except explosives, used in the United States is not over 5,000,000 gal. per year.

## POCKET AMMETER IS MADE IN SUBSTANTIAL FORM

For testing electric batteries, an ammeter has been invented which is designed to withstand rough usage. It is housed in a cylindrical case, at the top of which a graduated tongue protrudes when a contact is made. When not in use a cap is screwed in place to inclose the instrument and make it dirt and moisture-proof. It is capable of registering 30 amperes and is sufficiently accurate for general purposes. Its compactness permits it to be carried in a vest pocket, while it is not injured by being dropped, or by being packed in a kit with heavier tools.



and for older pupils not over 3½ in., according to some school authorities.

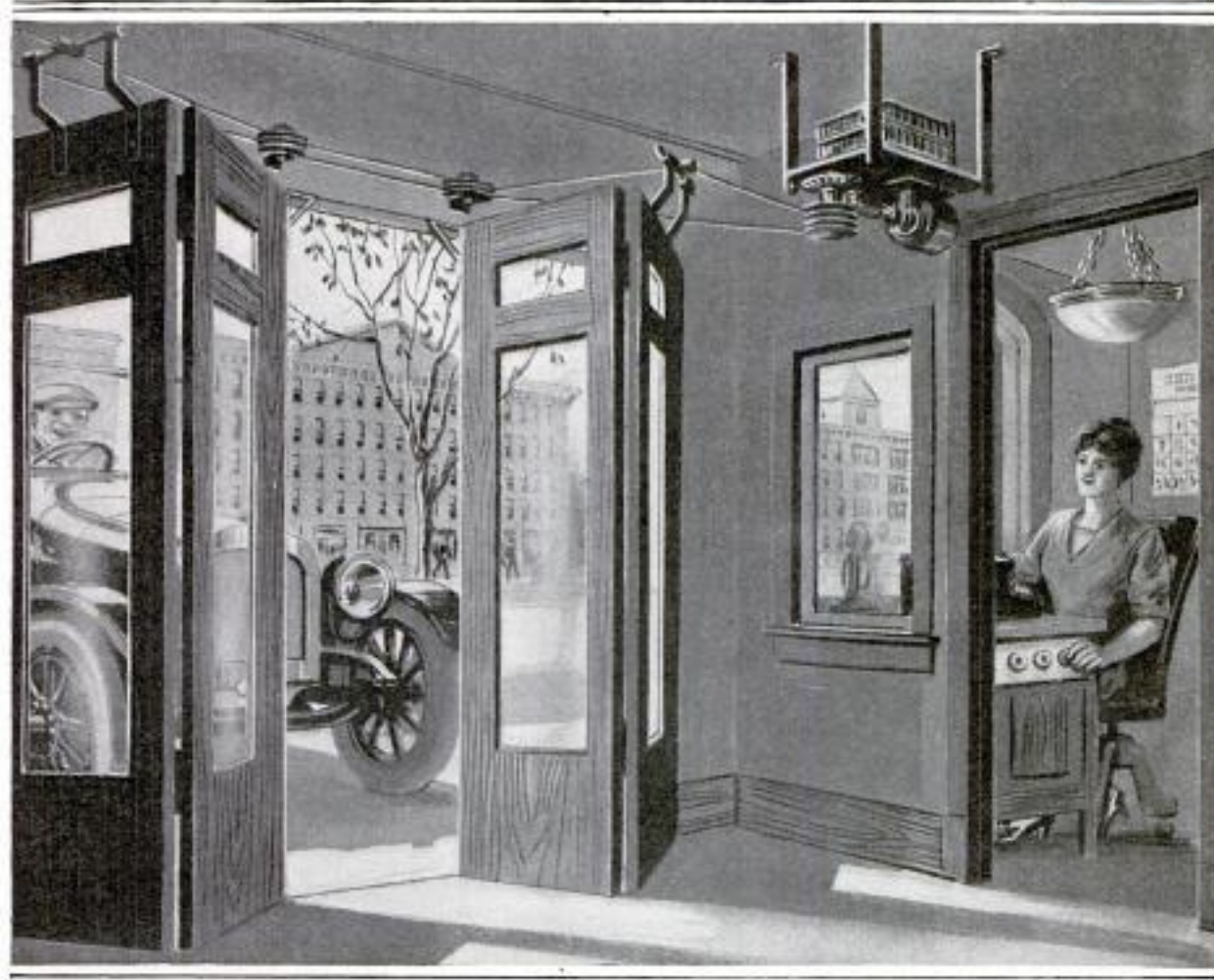

By Pressing a Button the Doors are Swung Back with Dispatch. The Expense of Keeping an Attendant at the Entrance is Eliminated, While Good Service is Assured

**F**OR installation in a public garage, where motor cars are continually entering and leaving the building, an electric apparatus has been devised for operating the doors. It is arranged so that by pressing a button located at a convenient point, the entrance may be opened or closed quickly, thus affording good service to patrons.

The apparatus is comparatively simple in construction, low in upkeep, and moderate in cost. Especially in a large garage, it effects a considerable saving, for it eliminates a door man and does away with the loss of time occasioned by mechanics and other employes leaving their work to answer repeated calls to the doors.

The device, which includes a motor that actuates a drum on which operating cables are wound, is suspended

from the ceiling above the top level of the doors it serves. Three controlling buttons are used. One of these causes the doors to be opened, a second permits the mechanism to be stopped almost instantly, should this be necessitated by an emergency of some kind, while pressure upon the third closes the doors. In other particulars the apparatus works automatically. In opening the doors it is only necessary to push one of the buttons and allow the mechanism to do the rest. The motor stops as soon as the doors are either opened or closed.

When an office is situated at the front of a building, so that a stenographer or clerk is able to see machines approaching the doors from both the outside and interior, or hear their signals, the buttons may be placed on their

desks, as well as at convenient places in the garage proper. While it is especially intended for garages, it is obvious that the apparatus might be installed wherever electric operation of doors or gates is desired.

### NEW BURNER CONVERTS FUEL 752 OIL INTO GAS

With a new kind of attachment that is designed to be installed in a stove or furnace of any type, ordinary fuel

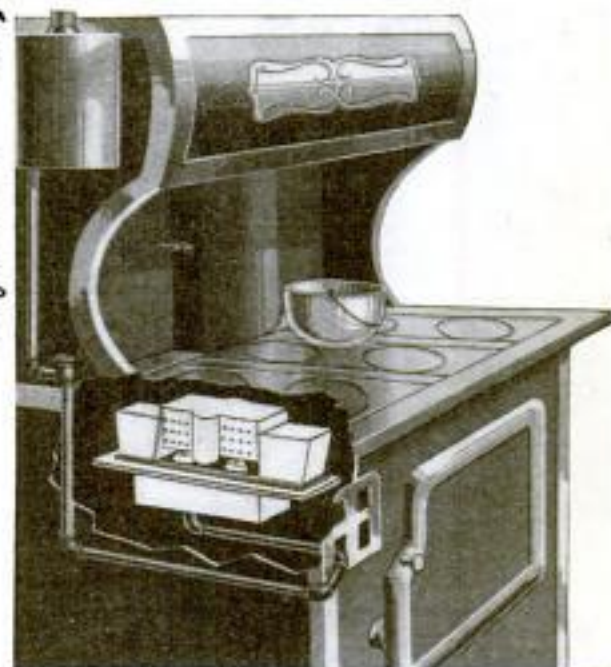

With This Device Ordinary Fuel Oil is Converted into Gas as Needed for Supplying the Burners

oil is converted into gas and in this form is used as a fuel for heating. The device consists of a single casting and is made in several sizes, and in both rectangular and circular shapes to make it suitable for different sizes and types of fire box. It is installed permanently in the fire box and is set in fire clay to prevent any passage of air except through the air ducts provided in the casting. The oil is converted into gas in the base of the burner by the intense heat of the flame. A small amount of air is admitted to the under side of the flame through perforations in the burner, but the greater part goes upward through ducts at the sides of the burner into an air drum, from which it drops directly downward upon

the flame, the burned gases passing out through openings at the sides of the burner and then to the chimney. The oil tank can be located anywhere, the only requirement being that it must be placed at a sufficient height to cause the oil to flow by gravity. For starting the burner all that is necessary is to admit oil to the base of the burner, in which is loosely laid an asbestos wick, and then light the oil. By the time this oil is burned out, there is a sufficient amount of gas started to maintain the flame.

### 832 CONE CLUTCH OF MOTOR CAR RUNS IN OIL BATH

In the latest model of one of the standard motor cars a cone clutch is employed which is completely housed and immersed in oil. In place of the customary leather facing, a stout fabric is used. The purpose of this is to enable a driver to slip the clutch at will, when negotiating rough roads, without fear of burning the facing. In other mechanical respects the clutch is like others of its type, operating by contact against the inner surface of the flywheel. Since it runs in a lubricant, however, the facing is kept pliable and in good condition for uniform friction. A quart of cylinder oil is the normal

A Fabric Facing is Used Instead of Leather and is Kept in a Pliable Condition by Oil

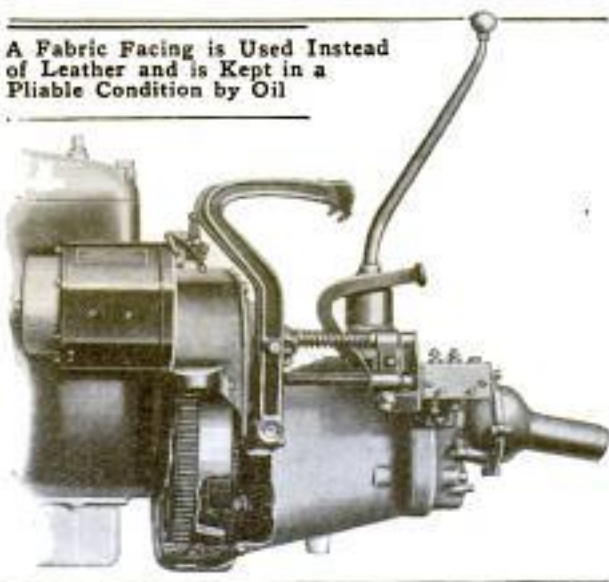

charge used. The housing is designed so that it may be readily removed when it is desired to inspect the clutch.

Maxwell Motor Sales  
Corp. in Detroit, Mich.  
Copyrighted Material

Gloria Light Co.  
1100 - 1104 Washington Blvd., Chicago



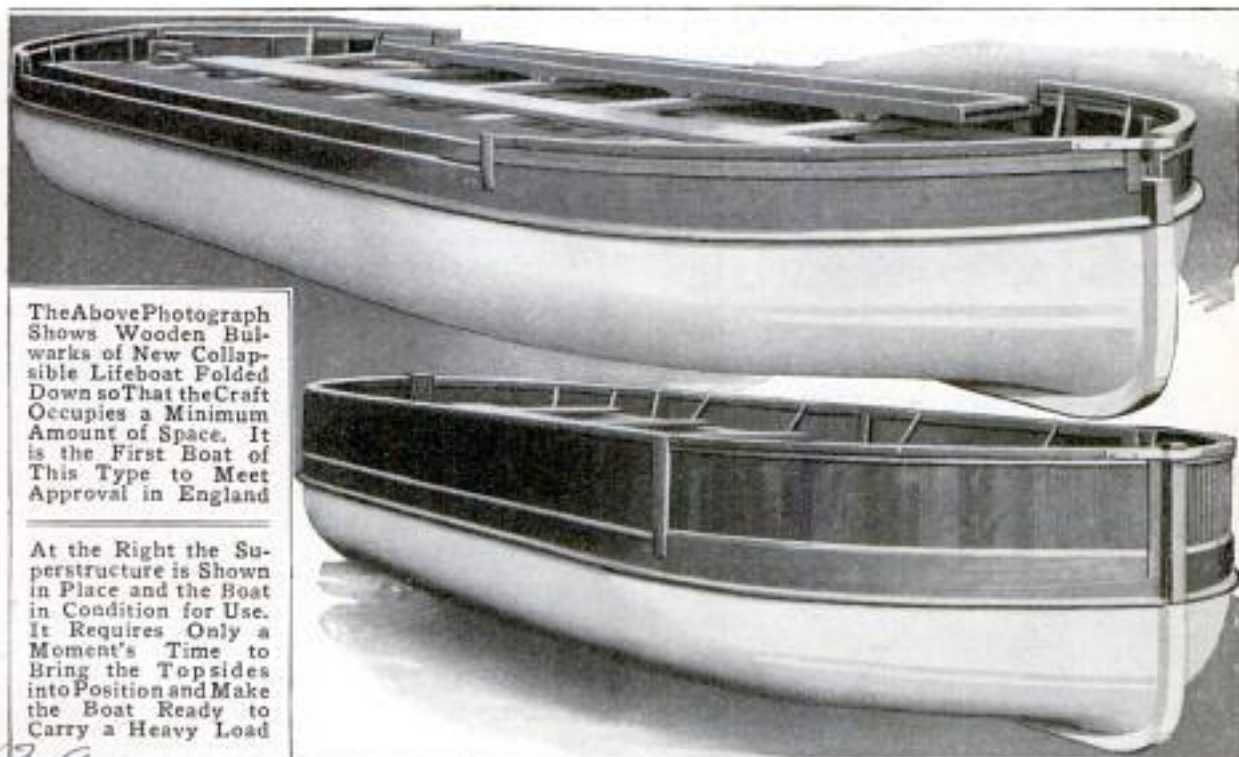

The Above Photograph Shows Wooden Bulwarks of New Collapsible Lifeboat Folded Down so That the Craft Occupies a Minimum Amount of Space. It is the First Boat of This Type to Meet Approval in England

At the Right the Superstructure is Shown in Place and the Boat in Condition for Use. It Requires Only a Moment's Time to Bring the Topsides into Position and Make the Boat Ready to Carry a Heavy Load

### NEW COLLAPSIBLE LIFEBOAT HAS WOODEN BULWARKS

Structural features which are believed to be altogether original are embodied in a collapsible lifeboat that was recently put through a series of severe tests before the marine department of the British Board of Trade. Instead of being constructed of canvas, the topsides, which when in position form a rigid, durable upper section, are built of wood. This form of construction was made practical by fitting amidships on both sides of the craft a straight wooden bulwark provided with a recess to receive sliding shutters. These are made of double thicknesses of mahogany in vertical strips, with canvas and lead between. Channel irons on the coaming and top gunwales provide grooves in which the shutters slide. When the latter are drawn out they complete the bulwark, but when not in use are protected from the weather and leave the fore and aft sections of the deck clear. Iron brackets connect the gunwales and seats, permitting the former to be raised simultaneously with the latter, which are supported by stanchions and may be locked or unlocked at one time. The upper stem

and sternposts are joined to the deck by hinges. The hull is full-bodied and is given internal buoyancy by a series of tanks. In addition to these, cork fenders run fore and aft to within 4 ft. of each end on the outside. The boat may be opened up ready for use in less than a minute by four men. When collapsed and nested, two of the boats occupy a space 4 ft. 6 in. high. The craft is built in several sizes, the smallest of which is 26 ft. in length, and during the Board of Trade tests easily carried 57 men.

### MILK-CAN COVER IS HELD IN PLACE BY GRIPS

In an attempt to devise a milk-can cover which may be fitted in place or removed easily, an eastern inventor has constructed a sheet-metal stopple which is secured to the rim of a receptacle by a nest of steel grips. One of these members is a spring which extends along the neck of the can at one side of the handle.



The Clear Seal Co.  
Manchester, N.H.

By pulling out on this the clasp is released. A rubber gasket is used in the seat of the stopple, which is a tapering cup that slips down the neck of the can into the milk and prevents the latter from churning.

### HOIST ELEVATES ASHES 799 FROM CELLAR

Handling heavy ash cans, barrels, kegs, and the like, between the basement and sidewalk of buildings is



Hand-Operated Elevator Lifts Objects from Basement

usually attended with difficulty and sometimes makes necessary the services of two men. A hoist, however, has been invented which will do the work in much simpler fashion.

A post is mounted on a central pivot

at the opening leading to the cellar. At its upper end is a drum operated by a crank and gearing. In elevating objects from the basement, the arm hangs over the opening, and the operator does the hoisting by means of the crank. On getting its load to the surface, the arm swings around on its support and deposits the burden on the sidewalk. To facilitate turning of the standard, ball bearings are provided. The whole contrivance folds down beneath the sidewalk when not in use.

### 795 ENGINEERS EXPERIMENT ON FLOOD-CONTROL METHODS

Activity of unusual nature took place in a small California valley a short time ago. Up among the rocks of a shaded ravine at one end of the little cañon, engineers constructed a masonry dam. In the center of the dam was an oblong hole, 7 ft. high and 5 ft. wide, closed by a special quick-acting gate.

Tests were being conducted on flood-control methods—tests on a cut-and-try basis with the actual floods, only on a somewhat limited scale, due to the size of the valley and the restricted storage capacity of the area back of the dam just completed. Methods of procedure during the tests were simple. Opening the large gate in the dam permitted water to gush out and run off down the valley in imitation of a genuine flood. The time required for the water to reach given distances, as well as other pertinent data, were carefully noted by engineers located along the route several thousand feet apart. After passage of the first flood another was run, the same in detail except that the valley had been cleared of rocks, excessive vegetation, and other natural barriers to floods. Then, later, these were restored, together with barriers of the engineers' own invention, and still further tests carried out.

Los Angeles County is shortly to expend over \$16,000,000 in flood-protection measures. Floods have inundated much valuable land in that sec-

*Gillis & Geoghean  
537 W. Broadway  
New York*

tion again and again, until the district, like Dayton, Ohio, has resolved to prevent if possible, once and for all, any further repetitions of the trouble. Because of peculiar topographical conditions in that section, which embrace high mountains, steep slopes, and broad valleys, all within a limited area, engineers have found that practically all known flood-protection measures will have to be used if further inundations are to be prevented. Thus forestation, impeding and storage reservoirs, channel improvement and spreading, are all included in the proposed schedule. Because of the lack

run. The data secured will be the means of saving much money during



Test Dam 24 Feet High and 75 Feet Wide Constructed by California Engineers to Experiment on Flood Performance

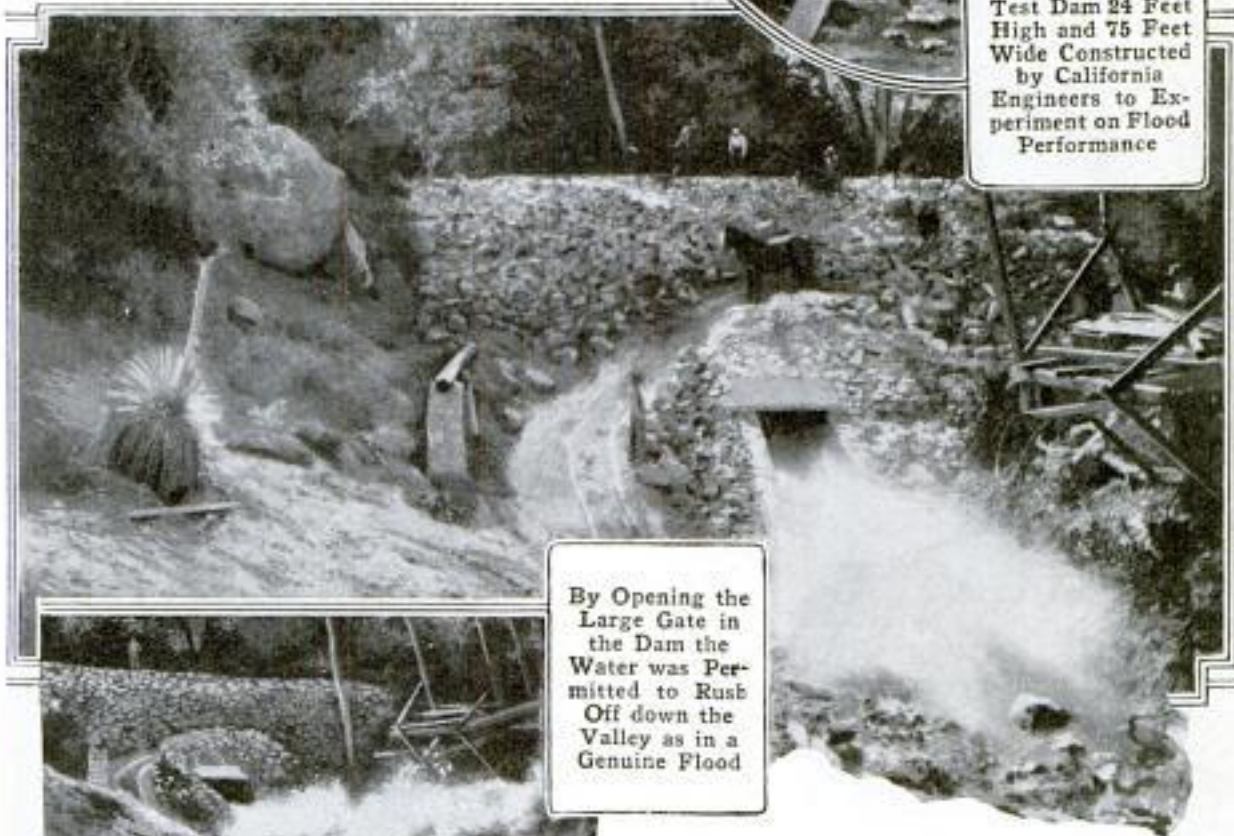

By Opening the Large Gate in the Dam the Water was Permitted to Rush Off down the Valley as in a Genuine Flood



Engineers Stationed along the Route Recorded Progress of Waters under Various Conditions

of accurate data on the precise performance of these several methods, the experimental dam and flood valley mentioned above was rigged up, and tests

construction of the actual flood barriers, in the opinion of the engineers.

404 — FISH ARE KEPT IN STREAMS BY REVOLVING SCREEN

By the use of a rotary screen, lately invented, a method has been found for preventing fish from getting into the irrigation ditches of the West and perishing in the open fields. For a number of years the game and fish author-

ities of Utah and New Mexico, as well as those of certain adjacent states, met much trouble in attempting to stop the

tain streams into irrigating canals proved inadequate, because these devices caught all of the floating debris and clogged the waterways. The new screen has been adopted officially in both Utah and New Mexico. It consists of an undershot water wheel, with folding blades, which is inclosed in a cylindrical wire netting. The blades fold on the upward stroke and open on the downward one, the water passing through at the bottom. In revolving, the screen moves with the current, or in a direction opposite to that of the wheel, and carries the debris over the top. While the purpose of the net is to hold back

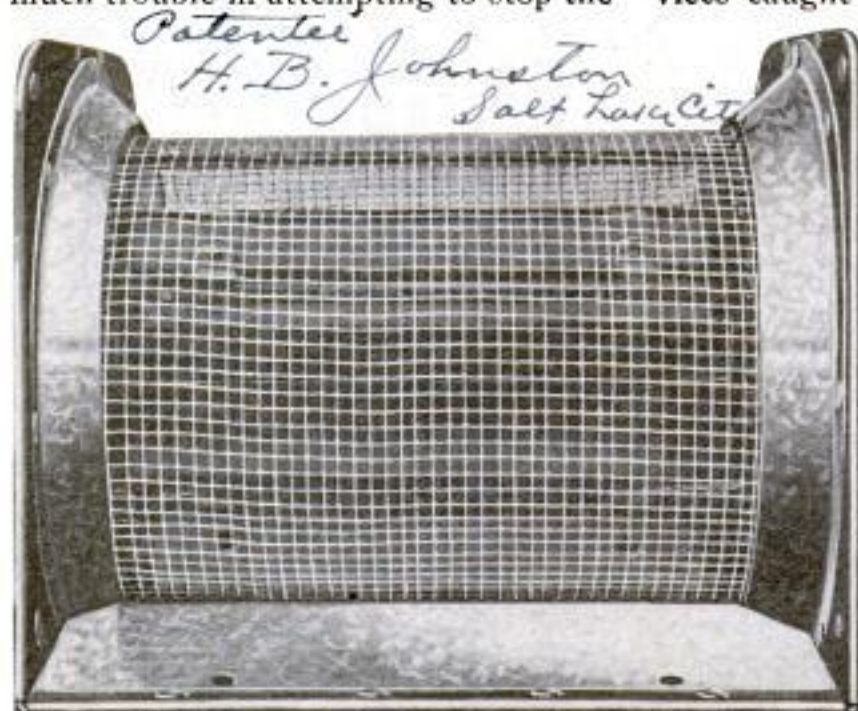

The Revolving Screen Carries the Debris over the Top, While the Water Passes beneath the Wheel

wholesale loss of fish from this cause. The installation of ordinary nets to check the passage of fish from moun-

tain streams into irrigating canals proved inadequate, because these devices caught all of the floating debris and clogged the waterways. The new screen has been adopted officially in both Utah and New Mexico. It consists of an undershot water wheel, with folding blades, which is inclosed in a cylindrical wire netting. The blades fold on the upward stroke and open on the downward one, the water passing through at the bottom. In revolving, the screen moves with the current, or in a direction opposite to that of the wheel, and carries the debris over the top. While the purpose of the net is to hold back

### SHELTER STATION HAS ROOF 812 OF METAL TILE

In Cincinnati a shelter station for the benefit of waiting street-car patrons was recently erected. It faces a government building at a corner near which over 90 per cent of the city's

street-car traffic passes. A feature in the design of the shelter station is its metal roof. Being shaped and painted to resemble clay tiling, a pleasing and artistic effect is given. Cincinnati is soon to have many such open-air waiting rooms erected in different parts of the city.



Convenient Shelter Station for Street-Car Patrons is Made Artistic with a Metal-Tile Roof

Edwards Mfg Co.  
Cincinnati, O.  
200-250

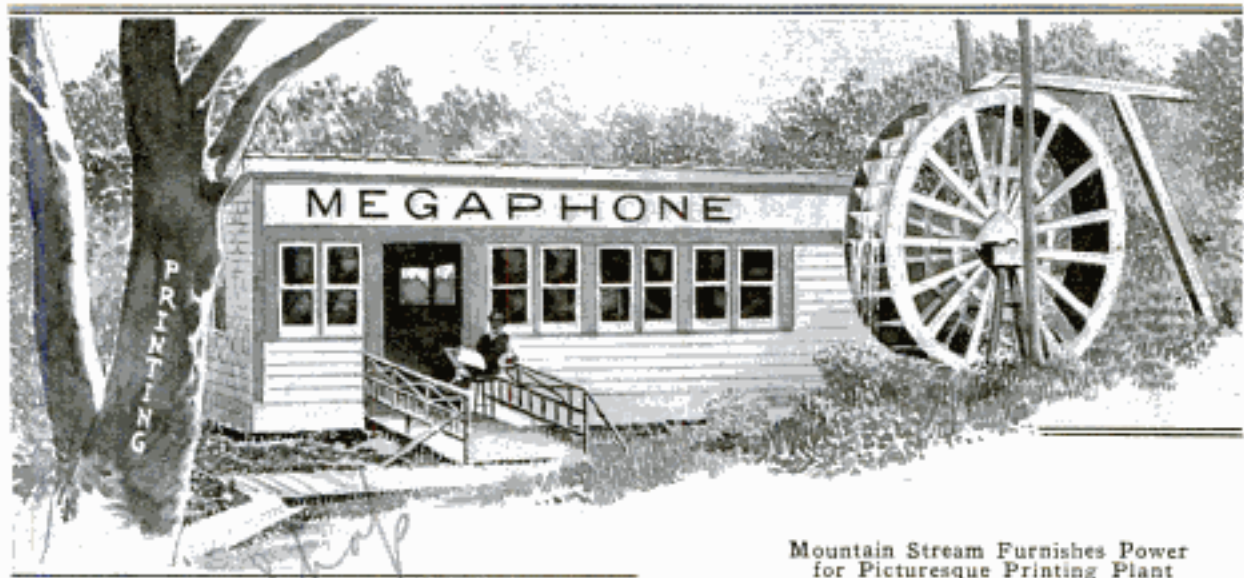

Mountain Stream Furnishes Power for Picturesque Printing Plant

*179* **PRINTING OFFICE HAS ODD ENVIRONMENT**

What is perhaps the most picturesque printing office in the world is situated in a small town in the state of Washington. A mountain stream which runs by the plant is utilized to supply necessary power for the presses and lighting. The big overshot wheel which serves in this connection is almost half again as high as the plant itself. In addition to job printing, a little weekly newspaper is issued from the office.

*845* **NEW POST-HOLE DIGGER HAS JOINTED SHANK**

Digging post holes with the ordinary spade and shovel is slow work, even if the tools are handled by an expert. The chief difficulty is getting the dirt out of the hole after it has been loosened, since the narrow confines of the shaft do not admit of much shovel manipulation. In an attempt to get around this difficulty a new form of digger has been developed. It much resembles an ordinary long-handled spade, except that the shank next to the blade is jointed in such way that the latter may be held at three different angles with respect to the handle. For plain digging as with an ordinary spade, the blade may be locked in a straight line with the handle. After getting deeper down into a hole the

handle may be swung forward, causing the blade to lock at right angles with the shank, forming a horizontal carrier for elevating dirt to the surface. By this method it is claimed that a much larger shovelful can be gathered together and lifted at one time than with ordinary tools, thus allowing



For Removing Dirt from Hole, However, Blade and Handle Lock at Right Angles

Spade Locks in Line with Handle for Straight Digging Operations, Acting as Ordinary Tool



more rapid work. For refilling purposes, or in ditching work, the blade may be set at the third, or acute, angle if desired. It may thus act as a rake for gathering in dirt.

*The Triple Tool Co.*  
*Texas*  
*W. N. Matthews & Brother, Inc.*  
*3722 Forest Park Blvd, St. Louis, Mo.*  
*Copyrighted Material*  
*Western Electric Co. Ltd. (Australia) Sydney, N. S. W.*  
*(Agents for N.Z. & Aust.)*  
*B5/24/16*

## PUBLIC FOUNTAIN BUILT OF 60 COBBLESTONES

An attractive feature that might well be copied in other cities is a public fountain, built of cobbles, recently



Cobblestone Fountain Erected in a City in Southern California

erected in a city in southern California. The fountain is a structure 18 ft. long, 10 ft. wide, and about 12 ft. high. With the exception of the roof, which is of red Spanish tile, and the heavy beams and rafters, the fountain

is composed entirely of cobbles and cement. At one end is a drinking fountain, and at the opposite end is a basin for dogs and other small animals, while the center is occupied by a large basin designed principally for horses. The water first enters the drinking fountain, and the overflow from this furnishes a supply for the two basins.

## AIR-COOLING APPARATUS 8589 OF SIMPLE DESIGN

For cooling and purifying the air in a room without employing electric current, chemicals, or ice, an eastern inventor has constructed a simple apparatus which has a very low operating expense where water is available at reasonable rates. It consists partly of a cylindrical tank

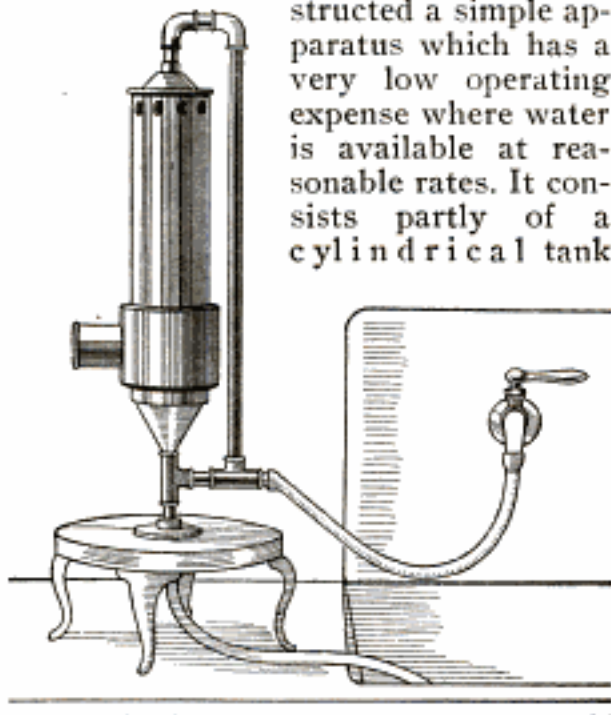

This Air-Purifying and Cooling Device may be Operated Economically Where Water Rates Are Reasonable

mounted vertically on a small standard. The lower end of this is cone-shaped and connects with a drain which carries off the water admitted at the top by a feed pipe. As the water enters the cylinder, it passes through a spray, mounted immediately above a series of air-intake holes, and strikes the blades of a fan, which it causes to revolve. The suction thus created draws air into the cylinder, where it is washed and cooled by the water which is broken up into a fine spray upon striking the fan vanes. By means of a special stop in the drain, the air is not allowed to escape from the tank excepting through a duct passing around the cylinder above the cone.

## NOVEL ICE-CREAM MACHINE IS REFRIGERATING PLANT

Designed especially as an accessory for confectionery shops, a refrigerating and ice-cream machine has lately been introduced which is built in one unit. It is made in two sizes, the smaller of which has a maximum daily capacity of about 100 gallons of cream, and a refrigeration value equivalent to the melting of a ton of ice. Both of

Carl F. Lundberg, (Inv.)  
36 Willow St., Hartford, Conn.

# R. K. Cronkrite 6439 Maryland Av.,  
 Lassen Ice Alchym Co. Inc.  
 111 Washington St. Chicago, Ill.  
 W. H. H. 175 N. La Salle St. Chicago, Ill.  
 Fort Madison, Ia. POPULAR MECHANICS 2900 233  
 \$650 - 500. cash - bal 6%  
 2990 - 990. " " "

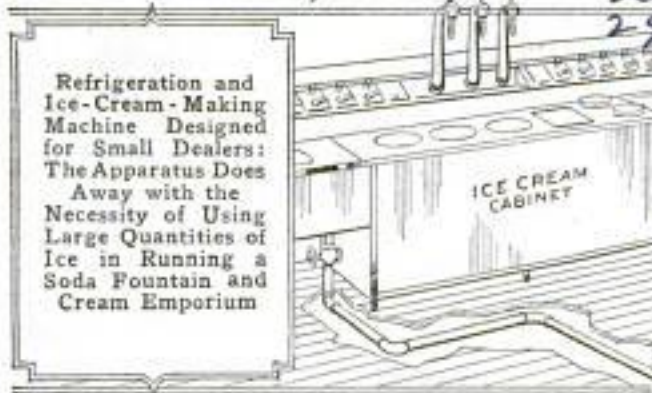

Refrigeration and Ice-Cream-Making Machine Designed for Small Dealers: The Apparatus Does Away with the Necessity of Using Large Quantities of Ice in Running a Soda Fountain and Cream Emporium

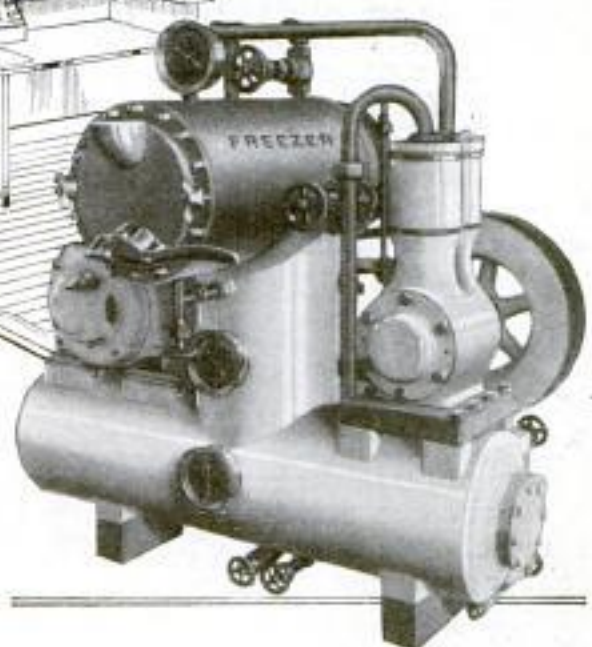

**GASOLINE-SUPPLY STATION 842  
 HANDLES ORDERS QUICKLY**

A gasoline-filling station lately put in service in a northern city has unusual facilities for the rapid dispatch of orders. The gasoline is kept underground in eight tanks having a capacity of 500 gal. each. From these it rises to smaller tanks above ground which hold quantities sufficient for moderate users. Compressed air supplies the force necessary for the rais-

its functions are performed by ammonia expansion. It is not an ice-making machine.

The apparatus is neatly finished in white enamel and German silver, and may be installed in a display window for advertising purposes. The mixture used in making cream is poured into a freezer, at the top of the device, which is driven by an electric motor. When frozen to a certain point, the cream is turned out and placed in a hardening cabinet, the temperature of which may be maintained at less than zero. This storage box is provided as a part of the equipment and may be installed be-  
 soda fountain, or elsewhere if desired.

The machine is 54 in. in length, 2 ft. wide, and 46 in. high. It does away with the necessity of using ice and greatly simplifies the work of making cream and keeping it solid. The large size has about three times the capacity of the small one.

☞The first train to be run over the government's Alaskan railroad made the trip from Seward to Mile 29 on Nov. 8, 1915, carrying passengers, mail, and freight.



Gasoline-Filling Station Especially Designed for Automobile Sales: Gauge Glasses on the Tanks at Each End of the Building Show How Much Gasoline Customer is Receiving

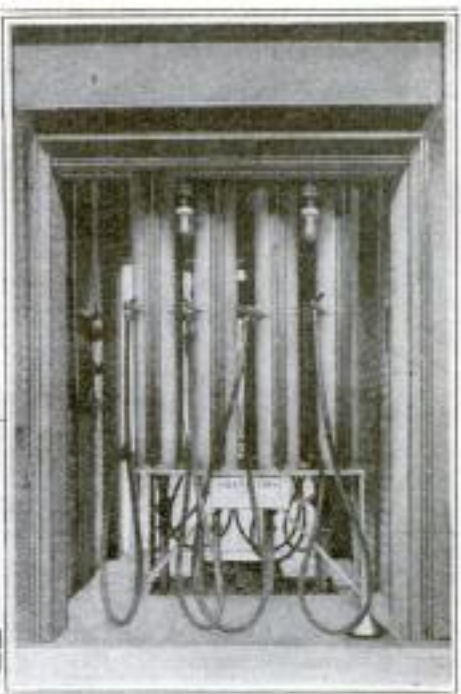

Van Tilburg Oil Co.  
 Minneapolis, Minn.

ing process. The small surface tanks are long and cylindrical in shape, and are provided with gauge glasses by which a customer may follow the amount of oil being delivered to his car. Aside from gasoline, the station also handles lubricating oils, these latter being kept in a system of tanks similar to the gasoline. Since the tanks are mounted close together, it is pos-

sible for an automobile to take on both oil and gasoline at the same time, thus reducing the period which usually has to be spent for these operations. The building housing the filling station is especially designed for the work, automobiles having ready access to the gasoline supplies. The central part of the building serves as a store for the sale of grease and minor accessories.

*Military*  
**TWO WAR AEROPLANES LAND  
 IN QUEER FASHION**

*885 The Aeroplane (London) 7/27/15*  
 Two military air craft landed at one of the French aerodromes recently in a most odd manner. The pilot of neither machine knew of the close proximity of the other and by a strange coincidence selected the same spot in alighting. The running gear of one aeroplane, a Voisin biplane, was just about to touch the ground when a Bleriot monoplane glided down at an angle from a higher level. The latter machine slid lightly onto the upper surface of the biplane and rode along with it until the momentum of both craft was spent and they came to rest. For an instant neither of the pilots

realized what had happened. No one was injured and very little damage was done to the aeroplanes. There are instances on record of somewhat similar things occurring in the air, which in one particular case ended the life of a quite well-known flier, but freak landings of this kind are unusual.

*516 Eng. Record Aug 14 '15*  
**WATER LEVEL CONTROLLED  
 BY ROLLER DAM**

A dam recently constructed across the Grand River in Colorado is equipped with a set of roller crests with which it is possible to maintain a practically uniform level in the reservoir in spite of the varying stages of water in the river. There are seven of the rollers, having an aggregate weight, including accessories, of 280 tons. The concrete weir on which they are mounted has a total length of

The Monoplane Landed on the Top Surface of the Biplane and Rode Along with It until Both Machines Came to Rest

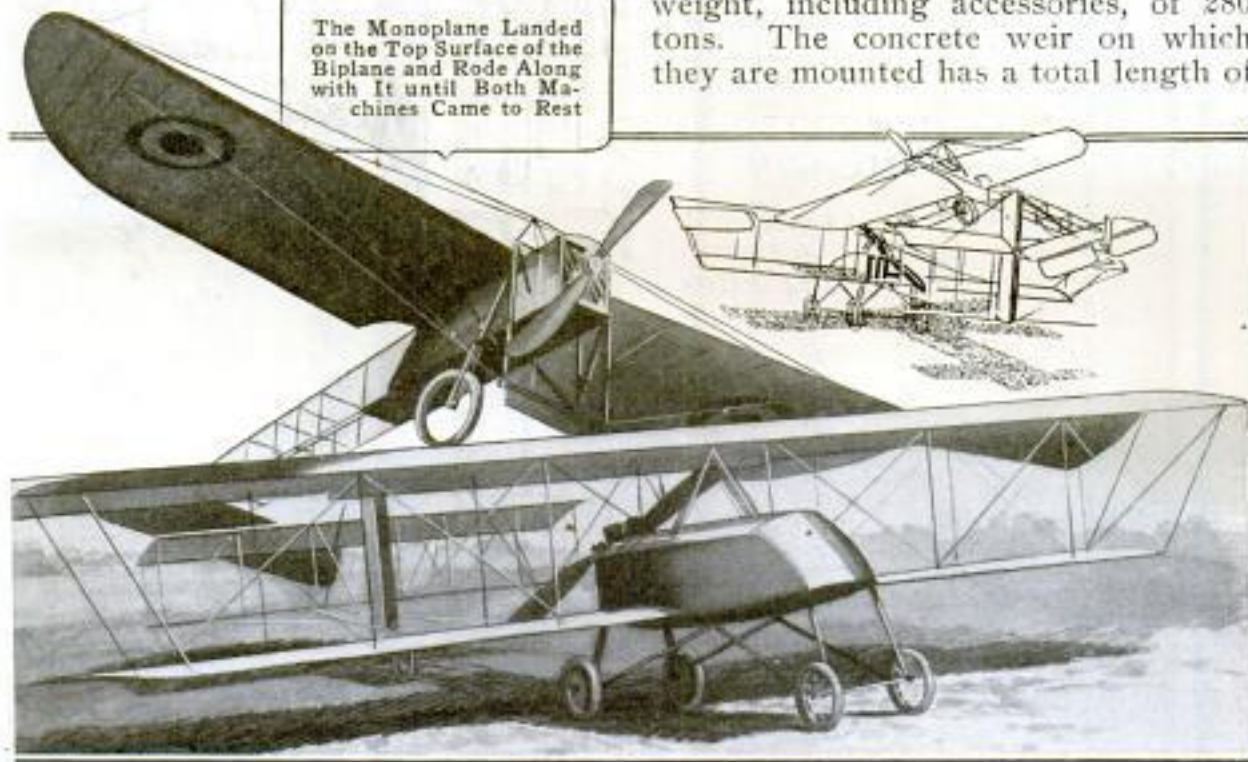



546 ft. Six of the rollers each have a length of 70 ft. and a height of  $10\frac{1}{4}$  ft., while one has a length of 60 ft. and is  $15\frac{1}{2}$  ft. high. This type of dam was adopted to prevent the flooding of a

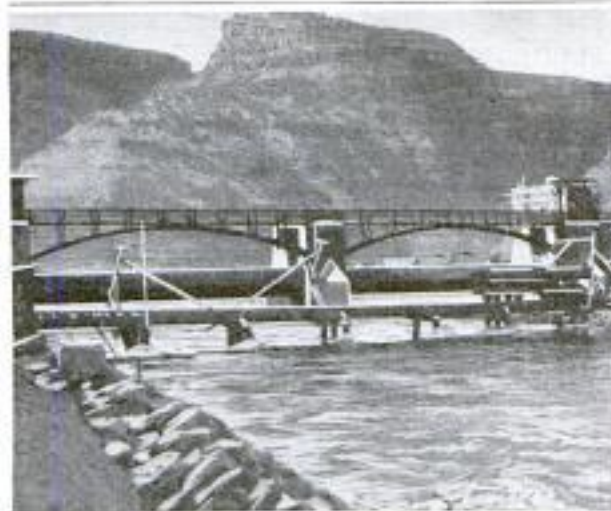

COURTESY ENGINEERING RECORD

Roller Dam Recently Built across the Grand River in Colorado: All the Rollers Except the One at the Right are Shown Raised to Permit the Water to Pass through the Dam

railroad track located along the river bank at a level only about three feet above the mean level of the water. In order to maintain a practically constant level in the reservoir the rollers are kept lowered on the weir at ordinary stages of water, but are raised in time of flood so that the water passes under them.

632

### SIMPLE MACHINE PURIFIES WATER FOR HOME USE

A machine, simple in design but claimed to be very effective in operation, is a late addition to apparatus available for water purification. The machine in its ordinary form is intended for the home, and is designed to handle the comparatively small amounts which are required for household use.

The apparatus is electrolytic in action. The water to be purified is held in a large glass jar, into which two electrodes project. One of the electrodes is hollow and cylindrical in shape, while the other is a round rod, and hangs within the cylinder. Current from an electric-light socket is



impressed across the electrodes, resulting in the usual development of oxygen and hydrogen gases. It is stated that the impurities and organic matter in the water are thrown down in the form of a flocculent, or flaky, precipitate. This settles in the bottom of the jar, and after the machine has run for a time, the purified water may



Apparatus Which Utilizes Electrolytic Action in Purification of Water

be poured off at the top. In this simple manner any desired amount of water may be rid of undesired matter.

*Murdock-Hirst Co.,  
437 Arcade Bldg., East Liverpool, O.*

**RUBBER STAMPS SAVE  
751 DRAFTSMAN'S TIME**

Architects and designers who have had occasion to draw the same thing over and over again in different parts

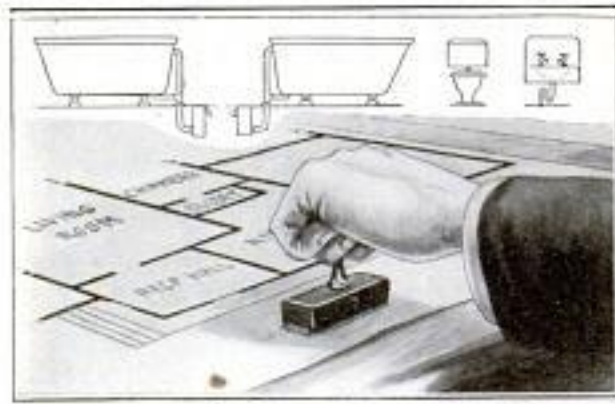

Rubber Stamps Permit the Ready Drawing In of Plumbing Fixtures

of a set of plans for a structure, will appreciate a new convenience being offered. This consists of a number of

rubber stamps, designed, in this case, particularly to represent the plumbing in a building. For instance, one of the stamps prints the outline drawing of a bathtub; another depicts a kitchen sink with the usual hot and cold-water faucets, and so on. Since all of the stamps are made on a scale to fit the average drawing, their ready use is an easy matter. Instead of spending time in drawing out each fixture to scale, the designer has simply to pick up one of the stamps, adjust it carefully to the drawing, and press down. An accurate printing of the whole sketch results. This may afterward be filled in with ink if the designer likes, as well as any connecting piping which may have been sketched in with a rule. Although thus far applied only to plumbing fixtures, the rubber-stamp idea has possibilities of still wider application to other ordinary kinds of drawings.

**NEW COURSES IN THE HIGH SCHOOLS OF CALIFORNIA**

789  
With the idea of training their students to engage in gainful occupations immediately after graduation, many of the high schools of the country are giving instruction in practical subjects that were not thought of as parts of a curriculum a few years ago. This tendency is particularly pronounced in California, where many new courses especially adapted to the diverse requirements of modern life have been installed. In high schools located in various parts of the state, for example, instruction is now given in the principles of automobile construction. In this work the boys are not only taught the mechanical principles involved but are set to work building and repairing automobiles, with the idea of enabling them to become competent workmen by the time they are graduated. A course that is equally popular is that in farming, and in this the school work is, as a rule, supplemented by work on a school farm. One of the largest school farms in the West is that con-

nected with a high school at Bakersfield, Cal., where the practical farm work includes the design and erection of farm buildings. In some of the schools there is also given a course in wireless telegraphy, to which a course in wireless telephony is now being added. One of the unusual courses is that in stagecraft, given in a high school in Los Angeles. The school auditorium has a large stage on which many school plays are produced, and nearly all the scenery and costumes for these plays are made by members of the stagecraft class. The course is open to both boys and girls, and includes the making and painting of scenery, the manufacture and use of stage properties, the principles and practice of stage lighting, the designing of costumes, and the art of making up. Other especially interesting courses are the printing arts, including linotype composition, and boat building. Courses in wood and iron work lead to the boat-building course.

Manual Arts High School, Los Angeles  
 Kern County High School,  
 Bakersfield, Calif.



Left: At Different Schools Instruction is Given in Principles of Motor-Car Construction by Competent Mechanics

Below: Radio Installation in High School at Bakersfield, California, Where Pupils are Taught to be Operators. A Number of Institutions Provide This Course for the Boys



Below: Constructing a Greenhouse at One of the Schools Where Agricultural Training is Given



Behind the Curtain at a Los Angeles Institution Where Mechanics of the Stage are Taught: The Students Learn to Manufacture Stage Properties, Build Scenery, and Make Costumes, as Well as Other Things



Feeding a Press in the Print Shop of a Los Angeles High School



Boat Building is Taught at a Number of Schools along the Coast

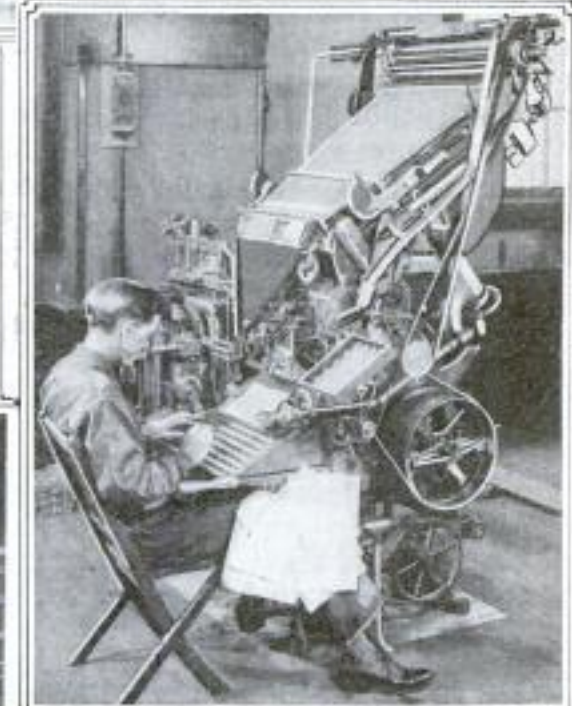

Operating a Linotype Machine at One of the Schools Which Offer Vocational-Training Courses

### CONCRETE BRIDGE IS BUILT 967 ALONG NEW LINES

Unusual methods of construction featured the erection of a concrete bridge at Portland, Me., recently.

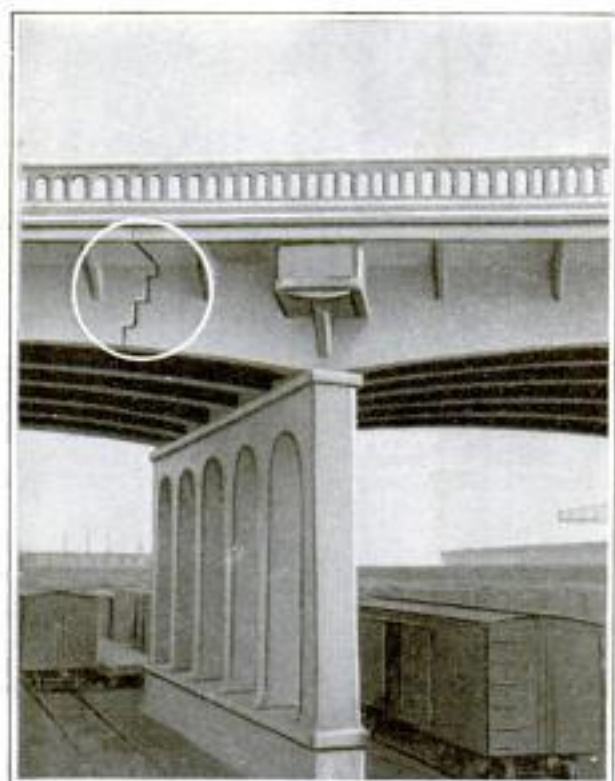

**A Portland, Maine, Bridge is Built with Unusual Manholes and Method of Allowing for Concrete Expansion with Changes in Temperature**

Chief among these was the manner of installing manholes for the conduit lines which crossed the bridge. Unlike the more usual method of molding a compartment in the solid concrete of a pier for manhole purposes, the designers of this viaduct provided for the separate molding of these conveniences. After becoming fully hardened in a form on the ground, they were hoisted to position just beneath the future sidewalk of the bridge and hooked in with the main reinforcements. Rods left protruding from the manhole sides permitted this hooking-up process, and after concrete had been poured in the main bridge beams, the whole affair became firmly locked together. Manholes so installed did not detract from the architectural appearance of the bridge, and at the same time afforded a cheap and effective solution of the problem of building

these features. The brackets supporting the sidewalk were also molded and put in place on the bridge in the same manner. Expansion and contraction of the long beams through temperature changes was provided for by making alternate spans of the suspended type. The huge slab of concrete forming the suspended section was in each case supported by overhangs, or cantilevers, from the solid spans on each side. A sort of "stair-step" joint at the junction of suspended and supporting spans allowed free expansion at all times.

### 884 HEADLIGHT IS IMPROVED FOR USE ON BABY CAB

Both novel and practical features are embodied in an electric headlight that has been devised for a baby carriage by an Illinois mechanic. The device consists of a lamp, reflector, and lens of a large flash light, fixed to a supporting bracket hinged on the top of a perambulator. The bulb is supplied with current by two dry cells carried in the bottom of the vehicle. It throws a shaft of light for a considerable distance so that a clear view of a sidewalk or crossing is given at night on poorly lighted streets. An additional function served by the lamp is that it pacifies the baby who occupies the cab. The child showed aversion against riding in the dark, and this peculiarity had much to do with the construction of the headlight.



**Ordinary Flash Light Reconstructed to Serve as a Headlight for a Baby Carriage**

*Inventor: Frank Peirce,*  
*Edwardsville, Ill.*

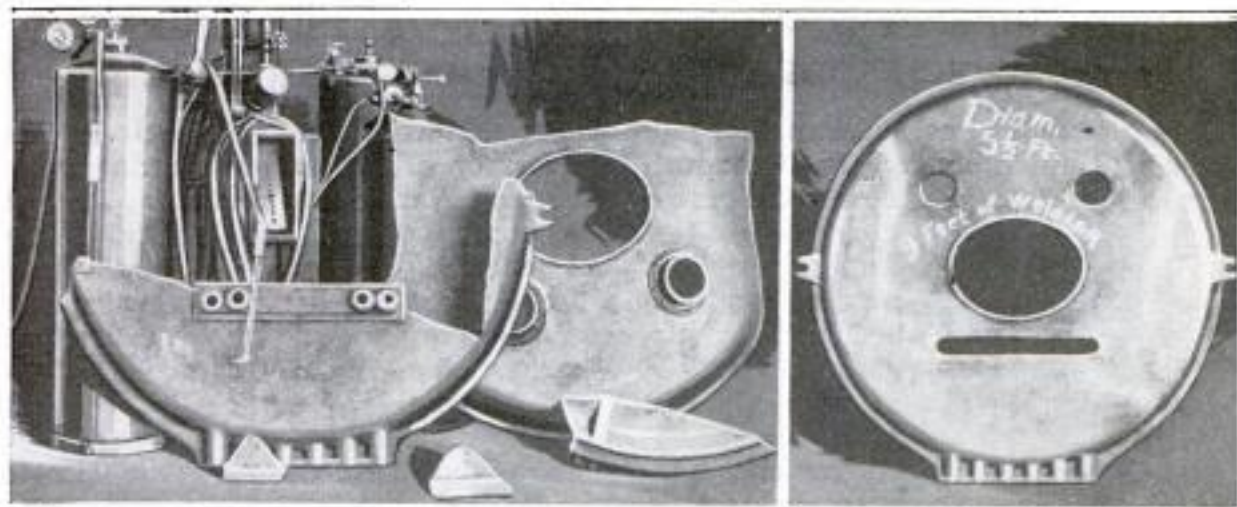

Large Transformer Cover Before and After being Repaired in Record Time with Oxyacetylene Flame

### 761 OXYACETYLENE WELDS HUGE TRANSFORMER COVER

Through accident a transformer cover was broken into numerous pieces in a Utah city recently. Because of the difficulty of readily securing a duplicate lid, it was resolved to weld the broken parts together with an oxyacetylene flame. The cover was  $5\frac{1}{2}$  ft. in diameter and the welds totaled nearly nine feet in length. The metal varied in thickness from  $\frac{3}{4}$  in. to  $1\frac{1}{8}$  in. Large and unwieldy as the work was, the completely repaired cover was returned to its owner within 24 hours after receipt. The interior of the usual transformer is filled with an insulating oil which it is highly important to keep from contact with moisture or water in any form. The latter will quickly destroy the insulating properties of oil, hence the solicitude usually evidenced for keeping transformers tightly covered and in good repair.

### 673 WOODEN TONGS PERMIT SAFE HANDLING OF FUSES

Around switchboards and cut-out boxes there is frequent need for pulling out and inserting fuses, due to the fact that they burn out occasionally when overloaded. To replace fuses with the fingers is sometimes a difficult task, because of the grip with which they are held by the clamping springs.

Then, too, the proximity of other fuses and bare metallic parts frequently gives an operator an unpleasant electric shock while attempting to make the change. To enable quick and safe removal of fuses, a manufacturer has recently gotten out a pair of tongs made of rock-elm wood, and neatly finished with an insulating varnish. The wood, being an insulator, of course prevents shocking the operator

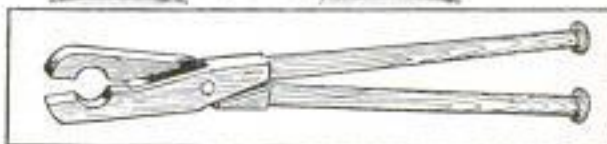
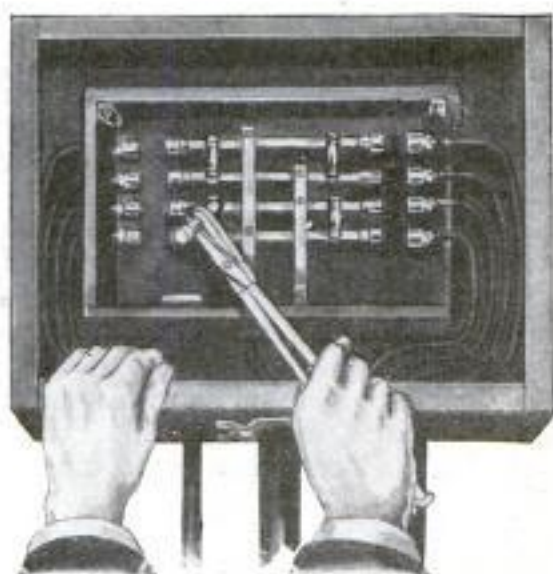

Wooden Tongs Permit Safe Removal of Fuses

as well as short-circuiting any metal parts with which it may come in contact.

*Meister Novelty Works,  
547 Third St., Milwaukee*  
Copyrighted material

MACHINE OFFERS SOLUTION  
OF TRANSFER PROBLEMS

835

The use and abuse of transfers is a subject of much concern to street-railway managements. Yet in spite of this

a simple way of dealing with the problem has been slow in appearing. Railway engineers have lately become considerably interested in a machine put out by a middle-western firm which promises to solve the principal difficulties heretofore met with.

The new machine stands on a pedestal and conveniently near the conductor as he collects fares. Upon a passenger's naming the line

to which he later wishes to change, the conductor presses down a lever at the top of the machine corresponding to that line, presses his foot on a pedal, and a printed transfer is automatically presented to the passenger immediately. The complete date, the hour, the locality, the conductor's number, and the name of the line transferred to, are all printed in the one stroke of the pedal. Blank transfers consist of nothing more than a bare roll of paper put into the machine at the beginning of the run. Thus the cost of printing the slips in the usual manner is wholly eliminated. From 60 to 70 transfers per minute can easily be issued on the machine, thus making for speed. From the fact that the machine automatically numbers each consecutive transfer, a check on the conductor and a record of his daily output of slips are made possible.



CUBA WANTS DESIGNS FOR  
"MAINE" MEMORIAL

An international competition for plans for a "Maine" memorial to be erected overlooking Havana Harbor, is announced by the Cuban Maine Memorial Commission. The total cost of the structure, not including that of placing, may not exceed \$33,000. Two prizes will be awarded, one of \$1,500 and the other of \$500, for the two best plans. The relics of the battleship which were presented by the United States to the Cuban government, namely, a turret, two cannon, an anchor, and a chain, should be the motif of the monument. It will stand in a triangular piece of ground not 400 feet from the water front, where it will be passed by thousands of persons daily and will be a conspicuous landmark for all ships entering the harbor.

HINDUS USE INNER TUBES  
FOR WATER SPOUTS

Inner tubes of no further service for automobile tires have been given a new usefulness on a southwestern ranch. Here the Hindus, now commonly employed as ranch hands in the region, have taken to using old inner tubes as water spouts for the filling of tank wagons. In such service the useful days of the tires are materially extended. Railroads have used



a cotton hose for the same purpose in filling engine tanks.

The tendency for bigger battle cruisers is illustrated by a recent request for longer drafting tables in the Bureau of Construction of the Navy Department.

M. N. Stearns, Columbus, Calif.

monetary system of Cuba from the former coinage where there was no national coinage to the use of the new money of the Republic has been effected without causing a ripple on the surface of business, and good results are already being noted.

Formerly Spanish, French, United States, and small quantities of other moneys circulated indiscriminately. On nearly every prominent corner in Cuban cities, and especially in Habana, in news, cigar, and lottery-ticket stands were money changers who did a thriving business out of the wide confusion of values. Many abuses and inconveniences arose from this condition of affairs. Banks and business houses had to keep their accounts in three moneys—Spanish, French, and American—and the values of the various coins were constant causes of misunderstandings and a detriment to commerce generally.

#### Coins Minted in United States.

Cuba arranged for money of its own, the banks cooperating, and the minting has been done in the United States. A presidential decree of September 11 forbade the use of other than Cuban and American money after December 1. It had the effect of immediately waking the people up to the imminence of the change, and there was a rush to unload accumulations of French and Spanish gold and silver. The money changers protested long and loud for more time; they passed resolutions, obtained a good deal of publicity in the papers, and urged that the change should be made more gradually, but to no avail.

The work of converting foreign coins went on steadily. The banks gathered up large quantities of European silver and gold, shipping most of it to the United States to be minted into Cuban money. Heavy shipments of American money and the Cuban coins came back in return. The money changers did a brisk business for a while, until the stock of hoarded centens, louis, francs, and pesos and smaller foreign tokens had come from hiding places and been converted. Then the "cambistas" had to sell their stocks for American and Cuban money—and found their occupation gone.

The Government and municipalities began paying all obligations in national money, banks began paying it out—and the thing was

1048

CUBA WANTS DESIGNS FOR "MAINE" MEMORIAL.

[Special Agent Garrard Harris.]

The Cuban Maine Memorial Commission, of which Gen. Emilio Nunez, Secretary of Agriculture of Cuba, is chairman, has called for international designs and bids for the Maine memorial which will be erected by the Government of Cuba. The presidential decree on the subject in part reads:

The plans and bids must be in the hands of the Secretary of Agriculture, president of the commission, before 11 o'clock on the morning of February 1, 1916, and on February 3 the plans will be opened publicly in the order in which they have been received, and will be exposed to the public for 15 days.

The monument will be raised in the Vedado on a triangular piece of ground formed by streets 17, 19, C, and the Calzado de Vedado. The artists may plan the monument in the form and position which they desire, but it is indispensable that the relics of the battleship which were presented by the United States to the Cuban Government—namely, a turret, two cannon, an anchor, and a chain—should be the motif of the monument.

The plans and bids must be original. The total cost, without including that of placing, may not exceed the sum of \$33,000. Two prizes will be given, one of \$1,500 and the other of \$500, for the best two plans, which will become the property of the State.

Admirable Site Chosen.

The Calzado de Vedado is a wide, paved avenue which skirts the sea from the Malecon, opposite Morro Castle, to and through the Vedado, the most beautiful residential section. The plot of ground is not 400 feet from the water, so the monument will look out upon the entrance to the harbor and be seen by all ships approaching and leaving. Thousands of people pass the spot each day, and a more beautiful location for the memorial could not have been selected.

In a few days I will forward a complete set of photographs showing the exact location of the memorial, the surroundings, etc., and photographs of the guns, turret pieces, chain, and anchor being placed on the ground. [Upon their arrival these photographs may be inspected at the Bureau of Foreign and Domestic Commerce, or its branch offices. Refer to file No. 780.] Unofficially, I have gained the impression that a design embracing the names of the men who died will make a favorable impression. These names may be obtained from the Navy Department, at Washington.

Commence Design 17/15 p 867



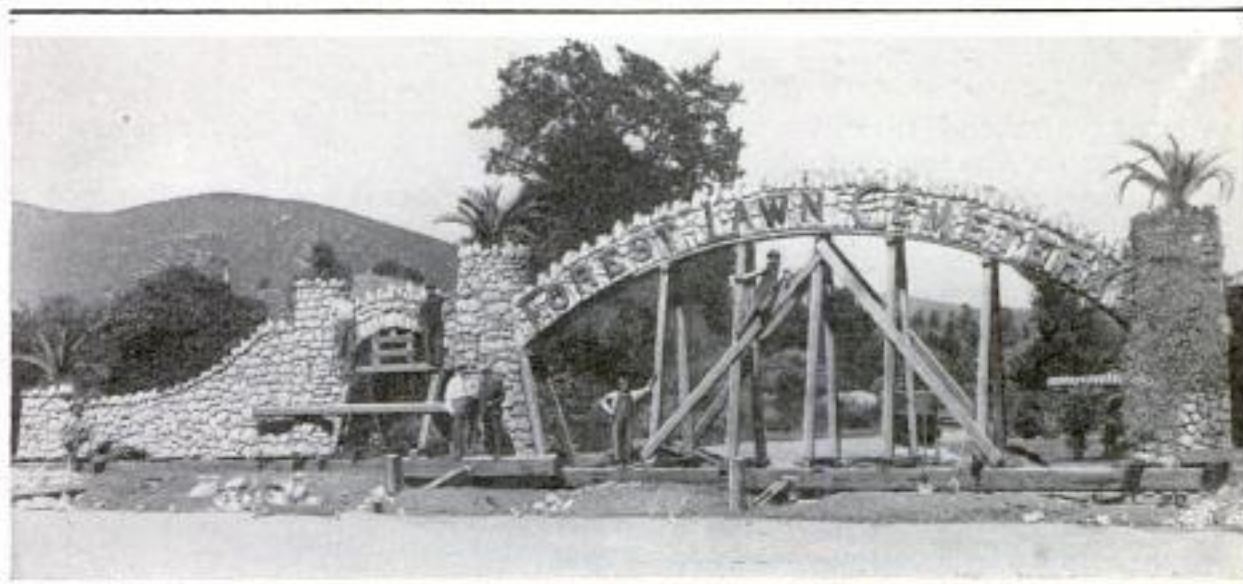

Cobblestone Archway Having a Span of 38 Feet was Moved on Rollers without Cracking

946 **MOVES COBBLESTONE ARCH  
SEVERAL FEET INTACT**

Owing to a change in street arrangement it was necessary a short time ago either to tear down or move an elaborate cobblestone archway over the entrance to a cemetery in a California city. Inasmuch as the new entrance to the grounds was only a few feet away in the new arrangement, it was decided to move rather than rebuild the structure. The arch itself spanned a distance of 38 ft. and the entire affair, including abutments, measured 105 ft. in length. No reinforcement of any kind had been used in the original building of the arch, making it especially difficult to move without cracking. However, the task was accomplished without mishap. Especial care was taken to adequately support the weakest parts of the structure in transit. The moving required 10 days as against a probable two months necessary to tear down and rebuild the structure, had that method been tried.

826 **LARGE SHADE SERVES AS  
PICTURE SCREEN**

What is claimed to be the largest roller shade ever constructed was recently completed for a high school at Greenfield, Ohio. The screen, which will be used as a moving-picture back-

ground, is built along the lines of the ordinary roller shade. It is 27 ft. wide and 22 ft. deep and made of the same fabric used in ordinary shade construction. The fact that the screen may readily be rolled up and put out of the way is a convenient feature in school



Large Shade is Used as Moving-Picture Screen in Ohio School

service. Also when rolled up, discoloration from dust or finger marks is prevented.

One counter in an eastern five and ten-cent store is now devoted exclusively to the sale of standardized automobile parts.

### COMPACT CRUCIBLE FURNACE 710 FOR BRASS FOUNDRY

Compactness and ease of manipulation are two of the features which have been incorporated in a crucible furnace

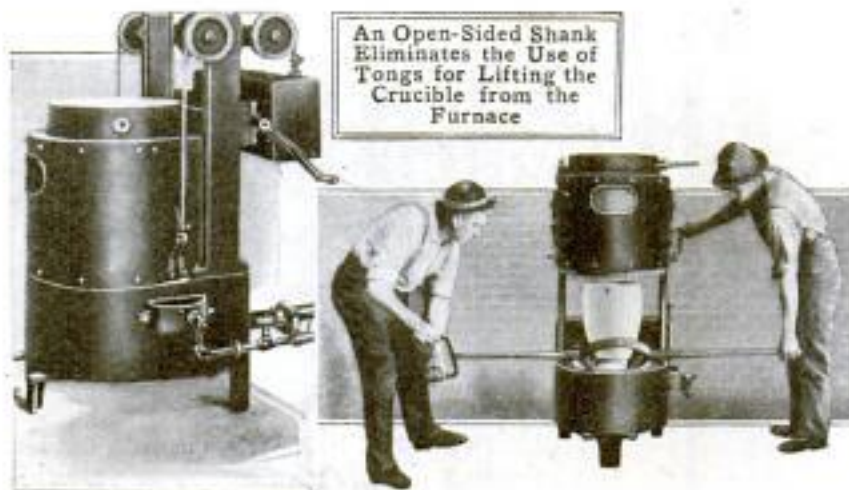

that has been designed to use either oil or gas as fuel. It is especially adapted for brass and bronze foundries and per-

mits molten metal to be poured directly from the crucible in which it is melted. The type designed to receive a No. 60 crucible is 34 in. in height and occupies a floor space of 2 ft. by 4 ft. The crucible chamber is arranged with a counterweight so that it may be raised or lowered easily by means of a rack and pinion. By lifting this the crucible may be removed easily with the aid of an open-sided shank. A blower capable of delivering approximately 250 cubic feet of air a minute at a pressure of from 10 to 16 ounces is used with it. The flame enters the combustion chamber at a tangent and fills the space surrounding the crucible. The apparatus is convenient when quick heat is needed for rush work.

### KNITTING HOOPS ARE MADE 886 IN NOVEL FORM

Mufflers, stocking caps, shawls, and many similar articles of apparel, may be made quite easily with the assistance of knitting rings of a simple type which have been introduced of late. The outfit consists of six hoops of graduated sizes fitted with a series of pegs.

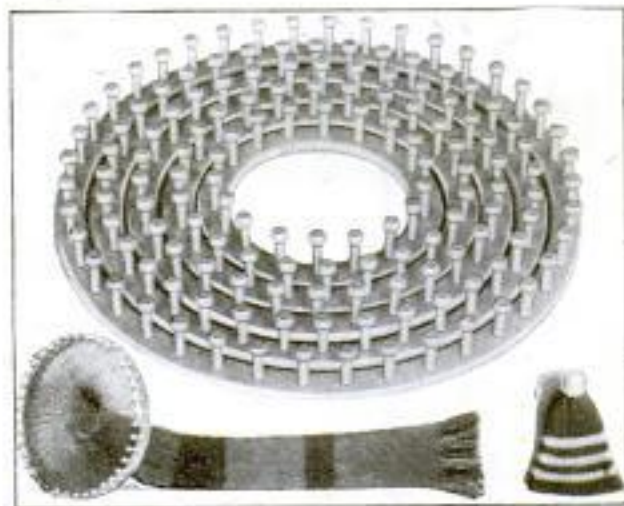

The Knitting Frames are Substantially Made and Finished in White Enamel or Natural Wood Color

Sweaters, scarfs, and other heavy things, are made on the largest of the rings, while doll clothes and tiny articles are knitted on the smallest frame. In using any one of the rings, a skein of yarn is first wound into a ball, an end tied loosely about one of the pegs and the material then woven in and out between the other members until the starting point is again reached. The second time around, the yarn is entwined on the opposite sides of the pegs. When this is completed a crochet hook is employed to cross one of the strands over the working strand and slip it about each peg in succession. This process is continued until the desired length in one color is reached, when other yarn is worked in to produce a stripe or band. To prevent it from unraveling, the work is crocheted off the hoop when it is completed.

With the evident intention of keeping pace with the times, a band of 20 gypsies now traveling in the middle West are using automobiles as a means of transportation.

National Sewer Products Co.,  
Knic-Knac-Knitter Dept.,  
Mishawaka, Ind.

# THE KEY TO RUSSIA'S DOOR

By LEROY KENNETH

981  
*16 Maple Grove, Barre, Vt.*



Above: The Canadian Ice Crusher "Minto" is Pushing through the Floes in the Northumberland Straits. The Shape of Its Bow is Shown at the Right

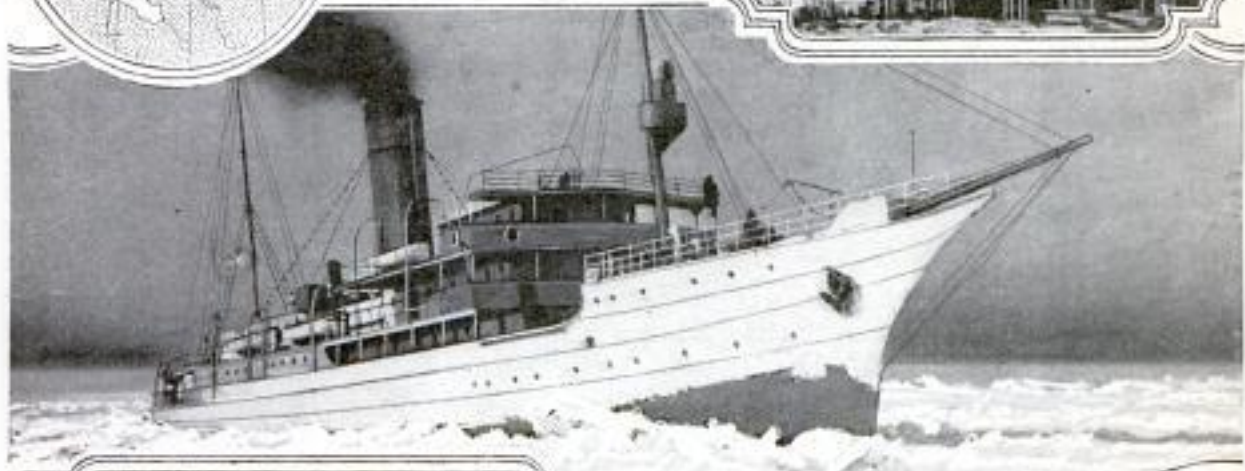

Here the "Earl Grey" is Shown Following a Lane Crushed through the Ice by the "Minto"

The Sharp-Prowed Ice Breaker "Earl Grey" Stuck in a Heavy Field in Northern Waters

**T**HE success or the failure of the "Minto," the ice crusher Canada has sent to clear the way at Archangel, means victory or disaster to the Russian army.

Russia is dependent on the outside world for her military supplies. Her Baltic ports are closed by the German navy. Her Black Sea ports can only be reached through the Dardanelles, and the allies have failed to force that passage. Supplies through Vladivostok must cross Siberia on a railroad lacking in rolling stock, and not completely double-tracked. Archangel is

her only remaining door to the world. The "Minto" is keeping that door open.

Last winter, Canada's new ice breaker, the "Earl Grey," with the "New Bruce" and the "Lintrose" from Newfoundland, and Russia's "Merrimac"—all ice breakers—tried to make Archangel a winter port. And last winter the Galician campaign of the Russian army astonished the world—until its ammunition gave out; then it was forced to retreat and its defeat became nearly a disaster. The failure of the Russian army to hold the territory it won was the direct result of the failure of the ice fleet at Archangel.

When Russia realized the allies might not succeed at the Dardanelles, she placed immense orders for rails and rolling stock in this country; but the slide in our own Panama Canal held the boats carrying the equipment in the Atlantic and forced them to choose between making the long trip around Africa or braving the submarines in the Mediterranean. The delay allowed the early Siberian winter to set in. Vladivostok is crowded with supplies, and the railroad service to Europe is still inadequate.

Russia must beat the ice at Archangel or face another munition famine. Jack Frost has always been pictured as her ally, but now he is fighting on the other side. He is trying to seal up Russia's only door. The "Minto" is keeping the door open.

The "Kyle," the "Bellaventure," the "Bonaventure," the "Biothic," and the "Misconopic" have been added to the fleet that failed last winter; they are all ice breakers; but the "Minto" is not an ice breaker: it is an ice crusher. The ice breakers have sharp prows that cleave through the ice, a principle that works rapidly and well—until the ice grows thicker than the draft of the ship, then the ice breaker is helpless.

The "Minto" has no keel forward of midship; instead, its bottom slants away abruptly at the water line. In the water it looks like a tramp down at the stern; but its bow and bottom are heavily plated, and its hull reinforced. When it rams an ice field at full speed,

it climbs onto the floe until its weight crushes through.

In the shallow waters of the St. Lawrence Gulf, where the fresh-water ice from the river sometimes banks until it rests on the bottom, the ice breaker is more useful, but in the Hudson Bay and the arctic the ice crusher is still king. The White Sea is deep at Archangel. The "Minto" is a willing boat, and brave, and the fate of Russia depends on its success.

Through forty miles of heavy ice the fleet must keep a channel. Night and day the ice breakers patrol the course up near the arctic circle. When they meet ice they cannot cut, the wireless calls the blunt-nosed "Minto," it bucks a lead through, and Russia's door to the world is kept open.

### 707 EUROPE USING SUBSTITUTES FOR ABSORBENT COTTON

*Bonaventura Reports 9/15/15*  
Owing to the unprecedented demand for absorbent cotton caused by the war, with the resulting high prices, substitutes for this material are being made and sold on an extensive scale in a number of European countries. In Germany, particularly, the price of cotton is extremely high and is getting higher, since that country is entirely shut off from the American market. The substitutes produced in that country are much cheaper than cotton, but their sale has been somewhat retarded by the fact that they do not possess all the good qualities of cotton. One substitute having a big sale in Berlin is made of pure pine cellulose, and is used chiefly to stop bleeding. It is claimed that it absorbs blood much better than cotton, but that it is not as good as a dressing for a wound. In Sweden a cellulose wadding for dressing wounds is being made from chemical-wool pulp. This material is prepared in thin sheets like tissue paper, but is crimped. Bog moss, which has the advantage of requiring little preparation, is being extensively used in London as a surgical dressing. This moss is permeated with minute tubes which make it one of the best absorbent materials known. The

*Rapid Addressing Machine Co.,  
610 Federal St., Chicago  
33-46 West 23rd St., New York  
27th Broadway, New York.*

*5/16  
D. Belknap  
President*

**POPULAR MECHANICS**

same material was on the market in Germany before the outbreak of the war, and is presumably used in that country at the present time.

**ADDRESSING MACHINE MADE FOR SMALL OFFICES**

*497*

For the convenience of business houses, clubs, and other institutions which have mailing lists of moderate size, a compact, fast addressing machine has been developed. It is quite portable, may be used on a desk or table and is operated by hand. Its capacity amounts to from 1,200 to 1,800 envelopes or post cards an hour. One of its features is the character of the stencils used. These are made of a specially prepared silk fiber, which contains no wax, and are cut on a standard typewriter. Any stenographer can perform the work. A small metal carrier

*"Belknap Addresser"*

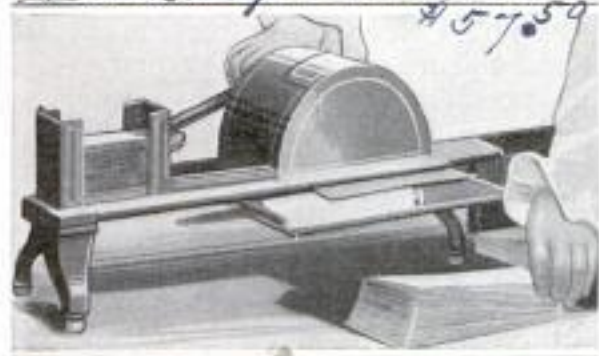

Hand-Operated Addressing Machine Capable of Printing Approximately 1,800 Envelopes an Hour

is clamped on the platen to hold the individual cards as they are cut. Each may be used many times without showing wear. When they are placed in the addressing machine they are carried forward to the printing position mechanically, while the envelopes, fed into one end of the device, are shot through, addressed, and discharged by turning a crank.

**WINDOW CURTAINS OPERATED BY ELECTRIC MOTORS**

*507*

Electric motors controlled from the lecture platform are used to operate the window curtains in a lecture hall at the University of Michigan, where as many as eight lectures requiring

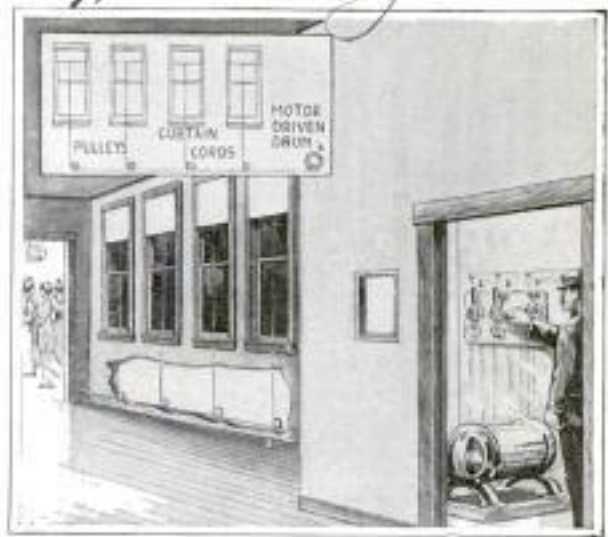

Window Curtains in a University Lecture Hall Operated by Electric Motors

a darkened room are given in one day. The curtain rollers are much like the ordinary rollers with the ratchet and pawl omitted, the cords being depended on to prevent the curtains from rolling up. These cords run through openings in the window sill and are attached to electrically driven drums. One motor operates several curtains. The control mechanism for the motors is installed on the platform in the cabinet with the lamp switches. The friction in the pulleys is sufficient to prevent the curtains from being rolled up when the motor is deenergized.

**ALUMINUM T-SQUARE TO SUPPLANT WOOD**

*9262*

Aluminum as a material for T-squares is rather unusual, yet an eastern architect has constructed one of this material, and he claims the new

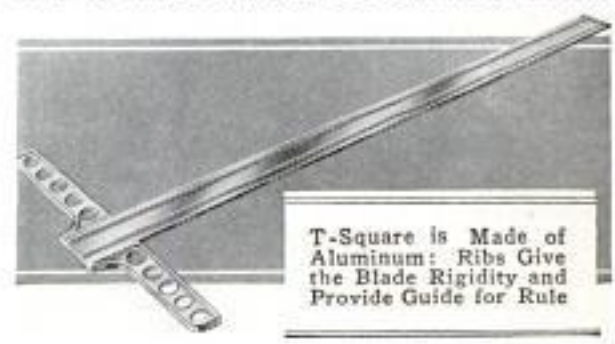

T-Square is Made of Aluminum: Ribs Give the Blade Rigidity and Provide Guide for Rule

type has several advantages over the ordinary wooden square. The blade on this square is stamped from sheet aluminum, and has two ribs running

*in Physics Bldg*

*Artists Supply Co.  
7610 Decatur Av., N. E.,  
Cleveland, O.*

down its length which not only give the blade rigidity, but provide a track along which a triangular rule may be run. The head is cast instead of stamped, and is suitably recessed for reception of the blade. Among the advantages claimed for the new square are its nonwarping features, and the fact that it will not smut nor blacken the paper on which it works.

### HOT-WATER HEAT SUPPLIED 731 BY KITCHEN RANGE

The latest plan for house heating is a system in which hot water for the radiators is supplied by the kitchen range, which is especially made for the purpose and is equipped with an unusually large fire box. The piping system is like that of an ordinary hot-water heating plant. Entirely sur-



rounding the fire box is a water back equipped with 22 tubular water passages, and these passages are so ar-

ranged that the hot gases from the fire come in contact with them on every side. In addition to this, the hot gases are made to heat the oven, the idea being to combine an efficient heating and cooking plant in one stove. By means of a connection with one of the main pipes, hot water is supplied to an ordinary hot-water tank and through this to the kitchen sink. In addition to the marked economy in fuel that is claimed for this system, it evidently has the advantage of being especially suitable for installation in flats and in cottages where only limited basement space is available.

1039  
**AMERICAN "GIBRALTAR"  
IN PACIFIC OCEAN**

*Marine Journal 11/6/15*  
Oahu, an island in the Hawaiian group, has been called America's Gibraltar because it is the only land available for a naval base in the Pacific within a circle whose center is this island and whose radius is equal to the distance from Hawaii to San Francisco. In the past decade the government has expended approximately \$13,000,000 in improving this rocky island as a naval base. Of this sum \$10,000,000 was used in developing a ship-repairing plant. The fortifications, including fire-control apparatus, submarine torpedo system, powerful wireless station, searchlights for watching mine fields at night, and batteries of howitzers, some of which are located on a ridge of mountains from 1,500 to 3,000 feet high, all combine to make this a strategic point ranking in strength and importance with Gibraltar.

872  
**MEASURING AND COMPUTING  
DEVICE FOR DRY GOODS**

As a means of preventing losses due to overmeasurement of piece goods and miscalculation of prices, a simple measuring and computing machine has been developed for use by clerks in dry-goods stores. It is a small device that may be attached to a rail at the rear of a counter and turned down out of sight when it is

*The Measuregraph Co.  
St. Louis, Mo.*



Overmeasurement and Miscalculation of Prices are Guarded Against by Employing the Device Which is Here being Used with Piece Goods



Dial and Price-Computing Scales on the Top Surface of the Machine: The Rollers Automatically Adjust Themselves to Receive Goods of Different Thicknesses



The Apparatus has Also been Adapted to Meet the Needs of the Ribbon Department: The Material is Wound from One Roll onto Another as Sold

not in use. It is operated by drawing the selvage of a piece of cloth between two rollers, which adjust themselves to receive material of various thicknesses. When this is done the yardage is measured and the retail price of the specific length indicated simultaneously by a dial and two rectangular scales. The machine may

be operated both backward and forward, so that in case a customer should decide to purchase two yards of cloth after three yards have been measured, it would only be necessary to draw the goods back until the indicator hands point to "two yards." The machine has also been adapted for the measuring of ribbon.

*French  
Measure*

*Warrant 461*

*Philo. Record 11/2/15*  
**ALLIES PLAN STEEL HOUSES FOR DEVASTATED AREA**      **NEW ELECTRIC VULCANIZER FOR AUTOMOBILE TIRES**

The construction of steel houses to take the place of the thousands of dwellings destroyed in the battle territory in Belgium and northern France has been the subject of negotiations between the allies' governments and certain American manufacturers. Estimates as to the cost of lumber showed that if large numbers of houses of uniform size and style could be made, steel would be a cheaper and more satisfactory material than wood. It is not anticipated that the structures would be occupied permanently, yet they must be sufficiently durable to last an indefinite period, if needed. The proposed steel houses are 12 ft. by 24 ft. in ground dimensions, and 9 ft. high. It is planned to make them available for soldiers also.

An electric vulcanizer of a new type for repairing automobile tires is equipped with a thermostatic cut-off which shuts off the current when the proper degree of heat for vulcanizing the rubber has been applied, and thus

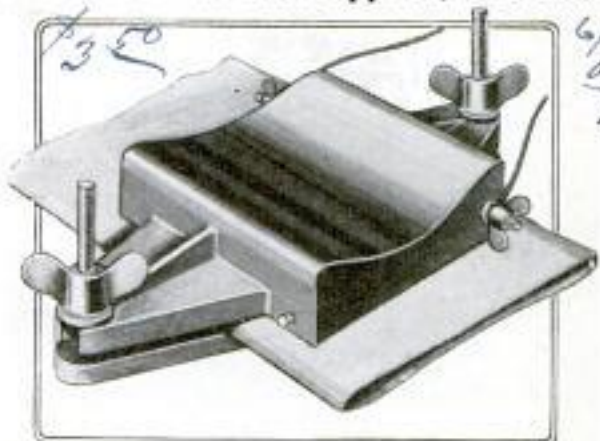

Tire Vulcanizer Controlled by Thermostat Which Cuts Off Current When Proper Degree of Heat is Reached

A large Chicago corporation has installed a shooting gallery as part of its recreation equipment for employes.

prevents the burning or overcuring of the tire. The vulcanizer is a simple and compact device, weighs less than

*Premier Electric Co.,  
#032 Ravenswood H.,  
4061 Chicago*

*6/16/15  
adv  
K152*

two pounds, and is operated by a 6-volt storage battery such as practically all automobiles are now equipped with. All that is necessary is to connect it with the battery, secure it to the tube or casing, and turn on the current by means of a push button. After this it needs no attention, as the current is shut off automatically at the proper time.

881

### HAND AND POWER SWEEPERS FOR INDUSTRIAL PLANTS

For cleaning industrial plants, warehouses, and similar institutions in which large floor areas require atten-

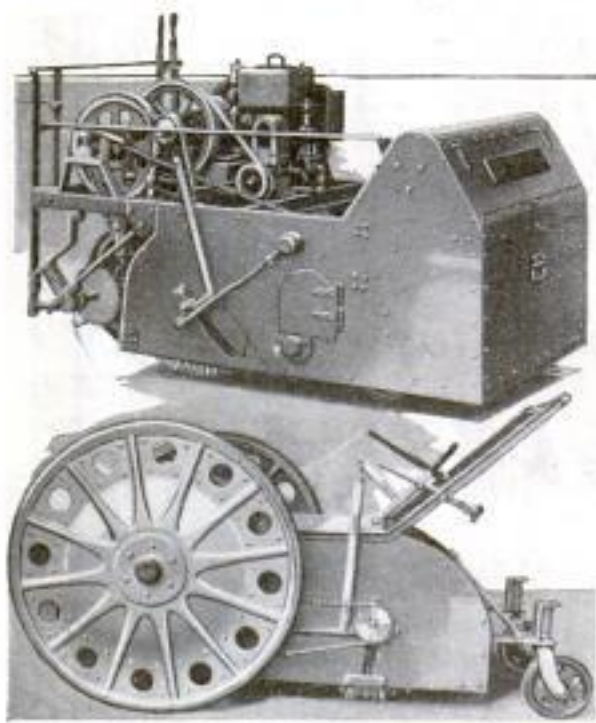

The Power-Driven Sweeper is Equipped with a Three-Horsepower Engine and Operates at a Low Cost. A Pressure of 26 Pounds is Sufficient to Work the Hand Machine on Ordinary Floors

tion, two fairly compact sweepers have been invented. One of these is operated by power, while the other is pushed by hand. In each instance the broom is so arranged that it adjusts itself to uneven surfaces, while a counterbalance enables its pressure to be varied according to conditions encountered and also makes compensation for the wear of the fiber.

In the power-driven machine the sweepings are brushed into a pan a few inches above the floor and deliv-

ered into a conveyor which carries the material into a bin of 2 cu. ft. capacity. This apparatus, which is three-wheeled, is provided with a 3-hp. gas engine, is slightly more than five feet in length, and weighs 700 lb. Normally it is capable of covering 27,000 sq. ft. of floor space in an hour.

The hand sweeper weighs 300 lb., is carried on two rubber-tired steel wheels and a pair of casters, and is propelled at a rate of two miles an hour by exerting a pressure of 26 lb. upon its handlebar. At this speed it is able to sweep about 20,000 sq. ft. of surface in an hour. The dirt caught in its sweeper pan is dumped into a bin by means of a lever.

Both devices can be operated within about four inches of a wall or curbing and used for sweeping driveways, loading platforms, and other surfaces of like character.

### ODD DISPUTE ABOUT

### FULL CREW LAW

Penna. N. R. folder 1037

A technical legal question, which is of very real interest to trainmen and the railroads in Pennsylvania, has been raised as to whether a combination coach and baggage car, under the Pennsylvania full-crew law, requires one more member on the crew because it is a car that is performing two functions. The law says that every train consisting of three passenger coaches and one baggage coach shall carry an engineman, a fireman, a conductor, a baggageman, and a flagman. The contention is now made that when a four-car train includes a combination baggage and passenger car there should be six in the crew, for that is the number required when a train contains four passenger coaches and a baggage car.

Many persons persist in applying five-cent stamps to letters addressed to Hawaii, or other of our island possessions, apparently ignorant of the fact that an ordinary letter will be carried for two cents.



## CALIFORNIA SUN PROVES EFFICIENT WOOL DRIER

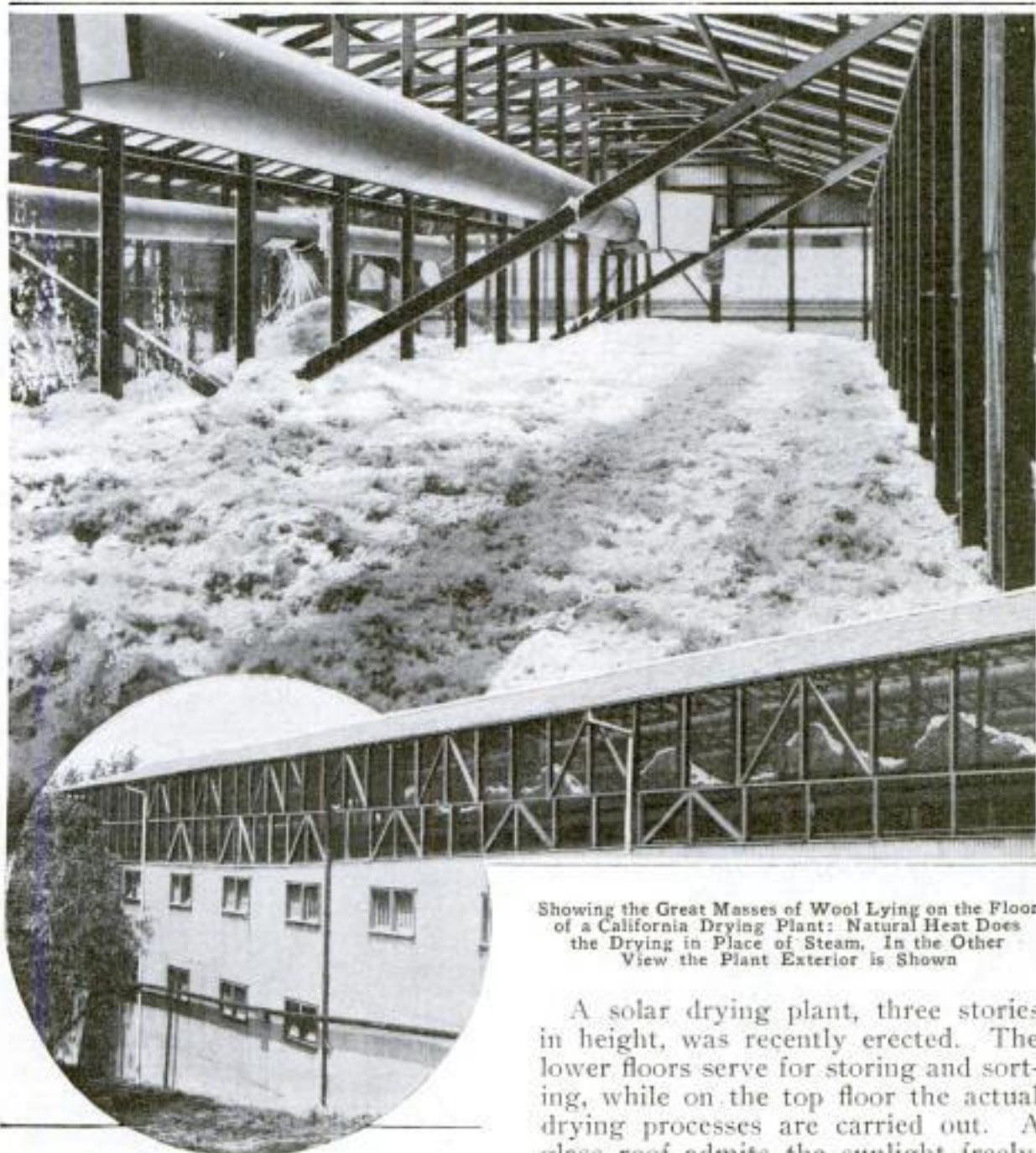

Showing the Great Masses of Wool Lying on the Floor of a California Drying Plant: Natural Heat Does the Drying in Place of Steam. In the Other View the Plant Exterior is Shown

In southern California the sun may be relied upon to shine approximately 350 days out of every 365. Moving-picture concerns have made substantial use of this fact in the taking of films. Another industry which is finding the California sun an asset is that of drying wool. The usual way to do this work is with steam, but here, because of the peculiar climate, an ancient system has been revived and found the better.

A solar drying plant, three stories in height, was recently erected. The lower floors serve for storing and sorting, while on the top floor the actual drying processes are carried out. A glass roof admits the sunlight freely, while screened sides allow ready circulation of air. On the floor are heaps of raw wool which are stirred constantly. The material comes from a scouring plant near by, where natural oils and greases have been removed. Currents of air in large pipes transport the wool from place to place. It is maintained that wool dried by sunlight has superior qualities over that deprived of moisture by steam or other artificial processes.

## STREET RAILWAY ERECTS

## 850 WAITING PLATFORMS

An innovation lately appearing along the street-railway tracks of Los An-



Concrete Waiting Platforms Protect Street-Railway Patrons from Passing Vehicle Traffic

geles consists of concrete waiting platforms of new and unusual design. Re-

alizing that on some of the broad avenues a person waiting for a car is likely to be run over by speeding automobiles, or may possibly get too near the tracks for safety, the street railway decided to build these special places at each corner for the accommodation and protection of intending patrons. The new stations consist merely of a cement platform a few inches above ground, and separated from street traffic by a curb. The track side is sufficiently far from the rails to prevent passing cars from coming in contact with anything within the confines of the platform. Aside from thus isolating and protecting patrons, the new stations have the further advantage of making it perfectly evident where cars start and stop, a convenience greatly appreciated by strangers in the city.

547  
CONTRASTING BURIAL LOTS USED FOR ADVERTISING

# Lucien Small (Gen. Sully) New Orleans La.



This Contrast between a Well-Kept Burial Lot and One That is Neglected is Used by a Monument Company for Advertising Its Business

The contrast between a well-kept burial lot and one that is neglected is used effectively by a monument company in Shreveport, La., for advertising its business. Near the sidewalk, where every passer-by can see it, is a neatly kept plot of

ground in which are several headstones. On the iron fence that incloses this lot is the sign "Lovingly Remembered." Near this is another lot that is overgrown with a tangle of grass and weeds and is inclosed by a tumble-down wooden fence on which is the sign "Sadly Forgotten." Obviously the contrasting plots attract attention.



Shreveport Monumental Works  
873 Texas St. Shreveport, La.  
A. Mc Guist, Proprietor.

998 *inquirer*

**FLEET SUBMARINES PRESENT  
DIFFICULT DESIGN PROBLEM**

*A. & N. Journal 11/13/15*

Naval engineers have found themselves in a rather difficult predicament due to recent congressional action. In a bill passed some time ago by that body provision was made for two fleet submarines that should have a surface speed of 28 miles an hour. Speeds above 22½ miles for submarines have been before unheard of. To get such a rate of travel, the engineers believe it will be necessary to use steam as motive power, with oil-fired boilers as a source of supply. Thus, upon submerging, the fires will be turned out, that the oxygen within the boat may not be used up. Radical changes in hull design will likewise have to be made in order to house the new type of motive power. The engines will be separated from the rest of the boat by heavy bulkheads.

**NEW ATTACHING DEVICE FOR  
8956 BUTTONS**

For attaching buttons in such a way that they can be easily removed and replaced, a new device designed to take the place of the screw button ordinarily used for this purpose has been invented and placed on the market. This device consists simply of a flat plate that is hinged to the shank of the button so that it can be passed through a buttonhole and laid flat on the opposite side of the cloth. On each of the two corners of the plate adjacent to the hinge is a blunt prong. The plate is inserted and turned across the buttonhole, then pressed down so that the prongs bear against the cloth.



*Irons & Russell Co.  
Providence, R.I.*

**OLD FORT NOW SERVES AS  
WATER TOWER**

Among the picturesque villages of the Channel Islands off the English coast evidences are still visible of other troubled times when Britain was on a war footing, even as today. Dotting the countryside in many places are stolid, black, forbidding old structures known as martello towers. On top of these stubby edifices, lumbering old cannon used to be mounted, and pointed toward France, then England's worst enemy.

In the peaceful days later on, however, the old forts were converted to various utilitarian uses. One of them is now serving as a water tower for a village street-sprinkling system, a use curiously in contrast to its one-time martial service. Surmounting the steel columns and water tank, which rise high above the old stone walls, is a chipper iron windmill of the kind familiar to every American farmer. Through the aid of brisk channel winds, this mill manages to keep the tank filled.



COPYRIGHT, E. O. CATTORD

*E. O. Cattord, Platte, Tongue Highdown  
Martello Towers, Channel Islands, Eng.*

**GIANT PENCIL AND PEN  
SERVE AS PILLARS 9736**

In designing the front of a stationery store recently erected, 12-ft. reproductions of a pencil and fountain pen were placed in vertical positions, like pillars, at the opposite sides of the building.

# Ira. E. Mosfield  
1000 St. Andrews Place  
Los Angeles

The former of these is 7 in. and the latter 9 in. in diameter. Each closely resembles its prototype, except in size. Together they form very novel sign-

9736

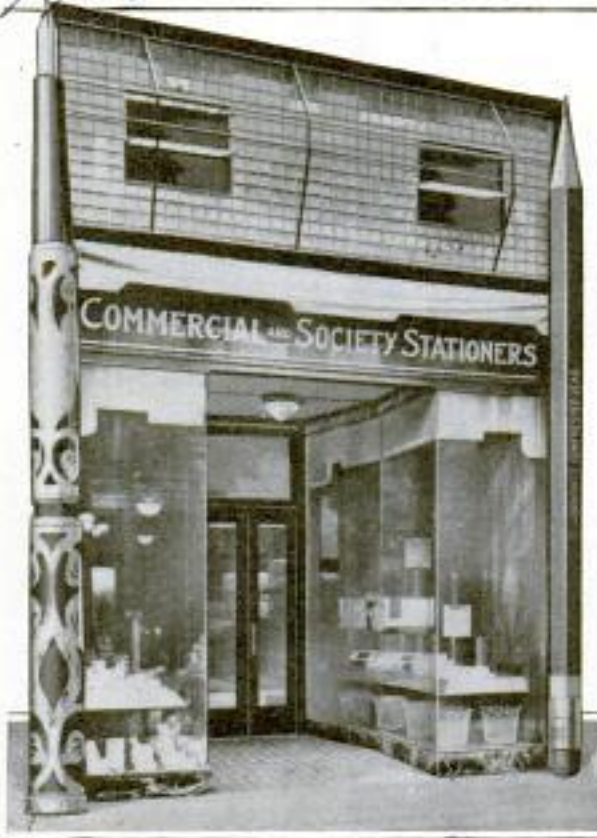

The Great Pencil and Pen Serve as Novel Signposts for This Stationery Store

posts for the shop, and have attracted much local notice. The barrel and cap of the pen are decorated with a standard design which gives much of the appearance of silver inlay. The details of the pencil have been worked out so well that by placing a sheet of paper over part of the accompanying photograph, so that only the former pillar is shown, it appears to be an ordinary pencil.

**OIL WASTE RECEIVES SCIENTIFIC STUDY**

1055 *The Engineer (London) 11/19/15*

Persons in charge of machinery have often been troubled with oil creeping over the outer surface of a bearing, the cause of this not always being exactly evident. The subject has received recent study by an English engineer. The fact that oil spreads even when the bearing is at ordinary temperatures

*T. C. Thomsen B.S.  
Ass'n of Mining Engineers*

is credited to the fact that air is drawn into the liquid by the rotation of the shaft and by rapid movement in circulating pipes. As a result minute bubbles fill the oil to saturation. As these come to the surface, they burst, creating a fine spray. It is the spray which settles on the bearing exterior. To remedy this condition, it is suggested that return pipes from bearings be made large enough to carry off surplus oil, bubbles and all. Or the installation of a vent pipe which opens out at a higher level than the oil-supply tank will cure the trouble.

646

**FARMER USES TANK HOUSE AS TEMPORARY RESIDENCE**

Being without sufficient funds to build a farmhouse of the style he desired, and needing a water supply badly, a western farmer decided to build himself a structure that would answer both purposes. The result was a towerlike building topped by a steel tank to give pressure to the water-supply system. The interior of the tower beneath the tank was divided into rooms, and in these the



Water Tower at the Rear of a Lot Serves as Temporary Farm Residence

farmer lived until enough funds were accumulated to build a house of more satisfactory character.

# Mrs. A. May Hoadley, U.S. Box 112, Velje, Calif.

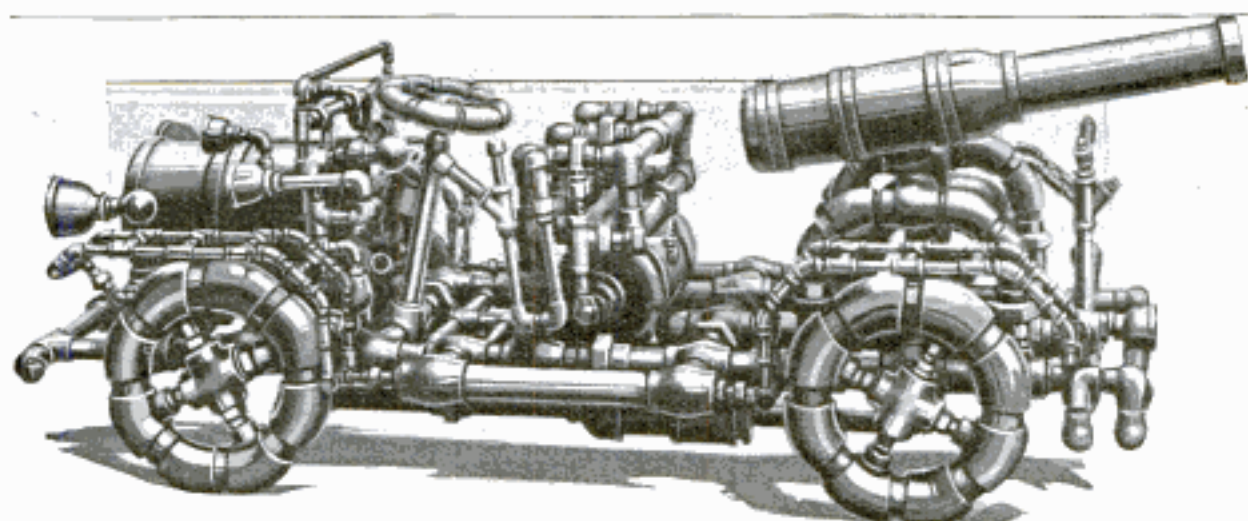

968 Military Automobile of Miniature Size Built Entirely of Odd Pipe Fittings

### PIPE FITTINGS ASSEMBLED INTO WARLIKE AUTO

A ferocious-appearing, though miniature, automobile of military type was recently constructed by an employe of an eastern manufacturing plant during spare moments. The machine, in spite of the huge cannon mounted above the rear wheels, is quite harmless, since the only materials used in its construction were a miscellaneous aggregation of pipe fittings. Practically every kind of fitting known to the trade has a place somewhere in the odd machine. Such attention was given to careful assembling that the many parts fit together harmoniously and give the machine an appearance complete as to details. The model is 6 ft. long, a little over 2 ft. wide, and weighs 700 lb. In constructing the odd vehicle 1,129 separate pieces were used.

### 9721 LIGHT-WEIGHT RESPIRATOR FOR FACTORY WORKERS

Many of the so-called occupational diseases are caused by the inhalation of dust, and to obviate this condition a respirator, made with a very fine screening of wire supplemented with other filtering mediums, has been introduced. Although it is claimed to be capable of blocking the passage of the finest dust particles, it does not hamper normal breathing. It is considerably

smaller in size than some other devices of similar character which are now in use, and fits snugly over the nose and mouth. It is held in this position by an elastic band that passes about the base of the head immediately below the ears. The body of the respirator is lined and covered with soft cloth. There is no metal or leather about it to touch or chafe the skin, while it is also exceedingly light in weight so that the user experiences no discomfort in wearing



Wire Screening of Fine Mesh Is One of the Filtering Mediums Employed in This Respirator, Which is Worn to Safeguard against the Inhalation of Dust in Factories, the Character of Some of Which is Shown, Highly Magnified, in the Two Inserts

it. A saturating pad is fastened over the front part of the device when it is employed in shops filled with noxious fumes.

Multi-Metal Separating Screens  
 87 Broadway 131st St. N.Y.  
 25 W. 19th New York  
 3/25/17

## DUST ARRESTER PURIFIES

## 729 FACTORY AIR

Designed to rid factory air of its burden of dust, an air purifier has lately been marketed. The invention consists

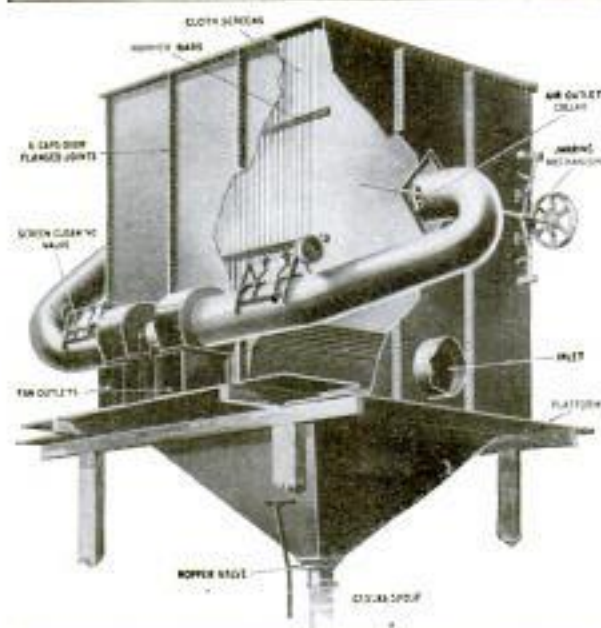

Machine Removes Emery Dust from Factory Air

of a series of cloth screens placed one behind the other and inclosed in a sheet-steel box provided with suitable entry ports and delivery points for the air. Dust from around all emery and polishing wheels is gathered in by means of suction fans and conveyed through pipes to the arrester, where the particles are blown against the several screens. These are mechanically agitated, which results not only in the dust being strained out of the air, but causes it to be shaken off the screens into the bottom of the box. A hopper and spout are provided so that the dust may be drawn off and carried away. Manufacturers claim even the dustiest air may be thoroughly cleaned with this machine.

¶An altitude of 11,000 ft. was attained recently by Lieut. R. C. Saufley, U. S. N., in a flying boat, a new record for this type. But it cannot be officially so recorded because the air craft's recording pen ran off the sheet at 9,000 feet.

## IDAHO TOWNS ARE LIGHTED

## 759 AND HEATED ELECTRICALLY.

#Chas. J. Feste Magic Idaho

To those who are accustomed to paying the usual city rates for electric energy, the condition which has been brought about in towns and rural districts along the Snake River in Idaho by the Minidoka power and irrigation project is no doubt novel. At Rupert, Idaho, a public high school is heated and lighted electrically, as mentioned at some length in a previous number of this magazine. Altogether, however, the town, which has a population of about 1,000, now uses 1,600 hp. in its homes and stores.

In houses which have cost only a few hundred dollars to erect it is not uncommon to find electric stoves, ranges, lights, washing and sewing machines, and other appliances. The same is likewise true in some other towns and in the country for miles along the river. The farmers not infrequently turn their grindstones and operate separators and other machines by power. And this is all because of the cheapness of hydroelectric energy.

The Minidoka undertaking itself is quite generally understood, but to many the numerous small installations scattered along the river are unknown. For nearly 500 miles through the state there are isolated pumping plants of various capacities. They are supplied with current from the government transmission lines, and in many instances amount to nothing but a small electric pump of probably two horsepower, which raises water 40 or 50 feet to a tract of 15 or more acres. Some of these installations cost no more than \$150, and by rendering little patches of land productive, which heretofore have been practically worthless, they are making possible hundreds of new homes. Correspondingly there are large plants supplying water to areas of several thousand acres after lifting it to heights of sometimes more than 200 feet. One of these units is near Payette, and uses 1,150 hp. to irrigate 7,000 acres of land lying at a considerable height above the avail-



Station at Indian Cove, Idaho, Where Water is Raised 250 Feet to Irrigate Hillsides Now under Cultivation



Long Eight-Foot Main through Which Water is Pumped to a Considerable Height to Irrigate Some 7,000 Acres of Land. The Installation Enables Crops to be Raised on Soil Which But a Short Time Ago Was of Little Value Because of the Lack of Moisture



High School at Rupert, Idaho, Which is Heated and Lighted Electrically

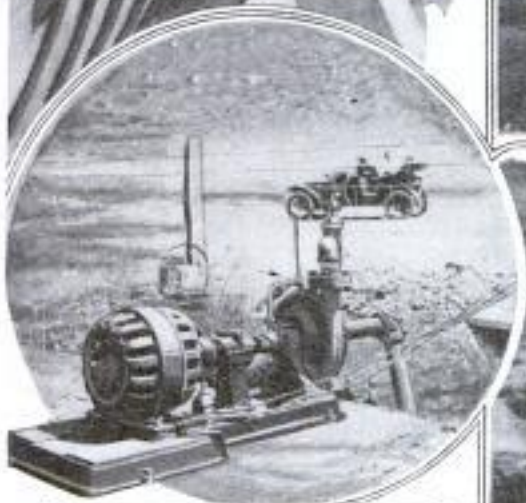

Small Pumping Installation in One of the Isolated Places

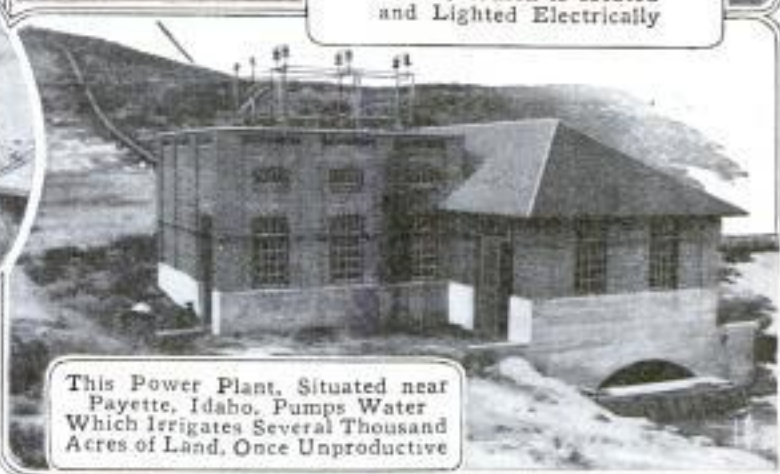

This Power Plant, Situated near Payette, Idaho, Pumps Water Which Irrigates Several Thousand Acres of Land, Once Unproductive

able water supply. The state is said to have more than 200 separate electric pumping stations in operation, which together are reclaiming tens of thousands of acres.

883—

### CONVENIENT STAND IS MADE FOR DESK TELEPHONE

It is not infrequent that a user of a residence telephone prefers the desk type of instrument but does not have a stand of convenient height, or a suitable desk, on which to accommodate it. Because of this condition a telephone-table outfit has been introduced which may be employed either in a home or office. It consists of a small stand with a stool which may be slipped beneath the former when not in use. Both pieces of furniture are of plain design and available either in golden oak or mission finish. Telephone equipment of either the magneto or central-energy type is supplied with the stand and seat, and the telephone is permanently mounted on the table top, or left unattached. All of the parts, aside from the transmitter and receiver, are concealed under the top of the table.



former when not in use. Both pieces of furniture are of plain design and available either in golden oak or mission finish. Telephone equipment of either the magneto or central-energy type is supplied with the stand and seat, and the telephone is permanently mounted on the table top, or left unattached. All of the parts, aside from the transmitter and receiver, are concealed under the top of the table.

1046—

### MORE USES FOR LONG WOOL THROUGH NEW PROCESS

A new English patent makes available for general use in manufacture by woolen mills the long, tough fibers of crossbred wool from mutton sheep of New Zealand, which heretofore has only been used advantageously in the machines of the worsted trade. The war, which indirectly has resulted in

developing additional uses for many other raw materials, is said to have been an incentive in producing this textile improvement. Heretofore the length and strength of the type of wool referred to has caused serious accidents in the carding machines of the woolen mills. The new invention does not displace any existing machinery or processes, but prepares the wool. No matter how long the fibers, they can be reduced to any desired length, after which they can be blended with other wool, shoddy, cotton, etc. Fabrics woven from it possess a texture that is soft to the touch, instead of harsh and wiry, as in the case of worsted materials. The invention does not produce additional waste but improves the carding, spinning, and weaving, besides increasing the output in all three stages of manufacture, it is said.

### TRIPOD CARRIED BENEATH COAT IN HANDY FASHION

As a solution for the annoyance and trouble attendant upon carrying a tripod by hand on picture-taking excursions, a camera enthusiast has devised a simple scheme. A metal tripod is used; one of the kind which folds compactly into a small space. This



is strapped close to the shoulder beneath the coat of the carrier, a rubber band holding the legs tightly together. In this position the tripod is out of the way, and the carrier is not put to the trouble of hanging onto it by hand. By always having a tripod along in this fashion, many good pictures are secured which otherwise would be lost for lack of a suitable camera support.

Consul Homer N. Byington  
Leeds, Eng.  
Smith & Hall

# Andrew G. Thome  
1134 Sixth St.  
Louisville, Ky.

Swedish-American Telephone Mfg. Co.  
 5-735 Ravenswood Av.  
 Chicago



## DEAF AND DUMB STUDENTS PLAY FOOTBALL

959

THE football eleven of a Virginia college for the deaf and dumb during a workout: All signals are given by signs, making it necessary for every man to watch the quarterback before each offensive play.



COPYRIGHT, INTERNATIONAL FILM SERVICE, INC.

238 William St., New York.

## NEW BALANCE USES CHAIN

## 844 INSTEAD OF WEIGHTS

An analytical balance designed to do away with small weights and their handling has been invented. Most existing scales for the use of chemists, and physicists, are of the beam type with a scale pan supported on either side of a central standard. In use, the object to be weighed is placed in one pan and the balancing weights in the other. The process is slow because of the delicacy of the apparatus. The inventor of the new balance has done away with the weight handling, however, by the simple expedient of hanging a chain to the beam on the weight side. The lower end of the chain is supported by a sliding indicator which runs up and down on a graduated scale. By lowering the indicator additional chain is made to hang from the beam, and thus weight is added to that side. Naturally, the reverse operation may be carried out and weight subtracted from the same side. A vernier and finely divided graduations on the ver-

tical scale enable accurate weighing to be done. The contrivance has been pronounced a decided success by experts who have tried it out. All movements of the chain and scale-pan supports may be controlled from without.



Analytical Balance Uses Chain Instead of Scale Weights

Christian Becker, Inc.  
92 Reade St., New York.

## RAILROAD COMMANDEERS

## 869 CAR FOR WATER TANK

An Illinois railroad was in a hurry for a water tower at one of its small-town stations recently. Inasmuch as



Coal Car has been Made to Serve as a Water Tank on an Illinois Railroad

the ordered tower persistently failed to arrive, officials felt it necessary to use emergency means. An empty coal car standing on a side track was seized upon, robbed of its trucks, and elevated to the top of a tower erected alongside the roadbed. The elevating process was carried out with the help of jacks, the ties forming the tower being placed beneath the car as fast as raised. Cracks in the sides and bottom of the improvised tank were calked, and a newly erected pumping station speedily filled the interior with the much-desired water. The odd station has been faithfully supplying passing locomotives ever since.

1033 DOGS CARRY DISEASES TO LIVE STOCK

That dogs are the carriers of such maladies as the foot and mouth disease is the contention of the Department of Agriculture, which has been investigating the question. A dog running

*Dept. of Agriculture  
Bulletin*

across an infected farm may easily carry in the dirt on his feet the most contagious animal diseases. Not only are germs brought to stock in this way but human beings also are liable to contagion. Ringworm, rabies, double-bored tapeworm, and in some instances, through the medium of fleas and ticks, the bubonic plague, have been carried by the faithful family pet. Careful bathing of the dog and careful selection of his food, which should never include viscera not thoroughly boiled, are among the preventive measures suggested.

MONSTER BELT IS USED IN  
964 SUGAR REFINERY

A seven-ply rubber belt, 1,443 ft. long, a yard wide, and weighing nearly six tons, was recently manufactured for a sugar refinery. It will be used as a conveyor of bagged sugar through the factory, carrying an immense load each day. The bags weigh 125 lb. each and fall on the belt from a height of 4 ft. Though rather rough treatment, the belt stands up well in this service. When new and freshly coiled up in the factory, the belt made a huge roll nearly eight feet in diameter.



Huge Rubber Conveyor Belt is Built for Hard Service in Sugar Refinery

**ELECTRICITY SUPPLIES HEAT**

**972 FOR EMBOSsing**  
*Elec. World, 10/30/15*

Embossing processes work much better when the dies are kept continuously hot. But it is often difficult to get the heat just at the point desired, and the steam or gas arrangements heretofore used have been cumbersome and hard to manipulate. A new electric embossing block is designed to make the work simpler. It consists of a die-holding plate back of which are three heating units controlled by a switch on the supply cord. This plate may be locked in the forms of any job press, and with its aid regular embossing work turned out. Most any form of die may be firmly held to its surface by means of screws through the many

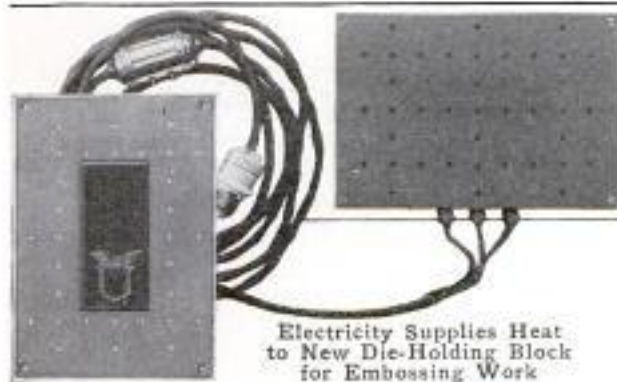

Electricity Supplies Heat to New Die-Holding Block for Embossing Work

holes, and thus the heat from the block is transferred directly to the die at the point where most needed. Attaching dies to the block by means of screws prevents the slipping which sometimes troubles other methods. Current consumption of the heating units is not excessive.

**882**  
**MOTORCYCLE AND SIDECAR  
FITTED FOR WINTER**

To completely inclose a motorcycle and its sidecar, giving thorough protection from rain and cold winds, a top has been devised which makes such a conveyance really practical for winter use. The whole contrivance is shielded, since an apron extends beneath the machine and prevents air currents sweeping in from below. The heat given off by the motor is sufficient to keep the interior quite comfortable

*P. I. Haynes & Co.,  
Columbus, O.*

even when the mercury is down. In the front curtain, which is provided with a liberal amount of window space,

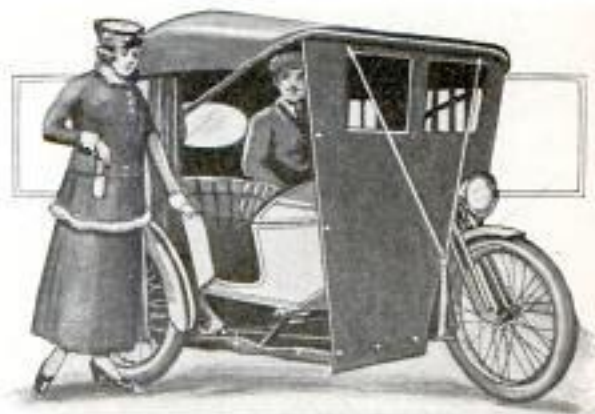

The Top and Side Curtains Provide Ample Protection during Severely Cold Weather

as are also the side and back drops, there is a small opening which allows the entrance of enough air to keep the engine cylinders from overheating. When thus equipped, only the wheels of a machine are exposed. The top is not unsightly, is built on a substantial frame, and does not interfere with safe driving.

**9785**  
**SCHOONER HAS PROPELLER  
MOUNTED OFF CENTER.** *Am's*

*Int. Marine Engineering*  
An unusual engine installation was lately made in a pilot schooner working out of an American harbor. It was desired to propel the boat by means of an oil engine, but this involved putting in a propeller and shaft. Not wishing

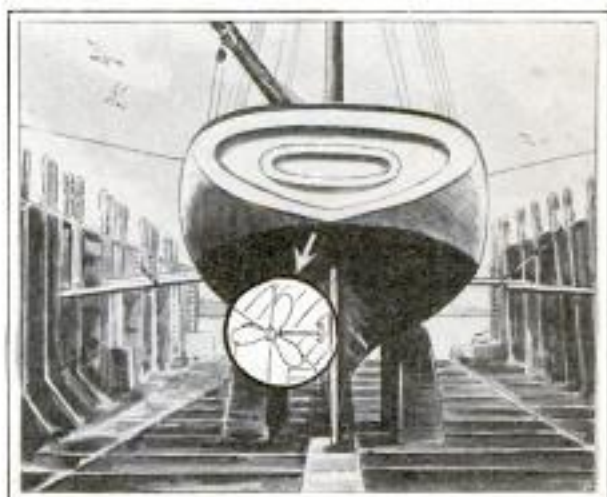

COURTESY INTERNATIONAL MARINE ENGINEERING

Propeller Shaft Carried Out of Port Side of Vessel Instead of through Sternpost

to disturb the rudderpost or other parts of the extreme stern in order to get the propeller on a center line of the vessel, it was decided to thrust the shaft through the side of the ship and let the propeller operate beside the sternpost instead of through it. In order that the propeller so mounted might not interfere with the steering qualities of the ship, the center of the engine shaft was kept practically at the center of lateral resistance. By so doing the propeller's effect on steering would be nearly neutral with the vessel going straight ahead.

746-2007  
**BICYCLE ATTACHMENT MAY  
CARRY RIDER OR LUGGAGE**

An attachment of simple and apparently strong construction has lately been devised for use on bicycles. To

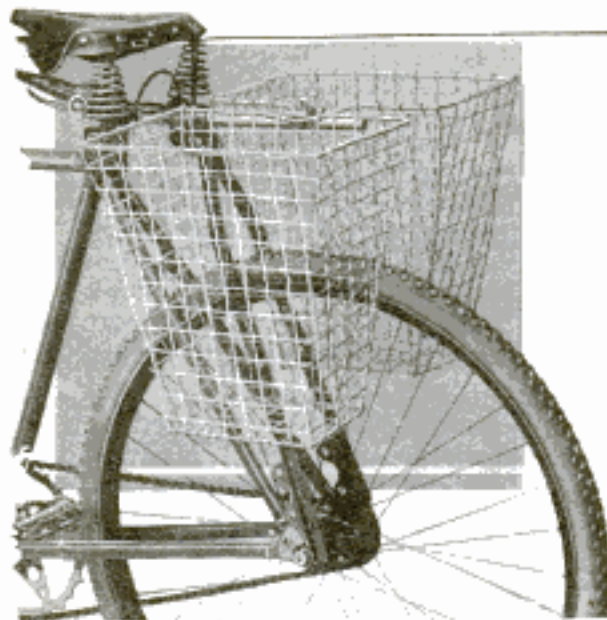

Attachment above Rear Wheel of Bicycle Either may Support an Extra Rider or Carry Luggage

the seat post of a bicycle a steel rod is clamped, which is supported by two ribbed braces reaching up from the rear hub. On the steel rod so attached a second saddle may be clamped, converting the wheel into a tandem bicycle. Or, if desired, two wire baskets may be hung on the rod, one on either side, thus providing a strong and roomy luggage carrier, which is said to be capable of support-

ing a weight of 400 lb. When the attachment is being used to carry an extra rider, adjustable L-shaped steps are provided which may be hung on the ribbed braces as a foot support for the passenger.

9496  
**TUNNEL 11,088 FEET LONG FOR  
JAPANESE TRAMWAY**

Engineering (London) 2/19/15  
As a part of an electric railway line built to connect Osaka, one of the chief commercial cities of Japan, with Nara, about 19 miles distant, there has been constructed a tunnel which penetrates the Ikomayama Mountains; in cross-sectional area it is said to be the largest tunnel in Japan. Its length, 11,088 ft., is said to be exceeded by only one other Japanese tunnel, namely, the Sasago tunnel, which is 15,219 ft. long, but will only accommodate a single railroad track. The more recent Ikoma tunnel, as it is called, is double-tracked. It required two years and eight months to complete the undertaking. The tunnel's location was accurately established by two independent triangulations; for the alinement a transit with a 15-in. telescope was employed. This was placed on a wooden tower on the highest point of the mountain. Because the wind swayed the tower slightly, it was necessary to make the observations on a very calm day. Excavations were begun at both ends simultaneously. The final error in alinement was only 1.3 in. in two miles. In making the excavations enormous rock pressure was encountered where water was in the fissures. On one occasion this caused a mass of rock to fall at a point 2,800 ft. from the eastern entrance, killing 19 men and imprisoning 147 others, who were rescued 49 hours later in a very exhausted condition.

ⒸThe bullets in a new shrapnel shell are welded to a wire, which, when the shell explodes, is thrown forward with a rapid whirling motion. The shell is apparently intended for breaking down wire entanglements.

ODD SEMIPRECIOUS STONE IS  
578 **ASTERIATED QUARTZ**

*C.S. Monitor 9/14/15*  
When exposed to the direct rays of the sun, or some other bright light, a new semiprecious stone which is being mounted in rings and la vallières exhibits in its depths a figure similar to a six-pointed star. It is recognized as an asteriated quartz, and because of its peculiarity, has been given the name of "starolite." The optical phenomenon is accounted for by the presence within the stone of numerous tiny air spaces that reflect the light in a star shape when the gem is cut in a convex form and not faceted. It is found in this country and is described as resembling a moonstone in coloring.

727  
*Harple*  
**CONCRETE HITCHING POSTS PART OF STREET CURBING**

Concrete hitching posts of a novel character are used in front of the Santa Aña residence of a Californian.

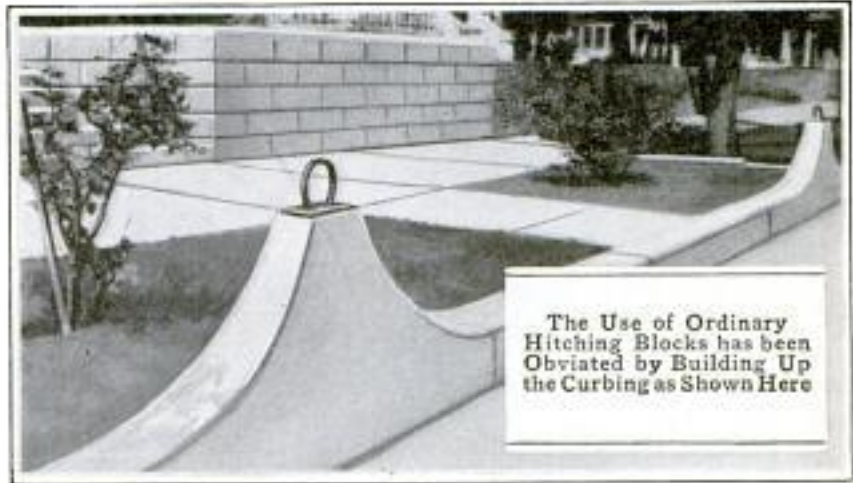

They are built as a part of the street curbing and are merely heavy projections extending about two feet above the parking level. At the base each is of the same thickness as the curb and has a length of approximately 3 1/2 ft. Likewise each tapers toward the top where a curved rod is firmly anchored and a heavy iron plate used as a covering for the concrete. They are separated by a cement walk which extends to the steps in front of the house. The general effect is both odd and attractive.

While the United States government was transferring a new 16-in. gun through the Hoosac tunnel on its way to the Sandy Hook proving ground recently, all lights in the tunnel were turned out to prevent the possibility of a short circuit caused by the presence of so large an amount of steel.

*807 # Crosby, 60+ Pullman Bldg Chicago*



**CYPRESS SHINGLES RESIST STORM BETTER THAN SLATE**

AN UNUSUAL result of the storm which recently wrought havoc in New Orleans was the shattering of a slate roof on a house which was badly wrenched also. A few feet away stood a barn with a cypress shingle roof that was scarcely damaged.

*Inv* *Harvey Kepler*  
*5016 Seventh, Devils Lake, N. D.*

**TIRE-REPAIR WASHERS GRIP RUBBER LIKE VISE**

For quick repairs to small holes in rubber tires a northern automobilist has brought out a clamplike contriv-

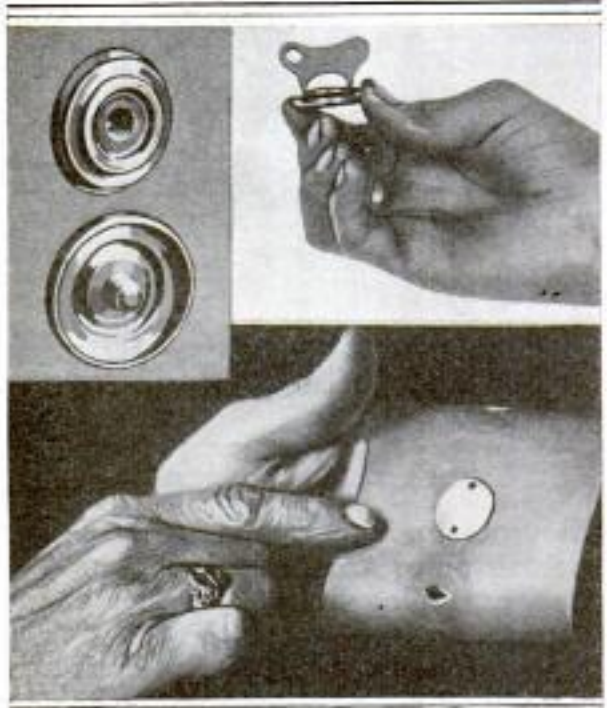

One-Half of This Clamp is Placed inside the Tire, and the Other Half Screwed onto It from Without

ance which, even though an emergency device, he claims has given satisfactory service over a 2,000-mile run. The invention consists merely of two simple washers, one rather cone-shaped and the other correspondingly concave, a suitable bolt connecting the two. In use, one of the washers is placed inside the tire and the other screwed onto it from without by means of a detachable key. As a result the rubber tissue is firmly held between the two halves of the clamp, entirely preventing, it is claimed, the escape of air from the hole.

1051

**"LIVE" RESTAURANT RAIL CAUSES DEATH**

*Engineer (London) 11/19/15*  
 A restaurant helper in Wales recently lost his life because of an electrical connection which had been made between a brass rail in front of the restaurant counter and a supply main.

*Neath*  
*So. Wales*

The restaurant proprietor, an Italian, who had caused this connection to be made, also placed in the floor in front of the counter a metal plate. While standing on the latter the helper accidentally touched the brass rail, with fatal results. This device, which the coroner afterward characterized as "stupid," was installed, the restaurant owner testified, to prevent small boys from stealing food from the counter. While the supply pressure was 220 volts, tests after the accident showed that 30 volts was the maximum that could be obtained from the rail. The facts that the helper was in poor health and had a weak heart apparently were causes contributing to his death.

**SOLDIERS SCALE SEA WALL IN IMPROMPTU FASHION**

170

The happy-go-lucky expedients to which American soldiers in the field resort in order to gain a desired end, and at the same time save themselves excessive labor, is interestingly demonstrated in an odd ladder recently devised to scale a sea wall on the Texas coast. Two old posts and scattered bits of driftwood were all the material available for its construction. The posts were laid side by side against the wall as the supporting beams, while stability to the steps laid thereon was secured by bracing one foot rest



*# Leigh F. J. Zerbe,*  
*2d Lieut. C. A. G., U. S. A.*  
*Ft. Crockett, Texas*

*Electric Shock*

against the next. Two old ropes provided the balustrade. This ladder saved the builders much exertion each day in scaling the wall by sheer force of arm and leg, as well as in footing it by roundabout paths to ascend the barrier at easier points.

1047—  
**INDIAN MUSIC RECORDED  
 BY PHONOGRAPH**

*Smithsonian Institute 12/11/15*

The preservation for posterity of about a thousand ancient Indian songs, such as once were sung all over this continent, has been accomplished by means of the phonograph, as a part of years of research conducted by the Bureau of American Ethnology under the Smithsonian Institution. Many of these musical efforts are quaint and very beautiful. In addition to recording them phonographically elaborate notations have been made regarding the singers and the history and religious meaning of the compositions. An especially constructed recording horn and recorder were part of the equipment used. Great care was exercised to secure native singers with good voices.

**LOUIS XVI DESK COSTS FOUR  
 830 YEARS' LABOR**

A desk, which took four years to construct, and is now valued at \$5,000, was recently completed by two artists in wood. It is an exact copy of one by David Rontgen, a famous wood carver of the 18th century, whose works in figural inlay are considered unsurpassed. A famous Louis XVI desk by him is now in the Austrian National Museum of Arts in Vienna, and this was studied by the two artists during six years. The only difference between the original desk and its copy is that the older one was made of Italian walnut with bronze decorations, while the replica is entirely of mahogany, excepting only the bits of inlaid wood.

The desk rises in four tiers, the lower three of which are paneled with inlay work. The top tier serves as a mounting for a clock. The whole

affair stands a fraction over 9 ft. high and is 4½ ft. wide. Painting, architecture, sculpture, and music are rep-



Copy of Famous Louis XVI Desk Which Took Four Years to Construct and is Decorated with Beautiful Inlaid Woods

resented pictorially in the inlay work, an accomplishment requiring a great deal of labor and artistic sense. Over 40 different kinds of woods, which the wood carvers themselves collected during several years, are used to give the many colors. A few of these varieties are: three kinds of rosewood for the red shades; ebony for the black; primavera, bird's-eye maple, and white maple for the yellows and greens; white oak and holly for the light whites; and Italian and black walnut for the browns.

*Wm Konnerth & George Fouse  
 526 Rosella Av., Watts, Calif.*

**AUTO RACER IS GUIDED BY  
ARMLESS DRIVER**

947  
Murple

An unusual method of handling an automobile was lately devised for the benefit of an armless driver. In place

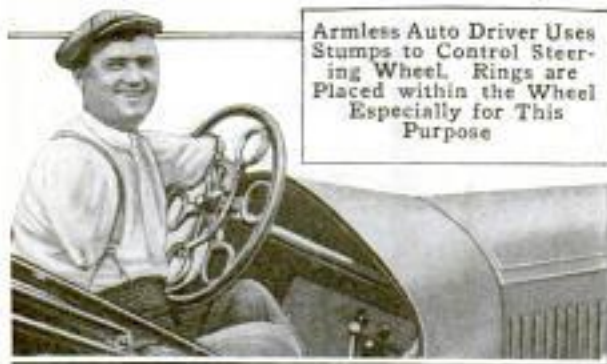

Armless Auto Driver Uses Stumps to Control Steering Wheel. Rings are Placed within the Wheel Especially for This Purpose

of spokes in the steering wheel a number of small hoops were provided. In these the driver may insert the arm stumps, thus guiding the car. Gasoline and spark levers are located above the wheel, that they may readily be moved with the same shortened limbs. Changes of gear are effected with a foot pedal. With a racing car thus fitted up, the driver has been touring the country, taking part in such speed events as were encountered. Speeds up to 58 miles per hour have thus far been obtained with this odd method of control. The handicaps under which the driver labors make close attention necessary.

8885

**STREET CLEANER COLLECTS DIRT AS IT SWEEPS**

Trials, which are said to have proved satisfactory, have recently been made in the East with a street-cleaning machine which sweeps and sprinkles a pavement in a single operation. Unlike many sweepers, this one picks up the dirt and deposits it in a series of trash receptacles, which are carried on a revolving rack back of the driver's seat, instead of merely sweeping it into the gutter from which it would have to be shoveled into wagons

by "white wings." When the trash cans are filled with sweepings they may be removed and others put in their place, which makes it unnecessary for the sweeper to travel possibly several miles to a dump before unloading the refuse it has collected. This allows the machine to continue steadily throughout the day cleaning pavement. With a team of horses, one man, it is said, is able to sweep 62,000 sq. ft. in eight hours.

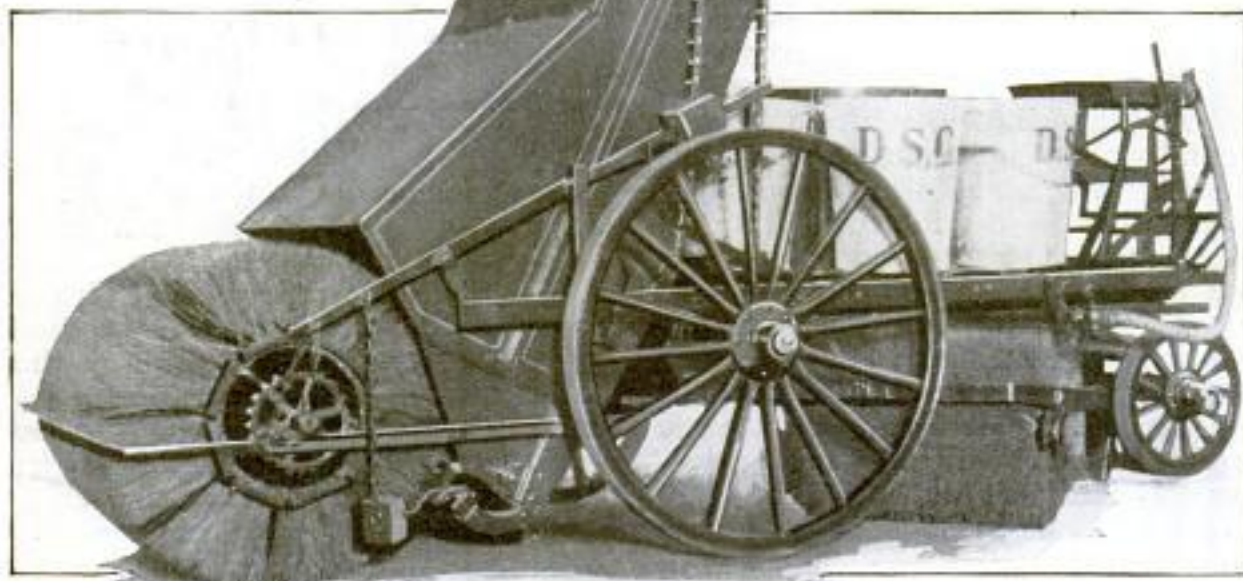

This Street-Cleaning and Sprinkling Machine Collects the Refuse Which It Sweeps from a Pavement

Merritt Street Sweeping Machine Co.  
523 East 18th St., New York





The Fine Residence of a Wealthy Guatemalan Sugar Raiser in Process of Construction. The Round Balls in Front of the House Are Heaps of Raw Brown Sugar Ready to be Carried on the Backs of Natives to a Refinery Perhaps a Hundred Miles or So Away

### SUGAR KING'S PALACE HAS 834 THATCHED ROOF

Little of the pomp and circumstance which surrounds American wealth troubles the richer landowners of the neighboring republic of Guatemala. The construction of a fine residence is a simple matter. One recently built by a wealthy sugar raiser is an interesting example. Constructed of the building materials always to be had for the taking in the rural districts, no great money outlay in its building was necessary. The walls are of adobe, obtained by the simple process of digging mud out of the ground. This material was formed into rough squares and baked simply by the heat of the sun. For the roof a heavy thatch of leaves from the cocoa palm was used. Native Indians do the work and are capable of turning out rather neatly built structures if given plenty of time. In the mountain districts some of the houses are round with conical roofs. The natives cap the tips on these cones with an inverted earthenware bowl to keep out the rain.

—  
A contract for 5,000,000 yd. of heavy woolen cloth, enough to supply 1,250,000 overcoats, has been let to an American firm by the Russian government.

### ELECTRIC CAPS FIRED WITH POCKET BLASTING MACHINE 464

One of the latest conveniences for use in coal mining, quarrying, and other work in which blasting is required, is a pocket machine capable of firing as many as five electrical caps simultaneously. Unlike the ordinary blasting machine, which is comparatively heavy and must be set up on level ground, this little machine weighs only 4½ lb. and is held in the hand when being used. In operating it, all that is necessary is to connect the wires leading to the charges, unscrew the cap attached to one end of the flexible handle, insert a key in the opening thus uncovered in the case, and give the key a quick, sharp twist. This generates the current that fires the caps. To guard against meddlers the blaster has only to keep the key in



*E. I. DuPont de Nemours  
Powder Co.*

*Wilming ton  
Del.*  
Copyrighted material

his pocket, as the machine cannot be operated without the key. The machine is 4½ in. high, 3⅝ in. wide, and 2⅛ in. thick, and is rounded at the edges so that it slips readily into the coat pocket.

264

**HISTORICAL MAP OF HARVARD YARD MADE IN CONCRETE**

In front of University Hall at Cambridge there is a concrete slab on which a permanent map of Harvard Yard has been worked out in an interesting manner. It shows the plan of the grounds, the sites and outlines of its various buildings, and the relative locations of the individual pieces of property acquired at different periods. Each tablet representing a university structure bears the name of the building and the date of its erection. The diagrams of original properties are marked off with dotted lines and in most instances named and dated. One of these plots bears the inscription, "Before 1642," and others, "Eaton before 1642," "Fellows' Orchard 1642," "Foster Estate 1836," and so on. The streets surrounding the yard are indicated, as are the gates and fence. The slab is raised about two feet.

1045  
**HUED ENAMELS FOR HEATING AND COOKING STOVES**

*Commerce Reports 12/1/15*  
Kitchen and heating stoves of various hues, in place of the deadly black, are a possible result of experiments now being undertaken by the United States Bureau of Standards to develop satisfactory colored enamels for cast iron. The present popular tendency to decorate coal stoves has proven a stimulus to this investigation. A good ground coat already has been developed, as well as a white cover coat for cast-iron stove parts. The white coat produced contains oxide of antimony in place of the more commonly used, but expensive, tin oxide.

7273  
**NEW SYSTEM OF HIGH-SPEED METAL CUTTING**

Cutter speeds and feeds from eight to ten times as high as those used in ordinary practice are made possible by a new system for cutting and milling metals that has recently been introduced. The essential feature of the system is the lubricant, which is supplied in about ten times the quantity heretofore used, so that the cutters work in a flowing stream of oil. For

*Cincinnati Milling Machine Co., Cincinnati, O.*

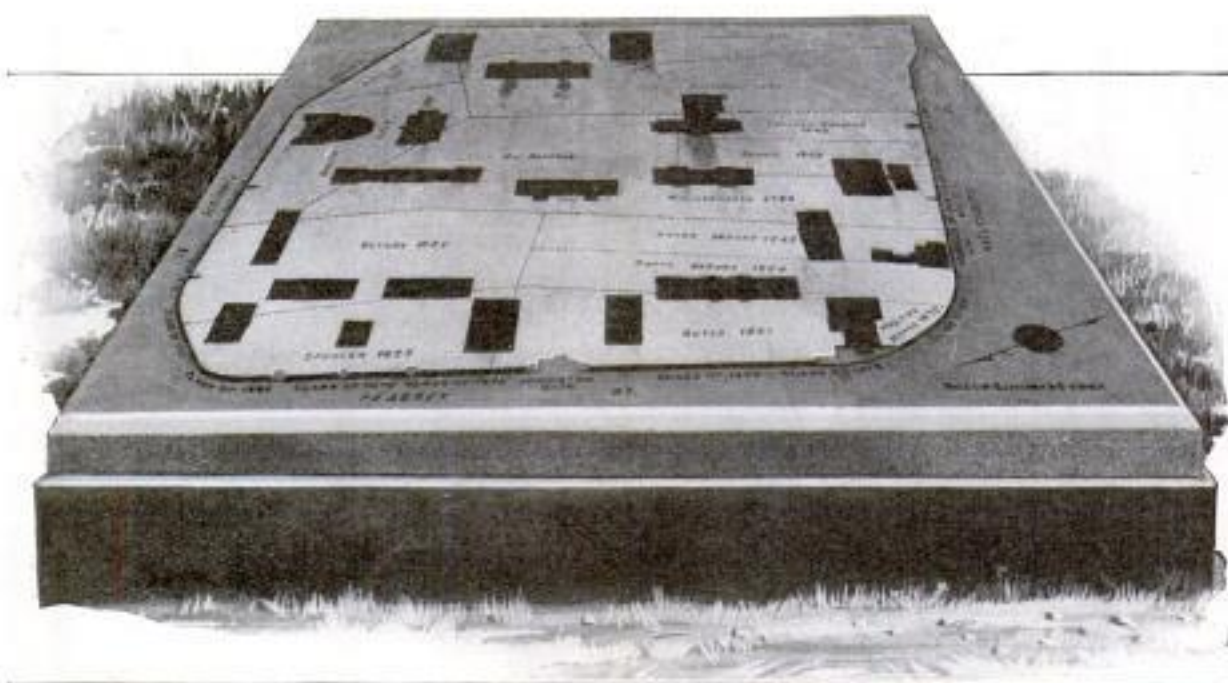

Each Tablet Represents a Harvard Building and Shows Its Date of Erection

COPYRIGHT, BOSTON PHOTO NEWS CO.

*114 State St  
Boston  
Mass*

Stream of Oil Cools Cutters in New System of Lathe and Mill Manipulation. By This Means Cutter Speed Ten Times That Ordinarily Used may Safely be Employed.

In One Test the Cutter was Run with a Peripheral Speed of 458 Feet per Minute and a Feed of  $30\frac{1}{2}$  Inches. A Smooth Finish and an Immense Pile of Chips Resulted

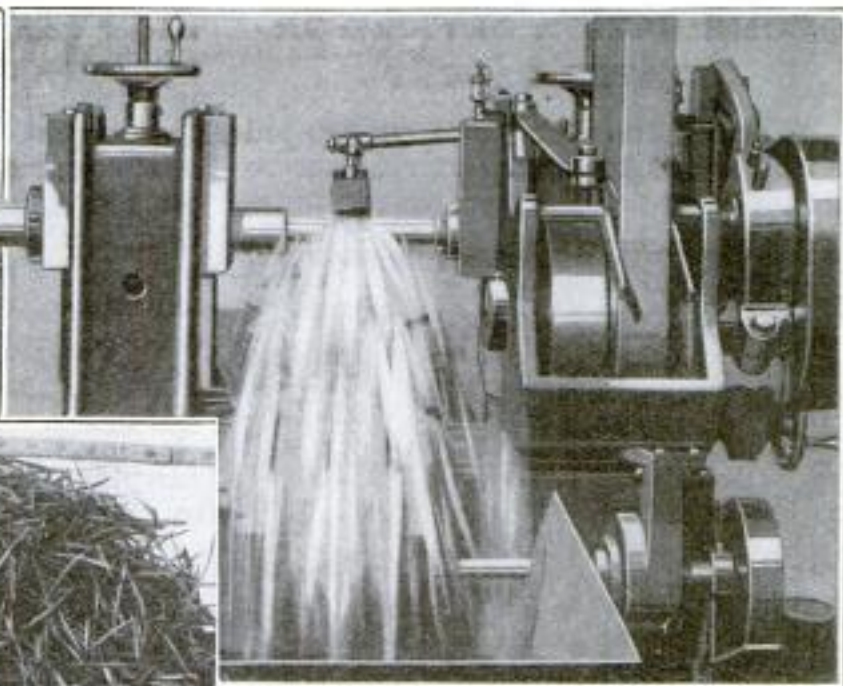

this reason the term "stream lubrication" has been applied to the system. The oil is supplied by a centrifugal pump which works in a reservoir located in the base of the machine, the oil being passed through a strainer as it leaves the cutter table and used repeatedly. To confine the oil directly to the work the table is covered with a hood. Provided the quantity is sufficient, almost any kind of lubricant can be used, the principal action of the oil being that of cooling. In one test with a spiral mill cutter, the cutter was run with a peripheral speed of 458 ft. per minute and with a feed of  $30\frac{1}{2}$  in. per minute, and the resulting finish was sufficiently good for surfaces that are to be bolted together.

846

### LUMBER METER CHECKS

#### WORK OF MACHINE

*Woodworker Oct 1915*

As an aid to determining the efficiency of woodworking machinery, a lumber meter has been invented. It consists of a barrelike mechanism much resembling the cyclometer on a bicycle, only larger. A wheel at one side of the case operates the registering machinery, the wheel being made to turn because of friction with passing

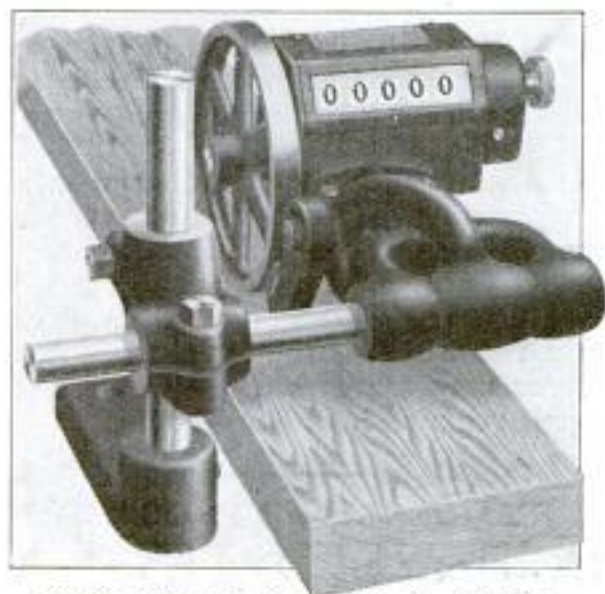

Machine Measures Passing Lumber, Enabling Efficiency of Machinery to be Determined

factory managements to decide whether the machine is giving its maximum usefulness or not.

⌈The German auxiliary cruiser "Kronprinz Wilhelm" is to be refitted as a passenger liner, but will remain interned at Norfolk until the end of the war.

*Durant Mfg Co.,  
Milwaukee, Wis.*

*R. S. Specialty Mfg. Co. 6906 Cedar Avenue  
Cleveland, O.*

268

*9573*

## POPULAR MECHANICS

### COMBINATION DEVICE FOR WATER FAUCET

A device consisting of a cup-shaped nozzle mounted on a water faucet so that it acts as a sanitary drinking foun-



Tilting Cup Upward Makes Faucet Serve as Drinking Fountain in Addition to Ordinary Functions

tain when turned upward and as an ordinary nozzle when turned downward is one of the latest conveniences in water-supply fixtures. The nozzle is carried on a tapering shaft and is held in place by a nut which is tightened to such a degree that, while easily movable, the nozzle remains in either position.

*948*

### METAL-SPRAYING PROCESS IS USED IN NEW FIELDS

*Promethers 7/14/15*  
Manufacturing cartridge cases by the metal-spraying process is a feat lately accomplished in the munitions-making field. The cartridges are first shaped up out of pasteboard, and later covered over with metal by the sprayer. Ammunition so made is said to be equal to the ordinary kind having metal cases, and because of its greater lightness is much easier handled and transported by freight or vessel. Also, a

*Zürcher Verein für  
Metallisierung,  
Zürich, Switz.*

soldier going into battle can load up with a larger supply of ammunition without being encumbered with excessive weight.

The making of heating elements for electric warming devices is another field in which the process is now being used. The metal is sprayed on porcelain tubes, or other suitable nonconducting, heat-resisting surfaces. After cooling, the metal shell is cut along certain lines, leaving in relief a wirelike spiral conductor on the porcelain for carrying heating currents. The cutting processes are carried out with the aid of electricity and a thin-edged carbon wheel. The wheel serves as one electrode of a low-voltage current and the metal coating as the other. A high current thereupon passed across the junction melts the metal neatly along whatever path followed by the wheel. Thus it is possible to cut the casings into other designs than spirals if desired.

### SPACE FOR NOTATION SLIPS IN CALENDAR STAND *831*

For the business man's desk a steel calendar stand is being made with a pocket in its base designed to accommodate 200 memorandum cards, 3 by 5 in. in size. In other respects the device is of the ordinary form and will receive a standard calendar pad such as is supplied by all stationers. It is finished in green enamel, has rounded corners, and is light in weight. By utilizing the space thus provided, it is unnecessary to add to the number of articles on a desk by using a special receiver for the notation slips.



ⒸThe first ship to comply with the new Federal seaman's law was the "El Monte," which left Galveston not long ago with a crew that had qualified by examination for coastwise service.

*Block-Memora Co.  
Cinti., O.*

*Inv. Anton E. Johnson  
Cambridge, Minn.*

*635*

**TWO EMBLEMS OF LIBERTY BEANS IN LARGE QUANTITIES ASSOCIATE AT EXPOSITION SORTED BY MACHINERY 576**

*The Upholsterer Sept 1915*

The ancient Liberty Bell of Revolutionary War fame was on exhibition during the past summer at the Panama-Pacific Exposition. Near it hung another old emblem of liberty, a rug of much more ancient history, yet holding a position among its own people strangely like that of the Liberty Bell among Americans.

The rug belonged to the Persians and was loaned by their shah especially for the exposition. It has a history dating back some 400 years B. C. At that time, it seems, Persia had a ruler by the name of Hoo Shang, who upon one occasion turned loose some 500 prisoners that were shut up because of religious beliefs. Out of gratitude the prisoners set to work on a marvelous rug which they presented to their liberator upon completion. Since then the rug has been handed down through the centuries, early acquiring a romantic significance among the Persians because of the story of its weaving.

For sorting large quantities of beans and removing those which are shriveled, a Minnesota inventor has constructed an apparatus which works quite efficiently.

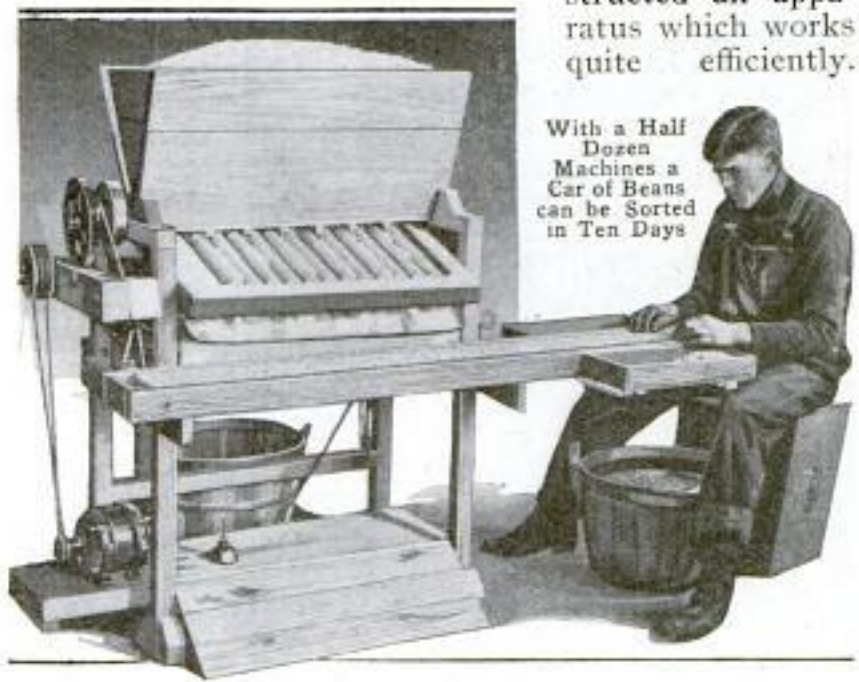

With a Half Dozen Machines a Car of Beans can be Sorted in Ten Days

Beneath, and extending in an inclined position from, one side of a hopper is a series of cylinders geared in pairs so that they revolve together like the rollers of a clothes wringer. The beans are guided through chutes to the upper ends of the rotating cylinders. Those with rough surfaces are caught between these members and eliminated. Smooth-surfaced beans, however, are allowed to slide down between the rollers onto a belt conveyor. The operator of the machine, who is seated at one end of this traveling apron, picks out by hand all of the black beans that may appear. A battery of six such apparatuses have sorted a car load of beans in 10 days.

*1050*

**HARD ROADS MADE FROM HOT ASPHALT AND PEA STONE**

Heavy asphaltic material applied hot under pressure, over which was spread a very liberal coating of pea stone, has proven a substantial and lasting composition for roads in a Canadian park. The surface of these thoroughfares has worn well and has been impervious to water. The repairing has been done while the depressions were still small, instead of allowing the roads gradually to deteriorate until extensive resurfacing was necessary. This method of maintenance was found to be comparatively inexpensive.

**LAMP FOR EYE, EAR, AND NOSE OPERATIONS 804**

When an operation on the eye, ear, or nose is to be performed in the home, or under other conditions where the usual lighting facilities provided in hospitals are not available, the greatest difficulty is often that of directing

*John H. Jackson  
Supt. Queen Victoria Niagara Falls Park,  
Niagara Falls, Ont.*

*Invo: Dr. Alfred Kahn  
804 34 East 40th St., New York.*

270

**POPULAR MECHANICS**

*Duplex Instrument Co. 16 Warren St. New York.*

a ray of light to the part to be operated on. To overcome this difficulty there has been devised a special electric lamp

1053  
joints so that it is easily raised or lowered, or turned in any direction with reference to the mouthpiece, an arrangement that makes it possible to direct the light to any desired point. Current for the lamp is supplied by a dry-cell battery which is inclosed in a case that can be carried in the pocket of the coat or vest. This battery is capable of supplying light for a period of about four hours.



Adjustable Electric Lamp for Eye, Ear, and Nose Operations: With the Fiber Mouthpiece Held between the Surgeon's Teeth the Light can be Directed to Any Desired Point

**BAROMETER IS ILLUMINATED BY GROOVE IN MOUNTING**

11/19/15  
As usually placed, a barometer is rather difficult to read, due to the black background commonly present. An English scientist has worked out a more satisfactory scheme. A board about six inches wide and somewhat longer than the barometer tube is hung in a window. Down the middle of the board a long narrow groove allows a restricted amount of light to pass through. Covering this slit with paper or ground glass reduces the light to a soft glow. Upon mounting the barometer tube in front of the groove a sheet of light illuminates its whole length, making reading an easy matter, with less eyestrain.

*S. J. Dimes  
70 Victoria St. W. 1st Eng.  
Westminster, London*

mounted on a fiber mouthpiece which is held between the surgeon's teeth. The lamp is connected to the mouthpiece by a series of links and universal

459

**GANG DRILL FOR WORKING STRUCTURAL STEEL**

A new machine that is likely to prove of the greatest value, especially in the manufacture of structural steel, is a gang drill with which it is possible to

drill accurately as many as 50 holes at one operation. The value of the machine in this kind of manufacture lies not only in the economy with which it can be operated but in the fact that

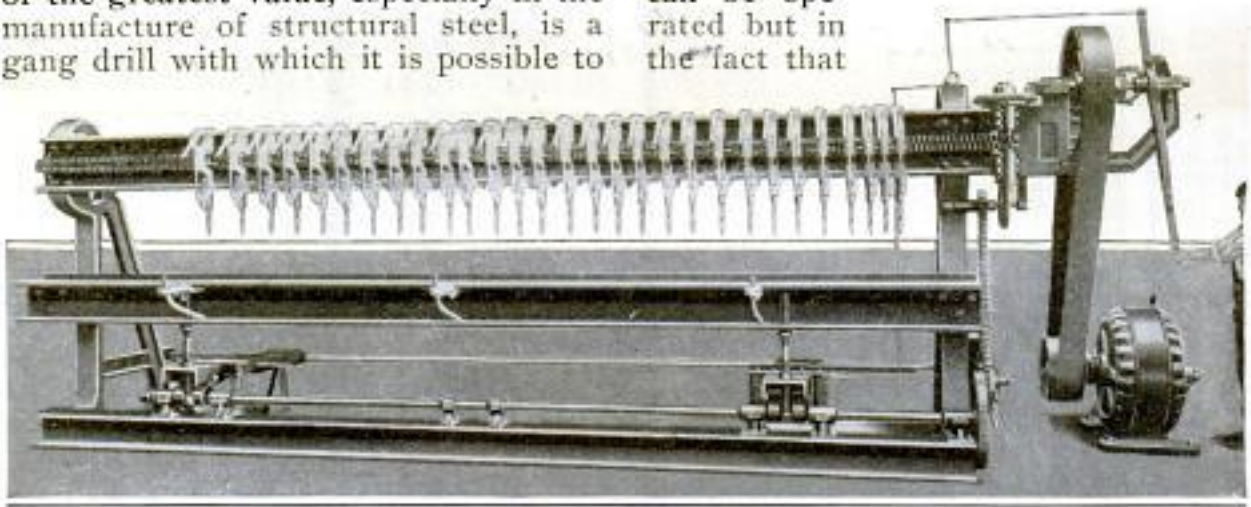

With This Gang Drill as Many as 50 Rivet Holes may be Drilled in a Steel Beam at One Operation

*Automatic Gang Drill Machine Co.,  
Los Angeles, Calif.*

it presents a practical means for substituting drilling for punching in the making of rivet holes, a thing that has long been recognized as desirable among makers of structural steel. The essential feature of the machine is a set of movable drill heads mounted on a horizontal beam with the drill bits projecting downward. These bits are equipped with sprockets through which they are driven by an endless chain that runs lengthwise of the beam and is operated by a driving mechanism at one end. The beam and drills do not move vertically, the material being fed up against the drill bits. For this purpose a table that moves in vertical guides is provided on which the material to be drilled is placed and clamped. The machine drills holes up to 1 in. in diameter through metal as much as 4 in. in thickness, and the drill heads can be set for any pitch with a minimum of  $2\frac{3}{4}$  in. The machine is capable of handling a beam 24 ft. long, 20 in. wide, and 24 in. deep. It is easily possible to handle beams longer than 24 ft. if the work is shifted.

**SCALE TRUCK WEIGHS GOODS WITHOUT UNLOADING** 841  
*Amer. Mechanist 9/23-15*

Loading and unloading small trucks for the purpose of weighing the material carried, is to be eliminated in a new type of truck being sold. The new carrier much resembles the ordinary shop truck except that it is capable of weighing as well as

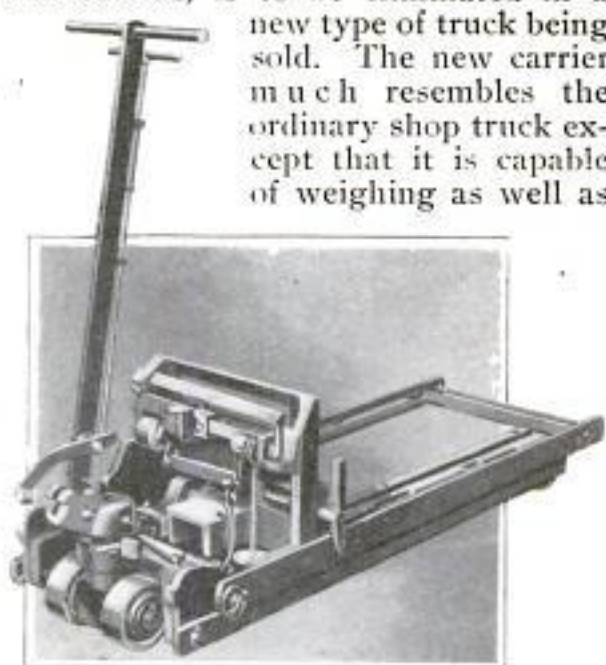

A Platform Scale is Made an Integral Part of This Shop Truck, and Unloading Heavy Weights for Weighing Purposes is Unnecessary

transporting its load. The top of the machine serves as the load holder for a platform scale, the weighing being done in the usual manner by sliding a weight along a beam. After weighing, the load may be lifted by moving a lever. The weight then rests on the side rods, relieving the scale mechanism of strain during transportation operations.

— 1052  
**MORE GIFTS OF TELESCOPES ASKED BY BRITISH**

The British government has recently repeated its former request for the gift or loan of telescopes that can be used with the batteries at the front. The appeal to the public says that telescopes on stands, deer-stalking telescopes, good pocket telescopes—in short anything that is not a toy—will be acceptable. Astronomical eyepieces not wanted for service will be removed and carefully numbered to correspond to the instruments from which they are taken, so that eventually the instruments may be returned to their owners intact.

**AUTOMATIC ANCHOR FOR STANDING HORSES** 375

According to members of the profession, one drawback to the driving of a laundry or other delivery wagon is that a heavy weight with a hitch strap tied to it has to be dropped out at every residence to keep the horse from running away. When such a weight has to be lifted in and out of the wagon a hundred or more times per day, it means considerable work. A Minneapolis manufacturer would prevent all this with an automatic device. When

✓ Detectives of an eastern railroad are constantly on the lookout to take photographs of any employe seen taking a drink of alcoholic liquor. On the same road the use of whisky as first aid to the injured has been prohibited.

*Lady Robert's Field Glass Friend, Nat. Service League,  
73 Victoria St., S.W., London.*

*Demotic Sales Co.,  
405 S. 5th St.,  
Minneapolis, Minn.*

the driver leaves his seat he disengages a lever with his foot, which permits a contrivance located on the hind axle to swing out and catch between the spokes of a rear wheel. Attached to

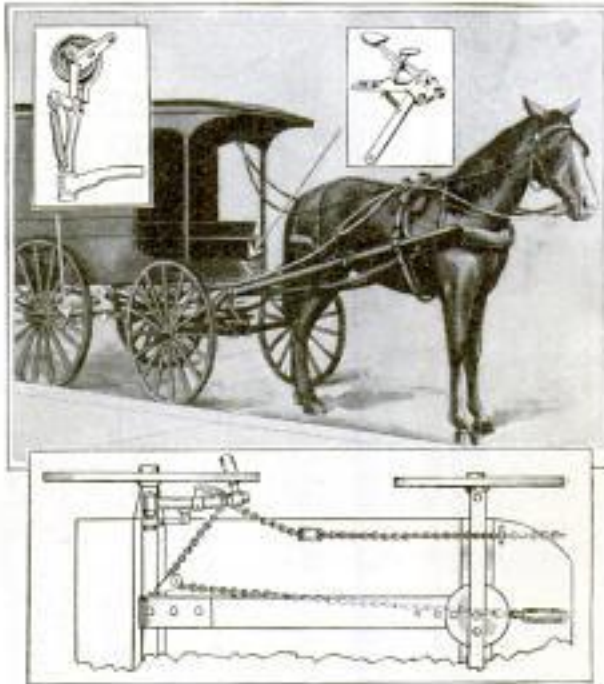

Horse is Prevented from Running Away by Lever Which Driver Locks into Hind Wheel with Foot Pedal upon Leaving. Rotation of Wheel Pulls on Lines, Stopping Horse

this apparatus is a pair of lines running to the horse's bit. Should the animal start to run away, the hind wheels, of course, revolve, causing a pull on these lines and theoretically bringing the horse to his haunches.

1038  
**SCARCITY OF COLORED INK  
EMBARRASSES PUBLISHERS**

*Engineering Record*  
Scarcity of dye materials for printing inks, due to the war, has caused one technical magazine, which for years has used a distinctive red cover, to resort to American substitutes. These have been so far from satisfactory that editorial explanation of the altered color of the magazine's cover has been made in its columns. Many other magazines have experienced similar embarrassment. Fortunately, Popular Mechanics Magazine, which likewise has been dependent on European markets for dyes in its cover inks, has on hand a supply sufficient to last for several years.

**ECONOMIC FORCES MAY JOIN  
AGAINST FUTURE WARS**

Of the many current proposals to lessen the probability of war in the future, one put forth as a referendum to the members of the Chamber of Commerce of the United States possesses certain features which raise the interesting question as to whether business men and commercial interests generally can establish international rules which will constitute a serious check on would-be belligerent nations.

When the present gigantic strife is over, asserts the referendum, to enormous indemnities will be added a greater charge due to rival armaments; disastrous tariff walls are predicted as another result. Whether or not this reasoning is sound, it seems certain that Europe's purchasing power will be greatly decreased after the war, and indirectly neutral countries dependent on Europe for trade will be similarly affected. Shortage of capital and a possible decline in European standards of living are foreseen. All this makes the prevention of war, even though confined to other countries, one in which America is economically interested.

Among the proposals embodied in the referendum now being considered by chambers of commerce in every state and the American chambers of commerce in Berlin, Paris, Milan, and Constantinople, is one to the effect that this country lead in establishing an international court which will be governed by certain established rules. Supplementing this, is suggested a council of conciliation, to deal with differences to which existing rules do not apply.

Such nations as do not submit their differences to these agencies are to be subjected to concerted economic pressure—"commercial ostracism." This failing, military force will be resorted to. The referendum has already enlisted the support of many who believe that it furnishes a practical means of displacing war with law.



### STEREOSCOPIC SUBSTITUTE FOR BULKY SAMPLES

As a substitute for bulky samples which often require many salesman's trunks, there has recently been brought out a binocular device which employs the principle of the old-fashioned stereoscope, but is more compact. The two-fold stereoscopic views used with this instrument are said to be much more effective than ordinary photographs in presenting vividly the merits of articles, particularly goods which cannot be well described, such as machinery. When in use, the instrument looks much like the familiar stereoscope, but by means of hinged joints it can be folded into small space. The specially mounted stereoscopic photographs also occupy small space, so that the instrument and 75 photographs can be inclosed in the case provided, which is no larger than a bill book.

Just as a jungle scene for the movies was completed the lion that played the leading part jumped for the camera and demolished it. Following this he walked calmly to the door of his cage and waited for the trainer to open it.

9582 *Art. 1000*

### FROSTED BULB ELIMINATES HEADLIGHT GLARE

There are many contrivances on the market at present for the elimination of automobile headlight glare, but one

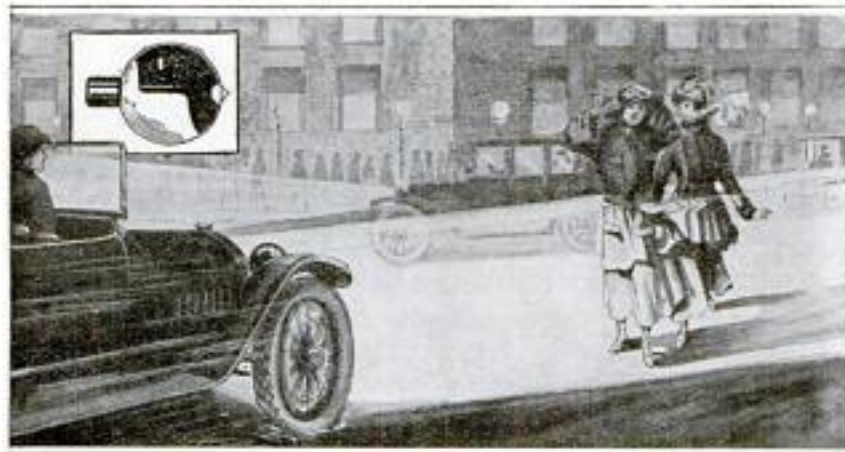

The Light through the Frosted Half of the Lamp in This Headlight is Projected to the Eyes of the Observer, Limiting the Glare

*H. C. Roberts Co.*  
*905 Arch St., Phila.*

### LOUD-SPEAKING TELEPHONE FOR USE IN MINE

Both for safety purposes and convenience, a loud-speaking telephone has been designed for underground mines. It is of heavy construction and capable of withstanding the effects of excessive moisture. The receivers are carried at the ends of two pivoted arms, while the megaphone extends like a funnel above the transmitter. An ordinary telephone conversation may be carried on with the instrument, or the loud-speaking part used for conveying instructions to different parts of a mine, or sounding a general alarm in case of an emergency.

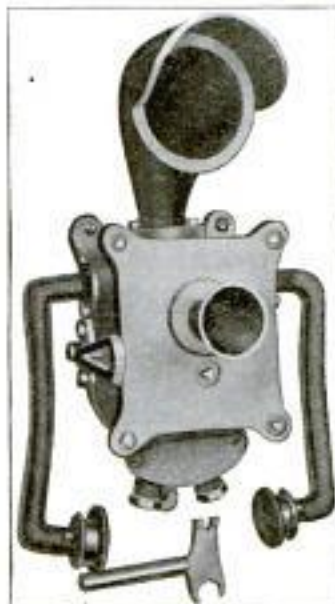

*Cont.*  
Chas. I. Deane  
Box 562, Walla Walla, Neb.

## CONCRETE PILE DRIVEN LIKE 9107 WOODEN ONE

One of the latest inventions in the way of concrete construction is a reinforced-concrete pile that can be driven

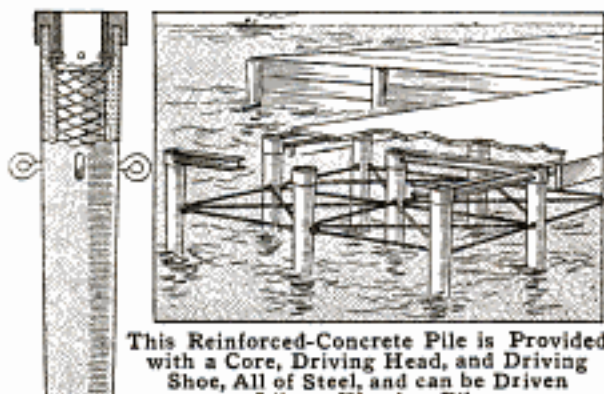

This Reinforced-Concrete Pile is Provided with a Core, Driving Head, and Driving Shoe, All of Steel, and can be Driven Like a Wooden Pile

in the same manner as a wooden pile with practically no danger of injury in the process. Running through the center of the pile from top to bottom is a conical tube which tapers toward the bottom and forms a steel core for the pile. To the top of this core a steel driving head is riveted, while a pointed steel driving shoe, having a threaded recess, is screwed to a threaded shank at the bottom. The concrete, which may be reinforced with steel mesh, is molded around this core so that the surface comes flush with the driving shoe and just fills an annular recess in the driving head. Two eyebolts screwed into the core and projecting beyond the concrete surface are used for handling the pile.

## 954 FLEXIBLE COATING IS NEW INSULATOR FOR ALUMINUM

*Sec. Am. 11/6/15*  
Because aluminum is a poorer conductor of electricity than copper, a wire of the former material must be made with a much larger cross section than the latter in order to have the same current-carrying capacity. This has made it difficult for aluminum to compete with copper, particularly among the insulated wires where the larger cross section requires so much larger covering. A new insulating skin for aluminum has lately been de-

vised, however, which promises to extend the field open to this metal. The new covering is made by passing the wire through electrolytic baths in which borax, aluminum borate, or sodium silicate are dissolved. In this process the wire serves as the anode. It emerges from one kind of a solution with a smooth, iridescent covering, or with a hard abrasive coat when another is used. The latter insulator will stand from 200 to 500 volts, and is only .0001 to .0004 in. thick. Wire coated in either way will stand bending but not rubbing, due to the fact that the coating is flexible but not free from abrasive elements.

## A MULTIPLE-LINE CLOTHES DRIER 8675

One of the latest conveniences for the housewife is a clothes drier consisting of five lines spaced apart by wooden end pieces and arranged to work on the principle of an endless chain. The five lines work on spaced pulleys supported on a wall or window ledge, while the single line that connects the end pieces works on a pulley that is supported either by a wall or a post. With this arrangement the lines can be filled from one point and drawn back and forth as required. The capacity of this system is five times that of a single line extending between the



This Clothes Drier Consists of Five Lines That are Spaced Apart by Wooden End Pieces

same supports, so that in a room 14 ft. wide, there is 70 ft. of line available. The five lines occupy a space 18 in. wide.

CA uniform system of type for the blind is now being introduced. Heretofore there have been five systems in use.

C. E. Skinner & L. W. Chubb  
Westinghouse Electric & Mfg. Co.  
E. Pittsburgh, Pa.

*Robert T. Stappin,  
269 First St.,  
Wassonville, Oukla.*

Willesden Paper & Canvas Works, Ltd.,  
 Willesden Junction, London, N. W., Eng.

POPULAR MECHANICS

Inventor: Frank H. Beck, Coverdale Road, Brondesbury, N. W., Eng.



Collapsible Canvas Hood is Arranged to Cover a Vehicle in Time of Storm or Hot Weather

### COLLAPSIBLE HOOD COVERS OMNIBUS TOP 719

An English invention lately marketed provides omnibus passengers with protection in time of rain or hot sun, and at other periods gives them all the conveniences of an open-air vehicle. A canvas hood, mounted on several U-shaped stays, is so arranged that by turning a small crank at the front end of the vehicle it may be raised and slid back along a track until it covers the whole top. When not in use, it folds compactly in a space above the driver's seat, leaving the top of the bus in open air and the passengers with an unobstructed view.

### EFFICIENCY THERMOMETERS

#### 827 EMPLOYED IN OFFICE

As a means of stimulating activity and increasing the efficiency of his office force, the manager of a Michigan business concern has inaugurated an interesting grading system. Printed cards bearing the general outline of a

graduated mercury thermometer are kept in a wall case where they may be read by the employes. Each card bears a date line and a space on which the number of an individual worker is written. The quantity and quality of each employe's work is graded once a



The Cards Indicate the Efficiency of Each Employee in the Office of a Michigan Concern

# Hinton Gilman, Battle Creek, Mich.  
 Mr. Edwin Piper, Manager Extension Dept.  
 Battle Creek Sanitarium  
 (Mich.)

week on a percentage basis. The cards are marked by filling in the "tube" spaces with red ink. When the column extends to the 85° point, for instance, it indicates that that was the efficiency reached during a certain week by the employe whose number the card bears. Although savoring of the time-clock system, the method is said to have proved beneficial, as it has tended to create friendly rivalry and encourage better work.

8398

### SHIELD STOPS DRAFT UNDER AUTOMOBILE TOP

A new attachment for automobiles is a shield that prevents the wind from streaming in between the glass windshield and the automobile top. This

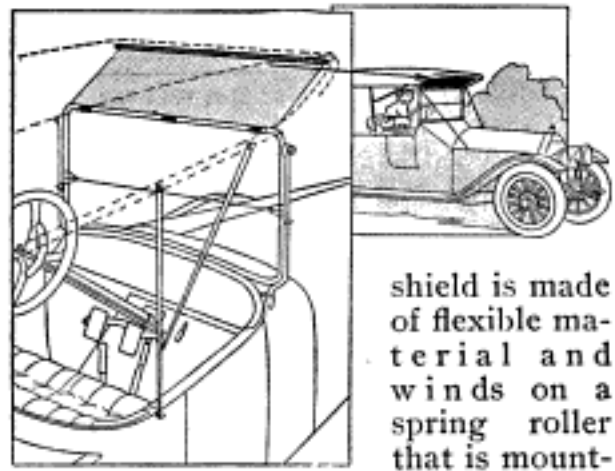

This Flexible Shield Prevents the Wind from Streaming In between the Glass Windshield and the Automobile Top

shield is made of flexible material and winds on a spring roller that is mounted at the front of the automobile top

and works after the fashion of a window-curtain roller. It is held to the top of the windshield by spring clips and winds up out of the way when these clips are released.

### 919 MAKING WARSHIPS INVISIBLE TO HOSTILE FLEETS

Once more the Navy Department is directing attention to the problem of devising some method of painting our war vessels so as to render them practically invisible to an enemy. Considerable thought has been given to this in the past, but so far as is evident,

without especial success. At the present, however, experiments are being conducted with a flotilla of destroyers on the coast of New England.

Although at first thought, the matter seems rather fantastic to the lay mind, it is nevertheless a subject of serious import. Already worth-while results have been attained by the British and Italians. The splotchwork painting of the fighters operating at the Dardanelles has been described previously. An Italian destroyer has also been painted with a false "bone in its teeth," which is intended to deceive the enemy's gunners by making them misjudge the speed of the vessel when firing.

Several years ago apparently remarkable results were accomplished by a New York artist. Although his plan seemed to be of value to the naval authorities, consideration of it was ultimately dropped because of the secrecy imposed. The principle of the scheme, to quote one authority, was "that a light on a surface oblique to the direction of the rays of light is less intense than on a surface perpendicular to the rays." The same tint or color of paint should not be used on a perpendicular surface, it has been reasoned, as is used on the oblique, if the desired effect is to be attained. The coloring of any surface, according to this, would depend upon the angle presented to the rays of light. The lighter colors would be used on shadowed surfaces, while the darker tints would be employed on normally lighted planes. The purpose of this is to make an object merge with its background. The difficulty encountered in accomplishing this obviously is that a ship is a moving body.

In order to demonstrate his scheme the eastern artist was allowed to work on the models of three ships. Two of these were painted in the usual manner, one being finished in white and the other in slate. The third was treated in accordance with the secret method. When the work was done, a number of officers were admitted to a well-lighted room in which the models were placed. The white and slate-colored ones were

#/Laul B. Rollins,  
Phoenix, Ariz.  
D-2975

in full view. The third, however, was not in evidence. It was only by shifting their positions and looking from specific angles that the "invisible" boat could be discerned at all.

995  
DIGGING TRENCHES IS TO

A. N. Journal 11/15/15  
SUPPLANT "BAG RUSH"

The old "bag rush" at Tufts College in Massachusetts is to be abolished as a method of settling class differences in favor of a new sport somewhat warlike in nature. The rival classes separate into two groups and endeavor to intrench themselves as for a battle in the quickest possible time. After the expiration of a certain period, the side having nearest completed the task is adjudged the winner. Another contest of value in war training consists in carrying sand bags. Each side endeavors to get the most bags removed from a common pile to their own intrenchments. Such exercise is thought to give valuable training as well as serving as a substantial outlet for youthful spirits.

9192  
VISITING CARD WITH MAP ON ITS REVERSE SIDE

In order to show the location of a residence in relation to subway and elevated stations, or other transportation lines, some persons, both in this country and abroad, are coming to use visiting cards which carry small street maps

Chas. B. Anderson  
46 Franklin Blvd.  
Wausau, Wis.



on their reverse sides. The purpose is to furnish one unfamiliar with the neighborhood a diagram which may be of assistance when wishing to find the address.

WARM WATER IS SUPPLIED BY NOVEL HEATER

Solar water heaters of simple, serviceable construction are coming to be used quite extensively in certain sec-

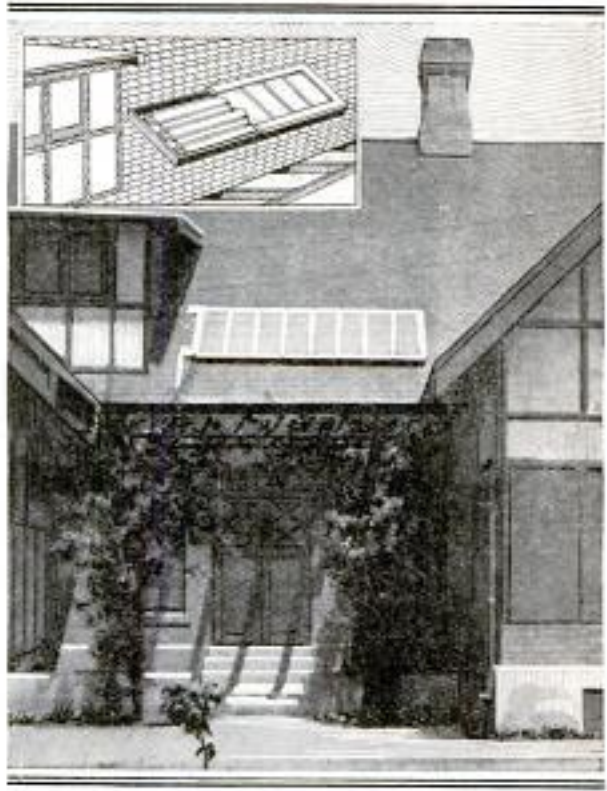

As the Water is Heated It Circulates to the Top of the Tank, an Equal Volume of Cold Water being Returned to the Coil through a Supply Pipe

tions of the Southwest, where the sun shines the majority of the time and the days are warm almost the year around. One of these apparatus, designed for a residence, consists partly of a flat coil fixed in a shallow, rectangular box covered with glass. The exterior of the pipes and the inside of the housing are painted black so as to retain as much heat as possible. The device is mounted on the roof, usually on the south side of a house where it will get the benefit of the sun for the greatest number of hours. In the peak of the roof, or sometimes hidden in a false chimney, is a tank which is connected with both the coil and a supply pipe. The appliance furnishes warm water for household purposes without cost other than the initial expense of installation. It may be arranged so as not to detract from the appearance of a house.

NOVEL AND PRACTICAL THINGS  
FOR THE HOMESimple Electric Heater  
for Small Rooms

1  
SMALL rooms can be kept warm during damp, chilly weather by the use of a light, portable electric heater which operates at a cost of about seven cents an hour. In the middle of a reflector, and surrounded by the coils, is a frosted globe that gives off a pleasing glow. The device is 18 in. high and may be attached to any lighting socket by means of a flexible cord which is supplied with it. During very cold weather it serves nicely as an auxiliary, or emergency, radiator.

Basket Holds Clothes  
While in Boiler

2  
One of the convenient devices lately introduced to lighten laundry work is a wire basket which fits inside of a boiler and holds the clothes while they are being sterilized. It is suspended on hooks which grip the edges of the container, holding it far enough from the bottom to permit free circulation of the water. When it is time to remove the linen, the basket is lifted out by means of two handles. This eliminates the need of using a clothes stick.

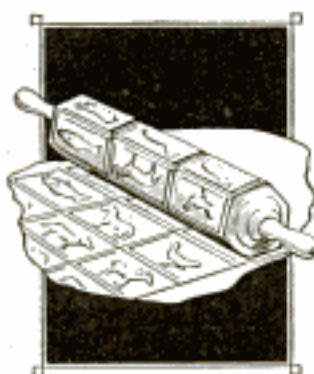
Cookie Roller Stamps  
Figures in Dough

3  
Cookies and small cakes with various designs in relief may be made easily with the assistance of a six-

4  
sided roller which has a series of three dies on each of its surfaces. Eighteen cakes, each slightly less than 2 in. square, are stamped by revolving the device once.

Convenient Kitchen Heater  
with Gas Kindler

5  
be ignited in a few minutes without the use of wood. It occupies a floor space 14 in. by 26 in. in size.



Attractive Tongs for Removing Olives from Bottle

6  
which may be opened by pressing the thumb against a plunger at one end of the instrument. They are equally convenient when one wishes to remove a cork from the inside of a bottle.

Bed springs of a new type are being introduced which are designed to prevent the spreading and shifting of

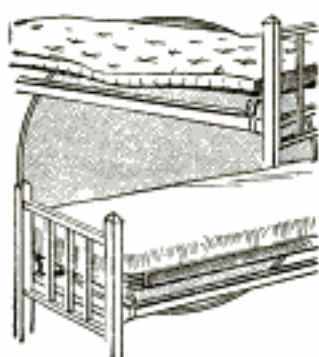

Side Guards Prevent Mattress from Spreading

- 1 ELECTRIC RADIATOR, Landers Frary and Clark, New Britain, Conn.  
*Electric Shop*
- 2 CLOTHES DRAINER, The Androck; Contributed by Mrs. Fred Telford;  
*andrews wife, gun works, Rockford, Ill.*
- 3 CAKE ROLLER, Contributed by Mrs. Fred Telford, *Western Springs, Ill.*  
*Michigan Stone Co., Detroit, Mich.*
- 4 GARLAND KITCHEN HEATER, Sold in Chicago by People's Gas Co. = 17<sup>00</sup>  
*Silver plated 502 solid 2<sup>00</sup>*
- 5 OLIVE TONGS, Baird-North Co., Providence, R. I.
- 6 THE ENGLANDER WITEDGE SPRING, *Englander, Spring Bed Co., 135th St. Brooklyn N.Y.*  
*Mrs. Vastal contributor, Chicago, 615 W. 39th St. San Francisco Calif.*
- ~~LOCKING LAMP GUARD, "Hubbell" product. Hubbell Inc.,~~  
*Hubbell Inc. 100 W. Madison St. Chicago*
- 7 Dish Pan to Protect Sink, *Amnicolor & Co. 31 So. Frederick St. Baltimore*
- 8 WATCHLITE, Bright Star Battery Co., N. Y. *Chicago, Montreal.*  
*Retail 1.75* *430 W. 14th St* *1463 So. Mich. Av*
- 9 LAUNDRY MACHINE, Mfg. by H. M. Sheer Co, Quincy, Ill.  
*P. D. L. & Co. = 25<sup>00</sup>*
- 10 DISH RINSER, *max* Thomsen & Co., Mfg. representatives, 358 W. Madison, Chicago.  
*804 Spaulding Bldg.*
- 11 ADJUSTABLE DRYER, Globe Mfg. Co., Portland, Ore.
- 12 CROCHET COTTON HOLDER, G. V. SALES CO., 12-14 Spruce St., N. Y.

*Sell dealers & jobbers only*

*(not same)*

*G. M. Thurnauer & Bro.  
83 North St. New York  
Sold by N. F. & Co. (Retail) Chgo.*

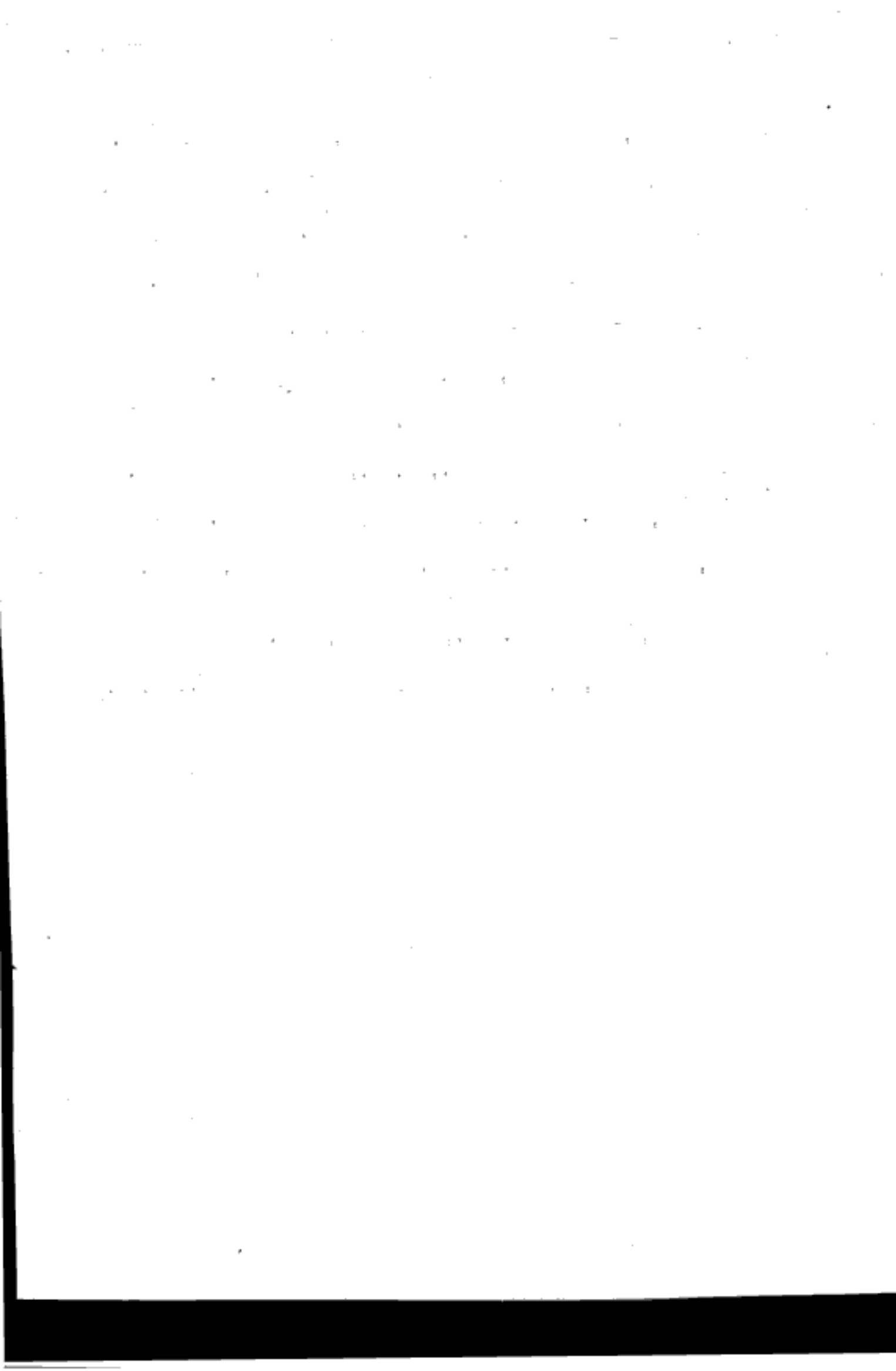



a mattress. They are provided with strong guards on each side which back up the mattress and hold it firmly in position. The side members are of link construction and held at each end by heavy coil springs.

Several good features are to be found in a rectangular dish pan especially designed to be used in a kitchen sink. It is supported on rubber-protected feet so that the waste pipe is not stopped when it is employed, nor the porcelain scratched. A removable, perforated drawer is fitted to the under side at the front. This serves as a grease trap and prevents the sink from becoming clogged.

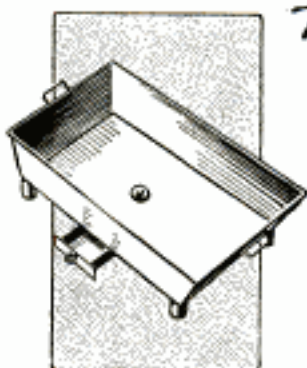

Dish Pan of Convenient Form for Kitchen Sink

Pocket flash lights are being made in numerous forms, but as novel as any is one fitted in a case similar to that of a watch. The lamp is sunk in the lower edge of the case, within which a compact battery is held. The device

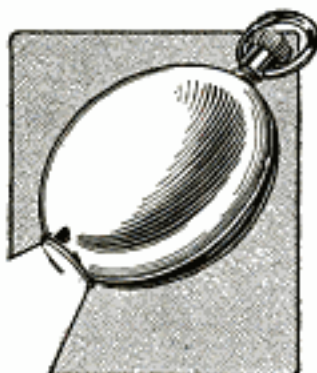

Pocket Flash Light Made in Form of Watch

is intended to be carried in the vest pocket at the anchor end of a watch chain. Although it is an oddity, it is also serviceable for the person who objects to the weight of larger lamps.

For domestic use a compact, gas-burning laundry apparatus has been invented which combines the



Compact Household Laundry Machine

properties of a washing machine, boiler, and stove. In principle it is somewhat similar to commercial washers and thoroughly cleans and sterilizes clothes in hot steam and boiling water in about 10 minutes. It is operated by turning a crank slowly.

Quite a convenient kitchen accessory is represented in a dish rinser designed to fit over a hot-water faucet. It is so constructed that by sliding a small lever to one side a spray is produced. By placing the dishes in a pan beneath this, they are thoroughly rinsed in a moment's time.



Dish Rinsers Fits over Hot-Water Faucet

To prevent the shrinkage of infants' garments after they have been washed, an adjustable form has been invented which keeps different pieces of apparel in the proper shape while they are drying. It is made of hard wood and folds into a small space when not in use. As a child grows, the form may be expanded to receive larger garments.



Drying Form for Children's Garments

To prevent balls and spools of crochet cotton from becoming soiled or tangled while in use, a simple holder has been devised for the sewing table. It allows the material to be unwound as it is required.

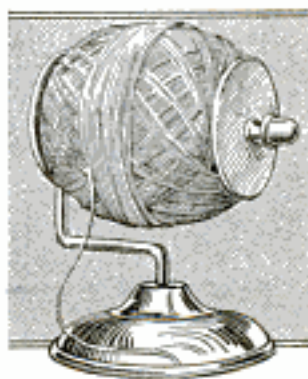

Holder for Ball of Crochet Cotton

Inv: W. L. Beard,  
Erie, Pa.

9369

### CHECK RAISING PREVENTED BY POCKET INSTRUMENT

To make the fraudulent raising of a bank check impossible, a new perforating device has been invented which in size corresponds to a fountain pen and which

also serves to identify its owner. The instrument is provided with a series of small, toothed wheels which, when rolled over

the part showing the denomination of a check, not only perforates the paper but also inks each of the hundreds of needle-point impressions. This makes it impossible for the original amount of the check to be changed. The wheels of the device are capable of being set to make various patterns of perforations. This enables the recording of the instrument at a bank so that its impressions are as distinctive to a banker as the signature written on a check. It also makes it possible for the device to be used by its holder as a means of personal identification when a specimen of its perforating is shown on a certified card.



Perforation Cherry Protector Co  
Erie, Pa.  
Sole Patent 1,251,500

908

### NEW PROCESS FOR STUDYING MICROSCOPIC PARTICLES

*Knowledge (London) Aug 15-240*  
A glimpse of the inconceivable smallness of the particles that compose material substances is given in the results of a new process, invented by a German scientist, in which is used much the same method for examining the material as that employed in counting the corpuscles of the blood. The material is first reduced to a fine powder and is then mixed with a measured quantity of some such material as glycerin or oil, the whole being shaken until thor-

oughly and evenly mixed. A minute quantity of the mixture, usually .01 cubic centimeter (about .0006 cu. in.), is then taken and diluted to one cubic centimeter (about .06 cu. in.). From this diluted mixture a single drop is taken, placed under the object glass of a device used in counting blood corpuscles, and subjected to a magnifying power of 550 diameters. The particles of the material being investigated are then easily counted. With this process it is possible to calculate closely not only the number of particles in a cubic centimeter or a cubic inch of the material, but to determine the degree of fineness to which it has been pulverized. In examining heavy spar that had been finely ground, one gram (about 1/28 ounce) was first found to contain 4,500,000,000 particles. After regrinding, the number rose to 12,000,000,000, and with a third grinding to 18,500,000,000. A sample of lampblack was found to contain 960,000,000,000 particles per gram.

### STEEL TIRE SHOE PREVENTS SLIPPING AND SKIDDING

A tire shoe made of spring steel, 1/8 in. thick, and fastened over the tire by a specially made strap, is the latest device for preventing slipping or skidding of automobile wheels. The inside of the shoe is smooth and has rounded edges so



that it cannot injure the tire, while the traction face is so shaped as to give the shoe a horse-shoe hold on the road. The strap is made of water-proof webbing that is said to be stronger than leather. Four of these shoes are ordinarily used, distributed evenly around the rim.

One of the largest plants in the world for the dressing of sealskins is being established in St. Louis.

Franklin Auto Shoe Co.  
Franklin, Ind.  
Patent

Laurentide Co.,  
Grand Mere, Que.

942

**REINDEER SUPPLANT GOATS  
IN CLEARING FOREST AREA**

An interesting experiment in practical nursery work was recently tried by a Canadian paper concern. An area in the vicinity planted to young evergreens persisted in growing up to hardwood shoots and other undesirable shrubbery. Inasmuch as the evergreens never would be good for paper unless allowed to grow unmolested, it was decided to turn a pair of goats into the territory in hopes of clearing off the objectionable vegetation. It was soon found, however, that tender young shoots of both hard woods and evergreens were equally attractive to the goats' palate, and this discovery promptly ended the trial. Later, as a further experiment, a herd of reindeer domesticated for winter travel in place of dogs, were turned into the wooded region. Their taste proved to be more discriminating, as only the undesired poplar, birch, and maple were touched. Thus a little matter of accommodating palates rendered a considerable service in getting the evergreens freed from the competitive growths.

**PULLEY USED AS BRAKE  
IN ROPE FIRE ESCAPE**

A rope-and-pulley fire escape of unusual design has lately been patented. With this type the user grasps an inclosed pulley with his right hand, crawls out of the window, and slides on a rope to the ground, his hold on the pulley checking the rate of descent, and in fact definitely determining that speed. This is possible through the peculiar design of the pulley. Within the shell it consists of an ordinary flanged wheel mounted on an axle in the usual way. The rope used in the descent is looped two or three times around this pulley and allowed to dangle down below, its upper end being attached to some anchor, on the window sill, or within the building. In going down, the rope slips through the pulley shell held by the user and revolves the wheel inside. The two

halves of the shell form a brake bearing on the pulley, and the tighter the two halves are squeezed together by



User of New Fire Escape Holds to Pulley in Sliding to Ground

the descending person, the slower the descent. Thus the user has definite control over his speed without tearing his hands on the passing rope. A leather glove with an adjustable wrist strap is provided in order to make holding to the pulley less difficult.

**BAGS FORMED AND FILLED  
IN ONE OPERATION**

A western inventor has applied the sausage-filler idea to the bagging of most any material. His contrivance consists essentially of a roll of paper or other bag-making material, which first passes through a forming device. During the process of shaping the bag, the latter is being filled with the grain, or other similar substance, to be

Inventor: August B. ... 1922 Poplar St. Mass. Cent., O.

1128025 - July 9, 1915.  
filed June 6, 1914  
Ser. 843359 - Pat. Sec. 7211 7518  
B 7/16/16

Inventor - Ad. M. Bates,  
90 Bates Valve Bag Co. Chicago  
236 S. Michigan  
7334 Kimbark St.

sacked. The shaping operations are accompanied by an interesting side-sewing process, or side-gluing process when the material is paper. The sew-

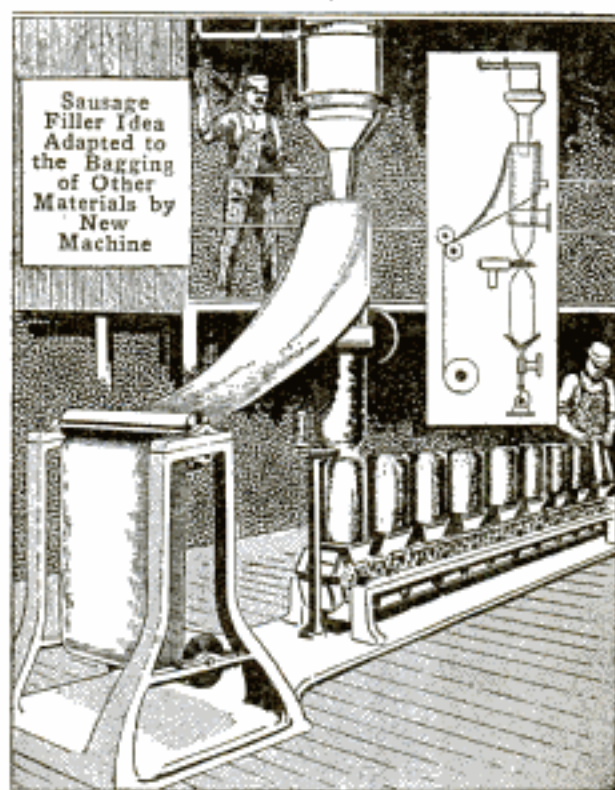

ing machine which operates in the case of cloth has to work with its needle vibrating back and forth horizontally, since the cloth runs down through the machine in a vertical direction. Still another sewing, or gluing, machine takes a reef at proper intervals in the tube as it is being made and filled in the forming device. The result is a series of sacks strung together not unlike sausages. It is only necessary to cut the connecting links, whereupon the machine sends forth a procession of filled and tightly bound packages.

### UNUSUAL RECORD IS MADE 910 BY TOURING CAR

Carrying five passengers along the Pacific highway, a six-cylinder motor car made a remarkable nonstop run of 2,050 miles in going from Tia Juana, Mexico, to Vancouver, B. C. Neither the engine nor the wheels were stopped once during the entire trip. The radiator was filled at the start and not

again touched until the destination had been reached. At one point it was found necessary to use chains and these were slipped on the rear wheels while the machine was in motion. The run was made in 124 hours and 20 minutes. On several occasions detours were made in order to avoid stopping the car. In passing the Columbia River between Washington and Oregon, a railroad bridge was crossed. When mealtimes came four members of the party ate while the fifth remained at the wheel, driving around a town or running in a circle until the others finished their repasts and he could be relieved. The success of the novel test was partly due to excellent driving, good luck with the tires, and carefully laid plans.

### TELEPHONE CABINETS MADE INTO BIRD HOUSES 9875

Wooden telephone cabinets that have been made practically unsalable by the advent of the steel battery cabinet and the desk telephone, are being utilized by one manufacturer for the making of bird houses. The houses are made in four types—the apartment, Swiss chalet, bungalow, and

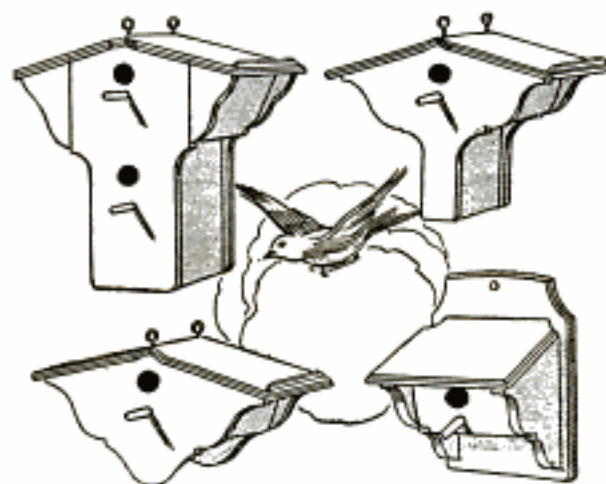

The Four Types of Bird Houses That are being Made from Wooden Telephone Cabinets

shanty types. Each house is made with openings of the right size to suit the particular class of bird that is to occupy it.

*Garford Mfg Co.  
Elyria, O.*



## A Hollow-Tile Ice House

By W. E. FRUDDEN

**T**HERE is one kind of material that makes a good wall for an ice house and that is hollow tile. The plans shown are for a house to hold 25 tons, the amount consumed by the average family for one year. This size makes an excellent one for the farmer. Ice stored in a tile structure of this kind will keep during the hot summer months without much loss, and it makes a building of a permanent nature.

The floor and foundations are made

construction. A crossie is nailed to each pair of rafters on the plate for use in supporting the ice-carrier track. The gable ends are of frame with ordinary barn siding, and the roof is covered with shingles fastened with galvanized nails. A ventilator is placed in each gable to provide a means for letting the excess moisture pass out.

The door, or doors, is built up in three-ply thickness, using a tarred-felt insulator between each layer. The door is best made in two sections, and



of concrete, using a mixture of 1 part cement, 3 parts sand, and 5 parts gravel. A drain pipe is placed in the center of the floor, and the concrete made sloping from every direction toward it. The tile walls are 8 in. thick and are laid up 9½ ft. above the concrete work. A wood plate is bolted to the top course of tile, and the rafters are cut and spiked to it as in ordinary building

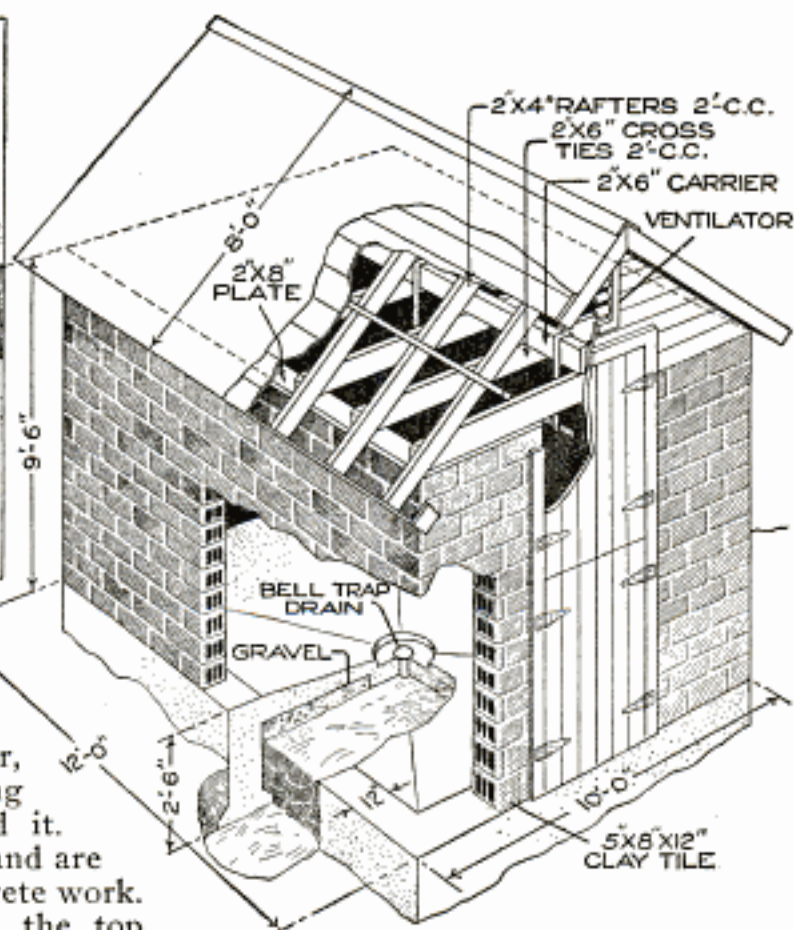

The Dead-Air Space Obtained by Using the Hollow Tile Makes an Ideal Construction for an Ice House

swung on heavy hinges. The frame for the door is constructed of 8-in. plank, and removable leaves are cut to fit the back of the frame, to hold the sawdust and ice away from the door.

To construct this building will require the following materials:

- 5 bbl. cement.
- 3 cu. yd. clean sharp sand.
- 5 cu. yd. coarse gravel.
- 840 hollow-clay building blocks, 5 by 8 by 12 in.
- 9 anchor bolts.
- 2 pieces 2 by 8-in. material, 10 ft. long, for plates.
- 2 pieces 2 by 8-in. material, 12 ft. long.
- 7 pieces 2 by 6-in. material, 10 ft. long, for cross-ties.
- 1 piece 2 by 6-in. material, 12 ft. long, for carrier-track support.
- 14 pieces 2 by 4-in. material, 8 ft. long, for rafters.
- 140 ft. 6-in. flooring, for doors.
- 225 ft. roof sheathing.
- 2,000 cedar shingles.

### Wagon Racks for Hauling Pipe

Plumbers and steam fitters, or anyone having occasion to use a wagon for hauling pipe, will find two such



The Racks Form Three Divisions in Which to Lay the Pipe to Prevent Rolling

racks as illustrated very handy to prevent the pipe from rolling about. The racks, or frames, are made of 2 by 4-in. material with bent iron uprights forming three places to lay the pipe. The method of bending these is clearly shown, and such a contrivance will prove very handy to use, it being a simple matter to toss the frames across the wagon box.—Contributed by Paterson D. Merrill, Chicago.

### Clearance of Milling Cutters

In grinding the clearance on the cutting edge of milling cutters, sufficient attention is usually not paid to the angle or exact amount of clearance the cutter will have on the work. This is a very important matter, as too much one way or the other will result in failure on the job.

If the clearance is too great, the cutter will have a tendency to chatter and make a rough finish, to say nothing of the disagreeable noise, and the loosening up of the bolts and clamps on the machine will cause the heel of the land to drag, making an uneven surface, and is liable to break the teeth.

The angle depends, to a great extent, on the diameter of the cutter and also on the material it is to cut, although, in general, milling cutters are used on almost anything that can be cut, from a piece of hard wood to high-carbon tool steel, making regular shapes, such as plain, slabbing, slanting, or angular, while in those that are made up for a special job and used for that purpose only, more attention must be given to the kind of material to be cut.

Generally soft materials will machine better with more clearance than tool steels, and the like, although conditions may cause the reverse to happen. Usually, for cutters up to 4 in. in diameter, from 6 to 7 deg. will be found ample on the outside diameter. Over and above this diameter, the angle may decrease, say,  $\frac{1}{4}$  deg. for each 1 in. in diameter, until 4 deg. is reached, which is about the minimum amount for any cutter.

The clearance on the teeth of end mills should be from 2 to 3 deg., when the cutters are used for roughing and finishing. If used for roughing alone, a little more clearance will give better results.—Contributed by A. Dane, Pottstown, Pa.

CA small piece of rosin stirred into melted babbitt will improve and make it run better. The rosin-treated babbitt will run into places where the plain will not enter.

### Filling Pits in Varnish on Pianos

If the varnish on a piano has pitted, fill the pits with a wax made as follows: Melt together  $\frac{1}{2}$  oz. of carnauba wax, 2 oz. japan wax, or white bees-wax, and 2 oz. of ceresin wax, in a suitable vessel. A good method is to place one vessel inside of another, place hot water in the outside one, and set them both on a stove. This is called a hot-water bath. When melted, add kerosene enough to form a mass like petroleum jelly, when cool. This may be tested by placing some of it on a piece of glass and letting it cool. If it seems too hard, add a little more kerosene. Rub in on the piano with a wool pad, giving two or more applications until the pits are filled.

### Storing Paint without Waste

In shops where a great deal of painting is done it is difficult to store the paint in such a manner that it will not thicken nor a skin form on the surface. The illustration shows how the difficulty may be overcome. The paint is kept in kegs which are filled and emptied through a spout made of  $1\frac{1}{2}$ -in. pipe, the end being covered with a pipe cap except when filling and emptying. The emptying is done by rolling the keg on skids to the proper position. By using small kegs, say 10-gal. size, the

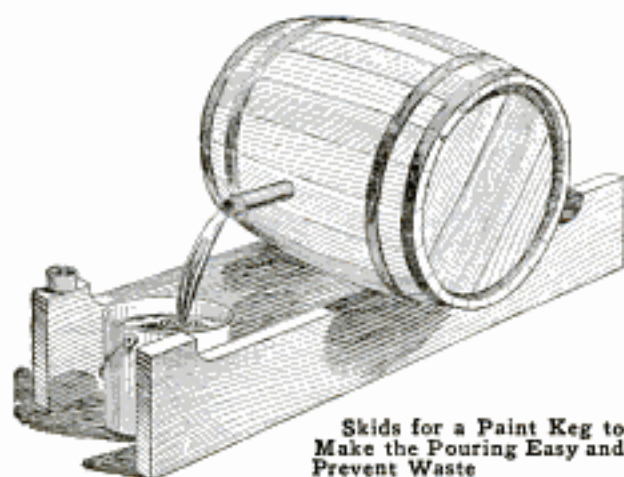

Skids for a Paint Keg to Make the Pouring Easy and Prevent Waste

paint may be shaken up before it is poured.—Contributed by J. J. O'Brien, Buffalo, N. Y.

### Connections for an Expansion Tank

In setting a radiator on the top, or attic, floor, make the connections to the expansion tank as shown, and there

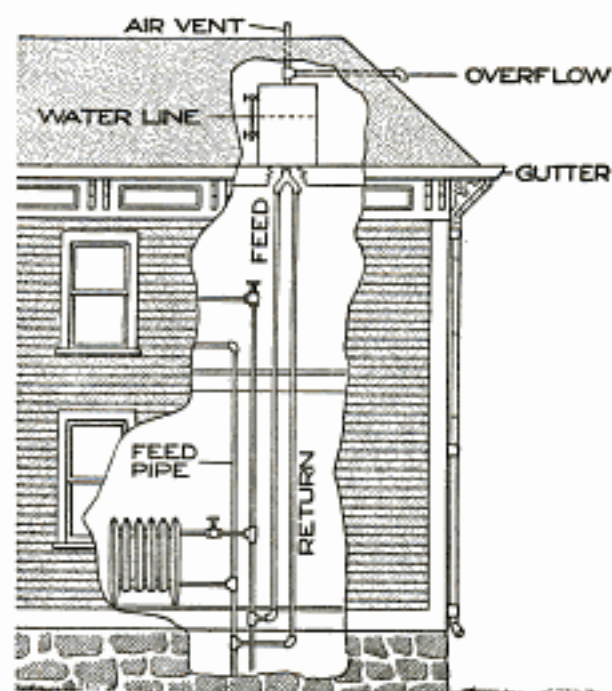

Pipe and Connections to the Attic Radiator and Expansion Tank to Keep the Latter from Freezing

will be no freezing of the water contained in it. A free circulation is obtained through the feed and return pipe to the radiator and it will always stay warm. The expansion tank will keep from freezing by installing a Y-connection, as shown.—Contributed by Geo. M. Crawley, Jr., Newark, N. J.

### Heating Floor of a Small Shop

The brick floor in my shop is very cold in winter, and to make it more comfortable, I removed the brick and dug a hole, 36 in. long, 18 in. wide, and 18 in. deep, in front of the lathe where I stood most of the time. An old two-burner oil stove was procured and set in the hole. I then covered the hole with a board, made to fit tightly, and bored a number of  $\frac{1}{2}$ -in. holes near the center. A large hole was also cut in at each side for draft. I was surprised at the results of this little heater.—Contributed by J. H. Priestly, Lawrence, Mass.

### Operating Electric Switch in Hall from Outside

Switches controlling porch lights are usually placed on the inside of the house in the hall. To find the key hole at night it is desirable to have a light from the outside. To be able to do this without changing the electric wiring, I bored a small hole through the faceplate of the switch box just outside of the box, ran a brass wire through, and turned a ring on the outside end and a right-angled bend with a small ring on the inside end. I can now turn the wire until the inside arm is over the button and by pulling it turn the light on. By locating the hole the same distance from both buttons, the lights can be turned off in a like manner from the outside.—Contributed by J. Maynard, Cleveland, Ohio.

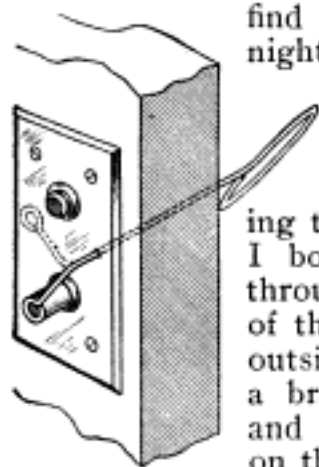

### Guide for a Rubber Stamp Used on Tracings

When using a rubber stamp on tracings, a certain amount of time is usually wasted in placing the stamp in the right position. A guide that will remedy this can be made of a strip of tin, or sheet brass, about  $\frac{1}{2}$  in. wide, and long enough to go

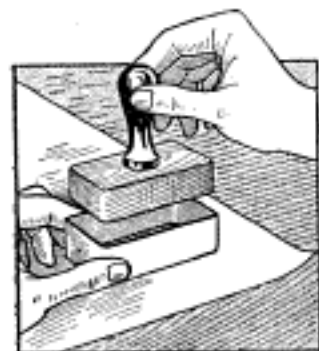

completely around the stamp block. When the ends are soldered together, it should be in the form of a loose-fitting frame. If this frame is laid accurately on the spot to be stamped, the impression will be in the correct position. — Contributed by Frank L. Matter, Portland, Ore.

### How to Carry a Large Glazed Window Sash

Having occasion to convey a heavy glazed sash for a window that was 3 by 4 ft. about half a mile, and not wishing to call a dray, I carried it in the following manner: I ran the chain off the sprocket wheels of my bicycle and drew it up alongside of the rear fork and tied it to the saddle. Resting the sash on one of the pedals and leaning it against the frame of the bicycle, it was easily and quickly conveyed to the desired spot.—Contributed by Dr. F. G. Swartz, Crosswell, Mich.

### Reinforcing a Rubber Hose

The radiator, as well as the motor, on one of the automobiles in a garage heated very badly, and it was found that a flattened hose was choking the water circulation. The hose had a sharp bend, as shown, which accounted for its being distorted. It was necessary to reinforce the hose in such a manner that it would keep its shape. To do this, a helical coil was made of  $\frac{1}{16}$ -in. steel wire of a pitch diameter

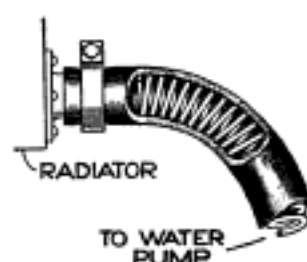

slightly larger than the inside of the hose. The purpose of making it larger was to enable it to be sprung into the tube. A tube, if reinforced in this manner, can be bent into any shape desired, and the opening will remain the same.

### Automatic Tap for High-Speed Work

The tap was designed for use by automobile manufacturers, and others, using a thread of very fine pitch, such as 24 threads to the inch. The tap is readily set for tapping to any depth, and when the desired depth is reached it automatically collapses, thus enabling a quick return. Upon being raised out of the tapped hole, the tap automatically expands to size.



As shown, the tap is set for cutting the thread. The cutting teeth are carried on the ends of the spring arms A, and on the under side of the spring arms is a lug fitting into B, causing the collapse, or release, of the cutting teeth from contact with the thread. The bracket C is secured to the main spindle bearing of the drill press, and in the slot D the pin E moves.

In use, the tap is set in a drill chuck, and the work is placed on the table of the drill press. The work is then raised as near the tap as possible, and the drill started. The tap is run down in the hole and upon reaching the depth for which the dogs have been set, the pin E comes in contact with the lower dog and is delayed, thus stopping the collapsing rod; and as the tap continues, the lugs spring into the groove B, col-

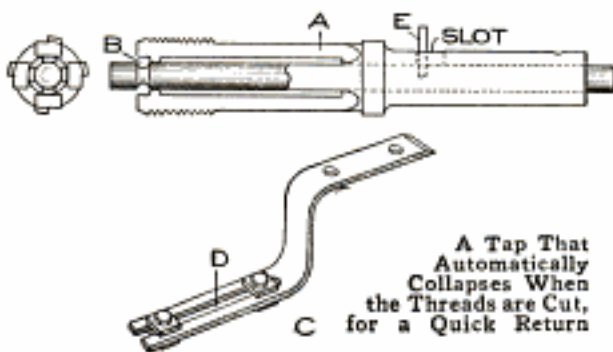

lapsing the tap. The tap is then raised, and when clear of the hole, the pin E strikes the upper dog, delaying the collapsing rod again in its upward movement, and pulling the tap into the cutting position.

### Holding Thin Disk or Ring in Chuck Jaws

When holding a thin disk, or ring, in the outer end of the jaws on a self-centering chuck, while boring or facing work, it is almost impossible to keep the surface true without something between the disk and the jaw. This may be accomplished by attaching a small ring, as shown in the illustration at A. It will be observed that the heavy ring is resting on the light one, which has an opening in it, to keep the ring a short distance away from the working surface and provide

clearance for the boring tool as it passes through. A similar chuck, holding a ring on the outside of the jaws,



A Ring Placed Back of a Disk being Worked in a Chuck to Keep the Surface True

is shown at B. In this case it is not necessary to reverse the jaws to turn the rings on the outside, which saves time and trouble.

### Supply-Water Tank for an Automobile Radiator

To prevent the engine in my automobile from overheating and to do away with the necessity of stopping for water on long trips, I installed a separate water tank by which the radiator can be filled at any time without having to stop. The general construction of the device is as follows: A 5-gal. galvanized-iron tank was installed under the rear seat, an outlet was made at the bottom, and pipe connections were run to the top of the radiator.

Two holes were made in the tank top for pipe plugs, one of which was drilled and fitted with a tire valve. Pump-hose connections were made from the tire valve to an air pump conveniently located at the driver's seat. The other plug was used for filling the tank. A valve was placed where it could be easily reached, in the water line running from the tank. It is only

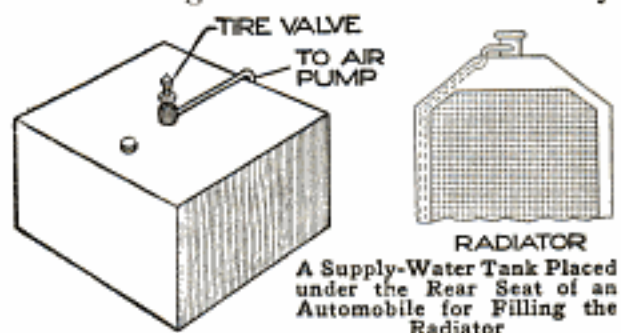

necessary to pump a little air in the tank and open the water valve to fill the radiator.—Contributed by Harry Gahan, Victoria, B. C.

### Making an Automobile-Engine Fan Bracket Rigid

The bracket supporting the cooling fan on an automobile engine became very loose, due to the insufficient base

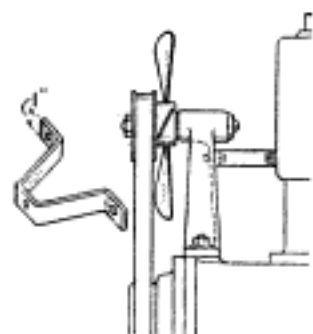

and holding power of the studs. This caused the fan to make a disagreeable noise when in operation, and a repair became necessary.

A piece of strap iron,  $\frac{3}{16}$  in. thick and 1 in. wide, was bent to the proper shape and fastened with studs to the bracket and to the cylinder wall. The studs used in the cylinder wall were coated with white lead to prevent any leakage. Upon fastening the bent piece of metal between the bracket and cylinder a rigid support was obtained and the trouble eliminated.—Contributed by Adolph Kline, New York City.

### Removing Small Bushings

Having occasion to remove a number of small brass bushings from certain parts of a pneumatic motor, I found them so placed that it was impossible to drive them out without damaging

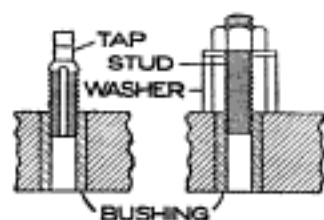

other parts. While they could have been chipped and broken down to remove them, it was not expedient, as that would occasion a loss of time on a hurry job.

The sketch makes clear a method used to get them out, which also can be applied in any case of a like nature.

As the bushings were worn to a point of uselessness, a tap was run down into them deep enough to make three or four threads. A stud was then inserted, and by means of a large washer and nut of the same size as

the stud, the bushing was easily drawn from the body of the device by turning the nut. This makes a safe and easy way for drawing bushings in a machine where it is impractical to force or draw them out by other means.—Contributed by F. W. Bentley, Missouri Valley, Iowa.

### To Prevent Oil Sticking to Lubricator Glasses

To keep the inside of a lubricator glass free from oil, dissolve a very small piece of soap in the water. This will make the glass slippery and prevent the oil from adhering to the glass. A piece of soap put in the glass about once a week, will be sufficient to keep the glass always clean.—Contributed by Harry Piel, North Bergen, N. J.

### Carrying Handle for Acetylene-Gas Tanks

Tanks containing compressed acetylene gas are not convenient to carry,

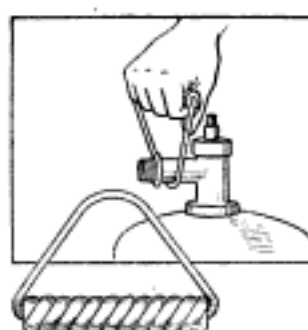

and for this reason I made a handle as follows: A piece of heavy wire, or leather thong, is run through a piece of pipe or flexible tubing, used for insulating electric-light

wires, and is applied on the valve end of the tank. This makes it easy to carry the tank just the same as a pail.—Contributed by E. K. Marshall, Oak Park, Ill.

### Glass as a Substitute for Tracing Cloth

Instead of using tracing cloth, or paper, in instances where the tracing is not to be kept as a record, a plain sheet of glass makes a good substitute, and one that possesses certain advantages. Take a plain piece of glass that is perfectly clean and dry, and it will take the drawing ink perfectly, and no sizing need be used. The ink dries as

quickly as on paper, and when dry, the tracing may be dusted or wiped off without the slightest injury to the tracing.

When the tracing is no longer wanted, a damp cloth will quickly remove the ink, and the glass is then available for another tracing. The centers are located by means of a small piece of rubber, leather, or the like, moistened and placed on the glass. This gives a good rest for the point of the compass. This idea simplifies the blueprinting work, as it does away with tracing cloth, and a single glass will do for many tracings, besides which the glass always lies flat, without the use of thumb tacks, and the finest line is readily seen. It will not draw and wrinkle when the air is humid and cause a defective blueprint.

#### A Hot-Dinner Pail

This is simply an adaptation of the fireless-cooker idea, changed only in size and thickness of the insulating sides. It is not guaranteed to keep food as hot as liquid in a vacuum bottle, but will, if properly used, serve the dinner appetizingly hot.

The drawing is self-explanatory. Tin is the best material both for the inner and outer sides, as well as for the three food decks and a square tea or coffee bottle. The filling between the two shells may be the best nonconductor that can be had, but sheets of solid cork offer the lightest and easiest-worked filling. After the insulating material and the inner shell are in place, the upper edge of the box is covered with a  $\frac{3}{4}$ -in. strip of tin, soldered neatly. The lid, swinging on soldered hinges and fastened down by a catch, strap, or any other convenient method, is simply a  $\frac{3}{4}$ -in. deep tin box, 10 in. long by  $6\frac{1}{2}$  in. wide, filled with the nonconducting material.

The decks and bottle are made with round corners, excepting the angles of the sides with the bottom, which are left square. The upper edges of the sides being rolled inward, any dish will stand firmly on top of any other one

inside of the box. In practice, the decks containing the hot food are first placed in position and pushed snugly

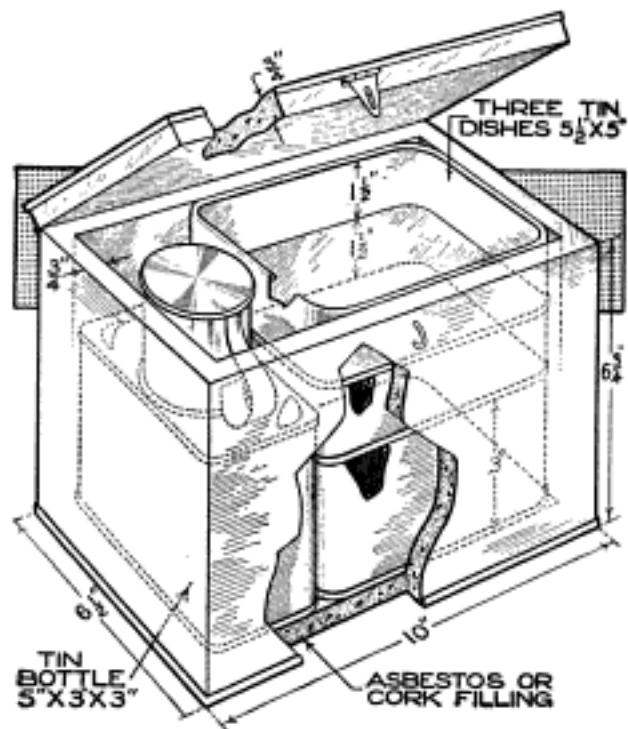

Pail Made Like a Fireless Cooker to Keep Edibles Hot until Lunch Time

against one end. The bottle is then set in, locking the decks in place. When lunch time comes, the bottle, of course, is first lifted out by the lugs soldered on its shoulders for that purpose, and the food decks are released. It may make the description of the decks a little more clear to state that they are just like large sardine boxes.

The dimensions given are intended to be merely suggestive and may be varied within reasonable limits. In fact, the idea lends itself to a number of variations from a simple individual two-deck kit to large boxes for automobile touring parties. Provision is easily made for carrying knives, forks, and spoons either inside or out.—Contributed by A. M. Parker, Edmonton, Canada.

☞ To oxidize brass and copper objects, use the following solution: Nitrate of iron, 2 oz.; hyposulphite of soda, 2 oz., and water, 1 pt. Immerse the object in this solution and leave it until the desired depth of color is obtained.

### Making Post Dig the Post Hole

In planting a piece of 1½-in. iron pipe for use as a hitching post, I tried to drive it into the frozen ground, but

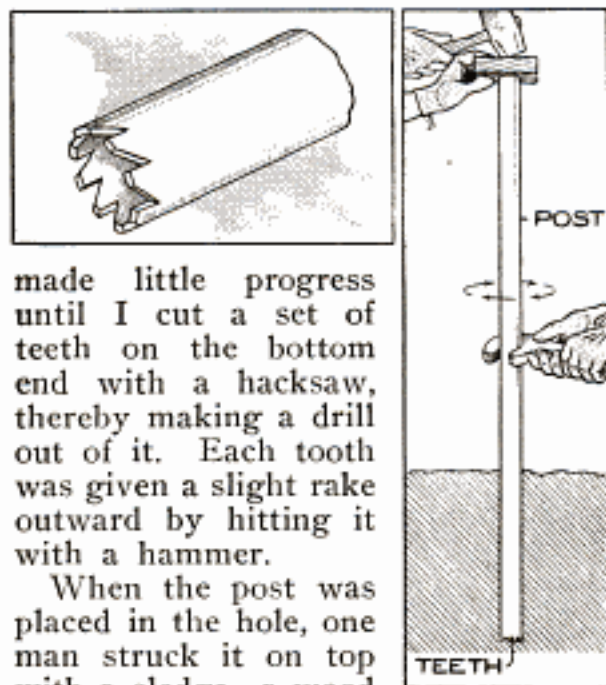

made little progress until I cut a set of teeth on the bottom end with a hacksaw, thereby making a drill out of it. Each tooth was given a slight rake outward by hitting it with a hammer.

When the post was placed in the hole, one man struck it on top with a sledge—a wood block being interposed to prevent battering—while I turned it with a pipe wrench. In this way I anchored the post quickly and firmly, as the teeth cut out the core of frozen earth just wide enough to receive the post. The core, of course, was forced up into the pipe.—Contributed by James M. Kane, Doylestown, Pa.

### Protecting a Fish Line in the Ice

In fishing with lines through the ice the lines are often frozen during the

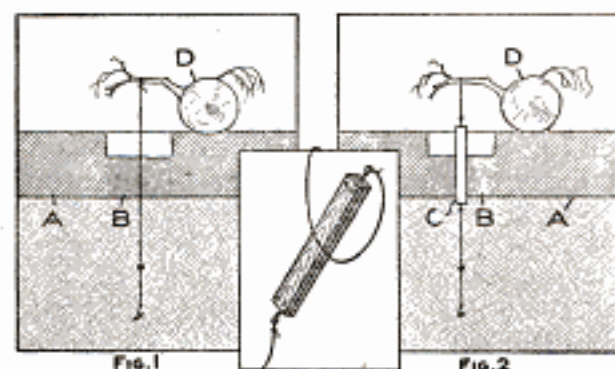

Boards Nailed over a Line to Protect It When Cutting Out the Ice

night, and frequently, when chopping the ice from around them, the lines are

cut. The section A shows the ice, and B is the ice frozen in the hole during the night. A line holder is shown at D. To protect the line, I use two boards, C, nailed together over the line. If these freeze in the hole, it is an easy matter to chop them out without injury to the line.—Contributed by Geo. Goodwin, Jr., North Temiskaming, Quebec.

### Weight, Power, and Speed, and the Light Automobile

The automobile-buying public takes in the various "arguments" put forth in favor of different cars as salesmen's talk and disregards some very important points in just this way, little guessing that a short period of use of the cars will prove many of the arguments to be truths backed up by indisputable principles of physics and engineering.

Consider, for instance, the arguments for and against the "light car." The light-car salesman claims more speed, more power, less fuel consumption, better hill-climbing qualities, and more carrying capacity, together with many other things that need not be mentioned. From an engineering standpoint the foregoing claims may be resolved into these factors: power, speed, and weight.

As an example, consider an engine of 30 h.p. It will move a light load farther than a heavy one, as with every increase of speed an increase of power in direct proportion is required; or to put it in another way, the power supplied remaining constant, the speed depends upon the load or weight that is moved. Naturally, it follows that a light car will go faster, uphill or on a level, than a heavier car of the same engine power carrying the same passenger weight. Also, the light car can go farther with one passenger than it can with five, the same being true of the heavy car as well. Hill climbing is merely raising a weight to a certain height, and the load it imposes upon the engine may simply be considered

another weight. The engine has then three weights to move: weight of car, weight of the passengers, and the "weight" of moving both uphill. If any one is lessened, or removed, the engine can move the remainder at a higher speed. Or to get a higher speed is an impossibility without a decrease in weight.

As the weight of the car is a part of the load the engine must move, the light car can be run by a smaller engine, or by less overloading of the same engine; hence the lower fuel consumption of the light car carrying the same passengers.

First, the power required is directly proportional to the weight and the speed with which it is moved; second, the weight that can be moved is directly proportional to the power applied and the speed with which it is moved, and, third, the speed is directly proportional to the weight moved and the power applied. Other factors enter into car service, but the foregoing statements should be kept in mind. Measured by them alone, the light car has many advantages.—Contributed by Donald A. Hampson, Middletown, New York.

### To Keep a Stovepipe Connected

The elbow is usually the first part of a stovepipe to pull loose where there is a long line. If, however, two loops of wire are twisted tightly around the pipe joints, at A and B, and also in the

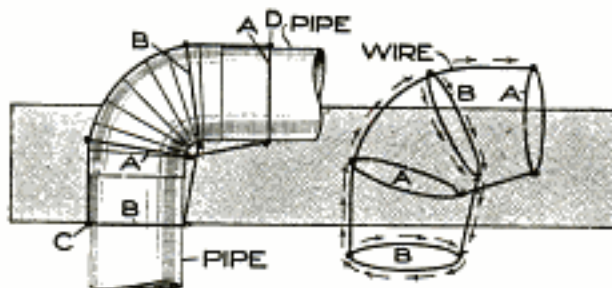

Tying the Elbow of a Stovepipe to Prevent Dislocation in a Long Line of Pipe

grooves of the elbow, then secured by the wire backbone from C to D, the danger of dislocation will be much lessened.

### Turning Large Sheave Wheels without a Lathe

Having a number of V-groove, 7-ft. sheave wheels that required machining to receive a dovetail packing stamped from rubber belting, as shown in the sketch, but no lathe large

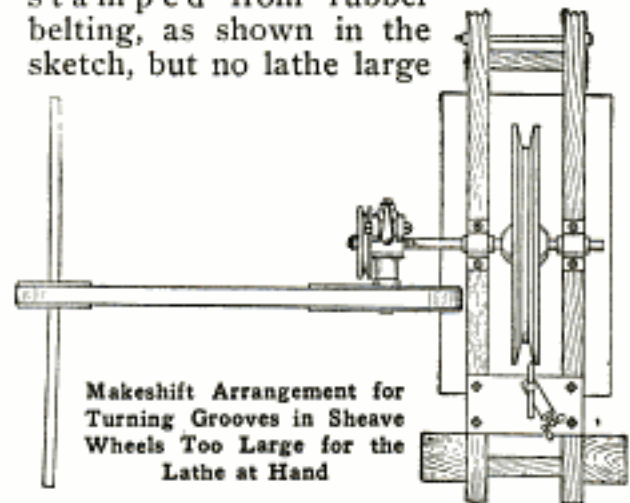

enough to swing them, I devised a temporary arrangement to do the work, as follows:

Two large timbers were placed over the motor pit, which lay parallel to the line shaft, and spreaders inserted between them and bolted together. They were braced sideways and the sheave wheel hung on an axle running in bearings attached to them.

The hand chain wheel was removed from a 2-ton chain block and a 14-in. pulley put in its place. The left chain wheel was removed and the square end of the shaft was inserted in the square socket previously cut in the end of the sheave-wheel axle. The chain blocks were fastened with a couple of large 7-in. bolts to a timber 12 in. square.

A heavy steel plate was then placed across the timbers in front of the sheave wheel, on which was mounted the extra tool-post head of the lathe. With this arrangement the speed was reduced and sufficient power obtained for practical work.—Contributed by H. V. Abeling, Burke, Idaho.

CA lemon that has been squeezed for cooking purposes is still just the thing for cleaning the brass of lamp burners, etc. Add a little salt, and the black will come off easily.

### Controlling the Inflation of a Gas Bag

What is known to mechanics as "bagging a pipe" is the insertion of a deflated rubber bag into a water or gas

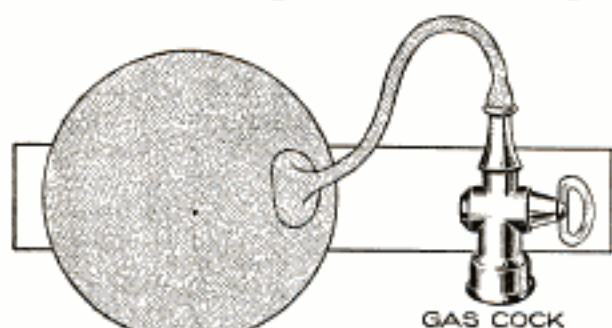

RUBBER BAG

Gas Cock Used in Hose Connection for Controlling the Inflation of a Gas Bag in a Pipe

main. The bag is inflated through a rubber tube attached to it. This inflation effectually prevents the passage of gas or liquid through the pipe.

Some mechanics attach a gas cock to the tube. The air hose is screwed into this cock, and when the bag is sufficiently blown up, the key is closed. This does away with the necessity of doubling the hose and tying it, as would have to be done if the gas cock were not used. It also permits an easy renewal of inflation.

### A Quickly Applied Lathe Dog

In roughing down a large number of shafts prior to grinding them, I found it took considerable time to adjust the

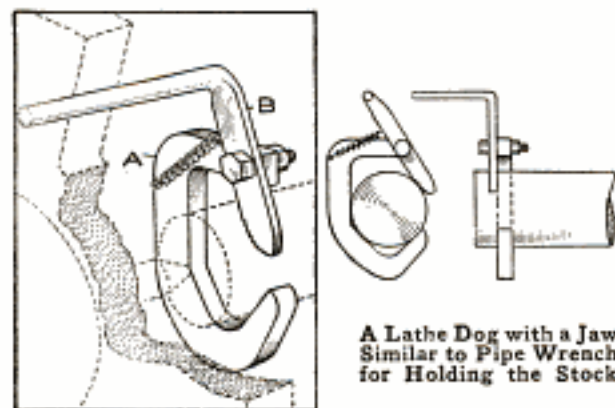

A Lathe Dog with a Jaw Similar to Pipe Wrench for Holding the Stock

dog and remove it. I set about making one as an improvement over the ordinary lathe dog and one that could be quickly applied, and the result was as illustrated. The body, or yoke, A, was

made of machine steel,  $2\frac{3}{4}$  in. long, 2 in. wide, and  $\frac{3}{4}$  in. thick, which was casehardened after it was forged into the shape shown. The tail B, on which a notched end was formed for holding the shaft, was made of tool steel and tempered. The tail swings on a pivot in the extending end of the yoke. A helical spring is placed in a drilled hole, as shown, to open the dog for removal. When driving the shaft it grips tightly the same as a pipe wrench.—Contributed by Jos. Pruell, Walpole, Mass.

### A Homemade Oil Cup

The oil cup illustrated can be made from scraps of material found about

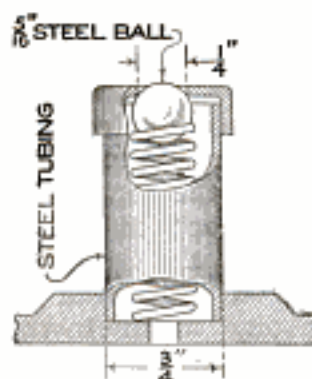

most shops. The body consists of a piece of steel tubing, threaded on both ends and turned into the thread of the bearing. The upper end is covered with an ordinary pipe cap, which is previously drilled

with a  $\frac{1}{4}$ -in. drill. A steel ball,  $\frac{5}{16}$  in. in diameter, and a helical spring, placed on the inside of the tube, complete the cup.

### Marking Tools by Electricity

While trying to find some effective way of marking my tools, I tried the following method, which worked satisfactorily. I connected one side of a 110-volt circuit to one terminal of a toaster, joined the other terminal of the toaster to the metal of the tool to be marked, and fastened a piece of lead pencil to one end of a piece of wire and connected it to the other side of the line wire. By lightly tracing my initials on the tool with the lead pencil, an indelible and clearly legible identification mark was made.—Contributed by Henry Worthmann, Jr., Chicago.

# BUILDING A HOME

By Geo. M. Petersen

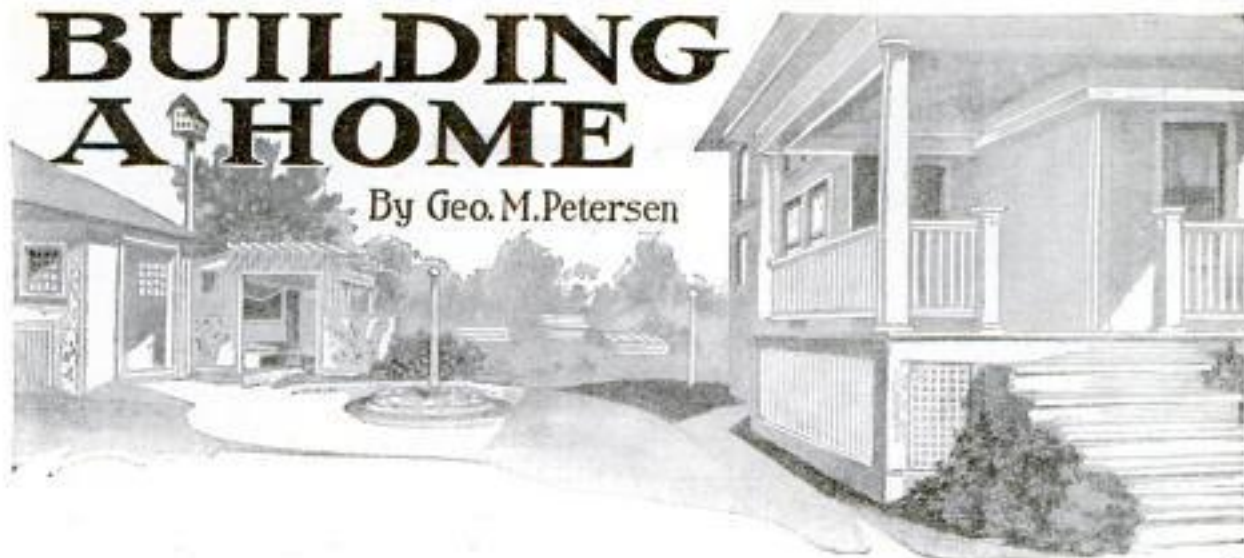

## Part XI—Roofings

**T**HE subject of roofings is one on which experienced builders and contractors differ, it being very seldom brought up in a gathering of these men but that a lively argument will be the result. For this reason only facts concerning the different roofing materials will be given, without recommending any one of them. There are numerous kinds of roof coverings in use at the present time that are giving satisfactory service. They are shingles, slates, asbestos shingles, asbestos corrugated sheets, metal shingles and tiles, tin, tile, gravel, prepared or ready-made roofings of numerous kinds, corrugated iron sheets, and canvas. While some of these roofings are only used for garages, veranda decks, dormer roofs, etc., yet they are roofings and will be treated as such.

### Shingle Roofs

Shingle roofs, when properly laid, give very fair service for from 10 to 20 years. In the old days when the shingles were split from a piece of straight-grained timber, it was nothing to be marveled at if a shingle roof lasted 60 years, or more, but the modern shingle is an entirely different proposition to handle. Practically all of our shingles today come from the state of Washington and are known as the Washington red-cedar shingles. They are cut from the butt of the log, the grain being reversed in every other one, as shown in Fig. 1. The shingles

are then bundled and kiln-dried to get out the last bit of moisture so that the freight rate to the central and eastern states will not be excessive. Many times stumps which have been dead for 5 or 10 years are cut over and made into shingles. Even though the stumps are dry, the shingles are kiln-dried after being cut, and still it is wondered why a shingle will split so easily in the hands.

Shingle roofs, bad as they are for lasting qualities, are comparatively cheap in cost and maintenance, and, when properly laid, give value for the amount expended. The common expression that anyone can lay shingles is a mistake. Anyone can put shingles on a roof, but it is almost certain that they will pull up or split so that the roof will leak. This will not be the fault of the shingles, but of the person that laid them. It may cost a few dollars more to do it right, but it will pay in the end.

A good shingler looks at the butt of the shingle and then lays it on the roof, as shown at A, Fig.

2. If this shingle has any tendency to warp or curl it will be downward, as shown at B, and will keep the roof tight. If the shingle is laid as shown at C, the result will be as at D. Shingles should never be laid that are more than 7 in. in width,



as they will expand and contract so much as to cause cracks in them. At least  $\frac{1}{8}$  in., and preferably  $\frac{1}{4}$  in., must

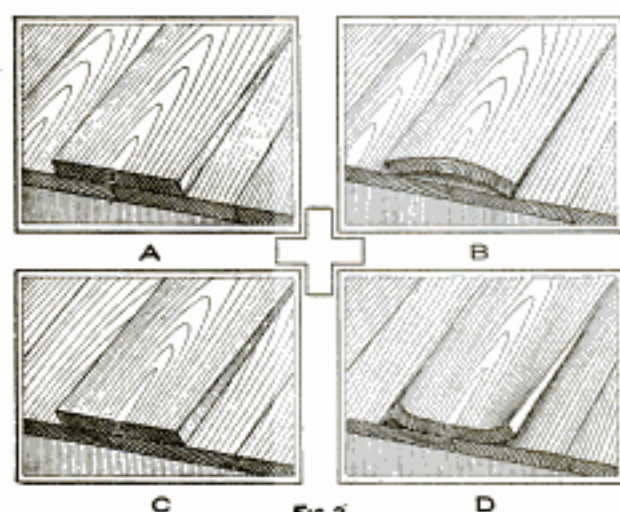

Fig. 2  
Proper and Improper Method of Laying Shingles to Make Them Lie Flat or Warp

be allowed between shingles for the expansion in wet weather, and for the same reason shingles must be fastened with only one nail to prevent splitting. The nail is placed near one edge, and in such a position that the overlapping shingle in the next course will just about cover it. The nails commonly used are four-penny cut, galvanized or zinc. Shingles should never be laid with joints over each other in the alternate courses, but as shown in Fig. 3, and never more than 5 in. to the weather,  $4\frac{1}{2}$  in. being much better. A

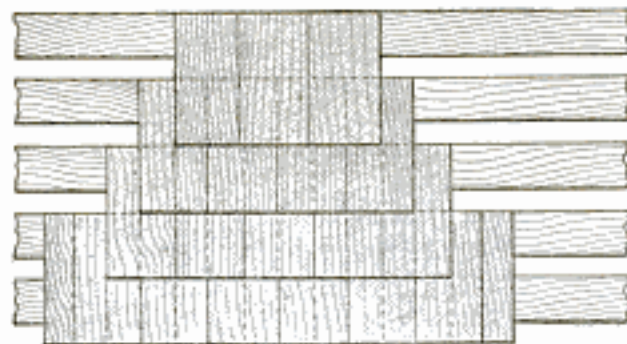

Fig. 3  
Shingles Laid so That the Third-Course Joints will Not Coincide with Those of the First

section of a shingled roof is shown in Fig. 4.

Wood shingles may be preserved and tinted by dipping them in a mixture of creosote oil and crude oil, half

and half, with a little color added. The creosote is the preservative, but it is quite hard on colors, and for that reason, and for the sake of economy, the crude oil is used. Creosote alone will give the shingles a dark-brown stain, while the mixture of both oils produces a light-brown color.

#### Slate Roofs

Plain-slate roofs, on account of their durability, fire-resisting qualities, and color effects, are probably the most common for the medium-priced home. Some of the colored slates cost as high as \$18 per hundred square feet, which is termed a square, and this price is a little too high for the medium-priced home. While the average cost of shingle roofs is about \$7 per square, with material and labor furnished by the contractor, the cost of good slate roofs will average about \$10 per square, although a grade of slate which is soft and shaky can be obtained for about \$8.50 per square. Of course, the price given is in addition to the cost of the lumber required for the roof boards, as slate should be laid over a matched-board roof. A section of a slate roof, Fig. 5, and a comparison of Figs. 4 and 5 will readily show which is the more expensive as far as the carpenter labor is concerned.

There are so many grades of slate that it may be best to give the gradings as used in Bangor, Pa., where the best slate is mined. A pure slate without any faults or blemishes is known as No. 1, clear. The No. 1, ribbon, is as well made as the No. 1, clear, but contains one or more ribbons which are high enough on the slate to be covered when laid, thereby presenting a No. 1 roof when finished. A ribbon is a black band, or streak, across the slate. The No. 2, ribbon, contains several ribbons, some of which cannot be covered when laid. The No. 2, clear, is without ribbons, but made from rough beds. The hard beds are a clear Bangor slate, not quite as smooth as the No. 1, clear, but much better than a No. 2, clear.

The size of slates range from 9 by 7



in. to 24 by 14 in., with about 35 intermediate sizes. The thickness of the slates may vary from  $\frac{1}{8}$  in. to  $\frac{1}{4}$  in., with the better grade all  $\frac{3}{16}$  in. thick. The large-size slates are the best adapted for plain roofs, as they make fewer joints, avoid small pieces at the valleys, and require a less number of nails.

A good slate should be both hard and tough. If the slate is too soft, the nail holes soon become enlarged, and allow the slate to work loose and blow away. If too brittle, the slate will fly to pieces in the process of "holing," and will be easily broken on the roof. Slate may be tested by rapping it sharply with the knuckles, producing a sharp metallic ring. The slate should break, but not splinter under the slater's ax, and should not be "tender" at the edges. Up to a few years ago, the slates were punched on the job, but at the present time the slate is holed and countersunk at the quarry, when so ordered. This latter method is much better, as the old way often damaged the slate.

The regular colors in which slate can be obtained are black, green, red, purple, dark blue, and gray. While the color does not necessarily affect the wearing quality of the slate, it sometimes shows the slate to be soft or from a new quarry. The deeper the quarry the harder the slate, and usually the darker the color. If a slate stands the

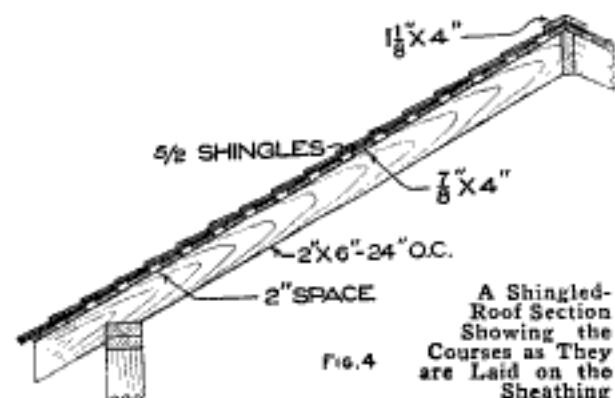

knuckle test, it is pretty safe to put on the roof. The colors most in demand for residence work are black, light green, mottled purple, and red, and there are very few greens and reds

that will not fade in time. The dark-purple slates sometimes have a large spot of light green on them, which, while it seldom affects the durability of the slate, greatly detracts from its appearance.

Slate should be laid over a tight

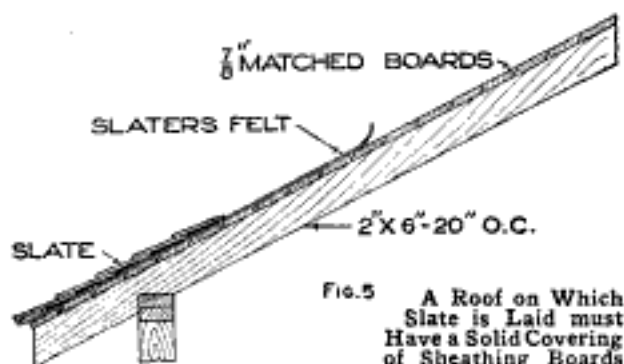

board roof, covered with tar paper or felt. Each course of slate should lap the preceding course by at least 3 in., and should be fastened with a three-penny or four-penny nail in each upper corner. Zinc, copper, galvanized, or tinned, nails should be used. Common nails will rust away quickly and allow the slate to be blown off the roof. If the expense can be met, it is advisable to use copper or zinc nails, and copper flashings. This will take care of all roof troubles for years to come. Roofs to be covered with slate should have a rise of at least 6 in. to the foot for large slates, and 8 in. to the foot, for the smaller ones. In really good work, the top course, the three bottom courses, and 1 ft. each way from all valleys and hips, should be bedded in elastic cement. Slates  $\frac{3}{16}$  in. thick will weigh about 650 lb. per square on the roof.

#### Asbestos Shingles

Practically all articles and materials used in building which are regarded as "standard" owe their origin and existence to some necessity. This is the case with asbestos shingles. The demand was for a material stronger than wood shingles, lighter than slate, and cooler than either. The remarkable heat-insulating qualities of asbestos shingles make them an ideal roof for the southern states.

Asbestos shingles are composed wholly of asbestos fiber, 15 per cent,

comb, using a square-cut corner, in Fig. 8.

These shingles may be obtained in various colors, the principal ones being gray and red. The gray shingles, laid with a red belt and red asbestos ridge, will make a roof that will bring forth a favorable comment at all times. Asbestos shingles weigh about 280 lb. per square on the roof.

The cost of asbestos shingles is about \$8.50 to \$9 per square, depending on the kind of roof, with a slight advance to these prices if red is used. These shingles are put on over a tight roof by carpenters, and the slate roofers are not very keen about recommending a material that can be put on by mechanics other than roofers. In a short time, however, the slate roofers will be forced to take hold of asbestos shingles, and then the general public will get the inside information on a really good product. Asbestos shingles are not an experiment, as they have been used on many buildings throughout this country, as well as on many government buildings, and by large corporations.

Before taking up the subject of the less common roofs, it will be well to consider the advantages and faults of the three principal roofings mentioned. The prospective home builder can quite accurately size up the roofing question, and decide for himself which one is the best suited for his needs, by the following table:

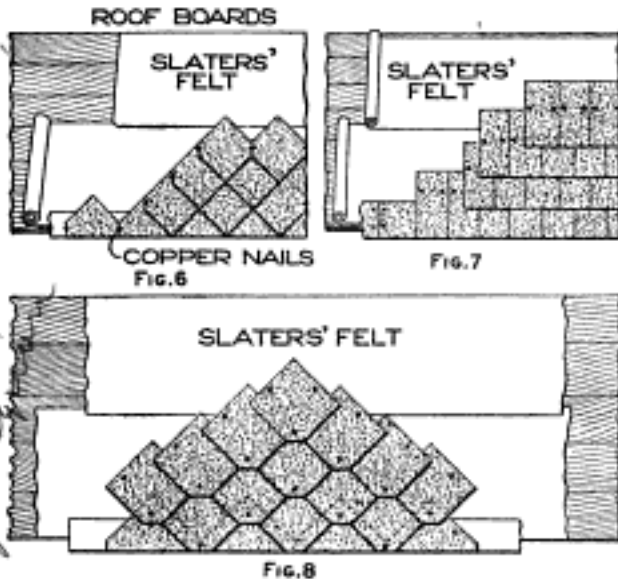

Three Methods of Laying Asbestos Shingles: The Diagonal, Straight, and Honeycomb

and Portland cement, 85 per cent. The mixture is combined with a sufficiently large volume of water to bring the cement into a colloid state, and then subjected to a pressure of about 650 tons to the square foot. The result is a smooth shingle of even thickness, which is not only light-weight, but resists fire absolutely. These shingles are  $\frac{3}{16}$  in. in thickness, and of various sizes and shapes, and are laid with copper storm nails that will never rust off.

The diagonal method of applying these shingles is shown in Fig. 6, the straight-laid, in Fig. 7, and the honey-

Material	Advantages	Faults
Wood shingles.....	Low initial expense. Easy to repair. Not affected by heat. Light in weight. Unlimited color effects by use of stains.	Inflammable, subject to decay and curl. Hot in summer, cold in winter. Subject to mossy growth in damp places.
Slate .....	Fire-resisting. Not affected by dampness. Large range of color effects. Warm in winter. Well advertised and known almost to every person.	High initial expense. Expensive to repair. Affected by frosts. Hot in summer. Heavy in weight. High expense for color effects. Breakable.
Asbestos .....	Fire-resisting. Not affected by dampness. Cool in summer. Warm in winter. Not affected by frost. Lighter than slate. Less expensive to repair than slate. Low cost for color effects. Practically unbreakable.	Heavier than shingles. More expensive to repair than shingles. High initial expense. Limited color effects. Not well known except by those in the business.

## Asbestos Corrugated Sheathing

This sheathing is made by the same process as the asbestos shingles, and possesses all the advantages of that product. It is used principally for factories, and is mentioned here solely for its use for roofs and walls of garages. If this sheathing is used on angle-iron studs and rafters, the garage will be absolutely fireproof. The method of applying this material on angle-iron rafters is shown in Fig. 9. The material only weighs 3 lb. per square foot, which is about the weight of No. 14 or 15 gauge corrugated sheet iron and steel.

While this material is rather expensive, the small quantity needed for the average garage will not cost very much.

## Metal Tile and Shingles

The beauty of Spanish tile is often desired where its great weight would be prohibitive, as it varies from 750 to 1,200 lb. per square. To overcome this disadvantage, the metal-shingle manufacturers have placed on the market the metal tile which closely resembles it, but weighs only slightly more than the corrugated sheet metal. These tiles are slid together, by various means used by the different manufacturers to make the joints tight. Metal interlocking shingles with raised pattern are also being manufactured, although metal roofings have never proven satisfactory.

Metal tile and shingles are a cheap roofing material, considering first cost only, light in weight, and extremely easy to apply, but they are certainly annoying in heavy rainstorms, as the continual tapping of the rain on the roof can be heard. The main fault with metal of any kind is that it corrodes easily. Applying paint on the exterior of the shingles will not protect the under side where the rusting sets in, and thus the life of the metal is very short.

These metal roofings cannot be used on flat, or almost flat, roofs, but only on roofs that have a pitch suitable for shingles.

## Tin Roofs

Tin roofs are generally used for flat surfaces where shingles or slate cannot

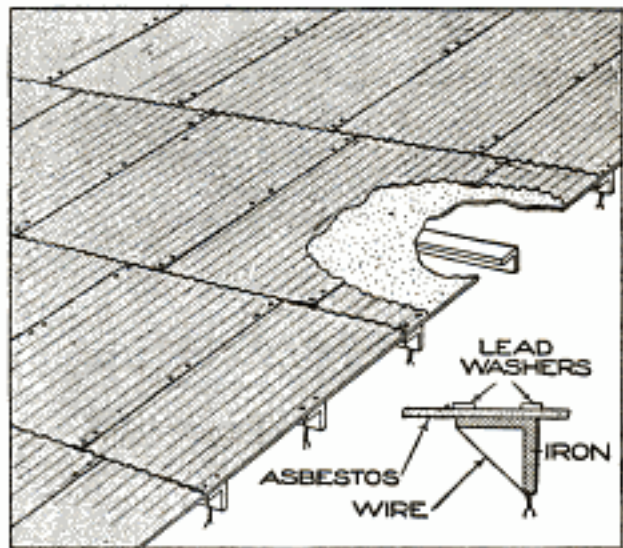

Fig. 9  
Asbestos Corrugated Sheathing as It is Applied to a Building Using Angle-Iron Rafters

be used. The sheets are made of soft steel, and sometimes of wrought iron, and are dipped in a bath of tin and lead until the surfaces are well covered. These sheets are designated as "terne plates" to distinguish them from plates coated only with tin, which are called "bright tin."

A number of mills now use a patent roller process for dipping the sheets, whereby the tin and lead is rolled into the sheet so that the coating can be thin, medium, or thick, according to the price obtained for the sheets. As the terne plates are the best, they alone will be considered. They are made in two thicknesses, viz., "IC," in which the iron body weighs 50 lb. per hundred square feet, and "IX," weighing 62½ lb. per hundred. For roofing, the lighter weight is preferable, because the expansion and contraction



Fig. 10



Fig. 11

A Flat Seam Well Hammered Down and Soldered, and the Standing Seam without Solder

is not so great and, therefore, is not so hard on the seams as it would be in the case of the thicker plates. For

gutters, conductors, flashing, etc., the IX plates should be used. The thickness of the iron adds absolutely nothing

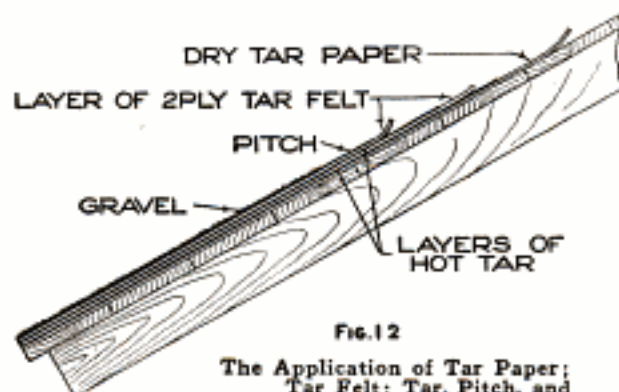

FIG. 12  
The Application of Tar Paper;  
Tar Felt; Tar, Pitch, and  
Gravel, for a Roof

ing to the durability of the plates, as this depends entirely upon the coating.

Roofs made with less than one-third pitch are made with flat seams and preferably covered with sheets 14 by 20 in., since a large number of seams stiffens the surface and helps to prevent buckles and rattling in stormy weather. The metal should be secured with 1-in. barbed and tinned roofing nails, placed not more than 6 in. apart and well under the edge. The seams should be well pounded down with a wood mallet, and sufficient time taken to sweat the solder into the seams properly, as shown in Fig. 10. The owner should see to it that nothing but good rosin is used as a soldering flux, as acid will attack any exposed iron

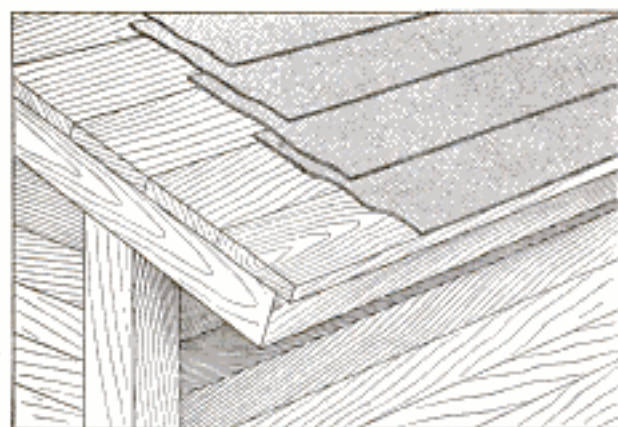

FIG. 13  
A Roof Composed of Five Layers of Three-Ply  
Asphalt-Saturated Felt

and cause it to rust out in a short time.

A good tin roof will last, if the material is of a good quality and properly

put on, for from 30 to 40 years. It should be kept well painted. Tinwork should never be given the first coat of paint until after it has been exposed to the weather for two or three weeks and well washed with rain to remove the grease from the surface. Painting the under side of the tin before laying it will greatly increase the lasting qualities, and if laid on felt paper, the noise will be deadened in a heavy rainstorm. The cost of a good flat-seam roof is about \$9.50 per square, and of a standing seam, \$9. A standing seam is mostly used on a steep roof and without solder, as shown in Fig. 11. The nails are not driven into the roof, only into the cleats at the seam.

#### Tile Roofs

Tile roofs, as mentioned previously, are used chiefly for the decorative

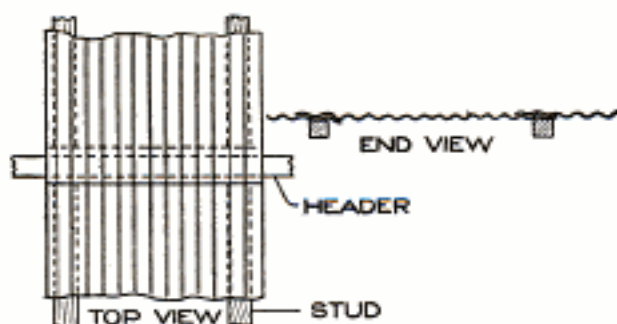

FIG. 14  
Method of Applying Corrugated Iron Sheets to a  
Roof, Showing the Lap on a Header

effect and not for reasons of durability. Roofing tile is very heavy and shows to advantage only on a roof of a building specially designed for it. It is an open question with roofers and architects whether a tile roof is preferable to a No. 1 slate roof or not. At present the slate roof is much more durable, although there are a few makes of tile that, when properly laid, have given good satisfaction.

#### Gravel Roofs

Gravel roofs are seldom used except on old houses, outbuildings, or flat roofs that would ordinarily require tin. While the gravel roof gives good service and is fairly durable, it is not fit for a new house, or an old one that is of any value, for the reason that a hot sun

will melt the tar and cause it to run into the gutters or drip from the eaves. For a flat roof, however, it is all right, as it cannot be seen over the gutters. In fact, authorities on the subject agree that gravel roof should not have a pitch of less than  $\frac{3}{8}$  in. or more than  $\frac{3}{4}$  in. to the foot in hot climates, and in no case more than 4 in. to the foot. Gravel roofs should first have a layer of dry tar paper laid over the roof boards, to prevent the pitch from running through the cracks. Over this is placed a layer of hot tar, and then another layer of two-ply tar felt; another layer of hot tar, and another layer of tar felt; a layer of pitch, and then the gravel. The tar felt should not weigh less than 14 lb. per square, single thickness, and a three-ply roof should have 70 lb. of tar and pitch to the square, and from 200 to 300 lb. of gravel.

A gravel roof of this kind can be put on for about \$3 per square, and if properly nailed with large-head, barbed, roofing nails, it should last from five to seven years. There are numerous methods in vogue, but the one mentioned will give very satisfactory results and is very reasonable in price. A sectional view of this roof is shown in Fig. 12. While this roof is not fire-proof, it is fire-resisting, and when the inflammable oil is burned out, it will cause the residue to swell and form a porous, incombustible mass.

#### Prepared and Ready Roofings

Prepared and ready roofings have been placed on the market to take the place of gravel roofs to a certain extent. These roofings are made of from one to five-ply material, which is nailed on the roof as one sheet. The edges

of these roofings are cemented together with a cement furnished by the manufacturers. These roofings are especially useful in repair work, as they can be put on right over the old shingles and save the cost of removing them. They are also valuable near a railroad or factory, where the fire hazard is too great for a shingle roof and the acid fumes from the smoke will corrode metal. They are very easy to apply and are guaranteed by the manufacturers for from 5 to 10 years. Most of these roofings have to be painted every two or three years to make the

guaranty good.

The prepared roofing which I have used with considerable success on coal trestles, and buildings of such nature, on which metal roofs cannot stand for more than a few months, is shown in

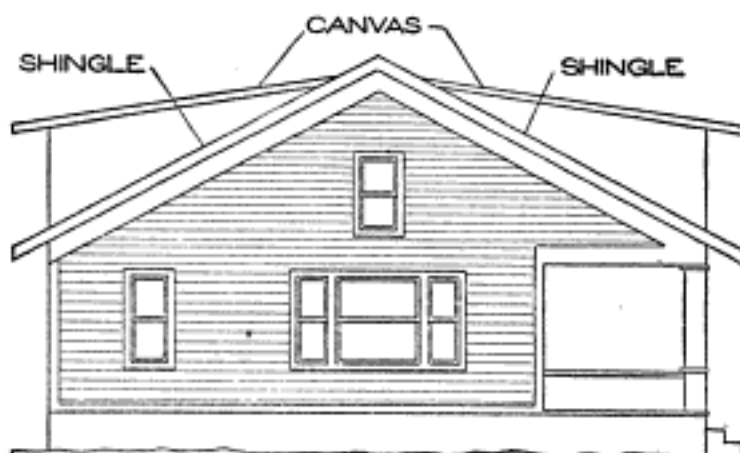

FIG. 15  
Flat Dormer Roofs Covered with Canvas That is Shrunk On,  
Then Coated with White Lead and Oil,  
to Make It Waterproof

Fig. 13. This roofing is composed of five layers of three-ply asphalt-saturated felt.

When selecting ready roofings, do not pick out those in which fine grit or stone is rolled into the surface, unless there is another layer of felt underneath applied to the roofing after the grit has been rolled in. The reason for this is that the great pressure under which the grit is forced into the felt often forces the tiny points of the material through the roofing, and in a few months the action of the elements will cause the roofing to draw away from the hole, and a leak results. These roofings range in price from \$3 per square up, put on the roof.

#### Corrugated Iron Sheets

These sheets can be obtained in various weights and in painted and galvanized finishes. The sheets are end-

lapped about 8 or 10 in., and headers are cut in at the joints. The side lap comes on the rafters and should be about three corrugations in width. This roofing, if galvanized, should last five or six years, and if painted, from three to four years. Its cost is about \$3 per square, placed. The application is shown in Fig. 14.

#### Canvas Roofing

This material is used mainly for second-story veranda-floor covering, and must not only be waterproof but tough enough to stand the wear of persons walking over it. There are many brands of deck canvas which can be purchased at a fancy price, but I

have had very good success with the following process, using regular 10-oz. duck or canvas: The canvas is first fastened with 17-oz. tinned carpet tacks and then wetted. Before it is well dried, it is painted with white lead and boiled linseed oil to make it waterproof. After this is dried, it is given two more coats of white lead and oil paint, and one coat every year to protect it. This roofing will last for years and give perfect satisfaction. I have often seen the cloth laid in white lead and oil without wetting, but it is difficult to get it tight by this method. This roofing I have used on flat dormer roofs, as shown in Fig. 15, with most satisfactory results.

#### Heating Water with Exhaust Steam

While making a repair on an exhaust-steam pipe in a box factory, the office employes asked me if I could make

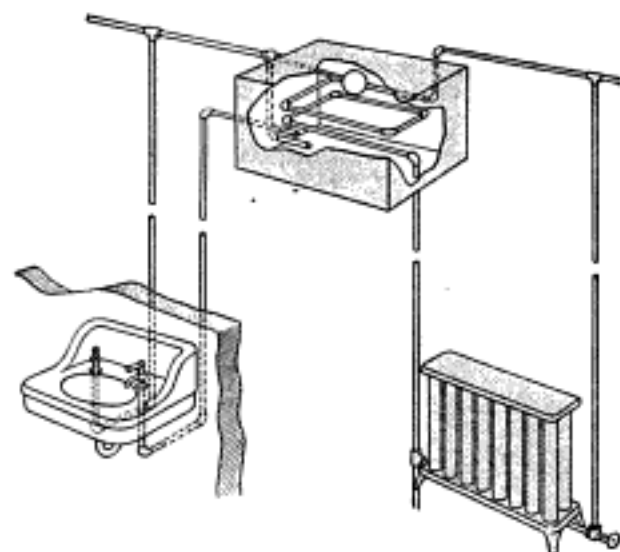

Connections for a Coil to Heat Water for a Lavatory by the Exhaust Steam

an arrangement for heating water without installing a hot-water boiler. After some consideration, the system was put in as shown in the sketch. I procured a plain box, lined it with galvanized sheet iron, made a steam coil with elbows and nipples, set it in the box, and connected it in the pipe system of a radiator. A ball cock and float, from a toilet flush tank, was used to shut off the water when the tank ran full. The

cold water, entering at the bottom and the center of the tank, spreads out and is quickly heated.—Contributed by J. Breidenbach, Brooklyn, N. Y.

#### Repairing a Cracked Soil Basin

One of the children allowed the seat and cover to drop on the soil basin, which cracked the bowl between two of the little flush holes in the water channel inside, the crack running down the bowl for about 2 in. so that when the latter was flushed a stream of water gushed out on the bathroom floor. A plumber was called and he tried to repair it temporarily by putting a patch of rubber and putty on the outside and lashing it on, but when the bowl was flushed it blew off. As this happened on a Saturday the plumber said he could not install a new bowl before the following Monday. In the meantime, I hit upon a handy plan that saved me a lot of inconvenience and the price of a new basin at that time. I mixed up a cup of plaster of Paris to a fairly thick cream and injected it into the small holes near the crack with a glass dropper taken from the medicine cabinet. As the water channel was wet it thinned out the plaster, and let it flow into the crack where it could be seen oozing out on each side. The plaster was allowed to set a couple

of hours, and when the bowl was flushed not a drop of water showed on the outside. The repair stood the test for eight months and was good when a new bowl was put in.—Contributed by Mrs. P. H. Murray, Fall River, Mass.

### To Prevent Whirling Motion of Liquid in a Funnel

Any light liquid, if hurriedly poured into a funnel, will immediately assume a whirling motion, and if one is not careful, the resultant centrifugal force will often spill a goodly amount of the liquid. The sketch shows how any ordinary metal funnel can be



provided with a piece of sheet metal so that the liquid poured into it will not at once commence the whirling motion, and the filling of the can, or receptacle, into which the funnel is inserted, can be accomplished in a much shorter time. The metal partitions in no way affect the flow of the liquid, and will save considerable expense when pouring gasoline or benzine.

### A Special Cabinetmaker's Clamp

In many cases where odd-shaped pieces are to be glued together, the ordinary clamp cannot be used, and some sort of holding device must be substituted. For such clamping I construct the temporary arrangement shown in the illustration. It consists of a piece of wood, strong enough to stand the strain and of a proper length to suit the work in hand. In the center of the wood a hole is bored to receive a bolt, and a wire loop to take in the parts to be clamped is provided. The nut of the bolt is set in the wood to prevent its turning, and the ends of the wire are looped over the ends of the wood. In operation, the bolt is turned up to make it press against the parts to be clamped.

A better arrangement of this clamp is to have a metal head, or crosspiece, and use a chain in place of the wire.

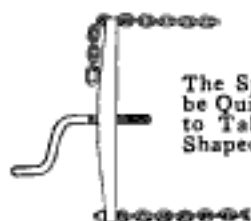
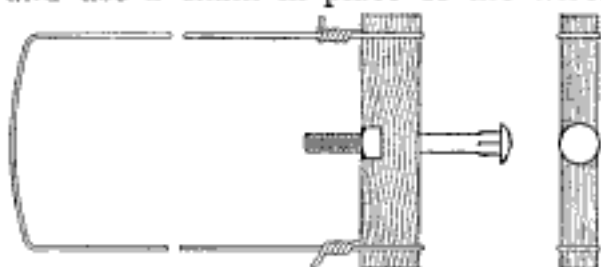

The Special Clamp can be Quickly Constructed to Take In Any Odd-Shaped Piece of Work

This makes it adjustable so it can be used for various-sized clamping operations.—Contributed by Wm. A. Robinson, Waynesboro, Pa.

### Hammer for Handling Cotters

Where there are numerous cotters to remove or replace, the hammer illustrated is quite a necessity. The pointed end is for removing the pins and the end of the handle is for separating the

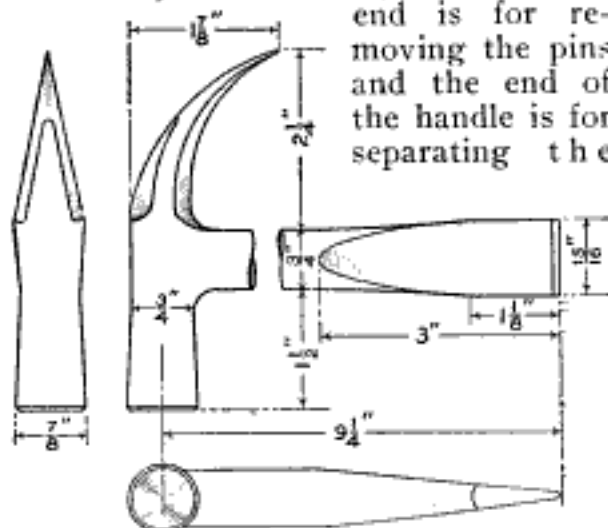

Hammer Made Entirely of Metal for Placing, Removing, and Fastening Cotters

legs after driving the cotter in place. It is constructed entirely of metal.—Contributed by Joseph K. Long, Renovo, Pa.

Ⓒ In cutting threads in the hub of any lathe chuck for a lathe spindle, do not hold it in another chuck, but screw the jaws on a perfectly true live center.

### A Multiple Window Opener

In several states factory buildings are required by law to have fireproof stairways, or towers, in which the windows on all the landings can be opened simultaneously to clear them of smoke in case of a fire. The sketch shows one scheme which is used. The lower sash is fixed and the upper one is heavier than its sash weights. By pulling down on the cable, which extends through all

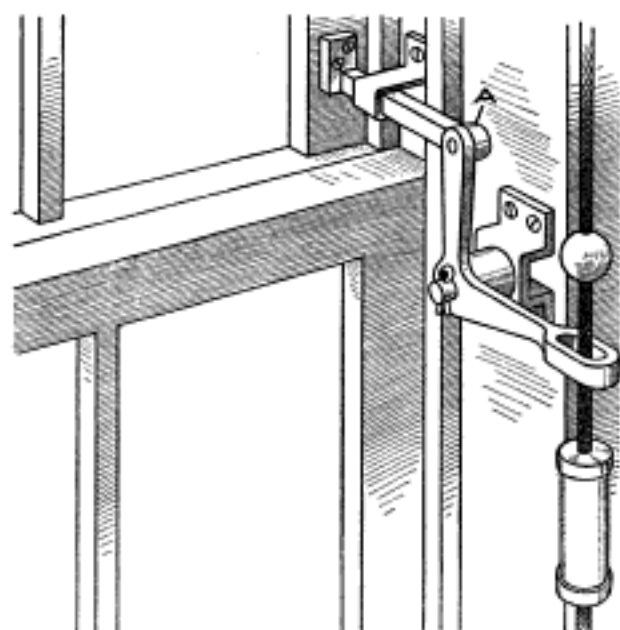

One of the Latches on a Window for Releasing the Upper Sash to Let It Drop

the floors, the latch A is withdrawn, and the heavy sash drops down, allowing the smoke to escape.

### To Start a Cold Automobile Engine

Many older types of automobiles have carburetors of old design, and they are not suited to the low-test gasoline which is being marketed at present. It is almost impossible under these circumstances to start them in cold weather.

In order to make the starting easy, I tried various means and finally hit on an infallible cure. The manifold was wrapped with a thin layer of asbestos paper, on which was wound a number of turns of nichrome resistance ribbon, and the ends were fastened with asbestos cord. A length of lamp cord was spliced to the two ends of

the ribbon, and an attachment plug fitted to the lamp cord. When this was plugged into a lamp socket, and the current turned on, the pipe was made quite hot in one minute, and the motor readily started without priming. It formerly took about half an hour to warm up the motor with hot water. Of course, it is necessary to have current for this way of starting and a little experimenting will be required to determine the proper amount of resistance wire to use, according to the voltage.—Contributed by Chas. C. Heyder, Hansford, W. Va.

### Extra Push Button for the Door Latch

In apartment houses fitted with an electric latch on the front door, the push button for working it is usually placed in the kitchen, which is obviously the place for it. If the apartment is long, it becomes tiresome when no one is in the kitchen to walk from the front to the back, every time the bell rings, to let a visitor in. This can be avoided very simply by fitting another push button in any convenient place in the front of the apartment and wiring it up in parallel with the kitchen button. No new battery is needed, just a length of double bell wire and the new push. The connections are shown in the sketch. The kitchen ends of the new wires are connected to the terminals of the old push without detaching the old wires, that is, they are put under the same terminals



Connections for an Extra Push Button at the Front of an Apartment for the Door Latch

and screwed up tightly. The front ends are connected to the new push button in the ordinary way. Pressing either button will open the latch.—Contributed by Morris G. Miller, New Rochelle, N. Y.





## A Ski Sled

BY GEORGE J. EGELBERG

**T**HE sled is built low and wide so that it will not tip easily. The skis, or runners, are cut 10 ft. long and 6 in. wide, from 1-in. ash boards that are straight-grained. At the points where the curve is to be formed, plane off about  $\frac{1}{4}$  in. on the upper side, but do not plane off any at the very tip end. This will allow the skis to be more easily bent. If it is not handy to steam the skis, put them in boiling water, and be sure that at least  $1\frac{1}{2}$  ft. of the points are covered. Provide a cover for the vessel, so that only very little steam may escape. Let them boil for at least one hour. A good method of bending the points is shown. When the skis are taken from the water, put them as quickly as possible in the bending blocks, side by side, and bend them with a slow, even pressure. Weight the extending ends and leave the skis in the blocks 8 or 10 hours to dry. Sharpen the points after they are bent.

The sled will run easier if the skis have a slight rocker curve. To make this curve, have the center block 6 in. while the two end blocks are  $5\frac{1}{2}$  in. high. A  $\frac{1}{4}$ -in. flat-head bolt is run through the ski, the block, and the

cross strip. The holes are countersunk in the surface for the heads of the bolts. The top is made of three 6-in. boards, fastened to the crosspieces. It is a good plan to brace the tips of the skis with a 2-in. strip.

### Clocks for the Craftsman

Three designs of clocks are shown, which can be easily made in oak, or other wood, that will match other furniture. The sizes of the pieces required are given by the dimensions in the drawings.

The clock is a matter of choice. Prices in most stores range from 75 cents up and the works are of the ordinary alarm-clock variety. After selecting the clock the small legs as well as

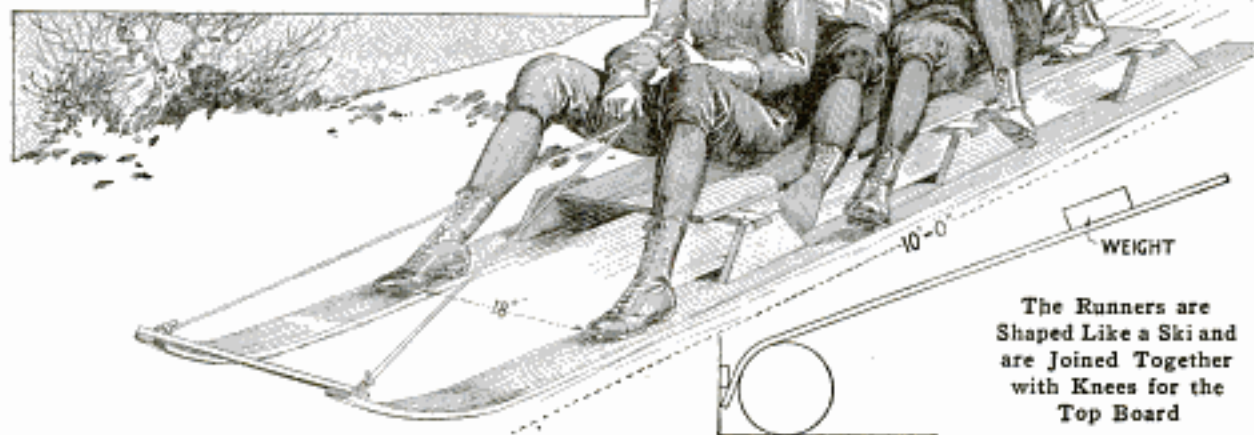

The Runners are Shaped Like a Ski and are Joined Together with Knees for the Top Board



turns of any magnet or bell wire at hand around a small piece of wood, and slipping the coil so formed into the slot on the under side of the base block. The winding may be from two or three turns of heavy wire up to several hundred turns of fine magnet wire, but after one or two trials, the maker will have no trouble in determining his particular requirements.

The final coil should be wound lengthwise on a wood core, and the whole packed neatly into the slot. Connect up the ends to the binding posts, and then glue in a thin piece to hold the coil in place.

By drilling a small horizontal hole through the base, as indicated by the two dotted lines in the top view of the working drawings, and inserting a small bar magnet,  $\frac{1}{8}$  in. in diameter, or less, the instrument may be rendered independent of the earth's magnetism and used without reference to the north point. Such a controlling magnet re-

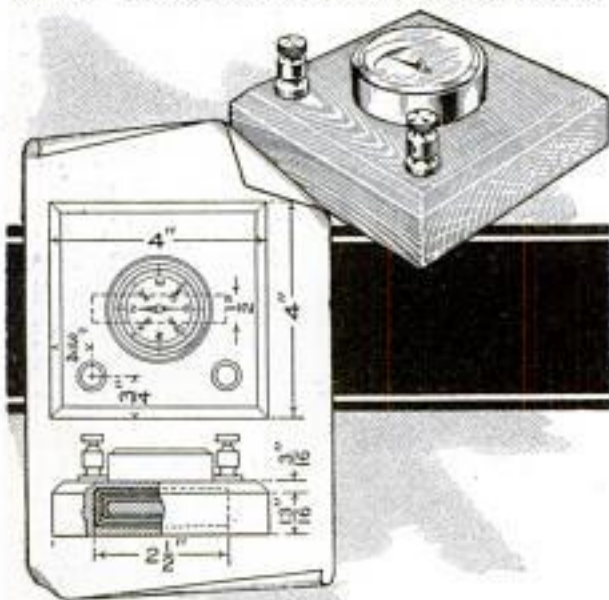

Galvanometer Made of a Compass Set on a Wood Base, with Coil and Wire Connections

duces the time required to bring the needle to rest after it has been violently deflected.

Woodwork about a house, when primed with white lead made quite thin in raw linseed oil, will never blister unless moisture gets back of it. Yellow-ocher priming will cause blistering at any time up to 20 years.

## A Perpetual Calendar

It is only necessary to set this calendar the first of each month, by sliding

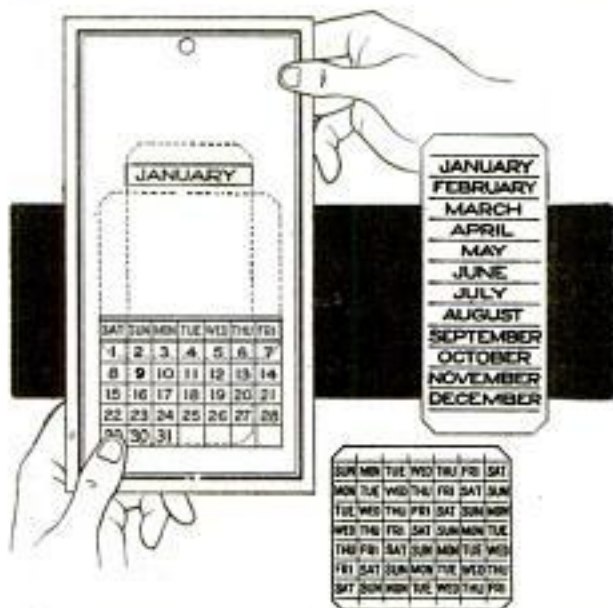

It Is Only Necessary to Change the Sliding Pieces to Set the Calendar for Each Month

the insertions up or down, to get the proper month or week. The calendar, as it is shown, is set for January, 1916. Saturday is the first day and Friday the seventh, and so on. It is not confusing and can be read either by the day or date. If the day is known it will show the date, and if the date is known it will show the day. The illustration clearly shows the parts, which can be cut from heavy paper or cardboard.

## Heater for the Experimenter

A convenient small heater for heating liquids in experimental work, and even in making a hot drink where there is no gas, can be readily made from an ordinary oil lamp and a small round can, having a crimped-on head or bottom. The can should be of such diameter that the prongs of the lamp burner will hold it firmly in place. A hole should be made in the bottom of the can. It is then placed, upside down, on the lamp burner. If the top comes too far from the flame, cut off a strip around the edge.—Contributed by Clarence S. H. Anderson, Worcester, Massachusetts.

### Receptacle for Shellac Varnish

A simple, inexpensive, and practical pot and cover for holding shellac varnish in the pattern shop, or at home, is shown in the sketch. It consists of a base made of wood having in the center a counter-bore into which a glass tumbler, or other container, is fitted. For the cover an ordinary flower-pot is used, fitting down over a ring on the base. An accumulation of shellac around the top cannot come in contact with the cover. The brush extends through the hole in the bottom of the flower-pot and is held suspended by means of a leather washer resting on it.—Contributed by J. D. Roberts, Kenosha, Wisconsin.

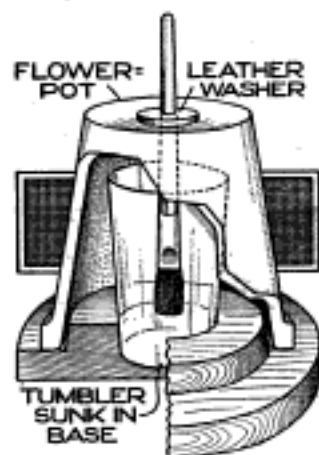

—

### Homemade Vaporizer

A simple vaporizer which can be used by designers to project their colors in a fluid spray, or by housekeepers to disinfect or perfume their apartments, can be made in the following manner: Two goose quills are forced through holes in a cork at right angles to each other, as shown. Place the vertical quill in a bottle containing the fluid to be sprayed and by blowing through the horizontal quill a very effective spray will be produced.—Contributed by Hazel Kolar, Maywood, Ill.



Old wringer clamps, used for holding the wringer to the tub, are very handy around a workbench.

### Tooth Powder Used on Tracing Cloth

Tooth powder is an excellent substitute for the powders which are sold for the purpose of preparing the glossy surface of tracing linen to receive ink. The gritty element removes the excess gloss which prevents the ink from taking hold. A second dusting with talcum powder makes a perfect surface for inking in.

### A Small Gas Furnace

A small gas furnace for melting small quantities of gold, silver, or other metals, can be easily made as follows: Procure a cylinder of stove-pipe iron of the desired size, say 4½ or 5 in. in diameter, and 6 in. long. Turn in the edge of one end so that it will hold loosely a disk of iron of the same thickness as the cylinder, to form the bottom. Punch ⅛-in. holes, about 1 in. apart, all over the cylinder and the bottom. This is to allow for the escape of moisture and air. Attach three legs to the sides with rivets, evenly spaced so as to raise the bottom

4 in. In the side of the cylinder cut a hole, 1¼ in. in diameter, its center being 1½ in. from the bottom. Select a glass bottle whose diameter is 1 or 1½ in. less than that of the cylinder.

Make a putty of fire clay, and add about five per cent of plaster of Paris, and also add about a teaspoonful of vinegar, to prevent a too rapid setting. Place a mass of the putty in the bottom of the cylinder and press in the bottle after its surfaces have been well greased. The bottle should be well centered in the cylinder. Press the bottle well down, so that its bottom is on a level with the lower edge of the hole in the side. Fill in the putty to form the sides, tamping it

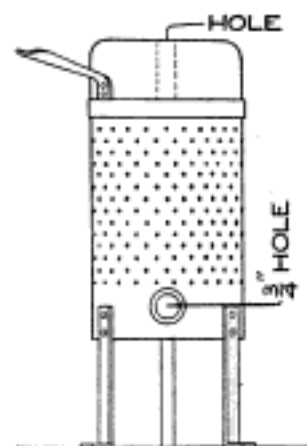

well all around the bottle, and build it up a little above the metal of the sides, carefully smoothing off the edge. With the fingers, or a spatula of some kind, cut out the putty in the hole to form an opening,  $\frac{3}{4}$  in. in diameter. Allow the putty to set for more than an hour, and then with a circular, or twisting, motion remove the bottle. To prevent a vacuum in the bottom that will prevent removing the bottle easily, puncture the putty that lies on the disk with a hatpin, to allow the air to pass in.

A few places will be found where the putty has not filled in properly, and these should be patched up while the filling is yet soft. The clay will probably shrink after standing for a time, and should be pressed out against the sides while in a plastic state. When dry, the furnace is ready for use.

In furnaces of this kind the jet of a large gas blowtorch is to be used. If a standard is rigged up to hold the blowtorch, it will be much easier for the operator. The jet from the pipe is thrown in the hole at the side and a crucible is placed in the furnace. It is well to make a cover similar to the body of the furnace with a hole in the center a little larger than the hole in the side.

A more efficient furnace can be made with two holes in the side, opposite each other, for using a double jet from blowtorches.—Contributed by James H. Beebe, Rochester, N.Y.

### The Magic Clock Hand

The hand, or pointer, is the only working part needed to perform the trick. A clockface can be drawn on any piece of white paper, and a pin stuck in its center on which the hand revolves. The hand A is cut from a piece of sheet brass, and may be in any form or design desired, but it must balance perfectly on the axle, which passes through a  $\frac{1}{4}$ -in. hole in the center, or else the magic part will fail. The illustration shows a good design

with dimensions that will cause it to balance well; however, this can be adjusted by removing some metal from the end that is heavier with a file or tinner's snips, or a bit of solder may be stuck to the lighter end.

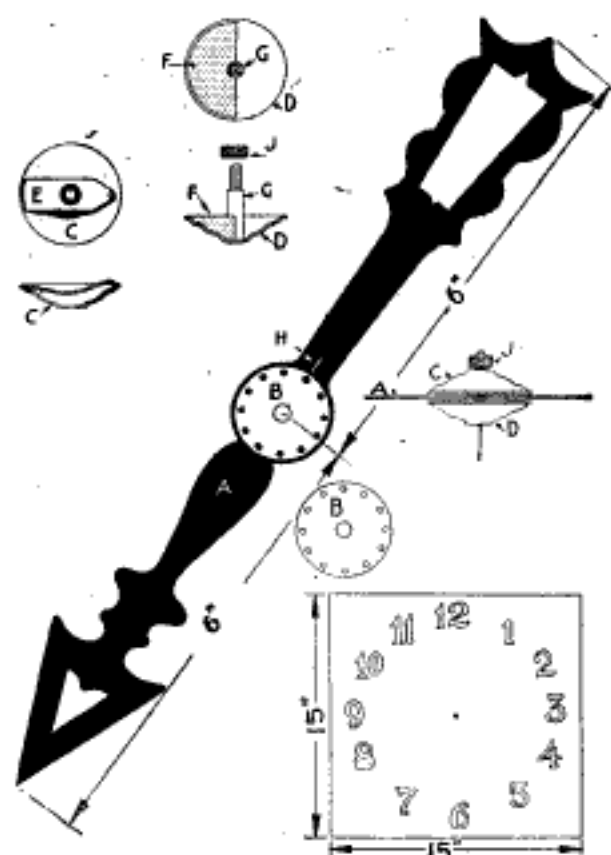

Design of a Hand That will Balance Well and the Parts for Its Axle

A disk, B, is cut from a piece of sheet brass,  $1\frac{1}{8}$  in. in diameter, twelve  $\frac{3}{32}$ -in. holes are drilled at equal distances apart near the edge, and a  $\frac{1}{4}$ -in. hole is drilled in its center. This disk is soldered to the hand where both  $\frac{1}{4}$ -in. holes will coincide. It is necessary to procure two washers, C and D, that are embossed, or raised, in the center, and about  $1\frac{1}{4}$  in. in diameter. These can be purchased from a dealer in curtain rods, the rod parts wanted being the washers used on the ends. A careful mechanic can raise the center portion of a brass disk by beating it over a hole with a ball-peen hammer.

One of the washers, C, has a spring, E, soldered at one end, and the other carries a small projection that will engage the holes in the disk, B. The

projection can be made by driving the metal out with a center punch, set on the opposite side.

The washer D is provided with a lead weight, F, and a  $\frac{1}{4}$ -in. stud, G, is soldered in the center. The stud has a  $\frac{1}{16}$ -in. hole drilled through its center for the pin axle. The weight is made by filling the washer with melted lead, which when cold is removed and sawn in two. One piece is then stuck in the washer with shellac. The stud is  $\frac{7}{8}$  in. long with the upper part, about  $\frac{1}{4}$  in. in length, filed, or turned down, smaller, and threaded. Just below the



thread, or on the shoulder, the body is filed square to fit a square hole filed in the face washer C carrying the spring. This square hole and stud end are necessary in order that both washers may turn together.

The dial can be made of a piece of thick cardboard, or thin wood, with the numbers from 1 to 12 painted on, like a clockface. A pin,  $\frac{1}{16}$  in. in diameter, or an ordinary large pin, is run through the center so that it will project on the face side on which the hand is to revolve.

The washer D with the weight is placed on the rear side of the hand with the fixed stud run through the hole in the center of the hand; then the washer C is placed on the square part of the stud, and the nut J, which should have a round, knurled edge, is turned on the threads. This will cause the projection on the spring E to engage one of the small holes on the disk B. In turning the two washers, C and D, with the thumb and first finger of the right hand, the projection snapping into the holes of the disk B can be felt. The hand is placed on the pin of the clockface, and the washers are turned so that the weight will make it point to 12. Scratch a mark on the hand at H, also mark a line on the front washer at this point. These lines are necessary, as they enable the performer to know how many holes to snap the spring over to have the hand point at any desired number.

By reversing the hand it will point to a different number; for instance, if set for 8 and put on the pin backward, it will point to 4, and so on, with other settings. The dial can be held in the hand, hung on a stand, or fastened to a wall, and can be used to tell the day of the week, time of day, cards selected, etc. The audience can call for any number on the clockface, and the setting of the disks is an easy matter while holding the hand, or pointer, in the hands, so that it cannot be detected.

#### Uses for Steel Wool

The use of steel wool in place of sandpaper when finishing off new or old work, when preparing it for varnishing or other finishes, will be found very helpful. It is put up in small packages and can be obtained in several grades of fineness. It is especially useful when removing old finishes, in and around moldings, etc., since it conforms

to irregular shapes as sandpaper will not. Put on a pair of heavy canvas gloves when using steel wool. They will keep the fine slivers out of the skin. These gloves will also be found useful when varnishing and painting.

### Turning Long Wood Rods

To turn a long wood rod of small diameter is not an easy job for the amateur, and a suitable tool for the purpose is seldom found in the amateur's outfit. The tool illustrated can be easily made from materials that are always at hand. A block of hard wood, A, is first provided, and a hole, B, large enough to admit the square strip from which the rod is to be turned, is bored in the end, whereupon the hole C, which has the diameter of the finished rod, is bored through the block. The hole D is next bored at right angles to the axis of the hole C, and so placed that its edge just touches the outer edge of the hole C. This hole is to receive an ordinary gouge, and must be of such size as to receive the gouge snugly.

The gouge is ground back far enough on the under side to make the cutting edge level with its back, and then beveled off on the inside to a sharp edge. The gouge E is placed in the hole D with the cutting edge on the center line, as shown, and held in place with a wood plug, F. A little soap applied to the bore C will prevent binding.

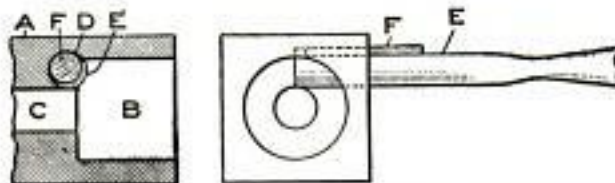

A Block of Wood Fashioned to Hold an Ordinary Gouge for Turning Small Wood Rods

To use the tool, a strip of wood is pointed sufficiently to allow it to enter the hole C a short distance. The strip may be rotated by holding it in the chuck of a lathe while the tool is held in the hand, using the handle of the gouge to prevent its turning with the stick.—Contributed by J. A. Brearley, Washington, D. C.

### Hanging Ladder for a Hatchway

A handy ladder to swing from a hatchway can be made of a solid plank, as shown. Cut the plank to the length desired and saw notches on each side to form steps. With a solid hook to fasten it in a similar hook in the ceiling, at the edge of the opening, it makes a novel yet practical ladder. — Contributed by Victor Carpenter, South Bend, Ind.

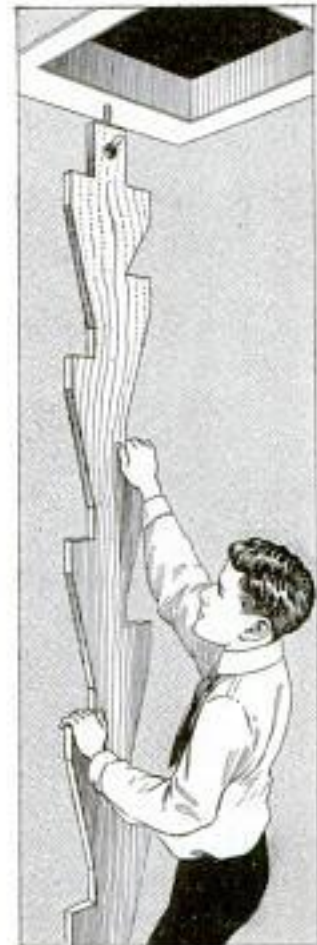

### An Oilcan Stopper

An empty cartridge shell makes an excellent stopper for an oilcan in case the original stopper becomes lost. The cap in the shell is removed and the hole enlarged with the tang of a file so that a leather thong can be inserted. A knot is tied in the thong on both sides of the base, to prevent the thong from slipping either way. The end of the thong is tied to the bail of the can.

### Enamel for Steel Fishing Rods

Make a thin solution of shellac in alcohol and add a teaspoonful of Venice turpentine to each half pint, and the same quantity of lampblack for a black enamel. Scrape the bare spots on the rod and heat it slightly, to melt the shellac for the first coat. Use a fine brush and apply two or three coats, which will give a smooth, glossy, and elastic surface that will not scale or crack.

### A Quickly Made Toy Electric Motor

The illustration shows a small electric motor of such simple construction that it can be easily made from odds and ends to be found in any amateur

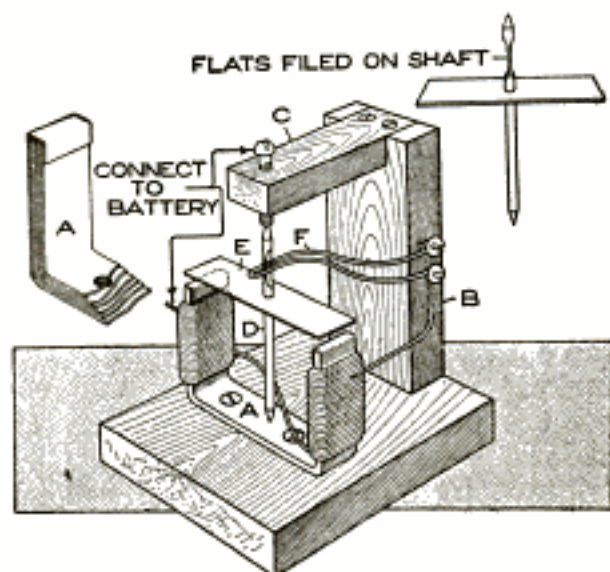

The Motor is Constructed of Pieces of Tin, a Nail, and Some Wood Blocks

workshop. Cut six strips,  $\frac{1}{2}$  in. wide and  $3\frac{1}{2}$  in. long, from an old tin can, and bend them together into a U-shape. This forms the magnet A. The outside piece should be a trifle longer than the others so that its ends can be turned over the other ends to keep them all in place. Screw this down on a small wood base. At one side of the wood base, fix an upright, B, and on top, a light wood bracket, C, to take the upper bearing of the motor. The shaft D is simply a wire nail with the head filed off and filed to a point. Drive it through a  $1\frac{1}{2}$ -in. length of the same kind of material as used for the magnet. This forms the rotating armature E.

Make a slight indentation with a center punch, or strong nail, exactly in the center of the base portion of the magnet to take the lower end of the shaft. For the upper bearing file the end of a brass screw off flat and make a similar indentation with a center punch, or by a few turns of a small drill. This screw should be adjusted in the bracket until the shaft rotates freely with the armature just clearing

the tips of the magnet. Wind about 40 turns of fairly thin cotton-covered copper wire—No. 24 or 26 gauge is suitable—around each limb of the magnet, first covering the latter with paper, to prevent the possibility of short-circuiting. The windings should be in opposite directions so that the connecting piece of the wire from one coil to the other passes across diagonally as shown in the illustration.

The brush F is formed by doubling up one of the free ends of the windings after removing the cotton covering and fixing it firmly with two screws to the side of the upright. After attaching, it should be bent until the outer end bears lightly on the shaft. Remove the shaft and at the point where the brush touched, file two flat surfaces on opposite sides of the nail in a direction at right angles to the longitudinal center line of the armature. On replacing the shaft the brush should be adjusted so that it makes contact twice in a revolution and remains clear at the flat portions. Connect up to a battery, one wire to the screw at the top of the motor and the other end to the open end of the windings. Give the armature a start and it will run at a terrific speed.—Contributed by Morris G. Miller, New Rochelle, N. Y.

### Gauge for Woodwork

A convenient gauge can be quickly made by using a block of wood and an

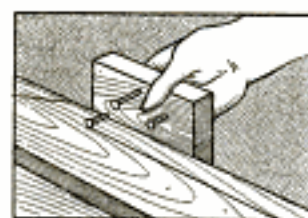

ordinary nail, or several nails for different widths can be placed in one block. Drive the nails straight into the block until the distance between the head and block is the required distance to be gauged. The rim of the nail head makes the mark as the block is drawn over the wood surface.—Contributed by E. P. Halde- man, Balboa, Canal Zone.





## Part II

**B**EFORE the beginner makes the attempt to ski, he should see that his complete outfit is perfectly suited to his purpose. The shoes should be nicely adjusted to fit snugly between the metal toe plates of the binding, and new holes should be punched in the straps wherever needed to adjust the harness snugly and comfortably to the feet. Many of the positions required in executing the various turns and swings may be practiced at home, that the novice may get some idea of the correct position of the feet and body assumed by expert skiers. For the initial practice outside, it is a good plan to select a frosty day when the snow is old and settled by the wind. This will introduce the novice to the sport under favorable conditions, while if the first trials are made shortly after a heavy snowfall, or upon a mild day when the snow is thawing, only discouragement will be experienced. Begin with one stick—or two if timid—and pick out an easy-sloping hill with a gradual run to the level ground. A few scattered trees and rocks will do no harm, for it is a good plan to learn how to avoid them from the beginning.

### How to Turn on Skis

This and the correct manner of standing on skis are easily mastered if the beginner will but remember that the weight of the body should rest largely upon the advanced foot without bending the body at the ankle too much, or raising the heel from the ski. This is the correct position to assume when standing for a rest and for sliding, and this as well as turning should be practiced on the level. To make

the kick turn, simply raise the point of the ski until the heel rests on the snow, as shown in Fig. 1. Swing the ski around by turning the point out and back until the two skis are point to heel, as shown in Fig. 2. When this, the most difficult position of the three, is assumed, raise the point of the other ski as high as convenient to avoid tripping, keep the heel down and swing the ski around over the heel of the other until both are facing in the same direction, as shown in Fig. 3. A little practice will make it possible for the novice to turn quickly, and if all turns are made with the advanced foot, when practicing on the level, no trouble will be experienced later on in attempting to turn on a steep slope. The stick is really indispensable for this practice, and while two may be used, the single stick will be found assistance enough for any active person.

When skiing on level ground the correct movement is rather more of a slide than the motion used in walking or skating. The body is thrown forward on one ski and the slide is made with both feet, most of the body weight being thrown on the advanced ski, while the rear foot is slid forward without stopping the forward travel, as shown in Fig. 4. The expert skier moves forward in long gliding steps without raising the ski, but bending the knees slightly to slide the ski ahead. The feet should be kept as close together as possible to make a narrow track and the stick used to lengthen the slide. At the beginning it is a good plan to endeavor to make a long slide with each advancement of the foot, rather than strive to take long

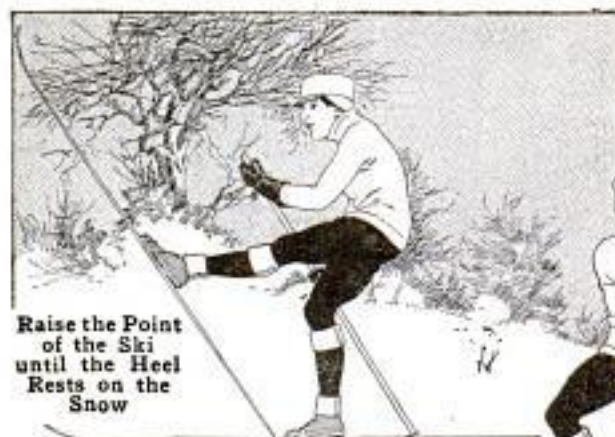

Raise the Point of the Ski until the Heel Rests on the Snow

FIG. 1

step," and which is made by advancing the foot with the legs somewhat wider apart, and the skis placed at not quite so acute an angle with the hill, is more useful when climbing the ordinary steep grade and is far less laborious. If the skier knows how to handle his im-



FIG. 2

steps. The speed of level running depends, of course, upon the condition of the snow. On hard, well-packed snow, sliding is easiest and greater speed obtained, while in deep and soft snow less speed is the rule. When skiing on the hard snow of a road, four miles an hour is the average speed, and for average level running, the skier will cover about the same distance as when walking along a good path.

When traveling uphill, the regular sliding gait will suffice if the slope is gradual, but when a steep grade is encountered and the ski slips backward, the skier stands quite erect, raises the point of his ski about 3 in., and slaps it down smartly, without pulling it backward or making any attempt to push his body forward with the stick. This slap of the ski makes the smooth surface of the runner adhere better than when the runner is slid forward in the usual manner. If the hill is very steep, the skier will naturally place his skis at right angles rather than permit the slipping backward. This is known as "side-stepping," and is shown in Fig. 5. In doing this, the heel of the ski must be raised clear of the snow and the upper foot lifted uphill, then the lower foot brought up to the last step of the upper foot, hence it is extremely tiring for other than a short distance.

A variation of this movement, which is known to skiers as the "half side

FIG. 3  
Swing the Ski Around by Turning the Point Out and Back

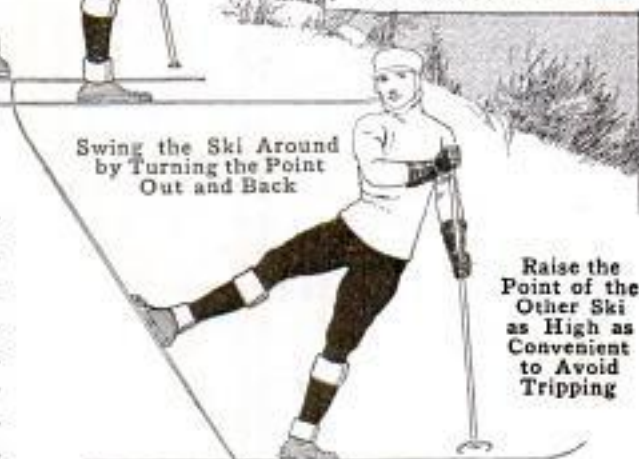

FIG. 3

Raise the Point of the Other Ski as High as Convenient to Avoid Tripping

FIG. 4  
The Body is Thrown Forward on One Ski and the Slide is Made with Both Feet

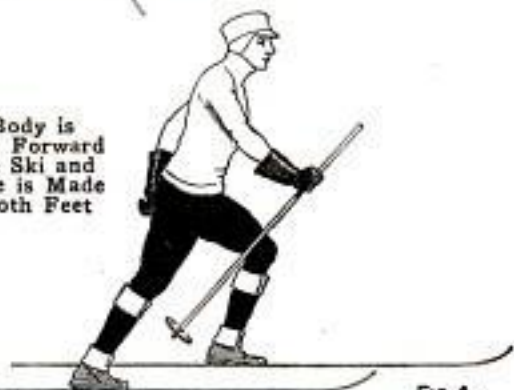

FIG. 4



FIG. 5

The Skier Naturally Places His Skis at Right Angles Rather than Permit the Slipping Backward

plements, side-stepping may be done backward when necessary.

The "herringbone" is another step which is much used when the skier wishes to travel up a short and steep incline. This step is made by stretching the legs rather wide apart and pointing the toes out,



When Running Downhill One Ski should Be in Advance of the Other a Few Inches

FIG. 7



The Herringbone is Much Used When the Skier Wishes to Travel up a Short and Steep Incline

FIG. 6



The Skier Runs Straight Downhill on One Ski and Uses the Other as a Brake

FIG. 8

On Hard Snow the Edges of the Skis may be Used to Check the Speed

FIG. 8

as shown in Fig. 6, at a decided angle, so that the knees are bent inward and the inside edges of the skis cut into the snow. A variation of this is the "half herringbone," the skis being turned out at a less acute angle. These special steps for special purposes are all useful now and then in mountain climbing, but when a long distance is to be covered, the skier will conserve his energy by mounting the hill in a zigzag fashion rather than attempting to climb straight up. The track of the skier will then resemble the course of a boat tacking through a narrow inlet against a head of wind, and while more ground is covered than when going straight up the steepest part of the hill, progress is faster and much hard work is avoided.

When running straight downhill, one ski should be in advance of the other a few inches, and the skis must be held quite close together so that they touch, or nearly so, as shown in Fig. 7. To make a narrow track, most expert skiers hold the knees together with the back knee slightly bent. However, the body should be perfectly and easily balanced. This is done, more or less intuitively, by beginning the run with the body thrown on the advanced foot, and when full speed is attained the weight automatically shifts to the rear foot. The novice will find it difficult at first to keep the skis together, there being an almost uncontrollable desire to separate them to

gain a better balance. A good track will come with a little practice, but if the skis are too short, or made without a groove, even an expert would be



compelled to keep his feet a trifle apart and make a double track in order to keep from falling.

When making the start preparatory for coasting downhill, the novice may, if the slope is moderately steep, face in the desired direction and assume the proper position by supporting himself with the stick. On most very steep slopes, where the best coasting is to be had, this is quite out of the question, and the skier must step around quickly by moving the lower ski first. This will be somewhat difficult to do until the novice gains more confidence, which will quickly come after a little practice, and it is a good plan to practice starting from the slope without the aid of the stick to anchor the body. Owing to the fact that the skis do not reach much speed at the start of the coast, even the slow novice will have plenty of time to make the turn and face in the right direction before much

speed is attained. A comparatively crouching position, secured by bending the knees and the body at the waist, will much lessen the liability of a fall forward. This position enables the skier to control the balance of his body with more certainty, and especially when coasting on a hill where patches of ice, or crusted snow, and soft spots of unpacked snow are encountered, a condition usually found wherever skiing is enjoyed. When coasting, the stick, or sticks, should be firmly grasped at the upper end with the looped thong, or strap, over the wrist, and the end dragging behind. Balancing is done entirely at the waist, and for straightaway running, the weight of the body will rest largely upon the rear ski. The long running surface of the ski will carry the skier over many bumps and hollows without disturbing the balance of the body or causing a fall, providing the novice does not lose his nerve. It is necessary to practice on rough and uneven ground if the skier desires ever to attain much expertness, and plenty of falls must be expected, but not dreaded by the beginner. A fall on skis is by no means fraught with danger, and one may fall with impunity providing all muscles are relaxed. Many beginners find falling the easiest manner of stopping, but this should not be necessary, providing the hints given are well understood and practiced. However, the novice should have no fear of falling if he wants to become proficient on skis, and to offset any timidity, which so very often causes the novice to lean backward and fall in this direction, it is a good plan to lean well forward to check this natural tendency. Getting up after a fall is easily enough managed if the head is pointing up the slope, but when the position is reversed much floundering is necessitated. It would seem that this would be obvious to all, yet the majority of beginners often forget it altogether.

Braking with the stick is only effective when the body is properly balanced, and the stick is kept well forward and as nearly vertical as possible.

Straddling the stick, sitting upon it, or leaning backward on it held at an angle, are slovenly methods which every novice should avoid.

The "snowplow" is most largely used by all good skiers for braking, stopping, and turning. This is accomplished by stretching the legs wide apart and at the same time turning the toes in as much as possible, thus presenting the side of the ski to the snow and retarding the speed. Aside from straddling the legs wide apart, the novice will have no trouble in learning this useful knack. For the first practice, pick out a fairly steep hill road, or a hillside where the snow is old and not soft. Begin the run as for coasting, and when good speed has been attained, spread the legs wide apart, turn the toes in and endeavor to control the speed with the skis rather than depend upon the stick. On hard snow the edges of the ski may be used to check the speed, but on ordinary soft and well-packed snow, the runner may be kept quite flat. This is well shown in Fig. 8.

The knack of "stemming" is a variation of the snowplow, inasmuch as the skier runs straight downhill on one ski, and turns the heel of the other ski outward and downward and uses it as a brake, as in Fig. 9. This is a very useful movement, and is largely used when coasting down steep slopes, and when one has learned the knack of it, stemming will serve for braking and steering, and is useful for stopping by turning the skiing course uphill. To learn it, select a steep hillside, coast down at an angle, with the feet a trifle apart, and endeavor to retard the speed with the stick and turn the heel of the lower ski outward. This makes the turn and the skier faces uphill and comes to a stop. By turning the heel of the lower ski outward and the heel of the upper ski inward, the skis will travel downhill with a sort of snowplow movement. When practicing these movements, the beginner should endeavor to use the stick as little as possible and learn to depend upon the skis for controlling the speed.

The "side slip" is useful on steep slopes, and is done by turning the skis so that the runners are at a decided angle to the course traveled. This affords the maximum braking by the skis alone, and is especially effective when combined with the braking done with the stick. Side-slipping may,

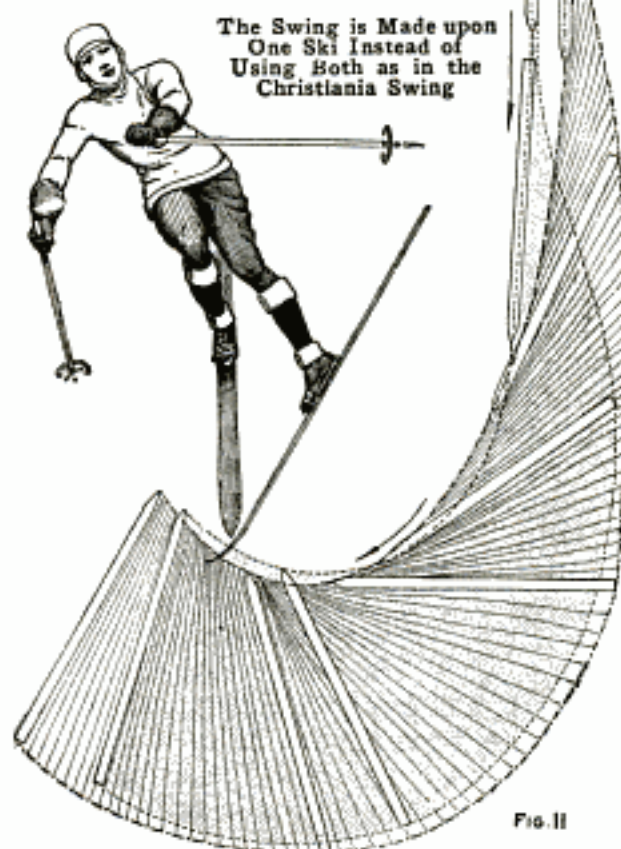

of course, be done while the skier is traveling forward, by keeping the skis close together so that the edges almost touch. While this movement checks the speed in much the same manner as stemming, side-slipping is less tiresome, since the weight of the body gives the required braking effect, while, in stemming, the muscles are called upon to keep the heel pressing outward.

Closely akin to side-slipping is the Christiania swing with the stick, which is accomplished by pressing with both heels at the same time, while the stick digs well into the snow above. This variation of the side slip is easily done, and the skier is turned sharply

uphill to come to a quick stop. When a sharp hill is met with, that is considered a bit too steep to take straight, this swing with the stick may be

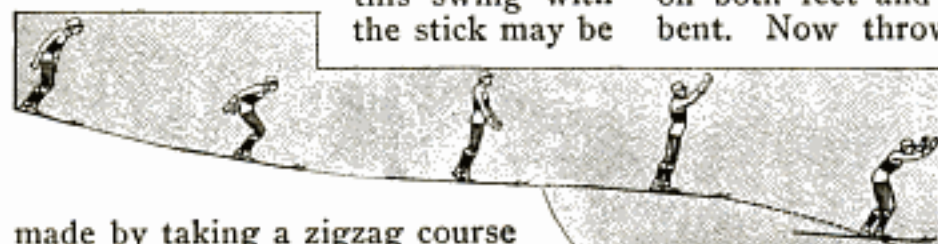

made by taking a zigzag course down grade, steering clear of any obstacles by snowplowing, stemming, or side-slipping; and turning the corners, or "tacking," by making use of the Christiania swing and the stick, as shown in Fig. 10.

The "S"-turn may likewise be used for turning corners, without the necessity for stopping to make the ordinary kick turn. A good way to learn this useful movement is to run straight downhill in a snowplow position, reduce the speed to a comfortable walking pace with the stick, and stem with the ski. If this is done with the right ski, the "S"-turn is made by throwing practically the whole weight of the body on the right ski, at the heel, and pressing it outward while the stick is carried ahead and below the skier. If the heels are kept well apart, and the toes close together, the skier will have no trouble about swinging around in a curve and be off on the other tack. About the only difficulty in making the "S"-turn is the position of the body, which must be thrown somewhat out and away from the hill. To the novice this at first seems to invite a fall, but a few trials will soon prove that the weight of the body must be thrown on the foot which circles on the outside of the curve, hence the apparently unnatural position of the body is essential for a good turn. By bringing the stick well forward and downhill, the skier uses his staff as a pivot upon which the turn is made.

The Christiania swing, made without the stick, is a favorite with expert ski runners when running on rough and steep ground and is a good way of stopping. The swing may be made both to the right and left. To make it

to the right, keep the skis close together, the right a trifle in advance, with the weight of the body equally on both feet and with knees slightly bent. Now throw the weight more forward and upon the toes, while the heels are carried forward and outward to the

To Make the Jump the Skier Assumes the Easy Position Required for Coasting Downhill

Fig. 12

left. The body must lean to the right—the direction in which the swing is made—and twisted somewhat at the waist; and the sharper the turn, the more the body must lean sideways to keep the balance. The swing to the left is made in the same fashion, only the left ski should be a trifle advanced and the body thrown to the left.

The Telemark swing is more difficult to master than the Christiania swing, because it is done on one foot, or ski, instead of using both, and as it is less powerful than the latter, it is of far less use for stopping. To make the Telemark swing to the right, assume the regular position for downhill coasting, and, advancing the left foot, turn the ski so that it rests on its edge as when making the snowplow, throw the body to the right and lean in toward the slope to keep the balance. To make the swing to the left, advance the right foot, turn the body to the left and lean as before. This is shown in Fig. 11. The Telemark turn is, in fact, made in the same manner as stemming, and the sharpness of the swing rests altogether upon the quickness with which the heel is thrown outward and the body turned in the direction the skier desires to swing. The swing is made upon one ski, and the key to the whole swing is the knack of raising the heel of the other foot off its ski until it rests upon the toes. That this is hard to do goes with the telling, and the novice should first acquire the knack of bal-

ancing by running straight downhill with the weight thrown on one foot. When this can be done, and not before then, the skier is ready to practice the turn. The Telemark swing, like all other turns, is easily acquired at slow and moderate speeds, and becomes more and more difficult to make as the speed is increased and the turn is made more sharply and quickly.

Jumping on skis is one of the most exhilarating winter sports, and it is a pity that it is not more popular wherever a medium-heavy fall of snow occurs. While touring on skis across a hilly country, there will be many natural jumps to encounter, for drifts, stumps, rocks, and other rises in the ground, when well covered and padded with snow, make good jumping-off places. While but a few skiers may have attempted such high leaps as the famous Holmenkollen, Fiskertorpet, or Foldberg, all who have done much ski running have done a little jumping, since, when running downhill, an unexpected dip is often encountered, and a rise in the ground causes the skier to leave the ground for a short distance and alight several feet below. Doubtless the skier has enjoyed the flying-like sensation of this brief moment, and very likely he has climbed the hill to repeat the jump. Moreover, this has very likely demonstrated that the distance of the jump depends upon the height of the dip, the speed of the skier passing over it, and likewise upon the spring of the body on the take-off. In making a jump of any height, the take-off may be level, pointing up or even downhill, and constructed with framework extending out from the hillside, or consist merely of a large boulder, or a pile of logs, well padded with snow. The height of the slope chosen will, of course, regulate the distance of the jump, and the place where the jumper alights should be fairly steep, since, if the skier lands upon a level place great difficulty will be experienced in keeping the balance. Therefore the usual jumping hill, where jumping competitions are held, is provided with a 30°, or steeper, landing

place, and this merges gradually into the outrun, or slope, connecting the hill with the level ground below.

For the safety of the skier, the snow should be firm but not icy or hard, and this is easily done by packing the



FIG. 13

Each Member of the Party should be Provided with a Ruck Sack of Good Capacity

snow down well by means of the skis. A good, thick padding of snow is of course essential, and a thickness of 2 ft. is really needed at the landing place and at the take-off. In our more northerly sections, plenty of snow usually falls, but wherever a few sportsmen get together, it is an easy matter to shovel sufficient snow to prepare a good and safe jumping hill.

To gain confidence and acquire some useful experience in jumping, the novice should practice leaping from a 2-ft. rise and gradually increase the height of the take-off by piling more snow upon it to increase its height. One or two packing cases firmly placed upon a smooth, steep hillside, and well padded with 2 ft. of well-trodden snow, will make a nice take-off. For the beginning the take-off may point slightly downhill or be fashioned level, and as the skier becomes more proficient, snow may be added to the edge so that the take-off will send the jumper well up into the air.

The knack of jumping is nothing more than balancing the body upon alighting, and the steeper the landing place the easier it is to keep the balance. To make the jump in good form, the skier assumes the easy position required for coasting downhill, as shown in Fig. 12. When within a dozen yards of the take-off the body is lowered until the skier is in a crouching position with the arms extending back as in the act of jumping. Arriving within a couple

of yards of the dip the body and arms are thrown forward, which transfers the weight of the body upon the toes, and the body is straightened up and the arms are raised not unlike the wings of a bird, to keep the perfect balance of the body. The straightening up of the body, known to skiers as "the sats," is the leap proper and must be timed so that the body assumes an erect position when the jumper is not less than 12 ft. from the edge of the take-off. The beginner will invariably jump too late, but after a little practice, and profiting by numerous mistakes, the take-off will be timed correctly. Alighting after a jump is best done by advancing one ski a trifle to keep the balance, and bending the knees a bit to lessen the impact. The jumper ends

with the Telemark or Christiania swing.

When taking tours of any length on skis, each member of the party should be provided with a ruck sack of good capacity. That of the expanding type, made with two outside pockets, and with gores at the sides, is a good, sensible pack. It should be made of 8-oz. waterproof khaki and fitted with shoulder straps of good width, to prevent chafing the shoulders. Leather ruck sacks are sometimes used, but are heavier in weight and more expensive, but no better. One member of the party should carry some kind of repairing outfit, consisting of an awl, a length of leather thong, a few spare straps, and a stout cord, or string. These sacks are shown in Fig. 13.

### Knife, Fork, and Spoon Holder

The holder is made of a piece of sheet copper of sufficient thickness to support the number of pieces of cut-

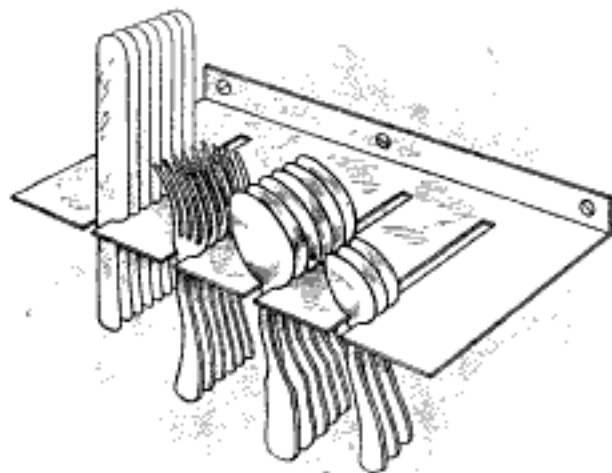

The Holder Keeps the Cutlery in a Position for Easy Selection and Grasping

lery used. The piece is notched to admit the different pieces, and its back edge is bent at right angles to provide means of fastening it to a support, a wall or the back of the kitchen cabinet. It will save space, as well as time, since it is much easier to grasp one of the articles when wanted than if they are kept in a drawer.—Contributed by L. E. Turner, New York City.

### Making Round Rods for Fish Poles

In looking forward to the enjoyment that may be had in the spring, it is well to prepare and overhaul the fishing apparatus or the shooting equipment. In doing so, it may be necessary to make a joint for the fish rod or perhaps a rod for the gun. These can be easily cut if they are sized and run through holes made in a piece of thin metal as follows: Make several holes of the desired sizes in a steel plate, and ream them out with a rather dull taper reamer, so as to leave a bur on one side. This bur should be filed down almost level with the surface of the metal, leaving the edges flat and sharp. If a rod of wood from which the article is to be made is put in a hole and drawn through from the opposite side to the bur, a nice round rod will result. As the rod becomes smaller, use a smaller hole until the required diameter is obtained. A saw plate that is not too thin is about the proper thing to use for the steel plate. It will be necessary to draw the temper to make the holes, but it is not necessary to retemper it after the holes are made.

☞ Celery keeps well in a small box of dry sand.



### A Magic Cabinet

The performer calls the attention of his audience to a cabinet mounted on short legs and having doors in the front, back, and top. The back door is opened, then the top and front, and an arm is thrust through to show that the cabinet is empty and without double doors or double walls. The performer also puts his wand beneath the box to show that there is no deception there. The doors are then closed, except the top, and reaching down, he takes out any number of articles, from handkerchiefs to rabbits, and then the front door is opened to show the box is empty, but upon closing the front door again, he is still able to produce articles until the supply is exhausted. Wonderful though this trick may appear, it is very simple, and if a person is handy with tools, it can be made from lumber taken from a packing box.

To make the cabinet, nail together, in the shape of a rectangle, two pieces, 16 in. long, 14 in. wide, and  $\frac{1}{2}$  in. thick, and two pieces 14 in. square and  $\frac{1}{2}$  in. thick. To one of the latter pieces fasten four legs, one at each corner. In the opposite piece, or the top, make an opening in the center, 8 in. square. This opening is covered with a door  $8\frac{1}{2}$  in. square, supplied with a knob to open it easily. A piece, 16 in. long and 14 in. wide, with an attached knob, is hinged to the front, for a door; also another for the back hinged in the same manner and with a knob. In the back there is a cutout made, 9 in. long and 7 in. wide, in the center. In this opening a swinging box is hung to hold the articles taken from the cabinet. The swinging box is made of two pieces, 9 in. long and 7 in. wide, and two pieces about  $\frac{1}{2}$  in. larger each way, nailed together on ends, cut triangular. This box is hinged in the opening so that it will swing in or out as desired and show a panel on either side of the door. The front door should have a panel nailed on each side of equal size, to make both doors appear alike.

After loading all the things desired to be shown in the triangular box, start

the trick by pushing this box into the cabinet and showing the outside; then open the back, and in doing so, push the triangular box out as the door swings back and away from the audience. This shows that there is noth-

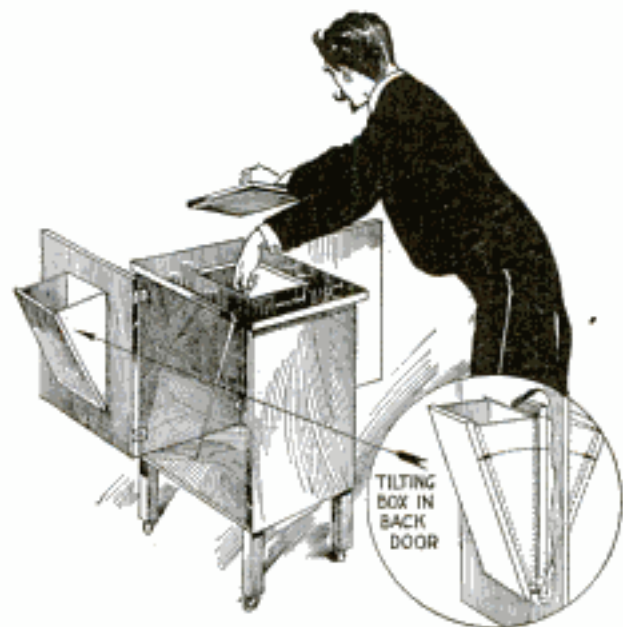

Open the Front Door and Top of the Cabinet and It will Appear Empty

ing to be seen but the panel. Open the front door and top, and the cabinet will appear empty. Close both front and back doors, and in making this change, push the triangular box in, and begin to take the things out through the top door.

By careful construction the cabinet can be made so that the doors will open freely and the triangular box swing easily so that it will not be seen in operating it. With a clever performer this trick is without an equal, as many variations can be made in the performance.

### Countersinking a Hole Smoothly

When a hole in a piece of steel, iron, or brass is being countersunk, the drill usually chatters, making the countersink rough. Where a smooth hole is required, it is best to make the countersink first and drill the hole afterward. By doing so the hole will be perfectly smooth.—Contributed by Chas. G. England, Washington, Pa.

1000

CEMENT-STUCCO FARMHOUSE WITH GARAGE

architect Herbert A. Shearer  
1101 Harrison Trust Co.  
P.O. 2 Ashland Park Chicago  
Letter #12/21/11

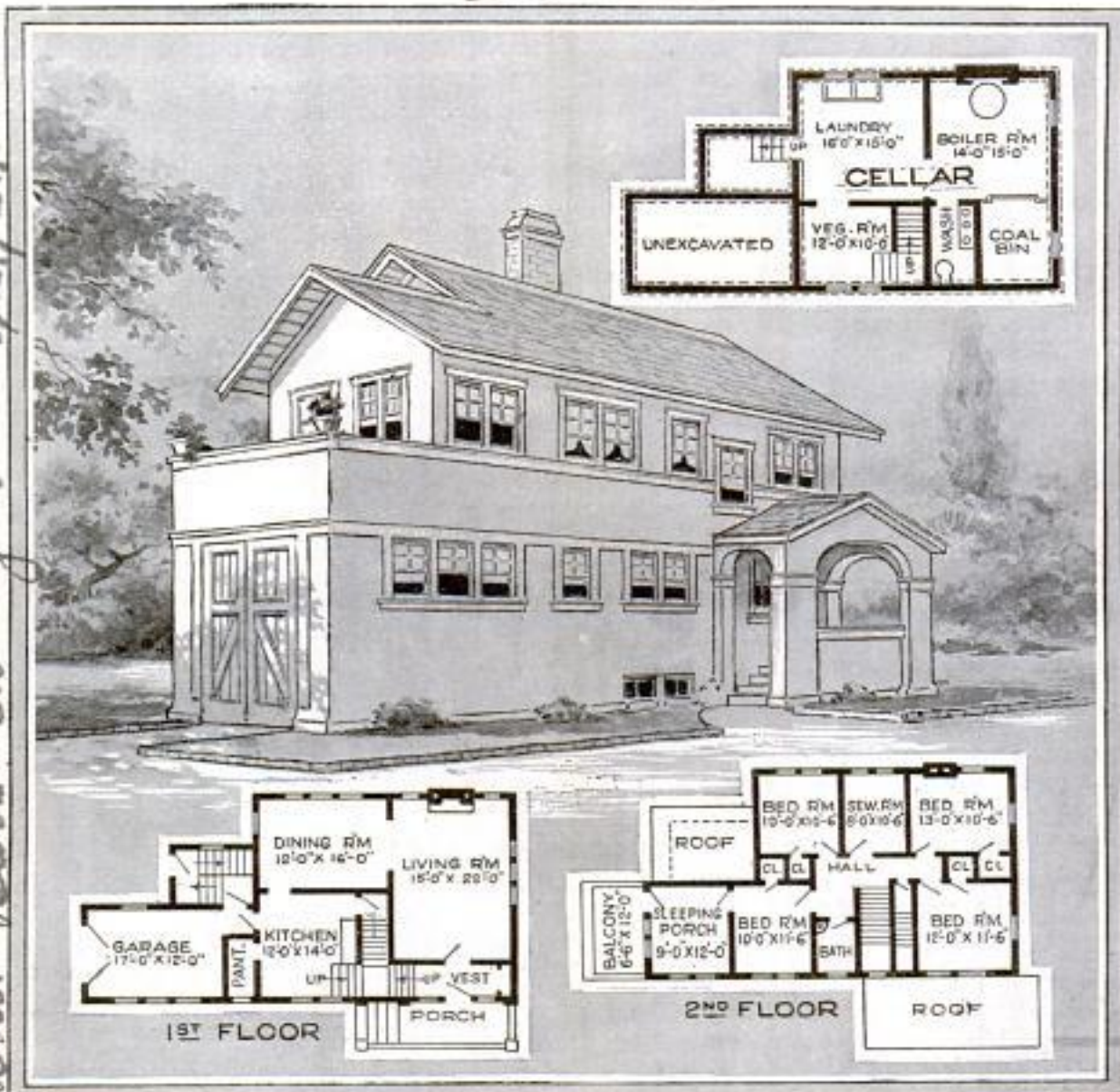

DESIGNED BY HERBERT A. SHEARER, CHICAGO  
1101 Harrison Trust Co.

THIS attractive farmhouse is designed with the idea of meeting all the requirements of farm life, including the housing of the help, at as low a cost as possible. The building is of frame construction with cement-stucco covering, while the foundations are of concrete. It is a full two-story structure with basement and with attic for storage. With soft wood used as interior finish, it is estimated to cost about \$2,500 without the heating plant. An unusual feature is the garage built into the rear of the house. The entire first floor is given over to the kitchen and pantry, living room, dining room, vestibule, and garage. On the second floor are four bedrooms, a sewing room, bath, and sleeping porch, the latter opening on a balcony. Each of the bedrooms is provided with ample closet room, and all the rooms on this floor with the exception of the sleeping porch have direct access to the hallway. The basement contains the heating plant, laundry, cold-storage room, coal storage, and a wash room for the workmen. The wall, steps, and floor of the front porch are of concrete, while the pillars and gable, like the remainder of the house, are of frame covered with cement-stucco. The building is roofed throughout with shingles.

IN accordance with the editorial policy of this magazine never to accept compensation in any form for what appears in our reading pages, and also to avoid all appearance of doing so, we are obliged to omit the name of the maker or the seller of any article described. This information, however, is kept on file and will be furnished free, by addressing Bureau of Information, Popular Mechanics Magazine, Chicago. [Editor.]

# \$794

for this ALADDIN  
Shipped ANYWHERE



## Buy Direct—Save from \$200 to \$1000

Aladdin home-builders save from \$200 to \$1000 by dealing direct with the manufacturer—instead of thru local dealers. You can do the same. You can keep the dealers' profits in your pocket and get the home you want at your price. Thousands of American families are living comfortably in Aladdin homes. Their hearty recommendations should point your way to success, satisfaction and saving in building your home.

**\$298**  
for this  
5-Room  
Home



At **\$498**  
this snug  
little  
home has  
a number  
of friends

This Charming  
Bungalow  
Home  
Complete  
**\$595**



Another  
Popular  
Bungalow  
**\$683**  
Complete



### Aladdin Price Includes Everything. What You Get:

Aladdin houses are complete. You get material absolutely guaranteed to be sufficient for the completion of your house, as follows: Sills, cut to fit; joists, cut to fit; sheathing, cut to fit; building paper; sub-floor, cut to fit; rafters, cut to fit; roof sheathing, cut to fit; siding, cut to fit; outside finish; knotless flooring, cut to fit; lath and plaster or plaster board; knotless inside finish, knotless doors, knotless casings, knotless base board, windows, sash, glass, nails of all sizes, locks, hinges, tin flashing, paints, oils, varnishes, stains, putty and shellac, with complete drawings, illustrations and instructions for erection—**The Complete House.** Send stamps today for the Aladdin Catalog No. 130— it tells all the interesting facts.

Highest  
AWARDS  
WORLD'S  
FAIR

**North American Construction Co.** Homebuilders to the Nation  
293 Aladdin Ave., BAY CITY, MICH.

### Why Aladdin Homebuilders Save Money

**BECAUSE:** They buy their lumber on an even footing with the lumber dealer.  
**BECAUSE:** They evade the usual 18% lumber waste.  
**BECAUSE:** Their carpenters save one day in every three building the home.  
**BECAUSE:** Aladdin helps them avoid the usual expensive mistakes.

First: You have the advantage of buying your lumber direct from the manufacturer, and not thru retail dealers. Thus you buy direct from the same source as the lumber dealer himself.

Second: The Aladdin Ready-Cut system designs houses to use mill run lengths of lumber, and your carpenter does not need to waste any material by cutting during the erection of your house. Thus you save the usual 18% waste.

Third: By avoiding the necessity for measuring, sawing and fitting by your carpenter, your labor bill will be reduced practically one-third.

Fourth: Aladdin's co-operation, instructions and advice during the erection of your home will fortify you against expensive mistakes so common to most inexperienced home builders.

A fact is established by actual experience, and not by theory.

Let the actual experience of thousands of Aladdin home builders prove to you that you will get a good home for less money with Aladdin's help.

### Dollar-a-Knot Guaranteed

Aladdin houses have set a new standard of quality for moderate priced American homes. Knotless lumber, free from ALL defects is furnished for all Aladdin dwellings in the siding, shingles, porch work, outside finishing lumber, floors, window casings and inside woodwork. The highest priced standard paints, oils, stains and varnishes are supplied, the best quality plaster—everything is of unquestioned value. (Hundreds of customers have written us: "We can't buy as good material at any price in our town.")

### Aladdin Houses Not Portable

Aladdin houses are not portable, not sectional, not knocked-down. They are identically the same, when erected, as any first class wooden house. They cannot be taken apart, taken down, nor removed. They are permanent, strong, warm and substantial in every part. The Aladdin catalog gives you a complete understanding of their many advantages.

### Aladdin Mills in Four States

Our mills are located in Michigan, Florida, Louisiana and Oregon. Shipment is made from the nearest mill. No matter where you live, your house comes in a straight line from forest to you. Long distance and excessive freight rates are cut out. No hold-up on the way. In a short time after shipment is received, you move into your own home.



I Built this Plant  
With My Profits



# Start In A Big For

## You Can Make \$3,000 This Year Repairing and Retreading Automobile Tires

1916 will be the biggest year in the automobile business—1916 will be the biggest year in the tire business—1916 will be YOUR biggest money-making year if you accept this opportunity. Success, wealth, power, independence, await the man who enters the tire repair business, at the beginning of its most prosperous period. It's not fiction nor a pretty story. It's an accepted fact. What I did in this business starting six years ago, you can do now. Your chances to win are ten to one better than mine. There will be more automobiles made during the next three years than in all time before. There is nothing that offers such a certainty of success. You can start small with a little investment, (\$50 and up), and build a big business from there. You are soon a manufacturer, getting the big end of the profits instead of the small.

## One Million Autos To Be Made In 1916

That's the amount the automobile manufacturers are planning to produce. Every one is getting ready for the big demand that is sure to come. Think what this means to the tire business. Think of the millions of new tires besides the tires already in use, that will need repairing and retreading. To the man who starts now in the tire repair business there is a wonderful future before him. No business under the sun offers such sure possibilities of big success.

### Punctures and Blow-Outs Are Common

Autoists are continually clamoring for tire repair work. Not a day passes but thousands of tires blow up—thousands of punctures are made and this will be always a condition with automobile tires. Repairing is a neces-

sity. The work has to be done. Simply open a shop—the work comes along with hardly any effort.

### Tires to Mend the Whole Year Round

Autos are used both winter and summer. No season to tide over without any work. You are busy continually, day in and day out, building a business that gets bigger and better—making you rich, prosperous and contented.

Any city, any town, any village, now offers wonderful money-making opportunities to the man in the tire repair business. The demand for the work is already ahead of the supply and over 4,000,000 more tires a year for the next three years will need repairing and retreading. Isn't this a business for you?

## Haywood's 1916 Tire Repair Plants Turn Out Work Quick at Big Profits

COMPLETE MACHINE  
\$50 AND UP

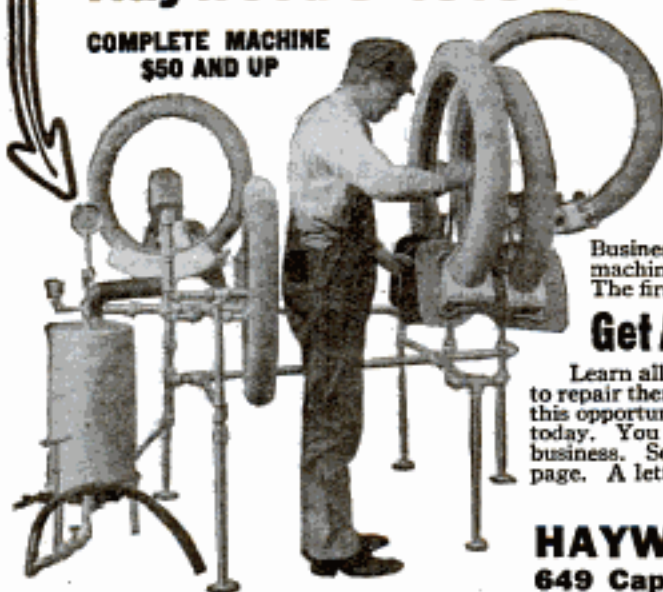

Be the first in your town with the Haywood Equipment. Mends tires best and quickest. Does the work at the biggest net profits to you. Plants are complete in the finest detail. Retreads, vulcanizes and does all kinds of repairing. Jobs please your customers. Price saves motorists money, but in turn gives you a big profit.

Experience is absolutely unnecessary. Just a little mechanical turn and follow directions is all that is required.

One machine will give you the start. That's the way I did it. Business grows fast from that time on. You soon need another machine, then another, and be able to buy them out of your profits. The first thing you know you are a real manufacturer—a success.

## Get All the Facts from the Big Free Catalog

Learn all the secrets of this proposition. Get details about tires and how to repair them. See the outfits in use. Get the stories of others who accepted this opportunity even when chances for success were not half what they are today. You will be surprised and delighted how easy it is to enter this business. Send your name and address only. Use the coupon on the other page. A letter or post card—but do it at once.

M. E. HAYWOOD, Pres.

**HAYWOOD TIRE & EQUIPMENT CO.**  
649 Capitol Ave. INDIANAPOLIS, IND.

# 1916 Business Yourself

Mail  
The  
Coupon



**This is YOUR Opportunity**

Here is undeniable evidence—your opportunity. There was never a better one for any man anywhere. Make the most of it while the chance is before you. Why keep tied down, shackled to the whims and purse strings of bosses? Why don't you hold the bag and make big money? I built the big business you see at the top of this advertisement—the business that I want to start you in. I have started others and they are now making money. Johnson, Texas, writes: "I make as high as \$18 a day in the tire repair business." **You can do it.** The coupon or post card will bring you complete information.

**Be a Leader, Gain Independence, Build for the Future, in a Big Growing Business of Your Own.**

One million autos a year is more than a mere prediction to automobile manufacturers; it is an accepted fact. There is hardly a manufacturer of consequence now making autos but his factories are being started—new machines for increasing outputs are being invented and installed. There is one industry whose wave of prosperity will wash up further than any other during this tide of automobile prosperity. This is the automobile tire industry. Every automobile means four new tires. The demand for one million autos means four million tires.

There are mighty few business undertakings that show such a remarkable future. The auto is here to stay. There is no question about that. Twentieth Century Business demands autos, and autos demand tire repair. It does not take much foresight to see where the tire repair man will step in for his share of the fortune. Tires are acknowledged the least durable part of the auto. They are a constant source of up-keep expenditure and any opportunity to save tires is eagerly grasped by every auto owner.

But as important as tire repairing is, it is of no more importance than the machine by which this work can be done. Machines are made now, simple in construction, simple to operate, by which any man with a slight mechanical turn of mind can repair auto tires.

Any man tired of working for others, wanting to get into a business for himself, it will pay him to investigate the opportunity that is offered in the tire repair business.

**You Can Start At Once Write Haywood NOW!**



M. E. Haywood, Pres.  
Haywood Tire & Equipment Co.  
619 Capitol Ave., Indianapolis, Ind.  
Dear Sir:— You can send me your book and full particulars about your 1916 Tire Repairing Machine. Send prices and complete descriptions first mail.

**Don't Wait Act-at Once- INVESTIGATE!**

Name .....

Address .....

Please Mention Popular Mechanics



## Know the Joys of Motorcycling

**T**HE sunshiny Spring mornings with that invigorating tang in the air will soon be here. *Then* you should know the joys of motorcycling and feel the freedom of going where you wish, when you wish. You can ride your

## Harley-Davidson

leisurely for the sheer joy of riding or you can open the throttle and travel at the speed of the wind to any desired place, even though it be miles and miles away.

The Harley-Davidson will make you master of the country for miles around. If you have a Harley-

Davidson sidecar, after hours and Sundays will be all too short for you and the family.

If you knew all that a Harley-Davidson motorcycle with sidecar would do for you, you too would realize that it is easier to own one than to do without.

Most dealers will make terms to suit your convenience. If you do not know your local Harley-Davidson dealer write the factory for catalog and full particulars.

**HARLEY-DAVIDSON MOTOR COMPANY**

*Producers of High-Grade Motorcycles for More Than Fourteen Years*

447 B Street

Milwaukee, Wis.

# BLUE STREAKS

**GOODYEAR**  
AKRON  
Motorcycle Tires



## On Every Leading Motorcycle

**L**AST year Goodyear Blue Streaks won every world's record for speed and endurance on track and road.

This year they have won a record that means far more to you.

Every leading motorcycle manufacturer is equipping his product with Goodyear Blue Streaks.

One manufacturer, or several, *might* go wrong in tire equipment.

But when all with a reputation to sustain unite on one tire, it means that that tire must be right.

And the Blue Streak is right, as you will find the first time you use it.

Big and sturdy, easy riding, safe and sure, no tire was ever better fitted to give unusual mileage, to lessen trouble, to increase speed and save power.

You will do well to accept the highest recommendation any tire can receive.

Use Blue Streaks on your old machine. Get them on the machine you buy.

Any dealer can sell you Blue Streaks. Ask for them, and accept no other.

**The Goodyear Tire & Rubber Company**  
Akron, Ohio

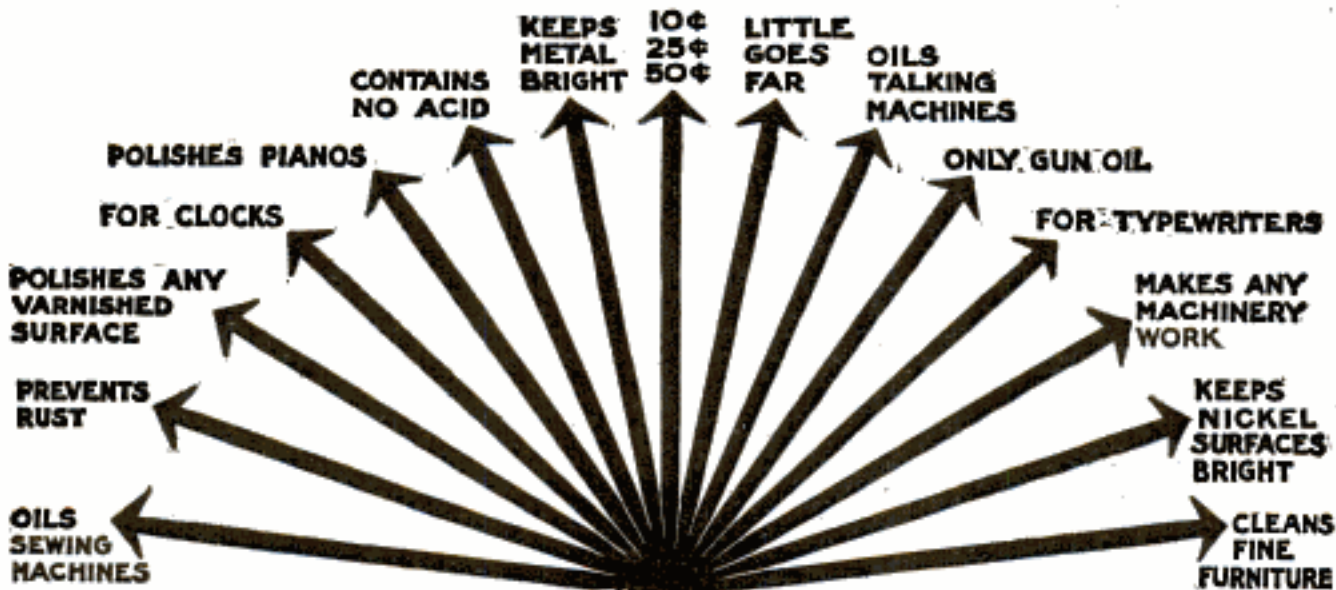

**FREE**

**FREE**



Try for yourself, without one cent of cost, what this marvelous oil will do. Sign your name and address in the triangle at the lower left hand of this ad—cut out around the black lines—and mail the coupon to us. We will send you immediately a generous sample bottle and full directions—do it now.

Try for yourself, without one cent of cost, what this marvelous oil will do. Sign your name and address in the triangle at the lower left hand of this ad—cut out around the black lines—and mail the coupon to us. We will send you immediately a generous sample bottle and full directions—do it now.

**FOR PARLOR.** 3 in One is the only oil on earth good for every house, cottage or castle. Removes all stains, wear marks, scratches and scars on piano or mahogany furniture. Restores original bright, beautiful finish. No grease—no acid—no varnish odors—helps everything—hurts nothing.

**FOR KITCHEN** 3 in One prevents red rust forming inside oven or anywhere on gas range. Try on wooden surface of kitchen cabinet. Makes ice cream freezer, coffee grinder, washing machine run easily, noiselessly. Prevents rust on refrigerator's metal shelves. Leaves no odor or grease or residue.

**FOR LIVING ROOM.** It quickly removes grime of use and time on library table, chairs, davenport, book case, at little cost and no work. Keeps all brass fixtures and chandeliers free from rust and tarnish. Best lubricant for grandfather clocks, alarm clocks.

**FOR DINING ROOM.** Wring out soft cloth in cold water. Apply a few drops of 3 in One. Go over surface of dining table, chairs, sideboard, buffet or china cabinet as though washing. Wipe thoroughly. Rub surface briskly with dry cloth. Easiest, cheapest, best method ever discovered for cleaning and polishing all veneered and varnished surfaces.

**FOR BEDROOM.** Wood and enamel metal beds cleaned and polished with 3 in One last longer and look better. It prevents grate fronts from rusting. Oils hinges and locks just right. For revolvers and guns it oils trigger and action, cleans out residue of burnt powder, prevents metal parts rusting.

**OTHER USES.** Sewing machine repair men "knock" 3 in One because a little of this good oil saves many dollars in repair bills. It makes every part of every machine work smoothly, easily. 3 in One stops hard pumping. Prevents leg ache and "broken backs."

Typewriters work better and last twice as long when oiled with 3 in One. Repair men won't tell you this—they have repairs and cheaper oils to sell. But don't take our word or their word. Just try 3 in One once.

3 SIZE BOTTLES: Small size, 1 oz., 10 cents; large size, 3 oz., 25 cents; Household size, 8 oz., 50 cents. Also in patent Handy Oil Cans, 3½ oz., 25c.

**3 in One Oil Co.**  
 42 CNP. Broadway  
 New York

Please send me, without one cent of expense, a generous sample bottle and 3 in One Dictionary.

Name.....  
 City..... Street.....

**3 in One Oil Co., 42 CNP. Broadway, N. Y.**



# SAXON ROADSTER

**\$395**

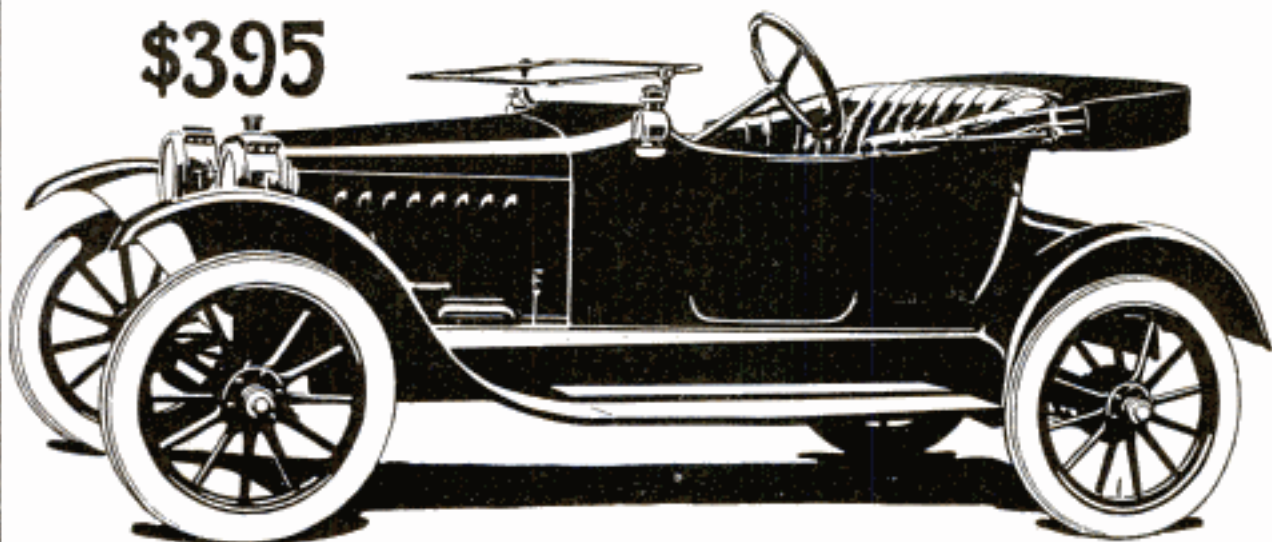

## Today's Choice among two-passenger cars

To those Saxon Roadster attractions which earned its present prestige among 35,000 owners we now add over a score of further improvements.

Judge the field of low-priced two-passenger cars by any gauge you like. In the end you'll agree that this new series Saxon Roadster stands out clearly—the pick of its class.

### Feature innovations you now find

**Three Speed Transmission.** This provides greater flexibility. Only the new series Saxon Roadster—among cars selling for less than \$400—has a three speed transmission.

**Saxon high speed motor.** This motor won widespread praise—when first brought out—for its power, smoothness, flexibility, ability to cool under all conditions and operative economy. It has been still further refined and developed.

**Timken Axles.** No better can be bought. **Ventilating Windshield, Signal Lamps** at side, **Adjustable Pedals**—all equipment of unmistakable desirability.

**A body of greater beauty**—a perfect streamline. You are proud to own it—to be seen in it.

More room. Plenty of leg length. Spacious comfort for two large people when seated.

Sliding gear transmission; and resilient vanadium steel cantilever springs; are additional features.

### "most economical car to own"

And not only that, but Saxon Roadster—all things considered—costs less to keep up than a good horse and buggy.

Against every sort of test it has maintained an average operating cost of one-fourth cent per mile per passenger.



Go see this new series Saxon Roadster at the nearest Saxon dealer's. Write for our interesting booklet "Saxon Days." Address Dept. J.

Saxon dealers are everywhere. See one nearest you and have a Saxon ride.

**Saxon Roadster \$395**

**Saxon "Six" \$785**

**Saxon Motor Car Company, Detroit**

(272)

# Most Remarkable Bargains Ever Offered

## Seamless Brussels Rug

No. MK177. Magnificent extra heavy seamless Brussels rug in two sizes, selected yarns—very attractive semi-oriental design. Looks well in any room. Colorings Tan, Red, Green and Brown harmoniously blended. A real bargain. Size 8 ft. 3 in. x 10 ft. 6 in. Price \$12.74

**\$1.00** Per Month  
Size 9 x 12 feet  
Price.....**\$13.96**  
**\$1.00** Per Month

## 5-Piece, 2-Inch Post Steel Bed Outfit Bargain

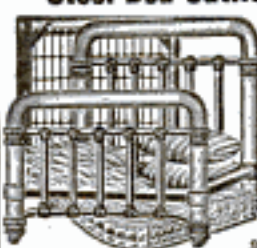

No. MK148. Elegant 2-inch continuous post steel bed, 3-in. fillers in artistic design, height head end 62 in.; link fabric steel frame springs, cotton top mattress and two 4½ lb. hen feather pillows 18 x 25 in. All sizes, 8 ft.; 3 ft. 6 in.; 4 ft. or 4 ft. 6 in., full size. Colors, White, Pea Green or Veris Martin. A remarkable bargain at our low price of only \$8.98

**75c** Per Month

## Oak Rocker

No. MK185. Solid oak; genuine quartered oak arms; golden finish. Front posts, front and top rails and side wings richly carved. Seat and back upholstered with brown imitation Spanish leather. Wood fibre and moss filling. Seat 18½ x 19 in., spiral springs, strong runners, heavy posts. 38 in. high. Price \$3.97.



**50c** Per Month

## Solid Oak Dining Table Bargain

No. MK181. Golden oak or fumed finish. Large 44 inch top, extends to 6 ft.; 4 in. rim, heavy octagon pedestal fitted to 24 inch platform which rests upon 4 Colonial scroll legs.



Excellent finished through-out. This is an elegant Dining Table, one that will grace any dining room. A real bargain at Hartman's remarkably low price. **\$11.95**

**75c** Per Month

## Dresser Bargain

No. MK180. Top of base 60x19 inches. French bevel plate mirror 24x20 inches, is supported by strong standards. Top of mirror frame has neat carving. 2 small extended drawers at top of base, two full length drawers below. A real bargain at our remarkably low price of only.....\$9.68



**75c** Per Month

## Washing Machine Bargain

No. MK105. Tub is 8 shirt capacity, of Louisiana red cypress, corrugated on inside for effective rubbing surface. Finished in natural color and bound by 3 steel hoops, 4-pronged, 10-in. cypress dasher block, cannot slip or crack. Gear ring is durable; roller bearings. Very easy to run. Tub is supported by 3 legs bolted into iron sockets. Does not tear clothes. Price \$4.50



**50c** Per Month

# No Money In Advance

Here is perfect credit and the most wonderful bargains ever offered. Remember, we say to you, "Order any of these bargains and send no money with your order—not one cent—see before you buy." Hartman's Mammoth Organization, with its \$10,000,000 Capital and Resources, makes it EASY for every one to furnish the home completely at SMALLEST COST and on terms positively unapproached by any other concern in the world.

## Hartman Will Trust You

No matter who you are or where you live. The proof is on this page. Order any of the articles shown here and it will be shipped to you at once without one penny sent in advance! USE IT AS YOUR OWN FOR 30 DAYS. If not fully convinced that it is the most remarkable bargain you ever heard of, return it at HARTMAN'S freight expense both ways and the trial will cost you nothing. If you are perfectly satisfied, keep the goods and pay for them in small monthly sums.



## 3-Piece Library Set

**\$1.00** Per Month

No. MK184. Choice quality solid oak, fumed finish. Table top 60x24 in., 2 roomy book ends, 7 in. connecting shelf. Panels at sides of book ends match panels on chairs. Chairs have 2-in. front posts fitted to genuine quarter-sawn oak arms, 3½ in. wide. Seats and backs upholstered with imitation Spanish leather. Heavy steel springs. Complete set.....\$12.65

## FREE—Hartman's Mammoth Bargain Book

We can ship but one of these bargains to each family at these amazing terms but when you get our Mammoth Bargain Book, you may order any amount WITHOUT RESTRICTION—and pay a little each month. The HARTMAN BARGAIN BOOK is unlike all others. Hundreds of pages—in colors—over 8,000 wonderful bargains in Furniture, Rugs, Carpets, Draperies, Beds, Jewelry, Closets, Stoves, Sewing Machines, Tableware, etc.

Send for it at once. Great opportunity to furnish your home at LOWEST COST and most liberal credit terms ever made. Ask for Catalog No. 88

HARTMAN FURNITURE AND CARPET CO.,  
3945 Wentworth Ave., Chicago, Ill.

If only catalog is wanted, place an X in this .  
If you wish any bargain shown here, fill in below. Write plainly. Send me Article No. ....

If I keep it I will pay \$.....in 30 days after arrival and \$.....per month.

Name .....

Address .....

City.....State.....

**HARTMAN**  
FURNITURE & CARPET CO.  
3945 Wentworth Avenue  
CHICAGO, ILL.

## "Wonder" Vacuum Sweeper

No. MK182. Noiseless fibre bearings and bellows lifting rods, steel frame dust bag, wide opening dust pan, pressed steel top, 4 drive wheels on brush, 3 bellows and 12 in. nozzle. Nickel-plated. Fully guaranteed. Price \$3.97

**50c** Per Month





*House of Joseph Lincoln, Esq., Hackensack, N. J.*

*Fernan & Light, Architects*

**I**F you would have the wood which possesses all the virtues of other woods, and has none of their shortcomings, for the outside of your home, insist on

## WHITE PINE

Three centuries of building experience in America have proved that White Pine withstands the attack of time and weather more successfully than any other wood.

It does not shrink, swell, crack, twist, warp or rot—and once in place it “stays put,” after years of exposure, even in the closest fitting mitres and in delicate mouldings and carvings. It takes paint and stains perfectly.

If your lumber dealer is unable to supply White Pine, we would appreciate the opportunity of being helpful to you in securing it.

*Address, WHITE PINE BUREAU,  
1226 Merchants Bank Building, St. Paul, Minn.*



“White Pine in Home-Building” is beautifully illustrated with old Colonial and Modern homes, full of valuable information and suggestions on home-building, and gives a short, concise statement of the merits of White Pine. Send for it now. There is no charge for it to prospective home-builders.

Representing  
The Northern Pine Manufacturers' Association of Minnesota, Wisconsin and Michigan, and The Associated White Pine Manufacturers of Idaho

*Please Mention Popular Mechanics*



## Get the Range of Smoking Satisfaction

Roll "Bull" Durham into a cigarette and you have a smoke with all the vim, vigor and dash of Uncle Sam's fighting men. That's why the American Army is an army of "Bull" Durham smokers. "Bull" puts snap into their action and "punch" into their systems. For a virile, lively, manly smoke, "roll your own" with "Bull."

# GENUINE "BULL" DURHAM SMOKING TOBACCO

"Bull" Durham is the mildest of all tobaccos—a fragrant, mellow-sweet tobacco that soothes the nerves and brings the happy, contented feeling that comes from thorough satisfaction.

Made of the famous "bright" Virginia-North Carolina leaf, "Bull" has been the great American smoke for three generations. There is no other tobacco like it. You "roll your own" with "Bull" and enjoy a real smoke.

THE AMERICAN TOBACCO COMPANY



Ask for FREE  
package of  
"papers" with  
each 5c sack



Please Mention Popular Mechanics

Copyrighted material

# Make Your Bike a MOTORCYCLE

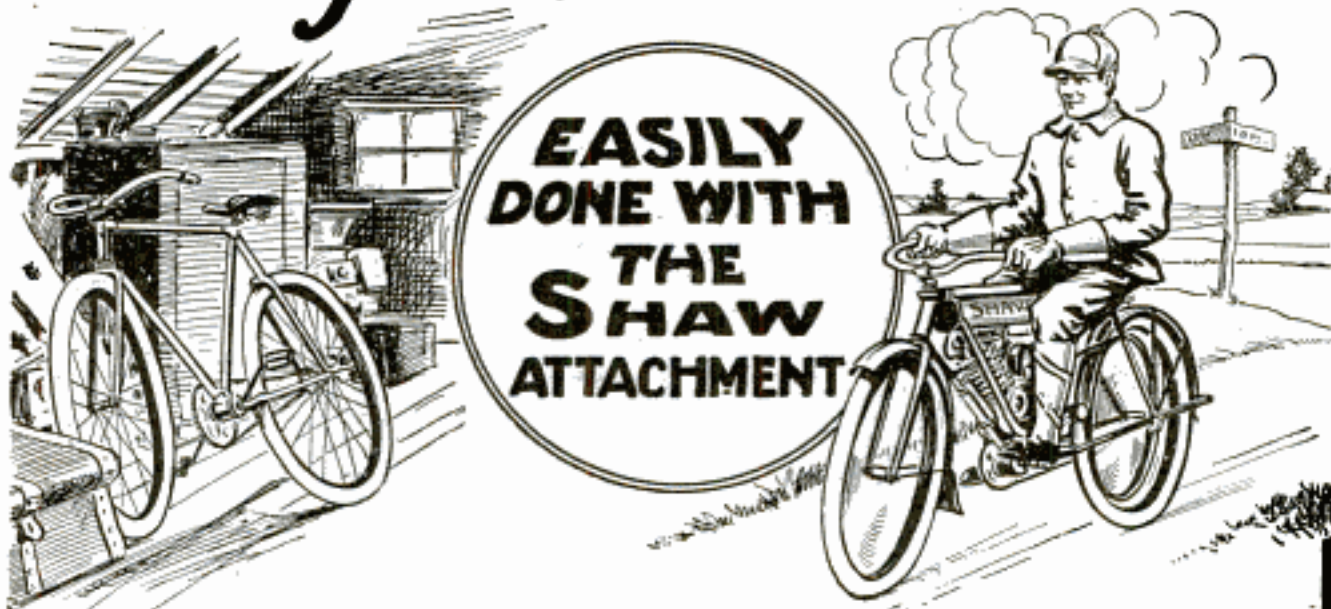

Don't envy the fellow who has a dependable motorcycle any longer. Don't sit back while your friends speed over city streets or country roads and enjoy the great out-of-doors without effort, just because you own a "foot-power" machine.

Your bicycle can be quickly transformed into a speedy, easy running, light weight motorcycle by using the Shaw Motor Attachment. There is no need for you to invest your money in a high priced motorcycle, because for a very small amount you can ride with them anywhere. Here is your opportunity.

## The Shaw Attachment Low in Price and Fits Any Bicycle

Anyone who can use an ordinary wrench and a screw driver can fit the Shaw Attachment to any bicycle in a short time. No brazing or changing of frame is needed. The Shaw Attachment weighs less than other motors and is arranged to balance perfectly, thus avoiding the vibration so common in most motors. The control is simple and dependable — absolute safety at all times is thus assured. The price is very low, and your old bike equipped as a motorcycle, will represent a big saving in comparison with the price of any motorcycle of equal speed and dependability.

### MAGNETO

The smallest electrically efficient magneto ever produced. High tension type. ONE PIECE FRAME of die cast aluminum, absolutely water-proof, dust-proof and oil-proof. Magnets of high-grade imported steel. This wonderful magneto is supplied with the SHAW MOTOR-CYCLE ATTACHMENT.

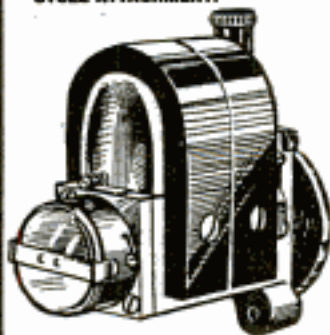

pulling power. No ordinary road is too rough for it, nor hill too steep. Every piece and every part represents only the highest grade materials that can be had. That is why we do not hesitate to cover each piece and each part with our broad and liberal guarantee against any defect in material or workmanship. We will replace any defective part within one year from date of purchase.

**Shaw Manufacturing Company**  
Dept. 153 Galesburg, Kansas

### What the SHAW Attachment Really Is

The Shaw Motorcycle Attachment consists of the famous Shaw motor—2½ H.P., all finished, assembled and tested, ready to be clamped to any bicycle frame. This motor is durably built, air cooled, of the four cycle type. The Shaw weighs much less than other motors.

Lunkenheimer Carburetor, simple and reliable. Muffler, reduces exhaust to a soft puffing, a very desirable feature. Belt, "V" shaped of special tanned, tough and flexible leather. Rear Pulley Rim of steel, complete with stays. Combination Tank for gasoline and oil (two compartments). Battery Case of strong fiber insulation, protecting battery and preventing short circuiting. The equipment is also offered with the Shaw Magneto, the smallest and most electrically efficient magneto on the market—weighing only 3 pounds, 11 ounces. Spark Plug.

Grip Control, Oiler, Clamps, etc. The entire outfit comes to you ready to be attached to your bicycle.

The Shaw Motorcycle Attachment will take you up hills of 20% grade—will go through sandy roads and surprise you with its

### WRITE TODAY

for our interesting and instructive book "Convert Your Bike into a Motorcycle"—tells all about the SHAW equipment and the wonderful SHAW MAGNETO—the marvel of marvels. There is no reason why you should pay the high prices demanded for a motorcycle if you have an ordinary bicycle. The SHAW ATTACHMENT will make it easy for you to possess a motorcycle of the highest type. Thousands of these attachments are in use in the United States, Canada and other Foreign countries.

### Use the Coupon and Mail Today

We will send you full information about this remarkable attachment, prices, etc., also list of second hand motorcycles.

## Free Book Coupon

SHAW MFG. CO., Dept. 153, Galesburg, Kans.

Send me your free book "Convert Your Bike into a Motorcycle," giving full particulars about the Shaw Attachment, also special list of used motorcycles of all makes.

Name.....

Post Office.....

Street or R. F. D..... State.....

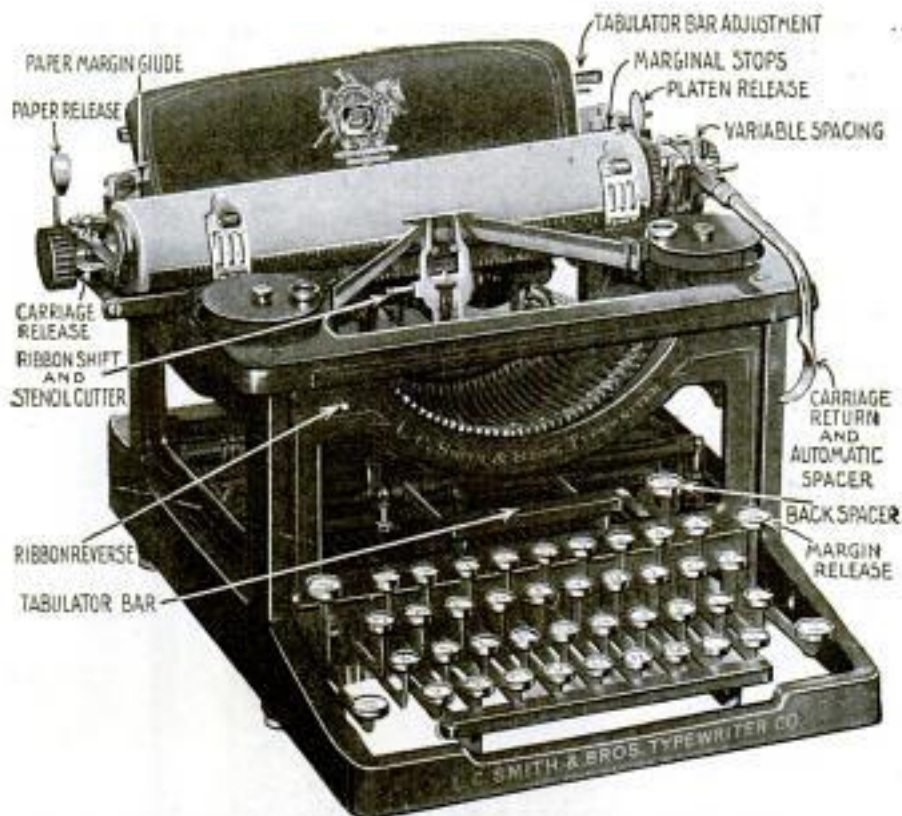

# TYPEWRITER SENSATION

Free TRIAL—Use As You Pay

Only \$2.50 a month until the low total price of \$48.80 is paid, and the machine is yours

This is absolutely the most generous typewriter offer ever made. Do not rent a machine when you can pay \$2.50 a month and own one. Think of it—Buying a \$100.00 machine for \$48.80. Cash price, \$45.45. Never before has anything like this been attempted.

Standard Visible **L. C. Smith**

Perfect machines, not damaged or shop worn. Standard size, Keyboard of Standard Universal arrangement writing 84 characters — universally used in teaching the touch system. The entire line of writing completely visible at all times, has the tabulator, the two color ribbon with automatic reverse, the Back Spacer, Ball Bearing type bars, Ball Bearing shift action, the carriage runs on Ball Bearings, in fact every late style feature and modern operating convenience. Comes to you with everything complete, tools, cover, operating book and instructions, ribbon, practice paper — nothing extra to buy. You cannot imagine the perfection of this beautiful reconstructed Ball Bearing typewriter until you have seen it. I have sold

several thousands of these perfect latest style Model No. 2 typewriters at this bargain price and every one of these thousands of satisfied customers had this beautiful, strictly up-to-date, visible machine on five days' free trial, before deciding to buy it. I will send it to you f. o. b. Chicago for five days' free trial on receipt of your request, without obligation of any kind on your part to purchase. It will sell itself, but if you are not satisfied this is the greatest typewriter bargain you ever saw, you can return it at my expense — but — you won't want to return it after you try it — you cannot equal this wonderful value anywhere.

**H. A. SMITH**  
510-231 N. Fifth Ave.  
CHICAGO, ILL.

Ship me a No. 2 L. C. Smith F. O. B. Chicago, as described in this advertisement. I will pay you the \$40.00 balance of the SPECIAL \$48.80 purchase price, at the rate of \$2.50 per month. The title to remain in you until fully paid for. It is understood that I have five days in which to examine and try the typewriter. If I choose not to keep it I will carefully repack it and return it to the express agent. It is understood that you give the standard guarantee for one year.

**You Take No Risk—Put In Your Order Now**

When the typewriter arrives deposit with the express agent \$8.80 and take the machine for five days' trial. If you are convinced that it is the best typewriter you ever saw, keep it and send me \$2.50 a month until our bargain price of \$48.80 is paid. If you don't want it, return it to the express agent, he will return your \$8.80 and return the typewriter to me. I will pay the return express charges. This machine is guaranteed just as if you paid \$100.00 for it. It is standard. Over one hundred thousand people own and use these typewriters and think them the best ever manufactured.

The supply at this price is very limited, the price will probably be raised when my next advertisement appears, so don't delay. Fill in the coupon today—mail to me—the typewriter will be shipped promptly. There is no red tape. I employ no solicitors—no collectors—no chattel mortgage. I deal direct with you — by mail only. It is simply understood that I retain title to the machine until the full \$48.80 is paid. You cannot lose. It is the greatest typewriter opportunity you will ever have.

Get the coupon in the mail today — sure

**HARRY A. SMITH, 510-231 N. Fifth Ave., Chicago**

Name .....

Address .....

.....Pop. Mech. Feb.

# FREE GRAPE FRUIT *and* FREE ORANGE TREES

To All Who Use the Attached Coupon



## You Can Start a Grove To-day

which will increase in value while you pay for it in small monthly payments

No need to give up your present business or position. No need to move to Florida until you are ready. When you do come you can move to an improved producing grove. We furnish the land, the trees and all labor. You can invest in land NOW and develop it any time you wish—or you can start immediate improvements either personally or thru our company. We raise our own guaranteed trees in our own nurseries which insures every purchaser of the best fruit trees that can be grown. This also insures a successful grove.

Now a few dollars monthly invested now in these rich productive Hillsboro County lands will soon multiply and develop into a life income is fully told in our large handsomely illustrated booklet—"The Call of the Southland."

**RIGHT NOW IS THE TIME TO INVEST IN OUR NEW LITHIA TRACT SUBURBAN TO TAMPA**, the metropolis of South Florida—Sited in the recognized center of Florida's Citrus Fruit belt. No better land can be found anywhere for fruit, truck, poultry and livestock.

This is the third great Hillsboro County tract that has been opened to homeseekers and investors by our old established, responsible, thoroughly experienced organization. Over 2,500 families are now rejoicing because they bought at opening prices in our two former tracts. Every family can tell you they got a square and generous deal.

Our new Lithia Tract now offers you the same wonderful opportunity—and more, because of the rapid growth and development on all sides within the past five years.

**Free—Absolutely Free—100 grapefruit and orange trees to each and every purchaser who reserves 10 acres or more NOW.** These trees will be held in our Nurseries until you are ready to plant them. This will give you a splendid start in developing a grove which will bring you an ever-increasing income and greatly increase the value of your entire farm.

Get our big new Florida book "The Call of the Southland"—look at the map—read the many enthusiastic testimonial letters from settlers now living on the farms they bought from us. Four big railroads intersect these suburban tracts—all the comforts of modern life right at hand.

Think of it—a 10-acre grove suburban to a city like this—a farm big enough to keep you in comfort all your lives, yet one you can pay for so easily that it will really surprise you.

Get the facts now. The Coupon brings them to you without cost or obligation. Get this new wonderful opportunity clearly before you while prices on this newly opened tract are still low and terms easy. Today \$1 per acre per month buys the land which can bring you independence and a future. Tomorrow—who can say?

Tear off the coupon and mail it now and we will lay before you, by return mail, full and complete information showing how you can easily become the owner of one of these beautiful grapefruit and orange groves, and why it is sure to prove the shrewdest, most profitable investment you can possibly make.

**NORTH TAMPA LAND CO.**  
C. E. THOMAS, President  
837 Marquette Building CHICAGO

The C. E. Thomas Nurseries are growing the finest varieties of grapefruit, orange, lime, fancy peach, plum and other semi-tropical fruit trees, which we are selling to land owners throughout the south, as well as our land buyers. There are no better trees grown than the C. E. Thomas Nurseries Warranted Citrus Fruit trees. Every tree fully guaranteed to grow.

If you already own land and are in the market for high-grade fruit trees do not fail to write for our New Illustrated Nursery Catalog before buying trees elsewhere. It is free and gives much valuable information on planting and caring for trees. The coupon is for our land book only.

No use trying to make yourself believe that savings bank interest will ever make you independent, nor 6% loans make you rich. Your money isn't working when you tie it up in such ways—it's LOAFING. Make your money work for YOU; right here in these rich fruit lands is your opportunity—here where a few dollars put to work NOW will reap all the benefit of development work constantly being done by the fast increasing population.

If you do not wish to improve your farm, you can in a few years, cash in on it from the investment standpoint without a stroke of work on your part. Think of it—an investment of a very few dollars a month—and a magnificent grapefruit and orange grove is the result almost before you know it.

North Tampa Land Co., P. M. 2-16  
837 Marquette Bldg., Chicago

Please send me your large Illustrated Book "The Call of the Southland" on choice Citrus Fruit and Truck Farms suburban to Tampa, Florida, and information on how I can have a grove developed on the monthly payment plan.

Name .....

Street No. ....

City..... State.....

# EARN \$20<sup>00</sup> TO \$30<sup>00</sup> A DAY



**T**HERE is no limit to your earning capacity—sounds exaggerated, but it isn't. In small town or large city there's a way for you to earn \$20 to \$30 a day—up to \$3,000 a year and more—with one of our **B. B. Power Vacuum Cleaners**—It's the kind of business you've been looking for—honorable, dignified and with big money-making possibilities. Investigate at once. Send the coupon—Today—Now is the time. The next six months mean a harvest of coin to Vacuum Cleaner operators.

## NOW ON 30 DAYS' TRIAL

Try the proposition 30 days—see for yourself the money in it for you. It's a great chance to start a business for yourself—just what you've been wanting to do—the very opening you need to throw off the yoke of daily wages—working for others at only a fraction of what you're worth. **Make a profit on yourself. Don't work at cost at a profit to someone else.**

## MAKE TREMENDOUS PROFITS

\$20 to \$30 a day should be easily made. Some work three machines—operate one themselves—hire men to work the others. They make big profits from others labor. Maybe that's what someone is doing to you. You're doing the work for small pay. He's getting the profits. Change that. Work for yourself. Get all the profits. Be independent.

## START A BUSINESS OF YOUR OWN

Remember how much you can earn daily. \$20 to \$30 is clear profit—\$5000 to \$10,000 a year. The profits of the machines will pay for it. It's a business that isn't over-run and don't forget there are thousands-and-thousands of homes that will never own a vacuum cleaner of their own. Hundreds more would never think of getting a machine of their own if they could depend upon YOU.



Write postal or letter or send coupon for Free Book. Tells whole story.

### MONEY FOR YOU

FREE BOOK COUPON

McCreery Mfg. Co.  
1034 Front St., Toledo, O.  
Please send me your free book and full information about the "Giant" Power Cleaner.

Name.....

Address.....

.....

.....

**YOU CAN START SMALL** Start with one home on a street—soon you are giving regular service to half the homes in that neighborhood. There are so many things to be cleaned—rugs, matting, carpets, mattresses, pillows, portieres, curtains, upholstered furniture, etc., etc., besides the floors, and the walls. With a "Giant" B. B. Vacuum Cleaner you do it all.

## OTHERS ARE DOING IT—SO CAN YOU

Churches, lodge rooms, dance halls, hotels—hundreds of places can use your work. No experience necessary—just a little push and courtesy. Clear \$3,000 upwards a year. **Mr. Rainbow, writes:** "The B. B. does all you claim. I knock out from \$20 to \$25 in six hours easily." When the money is earned it's practically all yours. The expense is trifling for the gasoline engine. **Mr. Staley, writes:** "It's the greatest dirt puller I ever saw. I make \$20 a day with it." Grasp all these opportunities. Learn that there is no other business where so small an investment will bring such wonderful returns. In fact we have such implicit confidence in the wonderful money-making possibilities of our "Giant" B. B. House Cleaner—that we will ship one to you on 30 days' trial.

**Come to See Us at Our Expense** Up to a distance of 300 miles we will pay your traveling expense if you buy. Start now—somewhere—anywhere. Send today for our free book and complete particulars regarding the 30 days' trial. Figure the number of homes in your town—compute how much it costs to clean them each week. You can get part or all of this business. You have scores of friends who would gladly start you with their work—others will surely follow. You can depend upon a nice profitable business from the start.

The McCreery Mfg. Co., 1034 Front St., Toledo, O.

## I will send my 25c book Improve Your Eyes For 10c stamps or coin

A high-grade exercise and massage method that quickly strengthens and beautifies the eyes.

Also a most beneficial system of exercises that will improve the muscles of the temples and sides of face, thereby facilitating mastication and vocal pronunciation. Completely illustrated. Entirely without apparatus.

## MUSCLE BUILDER

A steel spring exerciser and chest expander, with a complete course of twenty-four selected exercises for developing all the muscles of the body. It is equal to any \$3.00 exerciser. My price for a short time only, \$1.00.

**PROF. ANTHONY BARKER**  
4645 Barker Bldg., 110 W. 42d St., New York

Please Mention Popular Mechanics



## HERE YOU ARE, BOYS

A medalion pin of Foxy Grandpa. Everyone will notice it on the lapel of your coat and try to get a closer look at it. All you have to do is press the bulb.—Foxy Grandpa will finish the job by squirting a fine stream of water over the inquisitive one. Will squirt 20 feet. Greatest joke out. Order one today and fool your friends. Price 15c. Foxy Grandpa and Hooligan both for 25c. 5 for 50c or 1 doz. for \$1.00. A beautiful fountain pen free with every \$1.00 order.

AMERICAN SUPPLY CO., 918 Union St., St. Paul, Minn.

## \$4.00 SEISS

Powerful, Commanding, Warning Signal. Operated by touch of hand, either right or left—for short blast or long continuous sound, same as a Motor-Driven Horn.

**THE SEISS MFG. CO.**  
439 Dorr St., TOLEDO, O.



Model A





# I'll buy your Spare Time —pay you Big Money for it

## Start Today—No Experience or Investment Needed

If you believe you could sell "gold dollars for 57½ cents," I'll turn your spare time into money. No experience necessary. No traveling. No investment in stock. No collecting. Just place REX Visible Typewriters on Ten Day FREE Trial. Explain the low price, easy terms and long guarantee. Book the orders. Send them to me. That's all—except you get the biggest commission ever paid to a typewriter agent.

## Quality—Price—Terms

I have linked these three important factors for the First Time in the History of Typewriters

I have been 20 years in the typewriter industry—have sold 50,000 standard machines through agents. And I tell you positively that this is the best typewriter offer I ever made or heard of. It brings together, as never before, the three great sales factors—Price, Quality and Easy terms. No other manufacturer of standard typewriters has been able to do this.

### A \$100 Machine at Nearly Half Off

The New REX Visible is not a second-hand, "rebuilt" or "toy" typewriter, but a brand new, 1916 model, standard, \$100 machine—full size—full equipped with two-color ribbon, back-spacer, tabulator, automatic line lock, wide carriage, visible writing, tilt-back paper table, etc. It is by far the best and most up-to-date of the standard typewriters.

### Easy Terms Amount to Only a Few Cents a Day

My proposition opens the whole typewriter field to you. Your customers need not be "moneyed men." They can be from any walk in life. You offer terms that amount to only a few cents a day—make the typewriter cost less than pencils, pens and ink. They do not need to pay you any cash with the order and you give them Ten Days' FREE Trial.

## Brand NEW REX Standard 1916 Improved MODEL

10 Years Guarantee  
10 Day Trial FREE

I am spending thousands of dollars to bring this message to you. Will you spend 2c to send me the attached coupon and get full details of this amazing offer?

### Write Me Today for Your Demonstration Machine

As soon as I receive your request I send full information and attractive agency contract which you sign and return. I immediately Express our New REX Visible for your use and as a demonstration machine; without one cent of prepayment. When the machine is sold, you remit to me. You pay nothing until the sale is made. You cannot refuse such an offer as this.

### Send the Coupon (or a Postal) Today

H. M. BALLARD, Gen'l. Mgr.

## Rex Typewriter Co.

Dept. 37 Steger Bldg.  
Chicago

## World's Best Typewriter Offer

The Brand New REX Direct from the factory in which it is built at less than a good second hand machine

The New REX Visible costs as much to manufacture as any other standard \$100 machine. However, because we have no branch office, store and sales room expense—no salaries and expenses of branch managers and traveling salesmen—no pension list of aged employes and no over-capitalization, we make a better machine, a better price, and a better offer to our agents than has ever before been made on a brand new, standard typewriter.

### A Wonderful Selling Proposition

Could you ask for a surer chance to make money? You have the best machine, the lowest price, easiest terms, longest guarantee, fairest trial offer, most liberal commissions. I don't see how you, or any man who has spare time, can hesitate to write me, get full particulars and take this easy money.

### Fully Guaranteed for Ten Years

The REX Visible is guaranteed for ten years. This is the longest guarantee ever made on any typewriter. It absolutely protects against defects in material and workmanship. It assures a high-grade machine, with every essential feature for all practical typewriter requirements.



Mail This  
Coupon  
or a Postal

REX  
Typewriter Co.  
Dept. 37  
Steger Building  
Chicago

Mr. Ballard—  
Please send me,  
without obligation  
on my part, your new  
catalog and special  
offer to agents on your  
standard \$100 REX  
Visible Typewriter.

Name \_\_\_\_\_

Address \_\_\_\_\_

**DU PONT  
FABRIKOID**

REG. U. S. PAT. OFF.

## How Many Cars Have Hides?

a sequel to

### "How Many Hides Has a Cow?"

**M**ORE cars are now upholstered in Du Pont Fabrikoid than in any other material.

The number upholstered in leather counting all grades, *real grain leather* and *splits* or so-called "genuine leather" is steadily diminishing.

About 20% of the new pleasure cars sold in 1915 were upholstered in hides or hide splits. About 10% were upholstered in cloth. Of the remaining 70% upholstered in leather substitutes the majority were in Du Pont Fabrikoid, Motor Quality.

Four years ago nearly all automobiles were upholstered in good leather, *but* 1915 production was just about twice that of 1912; in the meantime the steadily decreasing hide supply has made prices soar.

The attempt to meet the famine in real grain leather by using and selling doctored splits as "genuine leather" has been a failure.

The public has learned the vast difference between real grain leather and so-called "genuine leather." Today automobile manufacturers face the choice of real grain leather or its nearest popular competitor, Du Pont Fabrikoid.

Real grain leather, because of scarcity and high price, is out of the question for popular priced models. And, since coated splits have proved impractical, the decision of the greatest makers of popular priced cars has been in favor of Du Pont Fabrikoid, Motor Quality, proved the most desirable after several years' use on hundreds of thousands of automobiles.

Du Pont Fabrikoid is not leather, but it has the artistic appearance and luxury of real grain leather, and in addition is waterproof, washable and will outwear the grade of "genuine leather" used on 90% of the cars that "have hides."

Fabrikoid Rayntite Tops are guaranteed one year against leaking. They do not get shabby because they are built to last.

A usable piece, 18 x 25 inches, sent postpaid for 50c. Booklet and small sample of Motor Quality sent free.

**Du Pont  
Fabrikoid Company  
Wilmington, Del.**

Works at Newburgh, N. Y.

Canadian Sales Office,  
Toronto



**\$3.50 VALUE** **\$2**  
for ONLY



## The Famous DURO Guaranteed Shirts

Specializing on this box makes possible this offer of 3 DURO Guaranteed Shirts sent prepaid by parcel post on receipt of \$2 (N. Y. Bank Draft).

Handsome silk tie included for names and addresses of five friends. This is the biggest selling and most famous box of shirts in the world. Advertised in 50 of the leading magazines. The only shirts guaranteed not to shrink, fade or rip in six months' wear or new shirts free. Made of fine white percale with neat stripes of blue, black and lavender. One shirt of each color to the box. Cut in the popular coat style, cuffs attached, hand laundered and very fashionable. Standard sizes, 14 to 17. Neckties are navy blue, black and lavender. Take your choice. It's a wonderful box for the money and well worth a trial. The shirts would cost you a dollar apiece and you would get no guarantee of wear. The tie would cost 50c. Illustrated literature on request, but save time by sending \$2 to-day with size and five names (your name not used), for if all the goods are not satisfactory on arrival we will gladly refund your money. Highest Bank References. Catalog of shirts of all kinds, neckwear, hosiery, handkerchiefs, underwear, pajamas and nightshirts.

**GOODELL & CO., Room 116, 158 E. 34th Street, New York**  
Largest Mail Order Shirt House in the World

Tests of zacaton grass, which grows abundantly from California and Texas southward to the Argentine Andes, show that it can be reduced to paper stock by the soda process more easily and cheaply than poplar wood.



**Remington Arms-Union Metallic Cartridge Co., New York**

Lubricant, Powder Solvent and Rust Preventive. Cannot gum. For guns, typewriters, razors, and all fine mechanisms. Write for folder. Invented, made and guaranteed by the



## Put Perrin "No Glares" On Your Car's Headlights

Avoid all danger from light-dazzled oncomers. Enjoy long, low, powerful light on both streets and country roads, with complete safety. Recommended by Police officials. Placed on lamp bulb permanently—always working—no buttons or levers. Over 100,000 in use.

**\$1 per set of two.** At your Dealer's or Garage or sent postpaid. Patented. Resist infringement. Insist on the Perrin "No Glare."  
**PERRIN MFG. CO., Detroit, Mich.**



## Made-to-Measure

**EXPRESS PREPAID \$2.75**

Pants cut in the latest style. Made to your individual measure. Fit, workmanship and wear guaranteed.

### No Extra Charge

for peg tops, no matter how extreme you order them.

**Agents** A good live hustler in every town to take orders for our **Wanted** celebrated made-to-measure clothes. Samples of all latest materials **FREE**.

### We Pay Big Money

to our agents everywhere. Turn your spare time into cash by taking orders for our stylish clothes. Write today for beautiful **FREE** outfit.

**THE PROGRESS TAILORING CO.**  
Dept. 870, CHICAGO, ILL.

# Save \$200 to \$500 on Your Home-Shipped Anywhere



All lumber, millwork, hardware, paint, including complete plans and specifications. Standard Home Plan No. 106. See Plan Book. **\$1062**

All lumber, millwork, hardware, paint, including complete plans and specifications. Standard Home Plan No. 301. See Plan Book. **\$744**

All lumber, millwork, hardware, paint, including complete plans and specifications. Standard Home Plan No. 121. See Plan Book. **\$1026**

All lumber, millwork, hardware, paint, including complete plans and specifications. Standard Home Plan No. 193. See Plan Book. **\$957**

Let Us Ship You a \$1500 Home Complete for \$1062—a \$1000 Home for \$744—a \$1400 Home for \$1026—a \$1250 Home for \$957

**PROOF** On 100 Homes like these, at prices from \$300 up and of all most artistic new varieties in handsome architectural effects we have owners' letters telling us they saved as high as \$200 to \$800 or more. Read this: E. J. Sutton, of Mass., wrote to us Nov. 8th, "I would like to say the lumber and millwork you sent for House Plan No. 140 (shown on page 44 of our Plan Book) was No. 1 in quality and quantity and worked out just as stated by you. We saved \$150

to \$200 by buying from you. A number of contractors have looked the house over and said it could not have been of better lumber." We have thousands of letters like this. Mr. Sutton lives far away. Think what you can save. Frank Mahannah, of Oklahoma, says (on Plan No. 106): "We are certainly very much pleased with the millwork we got of you. I guess by your figuring we saved \$300 to \$400 in the house. We got everything done very reasonable, and your figures in the lumber, also the millwork held out."

## "Factory-to-Consumer" Prices

Save enough to buy your lot. No agents or dealers. We sell through catalog only—rock bottom prices. Over 100,000 customers and three strong banks vouch for us. Everything wholesale.

**Ready Cut Homes** { Material Cut to fit } **Standard Homes** { Material in the Standard Way }

Buy either way. No architects' fees. No local lumber yard profits to pay. No delays. Over 300 choice plans in 2 big books FREE! Convenience ideas; well planned kitchens; pantry cases, linen closets; two panel Fir doors; bungalow trim, etc. Photos, color schemes, exact prices.

### Prompt Delivery—Satisfaction or Money Back

We ship 90 per cent of orders same day received. Freight paid both ways and money back if you are not satisfied. Also get 156 page illustrated book of 5000 Building and Remodeling Bargains—FREE! All shipped anywhere. Send coupon NOW.

**GORDON-VAN TINE CO.**

803 Federal St., Davenport, Iowa  
Established Half a Century

## 3 BIG PLAN BOOKS FREE

GORDON-VAN TINE CO., 803 Federal St., Davenport, Ia.  
Please send me Free the books checked.

- |  |   |
|--|---|
| <input type="checkbox"/> Standard Home Plan Book                   | <input type="checkbox"/> Ready-Cut Plan Book              |
| <input type="checkbox"/> 5000 Building Material Bargain Catalog    | <input type="checkbox"/> Garages (Ready-Cut and Portable) |
| <input type="checkbox"/> Hot Beds and Greenhouses for Home Growers | <input type="checkbox"/> Summer Cottages                  |

Name .....

St. No. .... City .....

State .....



Please Mention Popular Mechanics

**Burns Kerosene (Coal Oil)**

# LIGHTS WHOLE ROOM

**BEATS ELECTRIC OR GASOLINE**

## 10 DAYS FREE

**Charges Prepaid Send No Money**



We don't ask you to pay a cent until you have used this wonderful modern light in your own home ten days—we even pay transportation charges. You may return it at our expense if not perfectly satisfied after putting it to every possible test for 10 nights. You can't possibly lose a cent. We want to prove to you that it makes an ordinary oil lamp look like a candle; beats electric, gasoline or acetylene. Lights and is put out like old oil lamp. Tests by Government and 33 leading Universities show it

**Burns 50 Hours on One Gallon** common coal oil, and gives more than twice as much light as the best round wick open flame lamps. No odor, smoke or noise; simple, clean, no pressure, won't explode. Several million people already enjoying this powerful, steady light, nearest to sunlight. **Guaranteed.**

### Men Make \$50 to \$300 Per Month

with Rigs or Autos delivering the ALADDIN on our easy trial plan. No previous experience necessary. Practically every farm home and small town home will buy after trying. One farmer who had never sold anything in his life before writes: "I sold 57 lamps the first seven days." Another says: "I disposed of 37 lamps out of 31 calls." Thousands who are coining money endorse the Aladdin just as strongly. **NO MONEY REQUIRED.** We furnish capital to reliable men to get started. Ask for our distributor's plan, and learn how to make big money in unoccupied territory. **Sample sent for 10 Days' Free Trial.** We want one user in each locality to whom we can refer customers. Be the first and get our special introductory offer under which you get your own lamp free for showing it to a few neighbors and sending in their orders. Write quick for **10 DAY ABSOLUTELY FREE TRIAL.** Address nearest office.

**MANTLE LAMP COMPANY, 348 Aladdin Building**  
Largest Kerosene (Coal Oil) Mantle Lamp House in the World

**CHICAGO NEW YORK CITY PORTLAND, ORE. MONTREAL or WINNIPEG, CAN.**

**Won GOLD MEDAL at World's Exposition San Francisco**

**AGENTS WANTED**

for our independent hollow-wire lighting systems for homes, stores, public buildings, etc. Use common gasoline. Best and cheapest illumination known.

### AKRON LIGHTING SYSTEMS

are most improved, simplest and safest of all. Shed a clear, soft, bright light of high candle power. Also complete line of portable and street lamps and lanterns. Fully guaranteed. Our Agency proposition cannot be beat. Exclusive territory. Send quick for catalog and terms.

**Akron Gas Lamp Co., 522 So. Main St., Akron, O.**



Agents' outfit

**BEACON BURNER FREE**

**FITS YOUR OLD LAMP**

**100 Candle Power Incandescent** pure white light from (kerosene) coal oil. Beats either gas or electricity.

**COSTS ONLY 1 CENT FOR 6 HOURS**

We want one person in each locality to whom we can refer new customers. Take advantage of our Special Offer to secure a Beacon Burner **FREE.** Write today. **AGENTS WANTED.**

**HOME SUPPLY CO., 111 Home Bldg., Kansas City, Mo.**



**WHITE FLAME**

**BURNERS** make your old kerosene lamps and lanterns give a brilliant white light better than electricity or gas. Doubles your light. Saves oil. **NO MANTLE TO BREAK.** Guaranteed Safe and Reliable. Delights every user. Send now for complete sample, postpaid 35 cts. stamps or coin. 3 for \$1. **MONEY BACK IF NOT SATISFACTORY.** Live Representatives Wanted. Exclusive Territory.

**WHITE FLAME LIGHT CO., 68 Clark Bldg., Grand Rapids, Mich.**



**Sunshine Lamp FREE!**

**300 Candle Power**

**To Try in Your Own Home**

Turns night into day. Gives better light than gas, electricity or 18 ordinary lamps at one tenth the cost. For Homes, Stores, Halls, Churches. A child can carry it. Makes its own light from common gasoline. Absolutely SAFE.

**COSTS 1 CENT A NIGHT**

We want one person in each locality to whom we can refer new customers. Take advantage of our **SPECIAL FREE TRIAL OFFER.** Agents Wanted.

**SUNSHINE SAFETY LAMP CO.**  
616 Factory Bldg. Kansas City, Mo.



The number of blind persons throughout the world is estimated at 2,300,000, the United States having upward of 57,000.

**KEROSENE Gas Lamps**

**Make Your Business Prosperous and Your Home Cheerful**

by using our "Safety" Kerosene and Gasoline Gas Lamps. If we are not represented in your town we want an agent.

**BRILLIANT GAS LAMP CO.**  
1609X So. Wabash Ave., CHICAGO, ILL.



**300 Candle Power of Light**

**AT A COST OF 1/8c PER HOUR**

The Kerosene table lamp has one inverted mantle and **MAKES and BURNS ITS OWN GAS FROM COMMON KEROSENE or COAL OIL.** It gives a bright and steady white light **TEN TIMES as BRILLIANT** as an ordinary kerosene wick lamp.

**THE "QUICKLIT"** Gasoline table lamp can be **LIT WITH AN ORDINARY MATCH, LIKE CITY GAS.**

*Both styles equipped with automatic cleaning needle.*

**No smoke, no smell, no wicks to trim. A splendid proposition for dealers**

**LIVE AGENTS WANTED** Write today for further particulars, also complete illustrated catalog describing the above kerosene and gasoline lamps and hollow wire systems.

**THE NAGEL-CHASE MFG. CO., 152-160 East Erie St., CHICAGO, ILL., U.S.A.**  
The largest manufacturers of artificial lighting devices in the world.



# 5000 Home Things—3¢ a Day

## Credit Without Asking No References Required

You are welcome to credit on home things here—one to three years' time.

There is no red tape. No references are required. Simply ask for our Bargain Book and your Credit Card will come with it. Then order what you wish here on open charge account.

## Your Own Terms

Pay as you get your money. Most wage-earning customers pay a little each month. Farmers pay when they sell their crops. Simply

tell us how you wish to pay, and let us make terms to suit.

## 1 to 3 Years' Time

Even on small orders we allow a year to pay. On larger orders up to three years. No extra price, no interest.

We furnish millions of homes, so our purchasing power is enormous. We guarantee to save you from 15 to 50 per cent under any other prices, or an average of 30 per cent. All goods are shipped on 30 days' trial under that guarantee. If we don't make that saving, return them.

# Pay Nothing for a Month

Send No Money for a Month  
Try This Handsome Sofa Bed \$14<sup>95</sup>



Solid Oak, With Royal Imitation Leather Upholstering

If You Order from This Paper you may pay the usual monthly terms of \$1.25 after 30 days' trial. Richly carved frame is solid oak. Extra broad arms are decorated with carved Dragon heads. Front posts are extra heavy, with carved claw feet. Side panels are full length and of extra strength.

Broad Seat and Back are upholstered in black royal imitation leather, neatly diamond tufted over full setting of oil-tempered springs. Is easily changed into a comfortable bed, measuring 72 inches long and 44 inches wide.

No. 28H4B248. Price ..... \$14.59

## 5175 Bargains in

Furniture	Carpets—Rugs	Refrigerators
Silverware	Draperies—Linens	Sewing Machines
Cameras	Curtains—Bedding	Kitchen Cabinets
Baby Cabs	Oilcloth, etc.	Carpenters' Tools
Clocks	Chinaware—Lamps	Guns—Kitchen Ware

**Silver Set Free!** Our Bargain Book offers a Silver Set free—Knives, forks and spoons. It tells how any woman can get it without effort. See the offer in our book.

## Spiegel, May, Stern Co.

833 W. 35th Street, Chicago

We ask no customer on our books to pay a penny in advance. Goods are shipped on 30 days approval. If you return them for any reason we pay freight both ways.

Our customers make their first payment after that 30 days.

No other concern offers terms like these. Think of it—credit without asking. All the time you need. Fix your own terms of payment. Nothing in advance. And a big saving guaranteed.

## Dollar Book Free

Our mammoth spring Bargain Book is ready. It pictures 5175 bargains in home things, many in actual colors. This book with the mailing costs us \$1 per copy, but we send it free. Ask us for it—write today. A postal card will do. Your Credit Card will come with it.

We also publish a Stove Book—  
Also a Watch and Jewelry Catalog—  
Also 1000 Spring Styles for Women.  
Just tell us which book you want.

### CUT OUT THIS COUPON

SPIEGEL, MAY, STERN CO. (1019)  
833 W. 35th Street, Chicago

Mail me your Spring Bargain Book.  
Also the books I mark below.

.... Stove Book. .... Watches and Jewelry.  
.... 1000 Spring Styles for Women.

Name .....

Address .....

Check which catalogs you want.

# Your Own Terms—1 to 3 Years

# The Truth About Poultry

Get the Facts by Reading

## The One-Man Poultry Plant



Successful Methods of Men on Farms or Small Acreage. Complete in twelve parts; printed in one volume.

By DR. N. W. SANBORN

**R**EAL work, with real poultry, on a real New England Farm. This is a simple story of what has been done by a man, at forty-five years of age, town bred and city educated, getting out of practice of medicine, buying a small farm in the hill country, and making a success of the venture. Not only is the rearing of chicks and the management of adult fowl completely covered, but the interesting side issues of fruit growing, grain raising and the production of milk, that cannot be escaped on a real farm. You get rugged facts—rarely found in print. The truth about poultry as found in actual life on a one-man poultry farm.

**You Can Do the Same, Book Tells How**

**OUR SPECIAL OFFER**—The One-Man Poultry Plant, in twelve parts (book form), and the American Poultry Advocate, one year, for only 50 cts., book and Advocate, three years, for only \$1.00, if order is sent at once.

Our paper is handsomely illustrated, practical, progressive and up-to-date on poultry matters. Established 1892. 44 to 132 pages monthly. 50 cents a year. 3 months' trial 10 cents. Sample copy free. Catalogue of poultry literature free. Address

AMERICAN POULTRY ADVOCATE, 523 Hodgkins Bldg., Syracuse, N.Y.

# THE LITTLE BABY GRAND INCUBATOR ONLY \$5

34 years' experience in successful incubator building is embodied in this wonderful incubator.

## Built of Steel—50 Egg Size

Strictly a business machine. Guaranteed to hatch in any climate, all seasons. Self-regulating; sanitary. Sent on receipt of price by parcel post or express, charges paid. Complete, ready to operate, with full instructions. Send check or money order today.



Your money returned if you are not satisfied. We are reliable. See your banker. Send for free catalog. **RELIABLE INCUBATOR AND BROODER CO.** Box B-61 QUINCY, ILL.



# 25 TIMES World's Champion Belle City



**Incubator** 402,000 in use. Get the whole story told by the Championship Winners in my big, free book, "Hatching Facts." With book comes full description of incubator and brooder—my 10-year money-back guarantee—low prices—full particulars—and my \$1300.00 Gold Offers. Learn how I paid one user \$150, another \$50, many from \$45 down. Write me today for Free Book. **Jim Rohan, Pres. BELLE CITY INCUBATOR CO.** Box 164, Racine, Wis.



# LICE PROOF NESTS



Knudson's wonderful patented galvanized Steel Nests (not trap nest) banish lice and mites, keep hens healthy, make more eggs. Six nests per section. Sold on money-back guarantee.

18 Nests \$10.00



## More Eggs

That's the name of our new booklet. Send for it today. Tells how to increase your egg production. Ask for book or send \$3.50 one set or \$10.00 set of three sections (eighteen nests).

KNUDSON MFG. CO., Box 700, ST. JOSEPH, MO.

# Build a Chicken Income



The first step is to get in touch with the Johnsons, who have pointed the way to 650,000 others. Let me send you the book and show you how you can start with a small outlay and get a good big income coming your way.

## Old Trusty

provides an assured income with big average hatches the whole year around. Write for low price made by big output this year. We pay freight, East of Rockies—give 40 to 90 days' trial—10 year guarantee.

**M. M. JOHNSON CO.** Clay Center, Nebr.



# CONDON'S NEW LIGHTNING RADISH



Finest Early Radish in Existence. Ready to eat in 14 days. To introduce Our Northern Grown "Sure Crop" Live Seeds we will mail you **Big Package "Condon's New Lightning Radish"** and our Mammoth Illustrated 1916 Garden and Farm Guide. Send name and address on postal today sure.

**FREE**

**CONDON BROS., Seedsmen,** Rock River Valley Seed Farm Box 605 ROCKFORD, ILL.



## GREIDER'S FINE CATALOGUE

of pure bred poultry; 70 breeds illustrated and described, many in color. Perfect poultry guide—all facts, Low prices on stock and hatching eggs. Incubators and brooders. 21 years in business. You need this book. Send 10c for it—today.

**B. H. GREIDER** Box 19 RHEEMS, PA.

# FOY'S BIG BOOK FREE



**POULTRY AND SQUABS FOR PROFIT.** An encyclopedia of poultry information. Written by a man who knows. Leading varieties of poultry and pigeons in natural colors. Low prices on fowls and eggs. **FRANK FOY POULTRY FARM, Box 76, Clinton, Iowa**



## "The Profits In Poultry Keeping"

Is title of big FREE 1916 Year-Book and Poultry Guide. Describes Cyphers Popular-priced incubators, 3 styles—8 sizes, \$12 to \$40. Twenty years leadership. Write today.

**CYPHERS INCUBATOR CO.** Dept. 161 Buffalo, N.Y. New York Boston Chicago Kansas City Dallas Oakland



# MAKING POULTRY PAY

depends more on the knowledge you have of Poultry Culture than on expensive equipment or extensive space.

Let Director Quisenberry teach you how to raise poultry successfully and make a good living and a nice profit from a flock of thrifty hens. If you want to save money and make money in the poultry business write us today for our large illustrated Free Book, "Dollars and Sense in the Poultry Business." It points the way to success.

**American School of Poultry Husbandry** Box 75 Mountain Grove, Missouri





# Again, Down Go Engine Prices

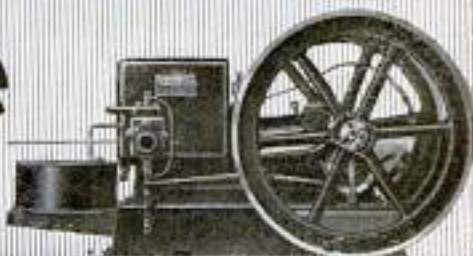

## Easy to own a good Engine Now for cash or on Easy Terms

ALL my business life I have done nothing but make engines. My factory is the only one which, starting in the engine business 29 years ago, has come through successfully under the same management with which it started. Only engine quality has made this possible. I have never had any trouble in keeping in the lead in engine quality. I had only to make the best engine I knew how, and to be honest and hold the respect and confidence of my customers. And I have done it. I take special pride in the fact that such a large part of my orders come through the recommendation of my old user-customers. This, together with the fact that I have for years had manufacturing advantages—including free natural gas from my own well for power, light and heat—explains why I am again able to reduce WITTE Engine prices another notch.

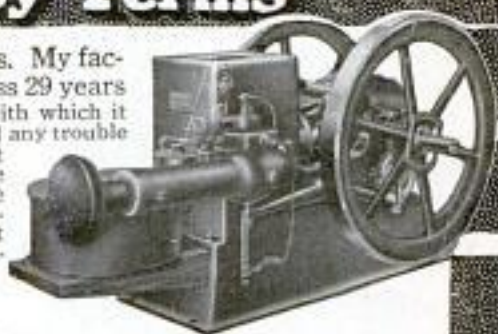

## WITTE ENGINES 5-Year Guarantee

**Kerosene, Distillate, Gasoline & Gas  
Stationary, Portable, Skidded and Sawrig Styles**

The rapid growth of my business has made it necessary to enlarge my already immense plant, more than doubling its former capacity. My entire factory is now better equipped than ever for economical engine production.



### Look at These Latest WITTE Prices:

**2 H-P \$34.95    4 H-P \$69.75    6 H-P \$97.75    8 H-P \$139.65    12 H-P \$197.00**  
**16 H-P 279.70    22 H-P 359.80    Portable and Sawrig Outfits proportionately low**

Engine quality is determined by the cost of operation, not alone by the price you pay to get it. The lowest cost of operation—the highest quality—comes from the smallest possible amount of fuel needed per horse-power hour—the certainty of steady power all day, as long as needed, with the least amount of watching and the least need of any repairs during the whole life of the engine. In this kind of quality, WITTE engines are known the world over, wherever they are used.

Write me today, so I can send you my new and liberal selling plan, under which a WITTE engine may earn its own cost while you pay for it.

### ED. H. WITTE, WITTE ENGINE WORKS

1740 Oakland Ave., Kansas City, Mo.  
1740 Empire Bldg., Pittsburgh, Pa.

### Most Understandable Engine Book FREE

Be sure to get my Great New Book before you arrange to try any engine. With my Book you will know **how to judge an engine**—how to pick out the engine that is best for your work—and what are the secrets of the old time high double prices in the engine business. If you don't say my book is worth

dollars to you in finding out about engine quality and value, I'll pay the postage to get it back.



ED. H. WITTE  
WITTE ENGINE  
WORKS

1740 Oakland Ave.,  
Kansas City, Mo.  
1740 Empire Bldg.,  
Pittsburgh, Pa.

With no obligation on my part, I should like to receive your latest and finest Engine Book, with your new Liberal Selling Plan.

Name.....

Address.....



Mail coupon  
for your free  
copy today.

postage to get it back.

Please Mention Popular Mechanics

## A Good Tip

THIS patent finger-tip gives the glove extra resistance just where it gets extra wear.

It is extra durable where the ordinary glove is weakest. Your hands will feel good, too, in this smooth *outseam* style.

## Hansen Gloves



This re-enforced tip is one reason why a Hansen is cheapest—because it wears best and longest. Made of horsehide and buckskin.

Insures you against heat, steam and hurt—with fine appearance. We have a wide line—500 individual styles of gloves and mittens, all of snug yet easy fit.

**Write for Free Book** Containing helpful information on hand protection. Write for it. Your dealer should have Hansen Gloves. If he hasn't we will see that you are supplied.

**O. C. HANSEN MFG. CO.**

291 Al Milwaukee St., Milwaukee, Wis.

## Here's a New Business



Reproduce Photographs of persons and scenes upon watch caps, dials, china, etc. Work easily done. Knowledge of photography not necessary. **TRIAL OUTFIT** with directions, \$2 postpaid—Contains enough solutions to make 16 reproductions (watch cap size) that you should sell from \$1.50 to \$2.50 each. Satisfaction guaranteed. **ORDER TODAY.**

American Arts & Crafts Company, Dept. D1, Boston, Mass.

**1/3 SAVED** Buy Direct From MANUFACTURER

**FREE BOOK**

### Do Your Own Plumbing and Heating

**NEW HARDIN EASY WAY**

Get our "Handy-Man" Free Book. Every home needs it. Shows new home improvements and everything in plumbing and heating supplies EXCLUSIVELY at wholesale prices—complete heating plants, bathroom outfits, sinks, pipe, fittings, water systems, lighting plants, etc. Any handy man can install our goods with this free book and free easy installing plans. \$500,000 plants behind our guarantee. Write today.

**The Hardin-Lavin Co.** 40 years at 4540-50 Cottage Grove Ave. **Chicago**

## TYPEWRITERS FACTORY TO YOU

Look at these bargains! Typewriters Rebuilt in our own Factories, and guaranteed for one year.

Underwoods \$25 to \$70	Royals \$25 to \$65
L. C. Smiths \$30 to \$55	Olivers \$20 to \$45
Brand new No. 2 Smith Premier \$45	
Special this month, Remington Visible No. 10, \$28.50	

We have others, of course. Send for catalogue describing them. Branch offices in principal cities.

**American Writing Machine Co., Inc., 345 Broadway, N. Y.**

## Typewriters

— All makes, Factory Rebuilt by the famous "Young Process"; look like new, guaranteed like new. Our big business insures "Square Deal" and permits lowest cash prices — \$10 and up; also machines rented — or sold on time. No matter what your requirements are, we can best serve you. Write and see — NOW.

**YOUNG TYPEWRITER CO., Dept. 356 CHICAGO**

**DOG CEMETERIES OF THE WORLD**—There are six principal cemeteries for dogs in the world, one in London, one in Paris, one in Dedham, a suburb of Boston, and the remaining three in the state of New York. These are Kanis Ruhe (Dog's Rest) on Yorktown Heights, near Peekskill; the Hartsdale Canine Cemetery, also in Westchester County; and the modest but beautiful burying ground at Hornell, in the western part of New York, says Our Dumb Animals.

## 10 Cents a Day

**Pays for This Cornet** An astounding offer! Only 10 cents a day buys this superb Triple Silver Plated Lyric Cornet. **FREE TRIAL** before you decide to buy. Write for our big new 250-page Band Catalog. Rock-bottom, direct-from-the-manufacturer's prices on all kinds of instruments. Pay for them at the rate of only a few cents a day. Generous allowances for old instruments. Free Trial. We supply the U. S. Govt. Write now.

**THE RUDOLPH WURLITZER CO., Dept. 1192**  
4th St., Cincinnati, Ohio S. Wabash Ave., Chicago

**WURLITZER**  
100 years of instrument making

Carrying Case Free with this superb triple silver plated Lyric Cornet.

## Health? Take Turkish Bath at Home—Only 2 Cents

Physicians are abandoning drugs for this new treatment. If your mind or body is tired, open your pores and feel the rapid change in your condition, at cost of 2c a bath. The Robinson Bath Cabinet is the only scientifically constructed bath cabinet ever made for the home. **Great \$2 Book Sent Free**—"The Philosophy of Health and Beauty." Write today. Agents Wanted.

**ROBINSON MFG. CO.**  
853 Factory Bldg. **TOLEDO, O.**

# DIAMONDS ON CREDIT

## BEAUTIFUL DIAMONDS SENT ON APPROVAL

### NO MONEY DOWN

Order any diamond from our catalog; we will send it, all charges paid. After you have made a thorough examination and are satisfied as to the quality and value, pay 20% of the price and only 10% per month thereafter. If not satisfactory, return it at our expense. Don't pay a cent until you are satisfied. Certificate furnished guaranteeing the quality of every diamond. Exchangeable any time for any other article at an annual increase in value of 7 1/2%. Send for our catalog Deluxe No. 6, it's free. **L. W. Sweet & Co., 2 & 4 Maiden Lane, New York City**





## A Judge Can't Smoke

in the courtroom — but he's going to enjoy his tobacco just the same. He gets a good, juicy chew of "PIPER" — that's the tobacco — *real* tobacco — rich and mellow — and chewing it gives him calmness — "the poise that comes from rumination"! When you chew

# PIPER Heidsieck

CHEWING TOBACCO—Champagne Flavor

you get the epicure's delight. The taste of "PIPER" carries with it that wonderfully wine-like flavor which has made the brand so justly famous. It combines with all the natural richness of splendid tobacco the mellow tang of ripe champagne.

Try "PIPER" just one week.

5c and 10c cuts, foil-wrapped, in slide boxes. Also 10c cuts, foil-wrapped, in metal boxes.

THE AMERICAN TOBACCO COMPANY

You'll see why thousands and thousands of American men of brains and eminence have used "PIPER" for years.

Only finest leaves of choicest tobacco go into the making of "PIPER." We go to the utmost expense to keep this superb tobacco clear up above all others, in a class by itself.



# PATENT SPECIALISTS

## VICTOR J. EVANS & CO.

### LARGEST PATENT AGENCY IN THE WORLD



THE largest Patent Agency in the world is the firm of Victor J. Evans & Company, of Washington, D. C., with branch offices in New York City, at Nos. 189, 191 Broadway; in Philadelphia, at No. 1429 Chestnut Street, and in Pittsburgh, at No. 514 Empire Building. The growth of this firm has reached such proportions as to necessitate the erection of a special building, the Victor Building, Nos. 720, 724 Ninth St., N. W., Washington, D. C., opposite the United States Patent Office, is the finest and most perfectly equipped office building in the country devoted exclusively to the patent business.

Evans & Company are but following the practice of the Patent Office, who, realizing the impossibility of any one man having a general knowledge sufficient to handle all classes of cases, have divided the Patent Office into forty-two divisions, each handling several classes of inventions, and it is through this system of specialists and experts forming the technical corps of their offices that this firm is enabled to secure



### Specialization

The field of invention is so vast that it is impossible for any one man to become an expert in all the different classes of invention. Only those practically skilled in the class to which an invention relates are capable of rendering efficient service. For this reason, this firm employs a number of patent lawyers and mechanical experts who have been selected for their special knowledge and ability in a certain line of invention.

In equipping their offices with experts and specialists who devote their time to one or two inventions, Messrs. Victor J.



### Patents that Protect and Pay

Any one will appreciate the advantage of this corps of experts over other attorneys, where one man has to handle all classes of patents submitted. This firm is enabled to direct a particular invention from the time it is submitted until the patent is secured, in the hands of experts in the class to which the invention relates, thus securing the best possible services. This firm has also helped a number of inventors who were in need of financial aid to obtain patents. This was accomplished by means of their Certificate of Patentability, which furnished the necessary proof of patentability, and thus enabled their clients to interest partners or secure financial assistance to protect their ideas.



### Assist Their Clients to Sell Their Inventions

Victor J. Evans & Company also assist their clients to sell their inventions by connecting the inventor with capital. They are constantly in receipt of requests from manufacturers, promoters, mail-order houses and others who are in the market for patents secured by them. They give their clients a list of Patent Buyers containing names and addresses of the persons desiring to purchase patents. This firm also advertises their clients' inventions free in Manufacturing Journals.

### Our Four Books Mailed Free

"HOW TO OBTAIN A PATENT" contains one-hundred mechanical movements illustrated. "WHAT TO INVENT" contains a valuable list of inventions wanted; also information concerning prizes offered for inventions amounting to \$1,000,000. "PATENTS THAT PAY" contains letters from clients for whom we have secured profitable patents. "FOREIGN PATENTS" contains full information regarding patents in foreign countries. Persons interested in patents should write for these books, which will be sent upon request, entirely without charge, by filling out the annexed coupon.



**FREE COUPON!**  
**VICTOR J. EVANS & CO., Patent Attorneys**  
 New York Offices: 189-191 Broadway Philadelphia Offices: 1429 Chestnut St.  
**ADDRESS MAIN OFFICES: 765 Ninth St., N. W. WASHINGTON, D. C.**

This Coupon, accompanied by model or sketch, with description of invention will entitle the sender to Free Opinion as to Patentability.

GENTLEMEN: Please send me FREE OF CHARGE your FOUR Books as described above.

NAME .....

ADDRESS .....

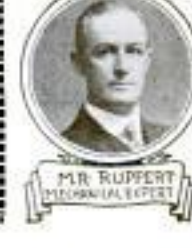

Please Mention Popular Mechanics

# WANTED IDEAS



Inquiries from Manufacturers and Other Buyers of Patents  
Who Are Looking for Good Ideas

## Protected by Owen Patents

Are constantly being received. Hundreds of ideas are wanted—a market exists for them to-day. YOURS may be one of them. Send for my free books and see for yourself—read the requests for inventions protected by me. Many are simple. You can help supply this demand.

As soon as my clients' rights are protected I aid in every practicable way, without charge, to sell. Their applications are advertised free—their patents are called to the attention of the proper prospective buyers—every necessary thing is done. Get my booklets and see.

## THESE ARE FREE

You will incur no obligation by writing me. A simple request will bring them to you—the finest, most reliable and instructive patent books published. A postal will do.

**"Successful Patents"**—a 72 page guide book, tells how to proceed; describes my advantageous business methods; gives references, testimonials, etc.

**"Stepping Stones"**—gives hundreds of hints of inventions wanted; articles from interviews of noted authorities; tells the truth about prizes for inventions.

**"Patent Promotion"**—tells you how to sell; why some inventors fail; discusses the value of your idea; how I aid my clients; manufacturing aids furnished you; recent successful patents, etc.

You will also be sent from time to time, as new inventions are wanted, full information concerning them. Only in this way can you keep up to date.

### Write for These To-day

Advice costs nothing. All communications confidential. Your work will receive my personal supervision—but my fees are no higher than others.

### Results Speak Loudest—But Here Are Some References

Columbia National Bank,  
Washington, D. C.  
National Locktile Co.,  
Washington, D. C.  
The Carnahan Press,  
Washington, D. C.  
Lightning Gun & Cycle Works,  
Oklahoma City, Okla.  
Antholene Mfg. Co.,  
Hutchinson, Kans.

National Back Co.,  
61 Hannover St.,  
Boston, Mass.  
The C. J. Loftus Co.,  
13 Spring Common,  
Youngstown, Ohio  
Whitehead Hosiery Mills,  
Burlington, N. C.  
Dickinson Mfg. Co.,  
Des Moines, Iowa.

A LARGE NUMBER OF OTHERS IN MY BOOKLETS.

### SPECIAL FREE REPORT

Send sketch or model of your invention for free report on patentability, practicability, etc.

**RICHARD B. OWEN** 9-303 OWEN BLDG.  
WASHINGTON, D. C.

Inventors submitting their inventions to me are protected in a tangible manner until their applications are filed.



# PATENTS SECURED OR FEE RETURNED

Latest and Most Complete Patent Book Ever Published for Free Distribution

WRITE FOR IT

Compare My **SERVICE** and **TERMS** with Those of Any First Class Attorney

Send Sketch, Photograph, or Model of your invention for an **ACTUAL SEARCH** of the Records of the Patent Office and report as to patentability — **FREE**. I give every detail of every case my closest personal attention and do not entrust your interests to assistants. Impartial advice on your ideas. I help you sell your patent. Terms moderate. My 90-page book tells what inventors should know before they apply for a patent.

**GEORGE P. KIMMEL**, Patent Lawyer, 200 Barrister Bldg. Washington, D. C.

## Inventors

Do Not Sacrifice Your Inventions

Get full money value. RELIABLE Book Free. Write

R. S. & A. B. LACEY  
624 Barrister Bldg., Washington, D. C.



**IDEAS = MONEY**  
**PATENTS THAT PAY**

Over \$600,812.00 made by clients. Proof given. Send data for free advice.

**2 WONDERFUL GUIDE BOOKS FREE**

Don't miss these books. Mail postal today.

**E. E. VROOMAN & CO., 871 F St., WASHINGTON, D. C.**

Send for **FREE BOOK** { **WHAT TO INVENT**  
**WHAT NOT TO INVENT**  
**HOW TO SELL YOUR PATENT**  
Copies of nearest Patents and report in every case without charge  
**H. L. WOODWARD, 9th and G Sts., WASHINGTON, D. C.**

## PATENTS

**C. L. PARKER**  
Formerly Member Examining Corps, U. S. Patent Office  
**PATENT LAWYER**  
MCGILL BLDG.  
WASHINGTON, D. C.

Patents, Trade Marks, Copyrights, Patent Litigation

Handbook for Inventors, "Protecting, Exploiting and Selling Inventions" sent free upon request.

Active Powers of Invention Center



**INVENTORS** Our Brain Belongs to You. Our Ideas Are Free of Charge.

All we want in return is to build your model, special machinery, dies, tools and jigs to manufacture sheet metal goods, etc. We are expert mechanics, over thirty years' experience and have one of the best equipped shops in the country. Ask for Booklet No. 17. Consultation free. Experimental work strictly confidential.

**A. Naecke & Son, J. Ohmann, A. Heldrich, Prop's**  
236-242 S. 9th St., Philadelphia, Pa.



SETS OF CASTINGS OF MODEL ENGINES

ALL CASTINGS TO ORDER  
CLEAR WHEELS & PARTS OF MOTORS  
H. H. WIGHTMAN & CO.

**MECHANICAL SUPPLIES AND MATERIAL** of all kinds. EXPERIMENTAL AND LIGHT MACHINE WORK to order.  
132 MILK STREET. BOSTON

**NEW WIRELESS SYSTEM PLANNED IN SOUTH AMERICA**—The Argentine government recently granted a concession to a New York company for the construction of a high-powered wireless station near Buenos Aires. It is to be one of a series of such stations in various countries of Central and South America. The system is said to be the same as that adopted by the

## Protective Patents

Procured Promptly. No fee refund, no guarantee certificate, no so-called prize or free search schemes used in our business. Inventors 112 page Blue Book sent on request.

**Robb & Robb, 211-215A Southern Bldg., Washington, D. C.**

# PATENTS THAT PROTECT and PAY

Advice free. Terms reasonable. Highest references. Best results. Send sketch or model for FREE examination and opinion.

**BONDED** and recommended Patent Lawyer in the Rand-McNally Directory of Bankers and Attorneys Published by Rand-McNally & Co., Chicago, Ill. Recommended Patent Attorney in the Bankers Register and special list of selected lawyers published by the Credit Company, Pontiac Building, Chicago, Sharp & Alliman's Directory of Lawyers and Bankers of Philadelphia, Martindale's American Legal Directory of New York City, and the Con. P. Curran Directory of Bankers and Lawyers of St. Louis.

**ALL BUSINESS GIVEN PROMPT AND PROPER ATTENTION**

A large list of strong recommendations furnished free

**WATSON E. COLEMAN, Patent Lawyer, 624 F St., Washington, D. C.**

# Manufacturers Calling for Over Two Hundred Inventions

## Money Is Waiting to Back the Good Idea

(By a Washington Patent Attorney)

Never was there so good an opportunity for the inventor of something—*anything*—of merit as right now.

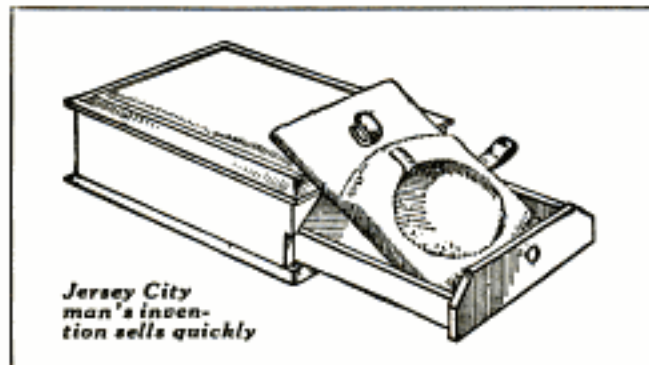

Jersey City man's invention sells quickly

Manufacturers with money and facilities are asking for ideas—*calling* for them. The supply is not nearly equal to demand. Over 200 inventions are asked for in a list just given in a little book "What to Invent." The demand is not for anything extraordinary—just the common everyday things that make work easier or life more pleasant in the household, the shop or the field.

You might think the possibilities of the window screen had been exhausted, but I know of 28 concerns that are looking for a new screen, duly covered by patent, which they can manufacture. I know of 46 manufacturers and others who are ready to manufacture any good, patented household article such as can openers, baking pans, coffee pots, washing machines, carpet sweepers and other devices.

Within the last few weeks I have received forty special requests for a dishwasher and drainer; seventeen others request an improvement in scissors. Manufacturers know that everyone must have a pair of scissors in the house, and they realize that a novelty in them would always sell in place of the old kind, and hence the demand. Among my letters are sixteen requests for a device to turn sheet music on a music stand or piano, and seventeen people are interested in the purchase of a patent on a device for holding an electric light in any position. Besides these there are hundreds of manufacturers who do not specify any particular device but state that they would be interested in anything of merit.



Coupling hook adopted by Pennsylvania R. R.

A Chicago man says: "I want something that can be sold to farmers by mail. There is practically no limit to the investment my associates would make in a good proposition." A man in Woodhaven, N. Y., says he is in the market for a small household article, light in weight, which can be sold somewhere around ten cents.

A prominent manufacturing company is interested in something to sell to hardware stores, but would also be interested in other things promising to be money-makers.

A man in Revere, Mass., says: "I am looking for something that can be manufactured, plant equipped, etc., and marketed for an outlay of not over twenty-five thousand dollars."

A big textile machinery company says they are interested in newly patented devices that can be either bought outright or manufactured on royalty. They do not require machinery inventions alone, but anything of merit.

A company in Belvidere, Illinois, wants patents on small tools or metal novelties.

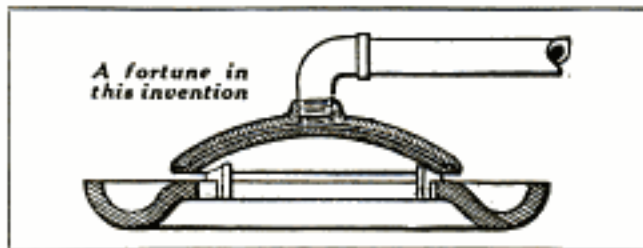

A fortune in this invention

A Dayton, Ohio, concern writes for some machine or device that would have a general sale throughout the land.

The names and addresses of these prospective purchasers are supplied absolutely without charge by Messrs. Chandlee & Chandlee to those who obtain patents through their firm. This firm has been in practice before the Patent Office for over twenty years, and its members are, consequently, familiar with every detail of patent work. They also issue a booklet entitled "How to Obtain a Patent," which tells in simple words just how to go about protecting an invention. The two books, "What to Invent" and "How to Obtain a Patent," are both free. Why don't you write for them and learn what manufacturers are looking for and how to protect your ideas? If you have an invention, send a sketch or model and description of it to Chandlee & Chandlee, 969 F Street, Washington, D. C. They will give you a free opinion as to whether or not it can be patented.

# U.S. PATENTS



**FREE** →

**BOOK-BULLETINS & ADVICE**

**REGISTERED ATTORNEYS**

**LANCASTER & ALLWINE**

204 OURAY BLDG.

WASHINGTON, D. C.

## Don't Lose Your Rights

We publish forms called "Evidence of Conception" by which you can establish your rights before sending the invention to anyone. It is your best protection. We issue up-to-date bulletins of improvements wanted; aid inventors to promote their rights; render reliable opinions free of charge and secure valuable patents and trade marks on reasonable terms. Personal service assured by our **Service Guarantee Contract**. References: 2nd National Bank, Washington, J. P. Roth Packing Co., Cincinnati.

### SIMPLY MAIL COUPON

LANCASTER & ALLWINE, 204 Ouray Bldg., Washington, D. C.  
Send me free, book "Inventions—Patenting and Promoting," Bulletins of Improvements Wanted and blank form, "Evidence of Conception."

Name.....

Address.....



A complete line of appliances for the transmission of Power. Anything from a bolt to a complete mill or factory outfit. Send for catalogue. Largest Manufacturers of Pulleys in the country.

**W.A. Jones Foundry & Machine Co.** 1400 W. North Ave. CHICAGO

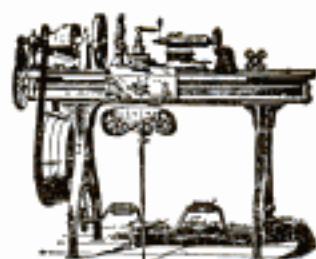

# LATHES

**9 to 18-inch Swing**

List price \$75 and up according to size. When ready to buy send for Lathe Catalog and prices.

**W. F. & John Barnes Co.**  
100 Ruby Street, ROCKFORD, ILL.

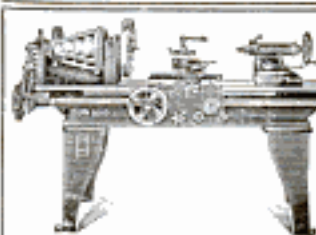

## South Bend Lathes

For the Machine and Repair Shop

**How to Run a Lathe**  
A 50 cent book for 10 cents. Postpaid, stamps accepted.

**Straight or Gap Beds.** Send for free catalog giving prices on entire line.  
**SOUTH BEND LATHE WORKS**  
423 Madison St., South Bend, Ind.

**FORTUNES are LOST in PATENTS which do not PROTECT the INVENTION**

## NORMAN T. WHITAKER

PATENT LAWYER

ATTORNEY AT LAW and MECHANICAL ENGINEER

Former Ass't Examiner U. S. Patent Office

Suite 22 Legal Bldg. (Opp. U. S. Patent Office)  
WASHINGTON, D. C.

Advice Free

Inquiries Solicited

Competent Service

Prompt Attention

# INVENT SOMETHING

Your Ideas may bring wealth. Our Free Book tells what to invent and How to Obtain a Patent through our New Credit System. Write today. **WATERS & CO., 4102 Warder Bldg., Washington, D.C.**

## Models and Gears

## Experimenters—Inventors

Developing inventions and making working models our specialty. Well equipped shop and staff of experts at your service. Carry complete stock of gears. Shipments same day order received. Send 4c stamps for booklet of inventors' supplies. **UNION MODEL WORKS, Est. 1882, 121 S. Clark St., CHICAGO**

United States recently for long-distance communications. The object of the wireless development is to place these countries in direct and intimate touch with North Amer-



## MODELS BUILT FOR INVENTORS

Practical, economical and modern methods of Model and Machine construction. Scientific Experimental Work. Expert designing and building of special Models, Tools and Machinery. Our staff of Skilled Mechanics assist customers to develop and perfect ideas, patents and inventions, etc. Let us take care of your mechanical requirements. **Regal Model & Tool Works, 122 S. Clark St., Chicago**



## BRASS GEARS

Cut by an entirely new process. The most accurate made and at prices that cannot be equalled by others. Every gear has a hub, center painted ebony black, edges turned true, highest grade red brass, and much heavier than others. We carry the largest stock in the world and every gear listed is always shipped on date of order.

SEND FOR CATALOGUE

**CHICAGO STOCK GEAR WORKS**  
16 S. Fifth Av. Chicago

# SEBASTIAN LATHES HIGH QUALITY LOW PRICES

If you delight in good tools you will delight in Sebastian Lathes. For 25 years we have built lathes, and lathes only, employing skilled labor always, and improving equipment and machinery every year. Sebastian Lathes are **STANDARD FOR QUALITY—LOW IN PRICE**

They are accurate, economical, simple and durable. Many re-orders and voluntary letters from users of Sebastian Lathes prove this. The Sebastian reputation is back of every Sebastian Lathe. You are judge and jury when you buy a lathe. We are not satisfied until you are. Look over the complete line in our new catalog. It shows Lathes for general repair work, garage and automobile work, etc.

When you buy a lathe, say "Sebastian"

ADDRESS (FOR THE CATALOG)

**THE SEBASTIAN LATHE COMPANY, 107 Culvert St., Cincinnati, Ohio**

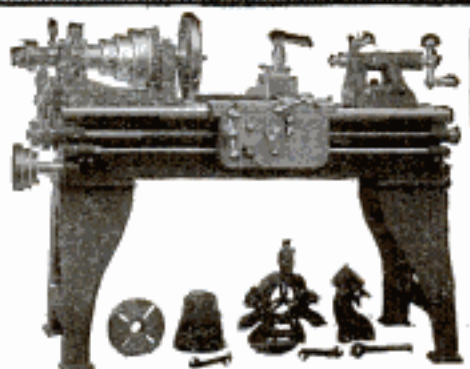

# Wanted—Ideas Inventors! Send for these Remarkable FREE BOOKS, Today

Complete and full information about patents, everything the inventor or manufacturer should know, has been included in these books. Never before has such an inexhaustible fund of valuable information been at the inventor's disposal. Regardless of the fact that the compilation of this information cost us thousands of dollars, we will send to all interested persons, any or all of these books, entirely without charge or obligation.

## “Millions In Patents”

This volume, 192 pages, tells the story of the romance of invention. The brain of the inventor is the magician that has made the ancient fairy tales come true. Millions have been paid for a hook, fortunes have come from a toy. Read “Millions in Patents,” and you will realize that this country and all the nations of the world are ready to enrich you beyond your wildest dreams if you can contribute one useful or amusing thing.

## “What Is a Trademark?”

It is not an exaggeration to say that billions of dollars have been made out of trademarks, labels and copyrights. He who can fashion a trademark or design a label which will make a product stand out above all similar products, is indisputably a genius for whose brains the world offers almost unlimited money.

## “Foreign Patents”

A good invention is bought not by one country but by the world. “Foreign Patents” shows you how the inventor may be paid by other countries and other peoples, as well as by this nation, for his ideas and his inventions. It explains how we, through our representatives in the capitals of the world, maintain for your benefit an endless chain of opportunities which, if you take advantage of them, will girdle the earth and make of your product an agent that may bring back to you rich rewards.

## “Inventions Needed”

This book, 256 pages, lays before you a description of the active and profitable field of invention. It tells you the inventions the world needs today, the devices manufacturers are seeking for their business, the ideas for which the public will pay big money. It gives great men's ideas of the most important things needed in inventions now. Science is the key to wealth, and this key can be turned best by the inventor. This book tells you why.

## “How to Get Your Patent and Your Money”

The man who invents needs the co-operation of the man who invests. This book, 132 pages, is a guide to the inventor. It describes, according to the teachings of our experience and the lessons of men made rich by patents, how the inventor may secure money; the right amount of money, for the device which his brain has constructed. If you have invented something and desire to learn what it will cost you to get your patent and what you must do to find your market, read this book.

## “Special Bulletin of Patent Buyers”

This bulletin, 64 pages, contains copies of hundreds of letters from wealthy men who are seeking to purchase patents. Next to the idea of the invention itself, the most valuable thing to the inventor is a hint of where there is a man ready to buy the invention or to finance the inventor so that his device can be readily marketed. We act as intermediary, without one cent of charge, between the man who invents and the man who invests.

We Secure Reliable Patents, Trade Marks,  
Copyrights, On Most Liberal Terms  
Ever Offered

Send Model or Sketch and Description of  
your invention for Free Search of  
the United States Patents

Rejected and Difficult Cases are Our Specialty

**RANDOLPH & CO.**  
600 F St., N. W., Washington, D. C.

**RANDOLPH & CO.,**  
WASHINGTON, D. C.

Gentlemen: Please send me, without obligation on my part, the books indicated on margin of this coupon. (Write on margin of coupon, names of books desired.)

NAME.....

STREET.....

CITY.....

STATE.....



**Earn \$125 to \$250 a Month**  
 in the Steam Engineering field. Prepare in your spare time for a Stationary or Marine Engineer's license, or position as Locomotive Engineer. These great books, written by 27 experts, contain all the information necessary to take up this well-paid work.

**Steam Engineering**

7 volumes; 2000 pages, 1x3 1/2 inches; 2500 illustrations, full page plates, diagrams, etc.; hundreds of valuable tables and formulas. Handsomely bound in half red morocco, gold stamped. Covers the construction and operation of stationary, locomotive and marine engines and boilers; the use of gas and gasoline engines for power and locomotion; the transformation of steam and gas power into electricity, and the application of steam and gas power to refrigeration, compressed air, etc.

**Examine These Books Free of Charge**

The entire seven volumes, not a sample volume, will be sent, express prepaid, on receipt of the coupon below. Look these books over for a whole week free. Then decide whether or not you want them. If you do, send us \$2.00 within seven days and \$2.00 a month - 80c a week - until the special advertising price of \$12.50 has been paid. Otherwise we'll take them back at our expense. In addition to this liberal discount from the regular price of \$35.00, we include with each set a \$12.00 Consulting Membership. This entitles you to the advice of a staff of experts for a whole year free.

**American Technical Society, Chicago:**

Please send Cyclopaedia of Steam Engineering for 7 days' free examination. I will send \$2.00 within 7 days and \$2.00 a month until I have paid \$12.50; otherwise I will notify you and hold the books subject to your order. Title not to pass until fully paid. Pop. Mech. 2-14

NAME.....  
 ADDRESS.....  
 REFERENCE.....

**The CRESCENT BENCH JOINTER**



is a handy machine for any wood worker to have. It is light, yet strong and durable, thoroughly efficient and gives satisfaction wherever used.

Ask today for our catalog giving complete description and listing about our line of hand saws, jointers, saw tables, planers, planers and matchers, disk grinders, swing cut off saws, stoppers, borers, mortisers, Universal wood workers, variety wood workers.

THE CRESCENT MACHINE CO., 93 Columbia St., Leontia, O.

**DO YOU HAVE KNIVES TO GRIND, SILVER TO POLISH, SMALL TOOLS TO OPERATE, WASHING MACHINES OR WRINGERS TO RUN? LET THE RED DEVIL**

**DO YOUR WORK**

Attached to any water faucet will develop up to 3 Horse Power according to size of pipe and water pressure. Only perfect small motor made. Improved bucket wheel construction.

6 in. Motor for Mechanics and Tradesmen, Washing Machine, 1/2 H. P., on 1/2 in. pipe, 50 lbs. water pressure; 1 H. P., on 3/4 in. pipe, 2 in. pipe. Net price \$5, cash with order.

No. 1422-4 in. Motor for grinding, polishing, fans, sewing machines; for Doctors, Dentists, Druggists, etc., with emery, buffing wheel, silver polish and pulley, \$3.

No. 1423-4 in. Motor and pulley only \$2.50, cash with order.

Money back for any reason. Order your motor from dealer or from us. Send your water pressure and size of supply pipe. Active Agents wanted. Catalog free.

Only Motor to do this work



**DIVINE WATER MOTOR CO DEPT P. UTICA, N.Y.**

**"IDEAL" Lawn Mower Grinder**



Grinds all makes of Mowers perfectly in 15 minutes without removing wheels, ratchets or reel-knife. Ball-bearing; operated by either hand or power. Skate Sharpener Attachment for sharpening skates.

"You Grind It As You Find It"

**Write Today** for full information of this great labor-saver and money-maker. Will do the work so much better, quicker and easier you cannot afford to do without it. The only practical machine for sharpening Lawn Mowers on the market. Over 7000 in use. Fully warranted. Sold on easy-payment terms. Write today. Don't delay.  
**THE ROOT-HEATH MFG. CO., Plymouth, O.**

ica, and through it with Europe and the Orient. Up to the present practically all news between Argentina and the United States has gone through European agencies.

**MONEY FREE BIG BOOKLET TELLING HOW TO GROW MUSHROOMS**  
 at home all the year. Big profits. Take advantage of this wonderful opportunity to become independent. Write Nat'l Spawn Co., Dept. 12, Boston, Mass.

**BUY PLUMBING and HEATING SUPPLIES at WHOLESALE Will Save You 30%**  
 Don't pay retail prices. Full stock on hand for prompt shipment. Send for free catalog.  
**B. P. KAROL, 800-802 South Kedzie Ave., CHICAGO**

**Runs on Alcohol At Cost of Less than 1/2c an Hour**  
 anywhere without electricity, springs or batteries. Superb construction. 12-inch blades. Adjustable roller bearing. Reliable. A proved comfort. Prompt delivery. The original and only Lake Breeze Motor manufactured according to the design of the inventor and under his direct and personal supervision.  
**Keep Cool \$15 Cash with Order**  
**Lake Breeze Motor, 122 N. Jefferson St., Chicago**

**Water Pumps Water**

with a Rife Ram. Plenty of it for every purpose about your farm and country home - day and night, winter and summer, without fuel, labor, freezing or repairs. The

**RIFE RAM**

is operated by any small stream having a fall of three feet or more and a supply of three or more gallons per minute. Fills high elevated tanks or operates air pressure system. Easy to install. First cost the only cost. Always on the job; over 11,000 in daily use. Tell us your water supply conditions. Ask for free estimate and catalog. Now is the time to install. Write today.

**RIFE ENGINE CO., 3131 Trinity Building, NEW YORK**





# PATENTS

OVER 70 YEARS' EXPERIENCE

TRADE MARKS  
DESIGNS  
COPYRIGHTS, &c.

Anyone sending a sketch and description may quickly ascertain our opinion free whether an invention is probably patentable. Communications strictly confidential. HANDBOOK on Patents sent free. Oldest agency for securing patents. Patents taken through Munn & Co. receive special notice, without charge, in the

## Scientific American.

A handsomely illustrated weekly. Largest circulation of any scientific journal. Terms, \$3 a year; four months, \$1. Sold by all newsdealers.

**MUNN & CO.** 672 Woolworth Bldg., NEW YORK  
Washington Office, 625 F St., Washington, D. C.

## MOVING PICTURE BUSINESS

Write For  
FREE Catalog



On Our Easy Payment Plan

Make \$20 to \$50 per night

With our Moving Picture Outfit  
We sell everything—Films, too.

Moving Picture Sales Co.  
Dept. P 540 Plymouth Place, Chicago, Ill.

## BIG CHANCE FOR AGENTS



You can earn BIG MONEY

Selling the most complete line of guaranteed transparent handle Knives and Razors with Photo, Name and Lodge Emblem—also full line of cutlery. Write today for catalogue and terms. Golden Rule Cutlery Co., 554 W. Lake St., Dept. 325, Chicago, Ill.



Print  
Your  
Own

Cards, circulars, book, paper. Press \$5. Larger \$25. Rotary \$60. Save money. Print for others, big profit. All easy, rules sent. Write factory today for catalogue of presses, TYPE, cards, paper, samples. It will pay you well. THE PRESS CO., Meriden, Connecticut

## Go into MOVING PICTURE BUSINESS

Small Capital Starts You

on our easy payment plan. Begin now and get your share. We sell everything. Write TODAY.

Atlas Moving Picture Co.  
Dept. 40 525 S. Dearborn St., Chicago

## You Can Make Big Money

C. F. Larson has made over \$1000, selling Matchless Gas Lighters.

E. C. Haines made \$17.19 in one day. You too can make big money.

The Matchless Gas Lighter lights gas or gasoline. Safer, cleaner, handier and cheaper than matches.

Send 25c for agents' sample and big money making offer. STEEL STAMPING CO., Dept. 29, 143 W. Austin Avenue, CHICAGO

# DIAMONDS

ON CREDIT—\$  
TERMS AS LOW AS

# 250

A MONTH

Ladies' Loftis  
Becher Ring  
designed  
to make  
Diamond  
appear  
larger  
than  
it  
is.

Great Reduction  
in Credit Terms  
and Prices  
Think of it! A high  
grade, guaranteed,  
genuine diamond, per-  
fect in cut and full of  
flery brilliancy, set in  
solid gold or platinum  
mounting for only \$2.50  
a month—8 cents a  
day.

The Loftis  
7-Diamond  
Cluster Ring  
Contains 7 Dia-  
monds set so that the  
cluster has the appear-  
ance of a beautiful Sol-  
itaire Diamond that  
costs 3 or 4  
times as  
much.



Send for 116-page Jewelry Catalog containing over 2000 beautiful illustrations of Diamonds, Watches, Silverware, etc. Make a selection either for yourself or as a gift for a friend or loved one. We will send the article for your examination, all charges prepaid by us. You assume no risk; you are under no obligation. You Don't Pay a Cent until you see and examine the article. If perfectly satisfied pay one-fifth of the purchase price and the balance in eight equal monthly payments. If not entirely satisfied, return at our expense. Whether you buy or not, get Our Catalog. It is an education in Diamond and Jewelry values and easy credit buying. Send for catalog today—before you forget. It is FREE.

LOFTIS BROS. & CO., The National Credit Jewelers  
Dept. K894, 100 to 108 N. State Street, Chicago, Illinois  
(Established 1888) Stores in: Chicago Pittsburgh St. Louis Omaha

## AGENTS \$10 to \$20 PER DAY!



New Pure Aluminum Hot Water Bottle—will outwear 100 Rubber ones. Lasts a lifetime. Low price makes quick sales. Write for sample and large catalog of 400 other Specials. AMERICAN ALUMINUM MFG. CO. Div. B. M. LEMONT, ILL.

## AGENTS \$6 a Day

Should be easily made selling our Concentrated Non-Alcoholic Food Flavors, Soaps, Perfumes and Toilet Preparations. Over 100 kinds, put up in collapsible tubes. Ten times the strength of bottle extracts. Every home in city or country is a possible customer. Entirely new. Quick sellers. Good repeaters. Not sold in stores. No competition. 100 per cent profit to agents. Little or no capital required. Elegant sample case for workers.



Start now while it's new. Write today—a postcard FREE will do—for full particulars

American Products Co., 4144 Third St., Cincinnati, Ohio

Hand Forged  
Razor Steel  
Blades. No. 57

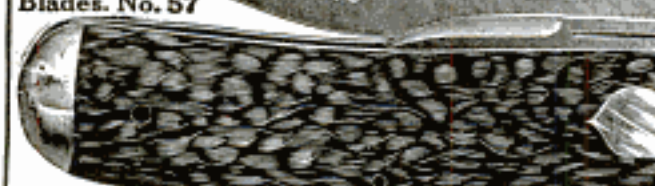

This \$2 KNIFE 83¢  
DIRECT AT FACTORY PRICE

Handy shaped blade makes this knife best for mechanics, sportsmen and farmers; light but strong; resharpened easily. Stag handle, German silver finish; blades file tested, hand forged from razor steel and warrant ed. Sample 83c, 3 for \$2 postpaid. Cheapest post! \$2 each. Send for our 80 Page List and "How to use a Razor" FREE MAHER & GROSH CO., 106 A. St., Toledo, Ohio.

# Easy to own this good engine now

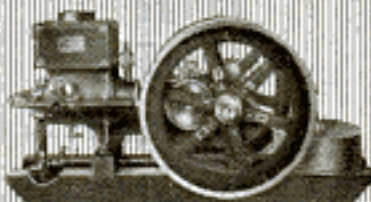

Send for my new, money-saving offer, before you arrange to try any engine, for any price. Compare my engine with any other, consider my low prices — (easy terms, if you wish), and you will see your advantage in having one of my

## BAUER ENGINES

Gasoline, Kerosene, Distillate, Gas

Sizes, 2, 3, 5, 7, 9, 12, and 16 horsepower. Now sold only direct from my own factory at surprisingly low prices. All sizes are of the up-to-date, long-stroke, valves-in-head, even speed type of engine. You can more intelligently select your engine after you have studied my engine book and my newest offer.

## Guaranteed 5 Years Sold Direct from Factory to User

Over 20 years ago I made my first engine with my own hands, and the many thousands I have since made by their record of easy usefulness and great durability, prove that you take no risk when you get a Bauer engine.

## Write for My Free Book

Send me your full address, now, so I can send you by return mail, my free book, which fully explains my engines, and shows how easy you can own a good engine, for a live-and-let-live price. Send the coupon or write me today.

**A. F. BAUER  
ENGINE CO.**  
477 Bauer Block  
KANSAS CITY, MO.

Gentlemen:— Please send me without obligation on my part, your Free book and latest offer.

**A. F. Bauer  
Engine Co.**  
477 Bauer Block  
Kansas City, Mo.

Name.....

Address.....

City.....State.....

Please Mention Popular Mechanics

## Power for Forty Litchfielders

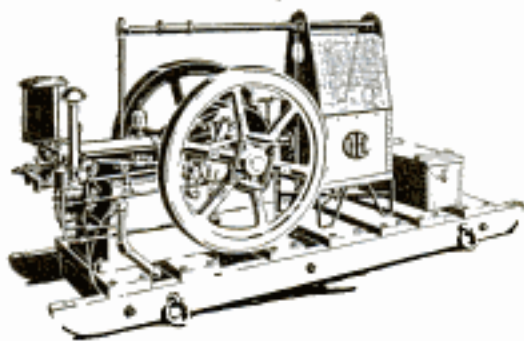

**T**WENTY Titan engines of all sizes — all kerosene burners—were lined up in front of a dealer's store at Litchfield, Minn., one day last summer. That day their new owners took them out to supply good reliable power in twenty locations. A few months later Litchfield saw the same thing happen again.

Two big Titan engine delivery days in that town last year. In many hundreds of towns you will find this same popularity of International Harvester Titan engines—the proven best power—Grand Prize winner at San Francisco. This is the same popularity that has sold over a quarter million Titans, for every conceivable power use.

Buy a Titan and save fuel and repair bills and save trouble. Titan engines are made in all approved styles, sizes from 1 to 50 horse-power, operating on low as well as high-grade fuels. Drop us a line. We'll send you full information, and make it easy for you to get the most reliable engine made.

**International Harvester Company of America**  
(Incorporated)  
16 Harvester Building Chicago U S A

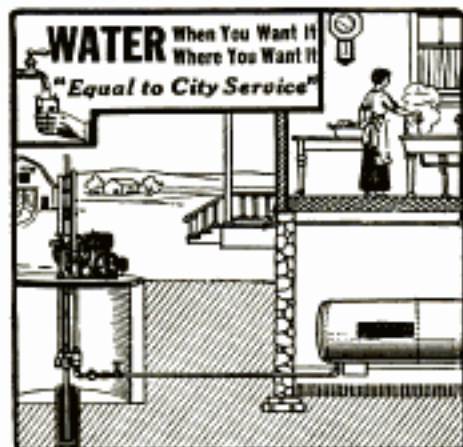

Water under pressure in your home will make housework easier, add to comfort, and increase the property value.

All water requirements of farm homes are met at moderate cost with our pneumatic pressure outfits.

May we give you details?

**Fairbanks, Morse & Co.**

New York CHICAGO San Francisco  
and many other cities

(449-61L)

## Meco ENGINES

Gasoline, Kerosene & Gas

### Prove Their Quality

Write us, giving dealer's name and we will tell you how to get a high-grade Meco Engine for trial, and send you our Engine Catalog to select the kind of engine you want.

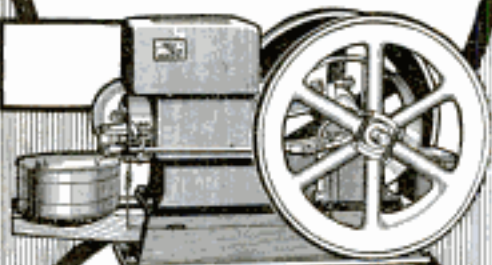

### COSTS YOU LESS

2 H-P, \$35.10; 3 H-P, \$52.65; 4 H-P, \$70.20; 6 H-P, \$100; 8 H-P, \$140.40; 12 H-P, \$210.50.

Built for hard, heavy work, compact, easy to run; few parts, and save their cost in fuel first year.

### Guaranteed 5 Years

Don't pay more than our prices for any high-grade engine until you have tried the Meco. Write for Catalog today.

Manufacturers Engine Company

1822 Crystal Avenue, Kansas City, Missouri.

**HOW WE LIVE**—Passing by an apartment building on the South Side of Chicago the other evening, we heard something very strange to twentieth-century ears, a fine, high, quavering voice—evidently the voice of an elderly woman—singing "The Old Oaken Bucket." Now, we don't have old oaken buckets in these days. We doubt very much if one could scare up half a dozen in the whole length and breadth of Chicago, among her two

## POWER

for farm, ranch, shop, to pump, saw, excavate, hoist, irrigate, can be had in Galloway engines from 1½ to 16 h.p. All styles, 200,000 customers testify to quality. Prices from ¼ to ½ what's usually asked. Low freight.

W.M. GALLOWAY COMPANY

Box 965

WATERLOO, IOWA.



Rev. P-6

**2 H.P. \$35** Auto Throttle Governed not hit and miss governed. One of the many exclusive features found in no other low priced engine.

Auto Throttle Governor means smooth, even, economical power for every work. Wonderful engine valve. Will operate electric light plant, run machinery, pump water, etc. Hopper cooled. Price complete with gasoline tank, electrical equipment, etc., ready to run, only \$35. Further details and catalog free. Write today.

C. BENNINGHOFFEN & SONS, Dept. 125, Hamilton, Ohio

## FARM VIM MARINE ENGINES

Get a VIM Engine and save money. VIM Midport 1½ H.P. Farm Motor shown below does all the chores—churn, wash, pump, separate, strain, etc. Women operate easily. No complicated parts. Weighs only 75 lbs. Water cooled, automatic lubrication. Comes ready to run. Guaranteed. Full line marine engines ½ to 27 H.P.; 1, 2 and 3 cpl.; Speed, pleasure and heavy duty types. Gasoline or kerosene. Double ignition. Non-backfiring. Strong, simple, accessible—absolutely dependable. Built for a lifetime. The boat-builder's stand-by, the boat-owner's pride. When writing for catalogs, please mention whether interested in stationary or marine engines, or both. Ask for attractive agency offer. The Vim Motor Company, 602 Water St., Sandusky, Ohio

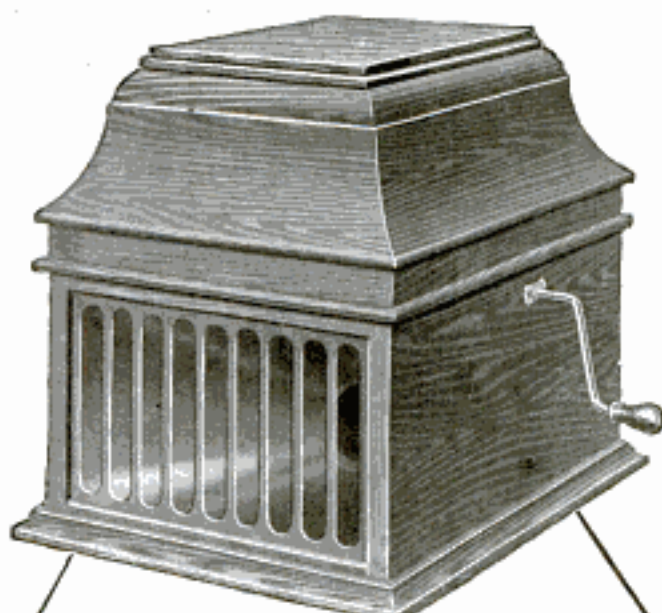

# \$100

## and You Keep This Superb New Edison

An astounding offer—the great New Edison with the new Diamond Stylus reproducer and your choice of all the brand new Diamond Amberol Records will be sent to you on **free trial without a penny down. The finest, the best that money can buy** at very very much less than the price at which imitations of the genuine Edison are offered—a **rock-bottom offer direct from us.**

## Entertain Your Friends

Hear all the latest up-to-date song hits of the big cities. Laugh until the tears stream down your face from laughing at the funniest of minstrel shows. Entertain your family and your friends with everything from Grand Opera to Comic Vaudeville—then if you choose, send the outfit back to us at our expense.

## Rock-Bottom Direct Offer

If you wish to keep Mr. Edison's superb new instrument, send us only \$1.00 after the free trial. Pay the balance on the easiest kind of monthly payments.

Think of it—a \$1.00 payment, and a few dollars a month to get this brand new style outfit—the Diamond Stylus reproducer, the musical quality—the same Diamond Amberol Records—all the musical results of the highest price outfits—yes, the greatest value for \$1.00 down, balance on **easiest monthly terms.** Convince yourself—a free trial first! No money down, no C. O. D., not one cent to pay us unless you choose to keep the instrument.

## Our New Edison Catalog Sent Free

Your name and address on a postal or a letter (or just the coupon) is enough. No obligations in asking for the catalog. Get this offer—while this offer lasts. Fill out coupon today.

**F. K. BABSON**  
Edison Phonograph Distributors  
1192 Edison Block  
Chicago, Ill.

Canadian Office:  
355 Portage Ave.  
Winnipeg,  
Manitoba.

To  
**F. K. Babson**  
Edison  
Phonograph Distributors  
1192 Edison Bldg.  
Chicago, Ill.

Gentlemen: Please send me your New Edison Catalog and full particulars of your free trial offer on the new model Edison Phonograph.

Name.....

Address.....

Please Mention Popular Mechanics

# It's The Fuel Cost That Counts Most

## ELLIS ENGINE KEROSENE

**Give Perfect Service On The Cheapest**

**Free!** Write for 1918 Book: "ENGINE FACTS". Sent postpaid, free.

This 1½ H.P. "Ellis" has same cylinder capacity as many 2½ H.P. Engines. Ellis patent fuel device guarantees perfect service on kerosene, distillate or other cheap oils. Starts without cranking, runs either way; crankshaft extends both sides; throttling governor adjustable while running.

**9c A DAY** is its fuel cost, 6c per H.P. for each 10 hours. A wonder for pumping, separating, churning, sawing, lighting and countless other jobs. Let us tell you more about this and other Ellis engines. 3 to 18 H.P., vertical and horizontal, single and double cylinders.

**30 Days' Trial—Freight Prepaid—Guaranteed 10 Years**

**ELLIS ENGINE CO., 2887 E. Grand Blvd., Detroit, Mich.**

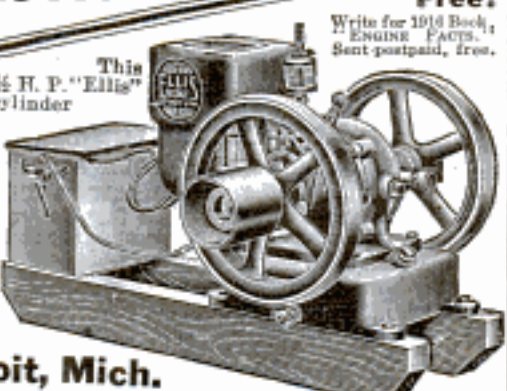

# BESSEMER

## KEROSENE ENGINE

**30 DAYS FREE TRIAL**

We don't make the most engines in the world—and we don't want to! We prefer to make one good engine rather than two poor ones. That is why thinking people buy the Bessemer. Figure ahead, and the Bessemer always comes out best. Made as a Kerosene engine—and not a converted gasoline type. Sizes 2, 4, 6, 8 and 10 H.P. Also direct connected to farm machinery, electric lighting plants, saws, hoists, etc. Get our facts and study them.

**LOWEST FUEL COST**

**Bessemer Oil Engine**

recommended where power from 15 to 200 H.P. is required. Burns crude and fuel oil and runs at about 1/3 to 1/4 cost of gasoline. Now being used in irrigation, flour mills, factories, lighting plants. This engine is revolutionizing the power question.

Get the facts by writing for Catalog "O"

**THE BESSEMER GAS ENGINE CO.**  
121 Lincoln Avenue  
GROVE CITY, PA.



## 4 H.P. Cushman Weighs Only 190 lbs. 8 H.P. 2 Cylinder Only 320 lbs.

Discussing light-weight motors recently, the Scientific American said: "Efficiency means light weight, reduced friction, and above everything else, lowered operating cost." Cushman Light-weight engines are today recognized as the leading American light-weight, high efficiency, all-purpose motors. Challenging comparison in minimum weight per horsepower, reduced friction, quality of material and workmanship and cost of operation.

Sizes 4 to 20 H.P. Throttle Governor. Schebler Carburetor. Forced Water Cooling System. Moving parts enclosed and run in bath of oil. Not cheap engines, but cheap in the long run. **ENGINE BOOK FREE.**

**Cushman Motor Works**  
882 N. 21st St., LINCOLN, NEB.

million and a half people. And if you took a motor ride, or an interurban or trolley ride for a few hours out into the rich farming districts of Illinois, you would not see very many old oaken buckets on the farms. Nine times out of ten what you would find would be a concrete-lined well or cistern, with a gasoline engine to pump the water, and a system of pipes running to the farmhouse, the barn, the chicken yard, and even to the pig trough. A thousand and one rustic songs and rustic proverbs are steadily going into oblivion as habits of life change. "The Old Oaken Bucket" is a rare figure of speech

## 1c IS WORTH DOLLARS

when you invest that 1c in a postal card to us. Here are a few of the good things in it for YOU—

1½ H.P., \$24.75	5 H.P., \$87.50
2 H.P., 28.75	6 H.P., 96.75
3 H.P., 33.90	8 H.P., 135.50
4 H.P., 68.90	10 H.P., 179.90
	12½ H.P., \$214.90

We guarantee against repairs forever

**OTTAWA MFG. CO., 2033 King St., Ottawa, Kans.**



**FOR YOUR OWN PROTECTION** and for the sake of your children and family you should have one of our

**Bohner Self-Cleansing Filters**

attached to your faucet. Insures you purest crystal water at no expense. "A health necessity." Write for particulars.

**BOHNER MANUFACTURING CO.**  
1009X S. Wabash Ave., Chicago, Ill.

**AGENTS WANTED**

Easily attached to the faucet without tools.



## Amazing Profits In Mushrooms

Anybody can add \$10 to \$40 per week to their income, in spare time, entire year growing mushrooms in cellars, sheds, barns, boxes, etc. I tell you where to sell, at highest prices.

Free Illustrated Instruction Booklet

**HIRAM BARTON**  
Desk 2, 329 W. 48th St., New York



# DIAMONDS

**ON CREDIT** 20% DOWN 10¢ A MONTH

The most beautiful Diamonds are the Blue-white, especially if absolutely perfect. **LYON DIAMONDS** are 1st Quality, Blue-white. A certificate furnished with every Diamond guaranteeing its value and providing for exchange at full purchase price. Goods sent prepaid for examination and approval. Write for Catalog No. 3.

**J. M. LYON & CO.,** (Incd 1842) 71-73 Nassau St., NEW YORK.



## Going to Build Remodel or Repair?

**YOU** can actually save from \$5.00 to \$500.00 on your building material bill, so write today for these two free books and see and judge for yourself.

Our Building Material Catalog shows 8,000 price bargains and our Plan Book shows splendid views and floor plans of 30 modern homes and bungalows. You can remodel, repair or build new for much less than you expected.

We ship everywhere everything in the way of high-grade lumber, flooring, roofings, doors, windows, storm sash, moldings, porch-work, screens, hotbeds, building hardware, paints, wallboard, plumbing, heating and water supply outfits, cement machinery and interior woodwork—**ALL AT WHOLESALE PRICES DIRECT TO YOU.**

Don't plan to build, repair or overhaul until you see these two great books. Quality, safe delivery and satisfaction absolutely guaranteed. Write for them today.

CHICAGO MILLWORK  
SUPPLY CO.  
1444 W. 37th St.  
Chicago, Ill.



Material Complete  
for Houses from  
**\$375.00** up

Catalog  
of  
8000  
Price  
Bargains

Beautifully  
Illustrated  
PLAN BOOK

**Books  
Are Free**

in this day and age. The angry father does not take his mischievous son behind the woodshed to spank him any more, because there are no woodsheds. In the cities we do not even have homes—or most of us do not. We live in apartments, or to give them a more common name—flats.—Straus Investors' Magazine.

Corundum mining in the United States has ceased. Artificial abrasives have displaced the natural product.

### Make Music Rolls

10 each. Inexpensive Learajan Perforator makes player-piano rolls from any piece of music written. Music knowledge unnecessary. Pleasure or profit. Details free.

LEARAJAN MANUFACTURING CO. DEPT B, HAMILTON, OHIO

Champion Racer



## MODEL AEROPLANES

Send 2c postage for Complete handbook of Models and Supplies.

WADING RIVER MFG. CO.  
WADING RIVER, N. Y.

Our set contains this and 9 other drawings, with instructions for building ..... \$1.00

## Try My *Rapid* Fireless Cooker 30 Days—FREE

Cook every meal on it. If you are not satisfied and delighted I will refund every cent. Get my

**SPECIAL LOW FACTORY PRICE**

direct to you. Cooker is aluminum lined throughout. Full set of famous "Wear Ever" aluminum cooking utensils comes with it. Ask for free book of valuable recipes.  
**WILLIAM CAMPBELL CO.**  
Dept. 64, DETROIT, MICH.



# This X Will Prove Your Ambition

Do you want a better position? Do you want to earn more? Do you want to get on in the world?

Then **prove** it by marking and mailing the attached coupon. That's easy, isn't it?

Then the **American School** will tell you how you can succeed in the work you choose—and will send you testimonials from ambitious men, some of them right near you, who have won through the **American School's** help.

Doing this simple thing will cost you nothing, nor place you under any obligation. It will bring you wonderful facts that will be worth while—yes, worth real money to you in the future.

Are you truly ambitious, or just fooling yourself? If you really mean to get ahead, prove your ambition by putting an "X" on the coupon and mailing it today.

No agent will call on you—the **American School** does not employ agents or collectors.

## American School of Correspondence, Chicago, U.S.A.

### Your Opportunity Coupon

Check the course you want and mail the coupon now

American School of Correspondence, Chicago, U.S.A.

Without any obligation on my part please send me your Bulletin and advise me how I can qualify for the position marked "X." Pop. Me. 2-16

- |                               |                            |
|-------------------------------|----------------------------|
| ....Electrical Engineer       | ....Lawyer                 |
| ....Elec. Light & Power Supt. | ....Business Law           |
| ....Hydroelectric Engineer    | ....Business Manager       |
| ....Telephone Engineer        | ....Auditor                |
| ....Architect                 | ....Accountant             |
| ....Architectural Draftsman   | ....Certified Public Acc't |
| ....Building Contractor       | ....Private Secretary      |
| ....Building Superintendent   | ....Stenographer           |
| ....Structural Engineer       | ....Bookkeeper             |
| ....Structural Draftsman      | ....Fire Ins. Inspector    |
| ....Mechanical Engineer       | ....Fire Ins. Adjuster     |
| ....Mechanical Draftsman      | ....Fire Ins. Expert       |
| ....Civil Engineer            | ....Sanitary Engineer      |
| ....Steam Engineer            | ....Plumber                |
| ....Shop Foreman              | ....Reclamation Eng.       |
| ....Shop Superintendent       | ....Textile Boss           |
| ....Sheet Metal Draftsman     | ....College Preparatory    |

We also prepare for civil service examinations in all engineering subjects

NAME .....

ADDRESS .....

# PREST-O-LITE

for  
MOTORCYCLES



## The Light That Is Not Injured by Bumps and Vibration

Brilliant, reliable light is as vital as fuel.

Prest-O-Lite is efficient and trouble proof—won't fail you in emergencies—and never needs attention that you yourself cannot give, easily and quickly.

Prest-O-Lite is as sturdy as your motorcycle itself. It stands the jolts. Thoroughly practical, dependable, and convenient. Costs less to buy and less to use than any other system of brilliant lighting.

### Judge Prest-O-Lite for Yourself

Use it for 30 Days on your Motorcycle—give it every test. Prove its superiority. Then if you can duplicate the service rendered at equal or less cost, you get your money back.

### When You Buy Complete Equipment

Buy the kind that will stand up under hard use. At a very attractive price, Prest-O-Lite, a lamp and a mechanical horn will give you dependable service. You can get this combination, from your dealer on any motorcycle you buy.

Send for complete information on motorcycle lighting. Your name and address on margin of this page brings it to you.

### The Prest-O-Lite Co., Inc.

The World's Largest Makers of Dissolved Acetylene  
Main Offices and Factory  
265 Speedway Indianapolis, Ind.  
Canadian Offices and Factory: Merriton, Ontario  
Prest-O-Lite Exchange Agencies Everywhere

Please Mention Popular Mechanics

## OVERHAULED AND REBUILT MOTORCYCLES



At  $\frac{1}{3}$  to  $\frac{1}{2}$  REGULAR PRICES  
Some as Low as \$40

We have the largest line of new and used motorcycles and supplies in the Country at the lowest prices. Every machine guaranteed. We handle parts and repairs for any machine on the market. Send us your machine to be overhauled. We exchange motorcycles. Motors and castings for airplanes and railway velocipedes.

FREE Write today for price list and catalog.

HARRY R. GEER CO.  
888 McLaren Ave., St. Louis, Mo.

## GARAGES \$14 HEATER

### Protect Your Car!

and protect yourself. Keep your garage as warm as your home! No more shivering; no more numb hands. Order a

### "REO" Gas Heater

Burns either natural or artificial gas. Insures your car against frozen radiator, etc. "REO" guaranteed safe. Exclusive Edwards Rubber Construction and Flame Protector insure absolute safety. "REO" is 33 in. high; 12 in. wide. Compact and strong. Comes all ready to put into your garage. Order now. You'll be glad you did.

THE EDWARDS MANUFACTURING CO.  
320-370 Eggleston Ave., Cincinnati, Ohio

Send In Your Order  
Act NOW! Today!



**WIRELESS STATION ON SOCIETY ISLANDS**  
—The radio station being built by the French government on Tahiti Island, Society Islands, is now ready to receive and transmit commercial messages.

This station, however, is of only temporary nature, and will be followed by a much more powerful plant. The former will have a power of 10 kw. and use a wave length of 600 meters (1,966 ft.), and messages sent from



### Convert Your Bicycle into a Motor-Cycle

Motor fits any wheel. BEST, MOST RELIABLE. Best hill climber. More STEFFEYS in use than all others. Stamp for circulars. STEFFEY MFG. CO., 5007 Brown Street, PHILA., PA.



## Mobil oils

A grade for each type of motor

SOME CAR! BOYS! Send for Booklet Today



### The Lad's Car

Send 20c today for Booklet, telling how to build this automobile. Complete instructions and descriptions of parts and sizes, illustrated with diagrams, blue print, cuts made from photographs, and price list of parts.

SPECIAL INDUCEMENT to first boy in your town  
Niagara Motor Car Corp'n, Dept. A, Niagara Falls, N. Y.



**3 CUSTOM SHIRTS FOR \$5.00**

I make shirts that fit you, because I make your shirts from your measurements and guarantee to take them back if they do not satisfy you.

I send you 100 samples to select from.

I send you measurement blank with rules. I send you the finished shirts express prepaid. No ready-made shirts in my shop, but facilities for quick delivery of the highest grade of custom work. Write for my samples. (Higher-priced fabrics, too.) Spring samples now ready. **No agents.**

CLARENCE E. HEAD (Master of Shirts), 110 Cayuga Street, ITHACA, N. Y.



**Don't Throw Away Your Worn Tires**

For over three years European motorists have been getting from 10,000 to 15,000 miles out of their tires by "half-rolling" them with Steel Studded Treads. In eight months 20,000 American motorists have followed their example and are saving \$50 to \$200 a year in tire expense.

**We ship on Approval** without a cent deposit, and allow you to be the judge.

**Durable Treads** double the life of your tires and are sold under a signed guarantee for 5,000 miles without puncture. Applied in your own garage in thirty minutes.

**Special Discount** offered to motorists in new territory on first shipment direct from factory. A postal will get full information and sample within a week. Size of tires. Don't wait—write today. Address nearest factory office.

**THE COLORADO TIRE & LEATHER CO.**  
244 Tread Bldg., Denver, Colo. Dept. B 44, Transportation Bldg., Chicago, Ill.  
Suite 442 Washworth Bldg., New York, N. Y.

It will be expected to reach Awani, New Zealand; Suva, Fiji, and the Samoan Islands. The permanent 300-kw. station, to be built later, will be operated by a 500-hp.

**Indian Motorcycles**

One, two and three speed Gears with cradle spring frame. Send for catalog.

**HENDEE MFG. CO., 711 State Street, SPRINGFIELD, MASS.**

**5-16 H. P. 1916 Peerless Motorcycles**



with Free Engine, Bosch Magneto, together with the best there is in Motorcycle construction, Power, Speed, Silence, Endurance, and those wearing qualities so essential for low cost of maintenance.

**5 MILES FOR ONE CENT**  
Agents Wanted—Liberal Discount

**PEERLESS MOTORCYCLE CO., 179 Huntington Ave., Boston, Mass.**

**Miami Power Bicycle** and U.S. Pat. Off.

**"100 Miles for 10 cts."**

Model 15, \$125  
Model 16, \$140

SAFE, SILENT, CLEAN

WRITE FOR CATALOG

**MIAMI CYCLE & MFG. CO., 120 Mobile Ave., Middletown, O.**

**Small Engines**

Our little guaranteed engines are unequalled for operating small machinery, washing machines, grinders, etc.

**SIEVERKROPP STARTER**

315 SEAT STARTER FOR FORD CARS

Shipped on trial. Send stamp for Booklet and Special Offer

**Sieverkropp Engine Co., 1224 18th St., Racine, Wis.**



**10¢ a Day**

now buys this superb **Baader Violin**

AN exquisite instrument—perfect in tone and superbly finished. Made by the great violin maker, J. A. Baader, and now offered direct to you at the rock-bottom price. You may pay this rock-bottom price at the rate of only 10 cents a day. 10 days' free trial. Write for special circular—send coupon at once.

**Your Choice of Instruments**

This Baader violin is only one of the bargains we have to offer. Write today for our new Violin catalog. There you will find illustrated products of the leading violin makers of the world—Farny, Baader, Glier, Heberlein, Fiedler, Wurlitzer and many others. Violins of the highest grade, as well as those of moderate prices—all special values. Priced from \$2.70 to \$50.00, and from \$90.00 to \$250.00. Write now.

**Rare Old Violins**

Our collection of rare old violins is one of the largest in America. Write today for Special Art Catalog.

## WURLITZER

200 years of instrument making

Get the benefit of our mammoth facilities for buying in large quantities. The house that supplies the United States Government now makes a startling money-saving offer direct to you. Write for circular.

### 10 Days' Free Trial

You cannot judge a violin by seeing it in a store or by playing upon it once. Play on one of these instruments in your own home, in your own way for ten full days. Then you will be able to decide.

If you are not satisfied send it back at our expense. If you wish to buy, pay only the rock-bottom price—at the rate of only a few cents a day.



### 10c a Day

now buys this superb Loric Cornet. Exquisite triple silver-plated long model Loric Cornet direct to you on a starting offer. Ten days free trial before you decide to buy. Liberal allowance for old instruments. Write today for 200-page Catalog—showing 2561 instruments that you have to choose from.

### Send the Coupon

Put your name and address on the coupon now and indicate catalogue matter you wish us to send you. Absolutely no obligation in sending the coupon. Do it now. Find out about the startling money-saving offer we are making. Write today—send Coupon or a Letter or a Post-card.

**The Rudolph Wurlitzer Co.**

Dept. 9192  
East 4th Street,  
Cincinnati, O.  
So. Wabash  
Avenue,  
Chicago

**The Rudolph Wurlitzer Co.**

Dept. 9192  
S. Wabash Av., Chicago  
4th St., Cincinnati

- Gentlemen—Please send me without obligations, free and prepaid the catalog matter checked below:
- The special violin circular.
- Special low priced violins under \$15.00
- Your 225 page illustrated catalog of musical instruments.
- Catalog of music stands, cases and other stringed instrument accessories.
- Art catalog of rare old violins.

Name \_\_\_\_\_

Address \_\_\_\_\_

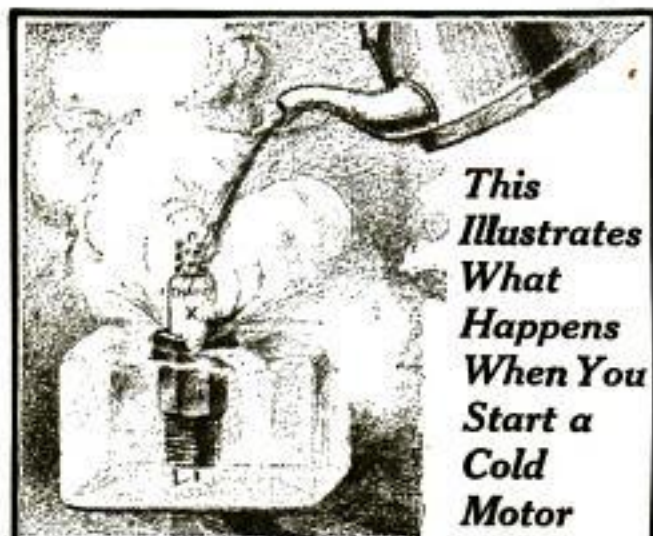

**This  
Illustrates  
What  
Happens  
When You  
Start a  
Cold  
Motor**

**W**HEN you "light the gas" under your cold spark plugs the effect is much the same as if you poured boiling water on a spark plug half buried in a cake of ice.

Unless the materials are exactly conditioned —

Unless the parts are accurately tooled and fitted —

Unless the contact points are properly cushioned where the strains come — something is bound to break.

If you would have absolutely reliable service, under all the varying strains of temperature, speed and load, see to it that your motor is equipped with



**Champion**  
TOLEDO MADE FOR THE WHOLE WORLD'S TRADE

## Dependable Spark Plugs

Every detail of their construction makes for endurance and dependability.

But to make them so dependable, we go to extremes of engineering and of processing which you would never dream of.

These extremes are practical only because their cost is distributed over such an enormous production. Year after year our output has been greater than that of all other makers of spark plugs combined. This season our output is doubled compared with last.

The spark plug which we designed to serve your motor we know, by actual comparative tests, will serve that particular kind of motor with greater efficiency than any other kind of plug you can buy. Your dealer knows which one it is and will gladly supply you.

*Be sure the name "Champion" is on the porcelain—not merely on the box.*

**Champion Spark Plug Co.**  
403 Avondale Ave. TOLEDO, O.

Please Mention Popular Mechanics



Design No. 524  
by Jud Yoho.  
Estimated Cost  
\$2800.

## ALL ABOUT BUNGALOWS

**BUNGALOW BOOK, 1916 De Luxe Edition**  
Contains the cream of 1000 practical and distinctive bungalows actually built for \$400 to \$4000, suited to any climate, with photos of exterior and interior views, plans, size of rooms, cost, etc. Also valuable suggestions on bungalow building written by an expert. **The largest exclusive Bungalow Book published. 112 pages. Price..... \$1.00 Postpaid**  
Worth many times its cost to any prospective builder. A smaller edition of same, only 50 cents. Send check, money-order or stamp. Money back if not satisfactory.

JUD YOH0, The Bungalow Craftsman, 55 Bungalow Bldg., SEATTLE, WASH.

## Big \$2 Offer—KEITH'S



The magazine for home builders, the recognized authority on planning, building and decorating Artistic Homes.

Each number contains 7 to 10 PLANS by leading architects. Subscription \$2. Newsstands, 20c copy. Twelve big house building numbers and your choice of

### KEITH'S BOOKS for the HOME BUILDER

140 Bungalows and Cottages	175 Plans costing below \$6000
140 Plans of Cottages	125 " " over \$6000
125 " " costing below \$4000	100 " Cement and Brick
125 " " " \$3000	50 Garages, 95 Duplex and Pairs

Any one of these \$1.00 Plan Books Free with a year's subscription, \$2.00

KEITH'S, 872 McKnight Bldg., Minneapolis, Minn.

## THIS BUNGALOW \$900 CAN BE BUILT FOR

This and many others in my new book, Building Plans for Modern Homes, will save you hundreds of dollars. One of the most complete and comprehensive books of plans ever published by any architect. Fifth edition just off the press. Two hundred and sixty floor plans and photographs of bungalows, etc., costing from \$300 up; gives sizes and cost to build. Sent postpaid for \$1.00



FREDERICK H. GOWING  
ARCHITECT  
18 Tremont St., BOSTON, MASS.

gasoline engine. There will be eight towers, each 328 ft. high, erected in parallel rows of four towers, and two antennae, one of 600 meters wave length, the other of 2,500 meters. With the permanent station it is expected that communication will be established with stations in Cochin-China, South America, Honolulu, Hawaii; San Francisco, Cal.; Sydney, Australia; and even in Martinique and Guadeloupe, West Indies.

## AGENTS—Make \$100 to \$300



per month easy selling our new Triplicate Sauce Pan. Cooking utensil for 3 different foods on one burner. 400 Specialties — all Whirlwind sellers. Write quick for exclusive territory and large catalogue. AMERICAN ALUMINUM MFG. CO. Div. S 61 LEMONT, ILL.

Buy From  
Mfrs. Direct

**Save Money**



Write for Kalamazoo catalog showing 500 styles and sizes of stoves and ranges — none better made — cash or easy payments — 30 days' trial — 360 days' approval test — \$100,000 guaranty.

We pay freight and ship within 24 hrs. Write today. Ask for Cat. No. 473.

KALAMAZOO STOVE CO., Mfrs.  
Kalamazoo, Mich.

A Kalamazoo  
Direct to You

We also make  
Malleable Iron Ranges





## Do You Need More Money?

**To Any Woman**

who has no special training and wants to earn money, I would recommend nothing better than selling World's Star goods.

When I started in this work, I had never done any soliciting of any kind, and it was with fear and trembling, but a determination to succeed. The commission on my first day's orders came to \$7.00. What other work is there that a woman can do to earn that amount? And there is absolutely no limit to the possibilities. One cannot help but succeed with World's Star goods, and enthusiasm. Both will lead to success.

—So writes Mrs. Littlefield of Oregon.

## World's Star Hosiery and Kleen-Knit Underwear

are sold only direct from Mill to the Home by our special representatives. This method insures to you not only lower prices for higher values, but the personal attention of our representative. In the privacy of your home you make your selection. The line includes everything in hosiery and underwear for all the family.

In more than 9000 cases we have helped ambitious, deserving women. You can do the same as they have done. Sell World's Star Hosiery and Kleen-Knit Underwear in your home town. No previous experience is necessary — we show you how to make money in an easy, congenial and profitable way. World's Star Hosiery and Kleen-Knit Underwear are known everywhere. Our advertising makes sales easy — the quality holds the trade.

Prompt Deliveries and Protected Territory. Our Free Catalog Tells Whole Story.

Write Today **Dept. 140 Bay City Mich.**

— We have been in business here for twenty-one years —

**LIFE SAVED BY RUBBER SOLES**—A pair of rubber-soled tennis shoes saved the life of a nine-year-old boy at Sullivan, Ind., recently, when lightning struck an iron stove poker he held in his hands. The boy had



**ÆTNA-IZE** Protect yourself and your family in case of sickness or accident. \$50 a week, and as high as \$15,000 for death. Write for particulars.

**ÆTNA LIFE INSURANCE COMPANY**  
Drawer 1341 Dept. PM. 2-16 Hartford, Conn.

IF IT ISN'T  
**AN EASTMAN**  
IT ISN'T A KODAK

**"Get a RECEIPT"**  
YOU ARE SURE OF IT from the MERCHANT WHO USES A NATIONAL CASH REGISTER

GENUINE PERFECT CUT

# DIAMONDS 97.50 Per Carat

**WE SAVE YOU 35% MONEY-BACK**

Only from Basch, Direct Importers, is it possible to get genuine perfect-cut diamonds at the world's lowest price \$97.50 per carat. Full \$150.00 per carat retail value.

**FREE Examination**  
Any selection from this ad. or from our catalog will be shipped for your approval, at our expense. You will not be obligated to buy unless you wish to.

**GUARANTEE** This legal contract is limited with every diamond we sell. Weight, quality and value guaranteed. Also allows full price in exchange at any time; we also agree to refund full purchase price less 10% any time within a year.

**1916 De Luxe Diamond Book FREE!** Send for this valuable book NOW! Free for the asking. Thousands of illustrations of diamonds, jewelry, etc., gives expert facts about diamonds needed to buy intelligently. Write to:

**L. BASCH & CO.**  
Dept. 23470 State & Quincy Sts.  
CHICAGO, U. S. A.

1-8 c. Diamond	\$12.00
1-4 carat Diamond	21.25
3-8 carat Diamond	35.00
1-2 c. Diamond	48.75
3-4 c. Diamond	71.25
1 carat Diamond	\$101.25



One of the 33 Styles

## Superb Wing Piano Shipped on 4 Weeks' Free Trial

Yes, we will ship you on 4 weeks' absolutely free trial a Genuine highest-grade Wing piano or player-piano DIRECT from our own factory freight prepaid. The most amazing piano offer ever made. We will allow you to use any Wing piano—you choice of 33 superb new styles in any shade of mahogany, walnut or oak—in your own home for 4 full weeks at our expense.

## No Money Down—Freight Prepaid

We ask no money down—no security—no bank deposit—no C. O. D. All freight prepaid. Just choose any Wing from our large catalog. We'll ship the instrument no money down, freight prepaid. Use it just as if you owned it. Let your friends play it. At the end of 4 weeks' trial, if you wish, you may return it at our expense. We pay return freight to New York. You alone are the judge. We employ no salesmen to visit and annoy you.

## Rock-Bottom DIRECT Offer

You will be amazed at our rock-bottom direct-from-our-factory proposition on the genuine highest-grade Wing, guaranteed 40 years. No other manufacturers dared to meet our baffling offer. Let us quote you prices that local dealers cannot approach. Cash or easiest monthly payments as you prefer—but first four weeks' free trial. Since 1868—for 47 years—we have been building Wing pianos—renowned everywhere for their sweetness of tone and sterling merit. The Wing has all the fine qualities and every improvement of any strictly high-grade piano and superior tone. You pay not a cent for the trial—no deposit.

## Valuable Book on Pianos Free

**"The Book of Complete Information About Pianos"**  
The N. Y. World says: "This is a book of educational interest every one should own." Tells you all about pianos, how to judge the fine points of quality and price in buying a piano. You will be astonished at the amount of information about piano quality and piano prices, and how to answer the arguments of piano salesmen. The Coupon brings this 136-page book FREE. This magnificent book, a complete encyclopedia on the piano, puts you on the making of a piano from start to finish. Free and prepaid, provided you write at once. With this piano book we will send free our beautiful catalog showing new art styles and full explanation of our Rock-Bottom Prices on the Wing Piano. Just drop a postal or a letter, or mail the coupon—today.

**WING & SON, Dept. 1192, (Estab. 1868)**

Wing Bldg., 9th Ave. and 18th St.

New York N. Y.

**Piano Book COUPON**

9th Ave. & 13th St. Dept 1192. New York, N. Y.

Gentlemen:—With the understanding that I am not buying anything, you may send me the 136-page Piano Book containing the ten tests, also your free shipment offer on the Wing Piano.

Name.....

Address.....

Please Mention Popular Mechanics



Blitzen Detector Stand. Holds any crystal, universal adjustment. High grade throughout. Price . . . **\$1.00**

## DEAL DIRECT WITH THE MANUFACTURER

We will save you time and money. Our new catalog "W" is filled with "up to the minute" wireless apparatus. Our new 112 page "Book of Electrical Apparatus" contains motors, dynamos, parts and materials, meters, lighting plants, storage batteries, phonographs, motion picture cameras, etc., at prices that will positively save you dollars. Both books sent for 6c stamps to cover mailing.



The best made, small Variable Condenser in the world. Glass case, Aluminum plates and base. Price . . . **\$4.00**

**CLAPP-EASTHAM CO. Manufacturers and Distributors** 147 Main Street, Cambridge, Mass.

## Improve Your WIRELESS

Make your apparatus more efficient, more powerful, more reliable with a

### THORDARSON Wireless Transformer

In three standard types—8,000, 10,000 and 20,000 volts—special windings to order. Connects direct to A. C. Circuit. Equipped with flexible impedance. Get one; it will triple your wireless' efficiency. Write NOW for our interesting new booklet.

Thordarson Electric Mfg. Co., 518 So. Jefferson St., Chicago



## Model Steam Engines

Guaranteed English Manufacture



Everything for making Model Engines, Boilers, Flying Machines, MODEL YACHTS, SHIPS, STEAM BOATS Everything for fitting Model Sailing Yachts, Torpedo Destroyers. Send for our FULLY ILLUSTRATED COPYRIGHT CATALOGUE, 900 engravings of Model Engines and Ships, Steam and Electric Boats, Parts, Fittings, Castings, Materials, Dynamos, Motors, Electrical, Mechanical, Scientific Amusements. Crowded with information of what we make and sell. By Mail, 10c. STEVENS'S MODEL DOCKYARD, 22 Q Aldgate, LONDON, ENGLAND Remit by International Postal Money Order; if coin is sent, letter must be registered



## DUCK'S No. 9—320 pp. Electrical and Wireless Catalog

JUST OFF THE PRESS

40 new pages of wireless instruments at startling prices. Many new items in the electrical line. This unrivaled catalog mailed upon receipt of 8c in stamps or coin, which may be deducted from first dollar purchase. Great cost of catalog and low prices prohibit distribution otherwise. This catalog contains anything and everything in the field of wireless and electrical supplies.

YOU CANNOT AFFORD TO BE WITHOUT IT

The Wm. B. Duck Co., 223-227 Superior Street, Toledo, Ohio

**ELECTRIC HOME, FARM, THEATRE, STORE and TOWN LIGHTING PLANTS.** \$18.00 Rectifier Charges Storage Batteries from Lamp Socket Lighting Your Auto Electrically for ONE CENT an hour. Lamps; Dynamos; Engines; Belts; Medical and Storage Batteries; Belts; Books; Sewing Machine and Power Motors; Railways; Bikes, Carriage, Fish, Rafting, Auto and Xmas Lights; Massage and Game Machines; Telephones; Picture Theatre Travelling and Permanent Equipments. Big Profits. Ten Cents an Hour Lights Theatre and H. F. Machine. Catalog 3 cts.

**OHIO ELECTRIC WORKS, CLEVELAND, OHIO**



**200 KINDS** Iron, Wood, Wire & Steel

**PUZZLES**

Catalog and 2 wire leaders and trick card only 10c.

**WESTERN PUZZLE WORKS** ST. PAUL, MINN.



## TRAPPERS!

Rogers pays highest cash prices for **FURS** We Charge no Commission. We have the best market in America. Write today for Free Price List. **ROGERS FUR CO., Dept. 452, St. Louis, Mo.**

## Send 10c for Copy of Our New Wireless Manual No. 2

YOU GET YOUR MONEY BACK ON AN ORDER OF \$1.00



It contains 120 pages and tells how to erect and maintain wireless telegraph stations. Shows a number of diagrams. Has the Morse and Continental Telegraph Codes. Illustrates the best instruments to use; tells what they are for and how to use them. Has many new diagrams and other valuable information not contained in any other book. Do not wait. Send your request now. Get the best 10c value you will ever buy.

## Send for Our Pocket Catalog P28

It contains 212 pages, with over 1,000 illustrations, and describes in plain, clear language all about Bells, Push Buttons, Batteries, Telephone and Telegraph Material, Electric Toys, Burglar and Fire Alarm Contrivances, Electric Call Bells, Electric Alarm Clocks, Medical Batteries, Motor Boat Horns, Electrically Heated Apparatus, Battery Connectors, Switches, Battery Gauges, Wireless Telegraph Instruments, Ignition Supplies, Etc.

**MANHATTAN ELECTRICAL SUPPLY COMPANY**

NEW YORK, 17 Park Place CHICAGO, 114 So. 5th Ave. ST. LOUIS, 1106 Pine St. San Francisco, 604 Mission St.

# His Coal Cost Cut In Half

**1/2 to 2/3 Guaranteed Saved  
The UNDERFEED Way**



You can't fail to get the real *money significance* to you of a letter like this—one among thousands of such others telling of more and better heat for less money the New-Feed UNDERFEED way. It's mighty interesting:

"In all my years as a householder I have never taken care of a furnace that requires less labor than the UNDERFEED. It is indeed truly remarkable how comfortably it has heated my home during this long and trying winter, on what, on a conservative basis, I should say would be about half what I have formerly expended on other furnaces with less favorable results.

(Signed) Jas. S. Copeland,  
98 Murray St., Binghamton, N. Y.

**WILLIAMSON** CUT  
NEW-FEED COAL  
**UNDERFEED** BILLS  
Furnaces and Boilers 1/2 to 2/3

## Save Your Coal Money Likewise

All this comfort and saving is due to the scientific principle of combustion of the New-Feed UNDERFEED. Coal is fed from *below*. The clean, live fire is always on top—in direct contact with the most effective radiation surfaces. Fire is never chilled, because there are no feed doors to open. There is no smoke, soot or gas, because these valuable heat elements are all consumed, since they must pass *UP* through the fire.

### Easy to Handle

A [boy of twelve can handle the New-Feed UNDERFEED with every success. A few easy strokes of the operating lever from a standing position, and the fire pot is replenished with coal. And the New-Feed UNDERFEED burns the cheaper grades of coal as effectively as others burn the costlier grades. No clinkers—no partly burned coal. Everything burned to clean white ashes—and few of them.

### Ask For Free Book

It is called "From Overfed to Underfed." Solves many a heating problem for you. It's free. No obligation. Just send the coupon today—NOW. Remember, a saving of 1/2 to 2/3 coal cost is actually Guaranteed the New-Feed UNDERFEED way—a guarantee backed by a million dollar concern.

**The Williamson Heater Co.**

(Formerly the Peck-Williamson Co.)

35 West Fifth Avenue Cincinnati, Ohio

**THE WILLIAMSON HEATER CO., 35 West Fifth Ave., Cincinnati, O.**

Tell me how to cut my coal bills from 1/2 to 2/3 with a Williamson New-Feed.

Warm Air.....Steam or Hot Water.....  
(Mark X after System interested in)

NAME.....

ADDRESS.....

MY DEALER'S NAME IS.....

DEALERS—Let us tell you about the New-Feed UNDERFEED and our new dealer proposition.



This cut-out view of the New-Feed UNDERFEED Furnace shows how it burns coal on the "candle" principle. Fuel is fed from below. Clean, effective flame always on top. All smoke, gas and dirt transformed into usable heat. No waste.



## Tobacco Habit Banished IN 12 to 120 HOURS

DR. ELDER'S TOBACCO BOON BANISHES all forms of Tobacco Habit in 12 to 120 hours. A positive and quick relief. A home treatment easy to take. Sure, lasting, harmless, no habit forming drugs. Hundreds of letters from satisfied patients. We guarantee results in every case or refund money. Send for our **Free Booklet** giving full information. Write today, this hour. **ELDER'S SANITARIUM, Desk 36, ST. JOSEPH, MO.**

**Build a WAR Aeroplane**

"Ideal" accurate Scale Drawings enable you to **EASILY** build 3 Ft. Flying Models of Aeroplanes now used in the European War.

Students of Aeronautics, everyone with an inquiring turn of mind, should construct one of these fascinating Models.

Prices of 3 Ft. Scale Drawings

Curtiss Flying Boat 25c	Bleriot Monoplane 15c
Curless Military Tractor 25c	Taube Monoplane.....25c
Hydroaeroplane 35c	Wright Biplane.....25c
Nieuport M'n'plane 25c	Cecil Peoli Racer.....25c

Complete Set of Eight, \$1.60 postpaid

Get 50-page **Aeroplane Book**, containing full information about models, parts, etc. 1c postpaid.

**Ideal Aeroplane & Supply Co., 87-88 West Broadway, New York**

## A NEW WAY To Get Your Clothes Free

**Make Big Money During Spare Time**

Something Different, bigger, more liberal than any offer ever made. **Lower prices—better clothes—bigger cash profits** Express paid on everything.

**Double Pay**

FREE clothes and cash besides. We don't ask you to use your cash profits for your own clothes. Ours is a new and better plan. **An Extra Present** with every order. Not a prize scheme. Choose what you want, work for it and get it besides your **Cash Profits. Complete Outfit FREE**, 56 real cloth samples, 50 Fashion Plates. Inside wholesale prices. Get the **big money**. Your name on a post card brings everything **FREE**.

**SPENCER MEAD CO., Dept. 270, Chicago**

**LYON & HEALY**

23-28 E. Adams St., Chicago

Send me your Catalog of Band Instruments.

Name .....

Address .....

I am interested in .....

## Climax Band Instruments

are better because they are American made. Cornets cost \$18.00, trombones \$14.00.

Send for complete Catalog at once and tell us what instrument you are interested in.

"I think your Climax Cornet is the easiest blowing instrument I have ever played."  
(Signed) FRANK MUNDAY.

**LYON & HEALY, Chicago**



## Murdock Wireless Receivers

**SPECIAL No. 55**

**2000 OHM COMPLETE SET  
ONLY \$4.00**

**FOURTEEN DAYS' TRIAL ALLOWED**

Better receivers cannot be bought for the money. Absolutely guaranteed. Satisfaction certain. *Catalog Free.*

**WM. J. MURDOCK CO.**

10 Carter Street  
CHELSEA, MASS.

680 Howard Street  
SAN FRANCISCO

## Complete Wireless Sending and Receiving Station \$8.90

Receives hundreds of miles. Sends 8 to 20 miles.

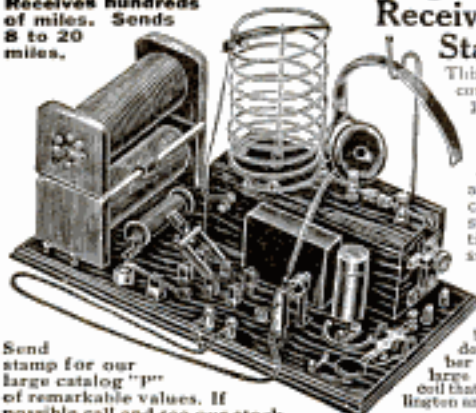

This remarkable station consists of a guaranteed 1 1/2 in. spark coil, machine turned tuned spark gap, our 1501 key, a flat plate condenser, assembled in an oak case, a large capacity helix, DPDT switch, 500 ohm potentiometer, buzzer and switch to tell if your 2 detectors are working, buzzer battery in nickel case, tubular condenser, bare wire wound double slide tuner, number 30 silk wire wound large 6 capacity loading coil that allows you to get Arlington and long wave stations.

Send stamp for our large catalog "P" of remarkable values. If possible call and see our stock.

**THE HANDEL ELECT. CO., 138-140 Centre St., NEW YORK**

Please Mention Popular Mechanics

## Complete Wireless Receiving Set

with 80 ohm double pole receiver, head band and cord  
Receives 1500 Miles  
With Suitable Aerial

**\$4.45**

Beautifully finished and fully guaranteed. Equipped with two-slide loose coupler, primary wound with No. 26 bare wire, secondary wound with No. 30 silk covered wire and divided off into 10 taps which are brought out on the end piece, contact being made by a phosphor bronze rotary switch with hard rubber knob. Our new, specially designed detector affords an exceptionally fine adjustment. A fixed condenser of exact capacity, specially constructed for this loose coupler gives added efficiency. An extra pair of binding posts is provided to which a variable condenser may be attached. All parts are of solid oak and mounted on a solid oak base.

Send stamp for our big wireless catalog "P" and free code chart made of unbreakable fibre.

**Universal El. Supply Co., 19 E. 32 St. N. Y. City**

Successors to Universal Wireless Co.  
All "Universal" sets are sold with 10 day trial privilege and money-back guarantee. Prompt shipments guaranteed.



## The Electrical Experimenter

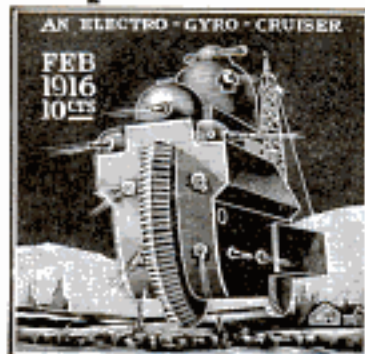

THE big electrical Magazine for those who dabble in electricity and Wireless. The "How-to-Make-It" magazine, chuck full of experiments and the latest electrical progress. Foremost authority on WIRELESS in the United States. Official organ of the Radio League of America. Over 200 wonderful illustrations with over 100 articles in each number. You are not keeping abreast with the times unless you read the **Electrical Experimenter**. One copy will convince you. Every issue also contains the snappiest and most up-to-date scientific stories that will delight you.

\$1.00 a Year. 10c at Newsstands

Send 10c for three numbers

**THE ELECTRICAL EXPERIMENTER**  
234 Fulton St., NEW YORK CITY

**CORROSION OF PIPES BY ACETYLENE GAS**—Tests have shown, says Power, that moist acetylene, as generated, attacks zinc, lead, brass, and nickel to a slight extent; iron is affected six to seven times as much; but copper suffers more than any other metal tested. Copper is quickly changed into a soft, porous, black mass. Tin,

**ELECTRIC LIGHT PLANTS** Complete gasoline engine, dynamo, switchboard and storage battery \$240.

Agents wanted. American Battery Co., 1130 Fulton St. Chicago (Estab. 1859.)

**GACHOO!** Make the whole family "just sneeze their heads off" without knowing why, with Gachoo, the new long distance harmless snuff. Sent anywhere for 10c, 3 for 25c, 1 doz. and special premium for 50c. **AMERICAN SUPPLY CO., St. Paul, Minn.**



When the "boys" spy the trim, dainty figure of alluring little Miss **SEPTEMBER MORN** so handsomely embossed on these WATCH Fobs, they go to them like hungry wolves. **ROSE GOLD FINISH**; twice the size shown here; genuine Leather strap. A smashing big hit! — get this classy fob and **BIG MONEY** agent's offer to-day, 25c. postpaid. **BUFFALO EMBLEM JEWELRY CO.**  
411 Morgan Building, Buffalo, N. Y.

**Boy Electrician** with 75 illustrations for making Batteries, Dynamos, Motors, Telegraph apparatus, Telephones, Lights, Bells, Alarms, Coils, "Wireless" Current Reverser, Electric Engine, Etc. By Electrical Experts so that anyone can understand it. With Cat. All 10c Ppd.  
**J. C. DORN, 705 So. Dearborn St., Dept. 100, Chicago, Ill.**

**Big Entertainer** 320 Jokes and Riddles, 153 Parlor Games and Magic, 15 Tricks with Cards, 73 Toasts, 7 Comic Recitations, 3 Monologues, 22 Funny Readings. Also Checkers, Chess, Dominoes, Fox and Geese, 9 Men Morris. All 10c. postpaid.  
**J. C. DORN, 705 So. Dearborn Street, Dept. 17, Chicago, Ill.**

**Boys' Own Toy Maker**  
Tells how to make a Talking Machine, Camera, Electrical Motor, Bicycle Boat, Canoe, Boomerang, Bobbed, Wind Mill, Microscope, Water Wheel and Motor, Stills, Toboggan, Snow Coaster and Sail Boat, Telephone, Electric Bell, Railroad Wind Mobile, Paddle Raft, Traps, Kites, etc. All 10c, postpaid.  
**J. C. DORN, 707 So. Dearborn St., Dept. 80, Chicago, Ill.**

# 7 Cents a Day Buys This Standard Visible Oliver Typewriter

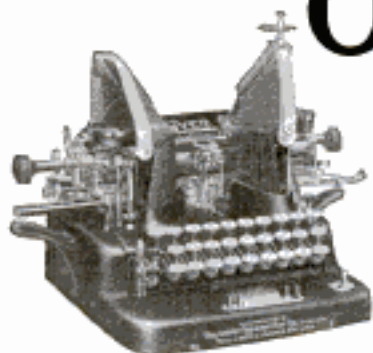

## Sensational Reduction

Our enormous purchasing power, tremendous output and the simplicity of our methods make this truly remarkable saving to you possible. Such an offer needs no high-priced salesman; no collectors. We are willing to let the typewriter do the talking and sell itself. We know from experience that a satisfied customer will pay. The simple coupon tells the story. Sign it and we will ship you one of the splendid machines—perfect in every detail. If it is not what you expected, if it fails to please you in any way, if you are not satisfied that it is the greatest bargain you were ever offered, get your money back. Read the coupon.

## Much Less Than Half Price FREE Trial—10 Year Guarantee

This is positively the best typewriter offer ever made. The typewriter is the genuine Model No. 5 Standard Visible Oliver, with complete and brand new equipment. Perfect machines only. Not shop worn, not damaged, inferior in no way. Back Spacer, Tabulator, Disappearing Indicator, not a feature lacking. Equal in quality in every respect to the \$100 article.

This amazing offer is not on some ancient style of blind typewriter, but on the wonderful Model 5 Oliver, the kind thousands of the world's best business firms are using today.

## Trial Order Coupon

UNITED STATES TYPEWRITER EXCHANGE  
Dept. 332, All-Light Building, Chicago, Ill.

Send me by express a No. 5 Oliver Typewriter on approval. I will leave \$3.80 with the express agent when I get the machine, the same to be returned to me in full if I return the typewriter within 10 days. If I keep it, the \$3.80 will apply on the purchase price of \$39.80, and I will pay the balance of \$36 in 18 consecutive monthly payments of \$2 each, commencing 1 month from delivery, title to the typewriter to remain in you until it is totally paid for.

Name..... Address.....

Two References.....

aluminum, bronze, german silver, and solder are practically unaffected. Thus it would appear that copper and brass, or other copper alloys, should not be used as piping for acetylene-gas supplies, and that iron should be well tinned rather than galvanized or nickelplated.

## SAFETY FOR THE HOME

The Smith & Wesson Automatic shoots when you mean to, not before—protection with safety. Catalogue on request. Smith & Wesson, 814 Stockbridge St., Springfield, Mass.

**MAZDA** Always etched on electric lamps to which MAZDA Service has been applied.

## Bausch and Lomb BALOPTICON

THE PERFECT STEREOPTICON

Bausch & Lomb Optical Co., 576 St. Paul St., Rochester, N. Y.

## Deafness Mastered



The day of imperfect hearing is past. Science rivals nature in the marvelous new 1916 Mears Ear Phone, "Intensitone" model—the world's greatest hearing device. It transmits sound without blur. Write today for our 15 days' free trial offer.

### Perfect Aid to Hearing

The Mears is the only scientific instrument for the deaf. It marvellously covers 90 degrees of sound, every range of tone of the human ear.

**Write for Free Book** Our free book is a highly valuable treatise on deafness. Write for it today—learn all about our 15 days' free trial offer and low direct laboratory price. If convenient to New York call for demonstration.



**MEARS EAR PHONE CO., Inc.**  
Desk 119K 45 W. 34th St., New York

## One Man and This Machine Will Earn

# \$50 to \$100

## Daily Profit



Not a dream—not a myth—but a reality. If you are honest—earnest, and anxious to go in business for yourself, I will help you. I have helped lots of men to make from \$500.00 to \$1500.00 per month. It's an honorable business—can be started most anywhere, in any town of over 500 population.

## A GOOD BUSINESS PROPOSITION

You want a business of your own. Go into the Popcorn Crispette business and make \$2000.00 to \$7000.00 a year. All you need is a machine, a few dollars and a good location. You can learn to make Crispettes in a day. They sell everywhere for a nickel a package. You make almost four cents profit.

## SEND FOR FREE BOOK

It tells the whole story—how and where to start, how to succeed, gives experiences of others, etc. It's worth reading, even if you don't start. If you're looking for a good thing and easy money, write today for FREE BOOK.

Rakin made \$1500.00 in one month with a Long Crispette Machine in a store window.

You can do equally as well, or even better.

**W. Z. LONG CO.**  
1139 High St.,  
SPRINGFIELD, OHIO

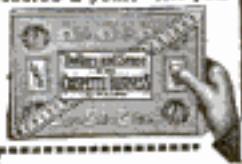

**W. Z. LONG CO.**  
1139 High St., Springfield, O.

Without any obligation at all, please send me free your book, "Dollars and Sense in the Crispette Business."

Name.....

Address.....

Please Mention Popular Mechanics

# 2c a Week Pays Wash Bill!

Write for  
**FREE Book**

## Electricity or Water-Power Does the Work

### Just a "Twist of the Wrist" Starts or Stops the Machine!

The 1900 Motor Washers are now at work in thousands of homes. They are doing the work formerly done by women, at a cost of 2c a week for power! Saving thousands upon thousands of dollars in wash bills. Saving worlds of wash-day troubles. Leaving the women free to do other work while the machines are doing the washing.

## The 1900 Motor Washer

1900 Water Motor Washer  
Can be connected with  
any water tap instantly

### Washes a Tubful in Six Minutes!

#### Handles Heavy Blankets or Dainty Laces

The outfit consists of the famous 1900 Washer with either Electric Motor or Water Motor. You turn on the power as easily as you turn on the light, and back and forth goes the tub, washing the clothes for dear life. Then, turn a lever, and the washer does the wringing. All so simple and easy that it is mere child's play.

### A Self-Working Wringer Sent With Every Washer!

The motor runs Washer and Wringer. We guarantee the perfect working of both. No extra charge for Wringer, which is one of the finest made. Write for **FREE BOOK** and 30 Days' **FREE TRIAL OFFER!** Don't doubt! Don't say it can't be done. The free book proves that it can. But we do not ask you to take our word for it. We offer to send a 1900 Motor Washer on absolute **Free Trial** for an entire month to any responsible person. Not a cent of security—nor a promise to buy. Just your word that you will give it a test. We even agree to pay the freight, and will take it back if it fails to do all we claim for it. A postal card with your name and address sent to us today will bring you the book free by return mail. All correspondence should be addressed to

Doing the wringing with  
1900 Electric Motor Washer



**1900 WASHER CO., 6225 Court St., BINGHAMTON, N. Y.**

OR, IF YOU LIVE IN CANADA, WRITE TO THE CANADIAN WASHER CO., 355 YONGE ST., TORONTO, CANADA.

(22)

## Ever Hear an S.O.S.?



One of these stormy days you may have real news for the boys, if you are using a Brandes Superior Head Set. It adds many miles to your range. Send 4c for Catalog P; a book full of valuable wireless information.

**C. BRANDES, Inc.**  
WIRELESS RECEIVER  
SPECIALISTS  
Room 817, 32 Union Square, New York

## BRANDES WIRELESS HEAD SETS

## Colorado Diamond



**Newest Product of Our Gem Mines**  
A beautiful Genuine Topaz, of purest white color, finest Diamond cut, wonderful brilliancy and great hardness. Endorsed by leading experts. Far superior to the best imitation Diamond ever produced. Remember we guarantee these stones to be genuine. Special price, \$2.00 each. Size, up to two carats. **FREE booklet.** Address

**COLORADO JEWELRY MFG. CO.**  
1526 1/2 Champa St. Dept. 47 Denver, Colo.

**THE SMALLEST NEWSPAPER IN THE WORLD**  
—The Gazette, issued daily at Norfolk Island, and produced with a typewriter at the cable office, contains only about 100 words, all cable news, and has a circulation of

## CORONA

Weights 6 lbs. Occupies little space. Durable, efficient. Costs but \$50. Write for booklet No. 13.

**FOLDING TYPEWRITER**  
CORONA TYPEWRITER CO., Inc., GROTON, N. Y. — New York: 141 West 42nd Street

<p><b>10¢</b></p>  <p><b>Static Machine.</b> Turning crank gives powerful 3 in. spark. No batteries required. Made of steel and hard rubber. Performs 500 experiments. Size 8 x 5 x 10 ins. Weight 6 lbs. Price . . . <b>\$3.70</b></p>	<p><b>3418</b></p>  <p><b>Smallest Tungsten Flashlight</b> made. Powerful light. Weight 4 oz. Price . . . <b>\$0.50</b></p>	<p><b>Hustler Motor.</b> Runs on 1 dry cell. Size 3 x 3 x 4 ins. Weight 1 lb. Price . . . <b>\$0.80</b></p>	<p><b>1043</b></p>  <p><b>Flashlight Lamps.</b> 3 1/2 Volts give brilliant light. Weight 4 oz. Price . . . <b>\$0.13</b></p>	<p><b>Dynamo.</b> Very powerful. Gives 6 Volts, 6 Amperes. Lights 12 tungsten lamps, charges storage cells, runs as power motor. NOT A TOY. Size 6 x 6 x 6 ins. Weight 7 lbs. Price . . . <b>\$3.69</b></p>	<p><b>1024</b></p>  <p><b>Telephone Receiver.</b> 75 Ohms. Hard rubber shell, powerful magnet. With two phones and no batteries, you can talk 500 feet. Size 2 1/2 x 1 1/2 ins. Weight 1 lb. Price <b>\$0.39</b></p>
<p><b>Wireless Detector.</b> Guaranteed to receive long distance messages with our \$0.39 telephone receiver, or money back. Our Cyclopedic sent FREE with it. Price <b>PREPAID \$0.10</b></p>	<p><b>9000</b></p> 	<p><b>100</b></p> 	<p><b>1331</b></p> 	<h1>BOYS</h1>	

We carry the largest stock of experimental electrical goods in the world, and are the originators of the Wireless experimental Business. ASK YOUR FRIENDS ABOUT US. When ordering above goods enclose postage, else goods must go by express. Shipping weights are given. We ship in 24 hours. Send today 4c. postage for a copy of our famous Electrical Cyclopedic No. 16 containing 658 illustrations, 2,000 articles. "Treatise on Wireless Telegraphy" and 29 coupons for free Wireless Course. With any of above goods, Cyclopedic included FREE. "Everything for the Experimenters" **THE ELECTRO IMPORTING CO., 233A Fulton Street, New York City**

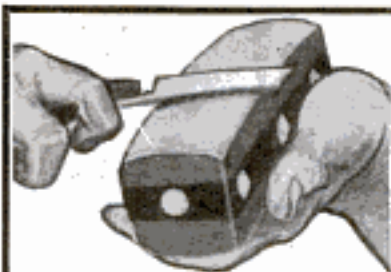

# How to Hone Your Razor

Hone and strop it yourself. Regular or safety. New idea. New principle in the Balihone. Makes your old

razor as good as new. Makes your safety blade better than new. Gives a hair-test edge. Balihone operates automatically. Hugs the hollow ground blade. Follows the bevel of the safety. Produces a marvelous edge every time. You can't fail with it. Send for one today and make your shaving a joy. Send coupon.

Name .....

Address .....

**BALIHONE CO.**  
Dept. 5246 Wilmette, Ill.

GENTLEMEN:

On your special offer send me prepaid one Balihone. I may return it and get my dollar back if not pleased. Enclosed is \$1.

**Use This Coupon**

## Send for a Two-Edge Balihone

The Balihone is a hone and a strop all in one. Both sides work automatically. It will make your poor razor shave beautifully. If you don't shave yourself tell your barber to get a Balihone. On this special introductory offer it will be sent prepaid to you for only \$1. Send today.

**Your Money Back** Use the Balihone 10 days. If you don't feel that it is worth ten times the price return it and get your dollar back in the next mail. The two edge Balihone sent to you postpaid on this special offer for only \$1.

**Send Today** Send only \$1 on this special offer. Your money returned if not delighted. Send the coupon or copy it on a piece of paper. Send only \$1. Send it now.

**THE BALIHONE COMPANY, Dept. 5246, WILMETTE, ILLINOIS**

### RELIEF TO TRUSS USERS

If you must wear a truss, have one that fits and is comfortable. Our New Sponge Rubber Pad (pat'd) is velvety, soft to the skin, pliable, cannot slip, extremely comfortable, adapts itself to ruptured parts. Is sanitary, long lived, holds ruptured parts in place with less pressure, allows blood circulation and produces many cures.

**New Scrotal Pad Needs No Leg Strap**  
Our new scrotal pad (pat'd) holds hernia perfectly without strap between legs in 8 out of 10 cases.

**FREE SAMPLE PAD** A Sample Akron Sponge Rubber Truss Pad (pat'd) will be sent absolutely FREE upon request, also booklet "Help to Truss Wearers." It's full of help. Ask your dealer, or write us. **THE AKRON TRUSS CO., Dept. 102, AKRON, OHIO**

### AGENTS \$60 A WEEK

We want Special Agents to travel by motorcycle selling our **300 Candle Power Outdoor Lamp and Safety Lantern**. Burns Kerosene. Can't explode. Can't set fire to anything. Burns in all kinds of weather. Rain proof, wind proof, bug proof. For farmers, teamsters, hucksters, plumbers, dairymen, campers — everybody needs it.

**This Motorcycle Given**

Write for plan how we furnish each representative with a motorcycle. This is no selling contest, where only one person wins. Anybody can earn this motorcycle. **WRITE FOR PARTICULARS.**

**THOMAS MFG. CO., 4048 East St., DAYTON, OHIO**

### SHOEMAKER'S BOOK ON POULTRY

and Almanac for 1916 has 200 pages with many colored plates of fowls true to life. It tells all about chickens, their prices, their care, diseases and remedies. All about incubators, their prices and their operation. All about poultry houses and how to build them. It's an encyclopedia of chickenhood. **YOU NEED IT. ONLY 15c.**

**C. C. SHOEMAKER, Box 1107, FREEPORT, ILL.**

three. One copy is handed to the Mission Station, and the rest of the issue is exhibited at two conspicuous spots on the local landscape, according to the Sydney (Australia) Bulletin.

### High Grade Violins 30 Days' Free Trial

Your choice from a large and carefully graded stock of representative instruments from the leading foreign violin makers. Strictly hand made and of superior tone, these violins are far superior to the average old violins sold at four times the price.

**Write Today.** Don't fail to send your name and address today for the superb Lewis catalog sent free and postpaid. Of value to everyone interested in high grade instruments. Learn how you can have your choice of these superb instruments on a free trial in your home. Write today. **Wm. Lewis & Son (Inc.) Dept. 1192, 225 S. Wabash Ave. Chicago**

**OUR SPECIALTIES:** Imported wood-varnishes and tools for violin makers.

## WANTED

### Railway Mail Clerks \$900 to \$1800 a Year (\$75 to \$150 a month)

Rapid advancement to higher Government Positions. "No lay-offs" because of STRIKES, WARS, FINANCIAL FLURRIES or the WHIMS OF SOME PETTY BOSS. THE POSITION IS YOURS FOR LIFE.

Country residents and city residents stand the same chance for immediate appointment. Common-sense education sufficient. Political influence NOT REQUIRED.

Write immediately for free list of Gov't positions now obtainable. Don't delay. Every day you lose means the loss of just so much chance of your early appointment.

**FRANKLIN INSTITUTE, Dept. H 97, Rochester, N. Y.**



Business Boom means hundreds of appointments

**FRANKLIN INSTITUTE (The Pathway to Plenty), Dept. H 97, ROCHESTER, N. Y.**

This coupon, filled out as directed, entitles the sender to free specimen questions; a free copy of our book, "Government Positions and How to Get Them," a list of Government positions now obtainable, and to consideration for Free Coaching for the examination here checked.

COUPON	
..Railway Mail Clerk.. (\$900 to \$1800)	..Customs Positions.. (\$900 to \$1500)
..Bookkeeper .....	..Stenographer..... (\$800 to \$1500)
..Postoffice Clerk .... (\$800 to \$1200)	..Internal Revenue.. (\$700 to \$1800)
..Postoffice Carrier .. (\$800 to \$1200)	..Clerk in the Departments at Washington..... (\$900 to \$1500)
..Rural Mail Carrier.. (\$500 to \$1200)	..Canadian Gov't Positions.....
..Auto Chauffeur.....	

Name..... Address..... H 97

Use this before you lose it. Write plainly.

# This Feed Saves Drills



**"YANKEE" VISE  
No. 990**

Swivel steel jaw opens  $2\frac{3}{8}$ " for taper work. Without swivel jaw, 3 in.

The "Yankee" Bench Drill has Automatic Ratchet-and-Friction Feed. You set the drill to the work by Friction Feed. Shift the little lever and the Ratchet Feed automatically maintains a steady, uniform pressure on large or small drills. No jamming of gears or smashing of teeth—no breaking of drills.

There is a fast and slow speed on No. 1005 controlled by a speed shifter, even when drill is at work.

The table can be raised or lowered, and there's a wheel for hand feeding. The table can be removed entirely to admit of work on large pieces.

## "YANKEE" Bench Drill

No. 1003—one speed, Height 18 $\frac{3}{4}$  in. Holds drills up to  $\frac{1}{4}$ " diameter.

No. 1005—two speeds, Height 28 in. Holds drills up to  $\frac{1}{2}$ " diameter.

Hardened tool steel 3 jaw chuck.

"Yankee" Vise No. 990, shown in above illustration, holds work securely. Fastened to table of drill by bolt. Can be used on bench. Machined at right angles on bottom, sides and end.

## "YANKEE" TOOLS

*Make Better Mechanics*

Your dealer can supply you

Write for "'Yankee' Tool Book" showing all the "Yankee" metal- and wood-boring and screw driving and drawing tools. Free.

**NORTH BROS. MFG. CO., Philadelphia**

# Look Men! Some Work Suit!

A revolutionizing idea in a work garment.



Patented button-down skirt showing neat jacket effect.



Skirt up showing suspenders which are attached to back of jacket.



Showing the convenient drop seat arrangement.

The most comfortable on earth! Swellest looking. No belt to bind. No suspenders to chafe. No coat tails to bunch or catch in machinery. Exclusive Patented Button Down Skirt with convenient Drop Seat. All seams are double stitched. Guaranteed not to rip. Plenty of pockets.

## Union Made "Fits the Figure"

Don't confuse the "SENSIBLE" with the cumbersome one-piece suits. It's an absolutely different kind of combination suit. Order from your dealer or send direct to us. Express stripe, \$2; Stüfel blue, \$2; Government standard khaki \$3.50. Your money back if you do not think it the greatest work suit you ever saw or tried. Write for descriptive circular.

**JOHNSTON & LARIMER  
MFG. COMPANY,  
Dept. PM Wichita, Kan.**

**SENSIBLE**  
COMBINATION WORK SUIT



Patented  
June 8, 1915

**ARTISTIC ADVERTISING ON LONDON RAILROAD TICKETS**—A hitherto unsuspected relation to art, says the London Railway Magazine, is now claimed for the railway ticket, since the backs of those issued by the Metropolitan Railway are being illustrated by a variety of designs drawn by a well-known artist. A new poster, "It's a Pity to Puncture the Picture," is now on view at all Metropolitan Railway stations. The drawings are employed in connection with approved



## TOOL CASES

For Up-to-Date TOOLMAKERS and MACHINISTS

We carry the finest and most complete line of mechanics' toolcases and tools in the country. We guarantee to please you or refund money. Write for free catalogue.

**J. M. WATERSTON**

177 Jefferson Ave., E. Detroit, Mich.

50  
Mends  
for  
50  
Cents



Price  
50c

## Genuine Solder

With an ordinary match it easily mends and solders metals permanently. Used by the housewife, farmer, electrician, automobilist, moving picture operator, jeweler, merchant and mechanic.

### AGENTS WANTED

Show what it will do and it sells itself. Everybody wants SOLDERALL. Send 50c for large tube. Your money back if dissatisfied.

**EMENAR CO., 53 E. 23rd St., New York City**





ON EVERY SIDE you will find

# WHITING-ADAMS

TRADE **VULCAN** MARK  
RUBBER CEMENTED

# BRUSHES

Bristles fastened with Vulcanized Hard Rubber, and held in a vise-like grip. Shedding of bristles and failure of brushes impossible.

The most extensive and best line of Brushes in the world

Send for illustrated literature

**John L. Whiting-J. J. Adams Co.**  
690 to 710 Harrison Ave., Boston, U. S. A.

Brush Manufacturers for Over 100 Years

Whiting-Adams Brushes Awarded Gold Medal, the highest award at Panama-Pacific Exposition, 1915

## Stanley Tools



# Stanley Aluminum Plumbs and Levels

Something new in the Level line. Exceptionally strong and well made. Will not rust or warp.

Both tops and bottoms are milled and ground to insure two perfectly parallel surfaces.

The glasses are fully protected by "eclipse" covers.

*Made in three lengths—*

12 inches long—weight 1 lb. . . .	\$3.50
18 inches long—weight 1½ lb. . . .	4.25
24 inches long—weight 1¾ lb. . . .	5.00

If you cannot procure this tool from your hardware dealer, we will send same, postage prepaid, on receipt of the price mentioned above.

ADDRESS

**STANLEY RULE & LEVEL CO.**  
NEW BRITAIN, CONN. U.S.A.



### Large Profits from Small Capital

A Business of your own bringing you an income of at least \$10.00 per day with practically no experience or overhead expense.

**THE GREEN AUTOMATIC MACHINE**

sharpens, hones and strogs all kinds of safety razor blades, all in one operation, at the rate of 150 to 200 blades per hour, you can readily figure your profits. Let us send you our free booklet explaining every thing.

**Am. Sharpening Machine Co. (Inc.)**  
Dept. 2 184 Washington St., Chicago

# UNION Tool Chests



Over 15 Different Styles and Sizes

Plain or Quartered Oak or Leatherette covered. Design, material and workmanship of the best.

**Let Us Save Your Tools and Money**

If dealer does not carry, we have a special offer that will interest you. You cannot afford to go without a Union. Chest guaranteed to meet your entire approval or money back.

WRITE TODAY—CATALOG FREE

**UNION TOOL CHEST WORKS**  
22 Railroad St. Rochester, N. Y.

# THE AWL YOU WANT

See That Reel



Is the genuine MYERS \$1.00 "Look Stitch" Sewing Awl with the exclusive feature. See thread reel in front of handle under the fingertip. Natural tension. Sews heavy or light material, diamond point, full grooved needles used to protect the thread when sewing.

**C. A. MYERS COMPANY, 6339 University Ave., Chicago, Illinois**



# Opens up when the thread is cut

Note the lever at the end of the arrow. When the thread on the pipe is cut, throw this lever to the left and the dies expand, clearing the thread. That is a typical time-saving feature of

# OSTER BULL DOG DIE STOCKS

Ask for the booklet "The Bulldog Tale"—it shows you eleven convenient sizes of this tool, plain or ratchet types. Free by return mail on request.

**THE OSTER MFG. CO.**  
2100 East 61st St. CLEVELAND, OHIO

Please send "The Bulldog Tale" to

Name.....  
Business.....  
Address.....

(2100-2)

## For Mechanics Who Want the Best— Brown & Sharpe Fine Tools

OF COURSE when you buy a tool for measuring you expect it to be accurate, and in addition to stay that way through years of every day use. Or, if it is a tool for general work, like a centre punch or dividers, it must stand up well to the hard knocks of shop work. Well, you can not be sure of this from appearances; you have to depend on the trade mark.

Fifty years of tool making are behind the B. & S. trade mark. This is your assurance of equipment that is accurate, sturdy, finely finished and handy,—the kind you like, whether it is a micrometer, rule, square, protractor, gauge or other piece of mechanic's kit. Clever brains, skillful hands, the best materials, expert attention to every detail combine to make the quality of B. & S. Tools. Remember the trade mark.

Get our free catalog No. 26 from the hardware store or write us for free copy.

**Brown & Sharpe Mfg. Co.**  
Providence Rhode Island



**DOUBLE SERVICE AND  
WEIGHS BUT ONE  
OUNCE MORE**



*Saves  
Space and Weight*

### CRESCENT DOUBLE-END ADJUSTABLE WRENCH

One Double-End Crescent is equivalent to two single-end wrenches. Made from our own formula steel. Special heat treatment adds strength. Jaws never stick because Crescent bearings are perfect. Satisfaction guaranteed or your money back.

[6-8-in., capacity  $\frac{1}{2}$ - $\frac{11}{16}$  in., \$1.25. 8-10-in., capacity  $\frac{3}{4}$ - $\frac{1}{2}$  in., \$1.50. Also seven sizes of single-end. From your hardware or auto accessory dealer or sent postpaid on receipt of price.]

**CRESCENT TOOL CO.**  
JAMESTOWN, N. Y.

advertisements which the Metropolitan Company have arranged to have printed on the backs of all their tickets. Although the idea of utilizing railway tickets for publicity purposes is not absolutely new, the combination of art and advertising in the manner now proposed and in conjunction with posters is quite original.

There are 7,000 wireless ship stations in the world requiring over 15,000 licensed men to operate them.



#### ToolCases for Toolmakers and Machinists

Keep your tools orderly arranged in a Gerstner Portable Tool Case. There's a place for every tool in one of the felt lined drawers. Every up-to-date mechanic needs one and you'll find our Cases the best built, easiest and most practical on the market. We guarantee to please or refund all money. Write for our free booklet.

*Gerstner Sons*

Mfrs. of Mechanics' High Grade Tool Cases  
808 Columbia St., DAYTON, OHIO



### No. 1900 RED DEVIL FENCE TOOL

A necessity on farm, garden, etc., where heavy tools are needed for erecting wire fencing. Will pull out or drive staples, stretch wire fencing, etc. At your dealer's or send \$1.00 for sample, postpaid. Send for booklet of other "Red Devil" tools.

**Smith & Hemenway Co.**  
161 Chambers St., New York

## The Neverip and the Speedy Stitcher

SAMPLE



50c

The two greatest inventions with which the unskilled man can repair leather goods or any heavy material. Needles and thread are inside the handle. **FAST SELLERS.**

**Agents Wanted** Foreign trade solicited. Advertising circulars in different languages. **Stewart-Skinner Co., 26 Hermon St., Worcester, Mass., U. S. A.**



### Portable Cases

FOR TOOL MAKERS  
AND MACHINISTS

Twelve styles, felt lined drawers, solid brass trimmings, best of material, beautiful finish, low prices, satisfaction guaranteed. Ask for booklet of cases built for service.

**The Pilliod Lumber Co.**  
SWANTON, OHIO

LET US SEND YOU

### "The Professor and the Saw"

an illustrated booklet which besides an interesting story tells how to build useful things and gives valuable information about tools, especially

### SIMONDS SAWS

which are unsurpassed for all uses in fast and sharp-cutting and edge-holding qualities. **WRITE FOR BOOKLET 11.**

**SIMONDS MANUFACTURING CO., "The Saw Makers"**  
5 Factories FITCHBURG, MASS. 11 Branches

MILLERS FALLS

TOOLS

Braces  
Drills

Hack Saws  
Mitre Boxes

Do Better Work and Last Longer

Write for catalog showing complete line

**MILLERS FALLS CO., Millers Falls, Mass.**

All the best equipped warships carry wireless, and according to an English estimate, of the nations now at war Great Britain has 500 navy vessels so equipped; Germany, 209; Italy, 200; France, 180; Russia, 110; Japan, 70, and Austria, 60.

### Will You Take Orders?

Your spare time is worth \$10 a day demonstrating the 1917 Model, Steel, 18-in.-1 Automatic Hand-Tool. Equals separate tools costing \$160. Lifting and pulling jack; fence building tool; stump and post puller; baler; press; hoist; vise; etc. No experience needed. Demonstrator free. Credit given. Exclusive territory. Write for special factory agency offer.

**Chas. E. Benefiel Co., 293-B Industrial Bldg., Indianapolis, Ind.**

## BILLINGS & SPENCER

### TOOLS

Special Kits

for  
Ford Cars

HARTFORD, CT.

Wrenches  
Pliers  
Sc. Drivers  
Hammers  
Ratchets  
Wrench Kits  
Tool Kits

## STANWELD Cold Drawn SEAMLESS STEEL TUBING

Lightest, smoothest, strongest Steel Tubing made. World's largest manufacturers of bicycles, motorcycles and automobiles use it exclusively. Send for Folder "A."

**THE STANDARD WELDING COMPANY**  
Main Office and Factory CLEVELAND, OHIO



## \$125.00 to \$300.00 A Month—For You

**H**AVE you the training that equips you to hold a position paying \$125 to \$300 a month? Have you the same knowledge as the man who gets the fat pay envelope? If you are ambitious—send the coupon below and find out about the opportunities that await you in the profession of Signal Engineering. **Salaries are paid to men who know.** You can get just the kind of training you need to accept one of the big jobs, right in your own home—during your spare time. **We need men.** Send the coupon today for our new book telling you all about it.

## Be a Signal Engineer

The profession of Signal Engineering is only in its infancy. There are thousands of miles of block signals to be installed. Signal Engineers, supervisors, inspectors and foremen are required to superintend this installation. Hundreds of maintainers and battery men are needed to maintain the systems already in use.

Your duties may take you from coast to coast. Free transportation is liberally awarded. You can be located steadily at one place, if you prefer. The high place and fat pay envelope may be yours. Send coupon for free Signal Book today.

## \$125.00 to \$300.00 a Month

That is an ordinary salary for Signalmen—many Signal Engineers make much more. In the Signal Department positions of authority, paying from \$175 a month up, are open to the men who have had the kind of training you can get right in your own home. Get your name and address on the coupon.

## We Need Men

The profession of Signal Engineering is calling to ambitious men. Our ranks are not overcrowded. **There are opportunities—golden ones, awaiting the men who answer the call.** In our profession you will have the chance you have been looking for. **We are calling you.** Write.

### Two Big Outfits Free

Complete Signal Engineer's Outfit and Complete Draftsman's Outfit given away absolutely FREE to our students.

## Send the Coupon for Big New Book

Put your name and address on the coupon or on a letter or a post card now, and send it to us. Absolutely no obligations of any kind. We will send you our big new book absolutely free and prepaid. Read about the opportunities that await you. The book is free. Send the coupon for it now—it's the first step toward the realization of your ambitions. Do it right now.

**Department of Signaling**

Room 9192  
1810 Wilson Ave.  
Ravenwood Station  
Chicago

Name.....

Address.....

Age..... Occupation.....

**Department of Signaling**

Room 9192  
1810 Wilson Avenue  
Ravenwood Station  
Chicago, Illinois

Gentlemen: Please send me absolutely free and prepaid your new book on Signal Engineering. Also full particulars about your great special free outfit offer. It is distinctly understood that I assume no obligations of any kind.

Please Mention Popular Mechanics

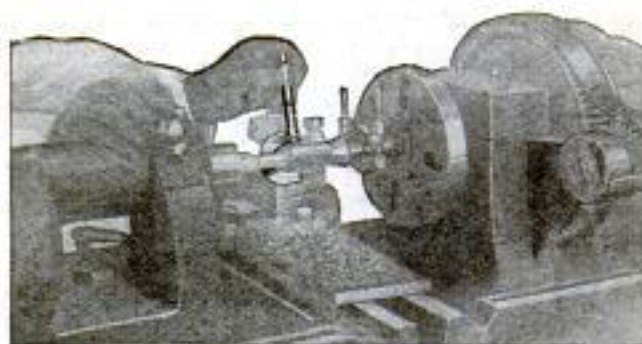

## Save the Seconds

**W**HETHER you are a machinist, a foreman, a superintendent, an engineer or a manufacturer, your success depends largely on the seconds saved.

# Starrett Tools

and Instruments of Precision

are designed to save time. For example, the Starrett Quick Adjusting Micrometer can be instantly opened or closed to any point ready for the fine adjustment.

Other Starrett Tools are Vernier calipers, combination squares, steel tapes and rules, dividers, hack saws, wrench sets, screwdrivers, expansion pliers.

Send for free catalog No. 20-AP

**The L. S. Starrett Company**

"The World's Greatest Tool Makers"

**Athol, Mass.**

New York

London

Chicago



## A Carborundum Stone Makes a Dull Tool Sharp



**T**AKE this Carborundum Combination Bench Stone for instance. It is an ideal stone for the carpenter or mechanic. It is positively unequalled in its hardness, sharpness, and fast-cutting qualities. Just the right size for the tool kit, and a mighty useful little stone to have around.

☞ There are chisels, planes, gouges, and other edge tools that are constantly getting dull. You are bound to find that the very best insurance against dull tools is a Carborundum Combination Stone.

☞ The coarse side takes out the nicks, and brings the tool to an edge, and the fine side gives it a smooth, keen edge.

*From your hardware dealer or direct. Catalog sent free upon request.*

**The  
Carborundum Company**  
Niagara Falls, N. Y.



"Mary, do you know that I believe the war would stop mighty quick if they used Caldwell Auger Bits instead of bullets."

Joe is right. The comparison is not so bad after all, for a

## Caldwell High Speed Auger Bit

will go through any thickness of wood for it will not choke; is made any length desired, and will travel at double speed. Write for Catalog.

Prices: 4-16, 30c; 5-16, 32c; 6-16, 35c; 7-16, 38c; 8-16, 40c; 9-16, 45c; 10-16, 50c; 11- and 12-16, 55c; 13- and 14-16, 60c; 15- and 16-16, 65c. Sets, \$5.00.

**CALDWELL AUGER BIT CO.**  
LEBANON, N. H., U. S. A.

Third in our "Factory to Financier" Series

The exports of horseshoes, in the fiscal year ended June 30, 1915, were 29,157,243 lb. against 2,723,806 lb. in the year 1914. The war is responsible for this enormous increase.

## YOU NEED THIS TOOL

**GASOLINE  
SOLDERING IRON  
BLOW-TORCH**



Address Dept. 1, Emmelmann Bros. Mfg. Co., Indianapolis, Ind., U.S.A.

### MECHANIC'S POCKET SECRETARY

Constructed of finest steel. Just push the button and out comes the article you require. Worth \$1.00. Postpaid

15c

Get One To-day



10 in 1 -

Adjustable Pencil, pen, paper knife, ink eraser, pencil sharpener, nail file and cleaner, mechanic's marking point, fine compass with screw attachment, foot rule.

ARDEE CO., Dept. 750, STAMFORD, CONN.

## "Interlox" SAVES TIME, TEMPER AND TROUBLE

**MASTER SLIDE RULE**

The Only Interlocking Rule made—and the Only one whereby inside measurements of doors, windows, etc., can be taken rapidly and accurately. Also superior to all others for outside measurements of walls, ceilings, etc. (If your hardware dealer hasn't this Rule, send us his name and 15c per foot on any length from 2 to 8 ft.) and it will be sent prepaid.



DAHL MFG. CO., 51 E. 42nd St., NEW YORK

SUPERIOR SINCE 1904

A limited number of slightly Trial-Worn and agents' demonstrating samples, will be sold, while they last, for **\$5 CASH WITH ORDER** subject to refund after 10-day trial. Guaranteed to be in perfect operating condition for at least 1 year.

E. Ganzer A.A.N. Co., 148 Duane St., New York

**Golden Gem**  
PORTABLE  
Adding Machine



Multiplies - Subtracts

# 40 to 50% Off Market Prices Diamonds-Watches-Jewelry

Our customers letters' continually prove this

**A FIRM** of over 60 years of unquestioned integrity is offering special diamond bargains right now. Exquisite gems which you can secure at prices you should not overlook. Read below the indisputable reasons that make these attractive prices possible. Then write for latest bulletin. Just issued.

We are diamond bankers. We loaned money to the former owners of the fine diamonds we now offer. The loans have not been paid. So we must sell the diamonds at a fraction of their proper value. You get the benefit.

Diamonds of the finest grade—beautiful, scintillating blue white gems—fully 50% below the normal figure. And fully guaranteed. Don't miss these great bargains. Write—write today for the latest bulletin.

## Diamond Banking

Our business as diamond bankers enables us not only to quote you amazing low prices, but it also enables us to get hold of the very choicest gems—diamonds which were selected originally by purchasers only after long study and investigation. We have often offered stones which cost originally more than \$100 for \$49 or less. You should write at once for the bulletin with complete descriptions and prices—now ready to mail.

No. 187249 is a magnificent blue white Westleton perfect cut quality Diamond Gem. The guaranteed weight is 3/4-3/16 kt. You can have it in this massive 1 1/2 kt. old tooth ring for \$89.40 with a \$75.00 guaranteed loan. Try to match at \$185.00.

A beautiful ring, suitable for a lady is under No. 264953. Guaranteed weight 1 1/2-3/32 kt. Quality blue white perfect cut Westleton. Unpaid loan price \$44.00. Guaranteed loan \$35.00. Try to match at \$80.00.

A cluster—one made up from exquisite unpaid loan jewels. Seven gorgeous diamonds in platinum set high in lady's ring. Looks like 1 1/4 kt. solitaire. Yours for just \$22.00. Try to match at \$45.00.

A 45.00 Hamilton, 21-jewel watch at unpaid loan price, \$18.75.

## Free Examination

**The DeRoy Money-Back Guarantees**

provide for Everything as offered; Exact weight to smallest fraction; Quality, color, etc. Exchange at full price; Exact cash loans.

We will send prepaid the gem or the watch of your choice on approval. See it and examine it for yourself. Compare it with any other you ever have seen—satisfy yourself that the price we are making you represents a most remarkable achievement even for a 60 year old house as large as ours—over \$700,000 behind us. If not satisfied with article after examining it, return at our expense.



## Send the Coupon

For Latest Bargain Bulletin  
Fill out the coupon and mail it now—or send letter or post card and get our big new bargain bulletin absolutely free. No obligations of any kind. Read our prices—then decide yourself. See the exquisite illustrations of the superb diamonds, watches, etc., you have to select from. Write now.

**Jos. DeRoy & Sons**  
Only opposite Post Office  
1911 DeRoy Building,  
Pittsburgh, Pa.

Reference by permission—Farmers Dep. Nat. Bank, Marine Nat. Bank or any Pittsburgh daily Newspaper.

**Jos. DeRoy & Sons**  
1911 DeRoy Bldg.  
Pittsburgh, Pa.

Gentlemen:—Please send me absolutely free and prepaid your new Bargain Bulletin of diamonds, watches and other jewelry. It is distinctly understood that I assume no obligations of any kind.

Name.....

Address.....

Please Mention Popular Mechanics



Build Your Own Boat and Save 75%

**\$37** Buys Patterns and Frame of This 23-Footer

## Saw, Plane, Hammer, Screwdriver—All the Tools You Need

You can saw straight, you can drive nails and screws. So you can assemble your new boat by the Brooks System.

You need know nothing of designing or of the fine points of boat-building—the materials for the boat come to you all ready to put together.

### Send for Big Free Catalog

We have three propositions: (1) We furnish you with the patterns. (2) Or we furnish you with the patterns and knocked-down frame. (3) Or we furnish you with the complete knocked-down boat. Fully illustrated instructions always included.

All the fitting of parts has been done by our experts. Our plan gives you as good a boat as any professional could make and better than most boat-builders now build. It's good exercise, too—it's more fun swinging a hammer than a dumb-bell.

Write for the Brooks Boat Book. See illustrations and descriptions of speed boats, family launches, hunting boats, sailboats, rowboats, sailing, paddling and power canoes. Many styles and sizes in each class.

## Fastest and Lowest Priced Boat in the World

17-Footer



15-Footer

**\$45**

10 to 32 Miles with 4 to 25 h.p.

These two semi-V bottom boats are our leaders—\$45 for the 17-footer, or \$25 for the 15-footer, buys the complete knock-down boat—best oak frame, clear cypress planking, decking and interior finish. Prices include hardware, everything except paint.

**\$25**

**Builder Agents Wanted**

**BROOKS MFG. CO., 8202 Rust Ave., Saginaw, Mich.**



GET THIS CATALOG  
FULL OF VALUABLE INFORMATION TO EVERY BOAT OWNER ON  
**RACING PROPELLER WHEELS, REVERSE GEARS AND MARINE ACCESSORIES**  
LARGE CATALOG FREE. SEND TODAY  
**MICHIGAN WHEEL CO.**  
1138 MONROE AVE., GRAND RAPIDS, MICH.

**Toledo MARINE MOTORS** NONE BETTER

"Nothing Cheap but the Price"

3 H. P. 1 cyl. complete	\$ 65.00
6 H. P. 1 " "	84.00
6 H. P. 2 " "	125.00
12 H. P. 2 " "	160.00
18 H. P. 3 " "	250.00

Fully guaranteed by a responsible concern. 2 cycle, 2 part, 3 1/2 x 3 1/2 and 4 1/2 x 4 1/2. Send for free catalog "C".

**THE UNIVERSAL MACHINE CO., Pike Ave., Bowling Green, O.**

**UNIVERSAL MOTORS**

4-cylinder 4-cycle, \$125 to \$160, 9 to 12 H. P., 600 to 1800 R.P.M. Fits all boats from 14 to 26 ft. Magneto, ignition, rear starter, automatic pump and lubrication.

**UNIVERSAL MOTOR CO., Dept. P, OSHKOSH, WIS.**

**Motor Perfection**

is what you get in Watkins Class "B" all iron motors. Especially fine for canoes and light boats. Constant and efficient.

3 H. P. single cylinder	45 lbs.
6 H. P. double cylinder	85 lbs.
12 H. P. four cylinder	155 lbs.

Are light, at the same time strong, accomplished by using semi-steel castings, high carbon steel shaft, bronze bearings, high class workmanship.

**THE WATKINS MOTOR CO.**  
837-839 W. 6th Street Cincinnati, Ohio

# "Old Town Canoes"

## Send for Catalog. Get Ready for Summer

You can get an "Old Town Canoe" at small cost and share the fun of canoeing. Every summer thousands take up this popular sport and become enthusiasts. Canoeing in an "Old Town" is their preference. Women enjoy it as well as men.

Read our Catalog and learn more about canoeing and "Old Town Canoes"—they are sound and safe; light, swift and easily paddled. The "Old Town" is the favorite of knowing guides. Priced \$30 up. 4000 canoes ready. Easy to buy from dealer or factory.

**OLD TOWN CANOE CO., 1562 Middle St., Old Town, Maine, U. S. A.**



# 5¢ A DAY BUYS A GIBSON



Terms as low as \$1.00 down—\$1.50 per month. Mandolin or Guitar sent on approval. The wonderful new Gibson violin construction has set the whole Mandolin and Guitar world talking. Get our new **Free Book**—112 pages—111 illustrations, a valuable fund of information for player and teacher. Also **Free** treatise on "How to Practice."

## Exclusive Features that Make Every Gibson Matchless:

**Stradivarius arching**—scientific graduation from thickness at center to thinness at rim, securing strength—sensitiveness—free vibration of entire sounding board. **Tilted neck, high bridge with extension string-holder**, securing increased string pressure that vibrates a larger sounding board, producing a richness of tone never before realized. **Reinforced, non-warpable neck—elevated guard plate or finger rest—easy action—adjustable string-bearing at bridge** overcoming sharpening of heavier strings in upper positions.

## Make \$1800 to \$5000 or More a Year Teaching and Selling the Gibson

Become a teacher. Splendid opportunities for either sex in every locality for private and class instruction and the sale of Gibsons. Gibson instruments have "made" many a teacher, professionally and financially. C. V. Ruttleman, Jackson, Mich., Teacher and Director, writes: "A \$7000 Gibson business for mine this year." C. A. Templeman, Teacher, Sioux City, Ia., writes: "84500 gross business for the year." AMERICA'S GREATEST MANDOLIN VIRTUOSO, Star Soloist for Co., UNQUALIFIEDLY ENDORSES THE GIBSON.

OPEN—A permanent teaching and business opportunity. Either sex. Other positions pending. **WRITE PROMPTLY**

year." WM. PLACE, JR., Victor Talking Machine

**Do Business on Our Capital** If a teacher, become our agent. Stock furnished. We help sell. Agent's territory protected. You make the profits. We pay the advertising. You pay for goods when sold; return goods not sold. Try our "Still Hunt." Catalog and thematic list free. Fill in coupon now.

**GIBSON MANDOLIN GUITAR CO. 162 Harrison Court KALAMAZOO, MICH.**



"Everyone A 'Gibson-ite'"  
Thompson's Mandolin Orchestra

FILL IN. TEAR OFF. MAIL TODAY.

Gibson Mandolin Guitar Co.

162 Harrison Ct., Kalamazoo, Mich.

Mandolin  Mando-bass

Mandola  Guitar

Mando-cello  Harp-guitar

Gentlemen: Without obligation send me free book complete catalog, free treatise and information about instrument checked in above square.

Name.....

Address.....

## AUTO GIVEN AWAY

We want representatives in every locality. No experience or capital necessary. Send us your name and address and by return mail we shall tell you how you can secure one of our new 1916 model 5-passenger touring cars free for demonstrating. Write today—do not delay—a postal card will do. Address

**ECLIPSE MOTOR CAR CO. 8518 Buhl Block DETROIT, MICH.**

## ROWBOAT MOTOR

# FERRO

### Make Your Own Motorboat—It's Easy

You can equip it with a complete power plant, Bosch high-tension magneto, full-boar fuel carburetor, solenoid muffler, weed-proof propeller, rudder and tiller at small expense. Simply clamp the Ferro on your rowboat. Speedy, reliable, easy to operate. Selling Ferro Motors is pleasant, profitable work. You only need buy one motor for demonstration. Some fine territory open for the first-come. Ask for agency proposition No. 215.

\$85 with Bosch high-tension magneto.  
\$65 with water-proof batteries.

The Ferro Machine & Foundry Company  
248 Hubbard Avenue Cleveland, Ohio



**DON'T GO ROWING - GO FERROWING**

Trade Mark **WEAR B.V.D.** U.S. Patent Office Registered and Foreign Countries **UNDERWEAR**



## ALORRA DIAMONDS

SPARKLE LIKE THE GENUINE—AT 1-40 THE COST

### SOLID GOLD RINGS

—stand acid, fire and expert examination. See them before buying. Any style ring, pin or stud. Catalog FREE. The Alorra Co., Dept. A7, 1408 Dearborn St., Chicago

## Get the Newest LA Engine Book

The question of selecting the right engine for that boat of yours is an important one. It will pay you well to get all the information possible before making your final decision, as the satisfaction you get from your outfit will depend largely upon the care you take in choosing your motor. You will find the new L-A engine book brim full of valuable hints and interesting engine information. It describes the complete line of L-A inboard and outboard motors for canoes, rowboats, pleasure boats, work boats, etc., and gives complete details of our liberal

### 30 DAYS' TRIAL PLAN

whereby you can have the privilege of proving out the quality of L-A Motors before making your final decision. Write for YOUR copy to-day. **Lockwood-Ash Motor Co.**

1339 Barton Av. Jackson, Mich.

AN LA ENGINE FOR EVERY PURSE AND PURPOSE.



Please Mention Popular Mechanics

## You Can Satisfy That Wanderlust—

that longing for mental and physical freedom, with a Mullins steel boat, designed and built by the same naval architects and master builders as the world's fastest 16-foot, 25 H. P. Hydroplane, shown in the picture.

From the 16-foot Launch to the 26-foot Automobile of the waterways, Mullins boats have smooth, clean hulls of pressed steel; cannot leak, waterlog, dry out, warp or open at the seams—never need calking.

Everyone interested in boating ought to have Mullins' big boat book—free on request  
**THE W. H. MULLINS COMPANY, 707 Franklin St., SALEM, OHIO**  
 World's Largest Manufacturers of Steel and Wooden Pleasure Boats



They are equipped with air-tight chambers fore and aft and are powered with 2 and 4-cycle motors of the most approved type—the last word in pleasure boats.

# MULLINS

## STEEL BOATS CAN'T SINK



### A 16 ft. Special Outboard Motor Boat

Fast, roomy and seaworthy. Built with sufficient buoyancy at stern to trim properly with extra weight of operator and motor.

**\$4800** Buys the Completed Boat Ready to Use. **\$3240** Complete K.D. Boat, Patterns & Instructions

Can be built by anyone during spare time. Write for our 1916 catalog showing our line of Cruisers, Runabouts, Special Boats, Row Boats, Canoes and Fishing Boats, complete or K.D.

**Dunphy Boat Mfg. Co., Box 19, Eau Claire, Wis.**

### SMALL CRUISERS

and boats of all sizes for pleasure or work, from the sturdy 16 footers to the big palatial cruising yachts and house boats are shown in the Specialized Boat Book issued by the Gray Motor Co., in conjunction with 110 of the leading boat builders of the country. Four times as many boats shown as you see at any Motor Boat Show. Two other books on Marine Engines. Any or all sent on request to

**GRAY MOTOR CO., Detroit, Michigan**  
 298 Gray Motor Bldg.



## EVINRUDE

Detachable rowboat and canoe motors. Single cylinder, Two-Cycle and Four-Cycle Twin models. Waterproof magneto, fly-wheel type, silencer and automatic reverse. **CATALOG FREE.**

Over 60,000 Sold  
**EVINRUDE MOTOR COMPANY**  
 312 Evinrude Block Milwaukee, Wis.

## Waterman PORTO

1916 Model leads the world in flexibility of speed control. The New Reversing Propeller permits perfect speed adjustment for any boat for racing or trolling. Original outboard motor—10th year—82,000 in use. Guaranteed for life. 31 h.p. Weighs 65 lbs. Automobile carburetor; high tension fly-wheel magneto with dual ignition; removable bearings; solid bronze skeg; 10 1/2 inch reversing propeller. Steers by rudder from any part of boat. Water-cooled exhaust manifold; noiseless under-water exhaust; spun copper water-jacket. Demand these essentials. If you want your money's worth. Write us to-day for free book showing full line. Our prices will surprise you.

**WATERMAN MOTOR CO., 230 Mt. Elliott Ave., Detroit, Mich.**



Makes Any Boat

A Motor Boat

## Prest-O-Torch

Costs less to buy than a good gasoline blow torch and costs less to use

In all soldering and brazing, the Prest-O-Torch avoids the delays and uncertainties of gasoline outfits. Provides a concentrated, intense flame that doesn't blow out even in a high wind. Needs no attention whatever. Used with handy sizes of Prest-O-Lite cylinders—ready-made gas. Style "A" sells for 75c (Canada 85c). Used with the small MC size Prest-O-Lite. Will braze up to 1/2 inch round rod. Can be fixed with handle and hook for added convenience in bench and overhead work. Style "C" Prest-O-Torch, for use with the larger sizes of Prest-O-Lite, is recommended for large work. Will braze up to 3/4 inch round rod. Sells for \$2.25 (Canada \$2.75).

Write for special literature and learn where you can see the Prest-O-Torch in operation.  
**THE PREST-O-LITE CO., Inc., 816 Speedway, Indianapolis, Ind.**  
 Canadian Factory, Merritt, Ont. Exchange Agencies Everywhere





# Marvelous New Valveless RADIOSENE Wickless Lamp

Burns vaporized kerosene by means of mantle—newly invented process—first valveless, wickless kerosene lamp on the market. Gives more light than tungsten electric bulb, from cheapest, safest of fuels—10¢ worth of oil lasts an average week. Simple and reliable to use—perfectly safe, lighted or extinguished.

**\$7.50**

Radiosene rays called "scientific sunlight," next thing to nature's own—brilliant, steady and restful to the eyes. University professor asserts, "Tests proved Radiosene light to be free from red rays and to radiate 150 actual candle-power. The ideal light for any home."

**AGENTS—Big Money for You**

Best proposition for hustling agents. Demonstration makes sure sales—fine chance for the right man to build up profitable business of his own. Write at once for terms and exclusive territory.

**SUPERIOR  
MANUFACTURING COMPANY  
294 Second St.  
ANN ARBOR, MICHIGAN**



**150  
CANDLE  
POWER.  
OF WHITE  
BRILLIANT  
LIGHT**

## The Cheapest Power on Earth



for any machine capable of being run by hand, is this **Stewart Little Major Engine**,  $\frac{1}{2}$  horse power. With battery, **\$27.50**; with high tension magneto, **\$37.50**.

The simplest, strongest and most practical big little engine ever offered. It operates for a full ten-hour work day on less than a half gallon of gasoline.

Just the thing to run a small press, washing machine, bone cutter, lathe, drills, small saw, cream separator, ice cream freezer, spraying outfit, pump, feed mill, etc. Stewart Engines in  $\frac{1}{2}$ , 2 or 3 horse power sizes.

Order today or write for catalogue.  
**CHICAGO FLEXIBLE SHAFT CO.**  
A617 N. La Salle St., Chicago, Ill.

## A MARVELOUSLY PRACTICAL COMBINED Tool is this **Stewart Handy Worker**

Comprises on one base a vise up to 4 $\frac{1}{2}$  inches; width of jaw, 4 inches; powerful pipe vise up to 1 $\frac{1}{2}$  inch pipe; a strong, sturdy anvil; cutting blade; drill press with two speeds; corundum grinding wheel, 5 inches x 1 inch, operated at 3 speeds, etc. Weighs, boxed, 90 pounds; complete, l. o. b. Chicago, **\$12.50** only.

A complete workshop. Order one or write for booklet.



**Chicago Flexible Shaft Company**  
A617 N. La Salle St.      Chicago, Illinois

Paint is a familiar word; "white lead" is not. 'Twould pay house-owners to learn to think

### Dutch Boy White Lead

where they now think simply "paint."

Send for Paint Tips 31

**NATIONAL LEAD COMPANY**

New York      Boston      Cincinnati      Cleveland  
Buffalo      Chicago      San Francisco      St. Louis  
(JOHN T. LEWIS & BROS. CO., Philadelphia)  
(NATIONAL LEAD & OIL CO., Pittsburgh)



**Blue White  
Perfect Cut**

**\$88**  
Per Carat

**NO MONEY IN ADVANCE!**

Send no money, not even a deposit! Just select any diamond, any mounting. We'll send it to you at our expense. Examine, test, compare in any way. If you don't want to keep it simply return. No obligation or even a penny of expense to you.



**SPECIAL**  
Ladies' and child's ring, 14k solid gold band made of mounting, perfect cut blue white genuine diamond, in velvet Jewel Case, \$10 value. Remit \$2.88 in any form you prefer. Money back any time within 30 days on request.

**2.88**

Look at these  
prices for  
**DIAMONDS**

Think of it! Only \$88 per carat for Genuine, Blue White, Perfect Cut Diamonds. And small sizes as low as \$50 per carat. Expert comparison proves the value fully \$150 per carat. You keep the difference—no middleman gets it. That's what it means to buy direct from the importer. You get every benefit of our big buying power and small profit plan.

$\frac{1}{8}$  carat

\$6.25

$\frac{1}{4}$  carat

\$15.50

$\frac{3}{8}$  carat

\$29.00

$\frac{1}{2}$  carat

\$40.25

$\frac{3}{4}$  carat

\$88.00

**BANKABLE, LEGAL  
MONEYBACK GUARANTEE**

Permits you to return any diamond bought from us through any bank in America, or direct to us, and receive **CASH REFUND**. No delay. No red tape. Cash refunded promptly without question. Guarantees also full purchase price in exchange forever. Also legally certifies carat weight, color, and value of the diamond.

**1916 De Luxe Book of Diamonds FREE!**

First to show 1916 styles. Tells all diamond facts needed to buy safely and intelligently. Enables you to judge diamonds like an expert. Write or mail post card. Absolutely Free.

References: Rogers Park National Bank of Chicago, your banker, or any commercial agency will tell you of our high standing.

**BARNARD & CO.**  
Dept. 889C, S.W. Cor. Wabash & Monroe St., CHICAGO



Please Mention Popular Mechanics

# APPLIED ELECTRICITY



## ONLY 50c A WEEK

Send today for your set of the greatest electrical reference library ever published. The new edition, just off the press, is recognized by big men in the electrical field as the most practical work of its kind. Covers completely the generation and use of electricity for power, light, transportation and communication, the construction and operation of dynamos and motors, central station engineering and telephone work, as well as wireless telegraphy and telephony and land and submarine telegraphy. Valuable alike to the beginner and expert.

The seven big volumes, written by thirty-two famous experts, contain 3,500 pages and 3,000 illustrations, full page plates, diagrams, single explanations, etc., with hundreds of valuable facts and figures. Substantially bound in half red morocco, gold stamped.

**Sent Absolutely Free** To prove to you that these books will help you in your own work every day, we'll trust you for seven days before you spend one penny. Simply fill in and mail the coupon below, and your set will be sent you immediately, express prepaid. Keep the books an entire week. Give them the hardest test you possibly can. They must make good with you or we take them back without question or annoyance. Despite the fact that the new edition is greatly enlarged, the price remains the same—\$25. Those, however, who take advantage of this great offer now are entitled to the special introductory price of \$19.50, payable in monthly installments of \$2 each. So don't delay, but send in the coupon now.

### Read These Subjects Carefully

Elements of Electricity—Electrical Measurements—Underwriter's Requirements—Theory, Calculation, Design and Construction of Direct Current Generators and Motors—Types of Generators and Motors—Management of Dynamo-Electric Machinery—Electric Lighting—Alternating Current Machinery—Power Transmission—Electric Railways—Self-Propelled Railway Cars—Power Stations—Switchgear and Switching—Storage Batteries—Applied Electro-chemistry—Electric Elevators—Electric Welding and Heating—Wire and Wireless Telegraphy.

### Free \$12.00 Consulting Membership

Our staff of 22 electrical experts answer every question you want to ask on electrical subjects absolutely free for a full year to every holder of a set of these books. This privilege has always cost \$12.00 and men tell us it is worth twice that amount in settling one problem alone. You get this service free if you buy the books after examination. This means \$12.00 saved if you act now. Read the coupon carefully. Then fill it out and mail today. The books will reach you promptly—express paid by us. After seven days send us \$2.00; otherwise, notify us for their return. Don't wait. You take no chances whatever. It costs nothing to inspect and you are nothing out if you do not care to buy. Mail the coupon today.

### Free Coupon Worth \$15.20 to You

American Technical Society

Please send me Cyclopedia of Applied Electricity for seven days' free examination. If I keep the books will send \$2.00 within seven days and \$2.00 a month until \$19.00 has been paid, when \$35 books and \$12 consulting membership will be mine. Otherwise will notify you and hold books subject to your order. Title not to pass until fully paid. Pop. Mech. 2-16

NAME .....

ADDRESS .....

As I have had no previous dealings with you, I refer you to

**AMERICAN TECHNICAL SOCIETY**  
Chicago  
U. S. A.

## Every Machine Shop

no matter how small, should have a grinder on hand, ready at all times for keeping your tools in proper condition. You do not need to buy a Grinder for every special job. You can grind your lathe centers, cutters, reamers, dies, tools, jigs, fixtures and a hundred other different jobs with the

# TEMCO

## Tool Post Grinder

And when the Grinder is not working on a machine, bolt it to a bench and you have a very practical little bench grinder. It is the handiest tool known for a machine shop. Has reversible switch for running motor either forward or backward—an offset head that is adjustable—lever feed, very sensitive but positive—vertical adjustment and many other convenient features. Use it in any part of the shop by simply connecting it to a drop cord, either A. C. or D. C.

One of the many needs for a Temco Tool Post Grinder



It keeps your tools in first class condition for getting out most efficient work. Often it does special kinds of work that ordinarily would take a machine costing several hundred dollars.

### Ask for One on Trial

Your dealer will order one for you and let you have it on trial. Our catalog shows a number of different ways of using the machine and gives full specifications.

**DON'T DELAY FINDING OUT ABOUT IT AT ONCE.**

**THE TEMCO ELECTRIC MOTOR COMPANY**  
123 Sugar Street  
LEIPSI, OHIO  
*Manufacturers of the famous Temco line of Electric Portable Drills*

Some 150 varieties of seaweed are used as food in the Orient.

## HARVEY EXPOSURE METER \$1

For Exteriors, Interiors, Night Photography and Color Plates. **ASK YOUR DEALER** or write  
**G. L. HARVEY, 105 South Dearborn St., CHICAGO**



## ACORN UNI-LITE FREE

Turns night into day. 300 candle power. Carry as a lantern; use anywhere as a lamp. Weather proof. For house, barn, garage, camp and around the farm. Write for big free offer. Special opportunity to farmers, stockmen and motorists. Agents make big money.

—WRITE TONIGHT—  
**ACORN BRASS MFG. CO., 604 Acorn Bldg., Chicago**

## 30 Days FREE TRIAL

and freight prepaid on the new 1916 "RANGER" bicycle. Write at once and get our big catalog and special offers before buying.

Marvelous improvements. Extraordinary values in our 1916 price offers. You cannot afford to buy without getting our latest propositions. **WRITE TODAY.**

Boys, be a "Rider Agent" and make big money taking orders for bicycles and supplies. Get our liberal terms on a sample to introduce the new "RANGER."

Tires, equipment, sundries and everything in the bicycle line half usual prices.

**MEAD CYCLE CO., DEPT. M108 CHICAGO**

## QUICK MONEY

### Growing Mushrooms

How to really make big money in mushrooms is fully explained in the wonderful book, "The Truth About Mushrooms." Everything explained from A to Z, at first hand, from the greatest practical authority in America. Add \$10 to \$70 a week to your income. Demand exceeds supply. Grow in cellars, sheds, boxes, etc. Small capital to start. Profits bigger and quicker. Anyone can do it. Women and children, too. New

is the best time. Send for FREE book of information.  
**Bureau of Mushroom Industry, Dep. 257, 1342 N. Clark St., Chicago**

Please Mention Popular Mechanics

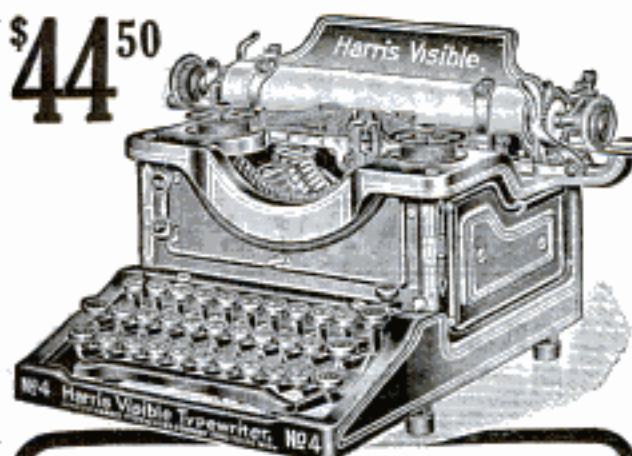
\$44<sup>50</sup>

## 30 DAYS' TRIAL

The wonderful Harris Visible Typewriter, same as used by Sears, Roebuck and Co.—over 800 in daily service in our big Chicago store—sold on 30 days' trial at our low price of \$44.50. The Harris is a guaranteed front strike visible writer with every valuable feature of most \$100.00 machines. At our price you save about \$50.00 over other standard typewriters. Write today for free beautifully illustrated typewriter catalog giving full details about the Harris Visible. Don't delay—act now! Ask for Typewriter Catalog No. 80P66.

Sears, Roebuck and Co., Chicago

A wireless station will be erected by the government at Coos Bay, Oregon, according to a recent San Francisco report.

**Pope**

Send for 1916 Catalogue.  
WESTFIELD MFG. CO.  
15 Lozier Ave., Westfield, Mass.

## U. S. "Chain Tread" Motorcycle Tire

All the Strength of the "Chain Tread" Automobile Tire.  
UNITED STATES TIRE CO., New York City

## Free Book on WASHING

Tells how to get a good-sized washing done in an hour with the **Thor Electric Washing Machine**. Also tells how the Thor pays for itself by saving wear on clothes and cost of help. Write for this big 48-page book, fully illustrated. Sent absolutely free. And we will also tell you about the special offer we are making. Write Today Get this book and information now.

HURLEY MACHINE CO., Dept. 1192, Chicago, Ill.

## "E-Z" Coin Safety Self-Filler Pen



A new safety self-filler for every man at any man's price. To fill merely insert coin or other article in slot and press once. Safety Cap prevents leakage if carried point down. Holder of Diamond Chased Vulcanized Rubber. 14 Kt. Gold Pen. Every part guaranteed. No. 315 Vest-Pocket size \$1.75. No. 316 Regular size \$2.00 Free Catalogue. Agents Wanted.

J. C. ULLRICH & CO., 27 Thames St., NEW YORK

## MECCANO Toy Engineering for Boys

Have piles of sport building working models of towers, bridges, cranes, derricks and anything you want to; build models of real things and learn how they work. Fine fun, too. MECCANO builds more models, better ones; builds easier and quicker. Every part is interchangeable; girders are ready to use, strong and rigid. It's the most practical, instructive and amusing construction toy for boys.

## 10,000 Models

were entered in our last prize contest. Build a new model and enter it in our \$1,000.00 Prize Contest. Now on—Contest closes March 1st, 1916.

MECCANO outfits cost \$1.00 to \$36.00. Some, costing \$3.00, \$5.00 and \$7.50, have the MECCANO Electric Motor. See them at your dealer's. Get one and build models! Sent express paid on receipt of price if you cannot procure from your dealer. Send the names and addresses of five boys and get the 144 page, story-book-catalogue free.

Send the names today!

MECCANO  
COMPANY, Inc.

Room 15  
71 West 23rd Street  
New York City



## No Money In Advance

### This Marvelous Camera ON FREE TRIAL!

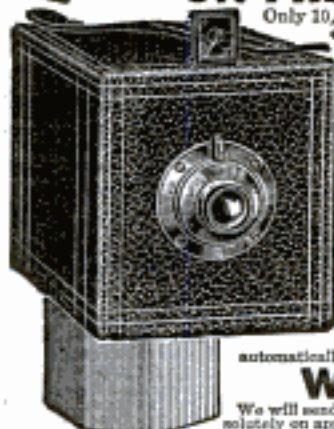

Only 10,000 of these marvelous, instantaneous picture-taking and making cameras to be sent out absolutely on approval without a penny in advance just to prove that it is the most wonderful invention—the camera sensation of the age. Just think of it—the Mandel-ette taken and makes finished pictures

### INSTANTLY!

You press the button, drop card in developer and in one minute take out a perfect, finished post card photo 2 1/2 x 3 1/2 inches in size. Camera, itself, is about 4 1/2 x 3 1/2 inches. Loads in daylight, is in 22 post cards at one time. No Film—No Plates—No Dark Room. It is instantaneous photography. Universal focus lens produces sharp pictures at all distances. Pictures develop and print automatically. Can't overdevelop; results amazing.

### We Trust You

We will send you the complete Mandel-ette outfit absolutely on approval, no references required, and give you 10 days to test it. If not satisfactory return at our expense. If you keep it simply pay \$1 when you get camera and \$1 per month until our special price of only \$5 is paid. No experience required. Plain instructions and everything complete with outfit so you can begin taking pictures the moment it arrives. We guarantee that even a child can operate it. Send coupon for camera.

### — THE CHICAGO FERROTYP COMPANY —

Desk 163 Ferrotyp Bldg., Chicago, Ill.

Send me one complete Mandel-ette Camera outfit including supply of post cards and instructions. I agree to pay \$1 when I get the camera, and if satisfied keep it and pay you \$1 a month until your special price of \$5 is paid. Otherwise I will return it at the end of 10 days.

Name.....  
Address.....

Please Mention Popular Mechanics



# Play Billiards at Home!

Under our easy payment plan, the expense is scarcely noticeable. You will be surprised to find how easily you can own a

## BURROWES

# Billiard and Pool Table

No special room is needed. The Burrowes Table can be set on your dining-room or library table, or mounted on its own legs or folding stand, and quickly set aside when not in use. Burrowes Tables are splendidly made and correct in every detail. The most expert shots, calling for skill of the highest order, can be executed with the utmost precision. Great experts say that the Burrowes Regis High-Speed Rubber Cushions are the best made. Sizes of Tables range up to 4½x9 ft. [standard].

## The Cost is Trifling

A few cents a day (far less than it costs to play in a public poolroom) will soon make you the owner of a handsome Burrowes Table. You can play on the Table while paying for it. Why not own your Table and play with your friends and family in the home atmosphere instead of spending a greater amount, with nothing to show for it, for rental of a public table?



**\$1.00  
DOWN**

Terms are very easy—\$1 or more down (depending upon size and style selected), and a small amount each month. Prices from \$15 up. CUES, BALLS, ETC., FREE.

E. T. BURROWES CO., 164 Spring Street, Portland, Me.

Please send catalog of Billiard Table offers.

Name .....

Address .....

### FREE TRIAL—NO RED TAPE

On receipt of first installment we will ship Table. Play on it one week. If unsatisfactory return it, and on its receipt we will refund your deposit. This insures you a free trial. Write today or mail the attached coupon.

We make the World-Famous Burrowes Rustless Screens and Folding Card Tables

Does The Socket Chafe Your Stump?  
If so, you are NOT wearing  
**BUCHSTEIN'S VULCANIZED FIBER LIMB** which is soothing to your stump, cool, neat, light, walls not much thicker than a silver dollar, strong  
*Guaranteed 5 Years!*

Sold on easy payments to good people. D. Buchstein Co., 113 6th St. S., Minneapolis, Minn.

## AGENTS \$60 WEEKLY

Robinson Folding Bath Tub. Big seller. Costs little, no plumbing, little water. Weight 15 pounds, folds into small roll. Full length bath, far better than tin tubs. Guaranteed 10 years. \$10 a day easily made. Write for free tub offer.

**ROBINSON CABINET MFG. CO. 4023 Factory St., Toledo, Ohio**

### WE ARE HEADQUARTERS FOR

# ELECTRICAL GOODS and WIRELESS APPARATUS

OUR NEW 224 pp. No. 7 CATALOG IS THE BEST ONE PUBLISHED

## EXPERIMENTERS

THIS IS THE Experimenter's Reference Book

It's the latest edition of the famous Amco Catalogue, contains over 300 pages and is fully illustrated. Complete description and prices of the latest electrical and experimental apparatus—Storage Batteries, Rectifiers, Transformers, Induction Coils, Wireless Apparatus, Lamps, Flashlights, Motors, X-Rays, Books, Tools, Electric Railways, Steam Engines, Water Motors, Hydraulics, Motors, Telegraphs, Telephones, Electrical Supplies, Model Aeroplanes and Parts for building your own apparatus. 6c in stamps will bring you this wonderful book. Contains a complete list of Wireless Calls, gives Codes, Wiring Diagrams, tells how to put up an aerial and install apparatus, etc.

Best catalog of Wireless and Electrical Apparatus, etc., published. Send for this catalog right away. Our prices will save you money.

6c in stamps brings it by return mail.

### LOTS OF FUN FOR BOYS!

2½ volt, 2 C. P. TUNGSTEN lamp, switch, socket, 20 ft. insulated wire and 3 coils of dry battery all ready to install. May be used to light a dark closet or hall.  
Price only 50c. Postage extra 15c

### LITTLE GIANT MOTOR

Is nearly 3 in. high. Runs at high speed on a single cell of battery. Very powerful and may be used to run small toys, etc. Just the motor every boy has been looking for. Sent postpaid for only 50c

### THE SIMPLEX TELEGRAPH OUTFIT

An opportunity for every boy to learn to telegraph and to put up a line with his gram. This is a full sized telegraph set, consisting of a fine key and sounder, mounted on a polished base. Will work any distance. An excellent Field Telegraph for Boy Scouts. Price, 95c. Postage Extra. Wt. 2 lbs.

### UPRIGHT STEAM ENGINE

A fine engine of the best materials. 9 in. high. The Right Engine for Any Boy. Runs at high speed. Each engine tested at factory and fully warranted. Sent postpaid for only 50c

### SIMPLEX WIRELESS OUTFIT

Every boy wants a wireless. Get in this interesting game and read the messages being around you. This outfit is the greatest bargain ever offered. Consists of a large double slide tuner, a sensitive detector, condenser, telephone receiver and cord. Weight 3 lbs. Special Price, Complete, \$2.25. Postage Extra.

### FUN WITH ELECTRICITY

Here is a rare chance to get started right in your study of electricity. This wonderful outfit contains 60 page book of instructions and all the apparatus for performing 60 interesting and spectacular experiments which will give any boy a practical knowledge of electricity.  
Price Only 50c. Postage 10c Extra

### FUN WITH MAGNETISM

This outfit contains 32 page book of instructions and all the apparatus for performing 61 fascinating experiments. It will give you some new ideas about electricity and magnetism in such an interesting way you can't help remembering it. Price only 25c. Postage extra 5c

### FUN WITH MAGNETISM

SEND 6 cents for our mammoth catalog

**ADAMS-MORGAN COMPANY** "The Experimenter's Supply House"  
25 Alvin Place UPPER MONTCLAIR, N. J.

Please Mention Popular Mechanics

## Keep Your Tools Sharp Make All Your Work Easy

WITH the Luther Hummer Tool Grinder you can put a keen cutting edge on any of your tools—easily and in a hurry, and sharp tools mean easy work. The wonderful Dimo-Grit (artificial diamond) sharpening wheels, which revolve 3000 times a minute, cut the hardest steel like emery cuts copper, 20 times as fast as a grindstone. No water needed—won't draw temper.

### LUTHER HUMMER Tool Grinder

Steel shaft-drive like an auto. Enclosed, dust-proof bearings and gears. All-metal frame. Ideal lubrication. Patented tool rests make it easy to give each tool proper bevel. Many special attachments.

#### Try It 30 Days at Our Risk

Let us send you this wonderful machine for a trial. When grinder arrives put it to any test you want—sharpen all your tools with it. If satisfied you can get along without it, return it at end of 30 days at our expense. Give us your hardware dealer's name and your own. Iron-clad, 5-year guarantee if you decide to keep it.

**LUTHER GRINDER MFG. CO.**  
916 Point St., MILWAUKEE, WIS.



Handiest, speediest, easiest-running, most accurate foot-power tool sharpener made. You'll be delighted with it.

## FREE to Hunters and Trappers

Fine Taxidermy Book Now Free! 22p.

with hundreds of photos of mounted birds and animals. Learn this profession. Save your trophies. Decorate your home and den. Great value to sportsmen.

**Learn to Stuff Birds** animals, game heads, tan furs, make rugs and robes. Quickly learned by men and boys. Big Profits from spare time. Intensely interesting. INVESTIGATE! Write Today for Free Book. Only a few free—no rush.

Northwestern Schools of Taxidermy, 9192 Elwood Bldg., Omaha, Neb.



## WOULD YOU

show this standard high grade 42 key fully visible typewriter to your friends and let them see wherein it excels any other \$100 typewriter, if by doing this and rendering other small assistance, you could easily have one to keep as your own? Then by post card or letter to us simply say, "Mail Particulars."

**WOODSTOCK TYPEWRITER CO., Dept. F 204, Chicago, Ill.**

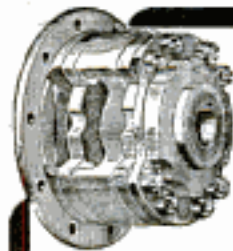

## Stop Skidding— Slipping and Sidesway

You can drive your car over snowy, slushy, sleety, slippery roads in safety, if it's equipped with the

### BAILEY Gearless Differential

In uneven going, power is always delivered to the solidly-grounded wheel—the loose wheel doesn't spin—and you pull right out of bad spots. Shipped on 30-day money-back offer. See dealer or write for circular.

**Ford, Overland and Chevrolet 490 Replacements Now Ready.**

Gearless Differential Co., 892 Woodward Ave., Detroit, Mich.

# Learn Electricity

**Earn \$2,500 To \$4,000 a Year** Your CHANCE has come! Your chance for big money. Your chance to do the kind of work you'll be proud of. Your chance to go into business for yourself. Think of it! You can now qualify AT HOME for that most wonderful of all fields open to the ambitious man—the great field of ELECTRICITY!



#### A. W. Wicks, E. E.

Formerly with the General Electric Co.; former General Manager of company manufacturing Jenney Electric Motors; also formerly with Fairbanks, Morse & Co.; now Consulting Engineer and Director of the Wicks Electrical Institute.

### Amazing Opportunity

What if you don't know a thing about electricity? I'll make the whole matter so simple for you that you can't help but learn. You don't have to buy a lot of books or equipment. I've solved this question of teaching electricity. And I'll show you that I have by giving you 20 of my personal lessons ABSOLUTELY FREE. Almost from the very first instructions you will have the knowledge and skill to do practical electrical work—earn good money—more than pay for your instruction as you go along.

## Be An Electrician

I will train you until you consider yourself competent regardless of the time it takes. I not only show you how to do expert electrical work but show you how to estimate on jobs so you can take contracts at big profits. That's what it means to be trained by a man of my practical experience in every phase of electricity. Take advantage of my big free 20 personal lessons offer. I make the cost so small and the payments so easy for you that you won't miss the money.

### MEN WANTED

Wherever you go there's always urgent demand for expert electricians at big pay. The watchword of the age is, "DO IT ELECTRICALLY." Electricity advances so fast that there's a big shortage of competent electricians.

## 20 LESSONS FREE

That's the sensational offer I am making to a few more ambitious men. I make it for two reasons. 1st—To show you how easy my instructions are to master. 2nd—To secure quick action on the part of a few more prospective students. This offer means that you get 20 complete personal lessons ABSOLUTELY FREE. But you must act quick. The offer closes in 23 days. So send the coupon or postcard at once. Don't delay. I'll send you full particulars. Do so TODAY.

**A. W. Wicks, E. E., Director,**  
Wicks Electrical Institute

81 W. Randolph St.,  
Dept. 65  
Chicago,  
Ill.

Send This  
Coupon

**A. W. WICKS, E. E.,**  
Director,

WICKS ELECTRICAL INSTITUTE  
81 W. Randolph St., Dep. 65 Chicago

Without obligation on me whatever, please send me full description of your personal instructions in Electricity and particulars of your special offer of 20 of your lessons free.



Name .....

Address .....

Please Mention Popular Mechanics

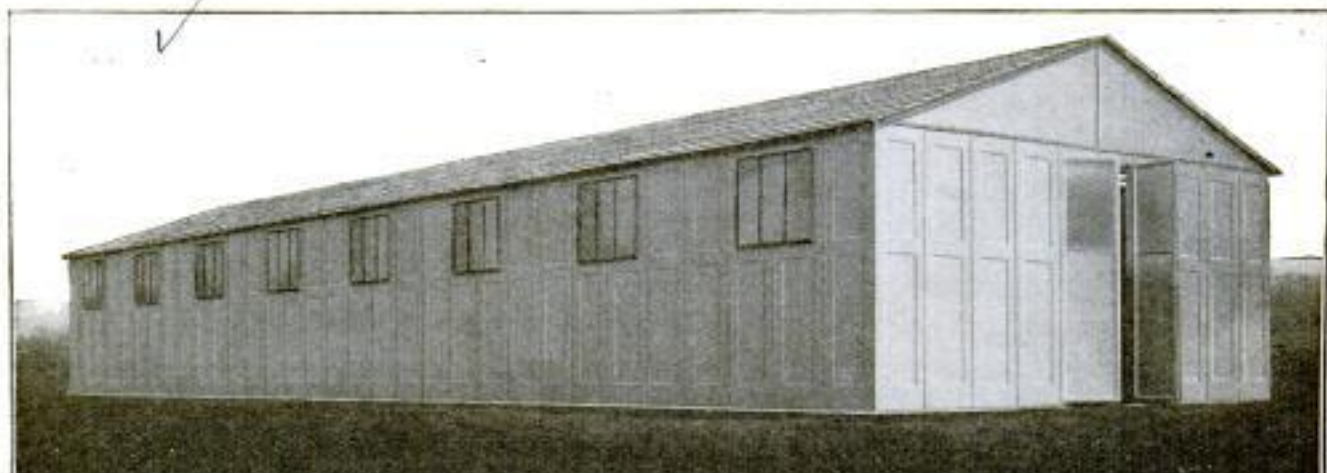

## KAHN PORTABLE STEEL BUILDINGS

Learn about the new type of economical, quickly-erected portable garages, houses, etc., that are *durable and permanent*. Not to be confused with flimsy light-metal construction.



Get our free book explaining the new easy method of steel construction. Made with interchangeable pressed-steel panels, easily assembled by means of a simple locking device; a hammer is the only tool required! Provided with steel sash and tile-like steel roof—all presenting a trim, pleasing appearance. Rigid, fireproof, weather tight; yet easily moved and re-erected. Can be readily enlarged. Made in standard sizes and shapes; shipped complete with sash, doors, etc., ready for erection. Suitable for garages, portable cottages, election booths, contractors' buildings, bathhouses, workshops, summer homes, etc.

Write for free book on Kahn Portable Steel Buildings, and learn all about this splendid modern type of construction.

**TRUSSED CONCRETE STEEL CO.**

Dept. P62 YOUNGSTOWN, OHIO

Selling agencies open in restricted territory; address Dept. K62.



## BRISCOE

TWENTY-FOUR

"The Latest Briscoe Beauty"

Full stream-line body; electric starting and lighting; 104-inch wheelbase; 3 1/8 x 5 1/8 long-stroke motor; full equipment.

**\$585** f. o. b. factory

Correspondence invited from responsible dealers.

**BRISCOE MOTOR COMPANY, 117 Wildwood Ave., JACKSON, MICH.**

## STOP Throwing Away Old Safety Blades

A Stag Sharpener makes old blades better than new—gives you a head barber shave every morning.

The only sharpener that both hones and strops.

Note wheel in holder sets blade always at proper angle.

Highest Awards Panama-Pacific Exposition, Sharpen Any Make Safety Blade.

Lasts a lifetime. Complete, nickel holder, barber's hone and strop, in neat case, \$1.00.

Money back if not satisfied. Dealers and Agents—write for our money-making proposition.

**STAG COMPANY, 34 S. State St., CHICAGO, ILL.**

**\$1**  
Post Paid



THINK of a detachable bicycle Motor that you can attach to any bicycle in 5 minutes and ride at any speed up to 25 miles an hour—100 to 125 miles on one gallon of gasoline. Thoroughly practical—simple and economical. Full control from one small thumb lever attached to the handle bars of the bicycle. Descriptive literature on request.

**A. O. SMITH COMPANY**

Motorwheel Division 127

**MILWAUKEE, WISCONSIN**

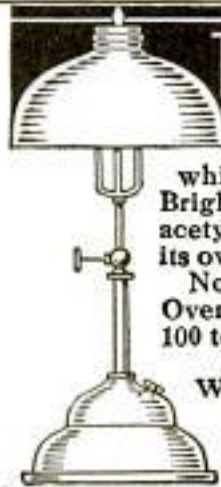

## The "BEST" LIGHT

A soft, luminous light, which casts no shadow. Brighter than electricity or acetylene. Makes and burns its own gas. Costs 2c a week. No dirt, smoke nor odor. Over 200 styles, ranging from 100 to 2000 candle power.

Absolutely guaranteed. Write for illustrated catalog.

AGENTS WANTED EVERYWHERE

**THE BEST LIGHT CO.**

324 E. 5th St., Canton, O.



Another prize "Muskie" caught at Red Iron, Connecticut River, by S. A. Harris, Hartford, Conn.

## "Bristol"

The Prize Winning Rods

FOR three successive years, in the greatest National Fishing Contests ever held, "BRISTOL" Rods have won more than twice as many prizes as any other rod. "BRISTOL" Steel is better than any wood, bamboo or any other material for regular fishing—the proof being that there are more "BRISTOL" Rods sold than any other ten rods combined. Every "BRISTOL" is guaranteed three years. There are imitations. Look for the trade-mark on the handle. Order of your dealer or, if he hasn't what you want, order by mail from us at no additional cost.

Write for Catalogue Free  
**THE HORTON MFG. CO.**  
196 Horton Street, Bristol, Conn.

Please Mention Popular Mechanics

# \$8,000 to \$10,000 YEARLY



## Make Money Out of Others' Fun

Pleasing the Public Pays Big Profits and owners of our famous attractions frequently make from \$8,000 to \$10,000 every year. We make everything in the Riding-Gallery and Carouselle line from the smallest to the highest grade. Bring in hundreds of dollars daily. It is a delightful, attractive, big paying, healthful business. Just the thing for the man who can't stand indoor work, or is not fit for heavy work.

Just the business for the man who has some money and wants to invest it to the best advantage. Our goods are finest appearing, easiest running, and most attractive line manufactured. They are simple in construction and require no special knowledge to operate. Our latest new 1915 Carouselle is mounted on trucks to facilitate and reduce cost of moving and shipping. If you want to get into a money-making business write today for catalog and particulars.

**HERSCHELL-SPILLMAN COMPANY**  
PARK AMUSEMENT OUTFITTERS

333 Sweeney St., N. Tonawanda, N. Y., U. S. A.

## TOOTH-ACHE STOP Stops the Pain & Stops the Tooth

Agents Wanted

**TOOTH-ACHE STOP** PRICE **25 CENTS** 3 for 50 Cents

**ENOUGH TO STOP 30 TOOTHACHES** Easy to use.

Inject a little of this paste into the hollow in the tooth and the **ACHE STOPS INSTANTLY**, and the tooth falls out, forming an antiseptic plug for the tooth. It is **absolutely painless**—will not spread and has no odor. Have it ready for use at all times—perfectly safe and at two in the morning.

**PRICE 25 CENTS; 3 FOR 50 CENTS. POSTPAID.**

Add Five Cents and we will be glad to send you a wonderful **MENTHOL ELECTRIC OINTMENT**, the best in the world. Possesses remarkable healing properties. Most efficacious for all inflammations, aches, burns, bruises, cuts, skin irritations, catarrhal affections, etc. See and see sizes. Try a post. You'll never be without it. **THE NATIONAL CHEMICAL CO., 7127 N. Clark Street, CHICAGO**



## Firestone CYCLE TIRES

Toughest, thickest, most resilient tread. Built like a motor-car tire. All sizes: Non-Skid and corrugated tread.

Firestone Tire and Rubber Company  
Akron, Ohio—Branches and Dealers Everywhere

## BUY YOUR FURNACE \$10 DOWN \$10 A MONTH



Our monthly payment plan of selling direct saves you the dealer's profits, and charges for installation. The

### JAHANT FURNACE

with the patented "Down Draft System" is best for residences, schools, hotels, churches, etc., because it delivers plenty of heat wherever and whenever desired at a saving of  $\frac{1}{3}$  to  $\frac{1}{2}$  in fuel bills. Install the Jahant yourself. We send complete outfit, freight prepaid with special plans, detailed instructions and all necessary tools for installation. Satisfaction guaranteed or money refunded.

WRITE FOR FREE ILLUSTRATED BOOK  
THE JAHANT HEATING CO.

200 Steiner Avenue AKRON, OHIO

# Save $\frac{1}{3}$ to $\frac{1}{2}$ on Fuel Bills

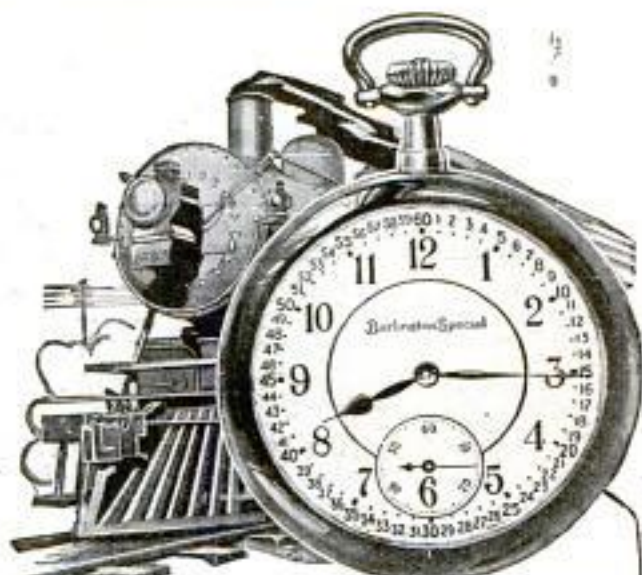

# 19 Jewel \$2.50

**Burlington**  
The Master Timepiece  
Now Direct For Only **4 Month**

## THE Superb Burlington Watch—adjusted to positions, adjusted to temperature and

adjusted to isochronism—now at the *direct* rock-bottom price—the same price that *even* the wholesale jeweler must pay—and in order to encourage everybody to secure this watch at once, pay this rock-bottom price, either for cash or \$2.50 a month on this great special offer. We send the watch on approval, *prepaid*. You risk absolutely nothing—you pay nothing, not one cent, unless you want this exceptional offer after seeing and thoroughly inspecting the watch.

Your own monogram inlaid in the superb gold struts case in any color of enamel you wish



## New Ideas in Watch Cases

All yours to choose from on this offer. Get catalog and see **Block and Ribbon Monograms—Diamond Set—Lodge—French Art—Dragon.**

## Watch Secrets

Explained in Our Book!

Learn the inside facts about watch prices and the many superior points of the Burlington over double-priced products. Just send the coupon or a letter or a postal. Don't delay—write—get this offer while it lasts.

**Burlington Watch Co.**  
19th Street and Marshall Blvd.  
Dept. 9192 Chicago, Ill.

Please send me (without obligations and prepaid), your free book on watches, with full explanation of your cash or \$2.50 a month offer on the Burlington Watches.

**Burlington  
Watch Co.**

19th St. and Marshall  
Blvd., Dept. 9192  
Chicago, Illinois

Name .....

Address .....

Please Mention Popular Mechanics

# Quick Shipments—of Standard Units

**F**OREHAND work on our part enables us to assure shipment of stock units of Fenestra Sash within ten days after we receive your order—even now, when the steel industry is overloaded with business. Thirty-one different styles and forty-five different sizes of

**Fenestra**  
SOLID STEEL WINDOWS  
"REG. U.S. PAT. OFF."

give you a wide range of sash from which to select, for immediate shipment. The thirty-one styles are shown below. This is important to those building this winter. Write for table of overall dimensions and combination widths.

**DETROIT STEEL PRODUCTS CO.**

Department B6

DETROIT, MICH.

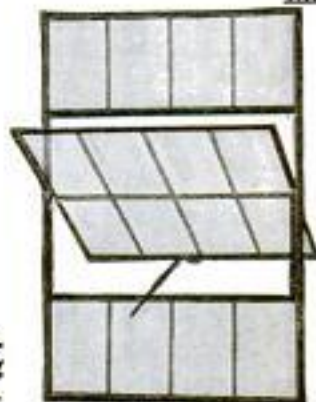

A Standard Fenestra Unit

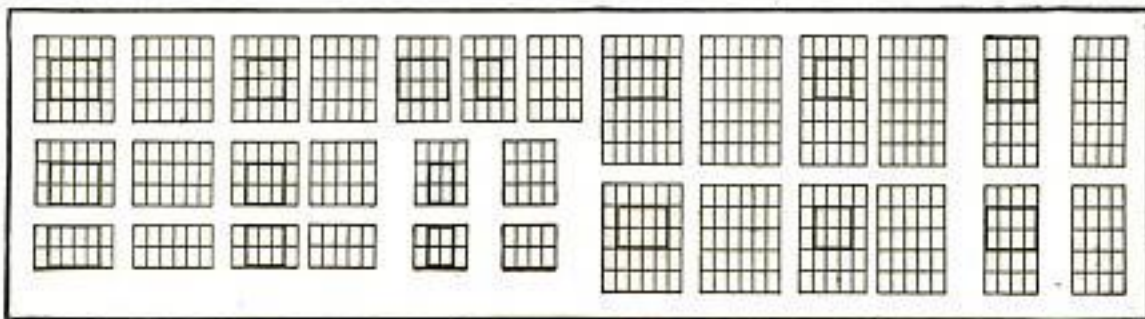

## FINE OLD VIOLINS

On Easy Payments  
30 Days Free Trial



allowed, no matter where you live. If not more than pleased with our values return violin **AT OUR EXPENSE**—and no harm done. Ability to play the violin brings social and financial success. Get a violin with a rich, mellow tone and it will create in you a desire to master it.

**Free! Magnificent Album-Catalog**

containing portraits of the world's greatest violinists since Paganini's time, a half-tone of "Stradivarius in His Workshop," and the romantic story of The King of Musical Instruments. A postal brings all to you **FREE**—no obligations.

**CREMONA VIOLIN SHOP**  
Dept. E541 CHICAGO

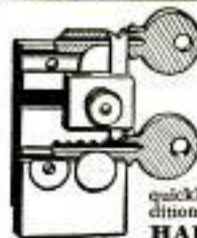

## THE HARRISON M. I. P. KEY FILING MACHINE

Makes duplicate Pin Tumbler Keys with absolute accuracy, and without injuring the original key. Price \$1.00. Special diamond shaped files 35c each or 4 for \$1.00. Net Cash. \$4.00 for the outfit complete.

**THE HARRISON C. K. KEY CLAMP** will make duplicate Common Keys of all kinds for Doors, Padlocks, Trunks, Cabinets, Lockers, etc., quickly and accurately. Price \$1.00. Both machines unconditionally guaranteed. Parcel Post Prepaid.

**HARRISON & CO., 81 New St., New York**



## FACTORY TO RIDER

Saves you big money. Buy direct and save \$10 to \$20 on a bicycle. **RANGER BICYCLES** now come in 94 styles, colors and sizes. Greatly improved; prices reduced. Other reliable models, \$11.95 up. **WE DELIVER FREE** to you on approval and 30 days trial and riding test. Our big **FREE** catalog shows everything new in bicycles and sundries. Write for it. **TIRES, lamps, wheels, parts and supplies at half usual prices.**

**Do not buy a bicycle, tires or sundries until you write and learn our wonderful new offers, low prices and liberal terms. A postal brings everything. Write now.**  
**MEAD CYCLE CO. DEPT. L108 CHICAGO**

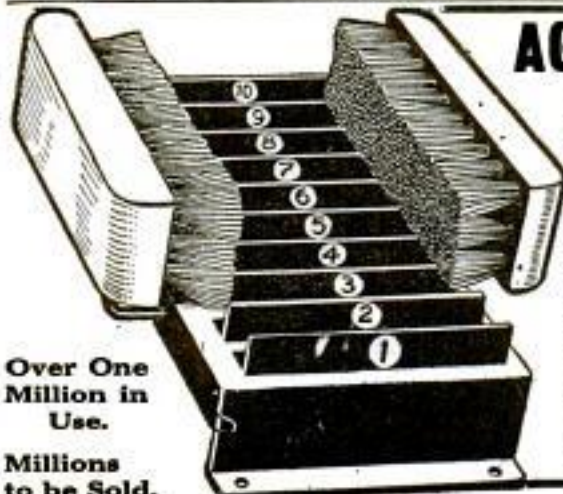

Over One Million in Use.

Millions to be Sold.

## AGENTS—The Million Dollar Hit!

New, wonderful home invention, just introduced, yet million sales already recorded. Tremendous, rapid sales stagger country. Agents happy—banking enormous profits daily. Mighty opportunity for you to get the mighty dollar. Failure impossible. **Experience unnecessary.** Money rolls in first hour—\$10 to \$30 daily. Amazing cash records made. Walters received

**\$50.00 FOR 7 HOURS' WORK**

Never sold goods before, **Arnold sold 160 in 2 days; Hagen 100 same time; Webb 10 per hour; O'Connell 25 first day.** Hundreds like these. You, too, can have money in abundance. **Grab's Scientific Shoe Cleaner** sells itself—you take orders—that's all. Every family wants one on their doorstep. Replaces unsightly, unsanitary, crude door mat. **Automatically removes mud, dirt, snow from shoe in one operation.** Cleans sole, sides, heel. Works like magic—sells like sixty. Saves drudgery, time, money, shoes—saves carpets, floors. Mechanical wonder. Has 7 new patented features not found in any other scraper—10 steel blades—10 dirt outlets—twin adjustable and removable brushes—compound springs. Rotates for sweeping. Can't clog—practically self-cleaning. Handsomely enameled. Nothing else like it. Nothing so popular—so easy to sell. **Selling price only \$1.00.** You make half—100 per cent. Satisfaction guaranteed. Write quick for free catalog—exclusive agency. Better still, see order, naming territory. Investigate anyhow.

**SECURITY MFG. CO., Dept. 233, TOLEDO, OHIO**



## Highland Bodies

*The World's Delivery Standard*

If you're contemplating using motor-delivery, you'll get more service, more style and more room by insisting on a Highland standard body.

There's a special Highland line for the Ford chassis, another for light chassis, and a third for heavier-duty trucks. Every Highland body is designed by trained engineers, who know how to distribute the load so that there will be the least stress and strain on the mechanism.

Write, mentioning your business, and we'll send photographs and description of a body that will exactly fit your business needs, together with a copy of our famous booklet.

**HIGHLAND BODY MANUFACTURING COMPANY**  
202 Elmwood Place Cincinnati, Ohio

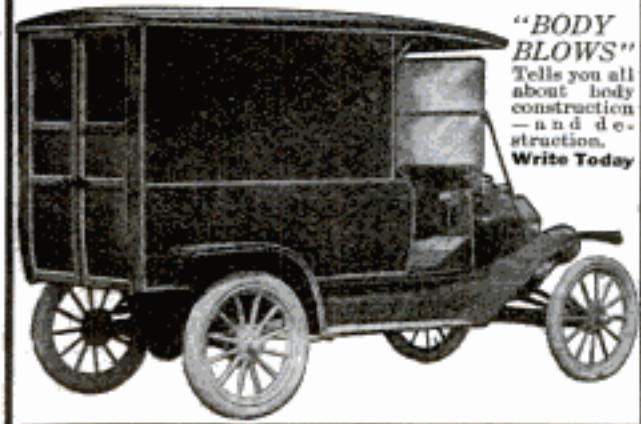

**"BODY BLOWS"**  
Tells you all about body construction — and destruction.  
Write Today

There are about 8,000 acres of parks in Greater New York. Bronx leads with 3,039 acres, Manhattan comes next with 1,460, Brooklyn has 1,141, Queens 1,000, and Richmond 140.

**INVENTORS** WANTING **FOREIGN PATENTS**  
at 1-2 rate, and U. S. priority rights get EX (gov.) FREE  
by Investors' League of U. S. expert att'y, get our latest terms, BUREAU of Patents, 7 Broadway, New York.  
**WE SHOW HOW** TO SELL **YOUR PATENT**



**At the Traps or in the Field**  
shoot shells loaded with Smokeless Shotgun Powder made by the  
**HERCULES POWDER CO.**



### Heat Without Fuel Cost

The new SUN RAY-DIATOR attaches to chimney of any oil lamp or gas light radiating heat and circulating warm air to all parts of room. Uses heat from light otherwise wasted. Does not affect light. Just the thing for bath room, play room or sitting room. Price 50c prepaid or details free. Agents everywhere can make money with the SUN RAY-DIATOR. Write Today.

The White Mfg. Co., Dept. S-13 Cincinnati

## Make \$45 Weekly

Sell our marvelous new Portable Lamp. Better than gas or electricity, or 20 coal oil lamps. Costs less. Burns 98% air, 2% fuel. Guaranteed 5 years.

### Sample on FREE Trial

You can prove at our expense that ours is the best and cheapest—that you can actually make \$45 or more weekly selling it. Territory FREE. Simply send name and address.

**J. B. HALL & COMPANY**  
810 Church Bldg. CHICAGO, ILL.



## Rock Bottom on the Very Best Steel Roofing Ever Made

This is positively the greatest roofing proposition ever made. Before you invest in new roof covering, siding or ceiling, first learn about the one best — by far the best from every viewpoint, and cheapest. Take no chances. Get Edwards' Freight Prepaid offers and note the big saving.



Reo Steel Cluster Shingles

## EDWARDS TIGHTCOTE REO STEEL SHINGLES

actually cost less — outlast three ordinary roofs — no painting or repairs. Rot-proof, fire-proof, rust-proof, and guaranteed lightning-proof. Any one can lay it, right over old shingles if you like.



Spanish Metal Tile

## Impossible To Rust Edges and Nail Holes

Every sheet of Edwards' Galvanized Steel Shingles, Roofing, Siding, Ceiling or finish is extra heavy galvanized, piece at a time, by our exclusive TIGHTCOTE patented process after sheet has been stamped and resquared. Side and edges are as heavily galvanized as body of sheet. Means no weak spots to rust or corrode. By means of Edwards' Patent Interlocking Device (see illustration) all nails are driven through underlayer of metal only — no exposure — no leaks.



Edwards Patent "Grip-Lock"



Corrugated

## Garage \$69.50 Up

Wide variety, many styles, all sizes of Portable, Fireproof Metal Garages, \$69.50 and up. Lowest prices ever made. Postal brings FREE 64-page Garage Catalog.



Garage

## FREE Roofing Book

Edwards' Reo Steel Cluster Shingles, V-Crimped, Corrugated, Standing Seam, Painted or Galvanized Roofing direct to you at "rock bottom" factory prices. Write today for FREIGHT PREPAID OFFER on the lowest prices ever made for World's Best Roofing, Free Samples and Roofing Book No. 250.

**THE EDWARDS MFG. CO.**  
200-250 Pike Street  
Cincinnati, Ohio

**WORLD'S GREATEST ROOFING BOOK**

Note construction of Patent Interlocking Device, protecting nail heads from weather — making roof absolutely water tight.

Name.....

Address.....

Largest Makers of Sheet Metal Products in the World

**AGENTS**

SALESMEN  
MANAGERS  
YOUNG OR OLD  
NEW BUSINESS

**NEW BUSINESS JUST OUT**

DROP THE DEAD ONES. AWAKE! START WITH THIS NEW INVENTION, THE 20th CENTURY WONDER

Get started in an honest, clean, reliable, permanent, money-making business. Sold on a money-back guarantee

*The Blackstone Water Power Vacuum Massage Machine*  
For the Home. No Cost to Operate. Lasts Life-Time

**LISTEN** No Competition, New Field, New Business. Price within reach of all. That's why it's easy to sell. Endorsed by Doctors and Masseurs, Removes Wrinkles, rounds out any part of the face or body, brings back Nature's beauty. Almost instant relief can be given all kinds of pains. A demonstration convinces the most skeptical person. Sales easily made.

**Read On! What Others Do, So Can You.**

Parker writes, sold eight machines first day. Margwarth says, I am making \$19.00 per day. Schermerhorn, eight dozen machines first month. Shaffer writes, am selling four out of five demonstrations. Vaughn, orders one dozen, four days later wires "ship six dozen by first Express." Lewis, sells four first hour. Men, women, everybody makes money. No experience necessary. Protected territory to active workers. We own all patents. Big book entitled, "The Power and Love of Beauty and Health" Free. Investigate now, today. A postal will do. A big surprise awaits you. Address, BLACKSTONE MFG. CO., 133 Meredith Bldg., Toledo, Ohio

**AGENTS**

GENERAL AGENTS  
ROAD MEN  
MAKE MONEY HERE  
Start Now - Today

**Boston Garter**

*Velvet Grip*

The maximum of worth is found in the "Boston"

Silk 50c Lisle 25c

GEORGE FROST CO. BOSTON

**Electric Light for Your Home**

This newly invented system enables every rural home to make their own electric current; operates from one to fifty lights; and will drive small electric motor, electric iron, toaster, etc. Everything complete in one compact unit; no batteries or switchboard. Uses standard lamps and fixtures that any dealer can supply. Nothing to watch but the small, high-speed gasoline motor, which requires slight attention once a week.

The ideal electric lighting system for country homes. Nothing like it ever sold before. Costs less than other systems to buy and to operate. Will last for years.

**WATERMAN MOTOR COMPANY**  
182 Mt. Elliott Ave. DETROIT, MICH.

Write today for descriptive literature and prices.

**Uni-Lectric**  
GASOLINE-ELECTRIC UNIT  
LIGHTING SYSTEM

**An Easy Way to Make Money**

Don't be content to plod along on a small salary. Be independent. Go in the tire repairing business and make \$60 or more a week. One man made \$45 the first day he received his outfit. Others are making \$25 a day and hundreds of wide-awake men are making \$200 to \$500 a month.

No experience needed. We teach you how. Very little capital required. But slight risk, as every car owner in your town is a possible customer. Jobs are plentiful because tires blow out and puncture every day.

**SHALER Tire Repair Outfit, \$60**

will do as much and as perfect work as the big \$250 to \$500 vulcanizing outfits. A boy can vulcanize perfectly with this simple machine. It's the only vulcanizer that has **Automatic Heat Control**. It must vulcanize just right. It can't undercure or overcure a tire. Requires no watching or regulating. You can learn to do expert tire vulcanizing in half an hour with the Shaler.

**WRITE FOR FREE BOOK** "HOW TO OPEN A TIRE REPAIR SHOP" and complete catalog which gives full information. WRITE QUICK BEFORE SOME HUSTLER GETS AHEAD OF YOU.

**C. A. SHALER CO., 2000 Fourth Street, WAUPUN, WIS.**

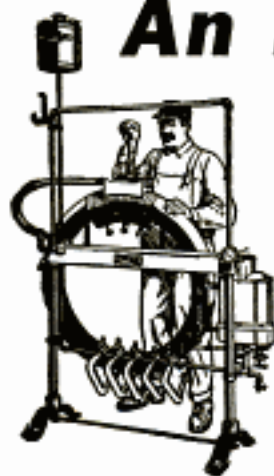

# HEADLIGHT OVERALLS

(Union Made)

Good News for the Man  
who wears Overalls

Despite the war, Headlight  
Overalls will continue to be  
dyed with genuine indigo  
fast blue dyes

"A smile of  
satisfaction  
with every  
pair."

Look  
for this  
ticket



**\$1.25** GENUINE  
per pair INDIGO FAST  
[In Canada \$1.35] BLUE DYE

If the war continues they are likely to go to \$1.50 later. Buy your year's supply now.

**War—Dyestuffs—Cotton**  
These three factors make necessary the new price. We will not reduce our quality. HEADLIGHTS will continue to be the best overalls in the world—the greatest value you can buy.

**Larned, Carter & Co., Detroit**  
(8) **World's Greatest Overall Makers**  
Factories: Detroit and Port Huron, Mich.  
St. Louis, Mo.; San Francisco, Cal.  
Canadian Factory - Sarnia, Ont.

Please Mention Popular Mechanics



## Net

Prices Direct to You

**A**BSOLUTELY net terms on any diamond you choose. You can now buy direct. No jobbers, no retailers to pay. Write for our net price catalog listing an exquisite collection of pure, blue-white

## Diamonds

Tiffany and Belcher rings, La Vallieres, brooches and other diamond jewelry. Every diamond a perfect gem. Selected by a famous expert. Perfectly cut to give maximum brilliancy. Richly mounted in solid gold settings.

**Free Examination** Not a cent down—you see the diamond before you accept it. We want you to compare these diamonds with others at twice their price.

**\$2.50 Monthly**  
Only \$2.50 a month will make you the wearer of a

beautiful diamond ring. Other terms, \$3.50 \$4.50 and up—and middlemen's profits cut out.

## Write

**For Net Price List and Illustrated Catalog**

Shows the different gems, styles of mountings and gives our importer's net prices with terms of payment. Do it now.

**BURLINGTON WATCH CO.**  
Dept. 1192  
Chicago, Ill.

**Burlington Watch Co.**  
Dept. 1192  
Chicago, Ill.

Without obligations send me your net price offer on diamonds; also send catalog.

Name .....

Address .....



No. 421  
Fern Stand  
30 in. high  
Top 16 in. sq.  
Our Price **\$4.25**  
Dealer's Price \$7

# Cut Cost of Your Furniture In Two

Shipped in sections, knock-down—saves factory space—packing costs and freight charges.

Direct from factory to you saves dealer's expenses and profits.



No. 450  
Genuine Red Cedar Chest  
49x22x20 in.  
Our Price **\$10**  
Dealer's Price \$18



No. 808  
30 in. high; top 23x43  
Library Table  
Our Price **\$12.75**  
Dealer's Price \$25

"Period Furniture"—over 100 designs—everything for the home, office or club. Every piece from *selected quarter sawed oak*. Hundreds of dealers are assembling Brooks "Master-Built" Furniture in their stores and selling it from forty to fifty per cent above our prices.

## Home Exhibitors Wanted

Exchange spare time for furniture or cash commissions. A new business for men or women. We ship from a single piece to carload lots. **Free Catalog** with full particulars.

**Brooks Manufacturing Company**  
2702 Rust Avenue, Saginaw, Mich.  
*Largest Plant of Its Kind in the World*

Our Price **\$9.75**

Dealer's Price \$17



Rocker No. 10  
Height, 35 in.  
Width, 31 in.; Depth, 21 in.



No. 314  
Our Price **\$19.75**  
Dealer's Price \$40

Extension 48 to 84 in.  
50x63x15 in.



No. 425  
Desk and Bookcase  
Our Price **\$29.75**  
Dealer's Price \$60

## Let Him Design Your Boat

**FREE**

This man is America's foremost small boat designer. He is Eli Townsend, designer of "Silver Heels," the famous 16-foot hydroplane with which a 19-year-old boy won nine Jersey Coast races out of nine tries. This boat is powered with an H. P. Caille Unit Plant. So harmonious is this combination of motor and boat that we purchased the original "Silver Heels" plans from Mr. Townsend. Now we offer a set of "Silver Heels" blue prints **FREE** with each Caille H. P. Unit Power Plant. Investigate this offer before planning your next year's boat. Also ask for our 1916 Marine Engine book No. 24 showing Caille motors from 2 to 30 H. P.

**THE CAILLE PERFECTION MOTOR CO.**

1523  
Caille Street

DETROIT,  
MICH.



In Russia about 1,300,000 men every year reach the age when they are liable for military service.

A high-power radio station has recently been erected by the government of Guatemala in Guatemala City.

**\$30 a Week EASY**

**MEN AND WOMEN WANTED TO SELL PERFECTO Kerosene Irons**



No experience necessary. Big profits selling this wonderful self-heating satisfaction guaranteed iron. Easy to operate and demonstrate. **Sells itself.** Use Kerosene, Coal Oil or Gasoline with same satisfactory results. **Absolutely safe, no smoke or odor.** Get facts in detail and let us tell you how to obtain **Free Sample** and start you in a big paying business. Sample case **FREE** to Agents.  
**PERFECTO SOD IRON FACTORY**  
Dept. P. 126 So. Clinton St., CHICAGO, ILL.

## 3 Years to Pay — for the — Sweet-Toned Meister Piano



**30 Days' Free Trial** We Pay the FREIGHT

You are not asked to deposit, or pay or advance a cent in any way until you write us and say that the MEISTER is entirely satisfactory and you wish to keep it. Then these are the terms of sale:

**\$1 a Week or \$5 a Month**

No Interest On Payments

No cash payment down. No extras of any kind. Piano stool and scarf free. Sold direct from the maker to you and we guarantee you a saving of \$100. Send now for our beautiful **Free Catalog**, which shows eight styles of Meister Pianos. Our resources exceed \$4,000,000.

**\$175** **Rothschild & Company** Dept. 16-R Chicago, Illinois

## Oxy-Acetylene Welding and Cutting

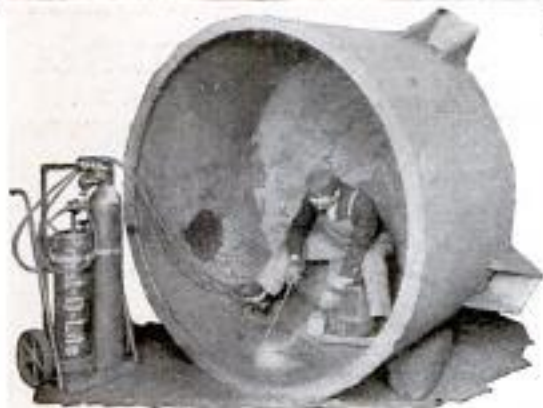

It would have cost \$120 to recast this kettle, to say nothing of the delay involved. The total welding cost by Prest-O-Lite Process, covering time and materials and gas, was \$4.60.

## Saved \$10,000 a Year On Repairs Alone

4,914 miscellaneous repairs—very few alike—were made in one railroad shop by oxy-acetylene welding at a cost of \$8,865.29. The cost by other methods, according to past records, would have been \$19,640.33—a clean-cut saving of \$10,755.03, in repair work alone, not counting the value of repaired parts, or cost of replacement.

In *your* shop there is an equal opportunity for proportionate savings.

Your junk pile can be made to pay you a profit. When heavy equipment breaks down, you can repair it, preventing costly replacements, delays and tie-ups in production.

Oxy-acetylene welding has an unlimited range of usefulness in manufacturing and construction work also. The process is easy to learn. We furnish thorough instructions with every outfit—also train your operators free of charge.

**Prest-O-Lite**  
PROCESS

Employs Prest-O-Lite Dissolved Acetylene (ready-made carbide gas) in portable cylinders—backed by Prest-O-Lite Service. Used as conveniently as cylinders of oxygen. Saves large initial outlay and heavy depreciation of making crude acetylene in carbide generators. Perfectly dried, cleaned and purified—makes better welds and is cheaper to use. Necessary equipment is not expensive. We furnish high-grade apparatus for \$60 (Canada \$75); acetylene service at additional cost. Adaptable for oxy-acetylene cutting with the addition of special cutting apparatus.

### Start Now—Get Full Details

Doing Oxy-Acetylene Welding for others is a good business opportunity for enterprising men. Immense and growing demand assures profitable operations right from the start.

Others are making enormous savings by oxy-acetylene welding. Ask us for data on any phase of welding work. Our oxy-acetylene literature, full of helpful suggestions, set free.

**The Prest-O-Lite Co., Inc.**

The World's Largest Makers of Dissolved Acetylene

Main Office and Factory: 816 Speedway, Indianapolis, Ind.

Canadian Office and Factory: Merriton, Ontario.

53 Branches and Charging Plants



# Turn Your Motorcycle

## Into an Automobile

"On or Off in  
30 Seconds"

Use your motorcycle alone all you want—then with half a minute's attention, hitch on this new 3-passenger, non-skidding, non-tipping auto and share your joy rides with wife and kiddies.



Instantly converts any standard motorcycle into a whole family-car. Best auto design, finish; spring seat and back are chased leather upholstered; semi-elliptic springs; crown fenders; complete.

**\$100**

F. O. B.  
BUFFALO

## A Practical Pleasure Car With Only Motorcycle Upkeep

Also regular and special body types for fast delivery.

Write for catalog. Give name and model of your motorcycle. Agent's name appreciated. Write now for early delivery.

**Greatest  
Invention  
Since Motorcycle  
Itself**

**Cygnets Rear Car Co.**  
Dept. M, BUFFALO, N. Y.

Dealers write for discounts and exclusive territory

■ CYGNET REAR CAR CO., Dept. M, Buffalo, N. Y.

■ Please send me full information about your Cygnets Rear Car.

■ Name.....

■ Address..... Model of Motorcycle.....

■ Dealer's Name.....

## It's Worth More Than \$1.50

Here is an Automatic Screw Driver well worth a place in the finest tool kit. It is strong, heavy, can be automatically changed for either right or left hand work by use of simple ratchet mechanism or can be made a stationary screw driver. It has three interchangeable Tool Steel Blades, the polished handle is well shaped for easy work—here's a tool that will drive home a screw quickly in any wood without any slips or mis-cues.



Other tools included under the famous Goodell-Pratt Brand are

Hacksaws  
Saw Sets  
Gauges  
Punches  
Micrometers  
Bit-Braces  
Grinders  
Calipers  
Squares  
Vises  
Drills  
Levels  
Lathes

The same honest material and workmanship is in every one of our 1500 good tools. We're constantly adding to our line. We can supply your every tool need. You are always assured of quality and satisfaction when you order under this label.

Write for Complete Illustrated Catalogue

GOODELL-PRATT COMPANY

*Toolsmiths*

Greenfield, Massachusetts

**GOODELL  
PRATT**

**1500 GOOD TOOLS**

Please Mention Popular Mechanics

## Veeder CLUTCH SPEED Counter

No. 21

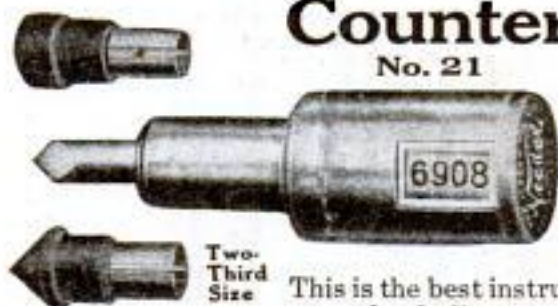

This is the best instrument for finding revolutions per minute of a shaft or any revolving part. Will measure high or low speeds. No stop-watch is required. Perfectly accurate. Cut is two-thirds size. Price **\$3**

Every engineer knows that the word Veeder stands for the finest counting devices in the world. We make a counter for practically every purpose, and will be glad to give you advice without charge, in connection with your particular line. We will be glad to send you free our illustrated booklet with information about these wonderful instruments. Send for it.

Cyclometers, Odometers, Tachometers and all kinds of counters. Fine Die Castings.

**Veeder Mfg. Co.** 4 Sargeant Street HARTFORD, CONN.

The average "life" of a horse at the front is only two months.

No Wick  
No Chimney  
No Torch  
No Danger  
No Odor

### POWERLIGHT

Highest Award World's Exp. 335  
C. P.—20 Hrs. 1 qt. Kerosene or Gasoline. Read and sew without spectacles.

**Daylight's GREATEST COMPETITOR**  
5 yr. Guarantee—20 styles—5 finishes.  
Everybody buys—Sure sale when seen.

**RETAILS \$5 AND UP**

AGENTS—Contract exclusive territory. Big Profit—Samples Loaned.  
**POWERLIGHT CO., 543 Broadway, NEW YORK**

POWERLIGHT  
LAMP  
WITH  
MIRROR

## INDOOR CLOSET

**More Comfortable, Healthful and Convenient than the Out-Door Privy**

Eliminates the out-door privy, open vault and cesspool. They are breeding places for germs. Have a warm, sanitary, odorless toilet right in your house. No going out in cold weather. A boon to invalids. Endorsed by State Boards of Health.

W. M. Davis writes: "Your indoor closet is giving absolute satisfaction. It is certainly the thing for a home without sewerage."

**Absolutely Odorless Put It Anywhere in the House**

The germs are killed by a chemical process in water in the container, which you empty once a month. **Absolutely no odor.** No more trouble to empty than dishwater. Closet absolutely gas-tight. Write for full description and price.

**Agents Wanted — Big Profits** Wonderful opportunities in every town, village and in the country. Best season just at hand. Every home is a good prospect. Sell eight out of every ten you call on. Ernest Hissell writes, "Have ten orders." U. A. Dierman says: "Ship at once, twenty closets and fifteen washstands. Sold them all in one community." Sells itself. Everybody hates the outdoor privy. Everybody wants a Ro-San Indoor Closet. Write quick for territory and full particulars.

**ROWE SANITARY MFG. CO., 201P Sixth St., Detroit, Mich.**  
Ask about the Ro-San Washstand — Hot and Cold Running Water Without Plumbing



## The Dread of Dentistry is Pyorrhea

(Sometimes called Riggs Disease)

It is characterized (among other symptoms) by bleeding, discolored gums, receding gums, sensitive teeth, bad breath and finally loosening and dropping out of the teeth.

DO YOU KNOW that 90 per cent of the people have it in the first, second or third stage—

DO YOU KNOW what causes it or what a terrible menace it is to your health— You should know how to recognize Pyorrhea when you see it and how to prevent and overcome it.

SEND ME YOUR NAME and without obligation of any kind I will send you FREE my illustrated booklet about this most common but dreadful disease of the gums. Also testimonial letters from hundreds of people who have treated themselves at home avoiding pain, loss of time, expensive treatment and false teeth. *25 years' success.*

DR. F. W. WILLARD, B872, Powers Bldg., Chicago, Ill.



## Watches On Credit

High Grade WALTHAM and ELGIN MOVEMENTS

We sell the finest watches made. No matter where you live,

**YOUR CREDIT IS GOOD**

Better goods at lower prices. Write for Big Free Catalog of Watches, Diamonds, Jewelry, Silverware and our Easy Terms of Payment. MILLER-HOEFFER COMPANY 607 Miller Bldg., Detroit, Michigan

## ALL STEEL GARAGE

### The Butler "Round Ruf"

Full protection and at least cost. Fire-proof. Corrugated. Easily put up. Attractive in appearance. Portable. Useful as a machinery, tool or storage building. Additional sections to increase length furnished at any time. If your dealer does not handle, write us for full information and prices.

BUTLER MFG. CO., 204 Butler Bldg., Kansas City, Mo.

## Private Weather Bureau

IN EVERY HOME

**A Reliable Barometer  
An Accurate Thermometer**

Actual Size 13 inches High

Indispensable to the farmer, business man, professional man, automobilist, in fact, to everybody who should know in advance what the weather will be. Will save you money and time.

FORECASTS WEATHER

# WEATHEROMETER

HOURS IN ADVANCE

**\$1.00 ONLY — Reduced from \$3.00**

Send us no money. Mail your order today and Weatherometer will be sent to you C. O. D. (10¢ extra). If you prefer you may enclose \$1.00 bill or money order with order. Satisfaction guaranteed.

This Instrument Imprinted Makes an Excellent Advertising Article  
**WINTHROP INSTRUMENT CO.**  
5 South Wabash Avenue, Dept. 24, CHICAGO



## Wake Up!

**D**RIVE out that tired feeling. Enter into the day's activities with a keen, wideawake brain. Enjoy to the utmost every minute you live. When your brain is fagged and when you are only half awake your senses are dull.

Try vibration just once. Let it "tune up" every nerve and fibre in your body. Then you will declare with thousands of men and women in all walks of life the White Cross Electric Vibrator is one of the greatest aids to health and happiness ever invented.

## Vital Strength

The virile force of robust manhood—the dynamic energy that gives man the power to do things may be yours through vibration. Write today for our new book that tells you what this great force has done for others.

# THE WHITE CROSS

ELECTRIC VIBRATOR

This remarkable invention has accomplished wonderful results. Physicians the world over endorse it. So simple is it constructed and so easy to operate that anyone can give himself vibratory treatments right in his own home. The fact that over 80% of the vibrators now in use bear the name White Cross is conclusive evidence of their excellence.

## Send the Coupon for New Book

Send your name and address in the coupon or on a letter or post card and get our new book "Health and Beauty" absolutely free. No obligations. Find out about this marvelous force that has been such a help to thousands. Also find out about our special reduced price and free trial offer. Write today.

### SPECIAL!

Special free trial and reduced price offer now being made. Send the Coupon.

Lindstrom-Smith Co.

Dept. 9192  
1100-10 S. Wabash Ave.  
CHICAGO, ILL.

We also manufacture White Cross Electric Stoves, Irons, Hair Dryers, Electric Lamps, Electric Fans, Electric Automobile Horns, Electric Curling Irons, Heating Pads, Small Motors, etc., etc.

**Dealers Write**

Name .....

Address .....

My Electrical Dealer's Name is .....

Please Mention Popular Mechanics

# REDUCE YOUR COAL BILLS 20 TO 50%



EASILY AND QUICKLY  
INSTALLED on your Furnace  
without Injury to the Door  
or Putting Out Fire

**\$22.50**

EXPRESS PREPAID

## We Will Prove Results on Your Own Furnace or Heating Plant by a 10-Day FREE TRIAL

The Crown Fuel Saver is easily and quickly installed on the door of the furnace, hot water, hot air or steam heater or garbage burner and requires no attention after installation. Has no adjustable parts to get out of order, and will last as long as your furnace. It creates more perfect combustion by superheating the air before it enters the fire-box which produces more heat, reducing coal gases, smoke, soot, ashes and clinkers, and permits the use of cheaper grades of coal with better results. It turns your wastes into profits and prevents your money from going up the chimney.

**We will promptly refund your money if  
our device fails to reduce your coal bills  
20% or more after a 10-day free trial.**

### Here is Our Proposition:—

If your local dealer cannot supply you with a Crown Fuel Saver, for a 10-day Free Trial, send us your order with remittance of \$22.50 (which is our Special Introductory Price) and we will send you at once by prepaid express one of our devices with simple instructions how to install in a few minutes on the door without injury to door or even putting out fire. After device is on, note the difference in heat, less coal burned, less ashes, less clinkers, less attention to fire, etc. If you are not more than satisfied with your purchase, send the device back at our expense, and we will promptly refund your money.

Hundreds of our devices installed have produced letters telling of the wonderful merits of the CROWN FUEL SAVERS. We will gladly mail you bonafide copies upon request. We prefer, however, to give you a practical demonstration on your own furnace or heating plant, which enables you to know positively its wonderful efficiency.

## The Crown Fuel Saver

will pay for itself in a season. It pays you a dividend from your coal pile year after year. Why not start today and turn your waste into profit? Literature, letters, etc., mailed you upon request.

The  
Crown  
Fuel  
Saver Co.  
30 N. LaSalle St.  
Chicago, Ill.

Enclosed find \$.....

for.....Crown Fuel Savers

which send me by.....  
express prepaid on 10-day trial with  
money back if not satisfactory.

No. and name furnace.....

Size of fire box.....shape.....

How many doors.....size.....

Good or poor draft.....is there stack damper.....

Name.....

Address.....

town.....State.....

## The Crown Fuel Saver Company

30 North La Salle Street  
CHICAGO, ILL.

### REFERENCES:—

Union Bank of  
Chicago or any  
Commercial  
Rating  
Company.

## WEBER THROTTLE- GOVERNED KEROSENE ENGINES

Lowest Priced Throttle-Governed Engine  
on the Market.

Save Half In Fuel. The 1916 model Weber solves the problem of low cost power for all time. Power and speed controlled by throttle, same as steam. No waste of fuel — no violent explosions. Throttle regulates amount of fuel to size of load. Sold on a five-year guarantee—two months' trial in shop or on farm. Shipped direct from factory at a big saving.



FREE BOOK—"How  
to Use Kerosene" and  
Engine Folder, sent post-  
paid. Address

WEBER ENGINE CO.  
Dept. 1772  
Kansas City, Mo.



## BOYS!

### Automatic-Repeating Pistol

SHOOTS a hole in a paper tape—fifteen  
hundred load reports from one charge.  
Made of blood gun-metal—8 inches long—  
easy action—absolutely harmless—no powder  
or projectile—permitted in any community.

FIVE EXTRA ROLLS FREE

THE AIRMATIC PISTOL CO.  
370 Citizens Building CLEVELAND, OHIO

**\$1.00**

Postage pre-  
paid anywhere  
U. S. or Can.

## IF \$10 to \$20 a Day Profits LOOKS GOOD TO YOU

Let us send you a Free Booklet of our

### Automatic Card Printing Press

Printing is ever-lastingly a big money-making  
enterprise anywhere. Don't delay. Write today.

S. B. FEUERSTEIN & CO.

Patentees and Manufacturers  
542 West Jackson Boulevard CHICAGO



## Comfort In-Door Closet

### ODORLESS, SANITARY GERM-PROOF

Every home without sewerage  
needs one. Most convenient, meri-  
torious home necessity in a cen-  
tury. A boon to sick people. Can  
be placed anywhere in house.

### Makes Outdoor Privy Unnecessary

Put a warm Comfort Toilet in your  
home; a guarantee of healthy, sani-  
tary conditions. Germ-life killed by  
chemicals in retort. Emptied once  
a month—no more trouble than  
throwing out coffee grounds. Needs no  
other attention. Boards of Health endorse it. Write  
now for literature, prices, etc.

### AGENTS CAN EARN \$10 TO \$25 DAILY

Here's something going like a prairie fire. Best thing  
that ever headed your way—big chance to clean up \$25 a  
day if you will hustle. Sale sure in every home without  
a toilet. Hardly any limit to your earning. Don't sleep  
over this. Send postal by next mail. Biggest money-  
making, easiest selling proposition ever put up to an  
agent. Exclusive territory. Write now for agents proposition.

COMFORT CHEMICAL CLOSET CO. 382 Factorie Bldg.  
TOLEDO, OHIO





# FLORIDA

## The Land of Flowers Wants You—Wants to Make You Independent

Florida wants to save you from dependence after age has scrap-heaped you. Florida wants to pay you \$3,000, \$5,000 or more a year for life. All Florida asks of you is a fair amount of work in your Orange or

Grapefruit Grove. While waiting for it to mature, you can more than pay your way by raising small fruits and vegetables between the trees. In the

## Sarasota Bay District On the West Coast

we have land rich in vegetable mold and certain chemical elements which classify it as combination soil.

**A Rare Soil** which grows grapefruit and oranges, vegetables and small fruits **all at the same time** with the same degree of certainty and perfection.

**On This Land** are wonderful grapefruit and orange groves 40 years old; some 20 years old, others 1, 2 and 3 years old, and still others just being set out. Between the trees are being raised **top-priced** strawberries, melons, celery, lettuce, cauliflower.

**A Few Acres** of this great soil will give you financial independence—a home amid oranges and sunshine.

**While Waiting** for your orange and grapefruit trees to mature you can "farm between the trees" and thus more than pay your way. E. B. Tucker sold \$522.00 worth of tomatoes from one acre. A. D. Albritton cleared \$524.00 on  $\frac{3}{4}$  acre of strawberries.

**You Have Cash Market** for everything. Rail and water transportation. Shippers' protective associations. Twice daily express and freight service.

**Sarasota-Venice Company**  
201 Pineapple Ave., Sarasota, Florida

**Abundant Rainfall** to mature all crops, but in addition anyone may have flowing artesian wells of pure, sweet water.

**Social Life** at Sarasota is ideal. Churches, schools, lodges, good neighbors, a modern town. The climate and recreations tourists travel far for and pay dearly.

**Come to Sarasota**—we want you and will give you ten years' time on your land payments. We will not permit you to purchase blindly; we give you a year's time to examine your land and **refund any payments you have made with 6% interest if you are not entirely satisfied.**

**Ask for Illustrated Book**—It explains all about our liberal, easy, safe payment plan. Contains many photographic scenes of Sarasota Bay District grapefruit and orange groves with vegetables growing between the trees. Shows scenes in town of Sarasota—paved streets, modern stores, handsome dwellings, \$25,000 school. Pictures of fishing, hunting and other sports. **Send Coupon for FREE BOOK.**

SARASOTA-VENICE COMPANY, 201 Pineapple Ave., Sarasota, Florida

You may send me Free Illustrated Book about lands suitable for grapefruit, oranges, small fruits and vegetables.

Name.....

Address.....

Town.....State.....

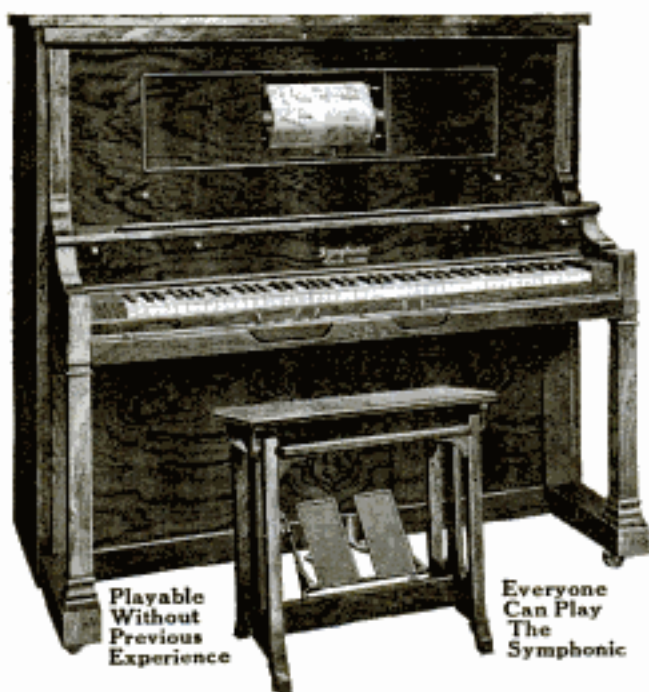

Playable  
Without  
Previous  
Experience

Everyone  
Can Play  
The  
Symphonic

## Symphonic Pianos and Player Pianos—

Are Made By Master Piano Builders

Mr. Ernest J. Knabe, Jr., and Mr. Wm. Knabe III, of Knabe Bros. Co., the makers of Symphonic Pianos and Player Pianos, are known among critical music lovers everywhere as skilled manufacturers of lifelong experience. They formerly built the Wm. Knabe Piano. Now they build Symphonics, which are entering their fourth year's sale at Factory-to-Family Prices at great savings, compared with usual prices for such instruments. Every Symphonic is shipped direct from Knabe Bros. Co. factories.

### Easy Monthly Payments 4 Years' Time—No Interest

From every standpoint our Symphonic offers are liberal, convenient and worthy of careful investigation and acceptance. Next to selling instruments of high quality at low prices, Factory-to-Family prices, easy easy payment terms should interest you. We allow four years' time in which to pay and make no extra charge in interest or rent. No longer need your home be without one of the best Pianos or Players. You can own and pay for a Symphonic.

### Symphonola Plays Victor and Columbia Records

Here is a full-sized instrument that will play the best records and in a pleasing manner. We invite a comparison of the Symphonola's tone with that of any and all other similar instruments. Our easy payments give you a year to pay.

#### Ask Now For Offers

Your request for the details of our interesting offers on Symphonics or the Symphonola will quickly bring all information. Send the coupon now and state instrument interested in.

MAIL THIS TODAY

**Larkin Co.** Dept. P. M. 216  
Buffalo, N. Y.

Tell me about offers on instrument checked and send the Musical Inst. Catalog.

Piano  Player  Symphonola

Name.....

P. O.....

State.....

St. or R. D.....

Address.....  
Complete With a Generous  
Selection of Records

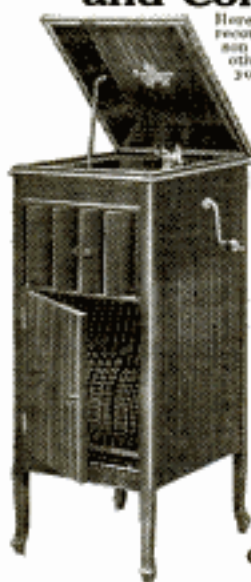

## Earn Money

this summer demonstrating the  
**Wisconsin Detachable Row Boat Motor**  
with weedless propeller, patented top adjustment,  
rudder steering or self-locking tiller, Exclusive, sales-  
making features; quick sales, good profits. Act at  
once. Get catalogs. Write WISCONSIN MACH. &  
MFG. CO., 10 Minor Street, Milwaukee, Wis.  
Makers of Marine Motors for 14 years

# 6 Months To Pay!

## Your Suit Made to Order

Think of getting a suit tailor made strictly according to your individual measurements and having 6 months to pay for it! No matter who you are, where you live, or what you do, we will make you the finest, snuggest suit you ever saw and give you an entire half year to pay for it!

## Save Half!

You actually and positively get the suit at about half what it would cost you elsewhere! Our tremendous buying gives us the pick of the world's greatest mills at lowest prices known. Therefore we can cut the price in half and still give you 6 months to pay. Don't pay double our price for cheap "ready mades." Don't pay other tailors two or three times as much as we charge.

## ONLY \$2.50 PER MONTH

You wear the suit while paying for it. Payments so marvellously easy you won't miss the money. We trust you absolutely. Your word is all the security we ask. No references, red tape, delay or collectors. No strings attached to this credit whatever. It's yours to use as freely as you wish. Don't class us with ordinary tailoring houses. Wear "different!" You'll be delighted.

## DeLuxe Book of New Styles FREE!

The most sumptuous style book ever published—our 1916 Spring and Summer Style Book! See the actual cloth samples of most beautiful weaves and patterns—the newest and latest. Also illustrations of choicest designs from world's greatest style centers. You'll marvel at this great book. Send postal or letter—get this magnificent free style book and full particulars of our startling offer. Don't miss this amazing opportunity. Don't delay! Write today—NOW!

**STANLEY ROGERS CO.**  
544 S. Clark St., Chicago, Ill.

## \$1,000 Reward

to anyone who proves that we do not make all garments absolutely tailor-made to your own individual measurements. Beware of the houses selling ALTERED "ready mades" as made-to-order clothes.

**A CURIOUS MINERAL**—Perhaps the most curious mineral found in the United States is staurolite, otherwise known as the "fairy stone." This is an iron-aluminum silicate found only in Virginia and North Carolina, the reddish-brown and brownish-black crystals occurring in well-defined single and double crosses. There is some commercial demand for the crosses as curios—a demand perhaps stimulated by a legend relating to their fairy origin.



## Gasoline and Steam Engines, 1-16 H. P. Up

Engine Castings, Dynamos, Motors, Small electric light plants. Electrical and mechanical specialties. Large catalogue and circulars for 5c.  
**DYNAMIC MFG. CO.,** First Nat'l Bank Bldg., CHICAGO

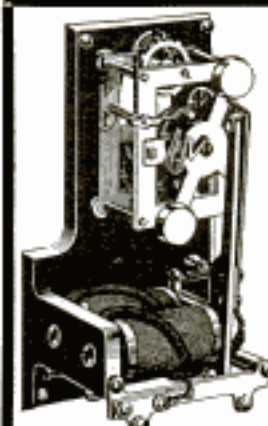

## Make Your Clock Self Winding

By simply replacing your old-style key-wound works with an American Self Winding Movement. Runs by two standard dry batteries a year to 18 months at a time. Will give you the correct time, year after year, without the bother of ever winding your clock.

Price \$4, ready to install.

For complete clocks see page 183, December issue. Remember—"You Never Have to Wind Them."

**American  
Self Winding Clock Co.**  
Marine Building CHICAGO

Size 6x3½ inches

Please Mention Popular Mechanics



*Hello Boys!*

This  
**AUTO**  
and  
**PONY**  
**FREE**

**500 PRIZES WORTH \$5000**

**For Boys Who Build the Best Models**

This new Erector Prize Offer of mine is the biggest ever made to boys. The present Erector prize contest ends March 1, 1916. I want you boys to keep right on building new and better models so I am making this new \$5000 prize offer which begins March 2, 1916, and ends March 1, 1917.

**ERECTOR**

*The Toy Like Structural Steel*

This time I am dividing the prizes in two classes. Boys over 12 years will compete for the Senior Prizes; the first Senior prize is a brand-new Saxon Automobile and the 249 other Senior prizes include motorcycles, canoes, camping outfits, hockey skates, magic sets, Erector sets, etc.

Boys of 12 years and under will compete for the Junior Prizes; the first Junior prize is a beautiful Shetland Pony and the 249 other Junior prizes include bicycles, tents, rink skates, air rifles, flashlights, magic sets, Erector sets, etc.

**Ask Your Dealer for January Tips. Tells All About New Prize Offer.**

Go to your toy dealer now—ask him for free copy of the January issue of my boys' magazine, **Erector Tips**. It tells all about the offer, illustrates prizes, etc. If your dealer hasn't it, write me, (giving dealer's name) and I will mail you a copy free.

A. C. GILBERT, President  
**THE MYSTO MFG. CO.**  
104 Fox St., New Haven, Conn.



This model won the first prize in the 1913-14 contest

The  
Druggist  
Will Tell  
You So



The next time you need Tooth Paste or Powder, Shaving Cream, Salve, or any preparation similar to the 125 Toilet Articles and Remedials comprising the SAN \* TOX line, step into any drug store where you see the San \* Tox Nurse trade-mark on the window and ask the druggist which of all makes he is willing to recommend. He will not only say SAN \* TOX, but he will guarantee every item and refund your money if you are not convinced after trial that they are indeed supreme. The best Druggist in every locality features SAN \* TOX, because its uniformly reliable purity and high quality lend distinction to his store. The highest standard of perfection is attained in

**SanTox**

*The Public Service Line*

It is a distinct public service to raise the standard of toilet and household preparations; to pass them on to the Consumer fresh and pure direct from the Laboratory; to deliver guaranteed satisfaction in attractive packages of fullest size and heaped-up measure.

If you have never tried SAN \* TOX, there is a treat waiting for you. The sign of the Nurse will point the way to a new opportunity—a personal advantage that you should not miss. Try SAN \* TOX today at the SAN \* TOX Druggist's risk. There is a SAN \* TOX druggist near you.

**THE DEPREE CHEMICAL COMPANY**  
Chicago, Illinois



*Please Mention Popular Mechanics*



# EXCELSIOR LIGHT WEIGHT



**\$135<sup>00</sup>**

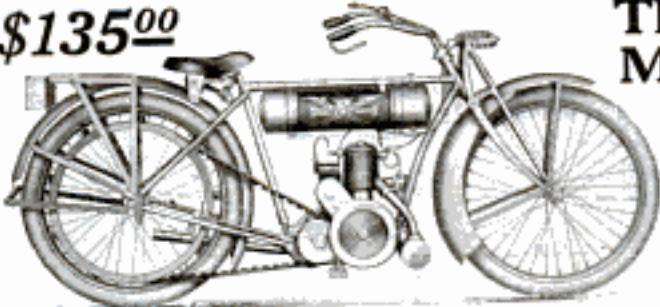

## The Biggest Hit in Motorcycle History

**Minimum Expense  
Maximum Service**

### A Motorcycle for Every Man and His Family

When we began advertising the new EXCELSIOR LIGHTWEIGHT we were flooded with inquiries. Now our dealers have demonstrators on hand their stores are crowded and the orders piling in. Experienced motorcyclists appreciate the Comfort, Safety and Economy of a lightweight motorcycle that will carry them anywhere at any reasonable speed at Minimum Cost and Maximum Safety. The Business Man, Student and Suburban Resident

appreciates that here is a machine that will afford him the Utmost Degree of Comfort and Safety without special preparation in the way of clothing, and they can be easily moved and stored anywhere. It is every man's motorcycle and the dealer's money maker. If you are a dealer, write for terms and territory. Everybody else see the nearest dealer or write us for catalog.

## Excelsior Motor Manufacturing & Supply Co.

3702 Cortland St., CHICAGO

### Buy Direct—Save Big Money

**1/2 USUAL PRICES**  
For Auto Tops

Fit any car, **\$6.80, \$8.85, \$10.25** up, without frame.  
**SEAT COVERS** For Fords, **\$3.45, \$5.60, \$7.00** up;  
 Overlands, **\$4.65, \$5.60, \$9.45** up;  
 Buicks, **\$5.00, \$7.00, \$10.50** up. All others same rate.

**ONE MAN TOPS Complete \$15.85 and up**

Our local representative will give you expert advice free and save you big money. Write for his address with free catalogs and samples.  
**AUTO SPECIALTY FACTORY, 1017 Spring St., Cincinnati, O.**  
 Limited territory still open. Write today for exclusive agency proposition.  
**DEALERS AND AGENTS**

See Our  
**Auto Expert**

A big sagebrush plow said to be capable of turning under thickets of brush 6 ft. high, was exhibited at the Panama-Pacific Exposition.

Cannons were first used in English ships at the siege of Calais in 1345.

## DOMELRE

Domestic - Electric - Refrigerator  
 Factory: Clyburn Avenue and Willow Street, Chicago, Ill.

The Electric Ice Man will soon be standard equipment in all good American homes. Men of ability and capital who want a real monopoly in their territory are obtaining our exclusive perpetual sales contracts. Get started on the ground floor of "The Next Great Business" by writing for our proposition today.

The Mechanical Refrigerator Company  
 718 Fisher Building, Chicago

**\$7<sup>50</sup>**

**\$7<sup>50</sup>**

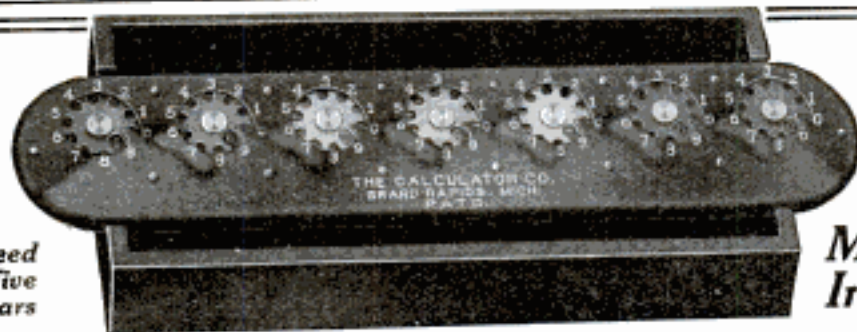

P.M.  
 Calculator Sales Co.,  
 Grand Rapids, Mich.

**Guaranteed for Five Years**

**Marvelous Invention**

## The Calculator Adding Machine

Does the work of the high-priced, non-listing machines. High speed. Absolute accuracy and efficiency. Indispensable in factories, shops, big or little businesses. Time saved pays cost of machine many times a year. 10,000 satisfied users.

Send for Illustrated Booklet and Our **FREE TRIAL OFFER.**  
**CALCULATOR SALES CO., GRAND RAPIDS, MICH.**

Name.....

Occupation.....

Street No.....

City and State.....

Please Mention Popular Mechanics

Free  
Instruc-  
tion  
Book



10  
Days'  
FREE  
Trial

## Underwood Typewriter At Less than $\frac{1}{2}$ Manufacturer's Price

You May  $\left\{ \begin{array}{l} \text{Rent} \\ \text{OR} \\ \text{Buy} \end{array} \right.$   $\left\{ \begin{array}{l} \text{Applying Rent} \\ \text{on Purchase Price} \\ \text{For Cash or on} \\ \text{Easy Payments} \end{array} \right.$

Every reader of Popular Mechanics should take advantage of this Supreme Opportunity to get a **Genuine Underwood Typewriter** at less than half Manufacturer's Price. Remember, you need not buy at once, but Rent an Underwood; then if you decide to purchase it, the rental you have paid will be applied on purchase price. Let us send you an

### Underwood Typewriter on 10 Days' Free Trial

If you are **not** thoroughly pleased with it, send it back at **our expense**—in no way will you be obligated. If satisfactory, you may rent it, and **every cent of the rental you have paid for six months will be applied on the purchase price.**

#### Easier Work—Extra Money

An Underwood Typewriter will serve the dual purpose of making your work easier, while at the same time opening an avenue to extra money.

Manuscripts will bring you from ten to twenty cents a sheet. Scholarly articles, human-interest stories and photoplay scenarios are in big demand now and bring big money. Typewritten manuscript in every case brings greater attention from publishers. They pay scant heed to long-hand manuscript.

You people who are looking for a way to earn extra money in your spare time can do so with a typewriter. The Underwood, as you know is the standard machine of the country and is easy to operate.

With our free instruction book sent with every machine it will take you only a few hours to learn the vital points and your speed after a little practice will surprise you. The many opportunities for this kind of work is right at hand. Get your start now and work will come even without solicitation.

#### You Can Get An Underwood Free

Our Agency Plan enables you to pay for a machine with commissions earned. No canvassing—No soliciting. Send coupon for full particulars of Underwood Offer No. 152.

Typewriter  
Emporium,  
Chicago

Without expense or obligation to me you may tell me all about your Underwood Offer No. 152.

### Typewriter Emporium, Chicago

*Largest Independent Typewriter Dealers in the World*  
During 23 years of successful business we have sold and rented over 150,000 machines

Name.....

Address.....

Town.....State.....

MAIL THIS COUPON TODAY

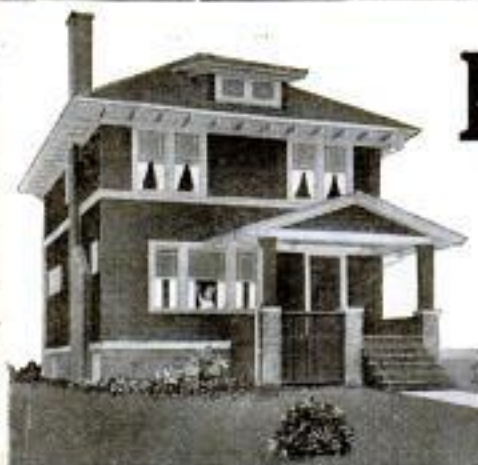

SENATOR

See what our astonishing price includes. Large reception hall adjoining an exceptionally spacious living-room. Fine, broad dining room. Perfectly appointed kitchen. Four big bedrooms with 4 big closets and bath upstairs. The ideal proportion of space for each room, most handily arranged. Our price \$995. And this includes all lumber, hardware, paint, glass—every part cut to exact fit. You will save \$500 on this home. Terms: Cash Payment and \$22.96 per month.



THE ARLINGTON

A very popular Plan and Size—and one of the most remarkable values we have ever offered. A 7-room Beauty—large living-room, dining room and kitchen. Three spacious bedrooms. Bath. Four closets. Fine big porch with Etruscan columns. Price \$1283.45. Terms: Cash Payment and \$29.53 per month.



MIRACLE

The beauty of this picturesque 5-room bungalow wins every home builder. Note the handsome porch with its large columns. Then the artistic taper trim. Inside—a cozy arrangement with living room and dining room, 2 bedrooms and bath and spacious kitchen. All for \$656—saving you an average of \$520. Terms: Cash payment and \$15.12 per month.



THE GLADKEN

An amazing value—four exceptional rooms—fine big porch—back entry. Furnished complete, ready for the nail. Only \$398.90! Terms: Reasonable payment down, \$9.19 per month.

# Read How Mrs. Wilson Saved \$700 On This Home

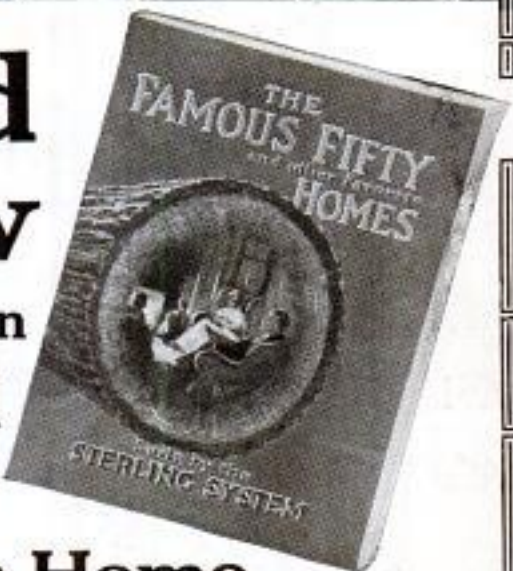

Send at once for the new, fine, big Sterling Book and save half on your Home. Forty-seven per cent in actual cash! Not "claims" or "estimates" but Sworn FACTS given by *Customer Records*. THE AVERAGE OF ALL IS 47%!

Get this book now—your first move. See there how real Homes are sold straight from the tree itself saving all middlemen's profits.

See there how selected materials are cut-to-fit by special power machines with polished precision saving all waste and two-thirds the labor—and making construction perfect.

See there the finest Home plans in America—contest-winners—the pick of eight thousand designs.

See there the most amazing offer ever made—half the money left with you as a cash-in-your-hand-guarantee!

## Two Years to Pay

Beauty—solidity—speed and ease as well as record economy. And we meet you half way with the greatest credit ever offered.

You pay half down; keep the remainder as guarantee; pay light rent for two short years; then the Home is yours forever.

## Don't Miss the Book

The new Sterling Book just 30 days old has carried the country by storm. It would be folly to miss it. For it's worth its weight in pure gold to you. And a postal brings it.

Not only a certain saving of nearly half; not only the finest designs ever listed; not only grooved-tight construction—and clear, sound materials—and wide-open credit; but a Service that takes care of you right to the finish.

It's a wonderful, wonderful opportunity. Don't miss it. Send post card today.

**INTERNATIONAL MILL & TIMBER CO.**  
45 Sterling Place Dept. Q-20 BAY CITY, MICH.

**How**  
Mr. Ewing  
saved \$500.00

**How**  
Mr. Burke  
saved \$800.00

**How**  
Mr. Fulmer  
saved \$800.00

**How**  
Mr. Way  
saved \$950.00

**How**  
Mr. Camp  
saved \$300.00

**How**  
Mr. Jenkins  
saved \$400.00

**How**  
Mr. Driesbach  
saved \$300.00

**How**  
Mr. Gossage  
saved \$300.00

**How**  
Mrs. Cornell  
saved \$200.00

**How**  
Mr. Walser  
saved \$240.00

**How**  
thousands now living in Sterling Homes have saved an average of 47% on the best Homes ever built. Names and addresses on request.

# Genuine Imported English Serge

Made - **\$14.50**  
to-Order  
For Only

**G**LENN Urquart Plaids—Tartan Plaids, Shepherd Plaids, Fancy and Pencil Stripes, Two tone stripes. Your choice of any cloth, plain or fancy weaves, rough mill finish or smooth finish—tailored to your own measure at prices that will astound you.

Send the coupon for our new Style Book and read of the remarkable bargains in tailored-to-measure clothing. Newest fabrics—at prices never before equaled by any other high-grade house.

The Imported English Serge is but one of the bargains we offer. Just think of it! A genuine Imported English Serge—made to your measure for only \$14.50.

Pay \$4.50 first and the balance in small monthly payments. Your credit is good.

## On Credit!

You do not pay a cent unless you are delighted with the suit—after it has been tailored to your own measure. See for yourself before you decide to buy. Note the perfect fit—note how carefully it is made in the latest style—compare it with any other suit you ever bought—then, if you are not satisfied, send it back.

If you decide to buy—you may pay the bargain price—a little each month. Your credit is good.

## New Style Book

and Samples of the Latest Fabrics—FREE

Send the coupon for our Style Book and samples at once. See for yourself the astounding bargains

we are making. Examine carefully the newest fabrics. See handsome illustrations of the latest New York styles. The Style Book is free—write for it today. You will be under no obligations—and your name will be recorded so that you can take advantage of these great price reductions made for introductory purpose.

## Send the Coupon

For free colored Style Book and samples of the newest fabrics for suits and overcoats. We can have your suit ready in 10 days. Send for booklet and free imported samples.

**Babson Bros.** Dept. 1192  
19th Street Chicago

**Babson Bros.**  
Dept. 1192 Chicago

Gentlemen:—Please send me your free colored Style Book and samples of fabrics for suits and overcoats. Also explain your easy credit terms.

Name .....

Address .....



# Must Sell 50,000 ELGIN Watches This Year

## Our Rock-Bottom Prices And Easy Terms Will Do It

We must sell 50,000 Elgin Watches this year. We have to do it to protect our factory contracts. That's more than 4000 watches a month, nearly 200 a day, but we will do it.

Yet, do you know what this means to you? It means the Newest Models, the finest Elgins at **cut prices \$12.75 to \$26.50.** It means that we give you the Rock-

**\$3 Chain FREE** *If You Buy This Month!*

**Therefore, no matter where you live, write for our Big Free Catalog at once.** You are invited to open an account with us. Whether it be Watches, Diamonds or Jewelry, Silverware, Musical Instruments, Shoes, Clothing, Sewing machines, Leather Travellers' Cases, Guns or Bicycles, **you get it here on easy payments at money-saving prices.**

## 17, 19 and 21 JEWEL

We have the very watch you have been waiting for. High-grade, thin Model Elgins at a **saving of a third to a half** with such liberal terms thrown in for **good measure** that you'll never miss the money. So no matter whether you are rich or poor, it's all the same to us. Our little payments make your credit good and the volume of our business in all parts of the country, combined with big factory contracts, enables us to make you the astoundingly easy terms of only

## \$2 a Month!

**Now Ready** **New Models, Exclusive Designs, Richly Enameled, Original Engravings, Just out.** In our new Catalog only, will you find the Beautiful New Model "Classic," the new "Universal," the new "California," the new "Diamondette," the new "Sunshine," the new "Double Circle," — all marvelously beautiful. And when you see the cases themselves, you'll agree that no illustration or printed page, can adequately convey the full splendor of these magnificent models. They are gorgeous in design and execution. They convey to the eye that degree of joy and satisfaction, made possible only by their richness of quality, gold enamels and the artist's touch. They have no lines that you would re-

move. They lack none that you would add. They instantly command your unalloyed admiration. They carry their own evidence of superb quality and in the rigid gold assay test, stand in a class by themselves.

**Send No Money** But write today. Send your name and address for the most interesting Catalog in America. A catalog with a thousand illustrations. A book that tells all about the Easy Way—the Harris-Goar Way. It shows you and everybody how to own a fine Watch, a Diamond, a Suit or Overcoat, a Bicycle, Camera, a Sewing Machine or Musical Instruments, all Rock-Bottom Prices without missing the money.

You pay no interest—we ask no security—no red tape. We don't need the money and all we ask is just common, everyday honesty among men, and our wholesale prices save you nearly half. Send your name and address today.

**HARRIS-GOAR CO. Dept. 1851 KANSAS CITY, Mo.**  
*The House That Sells More Elgin Watches Than Any Other Firm in the World.*



## AUTO GIVEN AWAY

We want representatives in every locality. No experience or capital necessary. Send us your name and address and by return mail we shall tell you how you can secure one of our new 1916 model 5-passenger touring cars free for demonstrating. Write today—do not delay—a postal card will do. Address

**ECLIPSE MOTOR CAR CO. 851C Buhl Block DETROIT, MICH.**

*Please Mention Popular Mechanics*



## GOOD AGENTS

Wide awake, energetic Men can secure protected Territory to sell our portable Lamps, Lighting Systems and our 250 C. P. Inc. Gasoline Lanterns, which are positively the simplest and most practical gasoline devices on the market. We challenge competition, **Your Chance.** Territory is being rapidly taken. If you want a good, steady income, write us TODAY.

INTERNATIONAL LIGHT NOVELTY & SPECIALTY CO.  
426 So. Clinton St., Dept. 79, CHICAGO, ILL.



## 3 1/3 c a Day

now buys a dazzling Lachnite Gem. Their brilliance is eternal—they stand fire and acid tests and cut glass like diamonds. Cost but one third as much. Set in solid gold. The newest design. Golden Free Trial. See our new jewelry book. Write for Big Jewelry Book Your name and address is enough. No obligations whatsoever. Write today—now.

**HAROLD LACHMAN COMPANY**  
52 N. Michigan Avenue, Dept. 1192 Chicago, Ill.







## “There, Mother, Just As You Predicted—”

Missing the “game-ball” *right in front of the pocket* is only one of the whimsical turns with which Home Billiards abounds. It’s part of the frolic to twit the family sharp-shooter. So leave it to mother and the boys to hold their own.

Your family deserves this daily sport and exercise that Brunswick Carom and Pocket Tables are providing for thousands of homes.

Send today for our color-illustrated book of details. *It’s free.*

# Brunswick “Baby Grand”

“Grand,” “Convertible” and “Quick Demountable” Billiard Tables  
Now \$27 Up—Pay 10c a Day

Brunswick Home Tables are scientifically built, with accurate angles, fast ever-level billiard beds and quick-acting Monarch cushions—the choice of experts. Why buy a toy table when a real grown-up Brunswick costs so little? By paying while playing, you never will miss the amount.

### Any Home Has Room

Now you can get a genuine Brunswick in any size your home requires. Our “Quick-Demountable” fits on top of your library or dining table, or comes with folding or quick-detachable legs.

“Grand” and “Baby Grand”—for homes with a spare room, attic, basement or den—are the finest and fastest in the world.



“BABY GRAND”  
Carom and Pocket Billiard Style

### 30-Day Trial—Outfit FREE

Balls, Cues, Rack, Markers, Spirit Level, Expert Book of 33 Games, etc., all included free with every Brunswick. No extras to buy—no heavy after-expense.

Our plan lets you try the table *30 days FREE*. Then pay monthly, *as little as 10 cents a day!*

Send at once for our widely-read book, “Billiards—The Home Magnet,” that shows these tables in realistic colors, discloses factory prices and full details. New edition now ready. Mail the coupon for this valuable book today. *It’s FREE.*

### Mail This For Billiard Book FREE!

The Brunswick-Balke-Collender Co., (512)  
Dept. 25Z, 623-633 S. Wabash Av., Chicago  
Send free, postpaid, your color-book

“Billiards—The Home Magnet”  
and tell about your home trial offer.

Name.....

Address.....

Please Mention Popular Mechanics



Operator

Installer

Lineman

Clerk

## The Picked Army of the Telephone

The whole telephone-using public is interested in the army of telephone employees—what kind of people are they, how are they selected and trained, how are they housed and equipped, and are they well paid and loyal.

Ten billion messages a year are handled by the organization of the Bell System, and the task is entrusted to an army of 160,000 loyal men and women.

No one of these messages can be put through by an individual employee. In every case there must be the complete telephone machine or system in working order, with every manager, engineer, clerk, operator, lineman and installer co-operating with one another and with the public.

The Bell System has attracted the brightest, most capable people for each branch of work. The training is

thorough and the worker must be specially fitted for his position.

Workrooms are healthful and attractive, every possible mechanical device being provided to promote efficiency, speed and comfort.

Good wages, an opportunity for advancement and prompt recognition of merit are the rule throughout the Bell System.

An ample reserve fund is set aside for pensions, accident and sick benefits and insurance for employees, both men and women. "Few if any industries," reports the Department of Commerce and Labor, "present so much or such widely distributed, intelligent care for the health and welfare of their women workers as is found among the telephone companies."

These are some of the reasons why Bell telephone service is the best in the world.



**AMERICAN TELEPHONE AND TELEGRAPH COMPANY  
AND ASSOCIATED COMPANIES**

**One Policy**

**One System**

**Universal Service**

*Please Mention Popular Mechanics*

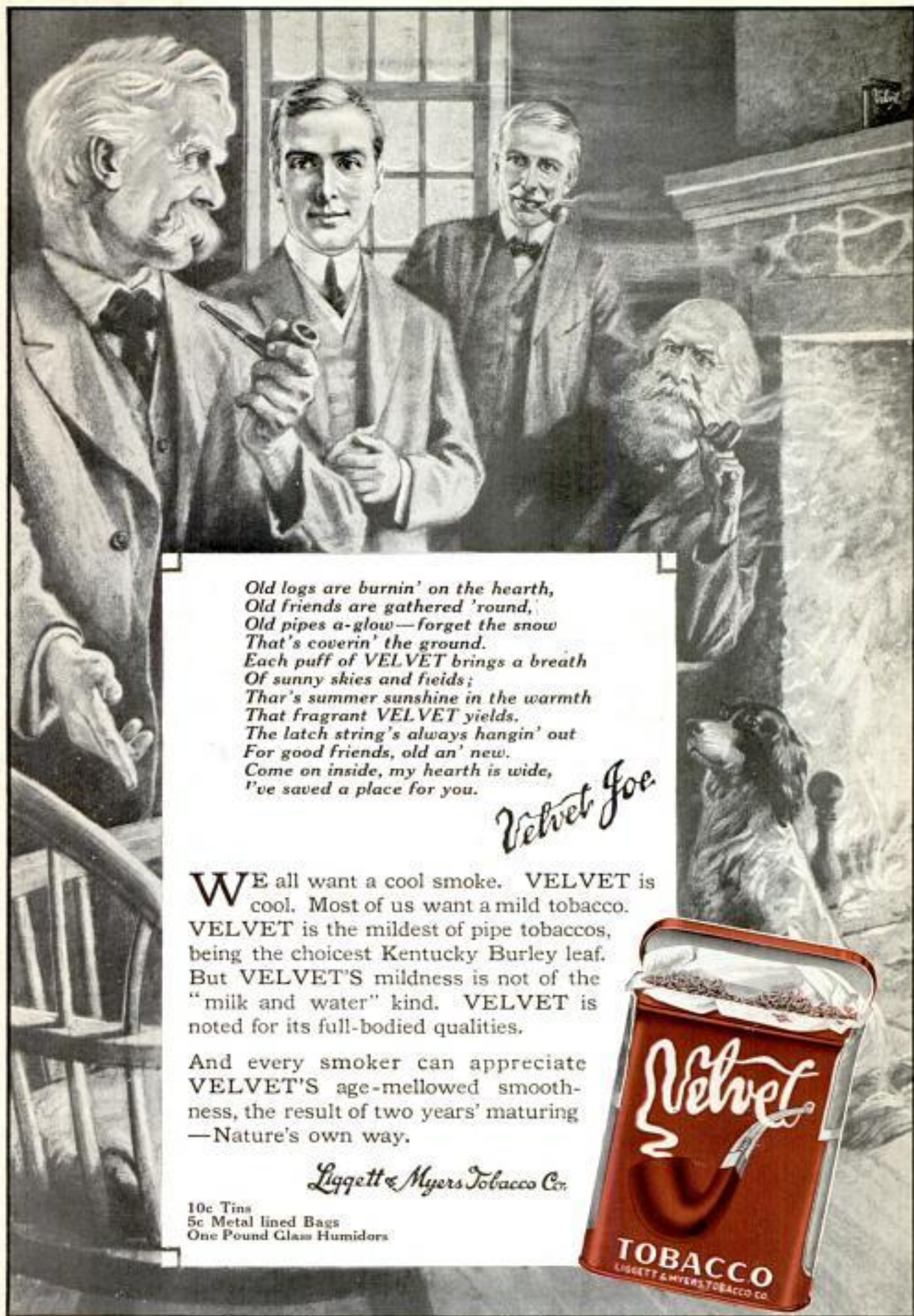

*Old logs are burnin' on the hearth,  
Old friends are gathered 'round,  
Old pipes a-glow—forget the snow  
That's coverin' the ground.  
Each puff of VELVET brings a breath  
Of sunny skies and fields;  
That's summer sunshine in the warmth  
That fragrant VELVET yields.  
The latch string's always hangin' out  
For good friends, old an' new.  
Come on inside, my hearth is wide,  
I've saved a place for you.*

*Velvet Goe*

**W**E all want a cool smoke. VELVET is cool. Most of us want a mild tobacco. VELVET is the mildest of pipe tobaccos, being the choicest Kentucky Burley leaf. But VELVET'S mildness is not of the "milk and water" kind. VELVET is noted for its full-bodied qualities.

And every smoker can appreciate VELVET'S age-mellowed smoothness, the result of two years' maturing—Nature's own way.

*Liggett & Myers Tobacco Co.*

10c Tins  
5c Metal lined Bags  
One Pound Glass Humidors



Even if you oversleep  
you needn't undershave

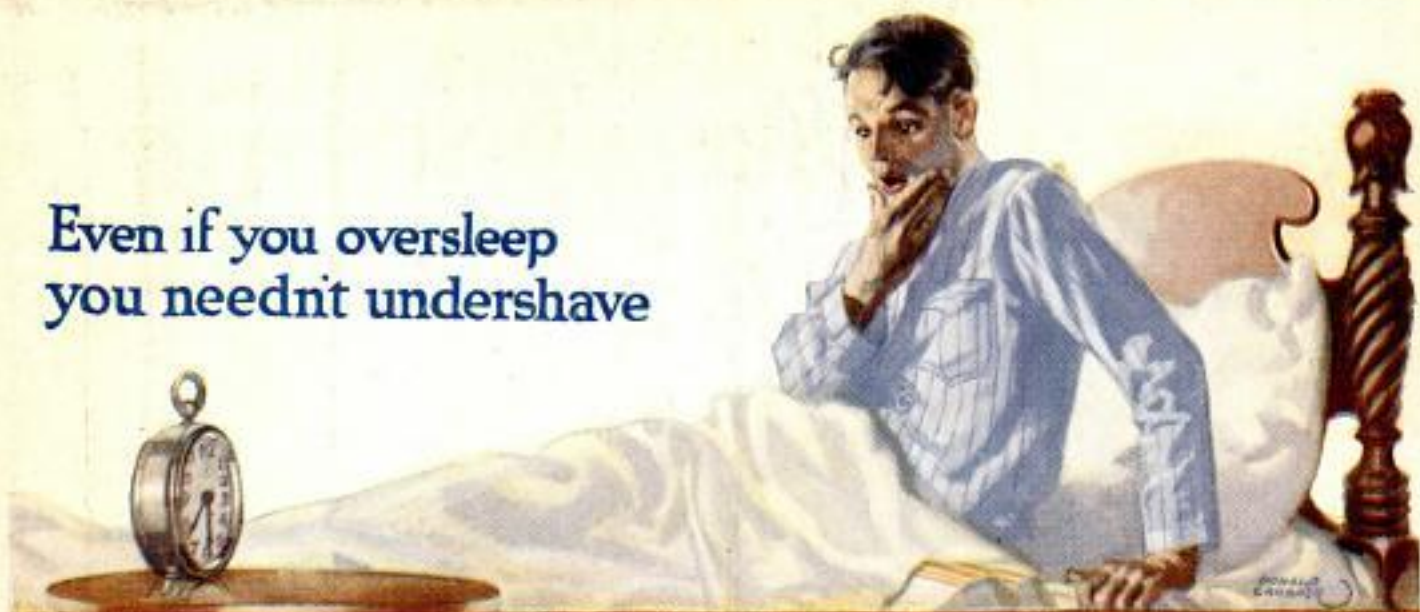

If you *must* shave in a hurry, you *can*, with Colgate's Rapid-Shave Powder. Shake a little on the wet brush and work up the lather right on the moistened face—only a short time needed with

# COLGATE'S RAPID-SHAVE POWDER

TRADE MARK

Colgate's lathers instantly and softens the beard thoroughly *without* any mussy "rubbing in" with the fingers. Your razor works swiftly, easily.

Colgate's lather properly made does *not* cling to the razor edge and "slow you up."

And when you're done, the soap washes *off* easily. Colgate's Rapid-Shave Powder will gain you time and comfort. The same perfect lather with Colgate's Shaving Stick or Shaving Cream. A trial size of any one sent for 4c in stamps.



**COLGATE & CO.**

Dept. 81 199 Fulton St., New York

Canadian Address: Drummond Building, Montreal

Makers of Cashmere Bouquet Soap—luxurious, lasting, refined.