

THIS ISSUE 440,000 COPIES

# POPULAR MECHANICS

## MAGAZINE

WRITE TO UNDERSTAND IT

TRADE MARK



Copyrighted material



## \$727 buys the material to Build This Home

Clear, KNOTLESS Cypress siding, No. 1 Dimension lumber, Guaranteed Roofing, Creosoted wall plates, Clear Modern Craftsman style interior finish. Clear Millwork, Doors and Windows. Satin-finish hardware. All guaranteed and backed by our \$10,000,000.00 capital.

This elegant substantial bungalow (No. 183—five rooms and bath) shipped direct-to-you—No money in advance. You risk nothing. Pay according to our liberal terms.



**\$473** No. 109. Five Rooms and bath, closets, etc.



### FREE Book of 100 Harris Homes

Over 100 actual designs of Harris homes, barns, garages, etc., illustrated by beautiful photographic engravings. Complete floor plans, material list and prices shown for each one. Book explains the Sensibly Cut-To-Fit Harris Way, gives our liberal terms, and much valuable information. Your copy mailed to you free of any cost or obligation.

#### MAIL COUPON NOW!

HARRIS BROS. CO., Dept. AL-7.  
Send me Free Books marked X.

- |  |                                   |
|--|-----------------------------------|
| <input type="checkbox"/> Book 100 Harris Homes | <input type="checkbox"/> Plumbing |
| <input type="checkbox"/> Building Material     | <input type="checkbox"/> Roofing  |

Name .....

Address .....

## Sensibly Cut-to-Fit The Harris Way

The most economical and practical of all cut-to-fit methods. The Harris Way—the result of 23 years of practical building experience reduces building expenses to the minimum. First you save from 20 to 50% on material, and then cut your expense bills way down by building our guaranteed no shortage Sensibly Cut-To-Fit Harris Way.

### Saved \$510.00

Harris Brothers Co.,  
Greensburg, Pa.  
As to quality and quantity of material furnished me for my home, (No. 131), I am highly pleased. I have made a saving of \$510.00 and have had sufficient material for the smallest detail. I could not have duplicated this design for twice the amount paid your firm. Also might state further that Plans and working sheets for this design worked out to the letter. I am always your friend for your fair and courteous treatment.

Yours respectfully,  
H. H. HENRY.

### Plumbing Our Plumbing

smashes all prices on high grade materials. Install your own plumbing with the aid of our free expert engineering service.

Complete porcelain roll rim bath tubs, at \$11.00.  
Bath-room outfits at \$29.75.

Send for free Plumbing Book to-day.

### Roofing

We offer the century's greatest bargains in high grade roofing, wall board, ornamental steel plates, etc. Our Ajax brand, rubber surface, 3-ply at 96c per roll of 108 sq. ft.

Galvanized steel at \$1.95 per 100 sq. ft.

Write for our big FREE Roofing Book to-day.

### Greatest Bargains of the Century

in Lumber, Millwork and other building materials. We ship direct-to-you from our great manufacturing plant. Get our free Building Material Catalog.

**HARRIS BROS. CO.**  
35th & IRON STS. CHICAGO



**\$583** No. 61. Six rooms\* and bath, closets, etc.



### FREE Plan Offer & Specifications

Complete building Blue Prints, exact material lists and specifications for any Design on this page at the special price of \$1.00 with the coupon below. Our regular price \$2.00. Material illustrated and described. Our blue prints set would cost \$50.00 to \$100.00. We send them to you for \$1.00. 50c refunded, if plans do not suit. If you purchase materials from us, plans are free.

**\$960** No. 131. Eight rooms and bath, closets, etc.



# The Victor Record catalog is the most complete catalog of music in all the world

and tells you exactly what a Victor or Victrola will bring into your home

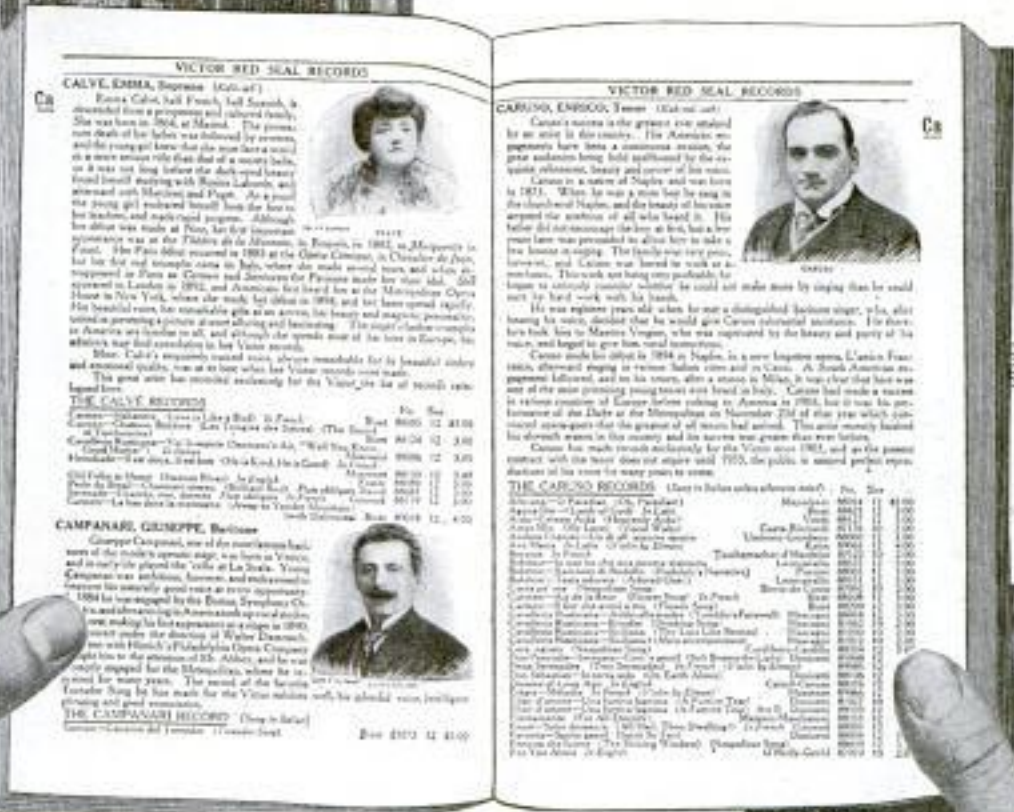

It gives you a volume of information about operas, artists, and composers, and contains numerous portraits and illustrations. It shows you how easily all the music of all the world can become an entertaining and instructive part of your every-day life. This 450-page book lists more than 5000 Victor Records, and is of interest to every one.

It costs us more than \$150,000 every year, and we want every music lover to have a copy.

Any Victor dealer will gladly give you a copy of this great catalog of music, or send to us and we will mail you a copy free, postage paid.

There are Victors and Victrolas in great variety of styles from \$10 to \$400.

**Victor Talking Machine Co., Camden, N. J., U. S. A.**

Berliner Gramophone Co., Montreal, Canadian Distributors

Always use Victor Machines with Victor Records and Victor Needles—the combination. There is no other way to get the unequalled Victor tone.



New Victor Records demonstrated at all dealers on the 28th of each month

This One



NX8R-35E-XEF8

aterial

*"Oh, how artistic, simple and yet distinguished this*

# Cypress Furniture

*is!—and to think that you made it yourself! You have a natural gift for Cabinet work, haven't you?"*

*He—"Not exactly that—all I had was the New Cypress Furniture Instruction Book. It is you, my dear, who have the 'Gift!'"*



**These are the days of thrift  
—as well as the days of sentiment**

**Can intelligent thrift and the healthy "homey" sentiment express themselves in any other way quite so well as in "home-grown" furniture? (Use an "easy" wood.)**

**Vol. 38** of the famous Cypress Pocket Library—"indispensable to every home-owner and home-hoper in the land,"—contains original designs, made for us by authoritative furniture artists, of SEVEN PIECES of Necessary Furniture. Why buy them? Why not make them yourself, of Cypress, "the wood eternal"? (It's easy on edged tools.)

**Vol. 38** contains full detail sketches, specifications and careful instructions. Tells how to make well-designed, "craftsy" furniture in your spare hours at home. "Home-grown furniture is best of all; you love it as well as use it." Just you try it!

Write tonight for **Volume 38—absolutely new, and a welcome addition indeed.**

When planning a Pergola, Mansion, Bungalow, pasture-fence or sleeping porch, remember—"With CYPRESS you BUILD BUT ONCE."

Let our "ALL-ROUND HELPS DEPARTMENT" help YOU.

Our entire resources are at your service with Reliable Personal Counsel.

**SOUTHERN CYPRESS MANUFACTURERS' ASSOCIATION**

1219 HIBERNIA BANK BUILDING, NEW ORLEANS, LA. OR 1219 HEARD NATIONAL BANK BUILDING, JACKSONVILLE, FLA.

INSIST ON CYPRESS AT YOUR LOCAL DEALER'S.

IF HE HASN'T IT, LET US KNOW IMMEDIATELY.

Please Mention Popular Mechanics

# Popular Mechanics Magazine

6 N. Michigan Avenue, Chicago, U. S. A.

EDITED BY H. H. WINDSOR

England: The International News Co.  
5 Beams Bldg., Chancery Lane, London, E. C.

Australia:  
The Australasian News Co.

ISSUED MONTHLY

SUBSCRIPTION:

SINGLE COPY, 15 CENTS

In United States, and its possessions, Cuba and Mexico, per year, postpaid . . . . . \$1.50  
To Canada . . . . . 1.75  
To all other countries in the Postal Union . . . . . 2.50

All subscriptions are discontinued at expiration. Please examine the date printed on your wrapper.  
Entered as Second Class Matter Sept. 15, 1905, at the Post Office at Chicago, Illinois, under Act of March 3rd, 1879.  
Entered as Second Class Matter at the Post Office Department, Canada.  
Published monthly by POPULAR MECHANICS CO. Copyright, 1915, by H. H. WINDSOR.  
Copyright, in France.

"Malva Blanc" 67

## Contents for January, 1916

Addressing Machine, Hand, Is Office Convenience	71	Chair, Easy, and Bed Made in One Piece	16
Aerial Defenses of Paris, by Searle Hendee	33	Chest, Capacious Cedar, Makes Nest Settee	63
Aeroplane Builders Test Propellers with Barge	108	Chimneys, Extending, Is New and Dangerous	
Aeroplane—Flier Launched from Speeding Vessel	47	Work	66
Aeroplane Militia, Organization of New York	9	Church, Pool Hall, and Saloon under One Roof	88
Alarm, Night Rain for Bedchamber	118	Clock, Factory, Employed to Promote Safety	100
Anchor, Barbed Steel Made without Loose Parts	121	Clock, Novel, Model Engine Is Housing for	72
Ankle Bouquet, Debut of as Feminine Ornament	84	Clothesline Outfit for Woman Traveler	119
Automobile Attachment Counteracts Glare	21	Coast Line of the United States, Length of	100
Automobile, Children Ride to School in Combination	68	Coaster, New, Early Bicycle Prototype of	41
Automobile, Drip Pan for Made of Oiled Paper	120	Concrete Bridge Stands Up under Immense Load	106
Automobile Hoods, Machine Cuts Ventilator Slits in	32	Concrete, Poor, Is Cause of Silo's Collapse	95
Automobile Jack Lifts on Wheel at Hub	112	Concrete Work Taught School Children	80
Automobile—Safety Towline Hook Made for Use of Motorists	65	Digging Machine, Quick Work of Telephone Gang Aided by	84
Automobile—Schooner, Odd Overland, Used on West Coast	46	Dish Washer, Mechanical, for Domestic Use	119
Automobile Seat, Wedge Shape Cushion Made for Automobile Service Depots Designed Attractively	69	Dogs, Alaskan, for Service with French Army	39
Automobile, Small, Queer Antic is Performed by	98	Doll, New Type of Teaches Children Embroidery	61
Automobile Truck Cleans and Oils Streets	62	Dome, Would Sell Cast Iron Capitol	68
Automobile Tube Forms Miniature Balloon	103	Doorbell and Hall Lamp, Combination Switch for	2
Automobile, Two Passenger Trailer for	81	Dredge Reclaims Tide Flats of Western City	115
Automobile Well Fitted for Long Junkets	122	Drinking Tube Equipped with Filter	113
Automobile Windshields are Cleaned Electrically	5	Eggs, New Container for Safe Shipping of	61
Automobiles, Combined Crank and Tire Pump for	82	Electric Fans, Ornamental, for Every Room in Home	110
Automobiles, Train Dispatching System for	111	Electric Lamp Chains, Luminous Bulb for	118
Ball Score, Boy on Roller Skates Delivers	68	Electric Range, Tiny, Made as Toy for Children	79
Balloons Carry Poisonous Gas into Fortress	32	Elevator, Temporary, Used on Outside of Hotel	31
Bath, Crude Shower Real Luxury for Soldiers	1	Exit, Emergency, Designed for Ships' Firerooms	87
Bathub and Washstand, Combination	46	Explosion, Boiler, Starts Train of Trouble	26
Bicycle Chains, Automatic Cleaner for	98	Explosives, Stopping Landslide with	117
Blasting Caps, Delay Electric Aid in Counting Explosions	113	Farming, Kiowa Indian Boys Taught	18
Blind Man without Arms Reads Raised Letters	28	Ferry, New, Largest on Great Lakes	94
Bottle, Champagne, Throws Hidden Confetti	8	Finger Stalls Designed for Use of Typists	64
Bridge Curved about Tree in Pacific Northwest	25	Fire Engine, Jets from Break Rock Formation	102
Brush of Unusual Length Attracts Attention	89	Fires, New Plan for Locating Forest	112
Building, Farmer Originates New Style of Grain	93	Flood, Heavy Concrete Slabs are Routed by	103
Buildings—How Federal Structures are Planned and Built, by J. Crosby McCarthy	73	Floor Duster Shaped to Clean Corners	119
Bulletin Board for Public Notices, Town Has	65	Flower Bulb Market, Home Growers to Supply	31
Cake, Mammoth Birthday Advertises Sale	106	Footprints, Infants', Used for Identification	92
Canal, Many Ships Blocked by Stoppage of	47	Forests, Free Timber Cuttings in National	110
Carbonic Acid Employed in Treating Wounds	2	Fuse Lighter, Powder Filled Lead Tube Forms	93
Cards, Odd Metal Case for Business	119	Games for the Blind Which may be Played Anywhere, by Harold Wolter	11
Celery Bleacher, New, Made of Black Paper	60	Garbage Incinerator and Water Heater	119
		Gas Line, Muskogee to Belt City with Long	17
		Gas Table Burner Takes Place of Alcohol	67
		Hay, Prize, Indian Grows on Roof of His House	83
		Heater, Novel, for Stored Liquid	122
		Horses, Shoeing Spirited, without Danger	72

[\[Continued on Page 6\]](#)

Popular Mechanics offers no premiums; does not join in "clubbing offers," and employs no solicitors to secure subscriptions. It is for sale by nearly every newsdealer in the United States and Canada.

## [Contents—Continued]

House—Residence, Attractive Addition to Brick..	160	Telegraph System, New Printing, Has Great Capacity	22
Hunter, Forest Ranger in Winter Becomes.....	63	Telephone Cover, Artistic.....	10
Hydroplane—Sea Sled and Aeroplanes to Cover Mail Routes.....	44	Telephone, Loud Speaking, for Window Demonstrator.....	4
Instruction in Trades, Institute Gives Useful.....	106	Telephone Receiver Cushion Aids in Hearing.....	93
Jaw Brace for Dental and Surgical Work.....	121	Telephones Aid in Rapid Action of Credit System.....	86
Lamp Shades, Silk, Treated with Mica.....	30	Telephones, Loud Speaking, Used at Country Club.....	83
Lamps, Kerosene, Convert into Carbide Burners.....	20	Telephones Replace Waiters in Jersey Restaurant.....	44
Laundry Company, Novel Service Provided by.....	96	Tie Peeling Field, Compressed Air Drives Ax Out of.....	103
Locomotive, New Type of Oil Burning.....	102	Tires, Protecting in Hot Climates.....	92
Lubricator, Automatic, for Railway Car Journals.....	120	Torpedo, Aerial, of Great Power.....	25
Lumber, Three Million Feet of, on Long Trip.....	113	Torpedo, Firing from Deck of American Destroyer.....	90
Mail Box, Neat, is Erected before Country Place.....	62	Tower Is Convenient Rest Room.....	111
Meat, How France Prepares for Her Soldiers.....	26	Tractor, Auto, Performs Heavy Hauling Feat.....	24
Medals, Gold, Award at San Francisco Fair.....	20	Traffic Warning Device for Motor Cars.....	27
Mines, Repeating Contact, Used by Germans.....	20	Transformer, Burned Out, Causes Fatal Accident.....	94
Mirror, Conveniently Lighted Toilet.....	118	Tree, Ancient Elm, Forms Porch Foundation.....	111
Money, Foreign, is Barred by Cuban Decree.....	32	Tree, Immense Concrete Filling Renews Vitality of.....	70
Morse Code is Used in Talking to Edison.....	21	Tree, Living, Used as a Gin Pole.....	21
Motor for Making Bicycle into Motorcycle.....	9	Tree Pruning Eradicates Insect Pests.....	84
Motorboats—"Submarine Chasers" to Guard British Coast.....	69	Trees, Chestnut, Blight Killing in Pennsylvania.....	30
Motorcycle, From Coast to Coast and Return by Moving Pictures—Making a Jungle Thriller.....	6	Trees, Dwarf, Growing of Is Profitable Pastime.....	78
Naturalization of Aliens is Urged by Government Novel and Practical Things for the Home.....	118	Uniforms, Military, Germans Institute Reform in.....	4
Nutcracker, Serviceable, of New Form.....	118	Voting Machine, Congress may Use New.....	88
Order Blank, Novel Mail, Requires No Envelope.....	116	Walking Sticks are Used Instead of Crutches.....	113
Padlock of Freak Shape Has Many Uses.....	59	War Data, French Establish Office to Collect.....	110
Parade, Novel Eugenic, Human Wrecks in.....	15	War, European: Alpine Forces, Hardships Met by Warring.....	49
Paving Values, City Teaches Taxpayers.....	99	Bandages and Dressings for Wounded, Making Camps, Striking Scenes in Different War.....	55
Phonograph Records, Successive, are Played Automatically.....	16	Efficiency, System and Order Mark German.....	56
Photographers, Distance Gauge is Aid to.....	18	France's Great Drive in the Western Theater.....	48
Pipes, Clay, Manufacturing in Quaint City of Gouda.....	94	Horses, War, in Battle and at Hospital Base.....	53
Platinum, Scarcity of Hampers Jewelers.....	120	Maimed Soldiers, Teaching New Occupations.....	58
Plow Built for Marshes Used in South.....	112	Prisoners, Everyday Life of European War.....	57
Potash, Mineral, Extracted from Alunite.....	121	Ruses, Ingenious, Resorted to in War.....	50
Projecting Image of Opaque Object, New Way of.....	115	Trenches, German Battle, in the Building.....	54
Rail Grinder That may be Moved with Ease.....	109	Wardrobe, Built In, with Telescoping Carriers.....	28
Railroad Car, Steel, Studying Effect of Fire upon Railroad Crossing, Shock Eliminated in New.....	82	Washing Machine, Compact Power Driven.....	118
Railroad Freight Car Roofs, Device for Finding Leaks in.....	97	Watch, Hands on Move in Reverse Direction.....	17
Railroad Traffic, Elevated, Handled on Pay-as-You-Enter Plan.....	70	Water Wheel, Old, Still Saws Wood.....	78
Reservoir, Large Reinforced Concrete, in Course of Building at Schenectady.....	105	Weeds, Railroad Uses Gasoline Power to Mow.....	79
Ring, Novel, with Friendship Links.....	118	Whooping Cough Band Worn by Child.....	89
Road Exhibit of Iowa Commission, Instructive.....	109	Wine, Alcohol Barred from New Type of.....	41
Road—Where Park Highway Cuts Continental Divide.....	19	Wireless Equipment, Portable, Carried on Belt.....	80
"Rookies," Volunteer, at Fort Sheridan.....	40	Women, Many, Good Drivers of Motor Cars.....	28
Rope Testing Machine's Work Saves Life.....	100	Wrench, New, is Designed to Grip with Great Force.....	84
Rust, Makeshift Appliances Remove Quickly.....	80	Writing Desk and Table Formed by Tea Wagon.....	117
Salt from Sea, Natives of Philippines Derive.....	96	<b>SHOP NOTES</b>	
Sands, Analysis of is Made Simpler Process.....	59	Asbestos, Plastic, Retaining Surface for.....	137
Saw, Electric, Trimming Veneer Edges with.....	67	Automobile Engine Bed, Flexible Holding Means for.....	126
School, Part Time, Started by Company for Boys.....	10	Automobile Spring Bolt Caps, Preventing Loss of Automobile Springs, Care of.....	130
Screwdriver, New, Covered with Rubber Insulation.....	32	Automobile Top, Efficient.....	142
Screws, Used in Woodwork, Metal Sockets for.....	115	Automobiles, Disconnecter for Electric Horns on.....	138
Shield for Trap Shooters Built by Odd Contract.....	97	Bench Stop That Clamps the Work.....	131
Ship—"Nevada" Given Workout.....	3	Bookkeepers, Hand Rest for.....	128
Ships—Gooselike Monitors Proof against Torpedoes.....	8	Bookkeeper's Hand Rest, To Prevent from Slipping.....	141
Shoe Fasteners, Spring Links Used as.....	119	Boot, To Keep from Rubbing Heel.....	130
Shoe, Metal, Advertises Footwear Dealer.....	29	Chains, Skid, Use of.....	140
Shotgun Rack, Adjustable, for Duck Boat.....	45	Clamp for Inaccessible Places.....	132
Smudge Pot, Self-Lighting for Orchardists.....	108	Clockface, Marking Circles on.....	131
Soldiers—Last of Civil War Men is Mustered Out Sounding Machine Worked by Steam Engine.....	2	Clothesline, Double Capacity.....	142
Speed, High, Permitted on Private Boulevard.....	64	Electric Wires, Fishing into Walls.....	130
Speedometer Sets Limit at Which Auto may Run.....	101	Engine, Switch, Fire Hose Attachment to.....	139
Spies Use Newspapers to Transmit War News.....	47	Fireplace Grate, Emergency.....	125
Sports Costumes—Snug Winter Togs for the Outdoor Girl.....	42	Gauge, Convenient Test.....	142
Sports, Gay Winter, Frozen Saranac Lake Home of.....	27	Gear Patterns, Making Teeth for Quickly.....	128
Storms, X, Significance of Found by Radio Experts.....	60	Guard for a Punch Press.....	140
Stove, Electric, is Built in Kitchen Wall.....	4	Home, Building a: Part X—Built-In Features.....	133
Stove, Garage, Eliminates Gas Danger.....	117	Hone, Oil, Keeping True.....	131
Street Car can be Called at Will with Push Button.....	117	Hose Drainer for Small Fire Stations.....	123
Street Crossing, Society Educating Public to Use.....	86	Ladder, Lock for.....	139
Submarines, America's Latest.....	91	Lathe, Beveling and Chamfering Tool for.....	131
		Lathe, Large, To Stop Chattering of.....	141
		Lettering Instrument for Draftsmen.....	125
		Locomotive Crank Arm, Removing Easily.....	127
		Lubricant, Cutting, for Unpickled Steel Castings.....	138

[Contents Continued on Page 8]

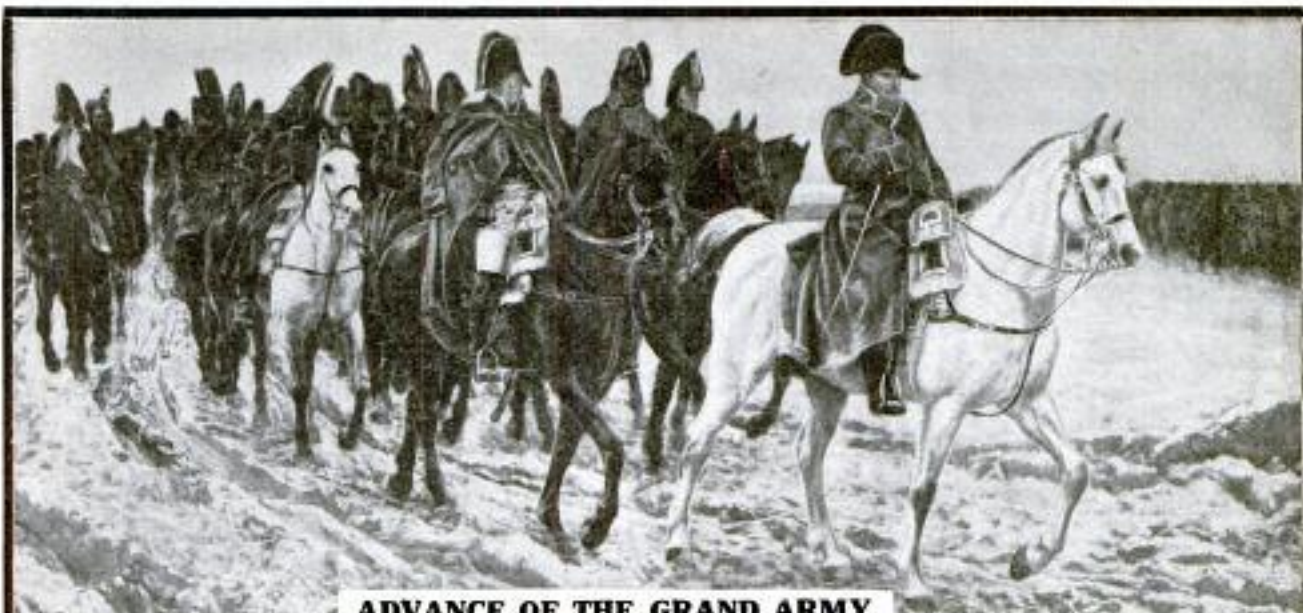

ADVANCE OF THE GRAND ARMY

**NAPOLEON'S** name fills more pages in the world's solemn history than that of any other mortal. The advance of his Grand Army into Russia is the turning point of his career and marks the beginning of his downfall. Mighty armies are once again marching over the same battlefields where Napoleon fought a hundred years ago. All the causes of this mighty struggle may be learned from the pages of history. The one complete, accurate, authoritative and reliable history, containing the rise and fall of every empire, kingdom, principality and power, is the world famed publication,

## Ridpath's History of the World

Dr. John Clark Ridpath is universally recognized as America's greatest historian. Other men have written histories of one nation or period; Gibbon of Rome, Macaulay of England, Guizot of France, but it remained for Dr. Ridpath to write a history of the entire World from the earliest civilization down to the present day.

### A Very Low Price and Easy Terms

We will name our special low price and easy terms of payment only in direct letters. A coupon for your convenience is printed on the lower corner of this advertisement. Tear off the coupon, write your name and address plainly and mail now before you forget it. We will mail you 46 free sample pages without any obligation on your part to buy. These will give you some idea of the splendid illustrations and the wonderfully beautiful style in which the work is written. We employ no agents, nor do we sell through bookstores, so there is no agents' commission or book dealers' profits to pay. Our plan of sale enables us to ship direct from factory to customer and guarantee satisfaction.

### Six Thousand Years of History

RIDPATH takes you back to the dawn of History, long before the Pyramids of Egypt were built; down through the romantic troubled times of Chaldea's grandeur and Assyria's magnificence; of Babylonia's wealth and luxury; of Greek and Roman splendor; of Mohammedan culture and refinement to the dawn of yesterday. He covers every race, every nation, every time, and holds you spellbound by his wonderful eloquence.

### Endorsed by Thousands

RIDPATH is endorsed by Presidents of the United States, practically all university and college presidents, and by a quarter of a million Americans who own and love it. Don't you think it would be worth while to mail us the coupon and receive the 46 sample pages from the History? They are free.

### Ridpath's Graphic Style

RIDPATH pictures the great historical events as though they were happening before your eyes; he carries you with him to see the battles of old; to meet kings and queens and warriors; to sit in the Roman Senate; to march against Saladin and his dark-skinned followers; to sail the southern seas with Drake; to circumnavigate the globe with Magellan. He combines absorbing interest with supreme reliability.

**WESTERN NEWSPAPER ASSOCIATION  
CHICAGO**



**FOLD HERE, TEAR OUT, SIGN AND MAIL**

1  
16  
**FREE COUPON**

**WESTERN NEWSPAPER ASSOCIATION**  
H. E. SEVER, Pres.  
140 SO. DEARBORN ST.  
CHICAGO, ILL.

Please mail, without cost to me, sample pages of Ridpath's History of the World, containing photographs of Napoleon, Caesar and other great characters in history, and write me full particulars of your special offer to Popular Mechanics readers.

NAME .....

ADDRESS .....

# Send



Today for **DYKE'S**  
**Free 32 PAGE Book**

explaining how to get into the

**AUTOMOBILE  
BUSINESS**

**AND ITS OPPORTUNITIES**

Just Mail the Coupon Below. This booklet is interesting and instructive in itself. Learn how you can get all this training for only \$15. Fill out coupon below or write a postal—but do it now. Hundreds have learned the

**AUTOMOBILE BUSINESS  
AT HOME** During Their Spare  
Time By Mail With  
**Dyke's New Idea  
Working Model Method**

If we prove to you that we have started hundreds of others into the repair business and as chauffeurs—who had no previous experience and who knew no more about an auto than you do right now—you must admit we can do the same for you. Write me today—and let me prove it.

**The AUTOMOBILE BUSINESS is Growing**

We Assist Students Getting Actual Driving Experience

More help needed and big pay. No other business offers such opportunities. It's easy to learn. An Auto Repairman is not a machinist—his work consists of adjustments and re-fitting worn parts, "knowing the principle," that's the thing. One of our students writes: "Before I started with your course I was a clerk at \$50 per month. After finishing I followed your instructions, started a repair shop and cleared \$122 the first month—pretty good for the first month." Let us show you this and many other letters. You can learn the same as this young man by

**DYKE'S NEW IDEA OF TEACHING BY MAIL WITH WORKING MODELS**

On these models you get actual practice, see the actual operation and learn more than you could from the auto itself—it's easy and quick. You don't have to study hard with this system—we teach through the eye—a new idea. Mr. Dyke is the originator of the system of teaching by mail with models—therefore bears of initials.

**Our Employment Plan for Students**

represents years of work to provide something that no other school had, namely, a way for the student to get started in the practical line of work.

Mr. Dyke has been identified as a pioneer inventor, supply man, etc., with the auto industry since its beginning. He originated the first auto supply co. and published the first book on autos in America. No other man with such experience is today teaching others.

Dyke's Correspondence School of Motoring  
Box 196, Roe Bldg.  
St. Louis, Mo.

**Mail This Free Coupon Now**

Send me your free 32-page booklet about your New Idea Working Model Course and testimonials and proofs. It is understood I am under no obligations in sending for this

for Mr. Dyke's 32-Page Booklet. Write for it—now! It is interesting and instructive in itself. Learn how you can get all this training for only \$15. Fill out below or write a postal—but do it now.

Name .....

Dyke's Correspondence School of Motoring  
Box 196, Roe Bldg.  
St. Louis, Mo.

Address .....

(Contents—Continued from page 6)

Moving Pictures, How to Make Aluminum Screen for	126
Nozzle for a Fine Spray	132
Oil Indicator, Homemade	130
Pail, Dinner, Catches to Hold Food Deck in	138
Paint, Antirust and Fireproof	129
Patterns, White Metal, To Fasten Runners in	141
Pavements, Road, Curb Blocks for	128
Pipe Ends, Reinforcing Flattened	132
Pipes, Thawing Frozen Water	123
Piston Rings, Figuring Width of Slot to Cut in	124
Planer Bed, To Stop at Same Point Each Time	141
Scales, Doubling Capacity of Spring	142
Shelf, Folding Shaving Material	129
Signs, Protecting Surfaces of Enameled Road	123
Spark Plugs, Coverings for Marine Motor	140
Springs, Recesses for Coiled	124
Tire Pump, Extension for	139
Vise, Planer, Squaring	132
Washing Machine Water Heater	126
Water, Hot, To Keep Constantly at Faucet	124
Windows, Spraying Pipe for Washing	127
Wire, Measuring without a Gauge	139
Wrench, Monkey, To Set Jaw of	138

## AMATEUR MECHANICS

Alcohol Stove, Emergency	159
Alley, Parlor Cue	143
Balloons, Filling Toy Rubber with Hydrogen	154
Bench Receptacles for Small Articles	159
Cabinet or Cellarette, Smoker's	158
Droplight, Locating in the Dark	155
Hall Seat with Storage Compartment	146
Hooks, Screw, Putting In Neatly	146
Motor Controller, Simple	156
Polishing Instrument Bases	154
Push Buttons, Miniature	157
Ruler with Round and Flat Edges	159
Screw, Experimental Lead, How to Make	155
Skis and Ski Running:	
Part I—Prominent Types of Skis	147
Trap, Self-Setting Rat	155
Trick, Glass and Hat	144
Trouser Hanger	159
Window Ventilator	146

**LEARN TO WRITE EARN \$25 to \$100 A WEEK**

ADVERTISEMENTS We can positively show you by mail How to increase your salary. BOOK MAILED FREE.

PAGE-DAVIS CO., 112 Page Building Chicago, Ill., or 159 Nassau St., New York

**LEARN WATCHMAKING**

and become independent. Good-paying positions secured.

Easy to learn. Send for FREE CATALOG.

ST. LOUIS WATCHMAKING SCHOOL, Dept. 5, ST. LOUIS, MO.



**LEARN TO BE A Show Card Writer**

Unlimited Demand. \$18 to \$45 a Week

Pleasant, Fascinating, Profitable Work. Earn money after first few lessons. Expert teaches personally by mail. \$1 per lesson.

**EASY SHOW CARD SYSTEM**

Dept. G, 105 Chambers St., NEW YORK

## 40 ALPHABETS

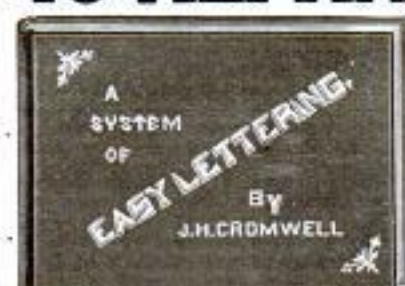

Contents:

**Block Letters:**  
Heavy, Outline, Condensed, Expanded, Fancy, Shaded and Italics.  
**Gothic:**  
Condensed, Expanded, Italics.  
**Roman:**  
Fancy, Italics.  
**Script:** Modern, Architectural.

**14,000 COPIES SOLD**  
**Spon & Chamberlain**  
123 P. M. Liberty St., NEW YORK

**55c Postpaid**



# Don't Envy Successful Men Be One!



## THE WAGES

Of Bookkeepers, Clerks and other untrained help is from \$12 to \$20 a Week

As long as you neglect to obtain special training you will belong to this class. You will be one of the "help." You must "keep your nose on the grindstone." You can't demand a raise because hundreds of men are willing to take your job—and for less money. No matter how honest or how faithful you are—or how hard you work—the wages will be not more than \$20 a week. That is the limit—you can take it or leave it. If you want more salary you must obtain special training—there is no other way. Why work hard for wages of from \$12 to \$20 a week when you can become a Trained Accountant and draw a salary of from \$3,000 a year up?

## Be An Expert Accountant

500,000 Firms Need Them Only 2,000 in America

TODAY, in America alone, there are over 500,000 large firms that need annual, or semi-annual audits. In every large city there are hundreds of openings for trained accountants. As there are only about 2,000 certified public

accountants in America, the demand far exceeds the supply. For this reason the incomes and salaries paid are good. Just as soon as you complete the La Salle Course, your chances for obtaining immediate employment will be excellent—no weeks or months hunting for a job—the position will seek you. If you complete the course with satisfactory grades you will be fully qualified for one of these positions.

**We Will Train and Coach You In Your Home—By Mail—In Your Spare Time**

Hold your present position. Earn while you learn. Study when you feel most like it. Advance as rapidly or as slowly as you desire. Study a little every day in your leisure time—part of which is now wasted. You can complete our entire course become a master accountant—in less time than any other because our system will teach you the "working-knecks" and "short-cuts" employed by experts. In this our course differs from all others

**Under Personal Supervision of William Arthur Chase, C. P. A.**

You will receive your training under the direct personal supervision of William Arthur Chase, an accountant of National prominence, who is Ex-President of the American Association of C. P. A. Examiners, and Ex-Secretary of the Illinois State Board of Examiners in Accountancy.

**The Course** was prepared by some of the world's most noted accountancy experts. It fully covers the field—Theory of Accounts—Practical Accounting—Cost Accounting—Auditing—Business Law, etc. It will prepare you for the Examination in any state.

**Quit—The "Shirt Sleeve Class"** Why "grind" along, day after day, with the other untrained "help" waiting for a raise that may not come—and will be small even if it does? Determine to get out of the "shirt-sleeve" class. Resolve to bid goodby forever to hard work, long hours, and low wages. Decide to become a trained accountant—to direct others—and to draw a "man's" salary.

**Choose Your Future Today**—The first thing to do is to mail the coupon. Remember that if you don't mail it today—the chances are that you never will. Quit dreaming—and act. Write your name and address on the Coupon. Mail it. We will send you the Free Booklet: "What Every Bookkeeper Should Know," which explains state examinations, state regulations, salaries, etc.—also complete information concerning the course—and by return mail.

La Salle Extension University, Dept H-332 Chicago Ill.

## THE SALARY

Of a Trained Accountant is from \$3,000 to \$10,000 Yearly

Trained accountants get large salaries because there are only a few hundred of them—while thousands of firms need them. For this reason an expert can demand and get big pay. Then why don't you become a trained accountant? It is not very difficult, after all. The La Salle System will make it easy for you. Our course is written in a clear and simple manner. Everything is fully explained. You cannot help but learn. Under the personal supervision of our instructors—and the coaching of our experts—you will soon be qualified to earn a good salary. With our help—if you have average intelligence, and are determined—failure is impossible.

## La Salle Special GUARANTEE

We give the student a written agreement signed by our Treasurer, that if the student completes the course with satisfactory grades, and fails to pass the Certified Public Accountants' examination held in any state, we will give him special instruction and help—without additional charge—until he does pass.

La Salle Extension University  
Dept. H-332, Chicago, Ill.

Send at once your free Book containing What Every Bookkeeper Should Know with full details of your Course in Higher Accountancy; also advise me about Special Reduced Rate. I am obligated in no way.

Name.....

Street No.....

City.....State.....

Please Mention Popular Mechanics



# A BIGGER JOB For YOU

Earn from \$35 to \$100 Weekly as a

# TRAFFIC MANAGER

Modern transportation is a jungle of routes and rates calling for specialists who, like the pathfinders of old, have expert knowledge of the trails of traffic. How to route shipments to obtain shortest mileage and quickest deliveries and how to classify goods to obtain lowest rates are two vital factors in business competition. The man who knows how is so valuable to his employer that he commands respect and big remuneration.

## Big Salaries Paid To Traffic Managers

Expert traffic managers command from \$2,500 to \$10,000 a year. Why not prepare yourself to fill one of these lucrative positions?

## New and Uncrowded Profession

Every railroad and over one half million large shippers in the United States need expert traffic men, and this need is recognized as never before because of the recently enacted railroad rate laws and interstate commerce regulations. The demand for trained and efficient traffic men is many times greater than the supply. There's a room for you.

## Study Traffic and Interstate Commerce

Decide now to become a traffic man. Our Interstate Commerce Course enables you to study at home, without leaving your occupation or sacrificing present income, and to become thoroughly versed and proficient in the strategy of shipping, including routes and classifications, interstate commerce rules and regulations, etc. The instruction is given by some of the biggest traffic managers in the country. The course is easy to grasp and thoroughly practical. Anyone with ordinary intelligence, with reasonable application, can master this new profession.

**FREE PORTFOLIO** Clip coupon below, sign and mail at once, and we will send you FREE, postpaid, a handsome portfolio containing complete information concerning the opportunities and requirements of this attractive profession. Get posted at once. Clip coupon.

LaSALLE EXTENSION UNIVERSITY, Dept. C. 297, Chicago

## COUPON

La Salle Extension University  
Dept. C. 297, Chicago, Ill.

I am interested in the new profession—  
Traffic Management. Please send me full in-  
formation and Traffic Book, free of all cost.

Name .....

Occupation .....

# FREE PORTFOLIO



Write Address on the Margin Plainly.



## Learn a Paying Profession

that assures you a good income and position for life.  
For twenty years we have successfully taught

# PHOTOGRAPHY

Photo-Engraving and Three-Color Work

Our graduates earn \$20 to \$50 a week. We assist them to secure these positions. Learn how you can become successful. Terms easy—living inexpensive. Write for catalogue—NOW!  
ILLINOIS COLLEGE OF PHOTOGRAPHY, 999 Wabash Avenue, Effingham, Ill.

**ELECTRICAL** men with training are always in demand. Having trained over 2000 young men in the past 22 years in the fundamentals of Applied Electricity, **The Bliss Electrical School**, with its well-equipped shops and laboratories, is peculiarly well qualified to give a condensed course in Electrical

## ENGINEERING



including Mathematics, Steam and Gas Engines, Mechanical Drawing, Shop Work, and Theoretical and Practical Electricity, in all branches. Students construct dynamo, install wiring and test efficiency of electrical machinery. Course, with diploma, complete

## IN ONE YEAR

For practical young men with limited time. 24th year opens Sept. 27th. Catalogue on request. 105 Takoma Ave., Washington, D. C.

ESTAB. 1892

# BODEE TRADE



# DENTAL SCHOOL

15-17 W. 44th St.

NEW YORK CITY

LEARN IN 3 MONTHS TO EARN \$1300 TO \$4000 A YEAR

Our valuable book "P" tells how. It's Free—write for it. Anyone from 16 to 60 years old can easily learn Mechanical Dentistry. The Demand is like a gold mine. Unexplored. We are constantly called upon to fill good-salaried positions. Why not qualify for one? No book study. All practical work. We guarantee that you can earn before completion of the Course. Tuition payable in instalments.

## Practical Electrical Education

Our practical course in Electrical Science and Engineering trains you to get and keep the big-pay jobs. Enter at any time, no matter what your education. Advance as fast as you can master what we teach. Course combines theory with actual practice in all branches of electrical work. Individual instruction. Positions paying \$1,500 a year up, waiting for graduates. WRITE FOR FREE ILLUSTRATED CATALOG. Eleventh year. School begins Jan. 24th, 1914.

School of Engineering of Milwaukee, 232 1/2 St. Bldg., Milwaukee, Wis.



## EARN TELEGRAPH

Morse and Wireless—R. R. Accounting (Station Agency) taught. Splendid opportunities. Positions secured. Marconi Co. takes our wireless graduates. We own and exclusively occupy two large modern buildings equipped with R. R. and Western Union wires and complete \$1,000 Marconi Wireless Station. Largest School—established 40 years. Investment \$25,000. Endorsed by Railroad, Marconi and Western Union Officials. Expert practical teachers. Low living expenses; easily earned if desired. Tuition low. Easy payments. Correspondence courses also. Catalogue free.

Dodge's Telegraph, Ry. & Wireless Institute  
8th Street, Valparaiso, Ind.

## The University of Chicago

# HOME STUDY

in addition to resident work, offers also instruction by correspondence.

For detailed information address

24th Year U. of C. (Div. 20) Chicago, Ill.



FREE



# THE LAW TRAINED MAN

## This Inspiring Book Free To Ambitious Men

**This intensely interesting and instructive 165-page book tells you how a knowledge of law has proved to be the stepping stone for thousands of men to larger incomes and to power and achievement.**

It tells you of the great and increasing demand for lawyers and how you can become one. It tells you why law trained men are now selected for most positions of responsibility in business, public life and social work—and how you can grasp these opportunities.

It shows you how you can become law trained without leaving your home or business by a method which includes the comprehensive features of the best resident law schools and is endorsed by distinguished men throughout the country in whose opinion you have the utmost confidence. Send for your copy of "The Law Trained Man," today.

### Modern American Law Course and Service of Blackstone Institute

Blackstone Institute (including The Sprague Correspondence School of Law) was founded in 1890, and is by far the oldest and largest law school for non-resident instruction in the world.

We have successfully trained more than thirty thousand men and women in law. Among our graduates are the Governor of a State, United States Senators and Congressmen, State, County and City Officials, many Judges and thousands of successful Lawyers and business men everywhere. This notable record extending over twenty-five years is the most convincing evidence that we produce results—and it is results that count.

Address, Extension Division 1351



**Blackstone Institute**  
20 West Jackson Blvd., Chicago.

Chief Justice Ladd of the Supreme Court of Iowa, says: "Every person interested in the law will receive from Blackstone Institute an unusually excellent—in fact, the best, non-resident system of instruction."

The Course has been prepared especially for home study by eighty eminent judges and law writers. It is clearly written in simple, non-technical language. It is practical, yet reads like an interesting story. Preliminary education is not necessary. You can read in spare time at home, and you will benefit from the day you start. Our Course and Service will prepare you on all subjects required in the bar examinations, as it has already done for thousands of others in your own state, and every other state in the Union. It will equip you to become a leader in business or public life—and to attain positions of honor and profit open only to law trained men.

### Special Offer—Investigate Free

The recent union of The Sprague Correspondence School of Law with Blackstone Institute and the resulting increase in our facilities enable us to make you a most important Special Offer. Investigate now by sending post card or letter, or clipping the coupon for our 165-page free book and full particulars. No cost or obligation.

**FREE  
BOOK  
COUPON**

Address, Extension Div. 1351  
**BLACKSTONE INSTITUTE**  
20 W. Jackson Blvd., Chicago.

Please send me your 165-page free book, "The Law Trained Man," and full particulars of your Law Course and Service and Special Offer. No cost or obligation.

Name \_\_\_\_\_

Address \_\_\_\_\_

Please Mention Popular Mechanics

## Here's YOUR Chance to Learn **DRAFTING**

This Complete \$15 Drawing Outfit and Full Instructions in Mechanical Drawing **FREE**

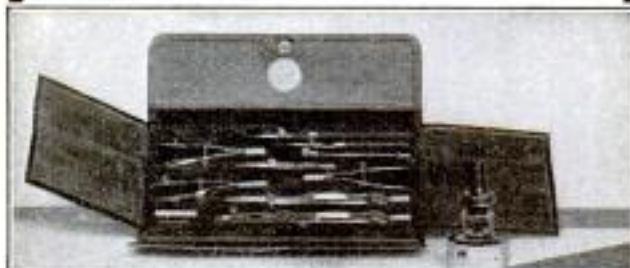

There's a good job waiting for you. The country is facing greater prosperity than it has ever before experienced. Far-seeing men are getting ready for boom times. Get this training now and share in the coming prosperity.



**CHARLES W. MOREY**  
President of the College  
and Head of a Large Chicago  
Firm of Civil, Mechanical and  
Electrical Engineers and  
Contractors.

## Men Wanted AT BIG SALARIES

This is a rare chance for a few wide-awake young men

On account of the rapidly increasing demand for trained draftsmen Pres. Morey has issued orders that instruction be furnished to a limited number of young men who are inclined along engineering or architectural lines. Read about this great offer below—then mark and mail the coupon.

**STUDY AT HOME** Devote your spare hours for a short time only and learn this profitable and pleasant profession, and get in the class drawing the big pay envelope. Hundreds of men are in daily attendance at this old established college. In your own home you can do the same work these men are doing, and the same experts that teach them will guide you toward the big job. These well known engineers prepare your instruction matter. Your work is examined and approved by them. They know exactly the practical training you need and they train you. No books to sell. Live, up-to-date blue prints of work in actual construction. In your own home you work with plans of machinery, buildings, steel work, etc., actually being constructed in Chicago, New York and other large cities.

### ELECTRICAL DRAFTING AND DESIGN

No other similar correspondence course in America has a resident college of National reputation back of it, nor a faculty of active experts actually engaged in municipal and corporation engineering work. These men know exactly the kind of training you need because they are in constant charge of big work.

## \$45 COURSE FREE IN MECHANICAL DRAFTING

This College has set aside a limited number of Free Scholarships and will give the regular \$45 Course in Mechanical Drawing Free with any one of the Home Study Courses named in the coupon below—this is in addition to the complete \$15 Drawing Outfit which is also furnished to students free. Take advantage of this unusually liberal offer today, as it will be withdrawn when the allotted number of Free Scholarships has been awarded. It costs you nothing to get full information. No obligation on you.

### ACT NOW—FILL OUT COUPON TODAY

- |                           |                       |
|---------------------------|-----------------------|
| —Electrical Drafting      | —Builders' Course     |
| —Machine Drafting         | —Plan Reading         |
| —Architectural Drafting   | —Estimating           |
| —Structural Drafting      | —Sheet Metal Drafting |
| —Civil Engineering (1050) | —Surveying            |

Name.....

Address.....

Town.....State.....

College or Home Study Course.....

**CHICAGO TECHNICAL COLLEGE**  
1050 Lake View Building, Chicago, Illinois

Please Mention Popular Mechanics

## A Civil Service Job For YOU—

A job with Uncle Sam under Civil Service protection means employment for life with good pay, short hours, pleasant work, annual vacations and the assurance that you will get your pay regularly in spite of panics or hard times.

Post Office, Railway Mail, Rural Carrier, Custom - Internal Revenue and other examinations are coming soon.

If you're an American citizen, 18 or over, we can help you secure one of these good jobs. Our 64-page booklet tells how you can prepare for "exams" under personal supervision of a former U. S. Civil Service Secretary-Examiner—a man who knows and whose knowledge is at your disposal.

Write today for booklet. It's free, without obligation.

**PATTERSON CIVIL SERVICE SCHOOL**  
116 Irving Place  
ROCHESTER, N. Y.



Send now  
\$1.00 for  
12 issues

## A CHANCE to MAKE \$100

For \$1.00 you will get 12 issues of the

### Students ART Magazine

and a chance to work on over \$100.00 worth of cash art assignments. The magazine publishes and criticizes amateurs' work, articles on Cartooning, Designing, Illustrating, Lettering and Chain-Folding. Especially valuable to correspondence art students. **Clare Briggs, Ryan Walker and other noted artists, contributors.** Stands for Clean Art, High Thinking and Right Living. Interesting, Artistic, Unique. Money refunded if not satisfactory. Send NOW—\$1 bill or stamps, to the Editor



**G. H. LOCKWOOD**  
Dept. 68, Kalamazoo, Mich.



## IF YOU STAMMER

Attend no stammering school until you get my big FREE book and special rate. Largest and most successful institution of its kind in the world. Two large modern school buildings fully equipped for treatment of stammering under my advanced natural method. No sing-songing or time-beating. Established 14 years. Known everywhere as the best. Personal instruction given each student. Write today for full particulars. **Lee Wells Millard, Pres.**  
North-Western School for Stammerers, 2317 1/2nd Ave., Milwaukee, Wis.

**LEARN TO PAINT SIGNS and SHOW CARDS**

I'll teach you personally by mail, 16 years' successful teaching. Big field for men and women. You can Earn \$18.00 to \$45.00 a Week. Scherer (Chicago) writes: "Your instruction is great. Highly pleased." Full details promptly on request.

**DETROIT SCHOOL OF LETTERING**  
Chas. J. Stronig, Founder Dept. 501, Detroit, Mich.



## BE A DETECTIVE

Earn from \$150.00 to \$300.00 per month; travel over the world. Write **C. T. LUDWIG, 133 Westover Bldg., Kansas City, Mo.**

**DON'T TRY TO BE A CHAUFFEUR**

GET THIS BOOK FIRST.

or go to ANY SCHOOL to learn, or part with your hard earned dollars until you have read our valuable guide FIRST. It tells what you should PAY and what you should GET. Do not be deceived by schools which claim everything and give you nothing. **YOU CAN'T AFFORD TO SPEND ONE CENT TILL YOU GET OUR GUIDE.** It costs nothing and may save you many dollars. Write now for this FREE BOOK.

**PRACTICAL AUTO SCHOOL, 68 Beaver St., New York**

## JEWELRY ENGRAVING

We teach you, by our new and original method of instruction, this clean, fascinating and profitable business right at your home, and furnish you all tools needed absolutely free. Write for free book to the **WISCONSIN SCHOOL OF ENGRAVING, 5th Bldg., MILWAUKEE, WIS.**

Please Mention Popular Mechanics

# Succeed Through Electricity

**This interesting story shows you the way to greater success in the Electrical Field.**



### Read These Testimonials

"Any Electrician, Operating Engineer, or Student who wants to do his own construction or further advance himself in the Electrical field should have a set of these books."

JOHN KELLEY  
116 Union St., Newark, O.

"For the man not getting a college training and even in that case, I can sincerely say I do not believe there is a better set of books in the market today."

LLOYD D. HUFFMAN  
Dayton, O.

"We consider Hawkins Electrical Guides the most complete and complete set of electrical references in the market."

NOBLE ELECTRIC WORKS  
Monterey, Cal.

"Hawkins surely knows the art of condensing information."

ERNEST F. BART,  
Buckland, Conn.

This is the Electrical age. Electricity now controls more trades, directs more men, offers more opportunities than any other power that man has yet discovered. Through *exact* knowledge of Electricity you will advance in salary and position.

## Hawkins Electrical Guides Will Show You How

These books are the standard works on Electrical Science. They are a complete and up-to-date course in Electrical Engineering, presenting the information in a way you can use it. Only \$1.00 per volume and owners of the set say there are no better electrical books published at any price.

**Specially Arranged for Home Study and Reference** They fit your pocket and your pocket book. Beautifully bound in flexible black leather with gold edges. Easy to read and handle. You can carry each single volume about with you until you have mastered the subject it contains. Written in the form of questions you would ask and the answers to them—in plain, practical, everyday language, complete, concise, authentic and to the point. Over 3200 pages and more than 4,000 illustrations.

10 NUMBERS IN ALL

**1<sup>00</sup>**  
A Number  
**PAYABLE**  
**1<sup>00</sup>**  
A Month



## Shipped to You FREE

**YOUR FREE COUPON**

Send no money. Examine the books first. Decide for yourself that they are the most complete library of Electricity ever published and that you cannot afford to be without them. Every book is complete in itself, but the complete set is the best bargain. The last volumes are just coming off the press. **Eight numbers now ready.**

### Easy Payments

Accept this unusual offer now—today. Each page—every illustration will convince you of the big value we are offering. See the books first, then decide. If you decide to keep them you can make settlement at only \$1.00 monthly until paid for.

**A FEW OF THE SUBJECTS**  
Magnetism—Induction—Experiments—Dynamics—Electric Machinery—Motors—Armatures—Armature Windings—Installing of Dynamos—Electrical Instrument Testing—Practical Management of Dynamos and Motors—Distribution Systems—Wiring—Wiring Diagrams—Sign Flashers—Storage Batteries—Principles of Alternating Currents and Alternators—Alternating Current Motors—Transformers—Converters—Rectifiers—Alternating Current Systems—Circuit Breakers—Measuring Instruments—Switch Boards—Wiring—Power Stations—Installing—Telephonic—Telegraphic—Wireless—Bells—Lighting—Railways. Also many Modern Practical Applications of Electricity and Ready Reference Index of the 10 numbers.

**Theo. Audel & Co.**  
72 Fifth Ave.  
NEW YORK

Signature .....

Occupation .....

Business Address .....

Residence .....

Reference ..... Jan. P. M.

**Theo. Audel & Co.**  
72 Fifth Ave., N. Y.

Please send me for FREE examination Hawkins Electrical Guides (Price \$1.00 each). Ship at once prepaid the first eight numbers. If satisfactory I agree to send you \$1.00 each month until paid.

Please Mention Popular Mechanics



## "The Power of Law Training"

SEND the coupon now for our new 171-page free book "The Power of Law Training." It carries a vital and inspiring message to every ambitious man—to the man who is already successful—to the young man just starting out in life—to the man who has already made his start but has not yet hit his stride—to all men who realize the need of more power. "The Power of Law Training" will give you a remarkable insight into the vital relation of law to business. Write for your copy today—now. It's FREE.



## If You Know Law—

The power of the man with law training is apparent all about you. Look to the men of your own acquaintance who have achieved the most—look to the men who stand high in the affairs of the nation. Almost without exception you will find them Law trained. The man with the Law training is the man of power—the leader.

## Learn from Masters of the Law!

Through the Course and Service of the American Correspondence School of Law—the oldest and largest institution of its kind in the world, you read law right in your own home—directed by men who stand preeminent in the profession. You may become law trained or prepare for the practice of law. More than 40,000 men have utilized this Course and Service to their advantage and recommend it highly.

With this Course and Service is included a complete and comprehensive cyclopedia of the law without extra charge. Special reduced price offer now being made in many localities.

## Send the Coupon!



Put your name and address in the coupon or on a letter or post card now and get the big 171-page free book, "The Power of Law Training." It's free. No obligations of any kind. Write today.

American Correspondence School of Law  
1191 Manhattan Building Chicago

American Correspondence School of Law  
1191 Manhattan Bldg., Chicago

Gentlemen:—Please send me free and prepaid your 171-page book, "The Power of Law Training" and particulars of your special reduced price offer.

Name.....

Address.....

Please Mention Popular Mechanics

## SHORTHAND IN 30 DAYS

We absolutely guarantee to teach shorthand complete in only thirty days. You can learn in spare time in your own home, no matter where you live. No need to spend months as with old systems. Boyd's Syllabic System is easy to learn—easy to write—easy to read. Simple. Practical. Speedy. Sure. No ruled lines—no positions—no shading as in other systems. No long lists of word signs to confuse. Only nine characters to learn and you have the entire English language at your absolute command. The best system for stenographers, private secretaries, newspaper reporters and railroad men. Lawyers, ministers, teachers, physicians, literary folk and business men and women may now learn shorthand for their own use. Does not take continual daily practice as with other systems. Our graduates hold high grade positions everywhere. Send today for booklets, testimonials, etc.

Chicago Correspondence Schools  
969 Unity Bldg., CHICAGO, ILL.

## Music Lessons Free in Your Home

NEW WAY—LEARN TO PLAY BY NOTE—Piano, Organ, Violin, Banjo, Mandolin, Cornet, Harp, Cello or to sing. Thousands now learning by free weekly lessons, paying only for music and postage—that is small. No extras. Beginners or advanced pupils. Everything illustrated, plain, simple, systematic. Free lectures each course, 16 years' success. Start at once. Send your name and get free booklet by return mail. Address U. S. School of Music, Box 132, 225 5th Ave., N. Y. City.

## LEARN WATCH REPAIRING

Be a watchmaker—you can learn this profitable trade by correspondence in a few weeks in your own home by the DeSelms Chart System. After you complete the course you will know a watch from A to Z. You will know just what the matter is and how to repair one. When you graduate you will be a practical watchmaker and repairer and competent to fill any position. Positions for our graduates.

Ask for our Free Book. It explains our system and terms.  
THE DESELMS WATCH SCHOOL  
23 Ferry Street ATTICA, INDIANA



## A GOOD POSITION

with UNCLE SAM is most desirable. Life positions, pleasant surroundings, good pay, steady work, short hours, promotions on merit. Both sexes. No political pull. Thousands of appointments yearly. Most thorough preparation \$5. Returned if not appointed. Full information and questions used by the Civil Service Commission free.

AMERICAN CIVIL SERVICE SCHOOL WASHINGTON, D. C.

## DRAWING

Learn by mail in your own home. Cartooning, Newspaper, Magazine and Commercial Illustrating, also

Water-Color and Oil Painting

Learn Drawing or Painting for profit and pleasure. We can develop your talent. This school has taught thousands. Free Scholarship Award—special limited offer. Your name and address brings you full explanation and our handsome illustrated Art Annual by return mail. Don't delay. Write today.

FINE ARTS INSTITUTE, Studio 211, Omaha, Neb.



## AT HOME Learn TO SING

Send 2-cent Stamp for Helpful Booklet, "The Voice Made Beautiful."

HARVEY SUTHERLAND, 813 President St., Brooklyn, N. Y.

## ARITHMETIC SELF-TAUGHT

A plain, easily-understood volume for all who have not had the opportunity of learning this subject thoroughly, or who have forgotten what they once learned. 257 Pages. Requires no teacher. This great little book sent postpaid for 60 CENTS. Stamps accepted.

GEO. A. ZELLER BOOK CO.  
Est. 1876, 407 W. Belle Place, ST. LOUIS, MO.

SPANGENBERG'S  
PRACTICAL  
ARITHMETIC  
Self-Taught

# MORE Trained MEN WANTED \$75 to \$350 A MONTH



**T**HE supply of trained men to fill the thousand and one distinct trades the automobile business has created, is far and away below the demand. The Automobile Training School of Kansas City has graduated thousands of students. A whole army of our students are making big money today. Many are now holding responsible positions in some of the largest automobile factories in America. Hundreds are in business for themselves, as garage owners, factory representatives, agents, dealers, etc. Hundreds more are managers of garages, repair shops or getting good money as drivers, demonstrators, tractor and power farming experts. The demand is for more men — **more trained men**. The positions are open — the big money is waiting. **ANY AMBITIOUS MAN CAN QUALIFY FOR A PERMANENT, BIG-PAYING JOB IN A SHORT TIME.** You can earn from

## \$75 to \$350 A Month

We train you in every branch of the automobile business. What thousands of others have done — you can do. Ambition is all you need.

### Only 6 Weeks Required to Prepare You

That is all the time we ask — six weeks, to prepare you for a good position, paying good money — more than you are making now — more than you can hope to make without a complete knowledge and understanding of a twentieth century business. Our course of instruction is unsurpassed. It is the acknowledged standard.

Write today for big illustrated book,

### "How to Make Money in the Automobile Business"

Read letters from our graduates.

Learn why we are the **largest automobile training school in the world** — why we have more floor space — more equipment — more expert instructors than any similar institution in the world.

The Automobile Training School is the largest and most successful institution of the kind in the entire world.



We own and operate two of the largest garages and repair shops in the west. Hundreds of cars of all makes are here at our command. Students work on these cars — make real repairs. We use no charts or books.

### No Books or Charts — No Tools to Buy

Mr. H. J. Rahe, president and founder of the Automobile Training School, is the originator of the RAHE SYSTEM OF PRACTICAL AUTOMOBILE INSTRUCTION. Our students work on REAL CARS — not theories. In many instances, we place men in big paying positions even before they complete the course of instruction.

Don't lead a hand to mouth existence, working for small pay without a future before you! Investigate the Rahe Automobile Training School, our system and the wonderful success we have experienced in training men for the automobile business.

## \$50 FREE SCHOLARSHIP

We want to enroll the full capacity of our school a month earlier this year, and to all students entering now, we are giving a Free Scholarship for Complete Course in Power Farming, Gas and Stationary Engineering. This is a valuable course, given absolutely free in addition to our regular course of instruction in all branches of the automobile business. The development of power farming is second only to the automobile business itself. Come and see our large tractor testing field and the most complete tractor and power farming equipment in the Middle West. With this added knowledge you can reap big profits in an entirely new field.

H. J. RAHE, President

### AUTOMOBILE TRAINING SCHOOL

1048 Locust Street, KANSAS CITY, MO.

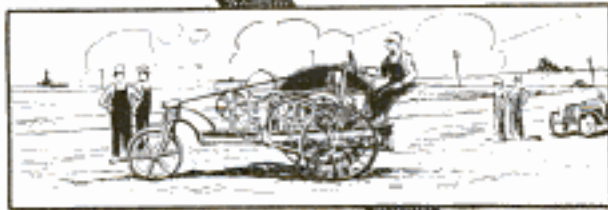

### FREE SCHOLARSHIP IN THE BOOK COUPON

H. J. Rahe, Pres., Automobile Training School, 1048 Locust St., Kansas City, Mo.  
Send me your 60-page book "How to Make Money in the Automobile Business."

Name .....

Town ..... State .....

## AUTOMOBILE DRIVERS AND REPAIRERS EARN \$75 TO \$150 A MONTH

The demand for automobile drivers and repairers exceeds the supply. Decide now to fit yourself for one of these well-paying jobs. You can do it—easily—in your spare time and in your own home. These brand new books—the most practical ever written on automobile engineering—will quickly make you an expert driver or repairer.

## AUTO ENGINEERING

**\$25.00 Set Now \$14.80—50c a Week**

This auto library contains 2,000 pages, with 1,800 illustrations that make technical points as simple as A-B-C; full-page plates that literally pick the mechanism to pieces before your very eyes; drawings and diagrams that show the working of all the principles employed in the various types of motors. Bound in half red marocco, gold stamped. These five volumes are a most remarkable value at the regular price. Yet we offer a limited number of sets at a special introductory price of \$14.80—payable \$2 a month.

**SHIPPED FREE** Test these books before you buy. You wouldn't buy a car until you had tried it out. Buy books the same way. We send the full 5 volumes to you, express prepaid, for 7 days' free examination. Look them over for a whole week free. See if they don't contain everything a driver or repairer should know. If the books are what you want, send us \$2. Otherwise we'll take them back, paying the express both ways ourselves. In addition to this liberal discount from the regular price of \$25.00, we include with each set a \$12.00 Consulting Membership. This entitles you to the advice of a staff of practical experts for a whole year free.

### American Technical Society, Chicago:

Please send *Cyclopedia of Automobile Engineering* for 7 days' free examination. I will send \$2.00 within 7 days and \$2.00 a month until I have paid \$14.80, otherwise I will notify you and hold the books subject to your order. Title not to pass until fully paid. Pop. Mech. 3-16

NAME.....

ADDRESS.....

REFERENCE.....



# "HELP WANTED"

—Uncle Sam.

**Railway Mail Clerks  
Postoffice Clerks  
City Mail Carriers  
Clerks in Customs and Internal  
Revenue Services**

Thousands of Appointments Coming

**\$800.00 to \$1800.00 a Year  
for LIFE**

No "layoffs" without pay, because of strikes, wars, financial hurries or the whims of some petty boss. Excellent opportunities for quick advancement to Higher Government Positions. If you want immediate appointment, send **TODAY** for our free list of positions now obtainable. Any delay means the loss of just so much time in getting appointment.

**SEND COUPON BELOW**

**FRANKLIN INSTITUTE**  
Dept. G 104, ROCHESTER, N. Y.

**Act at Once**

This coupon, filled out as directed, entitles the sender to free sample questions; a free copy of our book, "Government Positions and How to Get Them"; free list of positions now obtainable, and to consideration for Free Coaching for the examination here checked.

COUPON			
..... Railway Mail Clerk	\$800 to \$1800	..... Customs Positions	\$800 to \$1500
..... Postoffice Clerk	\$800 to \$1200	..... Internal Revenue	\$700 to \$1800
..... Postoffice Carrier	\$800 to \$1200	..... Stenographer	\$800 to \$1500
..... Rural Mail Carrier	\$500 to \$1200	..... Clerk in the Department	at Washington
..... Bookkeeper	\$900 to \$1800	..... Canadian Government Positions	.....

Name.....  
Address..... G104

Use this before you lose it. Write plainly  
**Please Mention Popular Mechanics**

## "LEARN BY DOING"

Get a complete training by actual practice. Get the knack of "HOW" together with the theory of "WHY" and the best business methods used in the World of Electrical Activity.

The N.Y. Electrical School is the pioneer and premier school of the "Learn by Doing" method. When you have completed this Course you shall be fully qualified to handle ALL branches of Electrical industry.

The equipment of this School is unequalled and up-to-the-minute. No preparation needed to become a "learner" in this School. You can start to learn on any day of any week throughout the whole year. *Visitors heartily welcomed. Send for catalogue.*

44 West 17th St. New York City  
**N. Y. ELECTRICAL SCHOOL**

REVERSIBLE

# "Linene"

TRADE MARK

COLLARS



Send 2 Cents  
in U. S. Stamps to pay postage and -  
we will send you for a starch-finished

**SAMPLE COLLAR**

State size and which style wanted

REVERSIBLE COLLAR CO., Dept. U, Boston, Mass.

# MAGIC TRICKS



Let us send you two clever card tricks-puzzling to your audience, yet easy to do. Also booklets illustrating numerous Magic and Card Tricks. All For 10¢

We have a special number of new Card Tricks Sent for 40¢ postpaid

**THE MAGIC SHOP** 52 N. 13th St. Phila., Pa.

## Every Boy His Own Toymaker



Greatest boys' book ever written. Tells how to make a Steam Engine, Telephone, Magic Lantern, Boats, kites, balloons, electrical and mechanical toys, traps, fishing tackle, 200 illustrations, also catalog of 150 puzzles, picture cards and "DOUBLE THREAT" warbler and bird call all for only 10¢. **WESTERN PUZZLE CO., ST. PAUL, MINN.**

## Learn Watchmaking At Home



You can learn by our modern and original system of instruction every part of the Watchmaker's Trade at home as good or better than at a shop. You can earn money while learning and secure a well paying position or start in business after completing our course of instruction. Good watchmakers are always in demand and earn from \$20 to \$35 per week. For particulars apply to the Wisconsin School of Watchmaking, Strub Bldg., Milwaukee, Wis.



# LAW-TRAINED MEN

## Earn \$3000 to \$10,000 Annually

Now is the time for you to begin the study of Law—it offers you more today than ever. The growth of the departments of the government; the extension of commerce; the vast increase of business; the endless multiplication of firms, associations, corporations, combines and trusts, have created new opportunities for thousands of law-trained men. There are **not nearly enough** to fill requirements.

Law has brought wealth, fame and position to the majority of our most successful men in business and political life. Nearly all of our presidents, cabinet officers, congressmen, city and state officials are legally trained. Many were born in poverty and obscurity, but Law put them into positions of power.

## It Is Easy For You NOW!

If you can read and write intelligently, we can train you to become a competent Lawyer—train you in your home, during spare time, by mail, no matter where you live. Don't think that you need natural talent. Don't think that it is an impossible, long, hard climb. It is no great task to become a lawyer by our **simplified, modern course**. You need no longer spend years in preparation and years in college to master this dignified profession. You need not give up nor neglect your present work—you need not deny yourself pleasure. A little spare time at night is all that is required.

### Only Method Endorsed by Colleges

Our Law Text is written in plain language by America's foremost legal authorities and professors of law in big resident colleges such as University of Wisconsin, Leland Stanford University, University of Chicago, Harvard, University of Michigan, Northwestern University, and University of Nebraska. The LaSalle Course is recognized as the foremost home-study Law Course—it follows the method used in the big resident colleges. Former Pres. of the state University of Iowa George E. McLean, said: "The professors who wrote your text books are men of highest rank in our best colleges." Our improved and simplified method gives you all the advantages of the case and text book systems. It is the same as having the world's great legal professors in your own home to teach you privately. Don't think that the text books are dry or uninteresting. Once you begin to read these fascinating books you will never quit until you have completed them. Many of America's greatest Lawyers learned Law at home. **Our Graduates Pass Bar Examinations in Any State** and have attained highest records in competition with graduates of leading resident schools. **We Guarantee to Coach Free Until Successful.**

### BECOME AN LL. B.

The Laws of the State of Illinois authorize us to confer on our graduates the Degree of Bachelor of Laws (LL.B.).

The LaSalle Degree and Diploma will make you a recognized legal authority with power and dignity. The great success of our students is due to the service we render them. We have letters from hundreds of successful students everywhere to prove the absolute superiority of our methods of instruction. We enroll more students every month than any other University home-study Law school in the world. The LaSalle Extension University is a powerful, reliable institution—the largest and most complete institution of its kind in the world. Our graduates are recognized as competent, trustworthy lawyers and can be found in every state in the Union. We show **actual results**—we make no claim that we cannot prove absolutely—letters from successful students verify this.

### Remarkable FREE Book

America's most successful Lawyers. A book that tells you how they succeeded. A book that points the way to greatness. A book that shows you how to start right. A book that puts you on the path of some of our graduates. A book that tells you how to succeed. If you expect to become a Lawyer, you should have this book, no matter what school you now have in mind.

### Complete Law Library Furnished Great Special Offer!

Each student enrolling now will receive, at once, without additional cost, our complete Law Library—a magnificent set richly bound—14 volumes of American Law and Procedure—completely covering all branches of Law. This big set of Law books alone is worth the price of the course—they cost us over \$50,000 to prepare—they are the combined master work of many of America's most noted legal experts. They are given when you enroll—you are not compelled to wait.

### Special Business Men's Course

Every business man should have our special course in commercial law. A knowledge of law is vitally important to every business man. Many of our students are business men who recognize the necessity of legal training and the superiority of our simplified method of teaching commercial law. Write us today about our Special Course for Business Men.

### FREE Complete Course in Public Speaking

For a limited time we are giving, absolutely FREE, to new students our new complete home-study course in Public Speaking. Prepared by Dr. Frederick B. Robinson, A. B., A. M., Ph. D., Professor of Public Speaking, College of City of New York; Editor, Public Speaking Review; Special Lecturer on Public Speaking at various Universities, etc., etc. Be sure to mail coupon today and learn how YOU can get this efficient, complete course absolutely free.

### Start Now!

No matter what your age or occupation—no matter where you live, how small your salary or how little time you have, our method of home training will prepare you to be a successful Lawyer. **DON'T LET COST WORRY YOU—the cost is very small—we make the payments to suit you.**

### Our Guarantee

We guarantee to coach FREE and until successful any LaSalle student failing to pass a bar examination. Our University Extension Course embraces both theory and practice. It follows closely the methods of the large resident Universities with the addition of important special features.



LaSalle Extension University,  
Dept. F-219 Chicago, Ill.

Please send me—FREE—copy of your big, illustrated book, "EVIDENCE" and "VALUABLE LAW GUIDE" at once. Also send me full particulars of your free Public Speaking Course offer.

### Mail Coupon—Get Free Books

Opportunities come only to prepared men. Everything must have its beginning. Make YOUR start today by mailing the coupon. Our big free books tell all about our thorough University training in law at home. Don't allow lack of money to interfere. Remember the LaSalle enrolls and graduates more students than any others. There's a reason. Learn why. No "extras"—everything, including the modern LaSalle Law Library, if you enroll now. Send coupon at once.

LaSalle Extension University, Dept. F-219 Chicago, Ill.

Name.....

Street and No.....

City..... State.....



## Because

*I want ambitious men to become high salaried Draftsmen through my practical working training—therefore:*

# I Will Give You This Set of Drawing Instruments

The Chief Draftsman of a large and well-known company will give you this complete draftsman's outfit absolutely free. It does not cost you a penny. Besides these Imported regular draftsman's instruments shown here, I also give you absolutely free a 20x25 inch drawing board, a 24-inch T-square, a draftsman's triangle rule, supply of drawing paper, 2 triangles and French curve, pencils and erasers, drawing thumb tacks, etc., in fact a complete and first-class regular Draftsman's Working Outfit as soon as you enroll. This is just the same kind of an outfit I use myself. Genuine working instruments. You could not get this outfit for less than \$15. But now on this special offer, I will give it to you absolutely free.

## And Train You For a \$200 Position

I am Chief Draftsman of an old and well known company. There is a constant demand for trained draftsmen all over the country and I will give you just the kind of training that will qualify you to hold one of these big paying positions. \$125 to \$200 a month straight salary is an ordinary pay for a good draftsman. I will give you just the kind of training that you need to hold one of these fine jobs, right in your own home during your spare time. I know the kind of training that you must have in order to get the highest salary—and that is just exactly the kind of training that I will give to you. During the last twenty years I have trained some of the highest paid men. Their success in the profession is well known. You can do as well—or better than they.

### SPECIAL!

For a limited time I am making a special price offer in order to complete a new class ready to start. Send for free book at once, today.

## Send Me the Coupon For FREE New Book

Put your name and address in the coupon or on a letter or postcard now and send to me at once for my new book "Successful Draftsmanship." Find out about the golden opportunities that await you in our profession. Find out how you can get just exactly the kind of training that you need to hold a position paying from \$125 to \$200 a month at once. Absolutely no obligations in getting the book. Just put your name and address on the coupon. But send it now—immediately while I am making this special offer.

**CHIEF DRAFTSMAN DOBE**  
Div. 1191, Engineer's Equipment Co., Chicago

**Chief Draftsman Dobe**  
Engineer's Equipment Co.  
Division 1191, CHICAGO, ILL.

Without any obligation to me whatsoever, please mail your book "Successful Draftsmanship," and full particulars of your liberal "Personal Instruction" offer to a few students. It is understood that I am obligated in no way whatever.



Name.....

Address.....

# CLASSIFIED ADVERTISEMENTS

WORLD'S BEST WANT AD MEDIUM

We have records to prove that a classified ad in these columns will find a buyer for almost anything which can be sold. Doubtless you have some article of value to some one else which you no longer need. Why not turn it into money?

Advertisements in this section, 15 cents per word, each insertion, minimum 10 words, payable in advance. To insure ads being inserted under proper classified head in the February issue, copy must reach this office not later than January 1st.

Popular Mechanics Magazine, Chicago.

Gentlemen: I regard Popular Mechanics as one of the best advertising mediums to get in touch with good agents everywhere. My ads have brought me business from every state in the Union, as well as many foreign countries, including Cuba, Hawaii, New Zealand, Philippines, Alaska, Canal Zone, Trinidad, Canada, Ireland, Germany, and several others. When I have other articles to advertise, you may rest assured you will get your share, without solicitation. With best wishes, sincerely yours,

ED H. IRWIN.

## AUTOMOBILES

**AUTOMOBILE Repairs**—Automobile owners, Garages and Repairmen should subscribe for the Automobile Dealer and Repairer; 150-page illustrated monthly devoted exclusively to the care and repair of the car. The only magazine in the world devoted to the practical side of motoring. \$1 per year; 15 cents per copy. Postals not answered. Charles D. Sherman, 30 Windsor Road, Hartford, Conn.

**AUTOMOBILE Instruction**—\$35.25. Four weeks' course. Best-equipped school in the country. Men enrolled from all parts of the U. S. Booklet P. M. on request. West Side Y. M. C. A., 318 West 57th Street, New York.

**THOMAS Flyer**—6 cyl., 90 H. P., 4 passenger. Excellent condition. Speed seventy miles per hour. \$750. J. Dietrich, 1317 Kensington Ave., Youngstown, O.

**STORAGE Battery Chargers** earn big profits. Engine or city current operates. Easy payments. Hobart Brothers, Troy, Ohio.

**AUTOMOBILE Radiators Repaired.** We make hub-caps, levers, crankcases, radiator-caps, etc. Send old part as sample. Oxy-Acetylene Welding. Terms: Express C. O. D. Denver Brass Works, Automobile Dept., Denver, Colo.

**CYLINDER Grinding, Pistons, Wrist-pins;** first-class equipment. Sixteen years' experience and specializing in this work enables us to do high grade work at lowest prices. We manufacture the individually cast, heat-treated piston rings. Bridgeport Piston Ring Co., Bridgeport, Conn.

**MAKE money selling "Little Hustler,"** \$285; auto truck. Stamp brings circulars. Wells Auto Works, Canal Dover, Ohio.

**PAINT Your Car Yourself**—Save \$25 to \$75 by doing the work at home with the Arsenal system. Our big free booklet "The Car Beautiful" tells how. Send for it today. Arsenal Varnish Co., Dept. P, Rock Island, Ill.

**CYLINDER regrinding or reboring.** Extra light pistons and perfect rings fitted. Advise make and model, and number of bores, so we may quote. The Everts Machine Company, 14 Hicks Street, Hartford, Conn.

**AUTO owners double tread your own old tires;** two in one; it's easy; 50c per tire per 1,000 miles; repair men make big money at this business. Agents Wanted. Tire Trading Co., Newark, N. J.

## AUTOMOBILE SUPPLIES

**QUICK and shiny polish for metals.** Agents wanted. Exclusive territory, 50% profit. Initial stock costs \$12.63. Sample free. Cardinal Manufacturing Company, 1744 Columbus Road, Cleveland, Ohio.

**ATTACH a Vacuum Cleaner on your Auto,** go into the Carpet Cleaning Business, and earn an income of \$15.00 a day upwards. Write quick. Thurman Vacuum Cleaner Co., Dept. A, St. Louis, Mo.

**10 3/4"x4 1/2" AIR compressors** \$20 each. J. D. Silberstein, Toledo, Ohio.

**PISTON rings any size or width 25 cents each.** Repair parts for Ford and Maxwell cars at equally low prices. Grossman Auto Parts Company, White Plains, N. Y.

**BUICK Radiators**—40 H. P.—1910 and 1911. Price \$25.00 each; also Model-R-Ford rear axle \$19.00; Front axle \$5.00; Buick 2-cylinder rear axle \$19.00; all axles with wheels. Gifford Auto Parts Co., Bayonne, N. J.

**6 CYLINDER Thomas Motor** \$175. Brush Eng. \$50. Delco Starter and generator \$33. Overland motor \$75. 4 speed trans. \$60. Presto B tanks \$10. Auto Salvage Co., 1436 Wabash Ave., Chicago.

**AUTOMOBILE Parts** of all descriptions bought and sold. Prices right. Parts Dept. Motor Parts Listing Company, Detroit, Mich.

**SPARK Plugs** \$1.25 each, postpaid, cash with order. Satisfaction guaranteed or money refunded. Logan Co., 218 Fourth St., Logansport, Ind.

**ACT quick!** Automobile gasoline going up. Sell "Gas-Tonic." Equals gasoline at 3c a gallon. Eliminates Carbon. Dollar an hour profit. Sales guaranteed. White Mfg. Co., Dept. M, Cincinnati, O.

**VULCANIZER for shop.** Bargain. Vandergool's, Springfield, Ohio.

**A WRITTEN guarantee** for 5,000 miles without puncture. European Motorists are getting 10,000 miles out of their tires by increasing them about one-half inch in size. In eight months 29,000 American Motorists have followed their example. It's so easy that you can do it in your own garage in thirty minutes, no matter what condition your tires are in. Send for free catalog, sample and copy of guarantee. Colorado Tire & Leather Co., 143 Tread Bldg., Denver, Colo.

**NEW 6-cyl. High-tension magnetos,** \$33. O'Brien, 6350 State, Chicago.

**"THE How and Why of the Automobile"**—A 208-page book of practical information for seekers after the fundamental facts regarding the gasoline engine and its application to the motor car. Interesting and instructive to both the beginner and the expert. Bound in full cloth—250 illustrations. Price \$1 postpaid. Popular Mechanics Book Dept., 6 N. Michigan Ave., Chicago.

**GET our prices on Automobile Tops, Curtains, Hoods, Radiator Covers, etc.** We can save you money. Motor Parts Listing Company, Supply Dept., Detroit, Mich.

**EXPLOSION Whistle.** Fits priming cup. Most powerful signal made. Rapid seller owing to real value. Buell Manufacturing Co., 1141 E. 46th St., Chicago.

**RECTIFIERS for garages.** All sizes. Charge one to eight batteries, \$12 upwards. American Battery Company, 1129 Fulton St., Chicago.

**THE Modern Auto Fuel,** better than I claim, the users claim. "Gids" fuel for increasing the efficiency of gasoline engines. One cent per gallon eliminates carbon trouble, increases power, speed, and mileage, facilitates starting. Ask what the users say of its merits. Agents wanted, exclusive territory; repeat proposition. 100 tablets \$1.00; 600, \$5.00. Absolutely non-injurious. "Gids" registered United States Patent Office, 105513. Fred M. Giddings, Manufacturer, 63 Simmons St., Galesburg, Illinois.

## FORD ACCESSORIES

**COMMUTATOR** best and most complete at one dollar each mailed to any address prepaid. Gears, axle and propeller shafts at cut prices. Grossman Auto Parts Company, White Plains, N. Y.

**SALESMEN sell Fordowners "Best Automatic Shock Absorbers,"** \$6.00 set of four. 4,200 sets sold in November. Los Angeles agent sold 200 sets nine days. Liberal commission, exclusive territory. Secure "Best" line Ford Starters, Steering Devices, etc. Jarkels Campbell Co., Minneapolis, Minn. Dept. 20.

**"FORD" comic postals!** Best jokes. 3 samples, dime, 12 for quarter. Agents wanted. Burkhardt Sales Co., Incorporated, Milbank, S. D.

**FORD Owners.** Our \$12 JHC Starter is the best ever made, buy one. You will like it, if not, we will refund your money. Agents and Dealers write for particulars. JHC Starter, Columbia Theatre Bldg., Broadway and 47th St., New York.

**NEW 300-page book** on the Ford car for every Ford owner, dealer and repairman. Deals fully with construction, operation and repair. 100 engravings. Best and most complete Ford book ever published. Price, \$1 postpaid. Also Ford Engine Chart—25x38 in. Location of engine troubles made easy. Price, 25c postpaid. Your money back if not satisfied. Popular Mechanics Book Dept., 6 N. Michigan Ave., Chicago.

**"STEER Relief" for Fords.** Guaranteed Best Made. Want Agents. Sample \$3.00; prepaid. C. B. Post, New London, Ohio.

## MOTORCYCLES, BICYCLES & SUPPLIES

**1913 EXCELSIOR.** Demonstrator. Twin cylinder. Like new. Fully equipped. Sale price \$65. Indian twin. Light, speedometer, horn, tandem. Enamel, tires and motor like new. Snap \$45. Curtiss. Fully equipped. Good shape. \$25. Ask for December bargain bulletin. 100 motorcycles to select from. All Bargains. Largest motorcycle store in the United States. Exchange any goods not satisfactory or refund money. Wandersee Company, 129 Gratiot Ave., Branch store, 2906 Woodward Ave., Detroit, Mich.

**SEND for latest Bulletin** of real Motorcycle Bargains, used and slightly used, all makes, models and prices; if you have \$25 and really want a powerful Motorcycle, send for this Bulletin; hundreds of machines at all prices, new ones on easy payments; tell us what you want and how much you can pay; we can fix you up. Peerless Motorcycle Co., Dorchester, Mass.

**SAVE 1/3 on used motorcycles.** \$3,000 worth for \$2,000. Indians, Harleys, Excelsiors, Thors, and many others. Write for list. Frank P. Gravatt, Atlantic City, N. J.

**NEW, Smith Motor Wheel, Bicycle, Accessories,** used 39 miles; \$102 value—sell \$75. E. C. Courtwright, Sedan, Kans.

**USED and rebuilt motorcycles—all makes.** Yales \$50.00 up; Harley-Davidsons \$35.00 up; Indians \$25.00 up; Reading-Standards \$25.00 up. Get our Bulletin No. 2. W. J. Walker, 178-182 Columbus Ave., Boston, Mass.

**DON'T buy a Bicycle Motor Attachment** until you get our catalogue and prices. Shaw Mfg. Co., Dept. 27, Galesburg, Kansas.

**FOR Sale**—5-35 Harley-Davidson. Guaranteed first-class condition. \$138. Joe Ries, Carroll, Iowa.

**1914 DE LUXE, Dream tandem No. 1,** prestolite, horn. \$160. Chas. Koepke, Peru, Indiana.

**FEW good motorcycles, cheap, come quick.** C. E. Crout, Mattapan, Mass.

**WRITE today for our list of Motorcycle Bargains.** The greatest values in the country. Every machine fully warranted in perfect running order. David Stern Co., 1047 W. Madison St., Chicago, Ill.

**FOR Sale:** 1913 Indian Twin. A No. 1 condition. Tires nearly new. Pump. Tandem Seat, etc. Worth \$125. Make offer. J. Fred Page, 107 Hall Ave., Jamestown, N. Y.

**EXCELSIOR 1915** Three-speed. Electrically equipped. Pullman Side Car. \$225. A. A. Baker, Deer River, Minn.

ALL used motorcycles at lowest prices. Send for list. Secher & Hofelins, Buffalo, N. Y.

FOR Sale—Single Excelsior—\$60. Joseph Trabold, Coldwater, N. Y.

**MOTORCYCLE** accessories. Long leather leggings \$1. Spark plugs, any size 25 cents. Holger carburetors, \$3.95. Stewart-Wanner Signals, \$2.50. Goodyear 28x3 tubes, 98 cents. Motorcycle pedals, 69 cents. Large motorcycle saddles, \$1.98. Ask for bargain sheet showing cuts. Any goods not satisfactory will be exchanged or money refunded. Largest motorcycle dealer in United States. Wanderer Company, 129 Gratiot Ave., 2994 Woodward Ave., Detroit, Mich.

1913 YALE, chain-drive twin, \$95. Ralph Mount, Marion, Ohio.

SEND for list of used Indian motorcycles. Every one overhauled by expert workmen, and guaranteed right. Geo. H. Bacheider, P. O. Sq., Lowell, Mass.

YALE Single, good shape, freight prepaid, \$47.50. Paul P. Eberts, Cabot, Arkansas.

ALL parts to all motorcycles, 50% saving. O'Brien, 6550 State, Chicago.

**BARGAIN 1913 Excelsior** Twin, equipped, \$110. Write Howard Nelson, Blackburn, Carlinville, Ill.

**EXCELSIOR**, good order, \$55. Benj. H. Taylor, 2131 W. 94th St., Cleveland, Ohio.

**NEW Motorcycle Book—Just Published—** Motorcycles, Side Cars and Cyclecars, Their Construction, Management and Repair—750 pages, cloth, 250 illustrations. The Dealer, Mechanic and Rider will find this treatise a work of reference without an equal. Price \$1.50 postpaid. Popular Mechanics Book Dept., 6 N. Michigan Ave., Chicago.

1914 HENDERSON motorcycle and Rogers side-car, \$210. Perfect condition. New casings. Bringham, R-8, Box 99A, Dallas, Tex.

PIERCE Arrow Motorcycles, good condition, bargain, Albert Holz, 828 Fifth St., Cincinnati, Ohio.

SMITH Motor Wheel and Bicycle \$65. V. W. Whitechurch, Saranah, Me.

BRAND new 1915 Indian twin, 15 horse, \$175. C. L. Gardiner, Binghamton, N. Y.

FOR Sale: Used machines, parts for 1915 Jefferson Twin, Smith motor wheel. Lincoln & Kimball, Belvidere, Ill.

NEW Sidecars \$60; others \$20 to \$45. Expert Motorcycle repairing. Motor Works, 1551 Michigan Ave., Chicago.

**BARGAINS—Used motorcycles and motorwheels.** Edward Ryan, Poughkeepsie, New York.

\$50 TO \$150 buys the best motorcycles; every make and model in our large stock must be cleared. Half price. Send for list today. Brown Music Co., 3018 E. 91st St., Chicago, Ill.

**MOTORCYCLES** and bicycles at cut prices; singles and twins \$25 to \$30. Motorcycle tires \$3; automobile tires \$3. Second-hand bicycles \$5; tandems \$13. New bicycles and motorcycles at factory prices. Buy direct, save dealer's profits. Send for catalog. Deninger Cycle Co., Rochester, N. Y.

**BIG bargains** in second-hand motorcycles, \$25 up. Indians, Harleys, Thors, Excelsiors and Mercks. Write for description, Howard A. French & Co., Baltimore, Md.

**SUPPLIES—Our big catalogue** with prices lower than usual sent free to motorcycle owners. Meco, Hammondspoint, N. Y.

**MOTORCYCLES**, accessories, repair parts for all makes. Thousands of dollars given away by our special profit sharing plan. Write for it. Motorcycle Parts Mfg. Wks., 2127 Michigan Avenue, Chicago.

I HAVE two motorcycles I will sell for \$150. They are 1913 Indian and Excelsior, both in good running condition. First check for same will get bargain. Emil J. Krinsky, 1424-26 So. Michigan Ave., Chicago.

**BIG bargains** in good motorcycles we have taken in exchange on new ones. Send for special bargain list. Shaw Mfg. Co., Galesburg, Kansas.

WANT to sell your motorcycle? I have a method which has sold many. Write me today for free information. F. W. Johnson, Room 890, 78 E. Madison St., Chicago.

\$225 NEW Twin 9 H. P. 1915 Flanders Motorcycles. Equipped with P. N. Tandem. A few left at \$138.50. Catalogue on request. Gotham Sporting Goods Co., 57 Warren St., N. Y.

**MOTORCYCLE** cylinders reground, fitted with new piston and rings \$5.00, guaranteed. Muncie Piston Co., Muncie, Ind.

BRAND new motorcycles, standard makes, on easy terms; descriptive circular free. Smith, 610 Center St., Brockton, Mass.

**YEAR-END** sale of high-grade slightly used motorcycles. This time of year we close out all our used motorcycles. All standard makes, twins and singles, belt and chain drives. Prices \$25 and up. Write for complete list. Gotham Sporting Goods Co., 57 Warren St., New York City.

SAVE one half on repairs and accessories for all makes—get circular, Jones "The Parts Man," Brockton, Mass.

EASY terms on rebuilt motorcycles—get new list "P." \$25 up. Rebuilt Motorcycle Co., Brockton, Mass.

## WELDING

**ATTENTION**, all Manufacturing concerns, Automobile Manufacturers, Garage and Repair men and Welding Shops. Why weld, when So-Luminum, the newest and strongest great discovery in aluminum solder, does the work in half the time and expense of welding broken crank cases, manifold pipes, etc. Runs low temperature, used with gasoline torch. No flux. Tested and used already by U. S. Navy, International Motor, Locomobile, Packard, Pierce-Arrow, Simplex and many other leading Automobile and Manufacturing companies. \$3.50 per lb.; sample bar, \$1.50. Write for Booklet 3, So-Luminum Mfg. & Eng. Co., Inc., United States Rubber Co. Bldg., 1790 Broadway, New York.

**OXY-ACETYLENE** Welding and Cutting is the title of a brand new practical instruction book on the methods of doing this work. It includes the operation and care of Acetylene Generating Plants and the Oxygen Process for removal of carbon. 280 pages, 78 illustrations, pocket size, cloth, \$1.00; leather, \$1.50 postpaid. Popular Mechanics Book Dept., 6 N. Michigan Ave., Chicago.

**WELDING** Plants, \$25 to \$250. Liberal terms. Write Bermo Co., Omaha, Neb., U. S. A.

**WELDERS**, make money selling acetylene welding torches. Reich Welding Works, New York.

## AERONAUTICS

**LIGHT** Weight Gasoline Engines, 2 1/2 lbs. Guaranteed 1/2 H. P. The Weiss Co., Torrington, Conn.

**SECOND-HAND** aeroplanes and flying boats cheap for quick disposal. The Aero Mart, 116 So. Michigan Ave., Chicago.

**YOUR** ideas may bring you wealth, if patented through credit system. Send sketch. Free search. Book free. Waters & Co., 5103 Warder Bldg., Washington, D. C.

**GENUINE** Bleriot with Gnome Motor, 50-hp. Roberts, 50-hp. Call, 8-hp. Curtiss Motors, three Curtiss Tires, Will trade Bleriot for Automobile. Albert Holz, 828 Fifth St., Cincinnati, Ohio.

**TURNBUCKLES:** National Aero Varnish, National Aeroplane Company, Machinery Hall, Chicago.

**WISH** to correspond with men who desire to become aviators but who have not enough money to pay for a full course. Will pay part of course and take percentage of your earnings. The Aero Mart, 116 So. Michigan Ave., Chicago, Ill.

**BICYCLE** Monoplane. Something that anyone can build. Up-to-date in Mechanical ranks. Drawings 25c coin. Elmer Hammel, Raspsburg, Md.

**DAMAGED** motors, "planes," parts, bought, overhauled, sold. E. D. Pendleton, North Fond du Lac, Wis.

**BUILDING** and Flying an Aeroplane—160-page handbook covering the building of small models and full sized gliders and machines. In both biplane and monoplane models the well-known Curtiss and Bleriot types are followed. Fully illustrated with detail drawings. Price, \$1 postpaid. Popular Mechanics Book Dept., 6 N. Michigan Ave., Chicago.

**HOW** to Make a Biplane Glider—Our book "Amateur Mechanics No. 2" contains a complete detailed description of how to make one. Price of book 25c postpaid. Popular Mechanics Book Dept., 6 N. Michigan Ave., Chicago.

**AIRSHIPS**, involving powerful natural forces perfected. Absolutely safe and will fly indefinitely. Early deliveries. Low cost, no complications. A. Konaske, 180 Mack St., Detroit.

**EXACT** 3-ft. Model War Aeroplanes. Guaranteed to Fly. Complete plans, scale drawings, precise, understandable instructions: Curtiss Military Tractor 25c; Taube 25c; Bleriot 15c; Nieuport 25c; Curtiss Flying Boat 25c; Wright 25c; "Post" 25c. Any or all parts at small cost. Our 1916 Aeroplane Book contains full information, 5c postpaid. Ideal Aeroplane Co., 82 1/2 West Broadway, N. Y.

**AVIATION** Motors, all makes, up to 150 H.P., \$250 up. Complete aeroplanes, all types, \$500 up. State your needs. Aero Exchange, 38 Park Row, N. Y. C.

**CATALOG "H"** off the press, most complete aeronautical catalog ever published, sent for 6 red stamps. Motor Catalog, 8c; propeller catalog, 6c. Heath Aerial Vehicle Co., Chicago.

## BOOKS AND PERIODICALS

**PRACTICAL** Hand Books. Automobile Troubles—Gas Engine Troubles—Electric Starters—Ignition and Valve Setting tables. Send for complete catalog. Charles C. Thompson Co., 509 Plymouth Court, Chicago.

"**STRUCTURAL** Drafting," \$1.00; "Lettering," 25c. W. D. Browning, Memphis, Tenn.

**MATHEMATICAL** Revelation—"Herrick & Horton's Comparative Cancellation Calculator." Solves all Arithmetical and Geometrical Calculations with ease, accuracy and large saving of figures. 150 pages, \$1.00 postpaid. Circulans free. Herrick & Horton, Publishers, Princeton, Ill.

**MAKE** Your Own Wireless Set—This new book "How To Make a Wireless Receiving Set for Time Signals" gives accurate, simple directions and diagrams covering every step. You use ordinary tools and require very small outfit. Send 25c coin today. C. Brandes, Inc., Room 817, 32 Union Square, New York.

**USED BOOKS—Extraordinary Bargains.** Catalog. Higens's, A-2441 Post, San Francisco.

**METAL** Work and Etching—A 96-page hand book for art metal workers telling how to make a great variety of useful and ornamental objects, such as desk sets, art-crafts, jewelry, etc. Price, 50c postpaid. Popular Mechanics Book Dept., 6 N. Michigan Ave., Chicago.

**VOLUMES** and sets on all technical subjects bought, sold, exchanged, rented. Correspondence-school books specialty. Boston Book Exchange, 1236 Washington St., Boston, Mass.

**55 VALUABLE** Formulas, Tricks, Illustrations and Household Hints in our interesting Magazine for two issues. Sent complete for 10c. Blandon Novelty Co., Blandon, Pa.

**BOOKS** worth while; instructive and entertaining. Puzzles, Tricks, Novelties. Illustrated catalogue, free. Auburn Supply Co., Dept. 115, 7517 Peoria St., Chicago.

**HOW** to make Wireless Instruments, 25c. We supply any book published. Catalogue free. Dept. A. Gramercy Efficiency Bureau, 151 East 18th, New York.

**BOOKKEEPING**, Expert Auditing, Rapid Arithmetic, 50c. Garfield Commercial School, 1016 Germantown Ave., Philadelphia.

**BIG** book revealing Mind Reading, Mysteries and Wonders, 10c. G. Elaca, Owosso, Mich.

**FORD** Joke Book, 64 pages, 10c. Agents wanted. Richard Lavery, Astbury Park, N. J.

"**MEMORY'S** Aid"—Make After Dinner Speeches—Toasts—Quotations. 20c. "Told on the Way," sprightly European Trip, 30c. Self-Educational Book catalogue Free. Drift Publications, 69 Washington Street, Chicago.

**CORRESPONDENCE** Courses. Technical Books. Civil Service, etc., bought, sold. Easy payments. Catalogue. Lists for postal. C. Bubbs, Detroit, Michigan. Green Island, N. Y.

**MEN—Rope** splicing; knots; hitches. Complete handbook, 100 "Ill." 10c coin. G. Brady, 764 Jackson, Chicago.

**ENGINEERS'** questions and answers for license, by Hobson, for twenty-five cents, postpaid. Send stamps. Kelly's Book Store, Philadelphia, Pa.

**SPARKS—a** snappy motorcycle monthly—send stamp for copy. Address Editor Sparks, Prince St., Brockton, Mass.

**BINDER** for Popular Mechanics magazines. Best adjustable magazine binder on the market made especially to hold any number from one to six copies of this magazine with name "Popular Mechanics" in gold letters on front cover. No laces or cutting or perforating of pages necessary. Simple, unique adjustment; handsome, durable and neat. We buy in quantities and can offer our readers this regular \$1.50 binder for \$1.25, all shipping charges prepaid. Address Popular Mechanics Book Dept., 6 N. Michigan Avenue, Chicago.

READ these great books about the War: 1. Germany and the Next War, by Gen. F. Von Bernhardi (discloses Germany's war plans for crushing England and France. Price 85 cents). 2. Secrets of the German War Office (by A. K. Graves, for twelve years a spy in the Kaiser's service. Price \$1.60). 3. Germany's Fighting Machine (by E. F. Henderson. Divided into three parts, The War, The Army and The Navy. Price \$1.35). 4. Men Around the Kaiser (by F. W. Wile. Tells about those men who figure most prominently in the affairs of Germany at the present time. Price \$1.35). 5. The Germans (by I. A. B. Wylie. A graphic picture of the German people on the eve of the great conflict. Price \$2.15). 6. The War and America (by Hugo Munsterberg, the great German-American. Price \$1.10). 7. War's Aftermath (a study of the deterioration of the quality of stock occasioned by the lamentable waste of war. Price 85 cents). Popular Mechanics Book Dept., 6 N. Michigan Ave., Chicago.

#### EDUCATIONAL AND INSTRUCTION

**SHORTHAND**—Reliable System, Principles and speed in 30 lessons. (Copyrighted.) Insures good positions. Writers in demand. Study at home in spare-time. Write for special terms to Popular Mechanics' readers. American School of Phonography, Cleveland, O.

**NEW, easy shorthand.** Students write business letters after fourth lesson. Touch Typewriting. English. Personal correction of work. Investigate. Home Study School, 409 Caesar Mich Building, Providence, R. I.

**TRICKS of the Trades**—Valuable information on Drawing, Lettering, Sign Painting, Illustrated. \$1.00. Specimen pages free. D. Freedburn, Hicksville, Ohio.

**WRITE** 100 words a minute with shorthand using longhand letters. The only practical substitute for stenography. Quickly learned. Self-teaching Manual, \$1. Sample lesson free. Premier Shorthand School, Dept. 14, Washington, D. C.

**SHORTHAND** in four weeks. Mail Course, Lewis System, new, practical, speedy; eight characters. Free descriptive matter. P. C. Feather, Mgr., 607 Curry Bldg., Pittsburgh, Pa.

**BECOME** a meter reader. Send 10c for Booklet of instructions. Platt, 2268 Oregon Ave., Cleveland, Ohio.

**MOULDS** and models for ornamental casting of novelties, statuary, garden furniture, in cement, plaster, Italian marble, etc. Free illustrated catalogue displaying large assortment. Both, A-45 Frost St., Brooklyn, N. Y.

**EXPERIMENTS.** A new 256 page book that gives practical information for building simple, efficient apparatus at small cost, conducting tests and experiments, establishing a laboratory and applying the best experimental methods. Shows you what you can do with your own brains and hands. Both amateur and commercial work is covered. Send for complete description free or book itself sent postpaid upon receipt of price, \$1.50. Popular Mechanics Book Dept., 6 N. Michigan Ave., Chicago, Ill.

**WANT** to secure a marine or steam engineers' license? For that great class of ambitious and hard working men, the oilers, coal-passers, water-tenders, firemen or anyone who wants real practical and useful information regarding the every-day operation of a steam plant, Chief McAllister of the U. S. Revenue Cutter Service has written an engineering story called "McAndrew's Floating School," that makes it possible for those who have not had previous training to absorb the necessary information. Cloth, 250 pages and 37 diagrams. Price, \$2. Popular Mechanics Book Dept., 6 N. Michigan Ave., Chicago.

**YALE** Drafting School. Post Office Drawer 143, New Haven, Connecticut. New, up-to-date method of correspondence instruction in Drafting and Machine Design. No money down—No money in advance. Full particulars upon request.

**PENMANSHIP** successfully taught by mail. Write for specimen. J. M. Moore, Penman, Findlay, O.

**CARRY** a Gilson Pocket Slide Rule (Patented). It will solve any mathematical problem rapidly and accurately. Price with complete instructions, 50c. Circulars free. Gilson Slide Rule Company, Niles, Michigan.

**\$10.00 PER DAY** made laying Tile. Mosaic Tile laying taught in one lesson. For particulars address Tile Dept., 609-10-11 Oxford Bldg., Chicago.

**PHOTOGRAPHY** taught in one month at Johnson's Studio, Oswego, N. Y.

**THOROUGH** personal coaching in Journalism by mail; lowest rates; easy payments; references; sample lesson, 50 cents; particulars free. Editor, Box 119, Camden, N. J.

**ARTIFICIAL** Marble, Sanitary flooring, ornamental casting, concrete, plaster, papier-mache, interior decorations, garden furniture, statuary, life casting, elastic moulds, electro bronze depositing (immensely profitable work), complete instructions \$1; particulars. 200 illustrations free. Mahler, D-117 Russell St., Brooklyn, N. Y.

**PERSONAL** instructions in Show Card Writing by experienced man. Short course. Original methods, results guaranteed. C. L. McKie, Dept. M, Ypsilanti, Mich.

**STAMMERERS**—Let me cure you at home. New, sure method. Expense small. Results permanent. Write immediately. My terms will please you. R. Arnaud, Keene, N. H.

**DETROIT** Technical Institute offers courses university grade in Automobile, Chemical, Electrical, and Mechanical Engineering, Law, Accountancy, Business Administration, Pharmacy, Salesmanship, Advertising, Real Estate, Credits and Watchmaking. Bulletin free. Address Director of Education, Room 311, Y. M. C. A., Detroit, Mich.

**FREEHAND** Lettering, recognized standard for draftsmen and students, taught to perfection. C. W. Reinhardt, Arlington, N. J.

#### TRADE SCHOOLS

**COME** to Seattle, the gateway to Alaska and Orient. Learn practical electrical, gas, steam engineering, mechanical drawing, machine-shop practice, automobile construction. Splendid openings for ambitious students when competent. Seattle Engineering School, Seattle, Washington.

**ELECTRICITY.** Plumbing, Bricklaying, Mechanical, Architectural and other Drafting Courses, Motion Picture Operating taught by practical work. Largest, best equipped practical trades school in America. Short time to learn. Small cost, easy payments. Write for big illustrated book; it's free. Coyne National Trade Schools, Dept. 1291, Chicago, Ill.

**NEW Handy Manual** on Plumbing, Heating, Ventilating and Mechanical Refrigeration. A practical book for practical men. 350 pages fully illustrated with cuts and diagrams. Pocket size. Cloth. Price, \$1.15, postpaid. Popular Mechanics Book Dept., 6 N. Michigan Ave., Chicago.

#### TELEGRAPHY

**TELEGRAPHY**—Morse and Wireless—taught at home in half usual time. The Omnigraph Automatic Transmitter combined with sounder or buzzer sends you messages, any speed, just as expert operator would. Used by U. S. Gov't to examine all applicants for licenses. Trifling cost. Catalog free. Omnigraph Mfg. Co., 41-G Cortlandt St., New York.

**TELEGRAPHY**—Morse and Wireless—also Station Agency taught. R. B. and Western Union wires and complete Marconi Wireless Station in school. Graduates assisted. Marconi Co. employs our wireless graduates. Low living expense—easily earned. Largest school—established 49 years. Investment \$25,000. Correspondence courses also. Catalog Free. Dodge's Institute, 15th St., Valparaiso, Ind.

#### WIRELESS

**PERSONAL** instruction in wireless through the mail by former Assistant Engineer to Marconi Company. 1302 Lake View Building, Chicago, Ill.

#### LETTER SPECIALISTS

**FOR \$3.** with order, I will write you a logical, convincing, hard-hitting sales letter that will bring you real business and win you real profits. Tenth successful year. I want new clients. Can I help you? H. A. Stern, 1127 Gaylord, Denver, Colo.

#### PICTURES, POSTCARDS, PENNANTS

**EXCHANGE** pretty postcards with our members far and near. Best card club. Membership, 10c. Jolly Card Exchange, Eighth St., Decatur, Indiana.

**IF** you really want to exchange postcards, try our splendid club. Lists circulate in many countries. Membership, 10c. Halcyon Club, Box 133, Erie, Pa.

**SEND** Pictures and Art Photos of the better class. Catalog and six real photo samples 25c. Box 436, Bridgeport, Illinois.

**RECEIVE** pretty view cards from many countries. Membership and 6 pretty cards 10c. Riverside Club, Dept. 10, Knoxville, Md.

**MEMBERSHIP** printed immediately 10c. Protect your memorandums with secret writing code, 10c. Pacific Card Exchange, Bryn Mawr, Wash.

**POLLY-WOGGING** by Motor, Michigan to California. Pictures taken en route. Prehistoric cities, Cliff Dwellers, Old Missions, Cactus, Orange Groves and Surf. Brief history. Club rates 50 pictures 25 cents first hundred orders. P. H. Ritchey, Station "L," Los Angeles, Cal.

**COLLEGE** and State Pennants, 9 1/2 x 26 inches. 15 assorted, 50c; 6 assorted, 25c. Postpaid. Lynch Specialty Co., Joplin, Mo.

**POSTCARD** Collecting, extremely interesting. Live club. Membership, including magazine stories, etc., 10c. Elite Exchange, R38, 3684 Milwaukee Ave., Chicago.

**3,000 SELECTED** Cartoons for \$3. A Panorama of World Events, Political, Industrial—Social—Humorous—Tragic—all of intense human interest. A wonderful collection of 3,000 cartoons reproduced from the newspapers of the United States, Canada, Mexico, Cuba and the cities of the Old World, has been made by Cartoons Magazine from more than one hundred and fifty thousand published cartoons, and bound in an artistic and durable cover, are now ready for your library table. Vol. I, Jan.-June, 1912—\$1. Vol. II, July-Dec., 1912—\$1. Vol. III, Jan.-May, 1913—\$1. Cartoons, 78 E. Madison St., Chicago.

**CROSS-SECTIONAL** view of ocean liner "Britannic," showing interior arrangement of ship in colors, size, 14x20 inches, on heavy plate paper for framing or hanging. Very interesting. Reproduced from front cover design of July issue Popular Mechanics. Will be sent postpaid to any address in the world on receipt of 4 cents in stamps to cover packing and mailing. Popular Mechanics Magazine, 6 N. Michigan Ave., Chicago.

**POSTCARDS** from everywhere. Join our Jolly Club. Send 10c. H. J. Teeple, Decatur, Indiana.

**200 ILLUSTRATIONS** Free. Beautiful art casts. Mahler, K-117 Russell St., Brooklyn, N. Y.

#### CAMERAS AND PHOTO SUPPLIES

**IF** you have a High-grade Camera, Lens, Kodak, or Motion-Picture Camera, and want to turn it into cash, write us today. State particulars, price, etc. We buy and trade, sell or exchange everything in Cameras from Vest Pocket to Graflex. Prompt, satisfactory service and a square deal to all. David Stern Co., 1047 1/2 W. Madison St., Chicago, Ill. In business since 1885.

**ROLL** Film developed, 10c a roll. Parks 20c each; Prints, Brownies, 2c; 1x, 3x4, 3x5, and Post Cards, 3c each. Work returned next day. Postage paid. Kodak Film Finishing Co., 112 Merchants Station, St. Louis.

**HAVE** you a Camera? Write for samples of my magazines, American Photography and Popular Photography, which tell you how to make better pictures and earn money. F. R. Prairie, 701 Pope Bldg., Boston.

**INSTRUCTIONS** and formulas for Phosphorescent Photos, Disappearing Photos, Photos on Apples, Cloth, Chinaware, etc. Simple Enlarger, Trick Pictures, 25 in all, for 25c. Disappearing Photo Free with each order. Money-Back Basis. P. Benson, Stewartville, Minn.

**FILMS** developed, ten cents per roll; film packs, twenty cents. Postcard prints, four cents; smaller sizes, three cents. Guy Hall, Chapman, Kansas.

**LET** me finish your next roll of Kodak Films. Send 10c for trial order. Slocum, 406 Main, Peoria, Ill.

**SEND** us six of your favorite negatives, any size, and 10c (stamps) for 6 prints. Or send any size roll of film for development and 6 prints for 10c. 10-inch mounted enlargements 25c. Mention this ad. Roanoke Cycle Company, Roanoke, Va.

**FILMS** developed, 10c; prints, 3c to 5c. A reputable incorporated company conducting largest existing plant. Price list and special offer. Enlargements our specialty. Chicago Photo Finishing Co., 54 W. Lake St., Dept. A, Chicago.

**ANY** film developed, 5c. Prints, 3/4x5/4 and smaller, 3c. 21-hour service. National Photo Finishing Co., Dept. 10, Omaha, Neb.

**FILMS** developed 5c. Prints 3c each any size. L. Loney, Hartford City, Ind.

**SEND** your photo and 25 cents and receive six "Carte de visite." Photo returned unharmed. Eclipse Mfg. Co., Box 462, Trenton, N. J.

**AMAZE** your friends with your beautiful colored photo prints. Send immediately for set of materials and instructions of remarkable process, enabling you to turn out on first trial, colored prints, rivaling the best professional work. A profitable pastime for winter months. To introduce our products only \$1.00 postpaid, while they last. The Photokrome Co., Box 113, Scranton, Pa.

**FILMS** developed 10c, all sizes. Prints 2 1/4-3 1/4, 3c; 2 1/2-4 1/4, 3 1/2-5 1/2, 3 1/4-4 1/4, 4c; Post Cards, 50c doz. Work guaranteed and returned 24 hours after receiving. Postpaid. Send negatives for samples. Girard's Commercial Photo Shop, Holyoke, Mass.

**MONEY** for amateurs Photographic Initial Correspondence Cards—send print and 25 cents for sample dozen. Particulars free. 8x10 Enlargements 19 cents—6 for \$1. Ashton Photo Works, Ashton, Ill.

**8x10 ENLARGEMENTS** 20c. 6, \$1.00. Sprauer, Stahlheber Rd., Hamilton, Ohio.

**BEGIN** year with subscription, Photo-Era Magazine, \$1.50. Copy with club-offers, five cents. 380 Bolyston St., Boston, Mass.

**KODAK** Films Developed, 10c per roll, any size. Prompt attention given mail orders. Prints, 2 1/4x3 1/4 to 3 1/4x4 1/4, 3c, 4x5 to 3 1/4x5 1/2, 4c. J. M. Manning, Box D, 1043 Third Ave., New York City.

**SECOND-HAND** Lenses. All makes and sizes. Work just as well as new ones. Send for our bargain list. Hyatt's Photo Supply House, St. Louis, Mo.

**BIG** Money Saved on Photographic Lenses and Apparatus—goods exchanged; repairing done. Ralph J. Golsen, 5123 Kenmore Ave., Chicago, Department P.

#### MOTION PICTURES

**BE** a Motion Picture Operator and earn big money for short hours, easy, pleasant work. We teach by practical work on the finest equipment. Write for free catalog. Coyne Trade Schools, Dept. 7191, Chicago, Ill.

**ELECTRIC** lights for movies. Anyone can operate generator from engine. Saves lighting bills. Easy payments. Hobart Brothers, Troy, Ohio.

**BIG** money writing Photo-plays: details free to beginners. No correspondence course. Producers League, 290 Wainwright, St. Louis.

**MAKE** \$50.00 clear nightly. We start you in the moving-picture business on the installment plan. No experience necessary. Write for free catalog. Monarch Film Service, Dept. P, Memphis, Tenn.

**BIG** Money Writing Moving-Picture Plays. Constant demand. Correspondence course; literary ability unnecessary. Write for free booklet, "How to Write Moving-Picture Plays." Universal Publishing Co., 293 Fergus Falls, Minnesota.

**SPOT** cash paid for second-hand high-grade Motion-Picture Cameras, Lenses, etc. Write us today. David Stern Co., 1047 W. Madison St., Chicago, Ill.

**WRITE** Photoplays, Short Stories, Poems. Big demand. No correspondence course. Start writing and selling at once. Details free. Atlas Publishing Co., 304, Cincinnati.

**MOTION** Picture Films for sale, \$2 reel up. Box 417, Montpelier, Vermont.

**MAKE** a complete Motion Picture Camera and Projector from instructions given in our book Amateur Mechanics No. 4. Full details given. Not hard to construct. Worlds of enjoyment taking and exhibiting subjects dear to the heart. Price of book only 25c, postpaid. Popular Mechanics Book Dept., 6 N. Michigan Ave., Chicago.

**WRITE** Photoplays, Instructions, Markets 25c. Write Plays, Sketches, Instructions, Markets 25c. Both 40c. E. L. Gamble, Playwright, East Liverpool, O.

**WRITE** Photoplays—Earn a big income. Our book tells how. Details free. Enterprise Co., PM-3348 Lowe Ave., Chicago.

**MOTION** Picture Work—A large \$18-page book covering every phase of the moving picture, its production and its theatre. Indispensable for reference and instruction to the thousands of workers in the motion picture field. Price, \$3, postpaid. Popular Mechanics Book Dept., 6 N. Michigan Ave., Chicago.

**WRITE** Stories for Moving Pictures. Interesting, profitable. Work in spare time. Full particulars free. G. B. D., Box 23, Hollywood Station, Los Angeles, Calif.

**MOTION** Picture Outfits bought and sold. Bargain List. National Equipment Company, 417 West Michigan Street, Duluth, Minn.

**HOW** to Write Photoplays is a brand-new volume devoted to motion-picture playwriting. Contains model scenario, a list of 36 scenario buyers, and all information necessary. Price 35c. Photoplay Pub. Co., PM-3348 Lowe Ave., Chicago.

**\$55 PROFIT** Nightly—Moving Picture Business—small capital starts you, no experience needed. Teach you—furnish everything. Ralph J. Golsen, 5123 Kenmore Ave., Chicago, Dept. M.

**MAKE** big money writing moving picture plays. Previous experience, literary talent or correspondence course unnecessary. Free details and special offer. E-Z Scenario Co., 609 West 125th St., New York.

#### BUSINESS OPPORTUNITIES

**LISTEN**—Start the New Year right: learn to make my sparkling chipped glass name plates; make \$15 a day; write for my big free 32-page illustrated book, tells how. E. E. Palmer, Wooster, O.

**20,000 FORMULAS**, Recipes, 530p, volume, \$1. 3,000 valuable trade secrets, formulas, 368p, volume, 40c. 1,000 selected formulas, 116p, volume, 25c. All three, \$1.53. Satisfaction guaranteed. Ideal Book Shop, 5311-A, Belleplaine Ave., Chicago.

**SPOT** cash paid for second-hand high-grade Cameras, Lenses, Kodaks, Motion-Picture Cameras, Microscopes, Binoculars, Surveyors' Levels, Transits, etc. David Stern Co., 1047 W. Madison St., Chicago, Ill.

**HERE'S** a real opportunity: First hand information about Patents, Copyrights, Claims, Government Contracts; Congressional and Departmental information—anything. Write for our free book "It Pays to Know." Washington Information Bureau, Dept. 12, Washington, D. C.

**"67 MONEY-MAKING PLANS"** fully explained—tried and true, 10c. "Nicholson," Bristol, Indiana.

**"DOLLARS"** yearly in your back yard. No ginseng, mushroom dope. New ideas never before published, particulars free. Metz, 313 East 89th St., New York.

**DEVOTE** your time to money-making mail order business. New Parcels Post Co-operative accumulative plan. Free start. Dean, 244 W. 41st St., N. Y.

**PATENTABLE** ideas wanted—Send for 3 free books. R. R. Owen, 30 Owen Bldg., Washington, D. C.

**I NEED** Ambitious Co-operators for my world-wide mail-order business; operate from your own home in spare time; no canvassing or peddling; experience unnecessary; you should make \$50 weekly. Butler, 561 Factories, Toledo, Ohio.

**WRITE** Photoplays, Short Stories, Poems. Big demand. No correspondence course. Start writing and selling at once. Details free. Atlas Publishing Co., 304, Cincinnati.

**BE** your own boss: "Chemical Service" will show you how. Write today for particulars. Chemical Service, 1680 E. 80th Street, Cleveland, Ohio.

**RESILVERING** Mirrors, Renewing Dry Batteries, 150 selected formulas 25c. "Ideal," 3311-A, Belleplaine Ave., Chicago.

**LEARN** to collect money. Good income; quick results. Send for free booklet, "Skillful Collecting." Collectors' Association, Long Street, Newark, Ohio.

**QUALITY** Paint 15c gal. Stamp brings particulars. Obetz, Hayesville, Ohio.

**"HIRE Yourself as Boss."** Big corporation will back you in Money-Making Mail-Order Business selling guaranteed Goods. Start spare time. Small capital. No canvassing. Wm. J. Dick, Mgr., Dept. E-10, 21 W. Lake St., Chicago.

**555 MONEY-MAKING FORMULAS**, 10c. Process Company, 414 Ft. Dearborn Building, Chicago.

**ASK** me about how I made \$32.50 in six hours. Dan Sweeney, Modesto, Cal.

**I WANT** to send you proof of the wonderful pulling power of Popular Mechanics classified pages. What's your proposition? Write me today. F. W. Johnson, Classified Dept., Popular Mechanics Magazine, 6 N. Michigan Ave., Chicago.

**BRYAN** Plastographed, why not Pres. Wilson? Plastography Instructions with formulas enable you to make life busts of your friends, portraying more delicate lines and shadows than photos or paintings. Very profitable work, easily learned; price \$1. A. Lincoln, Wilson or Victor Emmanuel mold free. School Plaques made to order. P. P. B. Spahr, York, Pa.

**WE** start you in business, furnishing everything; men and women, \$30.00 to \$200.00 weekly operating our "New System Specialty Candy Factories" home or small room anywhere; no canvassing. Opportunity Lifetime; booklet free. W. Bagnale Co., East Orange, N. J.

**MIRROR** resilvering is a paying trade. We have best instructions 25c. Auburn Supply Co., Dept. 1R, 7817 Peoria St., Chicago.

**COUNTY** and State patent rights for sale on an adjustable shade and curtain bracket; sample and particulars 25c. Will convince that we can start you in a profitable business on small capital. Address Probet Adjustable Bracket Co., Haledon, N. J.

**LEARN** to make picture moulding; easy to make the most beautiful designs. 50c per foot framing made for 5c. Make your home artistic or make money supplying your friends. For information, E. L. Wallace, Station H, Montreal, Canada.

**INVENT** something; your ideas may bring wealth; our free book tells what to invent and how to obtain a patent, through our new credit system; write today. Waters & Co., 4102 Warder Building, Washington, D. C.

**START** a second-hand store. We will help you. Free particulars. E. O. Worth, Mgr., Owosso, Mich.

**MAKE** \$10,000 yearly connecting land buyers and sellers by mail. Dunning Sys'tem, \$2.30. Particulars free. Dunning Co., Windsor, N. C.

**PENDLETON'S** Mail Order System for beginners; stationery free. Pendleton, 104, Box 1003, Atlantic City, N. J.

**I MADE** \$50,000 in five years with a small mail-order business; began with \$5 in my own home. I will show you how to do the work; no canvassing. Send for free booklet; tells how. Hancock, Box 867, Lockport, N. Y.

**LOOK** Here!—Five practical Business Plans and 50 Formulas, only 25c. "Cosques," 2846 Warren Ave., Chicago.

**EARN** \$100 weekly managing clean, legitimate mail order business. We furnish everything. Right party need not worry about capital. Splendid chance for intelligent, employed person to control independent business on profit-sharing basis, beginning in spare time, evenings at home. Particulars free. Opportunities Exchange, Buffalo, N. Y.

**CANDY** making a profitable and pleasing trade. Be your own employer. Our Candy Book tells how, 25c. Auburn Supply Co., Dept. 1C, 7817 Peoria St., Chicago.

**PATENT** Applications \$10. Why pay more? Best, surest, quickest service. Patent News, Dept., Washington, D. C.

**\$25,000—I MADE** it in mail order business. Had \$3 to start. No canvassing. Free Booklet tells how. Send 2c postage. Alb. Scott, Cohoes, N. Y.

**MOST** successful selling plan ever devised. \$25 to \$100 weekly profits. Particulars free. Dept. M, 108 Security Bldg., Davenport, Iowa.

**I PUBLISH** a wonderful magazine of money making plans, ideas, suggestions and inspiration! It will show you how to make more money. Sample, 10c. Booster Magazine, Northwestern Bldg., Chicago.

**BIG** Kansas company will start ambitious man or woman in fast growing Mail Order Business; any locality; \$3000 yearly; spare time; no canvassing; no experience. We furnish everything. Write for Unique Selling plan. Evestone, Pres., 502 W. 7th, Pittsburg, Kansas.

**MARKET** your spare moments intelligently; profitably; commercial information wanted; high grade opportunity, without canvassing. "Cico" Pmc, Evansville, Indiana.

**HOME** manufacturing: light work, good profit. "Genuine." Wharton, 680 Granville St., Vancouver, B. C.

**OPERATE** success proven mail order business under guarantee by reputable corporation—established eleven years. Everything furnished—no stock to carry. Save money—avoid mistakes. Merford Company, Incorporated, Dept. 156, Chicago.

**CONDUCT** a "Candy Kitchen"—Clear \$10 daily; practically no capital required; booklet free. The Kennon School, 142 W. Ontario St., Dept. A, Chicago.

**READ** Good Results—Greatest Mail Dealers—Agents Magazine published. Two Big Issues 10c. Good Results, 156P Washington, Chicago.

**START** in the carpet or clothes cleaning business. Now, Thurman Vacuum Process unequalled for commercial cleaning. We show you how. Easily learned. Only \$125 capital needed to earn good income in towns of 2,000 and over. Write today. Thurman Vacuum Cleaner Co., manufacturers of all types Vacuum Cleaners. Dept. H, St. Louis, U. S. A.

**IF** you work in a shop find out if the company has any lathes, turret lathes, screw machines or milling machines for sale and write me full particulars and price asked. I will pay you \$5 for each machine I buy. Pinner, 122 Water St., New York, N. Y.

**INVENTIONS** sold on commission. No advance fee. Patent News, E. Washington, D. C.

**WOULD** you like to own a good-paying Mail-Order Business? We have a line that gets repeat orders all the time. You can start in spare time; invest a dollar or two a week and soon own a nice business of your own. Particulars free. Natico, 4313 Lincoln Ave., Chicago.

**BE** Wise. Don't experiment in mail order. I can tell you how to succeed. B. Newham, Waukegan, Ill.

**HOW** to Operate a Mail Order Business. 30 Big Profit Plans and Year's Mailing service sent for 10c. Mail Dealers' Wholesale House, 521 Franklin Bldg., Chicago.

**WANT** Big Profits? Learn Tartaric Mirror Silvering. New process opens enormously profitable business. Particulars free. H. Barstow, 514 23rd Street, Oakland, Calif.

**INDEPENDENCE** and fortune quickly attained in the Manufacturing Mail Order business. I furnish Formulas, Manufacturing Processes and Trade Secrets in all lines. Sold under positive guarantee; 18 years' practical experience. Revision and improvement of Formulas and Processes—reduction of manufacturing cost—utilization of waste materials, etc., a specialty. Booklet, Formula List, and Valuable Information Free. W. L. Cummings, Ph. D., 127 Standard St., Syracuse, N. Y.

**LEARN** the real estate business. Our complete instruction book teaches: listing, appraising, management, salesmanship, insurance, brokerage, advertising, renting agency, forms, etc. 121 subjects. Exceeds \$20.00 correspondence course. Buckeye cover 75c; silk cloth \$1.00, postpaid. Catalogue free. Realty Book Company, 3982 Euclid Ave., Cleveland, Ohio.

**STOP** Here! Let me start you in a home business that will bring you money every day. Experience unnecessary. Spare time. No canvassing. I furnish everything. Send for proofs. Voorhies, Desk C. R., Omaha, Neb.

**LET** the parcels post help you. Add (\$15 to \$25 weekly) to your present salary or income. Start during spare time and build up a permanent mail-order business of your own. We show you how and help you make good. No canvassing. Experience unnecessary. The Parcels Post makes success doubly sure. Our new ideas and up-to-date plans bring the money. No so-called "Course of Instruction" to sell. We give that free. Write today. Address Pease Mfg. Co., Inc., Dept. A, 79 Broadway, Buffalo, N. Y.

**ADVERTISERS**, Mail Dealers. Our 1915 Rate Book lists 2,090 Principal Publications, rates, circulation. Includes 30 Mail-Order Plans. Price 10c. Dearborn Advertising Agency, 219 Franklin Bldg., Chicago.

**MANUFACTURERS**, Promoters and Patent Buyers are invited to write us stating the line of invention in which they are interested, as we can supply their wants in any class of patents. Victor J. Evans & Co., 162 Ninth St., Washington, D. C.

**MAKE** Money Repairing. Particulars, stamp. Houlgate, 1010 Cypress, Pasadena, Calif.

**I WILL** start you earning \$4 daily at home, silvering mirrors; free instructive booklet. G. F. Redmond, Dept. 306, Boston, Mass.

**INVENTORS**: We develop and perfect inventions, make models, dies, tools. Metal stamping and special manufacturing. Gerding Bros., Lion Bldg., Cincinnati, O.

**CARD** brings interesting literature, tells how to establish profitable mail order or local business. Be your own boss. Particulars free; write today. H. T. Ritch, Baker, Oreg.

**OWN** your business. My plan successful. Big profits. Small investment. Kightlinger, Wayne Av., East Orange, N. J.

**PERMANENT** income operating Ball Gum Vending Machines. Particulars Free. Gum samples 10c. Rice, 7122 Normal Blvd., Chicago.

**OPERATE** Mail-Order Book Business. Easiest, best paying line in Mail Order Field; everything furnished; folders, wholesale price lists, free. Rollins, Box 3572, Boston.

#### BUSINESS FOR SALE

**FOR** Sale: Cheap—Good Paying Sporting Goods, Indian Motorcycle, Bicycle, Business, anyone or all, to suit buyer. Guy W. Campbell Co., Waterloo, Iowa.

#### TO MANUFACTURERS

**SEND** us a list of your line and we will handle it through our mail-order department, first and largest in Hawaiian Islands. Goods bought for cash, sold on commission or consignment. We issue our own catalogue printed in Japanese and English. Send terms, samples and cuts. Hawaii Hochi Shu, Publisher of Hawaii Hochi, Daily Japanese Newspaper, Honolulu, T. H.

**WANTED**, Mail-order goods, at first hand. Miller, 2931 N. Sixth St., Phila., Pa.

#### MAIL ORDER SUPPLIES

**INCREASE** your sales. Place your proposition before the readers of "Cartoons Magazine." 20,000 copies guaranteed every month. Classified rate 2c per word. Mail in a trial ad today. Cartoons Classified Dept., 78 E. Madison St., Chicago.

**DIRECTORY** Postpaid \$1.00. Procter Sales-Purchase Company, Box 257, Chicago.

#### FOR ADVERTISERS

**YOUR** Thirty-Word Ad. in our big post-card magazine, 25c. Inch display, 50c. Elite Exchange, 3594 Milwaukee Ave., Chicago.

**BARGAIN**—20-word advertisement, one insertion, 35,000 circulation, and one year subscription, 25c; extra words one cent. Digest, Grand Rapids, Mich.

**ADVERTISE** right! Will write copy for ads or form-letters. Any business. Price \$1.00. Satisfaction guaranteed. Jones, Mackinaw, Mich.

**MAIL** Dealers—25 words in 40 magazines, 75c; in 100, \$1.25. Samples 5c. Lists free. Ireland Agency, Mauch Chunk, Pa.

**ADVERTISE!** 25 words in 100 monthlies, \$1. Sample Magazine Free. Other bargains. Stanford Agency, Sebring, Ohio.

**YOUR** thirteen word adv. in our 9x12 magazine reaching 20,000 boys for 25c. Extra words 2c. Country Boy Magazine, 2183 Mallers Bldg., Chicago.

**ADVERTISERS**—Here's your opportunity. Your proposition placed before the readers of "Cartoons Magazine" for only 2c per word. Circulation 20,000 copies guaranteed. Send a trial ad for our next issue. Cartoons Classified Dept., 6 N. Michigan Ave., Chicago, Ill.

**YOUR** advertisements placed in 36 different magazines for 3c per word; displayed, \$1.80 per inch; three times for price of two. List, particulars free. King's Magazine, Box 13-P, Little Silver, N. J.

#### BUSINESS SERVICE

**CORPORATION** Service System (P.M.). Clarksburg, West Virginia. Incorporates, organizes, represents companies throughout America. Saves expense. Information gladly furnished.

**INCORPORATE**. Our lawyers do the work, saving you time, annoyance and money in incorporating under the most liberal laws of Arizona. Laws and forms free. Southwestern Securities & Investment Co., Box D488, Phoenix, Ariz.

**NEVADA** incorporations operate everywhere. Save expenses. Most convenient popular standard charters. Forms—information—free. Corporation, Charter Trust Company (P.M.), Reno, Nevada.

#### AGENTS WANTED

**AGENTS!** 500% Profit. \$25.00 to \$50.00 a week; that's what our agents are making selling our new metallic sign letters for office windows, store windows and glass signs. For a quick, easy money making proposition for agents, salesmen and sign painters, there is nothing to equal the selling and putting up of our new metallic letters and numbers. There is no experience necessary to put up these signs. Anyone can succeed and make money right from the start. We will send you full particulars and you will see how easy it is to make money in this business. One agent says: "Have already put up 14 signs in this little burg and more in sight. Your letters are the best thing I have seen in years. Will soon be in a position to buy in 5,000 lots." Another says: "I am getting all the work I can do and the letters have given entire satisfaction everywhere." We are daily receiving such letters from agents who have started in the sign letter business. This is the only field that is not overcrowded. There is a big demand for window and glass signs in every town. You can sell to nearly trade or travel from town to town all over the country as you please. We would be pleased to send you a free sample and full particulars. Write today. Address The Metallic Sign Letter Co., 497 N. Clark Street, Chicago, U. S. A.

**MEN** and Women Agents: Money talks—how much are you making? If you are earning less than \$200 a month, no matter what your locality, you will positively be delighted with our Sentinel Burglar Alarm proposition. Many agents easily earn \$15.00 daily. Brand new invention. Sells quickly on sight to homes, offices. Patented. No competition. Free exclusive territory. Instantly attached any door knob. Impossible turn knob without ringing bell. No batteries, screws, nails. Handsomely nickel-plated. Retail \$1.00. Provides cheap burglar insurance. It's a big money maker. Let us prove why. If you mean business write today for liberal terms to agents. Marshall Dobbins & Co., Manufacturers, 1422 Marquette Bldg., Chicago.

**TAILORING** Agents Wanted. If \$10 to \$50 a week for your spare time interests you, write us quick for beautiful new sample outfit, 60 nifty fabrics, 32 swell styles, wholesale prices, measuring chart, tape line, etc., all free to you by return parcel post. We pay express charges and guarantee satisfaction on all our clothes. Your own suit special to show your friends, made to your measure and the finest you ever saw; new, nifty, stylish and first-class in every way. Write us quick. Even if you can't be our agent, get our proposition on a suit for yourself. Paragon Tailoring Company, Box 114, Chicago.

**SIGN** Letter Agents and Painters; 500% Profit Gold and Silver Sign Letters for Stores and Office Windows. Anyone can put on. Big demand. Free samples. Metallic Letter Co., 404 N. Clark St., Chicago.

**SELF** Hair Drying Comb just patented (not Electrical). Most wonderful article ever invented for women. Dries the hair in a few minutes, 100% profit; biggest thing in years. Metropolitan Sales Co., Tacoma Bldg., Chicago.

**WASH** clothes without rubbing. Our Tablet makes clothes cleaner and whiter, without rubbing, than is possible by the old way. Saves work, time and clothes. Contains no acid, lye, potash, lime or caustic soda—guaranteed will not injure the finest fabric. A splendid agents' proposition—every sample makes a permanent customer—big profits. Write for free sample and terms. Naptha Washing Tablet Co. (Inc.), 714 So. Dearborn St., Chicago, Ill.

**MEN** and women earn up to \$3,000.00 yearly distributing Guaranteed Hosiery from mill to wearer. All or part time. Repeat orders insure permanent increasing business. No capital or experience needed. D. Parker Mills, 2733 No. 12th St., Phila., Pa.

**AGENTS**—Use our capital, jump into big permanent business; New Automatic Fuel Saver, fits any stove or furnace; saves 25% fuel; exclusive territory. States Mfg. Co., 188 Consolidated Bldg., Chicago.

**GET** into your own business. Cut loose from lay-offs, short hours, and wage slavery. Our catchy soap and toilet combinations have put thousands on Prosperity Road. Tremendous saving to consumer—200% profit for you. Send postal quick for details. E. M. Davis Co., K64 Davis Bldg., Chicago.

**AGENTS** earn \$30 weekly selling our remedies. U. S. Pharmacal Co., Dept. P, Newark, N. J.

AGENTS make big money and become sales managers for our goods. Fast office sellers. Fine profits. Particulars and samples free. One Dip Pen Company, Dept. 2, Baltimore, Md.

AGENTS—Send for sample "Fretnot"—the wash day wonder. Be convinced you can do a whirlwind business. You can clear at least \$20 to \$100 weekly, according to spare or whole time. You don't have to talk, if she doesn't buy at sight, leave sample, she will be looking for you long before you are able to make the rounds again. Samples furnished free. Premiums for your customers. Exclusive territory granted to agents who can produce. Credit given. Don't call. P. M. Motter & Sons, 3213 Warren Ave., Chicago.

NEWEST wonder of the age! Silver, the polish that silver-plates. Actually rubs on sterling silver. Used everywhere. Sells on sight. Repeat orders. Big profits. Protection. Send 10c for sample and introductory offer. Carisa, 157 Cedar, New York, Dept. D.

\$61.50 WEEKLY introducing and selling a new gas light burner for kerosene lamps. Beautiful light. No chimney. No mantle. Perfectly safe. Simple in construction. Nothing to get broken or out of order. Will not burn out. Durable. Will last for years. Low price. Easy to sell. 200 per cent profit. Experience not necessary. Sample free. Why not try one on your lamp? Beware of imitations. No branch offices. Luther Manufacturing Co., Dept. 162, Cincinnati, Ohio.

EVERY household on farm, in small town or suburbs, where oil lamps are used, needs and will buy the wonderful Aladdin Mantle Lamp. Burns common coal oil (Kerosene); gives a light five times as bright as electric. Awarded gold medal at San Francisco Exposition. One farmer cleared over \$500.00 in six weeks; hundreds with rigs earning \$100.00 to \$300.00 per month. No cash required. We furnish capital to reliable men. Write quick for wholesale prices, territory and sample lamp for free trial. Address nearest office. Mantle Lamp Co., 517 Aladdin Bldg., Chicago, Ill. Mantle Lamp Co., 517 Thomas Bldg., New York City.

RELIABLE Manufacturer wants men and women to handle the best line of guaranteed hose, raincoats and neckwear in the market. Our proposition beats them all. Better merchandise, larger commissions for the agents. We protect you in your territory. Capital or experience not necessary. Important that you answer at once, territory going fast. Dept. X Wahbag Manufacturing Co., 263 Main St., Buffalo, N. Y.

AGENTS—Big profits, brand new, sells on sight. Cleans clothes, wooden goods and carpets. 10c brings selling sample and full particulars. J. Lacey Co., 1024 9th St., N. W., Washington, D. C.

AGENTS—Sell the Primus, genuine Swedish wickless, coal-oil stove. Smokeless, odorless. Twice the heat of gasoline at one-eighth the cost. No danger of explosion. Big profits. James Anderson & Sons, Sidney, Ohio, American distributors.

MAKE and sell your own goods. Formulas by Expert Chemists. Manufacturing Processes and Trade Secrets. Formula Catalog for Stamp, B. Mystic Company, Washington, D. C.

AGENTS—Kleanol Sanitary Brushes pay you big profits; fast sellers; big line. Get information from largest wire twisted brush makers. Kleanol Brush Co., Inc., Dept. 1, Springfield, Mass. Branches at Omaha, Nebr. Dallas, Tex.

AGENTS Wanted—No matter who you are, or where you live, or what you do, right now, before you turn the page, before you do another thing, send us your name and address so we can send you free our beautiful, heavy sample book, crowded with wonderful bargains in men's made to measure clothes, all the latest fabrics, advance styles, inside prices, measuring chart and everything needed to make \$5.00 to \$10.00 an hour in your spare time. Special offer on your own suit to advertise us. Don't miss this. We pay express and guarantee satisfaction. Send a postal now. American Woolen Mills Co., Dept. 114 Chicago.

READ the Agents Magazine and make more money. 2 issues 10c. Agent's Magazine, Chicago.

LIVE Agents can earn \$150 per month selling our "Zero" Priming device for Ford and other autos. Cranking made easy in cold weather. Easily installed. An exceptional opportunity for a responsible hustler. Write for particulars, or better, send \$2.75 for sample outfit. Gahn & McCormick Co., Dept. 27802, Streator, Ill.

YOU'RE wanted to make big money controlling exclusive territory selling new patented kerosene lamp burner and wick feeder. Doubles light. Everyone buys. Plans free. International Mfg., Dept. 539, Toledo, Ohio.

KEROSENE Gas Burners in Cook Stoves or Ranges stop use of wood or coal. Recently patented. Money-Maker for Agents. The Vapor-Gas Burner Co., Desk 8, Columbus, Ohio.

ENDLESS Neckties—Something new; twelve ties in one; costs no more than old style; man made \$70 three days; woman made \$92 week; write for special agents' offer. Endless Necktie Mfg. Co., Dept. 10, Kansas City, Mo.

WANTED—Men and women—to sell Comfort Shoes direct to wearers; easy sellers, good profits. Ideal Shoe Co., Boston, Mass.

SEND 25c for sample New Sanitary Telephone Mouth Guard. Agents wanted everywhere. Excellent for advertising purposes. Universal Sanitary Appliance Co., 104 Wall Street, New York.

PHOTO Pillow Tops, Portraits, Frames, Sheet Pictures, Photo Plates, Penmounts, Reprints credited. Prompt shipments; samples and catalogues free to agents; 30 days credit. Jas. C. Bailey Co., Desk A1, Chicago.

\$1,000 PER Man per County. Strange invention startles world—agents amazed. Ten inexperienced men divide \$40,000. Kerstad, a farmer, did \$2,200 in 14 days. Schleicher, a minister, \$195 first 12 hours. \$1,200 cold cash made, paid, banked by Stoneman in 30 days; \$15,000 to date. A hot or cold running water bath equipment for any home at only \$65.50. Self-heating. No plumbing or waterworks required. Investigate. Exclusive sale. Credit given. Send no money. Write letter or postal today. Allen Mfg. Co., 121 Allen Bldg., Toledo, Ohio.

AGENTS—200% profit. Wonderful little article. Sells like wildfire. Can be carried in pocket. Write at once for free sample. H. Mathews, 462 North St., Dayton, Ohio.

MANUFACTURERS' representative wanted in the cities of Buffalo, Cincinnati, New York, Pittsburgh, Indianapolis, Toledo, Newark, Jersey City, Detroit, Minneapolis, St. Louis and Rochester. The proposition is a superior gas range. Representative to secure quantity orders from builders and contractors. Actual experience as a salesman in this line not necessary, but acquaintance with building and contracting trade an advantage. Commission basis, insuring good income to able man. Address Range, Room 926, 78 E. Madison St., Chicago.

AGENTS—Large Manufacturer wants reliable Men, Women, to sell guaranteed Hosiery, Underwear, Shirts, direct to homes. Write for free samples. Madison Mills, 588 Broadway, New York.

WE pay \$80 a month salary and furnish rig and all expenses to introduce our guaranteed poultry and stock powders. Bigler Company, X368, Springfield, Illinois.

SPLENDID 30% Commission to Aggressive agent on new liberal \$2,600 accident policy. \$5 yearly pays for injuries and sickness. Double benefits, \$10. Photo-identification (in leather case) free with each policy. Underwriters, 1345 D. Ins. Exchange, Chicago.

NEW 50c kitchen invention cuts household work 1/2; saves \$20 yearly; 25c profit each sale. fifty sales daily easy. Demonstration creates sensation, Triumph Co., Transportation Bldg., Chicago.

AGENTS are coming money selling our big 10c Packages of 20 Assorted Postal Cards. "3,000 Varieties." "Big Profits." Sell everywhere at sight. Sample Packages 10c. Particulars Free. Sullivan Card Co., 1224 Van Buren St., Chicago, Ill.

AGENTS—Get particulars of one of the best paying propositions ever put on the market. Something no one else sells. Make \$4,000 yearly. Address E. M. Feltman, Sales Mgr., 3291 Third St., Cincinnati, O.

NEW \$2.50 pocket adder. Sell 10 daily easy. Excellent profit. Everyone buys. No competition. P. Bassett, 3921 Indiana Ave., Chicago.

I NEED ambitious Co-operators for my world-wide mail-order business; operate from your own home in spare time; no canvassing or peddling; experience unnecessary; you should make \$50 weekly. Butler, 560, Factories, Toledo, Ohio.

AGENTS—100% selling our Cough Syrup, Rheumatic and Kidney Remedy, Toilet Articles, etc. Every article fully guaranteed. Trye Drug Co., Lorain, Ohio.

AGENTS—\$160,000 in profits to be paid agents the coming year; amazing opportunity offered by a reputable \$50,000 Manufacturing Corporation; big factory to you profits; whirlwind repeat order product; enormous demand; get from \$50 to \$200 weekly. Kalamite Laundry Marvel works wonders; positively abolishes machinery, washboards, rubbing, washing machines; absolutely harmless; \$1.000 guarantee; astounds and delights women. Protected by trade mark registration, patent application, Bettens, Idaho, writes, "Rush 5,000 more packages." Valuable territory concessions; credit granted; all or spare time; no experience necessary; hurry; write today; get overwhelming proof; all free. Equitable Corporation, Dept. 346, 217 W. Superior St., Chicago.

MAKE \$21 Next Saturday. Brand new proposition, patented last January. Amazing invention, compressed air washing machine weighs but two pounds; excels work of high-priced machines. Customers excited; agents coming money. A sale at every house. Price only \$1.50; 200% profit. Cleans tub of clothes in three minutes; works like magic. F. Hughes made \$21 first eight hours. No charge for territory. Investigate. Write now. Wendell Co., 948 Oak St., Leipsic, O.

LADY or gentleman, fair education, to travel for old-established firm. No canvassing. Salary, \$936 per year, payable weekly, pursuant to contract. Expenses advanced. Address G. M. Nichols, Philadelphia, Pa., Pepper Bldg.

WE give liberal terms to men and women selling our Rayo Polishing Cloth, reduced to 15c; on the market for years; will clean any metal. Kearney, Bible House, New York.

AGENTS—\$10 daily selling our 15 up-to-the-minute household articles. Lightning sellers. Samples furnished active workers. Write J. White, Kalkaska, Mich.

ATTENTION! Clear \$30.00 weekly year round mailing music evenings. Why look further? Send 10c for facts, proof and elegant new music to Webber Music Company, Boston, Massachusetts.

200% PROFIT. You can't beat it. Sells everywhere. Free pocket sample. Our goods get the orders. Wm. J. Dick, Mgr., Dept. E-4, 20 W. Lake St., Chicago.

AGENTS Wanted—Agents make 500 per cent profit selling "Novelty Sign Cards." Merchants buy 10 to 100 on sight, 800 varieties. Catalogue free. Sullivan Co., 1234 Van Buren St., Chicago, Ill.

YOU can make big profits selling our Pure Aluminum Kitchen Utensils—Guaranteed for 20 years. Our specialties are not sold in stores, and they get the business for you. \$200,000 firm and liberal credit plan backs you. We have an attractive General Agency offer. Wm. J. Dick, Manager, Dept. E-21, 20 W. Lake St., Chicago.

AGENTS! Earn big commissions selling \$20 value all-wool made-to-measure suits for \$10.75 retail. No experience necessary. Chicago Woolen Mills, Dept. 100, 823 Jackson Blvd., Chicago.

"DECALKO" gold sign letters letter everything. New, Sensational. Enormous profits. Sample free. Wadhams, 90 Broadway, Brooklyn, N. Y.

HOUSEHOLD utility; large profits; re-peater; particulars free; sample 35 cents. O. J. Anderson, Chapman, Kansas.

AGENTS—50 Calling Cards 10c. F. Shepard, Rome, N. Y.

OUR Line-finding Copy Holder for Stenographers is a big money getter. Entirely new. Over 100% profit. Field unlimited. Business houses buy in quantities. Write at once for exclusive territory. Lineguide Mfg. Co., 169 North 5th Ave., Chicago.

THE "Show-Me" is the most unique, scientific, dependable low-priced clothes washer ever produced. Large demand easily developed your territory. Large profit to you. Establish thriving business your own. Address H-A Manufacturing Co., 490 Wornall Road, Kansas City, Mo.

STOVINK—Agents! Big money! Extraordinary stove blacking; will not burn off; sells to every home; repeats; rich opportunity; permanent business. Experience unnecessary. Season on, Hayden Griffin Co., Toledo, Ohio.

AGENTS Wanted Everywhere—To sell our attractive theatre Brass Poster Frames, Changeable Signs, Building Directories, Brass Signs, Brass Railings, Bank Fixtures, Adjustable Electric Light Brackets. Big demand; easy sales. Established 1882. Newman Manufacturing Company, Cincinnati, Ohio.



**RELIABLE** men 18 to 60 wanted in each locality to represent big sick and accident insurance company. Sell new idea policy to working people and collect monthly. No capital or experience required. We teach you the business. Build up a permanent increasing business all your own. Spare or full time. Big money made. Hustlers look no further. We fix you for life. Our marvellous new plan of insurance fills great country-wide need. Apply quick. W. G. Critchlow, Manager, Dept. 2706, Covington, Ky.

**ENORMOUS** profits manufacturing "Substitute for Eggs." Big demand in stores and homes. Formula and complete instructions 25c. "Ideal," 3311-A, Belleplaine Ave., Chicago.

**MORE** selling brains needed. More help wanted. This means you, Mr. and Mrs. Agent. Carma Non-alcoholic Food Flavors in tubes plus other lines. Our plan gets the cash. Mather-Carroll Co., 5233 Kimbark Ave., Chicago.

**TAILORING** Agents Wanted—Everywhere. Spring season 1916. Take orders for guaranteed Made-to-measure clothes. "Nelson System, of Special Values." "Four prices only"—\$15, \$20, \$25 and \$30. Agent's profit 30%. Special Raincoat Premium offer. Fine opportunity to earn big money and establish permanent business. Nelson Tailoring Company, 241 W. Van Buren St., Chicago.

**AGENTS** Deal in Dollars—Make Dollars. The Jules Folding Portable Electric Lamp containing new exclusive patented features. Some territories still open. For particulars address Rose Strauss Co., 215 W. 48th St., N. Y.

**A PRACTICAL** and Attractive Novelty. "Duplex Swedish Pencil Sharpener." No littered floor, cut or soiled fingers. Every Bank, Office, Home, School or Individual buys on demonstration. Big profits. Exclusive territory. Write for our interesting proposition. W. J. Gibson & Co., Fisher Bldg., Chicago.

**MAKE** More Money—Making Your Own Goods. I supply Original, Guaranteed Formulas—Trade-Secrets for Latest Specialties in all Lines. Latest Lists for Stamp. Liscombe Miller, Chemist, Tampa, Florida.

**\$70.00 TEN** Days—Hedrik's profit. Smith, Virginia, writes "sold 24 one house" Rodolph's Patented Curtain Rods. No nails, tacks, screws. Fits any window. Sample 10c. Rodolph, 472 Northwestern Building, Chicago.

**AGENTS**—Make a big cleanup, selling our household Specials. Quick sales. \$25 to \$75 weekly a cinch. Write for colored circulars and immediate appointment. E. M. Davis, Pres., 1044, Davis Bldg., Chicago.

**YOU** can do it. What? Make only 2 sales a day, \$3.69 net profit. More sales, more dollars. No limit to opportunity selling latest Aluminum Combination Set at a price the women go wild over. Write today and let me show you how to make at least \$3.60 a day. Sales Manager, 1423 Westmoreland St., Philadelphia.

**"LUMINO"** Changeable Letter Signs. A metal sign with embossed letters. Something new. Every merchant buys. Fastest Dollar Seller Ever Invented. 250% Profit. Write today. Changeable Sign Co., 581 East 102nd St., Cleveland.

**\$6.00 A DAY** profit selling our products. 25c box and terms 10c. C. Lutz Manufacturing Co., York, Pa.

**AGENTS**—Get newest, quickest sellers direct from makers—full list free. Nat'l Agents Assn., 1122 Michigan Ave., Chicago.

**BIG** Profits. New gold and silver sign letters. Free samples. Flexible Letter Co., 1642 Division St., Chicago.

**ENERGETIC** agents manufacture. Greatly increase profits. Write for plans. Eastern Exchange, Bridgton, Maine.

**AGENTS**: Latest household article out—Pin-Cushion and Spool Holder. Samples 25c. Northwestern Mfg., 1048 Lawdale Ave., Chicago.

**"LITTLE** Wonder" Ideal Needle Threader. Sample 10c. Stovers, Millersburg, Pa.

**FOOD** Products are easy sellers. Big profits. Repeat orders. R. Colvin Company, South Bend, Ind.

**HIGH** Class Specialty Salesmen! New electrical publicity device. Big commission. Protected territory. Technical experience unnecessary. H. A. Ray, Winamac, Indiana.

**AGENTS**—Emco Mop Wringer, 2 pounds, 100% ; sample 25c. Reference, Market Trust Bank. Emco, 523 Monroe St., Chicago.

**MAKE** your own Extracts and Perfumes. H. Lake Co., Adair, Ill.

**BIG** Profits selling guaranteed goods. \$2.50 premium with each sale brings business. Wellcroft-May Co., Dept. 1, Hackensack, N. J.

**CUSTOM** Raincoats. You can sell them. Big Commissions. Free raincoat to good agents. Imperial Raincoat Co., Clark 5, Boston, Mass.

**AGENTS**—Can make \$30 per week selling our new product. Every auto owner wants it. Write for free sample. The N. R. Rogers Co., Peru, Nebr.

**HANDLE** Subagents and Trade in your territory for the Japsell, nonbreakable gas mantle. Newest, selling fast everywhere. Your profits on the district sales assure a splendid income. Jules, 230 W. 48th St., N. Y.

**LIVE** agents investigate our new household specialty; rapid seller; great labor saver; particulars free. M. E. Cooper, R. N., 409 Pine St., Susquehanna, Pa.

**SELL** Luminous Crucifix. "Shines all Night," to Catholic institutions and families. Old Paducah Co., Paducah, Ky.

**"PEACE** Calendars," quick sellers. Mulhoney, Paxtang, Pa.

**I PUBLISH** a wonderful magazine of money making plans, ideas, suggestions and inspiration! It will show you how to make more money. Sample, 10c. Booster Magazine, Northwestern Bldg., Chicago.

**WHOLESALE** Importing Firm of Oriental goods, Japanese Toys, Paper, Silk goods, Indian Jewelry, etc., and Exporters of general goods, desire to extend connections with Agents and Manufacturers. Write for List. Direct Supply Association, Victoria, B. C.

**GET** rich profits—Own a business. Big Kansas Company offers fast selling Mail Order Line. Factory prices. Unique Selling methods pull quick big paying business. No canvassing. Spare time. We furnish everything. Copyrighted prospectus free. Eyestone, Pres., 591 W. 7th, Pittsburg, Kans.

**READ** Good Results—Greatest Mail Dealers—Agents Magazine published. Two big issues 10c. Good Results, 156P, Washington, Chicago.

**POSTCARDS** 90c per 1000 up. Comics, views, etc., 20,000 \$15. Samples 10c. Gross Onard Co., 2147 Arthur Ave., N. Y.

**AGENTS** Wanted: Auto heater for winter driving—sells on sight. Write before all territory is gone. Hill Pump Valve Co., 18 E. Kinzie St., Chicago.

**ACT** Quick! Automobile Gasoline going up. Sell Gaso-Tonic. Equals gasoline at 3c a gallon. Eliminates Carbon. Dollar an hour profit. Sales Guaranteed. White Mfg. Co., Dept. M, Cincinnati, Ohio.

**AGENTS** make \$5 to \$10 a day on the start. Atkinson writes: "The best proposition I have found in my forty years' canvassing." Permanent work. Household necessity. Selling 80%. Write today for General or Local Agents terms. Free sample. C. H. Stuart & Co., 10 Union St., Newark, New York.

**YOU** can be your own boss with our Key Check Outfit. Good for \$5 a day stamping names on pocket key checks, fobs, etc. Sample check with your name and address, 15 cents. Pease Die Works, Dept. M, Winchester, N. H.

**AGENTS** of ability and high character wanted on a new household article. Over 100 per cent profit. Special selling plan that pulls results. Address Merritt & Brock, 59 to 69 Temple Place, Boston, Mass.

**WE** are the largest manufacturers of twisted Wire Brushes in America. Highest grade goods, best service, largest profits. Our new Auto Specials are winners. Send for catalog. Fuller Brush Company, Hartford, Conn.; Rock Island, Ill.

**AGENTS**—Stamping names on Pocket Key Protectors; sample Check with your name and address, 12c. Stamping Outfits, Emblem Checks, Check Fobs, Name Plates. Hart Mfg. Co., Desk 2, 303 Degraw St., Brooklyn, N. Y.

**BIG** Profits for You! Manufacture Barley Crisp. New Confection. 5c package costs you 1c. Machine instructions complete \$7.50 prepaid. Send 10c for samples. Barley Crisp Co., 1295 Broadway, San Francisco.

**YOUNG** Man, would you accept a tailor-made suit just for showing it to your friends? If you live in a town smaller than 13,000, write Banner Tailoring Co., Dept. 214, Chicago, and get beautiful samples, styles and a wonderful offer.

**MAIL-ORDER** Opportunities: 25 new Propositions. No competition! Make 90c profit on dollar order; complete outfit 10c. Mail Dealers Wholesale House, 521 Franklin Bldg., Chicago.

**AGENTS**—Salary or commission. Greatest seller yet. Every user pen and ink buys on sight. 200 to 500 per cent profit. One agent's sales \$620 in six days; another \$32 in two hours. Monroe Mfg. Co., X9, La Crosse, Wis.

**INVENTIONS** sold on commission. Advertised free. No advance fee. Patent News, A, Washington, D. C.

**TREMENDOUS** seller, big profit. German silver tie forms. Sample sent for 10c. H. Fenton Company, 1984 Amsterdam Avenue, New York.

**WONDERFUL** Opportunity—Start as our agent, become manufacturer. Everyday necessities. Fastest repeat sellers. Marvellous profits. Proposition worth at least \$40 weekly. Samples free. Frederick Loh Company, 528 Warren St., Boston, Mass.

**MEN** to refinish lighting fixtures, brass beds, etc. All or spare time. No capital or canvassing. Experience unnecessary. Information free. Gunmetal Co., Dept. G, Decatur, Ill.

**YOU** can make \$333 as our general or local agent. Household necessity; saves 80 per cent; permanent business; exclusive territory; salary or commission; free sample; credit. J. Pitkin, 113 Redd St., Newark, N. Y.

**MEDALLIONS**—300% profit. Make up your own goods and be independent. Catalogue free. Resag Co., 1205 Randolph St., Chicago.

**500% PROFIT** selling our wonderful sign letters for office windows, store fronts and glass signs; resembles finest gold leaf; easily applied; samples free. Metallic Letter Co., 404 N. Clark St., Chicago.

**PORTRAIT** Agents: Our goods will make you big profits. Delivery guaranteed. Returns credited. Prompt shipments. Low prices. Send for latest catalogue and prices. Adam J. Kroll & Co., 692 Blue Island Ave., Chicago, Ill.

**SELL** Dry Goods Remnants. Greatest bargains on earth. Remnant Store Co., Cincinnati, Ohio.

**STOP** Here! Let me start you in a home business that will bring you money every day. Experience unnecessary. Spare time. No canvassing. I furnish everything. Send for proofs. Voochies, Desk C. R., Omaha, Neb.

**AGENTS**—Average \$5 to \$12 daily selling astonishing Aztec massage machine. New. Just patented. Different. No electricity or water power required. Nothing complicated. Affords exhilarating massage without cent expense. Lowest priced, but best outfit. Retail \$2.50 allowing you big end of the profit. Particulars and "beauty" folder free. Aztec Remedy Co., Dept. 132, Toledo, Ohio.

**AGENTS**—Make \$20 to \$60 weekly selling our 300 candle power gasoline table and hanging lamp for homes, stores, halls, churches; no wick, no chimney, no mantle trouble; costs 10c per night; exclusive territory; we loan you sample. Sunshine Safety Lamp Company, 920 Factory Bldg., Kansas City, Mo.

**"STEAM-NO-MORE"** for eye glasses. Everyone who wears glasses buys. Live agents 200% profit. Send 10 cents for 25c sample. Gray's Sales Agency, Port Huron, Mich.

**AGENTS**—Here's a brand new article, just ready for market. Make over 100% profit, with satisfied customers. Every mechanic needs one, sells quickly on sight; no competition. Our proposition is a winner. Don't wait. Write for it now. The Security Aluminum Rule Pocket Co., Ivanpah, Calif.

**ACCEPT** no agency until getting offer on Ho-Bo-Co Skin and Scalp Soap and Toilet Articles. Our plan new and different. Territory limited; write today. Rothco, 209 N. 2nd St., Louis.

**AGENTS**—Steady Income. Large manufacturer of Handkerchiefs and Dress Goods, etc., wishes representative in each locality. Factory to consumer. Big profits, honest goods. Whole or spare time. Credit given. Send for particulars. Fresno Mfg. Co., 59 Main St., Brooklyn, N. Y.

**AGENTS**—Brand new specialty Aluminum Triplicate Sauce Pan with detachable handle. Cooks 3 different foods on one burner. Saves gas. Lasts lifetime. \$100 to \$300 per month easy. Send for our catalogue of 400 other specialties. American Aluminum Mfg. Co., Div. J, 10, Lemont, Ill.

**SOAP** Agents—Our Vegetable Soap, Toilet Goods, Remedies, Flavorings, Excel—Outsell. Sample Free. F. A. Buchanan & Co., Dept. 54, St. Louis, Mo.

"GOLDINE" Sign Letters—1,000% profit. Sample free. Johnston Co., Quincy, Ill.

AGENTS—Biggest hit ever! Eleven-piece Toilet Article Set, selling like blazes at \$1; with \$1 Carving Set Free! Enormous profits! Tremendous sensation! Experience unnecessary. Engle made \$51.00 first week. Write quick! Pierce Co., Dept. P, 906 Lake St., Chicago.

AGENTS—\$5 daily selling our Handy Tool, 12 articles in one. Lightning seller. Sample free. Thomas Mfg. Company, 762 North St., Dayton, Ohio.

JUST show them—The new adjustable floor and wall mops, dustless dusters and sanitary brushes sell themselves. Big line. Big profits. Agents write Silver-Chamberlain Co., Dept. M, Clayton, N. J.

EASY, pleasant work for Mechanics, Shop Men, Clerks, during spare hours, will add many dollars to their salaries. Also want persons who can give full time. Big wages assured. Novelty Cutlery Co., 67 Bar St., Canton, Ohio.

\$15.00 MADE first day by 13-year-old boy with Shomescope. Woman made \$8.00 first hour. Particulars free. Shomescope Mfg. Co., 528 W. 13th St., Kansas City, Mo.

AGENTS—Sell rich-looking imported 30x 68 Hugs, \$1 each. Carter, Tenn., sold 115 in 4 days. Profit, \$57. You can do same. Write for sample offer selling plan; exclusive territory. Sample rug by parcel post prepaid, 98c. Condon, Importer, Stonington, Maine.

AGENTS—New, startling, marvelous invention—Adding Machine—counts both ways, adds, subtracts and multiplies. Offices, stores and factories buy from one to a dozen. Every demonstration sells. Does the work of a \$400.00 machine. Retail \$7.50. Immense profit. Write or wire the Calculator Sales Company, Grand Rapids, Michigan, for protected territory.

I WILL start you earning \$4 daily at home, silvering mirrors; free instructive booklet. G. F. Redmond, Dept. 306, Boston, Mass.

WRITE for our profitable agency offer selling automatic pipe and nut wrench. Superior Wrench Co., Box 1326, Marshalltown, Iowa.

HEATLESS Trouser Press. Guaranteed to press trousers in 5 minutes without labor or heat. Big profits, \$1.09 prepaid. Patented Goods Co., Dept. P, 3, 5 Liberty St., Poughkeepsie, New York.

MEN and Boys. All Wool Pants. \$5.00 value. All sizes—four colors. Samples by parcel post. Price \$1.65. Wells, 20 So. Second St., Philadelphia, Pa.

#### AGENCIES WANTED

WILL Sell your Goods. Distribute Samples, Circulars and Advertising Matters. By Agents or Mail. Gabower, 279 W. Main St., Amsterdam, N. Y.

ESTABLISHED manufacturers' agency want new line. Salesmen cover northwest. Write Currier Sales Co., Minneapolis, Minn.

WANTED—Coast rights for agents' specialties. We give results. Herrick & Wells, 128 Harold Ave., San Francisco, Calif.

#### SALESMEN WANTED

SALESMEN qualify as general representatives, become independent. Sell E. Z. devices for Ford cars. Rapid fire, sure repeating sellers. Starter \$10, operates from seat, stops embarrassment, mud-puddling and back-firing danger. Steerer, \$1.75, kills wobbling, holds roads, saves tires. \$6.00 (set of four) best on earth shock absorbers. \$25.00 Demountable belt farm power device with free bumper. Big commissions. Geo. H. Wilson, Manufacturer, 1041 Northwestern Bldg., Minneapolis, Minn.

SALESMEN—Country. Universally used Indoor Golf specialties—side line—small samples—liberal commission. The Golf Shop, Chicago.

SALESMEN—We have some excellent territory open to salesmen of ability. The Little Giant Ice Chippers and Breakers are made in twenty different styles and sizes and appeal to all who have use for chipped or broken ice. Write for catalog No. 20-X. R. A. Schmidt Company, Davenport, Iowa, U. S. A.

SALESMEN & Agents wanted everywhere, sell assorted "Nobema" Colors to clerks, merchants and others. Each purchaser secures free. High grade, newly patented air brush, also Show Card course (and brushes) Free! in leading correspondence school. Quick sales, big commission. References and small cash security for goods. Nobema Mfg. Co., Hartford Bldg., Chicago, Ill.

FACTORY employees, or men with large factory acquaintance, to quietly co-operate with our sales department. Splendid proposition. No canvassing necessary; no investment required; part or all time; good pay with opportunity for desirable connection with company having \$300,000.00 capital, fully paid. Address Sales Manager, Box 1745, Houston, Texas.

SALESMEN—Wanted everywhere by a responsible, established house. If you average sales of one or two machines a week, you make from \$2,000 to \$4,000 a year. Sell Chemical Fire Engines on Wheels to factories, stores, Fire Depts., etc. No capital required; exclusive territory; goods well advertised. Ajax Fire Engine Works, 95 Liberty St., N. Y. City.

WANTED—Hustlers to take orders for made-to-measure high-grade men's tailored suits from \$9.50 to \$22.00. Make \$25.00 to \$50.00 weekly. Elegant large book outfit free. Experience unnecessary. No pocket folder affair. Splendid opportunity to make money. Handy Dandy Line, Dept. 8, Sangamon St., Chicago.

GREAT opportunity for General Agents selling New Specialty to merchants. Retail \$5, \$10, \$15 each. Your profit 200%. No competition. Exclusive territory. Free samples. Sayers Co., 408 Wainwright, St. Louis, Mo.

SALESMEN, Sell Japanese Meerschaum Advertising Pipes. Exclusive or side line. Commission liberal. Curiosity seekers don't answer. Sample and particulars 13c. Dept. "A," Japanese Novelty Co., Clinton, Iowa.

EXCLUSIVE county rights. Sell Tankki; new auto fuel. Profitable. Tankki Chemical Co., Cleveland, Ohio.

ATTENTION—Specialty salesman would you like to sell merchandise that repeats? Would you like to have exclusive territory? Would you like to become a part of a large successful corporation? Would you like to earn from \$300 to \$500 monthly. If so address United Vacuum Sweeper Company, 1313 W. Congress St., Chicago, Ill.

SALESMAN—Exceptional opportunity to acquire an established business for yourself. Virgin territory. Automobile accessory that is in great demand. The proposition you have been looking for. The Liberty Bell Co., Cleveland, Ohio.

SALESMAN to control territory for the Pacific Fresh Air Heater. Over 300 installed in Oakland and Berkeley last season. Fine opportunity. Address, stating territory wanted, Pacific Service Company, Oakland, California.

SALESMEN: New electrical publicity device. Big commission. Protected territory. Technical experience unnecessary. Great side line. H. A. Ray, Winamac, Indiana.

SALESMAN—Experience selling farmers preferred; high class capable of earning \$200 to \$300 per month; state experience. H. O. Evans & Co., 1109 Wabash Ave., Chicago.

HELP-A-PHONE; the profitable side line for Salesmen. Write Ebnard, 415 Belden Ave., Chicago.

WANTED, Salesmen—To represent manufacturer. Must be wide-awake, energetic and able to produce. Excellent opportunity. Exclusive territory to right man. Box 190, Station C, Cleveland, Ohio.

SALESMEN: Acquainted with merchants. Large demand. Lib. comm. Pocket samples. Wirtz Salesbook Co., Chicago.

SALESMEN Wanted—Salesmen and Manufacturers' Agents to represent us everywhere among the Superintendents, Engineers and Purchasing Agents of manufacturing plants. Federal Graphite Mills, Cleveland, Ohio.

WANTED—Representatives everywhere. Exclusive territory. Gold sign letters for stores and office windows. Any one can put on. Write today for free sample. Metallico Letter Co., 403 N. Clark St., Chicago.

SALESMAN. Sell beautiful 28x58 Artkraft felt rugs for \$13.50 per doz. Your profit, \$3 per doz. Kelso, Battle Creek, Mich., sold 30 doz. last week. His profit, \$90. Write for exclusive territory and selling plan. Prepaid sample, \$1.50, refunded on first order. H. Condon, Mfr., Stonington, Maine.

SALESMEN—Get our plan for Monogramming Automobiles and Motorcycles by transfer method. Very large profits. Motorists' Accessories Co., Ashland, O.

#### HELP WANTED

THOUSANDS Men and Women Wanted. Get U. S. Government positions. \$75.00 month. Steady work. Common education sufficient. Write immediately for free list of positions now obtainable. Franklin Institute, Dept. E-21, Rochester, N. Y.

YOUR services are needed as Topographic Draftsman at excellent salary. You can learn from us soon. Get particulars. Columbia School of Drafting, McLachlen Bldg., Washington, D. C.

MEN, Women, common schooling, desiring Government positions, \$70 monthly. Write for list 312 immediately. Philadelphia Civil Service School, Philadelphia.

MEN—Women—18 or over, wanted by U. S. Government. \$78.00 month. Steady work. List of positions now obtainable free. Write immediately. Franklin Institute, Dept. E-21, Rochester, N. Y.

FREE Illustrated Book tells of about 300,000 protected positions in U. S. service. Thousands of vacancies every year. There is a big chance here for you, sure and generous pay, lifetime employment. Just ask for booklet CS-29. No obligation. Earl Hopkins, Washington, D. C.

WRITE Photo plays, Short Stories, Poems. Big demand. No correspondence course. Start writing and selling at once. Details free. Atlas Publishing Co., 3945, Cincinnati.

GET a Government Job! See ad on page 12. Write now—today! Patterson Civil Service School, Rochester, N. Y.

WANTED—Men—Women, 18 or over, \$75.00 month. Government Jobs. List positions free. Write immediately. Franklin Institute, Dept. E-21, Rochester, N. Y.

TREE Experts Coin Money. Free booklet tells how. Wilmette School of Tree Dentistry, Los Angeles, Calif.

CIRCULAR Distributors Wanted. Send Dime for Contract. Magazine, Oliver A. Barkley, Mount Pleasant, Pennsylvania.

BIG Kansas company will start ambitious man or woman in fast growing Mail Order Business; any locality; \$3,000 yearly; spare time; no canvassing; no experience. We furnish everything. Write for Unique Selling Plan. Eystone, Pres., 503 W. 7th, Pittsburg, Kansas.

OWN your own business. Make \$500 monthly. Carry no stock, just sample. S. O. S. Electric Pulser; new, powerful; making agents rich. Write quick for big special proposition. Commonwealth Mfg. Co., 440 Rialto, St. Louis, Mo.

RAILWAY Mail Clerks Wanted. \$75.00 month. Examinations coming everywhere. Specimen questions free. Write immediately. Franklin Institute, Dept. E-21, Rochester, N. Y.

YOUR ideas may bring you wealth, if patented through credit system. Send sketch. Free search. Book free. Waters & Co., 5103 Warder Bldg., Washington, D. C.

FIREMEN and Brakemen: \$100 monthly. Experience unnecessary. Hundreds needed by the best railroads everywhere. Particulars free. 810 Railway Bureau, East St. Louis, Ill.

MEN—Women—Wanted. \$75.00 month. List Government Jobs open—free. Franklin Institute, Dept. E-21, Rochester, N. Y.

EARN \$100 weekly managing clean legitimate mail order business. We furnish everything. Right party need not worry about capital. Splendid chance for intelligent, employed person to control independent business on profit-sharing basis; beginning in spare time, evenings at home. Particulars free. Opportunities Exchange, Buffalo, N. Y.

I PUBLISH a wonderful magazine of money making plans, ideas, suggestions and inspiration! It will show you how to make more money! Sample, 10c. Booster Magazine, Northwestern Bldg., Chicago.

CIRCULAR distributors wanted. Big commissions paid. U. S. Mfg. Co., Dept. 2, Columbus, Ohio.

MEN wanted for detective work. Also instructed by former U. S. Govt. detective. Write J. Ganser, 2309 Calumet, Chicago, Ill.

MARKET your spare moments intelligently, profitably; commercial information wanted; high grade opportunity, without canvassing. "CICO" Pmc, Evansville, Indiana.

LEARN Automobile trade in reliable School. Overhauling, Ignition, Machine Shop Work, Driving, up-to-date cars. Special Exposition rates. Many positions filled. Room and board while learning. Catalog free. National School of Engineering, Los Angeles. Established 1903.

**LEARN** Auto Driving and repairing. Earn while learning. Sample lessons free. Franklin Institute, Dept. E-302, Rochester, N. Y.

**GO on the Stage.** Vaudeville career offered you. Experience unnecessary. Managers endorse my method. Instructive vaudeville book free. Write today. Frederic LaDelle, Sits, 10, Jackson, Mich.

**BE a Detective—Earn** from \$150.00 to \$300.00 per month. Travel over the world. Write C. T. Ludwig, 349 Westover Building, Kansas City, Mo.

**SILVERING** mirrors, Plating tableware, auto-brass. Home booklet plans free. Clarence Sprinkle, Dept. 28, Marion, Ind.

**GOVERNMENT** Examinations. Most thorough preparation, \$5; returned if not appointed; particulars free. American Civil Service School, Washington, D. C.

**STOP Here!** Let me start you in a home business that will bring you money every day. Experience unnecessary. Spare time. No canvassing. I furnish everything. Send for proofs. Voorhies, Desk C. R., Omaha, Neb.

**WANTED—An Idea!** Who can think of some simple thing to patent? Protect your ideas; they may bring you wealth. Write for "Needed Inventions" and "How to Get Your Patent and Your Money." Randolph & Co., Patent Attorneys, Dept. 144, Washington, D. C.

**PLEASANT** spare-time work; mailing circulars. Good pay. No scheme. Details free. Home Pub. Society, 46 N. 12th, Philadelphia.

**FIREMEN,** Brakemen Wanted, all railroads; \$120 monthly. Experience unnecessary. Railway Association, Dept. 298, Brooklyn, N. Y.

**BECOME** Detectives. Large salaries; easy work. Write Chief Wagner, 1243 Lexington Avenue, New York.

**I WILL** start you earning \$4 daily at home, silvering mirrors; free instructive booklet. G. F. Redmond, Dept. 306, Boston, Mass.

**WISH** to hear at once from reliable single man capable of managing large ranch successfully. Mrs. Ward, Box 335, Valley, Neb.

#### FOR SALE

**ROWBOAT** Motor. I accepted a new Jewel Electric Rowboat motor for a debt and having no use for it will sell for \$59. Regular price \$75. The motor was never used and is in original case, just as it left the factory. W. J. Kuecker, 6 N. Michigan Ave., Chicago.

**REAL** bargains in high-grade Cameras, Lenses, Kodaks, Binoculars, Microscopes, Surveyors' Transits, etc. All goods slightly used, but equal to new. Away below regular prices. Write us today. David Stern Co., 1047 W. Madison St., Chicago.

**LOUISIANA** Pecans: best in the World. 3 pounds, parcel post paid for \$1.00, or 25 pounds for \$6.00, express paid. Darrington Pecan Co., New Orleans, La.

**TYPE** and Printing Material at bargain prices. Now is the time to buy. All sizes rebuilt Job Presses very cheap. Catalogue free. Philadelphia Printers' Supply Co., 14 So. Fifth St., Philadelphia.

**SPARK** Plugs. "Champion X." A number of them left over from Summer Resort garage. Will offer them at a bargain. Four for \$2.00. W. Story, 106 Beals Ave., Detroit, Mich.

**MOOSE** and Deer heads. Cheap. Mounted animals and birds. Reuben Saylor, 497 Broadway, Dayton, Ohio.

**SELIG** Moving Picture Camera \$125. Edison Projector \$50. Parlor Pool table \$25. O'Brien, 6350 State, Chicago.

**NEW \$29.00 "Flash" Auto** Automatic lighters for lighting acetylene headlights. \$7.00. Will trade. Write Bellaire Drug Co., Grand Rapids, Michigan.

**BIG** Bargain: Automatic Key and Check Stamping machine. Wynkoop, 201 Montgomery St., Jersey City, N. J.

**FOR** Sale: Air brush, 5x7 camera, Calcium Outfit, Morie booth. H. Tucher, Centerburg, Ohio.

**FIELD** and Marine. Day and Night Glasses, with beautiful case. 25-mile adjustment; \$30 value, only \$7.50. Money back if not satisfied. Well's Curiosity Shop, 20 8, Second St., Philadelphia, Pa.

**60 HP., 4 cyl.** gasoline engine; 36-60 Avery Separator; eight bottom John Deere plow, good condition. Bargain. Paul Edwards, Box 34, Shaunavon, Sask., Can.

#### SALE OR EXCHANGE

**FOR** Sale or Trade—Upright mahogany piano with automatic player and electric battery enclosed so no pedaling necessary. Plays master rolls. List price \$1,400. Entirely new. Will accept second-hand Ford five-passenger part payment. Owner must sell on account of moving. Best make on the market. Address T. W. J., care Popular Mechanics, Chicago.

**YOU** can sell or exchange almost anything through these classified pages. Tell me what you have and I'll send you some interesting information. No obligation whatever. Write me today. F. W. Johnson, Manager of classified advertising, 6 N. Michigan Ave., Chicago.

**COINS,** Notes, Stamps, Indian Relics, Guns, Pistols, Knives and all kinds of curious things exchanged for United Profit Sharing coupons. Booklet for stamp, Coin Exchange, New Rochelle, N. Y.

**WE** have prospects for anything you have to sell or trade. Guaranteed service. Write M. B. P., 391 Mollers Bldg., Chicago.

**LET'S** swap! What's got? What's new? Free advertising. Postal brings particulars. Swap Bulletin, Detroit, Michigan.

#### GUNS, SPORTING GOODS, ETC.

**DON'T** Be Mushy. Postal will bring catalogue of Famous Home Exercisers, direct from the Manufacturers. Peerless Athletic Supply Co., 383 Pearl St., Brooklyn, N. Y.

**FIREARMS—Old-time** and modern. Buy, sell, exchange all sorts. Stephen Van Busselaer, 49 Front St., New York City.

#### MACHINERY, TOOLS AND SUPPLIES

**FOR** Sale—Two  $\frac{1}{2}$ " Turret lathes; 17 high-speed Turning lathes, 3' bed; No. 7 Devine Vacuum Dryer Complete. Write Davidson Rubber Co., Boston.

**"RED** Devil" Mechanic's plier (drop forged steel). Most efficient. 5" size 60c. Style 53. Tool booklet free. Smith & Hemenway Co., 161B Chambers Street, New York City.

**FOR** Sale: New Power Hack Saw, capacity 4"x4", \$15.00. New 19" Sensitive Bench Drill Press, complete with chuck, capacity  $\frac{1}{2}$ ", \$15.00. Passman Bros., 30 S. Green St., Chicago, Ill.

**PULLEYS,** Gears, Sprockets, Shafting, Hangers; see page 158. W. A. Jones Foundry & Machine Co., Chicago.

**FOR** Sale—Starter and Crusher, thirty tons capacity; Smith Concrete Mixer. Address C. G. Reese, Elizabethtown, Pa.

**ENGINE** Lathe, swings 9 $\frac{1}{2}$  in., takes 25 in. between centers. Complete set gears cutting all size threads  $\frac{1}{2}$  in. to 40 in., \$43.50. Grammes & Sons, Allentown, Pa.

#### ENGINES, MOTORS AND DYNAMOS

**ALTERNATING** current rebuilt motors. Reliable makes only. Westinghouse, Emerson, Fort Wayne, Wagner, General Electric, Western,  $\frac{1}{2}$  H. P. \$13.00; 1/6 H. P. \$15.00. Other bargains, including direct current. Satisfaction guaranteed or money refunded. Write for illustrated list supplies and motors. Hyre Electric Co., 613Q, South Dearborn St., Chicago.

**ELECTRIC** lighting dynamo use your spare power. Save your lighting bills. Easy payments. Hobart Brothers, Troy, Ohio.

**ELECTRIC** Motors Alternating or Direct Current from \$4.50 up. Write for Catalogue. Omega Electric Co., 53 W. Jackson Blvd., Chicago.

**FOR** Sale—Several gasoline engines in first class condition. Valian Supply House, Alaska, W. Va.

**NEW** one-horse gasoline engine \$18. Herbert Palme, Route 1, Hayward, Calif.

**GREAT** bargain. Sell or trade. Complete vertical Nash 3-cyl. 75-H.P. producer, or natural-gas power plant for Electric motors. Wolters Bros., Fremont, Mich.

**REBUILT** Engines—We have on hand a number of rebuilt "Buffalo" engines, guaranteed, at greatly reduced prices. Write for bargain list. Buffalo Gasoline Motor Co., 1293-1305 Niagara Street, Buffalo, N. Y.

#### CEMENT

**CONCRETE** Building Block Machines and moulds. Free catalogue. 5 Market St., St. Louis, Mo.

#### ENGINE CASTINGS AND BLUE PRINTS

**GASOLINE** Engine Castings, with drawings. Cheap. Catalog for stamp. Novelty Manufacturing Co., 853 West 6th St., Cincinnati, Ohio.

**SMALL** Gasoline Engines and Castings with drawings. Crown Motor Works, Elgin, Ill.

#### BOATS, LAUNCHES, ETC.

**MOTORCRAFT** Encyclopedia—A 150-page book that tells 1001 things every motor boatman should know. How to overcome engine troubles. Price \$1, postpaid. Popular Mechanics Book Dept., 6 N. Michigan Ave., Chicago.

**BUILD** your own Steel boat from patterns. Material furnished, also finished boats. Catalogue free. Darrow Boat Co., Albion, Mich.

#### FOR THE SHOP

**JUST** Published—Popular Mechanics Shop Notes for 1916—529 Easy Ways to Do Hard Things in every department of mechanics. Over 600 illustrations. 224 pages (size 6 $\frac{1}{2}$ x9 $\frac{1}{2}$  in.). Price 50 cents, postpaid. Popular Mechanics Book Dept., 6 N. Michigan Ave., Chicago.

**FOR** That Boy—He will appreciate a copy of the great boy's book "The Boy Mechanic" that tells about 700 different things for boys to do and has 800 pictures. 489 (7x10) pages, cloth, big, handsome book for the price, \$1.50 postpaid. Popular Mechanics Book Dept., 6 N. Michigan Ave., Chicago.

#### BLACKSMITHS

**BLACKSMITHS,** Listen: Wear the smile that won't come off, by doing hard jobs easy with Toy's Modern Methods on blacksmithing. Making all welds solid, tempering all tools to a standard with colored tempering charts. All for one dollar. Samples free. W. M. Toy, Sidney, Ohio.

#### ELECTRICAL

**"BOY** Electrician" make Batteries, Motors, Engines. 75 illustrations, 10c. Renew Dry Batteries, 3 guaranteed processes, 20c. Both 25c. "Ideal," 3311-A Belleplaine Ave., Chicago.

**ELECTRICAL** Information Furnished. Any Three Questions Twelve Cents. Howard T. Cooper, P. O. Box A238, Chicago.

**ILLUSTRATED** wholesale bargain sheet supplies and motors. Send for your copy now. Hyre Electric Co., 613U South Dearborn St., Chicago.

**STORAGE** Batteries and parts. Eberhardt, 708 3rd Street, Milwaukee, Wis.

**YOUR** ideas may bring you wealth, if patented through credit system. Send sketch. Free search. Book free. Waters & Co., 5103 Warder Bldg., Washington, D. C.

#### STAMP COLLECTING

**24** VARIETIES Cuban stamps, 10 cents. List of 6,005 low-priced stamps free. Chambers Stamp Co., 111 P. Nassau St., New York City.

**STAMPS,** 75, all different, free. Postage 2c. Mention paper. Quaker Stamp Co., Toledo, Ohio.

**25** DIFFERENT British Colonials to applicants for stamps on approval who send 2c postage. Nickles, 123 Florida Ave., Washington, D. C.

**FREE!** 50 different stamps, or a grand set of 10 King George Indian. Send 4c postage and mention Gift F216. Bright & Son, 144 Strand, London, England.

**FREE—Choose** one. 50 Asiatic, 101 United States, 201 foreign, 50 Sweden, 50 Norway-Denmark, with six months' subscription McKel's Stamp Weekly, Boston, Mass. Remit 25c.

**STAMP** Free—Rare old Nicaragua stamp, value 75c; price lists, Bargain Lists, \$2 premium coupon, free for 2c postage. W. C. Phillips & Co., Glastonbury, Conn.

**FREE—South** American packet to approval applicants. Reference. Litten, Rock Island, Ill.

**FREE** to Approval Applicants—12 Different Unused Stamps. Send postage. Box 177, Rome, New York.

**INDIAN** States Postage Stamps—100 Varieties \$1.40. Lists Free. Dhaun and Sons, Patiala, India.

**LOW Priced Stamps on Approval.** \$10 Confederate bill free to applicants furnishing satisfactory references. G. V. Lovering, 2715 13th St., N. W., Washington, D. C.

**FOREIGN Covers,** eighty different, many registered, bearing one to five stamps, \$1.00. Robert C. Munroe, Longmeadow, Mass.

**PRUSSIA—3** different unused Prussia to all applicants for our high-grade approval selections. Send two-cent stamp for return postage. The Edgewood Stamp Co., Dept. H, Milford, Conn.

**STAMPS** on approval at 60 to 80% discount. Leon Cass, Stroudsburg, Pa.

**PACKET "A"** 100 varieties foreign, 20c—worth the money! Desirable stamps on approval, to collectors with satisfactory references. F. J. Pope, Box 45, Charlotte, Vermont.

**STAMPS—105** China, etc., stamp dictionary and list, 2c. Bullard, Sta. A, Boston.

**STAMPS** sent on approval at 70% discount. Precancelled, 1/2c each. Reference required. Emory Remick, Hanover, Pa.

**FREE;** dandy packet to approval Applicants. Murray, Rock Island, Ill.

**CANCELLED** Postage Stamps wanted. Latest Buying Catalog 10 cents. Michigan Stamp Co., Detroit.

**LOW priced approvals.** Mention paper and receive unused Department Stamp Free. S. E. Colman, 634 Keefer Place, Washington, D. C.

**STAMP Album** with 538 Genuine Stamps, incl. Old Mexico, Malay (tiger), China (dragon), Tasmania (landscape), Jamaica (waterfalls) etc., 10c, 100 diff. Jap. N. Zid., etc., 5c. Big List, Coupons etc., Free! We buy Stamps. Hussman Stamp Co., St. Louis, Mo.

**PACKET of 23** stamps; no two countries alike, 500 hinges. Set of \$1 and \$2 U. S. Rev., all for 5c. Mention paper. Miami Stamp Co., Toledo, Ohio.

**STAMPS—12** different from warring nations, 10c; 10 different foreign coins, 15c; 20 Belgium stamps, 10c. Lists free. Toledo Stamp Co., Toledo, Ohio.

**CHOICE** Canada collection, cheap. P. Andrus, Marzora St., London, Ont.

#### FLOUR & FEED MILLING MACHINERY

**SPECIAL** bargains in second hand Attrition mills, burr mills, crushers, corn shellers, bran dusters, dust collectors, purifiers, rods, double, single, 2 and 3-pair high roller mills, sieve bolters, receiving separators, scourers, etc. Write for description and prices. Sprout, Waldron & Co., P. O. Box 429, Muncy, Pa.

#### RARE COINS

**\$4.25 EACH** Paid for U. S. Flying Eagle Cents dated 1856. We pay cash premiums on hundreds of Old Coins. Send ten cents at once for New Illustrated Coin Value Book 47. It may mean your fortune. Clarke & Co., Coin Dealers, Box 15, Le Roy, N. Y.

**DOLLAR 1799,** Very Good, \$2.35. Large cent before 1821, good, 10c. Price List Free. Norman Shultz, King City, Mo.

**ALL for 50c.** A 25c California gold token, a Columbia Nickel coin book, Lucky Seed. C. J. Cargy, New Rochelle, N. Y.

**COIN Book 15c—3** large United States Cents 25c. Moore Coin Company, Commerce, Texas.

**THREE** Mexican War Dollars, 10c. Excelsior Exchange, Albuquerque, New Mexico.

**ALL for 60c.** A 25c, 50c, \$1.00, \$5.00, \$10.00, \$20.00. New uncirculated Mexican Notes. Coin Exchange, New Rochelle, N. Y.

**WILL pay \$750.00** cash for \$5 gold piece dated 1822 (without "In God We Trust"); \$50.00 for 1853 half without arrows; \$3.00 to \$50.00 cash for large cent 1799, etc. We pay cash premium for all large cents, eagle cents, 2c pieces, etc., and all rare U. S. and foreign coins, bills and stamps to 1912. Thousands of rare coins wanted. Many valuable pieces are in circulation. Send 4c. Get our Large Illustrated Coin Circular containing valuable information. It may mean much to you. You certainly have nothing to lose. Send to Numismatic Bank of Texas, Dept. H, Fort Worth, Texas.

**COINS—Antique** Relics, 5 curious rare coins with catalogue 10c. Ray Chapin, New Berlin, N. Y.

#### GAMES AND ENTERTAINMENTS

**MAGICIAN'S** New Magazine, containing the Cream of Magic, New Tricks Explained. For Amateurs and Professionals. Sample Copy, 10c; \$1.00 per year; Three Months' Trial, 25c. The Eagle Magician, 295 South Seventh St., Minneapolis, Minn.

**TRICKS,** puzzles, jokes, magic goods, sensational escapes, illusions and stage supplies. Big Catalog Free. Oaks Magic Co., Dept. 273, Oshkosh, Wis.

**CHARLIE** Chaplin's Comic Camera, 10c; Dozen, 25c. Sullivan, 130 Abbott Ave., Fitchburg, Mass.

**MAGICIANS'** tricks, escapes and Venetianist Figures. All the latest. Prices low. Big catalog free. Magic Parlors, 192 Clifford, Providence, R. I.

**GYPSY** Fortune Telling Cards with instructions, 50c by mail. Knorr & Co., Spring Valley, N. Y.

**WONDERFUL** Magic Trick Cards Free with Magic Catalog. Special Trick Cabinet \$1. Walden Company, Sun Bldg., New York.

**50 SONGS,** 100 Jokes, 75 Toasts and Piano Music full size and catalog of Songs, Jokes and Tricks, 10c Postpaid. Dash & Co., 2341 Herndon Ave., Chicago, Ill.

**"CHARLEY** Chaplin Puzzle." Big laugh every move. Price 15c. Park Novelty Co., 4233 Lake Park Ave., Chicago.

**800 TRICKS,** Puzzles, Games, Jokes, Songs, Fortune-telling Secrets and Illustrated catalog 10c. "Ideal" 3315-A, Belleplaine Ave., Chicago.

**PLAYS,** Vaudeville Sketches, Monologues, Dialogues, Speakers, Minstrel Material, Jokes, Recitations, Tableau, Drills, Musical Pieces, Entertainments for all occasions. Make-up Goods. Large Catalog Free. T. S. Demson & Co., Dept. 11, Chicago.

**USED** Magic Goods and Supplies that please. Bargain Catalogue free. Gilmore, Morgan Park, Chicago.

**BOYS' Latest** out. (Willard-Johnson) fight puzzle, and Joke catalogue, 10c. Wm. Mears, Anderson, Ind.

**CACHOO** Sneeze Powder, Iching Powder, Squirt Rings, Flashy Roll Stage Money, Tango Table, (New) 10c each. Catalogue free. Agents wanted. Empire Co., Olneyville, R. I.

**FUNABOUT** Fords—The book that contains the funny Ford stories that the whole nation has laughed over. The greatest book novelty of the year. A collection of nearly one hundred of the very latest and best current "Ford stories" in book form. 64 pages, 6 1/2 x 4 1/4 in. Heavy boards. Price 25 cents postpaid. Send for your copy now. Popular Mechanics Book Dept., 6 N. Michigan Ave., Chicago.

**BECOME** a Shadowgraphist; anyone can learn it. Book of instructions fully illustrated postpaid, 50c. M. Germanov, Box 429, Bridgeport, Conn.

**MAGIC** Pocket Trick, including professional catalog, 6c. Magic Co., Sta. 19, 249 West 38th St., New York.

**FREE!** "Modern Mystery," new book on Magic—just off the press. Hints, Suggestions, Explanations of Tricks, Magical Secrets, etc. Also Big Bargain Sheet of over 400 Magic Tricks and Books at lowest prices. Send 4c postage. Douglas, Kiowa, Okla.

**MAGIC:** We teach you to perform Tricks at home as good as the great professionals. Feature Acts in Mind Reading, Spiritualistic Work, Rope Ties, Escape Acts. Send for New Thumb Tie for stage work—7 illustrations; complete directions, 50c. Catalogue 100 pages, greatest on earth, 10c. Chicago Magic Co., Dept. B, 72 W. Adams St., Chicago, Ill.

**ORIGINAL** sensational new novelties. Tricks, puzzles and jokers' goods; fun for all. Be a live one among your friends. Send for large illustrated catalogue. J. Grandefeld Mfg., 1238 Theriot Ave., Bronx, New York.

**BE** a handcuff king. We teach you. Escape from handcuffs, boxes, ropes, etc. Secrets of 20 sensational escapes \$1. Particulars free. The Magcraft Co., Dept. A, Box 251, Detroit, Mich.

#### FOR BOYS

**BOYS** have made thousands of things from A. Neely Hall's nickel-plans. Illustrated catalog. Put-Together Shop, 8 Oak Park, Ill.

**BOYS,** make a Gomobile, Gobob. Complete instructions free. Write for them. A postal will do. Detroit Wood Products Co., 954 Field, Detroit, Mich.

**BOYS—We** guarantee you can earn a Scout Compass Watch or Revolver Flash Light free in one hour. Sears & Havlin, Cincinnati, O., Dept. M.

**BIG** New Book for Boys—The Boy Mechanic, Vol. II—Just Out—A sequel to, but containing nothing found in Vol. I. Tells all about 1,000 interesting things to make and do, 480 Pages; 995 illus. Cloth, Price, \$1.50 Postpaid. Send for descriptive circular. Popular Mechanics Book Dept., 6 N. Michigan Ave., Chicago.

**JUST** Out—Amateur Mechanics No. 7. For everyone that enjoys building homemade contrivances of every description this book will afford a wealth of practical ideas and suggestions of things both ornamental and useful. Over 290 articles. Fully illustrated, 128 pages (size 6 1/2 x 9 1/4 in.). Price 25 cents postpaid. Popular Mechanics Book Dept., 6 N. Michigan Ave., Chicago.

#### FOR MEN

**NO** more dull razors. I have solved the problem absolutely. Send 15c and learn how to keep your razor exquisitely smooth and keen. Satisfaction guaranteed. Dwight, 935 Brush St., Detroit, Mich.

**GILLETTE** Safety Razor, Regular \$5.00 outfit, \$3.87 postpaid. Moneyback guarantee. Norica Sales Co., 2 Convent Ave., New York.

**CIGARS—Real** Havana Perfectos, Sumatra wrappers, fragrant and full flavored \$3.00 per box of 50 delivered. Money refunded if not satisfied. Irving Cigar Co., 67 West 23rd St., New York City.

#### SAFETY BLADES SHARPENED

**SAFETY** Razor blades Resharpener by our "New Process," 2c each. Guaranteed better than when new. Each Blade Honed, Hair-Tested, Sterilized, and Wrapped Individually. Jones Keenedge Co., Jamaica Plain, Mass.

**SAFETY** Razor Blades Honed and Stripped to keen, smooth, shaving edge. Positively guaranteed. Six years in business. All blades 2 1/2 cents each. E. G. Hendrickson, 331 West Fortieth, Indianapolis, Ind.

**SAFETY** razors sharpened; two cents each. Guaranteed, Blade box free. Electro Stropping Co., 134 Shelby St., Detroit, Mich.

#### FOR THE HOME

**ARTISTIC** Lamps and Shades in metal and art glass easily made by the amateur craftsman from instructions given in our book of 18 designs ranging from ordinary reading lamps to pretentious chandeliers. Expense only slight. Price of book 50c postpaid. Popular Mechanics Book Dept., 6 N. Michigan Ave., Chicago.

**BEAUTIFUL** arts-crafts lamps—Anyone can make them out of paper, cardboard and wood. 16 designs. Inexpensive yet artistic. Complete book of instructions. Price, 50c postpaid. Popular Mechanics Book Dept., 6 N. Michigan Ave., Chicago.

**FIFTY** Calling Cards 25c. Gold or black ink. Bridgen Company, Waltham, Mass.

#### PIANOS AND MUSICAL INSTRUMENTS

**THE** Masterphone, Revolutionary invention for Talking Machines. Increases sound volume and clarifies to a wonderful degree. Caruso on hearing his own record produced with Masterphone attachment exclaimed "Ah! The voice of my youth!" Price \$2. Free Trial. Masterphone Sales Company, 20 Camp Street, Newark, N. J.

**PARTS** for all Standard Talking Machines. Second Hand machines at Bargain prices. Bellance Repair Co., 229 W. Elm St., Chicago.

#### MAILING LISTS

**FREE** to business men, copy of our comprehensive "Silent Salesman." Contains over 2,000 different classifications of Mailing lists with number and price of each list, and information every business man needs. Accept this free offer. Trade Circular Addressing Co., G. 104 1/2 W. Adams, Chicago.

**1,000** MAIL Order Beginners \$2.50, 100, 30c. B. Collins, Viola, Iowa.

**GUARANTEED** Wisconsin Rural names, \$1.50 per 1,000, 5,000 for \$6.00, 10,000 for \$10.00. Other states and classifications on request. Modern Name Supply Co., Milwaukee, Wis.

## MUSIC

VOCAL Instruction, Systematic Studies in "Tone Production." 25c coin brings three sample lessons. A. Franke, Voice Builder, 61 Auditorium Bldg., Chicago.

"DREAMS," the greatest waits ballad in years. For sale everywhere or direct from us. 10 cents. Marks-Goldsmith Co., Dept. 91, Washington, D. C.

RECORDS for Victrola, Columbia and Edison (disc or cylinder) Talking Machines, Edison Standard, 5c; Blue Amberol, 25c; Victrola, 15c; bought, sold and exchanged. Permanent Jewel Needle, \$1; Jewel point attachment for Victrola or Grafonola to play Edison disc records, \$2. Send for record list. Weill's Curiosity Shop, 20 S. 2nd St., Philadelphia, Pa.

MAKE Money Mailing Music Circulars. Plan free. Write Needham Music Co., 601, St. Louis, Mo.

## FORMULAS AND TRADE SECRETS

HOW to make a duplicator and 300 other manufacturing secrets, only 25 cents. Beckstrom Manufacturing Company, St. Paul, Minn.

OPPORTUNITY: Formulas for Cold Cream and other preparations, 50c each. B. Havecker, Jr., 108 Hilldale Ave., Jamaica, N. Y.

20,000 FORMULAS—Price \$1, postpaid; complete list 4c stamps. Edm. Bromley, Waterliff, N. Y.

FORMULA for corn remedy. Results guaranteed. Send 10c coin, to Box 208, Harboursville, Ky.

BEST Tanning Formula for all fur skins, \$1 postpaid. D. G. Peterson, Box 635, San Francisco, Calif.

10,000 SELECTED scientific, chemical, technological, and practical recipes and processes, including hundreds of so-called trade secrets for every business, alphabetically arranged in one large volume of 800 pages. Price \$3 prepaid. Popular Mechanics Book Dept., 6 N. Michigan Ave., Chicago.

1,500 FORMULAS 20c. 75 Manufacturing secrets, 10c. Resilvering Mirrors, Renewing Dry Batteries, 20c each. Guaranteed. All 50c. Catalogue free. "Ideal," 2311-A, Belleplaine Ave., Chicago.

GOLD, artificial. It is not possible by any tests that chemists know of to distinguish it from pure virgin gold. Formula \$1. P. Ballard, Wallawa, Oregon.

HIGH Grade Guaranteed Formulas for almost any occasion. Prices reasonable. Cole Chemical Co., Chicago.

## TYPEWRITERS AND SUPPLIES

LARGEST Stock of Typewriters in America—All makes; Underwoods, Olivetti, Remingtons, etc., one-fourth to one-half manufacturers' prices, \$15 up, rented anywhere applying rent on price; free trial; installment payments if desired. Write for catalogue 70. Typewriter Emporium (Established 1892), 34-36 West Lake Street, Chicago, Illinois.

LATE model No. 4 Underwood typewriters, like new, with two-color ribbon, back spacer, and automatic ribbon reverse, \$37.75, \$3.00 with order, balance C. O. D. Money-back guarantee if not satisfactory. P. L. Comegys, 115 S. Dearborn St., Chicago, Ill.

SPECIAL Note: If you want a real bargain in a dandy, high-class, substantially guaranteed rebuilt typewriter of any make—on time, rental or cash—be sure to write the big house today. Young Typewriter Co., Dept. 224, Chicago.

SMITH Premier, almost new, \$45. J. A. Stewart, Mattoon, Ill.

GOOD, serviceable typewriters \$7.50 and up. Post card brings list. First class ribbons, any machine, 25c. Hub Typewriter Co., 286 Devonshire St., Boston.

## PRINTING, ENGRAVING AND MULTIGRAPHING

LETTERHEADS—1,000, \$2.00; 2,000, \$3.50; 5,000, \$7.50; good grade bond paper, 16 pound; others charge more for same quality; samples free. Girard Job Shop, Dept. L-2, Girard, Kansas.

LETTERHEADS that look prosperous, carry weight, create confidence. Prices reasonable. Get Free Portfolio—judge for yourself. Cutler Brothers, Reading, Pa.

ENVELOPES. Statements, Billheads, Cards printed \$1.30 per thousand. Other printing low. Samples free. J. M. Hunt, Lambertville, N. J.

5,000 LETTERHEADS \$5.50; 5,000 Hammermill letterheads \$7.50. Samples free. Leag-Johnson Printing Co., Jackson, Tennessee.

GUMMED Labels 1x2 inches, 50c per 1,000; 3,000, \$1.00. Catalogue 2c. Get our prices on all labels. Helmers Co., Hoboken, N. J.

SEND copy for your Letterhead. We will submit sample for approval. Leach, McArthur, Ohio.

555 RIPPING Good Envelopes, \$1.00, 1,000, \$1.50. Welworth Co., Brightwood, Indianapolis.

1,000 GUMMED Labels, size 1x2 inches (printed to order), 50 cents, postpaid, Catalogue free! G. F. Edward Harrison, Baltimore, Md.

100 TWO color Letterheads and 100 Envelopes, bond; Postpaid, \$1. Satisfaction guaranteed. Catalogue, 2c red stamp. Westall Swift Printery, Worcester, Mass.

QUALITY Printing Prepaid—500 ether envelopes, noteheads, cards, statements, \$1.25; 1,000 \$1.85; 1,000 envelope slips, \$1. 1,000 6x3 circulars, \$1.75. 500 linen finish letterheads or envelopes, \$1.75; 1,000, \$3. Printing prepaid. Imitation typewritten letters. Stamp brings samples. Model Company, Manchester, Iowa.

HIGHEST class of engraving (Wedding Announcements, Invitations, Visiting, Business Cards, Office Stationery), also makers of wood cuts. Most reasonable prices. Send for samples. Glickman & Co., 111 Nassau St., New York.

LOWEST prices consistent with good work. Cards; 100, 25c; 500, 85c; 1,000, \$1.25. Charles Meinberg, 1608 Cambridge St., Cambridge, Mass.

LINEN Finish Envelopes, Letterheads, \$2.85 1,000 postpaid. Kigerpress, Montrose, Iowa.

100 BOND Envelopes printed, 50c postpaid. Samples. Francis Bauer, 477 N. Goodman, Rochester, N. Y.

ENVELOPES Statements, Billheads, Noteheads 500, \$1.00; 1,000, \$1.65; 5,000, \$7.50. Stackpole's Printery, Dixon, Ill.

PRINTING Press, paper cutter, type; complete outfit. Bargain. Willis, Canal Dover, Ohio.

100 LETTERHEADS, 100 Envelopes, 100 Cards all printed to order for 95c, prepaid. Sample list free. Homedes, 1520 Fountain St., Philadelphia, Pa.

150 HAMMERMILL Bond Letterheads and 150 envelopes printed to order, \$1 prepaid. Samples free. Andrew Brems, Corona, N. Y.

GOOD Printing at low prices. 1,000 good letterheads, envelopes, cards, billheads, labels, circulars, \$2.50. Samples free. Catalogues, booklets, and circulars our specialty. Ernest L. Fantus Co., 323 S. Dearborn St., Chicago.

25 BUSINESS Cards 10c; 1,000 3x6 circulars, 100 words, 85c postpaid. Chas. Walter, Lancaster, Ohio.

GOOD Printing; Low Prices—Letterheads; envelopes; \$2 thousand, 5,000, \$7.50. Samples sent. Frankfort Sun, Frankfort, Ohio.

REMARKABLE Bargains in Printing. Samples free. Excelsior Printery, Manchester, Maryland.

ILLUSTRATE your printing; cuts made from photographs, 85c. We print anything. Samples free. Commercial Press, Batavia, Ohio.

PROPER Printing. Not cheaper but better. 1,000 envelopes, letterheads, bill-heads circulars, \$2.50 per 1,000. Samples. Robison Printery, Curwensville, Pa.

PRINTING Outfits—Presses, type, supplies, type novelties. Send stamp for catalogue. Model Press, York, Penna.

MULTIGRAPHED Letters, complete—heading black, body purple, 25 lines copy, 1,000, \$3.50; 500, \$2.35; 250, \$1.75. Quick delivery, perfect work. Samples free. Franklin Letter Press, Waukegan, Ill.

MULTIGRAPH Letters, Letterheads—1,000 complete, \$3. Letters purple, heads black. Samples for stamp. Perfection Letter Company, Muncie, Indiana.

GUMMED Labels, 3000 60c, 40pp. Catalogue 2c. MacTaggart, 1235 Arch, Philadelphia, Pennsylvania.

## DUPLICATORS AND DEVICES

THE "Universal" reproduces 50 or more from one letter or anything written with pen or typewriter. 50,000 in use everywhere. Letter size, \$3.25. Sample work and booklet free. N. Reeves Duplicator Company, Park Building, Pittsburgh, Pa.

MULTIGRAPHS (rebuilt). Perfect  $\frac{1}{2}$  cost. Guaranteed. Ship on approval. John Paul, Bourse Bldg., Philadelphia, Pa.

OUR "Modern" Duplicator—Yours for \$2.40. No Glue or Gelatin. Always ready. All sizes. Free trial, 34,000 users. Standard for 15 years. Booklet free. Sole mfrs., J. E. Durkin & Reeves Co., 339 Fifth Ave., Pittsburgh, Pa.

DUPLICATORS, 9x12, price \$1. Make 50 copies from pen or typewritten original. Booklet Free. Scientek Laboratories, Dept. 1, Madison, Maine.

## PATENT ATTORNEYS

DON'T lose your rights to patent protection. Before proceeding further send for our blank form, "Evidence of Conception," to be signed and witnessed. Book, suggestions and advice free. Lancaster and Allwine, 221 Ouray Bldg., Washington, D. C.

PATENTS: Send model, sketch or drawing. Advice, 100 Mechanical Movements and 50 Perpetual Motions, Free. Fred G. Dieterich & Co., 61 Ouray Bldg., Washington, D. C.

PATENTS secured through credit system. Free search. Send sketch. Book and advice free. Waters & Co., 4280 Warder Bldg., Washington, D. C.

INVENTORS will receive prompt attention and advice from Edwin S. Clarkson, Patent Lawyer, 505 Victor Building, Washington, D. C. Established 1890.

PATENTS obtained through D. Swift being promptly sold to manufacturers. Write today for free books of "Inventions Needed" and surpassing references. D. Swift, 317 Seventh St., Washington, D. C.

INVENTORS, do you wish to know whether it will pay you to take out a patent? I am not a patent lawyer, and therefore can and will give you an unbiased opinion. I am an expert in commercial values. If you submit your invention, I will tell you its probable patentability, whether it is worth patenting and probable cash value afterwards. My only charge is \$5 for an opinion on each invention. Send full details, enclosing fee, to John F. Rogers, 501 Fifth Avenue, New York.

PATENTS secured or fee returned. Send sketch for free search. Latest and most complete patent book ever published for free distribution. George P. Kimmel, attorney, 212 Barrister Bldg., Washington, D. C.

WANTED—New Ideas. Write for List of Inventions Wanted, \$1,000,000 in prizes offered for inventions. Our Four Books sent free upon request. Victor J. Evans & Co., 166 Ninth St., Washington, D. C.

"PATENTS and Patent Possibilities" is a 72-page treatise which tells all about patents, what to invent and where to sell it. It gives honest advice to inventors and tells about the successes of some of my clients, also explaining what are frequent causes of failure. Manufacturers are constantly writing for protective patents upon all kinds of sound inventions. Can you help supply their wants? The book is free. Write for it today. H. S. Hill, 905 McLachlen Building, Washington, D. C.

INVENTORS: Do Not Sacrifice Your Inventions. Get full money value. Reliable Book Free. Write H. S. & A. B. Lacey, 629 Barrister Bldg., Washington, D. C.

PATENTS that protect and pay. Advice and books free. Rates reasonable—highest references; best results. Watson E. Coleman, Patent Lawyer, 624 F St., N. W., Washington, D. C.

PATENTS explained in my free books, telling what you should know—what to invent—what not to invent—how to sell your patent, etc. Write today. H. L. Woodward, 902 G St., Washington, D. C.

C. L. PARKER, Ex-member Examining Corps, Patent Office, Patent Attorney, 919 G St., Washington, D. C. Inventor's handbook, "Protecting, Exploiting and Selling Inventions," sent free upon request.

PATENTS That Pay. Proof given. Two wonderful guide books free. E. E. Freeman & Co., 871 F St., Washington, D. C.

PROTECTIVE patents procured promptly, 112 page blue book on patents sent on request. Trade-marks registered. Robb & Robb, 211-215 Southern Bldg., Washington, D. C.

PATENTABLE Ideas Wanted—Send for 3 free books. B. B. Owen, 39 Owen Bldg., Wash., D. C.

THE Patentome is free. An education in obtaining patents. Established 1865. Anderson & Son, Attorneys, 707 7th St., Washington, D. C.

**PATENTS**—Herbert Jenner, patent attorney and mechanical expert, 606 F St., Washington, D. C. I report free of charge if a patent can be had and its exact cost. Send for circular.

**PATENTS**—Trade-Marks. Send for my free book, "How To Get Them." It's full of information you should know. Joshua R. H. Poits, 8 Dearborn St., Chicago; 929 Chestnut St., Philadelphia; 805 G St., Washington.

**PATENTS**—Send sketch for free search and report. Books on patents and book of reference letters sent free. John S. Duffie & Co., 610 F St., Washington, D. C.

**PATENT** What You Invent. It may be valuable. Write me. No attorney's fee until patent is allowed. Estab. 1882. "Inventor's Guide" free. Franklin H. Hough, 522 Loan & Trust Bldg., Washington, D. C.

**PATENTS** secured promptly. Personal attention. Edward W. Kibbey, Patent Attorney, 563 Victor Bldg., Washington, D. C.

**PATENT** your invention. \$10,000 offered for inventions wanted. Booklet and opinion free. Milo B. Stevens & Co., Established 1884, 685 F St., Washington; 353 Monadnock Block, Chicago.

**NO** Attorney fees until patent allowed. Send sketch for free report. Books free. Frank Fuller, Washington, D. C.

**PATENTS** bring riches; protect your invention. Attorney's fee payable when patent allowed. Correspondence solicited; valuable advice free. Jaynes & Jaynes, 655 Kellogg, Washington, D. C.

**UNPATENTED** inventions sold on commission. No advance fee. Patent News, F. Washington, D. C.

#### FOR INVENTORS

**INVENTORS:** Patent your inventions through me and I will negotiate the sale of the patent free. Book on patents with List of Needed Inventions 5c. Sanders, 7 Webster Building, Chicago.

**PATENTS** secured through credit system. Free search. Send sketch. Book and advice free. Waters & Co., 4280 Warder Bldg., Washington, D. C.

**WE** have buyers of patents, all kinds. Want spring motor fan, tools, bottle closers, specialties. A. Levering, 2612 Stokley, Philadelphia.

**WIRE** goods all kinds made to order. Cooley, 553 W. Monroe, Chicago.

**PATENTABLE** Ideas Wanted—Send for 3 free books. R. B. Owen, 30 Owen Bldg., Wash., D. C.

**HAVE** you a Patent to sell? You'll be interested in my proposition. Write now for free particulars. F. W. Johnson, 6 N. Michigan Ave., Chicago.

**WANTED** information regarding good patent for sale. R. G. List, Minneapolis, Minn.

**IMMEDIATELY** write me if you have a Patent to sell. Thomas F. McCloskey, Davenport, Iowa.

**PATENTS, Trade-Marks and Copyrights.** Our handbook on patents will be sent free on request. All patents secured through us are described without cost to the patentee in the Scientific American. Munn & Co., Patent Attorneys, 672 Woolworth Bldg., N. Y. Washington, D. C., office, 625 F St.

**PATENTS** and Patentable Ideas sold. Best location and facilities. Fuller Company, 599 5th Ave. n. c., New York.

**SELL** your patent through the Patent Publicity Company, Browning Building, New York City. Particulars free.

**INVENTIONS**—Patenting and Promoting. A book containing practical advice and directions for inventors and manufacturers. Book, suggestions and advice free. Lancaster and Allwine, 221 Ouray Bldg., Washington, D. C.

**PATENTS** without advance attorney's fees. Send sketch for free report. Books free. Frank Fuller, Washington, D. C.

**INVENTIONS** sold on commission. No advance fee. Patent News, B. Washington, D. C.

**MECHANICAL** Engineers. Specialist in designing and perfecting inventions. 15 years experience. Send details for free estimate of cost. Albert S. Kux, 105 W. Monroe St., Chicago.

**WANTED**—An Ideal! Who can think of some simple thing to patent? Protect your ideas; they may bring you wealth. Write for "Needed Inventions" and "How to Get Your Patent and Your Money." Randolph & Co., Patent Attorneys, 620 F St., Washington, D. C.

**HAVE** You an Idea? If so, you should protect it by a patent. Send us a model or sketch for free opinion as to patentability. Write for our Four Books sent free to any address. Victor J. Evans & Co., 157 Ninth St., Washington, D. C.

**SECRETS** and original ideas safely developed. We advise, plan, develop and execute original ideas in strict confidence. We are specialists in appliances and apparatus for reducing operating costs. We design, build or improve experimental machinery, dies, tools, etc., for manufacturers and inventors. Confide in us and we will respect your rights. Farrand Engineering Company, 44 No. 4th Street, Philadelphia, Pa.

**INVENTIONS** commercialized on cash and royalty basis. Inventors, manufacturers and agents write: Adam Fisher Mfg. Co., 61 Fisher Bldg., St. Louis, Mo.

**LEARN** Systematic Inventing. Silver Dime brings trial lesson with actual working model. Inventions marketed. Simpson, Union Building, Cleveland.

**WANTED** by reliable concern specialties of merit to market on royalty or cash basis. C. C. Smith, Pres., Mansfield, Ohio.

#### INVENTIONS MARKETED

**YOUR** invention may come within the limits of our Laboratories' work. If so our Business Department will consider it. Copy of patent with stamps for return will receive prompt attention. McCormick Laboratories, Dayton, Ohio.

#### PATENTS FOR SALE

**CARPET** Cleaner. Consists of series of beaters and blower or Suction System with bag, collecting all dust. Operated like regular Carpet Cleaner. Royalty or Outright. Olof Englund, 3115 Seminary Ave., Chicago.

**FOR** Sale—Patent No. 1,156,714. Weed Remover and Combination Hoe, Rake and Spud; absolutely alone in its field. Mail-order possibilities. Has been sold to seed and supply houses at sight. Sale in fee or partnership with manufacturer. Address: Newwood, 816 W. North Ave., Baltimore.

**FOR** Sale—Trade or promotion, Canadian Patent. A kitchen necessity. Cheaply manufactured from cast iron, aluminum or pressed steel. Phil Eastman, Livingston Manor, N. Y.

**FOR** Sale or Royalty. Patent Anti-Kicking device for Cows. Lock Box 57, Parkersburg, Iowa.

**WONDERFUL** new "Rein Holder." Patent issued January, 1914. Can be manufactured for about 12c each. Big ready demand for this article. Will sell outright or royalty. E. F. Chambers, Currier's Crossing, Ont., Canada.

**PATENT** for Sale—Cutlery Cleaner; will retail for 10c. Write for circulars. J. Helstrom, 1389 Third Ave., N. Y.

**RAIL** Joint—Rails cannot separate. Removed at will. Simple in construction. Eliminates all danger. Edward E. August, 1439 S. State St., Chicago.

**U. S. AND** Canadian Patents. Sells on sight. Lack of means to push it. W. H. Willis, Box 312, Palacios, Texas.

**FOR** Sale or Royalty—U. S. and Canadian Patent. Automatic Indicating Door for locating sunken vessels. Best offer takes them. Alex J. Herbert, 199 E. Grand Ave., Highland Park, Mich.

**PATENT** on a small article of hardware for Women's use. For particulars address W. H. Fox, 1239 W. Lehigh Ave., Philadelphia, Pa.

**PATENT** Window Display Machine makes everything move. J. W. Schaefer, Beardstown, Ill.

**PAINT** Brush Holder. Simple; Efficient. Details on application. B. P. Arnest, P. O. Box 548, Denver, Colo.

**FOR** Sale; Best offer takes my 1/2 interest in Vacuum Cleaner. Patent No. 1,074,744. P. M. Schraut, 2716 Best Ave., Chicago, Ill.

**PATENT** No. 1080778 for Bale Ties. Chas. E. Pulver, Cosmopolis, Washington.

**PATENT** Buyers are invited to address our sales department for information on any class of Patents they wish to purchase or lease on a royalty. We have secured a number of valuable patents in all lines of invention. Mail Order, Department Store and Household Novelties a specialty. Victor J. Evans & Co., 160 Ninth St., Washington, D. C.

**RATCHET** Wrench, the best out. Vern Seivert, Elkton, South Dakota.

**FOR** Sale—Patent 1,143,531. Write E. E. Vrooman & Co., Washington, D. C.

**BEST** offer takes patent on bedspring tightener. Good thing. Box 402, Rushville, Neb.

#### MODELS AND MODEL SUPPLIES

**HIGH** grade models, experimental work, dies and tools. Inventions developed. J. A. Nelson, 101 N. Jefferson St., Chicago.

**PATTERN** makers! A book devoted to the principles of pattern and core making and molding. Written by G. H. Willard, a practical pattern maker of years' experience. This book, just published, treats the subject in a much more simple, direct and effective manner than most books along this line. 224 pages, 312 illustrations. Price, \$1, postpaid. Popular Mechanics Book Dept., 6 N. Michigan Ave., Chicago.

**NEW** Lithographic Model of a Monster Mallet Compound Locomotive. All parts shown and numbered. Size 9x19 in. in colors. Other models in series are, Atlantic Type Locomotive—Steamship—Automobile—Gas Engine—Steam Engine—Steam Turbine—Dynamo—Wireless Telegraph. Price, 50c each or set of 9 for \$1 postpaid. Popular Mechanics Book Dept., 6 N. Michigan Ave., Chicago.

**MODELS** made for inventors; general machine work; designing and perfecting; developing automatic devices and machinery. In a position to do all kinds of light tool and machine work. Prices reasonable; estimates cheerfully given. Ideal Machine Works, 62 Ann Street, New York City.

**WE** make working models for inventors; also dies and stamping of specialties, and carry a complete stock of brass gears and model supplies. Send for catalogue. The Pierce Model Works, 3495 Pierce Ave., Chicago, Ill.

**INVENTORS:** We manufacture metal articles of all kinds to order. Also, special machinery, tools and dies, punchings, lathe and screw machine work, metal spinings, castings, plating, wood and metal patterns, etc. Send sample for estimate and expert advice, free. The Eagle Mfg. Co., Dept. B., Cincinnati, O.

**SPECIAL** Electrical and Mechanical devices built to order. Models, Tools, Dies. Benj. Levi, 357 West Broadway, N. Y. City.

**FREE** catalogue of model supplies. Castings, metal specialties on contract. North Chicago Tool Works, 15 Grove Ave., North Chicago, Ill.

**PRODUCERS** of Results: Inventions developed. Models, Experimental Work, anything special in metal to order, novelties, spinning, forging, castings in any material, electrical devices, patterns of all kinds, plating, general manufacturing, designing, special tools, punches and dies, stampings. Send drawings or sample. Export information free. John's Machine & Stamping Works, Dept. C, Cleveland, Ohio.

#### MANUFACTURING

**WANTED**—Specialties with merit to manufacture and sell, particularly automobile specialties. Well-equipped manufacturing and merchandizing facilities. Hastings Mfg. Co., Hastings, Mich.

**LET** Our factory be Your factory. Metal specialties developed and correctly manufactured. L. R. Nelson Mfg. Co., Peoria, Ill.

**WANTED**—Patented or unpatented advertising novelties. Novelty Co., 5412 Ferdinand St., Chicago.

**WANTED** to manufacture small articles, or partner with developed idea. Beller, Martinsville, N. Y.

**INVENTIONS** perfected and manufactured. Reference: Your Banker. Russell Machine Co., Dallas, Texas.

**WIRE** Goods, all kinds, made to order. Cooley Mfg. Co., 553 W. Monroe St., Chicago.

# Learn Electricity

## Earn \$100 to \$300 a Month

Electricity, now but in its infancy, is destined to become the greatest factor in human existence during the present generation.

The opportunities for thoroughly trained men in this wonderful field are absolutely unlimited—the demand for such men, enormous. Big jobs, \$100 to \$300 a month, opening up all the time—our Free Employment Bureau unable to supply the demand at times.

## We Train You For a Big Job In Short Time— At Small Expense

You get your training under actual working conditions in our big shops—under the personal guidance of expert instructors who will fit you, in a remarkably short time, to take one of the big jobs opening up every day. Day and Evening classes, open all the year. Enter any time.

Our course of instruction is simple, clear and concise—no correspondence or text books to tangle you—you get real, every day shop work and master all its problems with the tools right in your own hands. All Tools and Materials Furnished FREE.

**Tuition Met By Easy Payments** Don't pass up this opportunity for lack of ready money. Our easy payment plan is for you if you need it and is strictly confidential. Because of the enormous demand, we are making a very special offer to new students. Mail the Coupon below—ask us to tell you all about it.

## Coyne National Trade Schools

### Men Wanted

FOR THESE TRADES

Plumbing, Bricklaying, Drafting  
Courses, Motion Picture Operating

**CHOOSE YOUR OWN FUTURE TODAY.** There are unlimited possibilities in any one of these trades. It's up to you—up to you to drift along at some job yielding mighty small pay—liable to a "let-out" every time times are tight—or you can sign the coupon below as the first step toward a big future—a big job at big pay. We train men by actual shop work in all of the above trades. Our graduates are qualified to demand from \$5 to \$8 a day right from the start or go into business for themselves—to the growth of which there is absolutely no limit.

**FREE TOOLS**  
We furnish all material and tools you use in taking any course **ABSOLUTELY FREE.** All we charge is a very small amount for tuition. Many of our students earn their expenses while taking their course.

**No Experience Needed** Don't allow yourself to be misled by a notion that you need previous experience—because you don't. Don't think you are either too young or too old—our successful students range from 15 to 50. We train you from the ground up—train you by the most fascinating actual shop work possible. All fully explained in our catalog.

**Send the Coupon Today For Our New Big FREE Book**

Send no money—you don't obligate yourself in any way. Just allow us to send our big **FREE** Book fully explaining the work of the Coyne National Trade Schools and the remarkable opportunities constantly opening for their trained men.

Don't be satisfied to work for mere living wages—don't be at the mercy of every adverse wind that blows. Get into a good trade—become an expert by our training, command your own salary—create a big future—mail coupon today.

B. W. COOKE, Director  
COYNE NATIONAL TRADE SCHOOLS  
39-51 E. Illinois St., Dept. 1191, Chicago, Ill.

WE OCCUPY  
ENTIRE BUILDING



**Mail This  
Coupon  
NOW** →

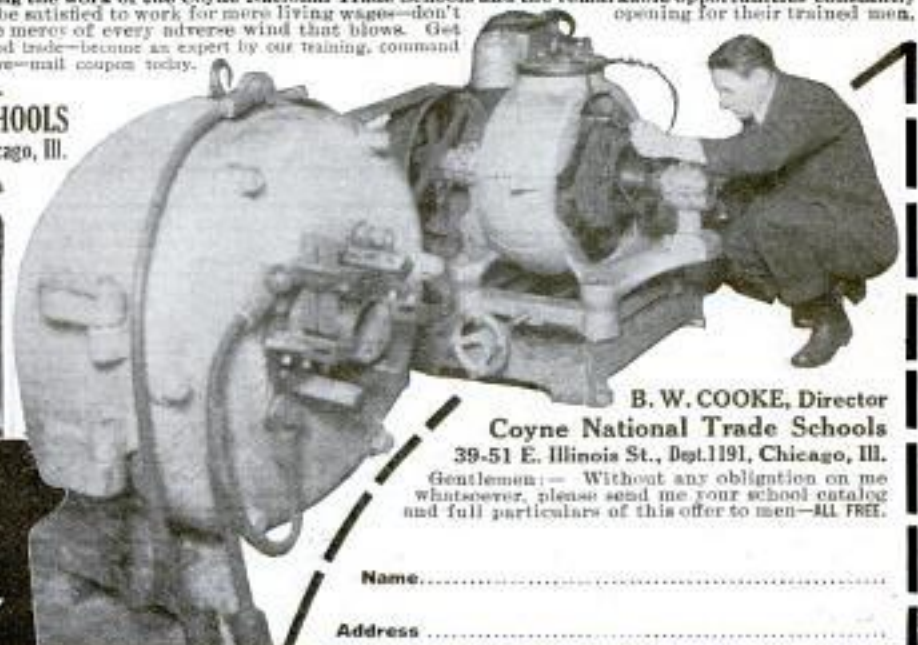

B. W. COOKE, Director  
Coyne National Trade Schools  
39-51 E. Illinois St., Dept. 1191, Chicago, Ill.

Gentlemen:— Without any obligation on me whatsoever, please send me your school catalog and full particulars of this offer to men—**ALL FREE.**

Name .....

Address .....

## Continued from Page 30

**CONTRACT Manufacturers of Hardware, Castings in Iron—Brass—Bronze. Stampings in Sheet Steel, Assembling and Finishing in Japan, Enamel and Electro Plating. We are equipped with Foundry, Pattern Shop, Press Room, Electro Plating and Japannery and wish to secure contract work. Tuttle & Bailey Mfg. Co., 32 Vanderbilt Avenue, New York City.**

**REAL ESTATE AND FARM LANDS**

**TEXAS** school land, for sale by the state, at \$2 per acre; 5 cents per acre cash and no more, for 40 years, but 3%. Send 6 cents postage for further information. Investor Pub. Co., Dept. 47, San Antonio, Tex.

**FIVE Acre** paying, bearing Orange and Grapefruit grove. Small dwelling, good water, exceptionally well located, close to county seat and magnificent lake. Price twenty-five hundred. Fifteen hundred down. R. Fortescue, Dade City, Fla.

**SOUTHERN** lands are low in price but high in productive value, make two to four crops a year and give largest profits in grain, vegetables, fruits, live stock and dairying. Unsurpassed climate, good markets. Southern Progress is on the Southern Railway. Publications on request. M. V. Richards, Commissioner, Room 64, Southern Railway, Washington, D. C.

**FOR Sale—720 acres, Union County, Ill.; 100 acres valley land, cultivated; 40 more cleared; 400 fenced; good buildings; plenty water; excellent stock farm; no taxes; price, \$10,000; payments. John Kasseran, Newton, Ill.**

**VIRGINIA** Farms \$15 per acre and up. Easy payments. Fruit, dairy, stock, mild climate. Raise spring lambs for early market. On railroad. Best markets near by. Write for farm lists, information and N. & W. Ry. Homeseeker, all free. F. H. LaBaume, Agri. Agt. Norfolk & Western Ry., Room 250, N. & W. Bldg., Roanoke, Va.

**ARE you weary of the North?**—Then come to Fruitland Park, Florida, a vicinity ideal for a home and for grapefruit and orange growing with big profits, where you can develop a grove with practically no expense and where the first crop you raise should pay for your land. For book of actual photographs and conservative data write today. Lake Co. Land Owners' Association, No. 33 Mack St., Fruitland Park, Florida.

**FARMS** for sale or exchange anywhere in the U. S. or Canada, direct from the owners. State where you want to locate. Information free. American Investment Association, 37 Palace Bldg., Minneapolis, Minn.

**WANTED**—To hear from owner of good farm or unimproved land for sale. H. L. Downing, 180 Palace Bldg., Minneapolis, Minn.

**ARKANSAS**—40 acres improved, \$650. \$250 down, balance four years. L. E. Smith, Lockesburg, Arkansas.

**CALIFORNIA** improved farms for sale. Write E. R. Walte, Shawnee, Okla.

**CHOICE** improved half section, excellent soil, water, buildings, stock, feed machinery, 7 1/2 acre early plowing. J. H. Keen, Bowdle, S. Dak.

**640 ACRES** Wheat Land. Deal with owner, Geo. Fletcher, Dept. A, Box 33, Sintaluta, Saskatchewan.

**REAL Estate Educator**—Containing inside information not generally known. "Don'ts" in Real Estate. "Pointers." Legal Forms, etc. It gives in condensed form the essential knowledge of the Real Estate Business. New revised edition covers Workmen's Compensation Act, Income Tax Law, Employers' Liability Act, Statute of Frauds. How to Sell Real Estate, etc. What you need to know; ought to know and want to know, 256 pages, cloth, \$1 postpaid. Popular Mechanics Book Dept., 6 N. Michigan Ave., Chicago.

**MONEY-MAKING** Farms throughout 15 Eastern States; 1 acre to 1,000 acres, \$15 per acre up; several with livestock, tools, and crops included, to settle estates; big illustrated catalogue free. E. A. Strout Farm Agency, Dept. 3343, 47 W. 34th St., New York.

**ARKANSAS**—5000 acres level valley land, \$6 to \$12 acre; 1/2 cash, balance 9 annual payments, 6% interest. Tracts of 40 acres up. Write for literature. Central Arkansas Farms Co., Gifford, Ark.

**SAN Joaquin Valley, California**—your place. 20 acres here in fruits, vegetables, alfalfa, with cows, pigs, poultry and bees will pay you steady, substantial profits. Delightful climate, rich soil, good schools, churches and roads. Thrifty, hospitable neighbors. Health, wealth and happiness await you. Why don't you go? Write for free booklet. C. L. Seagraves, Gen. Colonization Agent, AT&SF Ry., 1965 Ry. Exch., Chicago.

**FOR Sale**—4 Fine Fruit Farms, Hudson Valley, New York. Address, G. W. Platt, Real Estate, Red Hook, N. Y.

**YOU can own a Fully Matured, Profitable Grapefruit and Avocado Grove in Florida Without One Dollar of Cash outlay.** Does this sound too wonderful? It is not. It is common sense. This Opportunity is Limited. Write me now. A certain number only can get this. Bryant & Greenwood, Westminster Bldg., Chicago.

**SELL** your property quickly for cash, no matter where located. Don't pay big commissions. Particulars free. Real Estate Salesman Co., Desk B, Lincoln, Neb.

**I HAVE** a successful way of selling farms and farm lands. Write me for free particulars. No obligation whatever. E. J. Zimmer, 825 Tower Bldg., Chicago.

**20 ACRE, Roosevelt-Dam, Irrigated alfalfa farm, Phoenix, Arizona, \$3,500, 100, level, black soil, Wauwata, Chase Co., Neb., \$4,000. Cash or easy terms. (Rev.) Theodore Ludwig, York, Neb.**

**GINSENG**

**GINSENG** Culture, 10c. Golden Seal estimate \$6,000 an acre. Booklet giving my experience, 10c. W. N. Long, Florence, Ky.

**DOGS, BIRDS, POULTRY, ETC.**

**COON, Fox and Rabbit Hounds** sold on trial. Good as lives. Illustrated catalog 10 cents. Homestead Kennels, Plainfield, Ind.

**LLEWELLYN** Setter Pups, from working ancestry. Carried through hunting season, \$10 and \$12; 10 weeks old. S. N. Noyes, Cegswell, N. Dak.

**AT stud, Pekingese, English Toy Spaniels, Pomeranians, Schipperke, Puppies and grown for sale.** Schaefer, 814 So. Kedvale Avenue, Chicago, Illinois.

**RAISE** Guinea Pigs. We furnish stock, show you how and buy all you raise. Big demand. Thousands needed yearly. Easy to raise, very prolific and profitable. Particulars and contract for two-cent stamp. Caries Distributing Co., 707 West 74th St., Kansas City, Mo.

**GUINEA Pigs**—Fine pets. Profitable. \$2.50 pair. Particulars free. F. Trump, Springfield, Ohio.

**NEWFOUNDLAND, St. Bernard, Collie and Fox Terrier puppies.** Your money back if not pleased. Poultry and Dog Catalog free. Edwin A. Souder, Box P, Telford, Pa.

**GOLDFISH**—Rare specimens, artistic aquariums, waterplants. Circular free. Pioneer Goldfish Hatchery, Racine, Wis.

**PERSONAL**

**BROTHER**—Accidentally discovered root cures tobacco habit. Gladly send particulars. F. Stokes, Mohawk, Florida.

**STOP** Tobacco, without harmful drug-ging, quickly, secretly, inexpensively. Free booklet tells how. Hotex Remedy Company, Dept. B, Houston, Texas.

**ANTINIC**, the only Nicotine-Neutralizer for Pipe and Cigarettes. Write for particulars. Box 1137, Los Angeles, Calif.

**FREE**—Stop using Tobacco. Free. We will give free information how to conquer the habit easily and permanently. Results Guaranteed. Anti-Tobacco League, 618 Paxton Block, Omaha, Neb.

**MISCELLANEOUS**

**PRESENTS:** Tie Form (Turndown Collars) saves time, temper, 20c. Guard makes common razor, safety, 25c; California flower necklace with catalogue, 50c; Embosser your initial for stationary, 50c; sample initial, 2c stamp. Barclay Selling Co., 304 Barclay Block, Denver, Colo.

**BUFFALO Greenbacks.** Finest imitation possible. 5000—\$5.00; 1000—\$1.50; 100—35c. Roll—10c. Samples for stamp. Gil-novo, Morgan Park, Chicago.

**WANTED—Men—Women, 18 or over, \$75.00 month.** Government Jobs. List positions free. Write immediately. Franklin Institute, Dept E-22, Rochester, N. Y.

**\$2.50 POCKET Adder.** Send for circular. Bassett, 5921-M, Indiana Ave., Chicago.

**HOW do you do without Handy Andy?** Dime secures one. Essano Specialty Co., Cincinnati, Ohio.

**3,000 SELECTED Cartoons for \$3.** A Panorama of World Events, Political, Industrial—Social—Humorous—Tragic—all of intense human interest. A wonderful collection of 3,000 cartoons reproduced from the newspapers of the United States, Canada, Mexico, Cuba and the cities of the Old World, has been made by Cartoons Magazine from more than one hundred and fifty thousand published cartoons, and bound in an artistic and durable cover, are now ready for your library table. Vol. I, Jan.-June, 1912—\$1. Vol. II, July-Dec., 1912—\$1. Vol. III, Jan.-May, 1913—\$1. Cartoons, 78 E. Madison St., Chicago.

**WAR Atlas—Large 20-page (11x15 in.) Atlas of the War in Europe, containing large colored scale maps of the battle-ground, showing Europe, Austria, Serbia, Germany, England, Belgium, France, Russia, Italy, Greece, The World, etc. Special data showing comparison of armies and navies involved, pictures of rulers, etc. Price, 25 cents. Postage and packing, 5 cents additional. Address Popular Mechanics Book Dept., 6 N. Michigan Ave., Chicago.**

**INVENT** something; your ideas may bring wealth; our free book tells what to invent and how to obtain a patent, through our new credit system; write today. Waters & Co., 4102 Warder Building, Washington, D. C.

**ERADIUM (Luminous) Pull Chain Bulb** for Electric or Gas Light pull chain or key. Shines at night. Locates your chain in a "jiffy." Sample 35c. Auburn Supply Co., Dept. 1PC, 7817 Peor's St., Chicago.

**TATTOOING** Machines, Colors and Supplies for all interested in the Art. Get My Catalogue Now and be ready for the coming season. Prof. J. Barber, 70 1/2 Brush St., Detroit, Mich.

**WRITE** for Free Information regarding any Formula or Product and my latest lists of Guaranteed Reliable Formulas and Trade-Secrets for new Specialties in all Lines. Harry Liscombe Miller, Ph. D., Tampa, Florida.

**NICKEL** silver key checks with name and address, 25c. Grip tags with straps 50c. Address M. Jos. Mulhaupt, Lafayette, Ind.

**PEARLS** and Baroque bought and sold. Loose or mounted. Bargains for sale. Laverne Mapes, Indiana Harbor, Ind.

**CLEANING, Dyeing, Pressing.** Complete course, \$2.00. Al. Thomasson, Warren, Ill.

**ETCHING** names on tools, instructions 10c. Denison, 815 Beech, Terre Haute, Ind.

**HOTEL** Stickers for your suitcase, 6 assorted 10c. Eibert Hall, Fitchburg, Mass.

**CUTS** anybody can make. Simple, cheap process. Numerous specimens, convincing particulars, for stamp. M. Day, Windfall, Ind.

**MOTOR SLEIGHS,** ice-beds, 2-4 and more passengers, from \$303 up. Safe and speedy. Send for particulars. U. S. Aero, 38 Park Row, N. Y. C.

**GENUINE** Sioux Indian Beadwork and Curios, also Elk Teeth, Moccasins, Fobs, Belts, Handbags, Pouches, Wapclubs, Indian Costumes. Send 10c for price list. Strong Curio Co., Gordon, Neb.

**GREYGO** Hair Tonic positively restores Gray Hair to its natural color, prevents dandruff and falling hair. Gives needed nourishment to the hair-cells, insuring a healthy growth. Absolutely Not a Dye and guaranteed harmless. Testimonials. 50c and \$1.00 bottle postpaid in plain wrapper. Liberal sample bottle 25c. Vanco Laboratories, 323 N. 5th St., Camden, N. J.

**INDIAN** Baskets, Belles, Price free. G. Gilham, Highland Springs, Cal.

**GRANDFATHER'S** Clock Works, \$5. Slightly shop-worn, quantity limited, others with chimes, all prices; also several nice Grandfather's Clock cases, exceptional bargains. Clock Company, 1673 Buffner St., Philadelphia, Pa.





**FREE!** Best Offer Ever Made!

A superior course in **SHOW CARD** and **SIGN WRITING**, in leading correspondence school (not a book) and high grade **Air Brush**, given **free!** to purchasers of assorted "NOBEMA" ready-to-use **COLORES**. An **HONEST OFFER**, to **INTRODUCE** our **COLORES**. **Show Card Writing** is a fascinating, profitable trade, easy to learn. Get better pay, or have own business. **WITH** FOR ILLUSTRATED BOOK, **CIRCULARS** AND **INFORMATION**.  
**NOBEMA P.M. CO., 8 S. DEARBORN ST., CHICAGO, ILL.**

**LEARN OPTOMETRY**

**FITTING CLASSES** is a profitable Profession—for both sexes. Optometry laws now operative in 28 states afford graduates holding our degree opportunity of a dignified, comfortable and restricted calling. Needed every where. **Income unlimited**. Most optometrists **EARN FROM \$1500 TO \$3000 YEARLY**. **OUR EXTENSION**, Home Study, Department gives short and easy complete course. Study at home in spare time. No preliminary education necessary. Degrees granted to successful graduates. Write for our **FREE Catalog-Digest of Courses and Profession**.  
**CHICAGO SCHOOL OF REFRACTION**  
**LINCOLN BLDG., Suite 1008, CHICAGO, ILLINOIS**

**COPY THIS SKETCH**

and let me see what you can do with it. Illustrators and cartoonists earn from \$20 to \$125 a week or more. My practical system of personal individual lessons by mail will develop your talent. Fifteen years' successful work for newspapers and magazines qualifies me to teach you. Send me your sketch of President Wilson with 6c in stamps and I will send you a test lesson plate, also collection of drawings showing possibilities for you.



**The Landon School of Illustrating and Cartooning**  
**1438 Schofield Building, CLEVELAND, O.**

**FREE EXAMINATION**—Power plant engineering complete, including steam, electricity, turbines, refrigeration, is self-taught in the **Power Plant Library**, the most used engineers' library in existence. Write for free examination. **McGraw-Hill Book Co., Inc., 239 W. 29th St., N. Y.**

**FORD JOKE BOOK**

All the latest and best funny jokes and stories on the **FORD** automobile. Hundreds of them and all good ones. Also **JITNEY** jokes, **Moving Picture**, and **Stage Jokes**. Laugh till you shake. A **neat colored covered book** by mail for only **TEN CENTS**.

**PIKE PUBLISHING COMPANY**  
**Box 77, So. Norwalk, Conn.**



**THE BART CHALK-TALK**

Entertains an Audience. Educates you in entertaining. If you draw a little you can do the chalk-talk and make it pay. Bart furnishes you with the blues, the " patter," the drawings to make, and his own special crayon and equipment—everything he uses in a successful chalk-talk. Write **BART**, Daily News Cartoonist, Minneapolis. He will tell you about the chalk-talk. See Bart's ad on page 9, January Cartoons.



**AGENTS \$60 WEEKLY**

**Robinson Folding Bath Tub**. Big seller. Costs little, no plumbing, little water. Weight 25 pounds, folds into small roll. Full length baths, far better than tin tubs. Guaranteed 10 years. \$10 a day easily made. Write for free tub offer.  
**ROBINSON CABINET MFG. CO. 1295 Factory Bldg., Toledo, Ohio**



**150 Parodies ON Latest Songs 10c**

Norway, Araby, Old Green River, Come Back Dixie, Bon-Hon Bay, Down Home In Tenn., Down Amongst the Sheltering Palms, Tulip Time In Holland, Dublin Bay, It's a Long Way to Tipperary, I Didn't Realize My Boy So a Soldier, Tokio, Little Spark of Love, When You Were a Tulip, Michigan, Night In Dresden, Monday International Rag, In My Heart a 131 cubes, including Comic Dialogs, complete 10c; 3 for 20c.  
**J.C. DORN, 731 S. Dearborn St., Dept. 163, Chicago, Ill.**



**Chart of a Modern Submarine**

Showing and naming over 200 parts. Size 14x28 inches. Printed on Plate Paper. Price 25c Postpaid.  
**POPULAR MECHANICS BOOK DEPT.**  
**6 No. Michigan Blvd. CHICAGO**

## Why Didn't We Give Smith That \$1000. Raise?



## A Traffic Man Must Be Found

*"We have lost several times \$1000 on our freight charges since Smith left us. We MUST find a man to take his place."*

Why not fill one of the 95,000 positions as **Traffic Manager** yourself? It's easily possible. We're talking facts now—not theories. There's no vivid imagination behind these words.

### 95,000 Trained Traffic Men Are Needed Now

Here's the proof. There are 500,000 shippers in the United States. 100,000 of them are big enough to employ individual **Traffic Managers**. There are now 300 to 500 **Traffic Managers** in the country. That leaves 95,000 shippers without a **Traffic Manager**; a man they need; a trained man who can save them money.

### Special Talent Unnecessary

Thousands of men in America are in the wrong job, right perhaps, as far as the work is concerned, but wrong where the pay comes in. Few men can be contented in a job that doesn't pay well or offer a good chance for steady and sure advancement.

This is the day when far sighted, ambitious men climb out of the ruts and seek opportunities where the going is good.

To become a successful and highly paid **Traffic Manager**, only a common school education is necessary. You don't need "special talent".

### Unlimited Demand

Thousands of shippers realize their need of a trained traffic manager. But the supply of trained men doesn't begin to meet the demand.

Ask any shipper if the trained **Traffic Manager** isn't highly important and well paid. Ask him if it wouldn't be a good profession for you to get into.

Prepare now to fill one of these splendid positions. Send for our free catalog. It tells who we are, what we teach and how we do it. We'll train you to earn \$1800 to \$4000 a year as a **Traffic Manager**.

#### SALARIES:

**\$1800 TO \$4000 AND UP**  
 When you have mastered tariffs and freight rates, you can land in a job paying at least \$1800. If you get with a big firm, you can earn as high as \$30,000.

### FREE—New Book

There's no hard study. Our free book on **Traffic** tells all about it, explains clearly, concisely. Don't waste this opportunity. Enter this new profession. Use the coupon **NOW**—You'll never regret it.

**INTERSTATE TRAFFIC SCHOOL**  
 Dept. 161  
 FT. WAYNE, INDIANA

**Interstate Traffic School**  
 Dept. 161 Ft. Wayne, Ind.  
 Gentlemen: Send me absolutely free and prepaid your new book on the **Traffic Profession**.

Name.....

Address.....

Please Mention Popular Mechanics

# World's Record-Breaking Racing Cars Now at Sweeney Automobile School

**Learn to Drive and Repair**  
**See the World's Best Motors Rebuilt**

Seven of the largest and speediest racing cars ever built have just been brought to the Sweeney School for their winter overhauling. See the Jay-Eye-See, the world's largest racing dreadnaught with a 290 horse power motor, the world's record Briscoe beauty and four other famous racers. This is your opportunity to get right close to the racing game, as these cars have been entrusted to the Sweeney School to be overhauled and repaired. This is the first time such confidence has ever been displayed in the repair department of an automobile school and shows how Sweeney stands in the auto world.

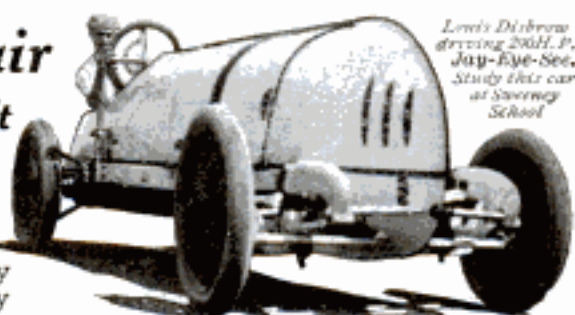

*Levi's Disbrow driving 200H. P. Jay-Eye-See. Study this car at Sweeney School*

**Our Own Racers** Besides this the Sweeney School will build two 120 horse power, 16 valve motored, racing cars of its own, to be driven by SWEENEY STUDENTS in great race meets of 1916. Here's a chance for a few ambitious, daring students to make name and fortune for themselves in a few months.

**The Sweeney System of Practical Auto Instruction** **Make \$5 Per Day and Up**

does not aim however merely to develop a few race drivers but to train young men to a good paying trade. My big illustrated book fully explains the opportunity open to YOU as chauffeur, mechanic, garage owner, salesman, etc. We have thousands of letters from men now making good who attribute their success to the practical Sweeney System of doing the work with your own hands which is now universally recognized as the most thorough, practical and interesting course of automobile instruction, leading to certain and profitable EMPLOYMENT. It embraces every point worth knowing, including vulcanizing, brazing, oxy-acetylene welding, lathe work, machine shop practice, testing, driving, truck repairing and operating, etc. AND YOU LEARN by doing the work on REAL CARS under the watchful eyes of skilled instructors.

21,000 tractors were sold this year. Over half a million automobiles. Who's going to drive and repair them? Men are in big demand. Our school is doing *double* the business it did last year. Nothing succeeds like success. Don't you want to make \$5 a day and up? There's money in the automobile business for you.

**From All Parts of U. S.**

Why is it that men come here from all parts of the country? Even from Canada—even from across the ocean. Because they find here a training they can get nowhere else in the world. The only place where the automobile business is taught by the Sweeney System of Practical Experience.

**Experience Is the Best Teacher**

This is the only way to learn. Do things with your own hands. Practice beats theory. We do not merely tell you how; we show you how, and you then do the work yourself. We have over 40 cars of all makes on our floor, eight trucks, five tractors, and our DRIVING TEACHERS keep out on the road nearly twelve hours a day. YOU GET PLENTY of WORK of all sorts.

**No Books Used; Tools Furnished Free**

The tuition is low and after you have paid that there are NO MORE expenses or extras you have to buy. If you could learn from a book there are lots published you could read at home, but **practical work** is the only method, and this is what makes my School so successful.

**This Big Book Costs Me 50 Cents BUT I SEND IT FREE**

If you are interested in planning your future and mean to investigate the opportunities before you, I will gladly send you my automobile book. This book is almost like a visit as it has 123 illustrations showing men at work in every department. It pictures the wonderful equipment of the Sweeney School. It shows how you are taught, shows the class of men you will associate with, portrays various phases of the automobile industry, explains how, when and where you begin to earn money, in a word is a complete encyclopedia of the subject. Simply send name and address today.

**E. J. SWEENEY**

**SWEENEY AUTOMOBILE SCHOOL**  
1168 E. 15th Street KANSAS CITY, MO.

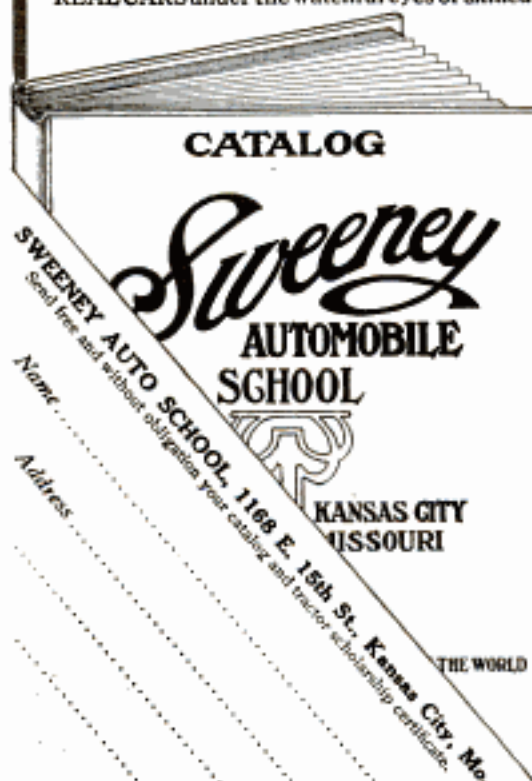

## Earn \$50 to \$100 Weekly You Can Easily Become a Traffic Manager



### BIG DEMAND FOR GOOD TRAFFIC MEN

Train your brains—learn transportation—become efficient. You can do this easily. In a short time you can be holding a responsible, high salaried position as a Traffic Manager. You can be a man among men—giving orders instead of taking them. Get ready to do this—prepare NOW. A man's idle hours are worth \$30 each—don't waste yours.

### Easy, Pleasant Study During Your Spare Hours

You can easily acquire valuable traffic knowledge during your idle hours at night. The American Commerce Association is an organization of Traffic Men by Traffic Men for Traffic Men. It numbers among its members and endorses many of America's noted traffic authorities. Its methods are thorough and practical. You can get in condensed form the training and knowledge which these traffic experts acquired only after many years of hard work and tedious study.

Ask us for a FREE copy of one of these valuable books. "Opportunities Along the Trails of Traffic," by H. G. Wilson. Straightforward and informative. "Traffic Efficiency," 92 pages. Tells the need of high salaried, efficient Traffic Men. "Millions Wasted in Traffic." Gives actual cases. Increase interest. Tells of Traffic Savings Opportunities.

**AMERICAN  
COMMERCE  
ASSOCIATION**  
Dept. 22,  
The Rookery  
CHICAGO, ILL.

## Traffic Inspectors WANTED

(BY THE R. R.'s)

**\$4 Per Day**

Here's a new profession—for 15,000 men ambitious to better themselves by special training. Positions now open pay \$4 Per Day to start; chances for advancement and travel unlimited. We train you thoroughly, quickly; give all necessary experience. Find out how men like you—clerks, salesmen, railroad men—are earning real money and advancement. Here's your big chance! Write for Free Booklet A2 now, lest you forget. Frontier Prep. School, Buffalo, N. Y.

Freehand  
Lettering

For Draftsmen taught by mail. If you want to get ahead of the boys alongside of you, and wish your salary increased rapidly, become an Expert in Freehand Lettering—in which you are deficient—systematically proceed; course by Recognized Authority. Personal criticism. Inquire or send \$1.00 for trial lesson.

C. W. REINHARDT, ARLINGTON, NEW JERSEY

## CIVIL SERVICE

positions are in all parts of the country. Good pay, steady work, life positions, congenial surroundings, promotions on merit, short hours, annual vacation and sick leave with pay. Many thousands appointed yearly. Both sexes. No political pull. Nearly 300,000 classified positions. Common school education sufficient. Full information and questions used by the Civil Service Commission free.

COLUMBIAN CORRESP. COLLEGE, Washington, D. C.

## REPAIR YOUR CAR THIS AUTO BOOK FREE

THE ONLY BOOK EVER COMPILED showing how to make emergency repairs. Contains hundreds of practical hints that will teach you more about automobiles, and save you time, money and repair bills. Send 25c (coin or stamps) for a 3 months' trial subscription to the new illustrated, valuable, helpful automobile magazine, and we will send you this instructive book FREE. Send today to **The American Chauffeur, 15 to 29 W. Sixth St., Cincinnati, O.**

## FEAR STAMMERS!

Consult Foote, the trained expert Psychologist. If you have tried many other methods and failed know that you cannot fail if you place yourself in my hands—either for personal treatment or by correspondence. I have studied psychology in the greatest Universities in the World. It is now recognized that the trained Psychologist is the only one who can successfully treat stammering. Mine is the only scientific method of treatment which will permanently eradicate your "FEAR." Write for booklet, "The Cure of Stammering."

Prof. F. B. Foote, Michigan Boulevard Building, Chicago, Illinois

**Learn Watchwork, Jewelrywork and Engraving.** A fine trade commanding a good salary, and your services are always in demand. Address HOROLOGICAL, Dept. P. Bradley Institute, Peoria, Ill. for our latest catalog.

## DON'T TAKE A COURSE IN MACHINE DRAFTING

Ill you've read my proposition. Practical, experienced Draftsman, regularly employed in large modern works, will teach a few men by mail. Best way to become a well-paid Draftsman. Special courses in Mathematics also. Instruments furnished. Rates very reasonable. Pay a part after in position. Draftsman, 252 S. Corona St., Denver, Colo.

## The Library of Original Sources

at a great bargain 10 beautiful, big volumes. Easy monthly payments. See our ads on page 7 October issue and page 31 November issue Popular Mechanics. UNIVERSITY RESEARCH, Dept. G, Milwaukee, Wisconsin

## LEARN WATCHMAKING AND ENGRAVING

Earn while learning. Most practical watch school. Individual instructions. Graduates in great demand. Book free. Chicago School of Watchmaking, 63 E. Van Buren St., Chicago

## J-M ASBESTOS ROOFINGS

Sometimes called "The Everlasting Roof." Investigate J-M Roof Registration always mindful of J-M Roofing Responsibility.

H. W. JOHNS-MANVILLE COMPANY  
2195  
New York and Every Large City

**LEARN TO DRAW** Illustrators, Cartoonists, Designers earn big money. Many of our pupils get paying positions before finishing course. Correspondence or local course; personal instruction. Send sample of work for free criticism, and 6c for illustrated book. Washington School of Art, 941 F St., Washington, D. C.

BEGIN NOW!

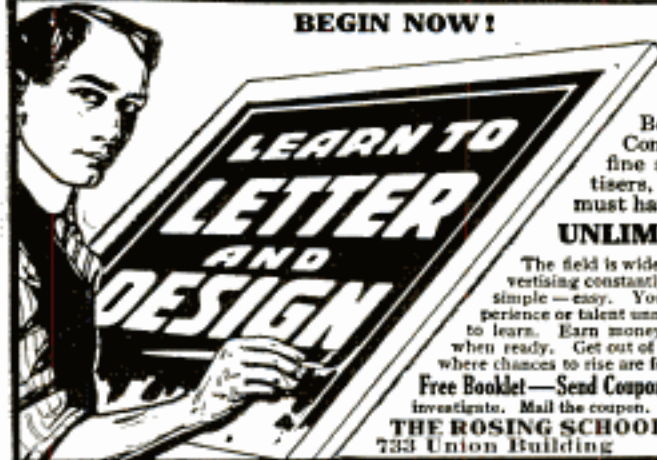

## Paint Signs and Show Cards Earn \$25 to \$75 Weekly

Become an expert in the fast growing field of commercial art. Command a real job—be a leader—get to be an art director at a fine salary. Publishers, printers, engravers, lithographers, advertisers, merchants, manufacturers, calendar makers, box makers, etc., must have letterers and designers, show card and sign writers.

### UNLIMITED DEMAND FOR TRAINED ARTISTS

The field is wide—and getting greater. Enormous increase in advertising constantly creates new positions. Fascinating work. Course simple—easy. You get my personal experience and guidance. Experience or talent unnecessary. Just practice. Only short time required to learn. Earn money after ninth lesson. I help you get a position when ready. Get out of the rat—aspire to bigger things—quit working where chances to rise are few. Get into big, new, growing and big salaried new field. It tells the whole story—proves the field and the money in it. At least investigate. Mail the coupon. Find out what you can do.

Free Booklet—Send Coupon Today  
THE ROSING SCHOOL OF LETTERING & DESIGN  
733 Union Building CLEVELAND, OHIO

Mr. Rosing:

Please send me free booklet and your proof.

Name .....

Address .....

# Get The Big Job-



## Earn \$1200 to \$3000 a Year As Electrical Meter Engineer

Get the big job. Earn the big salary. Get into the new profession. Where high salaried positions are seeking the men. Train yourself to fill one of these big jobs. There is one or more in every Electric Light Plant. The demand is growing daily for Meter Engineers. We have trained hundreds of others and placed them in big jobs. We can do the same for you.

### Learn at Home

Just a few short months at home during spare time. You learn while you earn. Course is interesting, concise, thorough. You learn all about meters and instruments. No problem will stump you. Step into an Electric Light Plant as Meter Engineer. Our course prepares you for every emergency.

#### From \$65 to \$125



When I began your course I was making \$65. I soon was able to take charge of standardizing Dept. with salary at \$90. Special work brought it to \$125 a month.

E. D. HENLEY

#### Three Raises in Salary



Am getting along fine here and your course has certainly been a great help. My salary now is three times what it was when I started your Course.

M. EVNRUD

### No Experience Needed

Course so clear anyone can understand it. You only need a common school education. No previous experience in electricity or meter work is necessary. No matter what you are doing now you can become competent in this new profession. The course is based on the practical knowledge of Big Men in the Electrical Meter Engineering field. Men who were first to realize the demand for Meter Engineers.

#### Offer of Big Job



I have just received an offer of a good position as Meter Engineer due to your recommendations. When

my employer heard of it he immediately increased my salary.

A. NELSON

#### Promoted—Raised 10%



Since I began working in the Meter Department of Duquesne Light Company I have been promoted twice

—the last promotion being to assistant foreman at 10% increase. H. M. SMELTZER

The Ft. Wayne  
Correspondence School  
Dept. 181, Ft. Wayne, Ind.

Gentlemen:— Send me, absolutely free and prepaid, your new literature on the Meter Engineering.

Name.....

Address.....

## Full Information FREE

Get the School Literature, terms, testimony from students and graduates. Outline of course, Duties of Meter Engineer—All Free—no obligations. Use the coupon.

### Write Today—"NOW"

Don't wait—get started toward the Big Job, —get the increased salary—but start today—"NOW."

The Ft. Wayne Correspondence School  
Dept. 181 Ft. Wayne, Ind.

### Our Money Back Guarantee

We guarantee to furnish you with our complete course of instruction in Electrical Meter Engineering and train you without charge, other than tuition as specified in our Enrollment Blank, until you are qualified to accept a position paying from \$75 to \$300 a month. Furthermore, we guarantee to assist you in securing a high grade position after you receive your Diploma. After receiving all supplies and instructions to which you are entitled, and after fulfilling all of your agreements, you are not perfectly satisfied, we see to refund the full amount of your tuition.

Come to Detroit  
the automobile center  
and

**LEARN THE AUTOMOBILE BUSINESS**

Detroit trained men get preference over all others, get jobs quick as soon as ready. *The reason*—study the heart in the center. Realize its tremendous power.

No other city, no other school can give you what Detroit offers. Factories shown are not all. Think what it means to learn at Detroit. Every factory knows us, endorses our school, glad to get our graduates. You're right in the middle of great auto activity. Men are needed everywhere as testers, repairmen, chauffeurs. Splendid chance to start in business. Hundreds of our graduates are doing it.

**Earn \$75 to \$300 a Month**

We teach you to handle any auto proposition. Our equipment is complete. Students actually build cars from start to finish, getting regular factory training in assembling, block-testing, road-testing, etc. That's the Detroit Way. All leading types of starting, lighting and ignition systems in operation. Learn to time motors, adjust carburetors, magnetos, valves, bearings, etc. Six-cylinder Lozier and 8-cylinder King are used for road instruction. We have a new Chalmers "6" chassis with overhead camshaft motor, the latest thing out.

**Detroit is the Place to Learn—Start Any Time**

There are 44 auto factories in Detroit. Our students have the privilege of going through any or all of them, including Detroit electric service department, while taking our course. You can't get these advantages and opportunities anywhere else. Detroit is the automobile center. You make faster time here and you get practical instruction. Come to Detroit and learn the business right. Enter classes any time.

### Great Demand for Detroit Trained Men

Garages throughout the country write us for men. Why not fit yourself for one of these good paying positions?

### Demand Greater Than Supply for Competent Men. Following Clipped from Daily Papers—All Parts of U.S.

Experienced motor mechanics, bearing scrapers, assemblers, repairmen; good wages. Henderson Motorcycle Co., 1158 Cass.

Chauffeur—Must be good driver, steady and reliable; one with knowledge of Pierce-Arrow cars preferred; no other but good mechanic need apply. Address Box B, No. 100 Free Press.

10 road testers, 20 garage repair men, final assemblers. Maxwell Motor Co., Inc., Oakland Ave. Plant.

40 Drivers—Come ready to work. Maxwell Motor Co., Inc., Oakland Avenue Plant.

Block Testers—Apply Continental Motor Mfg. Co.

Wanted—High-grade retail automobile sales manager. Box E, No. 52.

Automobile Repair Men wanted; must be experienced; none other need apply. Come ready for work. Auto-Kraft & Garage Co., rear 78-86 Forest Avenue, East.



### GUARANTEE

We guarantee to qualify you for a position as chauffeur, repairman, tester, salesman, demonstrator or garage man paying from \$75.00 to \$300.00 in a short time or refund your money. We have constantly more requests for men, at GOOD salaries than we can supply.

Write for full particulars. Ask for "Auto School News" and new Pictorial catalog—just out. Both free. Or, better still, jump on train and come to Detroit.

Dept. 301, 11-19 Selden Ave.  
Detroit, Mich., U. S. A.

### Michigan State Auto School Students are Competent to Fill Every Position and Make Good

Has Studebaker and Maxwell Agency  
La Farge, Wis., February 6, 1915.

Prof. C. G. Arthur,  
Michigan State Auto School, Detroit, Mich.  
Dear Sir:—I am getting along just fine. A friend of mine, Mr. Sloulin, and myself, have opened a garage in our home town, and we have been having all we could do. We have been doing overhauling this winter and have got enough work ahead waiting to keep us going until spring opens up. Thanks to what you have pounded into that old nut of mine, I have never been stuck yet. We have the agency for the Studebaker and Maxwell.

Yours truly, (Signed) O. C. HILL.

### Starting Garage of His Own, Couldn't Accept Position We Offered

Elma, Iowa, May 1st, 1915.  
Michigan State Auto School, Detroit, Mich.  
Gentlemen:—I thank you very much for the information sent me and am very sorry because I cannot accept the position as I am busy at the present time, putting up a garage. I am going into the business for myself and was compelled to turn down the position offered me. I am thankful that I went to Detroit to learn the auto business and wish the School the best of success. Sincerely yours, (Signed) CARL WEBER, Box No. 304, Elma, Iowa.

W. C. Garden, Tenn., is Chauffeur at \$25 a week and expenses. E. Livingston is head of government garage at Toronto. Hundreds of others in good paying positions.

### READ OUR GUARANTEE



### SEND THIS COUPON TODAY

Michigan State Auto School

.....I expect to leave here about..... for Detroit.

.....I would like to see your new pictorial catalog. (just out) and the Auto School News and will let you know later what I expect to do.

Name.....

Street.....

Post Office..... State.....

**Michigan State Auto School**

Dept. 301, 11-19 Selden Ave.  
Detroit, Mich., U. S. A.



# STOP USING A TRUSS

Do Away With Steel And Rubber Bands

## FREE TRIAL



Inner surface is made adhesive to secure the PLAPAO-PAD firmly to the body, keeping the PLAPAO continually applied and the pad from slipping. No straps, buckles or springs attached. Soft as velvet—easy to apply.

PATD  
APRIL 6  
1909

It's the Non-Slip- ping, yet Non-Rigid Pad and What is Within It That Counts

### FREE to 5,000 Truss Sufferers

To the first 5,000 Sufferers who write, I will send, ABSOLUTELY FREE, a sufficient quantity of the Plapao to positively convince them that this is the only logical, common-sense way of treating rupture. Plapao is a highly astringent medication placed within the Plapao-Pad and being absorbed through the skin, creates a wonderful feeling of relief and at the same time tends to strengthen the weakened muscles and thus permanently close the rupture opening. The process of recovery is natural, so you'll have no use for a truss—you can throw it away forever! Old and young have testified under oath that the Plapao-Pads cured their rupture—many of them long-standing, aggravated cases—without delay from work. Patent allowed in U. S. and foreign countries. Awarded Gold Medal at Rome and Grand Prix at Paris.

**Send No Money**—for a sufficient quantity of the Plapao is sent without charge to enable you to give it a thorough test; you pay nothing for this trial now or ever. Write for it and full information today. Address: Plapao Laboratories, Block 1427 St. Louis, Mo.

## Deafness Mastered



The day of imperfect hearing is past. Science rivals nature in the marvelous new 1916 Mears Ear Phone, thin receiver model—the world's greatest hearing device. It transmits sound without blur. Write today for our 15 days' free trial offer.

### Perfect Aid to Hearing

The Mears is the only scientific instrument for the deaf. It marvelously covers 90 degrees of sound, every range of tone of the human ear. **Write for Free Book** Our free book is a highly valuable treatise on deafness. Write for it today—learn all about our 15 days' free trial offer and low direct laboratory price. If convenient to New York call for demonstration.

FREE  
Book

MEARS EAR PHONE CO.  
Desk 1191, 45 W. 34th St., New York

## Don't Wear a Truss

Brooks' Appliance, the modern scientific invention, the wonderful new discovery that relieves rupture will be sent on trial. No obnoxious springs or pads.

### Brooks' Rupture Appliance

Has automatic Air Cushions. Binds and draws the broken parts together as you would a broken limb. No salves. No lies. Durable, cheap. Sent on trial to prove it. Protected by U. S. patents. Catalogue and measure blanks mailed free. Send name and address today.

C. E. BROOKS, 1817A State Street, Marshall, Mich.

# Deafness



Perfect hearing is now being restored in every condition of deafness or defective hearing from causes such as

Relaxed or Sunken Drums, Roaring or Hissing Sounds, Perforated, Partially Destroyed Drums, etc.

### Wilson Common-Sense Ear Drums

"Little Wireless Phones for the Ears"—require no medicine but effectively replace what is lacking or defective in the natural drums. They are simple devices, which the wearer easily fits into the ears where they are invisible. Soft, safe and comfortable to wear at all times.

Write today for our 168 page FREE book on DEAFNESS, giving you full particulars and plenty of testimonials.

WILSON EAR DRUM CO., Incorporated  
387 Inter-Southern Building LOUISVILLE, KY.

## NO MORE BALD HEADS



WHEN our VACUUM CAP is used a few minutes daily. We accept no pay until you have tried the Cap 60 days and are satisfied. The Vacuum Cap is an appliance that draws the blood to the Hair Roots and starts a new healthy crop of hair. It stops Dandruff, stops the hair from falling out.

Bought by Doctors and men who know that it is the only reasonable HAIR GROWER known to science. No Drugs Used. Write for application blank, testimonials, and booklet on "HAIR," sent sealed in plain envelope, FREE.

### THE MODERN VACUUM CAP CO.

Z. 559 BARCLAY, DENVER, COLO.

Erickson Artificial Limb Co., 38 Wash. Av. No., Minneapolis, Minn.  
Limb  
Does Not Chafe Overhead or  
Draw End of Stump  
Patented  
Each One \$2.00  
Information or Catalog Given

We are  
Under  
Govt.  
Bond

## Mammoth Jubilee Book Free

Picturing 5152 Home Things  
Get your book while the edition lasts.  
SPIEGEL, MAY, STERN CO., 1401 W. 35th St., Chicago

### WEAR

Trade Mark Registered **B.V.D.** U. S. Patent Office and Foreign Countries  
UNDERWEAR



**200 KINDS** Iron, Wood, Wire & Steel  
PUZZLES  
Catalog and 2 wire leaders and trick card only 10c.  
WESTERN PUZZLE WORKS  
ST. PAUL, MINN.

Does The Socket Chafe Your Stump?  
Yes, you are NOT wearing  
**BUCHSTEIN'S VULCANIZED FIBER LIMB** which is soothing to your stump, cool, neat, light, walls not much thicker than a silver dollar, strong  
Sold on easy payments to good people. D. Buchstein  
Co., 113 6th St. S., Minneapolis, Minn. **Guaranteed 5 Years!**

## Rider Agents Wanted

1916 Model  
in each town to ride and show a new 1916 model "RANGER" bicycle. Write for our liberal terms. **DELIVERED FREE** on approval and 30 days' trial. Send for big free catalog and particulars of most marvellous offer ever made on a bicycle. You will be astonished at our low prices and remarkable terms. **FACTORY CLEARING SALE**—a limited number of old models of various makes, \$7 to \$12. A few good second-hand wheels \$3 to \$5. Write if you want a bargain. Tires, lamps, wheels, sundries, parts, motorcycle supplies of all kinds at half usual prices. Write us before buying.  
**MEAD CYCLE CO., DEPT. K108, CHICAGO**



# Tobacco Habit BANISHED

## in 48 to 72 Hours



### Immediate Results

Trying to quit the tobacco habit unaided is a losing fight against heavy odds, and means a serious shock to your nervous system. So don't try it! Make the tobacco habit quit you. It will quit you if you will just take Tobacco Redeemer according to directions.

It doesn't make a particle of difference whether you've been a user of tobacco for a single month or for 50 years, or how much you use, or in what form you use it. Whether you smoke cigars, cigarettes, pipe, chew plug or fine cut or use snuff Tobacco Redeemer will positively remove all craving for tobacco in any form in from 48 to 72 hours. Your tobacco craving will begin to decrease after the very first dose—there's no long waiting for results.

Tobacco Redeemer contains no habit-forming drugs of any kind and is the most marvelously quick, absolutely scientific and thoroughly reliable remedy for the tobacco habit.

### Not a Substitute

Tobacco Redeemer is in no sense a substitute for tobacco, but is a radical, efficient treatment. After finishing the treatment you have absolutely no desire to use tobacco again or to continue the use of the remedy. It quiets the nerves, and will make you feel better in every way. If you really want to quit the tobacco habit—get rid of it so completely that when you see others using it, it will not awaken the slightest desire in you—you should at once begin a course of Tobacco Redeemer treatment for the habit.

### Results Absolutely Guaranteed

A single trial will convince the most skeptical. Our legal, binding, money-back guarantee goes with each full treatment. If Tobacco Redeemer fails to banish the tobacco habit when taken according to the plain and easy directions, your money will be cheerfully refunded upon demand.

### Let Us Send You Convincing Proof

If you're a slave of the tobacco habit and want to find a sure, quick way of quitting "for keeps" you owe it to yourself and to your family to mail the coupon below or send your name and address on a postal and receive our free booklet on the deadly effect of tobacco on the human system, and positive proof that Tobacco Redeemer will quickly free you from the habit.

Newell Pharmacal Company  
Dept. 300, St. Louis, Mo.



## Mail Coupon NOW for FREE Booklet

NEWELL PHARMACAL CO.,  
Dept. 300, St. Louis, Mo.

Please send, without obligating me in any way, your free booklet regarding the tobacco habit and proof that Tobacco Redeemer will positively free me from the tobacco habit.

Name .....

Street and No. ....

Town ..... State .....

Please Mention Popular Mechanics

## A 'Steel Trap' Memory

One that takes a tight grip on facts, figures, names, details of every kind and hangs onto them through life—that's the kind of memory you ought to have and the kind you can have if you will give me ten minutes of your spare time daily for a few weeks. I will make your mind an infallible classified index of the things it is to your advantage to remember—give you power to concentrate, overcome self-consciousness, enable you to think on your feet, and address an audience intelligently without hesitancy and without notes.



The Key to Success

Stop Forgetting

Henry Dickson, Principal, Dickson School of Memory

During the past 20 years I have trained thousands of people to STOP FORGETTING—aided them to greater business and social success—I know positively that the person with a strong, tenacious memory, though he be far behind at the beginning of the race for success, advances and soon out-distances his forgetful rival. The demands of commercial and professional life are so exacting in their details of facts and figures to be remembered, that to succeed or even hold your own you simply must possess a good memory.

### Get My Remarkable Memory Test Free

I've had this test—most ingenious and most exclusive memory test ever devised—copyrighted. I'll send it to you, free, also a copy of my book "How to Remember" and tell you how to obtain a copy of my De Luxe edition, "How to Speak in Public," a handsomely illustrated \$2 book, absolutely free.

HENRY DICKSON, Principal,  
Dickson School of Memory, 705 Hearst Bldg., Chicago

## Get This Car!



1916 Model-30 H. P.—5 Passenger—112 in. Wheelbase—Electric Lights and Starter—Hyatt Bearings—Demountable Rims—32x3 1/2 Tires—One Man Top—Stewart Speedometer.

the most fascinating and profitable business in the world today—the automobile business. I train you for success and give you the agency for the wonderful BIRCH MOTOR CAR—"The Car That Everybody Wants." You can get it if your name reaches me soon enough.

**\$3,000 to \$10,000 A Year** Earned by men trained to succeed in this great new industry. Let me show you how to make big money. You can learn quickly—in spare time—right at home—without giving up your present work.

**Write Quick!** The offer is strictly limited—may be withdrawn at any time. I want an agent in every county. Hurry—or you may be too late. Write now. A postal will do. Address me personally. Ralph Birchard, President.

Birch Motor College, Inc., 119 Tower Bldg., Chicago, Ill.

And the Agency FOR Your Territory

You can do it. I will show you how. Write at once for full details of my amazing offer. Biggest and best opportunity to enter

## \$100.00 TYPEWRITER

FREE While Learning

NEW POSITIONS READY

\$150.00 to \$300.00 monthly for men and women—new profession—entirely untraveled field. Thousands needed. LEARN AT OUR HISK.

CONFIDENTIAL SECRETARY—the new exciting position—right-hand aid to the big boss. Learn his secret methods—step into official position. Qualify through the Botsford New Method Touch Typewriting—the special method that amazed employers. New idea—write 1500 faster without looking. Steno-graphers' salaries doubling. Write for first lesson free. Earn while you learn in spare time, by mail.

Success or Money Back Tuition on easy terms. Write for proof of graduates needed; \$100 typewriter free while learning. SHORTHAND—FREE first lesson. If you wish to learn shorthand only, write for special offer on Botsford System—same as used by world-experts. Address James Patrick Ward, President, BOTSFORD INSTITUTE, 1102 Botsford Bldg., Chicago.



## Learn Piano Better & Faster

Obtain free book showing how QUINN WRITTEN METHOD saves three-quarters of time and money usually necessary to learn piano or organ. Scientific and systematic method, yet practical and simple. Play chords immediately, and a complete piece within few lessons. Successfully used by Dr. Quinn for over 25 years. Endorsed by leading musicians. Successful graduates everywhere. Learn at home either as a social accomplishment or for teaching. Diploma granted. Practice in spare time whenever you wish. For either adults or children. Special terms this month. Send today for FREE book "How to Learn Piano and Organ." No obligation. M. L. Quinn Conservatory, Box 650-KM, Chicago.



## If You Are a Shallow Breather

You most certainly are in need of Conscious Evolution to become fully alive and have the benefit of living in full. Why live an inferior life when you can become superior to yourself through Conscious Evolution?

**MY NEW BOOK** explains the human body as it has never been explained before. It tells of the dangers and after effects of exercise and conscious deep breathing. My free book will prove of great value to you. If you desire to be more successful, to have greater will power and the successful powers, physical, physiological and mental, you cannot afford to be without my free book. Write for it today.

ALOIS P. SWOBODA

1315 Aeolian Hall NEW YORK CITY

## Public Speaking Taught at Home



Write now for special offer. We train you, in spare time by mail. Be a powerful, convincing speaker. Overcome "stage fright"—enlarge your vocabulary—train your memory—gain self-confidence—become more popular. Learn to use your voice effectively—to enunciate your words—how and when to use gestures—what style of speech to use on different occasions, etc.

**Special Offer—Write Now** Special discount

limited number of new students. So write for particulars now while this offer lasts. No obligation or expense to you. American Correspondence School of Law, Chicago, Ill.

## Personal Influence



That force of personality variously termed "Will Power," "Personal Magnetism," "Stamina," etc.—the thing that more than anything else spells the difference between success and failure—is inborn in every individual and needs but little cultivation to be brought forth in all its strength. In the race for money, position, power, love and all that makes for complete happiness, you are sadly handicapped without an understanding of this power. My system equips you in a practical way to influence—yes, control others. Years of success and thousands of delighted students vouch for its quick results. Write today for my

**ILLUSTRATED TREATISE FREE & FULL PARTICULARS FREE**

It tells about this wonderful influence and how you may yourself master it in your own home with the assurance of guaranteed success. Don't send any money, but send name and address at once for this Free Treatise.

M. D. BETTS, Sta. 610, Jackson, Mich.



# ELECTRICAL ENGINEERS

## Earn \$125 to \$250 a Month

The demand for Electrical Engineers at \$125 to \$250 a month far exceeds the supply. Engineering and power companies everywhere are searching for specially trained men. No previous experience necessary to take up this interesting work. Decide to fit yourself for one of these high-salaried positions.

The American School will train you to be a well-paid electrical worker in a short time at small expense. Our staff of practical engineers will give you individual instruction and advice. You can start in right now to prepare yourself for a better job and bigger pay.

**Earn While Learning** No need to give up your present occupation. We train you at home—solely by correspondence—as we have successfully trained thousands of others in the past eighteen years. Pocket-size textbooks, prepared by famous electrical experts, enable you to study anywhere—at any time. Papers examined and corrected only by experienced technical graduates.

## Electrical Book FREE

Send the coupon for your copy of our 56-page Free Book. Tells how easy it is to master Electricity, and gives full particulars regarding the course you are most interested in. **Don't hold back because of the money. The cost is small, and you can pay for your instruction as you progress—in small monthly installments.**

Mark and mail the coupon today. This is wonderful opportunity to get into a profession that pays big money. No obligation in sending the coupon. **Mail it now!**

**AMERICAN SCHOOL OF CORRESPONDENCE, CHICAGO, U. S. A.**

### \$800 to \$2400 in Three Years

"The work I did with you advanced my salary from \$800 to \$2400 in three years."—RUDOLPH F. KOOP, *Dorchester, Mass.* (Graduate, Electrical Engineering.)

### Made Chief Electrician

"About two months ago I was appointed Chief Electrician of the spectroscopy plant of the American Locomotive Co."—L. A. WARREN, JR., *Schenectady, N. Y.* (Graduate, Electrical Engineering.)

## Free Book Coupon

American School of Correspondence, Chicago, U. S. A.

Without any obligation on my part, please send me your Free Book and complete information regarding a course in  Electrical Engineering  Telephone Engineering  Hydroelectrical Engineering  Power House Superintendence  Wireless Telegraphy. Pop. Mech. 1-16

NAME.....

ADDRESS.....

## Do You Like to Draw ?

### Cartoonists Are Well Paid

We will not give you any grand prize if you answer this ad. Nor will we claim to make you rich in a week. But if you are anxious to develop your talent with a successful cartoonist, so you can make money, send a copy of this picture, with 5c in stamps for portfolio of cartoons and sample lesson plate, and let us explain.

The W. L. Evans School of Cartooning  
821 Leader Bldg., Cleveland, O.



## GOOD MEN WANTED

at once to learn the auto business. Big future for you or anyone who makes himself an auto expert. You learn here by doing the work yourself. Lifetime opportunity to learn the highest and most expensive auto work ever given. Omaha's NEW Auto Training College, one of the largest in the west, conducted by experienced Automobile men of Omaha, giving the highest and finest practical auto training work to be found anywhere. Experienced repairers—men come and take to become experts. You get than you can at any shop, we have equipment, and instructors ciples that they

# AUTO

College

**\$900 to \$3,000 a YEAR, Salary or Bus. Profits** by Repairing or Garage, or as Salesman, Factory Testers, Chauffeurs, Repairmen, Starter Experts or Garage Manager. If ever you are going to make a change to get into a higher paying and more pleasant line of work, DO IT NOW, the opportunities are the best now that they have ever been. Take our wonderful training course now until you are competent, and then go right into the automobile business from here. Positions now open needing capable men, and we want some good men at once to take up this work. Special \$50 course in Elee, Starting and Troubleshooting FREE with regular course. Learn here in 6 wks. or more, tuition small. Life scholarship. Work easy and interesting. Many make expenses while learning. Free catalog at once.

**AMERICAN AUTO COLLEGE, 653 Auto Bldg., Omaha, Neb.**

## MEN WANTED

Prepare as Firemen, Brakemen, Electric Motormen, and colored Train Porters. First Class Standard Roads. Hundreds put to work—\$65 to \$150 a month without any experience. **500 more wanted. Uniforms and passes arranged for when necessary. Enclose stamp for Application Blank. Name position you want.**

I. RAILWAY C. I., Dept. 35, Indianapolis, Ind.



## WANTED

**Railway Mail Clerks**  
**\$900 to \$1800 a Year**  
**(\$75 to \$150 a month)**

Rapid advancement to higher Government Positions. "No lay-offs" because of STRIKES, WARS, FINANCIAL FLURRIES or the WHIMS OF SOME PETTY BOSS. THE POSITION IS YOURS FOR LIFE.

Country residents and city residents stand the same chance for immediate appointment. Common-sense education sufficient. Political influence NOT REQUIRED.

Write immediately for schedule showing the places and dates of THE SPRING GOVT examinations. Don't delay. Every day you lose means the loss of just so much coaching before the rapidly approaching examinations.

**FRANKLIN INSTITUTE, Dept. G 106, Rochester, N. Y.**



Business Boom means hundreds of appointments

**FRANKLIN INSTITUTE (The Pathway to Plenty), Dept. G 106, ROCHESTER, N. Y.**

This coupon, filled out as directed, entitles the sender to free specimen questions; a free copy of our book, "Government Positions and How to Get Them," a list of Government positions now obtainable, and to consideration for Free Coaching for the examination here checked.

### COUPON

Railway Mail Clerk... (\$900 to \$1800)  
 Bookkeeper..... (\$900 to \$1800)  
 Postoffice Clerk.... (\$900 to \$1200)  
 Postoffice Carrier... (\$900 to \$1200)  
 Rural Mail Carrier... (\$500 to \$1200)  
 Auto Chauffeur.....

Customs Positions... (\$800 to \$1500)  
 Stenographer..... (\$800 to \$1500)  
 Internal Revenue... (\$700 to \$1800)  
 Clerk in the Departments at Washington..... (\$800 to \$1500)  
 Canadian Gov't Positions.....

Name..... Address..... G106

Use this before you lose it. Write plainly.

## GRASP THIS OPPORTUNITY TO LEARN THE AUTO BUSINESS

Earn a Splendid Salary or Have a Business of Your Own

RIGHT NOW is the time to start. Over 2 million cars are now in use; nearly a million more next year; and practically no limit for the future. That means wonderful opportunities for properly trained men. Over 3000 graduates are making good money as Chauffeurs, Testers, Mechanical Experts, Repairmen, Shop Foremen, Demonstrators, Dealers, etc., etc. We have constant calls for more and more men; our graduates get jobs quickly because our School has an established reputation for practical and up-to-date training.



## CLEVELAND AUTOMOBILE SCHOOL

12 Years of Success — Oldest and Best Established

Latest Equipment — Individual Instruction

UP-TO-DATE Training in 4 Weeks, including repairing and driving high powered cars; careful painstaking and individual instruction; latest types lighting and starting equipment; Knight and all other type motors; new 8-cyl. car here, Twin-Six on the way; every type of every part of auto—most completely equipped auto school in America—the most practical, experienced and helpful teachers. COME AND JOIN US.



A corner in our repair shop

C. H. Pratt, Chief Instructor

### Tuition and Board Low

right near the school, with congenial company and surroundings. We help you get located and feel at home.

*New Classes Forming; Write at Once for Catalog and Terms.*

### Cleveland Automobile School

Clyde H. Pratt, President

2338 Euclid Ave., Cleveland, Ohio

### A New Instrument TEACHES ANYONE TO TUNE PIANOS

No Musical Ear or Training Necessary. An amazing invention—a marvel of science. Teaches anyone to tune pianos. The New (Tune-a-Phone) method is absolutely accurate. Eliminates guess-work. Positively unerring. Guaranteed. Endorsed by authorities. Turn your spare time to profit. Learn this well paying, independent profession at home.

**\$5 TO \$15 A DAY—NOW EASY**

Opportunity for you in your town to make BIG MONEY. Daniels, Kans. (mechanist) MADE \$10 FIRST WEEK. Chances equal for MEN and WOMEN, country over. Work is all profit. INVESTIGATE. Get FREE booklet of interesting facts and records. Send name and address.

WILES BRYANT SCHOOL OF PIANO TUNING, 500 Institute Bldg., Battle Creek, Mich.



### SHOW CARD WRITERS

EARN \$80 TO \$200 A MONTH

**LEARN FREE!**

We will furnish a thorough course in Show Card Writing and Lettering absolutely free to introduce our colors if you will purchase an assortment of Alpha Colors to use while practicing. Particulars for stamp.

ALPHA COLOR COMPANY, Inc., Dept. K, 81 East 125th St., N. Y. City

VIOLIN, MANDOLIN,  
GUITAR or CORNET

FREE FINE TONE

To introduce our wonderful new system of teaching note music by mail, Violin, Guitar, Mandolin, Piano, Organ or Cornet, will give you a dandy instrument absolutely FREE and guarantee to make you a player or no charge. Complete outfit FREE. Write at once. Special offer to first pupil. No obligation. SLINGERLAND'S CORRESPONDENCE SCHOOL OF MUSIC, Dept. 9, Chicago, Ill.



### BE A BANKER

Splendid opportunities. Pleasant work, short hours, all holidays off, yearly vacation with pay, good salary. Learn at home. Diploma in six months. Catalog free. EDGAR G. ALCOORN, Pres. AMERICAN SCHOOL OF BANKING, 419 E. State Street, COLUMBUS, OHIO



### TRAVELING MEN

EARN \$2,000 TO \$10,000 A YEAR We will teach you to be a high grade salesman, in eight weeks at home and assure you definite proposition from a large number of reliable firms who offer our students opportunities to earn Big Pay while they are learning. No former experience required. Write today for particulars, list of hundreds of good openings and testimonials from hundreds of our students now earning \$100 to \$500 a month. Address: nearest Office. Dept. 507, NATIONAL SALESMEN'S TRAINING ASSN. Chicago New York San Francisco

LEARNED BY ALMOST ANYONE AT HOME SMALL COST

Send today 2c stamp for particulars and proof.

O. A. SMITH, Room D 134, 823 Bigelow St., PEORIA, ILL.

### I Want Men

Like YOU Who Want to Make \$3,000 a Year, or More



We need a good, live man right now in your territory to handle real estate deals for us. No experience or capital necessary. We teach you the Real Estate Business and appoint you our agent in your locality. Easy work; large profits. WE OPERATE EVERYWHERE. WRITE FOR FREE BOOK. MORDEN REAL ESTATE SCHOOL, 400 Palace Bldg., Minneapolis, Minn.

Please Mention Popular Mechanics



## \$125 to \$300 a Month

Send the coupon below and find out about the opportunities in the profession of Signal Engineering. Big salaries are being paid—\$125 to \$300 a month is an ordinary salary for the man who has the proper training. You can get just this kind of training right in your own home—during your spare time. We need men. Send the coupon for the book that tells you all about it. You owe it to yourself to find out about the opportunities that are offered to you. Send the coupon now.

## Be a Signal Engineer We Need Men

Be the man who gets the fat pay envelope. The profession of Signal Engineering is only in its infancy. There are thousands of miles of block signals to be installed. Signal Engineers, supervisors, inspectors and foremen are required to superintend this installation. Hundreds of maintainers and battery men are needed to maintain the systems already in use.

Your duties may take you from coast to coast. Railroad men are always in a fortunate position to travel and see the world because free transportation is liberally awarded. You can accept a position where you will be located steadily at one place, if you prefer—the position of authority—the high place and the fat pay envelope may be yours. Send the coupon for the free Signal Book.

The profession of Signal Engineering is calling to ambitious men. Our ranks are not over-crowded. There are opportunities—golden ones, awaiting the men who answer the call. Block signal systems are no longer in the experimental stage. All over the country they are being installed. Some States have legislated to compel the railroads to install systems immediately. In our profession you will have the chance you have been looking for. We are calling you. Don't fail to send the coupon today for our big free Signal Book and full particulars.

### Two Big Outfits FREE

Complete Signal Engineer's Outfit and Complete Draftsman's Outfit given away absolutely free to our students.

### Department of Signaling

Room 1191, 1810 Wilson Ave. Ravenswood Station, Chicago

Gentlemen:—Please send me absolutely free and prepaid your big new book on Signal Engineering. Also full particulars about your great special free outfit offer. It is distinctly understood that I assume no obligations of any kind.

## Send Coupon for Big New Book

Put your name and address on the coupon or on a letter or a postcard now, and send it to us. Absolutely no obligations of any kind. We will send you our big new book absolutely free, and prepaid. Read about this fascinating profession. Read about the opportunities that await you. The book is free. Send the coupon for it now—it's the first step toward the realization of your ambition. Get your name and address in at once.

### Department of Signaling

Room 1191, 1810 Wilson Ave., Ravenswood Station, Chicago

Name.....

Address.....

Age..... Occupation.....



# SELF MASTERY

## BRINGS HEALTH AND HAPPINESS

Make yourself the strong, healthy, happy person you should be and can be. Train your mind and body together to resist and repel the negative and dispiriting forces to which you succumb so easily. Be master instead of slave. Decide and act now instead of putting it off until some other time. Without placing yourself under the slightest obligation — without committing yourself in any way — without even exerting yourself, you can find out all about

**Leavitt-Science** and the many wonderful things it has done in placing men and women on the sunny side of life and putting them in complete possession of their natural rights of mental and physical ease and power. What Leavitt-Science has done for others, most of them skeptics at first, but believers at last, it can and will do for you. For 12 2c-stamps, to cover postage and packing, I will send you *The Story of Leavitt-Science* to read and consider, and with it the names of many men and women it has benefited and to whom you can write, if you wish? Send for this great book today.

**C. FRANKLIN LEAVITT, M. D.**  
Suite 946 14 West Washington Street  
CHICAGO ILLINOIS

## FREE Send for large Catalogue of Practical Mechanical Books FOR HOME STUDY

Best Books for Electricians, Telephone Men, Motion Picture Operators, Engineers, Railroad Men, Motormen, Draftsmen, Automobile Mechanics, Plumbers, Carpenters, Builders, Sign and Card Writers, also Book-keepers and Civil Service Applicants.



**F. J. DRAKE & CO., Dept. 8**  
1325 Michigan Ave., CHICAGO

This New Book Sent Prepaid  
Cloth Binding \$1.00  
Leather " 1.50



## The Problems of Science

By FEDERIGO ENRIQUES

Authorized translation by Katharine Royce, with an introduction by Josiah Royce. Cloth, \$2.50 net. A compendious survey of what has been done and is yet to be done in the scientific field.

The end for which we ought to strive to-day is a scientific education, which shall enable the workers in any field whatsoever to understand better the object of their own research.

**OPEN COURT PUBLISHING CO.**  
Publishers and Distributors of Scientific Books  
CHICAGO and LONDON



## Be an Artist AND DRAW for Magazines, Newspapers, Etc. Earn Big Money

All Branches of Art Taught BY MAIL or Local Classes. Write for illustrated booklet, terms and list of successful pupils. **ASSOCIATED ART STUDIOS, 2122 Flatiron Bldg., NEW YORK**

## SELF-CONSCIOUSNESS

Are you timid? Do you lose your nerve and become confused easily? Do you lack confidence, courage, aggressiveness, faith in your own ability? These faults are a big handicap in social or business affairs. My *Illustrated Treatise* tells you how they may be overcome. It's FREE! Write for it today.

**M. DeBETTS, Sta. 89, JACKSON, MICH.**

## LEARN TO PAINT SIGNS and SHOW CARDS

THERE'S MONEY IN IT



I'll teach you personally by mail. 16 years' successful teaching. Five courses: (1) Complete Lettering, Signs and Card Writing; (2) Show Card and Ticket Writing; (3) Lettering; (4) Advanced Show Card and Ticket Writing; (5) Advanced complete Course. You can succeed — big. No limit to the window cards, sale cards, banners, and signs used. Gold lettering on glass and wood valuable feature of course. Teaches everything you need. Pay good, work fascinating, hours short.

**EARN \$18.00 to \$45.00 a WEEK**

Schwartz, Del. writes: "Yours is the only school that really teaches." Weaver, Canada, writes: "Your course has increased my income 50%." Get in on this big thing, too. Your name and address brings full particulars.

**THE DETROIT SCHOOL OF LETTERING**  
Chas. J. Strong, Founder, Dept. 2010, Detroit, Mich.

### Guarantee —

I guarantee to place my graduates in positions paying \$25.00 to \$175.00 when they have graduated and are competent. We have constantly more requests for men at good salaries than we can supply.

## Learn How to WRESTLE

In Your Own Home By Mail

Yes, learn to become an expert wrestler right in your own home, by mail, from the greatest wrestler the world has ever known. Be an athlete, be strong, be healthy. Learn how to throw and handle big men with ease. Learn to defend yourself. All taught in our course of lessons, and illustrated with hundreds of charts and actual photographs by

### Farmer Burns and Frank Gotch

"Farmer Burns," the grand old man of the mat, taught Frank Gotch, the present World's Champion, all he knows about wrestling, so Gotch says. He will now teach you *Scientific Wrestling—Physical Culture—Jiu-Jitsu—Self Defense*. Every man and boy in America, no difference what age, needs this wonderful course of lessons. Write today—your name, age and address on a postcard or letter brings you our fine book absolutely free—no obligations of any kind. A splendid book on wrestling and physical culture. Write today stating your age.

**Farmer Burns School of Wrestling 1191 Range Bldg., Omaha**

This Wrestling Book FREE

Please Mention Popular Mechanics

# LAW STUDY at HOME

## Become an LL.B.

### The Only Law School of its Kind in America

#### Special and Exclusive Features

**ONLY** recognized resident law school in the United States conferring Degree of Bachelor of Laws LL.B.—by correspondence, strictly on the merits of its course. **ONLY** law school in U. S. conducting standard resident school and giving same instruction by mail. Only law school giving over 500 class-room lectures to its extension students. Only law school giving a full 3-year, University Law Course, by mail, having an actual faculty of over 30 prominent lawyers in active practice. Only law school in existence giving a Complete Course in Oratory and Public Speaking, in conjunction with its law course.

#### Our Degree LL.B.

We confer this Degree of Bachelor of Laws—LL.B.—only when the student has completed our full course with the necessary credits, to the satisfaction of the Faculty, exactly the same as in our resident school. This College is no "degree mill." Passing Bar Examination is not our standard for conferring this degree. Our degree stands for accomplishment, honor and distinction. It is worth working for, and a treasure to its possessor.



#### Direct From Class-Room to Student



From Lecture Room to Student  
No Other Law School Can Use  
This Illustration

choose, take part of our course by mail and finish in our resident school where he will receive full credit for all work done by mail.

#### Written Bar Guarantee

We give an absolute written guarantee to prepare our students to pass bar examinations.

The Hamilton College of Law is a regular, thoroughly recognized, bona-fide College of Law and NOT an "institute," "correspondence school," or a corporation selling sets of law books under the guise of teaching law.

This College occupies the entire third floor of the New Advertising Building where its large and commodious Class-rooms, Extensive Library and executive offices are located. School and Course Highly Endorsed and recommended by Government Officials, Business Men, Noted Lawyers, Graduates and Students.

#### FREE COMPLETE COURSE IN ORATORY AND PUBLIC SPEAKING

This course has been prepared and written by Prof. Oscar G. Christgau, LL.M. (Master of Laws), the regular resident school professor in charge of this work. Knowing law, from a lawyer's standpoint, he has prepared this series of 36 lectures to meet all the requirements of the practicing attorney. This Course in Oratory and Public Speaking sells, individually, for \$30.00, but it is absolutely free to Hamilton College students.

#### Our Law Library

Consists of 24 volumes of Students Standard Text Books, two volumes bound together under one cover for convenience, making a total of 12 books. These law books were prepared at an enormous cost especially for the students of the Hamilton College of Law, by one of the largest and best law book publishers in

America. This is the only set of law text books ever prepared exclusively for students' use. We would be glad to have you submit these books to any lawyer or judge in the country and get his opinion regarding them.



#### What Our Students Say

These 12 Volumes are Free to Students  
"No doubt you will be interested to hear that I was successful in the recent examination for admission to practice in our state."  
R. S. A..... Jr., Birmingham, Ala.

"You no doubt will be surprised to learn that I have been admitted to the Kentucky Bar. I made about 90% on this examination and was complimented very highly by the legal profession of my acquaintance."  
C..... D. M....., Ky.

"About the 1st of May of this year, after I had been studying with your College for only 14 months, I successfully passed the Texas Bar Examination. I certainly intend to go ahead with the 3rd year. I think an LL.B. is quite worth while."  
E. G. G....., Supt. Public Instruction, Tex.

"As an officer of instruction in a large University permit me to say that I consider your course admirable in conception and well carried out in detail of practice."  
E..... G....., N. Y.

"So enthusiastic and gratified am I over the progress made that I cannot refrain from writing you and expressing my appreciation."  
S. J. L....., A. B., M. A., Supt. Military Academy, Md.

"It gives me a good deal of pleasure to give you the result of my examination before the..... State Bar Commission. When I tell you that among those who ranked lower than I did were some college graduates, an attorney of another state, a former justice of the peace, and two who had done considerable work in an office under a good attorney, you will believe me when I say there is no school in the world, resident or otherwise, that will do as much for its students as the Hamilton College of Law."  
N. C. W....., Prof. Commercial Law,  
..... High School of Commerce, .....

Full names, addresses and letters mailed with literature. We have hundreds of similar letters. Send Free Coupon Today and get our Handsomely Illustrated Prospectus. Gives you a clear understanding of the Profession of Law, and how we are successfully teaching it by correspondence. It may mean the turning point in YOUR career.

## MAIL COUPON TODAY

**HAMILTON COLLEGE OF LAW**  
200 Advertising Building, Chicago, Ill.

Gentlemen:—Kindly send me your Illustrated Prospectus and full particulars regarding your successful and exclusive method of teaching law by mail.

Name.....

Address.....



**50c  
a Week**

Send today for your free-for-examination set of the greatest electrical library ever published. The 1915 edition, just off the press, is recognized by big men in the electrical field as the most practical work of its kind. Covers completely the generation and use of electricity for power, light, transportation and communication, the construction and operation of dynamos and motors, central station engineering and telephone work, as well as wireless telegraphy and telephony and land and submarine telegraphy. Valuable alike to the beginner and expert.

## Applied Electricity

Seven big volumes; 3500 7x10 inch pages; 3000 illustrations, full-page plates, diagrams, simple explanations, etc., with hundreds of valuable facts and figures. Handsomely bound in half red morocco, gold stamped.

**Earn \$150 to \$250 Monthly** Electrical Engineers earn from \$100 to \$250 a month. The work is pleasant—the hours short. These great books will fit you—in your spare time—to enter this fascinating, well-paid work. No previous experience necessary.

**Examine These Books Free of Charge** The entire seven volumes, not a sample volume, will be sent, express prepaid, on receipt of the coupon below. Look these books over for a whole week free. Then decide whether or not you want them. If you do, send us \$2.00 within seven days and \$2.00 a month—50c a week—until the special advertising price of \$10.80 has been paid. Otherwise we'll take them back at our expense. In addition to this liberal discount from the regular price of \$35.00, we include with each set a \$12.00 Consulting Membership. This entitles you to the advice of a staff of experts for a whole year free!

**AMERICAN TECHNICAL SOCIETY, CHICAGO, U. S. A.**

**American Technical Society, Chicago:**

Please send Cyclopaedia of Applied Electricity for 7 days' free examination. I will send \$2.00 within 7 days and \$2.00 a month until I have paid \$10.80; otherwise I will notify you and hold the books subject to your order. Title not to pass until fully paid. Pop. Mech. 1-16

NAME.....

ADDRESS.....

REFERENCE.....

## Learn to Write

### I Teach by Mail

I CAN make a good penman of you at your home during spare time, no matter where you live or how poorly you now write. My simplified system has shown thousands of others the way to good penmanship during the past twenty years—it can and will do the same for YOU!

**Beautifully Illustrated Book "How to Become a Good Penman" FREE!**

It contains general information, with testimonials and beautiful specimens of penmanship showing what others have accomplished by the Tambllyn System. (Your name elegantly written on a card if you enclose stamp for postage.) WRITE TODAY. Address

**F. W. TAMBLYN**  
418 Meyer Bldg., Kansas City, Mo., U. S. A.



*F. W. Tambllyn*

Please Mention Popular Mechanics

# YOU CAN EARN THIS MAGNIFICENT BUSH MOTOR CAR

And the Agency for Your Territory



5-Pass. 28-H. P.

Write quick for full particulars of this wonderful offer! Send your name **before some other man gets your territory.** You can earn a Car and at the same time qualify yourself to

**MAKE \$3,000 TO \$5,000 A YEAR AND UP** in the Automobile business—Driving, Repairing, Garage and Selling. Close to a **billion dollars** will be spent this year in the United States for automobiles and supplies. I'll show you how to get **your share** of this vast fortune.

## Full Information FREE—Write Quick

Costs you nothing to get full details of this remarkable AUTO Offer. Unequaled opportunity for ambitious men and boys. Don't delay.



Write NOW—before you turn this page. A postal will do. Just say, "Send me your auto offer." Address **J. H. Bush, President.**

**BUSH MOTOR COLLEGE, Inc.**

DEPT. 117, BUSH BUILDING  
NORTH CLARK STREET AND CHICAGO AVENUE, CHICAGO, ILLINOIS

## LETTERING AND DESIGN

Invest your spare time. Learn Craft Writing, Sign Printing or Commercial Lettering and Design. Earn a steadily increasing income or start in business. Rosing's personal instruction makes course self-paying. P. Wenzel writes "Your lessons are great." Constant demand for graduates. Assistance in obtaining positions. Investments now. **FREE BOOK.** THE ROSING SCHOOL OF LETTERING & DESIGN

721 Union Bldg. Cleveland, Ohio

## MUSIC TAUGHT FREE

**IN YOUR OWN HOME**

You can read music like this quickly

Write today for our booklet. It tells how to learn to play Piano, Organ, Violin, Mandolin, Guitar, Banjo, etc. Beginners or advanced pupils. **AMERICAN SCHOOL OF MUSIC, 51 Lakeside Bldg., Chicago**

## DRAWING

Caricature, Cartoon, Comic, Commercial, Fashion, Newspaper and Magazine Illustrating taught by mail. Illustrated book 6c in stamps. **THE BOSTON SCHOOL OF DRAWING, 755M Boylston St. BOSTON, MASS.**

**BE AN ILLUSTRATOR.** Learn to draw. We will teach you. School of Illustration 112 Page Bldg. Chicago, Ill.

by mail how to draw for magazines and newspapers  
Send for Catalog

## Chicago Correspondence School of Law

Prepares Students at Home for the Bar. Four Courses of Study: College, Post-Graduate, Business Law and Bar Examination Review. **Actual Daily Lessons** by a recognized School that is approved by Bench and Bar. Write today for **FREE Catalog** and Rules for Admission to the Bar.

**520 Reaper Block, Chicago**



**Extra  
Special  
Offer!**

**20  
Lessons  
FREE!**

**Send  
the  
Coupon**

# You Can Now Learn at Home To Be An ELECTRICIAN

This is the age of Electrical Miracles!

Electricity rules supreme as the motive power of the world. Its wonders are growing every day, on every side of us, in every aspect of modern life and industry. It is opportunity! And still, as Thos. Edison says, the field of Electricity is only in its infancy. The student of Electricity today will startle us with new marvels tomorrow. Right now we need men who

know Electricity. There are not enough electrical workers to fill the big paying positions open. Every day the call for men grows more insistent. Feeling the pressure of this demand we are now making a remarkable special offer to students at this time.

## EARN \$2,500 TO \$4,000 A YEAR

**I Will Teach You Personally By Mail**

I will give you my personal and individual attention. Makes no difference who you are, where you live or what you do, I will train you by mail to become an Expert Electrician capable of earning \$2,500 to \$4,000 a year. My instruction is based on my own extensive, practical, everyday experience. I know just the kind of training you need for the big money job. No needless theory—no drudgery. You don't have to take a minute from your regular work.

Don't think you have to have some electrical experience or knowledge to take advantage of this opportunity. Under my new system of instruction you don't!

You will marvel at the progress you will make under my instruction. Each lesson makes you more eager for the next. And in an astonishingly short time you have mastered the entire course and become an Expert Electrician! The cost to you just now is so small as to be insignificant. You can pay the small tuition fee in payments so easy that you'll scarcely miss the money.

## 20 Complete Lessons FREE!

Never before has an offer so liberal been made on a Course in Electricity—probably will never be made again. I make it now because at the present time there is an unusual demand for trained Electricians and it is to my advantage to offer exceptional inducements to prospective students. I want to make it

so easy for ambitious men that no possible excuse can be had for not accepting my wonderfully liberal offer. But the Free Lesson offer is limited, good for only 23 days. And there are only a limited number of these lessons to be given away free. So send the coupon at once. Let the free lessons prove how easy it is to become an Expert Electrician by my methods.

**Send No Money—Just This Coupon!**

Write today for full description of course and particulars of our amazing offer of 20 lessons Free. Even if you had not planned to enter the Electrical field don't fail to get all facts of this remarkable opportunity. Send coupon or postcard. No obligations on your part. Act at once—while this offer is open.

**A. W. WICKS, B. S., Pres. and Director,  
WICKS ELECTRICAL INSTITUTE,  
Dept. 57  
81 W Randolph  
Street,  
Chicago,  
Ill.**

**FREE  
Coupon**

**A. W. WICKS,  
B. S.,  
Pres. and Director  
Wicks Elec. Institute,  
81 W. Randolph Street,  
Dept. 57 Chicago, Ill.**

Without obligating me in any way whatever, please send me full description of your course in Electricity and particulars of your special offer of 20 lessons free.

**ALBERT  
WOOD  
WICKS,  
B. S.**

Former Sales Engineer of the General Electric Co.; former General Manager of company manufacturing Jenney Electric Motors; former Sales Engineer of Fairbanks, Morse & Co.; now Consulting Engineer, also President and Director of the Wicks Electrical Institute.

Name.....

Address.....

Please Mention Popular Mechanics

# An Official Notice

**T**HE new 11th edition of The Encyclopaedia Britannica after this date will be sold in two forms:

- 1.—The "Cambridge University" issue—the work as at present published by the Cambridge University Press, England, and sold in America by The Encyclopaedia Britannica Corporation; a large-page book, printed from large type and with wide margins; in general, the form that it has appeared in since 1768 when the first edition was published.
- 2.—The "Handy Volume" issue, designed for a wider public, at a popular price; an entirely new form, more economically manufactured, printed from new plates, with smaller page, smaller margins and smaller type. It will be sold exclusively by Sears, Roebuck and Co., Chicago.

The text, illustrations, maps, in short, the entire contents are exactly the same in both issues. Both will be printed on Britannica India Paper.

The Encyclopaedia Britannica, 11th edition, in both forms consists of

29 volumes,  
41,000 articles by  
1,500 contributors  
30,000 pages  
44,000,000 words  
15,000 illustrations and maps

**T**HE Encyclopaedia Britannica is at once the oldest and the newest of works of reference. First published in 1768, twenty-one years before the inauguration of Washington as President, it has again and again been rewritten and re-issued in enlarged and improved form. Each edition has been more successful than its predecessor. The new Eleventh Edition of the Britannica is the culmination of a century and a half of constant progress. How useful The Encyclopaedia Britannica is now and has been for six generations is proved by the fact that more copies of it have been sold than of all other encyclopaedias combined.

The following are the lowest prices for sets of the "Cambridge University" issue printed on India Paper:

Cloth . . . . . \$166.75  
Full Sheep . . . . . 203.25  
Suede . . . . . 255.25  
Morocco . . . . . 267.50

or, if the order is accompanied by a first payment of \$5.00 and the purchase completed on monthly payments of \$5.00 each, at a little more than these prices.

*We guarantee, as holders of the American copyright, that we will not reduce these prices in the future.*

The present prices for the "Handy Volume" issue, printed on India Paper, are:

Cloth . . . . . \$58.88  
Full Sheep . . . . . 68.54  
¼ Levant . . . . . 81.88  
Full Levant . . . . . 92.00

or, if the order is accompanied by a first payment of \$1.00 and the purchase completed on small monthly payments, at a little more than these prices.

*These prices are subject to advance. To order the "Handy Volume" issue, or to get more information about it, write to Sears, Roebuck and Co., Chicago, the sole distributors.*

*We guarantee that in both issues the text, illustrations, maps and plates throughout, the India Paper on which the text is printed, and the leather and cloth in which the volumes are bound, are the same.*

**THE ENCYCLOPAEDIA BRITANNICA CORPORATION**

By H. E. Hooper, President

120 W. 32nd Street, New York



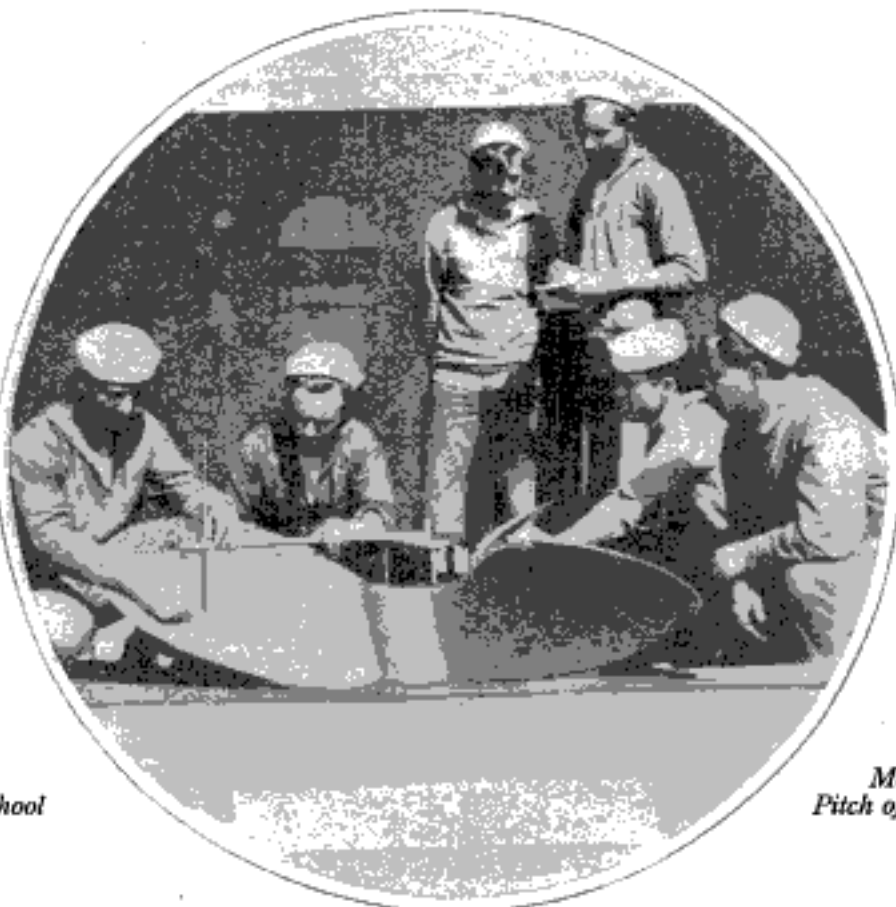

*In the Navy  
Artificer School*

*Measuring the  
Pitch of a Propeller*

## Navy Trades Pay Well

If you are between 18 and 25, ambitious and of mechanical bent, this will interest you:

THE NAVY offers exceptional opportunities for men skilled in mechanical trades. The modern dreadnaught, destroyer and submarine are filled with the most intricate and complicated machinery, requiring expert men in many different trades. Trade schools are maintained by the Navy for the instruction of recruits who show an aptitude for a trade or some special branch of Navy work.

IN THE NAVY you have every incentive to excel in your work; you will find advancement steady and dependent upon your skill and conduct; and you are sure of steady employment and increased pay with each enlistment. Promotion does not stop with the enlisted grades, but continues through the warrant grades and to a commission.

IN THE NAVY you will find the work for which you are best fitted. If you have finished your time at a trade such as machinist, carpenter, coppersmith, etc., you can enter the service at a high rate of pay, the age limit for which is 30 years. If you have but partially completed your trade, you may enlist in one of the lower ratings, and receive a course of instruction at Government expense before being assigned to duty on board ship. Young men between 17 and 25, without knowledge of a trade may enlist as apprentice seamen.

THOUSANDS OF MEN are now enjoying the benefits of good paying positions as the result of Navy training. This opportunity is open to *you* if you are ambitious.

Apply for particulars at any Navy recruiting station, or address — Box 68

**BUREAU OF NAVIGATION**  
NAVY DEPARTMENT WASHINGTON, D. C.

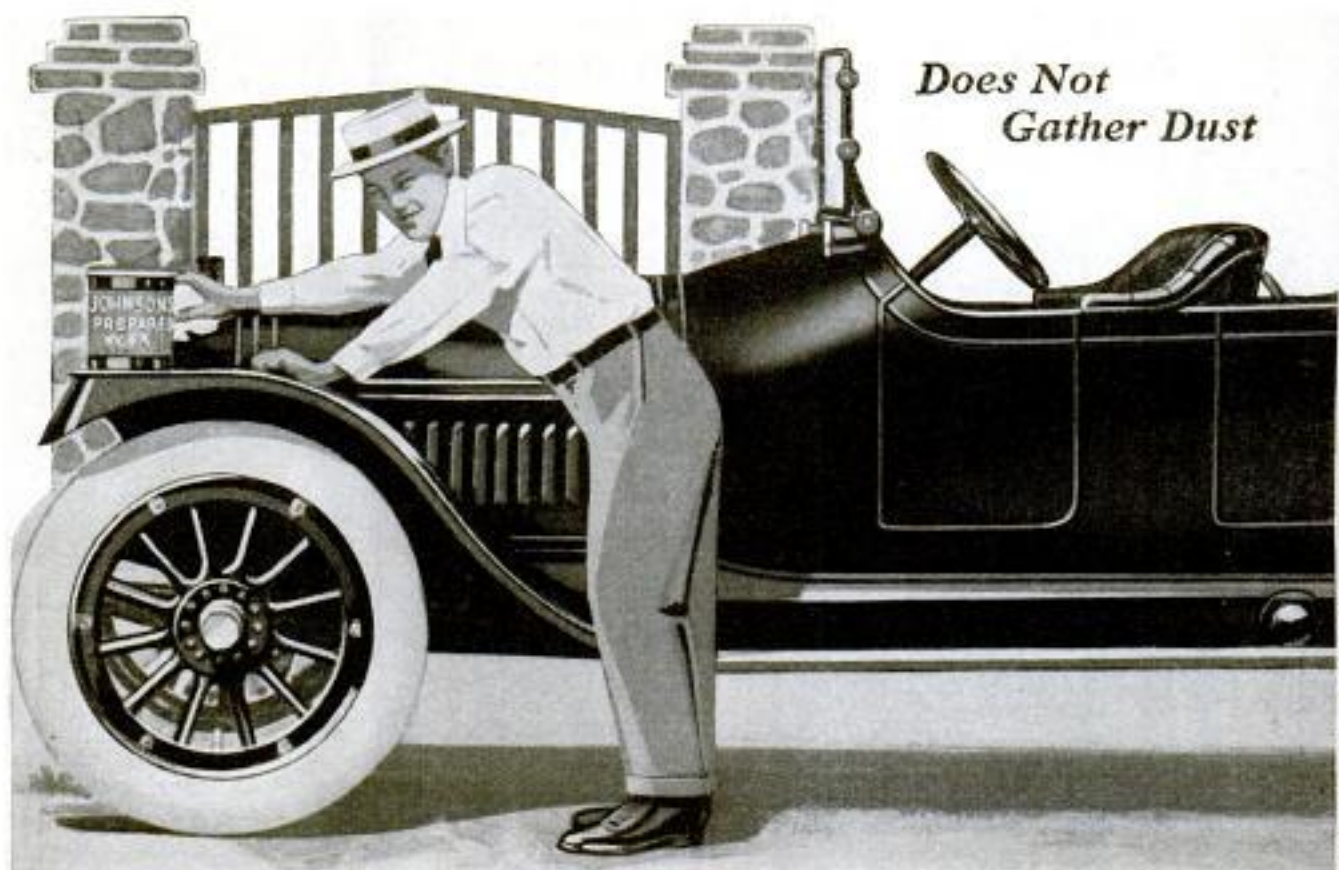

## Keep Your Car Like New With **JOHNSON'S PREPARED WAX**

It cleans, polishes and finishes in one operation. It will keep the body, hood and fenders of **new cars** bright and good looking for an indefinite time—and will make **old cars** look as well as a coat of paint and varnish.

Johnson's Prepared Wax imparts a perfectly hard, dry, glasslike finish that cannot collect dust. It forms a thin, protecting film over the varnish—greatly prolonging its life. It prevents checking and cracking—covers up small scratches and

### *"Sheds Water Like a Duck's Back"*

There are dozens of uses for Johnson's Prepared Wax—you will find it splendid as a polish for

**Floors**

**Linoleum**

**Woodwork**

**Pianos**

**Furniture**

**Leather Goods**

**Desks**

**Golf Clubs**

**Gun Stocks, etc.**

S. C. JOHNSON & SON, Racine, Wis. PA1

I enclose 10c for Instruction Book on Home Beautifying and a can of Johnson's Prepared Wax—sufficient for a small floor, an automobile, a piano or several pieces of furniture.

Name.....

Address.....

City & State.....

Johnson's Prepared Wax gives perfect results over any finish—varnish, shellac or oil.

Send us the coupon and 10c for a can of Johnson's Prepared Wax—sufficient for polishing an automobile, a piano, or several pieces of furniture.

**S. C. JOHNSON & SON**  
"The Wood Finishing Authorities"  
RACINE, WIS.

"Makes a 'wash' last four weeks instead of one."

J. H. Williams,  
1019 Hearst Bldg.  
Chicago

"Made my car like new again."

Edwin F. Kuhn,  
Ormond, N. J.

"Can't be beat for polishing a car."

J. E. Emmons,  
Greenwood, Miss.

"I have put it to every conceivable test, and as a chauffeur of 10 years standing, I can safely say that your Wax is par-excellence."

R. T. Lee, 89 Albion St.,  
Branford, Ont.

Please Mention Popular Mechanics

# Popular Mechanics Magazine

REGISTERED IN U. S. PATENT OFFICE

WRITTEN SO YOU CAN UNDERSTAND IT

Vol. 25

JANUARY, 1916

No. 1

## Crude Shower Bath Real Luxury for Soldiers

**I**N one of the French army camps the soldiers have improvised a shower bath which is as thoroughly amusing in appearance as it is ingenious in construction. Its ludicrous mechanical features are so pronounced that it would seem more of a travesty than a convenience were it not for the fact that it was in very general demand until late in the fall.

The contrivance is built beside a small stream and consists essentially of a large spider, having tin cups arranged about its periphery; two water wheels, a bucket, a piece of tubing, and a rose. As the large wheel is revolved by the smaller ones, the cups are dipped into the stream and carried up to a point where they are tripped and their contents emptied into a bucket, which is held on a platform several feet from the ground. Obviously the water is carried from this reservoir through the hose to the spray. Primitive as it is, the apparatus

works and provides the men with a much-needed facility for bathing.

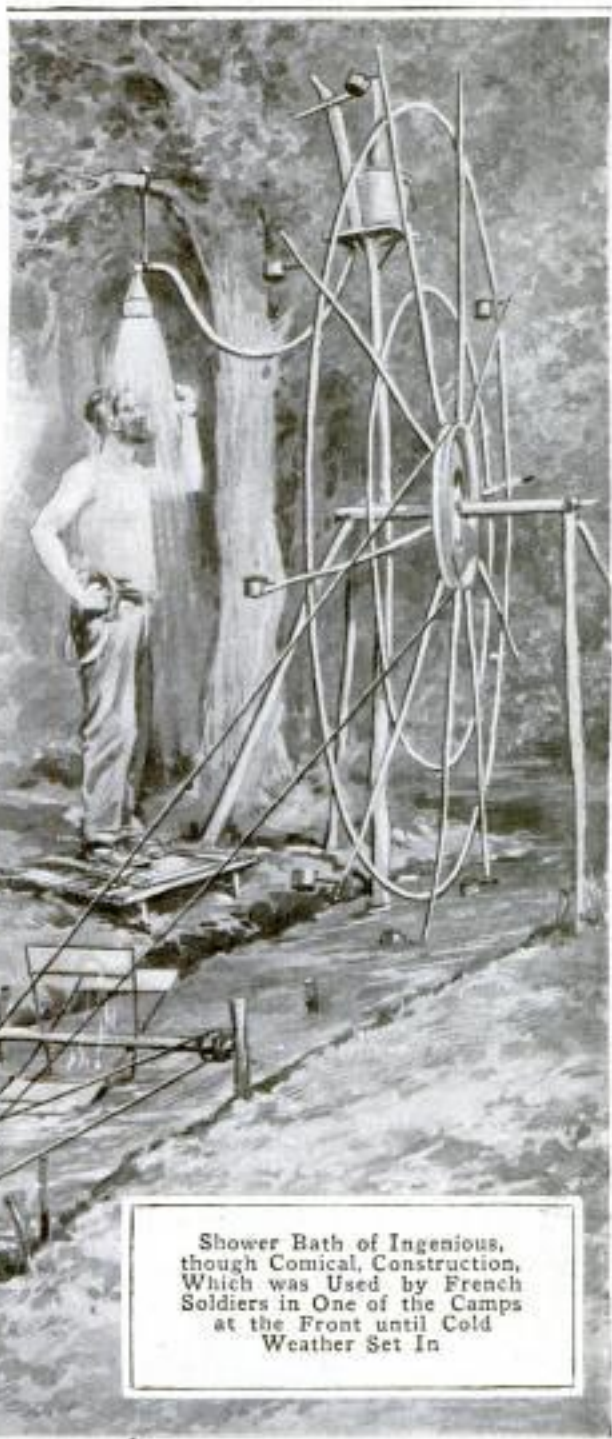

Shower Bath of Ingenious, though Comical, Construction, Which was Used by French Soldiers in One of the Camps at the Front until Cold Weather Set In

Inventor:  
John G. Glover,  
Machine, Quebec.

Commercial Report  
p 208 Oct, 1914

## POPULAR MECHANICS

### A COMBINATION SWITCH FOR DOORBELL AND HALL LAMP

A Canadian inventor offers a new solution for the exasperating trouble

### SOUNDING MACHINE WORKED BY STEAM ENGINE

A great increase in speed in making soundings has been brought about on the steamer "McArthur" and the launch "Delta," both of the Coast and Geodetic Survey, by the installation of a steam engine for operating the sounding machine. Some idea of the speed of handling is given in the fact that with this equipment a sounding to a depth of 900 ft. can be made in two minutes, while the engine reels in the wire at the rate of 720 ft. a minute. The wire is paid out over an arm that swings upward when the lead strikes bottom and takes up the slack until the brakes are applied. The "McArthur" can easily go ahead



The Outer Switch Operates the Doorbell; the Inner, the Hall Lamp

attendant on coming home to a darkened hallway at night. His idea embodies a switch to be operated in connection with a doorbell push button, causing a hall light to be turned on at the same time the doorbell is rung. The push button has an extension in the shape of a rod which runs to a switch for operating the light. Pushing the button rings the doorbell in the usual manner, and also closes the light switch through the medium of the rod. When pressure on the push button is released, a spring within the button causes the rod to return to its former position, opening the bell circuit, but leaving the light burning. The light may be turned on or off at any time by means of two other push buttons which work directly on the light switch itself.

A general revival of freight traffic, unequaled since 1907, is reported by railways centering in New York City.

with 600 ft. of wire out, and in sounding at a depth as great as 780 ft. it is possible to go ahead immediately after the sounding is read and have the lead up and ready before the stop is made for the next sounding.

### CARBONIC ACID EMPLOYED IN TREATING WOUNDS

Military surgeons with the German army are taking advantage of the pain-stilling and disinfecting properties of carbonic acid in the treatment of wounds by utilizing an effervescent powder which is now being prepared. This is composed of 10 parts sodium bicarbonate, 9 parts tartaric acid, and 19 parts sugar. The ingredients are thoroughly mixed and then crushed to about the fineness of granulated sugar. The substance is applied freely to the surface of a wound, the moisture of which causes it to effervesce and liberate carbonic acid.

Prometheus 9/11/15

836

*R. S. ...*

# NEW AMERICAN FIGHTER GIVEN WORKOUT



**T**HE dreadnaught "Nevada" and its sister ship "Oklahoma" embody the "everything or nothing" idea of protection. The "Nevada," shown here with Manhattan bridge in the background, is passing down East River from the Navy Yard. During one of its standardization tests recently the vessel made a speed of 24.22 miles an hour. It mounts ten 14-in. guns and is provided with four submerged 21-in. torpedo tubes.

COPYRIGHT BY E. MULLER, JR.

*P. O. Box 530, New York*

*Inventor:*  
H. A. Lowe, 509 Hill St., Missoula, Mont.

### ELECTRIC STOVE IS BUILT IN 827 KITCHEN WALL

To minimize the amount of space ordinarily occupied by a cooking range, a Montana inventor has designed a compact, built-in electric stove for the kitchen wall. It may be constructed in various sizes to meet the needs of different families, and offers especial con-

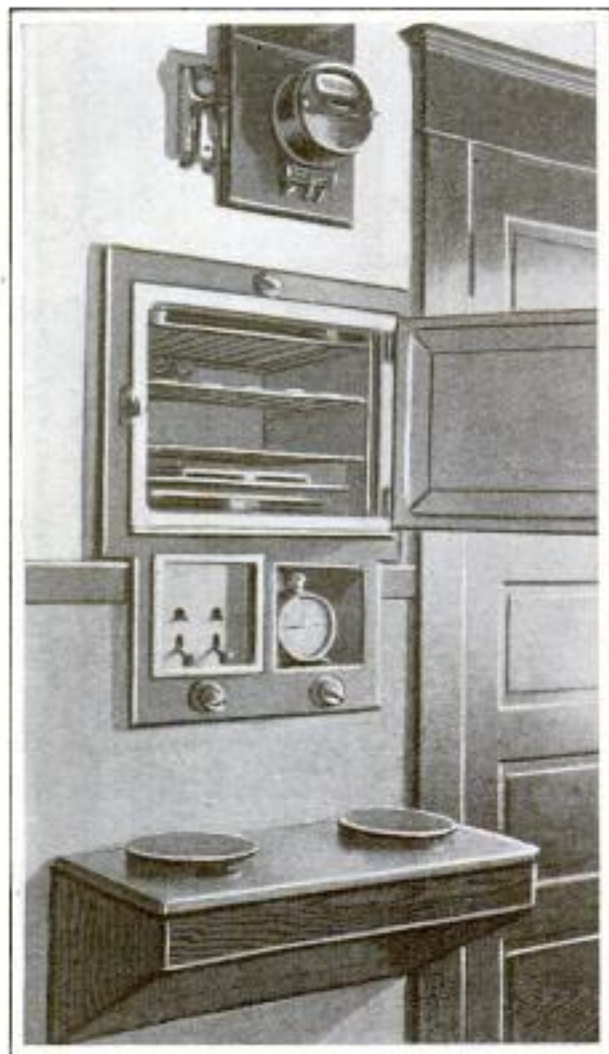

Compact Electric Stove and Oven Built in Kitchen Wall

venience for those who reside in cramped city flats. The oven is set flush with the wall and immediately above a shelf on which hot plates are mounted. It is insulated on five sides by a 4-in. thickness of mineral wool and asbestos. In addition to a manual switch, the oven current is controlled by both a clock switch and thermostat, so that the heat may be shut off automatically at a predetermined time or

when a prescribed temperature is reached. The whole contrivance occupies no more room than a short pantry shelf. The number of hot plates used may be varied according to the needs of the individual. Application for patent rights has been made by the inventor.

### *C. S. Monitor 11/5/15* GERMANS INSTITUTE REFORM 917 IN MILITARY ATTIRE

Through an imperial decree recently issued, a long advocated reform in the dress of the German soldier has been effected. General uniformity in color and design and the elimination of distinctive apparel for officers are the salient features of the new regulations. The introduction of the change at this time is due to the fact that the previous stock of cloth and personal equipment has been completely used up during the present war. All military uniforms, it is understood, with the exception of those of the jaeger regiments, will be made of field-gray. The sharpshooters, or jaegers, will be clothed in green-gray. One cut of gray trousers and one style of black boots will be worn in every branch of the army. An officer will be scarcely distinguishable from a private. Regimental distinctions will be shown only by decorations and the facings of the uniforms, which will be of a quiet color. All trappings and harness are to be black, and haversacks gray. In time of peace it is possible that a finer cloth will be used in the officers' uniforms than in those of privates, but the color and general appearance will be the same in each instance.

### LOUD-SPEAKING TELEPHONE FOR WINDOW DEMONSTRATOR 867 H

By adapting it to meet the needs of window demonstrators, who advertise special commodities on sale at retail stores, a new and rather practical use is being made of the loud-speaking telephone. A pair of megaphones is mounted on the outside of a building at a convenient height and provided with

#Hebert Metz  
342 Flushing Av.

(Mason) B. H. Hogan, L. I. Copyrighted material

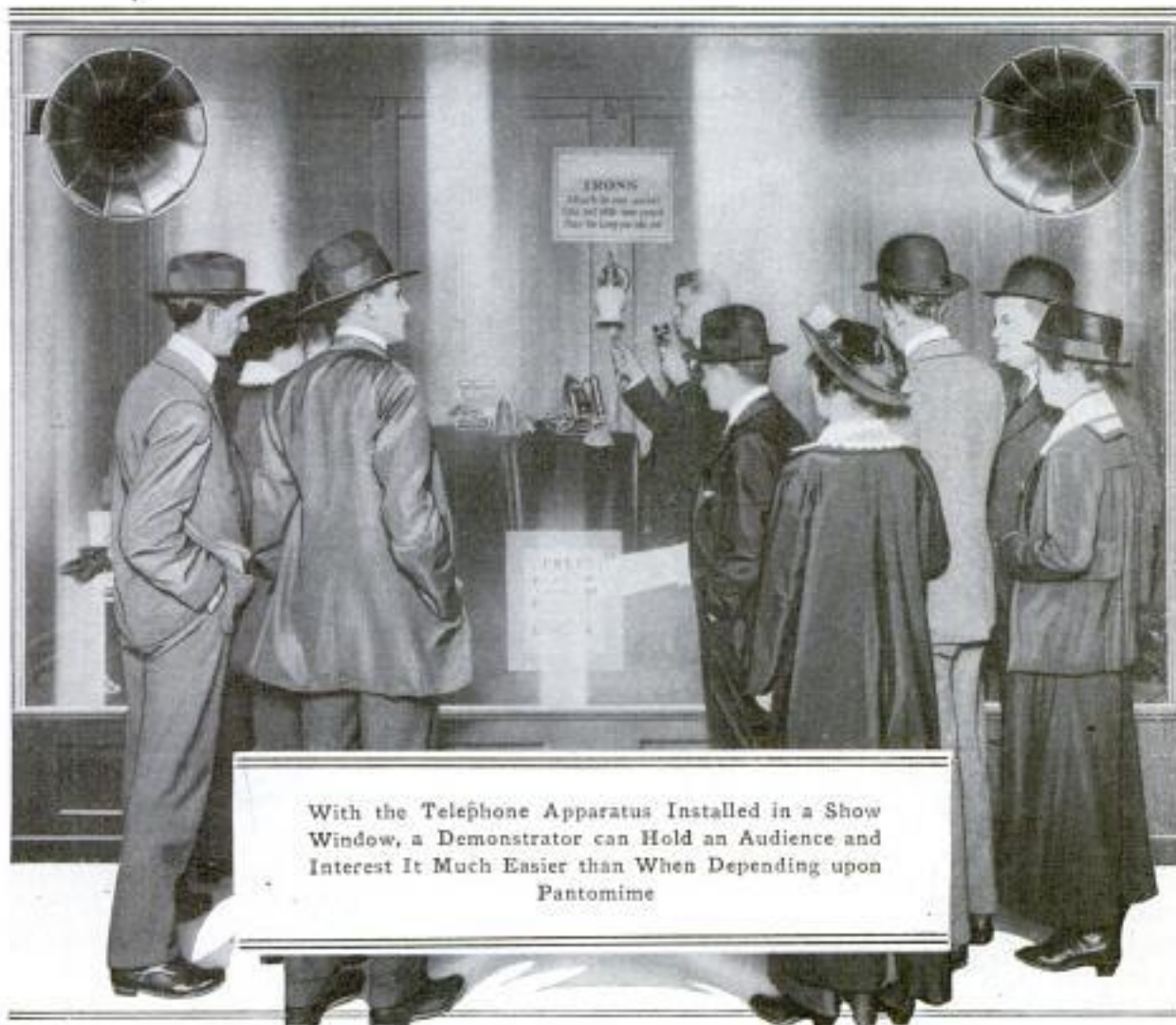

With the Telephone Apparatus Installed in a Show Window, a Demonstrator can Hold an Audience and Interest It Much Easier than When Depending upon Pantomime

receivers which are connected with a transmitter. With this facility a demonstrator is enabled to make his discourse clearly understood by an audience on the sidewalk in front of him, instead of having to depend upon pantomime, or printed cards, to convey his message. In addition to the opportunity it affords for putting across snappy, business-getting talks, the use of the equipment in this capacity acts as an added attraction, as its novelty serves to draw the attention of passers-by to a window.

674  
 A  
**AUTO WINDSHIELDS ARE  
 CLEANED ELECTRICALLY**

A means has been devised whereby automobile windshields may be kept clear of frost and snow by electricity. A coil of wire, oval in shape and perhaps six or eight inches in longest

inside dimension, is clamped against the glass of the windshield by means of springs attached to the frame. Current from a storage battery is sent through the coil, the latter having enough resistance to produce considerable heat. This heat is said to be

"Way-C"



Heat from the Coil Clamped on the Windshield Keeps Glass from Freezing Over in Winter

sufficient to melt frost and snow from the shield, at all times permitting the chauffeur a clear view ahead under the most adverse conditions.

Fuller Electrical Appliances Co.  
 Wellesley, Mass.

652  
 M  
 MAKING A JUNGLE THRILLER FOR THE MOVIES

 # Paul Henry Dowling, Stanford Univ  
 Calif

AN idea of the danger that motion-picture players are sometimes required to face in staging scenes in which wild animals take part, as well as of the careful and tedious process followed, is given in the work of producing an act in one of the serial thrillers now popular with the movie-going public. On the screen the act is shown as a continuous series of rapidly moving pictures. In the studio the whole matter has a very different look. At the start, a woman, dressed in the costume of a circus performer, is seen standing in a small inclosed "jungle" waiting for a crouching lion to spring. At a sharp command the motion-picture camera begins to click, and a few minutes later when the command "cut" is given, the camera is stopped instantly. Then, while the camera man waits, the costume of the "circus woman" is hurriedly transferred to a man of powerful build who is able to stand the weight of the springing animal, and the camera is again set going. As the man goes down under the weight of the powerful beast the camera is again stopped, and, while the lion is held over the prostrate man, the assistants tear open his shirt, paint blood stains on his back, and whip the animal into a snarling attitude over his neck just as the camera starts the third time. Next, a circus clown steps into the range of the camera, approaches the "dead woman" and grasps a jewel that hangs from her neck.

Although there was a big element of real danger in this incident, the position of the actor was at no time so perilous as it might seem. The lion had been subjected to a long series of rehearsals for this particular act, and was watched and controlled by trainers every second to prevent his making a real attack. The whip of a trainer, who stood just outside the picture, or concealed behind some of the imitation underbrush, was constantly snapping at the animal's back, while on the opposite side of the arena stood another trainer with

a loaded gun ready for instant use in case of a real attack. The man with the gun needed the utmost coolness and judgment, for the lion used in the act is valued at \$16,000, and a shot, except in case of necessity, would have been a costly and disastrous mistake. In spite of all the precautions that it was possible to take, it undoubtedly required the highest class of nerve for the man to lie still under the savage beast while its jaws hung menacingly only a few inches from his neck.

The "jungle arena" in which this act was produced is part of a Los Angeles establishment, recently placed in serv-



ice and said to be the largest and best arranged in the country. The arena is a six-sided inclosure, about 140 feet wide between parallel sides, and in it all the wild-animal acts are staged. It is divided into six triangular sections





Typical Scene in a Los Angeles Movie "Jungle." The Picture Below Shows How the Arena is Divided into Sections with the Camera Island at the Center; Section at Back is "Made Up" for an Arctic Scene

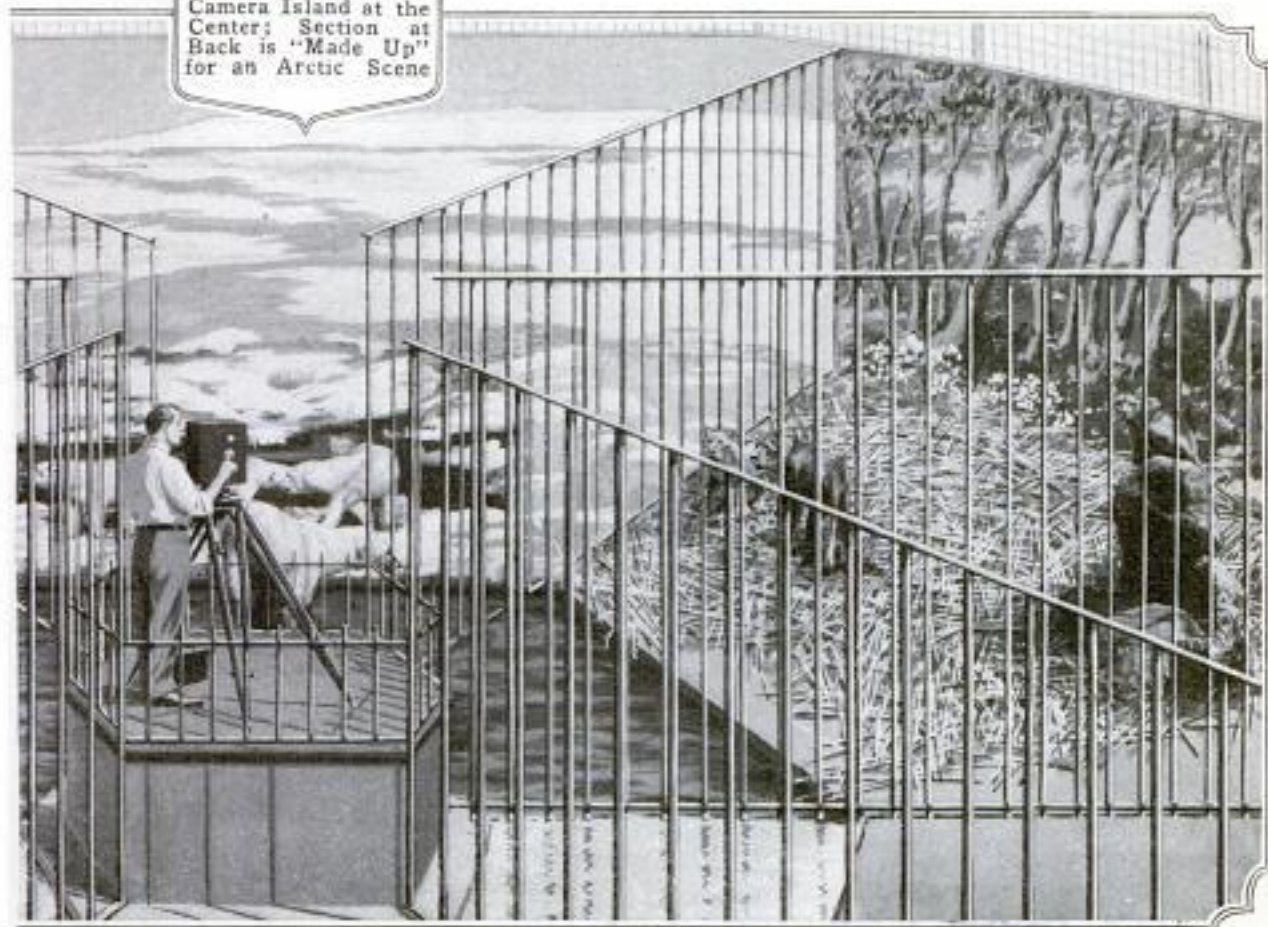

by iron fences running from the center to the junctions of the sides, while at the center is the camera island, a concrete platform inclosed by an iron fence. Each of these triangular sections constitutes a separate "jungle,"

so that it is possible to have six acts going on at one time. Encircling the camera island is a moat, 6 ft. wide and 4 ft. deep, which is kept filled with water as a protection for the camera man and director as well as a means

of escape for the players in case of necessity. The dividing fence extends only a few inches below the surface of the water in the moat, so that all a performer has to do to escape a threatened attack is to dive into the water and come out in the adjoining section of the arena.

These "jungles" are in many ways as artificial as the setting of a theater stage, about the only real objects being the dead trees scattered about the inclosures. The wooden exterior walls carry painted landscapes. Sand and

straw make the ground of the forest, while even the boulders on which the animals crouch are artificial, being made of wood and wire, well plastered with brown clay. In spite of the facts that the jungle is "made up," and that it is inclosed by fences over which spectators watch the proceedings, the finished picture is as realistic as the real thing. Not only the jungle, but arctic scenes as well, are regularly staged in this arena, a liberal application of white paint being sufficient to give a perfect illusion of snow and ice.

**CHAMPAGNE BOTTLE THROWS  
HIDDEN CONFETTI**

Americans, when in the mood for throwing confetti, or rice, or old shoes, generally do it by the sackful. A French dealer has figured out what he evidently considers a more refined way. Just beneath the stopper on an imitation champagne bottle he places a charge of confetti in a capsule. Upon

opening the bottle a spring mechanism shoots the confetti out into the faces of the would-be imbibers of spirits. The innocent appearance of the bottle, together with its possibilities as a present for newly wedded couples, or New Year's celebrators, or the like, has made it a novelty of some attraction among practical-joke enthusiasts.

**GOOSELIKE MONITORS PROOF  
AGAINST TORPEDOES**

Monitors of a very queer sort were introduced not long ago at the Dardanelles by the allies. Amusing descriptions of these craft have been printed in London, but in spite of their ludicrous appearance it seems that they are real factors. Some time ago when one of the boats first put in at Kephalos Harbor in the Ægean it caused consternation. Instead of steaming in like an ordinary war vessel, it seemed to waddle through the water like a huge goose, and from a distance looked as if it were showing its bow to the stern. A large turret is carried on a high, flat deck. This mounts two 14-in. rifles. Just below the surface of the water the sides of the monitor bulge out about 10 ft. and then curve down. This peculiar hull construction accounts for the clumsy movements of the vessel, but it is said to make it proof against torpedoes. The ship is large and roomy. The only armament it carries in addition to the heavy guns are aerial rifles.



Innocent-Appearing Champagne Bottle Discharges  
Confetti upon Opening

Comptoir de l'Acier et du Fer, Paris, 3138  
43 Blvd. d'Alsace-Lorraine

912

*Shipping World*  
10727/15 p 208

857

ORGANIZATION OF NEW YORK "AEROPLANE MILITIA"

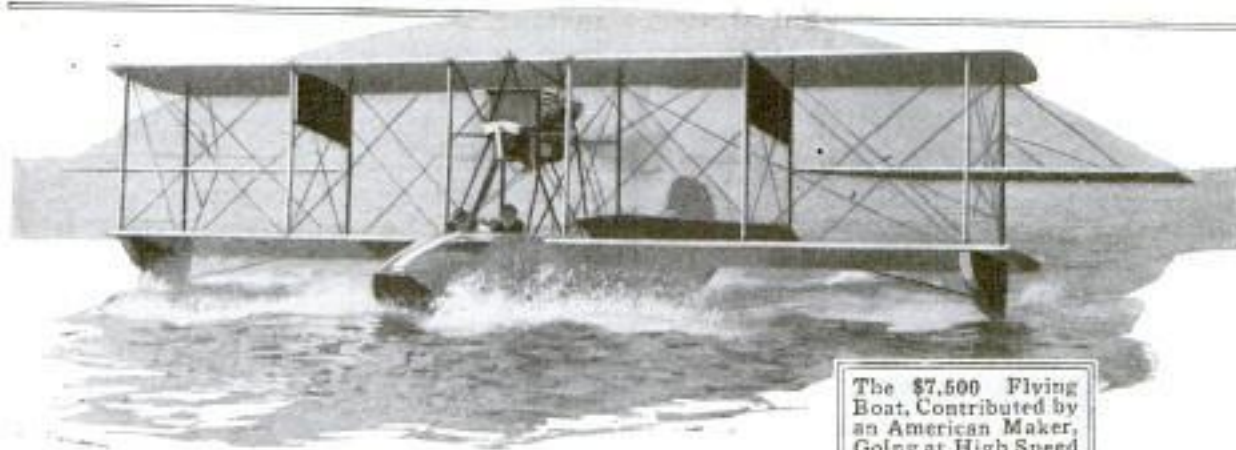

The \$7,500 Flying Boat, Contributed by an American Maker, Going at High Speed and at the Point of Rising from Water



The Flying Boat Ready for the Christening, with Naval Officer Who will Instruct the Flying Corps

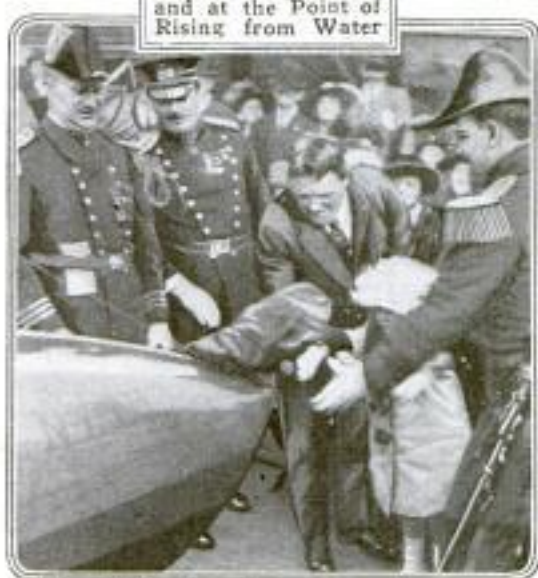

The Christening Ceremony: One of the Impressive Features of the Organization of the "Aeroplane Militia"

A beginning was made in the development of an element of vital importance in national defense when, on Nov. 1, 1915, the flying corps of the New York naval militia was organized. The important feature of this organization is that it is a part of the national guard and is composed of civilians who have volunteered to undergo the training that will fit them for service as airmen in case of war, and it is believed the idea is one that will be adopted in other states. The corps is to be instructed by officers of the United States Navy. When the organization of the corps was first proposed, Glenn H. Curtiss, a maker of aeroplanes, offered to contribute a flying boat of the most up-to-date type, estimated to cost about

\$7,500, as announced in this magazine at the time the offer was made. One of the features of the impressive ceremonies accompanying the organization of the corps was the christening of this craft, which was conducted after the manner of the christening of a naval vessel.

**MOTOR FOR MAKING BICYCLE INTO MOTORCYCLE \$35.00**

A complete gasoline motor so small and light that it can easily be held in the hands has been designed for making a bicycle into a motorcycle at the will of the owner. The motor fits within the frame of any diamond-frame bicycle, and the power is applied

*Cyclomotor Corp.,  
Arlington Bldg.,  
Rochester, N.Y.*

through a hoop-shaped belt pulley that is attached to the spokes of the rear wheel. The entire equipment weighs 21 lb., but provides power for driving



This Motor can be Fitted to Any Diamond-Shaped Bicycle Frame; Power is Transmitted through a Hoop-Shaped Belt Pulley Attached to the Spokes of the Rear Wheel

the bicycle at a speed of 25 miles an hour on level roads. A gasoline tank having a capacity of  $\frac{3}{4}$  gal. forms part of the equipment, and it is claimed that this supply is sufficient for carrying the rider a distance of from 60 to 70 miles. The principal advantage claimed for the motor in addition to its low cost is that it provides a light, clean, and durable motorcycle that is more easily handled and is less expensive to operate than the average ready-built machine.

#### PART-TIME SCHOOL STARTED BY COMPANY FOR BOYS

914 *Chicago Tribune 10/16/15*  
In the offices of a Chicago company where more than a hundred boys are employed, a very interesting educational experiment is being conducted. Three days each week between noon and two o'clock every boy attends school. This represents an instance of a large business organization attempting to overcome the detrimental effects of blind-alley jobs and to enable half-schooled youngsters to improve their status while employed. The man responsible for the execution of the plan asserts that the company has always

found the disposition of old office boys a difficult problem. In the majority of instances they are entirely unfitted to hold clerical or other positions of responsibility when the time comes that they are too old to serve longer as office attendants. By giving them the advantages of a part-time school it is hoped that they will be able to develop sufficiently to hold better places with the company instead of eventually being discharged. When the plan was suggested to the boys they all gave it hearty support and enrolled.

#### AN ARTISTIC TELEPHONE COVER

817  
One of the latest and most attractive of telephone covers consists of a shell made in the form of a globe around the lower part of which, as if furnishing support, is arranged a number of delicately modeled figures. On the globe the surface of the earth is shown in relief. The shell is made of wood fiber and is strong but light. It consists of two pieces which are hinged together at the back, and is of such size that when closed it entirely conceals the telephone. The cover is finished either in ivory or old gold.



This Telephone Cover Consists of a Hinged Shell Made of Wood Fiber

Chicago Telephone Co. Wm. H. Hoops & Co.  
212 W. Washington 531 So. Wabash av.  
Chgo. Chgo.

# GAMES FOR THE BLIND WHICH MAY BE PLAYED ANYWHERE

By HAROLD MOLTER

*Principal of Boys' Department, Perkins Institute for the Blind*

*Waltham, Mass.*

AT a recent exhibition of the activities of blind children, the visitors were very much interested in the amusements of the boys and girls. A gymnastic exhibition in a school for blind children differs very little from one given at a gymnasium for seeing children, for it includes calisthenics, marching, apparatus work, and pyramid building. The boys play "hockey" with a tin can, on a cement floor, and "football" with the assistance of sighted players. The girls dance and play ring games with pleasure and ease, so that to a visitor there would seem to be little difference between the amusements of a blind and a seeing person. In running, wires are often used as guides, and for some games, bells are placed inside of footballs and baseballs.

When we examine the quiet games, we find that certain devices are usually necessary to enable the blind player to play the games of his sighted associates. The Germans have proven themselves the most active and versatile in preparing games for the blind, and it is interesting to note in this time of war, that their game of "siege" is characteristic of how these people train their children, in times of peace and play, to think about military strategy. A number of games here pictured have been imported from Germany. Any amateur mechanic can make all of them, and as the apparatus is light and easily handled, the games may be played anywhere—in the home having one or more blind members; on a park bench where blind friends are wont to meet on sunny days; or in factories or offices during lunch hours.

In general, wood is the most convenient material to use. Lines may be represented by little tacks, raised strips of wood or cardboard, or grooves. The grooves are the least desirable, for, to the fingers of a blind

person, a raised line is easier to follow than a groove. In the case of checkers and similar games, the little disks, or indicators, should have small projections underneath, which will fit into holes drilled in the proper places in the board, as in the mill game. In others, the board consists of little pockets formed by thin strips, as in halma. Sometimes it is possible to use thick cardboard in place of wood, for the playing board. This should be varnished or shellacked after the cardboard has been put into proper form.

Any game of cards may be adapted by using the raised dots which represent letters. These dots are punched by means of a sharp-pointed instrument called a stylus, which resembles an awl. The raised part of the dots should be on the face of the card. Blind people enjoy using cards with pictures, and for that reason the game of "baseball" is very popular. Plain cards are often used, however.

The solitaire games are interesting to those who have much time to themselves. The "pyramid" game consists of eight wooden disks, each smaller than the next one below it. These are moved to any one of the rods, one at a time, and always so that there is a smaller above a larger. The puzzle is solved when the whole pyramid has been transferred in its original form to either one of the rods which were unoccupied at the beginning.

The "fox and geese" game is often played with marbles. There is one unoccupied spot in the beginning and the play is as follows: One indicator (a marble or rod) jumps over another adjacent to it, and to the next space beyond, which of course must be vacant. In the beginning the center space is the only unoccupied spot. The indicator which has been jumped is removed. This operation of jumping and removing is continued until only one indicator is left at the center.

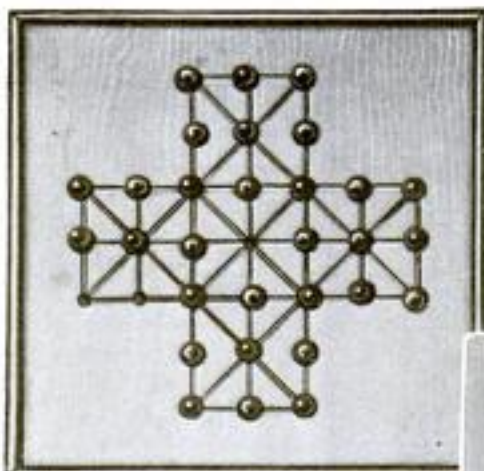

Below: Two Shapes of Checkermen, Resting in Depressions in the Board, are Used by Blind Opponents. Each Checker Has a Little Center Countersunk on One Side. When This Side is Turned Up, It Represents a King

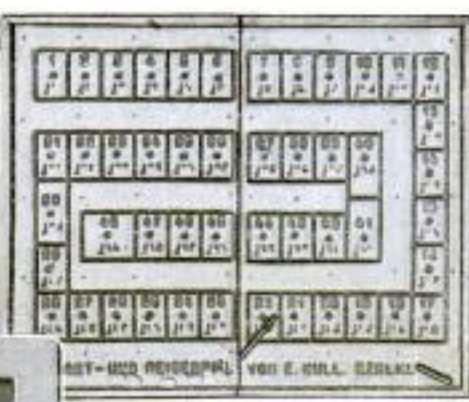

Exciting Events Occur on This Journey. The Travel Game Comes from Germany. Dice are Thrown to Determine the Route of the Traveler, While Pins Indicate His Location

Board for Playing "Fox and Geese": By a Process of Jumping, One Man should be Left in the Center at the End of the Game. Marbles are Used for Men

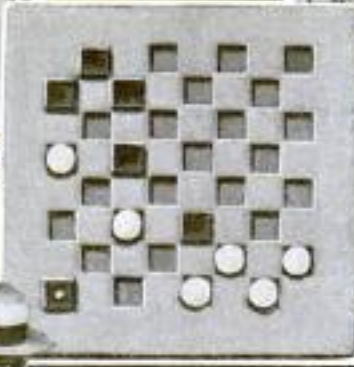

Blind Men Enjoying a Quiet Game of Checkers on Roof Garden for Jewish Blind, East Side, New York City



Lotto with Beads or Beans for Covers, and Holes in the Cardboard Number Sheets. The Figures are Raised and Dotted Characters are Used. This Old Game is Very Popular with the Blind



Above: Interlocking Dominoes are Cut from Compact Paper. Little Tacks are Used as Dots. Left: Archball. The First Girl in Each Line Claps Her Hands or Calls to the Girl Who Has the Ball

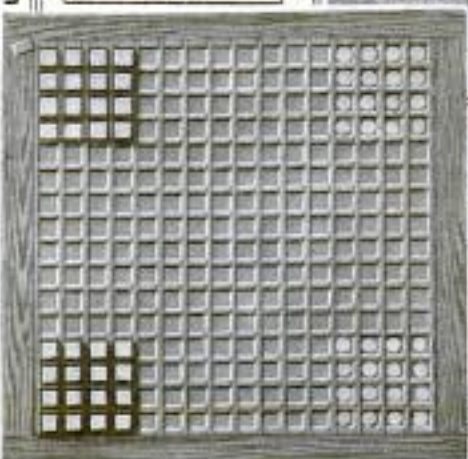

Left: Halma. The Wooden Indicators are Cut into Different Shapes at the Top for the Different Players

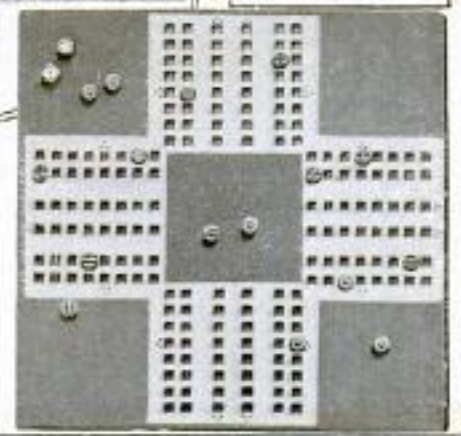

Right: Cardboard of a Very Durable Sort is Shellacked and Makes a Splendid Pachisi Board

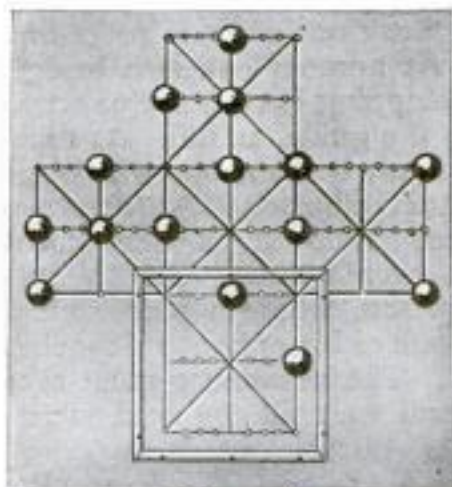

The Two Pictures Immediately Below Show Playing Cards for the Blind, Having Raised Dots to Represent Letters, and Two Blind Persons Deeply Engrossed in a Game

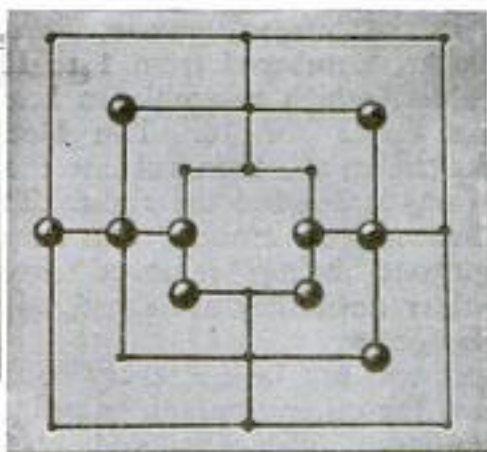

"Siege"—a Good Preparation for Chess: The Besieged Holds the Fort with Two Men. The Besieger Tries to Take the Fort

"Mill"—a Lively Game Originated in Germany: Three Men in Line Make a Mill, Causing the Opponent to Lose a Man



A German Game of Authors: These Carry the Information in Braille, but Blind People Like Pictures on the Cards as Well

AMERICAN BRAILLE ALPHABET AND NUMERALS.

⠠	⠠	⠠	⠠	⠠	⠠	⠠	⠠	⠠	⠠
a	b	c	d	e	f	g	h	i	l
k	l	m	n	o	p	q	r	s	t
u	v	w	x	y	z				
⠠	⠠	⠠	⠠	⠠	⠠	⠠	⠠	⠠	⠠
1	2	3	4	5	6	7	8	9	0

*In Print, Light Dots.*  
*In Braille, Print.*

"Fifteen"—a Game of Solitaire, and the "Pyramid," Always a Smaller Above a Larger

The Braille System of Reading for the Blind Consists of Combinations of Six or Less Dots in Different Positions

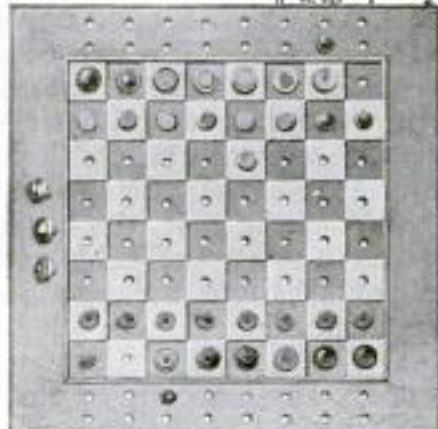

Left: A German Chess Board. The Light Squares are Raised, the Darker Squares are Lowered  
Right: An Ingenious Arrangement of the Old Game of Backgammon: The Cross Pieces Are Thin Strips of Wood

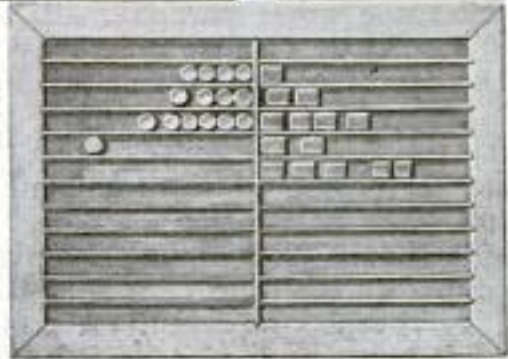

In the "fifteen" puzzle, there are 15 blocks, numbered from 1 to 15. The holder, which resembles a box cover, has space for 16. The blocks are shaken up and then put into the holder in any order but the right. They are then moved around, one at a time, without being removed from the holder until they are arranged in regular order.

It will not be necessary to describe how the other common games, such as dominoes, checkers, and chess, are played, but the three German games of "mill," "siege," and "travel" require some explanation. For the mill game there are 18 disks, nine for each of the two players. The disks are marked or shaped in two different ways, so that each player can distinguish those which belong to him. "A" places a disk on the board, in one of the little holes. Then "B" places one. Thus they continue, each one trying to place three of his own in line along the grooves, and at the same time trying to prevent his opponent from getting three of his disks in line. Three disks in a line, along a groove, constitute a mill. If a player succeeds in forming a mill, he is entitled to take one of his opponent's disks from the board, and keep it. When all of the disks have been placed, the players take turns in moving one disk at a time from one hole to an adjacent one, along the groove, thereby trying to form mills. When a player has only two disks left, he loses. When the disks are so arranged that neither player can move, the game is called a tie, and must be started anew.

The travel game is played with two dice and the other paraphernalia, as pictured. Little pins or tacks may be used to represent the eyes of the dice. Each player has a distinguishing pin as his "traveler," and moves along the squares according to the number recorded when he throws the dice. A guide is chosen from among the players, who receives from each four buttons or beans, representing travel money. When a player comes to a number which is already occupied, he

takes his position on the preceding number. At number five is a bridge. A player stopping here must pay two buttons to the guide, as toll. At nineteen is an inn, where anyone who stops has to pay three buttons. At forty-two is a maze. Who stops here must return to twenty-three. At twenty-five is a prison, where a player must stay until one of his opponents touches the prison. The newcomer must take his place and wait till the next victim comes. At thirty-eight is a grave. This means death, and the player must begin anew. Forty-five is a great obstacle. One pays two buttons and misses his turn at the dice thrice. He who touches at points twenty, thirty, and forty, may advance ten spaces. When a player throws just enough to carry him into forty-eight, he wins the game and receives all of the money from the guide.

The game of siege may be played by two players, the besieger and the besieged. The latter holds the fort (the little square with nine holes) in which he sets his two men, the pointed figures in the picture. The remainder of the board, consisting of 24 holes, is occupied by that many figures, the soldiers of the besiegers. All holes are connected by grooves or tacks. The besieged may move his men forward or backward, along all lines within and without. The object of the besieger is to occupy the holes within the fort. The besieged moves first, and alternates with the besieger. They move one hole at a time, and only one figure at a time. The besieged may move a besieger from the field, and occupy his place if the latter has an unoccupied hole behind him, and is directly confronted by the besieged from before. Where there are two, or more, besiegers in line, with an unoccupied hole between them, and the besieged is directly in front of the first, the latter may remove both from the field, and occupy the point behind the last besieger thus disarmed. Under these conditions alone may the besieged return at once to an unoccupied hole within the fort. If all points are occu-



pied there, the besieged must consider himself captured, and the fort lost. When the besieger has only nine men left, any of whom do not occupy the fort, the besieged wins. If the besieged is locked in the fort, so that he can make no further move, he loses the game. When the besieged is locked in and there are not more than nine

besiegers, the game is a tie and neither party wins.

These games, so commonly used in institutions, should be introduced into every private home which has one or more blind members. They afford pastime without danger, and the sightless soon become proficient players and often worthy opponents of anyone.

### 855 HUMAN WRECKS IN NOVEL EUGENIC PARADE

The dependent, alcoholic, criminal, and illiterate classes were individually represented by four men having the appearance of human wrecks who paraded through the Wall Street district of New York recently. The novel feature of the parade, or "exhibit," was that each man carried a sign calling attention to his particular deficiency and questioning his own right to have children. The

evident purpose of the parade was that of presenting a convincing argument in favor of eugenic marriage, and it is said to have been organized by a medical journal that is conducting a campaign for the promotion of this reform. The paraders with their unique signs were successful in attracting the attention of thousands of spectators along the streets.

Illuminating gas is being produced in Sweden from old railway ties.

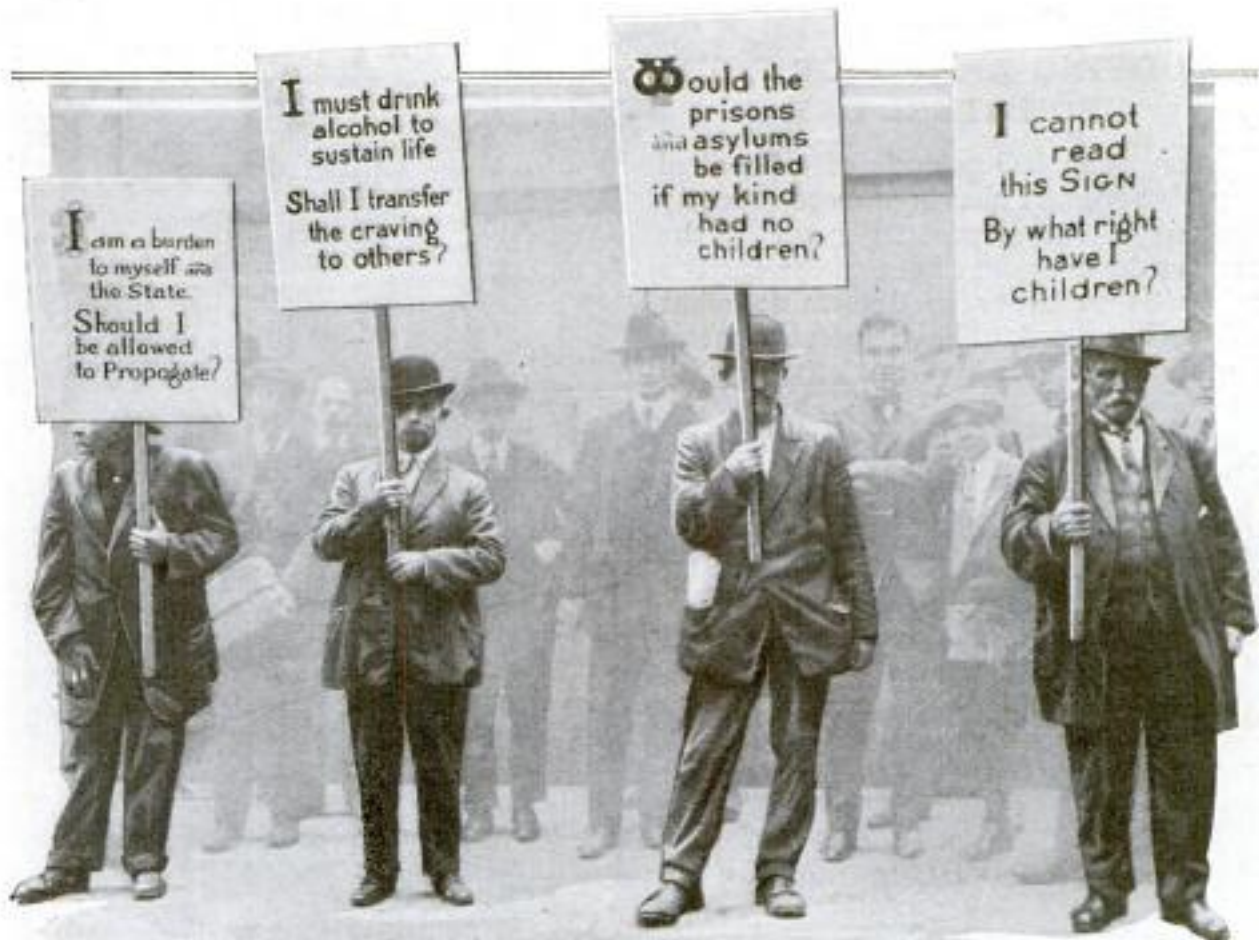

"Down-and-Outs" as They Appeared in a Eugenic Parade through the Wall Street District of New York

*Medical Reviews of Reviews,  
206 Broadway New York*

**SUCCESSIVE RECORDS ARE  
PLAYED AUTOMATICALLY**

9561

A phonograph has appeared which is designed to play a number of records



in succession, and to make the change from one record to the next automatically. Twelve wax cylinders may be placed on the machine at a time, a revolving-wheel arrangement bringing one record after another under a diamond-point

reproducer. Setting a convenient push button controls the number of selections the machine renders before stopping.

great heat, but without causing distortion or serious injury to the car proper. Some of the upholstering, paint, and window panes were damaged, of course, but this was expected, naturally. The result of the experiment showed that the car was capable of withstanding fire and therefore up to the standard demanded by the company in that particular. The incident furnishes an interesting example of the thorough manner in which some railway companies test equipment and supplies before accepting them.

**EASY ARMCHAIR AND BED  
MADE IN ONE PIECE**

742

One of the ingenious pieces of combination furniture that has recently been introduced for use in city flats and small houses is a large, comfortable armchair which in a few seconds may be converted into a single bed. Its framework is constructed entirely of steel, making it both sanitary and substantial. It is covered with different

**STUDYING EFFECT OF FIRE  
UPON STEEL CAR**

879

More than 200 pounds of oil-soaked rags, wood, and shavings were recently ignited in a steel passenger car by the testing department of one of the eastern railroads in order to determine what effect flames would have upon the metal framework. The material burned with

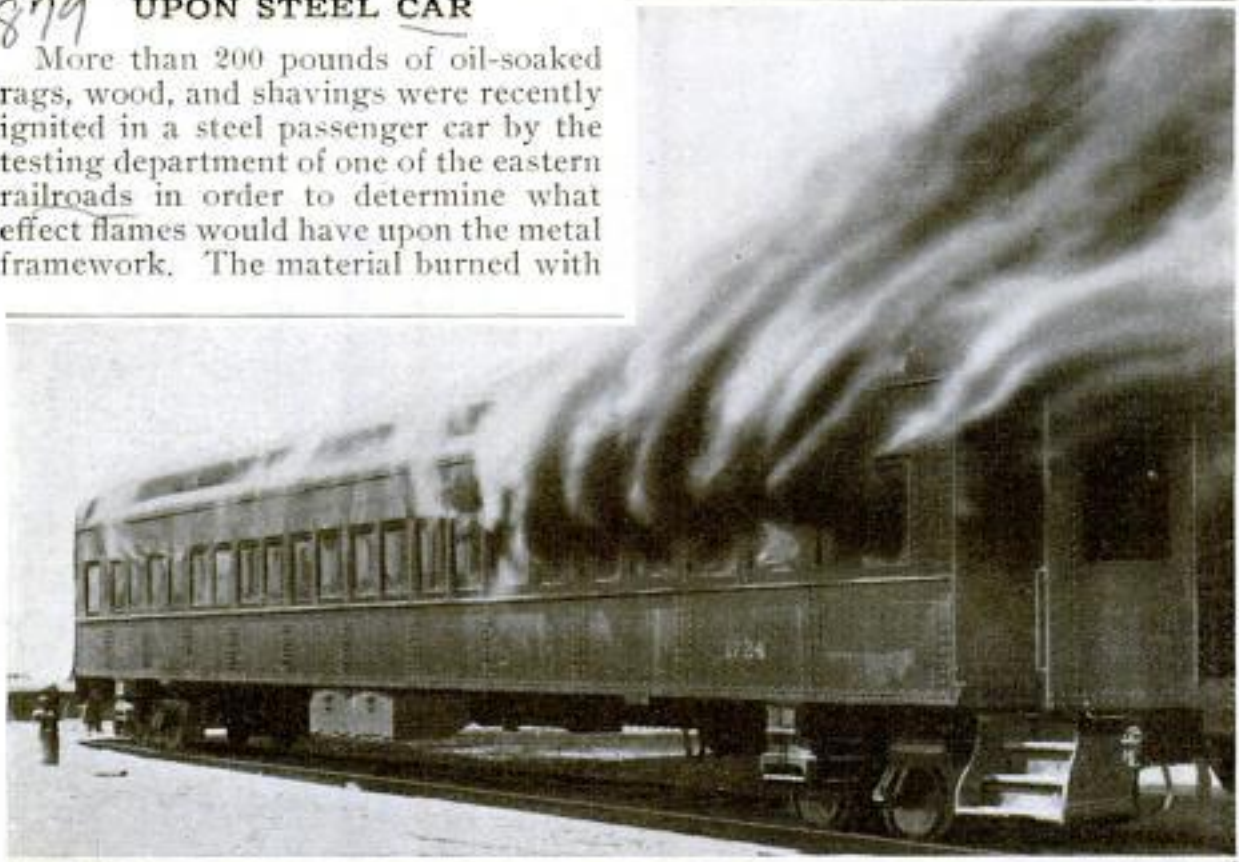

One Way of Determining the Quality of a Steel Passenger Car Is to Build a Hot Fire within It

# Stanley W. Toole  
327 McDonough St.  
Brooklyn, N. Y.

*Art Bedstead Co. not in J. 21*  
*37th + Rockwell, Chicago. 2/27/25*

**POPULAR MECHANICS**

*Living Rooms 1409 So. Mich.*



When Used as a Chair It Is Large and Comfortable. Only a Few Seconds are Required to Convert It into a Single Bed

materials, such as tapestry, leather, and velour, for living-room purposes, and cretonne, for a sun parlor, sleeping porch, or bedchamber. When unfolded, a bed, 6 ft. 9 in. long, is provided. There is sufficient space available to allow the bed to be fully made up before it is closed for the daytime. The chair is of ordinary appearance and has practically nothing about it to show that it is in reality a folding bed. When it is desired to use it as a couch, the head of the bed may be elevated to suit the user.

**HANDS ON WATCH MOVE IN 728 REVERSE DIRECTION**

A jeweler has devised a watch which runs backward, the figures on the dial being arranged in opposite direction to the usual kind. The watch was invented at the suggestion of a left-handed person who complained that it was always hard for her to tell time on the average clock, because she thought "left-handed." With the new type of dial the process of reading the hands was easier. Other left-handed persons seeing the new watch agreed that they could read it with more facility than

**MUSKOGEE TO BELT CITY WITH LONG GAS LINE**

*734*

Through the efforts of the Greater Muskogee Association, a community organization of Muskogee, Okla., the city has voted \$350,000 worth of bonds to build and operate a pipe line to the big gas fields lying near the place, for the purpose of furnishing four-cent gas in large quantities to manufacturers. The line will be made of 8-in. pipe, and will be about 20 miles in length for the part about Muskogee. A main supply line will run from this belt to the heart of Oklahoma's gas region, a distance of about 30 miles in all. It has been estimated locally that there is already enough gas developed to supply Muskogee with a hundred million feet daily, and the claim is made that the field is not more than one-fourth developed.

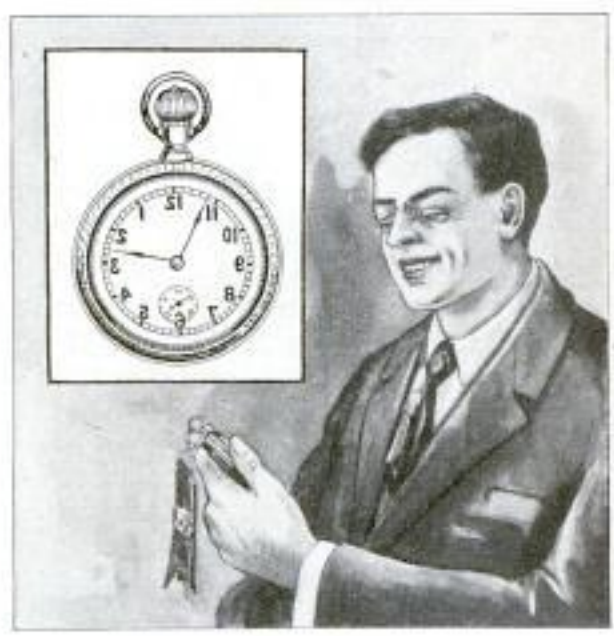

Time on This Watch Turns Backward in Its Flight

*Left Hand Clock & Watch Co.*  
*134 Potage St.*  
*Battle Creek, Mich.*

*Winter*

the other type, and in a little while there was a general demand for the odd timepiece. A company has been organized and left-handed watches and clocks in all sizes are now manufactured.

**DISTANCE GAUGE IS AID TO PHOTOGRAPHERS**

To assist amateur photographers in readily estimating focusing distances, a simple instrument has lately been

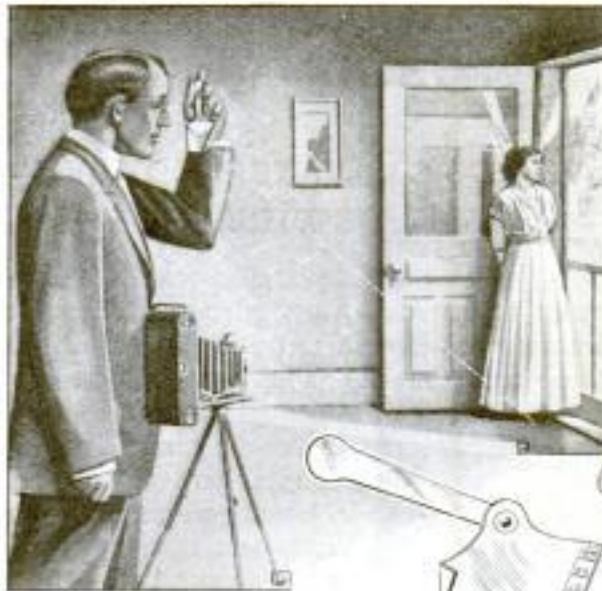

Simple Instrument Estimates Focusing Distances for Camera Work

produced. A handle is provided by which the user holds the instrument out at a convenient distance, keeping a small indicator on the contrivance in line with his eye and the base of the object which he intends to photograph. On a scale opposite the pointer the desired distance is at once indicated. For accurate work the ground between the observer and the object should be level, and the scale on the device properly suited to the user's height. For this purpose a number of scales are provided with the instrument.

Can ingenious method, just discovered, for smuggling benzine from Holland into Germany consists in inclosing benzine containers in hollowed-out spaces in the tombstones intended for the graves of German soldiers.

**KIOWA INDIAN BOYS TAUGHT FARMING**

Each of the Kiowa Indian boys attending the Riverside boarding school near Anadarko, Okla., is required to take the responsibility of tilling a plot of ground 11 ft. square. In spite of the diminutive size of these "farms," especially as judged by Oklahoma standards, the plan is said to be satisfactorily serving its purpose, which is that of providing the students with practical instruction in farming. Each of the little farms is an experiment station supplementing the work in the classroom. Recently a waterworks system was installed at the school, and a main feed ditch has been made past each of the farms. With this equipment the students will be taught the most modern methods of irrigation.

**FROM COAST TO COAST AND RETURN BY MOTORCYCLE**

What is said to be the first motorcycle trip ever made from the Atlantic to the Pacific coast and return was recently completed by two women living in Brooklyn, N. Y. On the west-bound trip a route passing through Chicago and Kansas City and then over the Santa Fe trail to Los Angeles was followed. After a trip up the coast to San Francisco, the return trip was made over the Overland route through Nevada, Utah, Wyoming, and Colorado, and through Chicago to the East. A total of five months was required for making the 6,000-mile journey.

**WHERE PARK HIGHWAY CUTS CONTINENTAL DIVIDE**

One of the interesting stretches of the new park-to-park highway, extending between Yellowstone and Glacier parks, is the continental-divide section. This part of the road has been constructed by the forest service with the cooperation of the counties through which it passes. On the crest of the Bitter Root Range at Sula, Mont., a

# Mrs E. Coultas  
Sula, Mont.

*A. W. Millam, 1132 E. 45th St., Chicago.*

*757*

*903*

*N.Y. Sun 10/13/15*

*906*

*Brooklyn Daily Eagle 10/17/15*

*Mrs. Aris Hotel (Kin?) 6900 14th av. Brooklyn, N.Y.*



Arch Marking the Continental Divide near Sula.

Montana, One of the High Points on the Road



A Mileage Post on the Park-to-Park Road

### BOUNDARY LINE

← TO ATLANTIC OCEAN      TO PACIFIC OCEAN →

BEAVERHEAD NATL. FOREST      BITTERROOT NATL. FOREST  
BEAVERHEAD CO.      RAVALLI CO.

TO	MILES	TO	MILES
BATTLEFIELD	18	BASE OF HILL	76
WISDOM	30	DARBY	32
JACKSON	48	HAMILTON	50
DILLON	95	MISSOULA	103
YELLOWSTONE PARK	233	GLACIER PARK	267

CONTINENTAL DIVIDE SECTION OF THE PARK-TO-PARK HIGHWAY CONSTRUCTED 1914 BY THE U.S. FOREST SERVICE IN COOPERATION WITH RAVALLI AND BEAVERHEAD COUNTIES

TURNOUT  
STOP AND  
LOOK AHEAD

Danger Points are Indicated by Warning Signs

One of the Information Boards Erected on the Bitter Root Range

rustic archway has been erected. About 100 yards east of this log structure is the source of Trail Creek, which leads to the Missouri River. Camp Creek, a tributary to the Missoula River, which feeds into the Columbia, begins about one mile to the west. Signboards carrying information of interest to overland tourists are attached to the supporting columns on each side of the arch. The mountainous part of

the continental-divide section is about seven miles in length and much of it is margined by cliffs and precipices. Dangerous points in the road are marked by warning signs, and the respective distances to various places are likewise given at intervals. The road will be opened to the public in 1916, and it is expected that a motor-stage service will be inaugurated between the two parks.

### CONVERT KEROSENE LAMPS INTO CARBIDE BURNERS

723

Germany's shortage of fuel oils has been responsible for the introduction of small acetylene generators which enable ordinary kerosene lamps to be converted into gas lights. These are being used particularly in rural districts and other places where electric or gas-illuminating facilities are not available.



One of the devices consists of a cylindrical receptacle that may be screwed into a lamp in place of the usual burner. It is filled with a specially prepared carbide and the lower portion extends into the bowl, which is half filled with water. This will burn for a number of hours on one charge, and gives off a brilliant light. It is refilled with carbide as the latter is needed. Lamps

designed solely for burning acetylene are also being used, but these do not represent new inventions. They are available in various sizes and types.

*Chgo Triton 1916/11*  
**REPEATING CONTACT MINES USED BY GERMANS**

916

According to unofficial advices from Paris, a new type of marine mine has been developed by the Germans and is being used off the coasts of France and Great Britain. The chain which holds the floating device in place is attached to a magazine anchor which rests on the bottom of the ocean and keeps one or more mines in reserve. When the first bomb is exploded, or removed by a sweeper, the pull on its chain releases one of the auxiliary bombs and causes it to rise from the bottom. It is not known exactly how this is accomplished, but it is assumed that some arrangement is made to permit the disengagement of the first mine from the anchor chain so that the anchor itself will remain intact. The principle is the same as that of a gun in which fresh cartridges are slipped into place as rapidly as the piece is discharged.

### GOLD MEDALS AWARDED AT SAN FRANCISCO FAIR

815

In the design of the gold medals awarded to exhibitors at the Panama-

real artistic worth. One side of the medal represents the meeting of the Atlantic and Pacific oceans, symbolized by two nude figures, a man and a woman, joining hands across the Isthmus of Panama. Under the figures is a Latin inscription the translation of which is "Man Joins What God Parted." On the reverse side of the medal are representations of the Tower of Jewels, the dominant feature of the exposition, and of the Fountain of Energy. The design was furnished by John Flanagan, an American sculptor and designer of medals and medallions. The medals, which are awarded as first



On One Side of This Gold Medal Issued by the Panama-Pacific Exposition Is a Symbol of the Meeting of the Atlantic and Pacific Oceans at Panama; on the Reverse Side Are Representations of the Tower of Jewels and the Fountain of Energy

Pacific Exposition a successful attempt has been made to produce a design of

prizes, were made at the United States mint at Philadelphia.

*Denver & Rio Grande R.R. Co.  
 Denver Colo.  
 F. A. Wadleigh Pass. Trf. Mgr.  
 Designed by John Flanagan,*

Chic. Herald 10/11/15  
" Tribune 10/20/15

**DOTS AND DASHES ARE USED  
IN TALKING TO EDISON**

888

For many years the deafness of Thomas A. Edison has been a thing of quite general knowledge. In this connection two rather interesting incidents have happened of late. During an early meeting of the naval advisory board an associate of Mr. Edison was seated beside him. When remarks were addressed to the inventor, and also when he wished information, he and his companion communicated in the Morse code. This was done by one of them tapping gently with a forefinger against the other's wrist.

It was shortly after this that a banquet was given at San Francisco by local telegraphers in honor of Mr. Edison. Telegraph receivers were arranged before various of the guests, senders placed in front of the speakers of the evening, and the instruments connected to wires, which were carried around the table on miniature poles. The address of welcome as well as all of the subsequent talks, including Mr. Edison's, were tapped off in code, making the occasion a speechless one.

**MOTOR-CAR ATTACHMENT  
COUNTERACTS GLARE**

*Antisuccess*  
*Shield*

A light diffuser designed to be carried on the windshield of an automobile



is the latest means for counteracting the glare from the headlight of an approaching car, as well as for preventing the eye strain caused by the glare of

the sunlight on the roadway. The device consists of a square of special amber glass mounted in a frame made up of brass rods and so arranged that the glass can be placed in any position to suit the line of vision of the driver. The device is easily attached to the windshield or removed from it when not needed.

**LIVING TREE USED AS A  
"GIN POLE"**

629

A Douglas-fir tree of large dimensions that happened to stand in the right position for the work in hand was cut off a hundred feet from the ground

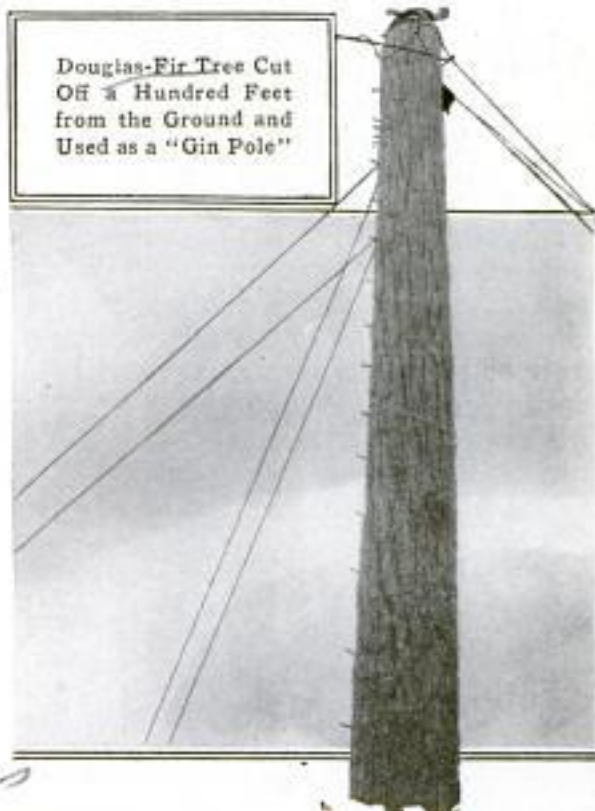

Douglas-Fir Tree Cut Off a Hundred Feet from the Ground and Used as a "Gin Pole"

and then used as it stood for a "gin pole" in handling timber during a recent government timber sale in the Wind River Valley in Washington. Preparing the tree for this use was recognized as a dangerous undertaking, and the foreman accordingly called for volunteers to do the work. The workmen first climbed the tree by means of telephone climbers and straps. The tree was about 200 ft. in height. The lower branches started at a height of about 100 ft. above the ground, and it was at this point that the top was cut off. The hazardous work of cutting off the hundred-foot top with its heavy branches and letting it drop to the ground was accomplished without accident. Then the iron bolts that serve as steps for reaching the top were driven into the tree and the novel "gin pole" was ready for the installation of the necessary lines and pulleys.

# Mrs. George T. Miller, Forest Service, Portland, Oregon.

San Francisco, Calif.  
Safety Headlight & Sun Glass Diffuser  
3/18/16

# E. R. Neil  
Box 112  
Los Altos, Calif.

# S. M. Yance, Gen. Supt. of Plant,  
W. U. Tel. Co., 195 Broadway  
NEW PRINTING TELEGRAPH SYSTEM HAS GREAT CAPACITY  
New York  
824

**S**TRIKING efficiency in telegraphic communication has been reached of late through the development of a new transmitting and receiving mechanism which is rapidly being put into general use in large cities throughout the country. It is a printing telegraph system of pronounced flexibility which materially increases the traffic-carrying capacity of existing wire facilities.

The apparatus is quite complex in some particulars. It is so simple in operation, however, that it obviates the need of employing telegraphers and resolves the work of sending and receiving messages to a simple routine of operating a typewriter keyboard and tearing off one communication after another as they are printed on a roll of paper. In this way a girl, entirely unversed in the Morse code and the use of a key, but experienced as a typist, is made just as capable of sending a telegram from New York to Chicago, or some other point, as if she were a veteran telegrapher.

Important as is this phase of the system, it is quite incidental when compared with some other of the attributes of the apparatus. The high-speed transmission and great volume of traffic that may be handled over one line represent the vital points of this invention. Although not representing the limit of flexibility of the system, quadruple-duplex operation is made possible. By this it is meant that four channels in each direction are provided on a single line. While greater speed is easily attained, 45 words a minute is the average rate of transmission used, which means that 180 words may be sent in each direction over a wire in one minute, or a total of 360.

The instruments included in the new equipment consist essentially of a tape perforator, electric transmitter, a distributor, a receiving printer, and an automatic controller. To understand the operation of these devices it is first necessary to differentiate between tape transmission and the old method. The code used is known as an equal-letter,

five-unit plan. Each individual signal requires exactly the same line-time for transmission and consists of five units, whether it represents a letter or a figure. A narrow tape is punched crosswise, each line of holes representing some specific character. This is done by a small machine fitted with a standard typewriter keyboard. When the letter "A" is struck, the tape is perforated with five holes representative of that letter in the code. An average of about 45 words a minute are punched in this way. The tape, as it is perforated, is extended to the transmitter. Fingers in this instrument pass through the holes and operate a series of levers which set up in turn the proper combinations for the signals.

Positive and negative impulses sent out by the transmitting mechanism actuate the printing receiver at the other end of the line and cause the message to be typed out. Every function performed by the printer is controlled by the perforations in the distant tape, even to the extent of line spacing and carriage shifting.

This explains roughly the manner in which the telegraphing is done. The most salient feature, however, is that not merely one message may be transmitted in each direction over a line in this way, but four messages in each direction, or a total of eight, simultaneously. This obviously requires the use of a battery of four transmitting and receiving instruments. The device known as the distributor makes this possible by alternately connecting first one and then another of the transmitting and receiving instruments for a brief flash in which one signal is sent. Thus in sending four distinct messages, a single letter of the first, second, third, and fourth is sent successively, and the routine then repeated. From this it may be seen that when a signal is being sent from one transmitter to a receiver, the other three senders and printers are not literally in operation.

Of the several instruments used, the distributor is the most interesting. To





The Above Instrument, a Distributor, Makes the Multiplex Operation Possible. It Is by Using an Apparatus of This Kind at Each End of a Line that the Signals Rendered by Different Transmitters are Directed to the Proper Receivers. At the Right Is a Perforator

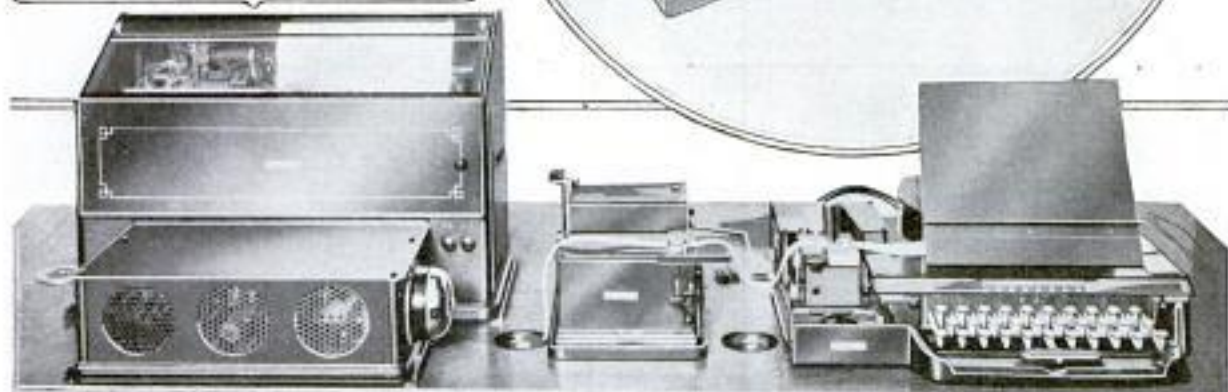
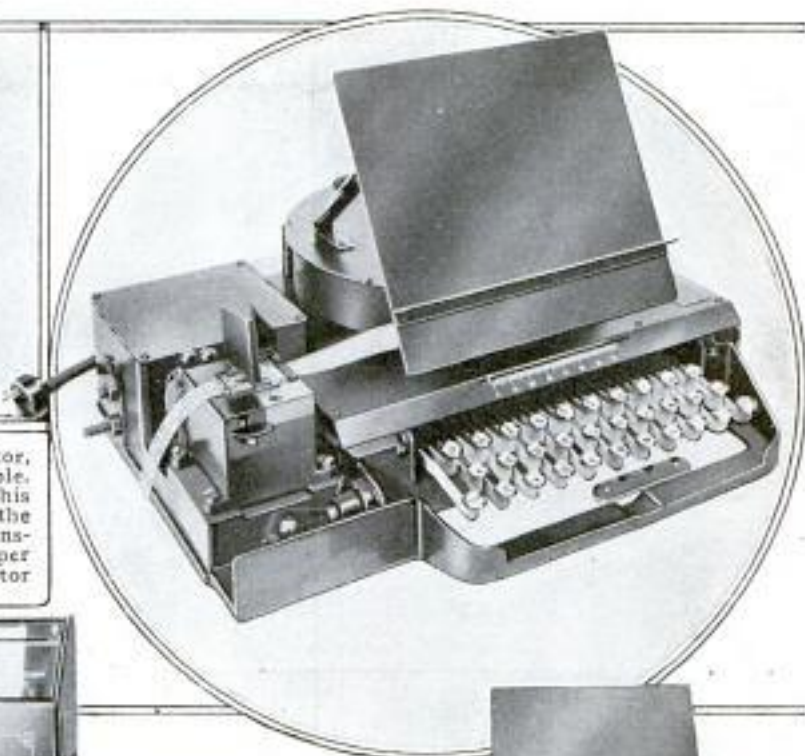

LOWER CASE	UPPER CODE	1	2	3	4	5
A	—	—	—	—	—	—
B	?	—	—	—	—	—
C	:	—	—	—	—	—
D	8	—	—	—	—	—
E	3	—	—	—	—	—
F	CITY	—	—	—	—	—
G	&	—	—	—	—	—
H	8	—	—	—	—	—
I	8	—	—	—	—	—
J	3	—	—	—	—	—
K	)	—	—	—	—	—
L	(	—	—	—	—	—
M	.	—	—	—	—	—
N	4	—	—	—	—	—
O	9	—	—	—	—	—
P	0	—	—	—	—	—
Q	1	—	—	—	—	—
R	4	—	—	—	—	—
S	THROUGH	—	—	—	—	—
T	5	—	—	—	—	—
U	7	—	—	—	—	—
V	:	—	—	—	—	—
W	2	—	—	—	—	—
X	/	—	—	—	—	—
Y	6	—	—	—	—	—
Z	—	—	—	—	—	—
CARRIAGE RETURN	—	—	—	—	—	—
LINE FEED	—	—	—	—	—	—
LETTER SHIFT	—	—	—	—	—	—
FIGURE SHFT	—	—	—	—	—	—
SPACE	—	—	—	—	—	—

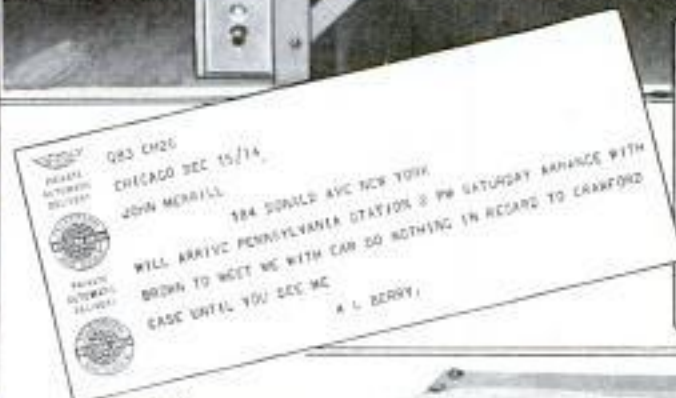

Extending from the Perforating Machine, Shown at the Right of the Instruments Grouped Above, Is a Transmitting Tape Which is being Fed into a Sender. Next to the Letter Is a Receiver Which Prints the Messages Ready for Delivery in the Form Shown at Left

The Arrangement of the Five-Unit, Equal-Letter Code is Shown at the Left. Just as Much Line-Time is Required in Sending One Character as Another. The Five Signals Shown below the Alphabet are Used in Controlling the Printer. A Close View of the Transmitter is Given at the Right



describe it briefly, its face is made up of concentric, segmented rings over which a series of contact brushes revolve. The outer of these is the receiving ring; the second, the correcting ring; the third, the sending ring; the fourth, the local ring, and so on. The outer one may be considered as being divided into quadrants, each including 10 segments, of which only alternate ones are used for selecting purposes. The third, or transmitting ring, is similarly divided and consists of 20 segments. A distributor is used at each end of a line, the sending ring of the one selecting the impulses and permitting their transmission to the quadrants of the receiving ring on the other.

Since a single signal is rendered by five distinct impulses, it may be seen that one of its units is transmitted from the sending ring of the distributor each time the contact brush passes over one of the five segments in any one of the quadrants. The distributors at oppo-

site ends of a line run in synchronism, so that when contact is made with one segment the impulse goes through the proper plate on the receiving ring of the other instrument and is thus conveyed to a specific printer. The synchronism is maintained by a very ingenious method through which the signaling impulses are made to provide correcting impulses.

The automatic controller, previously referred to, stops the sending instrument when the tape becomes taut. Thus when the perforating machine is not in operation, the transmitter continues its work only until it has taken up the slack in the tape, when it begins sending out spacing current which produces no effect upon the receiving printer at the opposite end of the line.

This explains only one of several methods of operation which are possible with the new system. Two-way operation, double-duplex, triple-duplex, and other methods, may be employed.

### AUTO TRACTOR PERFORMS HEAVY HAULING FEAT

833 An eastern contractor was recently confronted with the task of moving a 33-ton boiler a considerable distance cross-country from one power plant to another. At first he intended using horses for the work and figured it would take at least 28 of the animals to pull the heavy weight, together with a possible 10 or 12 more to help get the

thing started. However, an opportunity unexpectedly presented itself to make use of a gasoline tractor for the work. The tractor was rated at only 5 to 15 tons' capacity and the boiler and wagon weighed 41 tons in all. Curiously enough the tractor started this immense load without assistance and hauled it safely to its destination.

¶With a view to closer commercial relations with the United States, the republic of Bolivia, South America, is using motion pictures to advertise its industries among the business men of this country.

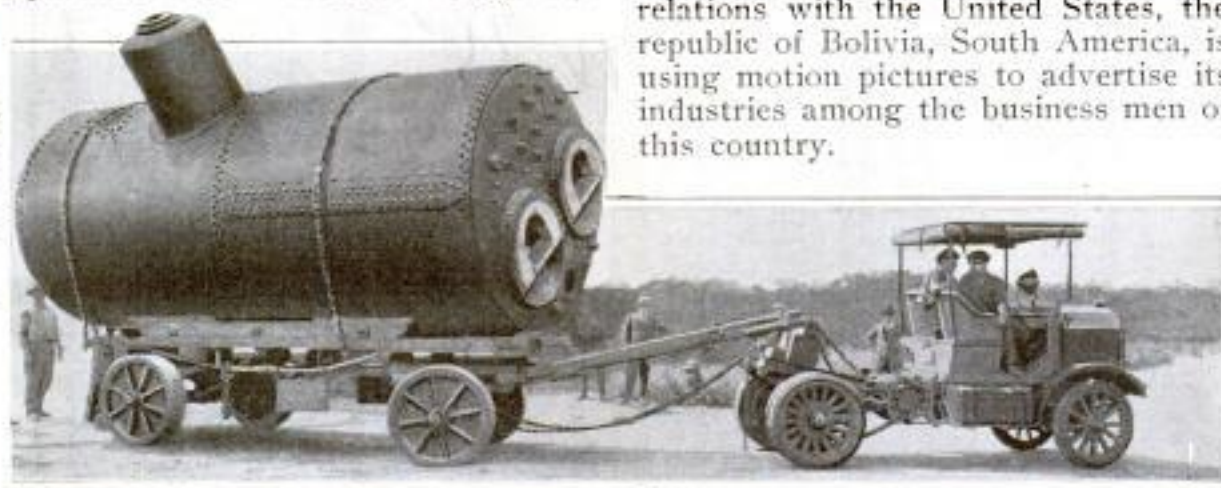

Automobile Tractor Successfully Hauls 41-Ton Load, a Task Ordinarily Requiring 30 to 40 Horses

*Knox Motors Ass'n. R. W. Snivley Adv. Mgr.  
Springfield, Mass.*

*The Henderson Co.  
Chilean, Penna.*

Inv: *Gen. F. Russell*  
*1208 Washington St. Ho. Golden, N.J.*  
POPULAR MECHANICS 25

856 AERIAL

### TORPEDO OF GREAT POWER

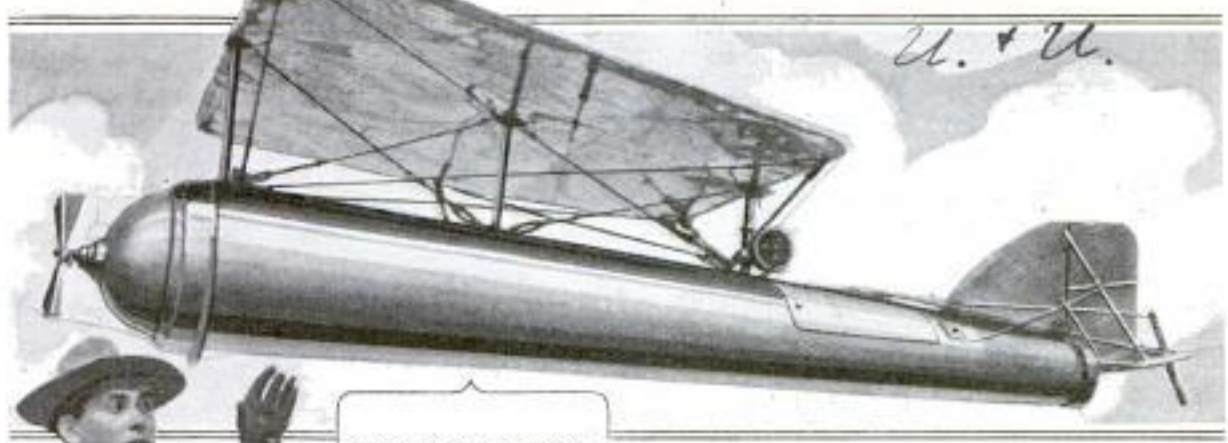

This Aerial Torpedo, the invention of an American, carries a 500-Pound Charge of High Explosive and is Directed in Its Flight by Wireless

either from an aeroplane or from a fixed wireless station. Some idea of its defensive value is given in the statement of the inventor that it would be possible to operate 500 of the torpedoes simultaneously from the top of the Woolworth building tower.

An aerial torpedo that carries 500 lb. of high explosive and is controlled in its flight by wireless has been invented by an American and was recently placed on exhibition in New York. Carrying such a charge as it does, this torpedo is by far the most destructive projectile of the kind ever made. The German aerial torpedo described in a recent number of this magazine, while controlled by wireless and used with destructive effect against the trenches of the allies on the western front, carried only from 100 to 150 lb. of high explosive. The new torpedo is 7 ft. 2 in. long and is equipped with wings somewhat like the wings of an aeroplane and with two propellers, one located at the bow and the other at the stern. Through the wireless control of the propelling and steering apparatus it can be steered up, or down, or horizontally, at the will of the operator. It is claimed by the inventor that one torpedo would be sufficient for destroying the post office in New York, while a "fleet" of such torpedoes operated from a wireless station 50 miles distant would be capable of depopulating a city the size of New York in a period of 24 hours. The torpedo can be operated

### BRIDGE CURVED ABOUT TREE IN PACIFIC NORTHWEST

769

As an illustration of how widespread the popular movement for the conservation of our trees has become, a small wagon bridge, which was constructed across a ravine in the Pacific Northwest some time ago, was curved



In Order to Avoid Felling This Cedar the Bridge was Built around It

# *Jas G. McLeurdy,*  
*Pt. Townsend,*  
*Wash.,*

so as to pass around a giant cedar. The structure was built in this way in order to avoid felling the tree, which stands in the hollow directly in the path of the road. While it is altogether possible that the expenditure of

labor which would have been required in removing the tree had much to do with the latter's preservation, the case serves as an example of how easily valuable trees may be spared even in road and country-bridge building.

**BOILER EXPLOSION STARTS**

**TRAIN OF TROUBLE**  
*East Weymouth*

Misfortunes of many kinds struck a Massachusetts town recently. Trouble started when a boiler blew itself out of a solid brick building and landed in a neighboring yard, a mass of dented steel and tangled piping. As a result of the explosion, an attending

as to put the machine entirely out of commission. Two firemen were seriously injured in this latter accident.

**HOW FRANCE PREPARES MEAT FOR HER SOLDIERS**

Two different processes are employed in preparing canned beef for the soldiers in the French army. One consists of partly cooking the meat, allowing the resulting broth to jelly, and then packing it in cans while cold. By this method about 40 per cent of the water in the meat is evaporated, making it, therefore, a more concentrated food than if it were raw. After the cans have been packed they are placed in an autoclave for an hour and a half and kept at a temperature of from 115° to 120° centigrade.

While this method has proved very satisfactory, its general adoption has been hindered because the necessary apparatus is available in only a few of the French canning factories, most of which in the past have been devoted chiefly to the preparation of canned vegetables. Because of this it was first necessary in many instances to resort to the plan of packing raw meat in cans and then allowing it to cook in an autoclave. This has the disadvantage of making the food uninviting in appearance. To overcome the objection at least partly, a certain quantity of rice and agar-agar

*Medical News 1915*

*#200 H. Davis, Jr.,  
15 Putnam Av., Braintree, Mass.*

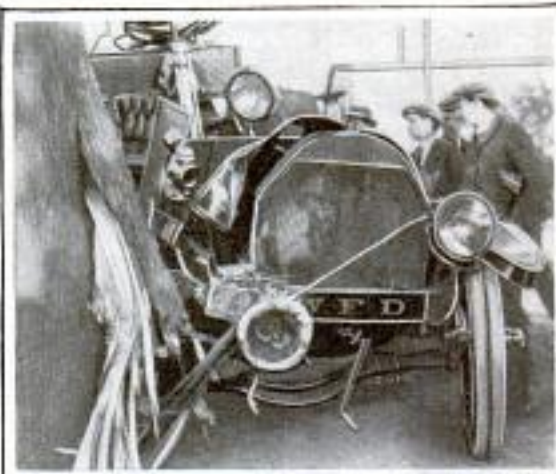

This Fire Truck Smashed into a Tree While Speeding to the Rescue of Victims of a Boiler Explosion. Two Firemen were Seriously Injured

In Exploding, the Boiler Demolished the Brick Walls of Its Building and Landed in a Neighboring Yard. The Engineer was Instantly Killed



engineer was instantly killed and 12 others seriously injured, not to mention damage caused by the demolishing of several brick walls and the blowing in of numerous windows. But this accident was indirectly the cause of still another. A fire truck had been sent speeding to the rescue immediately after the explosion. In the excitement, it ran squarely into a tree, breaking a wheel and smashing up the whole front end so completely

# M. Lavine  
 2434 Bancroft Way,  
 Berkeley, Calif.

POPULAR MECHANICS

27

Auto Accur

Signal  
 Rear

is now added to the meat. Both the rice and gelatinous substance absorb a large part of the juices, while the former adds considerable to the nutritive value of the food.

TRAFFIC-WARNING DEVICE

572 FOR MOTOR CARS

By attaching an indicator hand at the rear of his machine, a California motorist has devised a way of warning

9304

FROZEN SARANAC LAKE HOME OF GAY WINTER SPORTS

During the winter season each year, Saranac Lake, which is situated in the midst of the Adirondacks of northern New York State, is the scene of an almost continuous ice festival. Elaborate outdoor carnivals, such as are quite unknown in many sections of the country, flourish week in and week out throughout the long, cold months, under the most pleasing auspices. Crystal-white castles of medieval architecture and other types of structures, many of them very ornate and all of them built of ice blocks and fringed with snow, grace various parts of the lake. Snowshoe races, skating tournaments, skiing, and ice boating are among the many sports indulged in. It is only the coming of spring that interrupts the gala affairs and puts an end to the gay palaces of Boreas.



The Indicator Hand is Operated by Pulling a Cord Extended to the Steering Wheel

traffic when he intends to slow down his car or turn a corner. The "wrist" end of the device, which is made of wood and painted so as to be conspicuous, is pivoted and moves readily when a cord, which is attached to it and reaches to the steering wheel, is pulled.

The hand normal when the line is	drops to a position operating released.
----------------------------------	---

One of the Ice Palaces at Saranac Lake, the Scene of Many Gay Winter Festivals

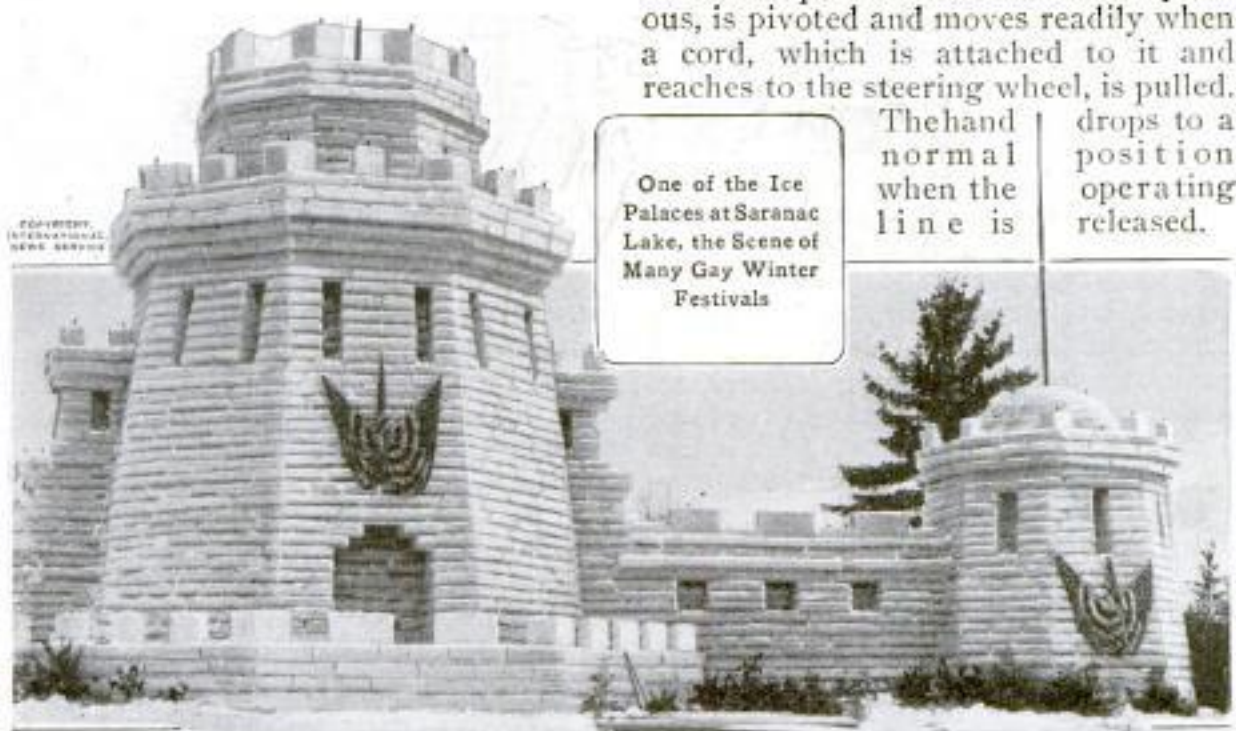

I-N-N-S.

296 BUILT-IN WARDROBE WITH  
TELESCOPING CARRIERS

The provision of sufficient closet room without the sacrifice of an undue amount of space is often one of the



This Built-In Wardrobe with Its Telescoping Carriers is Said to Require Less than Half as Much Space as an Ordinary Closet Rendering the Same Service



greatest problems connected with the design of a dwelling house. As a solution for this problem a new type of built-in wardrobe, which is said to require less than half as much space as an ordinary closet rendering the same service, has recently been brought out. The main feature of this wardrobe is an extension telescoping carrier on which are hung wishbone hangers. This carrier is so mounted that it can be drawn out of the closet for easy accessibility when garments are to be hung up or removed.

One of the side plates of the battleship "Maine," which had been imbedded in the mud at the bottom of Havana Harbor since 1898, was recently brought up by the anchor of the American steamship "Esperanta."

MANY WOMEN GOOD DRIVERS  
890 OF MOTOR CARS

Many women are as capable of driving motor cars as are men, according to an expression made recently by the head of a New York automobile school. The fact that one often encounters feminine chauffeurs on the road who are a menace to traffic should not be used as a criterion. Poor drivers are very common among men. Thus it is argued that because some women are utterly incapable of handling a car safely, women as a class should not be considered incompetent as drivers any more than should men. In the mind of the above authority, women are quick thinkers and actors when emergencies arise, while many of them also develop into fairly good mechanics and are able to keep a car well tuned. A European correspondent, in telling of the work of a woman chauffeur of an ambulance, recently described her careful driving. He concluded by giving it as his opinion that women ambulance drivers "would be just about the best for that sort of work."

BLIND MAN WITHOUT ARMS  
595 READS RAISED LETTERS

One of the residents of a home for railroad men at Highland Park, Ill., is both blind and armless. In spite of this handicap he is far from being helpless, and incidentally offers a rather striking example of the resourcefulness sometimes shown by men when put to an extreme test. Instead of depending entirely upon others, he has learned to care for himself in a remarkable way. He reads and also walks about in the grounds without assistance.

Since he has no hands with which to follow the raised characters in books provided for the blind, he uses his tongue. To most persons this would be little else than a maddening, nerve-killing ordeal, but to him it is a way to read and he makes use of it.

Stretched between two trees 130 ft. apart on the lawn at the institution, is a wire on which a large spool has been

Railroad Men's Home  
Highland Park, Ill.  
Copyrighted material

Medical News 10/9/15  
J. M. C. & Buller



Deprived of Both Arms and Sight, This Man Reads by Moving His Tongue over the Raised Letters of a Book. In Walking He Rests the Arm Stump on a Spool through Which a Wire Stretched between Trees is Threaded



strung. On pleasant days when the man wishes to exercise, he is taken to the line by one of his comrades or an attendant. He rests the stump of an arm over the spool and walks to and fro, guiding himself without difficulty.

The loss of his arms took from this man the things most useful to those who are blind, the hands. Other substitutes for the eyes were all that could save him from utter dependency, and he found them.

#### METAL SHOE ADVERTISES

#### 820 FOOTWEAR DEALER

A huge sheet-iron shoe ornamented a float in an Illinois industrial parade recently. Seven and a half feet high, over 14 feet long, and nearly five feet wide across the sole, it amply fulfilled its mission of attracting attention to a certain footwear dealer's wares. Nearly 500 pounds of Nos. 24 and 26 gauge galvanized iron went into the construction of the shoe. A picture was taken showing an ordinary leather shoe

from which the huge duplicate was made. The original covered only a small portion of the toe on the larger article. In making the latter every curve and angle in the original leather shoe was faithfully followed, each dimension being multiplied by 14 to give the proper size. Considerable skill in the tinner's art was required to give the proper curve to toe and heel.



Huge Shoe of Sheet Iron is Used for Advertising Purposes

Made by  
F. Meyer & Bros. Co., Peoria, Ill.  
Geo. Harms, Secy.

# Robert W. Phelps  
185 S. Ardmore Av.

Los Angeles, Calif.

MOTOR-CAR SERVICE DEPOTS

510 DESIGNED ATTRACTIVELY

Motor-car supply stations, at which gasoline, oil, and a limited variety of accessories are dealt in, have been



The Graceful Lines of This Structure, a Motor-Car Service Station, Make It Attractive, Rather Than an Eyesore to the Neighborhood in Which It is Situated

springing up throughout the residential districts of nearly every city of prominence. Often these depots consist of small brick huts, sheet-iron shacks or frame structures, most of them unsightly buildings which detract from the appearance of the neighborhoods in which they are located. In California, and particularly at Los Angeles, this condition is being ameliorated by the erection of small, attractive structures designed after the old Spanish missions of the Pacific coast and Southwest.

BLIGHT KILLING CHESTNUT TREES IN PENNSYLVANIA

Phila. Ledger 10/15/15

It is the belief of foresters that the chestnut will be practically extinct in Pennsylvania within a comparatively short time unless comprehensive measures are taken immediately to combat the blight which is ravaging it. Approximately \$70,000,000 damage has been done within the state during the last 10 years, according to recent estimates. In the vicinity of Philadelphia the conditions are worse than elsewhere. The tree is not only valuable for its nuts, but also for its lumber,

Samuel B. Detwiler,  
Supt. Penna. Chestnut Tree Blight Commission

which is utilized in the manufacture of furniture, in general construction work, and as material for poles. The bark is much used in tanning leather.

SILK SHADES FOR LAMPS  
753 TREATED WITH MICA

Ground mica is incorporated in a preparation which is being used in treating the inner surfaces of silk shades for gas and electric fixtures. Besides giving strength to the fabric and protecting it from the effect of heat, the minute particles of mineral tend to reflect much of the light that is ordinarily absorbed by such coverings. The shades are made in various colors and types for use with chandeliers, wall brackets, table lights, and floor lamps, and are fitted over wire frames. These are provided with grips which slip over electric globes and hold the shades firmly in position. A centering disk made of mica is used with each shade. This fits closely about the neck of a bulb, or rests on the top of it when the latter is held in an upright position, so

Below is Shown One of the Shades Fitted to a Gas Lamp and Provided with a Heat-Intercepting Drum



The Shade for the Electric Lamp Above is Cut Away to Show Frame Construction

as to remove the chances of the frame causing a short circuit. The top of the



shade is covered with the same kind of material as is used for the sides. The fabric employed in the shades designed for gas lamps is chemically treated to insure against fire, while the holders are fitted with mica cylinders which are intended to intercept the heat given off by the burners.

### HOME GROWERS TO SUPPLY FLOWER-BULB MARKET

*Dept. of Agriculture*

905  
Heretofore, the great bulk of flower bulbs sold by florists and seed dealers in this country has been imported from Holland, the annual importation amounting usually to about \$1,000,000. To encourage the growing of the Dutch bulbs in this country, as well as to provide native American bulbs of a superior quality, the Department of Agriculture has established a bulb-propagating garden near Bellingham, Wash., where the conditions of soil and climate are similar to those in the Netherlands. It appears from experiments that some American-grown bulbs, especially tulip bulbs, are freer from disease, and blossom from five to seven days earlier, than those imported from Europe. Certain flower bulbs, among them tulip and narcissus, have long been grown in limited quantities along the Atlantic and Pacific coasts and in the region of the Great Lakes.

### TEMPORARY ELEVATOR USED ON OUTSIDE OF HOTEL

767  
In order to convey materials from the street to different floors of one of New York's large hotels, which was recently renovated and redecorated, an elevator shaft was constructed on the outside of the building. This was a frame structure and accommodated a large freight lift. Wood, plaster, paper, and other materials needed in the work, were unloaded directly from wagons and shot to the places where they were required, while all of the debris was lowered to the street in the same manner. The plan was adopted

so that guests of the hostelry might not be disturbed or inconvenienced. Certain corridors were shut off while work



Freight Elevator on Outside of Hotel during the latter's Renovation

was being done in the rooms reached by them, and little evidence was displayed of what was going on. The outside lift made it unnecessary for the workmen to employ the regular freight elevators in the building for their purposes.

¶The Gazette de France, established nearly 300 years ago and the oldest newspaper in France, has suspended publication. The publishers expect to resume publication at the end of the war.

# M. T. Pugsley  
12 W. 109th  
New York

Mayo Mfg. Co.  
54 East 18th St.  
32 Chgo. POPULAR MECHANICS

### MACHINE CUTS VENTILATOR 717 SLITS IN AUTO HOODS

A late addition to the list of automobile tools consists of a machine for cutting louvers, or ventilator slits, in

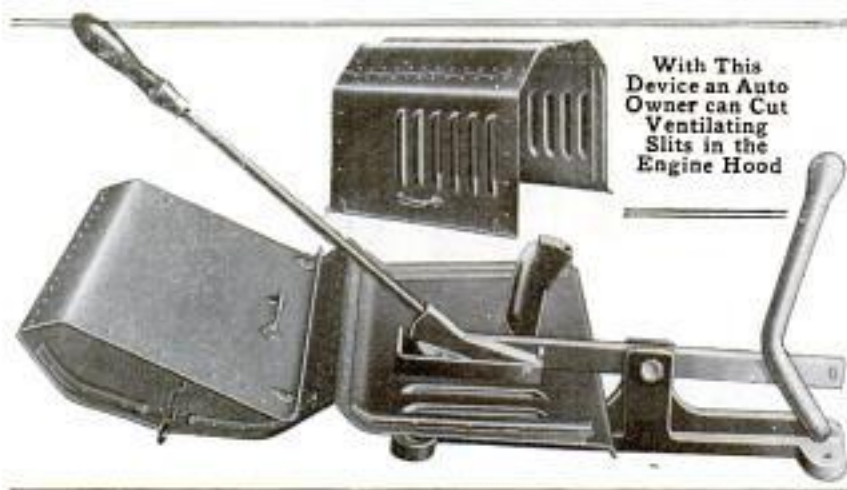

automobile hoods. Certain makes of machines are without louvers as a means for ventilating the region immediately over the engine, and to the owner who desires such a feature, the new instrument is a convenient article. It is simple in design, consisting only of a stamping die operated by a long lever. A suitable framework is provided to hold the hood in position while the work is being carried out.

### NEW SCREWDRIVER COVERED 750 WITH RUBBER INSULATION

Rubber is used as an insulating material for the handle and shank of a screwdriver lately designed for the use of mechanics and electricians when working on gas engines and electric apparatus. The tool tapers from the handle to the blade and has no shoulder or similar obstruction to interfere with its manipulation in difficult places. It has an overall length of 11¼ in. The blade constitutes the only piece of exposed metal, so the chance of short-circuiting is considerably less than it is when an ordinary instrument is employed.



### FOREIGN MONEY IS BARRED 913 BY CUBAN DECREE

Because of the excessive amount of European money in circulation throughout the republic, a decree has been issued by the president prohibiting the importation of all foreign silver and copper currency in Cuba except that of the United States. The further circulation of Spanish silver and copper money and the importation of Spanish and French gold in centenes and louis has also been barred. According to estimates there has been approximately

\$30,000,000 in Spanish and French gold and \$5,000,000 in Spanish silver in circulation in Cuba.

### BALLOONS CARRY POISONOUS 904 GAS INTO FORTRESS

A new and ingenious method used by the Germans for attacking the defenders of a fort with poisonous gas is reported from Petrograd. Balloons that are shaped somewhat like those with which children amuse themselves, but larger, are used for the purpose. Each balloon is filled with enough illuminating gas to make it float, while in a bottom compartment is a quantity of the poisonous gas. The balloons are set adrift on a favorable wind, and when they are directly above the fort that is being attacked, the German sharpshooters puncture them with rifle bullets. The bursting of the thin covering completely destroys the balloon. The illuminating gas rises, while the poisonous gas, being heavier than the air, settles into the fort. It is reported that the poisonous gas from 1,800 of these balloons was dropped by this method into the fortress at Ossowetz, and that this was the principal reason why the defenders were able to hold the fortress for only two days.

H. D. Smith Co.,  
Plantsville,  
Conn.

960

# AERIAL DEFENSES OF PARIS

By SEARLE HENDEE

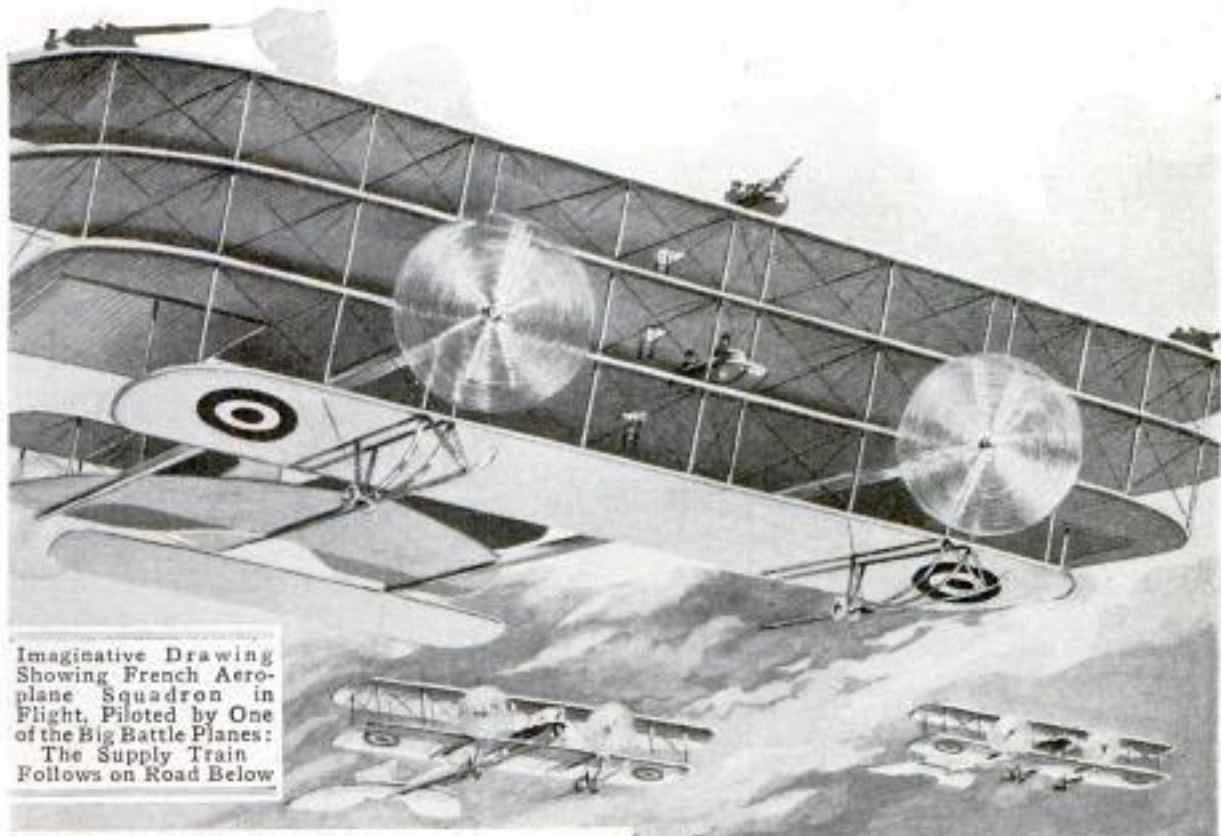

Imaginative Drawing Showing French Aeroplane Squadron in Flight, Piloted by One of the Big Battle Planes: The Supply Train Follows on Road Below

WHEN darkness and fog settle over London the city is gripped by fear and foreboding until the coming of dawn. Ears are strained to catch the first muffled sounds of approaching air craft. For many, the night is one of dread.

Paris slumbers peacefully, although but an hour's flight from the western battle front. A sense of security pervades the city. Aerial attacks are not feared and Zeppelins are thought of with mingled indifference and contempt.

While London is vulnerable from the sky, Paris is practically immune to danger. In the year and a half of aerial warfare the French have developed defenses faster than their enemy has improved its agencies of assault. For a year the capital has been comparatively free from anxiety. It has had but one Zeppelin visit, a so-called attack which was only an incident and netted the enemy nothing. The British metropolis, on the other hand, is protected



little more effectively than at the time of the first assault upon it. Its streets are darkened, it has an abundant supply of searchlights and aerial guns, and it maintains an aeroplane corps to resist invasion. Zeppelins, however, continue to cross the channel and bombard it while hidden in an impenetrable veil of fog.

successfully combating Germany's air navy, while the English are only commencing to develop a comprehensive defense. British military authorities, according to recent advices, have of late made a careful study of the French system of aerial defense in the hope of finding in it a suggestion for the better protection of London. At the same time several prominent American inventors are supposedly engaged in the problem.

Complete details of the Paris system of fortification are not known publicly in America. Most information of this character has naturally been withheld by the censors. The general idea of the plan, however, is partially understood, as are some of the ingenious instruments used for detecting the approach of hostile airships and ascertaining their ranges. Prior to the opening of hostilities abroad aerial defense was a nonentity. Almost all progress in this direction has been recent, and it therefore constitutes not only an important but a very new phase of this latest method of warfare.

Organization forms the basis of the defense system at Paris. Observatory and artillery posts are arranged in

long chains which extend throughout the city and radiate from it in all directions toward every part of the distant firing line. Each point is in telephonic communication with a central bureau situated in the city. The instant an enemy flying machine is sighted by any one of the numerous

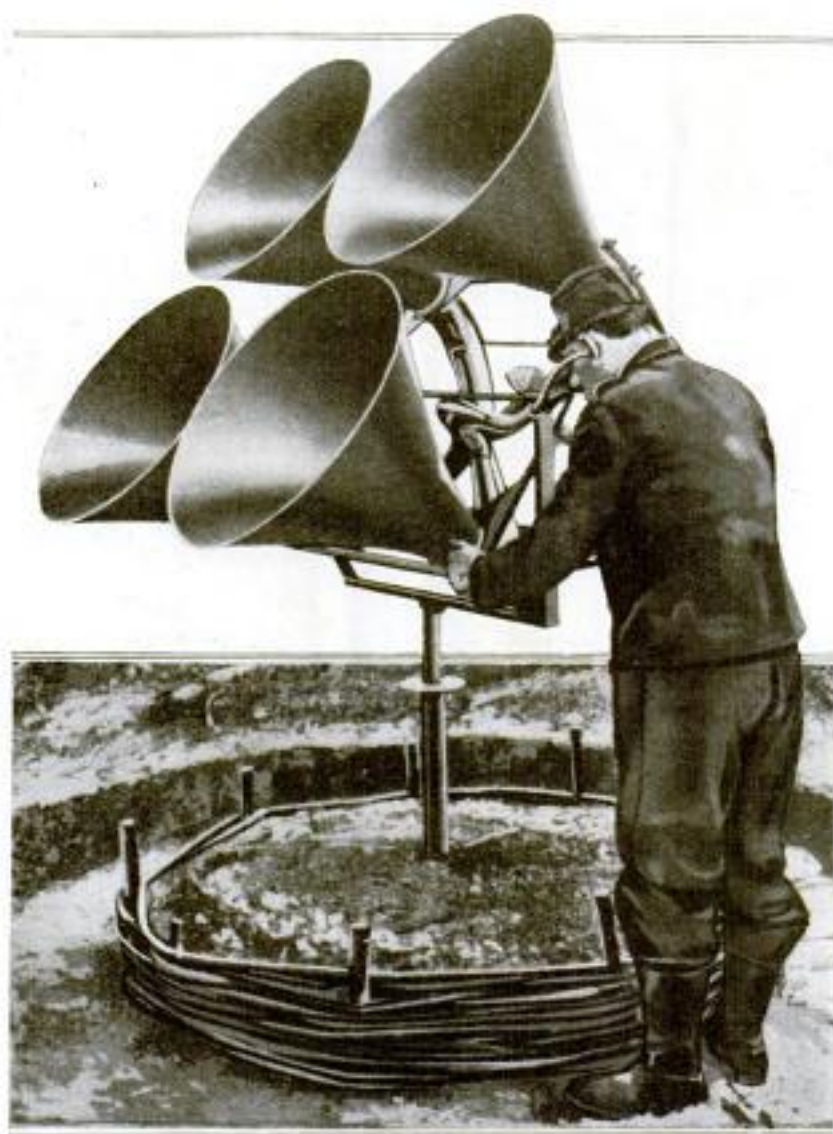

**This Detector, Which Consists of Four Megaphones Connected with a Microphone and Equipped with Receivers, is Used Both Day and Night: With It the Purr of an Aerial Engine may be Heard While the Machine Itself Is Invisible**

This shows briefly the contrasting conditions in London and Paris at the present time. The inability of the one to ward off assaults and the other's apparent freedom from trouble present graphically the difference between inadequate and scientific preparedness. The French have found a means of



Aerial Range-Finding Instruments with Which the Height, Distance, and Speed of Air Craft may be Determined: Equipment of This Kind is Supposed to Be in Use at Most of the Defense Posts Guarding Paris

One of the Large Searchlights Protecting Paris against Night Invasions



Part of a French Air-Craft Battery in Action at One of the Defensive Stations: The Gunner in the Foreground is Operating a High-Angle Gun, Mounted so That It may be Turned in Any Direction, and Firing Shrapnel

lookouts, it is known at headquarters. Immediately an alarm is sent out to the posts in various zones. At scattered points squadrons of swift aeroplanes are in readiness to spring into the air and give chase to an invader, while at all the stations covering the country between the city and the battle front, aerial guns are trained and range finders prepared to cope with the enemy.

During the first few months of the war Paris was repeatedly besieged by German aeroplanes. The craft made their appearance continually, much to the anxiety of citizens and military authorities alike. A former head of the aeronautical department was recalled to the capital to devise a system of protection, and the present scheme is the result. Since its inauguration the city has felt no danger, although numerous airmen have endeavored to reach it on many occasions.

The vigil is maintained constantly day and night at the outposts. Each of these little stations has a battery of two, or more, specially designed, high-angle, air-craft guns mounted so that they may be turned to any point of the compass quickly. On an elevation a few feet above the guns, observers are stationed with binoculars. Close at hand is a sensitive sound detector, by which the approach of an aeroplane or Zeppelin can frequently be told before it is visible. Near at hand are range finders, specially designed for aeronautical purposes, and instruments for determining the speed and relative height of an aeroplane in flight. A powerful searchlight is usually mounted close to the post, so that its rays may be focused on night invaders to assist the range takers and gunners.

The type of detector used by the French is both ingenious and simple. One of the chief advantages of the device is that darkness and fog do not interfere with its efficiency. It may be used both day and night with equal success. Essentially it consists of a nest of four large megaphones, all of which point in the same direction. These devices are connected with a microphone which amplifies the faint-

est sounds gathered by the wide-mouthed horns. The apparatus is held in a frame mounted on a heavy rod fixed in the ground, or to some solid base, so that it may be swung in any direction. A telephonic headgear employed by the "listener" enables him to detect the purr of an aeroplane or dirigible engine that may be operating at any point over a wide radius. By adjusting the megaphones carefully, the approximate course of a flying machine and its relative distance from the post may be ascertained. The detection of such a sound is a signal for a careful lookout. Then, with long-range glasses, and at night by the aid of searchlights, the identity of a craft is determined. If it is an enemy machine, a squadron of craft and fusillade after fusillade of shrapnel are sent after it.

Other instruments are utilized which quickly determine the height, distance, and approximate speed of an approaching machine visible through glasses. These calculations made, the gunners are able to time their shrapnel fuses correctly and fire with considerable accuracy. The computations are produced by a sliding gauge, or dial, so that no time is lost in the process. The figures are corrected continually that the gunners' work may be made effective.

Reports from London indicate that a group of picked French airmen are now assisting the British aerial corps in combating Zeppelin invasions. The French method of attacking an enemy in the air differs from that of the English, and it is understood that it is being adopted at London. When a hostile craft is first sighted the French fliers shoot into the air and pursue the same general course as that taken by their adversary, rising gradually so as not to be outdistanced. In this way they head off the invading airship, climb above it and drop bombs. The English airmen have persisted in spiraling upward and gaining altitude at the outset of their chase. This plan, it is said, has given the enemy an opportunity to bombard the city and escape.

An American has developed an ac-



Showing the Use in the Field of One of the Latest Schemes for Detecting the Presence of Hostile Air Craft and Determining Their Ranges. When the Installation is Permanent, the Megaphones are Controlled by One Operator

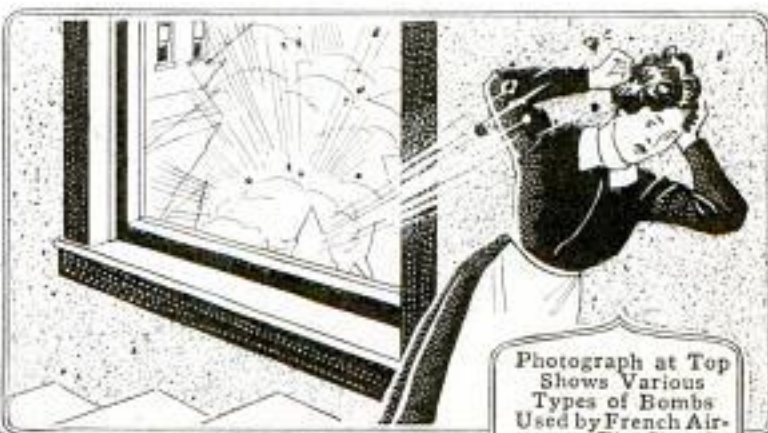

Photograph at Top Shows Various Types of Bombs Used by French Airmen. The Sketch Depicts One of the Dangers of Explosive Bombs. Flying Fragments Seldom Break through a Brick Wall, but Pass through Windows and Doors

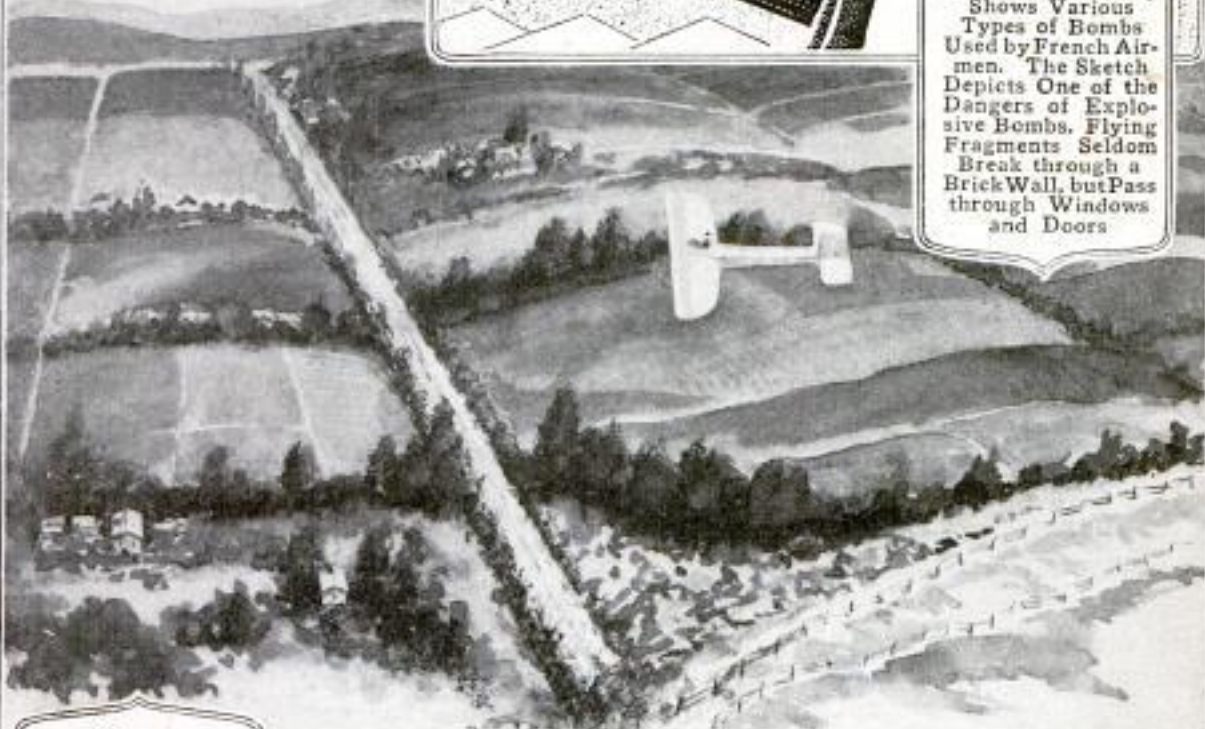

Canvas Painted to Resemble a Highway Erected over a Road between Two Communication Trenches, and a Large Body of French Troops Moved without being Noticed by German Airmen. Diagram Shows Arrangement

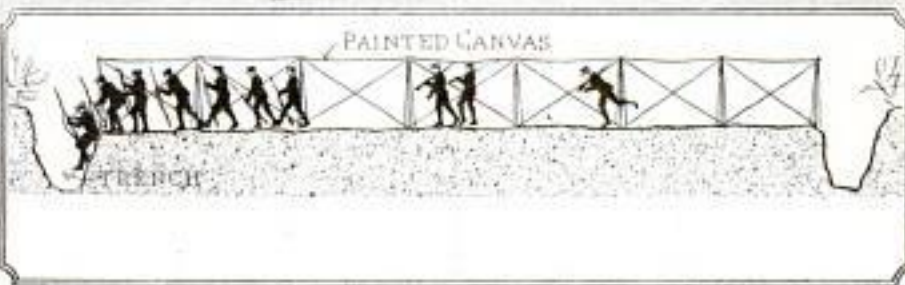

curate system for detecting the approach of an airship and ascertaining its exact range while it is still invisible. This invention is of particular interest both because of its origin and the fact that it is quite similar to a plan which is being evolved for the protection of London. Large horns mounted similarly to marine compasses and fitted with microphones are placed at the corners of a geometric figure of known dimensions. This may be triangular or square in form. In the field each megaphone is attended by an operator who adjusts it to the angle which permits him to hear most clearly the sound of an approaching flying machine. Thus the various instruments are all focused upon the same point. The position of the air craft is the apex of a pyramid or cone, according to the arrangement of the horn units. Calculations then give the distance of the machine and its location.

When this system is permanently installed, as for the protection of a city, all of the megaphones are rotated by one operator. The horns are continually swung in different directions until the noise of an aerial motor is heard. Then an electric instrument is employed in place of the telephonic headgear. This device, similar in construction to dual galvanometers set with their needles pointing at each other, is more sensitive than the human ear and makes an accurate comparison of the volume of sound affecting the microphones. When the horns are adjusted so that the indicators point to zero, the flying machine has been located. The direction in which the horns are pointing indicate the angle. The distance of the target, which is considered the apex of the figure outlined by the megaphones, is almost instantly computed by means of a sliding scale. With this information the gunners are able to fire upon the unseen object. The horns, placed several hundred yards apart, may be moved in synchronism, so that the course of an airship can be followed and the range corrected. When the proper instruments are utilized for magnifying the

sound, an air craft several miles distant may be detected and its range determined.

In addition to perfecting their remarkable system of defense, the French have developed their air craft in a noteworthy manner. Through the efforts of the aeronautical authorities the term "aerial navy" is no longer fictional. The nation has organized its air forces into squadrons composed of battle planes, cruisers, scouts, and "torpedo planes." The fleets maneuver in various formations as does an army regiment or naval squadron. The aerial fighters are organized in "esquadrilles," or squadrons, and are officially designated as such. A squadron is commanded by a commissioned officer who serves as a pilot, and is composed of six reconnaissance machines; two cruisers, each armed with a 3-in. gun; one large battle plane mounting two 3-in. guns and one machine rifle; nine motor trucks and trailers; nine portable hangars, and three motor cars.

The battle plane is understood to be three-decked, 30 ft. in height and 130 ft. in wing spread. It carries a complement of a dozen men and is equipped with either two or three engines. The 3-in. guns are mounted near the ends of its wings and the machine gun in the middle. Both it and the cruiser are recent developments. The latter is very swift in flight and has great climbing power. All of the machines are understood to be well protected with armor. Numerous squadrons of this formation have been organized. Some of them are being used for offensive operations against the Germans, while others are apparently retained for defensive purposes in and about Paris.

One of the most interesting of the many schemes France has devised for protection against German airmen was successfully employed some time ago in the Champagne district. It was necessary to move a large body of troops across an open place between two communication trenches which were more than a half mile apart. A large corps of artists were given the task of paint-



ing a long strip of canvas to resemble a road. In four days this part of the undertaking had been accomplished and the work of erecting the canvas on poles over a real road commenced. When the covering was in place the long columns of troops were marched beneath it in safety and without observation by the enemy. It was only early in the mornings and late in the afternoons that the passage could not be employed. At those times the shadows of the moving troops showed on

the canvas like dark blotches, and might have aroused the suspicion of enemy airmen. At all other times throughout the day, however, the deception was complete. The canvas looked like the road it covered and it was impossible for an airman to detect the difference.

Efficient organization, the utilization of clever subterfuges, trained corps of aerial fighters, special instruments, and good marksmanship, in the main constitute France's aeronautical defenses.

## ALASKAN DOGS FOR SERVICE WITH FRENCH ARMY

819 Because of the lack of suitable transportation facilities for the officers engaged in reconnoitering, the French troops operating in the mountains along the Swiss border found themselves seriously handicapped during the past winter. To overcome this difficulty the French government has bought more than 100 Alaskan dogs and with these the officers will be transported over the mountainous country in sleds. The dogs are to be driven by their

former owner, who is one of the best known of Alaskan trainers. One team of these dogs has a record of 18 miles an hour maintained for days over the snow, and it is thought they will be ideally suited to the requirements of reconnoitering in the mountains during a winter campaign. With the dogs, which were recently shipped from Seattle, went a large consignment of the dried fish which constitutes their favorite food.

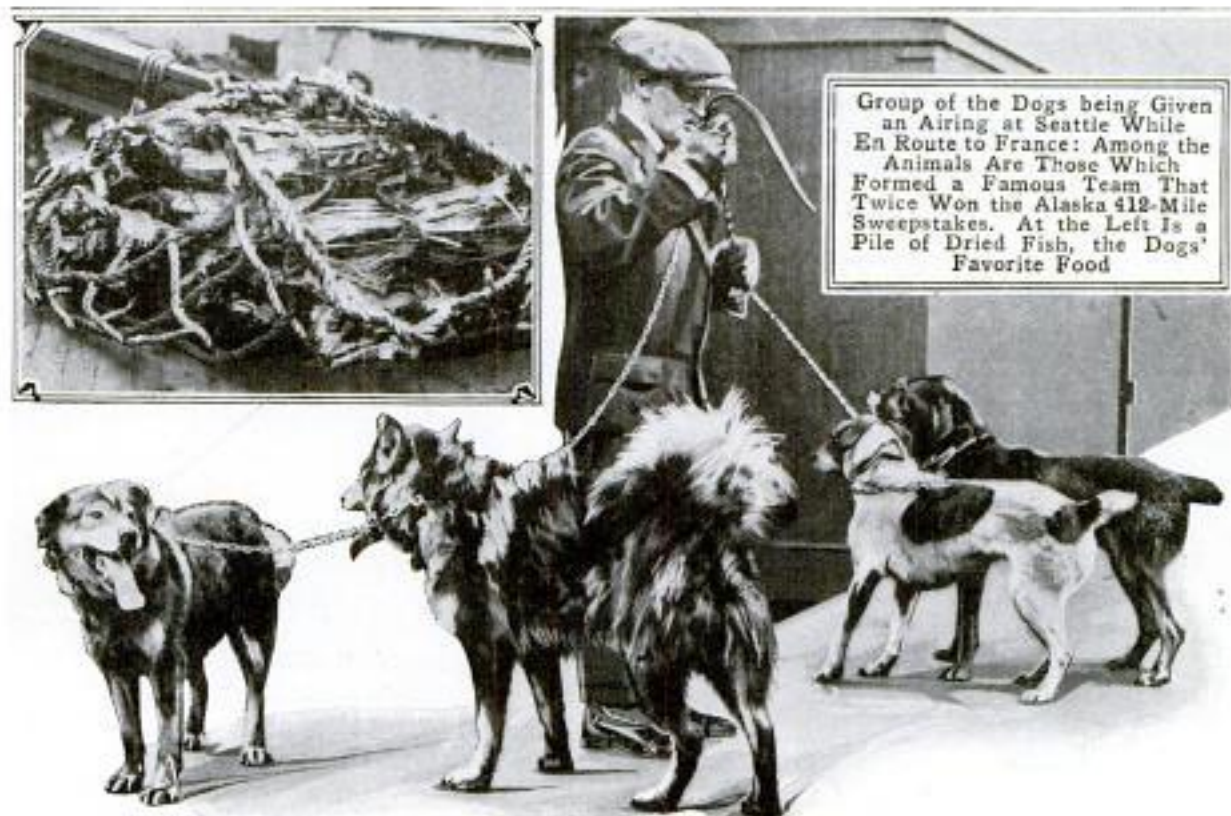

Group of the Dogs being Given an Airing at Seattle While En Route to France: Among the Animals Are Those Which Formed a Famous Team That Twice Won the Alaska 412-Mile Sweepstakes. At the Left Is a Pile of Dried Fish, the Dogs' Favorite Food

COPYRIGHT, INTERNATIONAL FILM SERVICE, INC.

235 William St., New York.

*Military Camp*

The "Rookies" in Trenches Prepared to Hold Their Own Against the Invading Marines

Troop of Cavalry Skirting the Shore to Attack the Invaders in the Rear

*I. N. F. Stevin*

## VOLUNTEER "ROOKIES" AT FORT SHERIDAN

For four weeks during the latter part of September and the early part of October, 1915, nearly 500 men from civil life who had temporarily abandoned their business or profession for a period of military training, lived on the lake front at Fort Sheridan, Ill., as men of the regular army live, and submitted to the same regulations and did the same work. Several judges, at least one congressman, and others prominent in business and professional lines, were included in the corps of volunteer "rookies." The principal

purpose of the encampment was to give the men a foundation of military training that would fit them to serve as officers of volunteers and as drill sergeants in case of war. A secondary purpose was doubtless that of demonstrating by means of an object lesson that a soldier cannot be made in a day—to show what it means in time and work to take a raw recruit and make him into a real soldier. Short as the time was, an immense amount of work was accomplished. The civilian "rookies" were drilled by men of

*Stevenson's Military 853*



Naval Reserves  
Landing on Lake  
Michigan Shore to  
Attack the  
"Rookies" in  
Their Trenches

the regular army, there being stationed at the encampment a company of regular infantry, a troop of cavalry, and a battery of field artillery. The day before the encampment closed the president's personal flag, which had been brought from Washington for the purpose, was raised and saluted. This is said to be the first time in 60 years that this flag has been allowed to leave the national capital without being accompanied by the chief executive.

#### ALCOHOL BARRED FROM NEW TYPE OF WINE

989 *Sc. Am. 11/20/15*  
Wine minus alcoholic ingredients has lately been brought out in the grape-raising regions of southern Europe. Ordinary wine is the basis from which the new kind is manufactured, the alcohol being drawn off by fractional distillation under relatively low pressures. All the ethers, aldehydes, and tannic acids of the original are preserved in the new product, giving it the usual pleasant taste and stimulating properties. Tannic acid in this form is believed to exercise protective action against typhus and cholera germs. The beverage is said to possess a taste quite different from grape juice, to which it might seem closely related.

*Described in L' Italia Agricola*

#### EARLY BICYCLE PROTOTYPE 714 OF NEW COASTER

One of the new coasting devices that has been introduced for children is designed much like some of the original bicycles. It is substantially constructed and is supplied with a foot brake which allows it to be controlled readily on the steepest grades. When used on the level it is propelled by pushing against the ground with one foot while the rider is either seated or standing. It is fitted with rubber tires and has a standard

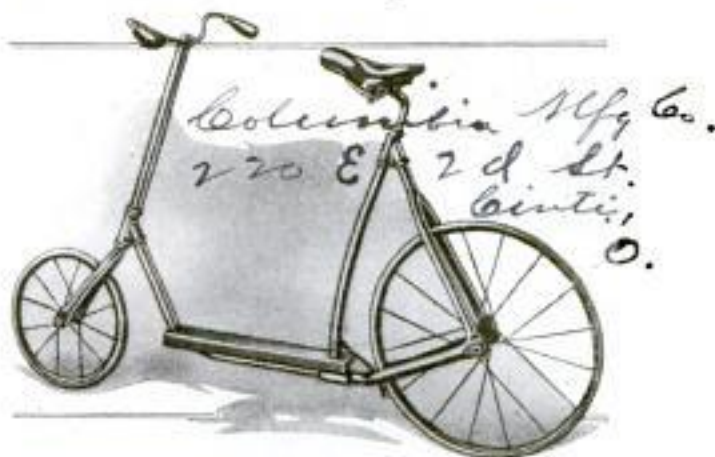

Novel Coaster Which Is Similar to Some of the First Bicycles Used in America

type of saddle which may be adjusted to various heights to suit different users.

956

SNUG WINTER TOGS FOR THE OUTDOOR GIRL



Serviceable and Stylish Snow and Ice Outfit Made Large and Roomy: It Has Leather Collar and Cuffs, Muff Pockets below the Belt, and Slips over the Head



Glazed-Kid Coat and Engadine Skirt of Contrasting Color Form Attractive Skating Suit



Smart "Tuxedo" Skating Set Which Is Both Jaunty and Distinctive: The Heavy Woolen Scarf is Hand-Knitted with Attractive Borders That Are Available in Various Colors. The Hat, Also Hand-Knitted, Sits Down over the Head with Just a Suggestion of a Slouch



Skiing Suit Procurable in Many Colors: Coat Has an Inverted Pleat in Back; Breeches Are Full at the Knees and Have Contrasting Cuffs. Puttees, Gauntlets, and a Combination Hood and Scarf Complete the Costume

PHOTO COPYRIGHTED INT. FILM SERVICE

WITH AN ABUNDANCE OF STYLE AND WARMTH



Reversible Sleighing Coat of Tan Spotproof Leather and Gabardine, with Hat to Match



One of the Most Pleasing Winter Costumes is Made for Hob Sledging. It Consists of Leather Coat, Colored Breeches, Puttees, Kid Hat, Angora Scarf, Gloves and Boots



The Catchy Skating Cap Above Is of White Knitted Material Combined with Colored Swiss Engadine. It Has an Ear Lap on the Left Side and the Scarf, Which is Attached to the Cap, Protects the Other Ear. The Sport Suit at the Left is Made of an Imported Material Which Sheds Water and Has Much Warmth



For Coasting and Snow Shoeing There is This Big Coat Made of Hudson-Bay Blanket in White with Contrasting Stripes. The Hood is Attached to the Coat and a Separate Scarf Worn about the Waist. It is Worn over Skiing Breeches

PHOTOS COPYRIGHTED BY INTERNATIONAL FILM SERVICE

Chicago Daily News 11/12/15  
U. & U.  
J. M. F. S.

953 SEA SLED AND AEROPLANES TO COVER MAIL ROUTES

Sea-sled mail service is to be inaugurated on the Magdalena River in the Republic of Colombia between Bogota, the capital, and the coast. By the water route the distance between the two points is more than 800 miles. It is expected that it will be covered at an average speed of nearly 40 miles an hour.

Tests were recently made on the Hudson River, near New York, with an oddly designed craft which has been built especially for this service. It is a broad-beamed glider equipped with a high-power motor and driven by two aerial propellers mounted at the stern. It is capable of carrying a number of passengers, and when loaded, draws only 5 in. of water. While traveling at its maximum speed, however, the sled requires only 1 in. of water, for it skims along barely cutting the surface. Its slight draft is made necessary by the shallowness of the river on which it is to operate.

The establishment of another interesting mail service is reported from New Mexico, where airmen are to carry

both mail and passengers via aeroplane between Gallup, near the border, and Ganado, Ariz. Keam's Canyon, Fort Defiance, and St. Michael are other points which will also be touched. Four flying machines will be employed, and a regular schedule maintained. This route extends across the desert and in the past has been covered by pony.

941 PHONES REPLACE WAITERS IN JERSEY RESTAURANT

Telephones are being used in one of the restaurants at Plainfield, N. J., as substitutes for waitresses. Instruments have been installed at each of the several tables and permit the guests to communicate their orders direct to the kitchen without suffering delay. The activities of the waitresses are confined solely to the serving of food. To simplify the system, each menu on the card is numbered so that a patron may render his order numerically. A switchboard operator makes a record of all orders and attends to the issuance of the checks. The guests are privileged to use the telephones for outside calls and likewise may re-

Used by The Big Co., Plainfield, N. J.

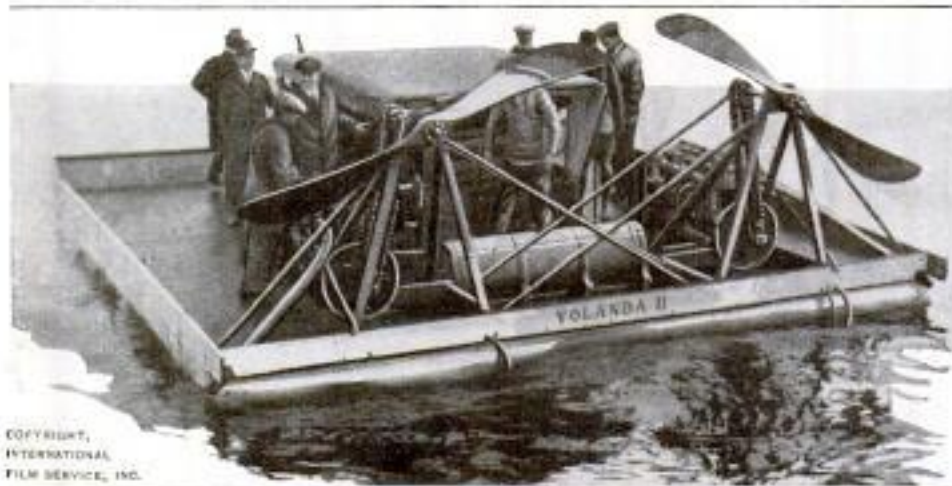

Stern View of the "Yolanda II," a Peculiarly Designed Hydroplane Built in America to be Used in Carrying Mail down the Magdalena River in Colombia

Lower Photograph Gives a General Idea of the Appearance of the Odd Craft, Which, When Traveling at Its Maximum Speed, Draws Only One Inch of Water



COPYRIGHT, INTERNATIONAL FILM SERVICE, INC.

COPYRIGHT UNSERWOOD & UNSERWOOD



ceive incoming messages without leaving their respective tables. By the inauguration of this scheme the company has been able to eliminate three-fourths of its waitresses and reduce expenses accordingly while maintaining satisfactory and novel service.

### LAST OF CIVIL-WAR MEN

#### 996 IS MUSTERED OUT

*Army & Navy Journal*  
 11/13/15  
 During recent years only a few men who saw active service in the Civil War have remained with the regular army in any capacity. The last of these, in the belief of officials, has now retired. The person on whom the distinction fell of being the only remaining war veteran in the service was Maj. Gen. Wm. H. Carter, his retirement taking place in November, 1915. According to War Department records he entered the army at the age of 12 and served as mounted dispatch bearer, and in the defense of Nashville. Thus he was hardly an officer or even an enlisted man at that time. The last officer, Maj. Gen. Geo. B. Davis, retired in 1911; and later the only private of war times, John L. Clem—afterward brigadier general—left the service. Thus the going of Major General Carter marked the departure of the last man who saw service of even minor character in Civil War days.

### ADJUSTABLE SHOTGUN RACK

#### 733 FOR DUCK BOAT

Both for the safety and convenience of duck shooters, an ingenious gun rack is being made that may be applied easily to the gunwale of a canoe or skiff. It consists of an adjustable arm, with rubber-covered, "U"-shaped holders at either extremity, supported at one



end of a curved bracket which is pivoted to a simple screw clamp. This may be attached or detached quickly. It is built of malleable iron, is finished in dead-grass-green enamel, and weighs 2½ lb. It may be taken apart without difficulty and packed in a suitcase or portage bag. When in use it holds a gun slightly inclined and in a convenient position for the hunter, so that he may grab it quickly when he needs it. The danger of accidentally discharging a piece and blowing a hole in the bottom of the boat is lessened considerably by using the rack.

#### "Universal Gun Bracket"



The Rest Supports a Gun so That It may be Easily Grabbed by a Hunter

*New Process Specialty Co.*  
*Enterprise Bldg*  
*Milwaukee.*

*Traveling  
Auto*

*Los Angeles, Calif.*

COMBINATION BATHTUB AND  
**625** WASHSTAND

A combination bathtub and washstand recently brought out by a western inventor not only economizes

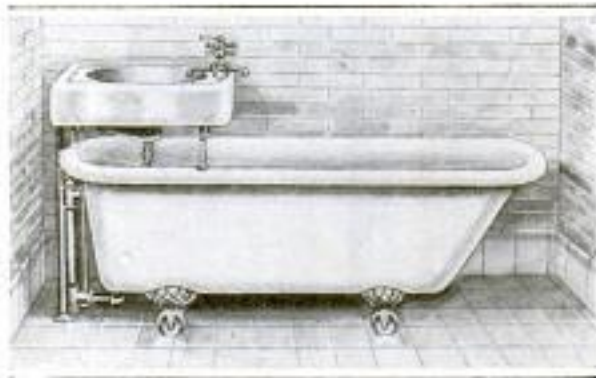

This Convenient Arrangement of Bathtub and Washstand Results in a Saving Both of Space and of Plumbing Work

space, an important feature in most city buildings, but results in a considerable saving in the cost of the plumbing work. The washstand is mounted on the "foot" of the bathtub and uses the same supply pipe and drain pipe. The position of the washstand is convenient either for a bather or for a person standing at the side of the bathtub. The washstand also furnishes a convenient handhold and eliminates much of the danger of slipping when getting into or out of the tub.

866 ODD OVERLAND SCHOONER  
USED ON WEST COAST

Several novel features are represented in a touring conveyance which is being used in promoting church-extension work on the Pacific coast. It is drawn by a light touring car which has been altered somewhat in order to make it serve as a tractor. Its chassis has been elongated and is supported at the rear on wheels driven by chains extended from the hubs of what is properly the rear axle of the machine. As may be seen by glancing at the accompanying photograph, this truck also carries the front end of the van, which is held by a swivel coupling that permits the contrivance to be steered. On the right side, at each end of what may be termed the trailer, a built-in folding bed is provided. Each of these is accessible from the inside of the van, and when folded out, is inclosed in canvas, forming an airy, comfortable bunk. The kitchen is situated at the fore end, where a gasoline stove, a sink, hot and cold running water, a cupboard, a cooling cabinet, a pantry, and a folding table are supplied. At the rear is a small dressing room and clothes closet. In the living room there is a built-in writing desk and bookcase.

# *Al. S. Waddell (5223 Santa Vieta St.) in Times N.Y.*

*866*



*Los Angeles*

Comfortable Traveling Quarters are Provided for Three Persons in This Odd Road Schooner

*S. W. Beasley, (owner)  
Pomona, Calif.*



958

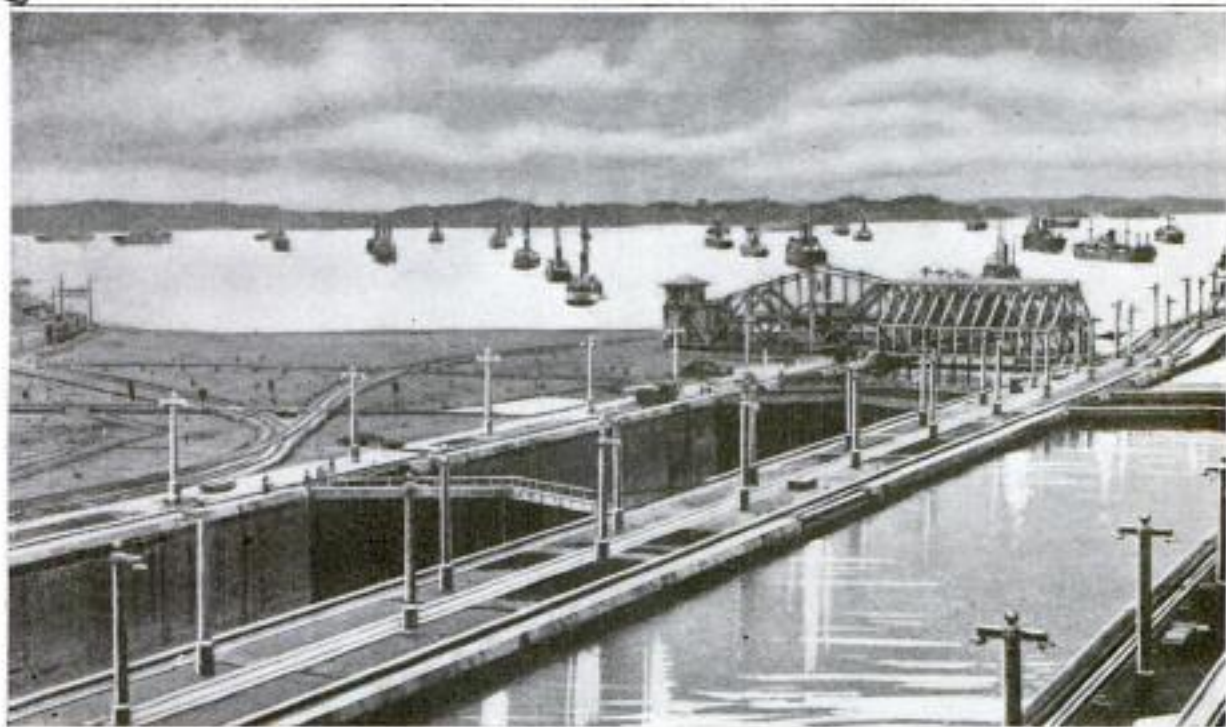

COPYRIGHT, INTERNATIONAL FILM SERVICE, INC.

MANY SHIPS BLOCKED BY STOPPAGE OF CANAL

VIEW of Gatun Lake at Panama Canal showing large fleet of merchant ships held up by the latest slide at Gold Hill in Gaillard Cut. The delivery of munitions and railway locomotives to Russia has been delayed, as have shipments of other cargoes to various ports. Coastwise traffic via the canal has likewise been suspended. The vessels shown here are awaiting the reopening of the waterway, instead of making the long trip around the Horn. Engineers believe that the passage will again be ready for traffic early in January.

FLIER LAUNCHED FROM  
SPEEDING VESSEL

997 *Army & Navy Journal*

What navy officials believe to be the most important development in the art of flying in recent years took place off the coast of Florida a short time ago. From the deck of the speeding "North Carolina," an aeroplane tender, an airman succeeded in launching his machine and soared away in successful flight. This achievement means that hereafter American battleships will be enabled to send forth scouting air craft even while proceeding under full speed, an invaluable asset in time of approaching encounter with an enemy squadron. To do the launching, the catapult arrangement described in the January, 1913, number of Popular Mechanics Magazine is employed. The aeroplane is mounted on a little car on which it is propelled down an inclined track at a speed bordering on 50 miles per hour. At the end of the rails the car suddenly stops, and the flying machine soars away under its own power.

SPIES USE NEWSPAPERS TO  
TRANSMIT WAR NEWS

993 *1/15*

The British postal department has discovered that spies have been using newspapers and periodicals as mediums of communication with their home governments. Whether the communicating is done by writing on margins, by crossing out words in the printed matter according to some secret system, or whether marked bits of paper have been rolled up with the news copies, is not stated. At any rate it appears to have definitely been established that important information was being sent enemy countries through the medium of newspapers forwarded by private individuals. To prevent this practice in the future, the government has ordered that the post-office department forward no papers or periodicals except those that come direct from publishing houses. Readers in foreign countries will therefore have to subscribe direct for their publications hereafter.

*#Navin  
Engineer & Naval Architect  
10/29/15*

# FRANCE'S GREAT DRIVE IN THE WESTERN THEATER



COPYRIGHT,  
UNDERWOOD & UNDERWOOD  
In a German Trench After the Kaiser's Forces had been Routed, Following a Long Artillery Bombardment, and the Position Captured by the French. The Soldiers are Seen Examining the Excavation and Searching for Souvenirs and Booty

Below is Given an Interesting Glimpse of One of the Zig-zag Communication Trenches during the Heat of the Great Offensive: On One Side German Prisoners, Just Surrendered, are being Escorted to the Rear, While at the Right Fresh Troops are Pushing through to the Firing Line



Tens of Thousands of Shells Rained against the German Positions Before the French Commenced Their Spectacular Rush. This Picture Shows One of the Heavy Artillery Pieces in Action during the Protracted Bombardment Which Lasted for Many Hours



## HARDSHIPS MET BY WARRING ALPINE FORCES



**H**AZARDOUS climb made over a rocky cliff by a force of Austrian mountain troops during an engagement with the Italians near the frontier. The soldiers are assisting a wounded comrade up a precipitous pass. Sights of this kind are very common in the Tyrol Alps and explain graphically why progress there has been slow.

## INGENIOUS RUSES RESORTED TO IN WAR



Sketch Showing King Emanuel of Italy and General Joffre Watching the Progress of a Battle in the Hills



One of the Italian Artillery's Heavy Guns Mounted on a Narrow Track in the Mountains of Tyrol. The Battery is Screened from the View of the Enemy behind a Clump of Trees



Large Store of Ammunition at the Rear of French Artillery Batteries Concealed from Airmen beneath a Thick Covering of Branches

## AND VIEWS FROM VARIOUS BATTLE CAMPS



This Panorama Gives a Very Clear Idea of the Type of Country in Which the Un-trained Serbian Forces are Defending Themselves



Dummy Horse Made of Barbed Wire and Used by the Germans as a Decoy. It was Captured from a Trench by the British

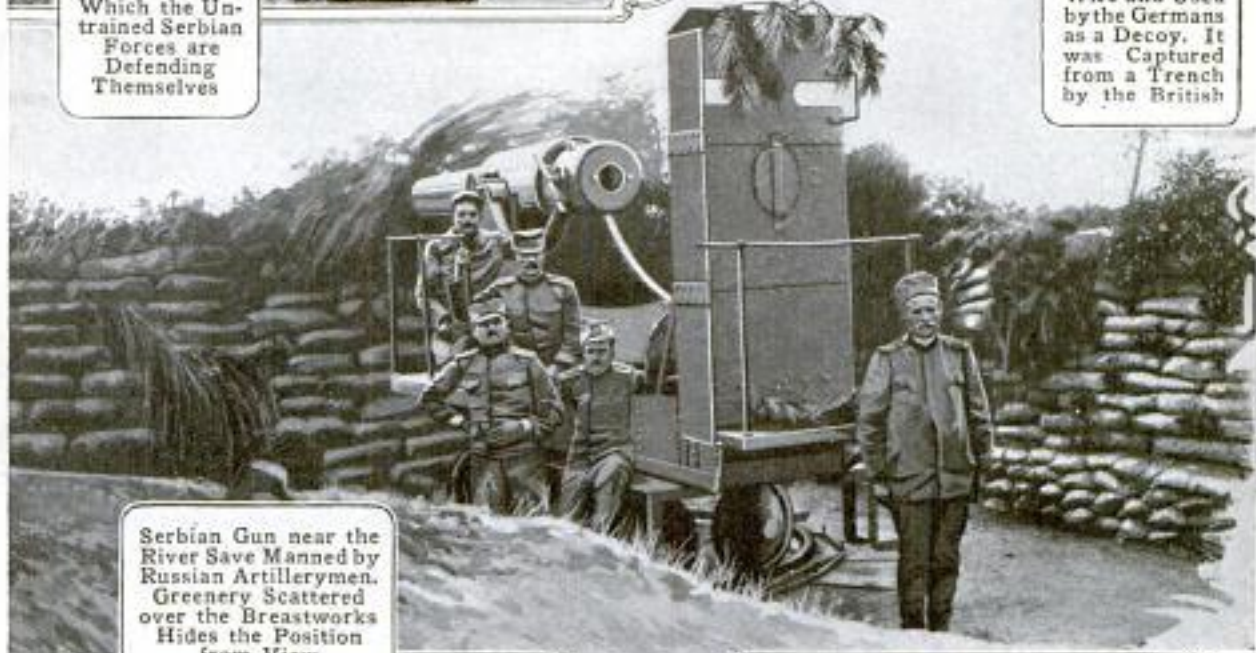

Serbian Gun near the River Save Manned by Russian Artillerymen. Greenery Scattered over the Breastworks Hides the Position from View



Large French Gun Surrounded by Logs and Painted to Resemble a Fallen Tree in Order to Deceive the Enemy's Aerial Scouts



This Shows an Armored Motor Car, Used by the Allies and Painted to Look Like a Small Brick Building. After It had been Discovered by German Gunners and Temporarily Disabled

## MAKING BANDAGES AND DRESSINGS FOR WOUNDED



British Women Working for Queen Mary's Needlework Guild Making Cotton Swabs for Use of Army Surgeons in the Field and at Military Hospitals



Medical Corps Using Acetylene Lamps and Electric Flash Lights in Searching for Wounded in a Woods at Night



Thousands of Yards of Bandages have been Made by the Workers. Here They are Winding the Long Strips of Chemically Treated Gauze into Rolls of Convenient Size

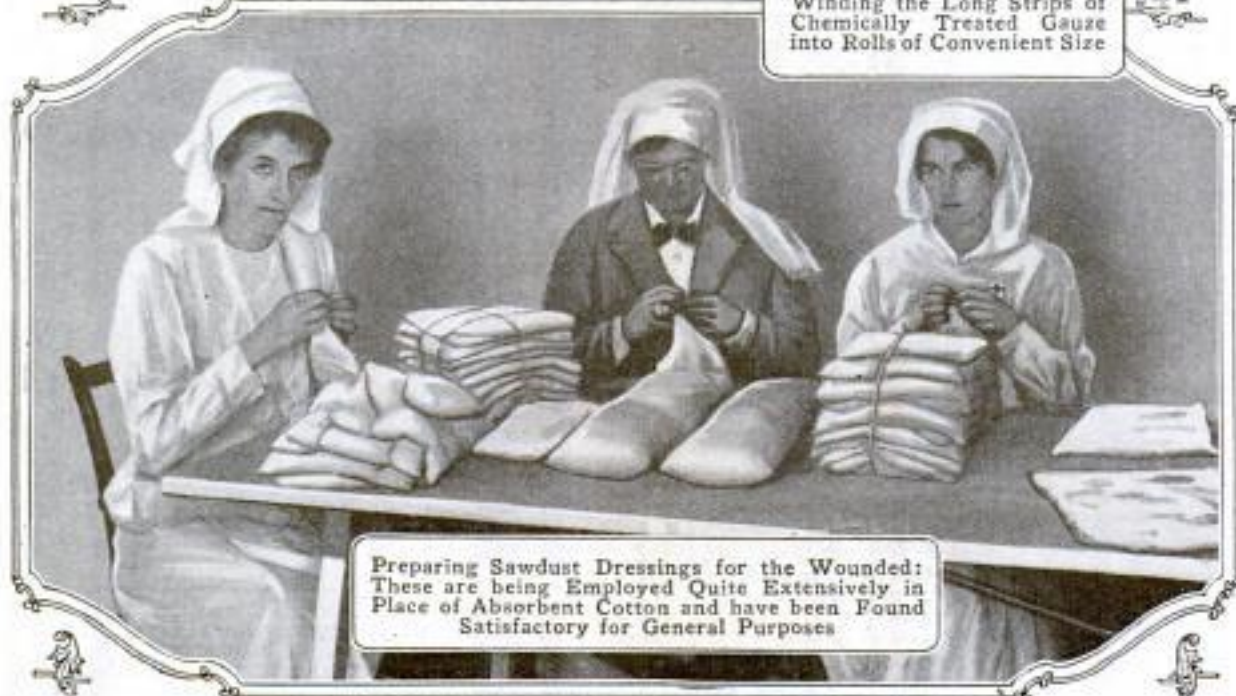

Preparing Sawdust Dressings for the Wounded: These are being Employed Quite Extensively in Place of Absorbent Cotton and have been Found Satisfactory for General Purposes

# WAR HORSES IN BATTLE AND AT HOSPITAL BASE



Charge of an Algerian Cavalry Detachment across the Dunes in Flanders: One of the Most Picturesque Photographs Received Since the Outbreak of Hostilities



In War the Loss of a Horse is as Costly as That of a Man, so Pains are Taken to Treat His Injuries and Aid His Recovery Whenever it is Feasible. Here a Wounded Animal is being Thrown Preparatory to an Operation



Interior of One of the Large Veterinary Hospitals in the Western Theater Where Disabled and Sick Horses are Cared for and Given Medical and Surgical Attention



Motor Ambulance in Which Horses Wounded in Battle are Carried to Veterinary Bases for Treatment



COPYRIGHT, INTERNATIONAL FILM SERVICE, INC.

## GERMAN BATTLE TRENCHES IN THE BUILDING



This Photograph Shows Pioneers Connected with the Engineering Corps of One of the Teutonic Armies Intrenching a Position Prior to Its Occupation by the Infantry



Carrying Reeds and Willow Poles to the Newly Dug Trench to be Used in Reinforcing Its Sides. The "Pioneers" Who Do This Work are Usually Recruited from Men Unfitted for Regular Fighting



Weaving the Springy Poles about Posts to Form a Substantial Lining for the Trench: This Goes Far in Preventing the Walls from Crumbling during Rainy Weather When the Ground becomes Watersoaked



## STRIKING SCENES IN DIFFERENT WAR CAMPS



Rats have become a menace in many of the trenches: Professional catchers are employed by the French to exterminate them.



Carrying the bodies of fallen soldiers to an awaiting grave behind the German lines: The size of this trench gives an idea of the modern meaning of "heavy losses."

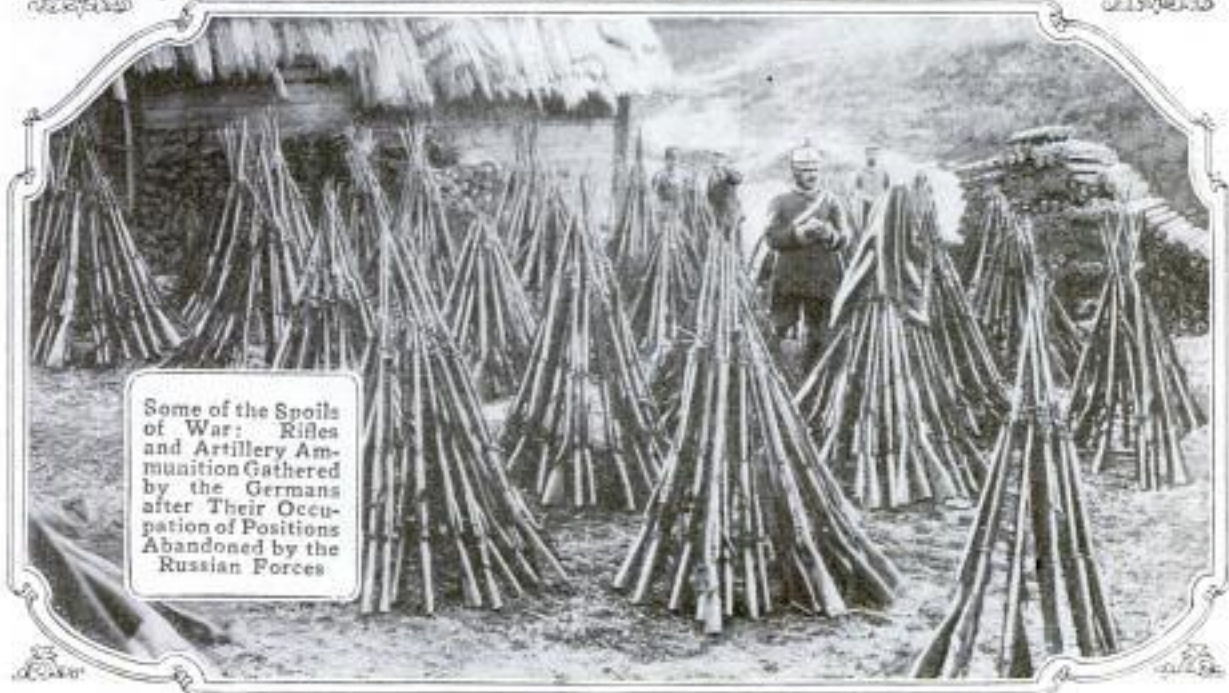

Some of the spoils of war: Rifles and artillery ammunition gathered by the Germans after their occupation of positions abandoned by the Russian forces.

## SYSTEM AND ORDER MARK GERMAN EFFICIENCY

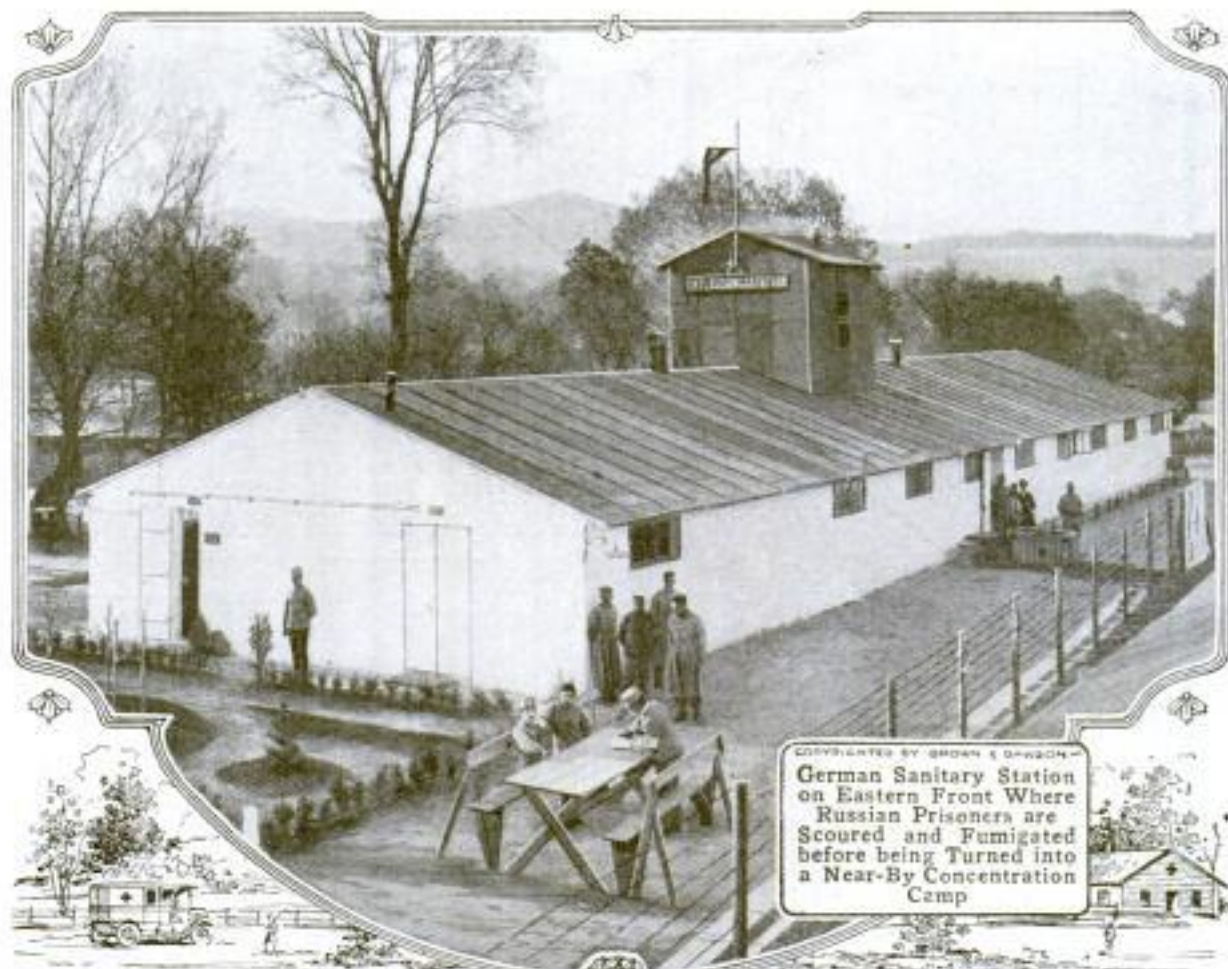

# EVERYDAY LIFE OF EUROPEAN WAR PRISONERS



Russian Prisoners of War. All of Them Badly Maimed, Arriving at Petrograd by Way of Sweden after being Exchanged with Germany



French Prisoners in Teuton Camp Studying the German Language under Tutelage of One of Their Comrades, a Professor of a Paris University



Tent Church with Altar and Organ in German Concentration Camp Where Protestant and Catholic Services are Held in Various Tongues



French Captives Operating Machines Which Chop Meat, Grind Peas, and Mash Potatoes for Consumption of Prisoners



PHOTOS COPYRIGHT,  
BROWN & CAMERON

# TEACHING MAIMED SOLDIERS NEW OCCUPATIONS



© INT. NEWS SERVICE

Wounded Soldier upon His Arrival in France being Decorated with the Cross of the Legion of Honor by President Poincaré

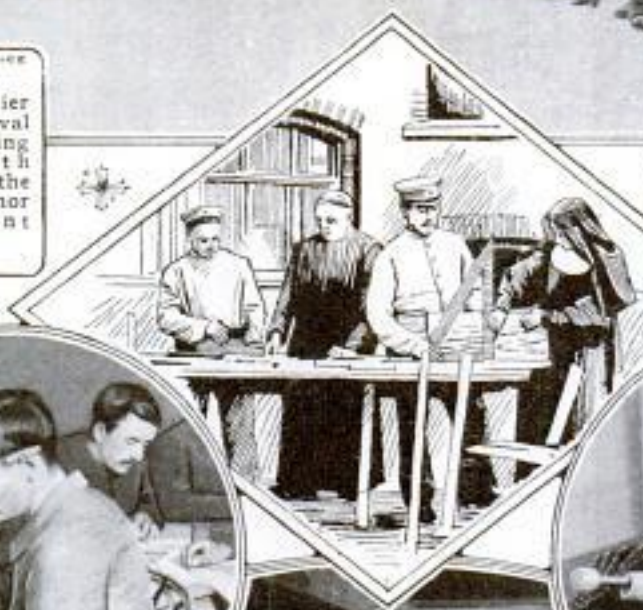

Belgian Priest and Nun Instructing the Wounded German Soldiers in Carpentry during Their Convalescence



© INT. NEWS SERVICE  
One-Arm Men being Schooled in Things That will Make Them Fit for Clerical Positions



© INT. NEWS SERVICE  
Badly Crippled Soldier Learning the Tailor Trade in Order to Become Self-Supporting



© COPYRIGHT, INTERNATIONAL NEWS SERVICE  
Many of the Crippled Soldiers are Instructed in Toy Making. Some Who Have Only One Arm Become Quite Skilled as Workmen

743 ANALYSIS OF SANDS IS MADE SIMPLER PROCESS

In erecting concrete structures the quality of the sand used is of the utmost importance. A machine has been invented which will make quick and accurate tests on this material as it is delivered load by load to the job. By this means uncertainty may be eliminated and an accurate knowledge obtained of the sand going into a structure at all stages in its erection.

Unlike most existing testers, this machine works with the material in a thoroughly wet condition, rather than extremely dry. The instrument consists of a long metal box divided into compartments by screens of known and accurate mesh. A measureful of the sand to be tested is poured into one end of the box, together with enough water to bring the total height up to an indicated level. The contrivance is then given a reciprocating motion, which results in the sand percolating through the several screens and accurately sorting itself into the definite sizes represented by the individual screens. Upon turn-

ing the instrument over, the sand is run off into a series of glass bottles arranged in tubelike formation along the side of the metal box—each bottle opening directly into its own compartment. Upon standing the instrument

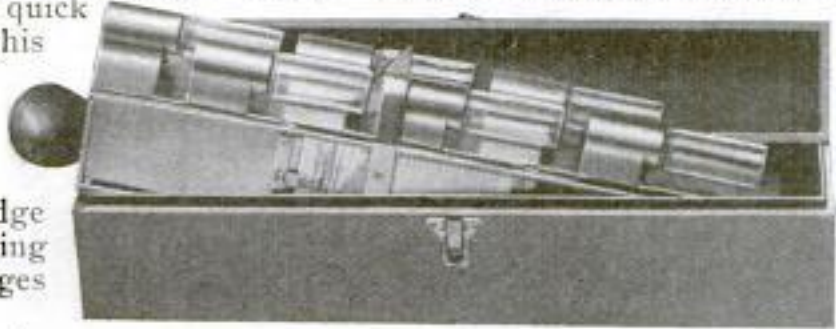

New Instrument Tests Sand While Wet Instead of Dry

on end, the sand settles in each container and the amount of each kind may then readily be determined by inspection. Adding together the heights of sand in each bottle gives the total amount put in, and a paper recording system is provided by which a permanent record of the heights given by the test may be made. From this it is an easy matter to figure out the percentage of each size of sand found in the original volume, and also to discover how much clay or other impurities may have been present. The instrument is readily carried about.

801 PADLOCK OF FREAK SHAPE HAS MANY USES

A padlock designed particularly for the use of automobilists was lately put on the market. The dominant feature of this lock is its "Bow" bow. Instead of the usual semi-circular form for slipping through a staple, or the like, the bow on this shackle is oval in shape and is divided at the middle into two jaws which open outward, hinge-fashion. A mechanism at the hinge, manipulated with a key, supplies the locking feature, and is capable of clamping the jaws in posi-



tion whatever their degree of opening. The lock is designed particularly for securing lap robes to their supporting bars in the tonneau of an automobile. Or a suitcase may be locked to a foot-rail and the chances of its being spirited away lessened. The gasoline and spark-control levers may be clamped to the framework just beneath the steering wheel and thus unauthorized use of the car be prevented. The large size of the bow permits the padlock gripping many things beyond the range of an ordinary lock of the kind.

Apple growers in the vicinity of New York are planning to ship to Europe enough apples to supply one to every soldier in the trenches and the hospitals.

Inventors Sales Co.  
 Smithport, Pa.  
 (distributors) Backus Novelty Co. Smithport, Pa.  
 Mrs.

2161242222 - 1912

*The Cloche Co., 131 Hudson St., New York.*  
 12" x 12" - 11.00 per 1000 - 1.25 per 100  
 14 x 14 - 14.00 " " 1.50 " "

**NEW CELERY BLEACHER MADE OF BLACK PAPER**

485

To do away with the necessity for "earthing up" celery in order to bleach it, a bleacher consisting of a cover de-



With These Covers Placed around the Celery Plants the Stalks are Thoroughly Bleached without Resort to the Usual "Earthing Up"

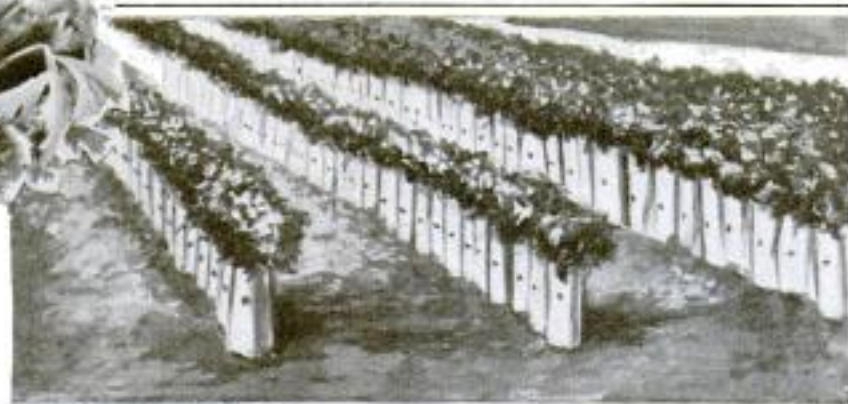

signed to be placed around the plant has recently been placed on the market. This bleacher is made of heavy black paper which excludes all light from the stalk. It comes in flat sheets which are simply bent around the plant and fastened with cord and buttons. The paper is waterproof and will withstand wet weather, so that with reasonable care the same bleachers can be used for several seasons.

**SIGNIFICANCE OF X-STORMS FOUND BY RADIO EXPERTS**

915

As a result of a comprehensive study, it has been found that the "strays," or static discharges commonly known as X-storms, which frequently interrupt radio communication are due to atmos-

pheric conditions that bring about thunderstorms. The prevailing belief in the past has been in contradiction to this. It has been considered that X-storms were the result of thunderstorms which in due time reached the zone where the "strays" were detected. Observations have been made at wire-

less stations in all parts of the world which have shown convincingly that X-storms are developed by the atmospheric conditions which subsequently result in thunderstorms. Ordinarily a day elapses after the presence of severe "strays" has been felt before lightning and rain come. The disturbances coincide with periods of low pressure, great wind velocity, radical temperature changes, and rapid barometer fluctuations. There are times when wireless instruments detect the presence of "strays" that thunderstorms do not follow. In such cases rain most always falls, however, and there are changes in temperature. The absence of electrical disturbances in such instances is said to be due to the fact that the atmospheric changes have not been of sufficient severity to produce noticeable lightning.

In the daytime, "strays" are often caused by purely local discharges which are too weak to cause lightning, but which herald the approach of unstable weather. It has also been observed that static disturbances recorded at night are more often due to non-local conditions than those occurring in the daytime.

As concrete examples of wireless apparatus offering a means of forecasting weather changes, the records of the

*London Engineer 9/17/15*  
*N.Y. Herald 11/7/15*

radio station at Malta show that severe "strays" prevailed on Aug. 22 and 23, 1914, while the heaviest rainfall of the month occurred on Aug. 24. Likewise during the nights of Sept. 22 and 23, of the same year, bad X-storms occurred and were followed by heavy rains.

### NEW TYPE OF DOLL TEACHES CHILDREN EMBROIDERY

798 The liking small children have for needlework and sewing is to be satisfied in a new and interesting way with a toy lately brought out. It consists of a family of pasteboard dolls of ordinary size, and accompanied by the usual complement of brightly colored, interchangeable garments — likewise pasteboard. Outlined on each gown, or coat, or whatever it may be, is an embroidery pattern through which needle holes are punched at short intervals. Several strands of brightly colored embroidery silk and a needle are a part of the set, and with these the small lady may embroider the doll dresses to her entire satisfaction, simply by following the punched holes in the outlined design.

### NEW CONTAINER FOR SAFE SHIPPING OF EGGS

270 The shipping of valuable eggs for hatching purposes is hazardous, since

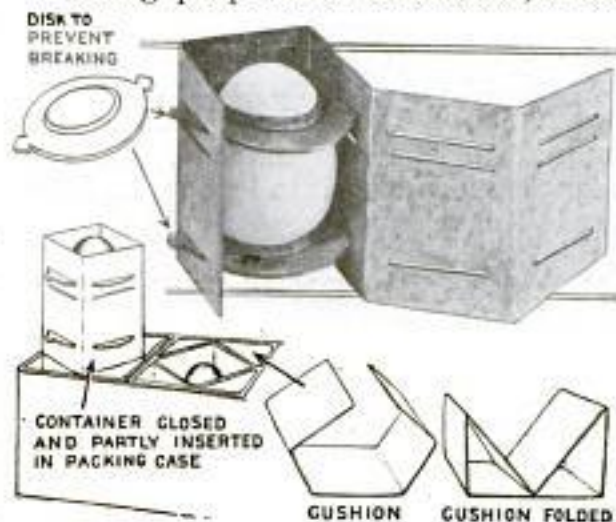

Eggs are Safely Shipped to Destination in New Type of Cushion Container

the jars and shaking up of travel are likely to injure the fertility of the eggs, even if they do emerge from the journey with unbroken shells. A new container has appeared on the market, however, which the manufacturers claim will eliminate a large share of this danger. In the new carrier a separate com-



partment is provided for each egg, which is held in a fixed position within the compartment by a washer at either end. The compartments are packed into a corrugated-fiber outside box, a series of air spaces being provided for free ventilation. By thus isolating each egg and holding it firmly in position the strains upon the delicate membranes within the egg are reduced, and the chances of causing it to lose its fertility are lessened.

*Rural*  
**NEAT MAIL BOX IS ERECTED  
 BEFORE COUNTRY PLACE**

*Rural*  
 Permanency and sightliness are two of the attributes incorporated in an attractive mail box that has been erected by a Californian in front of his country home. The receptacle itself is about 18 inches square, is made entirely of copper and fitted with a small door on one side. It is supported on a substantial brick pier, approximately four feet in height, which tapers slightly toward the top. Insomuch as the residence is a brick bungalow, this type of mail receiver



fits in with the general scheme nicely, besides showing a marked improvement in appearance over those devices commonly employed in our rural and suburban districts.

*701*  
**AUTO TRUCK CLEANS AND OILS  
 STREETS**

An auto truck that will either sprinkle, flush, or oil a street is a late addition to the equipment available for municipal roadway work. A large tank is mounted directly over the rear axle of the truck, and will hold 1,200 gal. of either oil or water. Sprinkler nozzles hang from the rear end of the chassis, while flusher pipes are just ahead of the hind wheels. At the extreme end of the car is attached a small seat for the convenience of an assistant operator. The latter controls a gasoline heating plant for warming up the tank when oil is being distributed. This second man also shifts the 16 oil nozzles to the right or left of the road as may be required. The chauffeur, besides driving the car, also controls oil and water pumps which keep the nozzles supplied. By thus combining oiling, flushing, and sprinkling functions all in one machine, and that an auto truck, street officials are now enabled to accomplish work more quickly and with much less investment in vehicles than formerly. The machines are especially useful in repair work or in the building of new roadways.



Flushing, Oiling, and Sprinkling of Streets is Readily Accomplished with New Type of Auto Truck

*White Co., Cleveland, O.*





*Ranger Mc Intyre in Malheur Forest, Ore.*  
Coyotes Killed by One Forest Ranger in Oregon during a Winter's Shooting

# *W. A. Du Sny, Clarendon Va.*  
**FOREST RANGER IN WINTER**

*9930* **BECOMES HUNTER**

During the winter when heavy snow in the mountains checks some of the activities of the forest ranger, he becomes a hunter. It is then his duty to devote attention to the extermination of wolves, coyotes, and other animals which prey upon cattle and sheep. Incidentally this work, besides furnishing good sport, also offers a means of increasing his income. In Oregon, for instance, a bounty of \$1.50 is paid for a coyote's head. The pelt, on the other hand, is worth several dollars. So, while drawing a government salary, the ranger is also collecting bounties and disposing of skins to furriers. In some localities the season's shooting nets many trophies and brings in considerable revenue to a good hunter and trapper.

Four-o'clock tea, served in the observation car, is a travel feature recently installed by a western railroad.

**CAPACIOUS CEDAR CHEST**

*843* **MAKES NEAT SETTEE**

Intended to provide a useful container for clothes as well as an artistic piece of furniture, a cedar chest made up in the form of a settee has been brought out. The utility of a cedar chest in protecting clothing and furs from moths is well known. Usually the chests are installed in front halls, or libraries, or bedrooms. By thus making them up in the form of settees

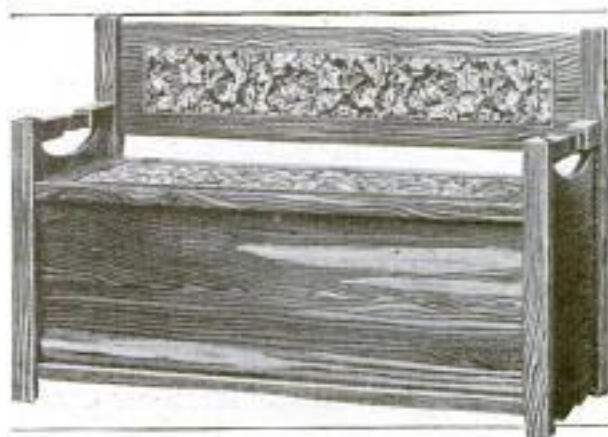

Cedar Chest and Settee Combined in One Article of Furniture

*J. R. Clark Co.*  
*Minneapolis*  
*Minn.*

of different patterns, the clothes containers are given an artistic usefulness not otherwise obtainable. An additional feature of these chests is the style of corner joint used. Instead of the common butt joint, a mitered corner is made and held together with a special "W"-shaped wedge. The bottom is held to its place by grooves cut

in the side walls. By such construction the use of screws or nails anywhere about the chests is rendered unnecessary, and warping of the boards in damp rooms prevented. The top of the chest forms a seat for the settee, and it, as well as the back, may be upholstered in tapestry or velour, if desired.

### FINGER STALLS DESIGNED FOR 345 USE OF TYPISTS

Rubber sheaths designed to be fitted over the fore part of the fingers are being made as nail and finger-tip pro-



The Sheaths Save a Typist's Fingers from Ink Stains and the Nails from being Worn and Broken

tectors for typists. They are invented to prevent the wearing and breaking of the nails and also to keep the fingers from being stained by the frequent handling of ribbons and carbon paper. The feeling of awkwardness disappears after they have been used for a short time, it is said.

A number of windowless and unheated cars, known as "fresh-air cars," are being run as a winter experiment on the elevated lines of Chicago.

### HIGH SPEED PERMITTED ON 605 PRIVATE BOULEVARD

Many city officials of the country are said to work a hardship on touring as well as resident motorists by passing stringent laws with regard to speed limits at which drivers may travel. Some of these limits are from 12 to 14 miles an hour, while in a few instances 25 miles an hour is permitted. The speed limits of San Fernando, Cal., range from 14 to 25 miles an hour, but squarely in the middle of the city is a private boulevard, the owners of which seem inclined to go to the other extreme, and have set the speed limit at 100 miles per hour.

This private boulevard is very wide and something like eight miles in length. It is as smooth as a table, but notwithstanding this fact, the auto drivers do not appear disposed to take advantage of the liberality of the owners by speeding. Usually they simply lean back in their seats and ramble along at an easy gait.



Owners of This Private Boulevard would Apparently Not Chafe Auto Drivers with Stringent Speed Regulations

Institute My Co. Akron O.

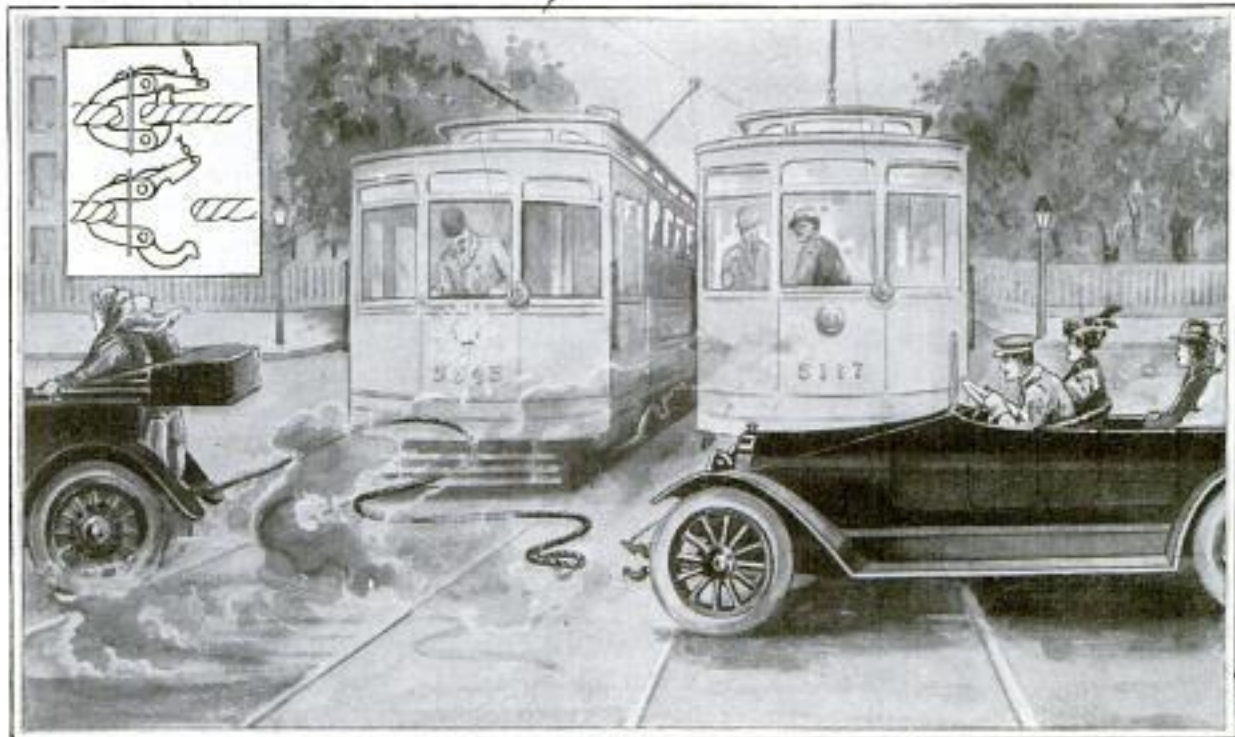

A Slight Jerk on the Trip Cord Releases the Towline and Places Each Car in the Control of Its Driver

**SAFETY TOWLINE HOOK MADE  
 9186 FOR USE OF MOTORISTS**

For lessening the chances of accident when a disabled motor car is being towed, a hook has been devised which permits a drag line to be disengaged quickly in case of an emergency. The hook is securely fastened to a rope attached to the fore axle of a crippled machine. Its two jaws grip the free end of a line extended from the tractor. These members are designed to hold firmly until released by a slight pull upon a trip cord held by the chauffeur of the car in tow. When an accident seems imminent, the two cars may thus be freed from one another, and each operator placed in control of his respective machine. If in crossing a railway track, for instance, the approach of a train is not noticed by the driver of the lead machine, the second car may be saved from a collision by pulling the trip cord and applying the brakes. The device is made in two patterns, one of which is intended to be fitted in the towline, as just described, and the other to be mounted permanently on the front axle, where it is always ready for use.

**TOWN HAS BULLETIN BOARD  
 697 FOR PUBLIC NOTICES**

Bairdstown, a California hamlet of some 200 persons, does not boast even a country weekly. Instead of a newspaper, however, it has a public bulletin board upon which are posted articles of community interest. These notices range from "want ads" to engagement announcements, funeral items, and town proclamations. The board is 3 ft. by 4 ft. in dimension, is built in the form of a case inclosed with glass doors, and is erected on one of the streets. It was acquired only recently and affords the community its sole means of making public announcements and circulating news, except through the school and churches.



*Style N. Mounted in Town (1 1/2 x 4) front panel 2.00  
 B " on front axle (3/4) " " 2.50  
 Finished in color of car 2.50 extra*

222  
 EXTENDING CHIMNEYS IS NEW  
 AND DANGEROUS WORK

To climb up a soot-covered, rusty ladder to the top of a tall chimney, there to work all day long amid puffs of hot gases and stifling black smoke, is not a task that the average man would envy. Added to the dirt and grime of the work is the danger of misstepping or losing one's balance. To do such work successfully requires a kind of quick thinking and sureness of foot not ordinarily met with. Yet a trade or profession which has lately arisen among bricklayers has need for just such qualities.

The new work is that of extending tall chimneys while still in service. With the expansions American factories are making, demands are continually strong for more boilers and more steam. These are generally provided, but difficulty is sometimes experienced in making the same old chimney carry off the gases from the additional new equipment. Already working up to capacity, the chimney is unable to supply sufficient draft. Building a new chimney means a large money outlay which the owners may be unable to supply. An alternative offers itself in extending the chimney already up, provided it was originally built strong enough to stand an addition.

This alternative is frequently chosen—hence the rise of the new profession. The workers climb up the narrow steps of the chimney and near the top they pass a rope around the structure to support a future scaffold. To do this they must place L-shaped, double-ended hooks over the rim of the chimney, and step in the loops at the lower ends. By advancing one hook ahead of the other, one of the workers proceeds around the chimney, carrying the rope with him. Only the narrow steel of the hook supports him in this process, and sometimes its hold among the loose bricks at the top is none too solid. Below him, 150 to 200 feet down, rise a jagged series of roofs, or perhaps the piles of scrap iron that usually accumulate in the back yards

COURTESY OF ENGINEERING NEWS  
 Building a 30-Foot Extension to a Brick Chimney:  
 High Winds and the Smoke Make  
 the Work Difficult

*Alphonse Custodis Chimney Const'n Co.  
 140 S. Dearborn St. Chgo.  
 95 Nassau St. New York*



New Gas Burner is Designed for Chafing Dishes or Light Table Use. A Griddle is Provided for Baking Cakes and Another Attachment Toasts Bread



of manufacturing plants. The wind whistles up with the dirt and grime of a factory city, and often the smoke from the stack itself curls down around the top, enveloping him in smothering, nauseous gas. Yet, somehow, through it all he gets the rope safely around. Then the scaffold with its supporting brackets is brought up and hooked on.

Afterward the process is but ordinary masonry, except for fighting of smoke and the care that has to be taken not to overstep the narrow planking of the scaffold. Upon some occasions the planking has caught fire from the smoke. Then has ensued a wild scramble for the ladder down the stack, accompanied by a mad ripping loose of the boards and a throwing of them into the stack, that they may not fall onto tar or shingled roofs below and, perhaps, start a serious conflagration. Some days the smoke is so bad that no work at all can be carried on. The furnaces cannot be stopped, for that would mean shutting down the factory, so the chimney workers necessarily have to lay off for a time, awaiting better weather conditions. Altogether it is hazardous work, but work that evolves some neatly finished chimneys.

### GAS TABLE BURNER TAKES PLACE OF ALCOHOL

As a heating unit for chafing dishes, and the like, a manufacturer is putting out a gas table burner of simple construction. An attachment permits bread to be readily toasted, and a small

griddle is provided for making light cakes. The burner is intended to take the place of alcohol in the chafing-dish field, and to compete with the inroads electricity is making in the same service.

### TRIMMING VENEER EDGES WITH ELECTRIC SAW

In place of the old-time drawshave method, a manufacturer has put on the market a veneer trimmer operated by an electric motor. By simply sliding the little tool along the edge of the extending veneer the unnecessary material is perfectly and quickly cut away. A set-screw located on top of the planer makes adjusting for exact surface work an easy matter. The saw operates at high enough speed to prevent glue from adhering to its surface. Provision is made for the safety of the operator by surrounding all movable parts with suitable guards.



A soft and silky fiber, known as "malva blanca," has been discovered in Cuba, and is said to give considerable promise of being an ideal material for sugar bags. The fibers will stand close weaving, will not shrink, and are stronger than hemp, it is stated.

Commercial Reports  
Oct. 20, 1915

Mattison's Machine Works Co.  
Beloit, Wis.

## BOY ON ROLLER SKATES

## 754 DELIVERS BALL SCORE

During the recent world's series a Maine shoe-manufacturing concern



adopted an unusual method of keeping its employes informed as to the progress of each day's games. A board was arranged with space for the score by innings and to display the day's batteries. This was fastened to a pole and a messenger on roller skates went through the factory immediately at the close of each inning. As a result the 1,000 or

more employes knew at all times how the games were progressing, and at the same time the demands that heretofore had been made on the company's telephone system to gain the same information were materially lessened.

## WOULD SELL CAST-IRON

## 808 CAPITOL DOME

*Engineering News '914/15*  
Custodians of the state capitol building at Madison, Wis., recently had an unusual commodity for sale. The old cast-iron dome on the roof of the building had been taken down to make way for one of more modern construction. In removing the old top the various pieces were separated in such manner that they could readily be reassembled, should the purchaser desire to use them again as a dome. The pieces for sale weighed nearly 1,000 tons in total, enough to delight most any junk man's heart, should he be the purchaser.

## CHILDREN RIDE TO SCHOOL IN COMBINATION AUTO

644  
When school opened this year in a town on the Oregon coast, the man who has the contract for carrying pupils from the surrounding territory found that the population had grown so that his seven-passenger car was not large enough to handle the business. He met the emergency with a simple expedient, however. Buying a secondhand car, he had it cut in two, and the rear half rigged up as a special conveyance, complete even to the attachment of a windshield. This he coupled to the rear of his regular automobile, trailer-fashion. With this addition to his regular carrying capacity, all the children along the route could be accommodated with ease.



Children are Transported to and from School in Combination Automobile

*Mr. Holly, Seaside, Oregon*

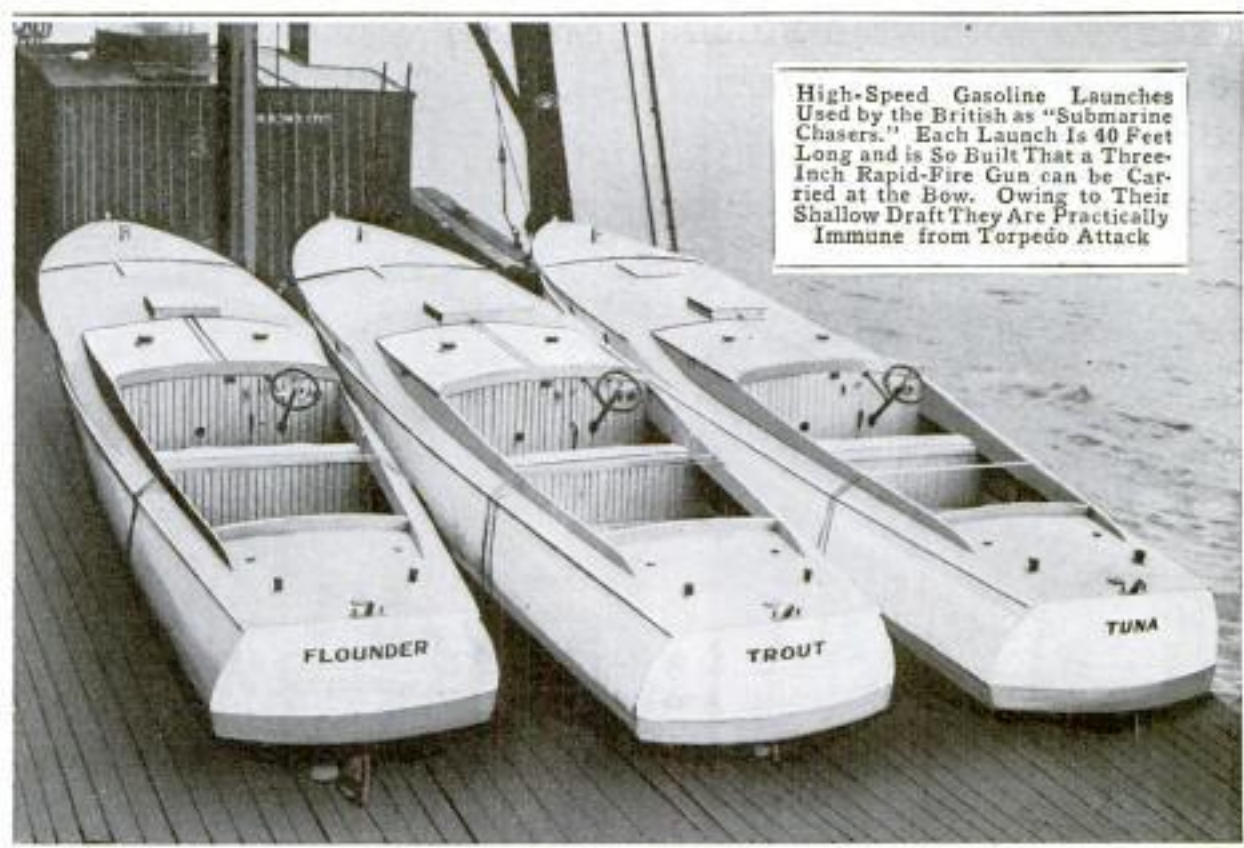

High-Speed Gasoline Launches Used by the British as "Submarine Chasers." Each Launch Is 40 Feet Long and is So Built That a Three-Inch Rapid-Fire Gun can be Carried at the Bow. Owing to Their Shallow Draft They Are Practically Immune from Torpedo Attack

COPYRIGHT BY BOSTON PHOTO NEWS CO.

730 "SUBMARINE CHASERS" TO GUARD BRITISH COAST

For guarding their coasts against German submarines the British have resorted to the use of "submarine chasers," which are simply high-speed gasoline launches capable of mounting guns of 3-in. caliber. These launches are all American-built, and out of 40 for which contract was placed with a Boston firm early in the year, six are known to have been completed and shipped to England. Each launch is 40 ft. long, is equipped with a 100-hp. engine, and is built and equipped to make a speed of 28 3/4 miles an hour. The steering gear is like that of an automobile. Living accommodations are provided on each vessel for two or three men. The hulls are of the V-bottom type, and the motors are equipped with a special carbureting device by means of which either gasoline or heavier oils may be used. The contract price is reported as \$4,000 for each of the launches. A novel feature of the launches is that each is named from some particular kind of fish.

448 WEDGE-SHAPE CUSHION MADE FOR MOTOR-CAR SEAT

To support the small of the back and fit the natural curve of the body, an auxiliary cushion has been designed for the chauffeur's seat in a motor car. It is 21 in. wide, 12 in. high, and 4 1/2 in. thick at the bottom. The front side tapers to the top, where it is 1/2 in. thick. The cushion is filled with sea hair and covered with leather. By re-

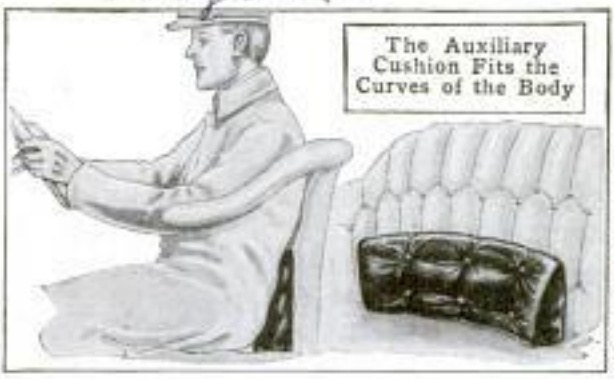

lieving the strain on the muscles of the back, for which the cushion is intended, a person is allowed to relax thoroughly and drive in comfort.

Leather 3.50  
 Lin. " 2.00  
 Fabric 2.00  
 (Chair's gray or outside of brown)

Holden Mfg. Co.,  
 St. Paul, Minn.  
 Copyrighted material

**IMMENSE CONCRETE FILLING**

*747* **RENEWS TREE'S VITALITY**

It took six and a half tons of solid concrete to revive the waning life of a stately sugar-maple tree on the lawn



**Oregon Tree Requires Concrete Column 41 Feet High as Interior Filling**

of an Oregon suburban residence. The concrete was poured down inside the hollow trunk, and after setting, formed a column 41 ft. in height, 11 ft. in diameter at the base, and 4 ft. through at the top, thought to be the largest fill of the kind ever made. Since completion of the work, the tree has shown distinct signs of new life.

The column was of unusual construction. Instead of being solid and

one piece from the base to the top, it was provided with numerous joints to allow for the tree's swaying with the wind. Expansion joints were also installed at convenient points to care for lengthening and shortening of the concrete with changes in temperature. As completed, the column is visible at only two points, one at the base and the other near the top. The bark and vigorous portions of the tree completely cover the remaining parts. In making ready for the concrete, the interior of the trunk was hollowed out by men with chisels, three of whom could work in the immense base at one time.

**ELEVATED TRAFFIC HANDLED ON PAY-AS-YOU-ENTER PLAN** *748*

*748* Believing present systems of handling elevated-railway crowds inefficient and wasteful of time, a Chicago inventor has proposed that overhead roads be operated on the pay-as-you-enter plan. In support of the idea it is maintained that ticket agents and platform guards could be done away with, passengers loaded and unloaded much more quickly than at present, and several thousand dollars saved the roads daily in miscellaneous expenses.

The system by which the inventor proposes to accomplish this has unusual features. All trains would consist of three cars or multiples thereof. The middle car of each three would have a door in its center for the entrance of passengers, and opposite this the conductor would stand ready to collect fares. In this the system differs radically from existing schemes, as these have agents at each station for the collection of fares, and the conductors have only to handle their trains. After passing through a turnstile in front of the fare taker in this new plan, passengers would be free to go to either end of the car or to the coach ahead or behind, these latter serving merely as extensions of the center car, and having no conductors or fare-collecting agencies. Owing to the fact that a large space is fenced off

*John H. Newman  
H. G. H. S. Evanson Sr., Chicago.  
Pat. Oct. 27, 1914.*





How Platform of Elevated Road may be Easily Adapted to the Use of Proposed Pay-as-You-Enter Trains

in front of the conductor, as many as 50 passengers might enter at once, and pay their fares while the train was en route to the next station, thus effecting a material saving in time. Exits are made through doors placed as in the ordinary elevated car, the opening and closing thereof, however, being under control of the conductor. Because of the one large entrance and the many exits, it is maintained that the new plan might cut in two the time necessary for station stops. A feature emphasized in advancing the system is that small changes in existing rolling stock would be necessary, and still less in station arrangement, this latter consisting principally in readjustment of gates and fences on platforms to prevent the mixing of incoming and outgoing crowds.

### HAND ADDRESSING MACHINE IS OFFICE CONVENIENCE

To fill the requirements of small offices with only moderate mailing lists, a light, hand-operated addressing machine has lately been put upon the market. Unlike the power-driven machines, this new development is only about the size of a typewriter, and the products it turns out much resemble typewritten work. Yet, for addressing, the machine is much quicker in operation and of simpler construction. Names and addresses on a company's mailing list are embossed once for all on metallic cards

which are kept in an index file. When it is desired to send out letters to those on the list, the cards are taken from the file and placed in a vertical pile in the back of the machine. Pushing down on a hand lever causes one of the cards to be fed forward beneath an ordinary inked ribbon. The next blow presses the envelope down against the embossed metal plate, the intervening ribbon causing the embossing to print on the envelope. Thus one blow prints a whole address closely resembling typewritten work. The

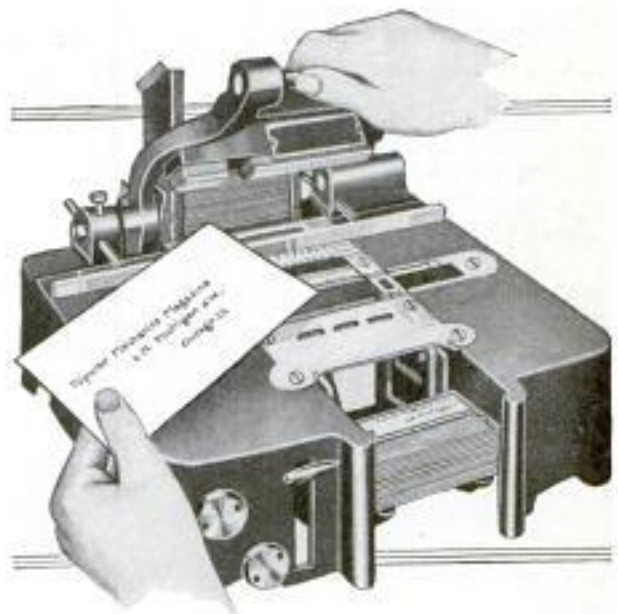

Mailing Machine Prints Whole Address in One Blow

result is naturally secured much quicker than the individual keys on a typewriter could spell out each separate word.

*The Addressograph Co.*  
*901 W. Van Buren, Chgo.*  
Copyrighted material

MODEL ENGINE IS HOUSING  
FOR NOVEL CLOCK

Quite a curious clock has been constructed by a Kansas mechanic in the

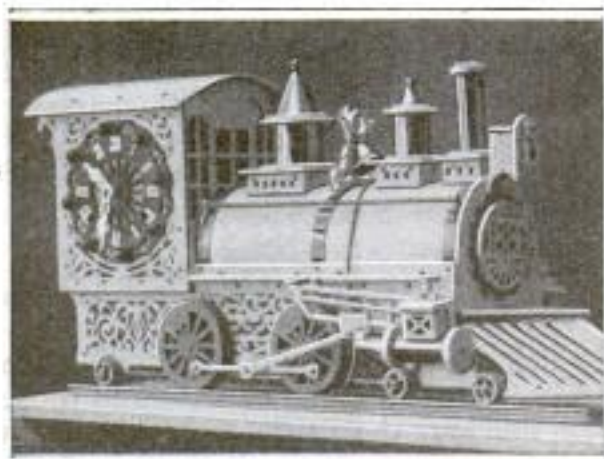

The Clock Strikes by Ringing the Small Bell Mounted on the Locomotive

form of a miniature locomotive. The dial, which is made of imitation ebony, is fixed on one side of the highly ornate cab of the engine and is studded

with small ruby and green-colored incandescent lamps. The interior of the cab is supplied with several other tiny globes, while the headlight, which is fitted with both a reflector and lens, also mounts a lamp. A switch controlled by the clock automatically turns the current on at six o'clock in the evening and cuts it off 12 hours later. The headlight, the lamps in the cab, and those on the face of the clock are wired in separate circuits. Each of these groups is flashed independently of the others at intervals of about 15 seconds and remains lighted for a period of approximately three seconds. The clock is of standard make and of the eight-day type. It strikes on the hour and half hour by ringing the engine bell and while doing this turns the driving wheels of the locomotive, which do not touch the tiny rock-ballasted track on which they apparently rest. A manual switch at the rear of the cab provides an auxiliary control of the lamps.

SHOEING SPIRITED HORSES WITHOUT DANGER

To eliminate the chance of a farrier being injured by an unruly horse or mule while performing his work, an ap-

paratus is used which holds one foot of the animal in the right position for shoeing and at the same time prevents him from kicking. The device consists of two timber brackets securely hinged

to a wall so that they may be swung out to form a temporary stall. At the outer ends the members are supported on iron standards. When a horse is led between these arms, a substantial gear is placed about his head so that he is restrained from moving it. A canvas belt is then passed beneath him, and his body is raised just enough to allow his feet to touch the floor only lightly. At the extremity of each arm, or bracket, is a mounting which receives an iron bar supplied with a leather clasp that fastens about the foot to be shod. The bar is then turned so that the beast's leg is held outstretched and in the proper position for the farrier to do his work.

With This Apparatus a Dangerous Horse may be Shod by a Farrier with Little Risk

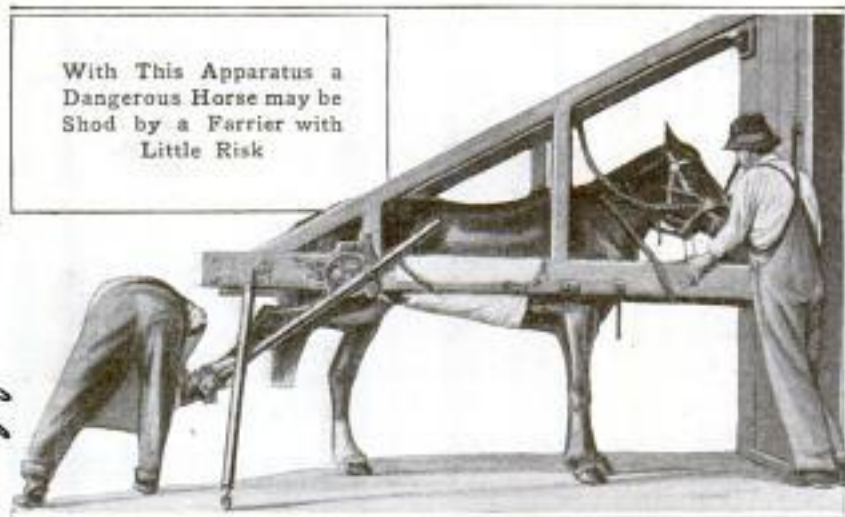

paratus is used which holds one foot of the animal in the right position for shoeing and at the same time prevents him from kicking. The device consists of two timber brackets securely hinged

clasp that fastens about the foot to be shod. The bar is then turned so that the beast's leg is held outstretched and in the proper position for the farrier to do his work.

Barnum Horse Shovel Co., Newark, N.J.  
Barnum Mfg Co., Newark, N.J.

# J. S. Bennett  
1003 Hibernia Bank Bldg  
New Orleans

*Byron R. Newton, Asst. Secy of the Treasury,  
Washington, D.C.*

## HOW FEDERAL STRUCTURES ARE PLANNED AND BUILT

9345

By J. CROSBY McCARTHY

WHEN buying stamps, registering a letter, obtaining a money order, or transacting other business, in a post office located in a government-owned building, few persons stop to consider just what events brought about the erection of that building; how the money which paid for it was appropriated; how its size, shape, and type of construction were decided upon, and how and by whom the site was selected. It is merely taken for granted that since it is a Federal building, it was erected by that impersonal and often misunderstood something called "the government."

In no way can a better conception of what is meant by "the government" be obtained, or a clearer insight into its activities be had, than by following the different steps which are taken from the time a movement for a Federal building is started in some town until the structure is completed and ready for occupancy. Take a building devoted exclusively to post-office uses, for instance, since there are more public buildings of this character than any other kind.

The first big step in obtaining a government-owned post office in a town is the introduction in congress of a bill authorizing its erection and appropriating a sum of money for this purpose. Citizens of the town have urged their congressman to "get them a Federal building." Or perhaps this same congressman has taken the initial step and set about it to "get a Federal building," just to show his constituents that their wants are being cared for properly. No matter who is responsible for this initial move, the congressman who is to introduce the bill authorizing the erection of the building usually makes some unofficial inquiries of the Post Office Department to ascertain the approximate amount of floor space the postal business of the town in question will necessitate, and from the supervising architect of the Treasury

Department, the approximate cost of the kind of building needed. Bills authorizing post offices usually are introduced in the house of representatives, but they may also be introduced in the senate.

The movement for the new post office now has been formally launched. The bill is promptly referred to the Committee on Public Buildings and Grounds of the house or of the senate, according to the place of its introduction. This committee calls on the Post Office Department for all the information it has at hand concerning the postal conditions at the town where the Federal building is wanted, including the amount and character of the mail handled there, the total amount of postal business transacted, and the amount of floor space which should be provided, liberal allowance being made for the expected growth of the community.

From the supervising architect, the committee then obtains an estimate of the amount of money needed to erect and equip a building of the size and character needed. Upon the information thus obtained the committee bases its approval or disapproval of the bill, cutting down the appropriation which it carries if it considers the amount excessive for the kind of building contemplated. The only limitation placed on the authorization of public buildings is the requirement that those designed for post-office purposes exclusively shall not be authorized unless the postal receipts of the community have reached \$10,000 a year. This provision, which was set forth in the act of March 4, 1913, has been ignored on many occasions, however. In fact, the bill of which it was a part carried appropriations for about 40 post offices to be erected in towns where the annual receipts were well below the \$10,000 mark. The population of a community has little or no bearing on determining the size of a post office to

be erected there. The cost of a government-owned building in towns between 500 and 5,000 population has ranged from \$40,000 to \$150,000. The postal receipts in many of these offices are insufficient to pay for heat, light, water, and janitor service after they are erected.

When a bill authorizing an appropriation for a post office receives a favorable report from the Committee on Public Buildings and Grounds it is usually included with a number of like items in what is known as an "omnibus bill," and it is in that form that it is enacted into law by congress. For several years the annual appropriation for Federal buildings has been in the neighborhood of \$12,000,000. The appropriation for the maintenance of these structures has been around \$6,000,000.

The bill having received the signature of the president, the Treasury Department in due course of time advertises for a site for the proposed structure. A special employe of the department, known as a site agent, is sent to the town to examine the sites offered, which, as a general rule, are quite numerous. To the assistant secretary of the treasury, who is in charge of the office of the supervising architect, the site agent then reports what he considers the best site and what he believes to be a fair price for the property. Negotiations for the purchase of the ground then are conducted.

The next step is the making of tentative floor-plan sketches which are based upon data concerning postal conditions at the town in which the building is to be erected. The sketches are forwarded to the Post Office Department, where they are passed upon by the committee on Federal buildings, of which the chief post-office inspector is chairman. The committee may order changes in the arrangement of rooms, location of doors and stairways, and other details. Finished drawings are then made and submitted to the postmaster-general for his approval. In cases where the building is not to be utilized exclusively for post-

office purposes, but is to house other Federal offices, these plans also must be approved by the secretaries of the departments which are allotted space. For instance, if in addition to a post office, the building is to contain provisions for Federal courts, army or navy recruiting offices, the office of an observer of the weather bureau, offices for customs and public-health service employes, the plans must be approved by the secretaries of the Post Office, Justice, Army, Navy, Agriculture, and Treasury departments. It is not often that as many Federal offices as this are housed in one building, but post offices and Federal courts are frequently provided for in one structure. Whenever an appropriation for a Federal building is made and it is not definitely stated that the money is to be used solely for post-office purposes, the heads of the several departments are notified before the preliminary sketches are made, and they are requested to state if they desire to have space allotted to their respective branches, and if so, how much.

The final plans having received the necessary approval, working drawings then are prepared. Specifications for the building are written and advertisements for bids are inserted in the newspapers in the town where the building is to be erected, and also in building-trade journals. The advertisements state that sealed proposals for the work shall be delivered to the Treasury Department to be opened in public at a specified hour on a certain day. Bidders generally are given from 30 to 45 days from the time of the publication of the advertisement in which to compile their estimates and send in their proposals. The low bidder receives the contract, providing it is not believed that it will be more advantageous to the government to accept one of the other bids. The recipient of the contract is required to give a bond insuring the fulfillment and the proper completion of the work. The supervising architect sees that the contractor receives an ample supply of blueprints of plans and working draw-



The Spanish Type of Architecture in Government Buildings: A Good Example Shown in the Post Office at Riverside, California

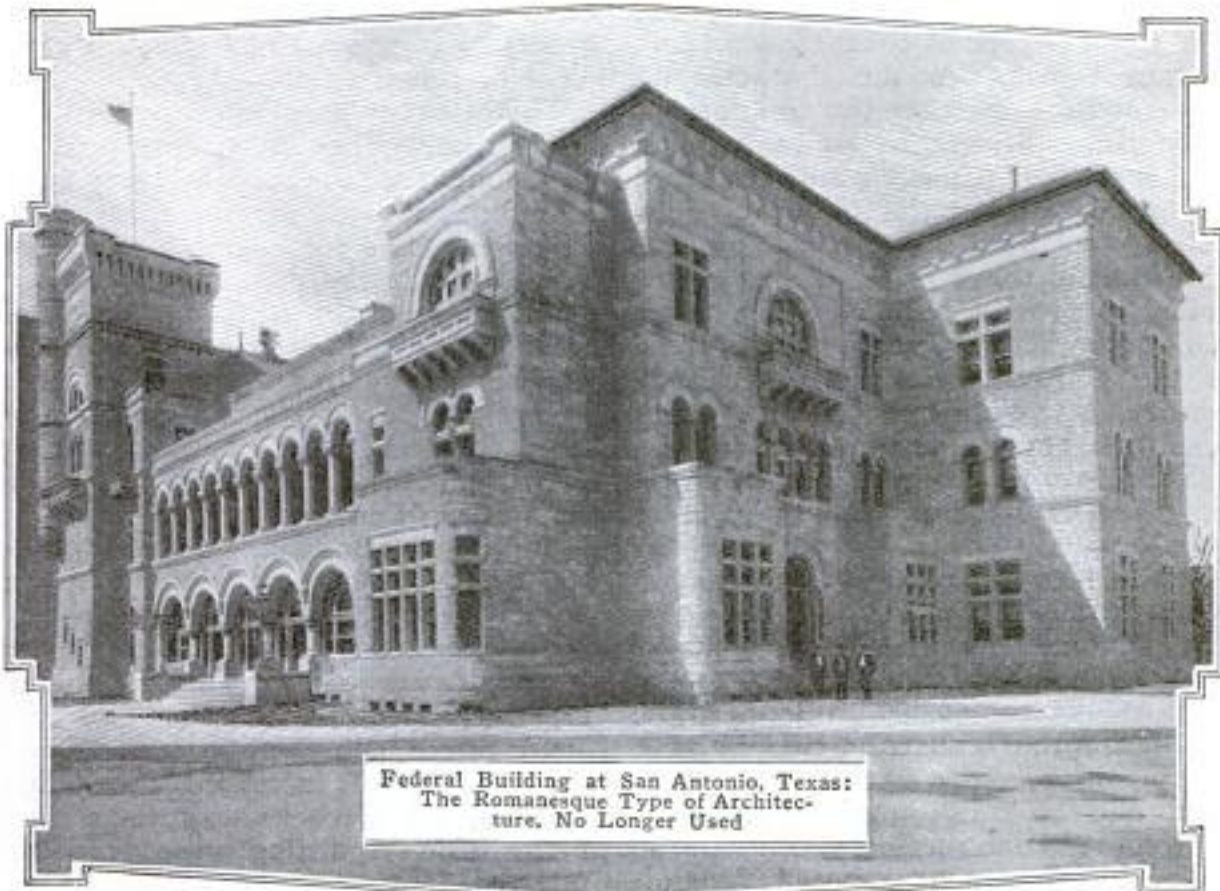

Federal Building at San Antonio, Texas:  
The Romanesque Type of Architecture, No Longer Used

ings for the use of his workmen. As soon as work on the building is ready to start, a member of the field force of the supervising architect's office is detailed as superintendent of construction, and it is his duty to see that the contract specifications are followed. When the building is completed a traveling inspector is detailed to examine it. If his report is satisfactory, the final settlement with the contractor is made. The building then is ready for occupancy.

There are no set rules governing the types of architecture to be followed in designing public buildings. But this does not mean that any style is apt to be adopted. For some years past the office of the supervising architect has adhered to a policy of eliminating the ornate in public buildings and of following only those designs which are considered appropriate for such structures. The Romanesque and the Gothic are styles which have long since been discarded, and the architecture of Federal buildings these days is for the most part along classic lines.

The size of the appropriation available for the work of course has an important bearing on the character of construction—whether the building is to be of marble, granite, or brick—and in this manner it has an indirect bearing on the design to be followed. Few frame structures are erected by the government these days, it being the policy to provide buildings of a more lasting character. Quarters for officers of the United States Public Health Service, at quarantine stations, occasionally are of frame construction.

There are few regulations in force as to fireproof construction of Federal buildings. In the case of those devoted to post offices where the annual postal receipts are not greater than \$15,000, only the first floor is made fireproof. Where the receipts range from \$15,000 to \$60,000 all floors must be of fireproof construction. Where the postal receipts exceed \$60,000 a year, the building must be entirely of fireproof construction.

The location of a proposed Federal

building often has an important bearing on the character of architecture which is followed in designing it. For instance, if the building is to be erected in a town which has some historical significance, the New England colonial type is apt to be followed. If it is to be erected in the Southwest, the Spanish type perhaps will be selected as being the most appropriate. Grecian architecture may be followed in a college or university town. The location of the site also may affect the selection of the design, for an effort is made to erect buildings that will harmonize with their surroundings as far as possible.

Standardization is practiced to a slight extent in designing Federal buildings in connection with such details as handrails, window fittings, lattice work, partitions, etc. The supervising architect's office has learned from experience the most satisfactory designs for such equipment, and building specifications are prepared accordingly. In order to facilitate things, working drawings of these details are kept on hand so that it will not be necessary to prepare new ones for each piece of construction.

There have been many efforts to bring about the standardization of government architecture, but they have been unsuccessful for the most part. In recent years considerable work has been saved in the preparation of floor plans, however, by utilizing the plans of buildings of like character and size which already have been erected. Since the interior arrangement of scores of small post offices is practically the same, much time and labor can be saved in this manner.

There are now more than 500 building operations on the program of the office of the supervising architect. With the present force it will take several years to prepare the plans necessary for these projects. This will mean that many communities which are in need of increased post-office facilities will have to wait their turn if the rule regarding precedence is followed.

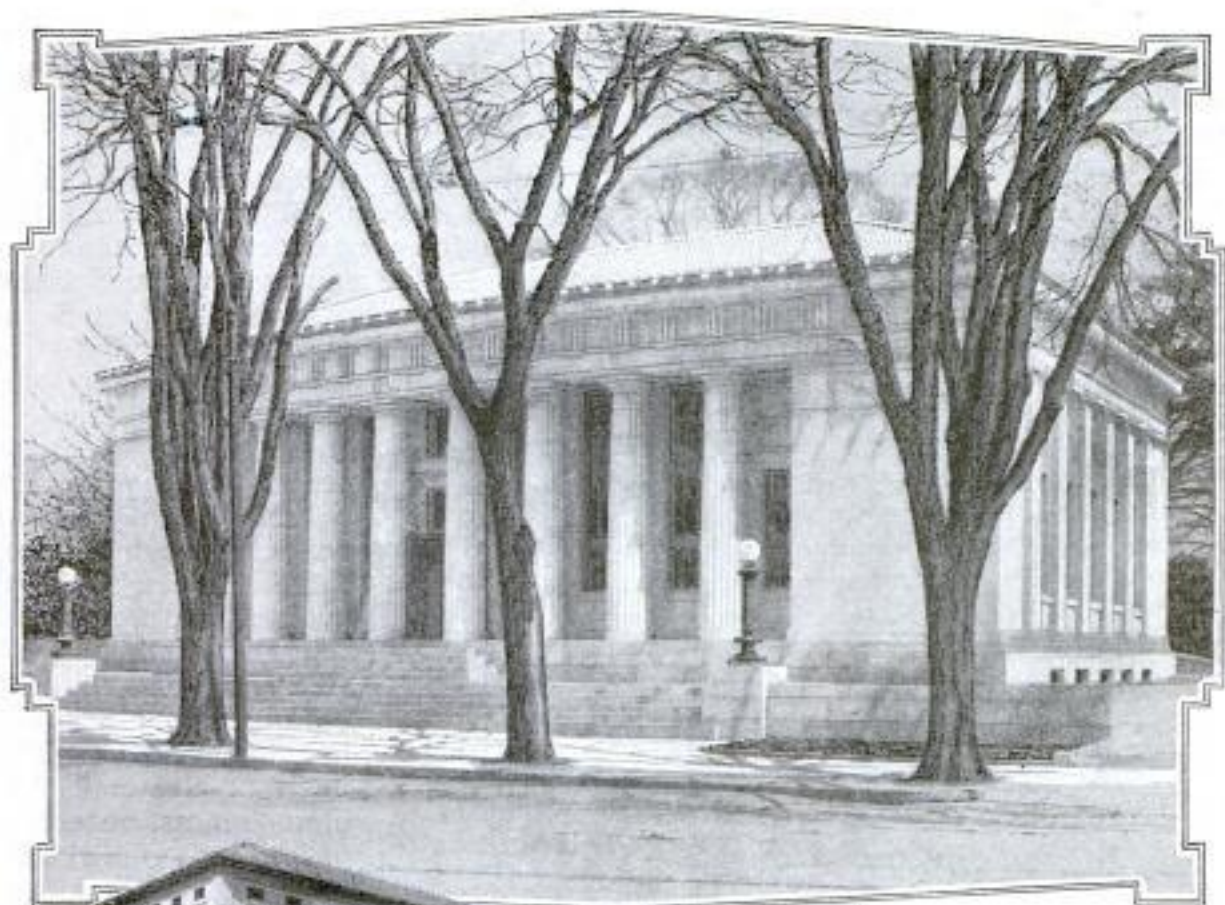

Top View: Post Office of Grecian Design at Westerly, Rhode Island

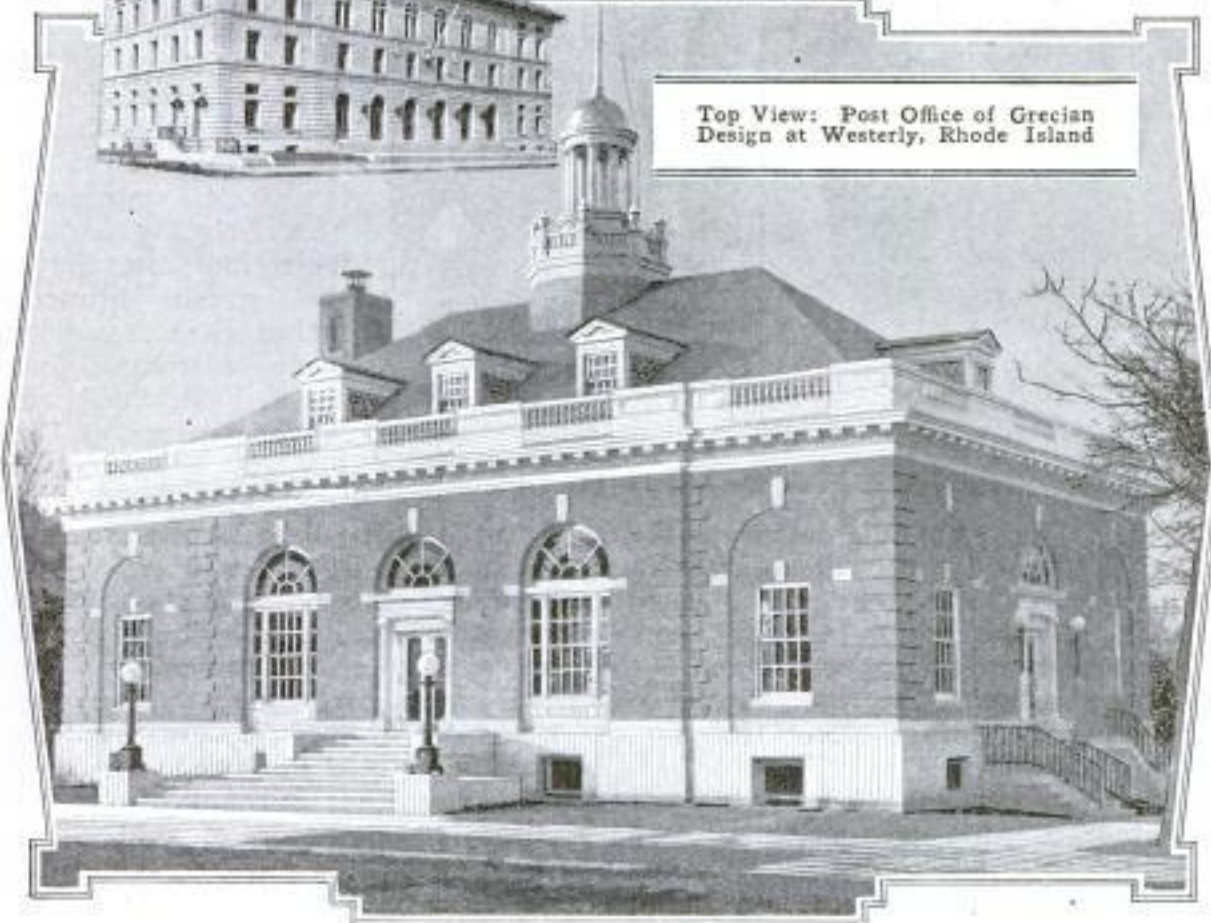

Lower View: The Centerville, Iowa, Post Office; the New England Colonial Type of Building.  
Insert: Federal Building at Phoenix, Arizona; Italian Style of Architecture

**OLD WATER WHEEL STILL**

416 **SAWS WOOD**

A creaking, ancient overshot water wheel is employed by a woodworker in St. Augustine, Fla., to turn a group of saws and planers. The wheel has a wooden axle some 10 in. in diameter, and the buckets on the rim are 4 ft. in

**GROWING OF DWARF TREES**

726 **IS PROFITABLE PASTIME**

Suburban residents of New York as well as several other eastern cities have found a new outlet for their energies in the raising of dwarf trees. The practice has claimed so much interested attention of late as almost to

take on the aspect of a fad. A peculiarity of these dwarf trees is that they may be trimmed and kept at heights varying from three to eight feet, even at maturity. Although of this small size, the trees will bear copiously, fruit hanging on the short limbs in great clusters. Apples, plums, peaches, pears, etc., may thus be grown in profusion, even if space for a garden is limited.

Some types of the trees make neat ornaments, and have found considerable use in landscape gardening. The brightly colored fruit hanging among the green branches makes the trees peculiarly attractive and as a background for flower gardens, and the like, their use is extending. Because of

the low height, all parts of a tree may be reached with little exertion, and trimming or spraying is therefore accomplished with ease. The trees take readily to spherical, conical, oval, and other ornamental shapes. Many new species are produced by grafting twigs of ordinary trees to stunted stock. In this way, Luther Burbank, the famous California originator of odd plants, has produced a dwarf pear simply by grafting a small limb from a pear tree to quince-tree stock, the latter being naturally of dwarf size.



Aged Water Wheel Supplies Southern Woodworking Plant with Power

length. The total diameter of the wheel is about 16 feet. Two artesian wells supply the water; one of them is 6 in. in diameter and 300 ft. deep, while the other is 8 in. across and 600 ft. to the bottom. The wheel is said to supply on an average about 10 horsepower.

owing to the exhaustion of the supply of jute heretofore used for the purpose, the Germans are now using silk and velvet in making sandbags for the trenches in Belgium.





Cutting Weeds on a Railroad with Gasoline Power Instead of Slow-Going Scythes

**RAILROAD USES GASOLINE POWER TO MOW WEEDS**

663

A mowing machine of unusual construction found employment among railroads during the past summer. Mounted on a small flat car was a gasoline engine, and on either side hung cutting bars for slicing off the weeds which flourish on railroad embankments. The engine was geared both to the car and to the cutting machinery, causing the whole contrivance to proceed along the track at two to three miles an hour, slashing the weeds as it went. In this way the three operators of the car could accomplish more work in a day than whole gangs of section men equipped with the usual scythe.

If a standard stove were used. The oven bakes cakes of fairy size, tiny loaves of bread, and very small pies. In design, the device is similar to many standard kitchen ranges. It is supplied with six burners and a complete set of tiny cooking utensils, while a cookbook, written expressly for young children, is also furnished. The range is intended to be connected with a lighting socket, and when in use consumes less energy than an electric flatiron. With it a cautious child may

**TINY ELECTRIC RANGE MADE AS TOY FOR CHILDREN**

664

Children may use with safety a miniature electric range which has lately been introduced. The stove is 15 in. in height, has a cooking surface, 8 in. by 11¼ in. in size, and an oven, 4½ in. wide, 2½ in. high, and 5 in. deep. Although it is purely a toy, it is at the same time a real range, for diminutive dishes may be prepared upon it with quite the same results as



This Electric Range Is 15 Inches in Height and Consumes Less Energy Than a Flatiron

play "house" and cook to its heart's content without danger of setting either itself or a residence afire.

*Retail - Commonwealth Electric Co. The Fair Electric Shop 86 E. Jackson Street*

*Hughes Electric Heating Co. 211 W. Schiller St., Chicago. Photo supplied by Western Electric Co. 463 West St. New York*

651 **CONCRETE WORK TAUGHT  
SCHOOL CHILDREN**

The spectacle of boys, eight or ten years old, making concrete fence posts, flowerpots, urns, pedestals, garden



Boys Make Fencing, Garden Seats, and Many Other Concrete Articles at School



seats, and even cement walks, would appear rather unusual, especially as a part of a school curriculum. But courses in such work were recently introduced in the schools of a western city, and have proven quite popular. In more advanced schools boys of greater age have been given similar courses, but local authorities believed that the many boys who will not go to

college, or even to high school, should have a working knowledge of a building material so universally used. The youths seem to enjoy the work and have turned out many articles of use at home and in school.

**MAKESHIFT APPLIANCES**

810 **REMOVE RUST QUICKLY**

After the waters from recent Galveston floods had subsided, local hardware dealers found themselves in sore need of apparatus to remove rust from stoves, cutlery, and other articles rendered more or less worthless by submersion and resulting dampness. Many interesting expedients were hit upon to remedy the rusted condition. To get the marks off smaller articles a homemade sand blast was employed. This consisted of a gasoline engine, an air pump, a sand tank, and a rubber hose having a nozzle at its outer end. The sand box was so placed that a thin stream constantly trickled into the nozzle. There the fine particles were struck by a powerful current from the compressed-air tank and thrown with great force against the rusted places on the articles being cleaned. In most cases this resulted in not only the blemishes being removed, but in the metals receiving a polish as well. The edged tools could not be cleaned by a sand blast, because of the necessity for resharpening. For these a steel brush, revolved at high speed by an electric motor, was employed. Tangles of rusty nails were made almost new by throwing them into a concrete mixer, from which they emerged separated and almost as good as new.

**PORTABLE RADIO EQUIPMENT**

973 **CARRIED ON BELT**

Messages have been satisfactorily transmitted short distances by means of a very compact and portable radio apparatus which has lately been demonstrated by an inventor at Bedford Hills, N. Y. The outfit is made to be

*Harry C. Blevins, Pres.  
Blum Hardware Co., Galveston, Texas.*

strapped about the waist and permits an exchange of signals between operators, at least one of whom may be walking at the time. It is believed by its designer to be particularly adapted for military purposes. There is also a possibility that it will be given a chance to show its worth in this capacity on the European battle fields.

The technical details of its construction have not been made public. In a rough way, however, its general arrangement is known. The sending equipment is contained in an oblong case secured to a belt. Electric energy is provided by five dry cells. A vibrator and transformer are provided. Aerials of the form commonly known are not employed. An uninsulated wire, however, four or five feet in length, extends out of the box and is connected with a canelike metal rod. For military purposes this wire would extend down a trouser leg of an operator and be connected with a metal spur fixed in one of his boots. It serves as an antenna from which impulses are radiated.

The receiving apparatus consists of a drum encircled by a wire coil. On top of the former is a detector. A telephonic headgear is worn. During the course of experiments conducted with the apparatus on an island off the

coast of Florida, it is said that messages were transmitted for a distance

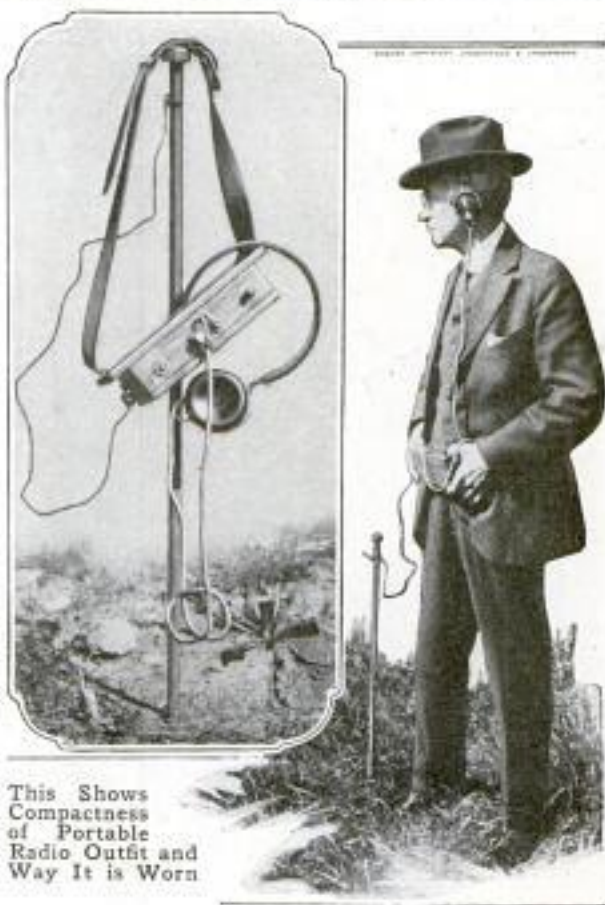

This Shows Compactness of Portable Radio Outfit and Way It is Worn

of approximately 18 miles. The practical working radius of the equipment, however, is expected to be about two or three miles.

## 8877 TWO-PASSENGER TRAILER FOR MOTOR CAR

In order to provide additional seating capacity for his motor car, an Iowa

man will comfortably seat.

This trailer is provided with a steel chassis and is attached to its tractor by means of a tongue that bolts to a cross-bar fastened to the rear springs of the automobile. It is also provided with a windshield which screens its occupants from any dust that may be thrown back by the



Homemade Trailer for Motor Car is Capable of Seating Two Persons

has constructed a two-wheeled trailer which he employs when he desires to

seated comfortably.

made by C. W. Bland  
Center Point, La.

343 **COMBINED CRANK AND TIRE PUMP FOR AUTOMOBILES**

By the use of a combined automobile crank and tire pump, which is easily substituted for the crank that

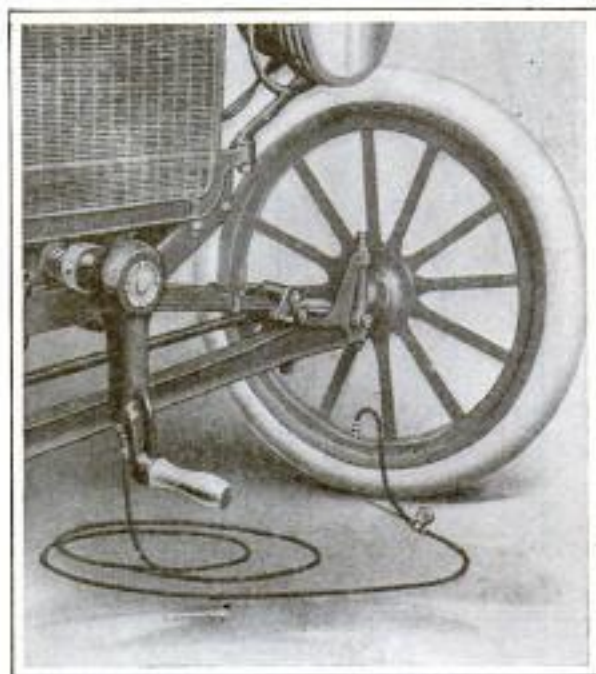

With This Combined Crank and Tire Pump the Power of the Engine is Used for Inflating the Tires

comes with the car, the work of inflating the tires is done with power from the engine. The pump is inside the crank, and to connect it with the drive shaft of the engine requires only the turning of a milled nut mounted on the shaft of the crank, the hose for conveying the air to the tires being attached to a threaded connection at the handle end of the crank. After the tires have been inflated, the pump is released from the drive shaft simply by turning the nut back to its original position, when the crank is ready to be used as a starting crank.

466 **SHOCK ELIMINATED IN NEW RAILWAY CROSSING**

The greatest objection to the rigid railway crossing of the present type is the hammer blow that results each time a wheel passes over a flangeway, and with the idea of eliminating this blow a number of shockless, or con-

tinuous-rail, crossings have been invented. One of these crossings of an original type has been in service near Los Angeles at the intersection of a busy electric line and a steam railway for six months, and is said to have proved remarkably satisfactory under the severe test to which it has been subjected in this location. The four rails that form the crossing proper work in vertical guides, and are so arranged and connected that when the pair constituting one track is down and out of the way of the wheel flanges, the pair constituting the other track is raised and in position to take the wheels of a train. The ends of the movable rails are mitered to form interlocking joints, thus providing for continuous support of the wheels while they are passing over the crossing. The vertical motion, which amounts to about  $1\frac{3}{4}$  in., is imparted by two wedges, one at each end of the rail, the rails being securely supported by the wedges when in the raised position. The rails and wedges are so connected that when the wedges are withdrawn they draw the rails down. The operating mechanism, which is inclosed in the foundation, consists of gears, links, and wedges, operated by a shaft, and all having a slow motion and ample wearing surfaces. The crossing may

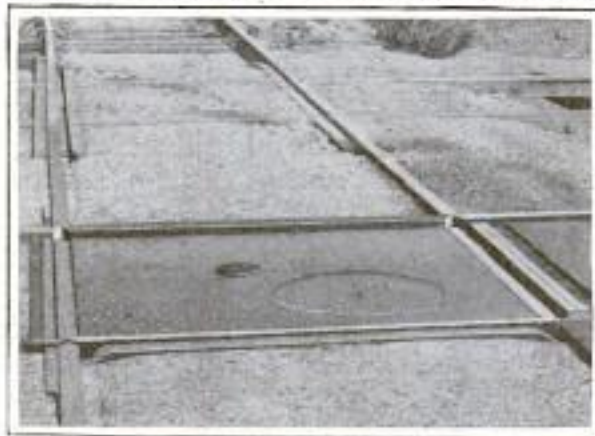

When One Pair of Rails in This Railway Crossing is Raised the Other Pair is in Lowered Position and Out of the Way of the Wheel Flanges

be operated by hand or by electrical contact by an approaching train, but is particularly intended for operation by a small electric motor controlled from an interlocking tower.

Cobb Shockless Railroad Crossing Co.  
1121 Central Bldg.  
Los Angeles.



Cutting Prize Hay on the Roof of an Indian's Cabin

### INDIAN GROWS PRIZE HAY ON ROOF OF HIS HOUSE

At a Western Montana fair which recently closed, a prize was offered for the best wild timothy displayed with agricultural products. When the award was made it was discovered that the winning sheaf had been cut from the sod roof of a cabin belonging to a full-blooded Flathead Indian. The fair secretary noticed the rank growth and induced the Indian to make the entry.

*"Dirty Johnny" - Flathead Indian Reservation.*

### LOUD-SPEAKING TELEPHONES USED AT COUNTRY CLUB

At one of the country clubs near Los Angeles, Cal., a loud-speaking telephone system has been installed and is employed in summoning caddies from their pavilion, which is situated some rods away. Formerly the caller used a megaphone and was frequently unable to make his voice heard when the wind was blowing against him. With the electric instru-

ment at hand, however, he is able to speak in a normal tone and be distinctly understood, so that trouble is obviated and his orders are carried out with dispatch. The same system is also used in paging club members and announcing the progress of golf matches.



Loud-Speaking Telephone Used in Calling Caddies from Their Pavilion at a Western Country Club

*# Green T. Hadley  
R. 6075 29*

*70. 39th St., New York.*

**NEW WRENCH IS DESIGNED TO GRIP WITH GREAT FORCE**

A pipe and nut wrench of unusual construction has appeared on the market of late. Unlike the common "monkey" wrench, this new device does not depend upon the twisting of a knurled nut for adjustment. Instead it is more or less automatic in action, the shifting back and forth of the handle opening and closing the jaws. A system of compound levers permits this action and provides the arrangement which causes the jaws to exert considerable force upon the pipe or other object being turned.

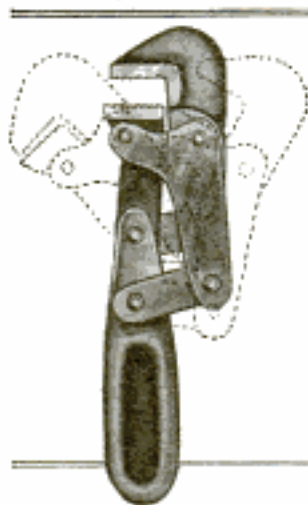

A system of compound levers permits this action and provides the arrangement which causes the jaws to exert considerable force upon the pipe or other object being turned.

**DEBUT OF ANKLE BOUQUET AS FEMININE ORNAMENT**

Feminine ideas of personal adornment change with the evolution of dress. So, richly embroidered hosiery became the vogue when slit skirts were in style. This season's modes in evening gowns and dancing frocks permit a conspicuous display of the ankles and therefore fashion assents to their decoration. One of the numerous attempts at this is to be found in the ankle bouquet, a freakish stab at ornamentation that has found certain exponents in the smart sets of both the East and middle West. The ankle bouquet is worn with dancing frocks and is held in place with either a narrow filigree band or a soft ribbon. It must be of dainty proportion and consist of flowers with delicate tints which harmonize with the costume worn. One may be used immediately above each ankle, or on only one limb, as best suits the taste of the individual.



One of the numerous attempts at this is to be found in the ankle bouquet, a freakish stab at ornamentation that has found certain exponents in the smart sets of both the East and middle West. The ankle bouquet is worn with dancing frocks and is held in place with either a narrow filigree band or a soft ribbon. It must be of dainty proportion and consist of flowers with delicate tints which harmonize with the costume worn. One may be used immediately above each ankle, or on only one limb, as best suits the taste of the individual.

row filigree band or a soft ribbon. It must be of dainty proportion and consist of flowers with delicate tints which harmonize with the costume worn. One may be used immediately above each ankle, or on only one limb, as best suits the taste of the individual.

**TREE PRUNING ERADICATES INSECT PESTS**

To rid orchards of the brown-tail moth, entomologists have suggested that all cobwebs, and such, be cut out of fruit trees in the fall and winter, for by so doing large numbers of the insects will be destroyed while in the caterpillar stage. Brown-tail moths are said to feed especially on apple, pear, cherry, oak, and willow trees, while hickory, ash, pine, and other coniferous trees, are avoided. Thus if the aged and rotten of the former group of trees are kept continually cleared off, together with superfluous brushwood that accumulates, one feeding ground for the pests will have been eliminated. Another pest, the gypsy moth, is found in the egg stage in the winter, and much can be done in the way of reducing next year's crop of the troublesome insects if the eggs and their hiding places are painted over with creosote whenever found. The creosote effectually prevents the eggs from hatching.

**QUICK WORK OF TELEPHONE GANG AIDED BY MACHINE**

During construction operations on the transcontinental telephone line completed only a short time ago, a number of unusual records for fast work were made. One of these was that of the pole gang which had the task of digging some 13,900 holes and setting as many poles near the western end of the route. Of material aid in this work was a digging machine remodeled and rigged up on the job. It consisted principally of a huge auger mounted on a frame on the back end of a wagon in such manner that it could be swung around

# S. P. Fullerton  
Pac. T. & T. Co.  
San Francisco

The Men Who Built the Last Connecting Links in the Now Famous Transcontinental Telephone Line Had Many Difficulties to Contend with, and Resorted to a Number of Interesting Expedients to Get the Work Completed on Time. One of the Most Interesting of the Work Savers Evolved Was the Post-Hole Digger Here Shown. With It 40 Holes per Hour could Easily be Made. The Digger was Mounted on a Wagon and Driven by a Gasoline Engine. It could be Tilted in a Number of Ways to Accommodate Uneven Ground, as the Several Pictures Show. Most of the Last Work on the Line was Done in Utah and Nevada. Climatic Conditions Were a Great Hindrance



and always be kept vertical, no matter what sort of ruts or gullies the several wheels of the wagon might be in. Propelling this auger was a gasoline engine mounted on the same frame. So equipped, the machine was found capable of digging a hole 16 in. in diameter and 4½ ft. deep in less than one minute. In some cases 40 holes per hour were dug, including 150-ft. removals from one hole to the next. Of the total 13,900 holes to be excavated,

9,730 were made by this type of machine. Contrasted with the slow and laborious spade-and-shovel method of digging holes, this system was found to be decidedly more swift and efficient.

All of this work was done over the desert plains and precipitous mountain districts that lie between Salt Lake City and San Francisco. Because of the lack of railroad facilities, nearly every pole had to be hauled to its place by wagon, together with the cross arms, and other material, that went into the line. Through shallow lakes, snowdrifts, sand dunes, uphill and down, the line went, always straight and ever headed toward a definite goal. Everything from blizzards to the baking heat of the desert was encountered by the men in the work, yet in spite of all difficulties the task was completed with remarkably few delays. Four automobile trucks, two hole-digging machines, three runabouts, 34 wagons, 116 horses, and one tractor of the caterpillar type were required in carrying on the work.

896

### TELEPHONES AID IN RAPID ACTION OF CREDIT SYSTEM

As a useful adjunct to the credit department of large retail stores, an American manufacturer is marketing



Stamping Machine and the Telephone a Clerk Uses to Call Up Credit Department: The Lower Dial on the Machine Selects the Particular Operator Desired

an electrical system which is said to be very rapid in action. When a customer buys something over the counter which he desires charged, the clerk telephones to the credit department for permission to accept such an order. The authorizing clerk at the credit department looks up the customer's rating in a card index conveniently at hand, and if the rating is satisfactory he calls to the inquiring salesman that he is ready to O. K. the order. This he does by pressing on a button which operates a stamping machine located at the salesman's side. The machinery is so arranged that it is impossible for the authorizing clerk to operate the stamping machine unless the order to be charged is in place, ready to be stamped. Among the advantages claimed for the system are quickness of service, both on account of the fact that an order slip does not have to leave the department to be authorized, and because telephone service is naturally more rapid than any other system; the credit office is in immediate

and direct communication with all departments, and can answer miscellaneous questions readily; and the generally quickened service leaves better satisfied customers.

182

### SOCIETY EDUCATING PUBLIC TO USE STREET CROSSING

In furthering a campaign to reduce the number of fatalities and serious accidents occurring in the thoroughfares of Gotham, attempts are being made to impress upon pedestrians the advisability of crossing streets only at their regular intersections. A large sign has been suspended above Fifth Avenue at Forty-Second Street by the Safety-First Society of New York admonishing the public against attempting to make a crossing in the middle of a block. In addition to this the two words, "Cross Here," have been painted in red letters on the curb lines at each of the four corners of the intersection. Lanes have also been



How the Society Urges Pedestrians against Unnecessary Carelessness in Crossing Busy Thoroughfares

marked off across the pavement for the guidance of pedestrians, and in these paths red footprints have been painted.



694 **EMERGENCY EXIT DESIGNED  
FOR SHIPS' FIREROOMS**

In an endeavor to provide a practical emergency escape for the safety of those confined in the boiler rooms of steamships, an eastern inventor has designed a water-seal exit. This consists of a large tank constructed in the floor of a fireroom and extending beneath a wall or bulkhead into an adjacent compartment. The container is filled with water into which the dividing partition extends for several inches, forming an effective seal against the passage of steam.

The purpose of this will be evident when it is remembered that existing boiler-room exits are not so built as to permit escape in case a pipe bursts, filling the compartment with gases and hot steam. In many of our dreadnaughts, for instance, an exit from a fireroom is a stairway, or trunk, leading to the gun deck. Access to this is usually gained through a water-tight door. In some cases a covered opening in the ceiling, reached by a ladder, comprises the exit. When a forced draft is used the interior of a boiler room is kept under pressure. Because of this and also because of the arrangement of the exits, safe-escape is cut off in case of a serious accident. If a door is opened after a pipe has burst, the steam will rush after the men, scalding and suffocating them.

With the tank installed, however, a person would have only to dive into the water, slip beneath the dividing partition and come up on the opposite side in another compartment. From there he could climb to an upper deck in safety. The water-seal exit would

obviously be used only in cases of emergency.

The application of the emergency escape to the boiler rooms of steamships, however, represents only one of the uses which may be made of it. In a large office building the engine room is ordinarily situated some distance below the street level. A stairway and

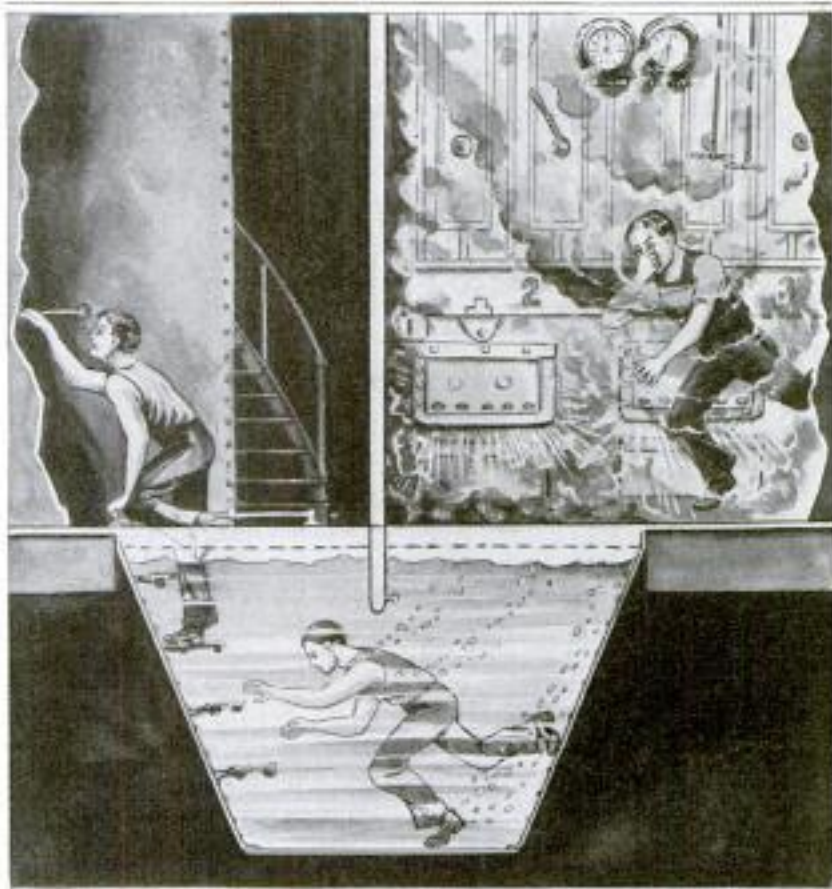

In the Event of an Accident Occurring in the Boiler Room, the Water-Sealed Exit Furnishes an Avenue of Escape

possibly an elevator shaft constitute the usual exits. An accident which would cause the compartment to be filled with hot steam or asphyxiating fumes might easily render these avenues of escape as dangerous as those in the aforementioned instance. Therefore the water-sealed exit might be used in numerous places where there are steam or ammonia pipes, or gas tanks.

Because of the scarcity of dyestuffs since the beginning of the European war, the government of Uruguay has had to change the color of some of its postage stamps.

755 CHURCH, POOL HALL, AND SALOON UNDER ONE ROOF

The residents of a Mexican settlement in an American city on the



Mexicans Use One Building for Church, Saloon, and Billiard Parlor

southern border possess a building serving dissimilar purposes. The

upper portion reached by the front steps is a church. Under it is a pool and billiard room, while the rear end of the building is occupied by a saloon where all sorts of drinks may be obtained at all hours of the day and night, Sunday excepted. There is said to be hardly a moment when the building is not occupied.

¶ In the vicinity of Mt. Hope mission in Alaska, 100 miles north of the arctic circle, it is stated, the wind velocity rarely falls below 20 miles per hour. Use is to be made of this fact in installing a new heating system for the mission, according to reports. Large windmills will be set up to furnish power for several electric generators, and current from these will operate heating coils and also light the place.

640 CONGRESS MAY VOTE WITH NEW TIME-SAVING MACHINE

At any meeting conducted under parliamentary rules considerable time is always wasted in tedious roll calls and voting. A machine has been invented, however, which aims to do away with this trouble. Con-

it installed in the legislative rooms of the national capitol.

The invention, as at present projected, consists of three essential parts: a push button sunk in each member's desk, guarded by a combination lock; a dial, also on each desk, to show the member how he is voting, and an indicator board above the speaker to show the assembly by means of letters and colored lights how the vote is progressing. When a question is put, each member may vote "Yes," "No," or "Present and not voting" as in case of pair.



Model of Voting Device to be Considered by Congress: Shows the Inventor, Desk Push Button, Speaker's Meter, Indicator Board, and Photographic Paraphernalia

gress has been considering the contrivance and at the next session is slated to take up the matter of having

Meters on the speaker's and clerk's desks show totals as members vote, but a member may change his vote as often as he wishes while the voting is in progress. When the speaker announces the ballot taken, the clerk disconnects the members, and a permanent record is photographed. The camera records each man's vote and the totals of the ballot, printing the record on paper—all in a few seconds. The board is then auto-

Inventor:

D. L. Bobroff  
915 Majestic Bldg.

Milwaukee, Wis.

matically cleared for the next vote. Wisconsin already has one of the systems installed in the state capitol. It is the invention of a young Milwaukee engineer.

**BRUSH OF UNUSUAL LENGTH  
571 ATTRACTS ATTENTION**

Four hundred and eleven feet is the unusual length of a brush recently produced by a Trenton, N. J., manufac-

**574 WHOOPING-COUGH BAND  
WORN BY CHILD**

As a precautionary measure against the spreading of whooping cough at Newark, N. J., a health ordinance makes it mandatory that every child, under 10 years of age, infected with the disease, wear an arm band indicative of the fact. For this purpose the health department of the city has adopted an official band. The background is yellow and a design in the form of a Maltese cross is printed in black on this. Within the cross the words "Whooping Cough" appear in large letters, as does "Newark Health Department." When a child is known to have whooping cough it is supposed to wear one of these labels, and in no

The Purpose to Which  
This Long Brush Is to be  
Put has been Kept Secret

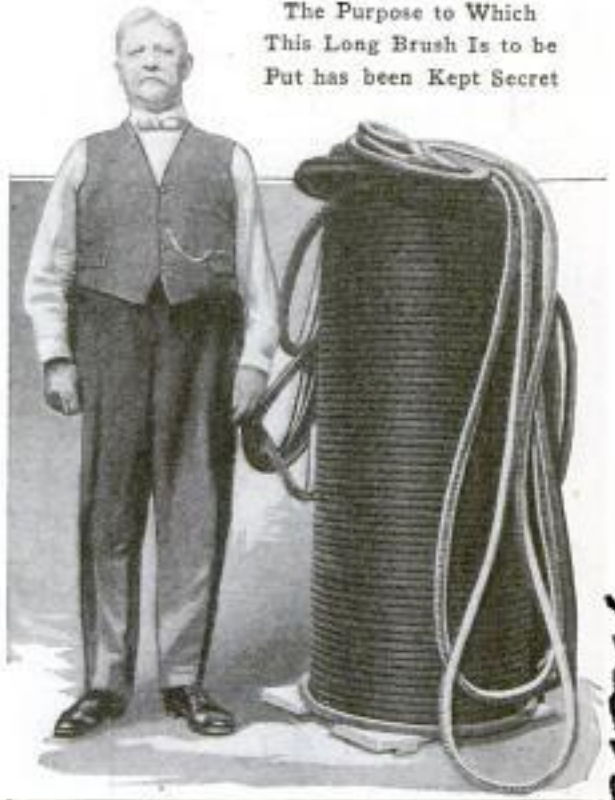

*Marion → Major R. W. Clayton  
113 Elm Street  
Trenton N. J.*

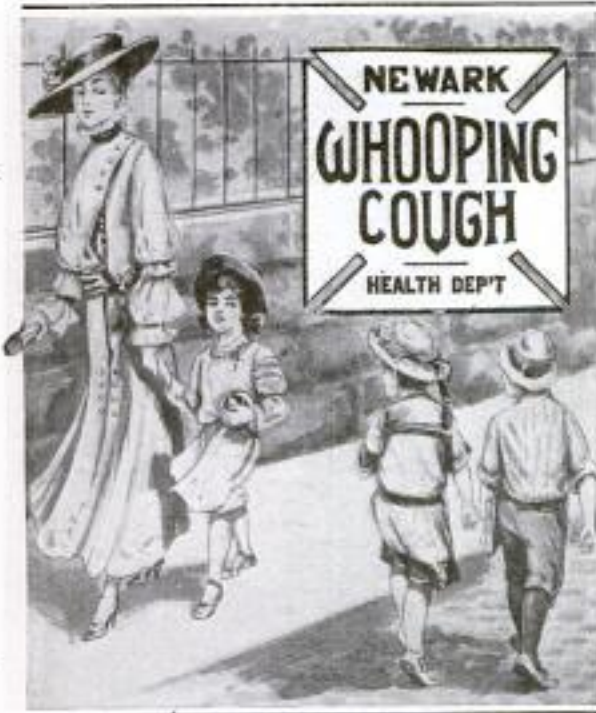

During the Quarantine Period, Every Child Suffering from Whooping Cough must Wear One of the Health Department's Arm Bands

turer. It is made in a single strip on a leather groundwork of uniform thickness, while the bristles are of the best quality obtainable. The identity of the purchaser as well as the purpose to which the brush is to be put have been withheld by the maker. There is little doubt, however, but that it is intended to be used in a munition factory for polishing and finishing shells. The brush is believed to be the longest of its kind that has ever been made in this country, but irrespective of this, it is of sufficient length to be a subject of comment.

case discard it, for a period of six weeks. The parent who fails to carry out the ruling is subject to court action.

Fields in a California valley were inundated last spring by a monster flow of mud from an erupting volcano. Contrary to expectations, the yield of crops in the fall was much greater than ever before, the mud acting as a first-class fertilizer.

*# L. R. W. Allison  
170 Roseville Ave.,  
Newark, N. J.*



FIRING TORPEDO FROM DECK OF  
AMERICAN DESTROYER

**T**HE instant it strikes the water the torpedo sinks to a depth of about 15 feet, and, owing to its automatic controlling machinery, it keeps uniformly at this depth as it speeds toward the mark.

COPYRIGHT BY E. MULLER, JR.

*P.O. Box 530, New York*

## AMERICA'S LATEST UNDER-SEA FIGHTERS

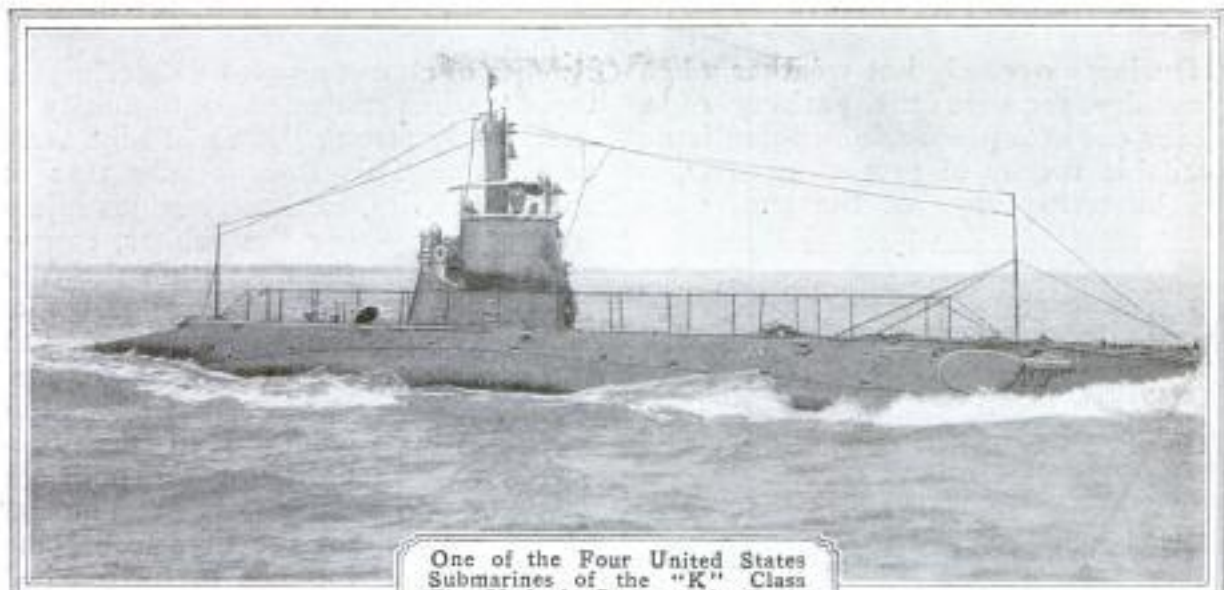

One of the Four United States Submarines of the "K" Class That Made the Cruise, under Their Own Power, from San Francisco to Honolulu

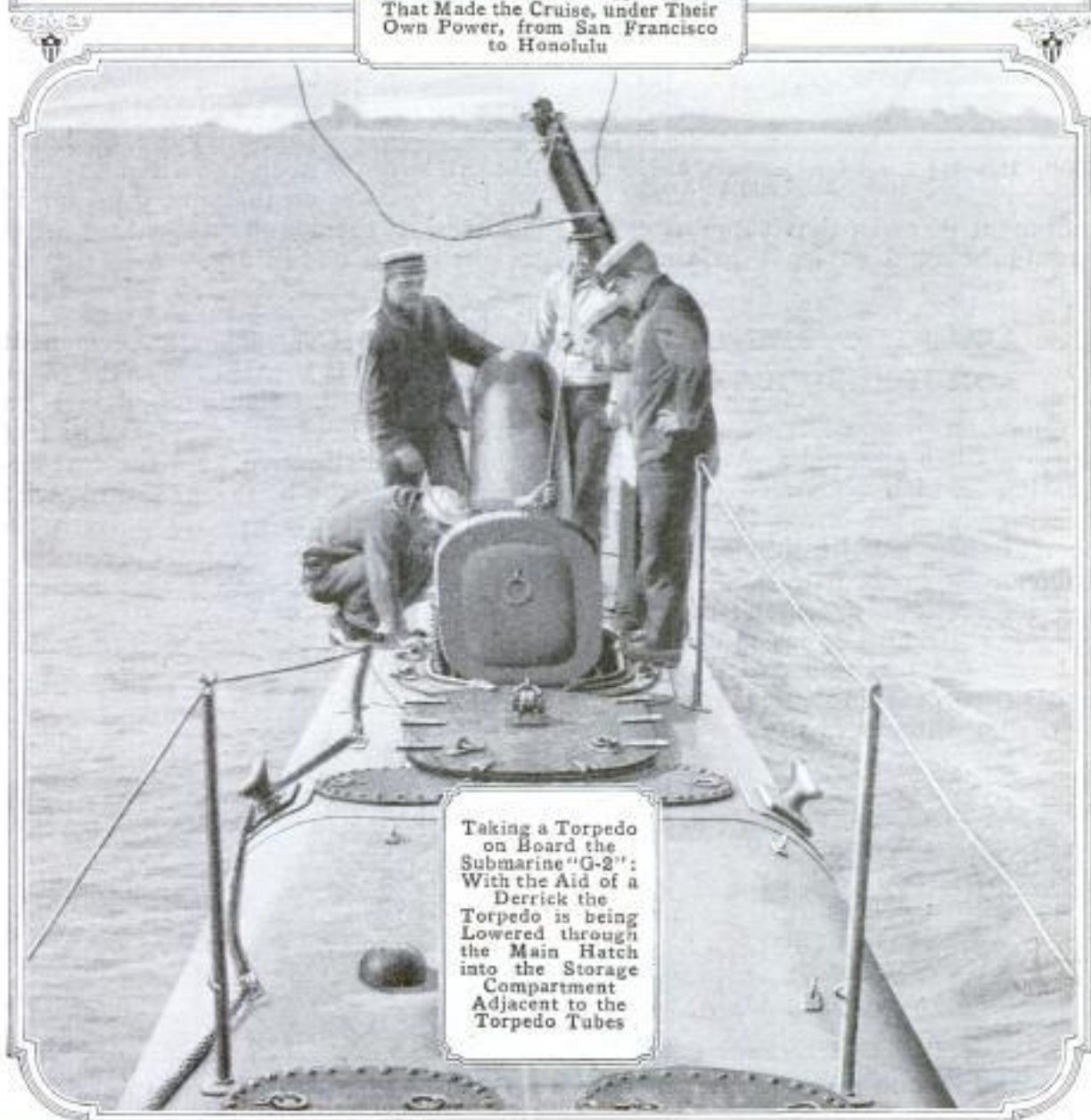

Taking a Torpedo on Board the Submarine "G-2": With the Aid of a Derrick the Torpedo is being Lowered through the Main Hatch into the Storage Compartment Adjacent to the Torpedo Tubes

## 9283 PROTECTING TIRES IN HOT CLIMATES

During extremely hot weather when necessity requires the parking of a motor car at a place where there is no available means of protecting it from the blistering rays of the sun, good

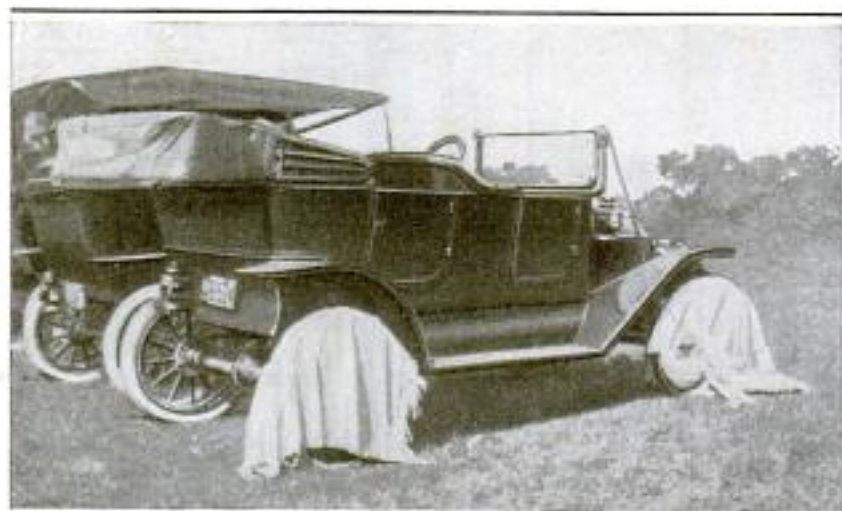

By Throwing Robes over the Tires, Serious Injury from Hot Sun Rays may be Averted

judgment dictates that some attention should be paid at least to the tires.

Rubber of almost any form deteriorates rapidly when subjected continuously to excessively strong light and high temperatures. This is especially true of an inflated tire, for heat, besides injuring the rubber, causes the air within the tubing to expand, sometimes to such a degree that a blowout results. When a machine is left standing in the sunlight for an hour or more it is not unusual for the tires to become too hot to be touched incautiously. The simple precaution of throwing robes, dusters, or almost anything that may be at hand, over the tires in such an instance goes far in

protecting them and preventing what might be serious injury.

## 778 INFANTS' FOOTPRINTS USED FOR IDENTIFICATION

One of Chicago's largest maternity hospitals has adopted a plan of identification which obviates practically every chance for either the accidental or malicious substitution of new-born babies. Before a baby is an hour old ink impressions are made of its feet. In doing this an ink pad is used on the soles of the feet and a pad of glossy paper then pressed against them. One of the advantages of the footprint sys-

tem is that it furnishes a permanent record which is kept on file at the office of the hospital. Every child is born with certain lines on the soles of its feet which are distinctive. As the feet develop in size the markings are likewise enlarged, but the general pattern remains the same.



After the Soles of the Feet have been Inked, a Pad of Glossy Paper is Pressed against Them. The Impressions are Then Filed in the Office of the Hospital

Chicago Lying-In Hospital  
 Vincennes av. & 50th St.

444 FARMER ORIGINATES A NEW  
 STYLE OF GRAIN BUILDING

In an attempt to rid himself in some degree of the necessity for making continuous repairs to buildings about the place, a Mississippi Valley farmer recently tried an experiment. Knowing of the durability of concrete, he undertook to make a corncrib and granary of that material. The result was a cheap and satisfactory building.

Round concrete fence posts were used as sides for the structure, spaced far enough apart to give the usual ventilation required in corncribs. The roof was supported by concrete columns at suitable intervals, and the framework of the roof, though of wood, was covered with concrete shingles. A center

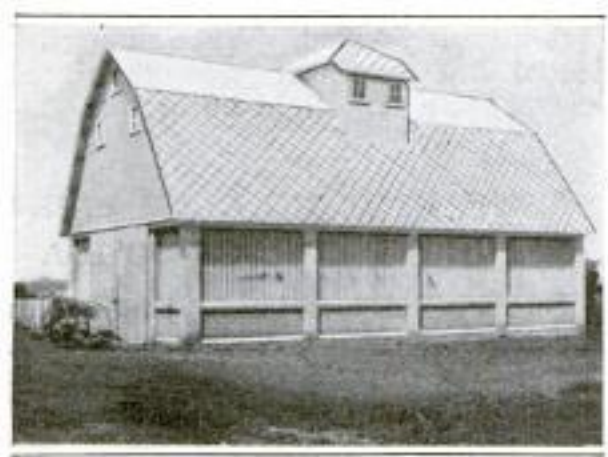

Concrete Corncrib and Granary Built by Middle-Western Farmer

driveway runs through the building. The upper floor is used for housing small grain, and an elevator, propelled by a gasoline engine, hoists corn or grain into the bins. The materials for the building cost in the neighborhood of \$700.

RECEIVER CUSHION AIDS IN HEARING

With the idea of relieving telephone users of the annoyance attendant on carrying on a conversation in noisy places, an eastern concern has put out what it calls a "receiver cushion." It is made of soft rubber and molded to fit snugly over the end of a receiver

and against the ear. It is said to shut off all outside sounds and materially



The Cushion Is Soft and Fits the Ear Closely

increase the ease with which messages may be heard.

739 POWDER-FILLED LEAD TUBE FORMS FUSE LIGHTER

To facilitate the work of setting off powder blasts, a fuse lighter of a novel type has lately been introduced. In general appearance it is much like an ordinary caster such as is used with heavy pieces of furniture. This frame holds a reel on which a small lead tubing filled with powder is wound. One end of this protrudes through a hole in the upper part of the device, permitting different lengths to be drawn out as they are needed. When it is ignited the powder spits out a tongue of flame

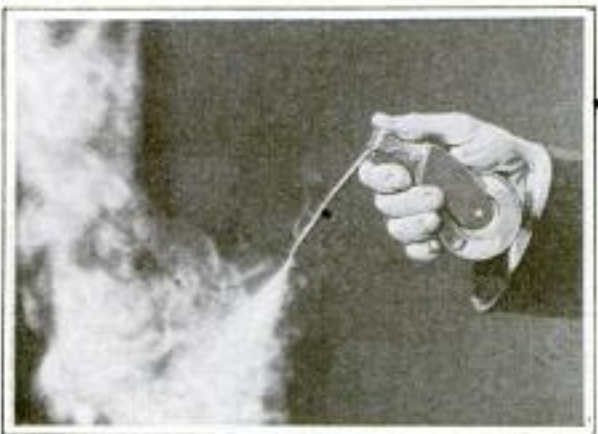

Fuse Lighter, for Use in Setting Off Powder Blasts, Which may be Carried in a Pocket Conveniently

50c

Ernaign. Brierford Co.,  
 J. W. Bowen, 60 W. W.

Distributor  
 J. W. Bowen

R. 110 - 117 N. Broad St., Phila., Penna.

several inches in length which quickly lights a fuse when brought into close contact with it. At the point from which the tube issues from the holder a small clipper is fixed. By pressing the thumb against this, the used portion of a tube is cut off.

**NEW FERRY LARGEST ON THE GREAT LAKES**

For service on Lake Ontario between Cobourg, Ontario, and Charlotte, N. Y., the port for Rochester, N. Y., there has recently been completed at Toronto the ferry "Ontario No. 2," the largest boat of the kind ever built for the Great Lakes. This boat is a twin-screw steamer of the shelter-deck type and is both a car ferry and a ferry for passenger traffic. It has track capacity for 30 standard railroad cars and accommodations for about 1,000 passengers, in addition to the officers and crew. The over-all length of the ship is 318 ft., the beam 54 ft., and the draft with full load 16 ft. 3 in. It is driven by triple-expansion engines having a total of 4,500 hp. The ship is equipped with water-tight bulkheads, both transverse and longitudinal, and with three water-ballast tanks. The guaranteed speed is 13 miles an hour in open water. The vessel is to run at all seasons of the year, and is built of exceptional strength so it can break through ice.

**BURNED - OUT TRANSFORMER CAUSES FATAL ACCIDENT**

A striking example of the need for intelligence and caution when an accident happens to electrical machinery is given in the recent burning out of a transformer that supplied current for the operation of a stone quarry. The instant the transformer burned out, a current of 4,000 volts was passed through the hoisting motors. Ignorant of what had happened the engineer in charge of the motors placed his hand on the lever. Owing to the heavy electrical charge in the machine he was held fast, but was not killed for the reason that he wore rubber shoes. In attempting to rescue the engineer, a workman took hold of his hands instead of shutting off the switch, and was instantly killed. When finally released the engineer was uninjured except for a few slight burns.

**MANUFACTURING CLAY PIPES IN QUAINT CITY OF GOUDA**

Edholm.  
One of the interesting handicrafts practiced at Gouda, a little old city a few miles outside of Rotterdam, is the manufacture of "churchwardens," as clay pipes with long stems are called. Skilled labor is so cheaply purchased in Holland that even today

Safety in Steam Operating  
Bureau of Mines, Washington, D.C.

624

86

248

Bolton  
Toronto, Ontario, Lake Ontario, Lake St. Lawrence, Lake Champlain, Lake George



This Car Ferry, the Largest on the Great Lakes, Is Capable of Carrying 30 Railroad Cars and 1,000 Passengers





"Churchwardens" for Which Gouda Is Famous, and One of Their Makers

this work is done by hand, just as it has been done for several centuries. The pipes are cast in plaster molds, filled with a fine, thoroughly kneaded clay that is procured in the vicinity of Gouda. The stems are bored with a long, oiled needle. After this work has been accomplished, the pipes are



Putting the Finishing Touches to a New Mold: This Is the Most Painstaking Part of the Work

Painting Quaint Holland Scenes on Some of the Choice Bowls

given a preliminary drying and polishing, and then placed in a kiln where they are baked. Many of the bowls, especially the choicer

specimens, are hand-painted in bright-colored, quaint designs. The men who do this work are very adept at bringing out their effects with a few strokes.

## POOR CONCRETE IS CAUSE OF SILO'S COLLAPSE

670

After being filled for the third time, a reinforced-concrete silo on a farm near Ft. Logan, Colo., recently broke apart. An insufficient amount of cement had been used in the concrete mixture when the structure was being erected, and this subsequently caused cracks to appear in a number of places. Wire fencing had been used as reinforcement and served to hold the sections together temporarily. Acid, probably acetic, developed by the fermentation of the ensilage, reached the wire through the fissures in the concrete and eventually weakened it to the point that one side of the structure suddenly gave away.

¶ The "immaculate white" characteristic of hospitals has been found fatiguing to the eye by British surgeons, and for this reason a number of British hospitals are being fitted up entirely in green, as the color is restful and offers no sharp contrast to the colors of the wound surfaces.

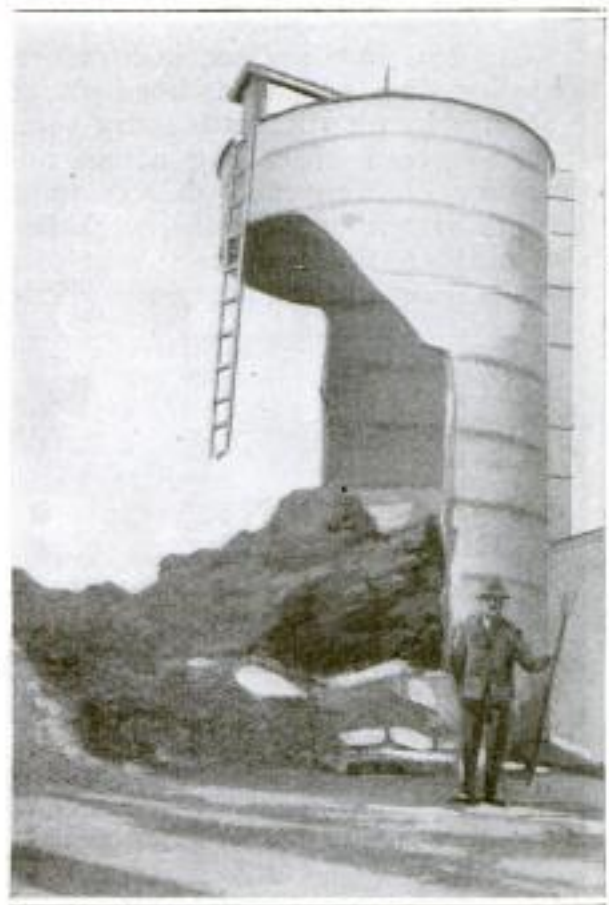

Too Sparing a Use of Cement in Mixing the Concrete Was the Cause of This Silo Breaking Apart While Filled

# Ed. Schimka  
Ft. Logan, Colo.  
Copyrighted material

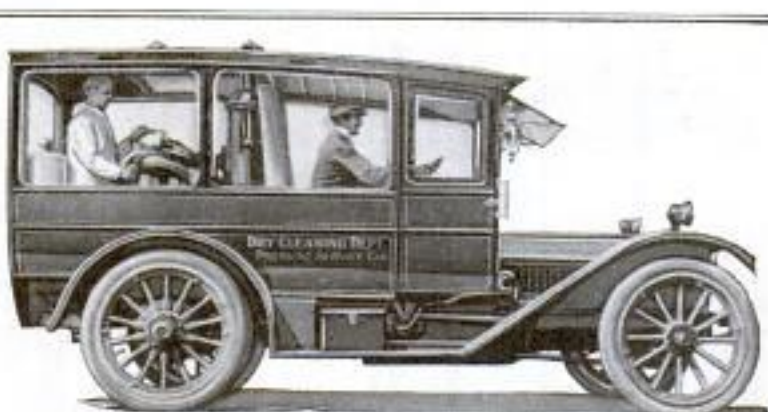

A Pressing Machine is Installed in the Car and Work is Done at a Patron's Door

at the curb line. The machine has an inclosed body in which is installed a steaming apparatus and a small work table. By this arrangement customers are afforded quicker service than could otherwise be maintained, and garments are not crushed by being carried around in a delivery wagon. Delays are eliminated, and the cost of the collection and delivery of clothes used where it improves the service and advertises the business.

**NOVEL SERVICE PROVIDED BY LAUNDRY COMPANY**

Men's suits are pressed in a motor-car tailor shop which has been placed in service by an Illinois laundry company. Instead of calling at an address for clothing and delivering it the following day after the work has been finished, the new car is sent to a patron's door and the pressing is done

**NATIVES OF PHILIPPINES DERIVE SALT FROM SEA**

Although few if any Americans look upon salt as being either an expensive necessity or a luxury, the contrary is almost the case with the poor classes of native Filipinos. These peasants, whose diet consists largely of fish,



Evaporating Ocean Water to Recover Salt in the Province of Cavite

# Monroe Woolley  
Fort Casey

Washington, D.C. Copyrighted material

consume large quantities of salt. Because they are usually unable to afford the imported product, their supply, to a considerable extent, depends upon home production. This means the evaporation of sea water and the recovery of the resulting saline deposit. In some localities this constitutes quite an industry and open-air salt beds are common.

### 524 DEVICE FOR FINDING LEAKS IN FREIGHT-CAR ROOFS

Detecting leaky roofs in freight cars is ordinarily a difficult task unless the car has been run through a rainstorm and part of the goods carried in the car damaged. To overcome this difficulty a western railroad has installed at its repair shops an apparatus with which the roof can be tested and all leaks found. This consists simply of a sprinkling head with which a powerful spray is thrown downward on the roof. When a car is brought in for repairs, it is run under the sprinkling head, the spray is turned on, and a repairman enters the car and plainly chalk-marks each leak. After the car has been repaired it is again run under the spray to see if all the leaks have been

stopped. Thousands of gallons of water are used daily with this apparatus, but in spite of this expense a great saving has been brought about,

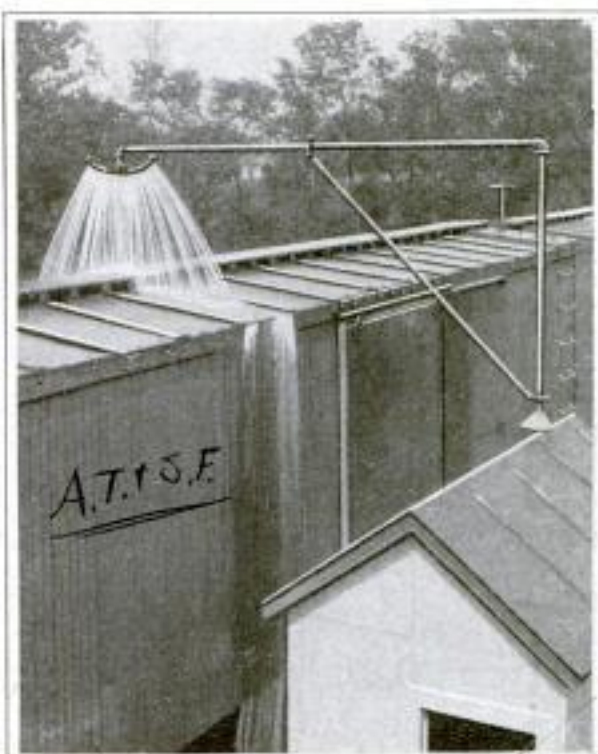

With This Sprinkling Apparatus All the Leaks in the Roof of a Freight Car are Quickly and Easily Found

owing to the fact that claims arising from water-soaked goods have been almost entirely done away with.

### 9602 SHIELD FOR TRAP SHOOTERS BUILT BY ODD CONTRACT

On the condition that he should receive all of the lead shot caught in its apron during a specified period, a Chicago contractor recently supplied the lumber and erected a shield 500 ft. in length and 40 ft. high before the traps at a local gun club. The structure is securely bolted to a row of telegraph poles and contains more than 50,000 sq. ft. of lumber. The apron extending along the full length of the wall is 60 ft. in width. It sags considerably in the middle, so

that the spent shot striking the shield rolls back into this gutter and is thus reclaimed.



All the Spent Shot Fired at This Shield is Reclaimed and Salvaged by the Contractor as Payment for Erecting the Structure

Chicago, Gun Club (Supr's Office)  
23rd + Mich. Av.  
Contractor J. S. Young

544 **QUEER ANTIC IS PERFORMED  
BY SMALL MOTOR CAR**

While running along a New Jersey road at a rate of about 25 miles an hour, a light delivery car recently struck a

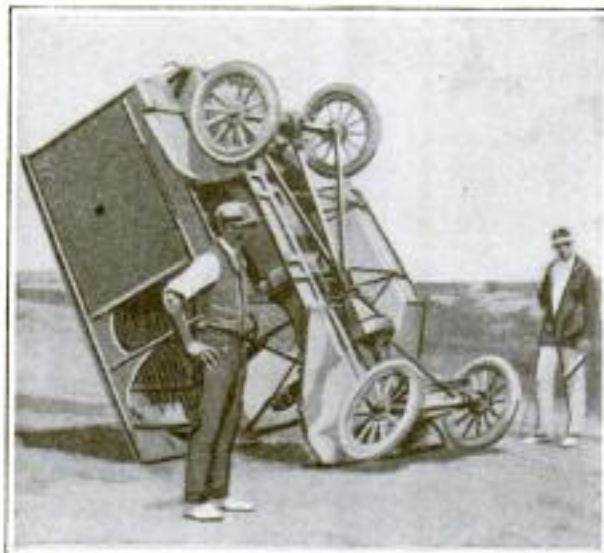

An Encounter with a Mudhole Was Responsible for This Curious Accident

mudhole and literally stood on its head. The accident happened when the machine was turned to one side of the roadway in passing another motor. The soft mud held one of the front wheels fast, causing the rear wheels to spin around with such force that the machine started to turn a somersault and ended by tilting on its radiator. The driver and his helper were thrown from their seats, but not injured. The engine continued to run as if nothing had happened until the gasoline ran out of the supply pipe and carburetor. Except for a bent radiator and a broken windshield the car was not damaged, and a few hours later it resumed its duties.

823 **NATURALIZATION OF ALIENS  
URGED BY GOVERNMENT**

A campaign for the unifying, education, and naturalization of foreign citizens in this country is being conducted by the Bureau of Education of the Department of the Interior. Lithographed posters of generous size were recently issued by the bureau discussing the subject in detail. These are

to be distributed throughout the post offices, industrial establishments, and public places in general, of the nation. In the upper central portion of the poster Uncle Sam is seen grasping the hand of an immigrant workman, while in the background loom up a public school, a residence, and a judge handing over naturalization papers to a successful candidate. These are emblematic of the successes and benefits to be attained in America.

"Learn English," advises the poster. "Attend night school, become a citizen. It means a better opportunity and a better home in America. It means a better job; a better chance for your children; a better America. Ask the nearest public school about classes. If there are none in your town, write to the United States Bureau of Education."

This spirit of welcome and wholesome suggestion is repeated on the poster in six other languages—Italian, Polish, Yiddish, Lithuanian, Bohemian, and Hungarian. To the 3,000,000 foreign-born whites, 10 years and over, in the United States, who cannot speak or write English, this invitation, and what it implies, will no doubt become doubly acceptable because of the use of the native language.

402 **AUTOMATIC CLEANER FOR  
BICYCLE CHAINS**

A simple device that keeps a bicycle chain free from mud and grit and requires no attention from the rider has recently been placed on the market. This device consists of a clip in which are mounted two

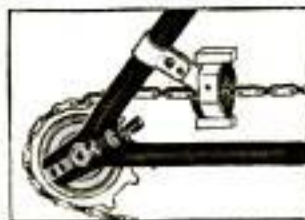

brushes made of hog's hair, and it is attached to the bicycle frame in such a way that the chain runs between these brushes. Automatic oiling of the chain is provided for by saturating the brushes in oil before starting on a trip. The brushes are easily cleaned by washing in gasoline or kerosene.

Chgo Herald '09 20/15  
Brooklyn Eagle '09 21/15

Hastings & Anderson Co.  
180 No. Market St.

(50) Cleaner Comp. 45¢ Chgo  
(10) Exp. Brushes 15¢ set.

## CITY TEACHES TAXPAYERS PAVING VALUES

696

Edholm

Improved Type of GRANITE BLOCK PAVEMENT on 6-Inch Concrete Base, Market St. from 29th St. to Lancaster Ave.

**The Construction of This Pavement Represents:** The latest and best practice in granite block paving work. A type designed to withstand the extremely heavy traffic on this street. A surface which will be smooth riding for automobiles and afford a good foothold for horses drawing heavy loads.

**Foundation Course.** The pavement is laid on a six (6) inch concrete base mixed in the proportions of one (1) part Portland cement, three (3) parts sand, and six (6) parts stone.

**Cushion Course.** Between the concrete foundation and the block surface course there is a two (2) inch sand cushion.

**Surface Course.** The improved granite blocks are from eight (8) to twelve (12) inches long, three and one-half (3½) to four and one-half (4½) inches wide, and from five (5) to five and one-half (5½) inches deep, accurately dressed. The joints are so cut that they have no more than three-eighths (3/8) of an inch depression from a straight edge laid in any direction across the head and held parallel to the general surface of the block. The joints are not more than one-half (½) inch wide at the top, and for a depth of one (1) inch, and not more than one (1) inch wide in any other part of the joint. They are filled with a grade of Portland cement and sand in the proportion of one (1) part of cement to one (1) part of sand.

The Information is Posted Adjacent to the Pavement Described

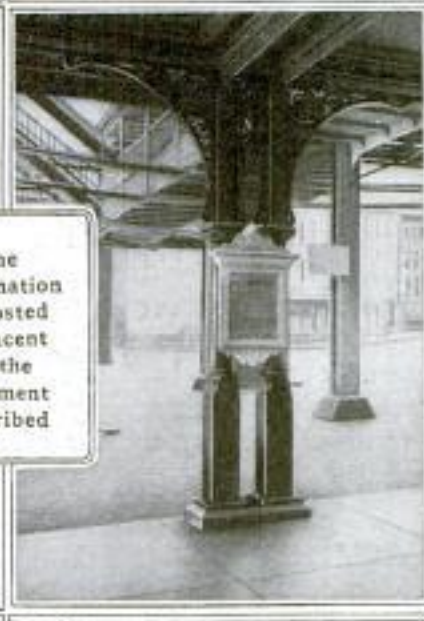

This Notice Describes the Character of a Pavement in Detail



DEPARTMENT OF PUBLIC WORKS  
Bureau of Highways and Street Cleaning  
This Highway, STENTON AVE. between Grower Lane and the Croshaw Branch P. R. R. Bridge, which Highway is on the boundary line of Philadelphia and Montgomery Counties, IS NOT MAINTAINED by the CITY OF PHILADELPHIA, but is under the care of Springfield Township

Above: A Sign Which Places the Responsibility for the Maintenance of a Certain Thoroughfare

Left: Another Sign Which Informs the Public Exactly What Kind of Work has been Done

At Philadelphia the municipal bureau of highways has adopted an interesting system of giving the public reliable information concerning various types of paving materials and their relative merits. The plan is in reality a publicity scheme through which taxpayers are instructed in technical phases of road building. This is being promoted by erecting signs describing in detail the character and specifications of different pavements. In put-

ting the idea into effect an experimental roadway was built. This was divided into a number of sections, each of which was paved with a different material, or by a different process. The thoroughfare is subject to normal traffic conditions and adjacent to each section a sign giving a thorough description of the pavement used is posted in a glass bulletin case. This gives interested persons an opportunity to study the wearing qualities

of various kinds of pavement at first hand.

Signs are also being placed along city streets where paving is being laid. It is intended to carry the idea out still further so that when repair work, such as patching and resurfacing, is being done, a placard will give the particulars of just what is under way. Signs will also be used to admonish abutting property owners, prior to the construction of a new pavement or the resurfacing of an old one, to install, or renew, street piping in order to avoid the subsequent necessity of tearing up a roadway to lay a new gas or water pipe.

### FACTORY CLOCK EMPLOYED TO PROMOTE SAFETY

In many places the stock phrase "Safety First," which has been universally used during the last few years in an attempt to minimize industrial accidents, is coming to be supplanted by the term "Safety Always," which is even more significant than the predecessor. A large manufacturing company, going on the theory that the



Workmen Who Watch the Clock in This Factory are Continually Reminded to Exercise Caution in Whatever They Do

psychology of impression is worthy of recognition, has placed in its plant a "Safety Always" clock. The dial of this bears the letters of the two words in lieu of the usual figures. It is assumed the average workman looks at a clock frequently during the course of a day and that this motto will make him constantly cautious.

### LENGTH OF THE COAST LINE OF THE UNITED STATES

Mainly in connection with the problem of national defense, inquiry is often made as to what is the length of the coast line of the United States. According to a statement issued by the Coast and Geodetic Survey the answer to this question is indefinite, since it depends on the extent to which the actual coast line is followed in making the measurement. There is a wide difference between a measurement that takes into account only the general lines of the coast and one in which every minute indentation is followed. Measured along its general trend the coast line of the United States and Alaska exceeds 11,500 miles, while the detailed coast line measured as closely as possible on large-scale maps is approximately 91,000 miles. On the same basis the general coast lines of the insular possessions and the Canal Zone have a total length of about 5,400 miles and the detailed coast lines a total length somewhat in excess of 12,000 miles.

### ROPE-TESTING MACHINE'S WORK SAVES LIFE

Ropes, even though they may appear to be in prime condition externally, are often faulty and filled with invisible defects. Spilling acid on some portion of their length has been known to be a most prolific source of rope troubles, for the injury caused by acid does not appear at once but after some months when the slow rot has had time to take effect. Exposure to weather or undue moisture may also create faulty places.

# Geo. J. Paul, 901 Plymouth Blvd., Chicago, Ill.  
Clock at entrance of Big Chila. Paint plant

861 Mining Journal 1/20/15

397

The HOFFECKER COMPANY  
MANUFACTURERS OF  
"THE STEADY HAND"  
SPEEDOMETERS  
MAIN OFFICE - MOTOR MART  
BOSTON



1779 Broadway, New York  
205 Abbott Bldg., Phila.

Popular Mechanics,

725

~~6 North Michigan Ave.,~~

~~The Hoffecker Speedometer Chicago, Ill.~~  
~~with a Yale lock attached~~  
D







9725

**SPEEDOMETER SETS LIMIT AT WHICH AUTO MAY RUN**

Since workmen on tall buildings, or similar structures, so often get themselves into positions where their existence depends entirely upon one or two ropes, it becomes imperative to know that these ropes are sound. In the case of short lengths it is comparatively easy to test ropes satisfactorily, but when the ropes are long and heavy, the problem becomes troublesome. A machine has been invented which will do this work automatically. On one end of a frame are a set of pulleys and a reel operated by an electric motor. On the other end of the frame is another set of pulleys, but these are mounted independently and their frame is capable of sliding back and forth in guides against the pull of a cable attached to a weighing machine. In use, the rope to be tested is first looped around the pulleys on the weighing end, then passed to the pulleys attached to the reel. The intermediate length of rope is kept under known tension by a brake applied to a pulley near the scales. The reel is operated continuously, the rope meanwhile undergoing the desired tension before being coiled up. In this way it is stated that upward of 400 feet of rope may be tested every ten minutes.

The ordinary functions of a speedometer—indicating rate of travel and mileage already covered—have been augmented by a third in a machine recently evolved by an eastern manufacturer. The new instrument is arranged to govern the speed of the car as the additional feature, and this is accomplished in a simple way. In the base of the speedometer frame is a small barrel containing tumblers and other mechanism of a Yale lock. Inserting the proper key in this lock permits a dial at the top to be revolved and set at any desired figure. This



Hoffmaster - Evans Co.  
 1312 Broad - Maca Sts., Phila., Pa.

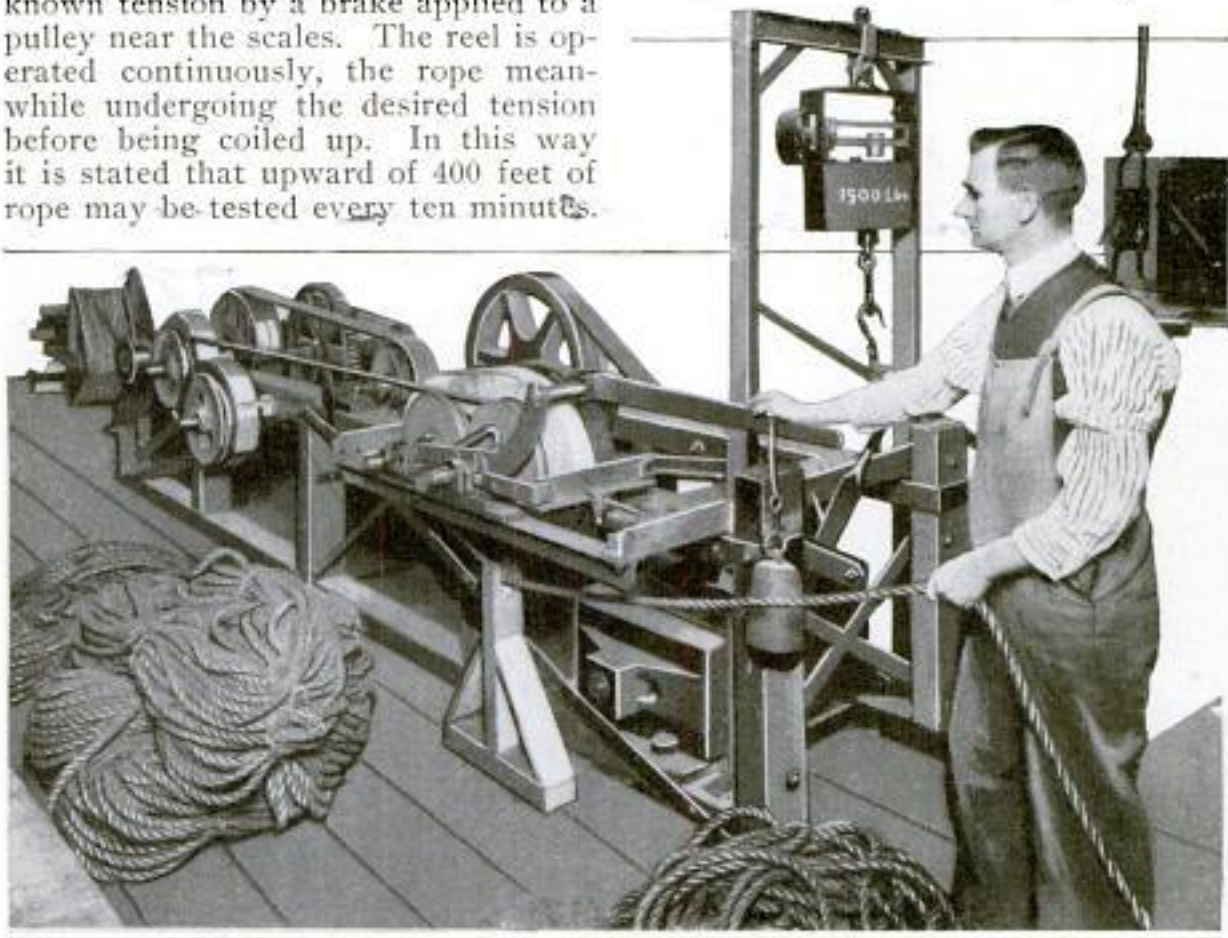

The Straight Length of Rope between the Pulleys in the Foreground and Those in the Back Is under a Tension Applied with a Brake and Measured with the Scales

figure will thereafter represent the speed above which the automobile cannot go, and withdrawing the key effectually prevents the numbers being changed.

In use, the contrivance works on the carburetor rod. When the indicator on the speedometer nears the speed set, a certain contact is formed within the instrument, causing an electromagnet slowly to close down the carburetor. A corresponding slackening of the automobile's speed results. This type of speedometer was evolved, according to the manufacturer, to fill the particular needs of the car owner who wants to be sure that the chauffeur, or other operator of his machine, does not run it at an excessive rate in his absence. Then, too, in other cases the setting of the locked dial might serve as evidence against a traffic officer's claims of undue speeding.

### NEW TYPE OF OIL-BURNING H32 LOCOMOTIVE

An oil-burning locomotive of a new type, designed particularly for construction work, is equipped with a boiler in which, it is claimed, a full

*H. K. Porter Co. 1208 Union Bank Bldg  
Pittsburgh Pa.*

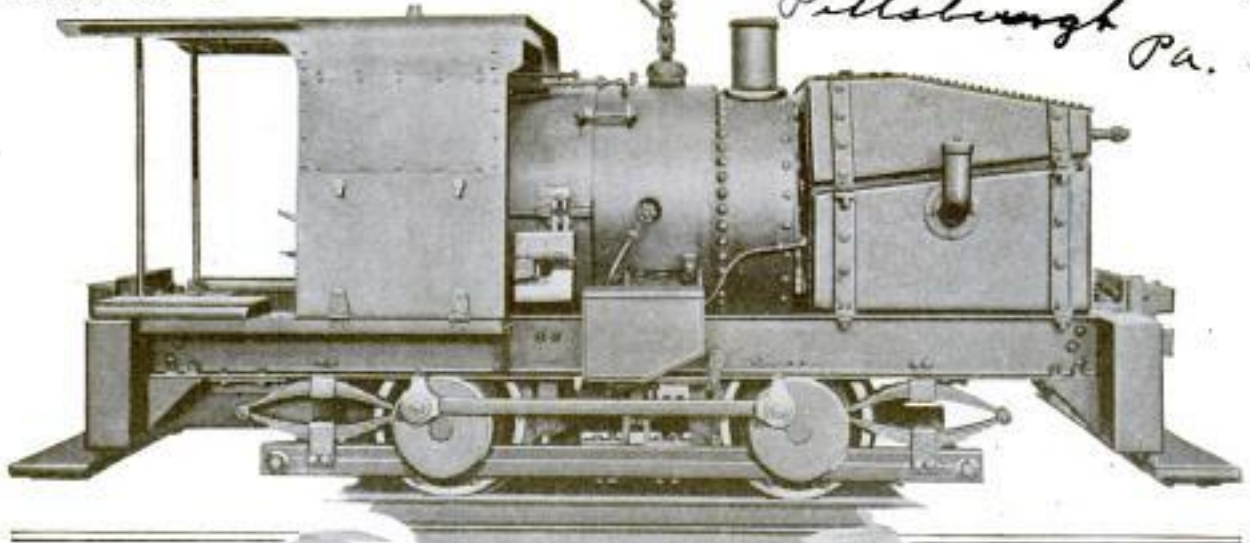

In This Oil-Burning Locomotive, Which is Designed Particularly for Construction Work, a Full Head of Steam can be Raised in 15 Minutes

head of steam can be raised in 15 minutes. The principal feature about

the boiler is the use of a large number of 1/2-in. copper flues, each about 16 in. long. These locomotives are made in sizes ranging from 2 tons to 12 tons. On the 5-ton size, which has a 2-ft. gauge, the complete boiler, with fire box and smoke box, measures only 34 in. in diameter and 37 in. in length. The engine is equipped with ball bearings, and the power is transmitted to the drivewheels through gearing. Any kind of fuel oil may be used.

### JETS FROM FIRE ENGINE BREAK ROCK FORMATION

*Engineering News '97/15*  
The tremendous digging power a small jet of water going at high velocity possesses, as well as the curious uses to which a fire engine may sometimes be put, were recently demonstrated in an interesting manner by a contractor on the Atlantic coast. While excavating in an ocean bed at the bottom of a small cofferdam he struck a rock formation which could not be broken by ordinary means. The smallness of the cofferdam precluded the use of blasting powder, the most obvious remedy, inasmuch as an explosion to break up the rock would also

blow up the cofferdam. As a solution, a fire engine was secured from a near-

by city, and a 1-in. jet at 150-lb. pressure forced against the resistant rocks. Oddly enough, this small but insistent stream of water was sufficient to loosen the pieces so that a clamshell bucket could get hold of them without difficulty. By this simple means what promised to be a constructional difficulty of some magnitude was quickly and easily solved.

### HEAVY CONCRETE SLABS ARE ROUTED BY FLOOD

9631

(Ohio)

A river current of 40 miles per hour recently tore up a long section of concrete road near a southern city. The road had been made in sections, 15 ft. by 30 ft. in size, and conformed more or less to the usual requirements of concrete-pavement construction. Each slab is stated to have weighed over 20 tons, and in some cases these were carried 30 ft. beyond the proper line of



A Recent Ohio River Flood Carried These 20-Ton Slabs 30 Feet Out of Line

the road. Even with such rough treatment the slabs seemed to be in rather fair condition, few being seriously cracked or injured.

*Railroad*

### COMPRESSED AIR DRIVES AX OUT OF TIE-PEELING FIELD

627

A compressed-air concern is putting out a chisel-and-pneumatic-hammer contrivance which is said to peel from 150 to 200 ties per day, and to reduce the cost per tie from two to three

cents. A vertical, single-acting air compressor, driven off a line shaft in



the usual shop, supplies the air for operating the new tool.

Time was when an expert peeler commanded a price of five cents per tie. This at first may not seem like a prohibitive amount, but it may easily run into thousands of dollars, as may be seen when it is considered that the average double-track system requires upward of 6,000 ties per mile. At five cents per tie the old-fashioned ax wielders would get \$300 for each mile.

### ESCAPING AUTOMOBILE TUBE FORMS MINIATURE BALLOON

658

A curious accident happened to an automobilist recently. While bowling along at a 30-mile-an-hour clip, a rear tire came partly off, permitting a portion of the inner tube to escape. When the driver had succeeded in stopping the car, and got down to inspect damages, he beheld the inner tube swelled into a huge balloon of football shape. The outer tire had pinched the inner one tight enough against the rim to inclose a considerable volume of air, thus causing the bulge.



#2. B. Houghton, S. S. S.  
Marion, O.

Ingersoll-Rand Co  
11 Broadway  
New York

779

# LARGE REINFORCED-CONCRETE RESERVOIR



Steel Reinforcement Laid over Frame Forms Ready for the Concrete to be Poured: This Is a Section of the Roof, Which Eventually will be Covered with Earth



The Basin When Finished will Hold More than 20,000,000 Gallons of Water. It is Situated on a Hill 250 Feet above the Lowest Part of the City. This Shows It Half Completed

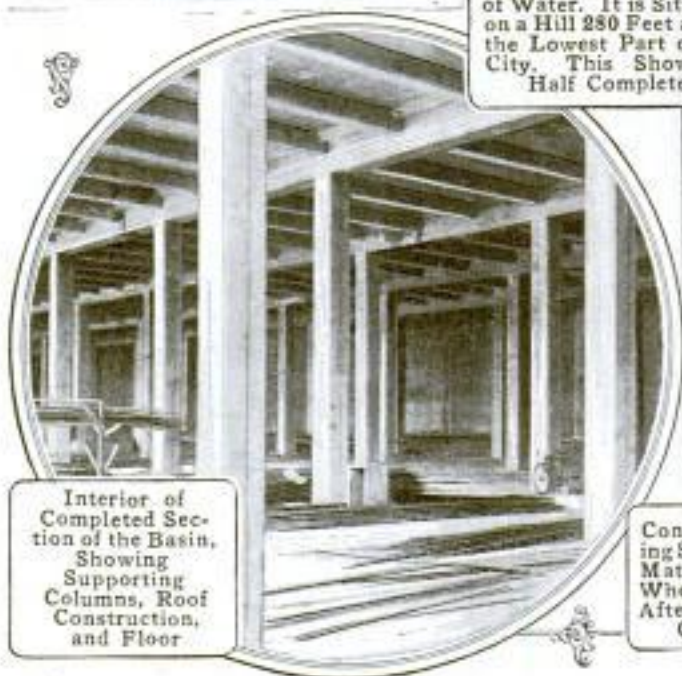

Interior of Completed Section of the Basin, Showing Supporting Columns, Roof Construction, and Floor

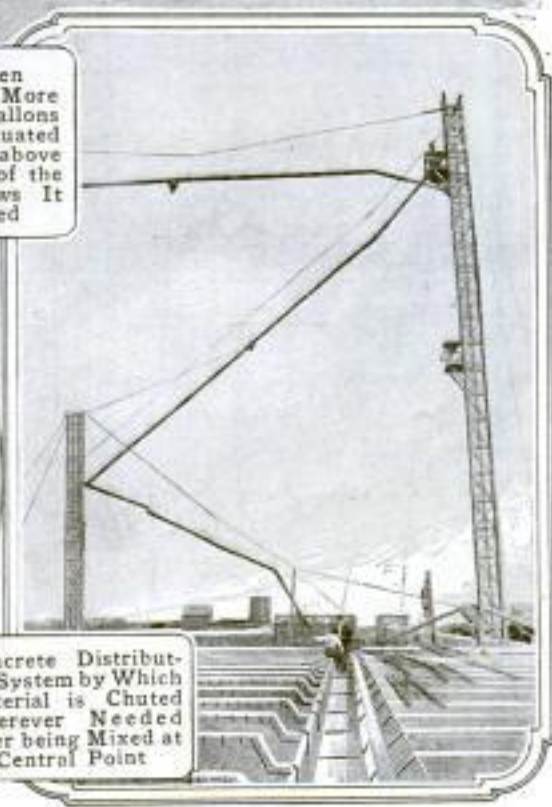

Concrete Distributing System by Which Material is Chuted Wherever Needed After being Mixed at Central Point

## IN COURSE OF BUILDING AT SCHENECTADY

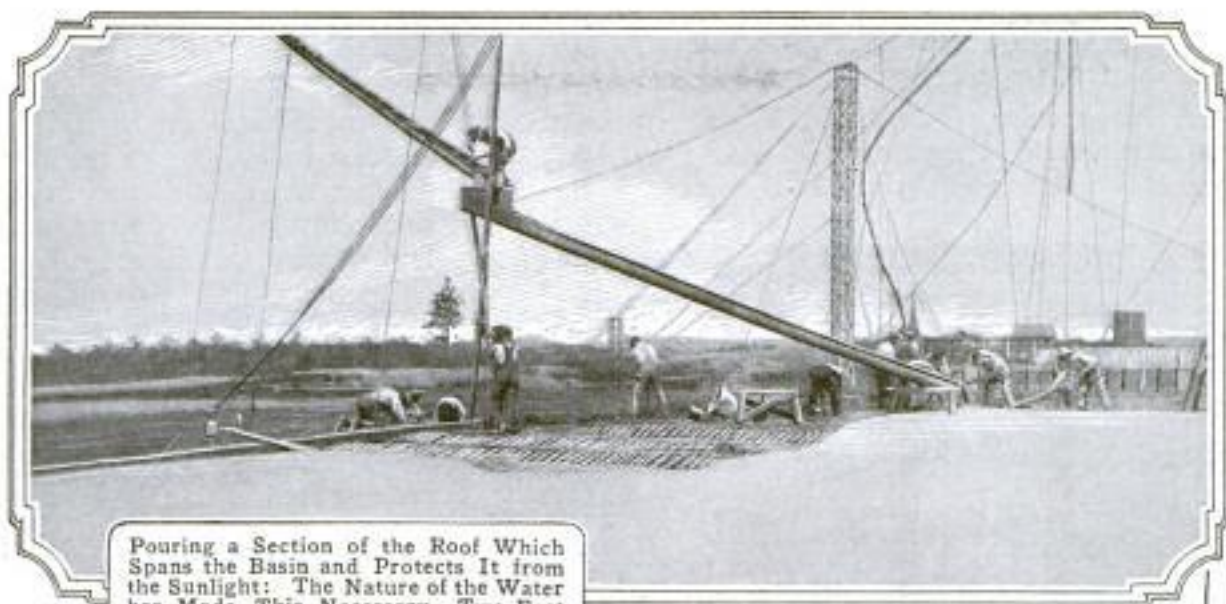

Pouring a Section of the Roof Which Spans the Basin and Protects It from the Sunlight: The Nature of the Water has Made This Necessary. Two Feet of Earth is Used to Cover the Concrete Work



The Reservoir, Which is 520 Feet Long and 260 Feet Wide, is Divided by a Heavy Concrete Wall, the Reinforcement of Which is Shown Here under Construction



Type of Steel Forms Used in Erecting Outer Walls of Reservoir, Which will be Fed by Artesian Wells

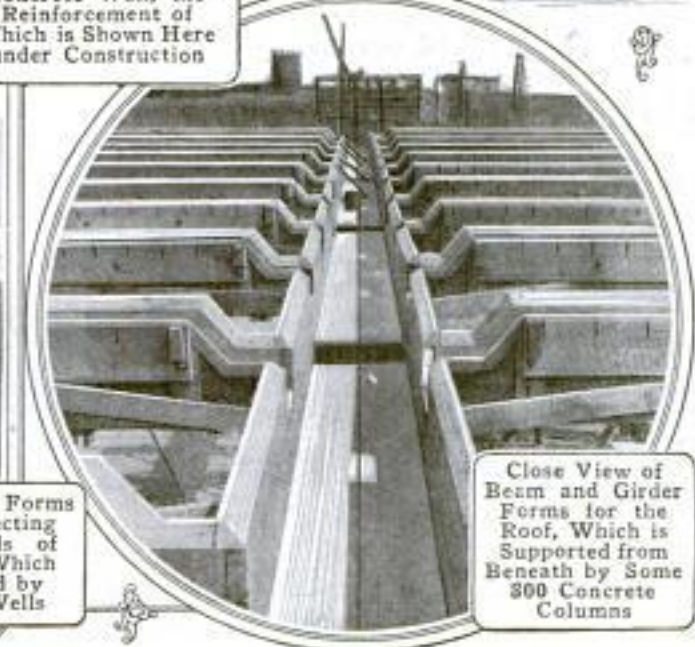

Close View of Beam and Girder Forms for the Roof, Which is Supported from Beneath by Some 300 Concrete Columns

**MAMMOTH BIRTHDAY CAKE  
ADVERTISES SALE**

758 A huge cake, 7 ft. high, 5½ ft. in diameter, and weighing 900 lb., was recently used to advertise a "birthday"



104  
Huge "Birthday" Cake Advertises Department Store Sale

*N. Jevons Co. Los Angeles, Calif.*  
anniversary sale in a department store. The recipe called for one barrel of flour, 1,250 eggs, 150 lb. of butter, 200 lb. of sugar, 1½ qt. of flavoring extract, and 2 lb. of baking powder. The cake was a most artistic example of the sugar-sculptor's art. Colored roses, shields, poppies, and cornucopias adorned the creation on all sides. Five columns supported the top layer, and crowning all was a replica of the Santa Barbara mission set around with miniature palms and orange trees. Practically everything on the cake was edible, and more than 30,000 patrons of the store received generous slices. Five of them won prizes of merchandise.

**INSTITUTE GIVES USEFUL IN-  
STRUCTION IN TRADES**

725 Classes that meet between 10 and 12 at night are soon to be on the regular schedule of a recently established Minneapolis trade school, the Dunwoody Institute. This odd time for class work was adopted because it best suited the convenience of a group of bakers who desired instruction. In many other ways this new development among educational institutions attempts to adapt itself to the needs of those it would teach.

Established only a short time ago by the will of the late William H. Dunwoody, the institution already gives instruction in bricklaying, carpentering, printing, plumbing, painting, plastering, automobile driving, boiler firing, steam engineering, machine work, electrical construction, and similar trades. Possessed of a \$3,250,000 endowment from the Dunwoody estate, tuition is free to students from any part of Minnesota. Supplementing the regular instruction work, attempt is made to give students that practical experience which only apprentice work has heretofore been able to supply. In so doing, it is hoped adequately to fulfill long-felt wants in certain of the trades. One of the most interesting courses is in smoke prevention for firemen, a knowledge of which is much needed because of current agitation against smoke in cities.

**CONCRETE BRIDGE STANDS UP  
390 UNDER IMMENSE LOAD**

The tremendous loads even a simple concrete bridge will withstand were demonstrated in a remarkable manner by recent government tests. That a concrete slab spanning a 16-ft. gap

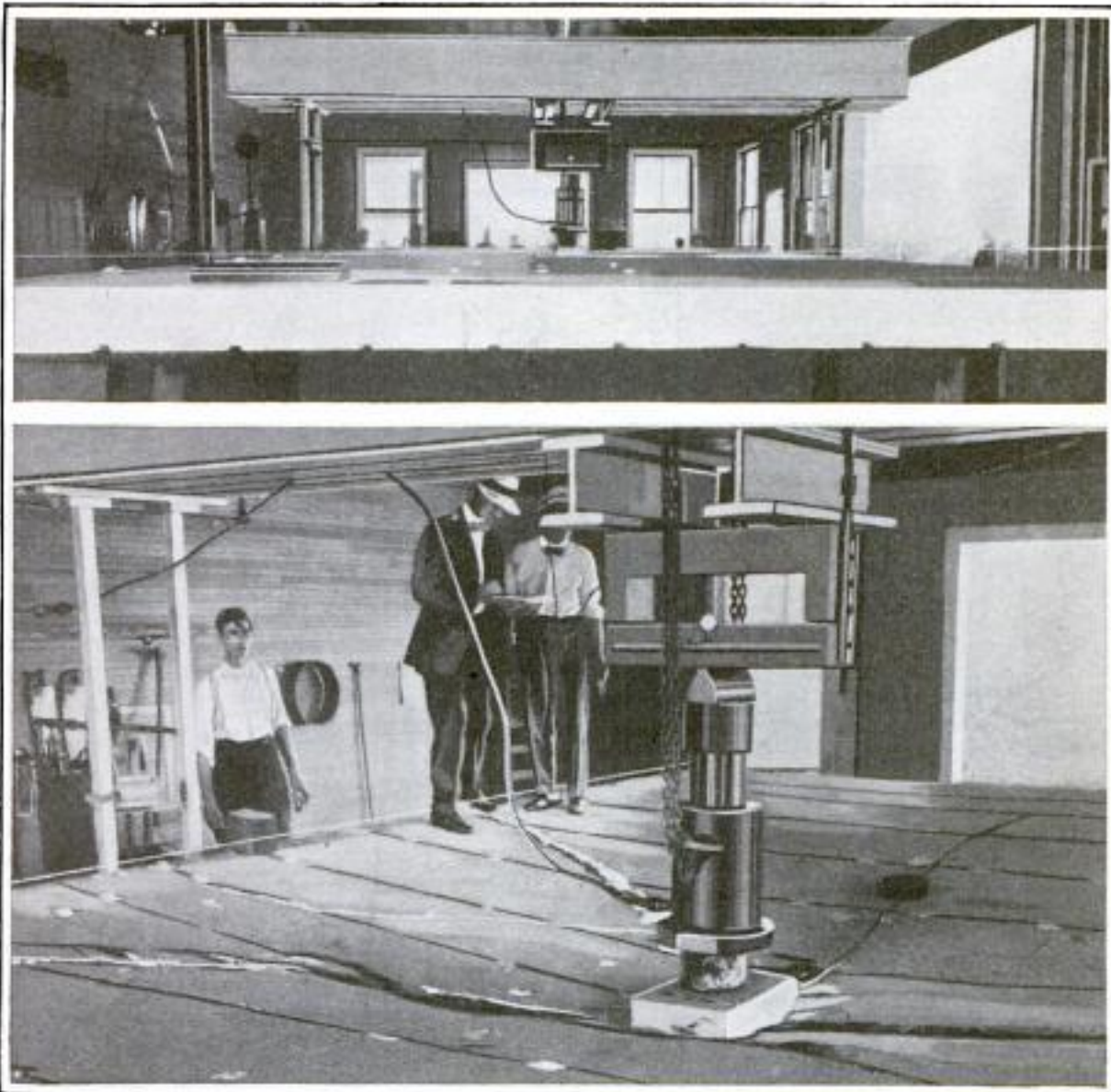

View of the Bridge before the Test, and Later While being Put under Pressure by the Hydraulic Jack

would safely support the weight of two heavy traction engines or motor trucks, even if applied at a point and in the center of the bridge, was amply demonstrated, in the opinion of the experts conducting the tests.

The "bridge" used for the tests was a slab 32 ft. wide, 10 in. thick, and of 16-ft. span. The load was applied by means of a hydraulic jack which worked against four heavy I-beams rigged above the bridge and bolted to the abutments with steel rods. The pressure produced by the jack bore down on a steel slab 1 ft. wide and 2 ft. long, placed in the center of the bridge. Under test the concrete did

not crack until a load of 90,000 lb. had been applied. An 84,000-lb. load produced a depression of but 5 in., and even after the center had sagged 8 in. the bridge still safely supported 25,000 lb. Curiously enough, less than a wheelbarrowful of concrete chipped off the bridge during the entire test. The concrete used in the bridge was a mixture of one part cement, two parts sand, and four parts gravel. It was reinforced with  $\frac{3}{4}$ -in. iron rods spaced  $8\frac{7}{8}$  in. apart, and  $11\frac{1}{2}$  in. from the bottom of the slab. The bridge was erected indoors, both to allow greater ease in testing and to protect apparatus from the weather.

*Inventor: Isaac G. Van Nest and design  
A. J. Nilleen, Los Angeles, Calif.  
108 J. 4135 Berenice Av.*

**POPULAR MECHANICS**

1102-616 July 7-'14 Vol. 204 p. 139

**SELF-LIGHTING SMUDGE POT**

**799 FOR ORCHARDISTS**

By the invention of a simple thermostatic controlling device, a Los Angeles man has devel-

ard type of pot, is regulated by a small copper rod. When the atmospheric temperature drops to a predetermined point, the contraction of the rod is sufficiently great to release a cup containing an acid. The liquid is poured

into a small chamber provided in the smudge pot. This holds a chemical substance which burns upon the addition of the acid, producing a flame that ignites the crude oil used in the pot. The thermostat may be adjusted so as to release the acid when the temperature falls to any specific degree. With this apparatus in use, an orchard may be protected from frost without personal attention being given it. The

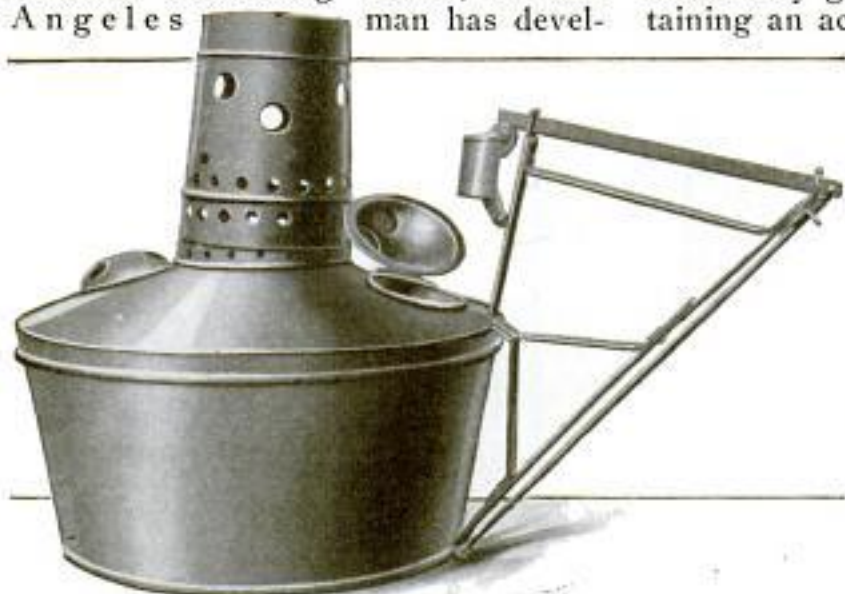

The Operating Device for This Smudge Pot is Controlled by a Copper Rod Which Serves as a Thermostat

oped an ingenious apparatus for rendering the smudge pots used by orchardists self-operating. The appliance, which may be fitted to any stand-

pots are placed beneath the trees and brought into use automatically when they are needed, instead of having to be lighted by hand.

**668 AEROPLANE BUILDERS TEST PROPELLERS WITH BARGE**

A large manufacturer of aeroplane propellers on the Atlantic coast has devised an effective way to test his products. A flat-bottomed boat, 30 ft. in length and 10 ft. wide, has been rigged up as a sort of hydroplane, using, however, an aerial propeller instead of one under water. A 40-hp. gasoline engine furnishes the power.

Locally the boat goes by the name of the "Water Skimmer," though its general outlines at first remind one of a slow-going barge. However, it is stated that the boat has sometimes attained a speed of 50 miles an hour during

these propeller tests, even though it does resemble a barge when at rest. The rate of speed a given propeller will drive the boat is used as a general criterion as to that type's worth and availability for aeroplanes.

Propellers made at this plant are said to be doing service for several of the warring European nations, as well as in our own country. Shaping the blades requires considerable skill.



40 HP Elvridge Engine

"Water Skimmer" is Used as Tester for Aeroplane Propellers

*American Propeller Co.  
243-249 E. Hamburg St  
Baltimore, Md.*



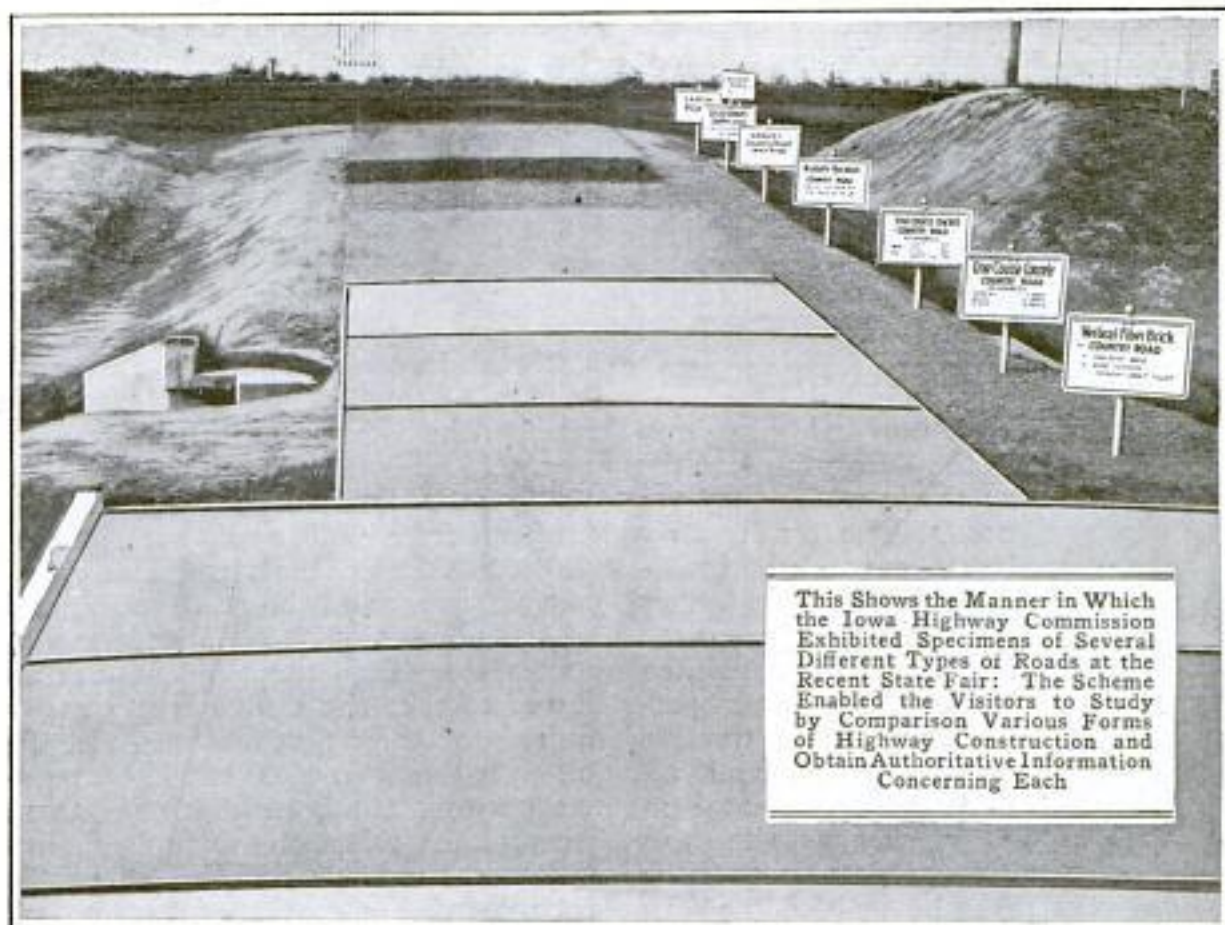

### INSTRUCTIVE ROAD EXHIBIT 791 OF IOWA COMMISSION

In furthering its campaign for better roads through the rural districts, the Iowa Highway Commission recently maintained an interesting exhibit at the state fair held at Des Moines. Various phases of road building were demonstrated and approved materials exhibited, so that thousands of persons were given authoritative information at first hand. Sections of road showing fiber brick, one and two-course concrete, asphaltic macadam, oiled gravel, and similar forms of construction, were built. These, being side by side, gave the visitors an opportunity to make a comparative study of different kinds of roads and learn the advantages of each. Concrete culverts, curbing, and other things pertinent to good roads, were also exhibited, while photographs illustrating different steps in construction, the conditions of existing roads of specific types, and bridges erected in various places were shown.

### RAIL GRINDER THAT MAY BE 34 MOVED WITH EASE

In street-railway work it is generally difficult to make repairs on track or overhead construction on account of the necessity for getting out of the way for every passing car. In the grinding of rail joints this is especially true. An English firm has recently marketed



Equipment & Engineering Co.  
2 & 3 Norfolk St. Strand  
London, E.C. 4

a machine built not unlike a wheelbarrow and so designed in general that it may promptly be removed from the rails at the passage of a car, and as promptly put to work again when the track is cleared. An additional feature

is the ease with which the pressure of the grinding wheel may be controlled—simply by pushing down on the handles against the tension of a spring. A small motor taking current from the trolley propels the grinding wheel.

**ORNAMENTAL ELECTRIC FANS FOR EVERY ROOM IN HOME**

Electric fans are now being made to harmonize with the decorations of the rooms in which they are used. The ordinary black-enameled, brass-vane device is no longer considered appropriate in a well-appointed home. The new patterns are very attractive in appearance and almost as ornamental in their way as the fans are serviceable. They are being designed in certain standard styles to match different kinds of furniture and also in special patterns suitable for certain rooms of a home. Thus a fan which is intended to be used in a bedchamber or dressing room is not necessarily of a type which would be in taste for a living room or library. They are provided with artistic pedestals which are of much the same character as those belonging with reading and piano lamps. Connections may be made with wall or floor sockets.



766  
Cruet Mfg. Co.  
258 W. 28th St., New York.

tlers or others living in or near the national forests. The free-use privilege was extended to about 40,000 persons. The value of the timber given away in this manner was \$206,464, while the revenue derived by the government from timber sold was \$1,179,448. In Alaska, the tremendous timber resources and the relative sparsity of the population make any formality unnecessary, and the residents are allowed to take the timber freely as required for their personal use. In the other national forests, however, regular permits are issued. Under these permits the value of the timber allotted to a single user is limited to \$20 each year. The cuttings must be such as will improve the forest conditions and are usually confined to dead and insect-infested timber, thinnings, and timber of inferior species.

**FRENCH ESTABLISH OFFICE TO COLLECT WAR DATA**

With a careful eye as to their standing before the world, the French are said to have established an office for the collection and dissemination of accurate data as to the course of events on the French side of the war. The men put in charge of the office are divided into four distinct groups; one for the collection and filing of photographic material, another having care of the archives, still another for foreign affairs, and a last devoted to public instruction and fine arts. All pictures, photographs, orders, records of military operations, reviews of enemy depredations, and such, are to be carefully gathered in and preserved. From time to time articles will be prepared giving the French side of matters in controversy.

**FREE TIMBER CUTTINGS IN THE NATIONAL FORESTS**

Of the 688,922,000 board feet of timber cut from the national forests during the year ended June 30, 1915, a trifle over 123,000,000 feet was taken under free-use permits issued to set-

622

Dept. of Agric.

from Pac. Telephone Magazine.

Traffic Control

TRAIN-DISPATCHING SYSTEM

862 FOR AUTOMOBILES

Telephone 10/20/15

On a steep, winding grade near Hood River, Oregon, where the road is too narrow to permit two automobiles to pass, a telephone line has been installed for enabling up-bound motorists to ascertain whether or not the road is clear. To find out if it is safe to proceed, the motorist, on arriving at the foot of the grade, simply steps to a telephone placed at the side of the road and calls up the watchman stationed at the summit. Before this system was installed, there were frequent tie-ups caused by the meeting of automobiles on the hill, which made it necessary in each case for the up-bound car to back to the foot of the dangerous grade.

TOWER IS CONVENIENT

650 REST ROOM

In the center of the principal street of Bakersfield, Cal., is a stone tower 80 ft. high and 20 ft. square. The tower has varied uses. In the top is the city clock; in the middle is a large alarm bell, and around the base is a corridor with entrances on all four sides. Stone benches are provided for tired pedestrians. An additional feature of the interior is a rest room. The tower is just one block from the city hall, the library, and the county courthouse. Because of this, the structure is a convenient meeting place for acquaintances from all parts of the city and county.



80 ft. high and 20 ft. square. The tower has varied uses. In the top is the city clock; in the middle is a large alarm bell, and around the base is a corridor with entrances on all four sides. Stone benches are provided for tired pedestrians. An additional feature of the interior is a rest room. The tower is just one block from the city hall, the library, and the county courthouse.

ask Mr. Windsor ANCIENT ELM FORMS PORCH

628 FOUNDATION

During the construction of a dwelling in Castine, Me., it was found that an ancient elm stood in the way



With a Shelf Cut in One Side, This Ancient Elm was Made to Serve as the Corner Foundation of the Porch

of one corner of the porch, and to avoid the necessity for cutting down the tree, it was decided to use it as a foundation. This was made possible through the fact that the tree stood in exactly the right position, and leaned away from the building sufficiently to allow room for the porch roof. The floor of the porch was simply framed into the tree, while a shelf cut in the side of the tree was made to serve as a base for the corner column.

The Russian army boot is being used this winter by the British in lieu of the older puttees, according to a report. This latter type of leg covering came into use during campaigns in India, where its chief utility was as a protection against snake bites. But Russian army boots during the winter of 1914-15 were found much more practical for service in colder climates.

# Mrs. J. Davis, 615 East Ocean Ave, Long Beach, Calif.

Inventor:

J. J. Kelleher, Elkader, Ia.

### AUTOMOBILE JACK LIFTS ON 9510 WHEEL AT HUB

An easily operated automobile jack recently invented has a loop which may be slipped over the projecting hub of the wheel to be raised. A single stroke downward on a convenient lever will then lift the wheel clear of the ground and hold it there until further movement is desired. The contrivance is adjustable as to height so that different-sized automobile wheels may be accommodated.



### PLOW BUILT FOR MARSHES 9646 USED IN SOUTH

For use in the reclamation work which is being done in some of the southern swamp lands, a power-driven plow has been invented which is capable of working in marshes. The machine consists of a motor tractor mounted on a caterpillar tread, behind which is a toboggan-shaped trailer which drags the ground and carries four disks which do the plowing. These disks are mounted so that they may be raised or

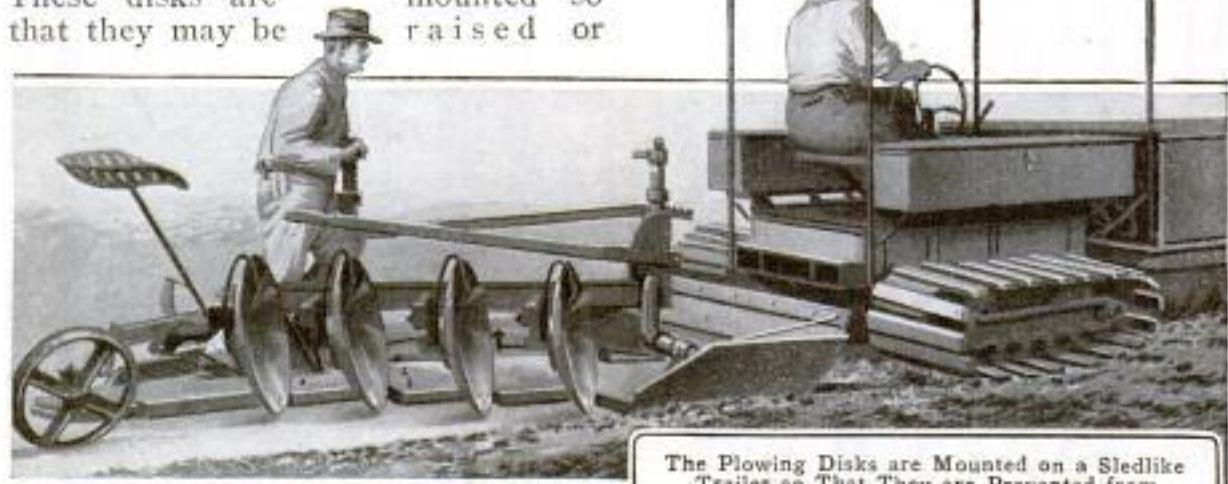

The Plowing Disks are Mounted on a Sledlike Trailer so That They are Prevented from Sinking Too Deeply into the Mire

lowered by a lever in essentially the same manner as if they were carried on a wheeled chassis. By this arrangement it is possible to run the machine over ground so deep in mire that the use of horses and ordinary farm machinery is out of the question.

### NEW PLAN FOR LOCATING FOREST FIRES

859 Telegraph and telephone poles along the railway lines are to play an important part in the work of fighting forest fires in Michigan, as the result of a plan just worked out by the chief warden of the state. The poles along the right of way of each railway are to be numbered consecutively, while the engineers traveling through districts where there is danger of fire are to be supplied with cards. On the discovery of a fire the engineer will mark the number of the pole nearest the blaze and will then throw the card from his cab window to the first section crew that he passes. Under the present rules an engineer is required to report a fire at his first stop, and much valuable time is sometimes lost in locating a section crew and dispatching it to the scene of the fire. Under the new plan this delay will be eliminated.

Chief Warden W. J. Peterson

Inventor:

A. R. Weber, Ponchartraine Grove, La.

**DELAY ELECTRIC CAPS AID IN COUNTING EXPLOSIONS**

741 By firing separate blasts with the aid of delay blasting caps, a means has been found for accurately counting all the holes which explode when a rock is shattered with dynamite, or other explosive. Ordinarily it is difficult to tell whether one or a dozen holes in a given area "went off" at the time of a blast. Believing all holes exploded, many a workman has ventured back to work too early, only to be killed or seriously injured by a belated blast. In firing a series in the new way, the second hole is fired with a delay blasting cap, the third with still another, and so on, until all have acted. This leaves sufficient time interval between explosions so that they may easily be counted, and checked off before workmen return to the danger area.

**DRINKING TUBE EQUIPPED WITH FILTER**

8701 A new sanitary drinking tube is made of aluminum and contains a bone-charcoal filter through which all the water must pass as it is drawn up through the tube. It is designed particularly for the benefit of motorists, and of travelers generally, who are compelled to drink water obtained from open wells, streams, or other doubtful sources.

*Woods Sanitary Drinking Tube*

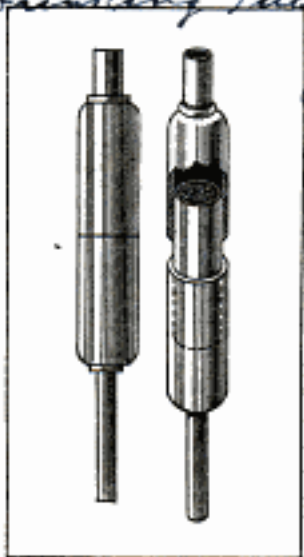

CA Chicago women's club has placed itself on record as opposing the use of cotton sacks as flour containers. Rather, they advocate the use of heavy paper as being much more sanitary for the purpose.

**WALKING STICKS ARE USED INSTEAD OF CRUTCHES**

124 When it is at all advisable to do so, specially designed walking sticks, instead of crutches, are being provided convalescent soldiers in the military hospitals of France. These are made with inclined rests for the forearms so that additional support is given the user. The hand grip is upturned slightly for the same reason. The object in using these canes is that with them a wounded man is able to regain the strength of his lower limbs much more quickly than otherwise. The walking stick forces him to make use of his feet, ankle, and knee joints. The average man recovering from injuries such as a broken leg or crippled foot, exhibits a strong tendency to avoid bearing his weight on his feet. The cane forces him to overcome this.



**THREE MILLION FEET OF LUMBER ON LONG TRIP**

744 One of the hugest orders of lumber ever filled crossed the continent a short time ago from the mills in Washington on the Pacific coast to Baltimore, Md., on Chesapeake Bay. The shipment was made up of 3,000,000 ft. of cypress, and 100 cars were required to carry it. These were divided into two trains of 34 cars each, and a third of 32 cars. The railroads used every means possible to rush the shipment, taking short cuts and giving the trains right of way over all other freights in terminal yards. But 17 days in all were required for the trip, and only four for the part between Chicago and Baltimore.

*Inventor: Mr. Schlick, Nancy, Indiana  
Patented by Prof. Dr. S. Michael*

*C. M. Sales Co.  
J. M. Clark 1535 St. Paul St.  
Denver, Colo.*

*Trays Harbor Lumber Co, Hoggan, Wash.  
C. M. & St. P. - B. O.  
United States Industrial Alcohol Co  
Baltimore, Md.*

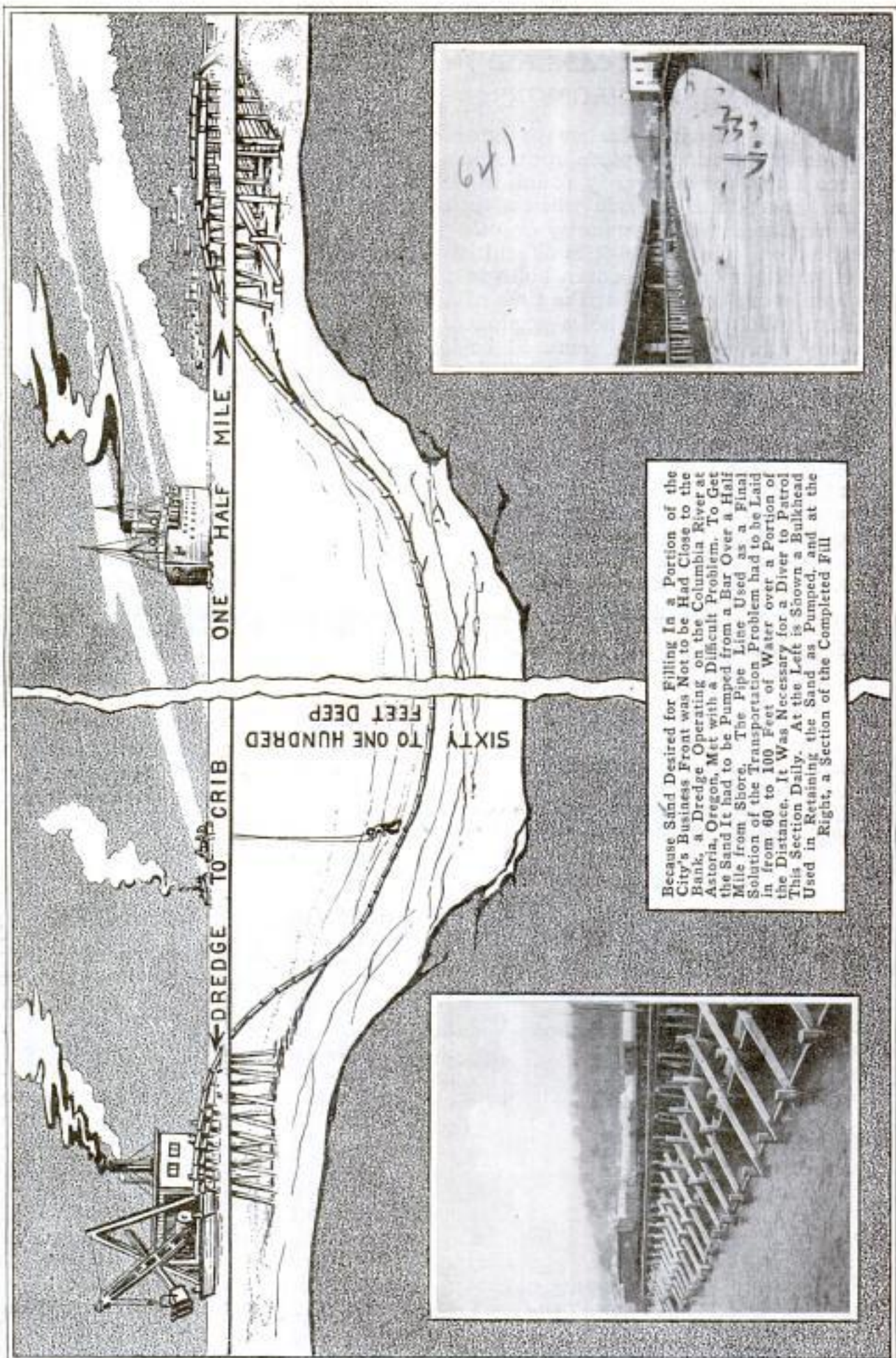

Because Sand Desired for Filling In a Portion of the City's Business Front was Not to be Had Close to the Bank, a Dredge Operating on the Columbia River at Astoria, Oregon, Met with a Difficult Problem. To Get the Sand It had to be Pumped from a Bar Over a Half Mile from Shore. The Pipe Line Used as a Final Solution of the Transportation Problem had to be Laid in from 60 to 100 Feet of Water over a Portion of the Distance. It Was Necessary for a Diver to Patrol This Section Daily. At the Left is Shown a Bulkhead Used in Retaining the Sand as Pumped, and at the Right, a Section of the Completed Fill

# Theron G. Sykes  
522 Eleventh St.,  
Astoria Oregon

6x1 DREDGE RECLAIMS TIDE FLATS OF WESTERN CITY

An ingenious scheme for filling in and building up an area of valuable but formerly much flooded land is being carried out at Astoria, Oregon. The business district stands on piles at the river edge, the district beneath being in a more or less continual state of inundation, due to the general lowness of the ground.

A bulkhead was built along the channel edge of the river for a distance of about one mile and a half, and behind this, sand from the river bottom is being dredged in. Owing to the soft mud composition at the bottom near the shore and the great depth of channel, it was necessary to go over a half mile out in the river to a sand bar in order to obtain suitable material for refilling. The dredge was anchored at the sand bar and the discharge pipe run on a trestle to the edge of the channel. Here, for a distance of about 1,200 feet, the discharge pipe had to be laid on the river bottom, in from 60 to 100 feet of water. After being brought to the surface at the bank, a trestle work carried the pipe the remaining distance to the fill. The underwater portion is patrolled daily by a diver. The material being clean white sand and put in with water, it settles at once, causing little delay before becoming hard and compact.

NEW WAY TO PROJECT IMAGE OF OPAQUE OBJECT

Two Pennsylvania inventors have recently devised a new method for projecting the images of opaque objects on a screen. The plan is quite different from that which has heretofore generally been followed and requires less illuminating power. Instead of the light source being outside of the path between the object to be reflected and the lens, it is put immediately between the object and the lens. A condensing lens is placed at the front of the projecting apparatus; back of it and on its major axis is a reflector;

back of this a source of light, and at the extreme back the object. The light is in this way thrown directly away from

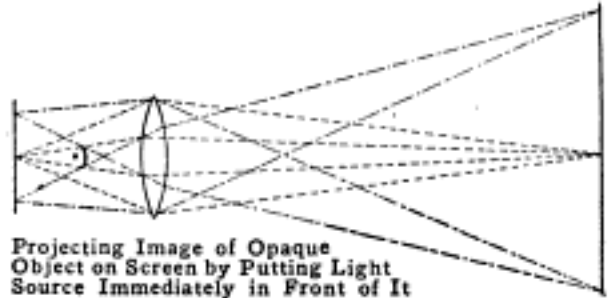

Projecting Image of Opaque Object on Screen by Putting Light Source Immediately in Front of It

the screen. The diffused rays from each point of the object pass through the lens and are projected upon the screen. No image of the arc, the reflector or the supporting members of either, is carried to the screen, because they are out of focus. In the accompanying drawing the wide end of the diagram represents the screen; the oval, the lens; the small curve, the reflector; the dot, the light source, and the short line, the object.

METAL SOCKETS FOR SCREWS USED IN WOODWORK

Threaded on the inside to receive a screw, a hollow brass pin, which may be driven into a piece of wood flush with its face so as to form a metal screw hole, is being made in different sizes capable of being used in practically all places where screws are commonly employed. One of the ideas back of the invention is to provide a permanent hole in order that a screw may be removed and replaced as many times as desired, without so chewing the wood that the holding power of the screw is weakened, necessitating the plugging of the hole. It may be used in interior finishing, as for instance in attaching the cleats to a window sash, and in nearly all kinds of cabinetwork.

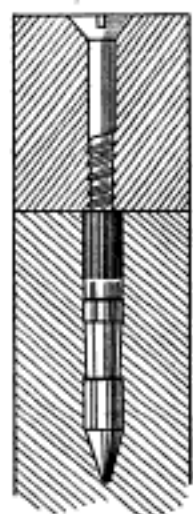

1132.269 Mech 16, 1915  
August 212-9219596

3rd & Hamilton St.  
Robert H. Hough  
Elec. Specialist  
Inventors  
Phila. Pa.

Stine Screw Holes Co.  
Escater, Ill.

329 **NOVEL MAIL-ORDER BLANK  
REQUIRES NO ENVELOPE**

Designed especially for general mail-order purposes, an order blank which may be posted without the use of an



The Order Blank may be Folded into the Form of an Envelope and Sent through the Mails as Such

envelope has been introduced. Except for a gummed flap on the left edge, the sheet is the same in appearance as many ordinary forms. It may be folded, however, into the shape of an envelope, the face of which bears the printed name and address of the firm

using it. It is employed as a convenience to customers in mailing special orders, and is not intended particularly for the use of company salesmen.

56 **STOPPING A LANDSLIDE  
WITH EXPLOSIVES**

Raising humps in the underlying stratum of fire clay by means of explosives was the novel and effective method used for stopping a slide that developed after a railway roadbed had been excavated along a sidehill in Pennsylvania. When the excavation was nearly completed there resulted a slide, 1,700 ft. in length, that extended back from the cut a maximum width of about 350 feet to the face of a rock cliff. About 40,000 cu. yd. of material in excess of that estimated for the excavation slid into the cut and was taken out by a steam shovel. An electric line that parallels the new track was practically put out of operation in spite of continual work of relining and re-surfacing. Investigation showed that the sliding material was about 10 feet deep, and that it rested on a solid bed of fire clay which acted as a sliding plane. To cure the trouble, holes spaced about 15 feet apart, and big enough for a man to work in, were first excavated to the bottom of the moving mass. In the bottom of each excavation a 2-in. hole was then drilled

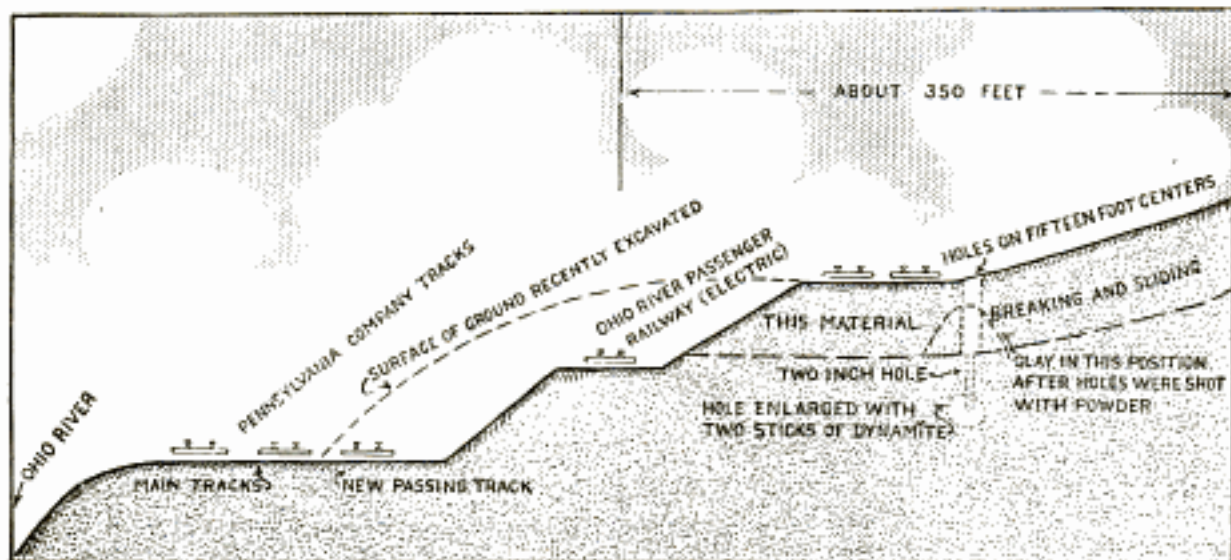

How the Humps were Formed by Explosives in the Underlying Clay Stratum to Stop a Landslide

Penna. Co. - C. & P. Division - Sidetown, To  
Pittsburgh Crucible Steel Co. Midland, Pa.  
Elect. Line - Ohio Passenger Ry. Copyrighted material



10 ft. into the clay and the bottom of the hole was expanded by the explosion of two sticks of dynamite. This made a pocket large enough to hold three kegs of black powder. When these charges of powder were fired, a series of mounds were raised in the clay that acted as abutments for holding back the loose material.

over the new Lake Washington Canal

**STREET CAR CAN BE CALLED AT WILL WITH PUSH BUTTON**

*Seattle*  
A city on the western coast has a street-car line which much resembles an elevator in an office building in operation. A prospective passenger arriving at either end of the road is invited by a sign to "Push the Button if You Want a Car." The "push" makes a car appear from somewhere down the line, much as an elevator responds to the same kind of call. Passengers are carried over a distance of half a mile, or more, by the car. The service was established by the traction company as a temporary expedient to carry passengers from one transfer point to another while a new bridge is being built over the old route. Only one man operates the lone car and his occupation will last six months, or more, before the bridge is finished.

wagon may be used in a living room, library, or bedchamber, books being



In Addition to the Ordinary Uses, This Tea Wagon may be Employed as a Table, Writing Desk, or Magazine Stand

kept on its shelves and writing materials deposited in its drawers.

**GARAGE STOVE ELIMINATES GAS DANGER**

A heating stove so arranged that no gases present in the room can come in contact with the flame has been placed on the market for use in garages and other buildings where there is danger from explosive gases. This is accomplished in a simple manner, the stove being set in a gas-tight wall so that it projects into the room and heats it by direct radiation, but with its feed door and all other openings through which gas might enter placed on the opposite side of the wall. The junction between the stove and wall is made tight to exclude the gases from the feed room.

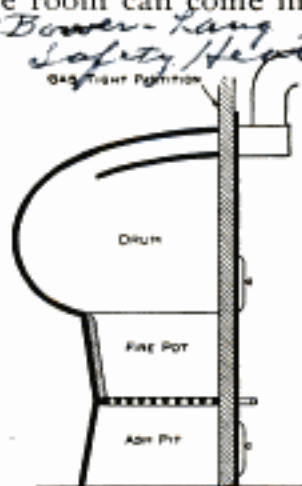

**WRITING DESK AND TABLE FORMED BY TEA WAGON**

Various household uses may be made of a combination tea wagon and portable table that has recently been brought out. It is provided with double drawers in which silver, linens, and other articles, are intended to be carried, and also has a sliding board suitable to be used in preparing sandwiches, cutting bread, or mixing salads. In addition to this it has two full-size shelves below the top. Instead of having a serving tray on the wagon, the top is divided into two sections which are so hinged that they may be folded over and form a table. By turning down only one leaf, however, a convenient desk is provided. When employed in this way, the tea

*Combination Products Co.  
2002 Clybourn Av.  
Chgo.*

Safety Heating Co. Agents  
Francis King Co. Agents  
St. East Orange, N. J.

## NOVEL AND PRACTICAL THINGS

## 772 FOR THE HOME



Night-Rain Alarm for Bedchamber

an electric alarm has been constructed. The apparatus is contained in an oblong box, intended to be placed on a sill, and consists essentially of a battery, buzzer, small lamp, and switch. The latter is an exposed disk. When rain falls upon this the circuit is closed, illuminating the globe and operating the buzzer.

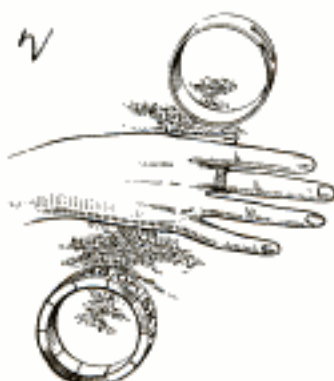

Novel Ring with Friendship Links

a ring similar in plan to the friendship bracelet. It is made with a special band that may be opened and closed to permit the insertion of small gold segments bearing on their faces the monograms of their donors. When a complete set of the initialed links is provided the band is permanently locked.



Conveniently Lighted Toilet Mirror

toilet mirror, lately introduced, is a cylindrical reflector holding a tubular lamp that throws its light through a narrow, adjustable opening. The glass is mounted in a nicked frame provided with folding legs. It is convenient for a woman's dressing table

and may also be used by a man when shaving. The light is cast where it is needed, while the user's eyes are protected by a shade.

and may also be used by a man when shaving. The light is cast where it is needed, while the user's eyes are protected by a shade.



Luminous Bulb for Electric-Lamp Chains

For the home in which there is a baby whose linen must be laundered every day or so, a small electric washing machine is made that may be used in a bathroom. It is compact, but also of generous capacity.

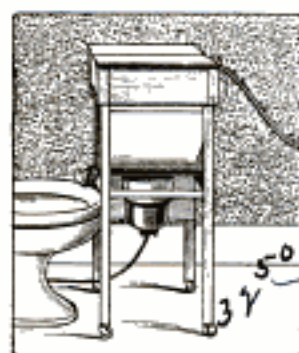

Compact Power-Driven Washing Machine

Quite a novel cracker for pecans, filberts, almonds, and similar nuts, has been brought out which en-



Serviceable Nut Cracker of New Form

ables the shells to be removed without crushing the kernels. The cracking is done by means of a screw instead of a hammer. It is finished in nickel.

Both convenient and economical features are contained in a combination water heater and garbage burner that has lately been designed for domestic use. The refuse chamber is located in the top of the device and the flue constructed to facilitate drying the refuse, which is burned by flames passing up from the fire box.

To replace the buttons and lacings used with footwear, spring fasteners have been invented. These consist of short spring links supplied with hooks at either end which slip into the eyelets of a shoe. One of the points claimed for them is that they provide elasticity where it is most needed and overcome the discomfort of tightly laced shoes.

Among the

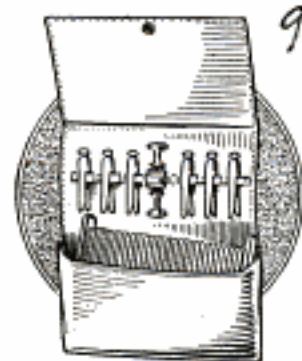

Clothesline Outfit for Woman Traveler

tacks, and a generous length of stanch cord packed in a folding leather case.

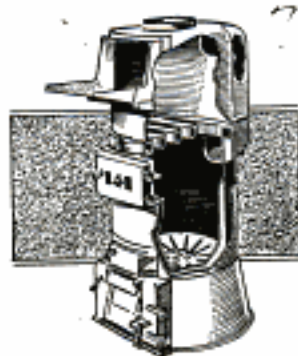

Garbage Incinerator and Water Heater



Spring Links Used as Shoe Fasteners

winter's novelties is a pocket clothesline outfit for women who occasionally wish to wash handkerchiefs, and similar articles, when traveling. It consists of six celluloid clothespins, a pair of glass-headed

With a new dusting mop, shaped something like a flared "V," it is not difficult for a maid to get at dirt in the corners of a floor or about the legs of radiators and heavy furniture, such as a piano.

It is made with a steel frame over which a cotton swab is slipped. The handle is fitted with a spring which holds it in a normal working position.

Made of metal and operated by a spring mechanism, an automatic card case has been devised which discharges a card through a narrow slit in the front end whenever pressure is applied against a small button provided on one side. It is large enough to accommodate about 50 business cards of the ordinary size and prevents them from being soiled while carried.

In an attempt to simplify kitchen work, a dish-washing machine suitable for the average household is being introduced. It is 18 in. long, 13 in. wide, and 10½ in. high, finished in porcelain enamel and fitted with wire baskets in which the dishes are placed. At one end of the device is a propeller which, when revolved, throws water over the dishes with considerable force. It may be operated either electrically or by hand.



Floor Duster Shaped to Clean Corners



Odd Metal Case for Business Cards



Mechanical Dish Washer for Domestic Use

**AUTOMATIC LUBRICATOR FOR RAILWAY-CAR JOURNALS**

7364

An ingenious automatic lubricator has been invented for preventing "hot boxes" on railroad cars. This lubricator is not designed to displace the usual method of oiling, but is an emergency device that comes into action only

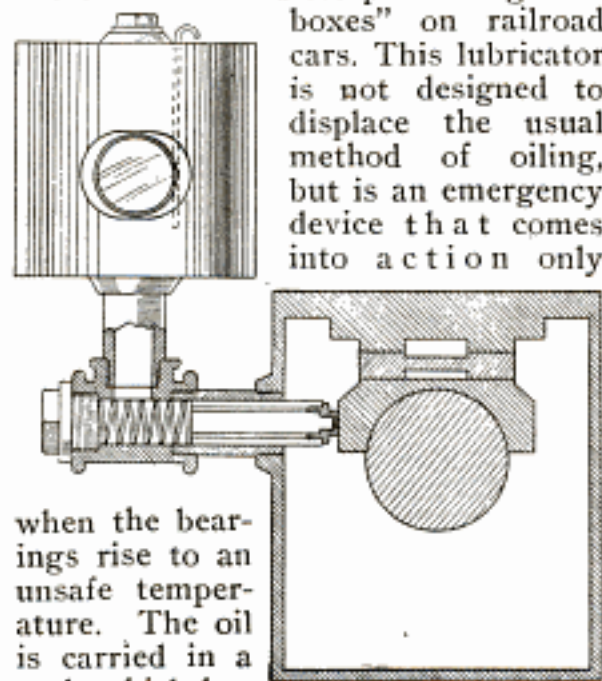

This Railway-Car Lubricator Fills the Journal Automatically with Oil When the Bearing Begins to Run Hot

when the bearings rise to an unsafe temperature. The oil is carried in a tank which has an outlet tube with a perforated head. The perforated head bears against the brass bearing through the action of a spring, and is normally filled and the perforations closed by a metal that fuses at a low temperature. When the bearing begins to run hot, this metal melts and flows out of the head, leaving the perforations clear, and the oil flows from the tank into the journal box. In order to preserve the oil and at the same time prevent the formation of a vacuum when the tank discharges, an air intake is provided that runs from the top of the tank down to a point well below the surface of the oil. After each action the tank must be refilled and a new supply of metal placed in the perforated head. A glass gauge on the tank shows at a glance whether the tank is full or empty.

In accordance with a government decree recently issued, the German language will in future be used exclusively in conducting the business of the Austrian state railways.

**SCARCITY OF PLATINUM**

**687 HAMPERS JEWELERS**

Keystone 9/28/15

Owing to an embargo the allies have placed on platinum, and similar metals, jewelers in this country are finding it difficult to obtain a sufficient supply. Iridium, a metal used to harden platinum, was recently quoted at \$70 an ounce, the statement being made that only 2,000 oz. of the material are to be had at present in the entire country. Platinum has been selling at \$56 an ounce, and palladium at \$50 an ounce.

The allied governments persistently refuse to allow the metals to leave their countries. This, according to men in the trade, is apparently due to the value the metals have in industrial processes much used at present on account of the war's demands. Then, too, it is thought that Germany probably needs a great deal of the metal, and the allies refuse to allow it to leave their hands because of the possibility of Germany securing it. The principal supply comes from the Ural Mountains in Russia, though this, too, has fallen off because of the miners having quit work to join the armies. If the war and the embargo continue much longer there is likely to be a genuine shortage of the metals in this country, in the belief of leading importers.

*Auto Access*

**DRIP PAN FOR MOTOR CAR MADE OF OILED PAPER**

8643

Among the motor-car accessories recently invented is a drip pan, which, when placed beneath a machine, prevents grease and oil from dropping on

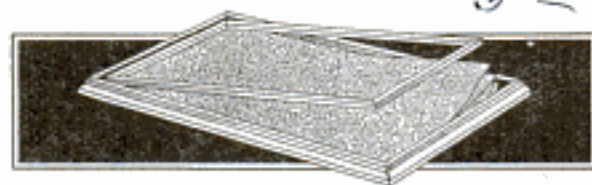

Convenient Drip Pan for Motor Car Which may be Kept Clean

a garage floor and is also so designed that it may be kept in a clean-looking condition itself without trouble. It consists of a wooden frame which

Foss-Hughes Co  
Phila Pa.

*Julius Hochstetler, 2 John St. New York*

holds a block of oiled paper. When the top sheet becomes coated with grease and dirt, the edge of the frame may be lifted and the leaf removed. This leaves a new, clean surface exposed.

**MINERAL POTASH EXTRACTED  
786 FROM ALUNITE**

The discovery of mineral potash in commercial quantities in an alunite deposit in Utah, together with a practical method of extracting it, as recently announced by the United States Geological Survey, is confidently expected to relieve agriculture in this country of the severe handicap from which it has suffered since the outbreak of the war and permanently to do away with the necessity for importing this material, which is essential both as a fertilizer and as an ingredient of high explosives. The vein on which the experiments have been made is located in Piute County, Utah. It is 10 ft. wide, has been traced for a distance of 3,500 ft., and is of unknown depth. Similar veins of alunite are known to exist in Colorado, Nevada, California, and Arizona, and present indications are that the supply of potash from this source is practically inexhaustible. How important this discovery may be is indicated by the statistics for 1913, during which year potassium salts to a total value of \$15,000,000 were imported from Germany. The imports of potash have been almost entirely cut off since the outbreak of the war.

Limousines with all-glass roofs are among the novelties soon to appear in the larger cities, according to those familiar with advanced practice in automobile design. Such vehicles have already gained marked popularity in Germany, where the material "cellon" instead of glass is used for the roofs. This remarkable substance greatly resembles glass in its general properties, but withstands rough handling much better.

**JAW BRACE FOR DENTAL AND  
8448 SURGICAL WORK**

A rubber jaw brace that has just been brought out for use in administering anesthetics in dental work and

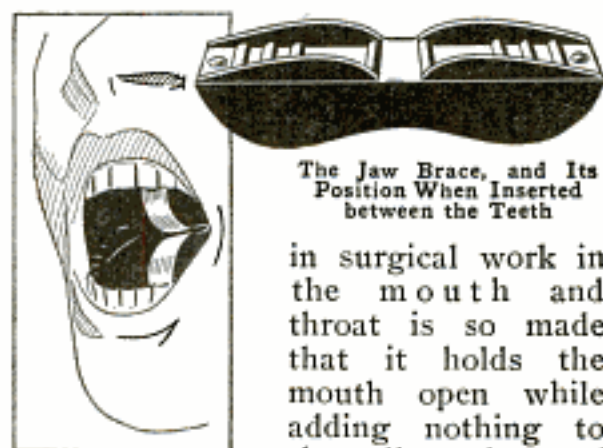

The Jaw Brace, and Its Position When Inserted between the Teeth

in surgical work in the mouth and throat is so made that it holds the mouth open while adding nothing to the discomfort of the patient. It conforms to any mouth, and one of its advantages is that there is no danger of its slipping down the throat, as it flies out of the mouth the moment it is released. In adjusting it, the ends are brought together between the thumb and finger, and the brace is placed between the teeth on one side with the ends to the front. It occupies a small space and leaves sufficient room for the operator.

**BARBED STEEL ANCHOR MADE  
9097 WITHOUT LOOSE PARTS**

Made without loose parts so that it may readily be driven into the ground, a new guy anchor has been invented which consists of a straight, 7/8-in. square steel bar, approximately 5 ft. in length and fitted near the pointed end with two sets of bent spring barbs. The opposite end is provided with a 1-in. eye for receiving the cable. The



Steel Guy Anchor That may be Driven into the Ground Readily

barbs are riveted to the rod and reinforced by short backing members. The weight of the anchor is approximately 20 pounds.

Barbed Anchor Mfg Co.  
Paul Jones Bldg.,  
Louisville, Ky.

Monsieur Pretaj  
10, Rue Surcouf, Paris.

122

## POPULAR MECHANICS

### NOVEL HEATER FOR STORED

LIQUIDS

A simple heating apparatus has been brought out in France for heating liquids that are stored in barrels,

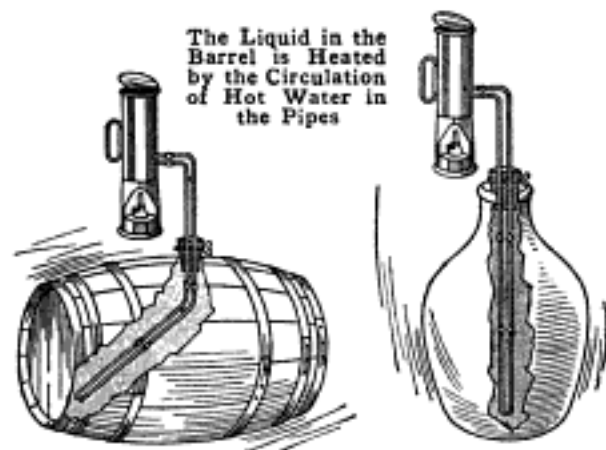

or other containers, and are likely to freeze or become too stiff from the cold to flow readily. The apparatus consists of a small water-filled tank, heated by a spirit lamp, with a U-shaped pipe extending down into the container and having both ends connected with the tank. When the water in the tank is heated it flows down one leg of the pipe and back to the tank through the other leg, maintaining a constant circulation of hot water.

### MOTOR CAR WELL FITTED FOR LONG JUNKETS

Few cars are more fully equipped for touring than one driven by a Michigan motorist who does much overland traveling. It is a six-cylinder, seven-passenger machine that has been fitted with many ingenious and utilitarian devices which make it a veritable camping outfit on wheels.

It is provided with very complete cooking facilities, has hot and cold running water, a disappearing dining table, a refrigerator capable of holding enough provisions for two days, a double hammock bed, and abundant storage space. With these accessories the tourist may travel for hundreds of miles in comfort without planning his itinerary to include towns with good hotels for night stops.

The dining table is fitted to the top and back of the front seat. Beneath this is a refrigerator which is drained through the floor of the car and only requires re-icing every 30 hours. The luncheon kit is of the suitcase type and includes vacuum bottles, all necessary dishes for serving several persons, and silverware. A dust-proof trunk is carried on a baggage rack at the rear. This is of sufficient size to hold three suitcases, thereby eliminating the discomfort which comes with crowding the tonneau. On the left running board is a special tool box in which various accessories, including a rubber vulcanizer, are packed. The tires are pumped and the upholstery cleaned by means of a four-cylinder pump permanently mounted with the motor.

When driving through city streets a small electric warning signal is used, but on country roads a powerful marine horn is employed. The car naturally is equipped with an electric starter and lights. In addition to the usual lighting equipment, however, there is a dome lamp for illuminating the interior of the machine at night when a stop is made and it is desired to read or write. Roller shades that may be operated from the driver's seat dim the headlights for city use, while a green pilot lamp, mounted on the left fender, assists approaching motorists to pass safely on narrow roads at night. A searchlight is also attached to the windshield on the driver's side of the car.

A hammock bed is designed to be hung lengthwise of the car above the seats. The right half of this may be set up so that one person may sleep while the car is driven by another. A lavatory is provided on the left running board, as well as a dish washer. A cold-water tank contains water for drinking and cooking purposes, and also supplies the radiator.

Ⓒ Motion pictures of British fleet maneuvers were recently taken under auspices of the admiralty. Half of the proceeds from display of these pictures will go to naval charities.

J. N. Brown, Editor,  
Battle Creek, Mich.  
Battle Creek, Mich.



## Protecting the Surfaces of Enameled Road Signs

The use of enameled road signs is becoming very popular, but a great deal of trouble is caused by boys throwing stones at the signs, which chip the enamel from the iron surface. I have found a remedy that has ended the trouble in this locality and saved many dollars, for the signs are expensive. This simple remedy, while not hindering the reading of the signs, will effectively protect them from serious injury if they are hit with a hard object. On the back of the sign at the top and bottom, holes are drilled, and supporting brackets are attached to hold a thin mesh wire over the face of the sign. This will protect the sign, and answers the purpose better than anything that has been used.—Contributed by C. H. Thomas, Kennett Square, Pa.

## Thawing Frozen Water Pipes

When the water freezes in the pipes of a house and the location of the frozen part is known, fill a water bag with hot water and place it on the frozen part, open the faucets to give vent, and before the water in the bag becomes cool the frozen part will be thawed out and the water running. This method has been used to advantage several times, and there is no danger of starting a fire as when using a gasoline torch.

## Hose Drainer for Small Fire Stations

A great many laborious methods are sometimes employed to drain the hose of small fire stations before winding them on the reel for the next emergency. I have seen them pulled over rafters, shafting, and any projection which afforded a drop sufficient to

drain the water out. The sketch illustrates a neat arrangement employed by

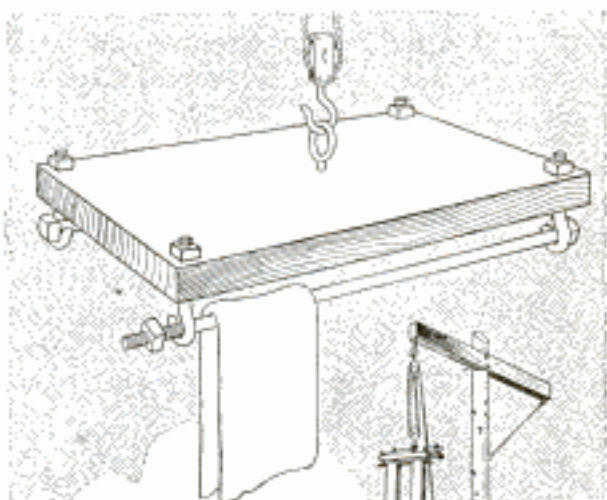

Hoist for Draining Lengths of Hose Used in a Small Fire Station

the department of a small western town which makes the draining operation a speedy and easy task. The cradle is sufficiently large to pull up six lengths of hose if necessary. The hose lengths are doubled at the center, and the long bolt is slipped through the bend. The whole number is then raised at once. When lowering them, the ends are carried out and laid flat, the entire number of



lengths being prepared for winding on the reel. The arrangement is inexpensively erected, and it saves a great deal of work in the draining before the hose is wound on the reel.—Contributed by F. W. Bentley, Jr., Missouri Valley, Iowa.

### Preventing the Loss of Spring-Bolt Caps

A most troublesome accident on one's automobile is to lose the cap of a spring bolt. These bolts are usually of a special type and carry a reservoir of grease for the purpose of lubricating the shackle. A spring inserted in the head against which the cap is screwed will prevent the latter from coming loose.

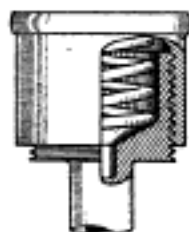

### Figuring Width of Slot to Cut in Piston Rings

When turning up a set of piston rings for a gas or steam engine, the "blank" is turned larger than the bore of the cylinder; then when the rings are cut off to the proper width a certain portion is cut out of each ring, and the ring is sprung, closing the gap, to fit in the cylinder. The spring thus created in the ring causes it at all times to fit the cylinder tightly and make the piston gas or steam-tight under all conditions.

To the novice, and to many experienced men, the amount to cut out of a ring is a matter of guesswork, although a simple calculation will reduce the uncertainty to a certainty. As a general

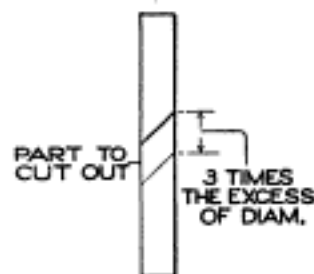

rule, blanks are turned  $\frac{1}{4}$  in. larger in diameter than the cylinder for every foot, and proportional amounts for smaller cylinders; a blank for a 12-in. cylinder being  $12\frac{1}{4}$  in. in diameter and a blank for a 6-in. cylinder,

$6\frac{1}{8}$  in. The amount to be cut out is three times the excess of size over the cylinder diameter, measuring on the circumference. For a 6-in. cylinder the amount would be  $3 \times \frac{1}{8}$  in., or  $\frac{3}{8}$  in. The exact amount would be  $3.1416 \times \frac{1}{8}$  in., or .392, or fully  $\frac{1}{64}$  more than stated, but it is better to cut just three times, and leave the excess for filing off the rough edges left by the saw cut, and allowing sufficient metal to make a nice, close fit of the ends.

### Recesses for Coiled Springs

In a certain hardware article a pawl was made to engage a rack, and was held by a coil spring set in a hole in the back of the pawl. The hole was drilled  $\frac{1}{4}$  in. in diameter, or .01 in. larger than the spring. So much

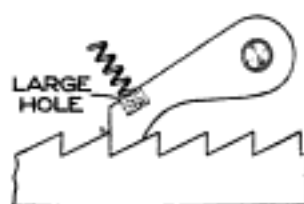

trouble was experienced by the spring working out that the sale of the article was seriously affected, and yet, for

certain reasons, the construction could not be changed. A tighter fit for the hole was tried, but each degree of tightness, while it lessened the trouble, reduced the resiliency of the spring. Purely by accident a gross of the pawls were put in with a hole  $\frac{3}{32}$  in. larger, and strange to say, no spring came out. As the adopted construction it proved a success.

### To Keep Hot Water Constantly at the Faucet

Some hot-water tanks are installed in the basement where they are connected either with the furnace or with a gas heater. When the water is drawn, it is necessary to let it run for a time until the hot water comes. To overcome this, I continued the pipe from the faucet back to the tank, making the connection at the lower part. This will keep the water in the pipe in motion and thus keep the hot water at the faucet and prevent the waste every time hot



water is wanted. I also put the hot-water pipe alongside the cold-water pipe to keep the latter from freezing. Where the pipe ran under the house, I cased it with boards to keep the heat in from the hot-water pipe.—Contributed by F. J. Schellhase, Mount Healthy, Ohio.

### A Lettering Instrument for Draftsmen

The illustration shows a device to take the place of the lettering triangles and templates. The tool is constructed entirely of wood, cherry preferred—excepting, of course, the screw A—and is so simple that very little description is required. Its method of operation is also apparent. The tool is designed for plain Gothic letters, although the head may be graduated for any style of letter, or for two or more styles.

The tool reads right and left, as shown, and possesses a far greater range than any triangle, or lettering template, in sizes of letters, since the blade can be made to telescope, so that by extending it, large sign letters can be formed with it. From the small size shown it is possible to make all letters on drawings from the large to the small,  $\frac{1}{8}$  in. high, used on drawings. The tool is very much neater in appearance than the standard lettering

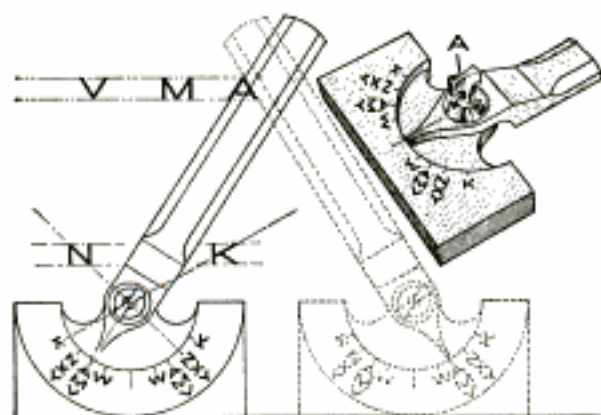

An Instrument to Take the Place of the Lettering Triangles and Templates Used by Draftsmen

triangles or templates, and occupies less space than the several triangles it replaces.—Contributed by J. B. Murphy, Plainfield, N. J.

### An Emergency Fireplace Grate

As usually constructed, fireplaces are built for wood only, and cannot be used for coal unless especially provided with

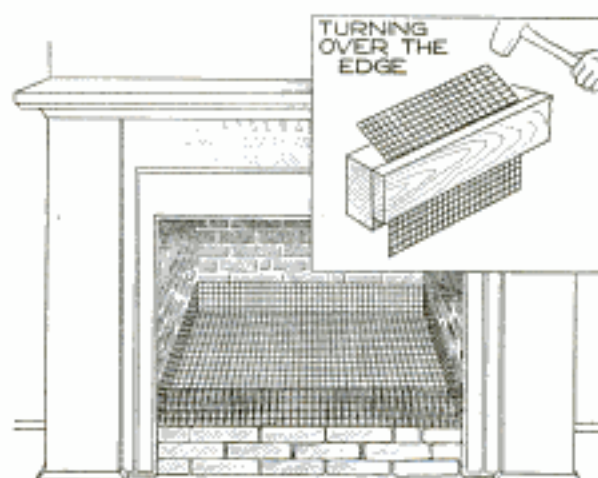

Grate Made of Coarse-Mesh Screen, to be Used for Coal in a Wood-Burning Fireplace

a suitable set of grates, which for the particular size and style of a fireplace might not be available. A removable grate for such an emergency can be made of woven wire screening, of about  $\frac{1}{4}$ -in. mesh and of  $\frac{1}{8}$ -in. wire. Most any piece of screen, such as is scrapped from a gravel screen, will answer the purpose, providing it has no hole that would allow the coal to drop through.

In laying out the screen preparatory to bending up the edges, as shown in the illustration, it is best to make a wood template which easily fits the fireplace. This shape can be marked off on the wire, leaving about 2 or 3 in. for bending up at the sides and ends. This border strip is cut at the corners to allow for the turning up of the edge. To turn the edges, fasten the screen to a beam, or the workbench edge, with a board on the outside, then beat the projecting edge over with a hammer.

The screen grate, when finished, can be supported with brick laid around the outer edges and on the floor of the fireplace, with one brick in the center, to prevent sagging under the heavy weight. The ashes can be removed in the usual manner from underneath the grate by means of a shovel. For appearance, and to prevent ashes from

falling out, a temporary row of brick can be set up in front of the grate.—  
Contributed by F. W. Buerstatte, Pullman, Wash.

### A Washing-Machine Water Heater

The illustration shows a simple homemade attachment for a washing machine, to keep the water hot. As

The Water is Heated and Kept Hot in the Machine All the Time While Washing



may be seen, the heating unit consists of two  $\frac{3}{4}$ -in. pipes, one return bend, two unions, and two close nipples, which are screwed into the sides of the machine. The stove is a single-burner hot plate. The unions permit the ready dismantling of the pipes in case they become clogged with dirt. This attachment, fitted to a power machine, lightens the work considerably.

### Flexible Holding Means for an Automobile-Engine Bed

It happens quite frequently that a supporting arm of a truck engine becomes fractured, due to sudden twists to which the frame is exposed on rough roads. A

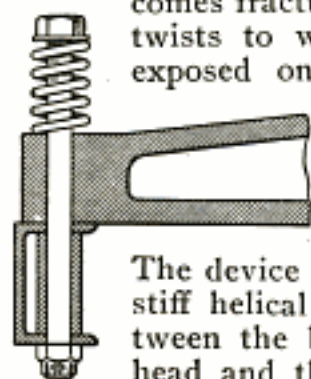

good method of fastening the engine of an automobile is shown in the sketch. The device consists of a rather stiff helical spring, placed between the bottom of the bolt head and the top of the boss on the supporting arm. The spring takes up the twists and strains given to the frame as the car passes over rough roads.

### How to Make an Aluminum Screen for Moving Pictures

In making an aluminum screen for moving-picture theaters, the amateur will find it a difficult job if he tries to apply the aluminum paint with a brush, as it dries too quickly for the inexperienced to put it on without making laps, and laps mean that veil effect that must be avoided if clear pictures are desired.

A simple way in which an amateur can make a first-class screen is as follows; the description being for a screen 8 by 10 ft., but the size can be varied to suit conditions. First make a light frame of wood to hold the cloth, then shrink the goods by washing it in alum water. A handful of alum to a 2-gal. pail of water makes the solution. When the cloth is dry, tack it on the frame, making sure that it is stretched tightly and without wrinkles. To make a neat job tack about every 4 in. The filler consists of 1 gal. linseed oil; 1 pt. japan drier, and 6 lb. of white lead. Stir until well mixed and apply with a brush, giving the cloth a second coat after letting the first dry 12 hours. When the second coat is dry, which requires about 16 hours if the room is moderately warm, it is ready for the aluminum, or bronzing, liquid. This is the proper condition of the cloth for either method. This size curtain will require  $\frac{1}{2}$  gal. of bronzing liquid, and if it cannot be readily obtained, use varnish slightly thinned with turpentine. Place the screen face up on horses, or on four chairs, and pour the liquid on it. Tilt the screen first one way and then the other so that the liquid will cover every part of the face, or smooth side. Sprinkle on aluminum bronze all over the screen before the liquid dries. Tilt the screen as before, and it is well to shake it also so that the bronze will be distributed over the surface. Place the screen on the horses, as level as possible, and let it lie until dry, which will require about two hours. Then stand the screen up on edge and tap it lightly on the back to jar off any loose bronzing powder. This will produce a screen without a lap or any veil effect. It is

the only method by which anyone not familiar with the different kinds of paints can handle a screen with the desired effect, leaving out the streaks and laps.—Contributed by Claude O. Soots, North Salem, Ind.

### Removing Locomotive Crank Arm Easily

When a main rod of an engine equipped with a valve gear has been taken off, the side rod cannot be removed until the crank arm is taken from its place. A great many locomotives with such valve gears have the crank arms, which fit in a bored-out portion of the crank pins, a drive fit and kept tightly in place with a long bolt through the crank pin. These crank arms are very difficult to remove, and for this reason the device illustrated was designed to make the work easy, and it gives entire satisfaction. The device is placed on the pin, and the wedges are driven in to remove the

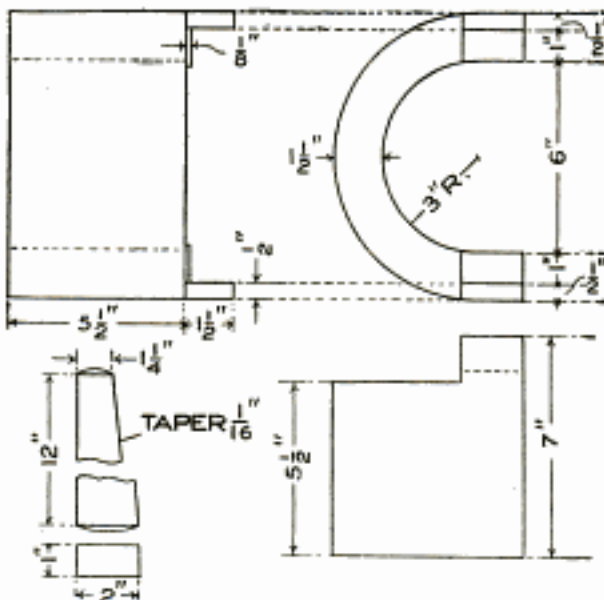

Eccentric-Crank Arms Made to a Drive Fit on Pins are Easily Removed

crank arms. The lugs are provided to keep the wedges from working out and away from where they are most effective.—Contributed by Joseph K. Long, Renovo, Pa.

Do not screw pipe together for either steam, water, or gas without putting white or red lead on the threads.

### Spraying Pipe for Washing Windows

A local merchant in a small town had some difficulty in washing the plate-

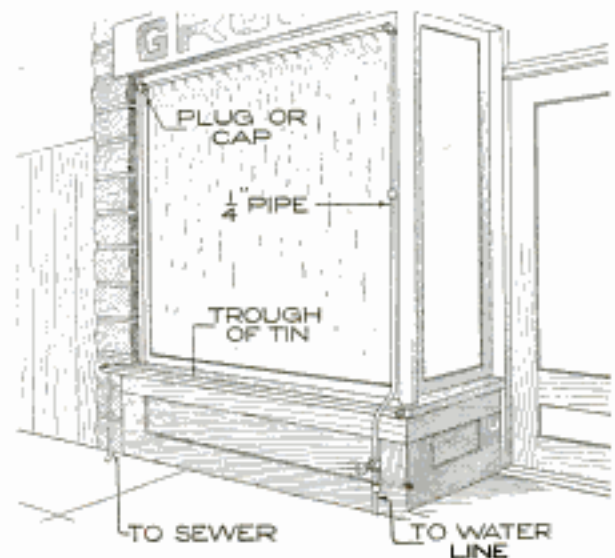

The Spray Pipe Flushes the Glass with Water, and the Drain Runs It to the Sewer

glass windows. One or two pedestrians accidentally stumbled into the bucket of water which the clerk was using to flush the window glass. The difficulty was overcome very nicely, by him and by many other merchants, in the following manner: A pipe perforated with small holes was run along the top of the window, and one end of the pipe was connected with a valve to the city water main inside of the store. At the bottom of the window a small tin trough or eave was run, one end of which emptied into the sewer drain. The water was turned on from the inside and a small valve was put in on the outside, to control the flow. The window was at once flushed with clean water, but at the same time without the necessity of handling a heavy pail and a splattering swab. All the work necessary was to dry the pane with the thin rubber blade for that purpose. The convenience of the arrangement was well worth the time and expense.

The minute specks sometimes seen on mahogany piano cases are caused by oil that exudes from the wood. Shellac varnish will not hold it back. The only cure is to rub it down and revarnish.

### Hand Rest for Bookkeepers

The one disadvantage of the ordinary arm rest for bookkeepers is that its surface is too low for comfort.

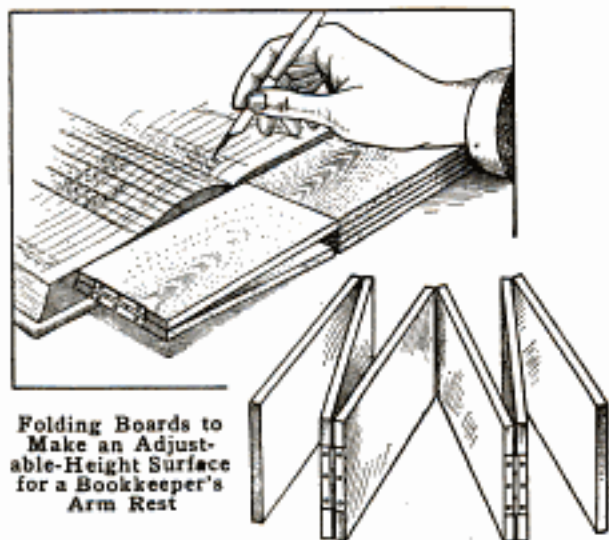

Folding Boards to Make an Adjustable-Height Surface for a Bookkeeper's Arm Rest

When its end is placed between the book pages the rest part is not level with the page on which the entry is to be made. This difficulty is entirely overcome by making a series of thin boards, the width desired for the rest and as long as the book page is wide. These are hinged together at the ends so that they will spread out similar to a hearth screen. It is easy to stack them for the proper height.

### Curb Blocks for Road Pavements

In making paved roadways in the country, and especially in sandy soil, there is no necessity for having a curb

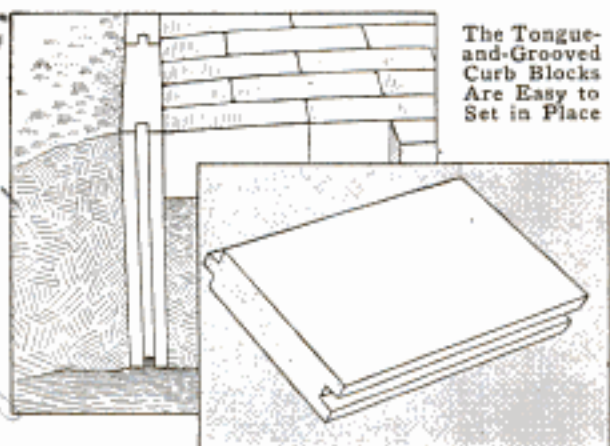

The Tongue-and-Grooved Curb Blocks Are Easy to Set in Place

with a gutter. The curb should be merely a support for the paving edges

or blocks and a protection against damage by the vehicle wheels. One municipality, where it was necessary to build a paved roadway in sandy soil, used an interlocking curb block that was tongued and grooved, the blocks being about 24 in. long, 18 in. deep, and 4 in. wide, made of concrete. These blocks were set in the soil on the curb line so that their upper edges were level with the tops of the paving blocks. The shape of the block and the manner in which it is placed in the earth are clearly shown in the illustration.

### Making Teeth for Gear Patterns Quickly

The making of teeth for gear patterns is always a tedious job, and when they are worked out one at a time, no matter how carefully they are laid out or how skillful the workman, the results are seldom satisfactory. With the use of the jig shown in the sketch and a correctly made sanding cylinder, hundreds of teeth may be made which will all be duplicates, and if the directions given here are carefully followed, it will be impossible to detect the slightest variation in size or contour between the first and the last tooth taken from the jig.

The jig is made the exact shape of the tooth required, but 3 or 4 in. longer, and with more than 1 in. of stock below what would be the root circle of the gear. It should be made of a piece of hard wood. This is planed up straight, with parallel sides and edges, and with the ends smoothed up for laying out the teeth. The laying out and working to the lines must be done very carefully. After the block is finished, the space for the tooth blank is cut away, and two screw holes are drilled to hold the blank in place during the finishing process. The projecting piece on the end of the jig is securely fastened with glue and a couple of brads. It should project about  $\frac{1}{4}$  inch.

For the sanding cylinder, turn up a piece of hard wood,  $2\frac{1}{2}$  or 3 in. in

Between St. Augustine & Daytona Fla.

diameter, and 1 in. or more longer than the jig. It should be the same diameter and perfectly straight from end to end. In the center a groove is then turned, about  $\frac{1}{4}$  or  $\frac{3}{8}$  in. longer than the tooth blank, and of a depth slightly greater than the thickness of a piece of No. 2 sandpaper. The object is to fill the turned-out portion with sandpaper and still have a cylinder that will be perfectly straight from end to end. The sandpaper is cut in narrow strips and wound around the cylinder like a helix, fastening it with glue as the winding proceeds.

A groove is then turned to take the raised, or projecting, piece on the jig, and it should be so located that the tooth-blank space will come directly over the sandpaper-covered part of the cylinder, with the sandpaper projecting  $\frac{1}{8}$  in. or more beyond the space at each end.

The tooth-blank stock is cut the exact length of the tooth, and should fit snugly in the space in the jig. The bottom of each tooth is first planed with a round plane to fit the root circle of the wheel, and the flanks are roughly shaped to the tooth outline.

The operation of this device is as follows: The sanding cylinder is put on the lathe centers and the belt thrown on; the jig with a blank in place is taken in both hands and held on the revolving cylinder with the projecting piece running in the groove turned for it. This brings the blank

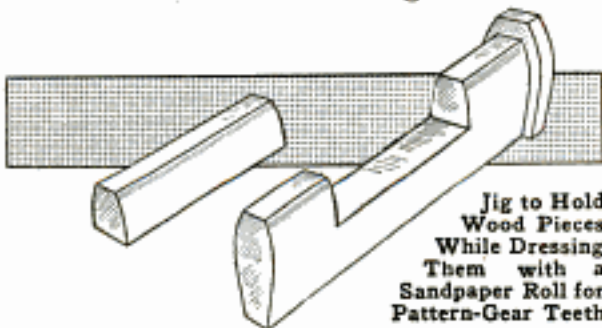

Jig to Hold Wood Pieces While Dressing Them with a Sandpaper Roll for Pattern-Gear Teeth

in contact with the sandpaper, which rapidly grinds it flush with that part of the jig that is in contact with the smooth ends of the cylinder. The jig is rocked back and forth while grinding, and the groove and projecting

piece keep it perfectly parallel with the axis of the cylinder.

Teeth for bevel wheels are made just as easily as for spur gears, and the same idea may be applied to many articles of woodwork that are to be duplicated many times.—Contributed by J. A. Shelly, Brooklyn, N. Y.

### A Folding Shaving-Material Shelf

A simple and useful shelf upon which to place a mirror, and other

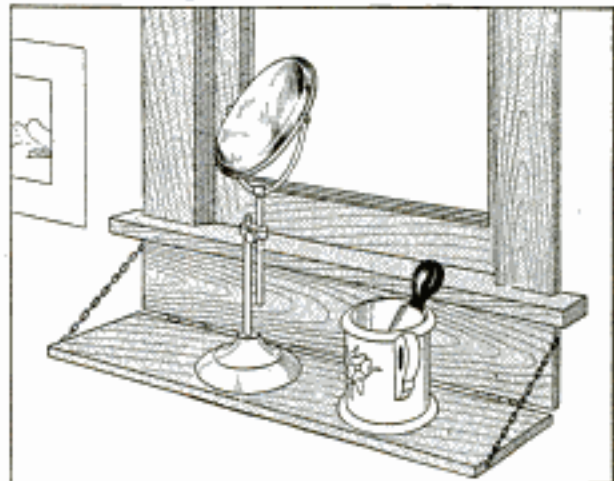

Shelf Attached to the Facing under a Window to Hold Toilet Articles While Shaving

toilet articles, while shaving, can be made as follows: Procure a board,  $\frac{1}{2}$  in. thick, and of the same length and width as the facing under the sill of the bathroom window, and fasten it to the lower edge of this piece with two small hinges, as shown. Support the ends with two pieces of small chain to hold the shelf at the right level. The position of the shelf affords a fine light, and if it is given the same finish as the woodwork of the bathroom, it will not be noticed when it is folded up.—Contributed by Frank L. Matter, Portland, Ore.

### Antirust and Fireproof Paint

A good antirust paint for structural work is made of red lead, 60 lb., zinc white, 30 lb., and graphite, 10 lb.; all ground in raw linseed oil. The addition of some china clay will prevent too rapid drying. To make a good fireproof paint use the preceding formula and add to it  $\frac{1}{2}$  lb. of boracic acid or sal ammoniac.

### Fishing Electric Wires into Walls

Having occasion to run an electric wire down between the plastering of a wall where the

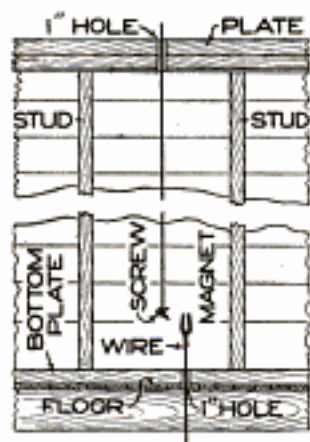

holes through the plate and the floor were not plumb, I tied a small iron screw to a line I let down through the ceiling-plate hole, and after feeling it hit the bottom I drew it back up about 1 ft. A small magnet was tied to

a stiff wire and inserted through the floor hole, and I was able to attract quickly the hanging screw, which was easily drawn through the hole.—Contributed by Ed. Kresko, Port Jefferson, N. Y.

### To Keep a Boot from Rubbing the Heel

To keep a boot that is rather loose from rubbing the heel and wearing the sock, take a piece of soft leather, about 15 in. long and 1½ in. wide, and prepare it as follows: Fasten a buckle on one end, and punch two or three holes in the other end for the buckle tongue. Cut a slit in the leather, beginning about 1 in. from the buckle and ending within 7 in. of the other end. Part the two pieces, slip the heel



Strap Split in the Center and Buckled over the Heel to Prevent Heel Movement

into the opening, pass the other end over the instep and buckle it on the outside. — Contributed by Maurice Fischer, Mokelumne Hill, Cal.

### Care of Automobile Springs

Many motorists do not give the attention to the car-body springs necessary to keep them in good condition. These springs need oil the same as any bearing on the car. Many cheap devices are on the market for opening the springs so that oil or graphite can be inserted, and this attention should be given at least every six months if the car is used regularly. The springs should be taken apart and polished once every year, and thoroughly greased before being put together.

### A Homemade Oil Indicator

An oil indicator placed on the dash of an automobile is a most desirable feature, since the driver can immediately tell whether the lubricating system is operating properly, and thus many times burned-out bearings will be avoided. The car I owned had no indicator, and I decided to construct one, which resulted in the

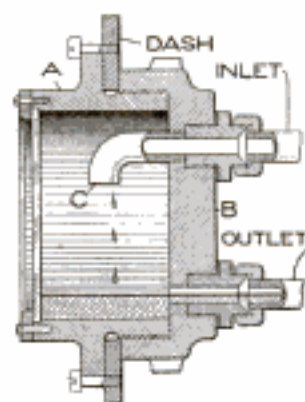

one illustrated made from parts picked up around the garage.

The body A of the indicator was made from an old hub cap, turned down on the inside and faced off on one edge, as shown. The cover B was made of an old adjusting nut of a clutch. Connections to and from the indicator were made by means of ordinary brass couplings, the upper, which is the inlet, being connected to a small pipe C for the purpose of leading the oil into the indicator. A glass cover is placed at the front of the instrument, as shown, which is held in place by means of a metal ring and small machine screws. The indicator is fastened to the dash in the manner shown, two machine screws being used to prevent it from turning and becoming loose.—Contributed by Adolph Kline.

### Keeping an Oil Hone True

A simple way to keep an oil hone true and in good cutting condition is as follows. Wet a sheet of No. 1½ sandpaper and lay it, sand side up, on a flat surface, iron preferred. Rub the cutting face of the hone on the sand surface until it is true and flat. Next rub the face of the hone with another oil hone. This will remove the grit, or sand, imbedded in the surface, which is most important. Finish by holding the face of the hone on a revolving sand grindstone while plenty of water is applied. This will tone up the cutting qualities.

### Marking Circles on a Clockface

In restoring an old clockface I used a mechanical aid to mark the circles bounding the hour numerals. It consisted of a wood arm pivoted on the post that holds the hands, and notched at two points to hold a ruling pen. For the sake of balance, the arm should extend for an equal distance on each side of the center. I found it much easier to make perfect circles in this way, as a ruling pen insures an even thickness of the lines and leaves no marks where they meet if the circles are drawn in sections. The old enamel

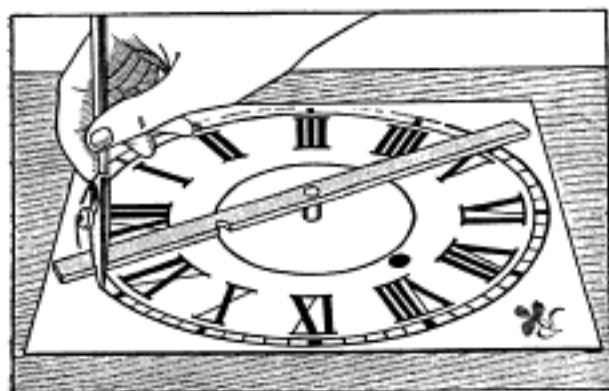

Drawing New Lines on an Old Clockface with the Aid of a Ruling Pen

surface took the drawing ink nicely after it had been washed with a weak solution of ammonia in water. The face was varnished after the marks were restored.—Contributed by James M. Kane, Doylestown, Pa.

### A Bench Stop That Clamps the Work

The stop consists of two oak or maple blocks, about 6 in. long and  $\frac{7}{8}$  in. thick, cut in the shape shown and fastened to the bench top with screws through their centers. They are so set that the opening toward the work will be about

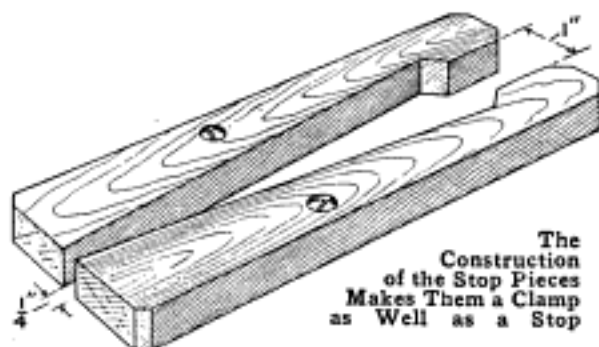

The Construction of the Stop Pieces Makes Them a Clamp as Well as a Stop

1 in. A board will be held firmly when it is pushed into the stop. The harder the work is pushed in, the tighter it will be held.—Contributed by T. S. Hastings, Detroit, Mich.

### Beveling and Chamfering Tool for a Lathe

A simple little tool which is very efficient within its range is shown in the illustration. The tool is designed to be carried in the machinist's tool chest as a part of his equipment. This tool is to take the place of the compound rest on the various machine tools where such a rest is not provided; in fact it is a miniature compound rest.

While this tool may be set at any angle by means of a protractor, its chief work is short chamfers, such as lathe, and other, centers; valves, taps; the ends of reamer blades, etc., where it is especially convenient. The travel of the tool, operated by the feed screw A, is 1 in., and this will not cause enough overhang to make the tool chatter, if ordinary care is used in its operation.

The screw B is recessed into the tool holder C, and acts as a guide to prevent the tool from turning under the cut. The shank square D of the turning tool is a tight push fit in the tool holder C. The tool holder must be a firm running fit in the casing. The

whole arrangement is set in the tool post just as an ordinary tool. If it is to be used on a very small lathe, or



Screw-Feed Chamfering Tool to Fit in the Tool Post of a Lathe, Planer, or Shaper

other machine where the tool post is too small, it may be clamped to the tool-post block.

### Clamp for Inaccessible Places

It often happens, when it becomes necessary to patch a piece of work, or part of a machine, worn out or otherwise damaged, that the place to be repaired is quite inaccessible for a clamp to hold the patch while drilling the rivet-pin holes. A piece of steel rod bent as shown, close enough to give it a spring clamping tension, overcomes the difficulty admirably.—Contributed by R. Hollis, Chicago.

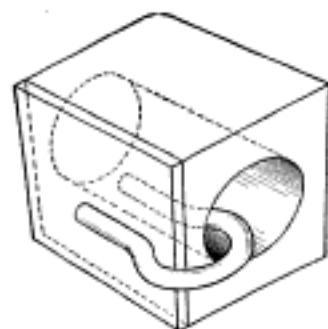

### Reinforcing Flattened Pipe Ends

Ordinary wrought-iron pipe, used as structural material for railings, knee braces, etc., is very desirable, because of its light weight and relatively great stiffness. It suffers from lack of strength at the flattened ends, however. These may be greatly improved by inserting a piece of pipe the next size smaller, or a flat bar of steel before flattening the metal.—J. J. O'Brien, Buffalo, N. Y.

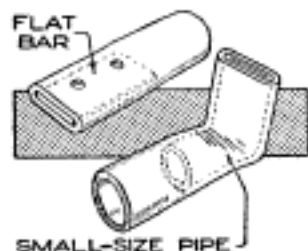

### Nozzle for a Fine Spray

For the purpose of coating a certain hardware specialty it was desired to pass the article before a fine spray, the spray to be forced by a power pump. It was also desired that the spray should come through a row of holes, about .003 in. in diameter, and extend in a straight line 1½ in. long directly across the path of the work. When it came to drilling the holes, it was found that a satisfactory spray could not be secured in this way. In the first place the holes were not close enough together, they would fill up, and some holes would blow more than others. The scheme finally hit upon was to run the pipe into the end of a piece of cold-rolled steel, 1½ in. in diameter, drilled and tapped to receive it. This hole was 2 in. deep, and at that depth four smaller holes were drilled crosswise, making eight outlets. The piece of steel ex-

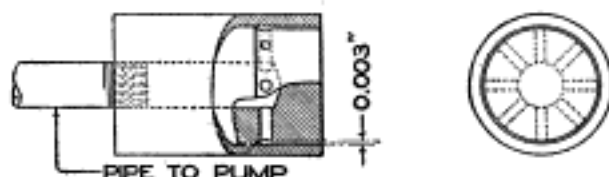

A Fine Spray, That will Not Clog, Obtained from an Annular Opening in the Nozzle

tending from the row of holes to the end was turned down, or reduced, .006 in. in diameter, and over the whole was pressed a piece of steel tubing having an inside diameter of 1½ in. This made an annular space .003 wide and covering the path of the work, 1½ in. wide, which gave a good spray.

### Squaring a Planer Vise

Clamp a long straightedge in the vise, and then it is an easy matter to measure from the straightedge to the edge of the planer table with a 2-ft. rule and get it square quickly. In shops that are kept up, this method is not used much, on account of using the tongue-and-groove in the bottom of the vise to fit in the planer slots, mostly used in small repair shops.—Contributed by W. E. Butler, Wausaukee, Ill.



# BUILDING A HOME

By Geo. M. Petersen

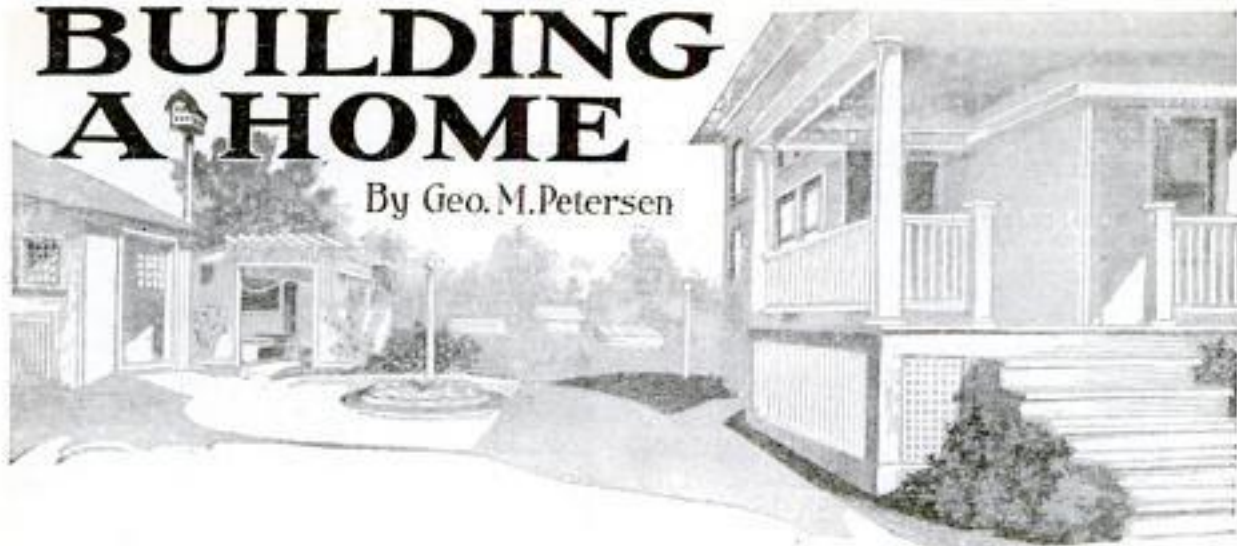

## PART X—Built-In Features

**I**N this day of modern invention it is possible to get built into a home almost anything which may be desired, such as refrigerators, wall safes, wall beds, and so on. While many of these so-called "specialties" are unnecessary, or even useless, there are a large number that are almost invaluable.

Many a housewife has had to lose an hour or two in the morning waiting for the iceman when she could have been doing her marketing and getting the "loose ends" picked up so that she could have the afternoon to herself. Also it is often the case that the iceman comes just after the floor has been

scrubbed and tracks it all up. In modern building practice this ice problem is solved very nicely. The refrigerator is built into the house so that it is not necessary to enter to deposit an ice cake, as this is put in through an icing door from the rear porch, from the sidewalk, or from a small platform built for the purpose. The ice water is conveyed from the refrigerator to the house sewer so that there is really no inconvenience at all.

From an economic standpoint it is doubtful whether the built-in or outdoor-icing refrigerator is of much advantage, but it is sure that the expense

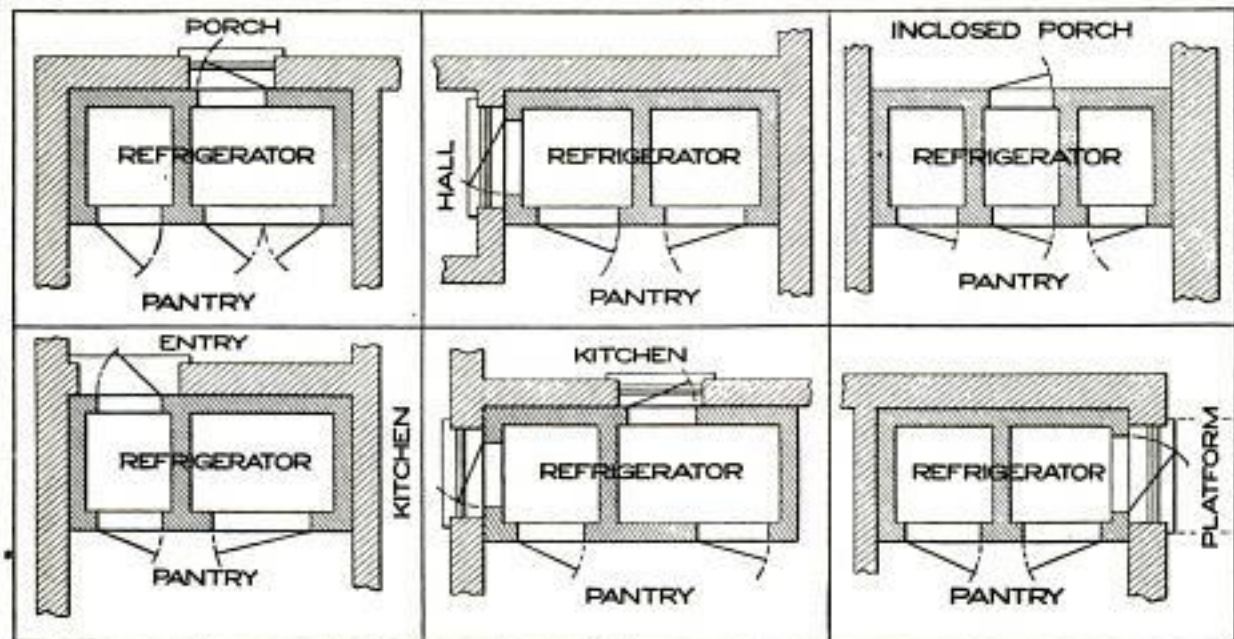

FIG. 1

The One Main Object When Locating the Position for a Refrigerator of Any Kind Is to Keep It near the Kitchen, yet Protected from the Kitchen Heat, Which would Naturally Increase the Consumption of Ice

of operation is not increased, and that the worry and thought necessary with the ordinary refrigerator is reduced greatly.

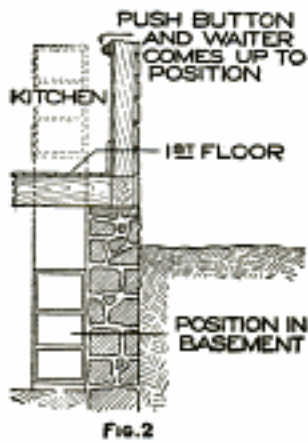

Fig. 2

These built-in refrigerators may be placed in any number of positions, as shown in Fig. 1, or as the owner may desire. The one main object when locating a position for a refrigerator of any kind is to keep it

near the kitchen, yet protect it from the kitchen heat, which would naturally increase the consumption of ice.

Should the owner object to the expense of the built-in refrigerator, he may purchase one with an "outside

icing door" and have a door cut through the outside wall to correspond with the door of the refrigerator.

The average person connects the dumb-waiter with apartment houses, saloons, restaurants, clubs, and the like, but gives it no consideration for his own private use. There are now on the market several dumb-waiters, operating as shown in Fig. 2. Many persons who use this type of dumb-waiter do not use ice, but put the perishable food on the waiter and push it down into the cool cellar, or, if there is no cellar, into a hole made for it. As there is no shaft necessary for the operation of the waiter it is entirely out of sight until wanted. The operation consists of pushing the button to bring the waiter up through the floor. Some of these waiters are equipped with small refrigerators. Either kind is very satisfactory in operation.

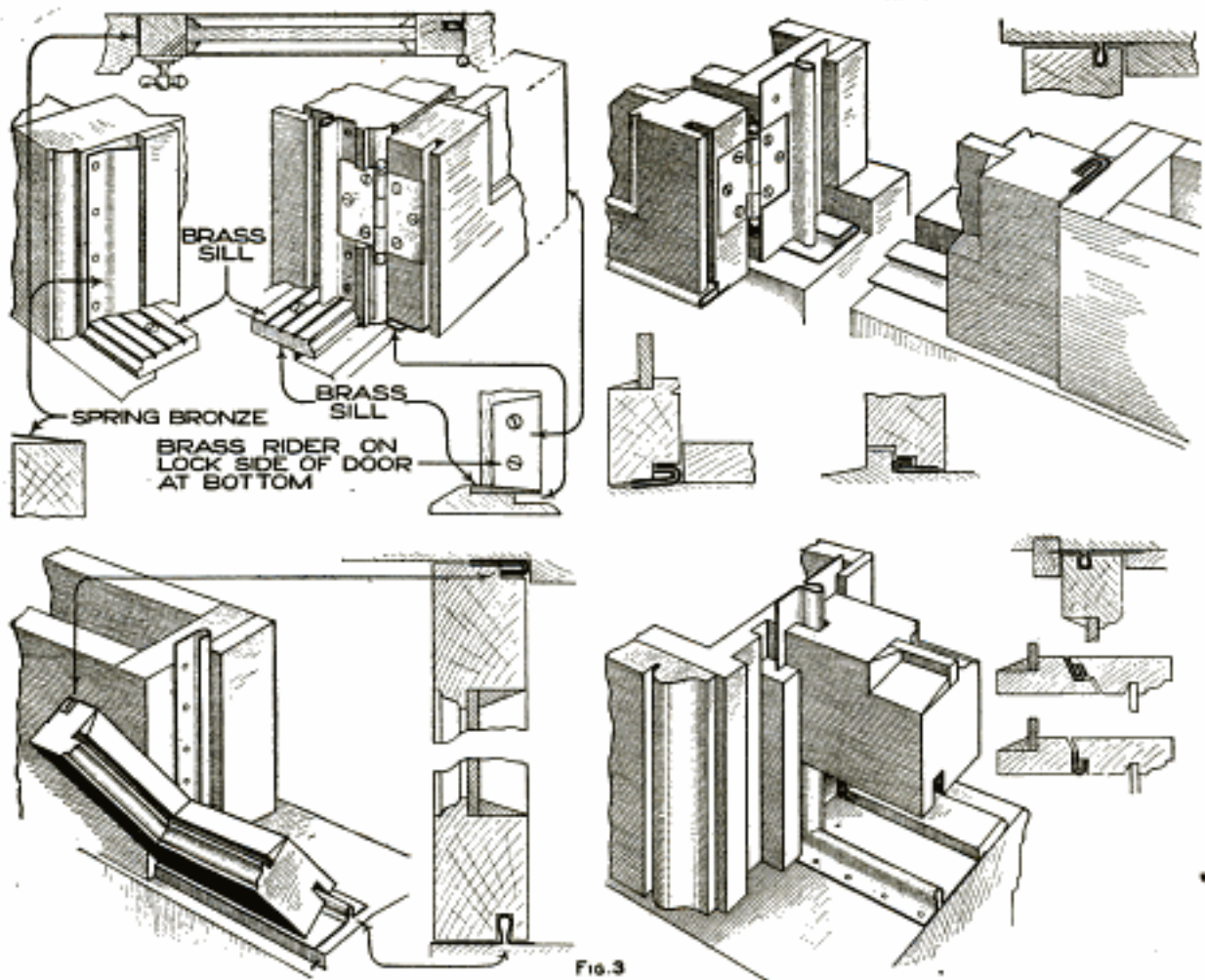

Fig. 3

Metal Weather Strips are Put in Place and Forgotten, Are Practically Invisible, and Need No Painting or Repairing, as They are Made of Bronze, Which Never Corrodes

Pullman Metal Weather Strip Co. York Pa.  
 All Metal Weatherstrips, Co. 226 W. Madison, Chicago

Chamberlain Metal Weather Strip Co.  
 109 - 3rd St.  
 Niagara Metal Weather Strip Co.  
 737 Main St. Buffalo, N. Y.

## Weather Strips

A few years ago metal weather strips were an experiment, but this experiment became so successful that today very few houses are erected in which the owner does not have some kind installed. The old-style storm windows and doors were either sticking or else letting in a draft. Ventilation during the winter was forgotten entirely, as the little hole allowed in most sash for ventilating purposes is of no use except to fool people who think that because air is cold it must be fresh. Exhaustive tests have proven that the average double, hung window leaks as much air as would a hole in the glass the size of a quarter. The worst place for air to pass a double, hung window is at the meeting rail where the sash come together when the window is closed. A good test for this is to hold a lighted match near the rail and see if the incoming air will blow it out. Because of this leakage of air it is almost compulsory to equip the windows with the old-fashioned heavy, leakable, nonventilating, bothersome storm sash, or else with the modern light, indestructible, and perfectly ventilating weather strips.

Storm sash must be put up in the fall and taken down in the spring, and they take up considerable storage space in the attic or basement, and are apt to be broken in making the change. They must be painted occasionally and renewed entirely every few years. Storm sash protect against snow, and to some extent against water and wind. They do not protect against dust, and being improperly ventilated, they are insanitary.

Metal weather strips are put in place and forgotten, are practically invisible and need no painting or repairs, as they are made of zinc and bronze, which never corrode. They protect the house from snow, rain, wind, dust, and everything of a like nature. The window is just as adaptable to ventilation as it is without the strips. In addition to all this, there remains the fact that practically all casement windows need protection throughout the year from

rain and wind, and this protection can be had by weather strips.

The method of applying these strips

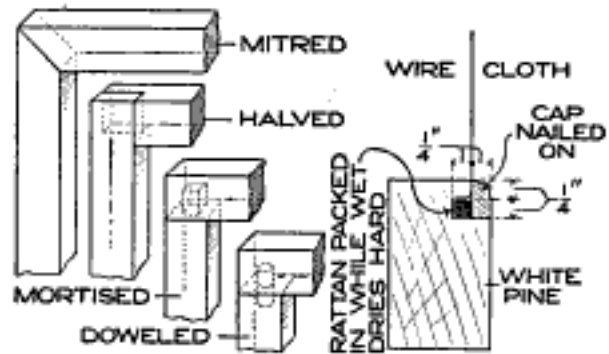

Fig. 4

There Are Two Kinds of Frames for Screens, Wood and Metal, the Wood Preferred

is shown in Fig. 3. Most of the manufacturers will sell to any person and give instructions for applying them, in which case it is cheaper than storm sash. If applied by an experienced worker, the cost will be about the same as for the storm sash, but the first cost of the strips is also the last cost, which is more than can be said of the old-fashioned storm sash.

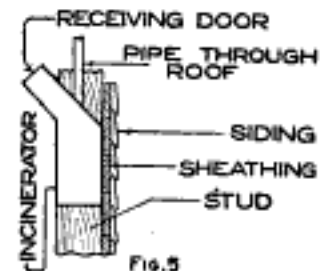

Fig. 5

## Window Screens

There are two kinds of frames for screens, wood and metal, with preference for the wood. Several corners for wood frames are shown in Fig. 4. When a wood frame is put together with dowels it will last for many years, and the screen may be easily rewired if necessary. Metal frames cause the wire

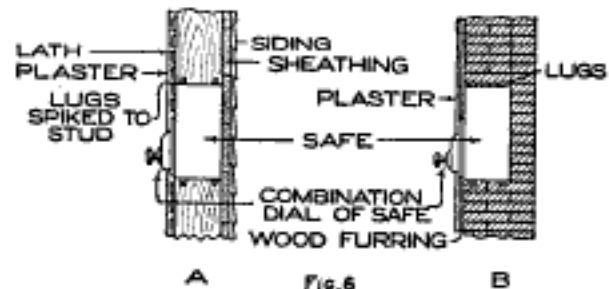

Fig. 6

Safes Are Another Convenience Which can be Had in Small Sizes and Built into a Wall

cloth to rust out sooner, and in most cases the frame must be sent back to

the factory for renewal, which is very expensive.

Next to the frame for the screen comes the wire cloth, or screen covering, which is of three kinds, black, galvanized, and bronze wire. Of course,

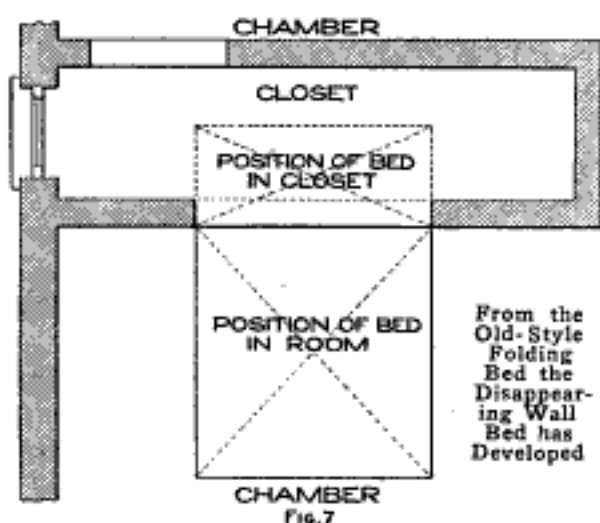

there are many special kinds of galvanized wire which are sold under copyrighted names, but the regular 12 and 14-mesh galvanized-wire cloth is very satisfactory. Black-wire cloth, while cheapest in initial cost, is expensive in the end, because it lasts only a year or two, unless it is painted once or twice a season, in which case it may last a year or two longer. Galvanized screens will last for years without any paint protection, and if the screen is to be submitted to continual use, always select the galvanized or bronze wire. Bronze wire will stand the elements without harm and will never corrode, but it is rather expensive. Very often the galvanized-wire cloth is used and painted black to cover up the silverlike finish of the galvanizing. Real fine-mesh bronze wire is sometimes used on sleeping porches which have no windows to protect the interior from rain. While the rain and snow will not work through this cloth, the closeness of the mesh will prevent a great quantity of air from passing through.

#### Electric-Plug Outlets

If the owner desires, and can afford, to purchase electrical-heating apparatus, he may obtain electric toasters,

chafing dishes, water heaters, bed warmers, curling irons, and, in fact, almost anything in the heat line. All the standard apparatus is satisfactory and reasonable in price. It is necessary for the owner to see that the plug outlets for the various pieces are in the proper locations. For instance, there should be one outlet in the kitchen wall for the electric flat-iron, and one for the electric stove and oven; two outlets, or more, in the dining room for the toaster and chafing dish. One outlet should be provided on each side of a lady's dressing table, one for the curling iron and one for the vibrator. The den, or library, should have an outlet for the cigar lighter; all living rooms should be provided with outlets in the base for table lights, and one should be installed in the bathroom for a water heater. If the owner is of a mechanical turn, he will do well to have two or three placed in that part of the house which he intends to use for his shop, one for an electric soldering copper, one for a small heater for making glue, and one for the vulcanizer, if he has an automobile.

#### Garbage Disposal

There are garbage incinerators, or burners, which are desirable even where the garbage is collected two or three times a week. Refuse breeds flies if it is left for a time, and by burning the garbage after each meal it is destroyed without odor. Most of these burners operate by gas and are designed like a stove with a pipe connection from the top into the chimney from the kitchen, or into a pipe which is run up just inside of the outside wall. Some of the burners are set into the wall with only the receiving door visible. No matter what kind of burner or incinerator is purchased, it will be worth its cost many times over in the feeling of cleanliness and comfort which it affords. The outline of one of these incinerators, set in a wall, is shown in Fig. 5.

#### Wall Safes

Another important addition to any house is a small wall safe that can be

purchased and built into either a frame or brick wall. When built into a frame wall, it is difficult to remove, and when built in a brick wall, the wall must be

The plans in Fig. 8 illustrate several examples of how wall beds could be installed in living rooms in smaller houses to be used in an emergency.

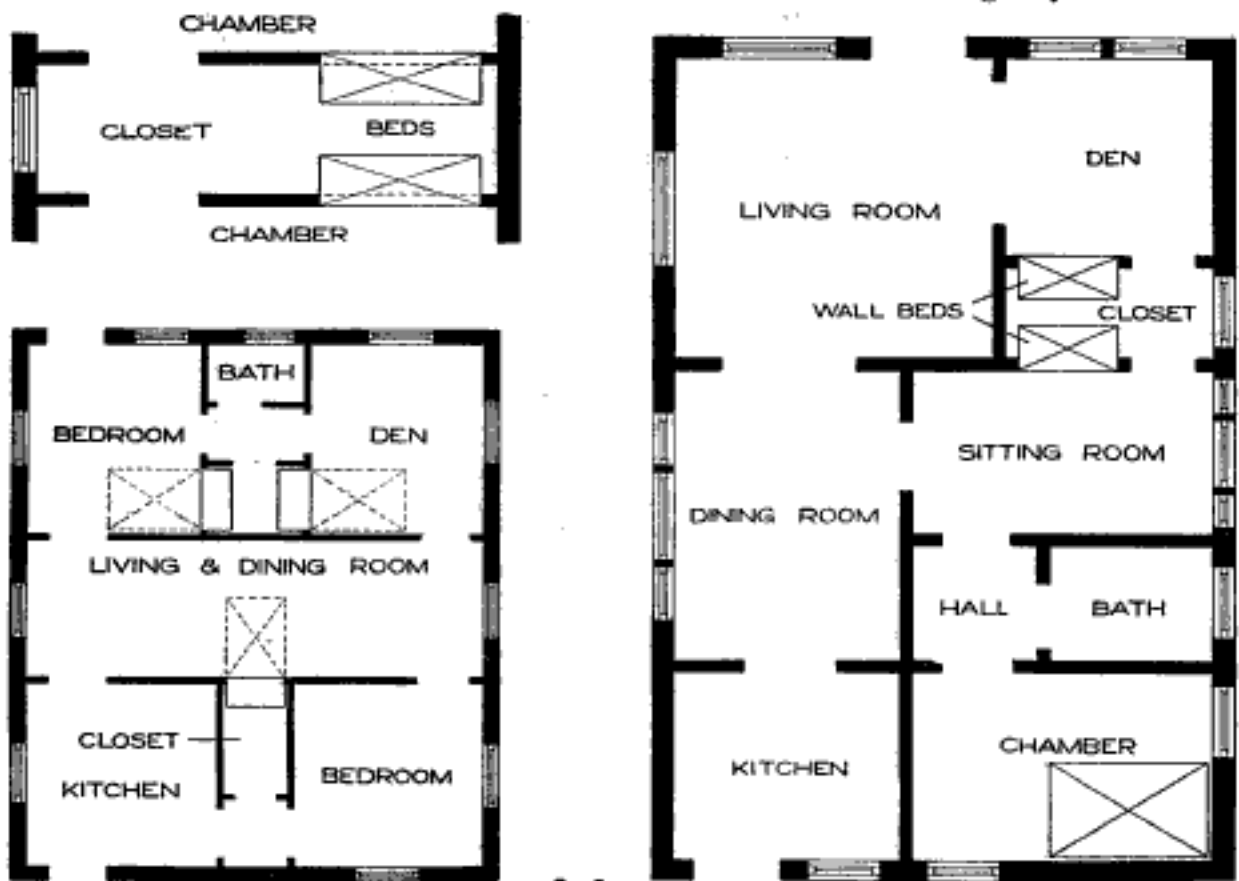

FIG. 8

Instances Where Wall Beds could be Used to Advantage in Smaller Houses by Installing Them in the Living Rooms, to be Used in an Emergency

torn out before the safe can be taken out. While these safes are small, they will hold quite a sum of money, insurance and other valuable papers, and jewelry; they have a regular combination lock and can be easily concealed behind a picture or drapery. A wall safe in frame construction is shown in Fig. 6, at A, and one placed in a brick or stone wall, at B.

**Disappearing Wall Beds**

The old-style wall bed has been condemned as insanitary. The folding bed was a necessary device, and from it has been derived the disappearing wall bed. These beds, as shown in Fig. 7, do not exactly fold up, but fold back or disappear into a space in the wall which is equipped with plenty of light and ventilation so that the bedding is thoroughly aired while out of the room.

Then there is the disappearing stairway, for use in reaching the attic, when there is no room for regular stairs. These stairs are lifted up and pushed upward. The counter weight on the handrail gets into action and closes up the ceiling opening with a solid wood panel after pulling the stairs completely out of sight. When it is to be used, a rope is pulled, out falls the panel, and the stairs slide down, all provided with a handrail. These are real stairways, and not ladders.

**Retaining Surface for Plastic Asbestos**

Covering a boiler, or any other surface, with plastic asbestos is greatly facilitated if a casing of wire screen is placed on the object. The wire acts as a retaining surface and insures a coating of uniform thickness.

*Reveler Marshall Stairway Co.  
Alton, O.*

*Murphy Door Bed Co.  
110 S. Dearborn  
Chgo*

### Catches to Hold Food Deck in a Dinner Pail



Occasionally my dinner pail would upset, and the food in the dinner deck push the cover off so that the contents would be spilled. To prevent this, I fastened two clips to the side of the dinner deck so that their upper ends would pass over the cover when the deck was pushed into the pail part.—Contributed by William H. Jones, Ladysmith, B. C.

### Cutting Lubricant for Unpickled Steel Castings

For finishing green, unpickled steel castings so as to leave the surface as smooth as possible, use a cutting fluid mixed as follows: To three parts of turpentine add one part lard. Apply this mixture with a brush.

### To Set the Jaw of a Monkey Wrench

In using a monkey wrench on nuts or bolts where there are several of one size, it is quite a help to keep the jaw set, since the adjusting sleeve will turn and move the jaw one way or the other. To remedy this, I drilled and tapped a hole for a 1/4-in. thumbscrew, as shown in the sketch. A slight turn, and the screw tightens on the sleeve and will keep it from turning.—Contributed by Chas. G. England, Washington, Pa.



for a 1/4-in. thumbscrew, as shown in the sketch. A slight turn, and the screw tightens on the sleeve and will keep it from turning.—Contributed by Chas. G. England, Washington, Pa.

### Disconnecter for Electric Horns on Automobiles

To prevent the small boy from sounding the electric horn, some owners of automobiles loosen one of the terminals when getting out at a stop. This method has the disadvantage that one may forget to replace the connection on returning, which makes an accident possible next time the horn should be sounded. A simple way out of the difficulty is to fit on a small spring switch, as shown in the illustration, under the cushion on the driver's seat.

Remove the cushion and cut a recess, 1/4 in. deep, in the center of the front edge of the seat frame. Make the spring from a piece of strong spring

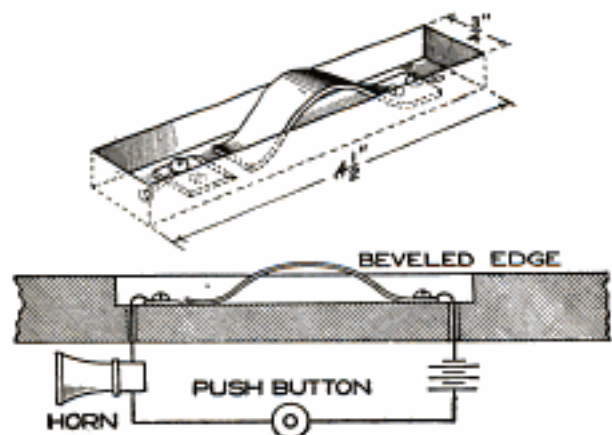

The Concealed Switch in the Circuit is Operated by the Cushion on the Driver's Seat

brass, 5/8 in. wide and curved, so that when it is in place the top of the bend will project 1/4 in. above the surface. Fix a small terminal plate just in front of the free end of the spring so that the pressure on top of it will cause the spring to straighten out and rest on the plate. The edge of the plate should be beveled to permit the end of the spring to slide over it freely. Make the connections as shown, passing the wires through holes in the seat. The spring should be strong enough to support the weight of the cushion easily without bending. As soon as the driver takes his seat, the horn is ready for sounding in the ordinary way.—Contributed by Morris G. Miller, New Rochelle, N. Y.

### Measuring Wire without a Gauge

When a gauge is not at hand to determine the size of a wire, closely wind a sufficient length on a smooth nail to cover exactly  $\frac{1}{2}$  in. and then count the number of turns. Double this number and refer to the following table, which will immediately give the correct gauge.

Gauge	Turns per inch	Gauge	Turns per inch
10	10	24	50
11	11	25	56
12	12	26	63
13	14	27	70
14	16	28	79
15	18	29	89
16	20	30	100
17	22	31	112
18	25	32	126
19	28	33	141
20	31	34	150
21	35	35	178
22	39	36	200
23	44		

With smaller sizes it is only necessary to wrap about  $\frac{1}{4}$  in. on the rod, or nail, to get the number of turns per inch.—Contributed by John D. Adams, Phoenix, Ariz.

### Fire-Hose Attachment to a Switch Engine

An effective pressure, sufficient to throw a stream of water for fighting fires, was obtained by the use of an attachment on the injector of a switch engine used about the yards of a railroad. When used for a fire, the valve A on the boiler line is closed, and the valve B to the fire hose, which is normally kept closed, is opened. The hose is kept attached and the end

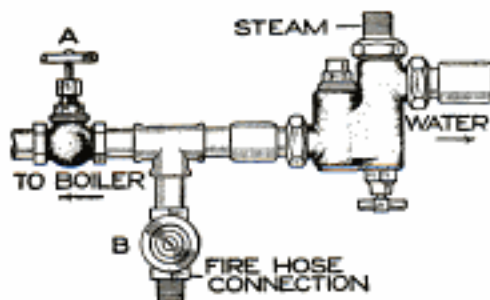

The Injector on the Engine Produces the Pressure for the Fire Hose

coiled on a reel at the side of the engine. As the tender carries 7,000 gal. of water, quite a supply is available for fire purposes before it runs too low for steaming.

### A Lock for a Ladder

Being desirous of leaving a ladder standing against my barn for observation purposes and not wanting the boys

A Door Covering the Rungs of a Ladder is Locked in Place to Prevent Boys from Climbing

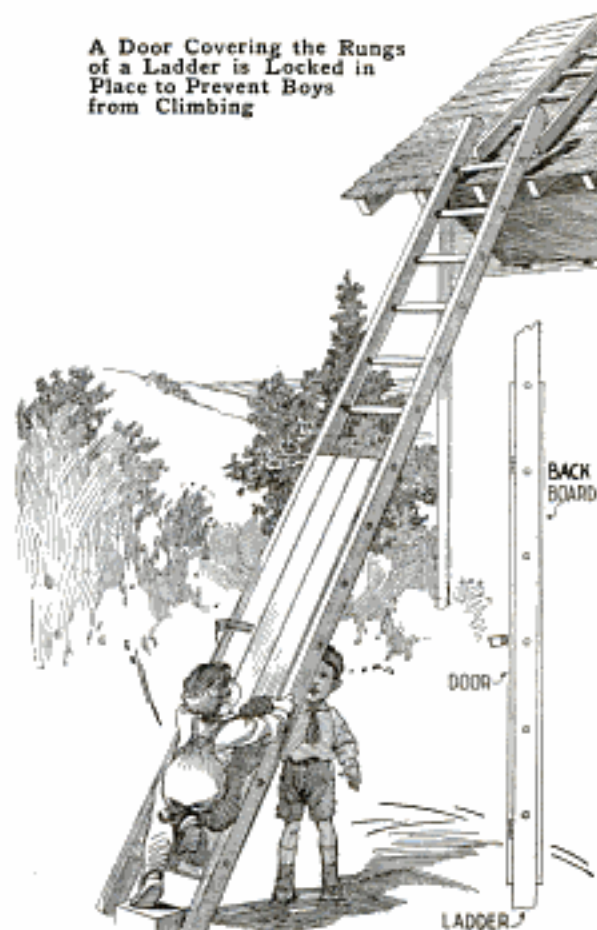

to be climbing it, I rigged up the ladder with a door which may be locked, as shown. The back of the ladder is also solidly boarded in.—Contributed by R. F. Pohle, Lynn, Mass.

### An Extension for a Tire Pump

On automobiles having the valve-in-the-head motors, many owners find it next to impossible to use a spark-plug impulse tire pump, a type that has done much to relieve the work of inflating the tires. On these motors the valve rods interfere with the application of the pump when a spark plug is removed.

To overcome this difficulty a special connection may be made. It will not cost much and will be well worth the making. One end is threaded to fit

the spark-plug threads in the cylinder, and the other to turn into the pump. Two plates should be put on the sides

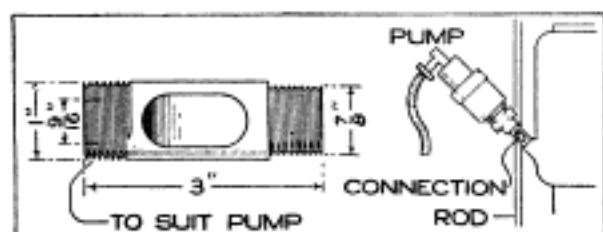

Connection to Attach a Tire Pump in a Spark-Plug Hole Where Valve Rods Interfere

so that a wrench can be used to tighten it. The illustration shows such a connection and how it is used.

### Guard for a Punch Press

Where it is necessary to feed pieces by hand into a punch press for forming them, the possibility of injuring the operator's hands is very great, and to eliminate this danger there must be some kind of movable guard that will not be in the way of the feeding of the press, yet obstruct the way just before, and at the time of, making the stroke. The illustration shows a form of guard I have employed with success.

The lever A should be about 12 to 1, which will move the wood pieces about 5 in. across the die, this being sufficient for small dies. The vertical length of the pieces is limited to the height of the ram when it is down. The space

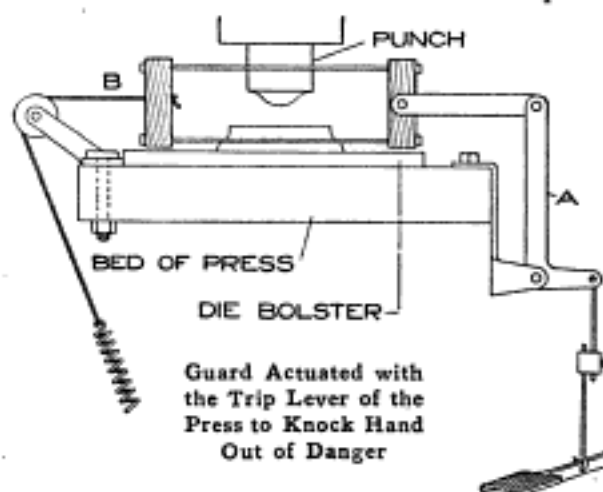

will be from  $4\frac{1}{2}$  to 5 in. The pieces are held together with  $\frac{1}{8}$ -in. wires. The guard is returned to its normal position with a small, round belt, or strong cord, attached and run over a

pulley to a long weak spring. The adjusting rod is hooked to the pedal near the footplate so that it will move farther than the part where the clutch rod is connected. In action, the wood piece B will be entirely across the die before the clutch is released, and will knock the hand away as it passes.—Contributed by S. C. Bunker, Brooklyn, N. Y.

### Coverings for Marine-Motor Spark Plugs

Having no way to cover my boat engine I devised a way to protect the spark plugs in the following manner:

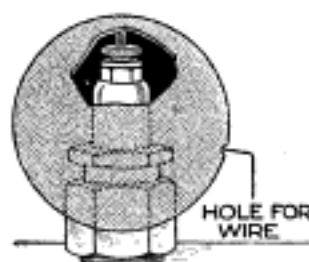

I purchased several hollow rubber balls, about 2 in. in diameter, and in each ball I cut a hole slightly larger than the base of the spark plug. About  $1\frac{1}{2}$  in. above this hole a smaller hole was cut for the wire connection to the plug. A slot was cut between the holes, and the ball slipped over the spark plug. The slit remains tightly closed when the ball is on the plug, thus forming a serviceable covering.—Contributed by L. H. Ritchie, Georgeville, Can.

### The Use of Skid Chains

Never drive an automobile with a skid chain on one of the rear wheels only. When skid chains are necessary, it is far better to use two chains—one on each rear tire. When but one chain is used and the brake is applied, the wheel to which the chain is attached will stop readily, but the wheel without a chain will spin around many times, which tends to grind off the tread and causes it to wear much faster than if two chains were used. On an actual try-out it was found, at the end of a 1,500-mile run, that the tire having the chain was not at all damaged and the tire without a chain had the tread almost worn off.



### To Fasten Runners in White-Metal Patterns

In making white-metal patterns, I have always found it difficult to fasten the runners securely to the pattern where they are to be used in bench molding. They can be firmly fastened, however, by casting them in the pattern when poured. The brass runners are first tinned, then a mold is made from the master pattern, and the brass runners are laid in their proper places. Then the runners are cut to cast the pattern so that the hot metal will flow around the brass pieces until the mold is full, which fastens them to the pattern. Two or more patterns are attached to the gate in the usual way.

I have two white-metal patterns that have been in use for some time, and they are still firmly attached to the gate, and are as satisfactory as brass patterns, while the cost is very much less. The patterns weigh  $3\frac{1}{2}$  lb.

Fastening Runners to White-Metal Patterns by Casting Them in the Piece When Poured

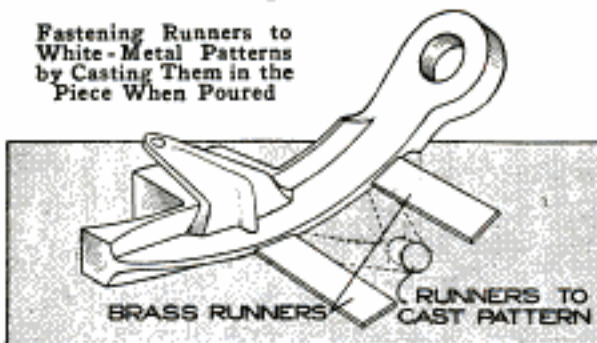

each, and where the runners are attached the metal is only  $\frac{3}{16}$  in. thick, which would make it very difficult to fasten them in the ordinary way.—Contributed by W. E. Smisor, Waterloo, Iowa.

### To Stop Planer Bed at Same Point Each Time

In planing out a keyway in a shaft, or up against a shoulder of any kind, it often happens that the planer will not stop at the same place every time, but goes farther, usually breaking the tool. Tighten up the reverse belt, and it will stop at the same place every stroke.—Contributed by W. E. Butler, Wausaukee, Wis.

### To Stop the Chattering of a Large Lathe

A large lathe in one of our shops always gave trouble when it was used for finishing large shafts and bushings. No matter how tightly the head bearings and the tailstock might be,

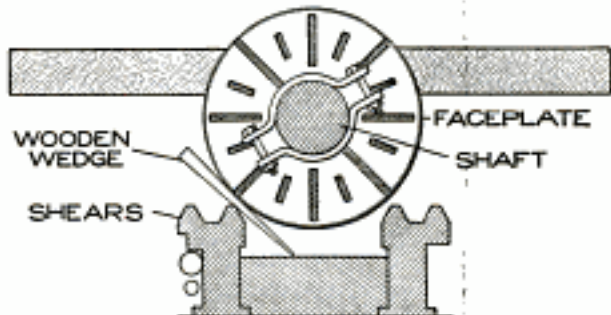

The Wedge, Driven in Snugly between the Shears and Faceplate Edge, Stops the Chatter

it would chatter. One day a new man was set to work on the lathe to turn up several large shafts. When he came to the finishing part, he stopped the chatter by inserting a long, thin taper wedge between the shears and the faceplate edge. The wedge was set snugly with a hammer.—Contributed by Joe V. Romig, Allentown, Pennsylvania.

### To Prevent Bookkeeper's Hand Rest from Slipping

The ordinary hand rest used by bookkeepers to slip in between the leaves of a large ledger gives considerable trouble by slipping out of place, if the book leaves are the least bit smooth. This can be easily remedied if two wide and thin rubber bands are

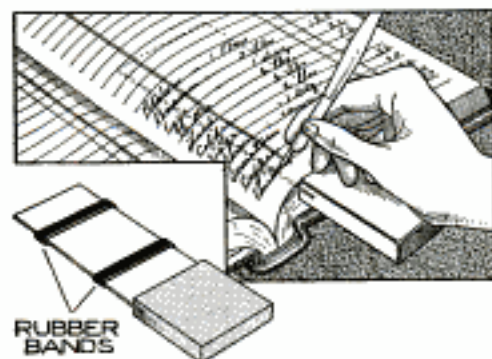

Rubber Bands on the Thin Portion of a Bookkeeper's Hand Rest to Prevent Its Slipping

placed over the thin portion that is inserted between the pages.

### An Efficient Automobile Top

The style of automobile top illustrated is specially adapted for tank trucks where its rear projection causes

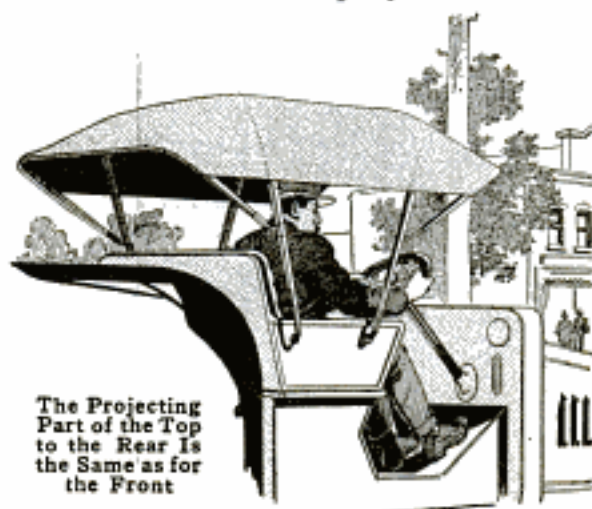

no interference with the load. It will be noticed that the top differs from the ordinary single-seat top in that it projects to the rear as well as to the front, keeping the driver's back shaded without the use of a curtain, which hinders the view when glancing backward.

### Doubling Capacity of Spring Scales

The ordinary variety of spring scales can be made to weigh double the amount given on the dial by the simple beam arrangement shown in the illustration. Suitable dimensions are given, although these may be varied to suit

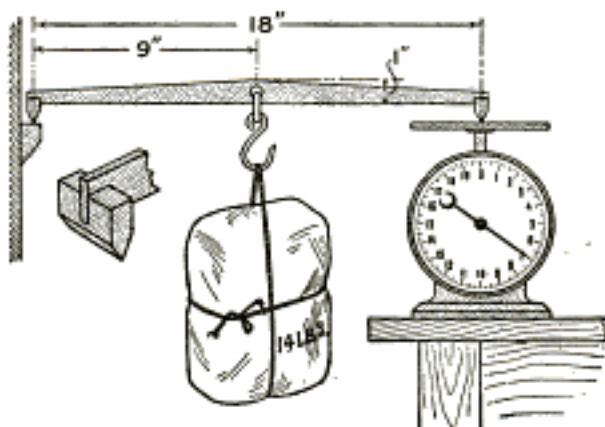

The Beam Provides a Means of Weighing Large Objects on a Small Spring Scale

the requirements. The only thing to remember is that the hook must be located exactly halfway along the beam

measuring between the two knife-edged pieces of wood fixed at the ends. The beam should be made of light but strong wood,  $\frac{1}{4}$  in. thick, and the end pieces 1 in. long. In use, the beam should be approximately level, with one end placed on the center of the scale platform and the other end set on a support, which could be a piece of wood nailed to the wall, or any other support. The object hung on the hook will show only half its weight on the dial. Thus if the pointer indicates 15 lb. the object weighs 30 pounds.

### A Convenient Test Gauge

A very convenient and easily made reference gauge for toolmakers and machinists is in the form of a finger ring. It is made of steel with three flat surfaces ground as shown in the illustration. The smaller dimension, A, should be about  $\frac{1}{32}$  in., and the larger one, B, in some common fraction. The ring may be made very artistic. It provides an accurate and always convenient reference gauge. A micrometer that is accurate at these two dimensions, that is one small and one large dimension, is usually safe for general work.

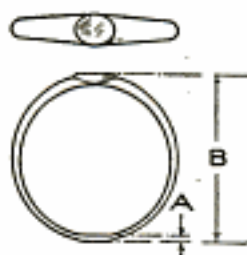

### A Double-Capacity Clothesline

A clothesline of double capacity can be made of any-width net, or mesh wire, stretched between two supports to keep the wire taut. Clothes may be hung on both sides of the wire. Sheets can be thrown over the whole wire and easily kept off the ground.—Contributed by Autrey Monsey, Trickham, Texas.

⚠ Do not use a reamer in a pipe, as the flux, used in welding or brazing, is as hard as glass and will ruin the reamer.



## A Parlor Cue Alley

By C. QUINCY IVES

**P**ARLOR cue alley is really a game of bowling except that it is played on a small raised board, and, instead of throwing the balls by hand, an ordinary billiard cue is used, the balls being about  $1\frac{1}{4}$  in. in diameter. The automatic

feature of this new game saves the time usually required to set up the pins, and assures that they will be set absolutely true each time.

To build this alley, first procure three planed boards, hard wood preferred, though they are more difficult to work; two, 10 ft. long, 9 in. wide, and  $\frac{1}{2}$  in. thick, and the

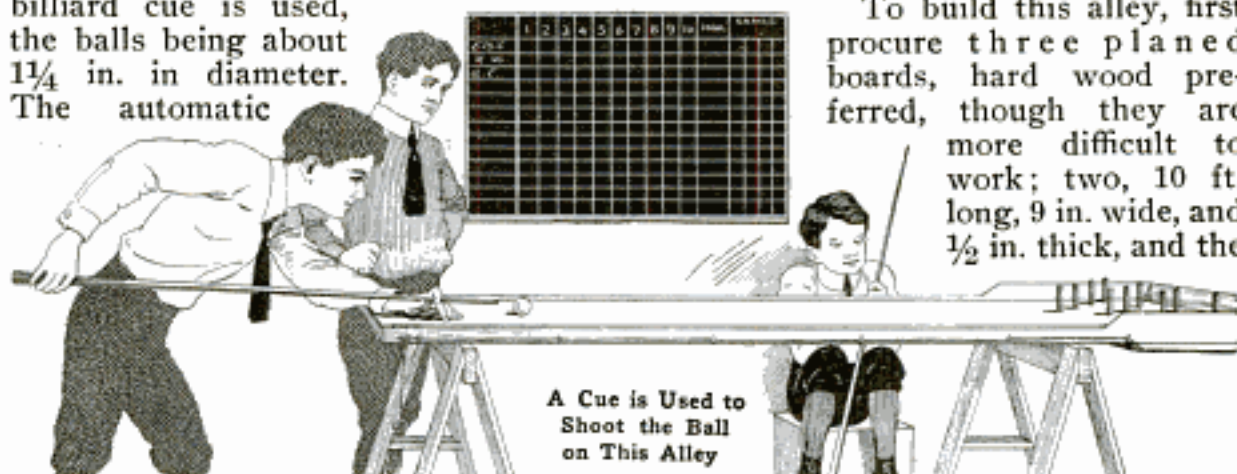

A Cue is Used to Shoot the Ball on This Alley

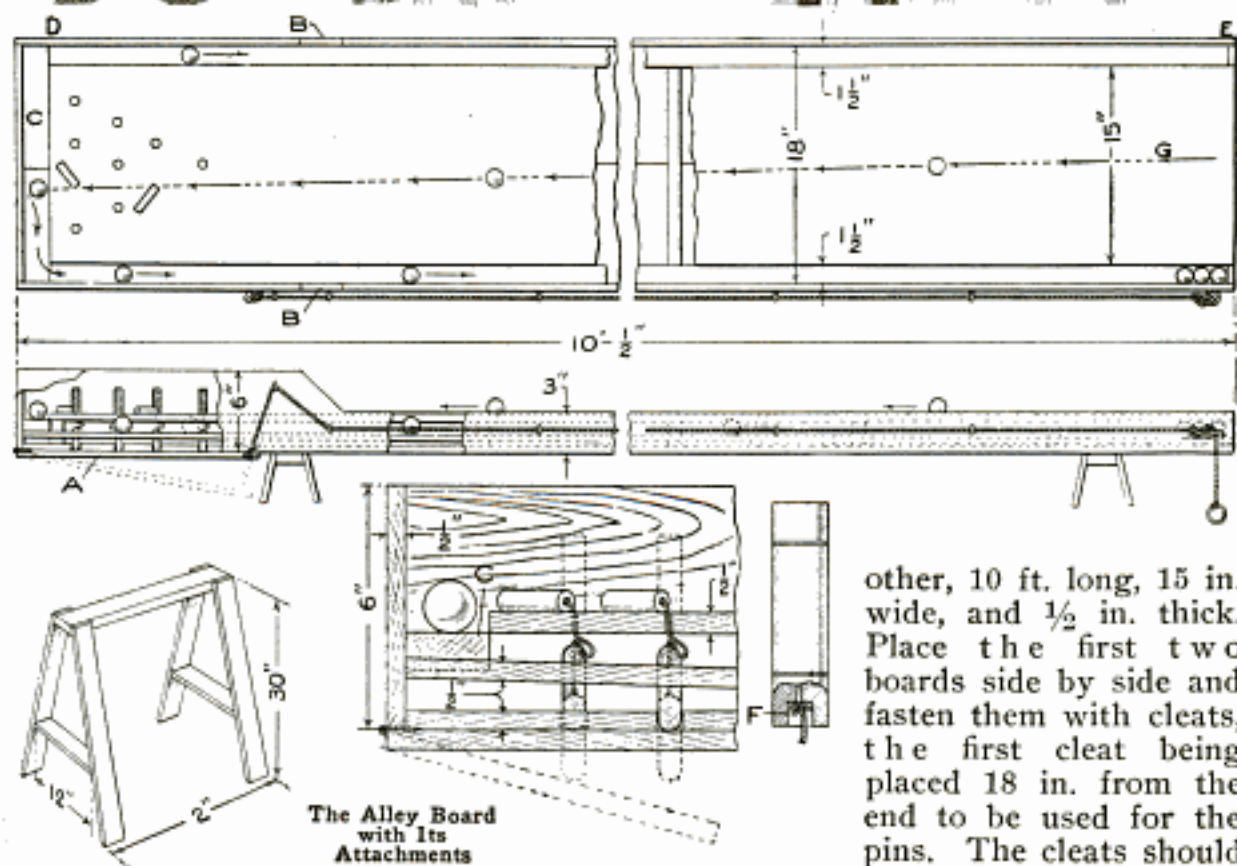

The Alley Board with Its Attachments

other, 10 ft. long, 15 in. wide, and  $\frac{1}{2}$  in. thick. Place the first two boards side by side and fasten them with cleats, the first cleat being placed 18 in. from the end to be used for the pins. The cleats should

be of  $\frac{3}{4}$  or  $\frac{7}{8}$ -in. material and cut as long as the upper board is wide, or 15 in. These are placed on top of the lower boards, or between the two. By placing the first one 18 in. from the end, clearance is obtained for the trap A. The other board is placed on the cleats and fastened, after it has been centrally located, with screws from the under side. The screws must not come through or the surface of the upper board be marred in any way so that the balls cannot roll freely. The difference in width of the lower board and the upper one provides  $1\frac{1}{2}$ -in. clearance on each side as grooves for the return of the balls.

Inclose the alley with boards, 3 in. wide and  $\frac{1}{2}$  in. thick, to the point B, and from there around the pin end with boards, 6 in. wide. The upper board should be cut to such a length that a space of 2 in. at the end C will be provided. Into this space is fitted a block of wood, about  $\frac{7}{8}$  in. thick, having its upper surface slightly pitched toward the sides of the alley to start the balls back to the front of the board. From the ends of this block two strips,  $1\frac{1}{2}$  in. wide, are fitted into the side grooves, from D to E, on an incline, to return the ball after each shot.

The location of each pin is marked on the end of the upper board, and small holes are drilled just large enough to admit pieces of stout cord, like a fishline, to pass through freely. The pins are made of hard wood, carefully balanced, so that one end will not

be heavier than the other. The lower end of each pin is drilled to make a recess, F, in which the cord is fastened with a screw or nail. Holes are bored through the bottom board,  $\frac{3}{8}$  in. in diameter, to correspond to the 10 small holes made through the upper one. Lead weights of about 2 oz. are fitted in the holes and attached to the strings from the pins. The ends of the weights should extend about  $\frac{1}{2}$  in. from the under side of the alley.

Attach a board, 18 in. square, with hinges to the end of the alley so that it will hang under the weights. A stout cord is run along the under side of the alley to the front end through screw eyes, and attached to the swinging board. By letting the board swing down the weights are released and they draw the pins into a standing position, accurately set for the next break. When set, the line is drawn, and the swinging board pushes the weights up and releases the pins.

The balls used are made of hard wood, and, if it is not desirable to make them, they can be purchased from a toy store. They are  $1\frac{1}{4}$  in. in diameter. Each player has three shots. The ball is placed on the spot G and shot with a billiard cue, the object being to knock down as many pins as possible; the score is kept as in bowling.

Horses can be made of metal and wood, as shown, for holding the alley at the proper height. The alley can be used on a large table, but horses are more convenient.

### The Glass-and-Hat Trick

The effect of this trick is as follows: The performer first exhibits a small table, about 2 ft. square, the top of which is covered with black velvet. He requests the loan of a Derby hat and a handkerchief, then takes an ordinary glass, filled with water, and places it on the table top, covers it with the handkerchief, and sets the hat on top of the glass. He then withdraws a short distance, and at a command, the glass appears to pass slowly through both hand-

kerchief and hat until the hat rests on the table top. The hat is then taken up and is handed to the owner, who finds the glass of water in the hat.

While this is seemingly impossible, the effect can be easily accomplished and the necessary apparatus can be made up cheaply if a table of suitable size can be had, although a kitchen table may be used if so desired, but a table about 2 ft. square is preferred, because it can be easily carried. The table is prepared as follows: Procure a block of wood, about 2 in. square and  $1\frac{1}{2}$  in.

thick, and glue it to the under side of the table in the center. Bore a  $\frac{1}{4}$ -in. hole through both the table top and the

glass. As the handkerchief is held in front of the glass the assistant pulls the disk up; thus the handkerchief is placed



block of wood. The top of the table must be covered with some black cloth, such as velvet. Using the hole bored as a center, cut out a piece of the table top to correspond with the diameter of the glass to be used, and about  $\frac{1}{8}$  in. deep. Fit into this depression a piece of round sheet brass. Procure a  $\frac{1}{4}$ -in. rod, about 6 in. long, and fasten the brass disk to one end of it so that the disk will fit into the round depression when the rod is run through the hole in the table top and block. The other, or lower, end of the rod is filed flat, and a small hole is drilled through it, the edges being smoothed to receive a thread. The top of the brass disk is covered with the same material as is used for covering the table top. This will make it appear to be one piece covering the table top. Fasten a strong black thread to one corner of the table top on the under side, and run it through the hole drilled through the end of the rod, then over a small window-curtain roller fastened into the opposite corner of the table top, where the thread is run down a table leg and through another pulley out under a rug or the floor to an assistant where the thread will not be seen. The metal disk can then be controlled without any apparent power. If the rod extends under the table too far, drape some velvet or fancy cloth around the table edge to cover it.

To begin the trick, the performer exhibits the glass of water, then sets it on the table just back of the disk, and in placing the borrowed handkerchief it is put on the disk rather than the

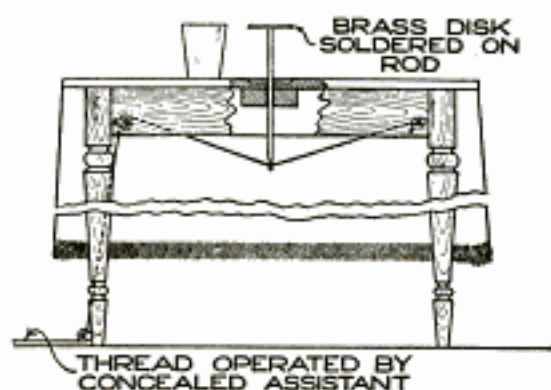

Apparently the Glass Filled with Water Passes Up through the Crown of the Hat and is Taken from It When the Trick is Completed

on the disk and the glass of water is left uncovered just behind it. The performer then starts to put the borrowed hat on the glass, crown up, and when, seeing his mistake, he apologizes, turns the hat over, and in doing so picks up the glass of water and places it in the hat. The hat is then set on the disk with the crown down. In turning the hat the glass is taken up with the first two fingers of the right hand. When the hat is raised, the glass is also raised with it, and while doing this the hat is slanted so as to hide the glass. In turning the hat over, the glass is brought into it. This is quite hard to explain, but a little practice will enable the performer to make no mistake. When the hat is placed on the disk the assistant slowly lets the disk down. It is very necessary to let the hat down slowly, as a sudden jerk is apt to tumble the hat over and spoil it as well as the trick. When the hat comes to rest on the table top, it is removed and handed to the owner with the glass of water in it.

### Hall Seat with Storage Compartment

The illustration represents a simple design for an easily made and substantial hall seat, provided with a compart-

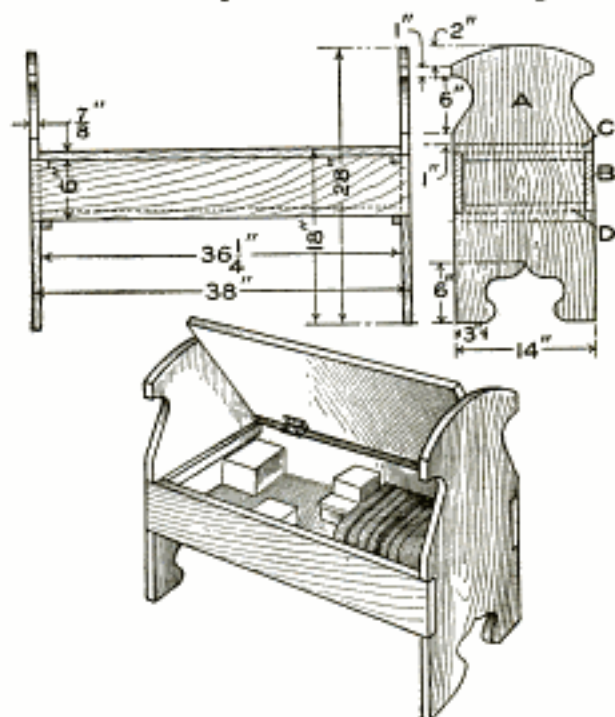

Details Showing the Construction of a Hall Seat to be Made in Mission Style

ment for odds and ends. It is advisable to make it of wood to match its surroundings. The following material is necessary:

- 2 ends,  $\frac{3}{8}$  by 14 by 28 in.
- 2 rails,  $\frac{3}{8}$  by 6 by 38 in.
- 1 seat board,  $\frac{3}{8}$  by 14 by 36  $\frac{1}{4}$  in.
- 1 bottom board,  $\frac{3}{8}$  by 12  $\frac{1}{4}$  by 36  $\frac{1}{4}$  in.
- 2 seat cleats,  $\frac{3}{8}$  by  $\frac{3}{8}$  by 12  $\frac{1}{4}$  in.
- 2 bottom cleats,  $\frac{3}{8}$  by  $\frac{3}{8}$  by 11  $\frac{1}{2}$  in.

The two ends, A, are marked to the same outline and cut with a coping or scroll saw. If a fine-toothed saw is used, the edges of the boards can be easily smoothed with sandpaper, otherwise a file is necessary to remove the coarse saw traces. The rails B are cut to size and squared up at the ends, after which they can be placed at the proper places on the ends A, which may then be marked for the notches to receive the rails. In fastening the rails to the end pieces, 2-in. round-head screws can be used. The seat C is attached to the back rail by 2-in. butt hinges. To prevent the seat from sagging in the middle, it is supported on each side by cleats screwed to the end pieces A. If

the seat is liable to warp it can be held straight by two cleats screwed underneath. The bottom board D may be held in place by means of screws through the rails, or by resting on cleats screwed to the end pieces. The seat, when assembled and thoroughly sandpapered, can be finished to suit.

### Putting In Screw Hooks Neatly

To prevent a wire hook, when the last few turns are given, from marring or scratching the surface, special care must be taken. A splendid way to do the work neatly is to first lay a piece of stiff paper on the surface where the hook is to be attached and hold it in place while starting the screw hook. Turn the hook in the usual way through the paper. When the hook is in place the paper can be removed by tearing it off.—Contributed by Emile Parent.

### A Window Ventilator

The illustration shows a ventilator I constructed to allow air to pass through between the upper and lower window sash. It consists of a board 8 or 10 in. wide, and as long as the window sash is wide. A short distance from one end it is marked and cut on a slant. The small piece removed is hinged to the main part so that it can be raised in taking the board

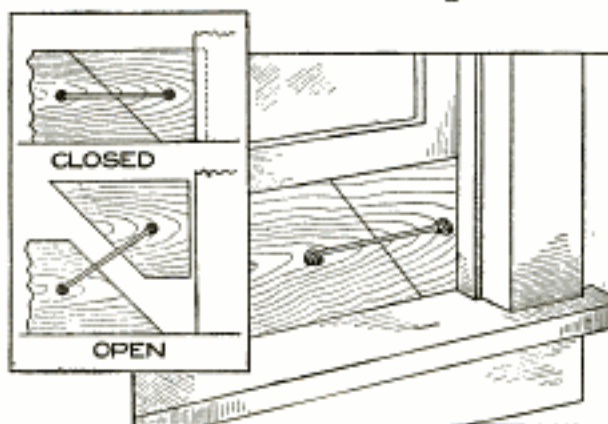

A Removable Window Board to Raise Lower Sash for Ventilation between the Sashes

from the window. When the sash rests on the board it cannot be removed from the window. — Contributed by David Hannigan, Orange, Connecticut.



## PART I—Prominent Types of Modern Skis

THE requirements of the modern ski call for a hard, flexible, and tough material, and while hickory, white ash, white maple, birch, yellow pine, white pine, and spruce are all used, the experienced ski runner considers hickory and ash to combine in the fullest measure the qualities most desired. Of course, every wood has its limitations as well as merits. Hickory is elastic and fairly tough, but heavy. Ash resembles hickory so far as elasticity is concerned, and its weight is about the same, but the wood contains soft layers. Birch possesses the requisite lightness, but is far too brittle to prove serviceable, and pine is open to the same objection. Maple makes an excellent ski, which can be finished very smooth so as to slide more easily than the other woods, but it is much less flexible than either hickory or ash.

### The Telemark-Model Ski

This form of ski, so called from the Telemarken province of Norway, where the art of ski running has reached a high order of skill, is probably the choice of the sportsmen wherever the exhilarating sport of ski running is practiced, and the larger portion of the members of the numerous skiing clubs use the Telemark-model ski. This type is practically identical with the most

popular model so long used in Telemarken, and the rule for its selection is to choose a pair whose length reaches the middle joint of the fingers when the arm is stretched above the head. There are various makers of this type of ski, and while the modeling will be found to differ but little, there are numerous brands sold which are fashioned of cheap and flimsy material, and consequently unsatisfactory in every respect.

The Telemark model is shown in Fig. 1, and from this sketch it will be seen that the wood has two curves or bends, one running its entire length to form a graceful arch, and the second, at the toe. The first one is technically known as the "arch," and the other curve the "bend," while the front or toe end of the ski is called the "point," and the rear end the "heel." In almost all skis the under, or running, surface is provided with a hollow, known as the "groove," which runs from the heel to the bend. It will be noticed in the drawing that the sides also are gently curved, thus making the ski a trifle broader at the ends than in the center. This curve affords a somewhat greater bend at the heel, and while some experts approve, others disapprove of it, but most ski runners agree that the curve should not be pronounced, or it will prove a handicap and make it difficult for the runner to secure a firm grip at the edge when ascending steep slopes covered with hard snow.

The "arch" of the ski is necessary to avoid bending when the weight of the body is on the runner, and the total height of this important curve should not exceed  $\frac{3}{4}$  in., for a too exaggerated arch will practically form a concave running surface and retard the speed,

since it will run on two edges, or points, instead of on the entire running surface. A slight arch may be reckoned necessary to offset the weight of the body, but the utility of the ski, in nearly every instance, will be less affected by too little arch than by too great a curve at this point.

A good ski is told at a glance by its bend, which must never be abruptly formed, nor carried too high. A maximum curve of 6 in. is all that is ever required, and to prevent breaking at this, the weakest, part of the ski, the bend must be gradual like the curve of a good bow, thus making it more flexible and elastic at this point. As a rule, the ski should be fashioned a trifle broader at the bend than at any other point, and the wood should be pared moderately thin, which will make it strong and resilient with plenty of spring, or "backbone."

The groove in the running surface is so formed as to make the ski steady and prevent "side slip" when running straightaway. In fact this groove may be compared to the keel of a boat, and as the latter may be made too deep, making it difficult to steer the craft and interfering with the turning, so will the badly formed groove interfere with the control of the ski. The Telemark round-faced groove is by far the best form, and for all-around use is commonly made  $\frac{1}{12}$  or  $\frac{1}{8}$  in. deep. Not all Telemark skis are thus fashioned, however, some being made without the groove, while others are provided with two, and I have seen one marked with three parallel hollows. The shallow groove is the most satisfactory for general use, and while a groove,  $\frac{3}{8}$  or  $\frac{1}{2}$  in. deep, is good enough for straightaway running, it makes turning more difficult.

To attach the ski binding, which secures the shoe to the runner, a hole in the form of a narrow slit is made just back of the center. This is the usual manner of attaching the foot binding, and while it cannot but weaken the ski to a certain extent, it is the best method for making a secure foot fastening, and weakens the wood to a much less ex-

tent than the use of bolts, or other metal fastening.

So far as finish is concerned, most Norwegian makers finish their skis with a coat of black paint, while other makers stain the wood, and some finish the wood in the natural color by varnishing. This applies to the upper surface only, the running surface being rubbed down with linseed oil and made smooth with wax.

#### The Swedish Ski

This type of ski is made quite long and comparatively narrow, with a deep groove, and is well adapted for running on the level or for gliding down slight slopes. This type of ski is commonly used in Lapland and to a less extent in the northern parts of Norway, but the great length and quick, short bend make this model less adapted for ordinary use, since the deep, rectangular groove slows down the speed, and the great length makes turning doubly difficult. For special conditions this type is probably useful, but it can scarcely be considered suited to the average use.

#### Lilienfeld Ski

This type of ski is favored by but comparatively few ski runners, and the modeling is inferior to the Telemark ski. The arch is excessive in height, the bend is abrupt and stiff, while the round point, fashioned to prevent sticking in loose brush, has apparently little value in actual use. The Lilienfeld ski is made without a groove, and since the whole model is shorter and broader than the usual type of ski, turning is more easily accomplished, but side slipping is, of course, considerably increased. Ease in turning is a desirable quality, to be sure, but steadiness and immunity from side slipping are far more valuable qualities in a ski designed for all-around use. In short, the Lilienfeld model possesses no decided advantages over the Telemark type, but has many points of inferiority. To one who has used both models there can be no question but that the Telemark model is preferable.

When purchasing skis the sportsman



will make no mistake in selecting the Telemark model, and for an active person the skis should be long enough to reach to the middle joint of the fingers, when the arms are stretched above the

straight running, uphill skiing, and for jumping.

The best materials are hickory, or white ash, with a straight, even grain running from end to end. Ash is well

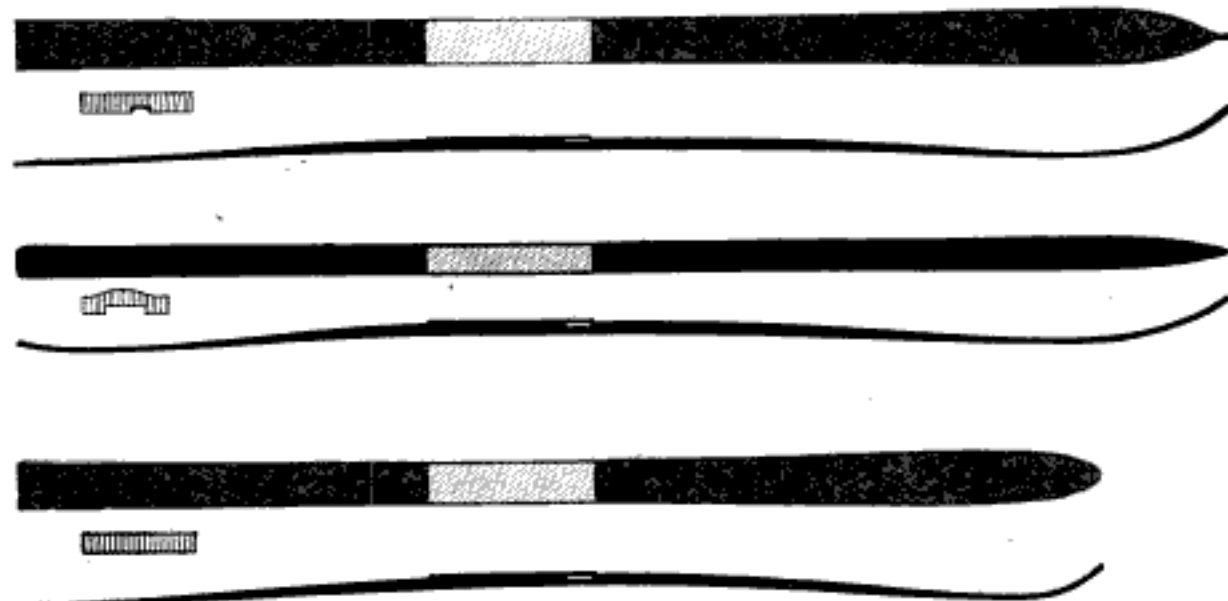

FIG. 1

The Telemark, Swedish, and Lilienfeld Models with Grooves and Grooveless Bottoms, the Telemark Being the Standard and Best All-Around Ski; the Swedish Is Long and Narrow with Upturned Heel, and the Lilienfeld Is Short with a Round Point, More Abrupt Bend, and without a Groove

head, and the ski is stood upright on its heel. The length of a pair so selected will be from  $7\frac{1}{2}$  to 8 ft. For elderly and less active persons, for individuals of short stature, and for ladies, skis reaching to the wrist joint will be about right; the length ranging from  $6\frac{1}{2}$  to 7 ft. For youths and children shorter skis, from 5 to 6 ft. in length, according to the size and strength of the person, are of course required.

For all-around use where a large amount of straight running is done, the running surface should be provided with a groove, but if there is not much straight work to be done, and ease in turning is regarded as an important factor, the running surface should be made smooth. This necessitates making the skis to order, for practically all ready-made skis of the Telemark model are fashioned with a shallow groove. However, a groove may be easily cut in at any time if wanted later on. While other types are at times preferred for special use in certain localities, the Telemark-model ski is the standard, being equally good for all kinds of work,

liked by many experts, but it would indeed be difficult to find a more satisfactory wood than our American hickory. In fact, many of the most prominent makers in Europe are now fashioning their skis from American timber. As a rule, the best well-seasoned ash, or hickory, is heavier in weight than an inferior grade, and this is why the expert skier considers weight as one of the reliable "earmarks" of first-class material. A good hickory, or ash, ski made by any reputable maker will give the fullest measure of satisfaction.

The finish of skis is purely a matter of personal taste, but practically all Norwegian skis are painted black on the upper side, while a few of the cheaper maple and pine implements are stained. The plain varnished finish protects the wood as well as paint, but allows the grain to show through, and is generally preferred by experts. The running surface must be as smooth as possible to obtain the best speed, and it must not be varnished, the wood being filled with several coats of linseed oil to which a little wax has been added.

Tar is used to some extent, but this preparation is mostly employed by Swedish makers.

#### The Requirements of Foot Binding

The manner in which the foot is secured to the ski is highly important, and while various kinds of "bindings" are

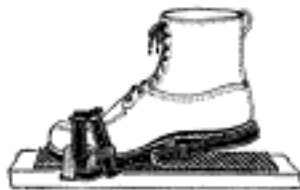

FIG. 2

in use, from the simple cane binding, which marked the first substantial improvement over the twisted birch withes originally used by the peasantry of Telemarken, the Huitfeldt bindings are for many reasons considered the best by experts. The ski runner must have a foot binding that is well secured under all ordinary conditions met with in ski running, and it must be quite rigid and without lateral play. It is desirable also that the foot be freed whenever a fall occurs, thus preventing possible sprains at the ankle and knee, as well as avoiding breakage of the straps. Again the heel of the skier should be free to move up and down for at least 3 in., but the binding should check the vertical movement at this height, thus easing the foot of undue strain when the ski is slid forward, in climbing or working on the level. These essential specifications are so well incorporated in the Huitfeldt model that the description and illustrations of this admirable attachment will suffice. As shown in Fig. 2, the boot is wedged into a firm position between the metal toe piece at the sides. To secure a rigid support, these toe pieces must be firmly wedged in position on the ski, and the skiing shoe should fit between them snugly and well. For this type of binding, a shoe having a stout sole is desirable so that it may keep rigid under the pressure of the body at various angles, and be heavy enough to stand the more or less constant chafing of the metal toe plates. One excellent feature of this binding is the arrangement of the toe and heel straps, which allow all necessary vertical movement of the foot, yet

at the same time provide a fairly rigid, strong, and reasonably light foot attachment. When fitted with the Ellefsen tightening clamp, and it is a good plan to order the Huitfeldt model so equipped, the skis are easily put on and taken off. A large number of experts prefer this binding above all others, but the Huitfeldt type of binding may be made by the skier if desired. Any metalworker or blacksmith can supply the metal toe pieces, and the binding may be completed by adding suitable straps, or the foot may be secured at the heel by leather thongs.

#### The Skiing Stick

While there are occasions when the proficient ski runner can dispense with the stick, as in jumping and practicing many fancy turns and swings, a good stick must be reckoned a valuable implement for climbing and downhill running, and often a help on a level. The beginner should not depend too much upon the stick, however, but should acquire the knack of handling the skis without this aid early in his practice. In short, the novice should practice both with and without the stick, that he may learn all the little points of balancing the body unaided, but every skier ought to know how to use the stick, that he may rely upon its assistance whenever necessary.

The use of two sticks may be of help for mountain climbing, but the majority of ski runners consider one stout stick to be of more real service. For downhill running, the extra stick is of no value whatever, but rather a hindrance, the one stick being all that is required for braking. In choosing a stick, its height may be such that it will reach to the shoulders of the skier, although many prefer a shorter one. On the average, a stick 5 ft. long will be found about right for most persons, while a proportionately shorter stick will be required for boys and girls. Bamboo of good quality is generally preferred, since it is light, elastic, and very stiff and strong. Hardwood sticks are a trifle heavier, but if fashioned from straight-grain hickory, or ash, are as

satisfactory as the bamboo. In any case, the end of the stick should be provided with a metal ice peg, and a ferrule to strengthen the wood at this point. A few inches above the peg a ring, or disk, is fastened, and this "snow washer" serves to keep the stick from sinking too deeply into the snow. Wicker rings, secured with thongs or straps, are much used, as are also disks of metal and hard rubber. A decided improvement over these materials has been brought out in a cup-shaped snow washer made of aluminum, which is flexible and fastened to the stick with clamps so that it can be easily shifted or removed at will. This feature is a good one, since the washer is often useful for assisting braking in soft snow, but is likely to catch and throw the runner if used upon crusted snow, hence the detachable arrangement is of value in that it supplies an easy way to take off the washer whenever desired. The sticks are shown in Fig. 3.

#### Necessities of the Skier's Outfit

For skiing an ordinary pair of heavy-soled lace shoes that fit well are suitable, but to keep the heel strap of a binding from slipping, the shoes should have broad, concave heels, or a small strap and buckle, firmly sewed in place at the extreme end of the heel, should be fitted to them. Personally, I prefer the heel strap to the special heel, but any cobbler can fit the shoes with either one. Specially designed skiing shoes, or boots, as shown in Fig. 4, are to be had at the sporting-goods dealers', and while good, are somewhat expensive, because most of them are imported. Of course, shoes for skiing must be amply large so that one or two pairs of woolen socks may be worn; two pairs of thin, woolen stockings being less bulky and very much warmer than one extremely heavy pair.

For clothing, the soft, smooth finish of the regulation mackinaw garments cannot be improved upon for outdoor winter wear, although any suitable material will serve as well. Smooth-finish material is the best in all cases, because cloth of rough texture will cause the

snow to stick and make it uncomfortable. Regulation mackinaw trousers, split at the bottom and fastened with tapes to tie close to the ankle, are as good as any, over which cloth puttees,

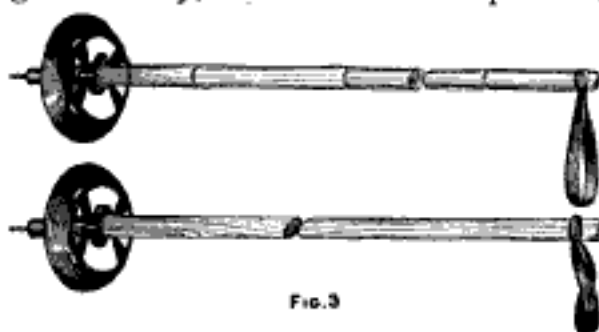

FIG. 3

Skiing Sticks with Staff of Bamboo or Hard Wood Having an Easily Removable Aluminum Washer

or leggings, may be worn to keep out the snow. For the coat, a mackinaw, made Norfolk-style, with belt and flap pockets secured with a button, have given me the most satisfaction. For ladies, close-fitting knickerbockers and leggings are generally preferred when a short skirt is worn.

#### How to Make Skis

To anyone who can use a saw and plane, the making of a pair of nicely balanced and durable skis is a very easy job. Ski making is far easier than snowshoe construction, since each runner is made from a single piece of plank, and no intricate filling is required. In choosing the wood, either hickory or ash will give satisfaction, because both are heavy woods, as well as strong and flexible, and may be worked down much



FIG. 4

Specially Designed Skiing Boots, Handmade for the Sport, with and without Heel Buckles

thinner than birch, fir, or other materials. If it is desired to fashion the skis from the rough material, procure two ash, or hickory, planks, about 9 ft. long and 2 in. thick. Should the maker wish

to hew his own material, select a sound and straight tree, about 10 in. in diameter, free from knots for at least 10 ft.,

how to pick out this desirable material by noting the run of the grain. This is very well shown in Fig. 6. The let-

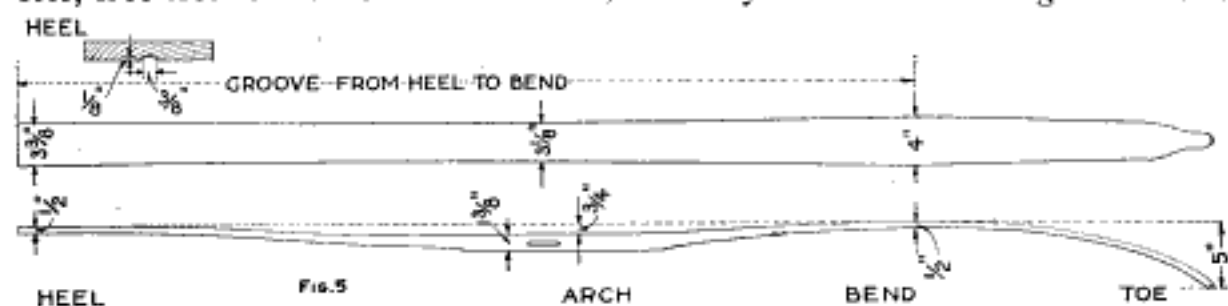

Fig. 5  
A Complete Layout Pattern for an Eight-Foot Ski: From These Dimensions It Is an Easy Matter to Fashion Skis Longer or Shorter by Making Use of These Well-Balanced Proportions

and fell it during the winter. Place the log in the crotch of a stump and cut a groove along its length with the ax, taking pains that the groove is straight and about 1 in. in depth. Turn the log over and make a like groove in the opposite side. Rap the bottom of the grooves lightly with the ax, to start the split, and drive in small wood wedges, gradually working them along as the wood splits. At some points the wood will very likely split away from the groove, but by cutting these fibers, the split may be kept along the grooves. As the strongest and best grain of the wood will lie closest to the bark, only enough of the outside should be hewn away to make a flat surface, for this is to be the running surface of the ski. Skis may be made in any length and width, but for a man of good height, 7 to 8 ft. is the correct length. In Fig. 5 is given a complete layout pattern for an 8-ft. ski, and from the dimensions it is an easy matter to fashion skis longer or shorter by making use of these well-balanced proportions. While the plan of the ski may be drawn directly on the plank, it is an excellent idea to make a paper pattern, and laying this down on the board, trace around it to get the correct outline.

When purchasing the sawed material, the buyer should endeavor to obtain a plank which has been sawed out from the lower portion of the trunk of the tree, from the outside. The dealer will not be able to assist in choosing lumber for this particular purpose, hence the buyer should know something about the growth of good wood in the tree, and

ters A, B, and C show the run of the grain produced by the ring growth of the tree, and D, E, and F indicate the appearance of rings, in the run of the grain seen in the sawed plank. The best possible choice for wood is represented by A and D, because the layers of good and elastic wood run deep, and there is practically no soft layers of punky wood. That represented by B and E, and that of C and F, contain a larger percentage of soft layers, and while skis can be, and often are, fashioned from this kind of material, the wood is less strong and flexible than that of wood showing the grain as A and D, hence the latter should be chosen whenever it is possible to do so. While wood of fairly close grain does not necessarily indicate inferiority, if the material is hickory, yet if ash is selected, the purchaser should select an open, or widely spaced, grain in preference to a close and even-grained plank. And this is so because in all trees the grain represents the more quickly grown soft wood—formed in the period of greatest growth, which is in the spring and summer months—hence the more grain present in the plank and the closer it runs, the more soft and punky wood is present, and the less durable the material will be for the purpose.

When drawing the dimensions on green, or partly seasoned, timber, a certain amount of shrinkage will occur, hence be sure to allow for this and make the width about  $\frac{1}{4}$  in. greater. When working seasoned lumber, this need not be taken into consideration.

After the outline of the ski has been sawed out, the bottom, or running surface, should be planed perfectly smooth, with the grain running straight and true from the point to the heel. The ski should be worked down to the desired dimensions before bending, and from the top, or upper, side only, never from the running surface. When the correct thickness has been reached, the bend at the point may be put in by soaking the wood well to make it pliable. This is most easily done by heating water in a wash boiler, and when the water boils, place the ski across the top and thoroughly soak the wood by mopping with the boiling water, using a cloth tied to a stick. That the bend may be gradual and not too abrupt, do not attempt to bend it to the desired arc at once, but gradually work the wood and resort to numerous hot-water treatments until a good 6-in. bend is obtained. The arch in the running surface is easily obtained, and if bent too much, is easily straightened out when cold. Of course, more bend must be given the skis than the actual curve will be when finished, since the wood will straighten out somewhat as it dries. Some kind of a form will come in handy, and this may be furnished by making a rough frame and placing a short length of log of the

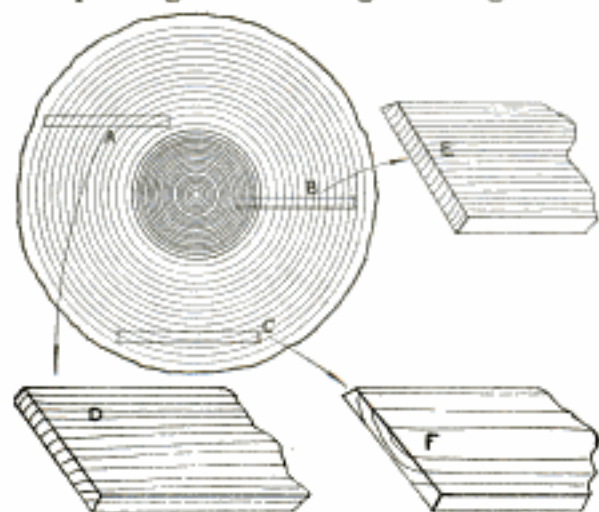

FIG. 6  
The Wood is Selected by the Way in Which the Growth of the Grain Runs

proper diameter at the bends, or the tips may be lashed, or cleated, to the floor of the workbench. A very easy method is shown in Fig. 7.

After the bends are made, the hole for the foot binding should be put in, and if the wood has been left plenty long, the skis may be trimmed off at the heel so that they will balance nicely when lifted by the toe straps. This is the best way, for while a few skiers prefer to make the heel light and weight it with lead, there is no advantage in doing so.

The groove in the exact center of the running surface should now be cut in, which is made about  $\frac{1}{8}$  in. deep, and  $\frac{3}{8}$  to  $\frac{1}{2}$  in. in width. A grooving plane is most convenient, but a small gouge, if carefully used, will do as well. The groove should run from the heel to the beginning of the bend.

To finish the ski, sandpaper top and bottom smooth, and rub down with linseed oil to which a little paraffin, or beeswax, has been added. The running surface of the ski should be finished with oil and waxed, and it is an advantage that the entire ski be finished in the same manner, as less snow will stick to the tops than if varnish is used. The experienced skier is more concerned about the running qualities of his skis than the finish, but the novice is more likely to be attracted by fancy implements. When varnished tops are wanted, a glossy and durable surface is obtained by

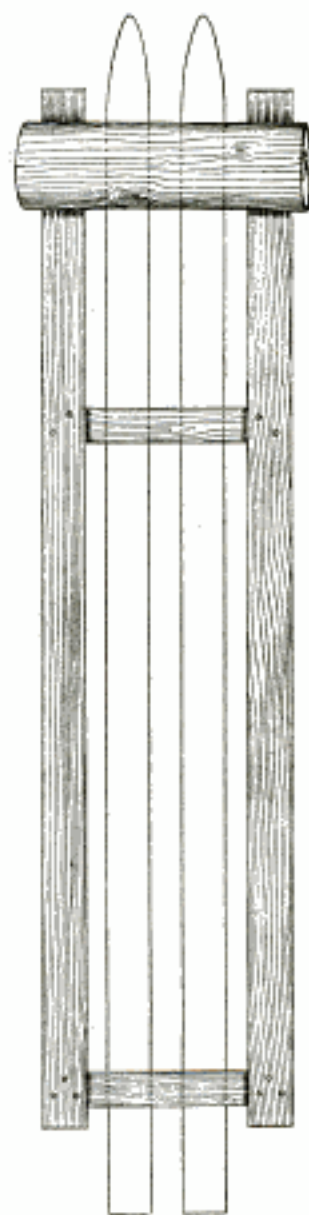

FIG. 7

brushing on a couple of coats of good spar varnish.

A tube, or cake, of wax should be carried by every skier, for the running surface must have numerous coatings that the snow may not stick to the wood. Both paraffin and beeswax are suitable, and the skier may use one of the several good preparations put up in tubes and in cakes, or melt up his own, as preferred. A good cake, or hard, wax is made by melting up 10 oz. of beeswax with 5 oz. of rosin. When

melted, stir in 1 oz. of turpentine and pour in small boxes to form cakes of convenient size.

The running surfaces are often waxed by rubbing the wax on and then going over the surfaces with a hot flat-iron. This is a good method, providing only a sufficient quantity of wax has been applied. A too liberal application of wax cannot be called a disadvantage when running downhill, but it will make the runners so slippery that climbing uphill is difficult.

### Filling Toy Rubber Balloons with Hydrogen

Any boy can easily convert a toy rubber balloon into a real flier by



Apparatus for Filling Toy Rubber Balloons with Hydrogen Gas to Make Them Fly to a Great Height

constructing the simple device shown in the illustration for filling it with hydrogen. Procure a clay pipe and break off the stem near the bowl. Bore a hole in a cork, or preferably a rubber stopper, selected to fit some bottle and insert the smaller end of the pipestem in the hole. As the stem tapers, if the hole has been made for the smaller end, a tight fit is assured by simply pressing the stem well into the cork. Tie the open end of the stem on the balloon tightly over the larger end of the pipestem, and have ready a thread

to tie the stem of the balloon when it is filled.

Procure from a local drug store 1 oz. of hydrochloric acid. Place some nails, or better still, a few strips of zinc, in the bottle and cover them with a little water, then pour a small quantity of the hydrochloric acid into the bottle and assemble as shown in the illustration. In a few minutes hydrogen gas will be given off, and if the joints are tight, the balloon will begin to fill. After it has expanded as much as it will stand without breaking, tie the end with the thread, and cut off any parts of the mouthpiece that may weigh it down. If sufficient gas has been passed into the balloon it will rise to the ceiling. Balloons filled in this manner have risen to a height of several hundred feet.

Caution: Do not allow the hydrochloric acid to come in contact with the skin or clothing, as it may cause frightful burns. Do not under any circumstance fill the balloon near a flame or allow fire to come near the bottle.—Contributed by Ralph C. Jenkins, Manchester, Vt.

### How to Polish Instrument Bases

There seems to be a feeling among mechanical and electrical experimenters that there is something mysterious about the process of wood finishing, and often one may see a really fine piece of apparatus spoiled by mounting it on a shellacked baseboard. I have found that it is a very simple matter

to produce almost a piano finish on all woods, even those as soft as poplar, in the following manner. Quick-drying wood dyes should be avoided. Simply rub down a piece of ordinary water-color cake into some plain water and apply freely with a rag, rubbing it in well. Any color may be obtained in this way, but if this is not convenient, use an oil stain made quite thin with turpentine. Next apply a thin coat of shellac, which should be sandpapered when it is dry. A coat of ordinary varnish is then applied, and when this is thoroughly dried, rub lightly with fine steel wool. One coat of varnish may be sufficient, although several coats will produce a richer finish. Rub the last coats down well with an oily rag dipped in some abrasive material, such as tooth powder or metal polish, and finish with a simple oil rub. A beautiful, soft, transparent effect may be obtained in this way on very ordinary woods. Any open-grained woods, such as oak, must be filled with a paste filler after staining.—Contributed by John D. Adams, Phoenix, Ariz.

#### Locating Droplight in the Dark

A simple device for locating a drop-light can be had by putting a nail or



The Cord Fastened to the Door Casing is Easily Located and Followed to the Lamp

screw eye into the side of the door casing, high enough to clear persons passing under it, but within easy reach of an uplifted hand, and running a cord from it to the light. It is not difficult to locate the cord attached to the casing and to follow it to the light.—Contributed by H. S. Craig, Rushford, Minnesota.

¶If kerosene oil is used when drilling, reaming, or turning malleable iron, it will make the work much smoother.

#### How to Make an Experimental Lead Screw

Often in experimental work a long, narrow, parallel screw is desired for regulating, or moving, some part of



A Copper Wire Wrapped around and Soldered to a Straight Rod for a Lead Screw

the apparatus in a straight line. A simple way of making such a screw is to tin thoroughly a small straight rod of the required length and diameter. After wiping off all the surplus solder while it is yet hot, wrap it with a sufficient length of bright copper wire and fasten the ends. This wire is then securely soldered in place by running the solder on while holding the screw over a blue gas flame. To make the solder run freely, brush frequently during the heating with a small mucilage brush dipped into the soldering acid. An even pitch can be secured by winding on two wires side by side at the same time, the second one being unwound before soldering.

#### Self-Setting Rat Trap

A suburbanite successfully trapped a bunch of rats by stretching a piece of stout elastic paper on the top of an open barrel. Spreading food on this paper he allowed it to remain until the suspicions of the rats were allayed, then he cut two right-angled slashes in the paper with a razor. Next morning



The Paper Stretched over the Barrel Top was Cut after Feeding the Rats on It for Some Time

he found seven of the pests in the barrel.

### A Simple Motor Controller

The controller described is very similar in operation to the types of controllers used on electric automobiles, and its operation may be easily followed by reference to the diagrammatic representation of its circuits, and

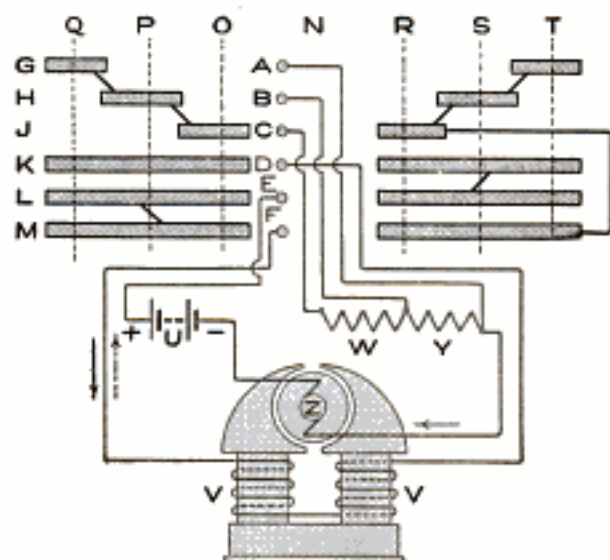

FIG. 1

Diagram of the Electrical Connections of a Controller to a Two-Pole Series Motor

those of a two-pole series motor to which it is connected, as shown in Fig. 1. The controller consists of six flat springs, represented as small circles and lettered A, B, C, D, E, and F, which make contact with pieces of narrow sheet brass mounted on a small wood cylinder, so arranged that it may be turned by means of a small handle located on top of the controller case in either direction from a point called neutral, which is marked N. When the cylinder of the controller is in the neutral position, all six contact springs are free from contact with any metal on the cylinder. The contacts around the cylinder in the six different horizontal positions are lettered G, H, J, K, L, and M. There are three different positions of the controller in either direction from the neutral point. Moving the cylinder in one direction will cause the armature of the motor to rotate in a certain direction at three different speeds, while moving the cylinder in a reverse direction will cause the armature to rotate in the opposite direction

at three different speeds, depending upon the exact position of the cylinder. These positions are designated by the letters O, P, and Q, for one way, and R, S, and T, for the other.

Supposing the cylinder to be rotated to the position marked O, the circuit may be traced from the positive terminal of the battery U, as follows: To contact spring E, to strip of brass L, to strip of brass M, to contact spring F, through the field windings VV, to contact spring D, to strip of brass K, to strip of brass J, to contact spring C, through resistance W and Y, to armature Z, through armature to the negative terminal of the battery. Moving the cylinder to the position P merely cuts out the resistance W, and to the position Q, cuts out the remaining resistance Y. The direction of the current through the armature and series field, for all positions of the cylinder to the left, is indicated by the full-line arrows. Moving the controller to the positions marked R, S, and T, will result in the same changes in circuit connections, as in the previous case, except the direction of the current in the series field windings will be reversed.

The construction of the controller may be carried out as follows: Obtain a cylindrical piece of wood,  $1\frac{3}{4}$  in. in diameter and  $3\frac{1}{8}$  in. long, preferably

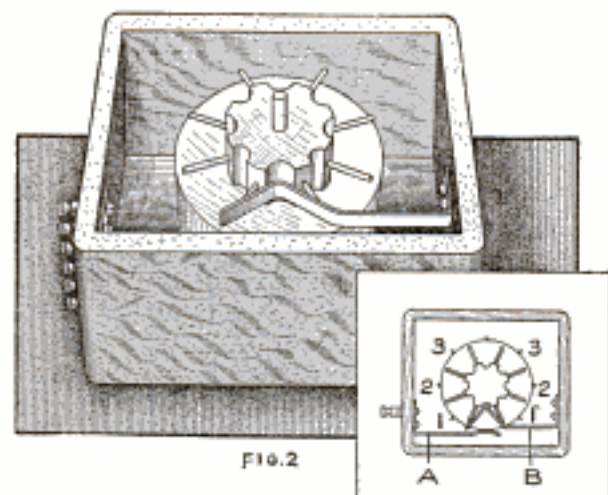

FIG. 2

Upper-End View of the Controller, Showing the Manner of Attaching the Springs

hard wood. Turn one end of this cylinder down to a diameter of  $\frac{1}{2}$  in., and drill a  $\frac{1}{4}$ -in. hole through its center from end to end. Divide the circum-



ference of the small-diameter portion into eight equal parts and drive a small nail into the cylinder at each division point, the nail being placed in the center of the surface lengthwise and perpendicular to the axis of the cylinder. Cut off all the nail heads so that the outer ends of the nails extend even with the surface of the outer, or large-size, cylinder. Divide the large part into eight equal parts so that the division points will be midway between the ends of the nails, and draw lines the full length of the cylinder on these points. Divide the cylinder lengthwise into seven equal parts and draw a line around it at each division point. Cut some  $\frac{1}{8}$ -in. strips from thin sheet brass and mount them on the cylinder to correspond to those shown in Fig. 1. Any one of the vertical division lines drawn on the cylinder may be taken as the neutral point. The pieces may be mounted by bending the ends over and sharpening them so that they can be driven into the wood. The various strips of brass should be connected electrically, as shown by the heavy lines in Fig. 1, but these connections must all be made so that they will not extend beyond the outer surface of the strips of brass.

A small rectangular frame is made, and the cylinder is mounted in a vertical position in it by means of a rod passing down through a hole in the top of the rectangle, through the hole in the cylinder and partly through the bottom of the rectangle. The upper part of the rod may be bent so as to form a handle. The rod must be fastened to the cylinder in some convenient way.

Make six flat springs similar to the one shown at A, Fig. 2, and mount them on the inside of the rectangle so that they will correspond in their vertical positions to the strips of brass on the cylinder. Six small binding posts mounted on the outside of the box and connected to these springs serve to make the external connections, and they should be marked so that they may be easily identified.

A flat spring,  $\frac{1}{4}$  in. wide, is made

similar to the one shown at B, Fig. 2. Mount this spring on the inside of the rectangle so it will mesh with the ends of the nails in the small part of the cylinder. The action of this spring is to make the cylinder stop at definite positions. The top of the case should be marked so that the position of the handle will indicate the position of the cylinder. Stops should also be provided so that the cylinder case cannot be turned all the way around.

### Miniature Push Buttons

A very neat and workmanlike push button may be made in the following manner: Procure an unused tan-shoe eyelet with an opening about  $\frac{3}{16}$  in. in diameter, and at the proper point drill a hole into the board in which the button is to be set. Force the eyelet in flush, using a little shellac to hold it in tightly. For the button proper, polish off and round one end of a piece of brass rod of a diameter that will move freely up and down in the eyelet. Solder a small piece of sheet brass across the lower end to keep it from coming out, then adjust and fasten on the two contact pieces, all as indicated in the sketch. The larger piece should be quite springy so as to bring the button back each time. The connections may be made by slipping the wires under the heads of the two wood screws that hold the contact pieces in place.

As every experimenter knows, it is almost impossible to drill a hole in the varnished base of an instrument without leaving a raw edge. Under such circumstances, when it is desired to make an opening for conducting cords, and the like, simply drill a hole with an ordinary drill and then set in a small shoe eyelet, which immediately presents a very finished appearance.

☞Vaseline, with a little powdered gum camphor added and heated over a slow fire, makes an excellent rust preventive for tools.



## Smoker's Cabinet or Cellarette

This design, when completed, takes up a wall space 20 in. wide by 31 in.

for the cabinet is made from  $\frac{3}{4}$ -in. material, squared up to fit between the sides, and be flush with their top edges while resting on the bottom crosspiece.

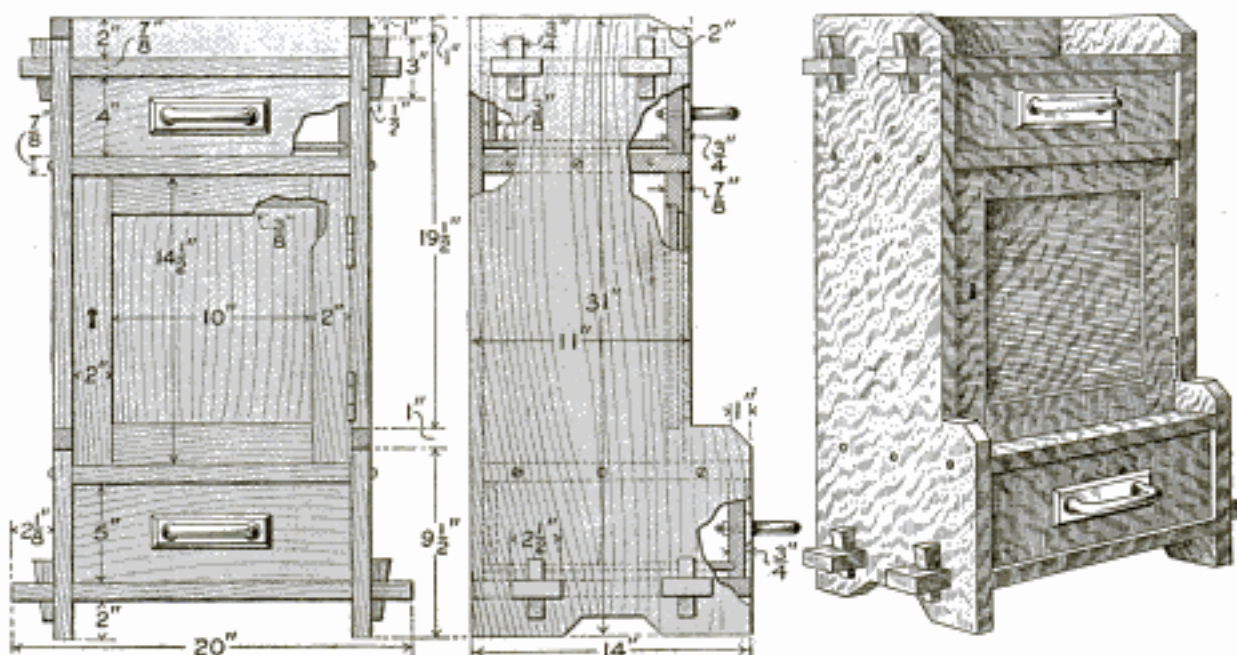

The Smoker's Cabinet Makes an Attractive Addition to the Furniture of a Den, and should be Made Up and Finished to Match Other Pieces of the Room

high, and extends out 14 in. The material necessary for it is as follows:

- 2 sides,  $\frac{3}{8}$  by 14 by 31 in.
- 1 back,  $\frac{3}{8}$  by 14 by 28  $\frac{1}{8}$  in.
- 1 bottom,  $\frac{3}{8}$  by 14 by 20 in.
- 1 top,  $\frac{3}{8}$  by 10  $\frac{1}{4}$  by 18  $\frac{3}{4}$  in.
- 1 bottom shelf,  $\frac{3}{8}$  by 14 by 14 in.
- 1 top shelf,  $\frac{3}{8}$  by 10  $\frac{1}{4}$  by 14 in.
- Door:
- 2 stiles,  $\frac{3}{8}$  by 2 by 14  $\frac{1}{2}$  in.
- 2 rails,  $\frac{3}{8}$  by 2 by 10 in. (not including tenons, if such are desired).
- 1 panel,  $\frac{3}{8}$  by 10  $\frac{1}{4}$  by 11  $\frac{1}{4}$  in.
- Upper drawer:
- 1 front,  $\frac{3}{8}$  by 4 by 14 in.
- 1 back,  $\frac{3}{8}$  by 3  $\frac{1}{4}$  by 13  $\frac{1}{4}$  in.
- 2 sides,  $\frac{1}{2}$  by 4 by 9  $\frac{1}{4}$  in.
- 1 bottom,  $\frac{3}{8}$  by 9  $\frac{1}{4}$  by 13  $\frac{1}{4}$  in.
- Lower drawer:
- 1 front,  $\frac{3}{8}$  by 5 by 14 in.
- 1 back,  $\frac{3}{8}$  by 4  $\frac{1}{4}$  by 13  $\frac{1}{4}$  in.
- 2 sides,  $\frac{1}{2}$  by 5 by 12  $\frac{1}{4}$  in.
- 1 bottom,  $\frac{3}{8}$  by 12  $\frac{1}{4}$  by 13  $\frac{1}{4}$  in.
- 1 piece for keys,  $\frac{3}{8}$  by 2  $\frac{1}{4}$  by 6  $\frac{1}{4}$  in.
- 1 pair hinges.
- 2 drawer pulls.
- Screws and nails.

In constructing the cabinet, the outer frame should first be made. The sides can be laid out and cut to the desired design. The top and bottom crosspieces should then be squared up, and the tenons cut as shown, the bottom tenons extending farther, to balance the design. The top is set in  $\frac{3}{4}$  in. from the back edge. Holes should be marked and cut for the  $\frac{3}{4}$ -in. keys, after which the four parts may be assembled, and suitable keys driven in place. The back

It can be fastened in place with nails. The top and bottom pieces of the cabinet proper can then be made, and secured in place with round-head screws, after which the door may be made and fitted. The stiles and rails of the door should be rabbeted for a  $\frac{3}{8}$ -in. square groove, to hold the panel in place. The frame can be made sufficiently strong, if properly glued and held together with dowel pins passing through the stiles into the rails. If it is desired to fasten the frame with tenons, an extra amount must be added to the length of the rails given in the stock list. The panel should not be glued in place, as the shrinkage of the wood will cause it to crack.

In making the drawers, the front should be rabbeted for a groove to fit the drawer bottom, and sidepieces can be fitted and nailed in place. These should be rabbeted for grooves, into which the bottom and end pieces fit.

If the cabinet is finished in mission style, or fumed oak, hammered copper or brass hinges and drawer pulls will go well with the general appearance of the design.

### Bench Receptacles for Small Articles

When working with small, round articles, such as ball bearings, it often happens that they roll off the bench and are lost. To remedy this, I bored several holes, each 2 in. in diameter, in a convenient place in the workbench top, making them about  $\frac{3}{8}$  in. deep, for the different articles. To make the small parts easily accessible the holes were filled in with thick paste made of plaster of Paris which was molded into a saucer shape. After the plaster became thoroughly dry the inner surface was painted over with white enamel. This made them easily cleaned with a damp cloth. Any article dropped into these depressions will roll to the center, and as the sides are curved it can be easily picked up when it is wanted.—Contributed by Frank L. Matter, Portland, Oregon.

### Ruler with Round and Flat Edges

Picking up a smooth piece of ordinary wood molding, intending to use it as a ruler, I found that its shape, A, combined the properties of the round ruler and flat ruler, as well as assuming the third position D. A simple

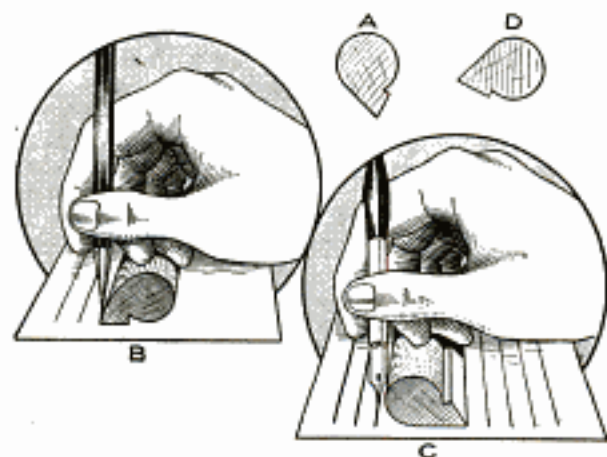

The Molding Presents a Round Edge for a Pen and a Flat One for a Pencil

reverse changes the edge from a round to a sharp or flat, accommodating it to a pen or pencil, as shown. Such a piece of molding can be procured from a local lumber dealer.—Contributed by James M. Kane, Doylestown, Pa.

### A Trouser Hanger

A wood frame, similar to a picture frame, is made up and hinged to the inner side of the closet door with its outer edge hung on two chains. The

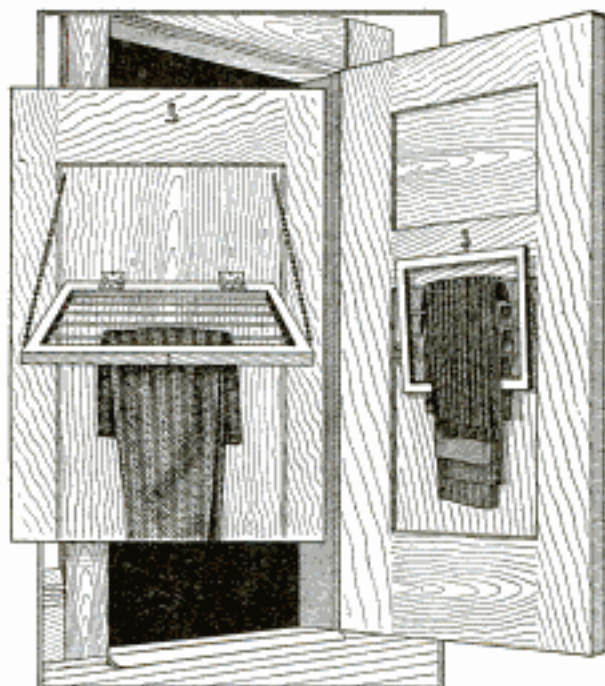

The Trousers can be Easily Hung on the Cross Bars to Keep the Crease in Them

inside of the frame is fitted with cross bars. After hanging the trousers on the cross bars the frame is swung up against the door where it is held with a hook. Several pairs of trousers can be hung on the frame, and when flat against the door it takes up very little space. The trousers are kept flat so that they will hold their crease.

### An Emergency Alcohol Stove

If a person starts on a picnic with a ketchup bottle full of wood alcohol placed in the lunch basket and suddenly discovers that the alcohol stove was left at home, it is not necessary to walk back to get it; just unscrew the cover of the ketchup bottle and bunch a piece of cloth large enough to fill the top, soak it thoroughly in the alcohol and light it. The metal top is just the right size to make a hot flame.

ⒸA box  $8\frac{1}{4}$  in. square and 4 in. deep will hold one gallon.

#. *Herman Shearer* Letter rec'd 8/21/24  
1101 *Harris Trust Bldg. (1105 W. Monroe St.)* Chicago.  
ATTRACTIVE ADDITION TO BRICK RESIDENCE

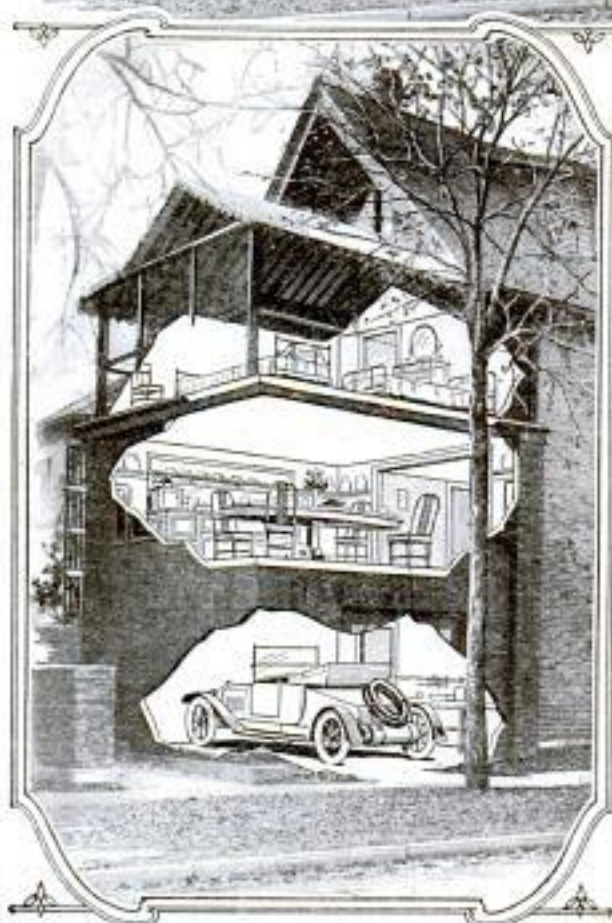
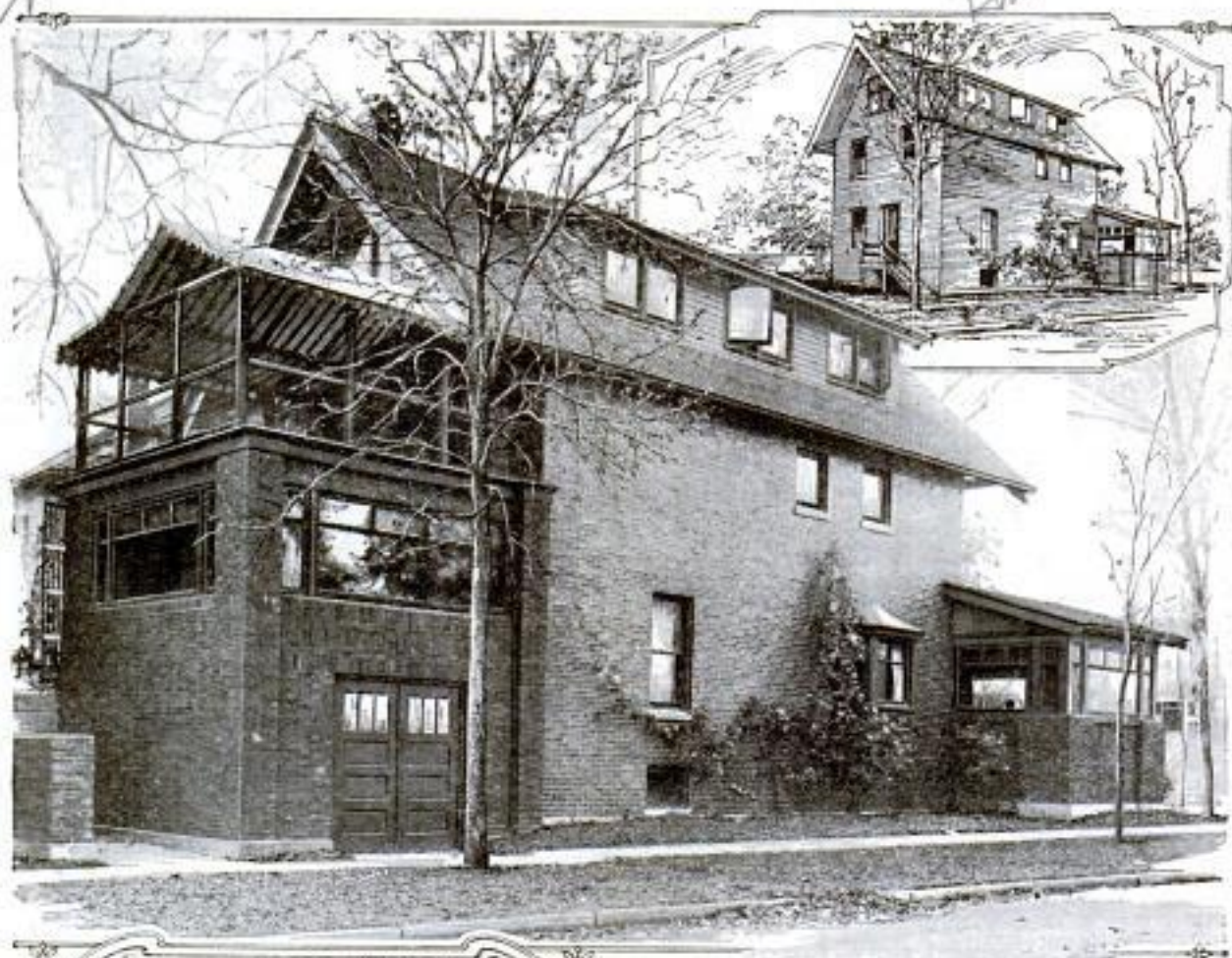

**A**FTER a new brick residence had been in service for some months the owner discovered that the dining room was too dark to be satisfactory and that he needed both a garage and a sleeping porch. These additional facilities, as well as an adequately lighted dining room, were provided at a moderate cost by the construction of a two-story addition at the rear of the building. The garage occupies the first story and the dining room the second story. Excellent lighting is provided for the dining room by windows extending entirely across each of the three sides. The sleeping porch, which is on the roof, is screened and is roofed with canvas firmly attached to wood framing. Aside from providing the needed facilities, the construction of the addition has brought about a marked improvement in the general lines of the building.

**I**N accordance with the editorial policy of this magazine never to accept compensation in any form for what appears in our reading pages, and also to avoid all appearance of doing so, we are obliged to omit the name of the maker or the seller of any article described. This information, however, is kept on file and will be furnished free, by addressing Bureau of Information, Popular Mechanics Magazine, Chicago. [Editor.]

**\$794**for this ALADDIN  
Shipped ANYWHERE

## Buy Direct—Save from \$200 to \$1000

Aladdin home-builders save from \$200 to \$1000 by dealing direct with the manufacturer—instead of thru local dealers. You can do the same. You can keep the dealers' profits in your pocket and get the home you want at your price. Thousands of American families are living comfortably in Aladdin homes. Their hearty recommendations should point your way to success, satisfaction and saving in building your home.

**\$298**  
for this  
5-Room  
Home



At **\$498**  
this snug  
little  
home has  
a number  
of friends

This Charming  
Bungalow  
Home  
Complete  
**\$595**



Another  
Popular  
Bungalow  
**\$683**  
Complete



**Aladdin Price Includes Everything. What You Get:**

Aladdin houses are complete. You get material absolutely guaranteed to be sufficient for the completion of your house, as follows: Sills, cut to fit; joists, cut to fit; studding, cut to fit; building paper; sub-floor, cut to fit; rafters, cut to fit; roof sheathing, cut to fit; siding, cut to fit; outside finish; knotless flooring, cut to fit; lath and plaster or plaster board; knotless inside finish, knotless doors, knotless casings, knotless base board, windows, sash, glass, nails of all sizes, locks, hinges, tin flashing, paints, oils, varnishes, stains, putty and spackle, with complete drawings, illustrations and instructions for erection—**The Complete House.** Send stamps today for the Aladdin Catalog No. 150—it tells all the interesting facts.

Highest  
AWARDS  
WORLD'S  
FAIR

**North American Construction Co.** Homebuilders  
to the Nation  
293 Aladdin Ave., BAY CITY, MICH.

### Why Aladdin Homebuilders Save Money

**BECAUSE:** They buy their lumber on an even footing with the lumber dealer.  
**BECAUSE:** They evade the usual 18% lumber waste.  
**BECAUSE:** Their carpenters save one day in every three building the home.  
**BECAUSE:** Aladdin helps them avoid the usual expensive mistakes.

First: You have the advantage of buying your lumber direct from the manufacturer, and not thru retail dealers. Thus you buy direct from the same source as the lumber dealer himself.

Second: The Aladdin Read-Cut system designs houses to use mill run lengths of lumber, and your carpenter does not need to waste any material by cutting during the erection of your house. Thus you save the usual 18% waste.

Third: By avoiding the necessity for measuring, sawing and fitting by your carpenter, your labor bill will be reduced practically one-third.

Fourth: Aladdin's co-operation, instructions and advice during the erection of your home will fortify you against expensive mistakes so common to most inexperienced home builders.

A fact is established by actual experience, and not by theory.

Let the actual experience of thousands of Aladdin home builders prove to you that you will get a good home for less money with Aladdin's help.

### Dollar-a-Knot Guaranteed

Aladdin houses have set a new standard of quality for moderate priced American homes. Knotless lumber, free from A.L.I. defects is furnished for all Aladdin dwellings in the siding, shingles, porch work, outside finishing lumber, floors, window casings and inside woodwork. The highest priced standard paints, oils, stains and varnishes are supplied, the best quality plaster—everything is of unquestioned value. (Hundreds of customers have written us: "We can't buy as good material at any price in our town.")

### Aladdin Houses Not Portable

Aladdin houses are not portable, not sectional, not knocked-down. They are identically the same, when erected, as any first-class wooden house. They cannot be taken apart, taken down, nor removed. They are permanent, strong, warm and substantial in every part. The Aladdin catalog gives you a complete understanding of their many advantages.

### Aladdin Mills in Four States

Our mills are located in Michigan, Florida, Louisiana and Oregon. Shipment is made from the nearest mill. No matter where you live, your house comes in a straight line from forest to you. Long distance and excessive freight rates are cut out. No hold-up on the way. In a short time after shipment is received, you move into your own home.



I Built this Plant  
With My Profits



# Start In A Big For

## You Can Make \$3,000 This Year Repairing and Retreading Automobile Tires

1916 will be the biggest year in the automobile business—1916 will be the biggest year in the tire business—1916 will be **YOUR** biggest money-making year if you accept this opportunity. Success, wealth, power, independence, await the man who enters the tire repair business, at the beginning of its most prosperous period. It's not fiction nor a pretty story. It's an accepted fact. What I did in this business starting six years ago, you can do now. Your chances to win are ten to one better than mine. There will be more automobiles made during the next three years than in all time before. There is nothing that offers such a certainty of success. You can start small with a little investment, (\$50 and up), and build a big business from there. You are soon a manufacturer, getting the big end of the profits instead of the small.

## One Million Autos To Be Made In 1916

That's the amount the automobile manufacturers are planning to produce. Every one is getting ready for the big demand that is sure to come. Think what this means to the tire business. Think of the millions of new tires besides the tires already in use, that will need repairing and retreading. To the man who starts now in the tire repair business there is a wonderful future before him. No business under the sun offers such sure possibilities of big success.

### Punctures and Blow-Outs Are Common

Autoists are continually clamoring for tire repair work. Not a day passes but thousands of tires blow up—thousands of punctures are made and this will be always a condition with automobile tires. Repairing is a neces-

sity. The work has to be done. Simply open a shop—the work comes along with hardly any effort.

### Tires to Mend the Whole Year Round

Autos are used both winter and summer. No season to tide over without any work. You are busy continually, day in and day out, building a business that gets bigger and better—making you rich, prosperous and contented.

Any city, any town, any village, now offers wonderful money-making opportunities to the man in the tire repair business. The demand for the work is already ahead of the supply and over 4,000,000 more tires a year for the next three years will need repairing and retreading. Isn't this a business for you?

## Haywood's 1916 Tire Repair Plants Turn Out Work Quick at Big Profits

COMPLETE MACHINE  
\$50 AND UP

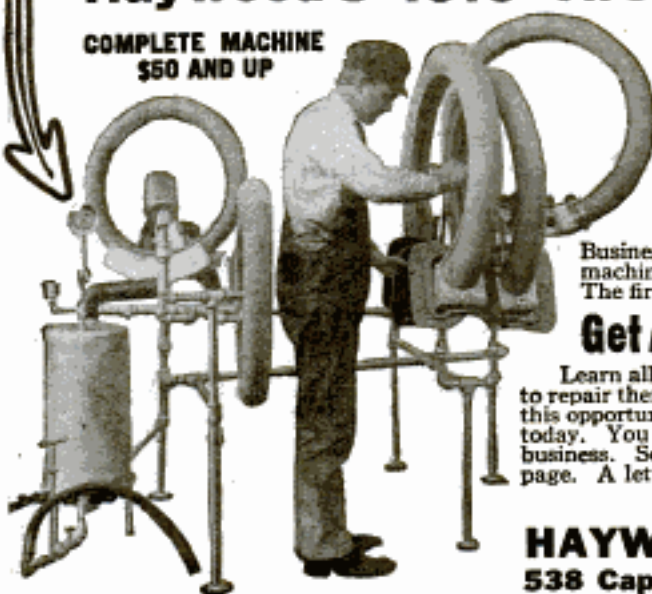

Be the first in your town with the Haywood Equipment. Mends tires best and quickest. Does the work at the biggest net profits to you. Plants are complete in the finest detail. Retreads, vulcanizes and does all kinds of repairing. Jobs please your customers. Price saves motorists money, but in turn gives you a big profit.

Experience is absolutely unnecessary. Just a little mechanical turn and follow directions is all that is required. One machine will give you the start. That's the way I did it.

Business grows fast from that time on. You soon need another machine, then another, and be able to buy them out of your profits. The first thing you know you are a real manufacturer—a success.

## Get All the Facts from the Big Free Catalog

Learn all the secrets of this proposition. Get details about tires and how to repair them. See the outfits in use. Get the stories of others who accepted this opportunity even when chances for success were not half what they are today. You will be surprised and delighted how easy it is to enter this business. Send your name and address only. Use the coupon on the other page. A letter or post card—but do it at once.

M. E. HAYWOOD, Pres.

**HAYWOOD TIRE & EQUIPMENT CO.**  
538 Capitol Ave. INDIANAPOLIS, IND.

# 1916 Business Yourself

Mail  
The  
Coupon

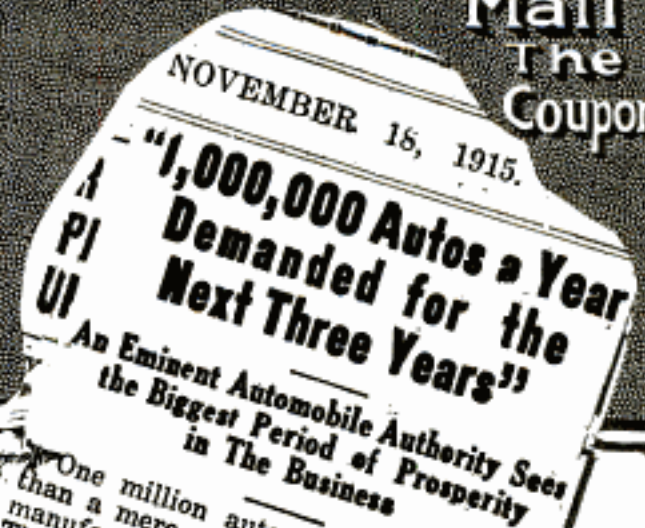

**This is YOUR Opportunity**

Here is undeniable evidence—your opportunity. There was never a better one for any man anywhere. Make the most of it while the chance is before you. Why keep tied down, shackled to the whims and purse strings of bosses? Why don't you hold the bag and make big money? I built the big business you see at the top of this advertisement—the business that I want to start you in. I have started others and they are now making money. Johnson, Texas, writes: "I make as high as \$18 a day in the tire repair business." **You can do it.** The coupon or post card will bring you complete information.

**Be a Leader, Gain Independence, Build for the Future, in a Big Growing Business of Your Own.**

One million autos a year is more than a mere prediction to automobile manufacturers; it is an accepted fact. There is hardly a manufacturer of consequence now making autos but factories are being started—new machines for increasing outputs are being invented and installed. There is one industry whose wave of prosperity will wash up further than any other during this tide of automobile prosperity. This is the automobile tire industry. Every auto made means four new tires. The demand for one million autos means four million tires.

There are mighty few business undertakings that show such a remarkable future. The auto is here to stay. There is no question about that. Twentieth Century Business demands autos, and autos demand tire repair men. It does not take much foresight to see where the tire repair man will step in for his share of the fortune. Tires are acknowledged the least durable part on the auto. They are a constant source of up-keep expenditure and any opportunity to save tires is eagerly grasped by every auto owner.

But as important as tire repairing is, it is of no more importance than the machine by which this work can be done. Machines are made now, simple in construction, simple to operate, by which any man with a slight mechanical turn of mind can repair auto tires.

To any man tired of working for others, wanting to get into a business for himself, it will pay him to investigate the opportunity that is offered in the tire repair business.

**You Can Start At Once Write Haywood NOW!**



**FREE COUPON**

M. E. Haywood, Pres.  
Haywood Tire & Equipment Co.  
538 Capitol Ave., Indianapolis, Ind.  
Dear Sir:— You can send me your book and full particulars about your 1916 Tire Repairing Machine. Send prices and complete descriptions first mail.

Name .....

Address .....

**Don't Wait Act-at Once- INVESTIGATE!**

Please Mention Popular Mechanics

# Get into a Paying Business

## Here's What a Chicago Tinsmith Did Who Wanted a Business of His Own

Sometime ago a tinsmith in Chicago wanted to go into business for himself. He had saved a little money, was a rider and had therefore seen the motorcycle business grow from nothing to a real business, so felt there was an opportunity in that field.

He wrote us to ask if there were any openings. He was full of energy and hustle and looked to us like a man who would make things move so we helped him to a lot of information on how to make a motorcycle store pay and recommended a good location in another city. Today he is a successful

business man, absolutely his own boss, making almost as much some months as he used to make in a year.

Nearly 3000 other men in business for themselves made a good living selling Harley-Davidsons last year. But in a selling organization the size of ours, composed as it is of so many dealers, some are satisfied with one-third the profit they might make. Each year at the opening of the new season we are compelled to replace some of these inactive ones.

A number of important changes have been made in our representation this year and more are being made from day to day. We have three or four excellent openings in large cities to say nothing of a number of smaller towns. If you are interested in getting into business for yourself write us today.

ADDRESS DESK "A"

**Harley-Davidson Motor Company**  
Producers of High Grade Motorcycles for Fourteen Years  
445 B Street Milwaukee, Wisconsin

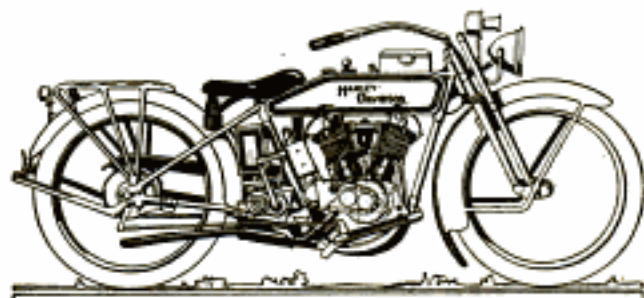

**1/3 SAVED** Buy Direct From MANUFACTURER



FREE BOOK

**Do Your Own Plumbing and Heating**  
NEW HARDIN EASY WAY

Get our "Handy-Man" Free Book. Every home needs it. Shows new home improvements and everything in plumbing and heating supplies EXCLUSIVELY at wholesale prices—complete heating plants, bathroom outfits, sinks, pipe, fittings, water systems, lighting plants, etc. Any handy man can install our goods with this free book and free easy installing plans. \$500,000 plants behind our guarantee. Write today.

The Hardin-Lavin Co., 40 yrs. at 4540-50 Cottage Grove Ave. Chicago

## The ARGO CAR

### STANDARD TREAD

4 cylinder Motor—Full Streamline Body—Electric Lighting and Starting System.

A wonderful car at the price. Write for descriptive literature.

**ARGO MOTOR COMPANY, Inc.**  
614 Main St. Jackson, Mich.

# BE OIL WISE—GET 50¢ SIZE

You'll get as much 3-in-One as if you bought 8 of the 10c bottles. And 3-in-One never loses its quality—never thickens, gums or turns rancid. Always sweet, fresh and good. 3-in-One has for 16 years been the leading Household Oil—Lubricating, Cleaning and Polishing, and Preventing Rust.

Use for oiling sewing machines, bicycles, talking machines, guns, reels, locks, clocks, etc. Use for cleaning and polishing fine pianos, tables, chairs, any furniture. Use for preventing rust on any metal surface.

**FREE** On receipt of your dealer's name we will send you free of cost a generous sample bottle and the valuable 3-in-One Dictionary. Try this good oil at our expense.

3-in-One is Sold at all Good Hardware, Drug, Grocery and General Stores

## 3-IN-ONE OIL COMPANY

42CNF. BROADWAY

NEW YORK





*The McCord home, Augusta, Ga., 101 years old—  
built of Southern Yellow Pine.*

**T**HERE is a lesson here for you. That lesson is that for strength, durability and economy no other building material equals

## Southern Yellow Pine

*“The Wood of Service”*

Investigate the advantages of SOUTHERN YELLOW PINE for interior trim—its workability, lasting qualities, beautiful grain and texture, its adaptability for any effect in color or method of finish.

SOUTHERN YELLOW PINE will provide the largest saving in your building cost and positively give maximum service. If you have a special building problem write us and we will send you FREE plans for homes, farm structures, garages, etc. Simply tell us your want and get the benefit of our FREE service.

**SOUTHERN PINE ASSOCIATION**

670 Interstate Bank Bldg.

NEW ORLEANS, LA.

# "Swift's Premium" Calendar for 1916



JESSIE WILLIAMS SMITH

## Little Red Riding Hood 4 Fairy Tale Pictures

By Jessie Williams Smith

This is one of the best and most novel calendars we have published. It is arranged in four leaves — each leaf picturing a scene from a popular fairy tale. A brief word story of the tale appears on the back of each picture.

The scenes are from the following fairy tales:  
Little Red Riding Hood :: Cinderella  
Goldilocks :: Jack and the Bean Stalk

Every child will delight in seeing these favorite fairy tale characters attractively illustrated in brilliant colors. Everybody will appreciate the artistic conception of these childlike myth children so masterfully painted by this famous artist. No advertising on them to prevent framing.

The calendar will be a daily reminder of the satisfaction given by

"SWIFT'S PREMIUM" HAMS AND BACON  
How to Get the Calendar

This beautiful calendar will be sent to any address in United States for 10 cents, coin or stamps:  
or—Trade-mark end of 5 "Swift's Premium" Oleomargarine cartons  
or—Labels from 5 "Swift's Premium" Blood Bacon cartons  
or—4 Covers from Brookfield Sausage cartons  
or—6 Maxine Elliott Soap wrappers  
or—10 West Coast Soap wrappers  
(Add 10¢ extra in Canada on account of duty)

Swift & Company 4232 Packers Ave. Chicago

Please Mention Popular Mechanics



# A B C

## of Chicken Profits — FREE

Send Johnson your name and get the bedrock facts on making profits with chickens. Learn how Johnson started 650,000 people the simplest and easiest way with his

### Old Trusty

Big production makes low price. And Johnson pays freight East of Rockies. Orders filled the day received. Write at once for new book whether you start now or not. Address

M. M. JOHNSON CO.  
Clay Center, Neb.



STILL  
LESS  
THAN  
\$10

40 to 90  
Day Trial



## LICE PROOF NESTS

Knudson's wonderful patented galvanized Steel Nests (not trap nest) banish lice and mites, keep hens healthy, make more eggs. Six nests per section. Sold on money-back guarantee.

18 Nests  
\$10.00

## More Eggs

That's the name of our new booklet. Send for it today. Tells how to increase your egg production. Ask for book or send \$3.50 one set or \$10.00 set of three sections (eighteen nests).

KNUDSON MFG. CO., Box 700, ST. JOSEPH, MO.

## MAKING POULTRY PAY

depends more on the knowledge you have of Poultry Culture than on expensive equipment or extensive space.

Let Director Quisenberry teach you how to raise poultry successfully and make a good living and a nice profit from a flock of thrifty hens.

If you want to save money and make money in the poultry business write us today for our large illustrated Free Book, "Dollars and Sense in the Poultry Business." It points the way to success.

American School of Poultry Husbandry  
Box 75 Mountain Grove, Missouri



## POULTRY PAPER

44-124 PAGE periodical, up-to-date; tells all you want to know about care and management of poultry for pleasure or profit. Four months for 10 cents. POULTRY ADVOCATE, Dept. 98, SYRACUSE, N. Y.

## Poultry Book FREE

"The Profits in Poultry Keeping," 172 pages. Describes our popular-priced incubators—3 styles, 8 sizes. 20 years leadership. Write today  
Cypfers Incubator Co., Dept. 161, Buffalo, N. Y.



## AGENTS—Make \$100 to \$300



per month easy selling our new Triplicate Sauce Pan. Cooking utensil for 3 different foods on one burner. 400 Specialties — all Whirlwind sellers. Write quick for exclusive territory and large catalogue.

AMERICAN ALUMINUM MFG. CO.  
Div. 5 61 LEMONT, ILL.

## 25 Times World's Champion 402,000 in Use

Get all facts, proofs, particulars — my low prices — money-back guaranty — also my \$1300.00 Gold Offers — all come with my big illustrated Free Book, "Hatching Facts," in colors. Write me today. JIM ROHAN, Pres.



Belle City  
Incubators  
and Brooders

BELLE CITY INCUBATOR CO., Box 164, Racine, Wis.



## The Salary Check keeps up while he's Sick

HE knew he could not stop appendicitis or pneumonia or acute indigestion, but he knew he could be ready for them if they did come. Do as he did; protect *your* bank account, *your* income, *your* wife and *your* children.



# AETNA-IZE



Do as this man did; take out an Aetna Disability Policy. It costs only \$60 a year if you are in a "Preferred" occupation and means just this:

**\$25 a week up to 52 weeks** while you are ill. \$25 a week for 100 weeks — nearly two years—if you lose the sight of both eyes by disease, or the use of both hands or feet or one hand and one foot by paralysis. Also payment of hospital charges or for one surgical operation.

**\$50 a week** as long as you are disabled by a railway, steamship or burning building accident. \$25 a week if disabled by an ordi-

nary accident. If you are killed in an accident, or lose two limbs or both eyes, we will pay from \$5,000 to \$15,000. Half as much for loss of one hand, foot or eye.

**If you become ill** next month and are laid up three or four months, you will be too late. Don't wait. Send this coupon now and protect yourself while you are well and strong.

### AETNA LIFE INSURANCE COMPANY

Drawer 1341 HARTFORD, CONN.

The largest company in the world writing Life, Accident, Health and Liability Insurance

Agency opportunities for all Casualty and Bonding lines

An Aetna agent has a national advertising campaign working for him all the time.

Name.....  
Occupation.....  
Bus. Address.....

AETNA LIFE INSURANCE COMPANY  
Drawer 1341 HARTFORD, CONN.  
I have marked the kinds of insurance  
I wish to know about: Accident   
Health  Disability   
\$250 Life Certificate   
My age is... years.  
I am in good health.

P.M. 1-16

Please Mention Popular Mechanics

# FREE

## A Genuine Leather Tobacco Pouch

In order to acquaint more men with the supreme enjoyment and satisfaction afforded by the wholesome, healthful "PIPER" habit, we will give this fine leather Tobacco Pouch, *Free*, to everyone sending 10 cents for a 10c cut of PIPER Heidsieck Chewing Tobacco.

The pouch is strongly made of fine tan leather, with a flap and patent snap clasp. Every man who loves a good chew will appreciate the convenience of this handsome, handy leather pouch to carry his tobacco in.

*Just holds a  
10-cent Cut of  
PIPER Heidsieck*

# PIPER Heidsieck

CHEWING TOBACCO—Champagne Flavor

PIPER Heidsieck is the *highest type* of chewing tobacco in the world. Every leaf of ripe, golden brown tobacco used in "PIPER" is carefully selected from Nature's choicest crops, clean, sweet and mellow.

*5c and 10c cuts, foil-wrapped, in slide boxes. Also 10c cuts, foil-wrapped, in metal boxes.*

The wonderful flavor of "PIPER" is different from that of all other tobaccos made—a rich, wine-like, delightful taste which never fails to make a friend. "PIPER" is famous the world over for this delicious "Champagne Flavor."

# FREE

Send 10 cents and we will send a full-sized 10-cent cut of "PIPER" and a handsome leather pouch **FREE**, anywhere in the U.S. Also a little folder telling about PIPER Heidsieck. The tobacco, the pouch and mailing expenses cost us 20 cents, and we are glad to spend the money to get you to try "PIPER." We know that once you have started, you will become a permanent friend of this wonderfully wholesome, healthful and satisfying tobacco. In writing please give name of your tobacco dealer.

THE AMERICAN TOBACCO COMPANY  
Room 1168, 484 Broome Street New York City

Please Mention Popular Mechanics

# Save 47%

## On Your Fine, New Home



### THE ARLINGTON

This charming eight-room beauty is an unusually large money-saver. You must see this plan. It is a remarkably fine piece of architecture. Splendid porch. Big living-room with dining-room adjoining through a clever colonnade and den opening off through French doors. Handy coat-closet. Model kitchen. Three large bedrooms with closets—lined closet and a very convenient bath. Altogether a perfect home. You can save easily \$700. Price \$1280.45. Terms: Cash payment and \$22.52 per month.



### THE COURTLEY

Don't build a \$3000 Home until you investigate this one at \$260, including picked materials ready cut-to-fit and extra-strength specifications. The plan is wonderful. Six large rooms and bath. Three bedrooms closets. Every convenience and a model arrangement. You will save \$425 on this Home. Terms: Cash payment down and \$15.10 per month.



### THE MIRACLE

The beauty of this picturesque 5-room bungalow wins every Home builder. Note the handsome porch with its large columns. Then the artistic taper trim. Inside—a cozy arrangement with living-room and dining-room, two bedrooms and bath and a spacious kitchen. All for \$266—saving you an average of \$200. Terms: Cash payment and \$11.02 per month.

**S**IGNED STATEMENTS from all our customers to date show that each saved, on the average, a clear forty-seven per cent. **Think what it means!** A part of this huge saving is in reduced cost of **building materials**. But the greater saving comes as a result of the Sterling Cut-To-Fit feature. We do all the measuring and sawing by electrically driven machinery; by modern methods which save all waste of materials; which do away with hand-sawing **COMPLETELY**; which save you at least **TWO-THIRDS** of the usual carpenter cost. Add the substantial saving in Material Costs and the huge saving in Labor Costs, and you have **FORTY-SEVEN Per Cent**.

Let's take an example: Materials, sawed and cut by hand, that would cost you \$1470 ordinarily, are furnished by us every piece cut to fit, for only \$1000. That's a net saving of \$470. Think what that means! **Almost \$500 Saved!**

Yet this is simply the average percentage saved by Sterling buyers.

## Why Pay Rent When We Give You Two Whole Years to Pay!

Other concerns demand full cash in advance. But we ask a reasonable first payment and allow you **two years** to pay the balance—small monthly payments—less, as a rule, than rent.

No wonder the **entire country** is fast becoming dotted with handsome Sterling Homes! Such Credit Terms and such Cash Savings are irresistible.

Why pay rent? Or why live in a house that does not please you in **EVERY** respect? Why when it **ISN'T NECESSARY!**

# Sterling System of Home Building

We want to tell you many more startling facts about the Sterling System; its vast Timber and Mill Resources; its economic efficiency; the wonderful Sterling Plans, selected from 8,000 designs; the splendid materials that go into Sterling Homes; the matchless Service we are rendering the Home Builders of America.

But please don't expect us to crowd such information upon a magazine page; or upon **40 such pages!** It can't be done! You must have the big **Sterling Book** with its entrancing Plans and multi-color Pictures of Bungalows, Cottages and Dwellings; with its wealth of practical Building Information.

## Send for the Book

You never have seen such a Book, for there's none other like it. It represents the accumulated experience of **YEARS**; and the work of many **MONTHS** in the assembling and arranging of invaluable Building Data. In it you will find beautiful Homes of all styles and sizes, at prices ranging all the way from \$300 to \$3000.

Until you have read the great Sterling Story, you cannot possibly appreciate the phenomenal strides recently made in the Building Industry. **Better Homes, Lower Prices, Liberal Terms**—all are now offered you by the Sterling System. Enclose 10c in stamps or silver to cover postage and packing. Send for this big Book now.

## INTERNATIONAL MILL & TIMBER CO.

Dept. Q-10

32 Sterling Place

BAY CITY, MICH.

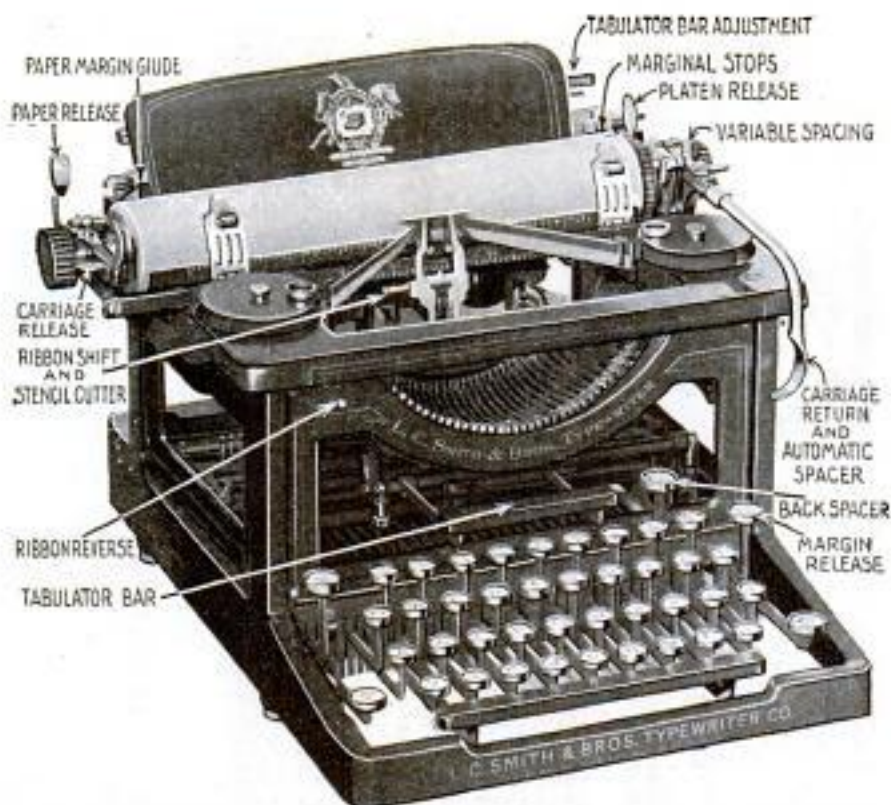

# TYPEWRITER SENSATION

**Free TRIAL—Use As You Pay**

**Only \$2.50 a month until the low total price of \$48.80 is paid, and the machine is yours**

This is absolutely the most generous typewriter offer ever made. Do not rent a machine when you can pay \$2.50 a month and own one. Think of it—Buying a \$100.00 machine for \$48.80. Cash price, \$45.45. Never before has anything like this been attempted.

## Standard Visible L. C. Smith

Perfect machines, not damaged or shop worn. Standard size, Keyboard of Standard Universal arrangement writing 84 characters — universally used in teaching the touch system. The entire line of writing completely visible at all times, has the tabulator, the two color ribbon with automatic reverse, the **Back Spacer**, Ball Bearing type bars, Ball Bearing shift action, the carriage runs on Ball Bearings, in fact every late style feature and modern operating convenience. Comes to you with everything complete, tools, cover, operating book and instructions, ribbon, practise paper—nothing extra to buy. You cannot imagine the perfection of this beautiful reconstructed Ball Bearing typewriter until you have seen it. I have sold several thousands of these perfect latest style Model No. 2 typewriters at this bargain price and every one of these thousands of satisfied customers had this beautiful, strictly up-to-date, visible machine on five days' free trial, before deciding to buy it. I will send it to you f. o. b. Chicago for five days' free trial on receipt of your request, without obligation of any kind on your part to purchase. It will sell itself, but if you are not satisfied this is the greatest typewriter bargain you ever saw, you can return it at my expense — but — you won't want to return it after you try it — you cannot equal this wonderful value anywhere.

**H. A. SMITH**  
510-231 N. Fifth Ave.  
CHICAGO, ILL.

Ship me a No. 2 L. C. Smith f. o. b. Chicago, as described in this advertisement. I will pay you the \$40.00 balance of the SPECIAL \$48.80 purchase price, at the rate of \$2.50 per month. The title to remain in you until fully paid for. It is understood that I have five days in which to examine and try the typewriter. If I choose not to keep it I will carefully repack it and return it to the express agent. It is understood that you give the standard guarantee for one year.

### You Take No Risk—Put In Your Order Now

When the typewriter arrives deposit with the express agent \$8.80 and take the machine for five days' trial. If you are convinced that it is the best typewriter you ever saw, keep it and send me \$2.50 a month until our bargain price of \$48.80 is paid. If you don't want it, return it to the express agent, he will return your \$8.80 and return the typewriter to me. I will pay the return express charges. This machine is guaranteed just as if you paid \$100.00 for it. It is standard. Over one hundred thousand people own and use these typewriters and think them the best ever manufactured.

The supply at this price is very limited, the price will probably be raised when my next advertisement appears, so don't delay. Fill in the coupon today—mail to me—the typewriter will be shipped promptly. There is no red tape. I employ no solicitors—no collectors—no chattel mortgage. I deal direct with you — by mail only. It is simply understood that I retain title to the machine until the full \$48.80 is paid. You cannot lose. It is the greatest typewriter opportunity you will ever have.

Get the coupon in the mail today — sure

**HARRY A. SMITH, 510-231 N. Fifth Ave., Chicago**

Name .....

Address .....

.....Pop. Meth. Jan.

# The Burlington SMASHES ALL WATCH PRICES



## Look!

- ☞ 19 Ruby and Sapphire Jewels—
- ☞ Adjusted to the second—
- ☞ Adjusted to temperature—
- ☞ Adjusted to isochronism—
- ☞ 25-year gold strata case—
- ☞ Genuine Montgomery Railroad Dial—
- ☞ New Ideas in Thin Cases.

# Only \$2.50 A Month

And all of this for \$2.50—only \$2.50 per month—a great reduction in watch prices—direct to you—positively the exact prices the wholesale dealer would have to pay. We do not care to quote these prices here, but write—write before you buy. Think of the high grade, guaranteed watch we offer here at such a remarkable price. Indeed, the days of exorbitant watch prices have passed.

## See It First

You don't pay a cent to anybody until you see the watch. We won't let you buy a Burlington Watch without seeing it. Look at the splendid beauty of the watch itself. Thin model, handsomely shaped—aristocratic in every line. Then look at the works. There you see the pinnacle of watch making. You understand how this wonder timepiece is adjusted to the very second.

Every fighting vessel in the U. S. Navy has the Burlington Watch aboard. This includes every torpedo boat—every submarine as well as the big Dreadnaughts.

## Send Your Name on This Free Coupon

Get the Burlington Watch Book by sending this coupon now. You will know a lot more about watch buying when you read it. You will be able to "steer clear" of the double-priced watches which are no better. Send the coupon today for the watch book and our offer.

### Burlington Watch Co.

19th St. & Marshall Blvd., Dept. 1191, Chicago, Ill.

### Burlington Watch Co.

19th Street and Marshall Blvd.  
Dept. 1191 Chicago, Ill.

Please send me (without obligation and prepaid) your free book on watches with full explanation of your cash or \$2.50 a month offer on the Burlington Watch.

Name.....

Address.....

Please Mention Popular Mechanics



## Don't Spoil a Good Suit

When you have work to do in garage, workshop, garden, cellar or anywhere that means contact with grime or grease, protect your clothes with a suit of

## FINCK'S "Detroit Special" Work Clothes

Millions wear them. Made for comfort and fit, of the best materials obtainable. The best clothes insurance you ever had in the famous garments that

### "WEAR LIKE A PIG'S NOSE"

If your dealer is out of them, send us his name with this ad and the price, and we'll send your garment promptly by prepaid parcel post.

High Back Overalls . . .	\$1.25
Suspender Overalls . . .	1.25
Jacket . . .	1.25
Vest High Back Overalls . . .	1.50
Combination Suits . . .	2.25

Light or dark Blue Denim — or Khaki

**W. M. Finck & Company**

1154 Gratiot Ave. DETROIT, MICH.



**HERE YOU ARE, BOYS** A medallion pin of Foxy Grandpa. Everyone will notice it on the lapel of your coat and try to get a closer look at it. All you have to do is press the bulb, — Foxy Grandpa will finish the job by squirting a fine stream of water over the inquisitive one. Will squirt 20 feet. Greatest joke out. Order one today and fool your friends. Price 15c. Foxy Grandpa and Heoligan both for 25c. 3 for 50c or 1 doz. for \$1.00. A beautiful fountain pen free with every \$1.00 order. **AMERICAN SUPPLY CO., 918 Union St., St. Paul, Minn.**

## You Can Make Big Money

C. F. Larsen has made over \$1000, selling Matchless Gas Lighters. E. C. Haines made \$17.10 in one day. You too can make big money. The Matchless Gas Lighter lights gas or gasoline. Safer, cleaner, handier and cheaper than matches. **Send 25c for agents' sample and big money making offer.** **STEEL STAMPING CO., Dept. 29, 143 W. Austin Avenue, CHICAGO**



## MONEY IN MUSHROOMS

**FREE BIG BOOKLET TELLING HOW TO GROW MUSHROOMS**

at home all the year. Big profits. Take advantage of this wonderful opportunity to become independent. Write **Nat'l Spawn Co., Dept. 12, Boston, Mass.**

## 1900 Motor Washer Electric or Water Power

on Free Trial to Readers of Popular Mechanics

Reduce household expenses by using this great laundry outfit. Cuts cost of washing to 2 cents per week. Write for Free Book, giving full details, to

**1900 WASHER CO., 6218 Court St., Binghamton, N. Y.**

Address Canadian 1900 Washer Co., 355 Yonge St., Toronto if you live in Canada

## Any Boy Can Build This "Ideal" Flying 3-ft. Taube

— a scientifically exact scale reduction of the famous German WAR AEROPLANE; guaranteed to rise from the ground by its own power and FLY. Affords delightful, fascinating and instructive sport. With an

High Grade, Substantial Fittings

"Ideal" Taube Construction Outfit you can easily build this wonderful miniature flying machine. Our outfit includes all parts in knock-down form with plain, easily-understood instructions for assembling. Delivered complete, all charges paid, only **\$4.25**

Taube Building and Flying Instructions alone, 25c. "Ideal" Model Aeroplanes are sold at toy, department and sporting goods stores. If your dealer can't supply you, write us.

Send 5c for our 86-page **Model Aeroplane Book**, containing full information about other models, supplies, etc.

**IDEAL AEROPLANE SUPPLY CO., 82-88 West Broadway, NEW YORK CITY**



**\$2.00** and you get this **Superb Cornet** An astounding offer. This Triple Silver Plated 18710 Cornet will be sent to you for only \$2.00. Pay the balance at the rate of only 15c a day. Free trial before you decide to buy.

**WURLITZER FREE Band Catalog!** Send your name and address and get our big 250-page Band Catalog. Buy direct from the manufacturer. Rock-bottom prices on all kinds of instruments — easy payments. Generous allowance for old instruments. We supply the U. S. Gov't.

Write today for **Free Band Catalog.** **THE RUDOLPH WURLITZER CO., Cincinnati, Ohio Dept. 1121 Chicago, Illinois**

Free Carrying Case — with this Superb Triple Silver Plated 18710 Cornet, genuine leather. Write today.

## THIS BUNGALOW \$900 CAN BE BUILT FOR

This and many others in our new book, Building Plans for Modern Homes, will save you hundreds of dollars. One of the most complete and comprehensive books of plans ever published by any architect. Fifth edition just off the press. Two hundred and fifty floor plans and photographs of bungalows, etc., costing from \$200 up. Gives sizes and cost to build. Sent postpaid for **\$1.00**



**FREDERICK H. GOWING ARCHITECT** 18 Tremont St., BOSTON, MASS.



# Read these two Pages in My New Book

## Before you buy any Kind of an Engine

Lower Cost of Demand for Low Prices

Price Making Lower Prices Now

Engine Power Lower Cost of Operation

Easy Terms of Purchase

Ed.H.Witte



Let me send you a WITTE Engine to earn its own cost while you pay for it.

ED. H. WITTE

My Latest PRICES:

F.O.B. Factory

Easy to Start No Cranking

STATIONARY ENGINES

2 H-P.	\$34.95
3 H-P.	52.45
4 H-P.	69.75
6 H-P.	97.75
8 H-P.	139.65
12 H-P.	197.00
16 H-P.	279.70
22 H-P.	359.50

PORTABLE ENGINES

2 H-P.	\$39.95
3 H-P.	60.50
4 H-P.	82.75
6 H-P.	127.75
8 H-P.	174.65
12 H-P.	237.00
16 H-P.	329.70
22 H-P.	412.30

ENGINE SAW-RIGS

4 H-P.	\$124.25
6 H-P.	152.25
8 H-P.	202.15
12 H-P.	267.00

5-Year Guarantee



READING these two pages in my New Free Book will save you **dollars** in buying your engine—they will tell you not only how to judge engines and how to make your selection intelligently, but, even more important, what the **cost of operation** should be.

You have the right to expect many years of hard, faithful work from the engine you buy. But the more it costs to operate—fuel consumed and upkeep expense—the less profit you will get from its use. The engine that will do its day's work for **one-fourth to one-half less fuel cost**, and that **keeps on working**, is the one to buy. It means an actual cash saving—a saving that may amount, in a 6 H-P engine, to \$90.00 to \$150.00 per year.

## Fuel Saving WITTE Engines

Kerosene, Distillate, Gasoline and Gas

WITTE engines save you money in **first cost**, in **fuel cost**, and in **upkeep cost**. They save in first cost, because I have a natural gas well which furnishes me free light and fuel for power; because my plant is equipped with specially built machinery from my own designs, and because, when you buy a WITTE engine, you deal directly with the maker. They save in fuel cost, because there is no fuel or energy wasted. They save in upkeep cost, because their parts are few and simple; friction and wear are reduced to a minimum, and the material used in their construction is the best.

Sent Direct From Factory to User—**CASH OR EASY TERMS.**

5-Year Guarantee on Efficiency and Durability.

WITTE engines **cost less** to begin with, and they **quickly pay for themselves in fuel saved**. Ease and safety in starting, delivery of more than rated power, long service, and the backing of a liberal 5-year guarantee—these are other WITTE features that mean much to you.

Send For My **Free Engine Book**

It will tell you how to know engines—how to find their good points and weak spots—and will explain why I can build WITTE engines for less money than others cost to manufacture, and build them so they give longer service, with less fuel cost.

**ED. H. WITTE**  
WITTE ENGINE WORKS

1748 Oakland Avenue  
1748 Empire Bldg.

Kansas City, Mo.  
Pittsburgh, Pa.



ED. H. WITTE, Witte Engine Works,  
1748 Oakland Avenue, Kansas City, Mo.  
1748 Empire Bldg., Pittsburgh, Pa.

Without obligation on my part, and with no cost to me, please send a copy of your finest and latest Engine Book, with details of your Liberal Selling Plan.

NAME.....

STREET AND NO.....

CITY.....

STATE.....

Please Mention Popular Mechanics



## Play Billiards at Home

# \$1 DOWN

For a few cents a day (payable monthly) you can soon own a Burrowes

Home Billiard and Pool Table of your own, and your friends and family can join you in this most absorbingly interesting and healthful of all indoor games. No special room is needed—the Burrowes Table can be set on dining or library table, or on its own legs or folding stand. Put up or taken down in a minute.

Burrowes Tables range in size up to 4½x9 ft. (standard) and therefore fit any room. The game is the same on any size Table, for the angles never vary, and cues, balls, etc. are proportionate to the size of the Table. To learn or practice on a Burrowes Table means to become proficient on any Billiard or Pool Table. Burrowes Tables are splendidly made and correct in every detail. The most delicate shots, calling for skill of the highest order, can be executed with the utmost precision. Great experts say that the Burrowes Rogers High-Speed Rubber Cushions are the best made.

**FREE TRIAL** Prices of Tables from \$15 up. Cues, balls, etc. free. Terms \$1 or more down (depending upon size and style selected) and a small amount each month. On receipt of the first installment we will ship Table. Play on it one week. If unsatisfactory return it, and on its receipt we will refund your deposit. This insures you a free trial. Write for catalogue giving prices, terms, etc.

**The E. T. BURROWES CO., 163 Spring St., Portland, Maine**

Mfrs. Burrowes Rustless Insect Screens, Cedar Chests, Folding Card Tables

# BURROWES

## Billiard and Pool Table

Did you ever stop to think what an unlimited source of amusement and pleasure a Billiard and Pool Table of your own, in your own home, would be? It is home practice that develops the expert shots, the great Billiard and Pool players.

## The Acetylene Blow Torch Prest-O-Torch

Costs less to buy than a good gasoline blow torch and costs less to use

In all soldering and brazing, the Prest-O-Torch avoids the delays and uncertainties of gasoline outfits. Provides a concentrated, intense flame that doesn't blow out even in a high wind. Needs no attention whatever. Used with handy sizes of Prest-O-Lite cylinders—ready-made gas. Style "A" sells for 75c (Canada 85c). Used with the small MC size Prest-O-Lite. Will braze up to ¼ inch round rod. Can be fitted with handle and hook for added convenience in bench and overhead work. Style "C" Prest-O-Torch, for use with the larger sizes of Prest-O-Lite, is recommended for large work. Will braze up to ½ inch round rod. Sells for \$2.25 (Canada \$2.75).

Write for special literature and learn where you can see the Prest-O-Torch in operation.  
**THE PREST-O-LITE CO., Inc., 816 Speedway, Indianapolis, Ind.**  
Canadian Factory, Merritt, Ont. Exchange Agencies Everywhere

## High Grade Violins 30 Days' Free Trial

Your choice from a large and carefully graded stock of representative instruments from the leading foreign violin makers. Strictly hand made and of superior tone, these violins are far superior to the average old violins sold at four times the price.  
**Write Today.** Don't fail to send your name and address today for the superb Lewis catalog sent free and postpaid. Of value to everyone interested in high grade instruments. Learn how you can have your choice of these superb instruments on a free trial in your home. Write today.  
**Wm. Lewis & Son (Inc.) Dept. 1191, 225 S. Wabash Ave. Chicago**  
**OUR SPECIALTIES:** Imported wood-varnishes and tools for violin makers.

A Football Jersey



## Be the First in Your Club

School, City or Town, to wear this pure, all wool sweater, double collar and cuffs. Your choice in colors. This jersey was selected by 10,000 of my customers for last season. Your chum will recommend it. My 1915-1916 catalogue is now ready. Write me and learn my offer for your club's order. Popular Prices. Best Grade Sporting Goods—Football, Basketball, Baseball, Tennis, Golf, etc. **WRITE ME NOW.**

**JACK SHANNON CO., Dept. 46, 54 E. Monroe St., Chicago**

## Send 10c for Copy of Our New Wireless Manual No. 2

YOU GET YOUR MONEY BACK ON AN ORDER OF \$1.00

It contains 120 pages and tells how to erect and maintain wireless telegraph stations. Shows a number of diagrams. Has the Morse and Continental Telegraph Codes. Illustrates the best instruments to use; tells what they are for and how to use them. Has many new diagrams and other valuable information not contained in any other book. Do not wait. Send your request now. Get the best 10c value you will ever buy.

## Send for Our Pocket Catalog P28

It contains 212 pages, with over 1,000 illustrations, and describes in plain, clear language all about Bells, Push Buttons, Batteries, Telephone and Telegraph Material, Electric Toys, Burglar and Fire Alarm Contrivances, Electric Call Bells, Electric Alarm Clocks, Medical Batteries, Motor Boat Horns, Electrically Heated Apparatus, Battery Connectors, Switches, Battery Gauges, Wireless Telegraph Instruments, Ignition Supplies, Etc.

## MANHATTAN ELECTRICAL SUPPLY COMPANY

NEW YORK, 17 Park Place

CHICAGO, 114 So. 5th Ave.

ST. LOUIS, 1106 Pine St.

San Francisco, 604 Mission St.

# Florida Grapefruit and Orange Groves

## EARN LARGE INCOMES



# You Can Start a Grove To-day

which will increase in value while you pay for it in small monthly payments

No need to give up your present business or position. No need to move to Florida until you are ready. When you do come you can move to an improved producing grove. We furnish the land, the trees and all labor. You can invest in land NOW and develop it any time you wish—or you can start immediate improvements either personally or thru our company. We raise our own guaranteed trees in our own nurseries which insures every purchaser of the best fruit trees that can be grown. This also insures a successful grove.

Now a few dollars monthly invested now in these rich productive Hillsboro County lands will soon multiply and develop into a life income is fully told in our large handsomely illustrated booklet—"The Call of the Southland."

**RIGHT NOW IS THE TIME TO INVEST IN OUR NEW LITHIA TRACT SUBURBAN TO TAMPA**, the metropolis of South Florida—situated in the recognized center of Florida's Citrus Fruit belt. No better land can be found anywhere for fruit, truck, poultry and livestock.

This is the third great Hillsboro County tract that has been opened to homeseekers and investors by our old established, responsible, thoroughly experienced organization. Over 2,500 families are now rejoicing because they bought at opening prices in our two former tracts. Every family can tell you they got a square and generous deal.

Our new Lithia Tract now offers you the same wonderful opportunity—and more, because of the rapid growth and development on all sides within the past five years.

**Free—Absolutely Free—100 grapefruit and orange trees** to each and every purchaser who reserves 10 acres or more NOW. These trees will be held in our Nurseries until you are ready to plant them. This will give you a splendid start in developing a grove which will bring you an ever-increasing income and greatly increase the value of your entire farm.

Get our big new Florida book "The Call of the Southland"—look at the map—read the many enthusiastic testimonial letters from settlers now living on the farms they bought from us. Four big railroads intersect these suburban tracts—all the comforts of modern life right at hand.

Think of it—a 10-acre grove suburban to a city like this—a farm big enough to keep you in comfort all your lives, yet one you can pay for so easily that it will really surprise you.

Get the facts now. The Coupon brings them to you without cost or obligation. Get this new wonderful opportunity clearly before you while prices on this newly opened tract are still low and terms easy. Today \$1 per acre per month buys the land which can bring you independence and a future. Tomorrow—who can say?

Tear off the coupon and mail it now and we will lay before you, by return mail, full and complete information showing how you can easily become the owner of one of these beautiful grapefruit and orange groves, and why it is sure to prove the shrewdest, most profitable investment you can possibly make.

**NORTH TAMPA LAND CO.**  
C. E. THOMAS, President  
837 Marquette Building CHICAGO

The C. E. Thomas Nurseries are growing the finest varieties of grapefruit, orange, lime, fancy peach, plum and other semi-tropical fruit trees, which we are selling to land owners throughout the south, as well as our land buyers. There are no better trees grown than the C. E. Thomas Nurseries Warranted Citrus Fruit trees. Every tree fully guaranteed to grow.

If you already own land and are in the market for high-grade fruit trees do not fail to write for our New Illustrated Nursery Catalog before buying trees elsewhere. It is free and gives much valuable information on planting and caring for trees. The coupon is for our land book only.

No use trying to make yourself believe that savings bank interest will ever make you independent, nor 8% loans make you rich. Your money isn't working when you tie it up in such ways—it's LOAFING. Make your money work for YOU; right here in these rich fruit lands is your opportunity—here where a few dollars put to work NOW will reap all the benefit of development work constantly being done by the fast increasing population.

If you do not wish to improve your farm, you can in a few years, cash in on it from the investment standpoint without a stroke of work on your part. Think of it—an investment of a very few dollars a month—and a magnificent grapefruit and orange grove is the result almost before you know it.

**North Tampa Land Co.,** P. M. 1-16  
837 Marquette Bldg., Chicago

Please send me your large Illustrated Book "The Call of the Southland" on choice Citrus Fruit and Truck Farms suburban to Tampa, Florida, and information on how I can have a grove developed on the monthly payment plan.

Name .....

Street No. ....

City..... State.....

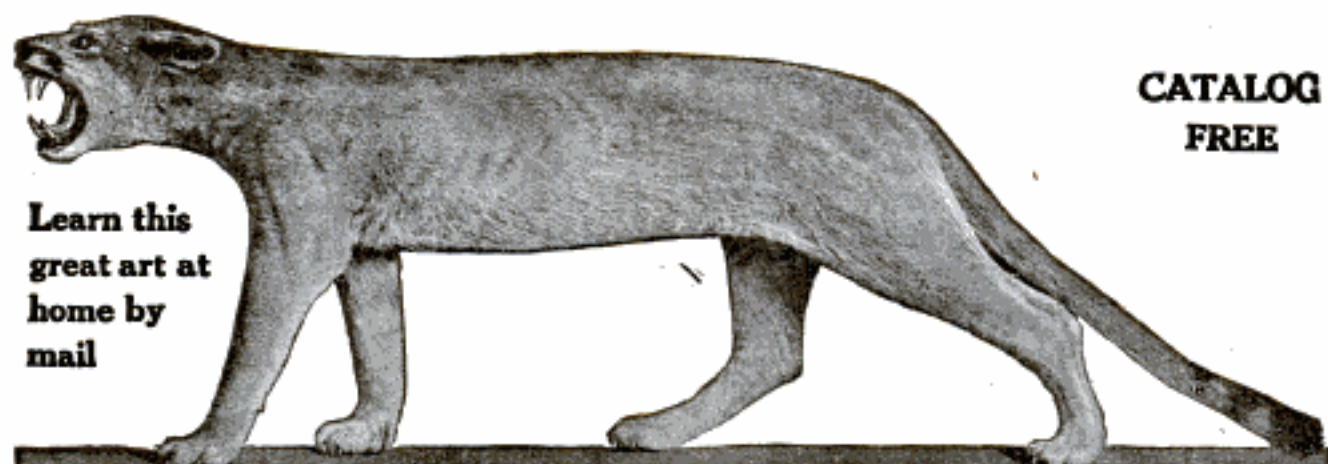

CATALOG  
FREE

Learn this  
great art at  
home by  
mail

## Mount Animals, Game Heads and Birds

The Splendid Art of Taxidermy can now be Learned Quickly in Your Own Home

**SPORTSMEN, HUNTERS, ANGLERS, NATURALISTS**—It is no longer necessary to lose your fine trophies nor to pay taxidermists exorbitant prices for stuffing them. You can now learn this great art for yourself easily and quickly during your spare time. We teach you by mail in your own home to successfully stuff and mount all trophies. Also to tan all kinds of hides and furs and make them into beautiful rugs and robes. Easy to learn by men, women and boys.

By taking our course of forty lessons you will soon be able to do perfect mounting and can decorate your home, office or den with the choicest of art. Thousands of men and women of every vocation, bankers, lawyers and business men, are members of our school and endorse it in the highest terms.



**Big Money in Taxidermy** Professional taxidermists earn from \$2,000 to \$3,000 a year and there are not half enough taxidermists to supply the demand. Mounted specimens sell readily for big prices. Many birds and animals now killed and thrown away can be turned into cash.

**TAXIDERMY BOOKS FREE**—We will send FREE postpaid our beautiful catalog, a copy of the Taxidermy Magazine, pictures of mounted game, sample diploma and hundreds of letters from students, all free. Write for these books today—now while you think of it. Remember you learn at home during your spare time. Write today.

**Northwestern School of Taxidermy, 1191 Elwood Bldg., Omaha, Neb.**

☛ We mount or sell all kinds of animals or game heads. Price list on request. Write today for our beautiful catalog and magazine.



**WOULD YOU LIKE TO OWN** a good paying mail order business? We have a line that gets repeat orders all the time. You can start in spare time; invest a dollar or two a week and soon own a nice business of your own. Particulars free. **NADICO, 4309 Lincoln Avenue, Chicago, Ill.**

Try My **Rapid** Fireless Cooker 30 Days—FREE



Cook every meal on it. If you are not satisfied and delighted I will refund every cent. Get my

**SPECIAL LOW FACTORY PRICE**

direct to you. Cooker is aluminum lined throughout. Full set of famous "Wear Ever" aluminum cooking utensils comes with it. Ask for free book of valuable recipes.

**WILLIAM CAMPBELL CO.**  
Dept. 64, DETROIT, MICH.



When the "boys" spy the trim, dainty figure of alluring little Miss

**SEPTEMBER MORN**

so handsomely embossed on these WATCH FOBs, they go to them like hungry wolves. **ROSE GOLD FINISH**; twice the size shown here; genuine Leather strap. A smashing big hit! —get this classy fob and **BIG MONEY** agent's offer to-day, 25c. postpaid.

**BUFFALO EMBLEM JEWELRY CO.**  
411 Morgan Building, Buffalo, N. Y.

## When You Build

please bear in mind that there is still plenty of

**WHITE PINE**

Send for our free booklet, "WHITE PINE IN HOME-BUILDING"

**WHITE PINE BUREAU**

1626 Merchants' Bank Bldg. ST. PAUL, MINN.

## AGENTS \$60 A WEEK

WONDERFUL NEW INVENTION—Big Seller

**New Keyless Doorlock**



No keys to carry—no keys to lose, works in the dark as well as light. Private combination, just like a safe. Best kind of burglar insurance. Can't be picked or opened with skeleton key. **NO MORTISE**; anyone can put it on. Easily attached to any door, only two screw holes necessary.

**Big Sales—Big Profits**

Low price makes easy sales. 100% profit for agents. Patented—no competition. Will give for territory, terms and canvassing sample.

**THOMAS LOCK CO., 3048 East St., DAYTON, O.**

Please Mention Popular Mechanics



A bunch of beauties caught with "BRISTOL" Rod No. 25 by A. E. Rehnert, Grand Lake, Mich.

**"Bristol"**  
Steel Fishing Rods

"BRISTOL" Rods have the quickness, action, strength and reliability, not only to catch fish but to give the fisherman the greatest joy in the sport of fishing.

"BRISTOL" Rods are made in 38 styles, ranging from \$1.50 to \$25.00. They are sold by 19,000 dealers. If you can't supply you, write us. **CATALOG—FREE**—pictures and describes all the different rods.

**NEW ART CALENDAR READY**  
Sent prepaid on receipt of 15c

The new 1916 "BRISTOL" Calendar is a full color reproduction of an oil painting by Philip R. Goodwin, the noted outdoor-sports artist. A very handsome decoration for home, den or camp.

**THE HORTON MFG. CO.**  
106 Horton St., Bristol, Conn.

# PATENTS

**IF YOU HAVE AN INVENTION** which you wish to patent you can write fully and freely to Munn & Co. for advice in regard to the best way of obtaining protection. Please send sketches or a model of your invention and a description of the device, explaining its operation.

All communications are strictly confidential. Our vast practice, extending over a period of seventy years, enables us in many cases to advise in regard to patentability without any expense to the client. Our Hand-Book on Patents is sent free on request. This explains our methods, terms, etc., in regard to *Patents, Trade Marks, Foreign Patents, etc.*

All patents secured through us are described without cost to the patentee in the *SCIENTIFIC AMERICAN*.

**MUNN & CO.**  
SOLICITORS OF PATENTS  
672 WOOLWORTH BLDG., NEW YORK  
and 625 F STREET, WASHINGTON, D. C.

The United States has more than 18,000 regularly established libraries which in all contain over 75,000,000 volumes.

## Bausch and Lomb BALOPTICON

THE PERFECT STEREOPTICON

Bausch & Lomb Optical Co., 576 St. Paul St., Rochester, N. Y.

## Small Engines

Our illustrated book tells all about our wonderful small engines in  $\frac{1}{2}$ , 1 and  $1\frac{1}{2}$  H. P.

### SIEVERKROPP STARTER

515 SEAT STARTER FOR FORD CARS

Shipped on trial. Send stamp for booklet and Special Offer.  
Sieverkropp Engine Co., 1224 18th St., Racine, Wis.

## BOYS JOIN THE LONE SCOUTS



**FREE** A big new boys' organization based on real boy life with Indian totem poles, signs and different degrees. The most useful organization ever started for boys. Over 60,000 members first four weeks. Does not cost a cent to belong (we do this so every boy can join). It is supported by the sale of its official publication, the **LONE SCOUT**

This 12 page paper tells all about the Lone Scouts and what they do, also contains stories of adventure, jokes, colored pictures and other matter which boys like. You need this paper to be a Lone Scout. Send 10c and names and addresses of 5 boys and we'll send you the Lone Scout (12 issues) for 15 weeks and send your membership certificate, badge and instructions free.

PUBLISHER, LONE SCOUT, 504 North Dearborn St., CHICAGO

# DIAMONDS

ON CREDIT

20% DOWN

10% A MONTH

The most beautiful Diamonds are the Blue-white, especially if absolutely perfect. **LYON DIAMONDS** are 1st Quality, Blue-white. A certificate furnished with every Diamond guaranteeing its value and providing for exchange at full purchase price. Goods sent prepaid for examination and approval. Write for Catalog No. 3.

10 per cent DISCOUNT FOR CASH  
**J. M. LYON & CO.,** (Est'd 1843) 71-73 Nassau St., NEW YORK.



## "New-Skin"

— to prevent infection

New-Skin is an antiseptic liquid for cuts, scrapes and little hurts. When it dries, it forms a water-proof "film" that protects the cut and allows it to heal.

Carry it with you always. Keep a bottle in the house.

Genuine New-Skin →

See directions and circular. Many uses. Prices (in U. S.): 10c., 25c., 50c. At druggists. Or send us 25c. in stamps for "home" size by Parcel Post. Address News-Skin Co., New York. (Dept. L.)



Always in glass bottles; red and gold paper cartons

# MAGAZINES



J. M. Hanson-Bennett Magazine Agency is the largest in the world. You can save money on the magazine you want by writing for

## This Catalog FREE

Our New Catalog lists more than 3000 Periodicals and Club Offers. It's a big Money-Saver. Send us your name and address on post card today and get this big free catalog. **Do it Now.**

Agents Wanted. Write for full particulars

**J. M. HANSON-BENNETT Magazine Agency**

250 Brooks Building : : CHICAGO, ILLINOIS

## GACHOO!

Make the whole family and all your friends "just sneeze their heads off" without knowing why, with **Cachoo**, the new long distance harmless snuff. Sent anywhere for 10c. 3 for 25c. 1 doz. and special premium for 90c. **AMERICAN SUPPLY CO., St. Paul, Miss.**



## Here's a New Business



Reproduce Photographs of persons and scenes upon watch caps, dials, cases, etc. Work easily done. Knowledge of photography not necessary. **TRIAL OUTFIT** with directions, 52 postpaid—Contains enough chemicals to make 10 reproductions (watch cap size) that you should sell from \$1.50 to \$2.50 each. Satisfaction guaranteed. **ORDER TODAY.**

**American Arts & Crafts Company, Dept. D1, Boston, Mass.**





# PATENT SPECIALISTS

## VICTOR J. EVANS & CO.

### LARGEST PATENT AGENCY IN THE WORLD



THE largest Patent Agency in the world is the firm of Victor J. Evans & Company, of Washington, D. C., with branch offices in New York City, at Nos. 189, 191 Broadway; in Philadelphia, at No. 1429 Chestnut Street, and in Pittsburgh, at No. 514 Empire Building. The growth of this firm has reached such proportions as to necessitate the erection of a special building, the Victor Building, Nos. 720, 724 Ninth St., N. W., Washington, D. C., opposite the United States Patent Office, is the finest and most perfectly equipped office building in the country devoted exclusively to the patent business.

Evans & Company are but following the practice of the Patent Office, who, realizing the impossibility of any one man having a general knowledge sufficient to handle all classes of cases, have divided the Patent Office into forty-two divisions, each handling several classes of inventions, and it is through this system of specialists and experts forming the technical corps of their offices that this firm is enabled to secure



### Specialization

The field of invention is so vast that it is impossible for any one man to become an expert in all the different classes of invention. Only those practically skilled in the class to which an invention relates are capable of rendering efficient service. For this reason, this firm employs a number of patent lawyers and mechanical experts who have been selected for their special knowledge and ability in a certain line of invention.

In equipping their offices with experts and specialists who devote their time to one or two inventions, Messrs. Victor J.



VICTOR J. EVANS

### Patents that Protect and Pay

Any one will appreciate the advantage of this corps of experts over other attorneys, where one man has to handle all classes of patents submitted. This firm is enabled to direct a particular invention from the time it is submitted until the patent is secured, in the hands of experts in the class to which the invention relates, thus securing the best possible services. This firm has also helped a number of inventors who were in need of financial aid to obtain patents. This was accomplished by means of their Certificate of Patentability, which furnished the necessary proof of patentability, and thus enabled their clients to interest partners or secure financial assistance to protect their ideas.



### Assist Their Clients to Sell Their Inventions

Victor J. Evans & Company also assist their clients to sell their inventions by connecting the inventor with capital. They are constantly in receipt of requests from manufacturers, promoters, mail-order houses and others who are in the market for patents secured by them. They give their clients a list of Patent Buyers containing names and addresses of the persons desiring to purchase patents. This firm also advertises their clients' inventions free in Manufacturing Journals and also distribute, free of charge, four books on patents which are the finest publications ever issued for free distribution. "HOW

TO OBTAIN A PATENT" contains one-hundred mechanical movements illustrated. "WHAT TO INVENT" contains a valuable list of inventions wanted; also information concerning prizes offered for inventions amounting to \$1,000,000. "PATENTS THAT PAY" contains letters from clients for whom we have secured profitable patents. "FOREIGN PATENTS" contains full information regarding patents in foreign countries. Persons interested in patents should write for these books, which will be sent upon request, entirely without charge or obligation, by filling out the annexed coupon.



### FREE COUPON!

### VICTOR J. EVANS & CO., Patent Attorneys

New York Offices: 189-191 Broadway Philadelphia Offices: 1429 Chestnut St.  
Main Offices: 765 Ninth St., N. W., Washington, D. C.

This Coupon, accompanied by model or sketch, with description of invention will entitle the sender to Free Opinion as to Patentability.

GENTLEMEN: Please send me FREE OF CHARGE your FOUR Books as described above.

NAME .....

ADDRESS .....

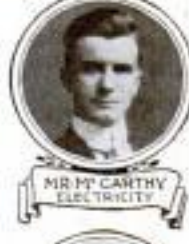

# WANTED IDEAS



Inquiries from Manufacturers and Other Buyers of Patents  
Who Are Looking for Good Ideas

## Protected by Owen Patents

Are constantly being received. Hundreds of ideas are wanted—a market exists for them to-day. YOURS may be one of them. Send for my free books and see for yourself—read the requests for inventions protected by me. Many are simple. You can help supply this demand.

As soon as my clients' rights are protected I aid in every practicable way, **without charge**, to sell. Their applications are advertised free—their patents are called to the attention of the proper prospective buyers—every necessary thing is done. Get my booklets and see.

## THESE ARE FREE

You will incur no obligation by writing me. A simple request will bring them to you—the finest, most reliable and instructive patent books published. A postal will do.

**"Successful Patents"**—a 72 page guide book, tells how to proceed; describes my advantageous business methods; gives references, testimonials, etc.

**"Stepping Stones"**—gives hundreds of hints of inventions wanted; articles from interviews of noted authorities; tells the truth about prizes for inventions.

**"Patent Promotion"**—tells you how to sell; why some inventors fail; discusses the value of your idea; how I aid my clients; manufacturing aids furnished you; recent successful patents, etc.

You will also be sent from time to time, as new inventions are wanted, full information concerning them. Only in this way can you keep up to date.

**Write for These To-day**—Advice costs nothing. All communications confidential. I secure patents or receive no compensation. Your work will receive my personal supervision—but my fees are no higher than others.

## Results Speak Loudest—But Here Are Some References

Columbia National Bank,  
Washington, D. C.  
National Locktile Co.,  
Washington, D. C.  
The Carnahan Press,  
Washington, D. C.  
Lightning Gun & Cycle Works,  
Oklahoma City, Okla.  
Antholene Mfg. Co.,  
Hutchinson, Kans.

National Rack Co.,  
61 Hannover St.,  
Boston, Mass.  
The C. J. Loftus Co.,  
13 Spring Common,  
Youngstown, Ohio  
Whitehead Hosiery Mills,  
Burlington, N. C.  
Dickinson Mfg. Co.,  
Des Moines, Iowa.

A LARGE NUMBER OF OTHERS IN MY BOOKLETS.

**RICHARD B. OWEN** 9-303 OWEN BLDG.  
WASHINGTON, D. C.

Inventors submitting their inventions to me are protected in a tangible manner until their applications are filed.



### Search of Records

Send sketch or model of your invention for free search of Patent Office Records and report on patentability.

# PATENTS THAT PROTECT and PAY

Advice free. Terms reasonable. Highest references. Best results.  
Send sketch or model for FREE examination and opinion.

BONDED and recommended Patent Lawyer in the Rand-McNally Directory of Bankers and Attorneys Published by Rand-McNally & Co., Chicago, Ill. Recommended Patent Attorney in the Bankers Register and special list of selected lawyers published by the Credit Company, Pontiac Building, Chicago, Sharp & Allen's Directory of Lawyers and Bankers of Philadelphia, Martindale's American Legal Directory of New York City, and the Con. P. Curran Directory of Bankers and Lawyers of St. Louis.

**ALL BUSINESS GIVEN PROMPT AND PROPER ATTENTION**

A large list of strong recommendations furnished free

**WATSON E. COLEMAN, Patent Lawyer, 624 F St., Washington, D. C.**

## Inventors

Do Not Sacrifice  
Your Inventions

Get full money value.  
RELIABLE Book Free. Write

R. S. & A. B. LACEY  
624 Barrister Bldg., Washington, D. C.



**IDEAS = MONEY**  
**PATENTS THAT PAY**



Over \$600,812.00 made  
by clients. Proof given.  
Send data for free advice.

**2 WONDERFUL GUIDE BOOKS FREE**

Don't miss these books. Mail postal today.

**E. E. VROOMAN & CO., 871 F St., WASHINGTON, D. C.**

Send for **FREE BOOK** { **WHAT TO INVENT**  
**WHAT NOT TO INVENT**  
**HOW TO SELL YOUR PATENT**  
Copies of nearest Patents and report in every case without charge  
**H. L. WOODWARD, 9th and G Sts., WASHINGTON, D. C.**

PATENTS AND TRADE MARKS

**LANCASTER & ALLWINE**



201 OURAY BLDG., WASHINGTON, D. C.

Book "Inventions — Patenting and Promoting" Free

Our co-operation with an Inventor is, FIRST, to help him establish his rights before he discloses the idea to ANY attorney; SECOND, to give a frank opinion whether it will pay to patent his idea, based upon our extensive knowledge of manufacturers' wants and facilities; THIRD, to obtain for him a patent which is in reality a valuable monopoly; FOURTH, to advise and assist him in the profiting by outright sale, territorial grants, obtaining royalty, or independent manufacturing of the invention; and FIFTH, aiding him to so profit by conferring with manufacturers, investors or distributors of machines.

Before sending a sketch to anyone, sign, witness, and deposit in our fire-proof vault our document

**EVIDENCE OF CONCEPTION**  
AND ESTABLISH YOUR RIGHTS

NEW FRUIT JUICES FOR THE HOME—That the juice of currants, blackberries, black raspberries, sour cherries, and peaches may be prepared and kept as suc-

**INVENT SOMETHING** Your Ideas may bring wealth. Our FREE BOOK tells what to INVENT and How to Obtain a patent through our NEW CREDIT SYSTEM. Write TODAY.  
**WATERS & CO.** 4182 Warder Bldg. WASHINGTON, D. C.

**PATENTS** C. L. PARKER  
Formerly Member Examining  
Corps, U. S. Patent Office  
**PATENT LAWYER**  
210 MCGILL BLDG.  
WASHINGTON, D. C.

Patents, Trade Marks, Copyrights, Patent Litigation  
Handbook for Inventors, "Protecting, Exploiting  
and Selling Inventions" sent free upon request.

# PATENTS SECURED OR FEE RETURNED

Compare My SERVICE and TERMS with Those of Any First Class Attorney

Latest and  
Most Complete  
Patent Book  
Ever Published  
for Free Dis-  
tribution

WRITE FOR IT

Send Sketch, Photograph, or Model of your invention for an ACTUAL SEARCH of the Records of the Patent Office and report as to patentability — FREE. I give every detail of every case my closest personal attention and do not entrust your interests to assistants. Impartial advice on your ideas. I help you sell your patent. Terms moderate. My 90-page book tells what inventors should know before they apply for a patent.

**GEORGE P. KIMMEL, Patent Lawyer** 200 Barrister Bldg. Washington, D. C.



# Wanted—Ideas Inventors! Send for these Remarkable FREE BOOKS, Today

Complete and full information about patents, everything the inventor or manufacturer should know, has been included in these books. Never before has such an inexhaustible fund of valuable information been at the inventor's disposal. Regardless of the fact that the compilation of this information cost us thousands of dollars, we will send to all interested persons, any or all of these books, entirely without charge or obligation.

## "Millions In Patents"

This volume, 182 pages, tells the story of the romance of invention. The brain of the inventor is the magician that has made the ancient fairy tales come true. Millions have been paid for a hook, fortunes have come from a toy. Read "Millions in Patents," and you will realize that this country and all the nations of the world are ready to enrich you beyond your wildest dreams if you can contribute one useful or amusing thing.

## "What Is a Trademark?"

It is not an exaggeration to say that billions of dollars have been made out of trademarks, labels and copyrights. He who can fashion a trademark or design a label which will make a product stand out above all similar products, is indisputably a genius for whose brains the world offers almost unlimited money.

## "Foreign Patents"

A good invention is bought not by one country but by the world. "Foreign Patents" shows you how the inventor may be paid by other countries and other peoples, as well as by this nation, for his ideas and his inventions. It explains how we, through our representatives in the capitals of the world, maintain for your benefit an endless chain of opportunities which, if you take advantage of them, will girdle the earth and make of your product an agent that may bring back to you rich rewards.

## "Inventions Needed"

This book, 256 pages, lays before you a description of the active and profitable field of invention. It tells you the inventions the world needs today, the devices manufacturers are seeking for their business, the ideas for which the public will pay big money. It gives great men's ideas of the most important things needed in inventions now. Science is the key to wealth, and this key can be turned best by the inventor. This book tells you why.

## "How to Get Your Patent and Your Money"

The man who invents needs the co-operation of the man who invests. This book, 132 pages, is a guide to the inventor. It describes, according to the teachings of our experience and the lessons of men made rich by patents, how the inventor may secure money; the right amount of money, for the device which his brain has constructed. If you have invented something and desire to learn what it will cost you to get your patent and what you must do to find your market, read this book.

## "Special Bulletin of Patent Buyers"

This bulletin, 64 pages, contains copies of hundreds of letters from wealthy men who are seeking to purchase patents. Next to the idea of the invention itself, the most valuable thing to the inventor is a hint of where there is a man ready to buy the invention or to finance the inventor so that his device can be readily marketed. We act as intermediary, without one cent of charge, between the man who invents and the man who invests.

**We Secure Reliable Patents, Trade Marks,  
Copyrights, On Most Liberal Terms  
Ever Offered**

**Send Model or Sketch and Description of  
your invention for Free Search of  
the United States Patents**

**Rejected and Difficult Cases are Our Specialty**

**RANDOLPH & CO.**  
600 F St., N. W., Washington, D. C.

**RANDOLPH & CO.,  
WASHINGTON, D. C.**

Gentlemen: Please send me, without obligation on my part, the books indicated on margin of this coupon. (Write on margin of coupon, names of books desired.)

NAME.....

STREET.....

CITY.....

STATE.....

# SEBASTIAN LATHES HIGH QUALITY LOW PRICES

If you delight in good tools you will delight in Sebastian Lathes. For 25 years we have built lathes, and lathes only, employing skilled labor always, and improving equipment and machinery every year. Sebastian Lathes are

## STANDARD FOR QUALITY—LOW IN PRICE

They are accurate, economical, simple and durable. Many re-orders and voluntary letters from users of Sebastian Lathes prove this. The Sebastian reputation is back of every Sebastian Lathe. You are judge and jury when you buy a lathe. We are not satisfied until you are. Look over the complete line in our new catalog. It shows Lathes for general repair work, garage and automobile work, etc.

When you buy a lathe, say "Sebastian"

ADDRESS (FOR THE CATALOG)

THE SEBASTIAN LATHE COMPANY, 107 Culvert St., Cincinnati, Ohio

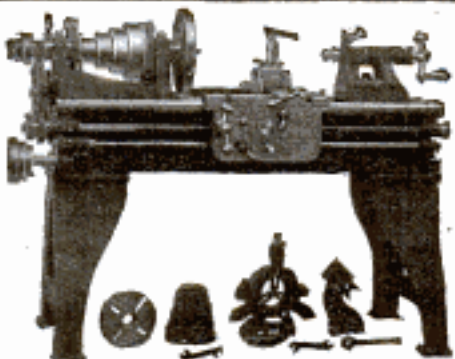

## A Constant Water Supply For Your Farm Home

Don't depend on a windmill or the back-breaking hand pump to fill your water tank. It's more reliable and economical to install a

## RIFE RAM

and be sure of a constant supply of fresh water, without fuel or attention. The Rife Ram operates by the flow of any stream having a fall of 3 feet or more and a supply of 3 gallons or more per minute. Will maintain air pressure system. Simple to install. Over 11,000 in use. Satisfaction guaranteed.

Write today for catalog and free estimate

RIFE ENGINE CO.

3131 Trinity Building NEW YORK

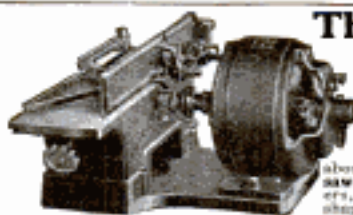

## The CRESCENT BENCH JOINTER

is a very handy little tool even in some of the largest shops. Besides a lot of amateur workers find in this little machine exactly what they have been looking for.

Ask today for our catalog giving complete description and telling about our line of hand saws, jointers, saw tables, planers, shapers and matchers, disk grinders, swing cut off saws, shapers, Universal wood workers, variety wood workers, betters.

THE CRESCENT MACHINE CO., 93 Columbia St., Leontia, O.



## INVENTORS Our Brain Belongs to You. Our Ideas Are Free of Charge.

All we want in return is to build your model, special machinery, dies, tools and jigs to manufacture sheet metal goods, etc. We are expert mechanics, over thirty years' experience and have one of the best equipped shops in the country. Ask for Booklet No. 17. Consultation free. Experimental work strictly confidential.

A. Nacke & Son, J. Urmann, A. Heldrich, Prop's  
214-242 S. 9th St., Philadelphia, Pa.

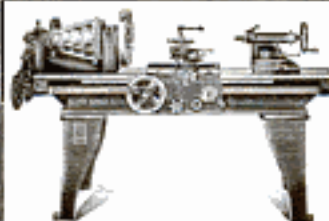

## South Bend Lathes

For the Machine and Repair Shop

How to Run a Lathe  
A 50 cent book for 10 cents.  
Postpaid, stamps accepted.

Straight or Gap Beds. Send for free catalog giving prices on entire line.

SOUTH BEND LATHE WORKS  
423 Madison St., South Bend, Ind.

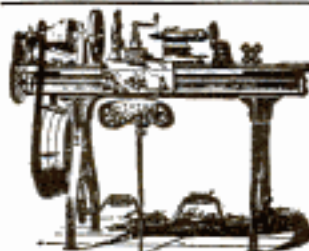

## LATHES

9 to 18-inch Swing

List price \$75 and up according to size. When ready to buy send for Lathe Catalog and prices.

W. F. & John Barnes Co.

100 Ruby Street, ROCKFORD, ILL.

DO YOU HAVE KNIVES TO GRIND, SILVER TO POLISH, SMALL TOOLS TO OPERATE, WASHING MACHINES OR WRINGERS TO RUN? LET THE RED DEVIL

DO YOUR WORK

Attached to any water faucet will develop up to 3 Horse Power according to size of pipe and water pressure. Only perfect small motor made. Improved bucket wheel construction.

6 in. Motor for Mechanics and Tradesmen. Washing Machine, 1/2 H. P., on 1/2 in. pipe, 80 lbs. water pressure; 1 H. P., on 3/4 in. pipe, 100 lbs. water pressure. Net price \$5, cash with order.

No. 1422—4 in. Motor for grinding, polishing, lams, sawing machines; for Doctors, Dentists, Druggists, etc., with emery, buffing wheel, silver polish and pulley, \$3.

No. 1433—4 in. Motor and pulley only \$2.50, cash with order.

Money back for any reason. Order your motor from dealer or from us. Send your water pressure and size of supply pipe. Active Agents wanted. Catalog free.

Only Motor to do this work



DIVINE WATER MOTOR CO  
DEPT P. UTICA, N.Y.

Please Mention Popular Mechanics

carefully as grape juice and by the same methods, has now been demonstrated in the course of a series of investigations into the whole question of fruit juices which the United States Department of Agriculture is conducting. The juices of the fruits mentioned, it has been found, retain their characteristic color and flavor after being sterilized and stored away, and can, therefore, be made available for use throughout the year. In this way it is thought much fruit that has hitherto been allowed to go to waste may be utilized.



## MODELS BUILT FOR INVENTORS

Practical, economical and modern methods of Model and Machine construction. Scientific Experimental Work. Expert designing and building of special Models, Tools and Machinery. Our staff of Skilled Mechanics assist customers to develop and perfect ideas, Patents and Inventions, etc.

Let us take care of your mechanical requirements.  
Regal Model & Tool Works, 122 S. Clark St., Chicago



## Models and Gears

Developing inventions and making working models our specialty. Well equipped shop and staff of experts at your service. Carry complete stock of gears. Shipments same day order received. Send 4c stamp for booklet of Inventors' Supplies.  
UNION MODEL WORKS, Est. 1882, 121 S. Clark St., CHICAGO



## Models and Supplies

We make working models of any description and material, also dies, tools and sheet metal stampings. Send your drawing or sample for estimate. Write for catalog of gears and model supplies.

The Pierce Model Works, 3405 Pierce Ave., Chicago, Ill.



## MECHANICAL SUPPLIES AND MATERIAL of all kinds.

EXPERIMENTAL AND LIGHT MACHINE WORK to order.  
132 MILK STREET, BOSTON



## BRASS GEARS

Cut by an entirely new process. The most accurate made and at prices that cannot be equaled by others. Every gear has a hub, center painted ebony black, edges turned true, highest grade red brass, and much heavier than others. We carry the largest stock in the world and every gear listed is always shipped on date of order.

SEND FOR CATALOGUE  
CHICAGO STOCK GEAR WORKS  
16 S. Fifth Av. Chicago



# World-Wide Call for New Inventions

By a WASHINGTON PATENT ATTORNEY

## War Closes Factories in Europe—America Has Become Bread Wagon for the World—American Manufacturers Must Have New Inventions to Meet World-Wide Demand

This is why there is such an unusual demand for new inventions. Inventors, take heed—now is the opportunity to realize on your ideas. Get that new invention patented. Get it in action. The call for new inventions is insistent and it is world-wide.



Buffer for Window Shade Sticks. A woman's valuable invention.

Our manufacturers must take up the manufacturing of goods where Europe left off. Must supply those articles European men, women and children need. Also those articles which Europe has been selling to us. The burden all falls on the American manufacturer and he appeals to the American inventor. The highest daily records of American exports have been made during the past fall.

The American manufacturer must now not only supply the increased demand in this country for goods; he must have things to take the places of the thousands of articles that Europe has been making in the past. Nothing hard or especially unusual is wanted—just everyday things. New things to be used here and abroad. Also improvements in old things. Improvements that will do the work better, or will cost less, are in demand.

The rubber-faced metal clip to go on the end of the curtain shade stick to prevent noise when it blows against the window frame is having wonderful success and shows what may be done with even a simple article. Another simple thing is the Sure-Grip Towel Holder that the inventor is selling with wonderful returns. The Concrete Cesspool illustrated has brought the inventor more than \$50,000 in the sale of state and county rights in addition to royalties.



THE SURE-GRIP TOWEL HOLDER

A big business built on a small invention of Towel Holder.

The demand for good inventions never ceases with us. A New York Specialty Co. wants a dish washer, odorless garbage can and mail order articles, while a man from Illinois

asks for anything that can be manufactured in a wood-working factory. A Lockport manufacturing concern wants patents on articles for household and office use, while a Newark concern writes: "What have you in a peanut vending machine that can be bought from the owner?" A Chicago, Illinois, man says: "I wish you would put my name on your list and keep it there for some time to come. I wish to buy a patent or operate on a royalty."

We have more than forty requests for patents on dish washers and drainers, sixteen requests for devices

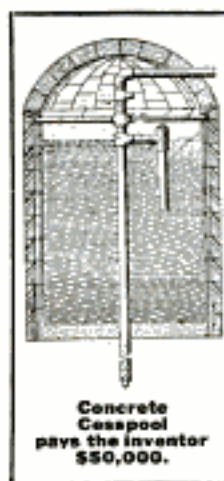

Concrete Cesspool pays the inventor \$50,000.

for turning sheet music. There are twenty-eight requests for attachments for automobiles, twenty-four for vacuum cleaners and many others for advertising novelties, ash receptacles, clothes pressing devices, envelope fasteners, fly traps, fruit pickers, games, mail boxes, toys, vegetable slicers, water filters, window cleaners, window screens and other things.

We advertise for manufacturers to consult us if they wish to buy patents or manufacture on royalty and these requests are in the letters that pour in from all over the country. Some say just what they want. Others say they want any good invention. We have arranged these names and addresses in convenient form and give them to our clients free of charge. Our book "What to Invent" gives a valuable list of suggestions. Send for it, and ask for our book "How to Obtain a Patent." They are both free. Send a sketch and description or model of any invention you may now have. It may be just one of the things asked for. We will give you a free opinion regarding patentability. If you have no invention, get our books and find out what is wanted and then invent one or more of them. Chandlee & Chandlee, Patent Attorneys, 969 F St., Washington, D. C.

**Burns Kerosene (Coal Oil)**

# LIGHTS WHOLE ROOM

**BEATS ELECTRIC OR GASOLINE**

## 10 DAYS FREE

**Charges Prepaid Send No Money**



We don't ask you to pay a cent until you have used this wonderful modern light in your own home ten days—we even pay transportation charges. You may return it at our expense if not perfectly satisfied after putting it to every possible test for 10 nights. You can't possibly lose a cent. We want to prove to you that it makes an ordinary oil lamp look like a candle; beats electric, gasoline or acetylene. Lights and is put out like old oil lamp. Tests by Government and 33 leading Universities show it.

**Burns 50 Hours on One Gallon** common coal oil, and gives more than twice as much light as the best round wick open flame lamps. No odor, smoke or noise; simple, clean, no pressure, won't explode. Several million people already enjoying this powerful, steady light, nearest to sunlight. **Guaranteed.**

### Men Make \$50 to \$300 Per Month

with Rigs or Autos delivering the ALADDIN on our easy trial plan. No previous experience necessary. Practically every farm home and small town home will buy after trying. One farmer who had never sold anything in his life before writes: "I sold 57 lamps the first seven days." Another says: "I disposed of 37 lamps out of 31 calls." Thousands who are coining money endorse the Aladdin just as strongly. **NO MONEY REQUIRED.** We furnish capital to reliable men to get started. Ask for our distributor's plan, and learn how to make big money in unoccupied territory. **Sample sent for 10 Days' Free Trial.** We want one user in each locality to whom we can refer customers. Be the first and get our special introductory offer under which you get your own lamp free for showing it to a few neighbors and sending in their orders. Write quick for **10 DAY ABSOLUTELY FREE TRIAL.** Address nearest office.

**MANTLE LAMP COMPANY, 348 Aladdin Building**  
*Largest Kerosene (Coal Oil) Mantle Lamp House in the World*

**CHICAGO NEW YORK CITY PORTLAND, ORE. MONTREAL or WINNIPEG, CAN.**

**Won GOLD MEDAL at World's Exposition San Francisco**



## The "BEST" LIGHT

A soft, luminous light, which casts no shadow. Brighter than electricity or acetylene. Makes and burns its own gas. Costs 2c a week. No dirt, smoke nor odor. Over 200 styles, ranging from 100 to 2000 candle power. Absolutely guaranteed. Write for illustrated catalog.

**AGENTS WANTED EVERYWHERE**  
**THE BEST LIGHT CO.**  
 324 E. 5th St., Canton, O.



## AGENTS WANTED

for independent hollow-wire lighting systems for homes, stores, etc.; also complete line of lanterns and portable and street lamps. Use common gasoline.

### AKRON GAS LAMPS

are most improved, simplest and safest of all. Best and cheapest illumination known. Shed a clear, soft, bright, white light of high candle power. Fully Guaranteed. Handy demonstration outfit. Our Agency Proposition cannot be beat. Exclusive territory. Write quick for Catalog and Terms.

**Akron Gas Lamp Co., 622 So. Main St., Akron, O.**



## BEACON BURNER FREE

**FITS YOUR OLD LAMP**

**100 Candle Power Incandescent** pure white light from (kerosene) coal oil. Beats either gas or electricity.

**COSTS ONLY 1 CENT FOR 6 HOURS**

We want one person in each locality to whom we can refer new customers. Take advantage of our Special Offer to secure a Beacon Burner FREE. Write today. **AGENTS WANTED.**

**HOME SUPPLY CO., 111 Home Bldg., Kansas City, Mo.**

**LONDON ANIMAL DEALER CLAIMS TO BE HARDEST WORKER**—A complaint by London undertakers' employes that they were worked too hard, led to the following statement by an animal dealer, as told



## KEROSENE Gas Lamps

**Make Your Business Prosperous and Your Home Cheerful**

by using our "Safety" Kerosene and Gasoline Gas Lamps. If we are not represented in your town we want an agent.

**BRILLIANT GAS LAMP CO.**  
 1009X So. Wabash Ave., CHICAGO, ILL.



# 300 Candle Power of Light

## AT A COST OF 1/8c PER HOUR

The Kerosene table lamp has one inverted mantle and **MAKES and BURNS ITS OWN GAS FROM COMMON KEROSENE or COAL OIL.** It gives a bright and steady white light **TEN TIMES AS BRILLIANT** as an ordinary kerosene wick lamp.

### THE "QUICKLIT"

Gasoline table lamp can be **LIT WITH AN ORDINARY MATCH, LIKE CITY GAS.**

*Both styles equipped with automatic cleaning needle.*

**No smoke, no smell, no wicks to trim. A splendid proposition for dealers**

**LIVE AGENTS WANTED** Write today for further particulars, also complete illustrated catalog describing the above kerosene and gasoline lamps and hollow wire systems.

**THE NAGEL-CHASE MFG. CO., 152-160 East Erie St., CHICAGO, ILL., U.S.A.**  
*The largest manufacturers of artificial lighting devices in the world.*



## BUY YOUR FURNACE \$10 DOWN \$10 A MONTH



Our monthly payment plan of selling direct saves you the dealer's profits and charges for installation. The

### JAHANT FURNACE

with the patented "Down Draft System" is best for residences, schools, hotels, churches, etc., because it delivers plenty of heat wherever and whenever desired at a saving of  $\frac{1}{2}$  to  $\frac{1}{3}$  in fuel bills. Install the Jahant yourself. We send complete outfit, freight prepaid with special plans, detailed instructions and all necessary tools for installation. Satisfaction guaranteed or money refunded.

WRITE FOR FREE ILLUSTRATED BOOK  
THE JAHANT HEATING CO.

200 Steiner Avenue

AKRON, OHIO

## Save $\frac{1}{3}$ to $\frac{1}{2}$ on Fuel Bills

### The Typewriter Opportunity

Will you let me send you this Standard Visible Typewriter—the Famous Model No. 5 OLIVER

with Inbuilt Tabulator and Back Spacer—on FREE TRIAL? No money in advance—no deposit—no C.O.D. If you find it to be the best typewriter you ever saw and want to keep it, I will make you a price that is lower than wholesale—lower than the lowest agents' prices and you can let typewriter pay for itself out of what it earns for you. Full Standard Equipment with machine. LIFE GUARANTEE. Because there are no American Typewriters going to Europe just now, I can make you a wonderful price inducement. BE SURE AND SEND TODAY for free Catalog and Full Details of this Greatest of Typewriter Offers. All information absolutely free. General Manager, TYPEWRITERS DISTRIBUTING SYNDICATE 1510-57K Wabash Ave., CHICAGO (343)

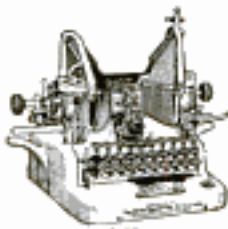

Model No. 5

recently in the Daily Mail:

"Our assistants get a proper amount of leisure, but proprietors and managers are always at it. Imagine a mother with perhaps three or four hundred children, divided into 30 or 40 different classes, each of which has to be fed on a different kind of food at a different time of the day, and each of which may contract a different kind of ailment at any time of the day—then you have

## WHITE FLAME

BURNERS make your old kerosene lamps and lanterns give a brilliant white light better than electricity or gas. Doubles your light. Saves oil. NO MANTLE TO BREAK. Guaranteed Safe and Reliable. Delights every user. Send now for complete sample postpaid 35 cts., stamps or coin. 3 for \$1. MONEY BACK IF NOT SATISFACTORY. Live Representatives Wanted. Exclusive Territory.

WHITE FLAME LIGHT CO., 68 Clark Bldg., Grand Rapids, Mich.



## TYPEWRITERS ALL MAKES

Prices \$15.00 up. SOLD or RENTED ANYWHERE at  $\frac{1}{4}$  to  $\frac{1}{2}$  MANUFACTURERS' PRICES, allowing RENTAL TO APPLY ON PRICE. Free Trial. Installation payments if desired. Write for Catalog 1.

TYPEWRITER EMPORIUM, 34-36 W. Lake St., Chicago, Ill.

## THE "VULCAN" INK PENCIL

Fully guaranteed. Made right to write right. Lasts a lifetime.



Highly polished rubber and safety lock cap. Absolutely non-leakable. A useful gift. Red or black. Long or short. \$1  
J. C. ULLRICH & CO., 27 Thames St., NEW YORK

SUPERIOR SINCE 1903

A limited number of slightly Trial-Worn and agents' demonstrating samples, will be sold, while they last, for

**\$5 CASH WITH ORDER** subject to refund after 10-day trial. Guaranteed to be in perfect operating condition for at least 1 year.

**Golden Gem PORTABLE Adding Machine**

Multiplicates - Subtracts

E. Garber A.A.M. Co., 148 Duane St., New York

# LAW FREE BOOK

Tells easiest and best way to acquire a legal training at home.

## New Course—New Text—New Method

Sixty handy pocket size law volumes. The ONLY complete series of law text books EVER PREPARED FOR CORRESPONDENCE INSTRUCTION. Written especially for the American School of Correspondence by 56 of America's greatest legal authorities, including deans and professors in leading residential law schools, judges of federal and state courts, and prominent practicing attorneys. HARVARD, YALE, PENNSYLVANIA, CHICAGO, WISCONSIN, ILLINOIS, MICHIGAN, and other

great universities have contributed to this wonderful aggregation of legal talent. No other school can furnish these remarkable law texts. Far superior to studying from a "Law Library" or "Cyclopedia of Law."

### America's Newest and Best Correspondence Law Course

The last word in American Law and Practice. Every branch of the law thoroughly covered. Stripped of all non-essentials and useless technicalities. Written in plain, simple, easily understood language. All legal terms thoroughly explained and made perfectly clear. 100% efficiency in law instruction. Simplicity of method makes it possible for you to get ALL the knowledge contained in the complete course. Handy pocket size text books enable you to study under any and all con-

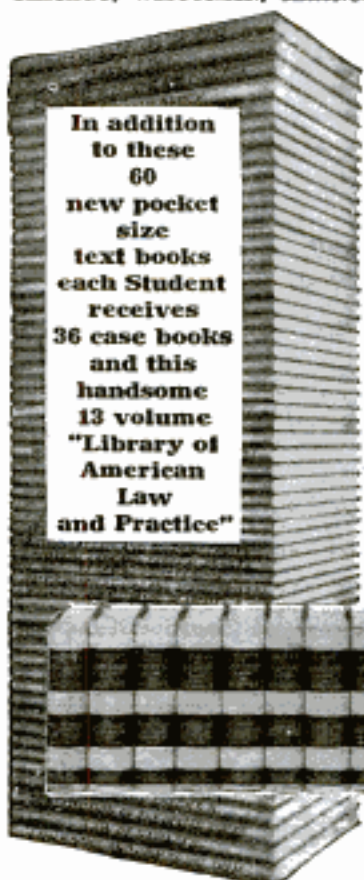

In addition to these 60 new pocket size text books each Student receives 36 case books and this handsome 13 volume "Library of American Law and Practice"

ditions. Have your lesson always in your pocket. Take advantage of every spare moment. Save time. Means quicker admission to the bar.

## The World's Greatest Correspondence School

For eighteen years the American School of Correspondence has stood at the head of all non-resident educational institutions. The only correspondence school in the United States chartered solely as an educational institution for the benefit of its students, not as a commercial enterprise for the benefit of stockholders. Enjoys the proud distinction of having graduated a higher percentage of its students than any other correspondence school in the world. Pre-eminently the best school for YOU.

## FREE BOOK COUPON

American School  
of Correspondence, Chicago, USA  
58th St. and Drexel Ave.

SENT FREE Special Law Book, "How To Acquire a Legal Training." Explains all about this wonderful new system of law instruction. Send for it today. Get full particulars regarding this great course at once. Eliminate all possibility of failure. Be Sure of Success. Fill in the coupon and mail it today. Better do it RIGHT NOW!!

Gentlemen: Please send me your FREE Law Book, "How To Acquire a Legal Training," and full particulars regarding your wonderful new system of correspondence law instruction.

NAME.....

ADDRESS.....

American School  
of Correspondence, Chicago, USA

Pop. Mech. 1-16

Please Mention Popular Mechanics

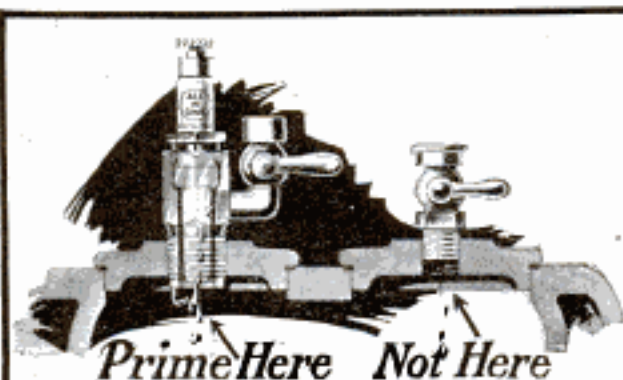

**Prime Here Not Here**

**O**NE drop of gasoline right at the spark is worth twenty drops anywhere else in your cylinders.

In a really cold cylinder, gasoline simply will not vaporize rapidly enough for the gas to travel to the spark. So priming through the priming cup, or by taking the spark plugs out, is not effective.

**All-in-One**



**Priming Plugs**

have a priming cup right on the plug. The gasoline trickles right down the core and drips from the electrode — right where the spark jumps.

A spark and gasoline at one and the same point at the same time means an explosion — that's all there is to it.

You may not need them often, but when you do need them, Priming Plugs are worth many, many times the few cents additional cost.

Your dealer will tell you which one is made to serve your motor.

Get a set today and be sure that there will be no starting delays this winter, no matter how low the mercury drops.

The price is \$1.25 each.

Like all Champion Spark Plugs, Champion Priming Plugs are uniformly dependable.

Be sure the name "Champion" is on the porcelain — not merely on the box.

All-in-One  
Champion  
\$1.25

**Champion Spark Plug Co.**  
402 Avondale Avenue TOLEDO, OHIO

Please Mention Popular Mechanics

## MAKE YOUR BIKE A MOTORCYCLE

at a small cost, by using our attachable outfit. Fits any Bicycle. Easily attached. No special tools required.

**"Used His Four Years"**

Harry A. Hyatt, of Boreas River, New York, writes: "About four years ago I received my motor attachment, and wish to say that I am satisfied with it in every way, for it has certainly given me good service. Anyone wanting a motorcycle or attachment, I would recommend them to the Shaw Manufacturing Co."

**FREE BOOK** Write today for bargain list and free booklet, fully describing the SHAW Bicycle Motor Attachment. Motorcycles all makes, new and second-hand, \$35.00 up.

**SHAW MANUFACTURING CO.**  
Dept. 6 GALESBURG, KANSAS



**All Steel Garage \$59.25**

**The Butler "Round Ruf" SIZE 10 x 14**

Full protection and at least cost. Fire-proof. Corrugated. Easily put up. Attractive in appearance. Portable. Useful as a machinery, tool or storage building. Additional sections to increase length furnished at any time. If your dealer does not handle, write us for full information and prices on other sizes. Write nearest office.

**BUTLER MFG. CO.**  
204 Butler Bldg., Kansas City, Mo.  
511-5th Ave. S.E., Minneapolis, Minn.  
Grain Bins, Tanks, Silos. Write for booklet on Stock Fountains and Hog Furniture.



**Convert Your Bicycle into a Motor-Cycle** Motor fits any wheel. BEST, MOST RELIABLE. Best hill climber. More STEFFEYS in use than all others. Stamp for circulars. STEFFEY MFG. CO., 5007 Brown Street, PHILA., PA.

## SAFETY FOR THE HOME

The Smith & Wesson Automatic shoots when you mean to, not before — protection with safety. Catalogue on request. Smith & Wesson, 814 Stockbridge St., Springfield, Mass.

**HENDERSON 4-CYLINDER MOTORCYCLE**

1916 Models

Single-Speed \$265 Two-Speed \$295

**HENDERSON MOTORCYCLE CO.**  
1160 Cass Ave. DETROIT, MICH.

**5-16 H. P. 1916 Peerless Motorcycles**

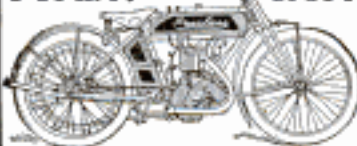

with Free Engine, Bosch Magneto, together with the best there is in Motorcycle construction. Power, Speed, Silence, Endurance, and those wearing qualities so essential for low cost of maintenance. 5 MILES FOR ONE CENT Agents Wanted—Liberal Discount!

PEERLESS MOTORCYCLE CO., 179 Huntington Ave., Boston, Mass.

# Diamonds on Credit

# Watches on Credit

**Christmas Presents—Wonderful Bargains. Send for Free Catalog**

This special selection of Diamond-set jewelry shows the most popular of the season's new mountings. Gorgeously beautiful Diamonds, of fiery brilliancy, set in solid gold or platinum. Prices are cut almost to cost. Any selection sent on approval, delivery charges prepaid. If satisfied, send one-fifth of the price as first payment, balance divided into eight equal amounts, payable monthly. If not just what you wish, return at our expense. Send for Our Handsome 116-Page Illustrated Catalog telling all about our easy credit plan. Over 2,000 suggestions for Christmas presents or for increased wear. All the new styles in jewelry—rings, studs, pearl pins, ear screws, brooches, bracelets, watches, chains, wrist watches, silverware, etc. Easy credit terms. Send for FREE Catalog TODAY.

**LOFTIS THE RELIABLE ORIGINAL DIAMOND AND WATCH CREDIT HOUSE**  
Dept. H894 108 N. State St.  
CHICAGO, ILLINOIS  
BROS & CO. 1268 Stores also in: Pittsburgh, St. Louis, Omaha



## Mobiloils

A grade for each type of motor



## Firestone CYCLE TIRES

Toughest, thickest, most resilient tread. Built like a motor-car tire. All sizes: Non-Skid and corrugated tread.

Firestone Tire and Rubber Company  
Akron, Ohio—Branches and Dealers Everywhere

some idea of the sort of life I lead. I work 13 hours a day, often longer, including Sundays, attending to my family of 400. This is a typical day of my life: 6:00 A. M.—Rise; 6:30 A. M.—Breakfast; 7:30 A. M.—Feed and clean horses; 8:30 A. M. to 8:30 P. M.—Cleaning and feeding dogs, birds, monkeys, parrots, guinea pigs, turkeys, gold fish, ducks, rabbits, mice, squirrels, snakes, leopard, tiger, and puma cubs.

## \$4.00 SEISS

Powerful, Commanding, Warning Signal. Operated by touch of hand, either right or left—for short blast or long continuous sound, same as a Motor-Driven Horn.

THE SEISS MFG. CO.  
439 Dorr St., TOLEDO, O.

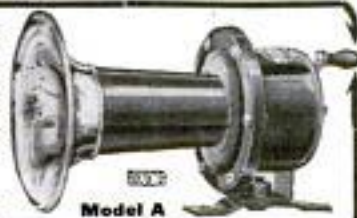

## Miami PowerBicycle

“100 Miles for 10 cts.”  
Model 15, \$125  
Model 16, \$140  
SAFE, SILENT, CLEAN  
WRITE FOR CATALOG  
MIAMI CYCLE & MFG. CO., 130 Noble Ave., Middletown, O.

**If you shoot** you need the **Ideal Hand Book**. Tells all about powders, bullets, primers, reloading tools for rifle, pistol and shotgun ammunition. Shows how to cut your ammunition expense in half. **160 pages**—sent free to shooters for 3 stamps postage by The Marlin Firearms Co., 65 W. St., New Haven, Conn.

## FREE SHOE BOOK SAVES \$20

“The Sole of Steel” describes my light, springy, comfortable, economical, waterproof, all-season, general purpose shoe that saves your feet, health and money. 1 pair of “Soles” outwears 3 to 4 pairs leather workshoes. Investigate before buying shoes again. Address, “The Steel Shoe Man,”

N. M. RUTHSTEIN, Dept. 132, RACINE, WIS.



## The Sure Shot Starter

Primes your engine on the coldest day. Simple, effective, sure. Outside compartment intended for gasoline. Inside receptacle to contain a cheap, harmless liquid. (Obtainable at any drug store.) This liquid vaporizes and furnishes immediate priming. Sent anywhere postpaid for \$1.00.

### MODERN SPECIALTIES

2187 E. 68th St. CLEVELAND, OHIO



## Build a WAR Aeroplane

“Ideal” accurate Scale Drawings and knocked down parts will enable you to EASILY build 3 Ft. Flying Models of those Aeroplanes now used in the European War. Students of Aeronautics, everyone with an inquiring turn of mind, should construct one of these fascinating Models.

Prices of 3 Ft. Scale Drawings  
Curtiss Flying Boat 25c Bleriot Monoplane 15c  
Curtis Military Tracer 25c Taube Monoplane 25c  
Hydroaeroplane 35c Wright Biplane 25c  
Nieuport M'n'plane 25c Cecil Puller Racer 25c  
Complete Set of Eight, \$1.60 postpaid  
Just Out 1918 catalog of Model Aeroplanes and Supplies. 62 pages. Postpaid 5c.  
Ideal Aeroplane & Supply Co., 82-84 West Broadway, New York

## Indian Motorcycles

One, two and three speed Gears with cradle spring frame. Send for catalog.

HENDEE MFG. CO., 711 State Street, SPRINGFIELD, MASS.

## Don't Throw Away Your Worn Tires

You can get 5,000 miles MORE service out of them. For over three years European motorists have been getting from 10,000 to 15,000 miles out of their tires by “half-soleing” them with Steel-Studded Treads.

In eight months 20,000 American motorists have followed their example and are saving \$50 to \$200 a year in tire expense.

**We Deliver Free** Without a cent deposit, prepay the express and allow you to be the judge. **Durable Treads** double the life of your tires and are sold under a signed guarantee for 5,000 miles without puncture Applied in your own garage in thirty minutes.

**Special Discount** offered to motorists in new territory on first shipment direct from factory. Don't take any more chances with your tires. Mail the coupon today and find out how to get 5,000 more miles out of them.

Tear off and Mail—Save the Discount  
**Colorado Tire & Leather Company**

144 Tread Bldg., Denver, Colo. Dept. A44, Transpacific Bldg., Chicago, Ill.  
Suite 441 Woolworth Bldg., New York, N. Y.

















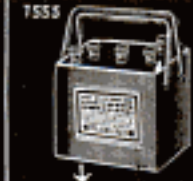

Gentlemen:—Please send me without obligation, sample, copy of 5,000 mile guarantee, special discount terms and book “10,000 Miles on One Set of Tires”.

Name .....

Address .....

My Tire Sizes are .....

# Boys! Here's your Xmas Present!

 2392 Boy Scout Knife, wt. 4 oz. .... <b>50c</b>	 2422 Hot Air Engine, wt. 2 lbs. .... <b>95c</b>	 3418 Nickel Pocket Light, wt. 4 oz. .... <b>50c</b>	 2421 Electric Bike Lamp, (no bat.) wt. 2 lbs. .... <b>\$1.15</b>	 1088 1" Bull Dog Spark Coil, wt. 6 lbs. .... <b>\$4.00</b>	 WIRELESS DETECTOR Real Wireless Detector, postpaid, ..... <b>10c</b>
 6000 Wireless Duffell Camera, wt. 3 lbs. .... <b>\$1.25</b>	 9000 3" Spark Static Machine, wt. 6 lbs. .... <b>\$3.75</b>	 1331 8 volt, 8 amp. Dynamo, wt. 7 lbs. .... <b>\$3.70</b>	 5602 Trolley Car Duffell with track, wt. 10 lbs. .... <b>\$5.65</b>	 1024 Real Telephone Receiver, wt. 1 lb. .... <b>40c</b>	 7555 6 volt, 6 amp. Storage Battery, ..... <b>\$8.00</b>
 2365 Rugby Football, guaranteed, wt. 2 lbs. .... <b>90c</b>	 1500 Wireless Receiving Duffell, wt. 4 lbs. .... <b>\$3.75</b>	 9201 45 Plate Rotary Condenser, wt. 3 lbs. .... <b>\$3.75</b>	 5707 18" Xmas Tree Ornament, wt. 3 lbs. .... <b>\$4.05</b>	 100 Little Weather Motor, wt. 1 lb. .... <b>85c</b>	 7109 Revolver Flashlight, wt. 1 lb. .... <b>95c</b>
 6717 Pedometer / Walk Meter, wt. 1 lb. .... <b>85c</b>	<p>When ordering any of the above, include postage, or goods must be sent by express collect. The goods shown here are <b>only a fraction</b> of our wonderful assortment, illustrated and described in our 275 page Cyclopaedia Catalog, containing 658 illustrations, Treatise on Wireless Telegraphy, List of all U. S. Wireless Call letters, Code Chart and 20 Coupons for Free Wireless Course. Cyclopaedia sent free for 4 cents to cover postage only. Send for a copy today.</p> <p align="center"><b>The Electro Importing Company</b>  <i>"Everything for the Experimenter"</i>            233A Fulton Street NEW YORK CITY, N. Y.</p>				 3356 New 5 volt Dry Battery, wt. 3 lbs. .... <b>35c</b>

**Boy Electrician** with 75 illustrations for making Batteries, Dynamos, Motors, Telegraph apparatus, Telephone, Lights, Bells, Alarms, Coils, "Wireless" Current Reverser, Electric Engine, Etc. By Electrical Experts so that anyone can understand it. With Cat. All **10c Ppd.**  
**J. C. DORN, 705 So. Dearborn St., Dept. 100, Chicago, Ill.**

**Big Entertainer** 320 Jokes and Riddles, 153 Parlor Games and Magic, 15 Tricks with Cards, 73 Toasts, 7 Comic Recitations, 3 Monologues, 22 Funny Readings. Also Checkers, Chess, Dominoes, Fox and Geese, 9 Men Morris. All **10c. postpaid.**  
**J. C. DORN, 706 So. Dearborn Street, Dept. 17, Chicago, Ill.**

**Boys' Own Toy Maker**  
 Tells how to make a Talking Machine, Camera, Electrical Motor, Bicycle Boat, Canoe, Boomerang, Bobolod, Wind Mill, Microscope, Water Wheel and Motor, Bells, Tokogan, Snow Coaster and Sail Boat, Telephone, Electric Bell, Railroad Wind Mobile, Paddle Raft, Traps, Kites, etc. All **10c. postpaid.**  
**J. C. DORN, 707 So. Dearborn St., Dept. 80, Chicago, Ill.**

SALT LAKE CITY HAS LINCOLN HIGHWAY INFORMATION BUREAU—For the benefit of tourists

## MODELS WE MAKE AND SELL

Steam Engines, Boilers and Fittings, Locomotives, Turbines, Engine Parts, Castings and Materials, Racing Yachts, Electric Launches, Steam Boats, Torpedo Destroyers, Ships' Fittings, Yacht Fittings, Dynamos and Motors, Electric Fittings, Flying Machines.

## ALL ENGLISH MAKE

Send for our Fully-illustrated Copyright Catalogue, 909 engravings  
 Crowded full of information of what we MAKE and SELL. Mechanical and Scientific Amusements.  
 BY MAIL, 10 CENTS

**STEVENS' MODEL DOCKYARD**  
 22 Q Aldgate London, England  
 Remit by International Postal Money Order. If coin is sent, letter must be registered.



## PLEASE THAT BOY

or, if you prefer, please yourself, by a gift of a pair of these

## Murdock Wireless Receivers

Real, high-resistance, wireless 'phones, standard in every detail, and possessing exceptional sensitiveness.

Complete double set, 2000 ohms . . . **\$4.00**

Complete double set, 3000 ohms . . . **\$5.00**

**WM. J. MURDOCK CO.**

Our catalog describes a splendid line of apparatus. It is free. Send for it today.

10 Carter St., CHELSEA, MASS.

680 Howard St., SAN FRANCISCO



## Who Holds the Record



in your neighborhood for long distance receiving? A Brandes Superior Type Head Set will help you earn that honor. Both receivers toned exactly alike, which overcomes distance. No other receiver at the price gives you equal results. Send 4 cents for Catalog P; it's full of wireless helps.

**C. BRANDES, Inc.**  
WIRELESS RECEIVER  
SPECIALISTS  
Room 617, 32 Union Square, New York

## BRANDES WIRELESS HEAD SETS



### "The Electrical Experimenter"

The big electrical Magazine for those who dabble in electricity and Wireless. Chuck full of experiments. Intensely interesting. Monthly prizes of \$5.00 for best experiments. Amateur Electricians. Wireless News. Latest Patents 100 articles, 100 to 150 illus. Read the great serial: "Baron Münchhausen's New Scientific Adventures." \$1.00 a year.

Send 10¢ for 3 issues

Electrical Experimenter 234 Fulton Street, N. Y.  
10c a copy at News-stands

coming through Salt Lake City, a local representative of the Lincoln Highway Association recently obtained permission to erect a booth to be used as headquarters for supplying the most complete and accurate information with reference to the condition of the Lincoln

**ELECTRIC LIGHT PLANTS** Complete gasoline engine, dynamo, switchboard and storage battery \$240.  
Agents wanted. American Battery Co., 1139 Fulton St. Chicago (Estab. 1889.)

**Old Stamps Wanted** FOR CASH. We buy rare or old stamps of any country, also old or large stamp collections, old letter files (from 1843 to 1870) of private individuals or old business or banking firms. **PREMIUM LIST 10c.** Address **C. E. HUSSMAN STAMP COMPANY, Dept. M. O., St. Louis, Mo.**

**ELECTRIC HOME, FARM, THEATRE, STORE and TOWN LIGHTING PLANTS.** \$18.00 Rectifier Charges Storage Batteries from Lamp Socket Lighting Your Auto Electrically for ONE CENT an hour. Lamps; Dynamos; Engines; Belts; Medical and Storage Batteries; Belts; Books; Sewing Machine and Power Motors; Railways; Bikes, Carriage, Fish, Hunting, Auto and Xmas Lights; Massage and Ozon Machines; Telephones. **MOTION** Picture Theatre Traveling and Permanent Equipments. Big Profits. Ten Cents an Hour lights Theatre and M. P. Machine. Catalog 3 cts.  
**OHIO ELECTRIC WORKS, CLEVELAND, OHIO**

## Complete Wireless Receiving Set

with 80 ohm double pole receiver, head band and cord

Receives 1500 Miles  
With Suitable Aerial

Beautifully finished  
and fully guaranteed.

Equipped with two-slide  
loose coupler, primary

wound with No. 26 bare  
wire, secondary wound

with No. 30 silk covered  
wire and divided off into

10 taps which are brought out on the end piece, contact being made by a phosphor bronze rotary switch with hard rubber knob. Our new, specially designed detector affords an exceptionally fine adjustment. A fixed condenser of exact capacity, specially constructed for this loose coupler gives added efficiency. An extra pair of binding posts is provided to which a variable condenser may be attached. All parts are of solid oak and mounted on a solid oak base.

Send stamp for our big wireless catalog "P"

and free code chart made of unbreakable glass.



\$4.45

**Universal Wireless Co.** 19 E. 32 St.  
N. Y. City

All "Universal" sets are sold with 10 day trial privilege and money-back guarantee. Prompt shipments guaranteed.

# 10 Days Free Trial

**YES, we will send you the Violin** of your choice for full 10 days' free trial. Play on it—test it in every way before you decide whether you wish to buy or not. Compare it with other instruments—then if you are not more than satisfied, **Send it back at our expense.** You do not pay us a penny for the use of the violin. Write for circular.

## Your Choice of Instruments

Write today for our new Violin catalog and see handsome illustrations in full color of all the superb instruments that you have to choose from. **There you will find illustrated products of the leading violin makers of the world—Fanny, Bader, Glier, Heberlein, Fiedler, Wurlitzer and many others.** Violins of the highest grade, as well as those of moderate prices—all special values. Priced from \$2.70 to \$30.00, and from \$50.00 to \$250.00.

**Rare Old Violins**  
Our collection of rare old violins is one of the largest in America. Write today for Special Art Catalog.

# WURLITZER

200 years of instrument making

Get the benefit of our mammoth facilities for buying in large quantities. The house that supplies the United States Government now makes a startling money-saving offer direct to you. Write for circular.

## Pay as You Wish

If you decide to keep the violin you have selected after you have tested it out for ten full days, pay the rock bottom price at the rate of **only a few cents a day.** No red tape. No collectors or mortgages. Your credit is good with the House of Wurlitzer.



10c a Day

now buys this superb Lyric Cornet. Exclusive triple silver-plated long model Lyric Cornet direct to you on a startling offer. Ten days free trial before you decide to buy. Liberal allowance for old instruments. Write today for 225-page Catalog showing 2261 instruments that you have to choose from.

## Send the Coupon

Put your name and address on the coupon now and indicate catalogue matter you wish us to send you. Absolutely no obligation in sending the coupon. Do it now. Find out about the startling money-saving offer we are making. Write today—send Coupon or a Letter or a Post-card.

**The Rudolph Wurlitzer Co.**

Dept. 9191

East 4th Street,

Cincinnati, O.

So. Wabash

Avenue,

Chicago

**The Rudolph Wurlitzer Co.**

Dept. 9191

S. Wabash Av., Chicago

4th St., Cincinnati

Gentlemen:—Please send me without obligations, free and prepaid the catalog matter checked below:

- The special violin circular.  
 Special low priced violins under \$15.00  
 Year 225 page illustrated catalog of musical instruments.  
 Catalog of music stands, cases and other affiliated instrument accessories.  
 Art catalog of rare old violins.

Name.....  
Address.....

Please Mention Popular Mechanics

# DUCK'S NEW BIG No. 9 320-PAGE ELECTRICAL and WIRELESS CATALOG

More than ever justifies your verdict that it is the *one* catalog worth while

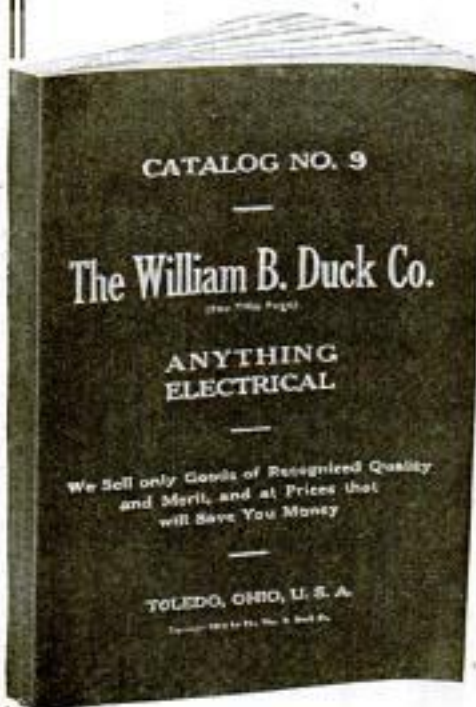

## Everything Electrical FOR THE BOY—HOME OR STORE

**Only 8c** in stamps will bring this unrivalled catalog to your home. The great cost of catalog and the exceptionally low prices (often times fully 25% below usual retail price) prohibits its distribution otherwise. You may deduct the 8c on first dollar purchase.

Our records show that 70% of our catalogs produce us patrons. Many of our competitors admit the waste of 90% of their catalogs. Who pays for them? This is the big, controlling reason why you should have our catalog, backed by a great selling and purchasing power, before even thinking of buying elsewhere.

**Over 40 New Pages of Wireless Instruments** and substantial reductions on many popular wireless instruments and standard electrical supplies.

### A FEW OF THE ARTICLES IN OUR CATALOG:

120 pp. Wireless Instruments (129 pages) magnet wire of all kinds, raw material, storage batteries, telegraph instruments, battery motors, commercial motors and generators, sewing machine motors, telephones, step-down transformers, massage vibrators, bells, push buttons, auto accessories, flash lights, hand lanterns, auto and miniature lamps, Xmas tree outfits, voltmeters, ammeters, lighting plants, Victrolas, air rifles, electric aeroplanes, model builders, electric railways, electrical and mechanical books and general electrical supplies.

**THE WILLIAM B. DUCK CO., 223-227 Superior St., TOLEDO, O.**

## COMPLETE SENDING AND RECEIVING WIRELESS STATION

CATALOG PRICE \$22.55

For the Holiday Season **\$15.85**



DDT Switch, 8 fat plate condenser in finished collapsible helix, our 150 key, and a 21 plate Clapp-Eastham Rotary Variable Condenser, and heavy fluted zinc spark gap.

Send stamp for our large catalog "P" of remarkable value

**THE HANDEL ELECTRIC CO., 138-140 CENTRE STREET, N. Y.**

Highway and other roads about Salt Lake City; weather conditions all along the road within the state, as well as at all the principal points along this and other routes in Utah. The station will also be provided with complete log books of the Lincoln Highway and all Utah



## Thordarson Improved TOY Transformer

An ideal Christmas gift for a little boy.

Runs adozes toys at once. Connects direct to light circuit, doing away with heavy, expensive batteries. Exclusive safety device absolutely prevents short circuit. Economical. Lasts forever. Write Today for descriptions and prices.

Thordarson Electric Mfg. Co., 501 S. Jefferson St., Chicago

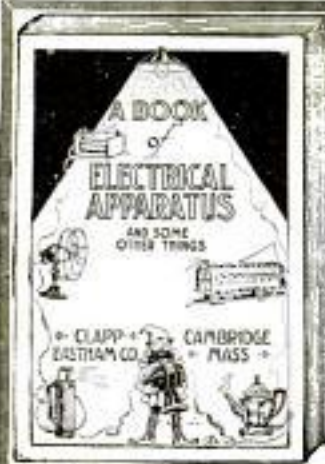

## DEAL DIRECT WITH THE MANUFACTURER

We will save you time and money. Our new catalog "W" is filled with "up to the minute" wireless apparatus. Our new 112 page "Book of Electrical Apparatus" contains motors, dynamos, parts and materials, meters, lighting plants, storage batteries, phonographs, motion picture cameras, etc., at prices that will positively save you dollars. Both books sent for 6c stamps to cover mailing.

**CLAPP-EASTHAM CO.**

Manufacturers and Distributors

147 Main St.

CAMBRIDGE, MASS.



The best made, small Variable Condenser in the world. Glass case, Aluminum plates and base. Price . . . **\$4.00**

**THE ONE-HAND WRENCH***Adjusts Easily with  
the Thumb***CRESCENT ADJUSTABLE  
• WRENCH •**

May be adjusted to the work with the hand holding the wrench. Always holds its adjustment perfectly. Adaptable to all work. Wont slip on Hexagon Nuts. *Each Genuine Crescent has Name in the Handle and is Guaranteed Satisfactory.*

[Seven sizes, 4 to 18-inch, 8-inch, 80 cts.  
Others in proportion. From your Hard-  
ware or Auto Accessory Dealer, or write to.]

**CRESCENT TOOL CO.**  
JAMESTOWN, N. Y.



**KEEN KUTTER**  
Tools and Cutlery

Made by  
Men Who  
Know, for  
Men Who  
Know

roads as well as directories of the city, information as to the hots and garages, etc. This is, as far as known, the first special Lincoln Highway information headquarters to be established.

**BILLINGS & SPENCER****TOOLS**

Your dealer probably has them. If not, write us.

HARTFORD, CT.

Wrenches  
Pliers  
Sc. Drivers  
Hammers  
Ratchets  
Wrench Kits  
Tool Kits

**THE AWL YOU WANT**

See That Reel



The Awl  
For All

Is the genuine MYERS \$1.00 "Lock Stitch" Sewing Awl with the exclusive feature. See thread reel in front of handle under the finger tips. Natural tension. Sews heavy or light material, diamond point, full grooved needles used to protect the thread when sewing.  
**C. A. MYERS COMPANY, 6339 University Ave., Chicago, Illinois**

**TOOL CASES**

For Up-to-Date TOOLMAKERS and MACHINISTS

We carry the finest and most complete line of mechanics' toolcases and tools in the country. We guarantee to please you or refund money. Write for free catalogue.

**J. M. WATERSTON**

177 Jefferson Ave., E. Detroit, Mich.

**What is "Standard?"**

A standard is that which is established and fixed as the measure of quantity, weight extent, value or quality.

Starrett Tools are Standard Tools. That means there is no slightest variation from the standard measures.

Oneten-thousandth of an inch measured by a Starrett instrument is exactly one ten-thousandth of an inch the world over.

**Starrett  
Tools**

on account of their accuracy proclaim the good workman. Modern methods of manufacture and inspection require the utmost accuracy and workmen are obliged to have the instruments for such work and skill in their use.

Starrett Tools are recognized by every superintendent in the land as tools of standard accuracy.

Starrett Tools include 2100 styles and sizes of fine instruments - steel rules, tapes, squares, levels, calipers and dividers, hack saws, micrometers, gages, speed indicators and many others.

For sale at leading hardware stores. Send for Free Catalog No. 20-A-P.

**THE L. S. STARRETT CO.**

"The World's Greatest Tool Makers"

Athol, Mass.

New York London  
Chicago

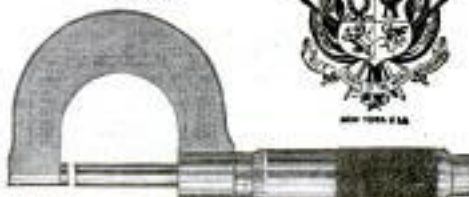

Please Mention Popular Mechanics



## If You—

lay out Machine work of any kind, or have to set up pieces on the Planer, Radial Drill, Milling Machine or Boring Machine, you need this handy and reliable

## Brown & Sharpe Universal Surface Gauge

To set the Scriber, you can swivel the spindle and swing it up or down to any position, then quickly clamp it solid by the knurled nut. There is also a fine screw adjustment for the Scriber point.

The base can be set on cylindrical work, using the groove in the bottom, or by pushing down the two gauge pins, can be brought square with an edge or T slot.

You should ask to see one of these Surface Gauges at the hardware or supply store, to appreciate its many features.

*Our Catalogue No. 26, free on request, shows a full line of Mechanics' Fine Tools.*

**BROWN & SHARPE MFG. CO.**  
PROVIDENCE, R. I.



### Portable Cases

FOR TOOL MAKERS  
AND MACHINISTS

Twelve styles, felt lined drawers, solid brass trimmings, best of material, beautiful finish, low prices, satisfaction guaranteed. Ask for booklet of cases built for service.

**The Pilliod Lumber Co.**  
SWANTON, OHIO

## YOU NEED THIS TOOL

GASOLINE  
SOLDERING IRON  
BLOW-TORCH



Address Dept. 1, Emmelmann Bros. Mfg. Co., Indianapolis, Ind., U.S.A.

IF IT ISN'T

# AN EASTMAN

IT ISN'T A KODAK



## You need this Plier for your Electrical work

Hand honed and tested to cut the finest silk insulated wire. Designed for delicate work around engines, motors, armatures, etc. This is just one of the styles of

### "Red Devil" Dependable Tools

Sample No. 622-5 in. postpaid for 70c.

TOOL BOOKLET FREE.

**SMITH & HEMENWAY CO., Inc.**  
161 Chambers St. NEW YORK CITY

## LODGE and SOCIETY Emblems In MIDGET Size

have an added dignity thru their uniqueness of size, retaining within the detail of design of the regular-sized emblems. Inserted in point of lapel and tightly screwed

In Solid Gold only, 50c

- |                         |                       |
|-------------------------|-----------------------|
| 1. Woodmen of World     | 12. Elks              |
| 2. Old Fellows          | 13. Men's Bible Class |
| 3. Redmen               | 14. Jr. U. American   |
| 4. Knights Columbus     | 15. Mechanics         |
| 5. Modern Woodmen       | 16. Knights Pythias   |
| 6. Masonic              | 17. Knights Templar   |
| 7. Ball & Chain Masonic | 18. Moose             |
| 8. Shrine               | 19. F. O. Eagles      |
| 9. Trowel Masonic       | 20. Grotto Masonic    |
| 10. Slipper Masonic     | 21. Old Glory         |
| 11. Keystone Masonic    | 22. The Bell          |

Illustrations are actual size

Write us for those not listed  
**THE PHILADELPHIA BADGE CO.**  
174 N. Eighth St. Philadelphia, Pa.



"AMERICAN"  
Key Cutter

## ADD TO YOUR INCOME With little effort you can make \$5 to \$10 a day

The "AMERICAN" is the only machine on the market (barring none) that sharpens, hones, and strops razors, sharpens all kinds safety razor blades, scissors, clippers, pocket knives, surgical instruments, etc. No previous experience required. REMEMBER THE "AMERICAN" Key-Cutter is a little wonder. Cuts Square, Angular or Round slots.

**AMERICAN SHARPENING MACHINE CO. (Inc.)**  
Dept. 1 184 W. Washington St. CHICAGO



"AMERICAN"  
Sharpener



"A Fast Brush for the Ponies"

Several Million Persons in the United States are continually using

## WHITING-ADAMS BRUSHES

Their use insures Economy of Cost and Perfect Results

Send for Illustrated Literature

Manufactured by

**JOHN L. WHITING - J. J. ADAMS CO.**  
BOSTON, U. S. A.

Brush Manufacturers for over One Hundred Years

Whiting-Adams Brushes Awarded Gold Medal, the highest award at Panama-Pacific Exposition, 1915

## THIS MACHINE WILL EARN \$20 to \$50 Daily Profit For You Making Cement Bricks and Blocks

Factory owners are the biggest money makers in America and this machine will place you in their ranks. You can start with little capital and even without experience. This machine makes pressed cement bricks and blocks under 80,000 pounds pressure. No tamping and easy work. It makes 1,000 blocks or 10,000 bricks daily. No burning required. Ready for the market in a few days' time. They are necessary for the



### Helm DRY WALL Building System

This is the system that appeals to builders, contractors and architects. It overcomes the opposition to concrete because it offers absolutely DRY WALL construction. It saves money for builders, as no furring and lathing are required, and it makes rigid walls and fireproof walls. This is the system which is bound to get you business and give you the advantage over all other products.



#### Send for This FREE CONCRETE BOOK

Tear off the corner coupon right now before you turn the page. Let this free book tell you all about

this great opportunity which is open to you today. It will tell you all the details of this system about the Helm Press and the DRY WALL building system. It will show you how easy it is to start a profitable business. It tells how each product is made, how it is cured and sold. Write today. Do it now.

**HELM BRICK MACHINE CO.**

221 Mitchell St.  
CADILLAC, MICH.

**Helm Brick  
Machine Co.**  
221 Mitchell St.,  
Cadillac, Mich.

Please send FREE the book on concrete and Helm Presses.

Name.....

Address.....

## AGENTS \$10 to \$20 PER DAY!



New Pure Aluminum Hot Water Bottle—will outwear 100 Rubber ones. Lasts a lifetime. Low price makes quick sales. Write for sample and large catalog of 400 other Specials.

**AMERICAN ALUMINUM MFG. CO.**  
Div. B. M. LEMONT, ILL.



### Put Perrin "No Glares" On Your Car's Headlights

Avoid all danger from light-dazzled oncomers. Enjoy long, low, powerful light on both streets and country roads, with complete safety. Recommended by Police officials. Placed on lamp bulb permanently—always working—no buttons or levers. Over 100,000 in use.

\$1 per set of two. At your Dealer's or Garage or sent postpaid. Patented. Resist imitations. Insist on the Perrin "No Glare."  
**PERRIN MFG. CO., Detroit, Mich.**

### "The Colorado Gem," Newest Product of Our Gem Mines



A beautiful Genuine Topaz, of purest white color, finest Diamond cut, wonderful brilliancy and great hardness. Endorsed by leading experts. Far superior to the best imitation Diamond ever produced. Remember, we guarantee these stones to be genuine. Special price, \$2.00 each, 3 for \$5.00. Size, up to two carats. Free booklet. Address with remittance.

**COLORADO JEWELRY MFG. CO.**  
1526 1/2 Champa St. Dept. 47 Denver, Colo.

### Typewriters

-- All makes, factory rebuilt by the famous "Young Process"; look like new, guaranteed like new. Our big business insures "Square Deal" and permits lowest cash prices -- \$10 and up; also machines rented -- or sold on time. No matter what your requirements are, we can best serve you. Write and see -- NOW.

**YOUNG TYPEWRITER CO., Dept. 345 CHICAGO**

## EASY PIPE THREADING



2 1/2 to 6-inch pipe usually isn't easy to thread, but one man can do it easily with an

### OSTER No. 17

as shown here

Portable.  
No pipe vise.  
No backing over threads.  
No leading screw.  
Get all the facts.

No. 17

Please send catalog to

Write for catalog, stating the nature of business.

**THE OSTER MFG. CO.**  
2100 E. 61st St.  
CLEVELAND, O.

NAME.....

BUSINESS.....

ADDRESS.....

CITY..... STATE..... (2100-1)

# Here's a "YANKEE" RATCHET TAP WRENCH

And the Only One of Its Kind



When tapping holes in difficult places where you can't "get at" the job with an ordinary tap wrench this "Yankee" Ratchet Tap Wrench will quickly and accurately do the work.

The "Yankee" Ratchet gives right- and left-hand and rigid adjustments.

The Crossbar is held by an ingenious "Yankee" device in any of three positions or can be removed. It gives ample leverage for large taps.

Knurled Thumb Piece, at top, is used to start and back out taps quickly.

It has a countersunk center on top face for use of wrench on lathe for tapping holes true.

Chuck with hardened steel jaws.

## "Yankee" Ratchet Tap Wrench

No. 250—Holds up to 3/16 in. taps. Length, 3 1/4 in. Price.....\$1.35

No. 251—Holds up to 5/16 in. taps. Length, 5 in. Price.....\$1.90

No. 1251—Same as No. 251 except length of shank, which gives 13 in. reach. For work in steel cars and in any place where long reach is needed. Price.....\$2.40

Your dealer can supply you.

Write for "Yankee" Tool Book" showing all the "Yankee" metal and wood-boring and screw-driving tools.

North Bros. Mfg. Company  
Philadelphia

# "YANKEE" TOOLS

Make Better Mechanics

Please Mention Popular Mechanics

## Stanley Tools



## Stanley Door Trim Plane

Will make mortises for Butts, Face Plates, Strike Plates, Escutcheons, etc., without the use of a butt gauge or chisel. In fact, it might very properly be termed a MECHANICAL CHISEL.

It is also a superior Router Plane for surfacing the bottom of grooves or other depressions parallel with the general surface of the work.

Length, 11 inches; weight, 3 lbs.

SEND FOR SPECIAL CIRCULAR.

## Price \$2.75 Each

If you cannot procure this tool from your Hardware Dealer, we will, upon receipt of price, send same postage prepaid to any part of the United States.

ADDRESS

**STANLEY RULE & LEVEL CO.**  
NEW BRITAIN, CONN. U.S.A.

## BUY PLUMBING and HEATING SUPPLIES



at WHOLESALE

Will Save  
You 30%

Don't pay retail prices. Full stock on hand for prompt shipment. Send for free catalog.

B. P. KAROL, 800-802 South Kedzie Ave., CHICAGO



## Amazing Profits In Mushrooms

Anybody can add \$10 to \$40 per week to their income, in spare time, entire year growing mushrooms in cellars, sheds, barns, boxes, etc. I tell you where to sell, at highest prices.

Free Illustrated Instruction Booklet

**HIRAM BARTON**  
Desk 2, 329 W. 48th St., New York

## Pay as You Wish

We'll send you a genuine Lachnite for you to wear for 10 full days. If you can tell it from a real diamond need it back at our expense. Costs but 1-sixth as much. If you decide to keep it pay only a few cents a month. Write for catalog.

### Genuine Lachnite Gems

Keep their dazzling fire forever. Set in solid gold. Cut by world renowned diamond cutters. Will stand fire and acid tests. All kinds of jewelry at astounding low prices. Easy payments. WRITE TODAY.  
H. Lachman Co., 12 N. Michigan Av., Chicago Dept. 1191



## Runs on Alcohol

At Cost of Less than 1/2¢ an Hour

anywhere without electricity, springs or batteries. Superb construction. 12-inch blades. Adjustable roller bearing. Reliable. A proved comfort. Prompt delivery. The original and only Lake Breeze Motor manufactured according to the design of the inventor and under his direct and personal supervision.

Keep Cool

\$15 Cash with Order

Lake Breeze Motor, 122 N. Jefferson St., Chicago



Are you inventive?  
Do you experiment?  
Are you a practical  
man about the house?

IT is in the home shop where many little odd jobs that save money can be done. Nearly everyone invents something with "millions in it" and the love for experimenting is universal. Among all the tools of your shop none will prove handier than a

## MILLERS FALLS BENCH DRILL PRESS No. 210

The chuck is of Star pattern—a larger gripper—holding round shanks from 0 to 1/2 inch. Jaws operated by springs that are protected from injury. Instantly changeable speed—adjustable crank and hand feed.

Strong cast iron standard finished in red and gray.

Height over all 24 inches—Maximum distance from chuck to table 9 inches. Weight 22 lbs.

Write for handy pocket catalogue illustrating complete line of quality special tools.

**MILLERS FALLS CO.**

"Toolmaker to the Master Mechanic"

MILLERS FALLS, MASS., and 28 Warren St., New York



A wireless station is being operated under the supervision of the physics department and the course in electrical engineering of the University of Wisconsin, at Madison. Its aerial, which has a sweep of 140 ft., is 130 ft. high and 15 ft. wide, is stretched from the chimney of one of the engineering buildings.



**Print  
Your  
Own**

Cards, circulars, book, paper. Press \$5. Larger \$18. Rotary \$90. Save money. Print for others, big profit. All easy, rules sent. Write factory today for catalogue of presses, TYPE, cards, paper, samples. It will pay you well.

THE PRESS CO., Meriden, Connecticut

## "Interlox" SAVES TIME, TEMPER AND TROUBLE

MASTER SLIDE RULE

The Only Interlocking Rule made—and the Only one whereby inside measurements of doors, windows, etc., can be taken rapidly and accurately. Also superior in all others for outside measurements of walls, ceilings, etc. If your hardware dealer hasn't this Rule, send to his name and 15c per foot (in any length from 2 to 8 ft.) and it will be sent prepaid.

Liberal Proposition  
for Dealers and Agents

DAHL MFG. CO., 51P E. 42nd St., NEW YORK

LET US SEND YOU

## "The Professor and the Saw"

an illustrated booklet which besides an interesting story tells how to build useful things and gives valuable information about tools, especially

## SIMONDS SAWS

which are unsurpassed for all uses in fast and sharp-cutting and edge-holding qualities. WRITE FOR BOOKLET 11.

SIMONDS MANUFACTURING CO., "The Saw Makers"  
5 Factories FITCHBURG, MASS. 11 Branches



## Tool Cases for Toolmakers and Machinists

Keep your tools orderly arranged in a Gerstner Portable Tool Case. There's a place for every tool in one of the felt lined drawers. Every up-to-date mechanic needs one and you'll find our Cases the best built, neatest and most practical on the market. We guarantee to please or refund all money. Write for our booklet!

*Gerstner Sons*

Mfrs. of Mechanics' High Grade Tool Cases  
808 Columbia St., DAYTON, OHIO

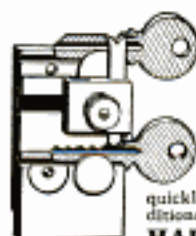

## THE HARRISON M. I. P. KEY FILING MACHINE

Makes duplicate Pin Tumbler Keys with absolute accuracy, and without injuring the original key. Price \$1.01. Special diamond shaped files 35c each or 4 for \$1.00. Net Cash. \$4.00 for the outfit complete.

## THE HARRISON C. K. KEY CLAMP

will make duplicate Common Keys of all kinds for Doors, Padlocks, Trunks, Cabinets, Lockers, etc., quickly and accurately. Price \$1.00. Both machines unconditionally guaranteed. Parcel Post Prepaid.

HARRISON & CO., 81 New St., New York

Hand Forged  
Razor Steel  
Blades. No. 57



This \$2 KNIFE 83¢  
DIRECT AT FACTORY PRICE

Handy shaped blade makes this knife best for mechanics, sportsmen and farmers; light but strong; resharpened easily. Stag handle, German silver finish; blades file tested, hand forged from razor steel and warrant cut. Sample 83c, 3 for \$2 postpaid.

Bestest steel \$2 each. Send for our 80 Page List and "How to use a Razor" FREE

MAHER & GROSH CO., 106 A. St., Toledo, Ohio.



**AUTOMOBILE OWNERS!  
DON'T HELP THE RE-  
PAIR MAN GROW RICH**

Do you know when you're being overcharged for repair work? A thorough knowledge of automobile repairing will not only prevent dishonest repair men from taking advantage of you, but will enable you to make the most difficult repairs yourself. Get this knowledge by a little study of the practical books pictured above. The five big volumes—just off the press—cover every type of motor car, motorcycle and motor boat.

**AUTO ENGINEERING**

**\$25.00 Set Now \$14.80—50c a Week**

This auto library contains 2,000 pages, with 1,500 illustrations that make technical points as simple as A-B-C; full-page plates that literally pick the mechanism to pieces before your very eyes; drawings and diagrams that show the working of all the principles employed in the various types of motors. Bound in half red morocco, gold stamped. These five volumes are a most remarkable value at the regular price. Yet we offer a limited number of sets at a special introductory price of \$14.80—payable \$1 a month.

**SHIPPED FREE** Test these books before you buy. You wouldn't buy a car until you had tried it out. Buy books the same way. We send the full 5 volumes to you, express prepaid, for 7 days' free examination. Look them over for a whole week free. See if they don't contain everything a driver or repairer should know. If the books are what you want, send us \$2. Otherwise we'll take them back, paying the express both ways ourselves. In addition to this liberal discount from the regular price of \$25.00, we include with each set a \$12.00 Consulting Membership. This entitles you to the advice of a staff of expert automobile repair men for a whole year free.

**American Technical Society, Chicago:**

Please send Cyclopaedia of Automobile Engineering for 7 days' free examination. I will send \$2.00 within 7 days and \$2.00 a month until I have paid \$14.80, otherwise I will notify you and hold the books subject to your order. Title not to pass until fully paid. Pop. Mech. 1-16

NAME.....  
ADDRESS.....  
REFERENCE.....

**No Money  
In Advance**

**This Marvelous Camera  
ON FREE TRIAL!**



Only 10,000 of these marvelous, instantaneous picture-taking and making cameras to be sent out absolutely on approval without a penny in advance just to prove that it is the most wonderful invention—the camera sensation of the age. Just think of it—the Mandel-ette takes and makes finished pictures

**INSTANTLY!**

You press the button, drop card in developer and in one minute take out a perfect, finished post card photo 2½x3½ inches in size. Camera, itself, is about 4½x5x7 inches. Loads in daylight, 16 to 50 post cards at one time. No Films—No Plates—No Dark Rooms. It is instantaneous photography. Universal focus lens produces sharp pictures at all distances. Pictures develop and print automatically. Can't overdevelop; results amazing.

**We Trust You**

We will send you the complete Mandel-ette outfit absolutely on approval, no references required, and give you 10 days to test it. If not satisfactory return at our expense. If you keep it simply pay \$1 when you get camera and \$1 per month until our special price of only \$5 is paid. No experience required. Plain instructions and everything complete with outfit so you can begin taking pictures the moment it arrives. We guarantee that even a child can operate it. Send coupon for camera.

**— THE CHICAGO FERROTYPY COMPANY —  
Desk 163 Ferrotypy Bldg., Chicago, Ill.**

Send me one complete Mandel-ette Camera outfit including supply of post cards and instructions. I agree to pay \$1 when I get the camera, and if satisfied keep it and pay you \$1 a month until your special price of \$5 is paid. Otherwise I will return it at the end of 10 days.

Name.....  
Address.....

Please Mention Popular Mechanics



**Run Your Ford,  
Overland or Chevrolet 490  
All Winter in Safety**

Skidding, slipping, sideways and stalling in bad spots will all be eliminated if you install the

**BAILEY Gearless Differential**

Gives positive drive to both rear wheels; all the advantage of a solid axle in straight going; power delivered only to wheel having traction in ruts or slush. Adds 50 per cent to comfort and safety; saves fuel, oil and tires. Thousands in use. Shipped ready to install on Money-back offer. See dealer or write for circular.

Gearless Differential Co., 892 Woodward Ave., Detroit, Mich.

**STOP Throwing Away  
Old Safety Blades**

A Stag Sharpener makes old blades better than new—gives you a head barber shave every morning. The only sharpener that both hones and strops.

Note wheel in holder sets blade always at proper angle. Highest Awards Panama-Pacific Exposition. Sharpens Any Make Safety Blade. Lasts a Lifetime. Complete, nickel holder, barber's hone and strop, in neat case, \$1.00. Money back if not satisfied. Dealers and Agents—write for our money-making proposition.

STAG COMPANY, 34 S. State St., CHICAGO, ILL.

**\$1  
Post Paid**



**3 YEARS TO PAY**

**Meister Piano** 30 days free trial in your own home

**\$1 A WEEK or \$5 A MONTH Price \$175.00**

No cash payment down. No interest—no extras. Piano stool and scarf free

**ROTHSCHILD & COMPANY  
Dept. 16P CHICAGO, ILL.**



**Agents Wanted!**

Either Sex. To sell our silver handle Embroidery Needles. The easiest and quickest seller ever placed in hands of agents. Show a woman what this needle is capable of producing and a sale is assured. Write for Terms. Address

**WHALE ART COMPANY  
6175 Virginia Ave. ST. LOUIS, MO.**

**FREE**

2 Plan Books—  
300 home plans.  
Ready-cut—  
material cut to fit.

Or Standard Homes—material in standard way. Also 156 page catalog of 5000 Building Bargains. Send a postal for the 2 Books. FREE!

**GORDON-VAN TINE COMPANY 5864 Case Street  
DAVENPORT, IOWA**

**Tobacco Habit Banished  
IN 12 to 120 HOURS**

**DR. ELDER'S TOBACCO BOON BANISHES** all forms of Tobacco Habit in 12 to 120 hours. A positive and quick relief. A home treatment easy to take. Sure, lasting, harmless, no habit forming drugs. Hundreds of letters from satisfied patients. We guarantee results in every case or refund money. Send for our Free Booklet giving full information. Write today, this hour.

**ELDER'S SANITARIUM, Desk 36, ST. JOSEPH, MO.**



**QUICK MONEY  
Growing Mushrooms**

How to really make big money in mushrooms, is fully explained in the wonderful book, "The Truth About Mushrooms." Everything explained from A to Z, at first hand, from the greatest practical authority in America. Add \$10 to \$10 a week to your income. Demand exceeds supply. Grow in cellars, sheds, boxes, etc. Small capital to start. Profits bigger and quicker. Anyone can do it. Women and children, too. Now

is the best time. Send for FREE book of information. Bureau of Mushroom Industry, Dept. 755, 1342 N. Clark St., Chicago



## Going to Build Remodel or Repair?

**YOU** can actually save from \$5.00 to \$500.00 on your building material bill, so write today for these two free books and see and judge for yourself.

Our Building Material Catalog shows 8,000 price bargains and our Plan Book shows splendid views and floor plans of 50 modern homes and bungalows. You can remodel, repair or build new for much less than you expected.

We ship everywhere everything in the way of high-grade lumber, flooring, roofings, doors, windows, storm sash, moldings, porch-work, screens, hotbeds, building hardware, paints, wallboard, plumbing, heating and water supply outfits, cement machinery and interior woodwork—**ALL AT WHOLESALE PRICES DIRECT TO YOU.**

Don't plan to build, repair or overhaul until you see these two great books. Quality, safe delivery and satisfaction absolutely guaranteed. Write for them today.

**CHICAGO MILLWORK SUPPLY CO.**  
1444 W. 37th St.  
Chicago, Ill.

**Books Are Free**

Catalog of 8000 Price Bargains

Beautifully Illustrated PLAN BOOK



Material Complete for Houses from \$375<sup>00</sup> up

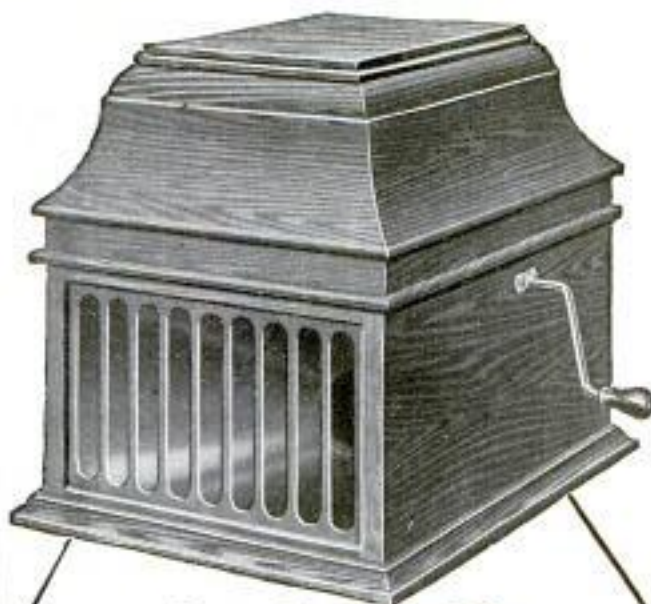

# \$1<sup>00</sup>

## and You Keep This Superb New Edison

An astounding offer—the great New Edison with the new Diamond Stylus reproducer and your choice of all the brand new Diamond Amberol Records will be sent to you on **free trial without a penny down.** The finest, the best that money can buy at very very much less than the price at which imitations of the genuine Edison are offered—a **rock-bottom offer direct from us.**

## Entertain Your Friends

Hear all the latest up-to-date song hits of the big cities. Laugh until the tears stream down your face from laughing at the funniest of minstrel shows. Entertain your family and your friends with everything from Grand Opera to Comic Vaudeville — then if you choose, send the outfit back to us at our expense.

## Rock-Bottom Direct Offer

If you wish to keep Mr. Edison's superb new instrument, send us only \$1.00 after the free trial. Pay the balance on the easiest kind of monthly payments.

Think of it — a \$1.00 payment, and a few dollars a month to get this brand new style outfit—the Diamond Stylus reproducer, the musical quality—the same Diamond Amberol Records—all the musical results of the highest price outfits—yes, the greatest value for \$1.00 down, balance on **easiest monthly terms.** Convince yourself — a free trial first! No money down, no C. O. D., not one cent to pay us unless you choose to keep the instrument.

## Our New Edison Catalog Sent Free

Your name and address on a postal or a letter (or just the coupon) is enough. No obligations in asking for the catalog. Get this offer — **while this offer lasts.** Fill out coupon today.

**F. K. BABSON**  
Edison Photograph Distributors  
1191 Edison Block  
Chicago, Ill.

Canadian Office:  
355 Portage Ave.  
Winnipeg,  
Manitoba.

Name.....

Address.....

To  
**F. K. Babson**  
Edison  
Photograph Distributors  
1191 Edison Bk.  
Chicago, Ill.

Gentlemen: Please send me your New Edison Catalog and full particulars of your free trial offer on the new model Edison Photograph.

## MOVING PICTURE BUSINESS

Write For FREE Catalog



On Our Easy Payment Plan

Make \$20 to \$50 per night

With our Moving Picture Outfit We sell everything—Films, too.

**Moving Picture Sales Co.**  
Dept. P 548 Plymouth Place, Chicago, Ill.

## Wins Big Trade!

Scores of drug, candy, fruit, cigar, news and department stores, picture theatres, etc., making \$25 to \$90 profits weekly with the famous **BUTTER-KIST Corn Popper** Runs itself. Pops 1 bush in 24 seconds—\$5.75 per hour. Makes dozens crowds. Folks can't resist the exciting fragrance. **FREE**—handsome book "The Little Gold Mine"—gives photographs, proof of profits, easy terms, etc. Write today.

**HOLCOMB & HOKE MFG. CO., 1795 Van Buren St., Indianapolis, Ind.**



## Buy Him a Real Knife FOR HIS CHRISTMAS GIFT



Not the ordinary gift knife, but a genuine hand forged English razor steel knife that will cut and hold its edge—fully guaranteed. We will put any photo or lodge emblem on one side of the transparent handle, and any name and address on the other.

### SPECIAL CHRISTMAS OFFER

No. 310—Governor Knife, 3 Blades, \$1.60. No. 320—Governor Knife, 2 Blades, \$1.25. **CUT IS TWO-THIRDS ACTUAL SIZE.**

**FREE** A Beautiful Pearl Handle Knife given absolutely free with a purchase of 3 Knives. **Get your order in today, now.**

Agents Wanted Everywhere. Write for Catalog and Terms.

**GOLDEN RULE CUTLERY CO., 552 W. Lake St., Dept. 305, CHICAGO, ILL.**

Please Mention Popular Mechanics

**KEROSENE ENGINE**

# BESSEMER

Backed by a Million Dollar Company

30 DAYS FREE TRIAL

With every Bessemer Engine you get a guarantee that means the best engine service in the world. You are assured of a Kerosene Engine that is built upon correct lines — built to run at lowest fuel cost — and give sure and steady power for years. Write us for some eye-opening facts as to what Bessemer Kerosene engines are doing. Sizes 2 to 10 H. P., and this means full horse-power, too! Direct connected to electric lighting plants, pumps, hoists, etc. Prompt shipments assured.

**BESSEMER OIL ENGINE**

recommended where power from 15 to 200 H. P. is required. Burns crude and fuel oil and runs at about  $\frac{1}{3}$  to  $\frac{1}{4}$  cost of gasoline. Now being used in irrigation, flour mills, factories, lighting plants. This engine is revolutionizing the power question.

Get the facts by writing for Catalog "O."

**The Bessemer Gas Engine Co.**  
121 Lincoln Ave. \* GROVE CITY, PA.





A complete line of appliances for the transmission of Power. Anything from a bolt to a complete mill or factory outfit. Send for catalogue. Largest Manufacturers of Pulleys in the country.



**W. A. Jones Foundry & Machine Co.** 1400 N. North Ave. CHICAGO

**4 H.P. Cushman Weighs Only 190 lbs**  
**8 H.P. 2 Cylinder Only 320 lbs**

Discussing light-weight motors recently, the Scientific American said: "Efficiency means light weight, reduced friction, and above everything else, lowered operating cost." Cushman Light-weight engines are today recognized as the leading American light-weight, high efficiency, all-purpose motors, challenging comparison in minimum weight per horsepower, reduced friction, quality of material and workmanship and cost of operation.

Sizes 4 to 20 H. P. Throttle Governor. Schebler Carburetor. Forced Water Cooling System. Moving parts enclosed and run in bath of oil. Not cheap engines, but cheap in the long run. ENGINE BOOK FREE.

**Cushman Motor Works**  
882 N. 21st St., LINCOLN, NEB.

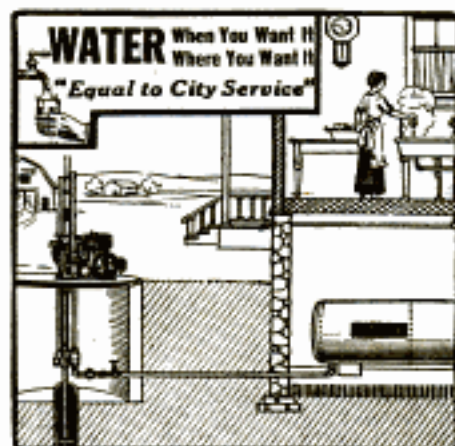
Water under pressure in your home will make housework easier, add to comfort, and increase the property value.

All water requirements of farm homes are met at moderate cost with our pneumatic pressure outfits.

May we give you details?

**Fairbanks, Morse & Co.**

New York CHICAGO San Francisco  
and many other cities

(449-611)

**THE TELEPHONE DIRECTORY A DEPOSITORY FOR VALUABLES**—The telephone book has apparently succeeded the Bible and the well-known sock as a depository for the family wealth. As a result the publishers of the Chicago telephone directory are having their troubles, says Telephony. It took 15 men a whole day to search 20,000 discarded telephone books before an envelope containing valuable papers, several small

**2 H.P. \$35** Auto Throttle Governed

not hit and miss governed. One of the many exclusive features found in no other low priced engine.

Auto Throttle Governor means smooth, even, economical power for every work. Wonderful engine value. Will operate electric light plant, run machinery, pump water, etc. Hopper cooled. Price complete with gasoline tank, electrical equipment, etc., ready to run, only \$35. Further details and catalog free. Write today.

**C. BENNINGHOFEN & SONS, Dept. 125, Hamilton, Ohio**



**SAVE 1/2 ON FUEL**

**WEBER THROTTLE GOVERNED KEROSENE ENGINE**

makes farm work cheap and easy. Uses Kerosene, Distillate, Gasoline, Gas, Naphtha.

**FREE 2 Months' Trial!**

A real free trial. Costs nothing to try. 2 1/2, 4, 6, 8, 10, 12 1/2, 15 horse-power at only \$16.00 per horse-power. 31 years of quality behind this amazing engine offer.

**Get This Book Today** Send name for valuable FREE book "How to Use Kerosene" and put money in your pocket. Learn how to use cheap fuel.

**WEBER ENGINE CO., Dept. 1771, Kansas City, Mo.**



Please Mention Popular Mechanics



**Ask Your Dealer**

for these new low engine prices.

Stationary: 2 H-P, \$35.10; 3 H-P, \$52.65; 4 H-P, \$70.20; 6 H-P, \$100; 8 H-P, \$140.40; 12 H-P, \$210.90. Portable Engines and Saw-rig Outfits proportionately low.

**Guaranteed 5 Years**

Before you buy any engine for any price, investigate our engines. If your dealer cannot supply you, write us, giving dealer's name, and we will send full information and tell you how to get an engine for trial. *Catalog Free.*

**MANUFACTURERS ENGINE CO.**  
1825 Crystal Ave. Kansas City, Mo



diamonds, a sapphire, and a diamond-studded platinum neck piece was located. Sixteen men worked nearly as long over 8,350 directories before they came across \$40 in cash, \$35.42 in checks, and valuable papers left in a book by another subscriber. Still other searchers looked through 3,500 volumes for \$30 which a subscriber said he had deposited in the directory bank.

**POWER**

for farm, ranch, shop, to pump, saw, excavate, hoist, irrigate, can be had in Galloway engines from 1 1/2 to 16 h.p. All styles. 200,000 customers testify to quality. Prices from 1/2 to 1/2 what's usually asked. Low freight.

**WM. GALLOWAY COMPANY**  
Box 965 Waterloo, Iowa.



**1c IS WORTH DOLLARS**

when you invest that 1c in a postal card to us. Here are a few of the good things in it for YOU—

1 1/2 H.P., \$24.75	5 H.P., \$87.50
2 H.P., 28.75	6 H.P., 96.75
3 H.P., 53.90	8 H.P., 135.50
4 H.P., 68.90	10 H.P., 179.90
12 1/2 H.P., \$214.90	

We guarantee against repairs forever  
OTTAWA MFG. CO., 2033 King St., Ottawa, Kans.



**FARM VIM MARINE ENGINES VIM ENGINES**

Get a VIM Engine and save money. VIM Motor 1 1/2 H.P. Farm Motor shown below does all the chores—churning, washing, suspending, separating, spraring, etc. Women operate easily. No complicated parts. Weighs only 24 lbs. Water cooled, automatic lubrication. Comes ready to run. Guaranteed. Full line marine engines 1/2 to 25 H.P.; 1, 2 and 3 cyl.; speed, pleasure and heavy duty types. Gasoline or kerosene. Double ignition. Non-backfiring. Strong, simple, accessible—absolutely dependable. Built for a lifetime. The boat-builder's stand-by, the boat-owner's pride. When writing for catalogs, please mention whether interested in stationary or marine engines, or both. Ask for attractive agency offer. The Vim Motor Company, 601 Water St., Sandusky, Ohio



Square Deal Miller Says—

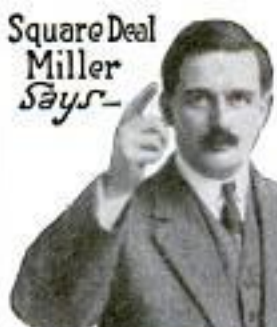

**1916 Models Now Ready!**

**Any Watch You Want On Credit**



**Waltham Hamilton Howard Elgin Illinois, Rockford**

**All Are 1916 Models.**

And I am the first man in the country to offer the **NEW 1916 MODELS** of America's best known watches. I have them all, the latest products of the world's most famous factories, and watches are by no means all. You can get too, the very latest style mountings for **Diamonds**, and the most up-to-date pieces of exquisite **Jewelry**. Whether you buy for cash or credit, the prices are right.

**NO MONEY DOWN \$2.75 A MONTH**  
**GIFT SPECIAL NO. 1**

**I Smash the Terms!**

My Square Deal methods—my high grade, well known merchandise, my liberal policies, right prices, lowest terms, have earned me my title—"Terms Smashing Miller." No catalog published offers such remarkable values, such smashing terms, as our brand new **1916 Free Book**.

**30 Day Free Trial**

**No Money Down Express Paid in Advance By Me**

That is the test that tells. Suppose you want a watch? Any make, any grade, any size, any case. I have it for you—just the watch that you want—a **1916 Model**—**NO MONEY DOWN**, Express Prepaid. You can try any one of America's best known timepieces for 30 days. **A Free Trial, a Full Month to Carry it in Your Pocket.**

**No References Demanded—An Open Account**

The same credit you get from your grocer liberally and cheerfully given. Arrangements are made for an Open Account as soon as you write. No red tape, no publicity, notes, nor collectors. Every transaction strictly confidential.

**Send This Today For Watch & Diamond Book**

Send me your name and address at once so I can mail you, Free and postpaid, the most beautiful catalog of its kind ever printed. I want you to see the **New 1916 Models** of America's best known watches. The book is a gem. It illustrates all makes of valuable **Watches, Elegant Genuine Diamonds**, and a vast assortment of **Beautiful Jewelry**, all on the easiest and most liberal terms.

Write today and get a letter from me that will make you a friend of mine from the start.

**SQUARE DEAL Miller, Pres., Miller-Hoeler Co. 590 MILLER BUILDING DETROIT, MICH.**

**SQUARE DEAL MILLER, Pres. 590 MILLER BLDG. DETROIT, MICH.**

Dear Sir: Please send me, without cost or obligation, your Big Book on all the 1916 Models, Genuine Diamonds and Jewelry and full information on your Easy Payment, No Money Down and 30 Day Trial Plan.

Name \_\_\_\_\_  
Address \_\_\_\_\_

Please Mention Popular Mechanics

# Health-Value In Fenestra

Bright, cheery hospital wards and solariums are easily secured through the use of

**Fenestra**  
SOLID STEEL WINDOWS  
"REG. U.S. PAT. OFF."

## WINDOW WALLS

The patient and convalescent receives a flood of healthful, invigorating daylight—vitaly important in restoring a sound physical condition.



Abundant ventilation and absolute fire retardancy are added Fenestra features.

Standard sizes of Fenestra Windows possess the advantage of low cost, early shipment, easy erection.

Build that hospital this winter. Save time and money by avoiding the spring rush.

Literature on request.

Detroit Steel Products Company  
Dept. A6, DETROIT, MICH.

Please Mention Popular Mechanics

## Look Men! Some Work Suit!

A revolutionizing idea in a work garment.



Patented button-down skirt showing neat jacket effect.



Skirt up showing suspenders which are attached to back of jacket.



Showing the convenient drop seat arrangement.

The most comfortable on earth! Sweetest looking. No belt to bind. No suspenders to chafe. No coat tails to bunch or catch in machinery. Exclusive Patented Button Down Skirt with convenient Drop Seat. All seams are double stitched. Guaranteed not to rip. Plenty of pockets.

### Union Made "Fits the Figure"

Don't confuse the "SENSIBLE" with the cumbersome one-piece suits. It's an absolutely different kind of combination suit. Order from your dealer or send direct to us. Express stripe, \$2; Stifel blue, \$2; Government standard khaki \$3.50. Your money back if you do not think it the greatest work suit you ever saw or tried. Write for descriptive circular.

JOHNSTON & LARIMER  
MFG. COMPANY,  
Dept. PM Wichita, Kan.



Patented  
June 8, 1915

**SENSIBLE**  
COMBINATION WORK SUIT

**The Litt Sho-Fur for FORD CARS**

This flat spring does the trick. Safety assured. No more tired wrists. Simplest, lightest, safest, and cheapest, perfect steering device on the market. Every Ford owner must have one. Write for full description. This is a gold mine for you. Ford Owners buy at sight. Dollar an hour profit. Sales guaranteed. Full details free.

Price **\$3**  
Prepaid

Agents at sight. Dollar an hour profit. Sales guaranteed. Full details free.

White Mfg. Co., Dept. P, Cincinnati, O.

## BOYS! SEND FOR BOOKLET



Special Inducement to the Wide Awake Boy in Your Town.  
NIAGARA MOTOR CAR CORP'N, Dept. A, NIAGARA FALLS, N.Y.



## Delivered to You Free

A sample 1916 model "Ranger" bicycle, on approval and 30 DAYS TRIAL and free riding test.

Write at once for large illustrated catalog showing complete line of bicycles, tires and supplies, and the most marvelous offer ever made on a bicycle. You will be astonished at our low prices and remarkable terms.

**RIDER AGENTS Wanted**—Boys, make money taking orders for Bicycles, Tires and Sundries from our big catalog. Do Business direct with the leading bicycle house in America. Do not buy until you know what we can do for you. WRITE TO US.

MEAD CYCLE CO., DEPT. K108, CHICAGO

## TYPEWRITERS FACTORY TO YOU

Look at these bargains! Typewriters Rebuilt in our own factories, and guaranteed for one year.

Underwoods \$25 to \$70      Royals \$25 to \$65  
L. C. Smiths \$20 to \$35      Olivetts \$20 to \$45  
Brand new No. 2 Smith Premier \$45

Special this month, Remington Visible No. 10, \$38.50

We have others, of course. Send for catalogue describing them. Branch offices in principal cities.  
American Writing Machine Co., Inc., 345 Broadway, N. Y.



## "IDEAL" Lawn Mower Grinder

Grinds all makes of Mowers perfectly in 15 minutes without removing wheels, ratchets or reel-knife. Ball-bearing; operated by either hand or power. Skate Sharpener Attachment for sharpening skates.



"You Grind It As You Find It"

Write Today for full information of this great labor-saver and money-maker. Will do the work so much better, quicker and easier you cannot afford to do without it. The only practical machine for sharpening Lawn Mowers on the market. Over 7000 in use. Fully warranted. Sold on easy-payment terms. Write today. Don't delay.  
**THE ROOT-HEATH MFG. CO., Plymouth, O.**

## EVINRUDE

Detachable Rowboat and Canoe Motors attached in a few minutes to any kind of boat, make it a power boat. Can be carried anywhere. Automatic Reverse, Built-in Magneto, Maxim Silencer. Illustrated Catalog free.

EVINRUDE MOTOR CO.  
33 Evinrude Block, Milwaukee, Wis., U. S. A.



## STANWELD Cold Drawn Seamless Steel TUBING

Lightest, smoothest, strongest Steel Tubing made. World's largest manufacturers of bicycles, motorcycles and automobiles use it exclusively. Send for Folder "A."

**THE STANDARD WELDING COMPANY**  
Main Office and Factory CLEVELAND, OHIO

## MECHANIC'S POCKET SECRETARY

Constructed of finest steel. Just push the button and out comes the article you require. Worth \$1.00. Postpaid

15c

Get One To-day



10 in 1 -

Adjustable Pencil, pen, paper knife, ink eraser, pencil sharpener, nail file and cleaner, mechanic's marking point, fine compass with screw attachment, foot rule.

ARDEE CO., Dept. 150, STAMFORD, CONN.

THINK of a detachable bicycle Motor that you can attach to any bicycle in 5 minutes and ride at any speed up to 25 miles an hour—100 to 125 miles on one gallon of gasoline. Thoroughly practical—simple and economical. Full control from one small thumb lever attached to the handle bars of the bicycle. Descriptive literature on request.

**A. O. SMITH COMPANY**  
Motorwheel Division 127  
MILWAUKEE, WISCONSIN

## Lowest Prices Ever Made on World's Best Roofing

This is positively the greatest roofing proposition ever made. Before you invest in new roof covering, siding or ceiling for any building you should first learn about the one best—by far the best from every viewpoint, and cheapest.



Reo Cluster Steel Shingles

## Edwards Tightcote STEEL SHINGLES

actually cost less and outlast three ordinary roofs—last a lifetime—when the building wears out you still have the roof—never needs painting or repairs. It is rot-proof, fire-proof, rust-proof, and guaranteed lightning-proof. Any one can lay it, right over old shingles if you like. special tools or experience required.



Corrugated

## Edges and Nail Holes Can Never Rust

Each and every sheet of Edwards Galvanized Steel Shingles, Roofing, Siding, Ceiling or finish is extra heavy galvanized, piece at a time, by our exclusive TIGHTCOTE patented process after sheet has been stamped and resquared.

Side and edges are as heavily galvanized as body of sheet. Means no weak spots to rust and corrode. Don't confuse with ordinary galvanized roofing. By Edwards Patent Interlocking Device, see illustration below, all nails are driven through underlayer of metal only—no exposure—no leaks.



Edwards Pat. "Grip-Lock"

## How to Test Galvanizing

Take any other piece of galvanized metal, bend it back and forth three or four times, hammer it down flat each time—then take your finger nail and flake off the loosened galvanizing. Make this same test with a piece of Edwards TIGHTCOTE Galvanized Steel Roofing—then note that the galvanizing is solid to the very edges—not a bit will flake off. Proves that not the space of a pin point can possibly be exposed to the weather and cannot wear out.



Spanish Metal Tile

## Lowest Factory Prices Freight Prepaid

We manufacture and sell all of the patterns of Edwards Reo Steel Shingles, Roofing, V-Crimped, Corrugated, Standing Seam, etc., painted or galvanized—or other building material direct from the largest and most up-to-date Metal Building Material Factory in existence, at rock-bottom factory prices. You keep the middle-men's profits in your pocket. We pay freight charges and give a permanent, binding guarantee against lightning losses—backed by our entire capital and resources.



Brick Siding

## GARAGE \$69.50

Wide variety, many styles, all sizes, \$69.50 and up.

## This FREE Book

shows clearly the material to use—the future material—easily supplants other roofing. Send today for your copy of Roofing Book No. 150.

**WORLD'S  
GREATEST  
ROOFING BOOK**

## Special Offer Coupon

The Edwards Mfg. Co.,  
100-150 Pike Street  
Cincinnati, Ohio

Please send FREE samples, Freight-Paid prices and World's Greatest Roofing Book No. 150.

## EDWARDS MFG. CO.

100-150 Pike Street  
CINCINNATI, OHIO

Note construction of patent interlocking Device, protecting nail heads from weather, making roof absolutely water-tight.

NAME.....

ADDRESS.....

We are the Largest Makers of Sheet Metal Products in the World.

Please Mention Popular Mechanics

**LYON & HEALY**

23-28 E. Adams St., Chicago

Send me your Catalog of Band Instruments.

Name .....

Address .....

I am interested in .....

**Do You Want the Best Cornet**

on the market for \$18.00?

The *American Climax* is made in the United States and guaranteed.**Send for Complete Catalog Today**

Tell us what instrument you are interested in.

"I think your Climax Cornet is the easiest blowing instrument I have ever played."  
(Signed) FRANK MUNDAY.

**LYON & HEALY, Chicago****UNCLE SAM WANTS YOU****Get a U. S. Government Job \$75 to \$150 a Month**

Rapid advancement to higher Government Positions. No "Layoffs" because of STRIKES, WARS, FINANCIAL FLURRIES or THE WHIMS OF SOME PETTY BOSS. THE POSITION IS YOURS FOR LIFE.

Country residents and city residents stand the same chance for immediate appointment.

Common sense education sufficient. Political influence NOT REQUIRED.

**We Will Coach 25 Candidates Free of Charge**

Write immediately for full list of many positions now obtainable. Don't delay. Every day you lose means the loss of just so much chance of early appointment.

**FREE COACHING COUPON****FRANKLIN INSTITUTE, Dept. G 97, Rochester, N. Y.**

This coupon, properly filled out, entitles the sender to free sample examination questions, full list of positions now obtainable, a free copy of our valuable copyrighted book, "Government Positions and How to Get Them," and to consideration for FREE COACHING for the Civil Service Examination here checked.

... Railway Mail Clerk	(\$900 to \$1800)	... Customs Positions	(\$600 to \$1500)
... Postoffice Clerk	(\$800 to \$1200)	... Internal Revenue	(\$700 to \$1800)
... Postoffice Carrier	(\$800 to \$1200)	... Stenographer	(\$900 to \$1500)
... Rural Mail Carrier	(\$600 to \$1200)	... Panama Canal Cl'k	(\$1200 to \$1800)

Name .....

85. Use this before you lose it. Write plainly.

**"I Would Not Part with It for \$10,000"**

So writes an enthusiastic, grateful customer. "Worth its weight in gold," says another. In like manner testify over 100,000 people who have worn it.

**The Natural Body Brace**  
For MEN and WOMEN.

Develops erect, graceful figure, overcomes WEAKNESS and AILMENTS of Women & Men.

Brings womanly beauty and manly strength, restful relief, ability to work and enjoy life.

**Banishes All These Troubles**

Does away with the strain and pain of standing and walking; replaces and supports misplaced internal organs; reduces enlarged abdomen; straightens and strengthens the back; corrects stooping shoulders; develops lungs, chest and bust; relieves backache and nervousness. Comfortable and easy to wear.

**Wear It 30 Days Free at Our Expense**

Write today for illustrated booklet, measurement blank, etc., and read our very liberal proposition.

**HOWARD C. RASH, Pres. Natural Body Brace Co.**  
223 Rash Building SALINA, KANSAS



For Children Also

**WOULD YOU**

show this standard high grade 42 key fully visible typewriter to your friends and let them see wherein it excels any other \$100 typewriter, if by doing this and rendering other small assistance, you could easily have one to keep as your own? Then by post card or letter to us simply say, "Mail Particulars."

GIVEN YOU

**WOODSTOCK TYPEWRITER CO., Dept. J 204, Chicago, Ill.**

**Make Music Rolls**

10 each. Inexpensive Learajan Perforator makes player-piano rolls from any piece of music written. Music knowledge unnecessary. Pleasure or profit. Details free.  
**LEARAJAN MANUFACTURING CO. DEPT. B, HAMILTON, OHIO**

**A 14-Inch Dancing Skeleton**

It dances, bows, rises or falls at your command. Also 1 Roll of Stage Money, 1 Imitation Diamond Ring, 1 Opera Glass Charm, 1 Gold Tooth, 1 Checker Board, New Puzzles; also Postage Stamp Flirtation, Parlor Pastimes and Card Tricks, and the great Gypsy Fortune Teller. All with a large Catalog of Novelties for 12 cents, 2 cents postage.

**ED. STRAUS, Dept. 9, 306 Water Street, BROOKLYN, N. Y.**

**INDOOR CLOSET****More Comfortable, Healthful and Convenient than the Out-Door Privy**

Eliminates the out-door privy, open vault and cesspool. They are breeding places for germs. Have a warm, sanitary, odorless toilet right in your house. No going out in cold weather. A boon to invalids. Endorsed by State Boards of Health.

W. M. Davis writes: "Your indoor closet is giving absolute satisfaction. It is certainly the thing for a home without sewerage."

**Absolutely Odorless Put It Anywhere in the House**

The germs are killed by a chemical process in water in the container, which you empty once a month. **Absolutely no odor.** No more trouble to empty than dishwasher. Closet absolutely guaranteed. Write for full description and price.

**Agents Wanted - Big Profits** Wonderful opportunities in every town, village and in the country. Best season just at hand. Every home is a good prospect. Sell eight out of every ten you call on. Ernest Redmill writes, "Have ten orders." G. A. Dismar says: "Ship at once twenty closets and fifteen washstands. Sold them all in one community." Sell Ro-San. Everybody hates the outdoor privy. Everybody wants a Ro-San Indoor Closet. Write quick for territory and full particulars.

**ROWE SANITARY MFG. CO., 101P Sixth St., Detroit, Mich.**  
Ask about the Ro-San Washstand - Hot and Cold Running Water Without Plumbing

# KEITH'S

## 16 Years

The Leading Authority on Home Building Will Give You Something Good



Pictures and Plans of this home in January KEITH'S Newsstands, 20c.

KEITH'S is a specialized monthly magazine complete in the latest ideas and Plans you cannot afford to miss. Each 72 and 100 page number gives many cuts and plans with interesting detailed write-ups of Homes planned by leading architects. Articles on "Inside the House" and "Home Decorations" by well-known experts. New materials and how to use them.

### Big Offer of the Year

Send \$2, the subscription price for one year, and we will enter you for 12 Big House Building Numbers and, in addition, mail postpaid, your CHOICE of any of KEITH'S

### Famous Plan Books:

146 Designs Bungalows & Cott. \$1.00	100 Designs, cement and brick \$1.00
144 Designs costing less \$3.00 1.50	50 Garages costing \$100 and up 1.00
132 Designs costing less \$4.00 1.50	200 Views of living rooms, halls, fireplaces, etc. 1.00
175 Designs costing less \$5.00 1.50	40 Duplex Houses and Flats .50
173 Designs costing less \$6.00 1.50	100 Designs costing \$2000 to 10,000 .50
123 Designs costing over \$6,000 1.50	

All 10 Books and KEITH'S a Year, \$8.00

M.L. KEITH, 871 McKnight Bldg., Minneapolis, Minn.

## CORONA

FOLDING TYPEWRITER

CORONA TYPEWRITER CO., Inc., GROTON, N. Y.

Weights 6 lbs. Occupies little space. Durable, efficient. Costs but \$50. Write for booklet No. 13.

New York: 141 West 42nd Street

### Do You Shoot? in an Old Story

Send for Book—A New Chapter in the history of projectile arms from primitive times to the most advanced sporting arms of today. Concise and interesting. Contains several full page game pictures in color. Send 50 cents (less than cost of production) to

REMINGTON ARMS-UNION METALLIC CARTRIDGE CO., 233 Broadway, New York City

### FOR YOUR OWN PROTECTION and for the sake of your children and family you should have one of our

### Bohner Self-Cleaning Filters

attached to your faucet. Insures you purest crystal water at no expense. "A health necessity." Write for particulars.

BOHNER MANUFACTURING CO.  
1009X S. Wabash Ave., Chicago, Ill.

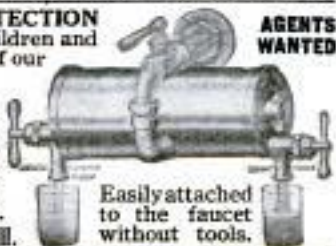

AGENTS WANTED

Easily attached to the faucet without tools.

## DIAMONDS 97.50 Per Carat

### WE SAVE YOU 35% MONEY-BACK

Only from Basch, Direct Importers, is it possible to get genuine perfect-cut diamonds at the world's lowest price \$97.50 per carat. Full \$150.00 per carat retail value.

### FREE Examination

Any selection from this ad. or from our catalog will be shipped for your approval, at our expense. You will not be obligated to buy unless you wish to.



This 14K solid gold mounting complete with

1.8 c. Diamond \$12.00
1-4 carat Diamond 21.25
5-8 carat Diamond 35.00
1-2 c. Diamond 48.75
3-4 c. Diamond 71.25
1 carat Diamond \$105.25

**GUARANTEE** The legal contract is issued with every diamond we sell. Weight, quality and value guaranteed. Also allows full price in exchange of any time; we also agree to refund full purchase price less 10% any time within a year.

### 1916 De Luxe Diamond Book FREE!

Send for this valuable book NOW! Free for the asking. Thousands of illustrations of diamonds, jewelry, etc. gives expert facts about diamonds needed to buy intelligently. Write to:

L. BASCH & CO.  
Dept. 17471 State & Quincy Sts.  
CHICAGO, U. S. A.



## Imported Drawing Instruments Free!!

YES, I will give you this exquisite set of imported drawing instruments absolutely free and I will give you a 90 x 25 inch drawing board, a 24-inch T square, a 12-inch rule, a supply of drawing paper, 2 triangles and a French curve, pencils, erasers, thumb tacks, etc. The instruments come in a superb plush lined leather case—they are genuine working instruments and I don't think you could duplicate this outfit for less than \$15. But I give it away absolutely free to the men who get my personal instruction.

## Be a Draftsman! Draw \$125 to \$175 Per Month

There is an urgent demand for skilled draftsmen. Companies are issuing calls every day for men to fill positions paying from \$125.00 to \$175.00 per month. I will give you just the training you need to hold one of these big jobs—right in your own home. Write now.

## Chief Draftsman Will Instruct You Personally

I am Chief Draftsman of a large and well known firm. I have been doing the highest paying expert



drafting work for a quarter of a century and I know just the kind of training that is demanded from men who get the big salaries. During my spare time I will train a few ambitious men to hold big jobs, while they remain in their own homes. You will get actual work to do—practical instruction until you consider yourself competent regardless of how long it takes. Write today—now—act at once.

### Pay As You Wish

I want ambitious men. Don't worry about the small charge I make for my instruction. Write today.

### Chief Draftsman Dobe

Engineer's Equipment Co., Div. 9191, Chicago, Ill.

### Send the Coupon for Big New Book

Send this coupon or a letter or a post card and get my new book. No obligations. Act now.

### Chief Draftsman Dobe

Engineer's Equipment Co., Inc.  
Div. 9191  
Chicago, Ill.

Name .....

Address .....

Without any obligations on my whatsoever, please mail your book "Successful Draftsmanship" and full particulars of your liberal "Personal Instruction" offer to a few students. It is understood that I am obligated in no way whatever.

# HEADLIGHT OVERALLS

(Union Made)

Don't say—"Give me a pair of overalls."  
Say—"Give me a pair of Headlights"  
—and get the biggest value for your money.

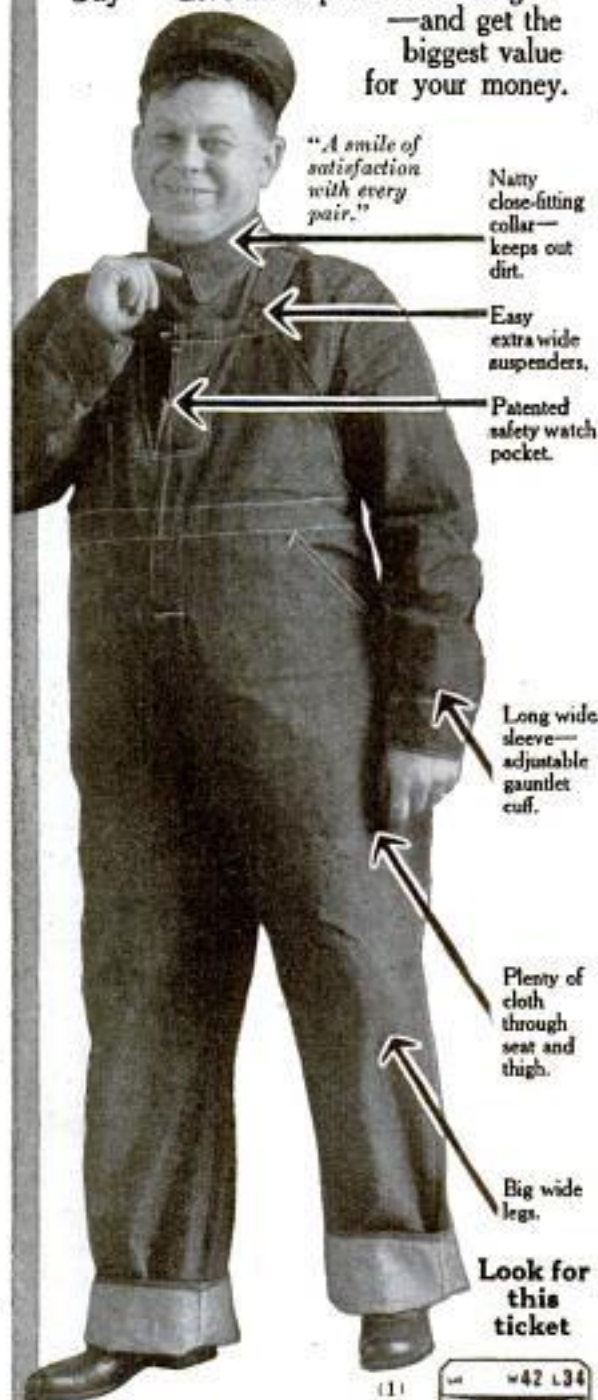

"A smile of satisfaction with every pair."

Natty close-fitting collar—keeps out dirt.

Easy extra wide suspenders.

Patented safety watch pocket.

Long wide sleeve—adjustable gauntlet cuff.

Plenty of cloth through seat and thigh.

Big wide legs.

Look for this ticket



Larned, Carter & Co., Detroit  
World's Greatest Overall Makers  
Factories: Detroit and Port Huron, Mich.  
St. Louis, Mo.; San Francisco, Cal.  
Canadian Factory - Sarnia, Ont.

## The Cheapest Power on Earth



for any machine capable of being run by hand, is this **Stewart Little Major Engine**,  $\frac{1}{2}$  horse power. With battery, \$27.50; with high tension magneto, \$37.50.

The simplest, strongest and most practical big little engine ever offered. It operates for a full ten-hour work day on less than a half gallon of gasoline.

Just the thing to run a small press, washing machine, bone cutter, lathe, drills, small saw, cream separator, ice cream freezer, spraying outfit, pump, feed mill, etc. Stewart Engines in  $\frac{1}{4}$ ,  $\frac{1}{2}$  or 3 horse power sizes.

Order today or write for catalog. **CHICAGO FLEXIBLE SHAFT CO.** 105 N. La Salle St., Chicago, Ill.

## A MARVELOUSLY PRACTICAL COMBINED Tool is this **Stewart Handy Worker**

Comprises on one base a vise up to 4  $\frac{1}{2}$  inches; width of jaw, 4 inches; powerful pipe vise up to 1  $\frac{1}{2}$  inch pipe; a strong, sturdy anvil; cutting handle; drill press with two speeds; corundum grinding wheel, 5 inches x 1 inch, operated at 3 speeds, etc.

Weights, boxed, 90 pounds; complete, 4 c. b. Chicago, **\$12.50** only. A complete workshop. Order one or write for booklet.



**Chicago Flexible Shaft Company**

105 N. La Salle St.

Chicago, Illinois

**PLATINUM NOW LITTLE USED IN ELECTRICAL INDUSTRY**—Although platinum utensils are still used largely in chemical laboratories and industries, the demand in the electrical industry for this metal is each year becoming less and less. Metallic molybdenum and tungsten have now to a great extent replaced the more expensive metal.



**ALORRA DIAMONDS**

SPARKLE LIKE THE GENUINE - AT 1-40 THE COST

**SOLID GOLD RINGS**

—stand solid, fire and expert examination. See them before buying. Any style ring, tin or stud. Catalog FREE. The Alorra Co., Dept. A7, 140 S. Dearborn St., Chicago

**Agents \$60 WEEKLY**

Robinson Folding Bath Tub. Big seller. Costs little, no plumbing, little water. Weight 15 pounds, folds into small roll. Full length baths, far better than tin tubs. Guaranteed 10 years. \$10 a day easily made. Write for free tub color. Robinson Cabinet Mfg. Co., 251 Factory Bldg., Toledo, O.

## ERECTOR



The Toy Like Structural Steel

Write for new free 24-page Book. Tells about Erector—the only construction toy with girders like real structural steel. I'll also send FREE 3 issues of my boys' magazine, *Erector Tips*, explaining \$3000 prize offer.

Write now—they're free.

A. C. Gilbert, President. **THE MYSTO MFG. CO.**, 104 Fox St., New Haven, Ct.



Please Mention Popular Mechanics



## Every Machine Shop

no matter how small, should have a binder on hand, ready at all times for keeping your tools in proper condition. You do not need to buy a Grinder for every special job. You can grind your lathe centers, cutters, reamers, dies, tools, jigs, fixtures and a hundred other different jobs with the

### TEMCO Tool Post Grinder

And when the Grinder is not working on a machine, bolt it to a bench and you have a very practical little bench grinder. It is the handiest tool known for a machine shop. Has reversible switch for running motor either forward or backward—an offset head that is adjustable—lever feed, very sensitive but positive—vertical adjustment and many other convenient features. Use it in any part of the shop by simply connecting it to a drop cord, either A. C. or D. C.

One of the many needs for a Temco Tool Post Grinder



It keeps your tools in first class condition for getting out most efficient work. Often it does special kinds of work that ordinarily would take a machine costing several hundred dollars.

#### Ask for One on Trial

Your dealer will order one for you and let you have it on trial. Our catalog shows a number of different ways of using the machine and gives full specifications.

**DON'T DELAY FINDING OUT ABOUT IT AT ONCE.**

**THE TEMCO ELECTRIC MOTOR COMPANY**  
122 Sugar Street LEIPSIK, OHIO

Manufacturers of the famous Temco line of Electric Portable Drills

## BOYS—Get MECCANO for Christmas

You can have heaps of fun building towers, skyscrapers, bridges, derricks, cranes and hundreds of other large and small models that work. MECCANO builds

**\$1,000.00  
Prize Contest  
Now On!**

### 10,000 MODELS

Builds easier, quicker and better. Builds more models, too. Every part is interchangeable. It's the constructional toy you should get for Christmas. Stores everywhere are displaying MECCANO. Tell the folks you want MECCANO. See the cards; \$1.00 to \$36.00. Look at No. 2x with the MECCANO Electric Motor for \$5.00; or the No. 1x, also with motor, for \$3.00. See the new improvements!

Get MECCANO for Christmas—it's the one, leading building toy. Send five boys' names and addresses and get the big, free story-book catalogue "Frank Hornby, the Boy Who Made a Million Dollars with a Toy." A 144 page book that tells about MECCANO. It's free—don't send any money or stamps—just 5 boys' names.

**FRANK HORNBY  
MECCANO COMPANY**



Room 15, 71 West 23rd St., New York City

### ACORN UNI-LITE FREE



Turns night into day. 300 candle power. Carry as a lantern; use anywhere as a lamp. Weather proof. For house, barn, garage, camp and around the farm. Write for big free offer. Special opportunity to farmers, stockmen and motorists. Agents make big money.

WRITE TONIGHT

ACORN BRASS MFG. CO., 603 Acorn Bldg., Chicago

### GET THIS CATALOG

FULL OF VALUABLE INFORMATION TO EVERY BOAT OWNER ON

RACING PROPELLER WHEELS,  
REVERSE GEARS AND  
MARINE ACCESSORIES

LARGE CATALOG FREE. SEND TODAY

MICHIGAN WHEEL CO.  
1139 MONROE AVE., GRAND RAPIDS, MICH.



## Made-to-Measure

EXPRESS PREPAID **\$2.75**

Pants cut in the latest style. Made to your individual measure. Fit, workmanship and wear guaranteed.

#### No Extra Charge

for peg tops, no matter how extreme you order them.

**Agents** A good live hustler in every town to take orders for our **Wanted** celebrated made-to-measure clothes. Samples of all latest materials FREE.

#### We Pay Big Money

to our agents everywhere. Turn your spare time into cash by taking orders for our stylish clothes. Write today for beautiful FREE outfit.

**THE PROGRESS TAILORING CO.**  
Dept. 870, CHICAGO, ILL.



**Blue White  
Perfect Cut**

**\$88**

Per Carat

**NO MONEY IN ADVANCE!**

Send no money, not even a deposit! Just select any diamond, any mounting. We'll send it to you at our expense. Examine, test, compare in any way. If you don't want to keep it simply return. No obligation or even a penny of expense to you.



Ladies' and child's ring, 14k solid gold band made mounting, perfect cut blue white genuine diamond. In velvet Jewel Case, \$10 value. Remit \$2.88 in any form you prefer. Money back any time within 30 days on request.

**2.88**

Look at these  
prices for  
**DIAMONDS**

Think of it! Only \$88 per carat for Genuine, Blue White, Perfect Cut Diamonds. And small sizes as low as \$50 per carat. Expert comparison proves the value fully \$150 per carat. You keep the difference—no middleman gets it. That's what it means to buy direct from the importer. You get every benefit of our big buying power and small profit plan.

**BANKABLE, LEGAL  
MONEYBACK GUARANTEE**

Permits you to return any diamond bought from us through any bank in America, or direct to us, and receive **CASH REFUND**. No delay. No red tape. Cash refunded promptly without question. Guarantees also full purchase price in exchange forever. Also legally certifies carat weight, color, and value of the diamond.

**1918  
De Luxe Book of Diamonds FREE!**

First to show 1918 styles. Tells all diamond facts needed to buy safely and intelligently. Enables you to judge diamonds like an expert. Write or mail post card. Absolutely Free.

References: Rogers Park National Bank of Chicago, your banker, or any commercial agency will tell you of our high standing.

**BARNARD & CO.**  
Dept. 888C, S.W. Cor. Wabash & Monroe St., CHICAGO

3/4 carat \$6.25

1/2 carat \$15.50

1/4 carat \$29.00

1/8 carat \$40.25

1/16 carat \$88.00

1/32 carat \$176.00

1/64 carat \$352.00

1/128 carat \$704.00

1/256 carat \$1408.00

1/512 carat \$2816.00

1/1024 carat \$5632.00

1/2048 carat \$11264.00

1/4096 carat \$22528.00

1/8192 carat \$45056.00

1/16384 carat \$90112.00

1/32768 carat \$180224.00

1/65536 carat \$360448.00

1/131072 carat \$720896.00

1/262144 carat \$1441792.00

1/524288 carat \$2883584.00

1/1048576 carat \$5767168.00

1/2097152 carat \$11534336.00

1/4194304 carat \$23068672.00

1/8388608 carat \$46137344.00

1/16777216 carat \$92274688.00

1/33554432 carat \$184549376.00

1/67108864 carat \$369098752.00

1/134217728 carat \$738197504.00

1/268435456 carat \$1476395008.00

1/536870912 carat \$2952790016.00

1/1073741824 carat \$5905580032.00

1/2147483648 carat \$11811160064.00

1/4294967296 carat \$23622320128.00

1/8589934592 carat \$47244640256.00

1/17179869184 carat \$94489280512.00

1/34359738368 carat \$188978561024.00

1/68719476736 carat \$377957122048.00

Please Mention Popular Mechanics

# PREST-O-LITE

FOR  
MOTORCYCLES

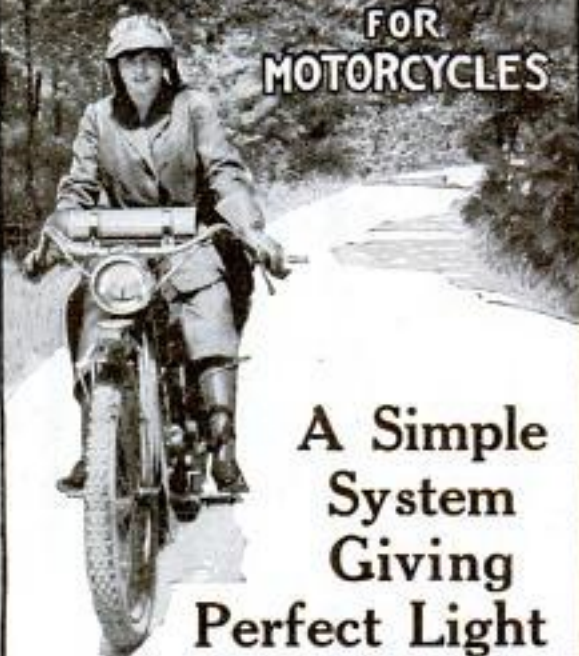

## A Simple System Giving Perfect Light at Small Cost

Because Prest-O-Lite gives perfect riding light, is simple and trouble-proof, never fails in emergencies, demands no attention you yourself cannot give, easily, quickly and inexpensively, because it stands the jolts, and is as sturdy as your motorcycle itself, *more riders use Prest-O-Lite than all other systems combined.*

Yet Prest-O-Lite costs less to buy and less to use than any other brilliant light.

### Sold on Money Back Basis

Prove Prest-O-Lite on your own machine. Use it for 30 Days. You are the judge if you want your money back.

### The Complete Equipment for Satisfaction

You can get Prest-O-Lite on any make of motorcycle. If you want a complete equipment, your dealer can give you Prest-O-Lite, a lamp and a mechanical horn — makes a splendid combination. Saves you money when you buy, and more when you use it.

Your name and address on the margin of this page will bring complete information on motorcycle lighting. Write today.

### The Prest-O-Lite Co., Inc.

The World's Largest Makers of Dissolved Acetylene

Main Offices and Factory:

265 Speedway, INDIANAPOLIS, IND.

Canadian Offices and Factory:

MERRITTON, ONTARIO

*Prest-O-Lite Exchange Agencies Everywhere*

## A Carborundum Stone Makes a Dull Tool Sharp



**T**AKE this Carborundum Combination Bench Stone for instance. It is an ideal stone for the carpenter or mechanic. It is positively unequalled in its hardness, sharpness, and fast-cutting qualities. Just the right size for the tool kit, and a mighty useful little stone to have around.

☞ There are chisels, planes, gouges, and other edge tools that are constantly getting dull. You are bound to find that the very best insurance against dull tools is a Carborundum Combination Stone.

☞ The coarse side takes out the nicks, and brings the tool to an edge, and the fine side gives it a smooth, keen edge.

*From your hardware dealer or direct. Catalog sent free upon request.*

The  
Carborundum Company  
Niagara Falls, N. Y.

*Please Mention Popular Mechanics*

Copyrighted material

# Electric Light for Your Home

This newly invented system enables every rural home to make their own electric current; operates from one to fifty lights; and will drive small electric motor, electric iron, toaster, etc. Everything complete in one compact unit; no batteries or switchboard. Uses standard lamps and fixtures that any dealer can supply. Nothing to watch but the small, high-speed gasoline motor, which requires slight attention once a week.

The ideal electric lighting system for country homes. Nothing like it ever sold before. Costs less than other systems to buy and to operate. Will last for years.

**WATERMAN MOTOR COMPANY**  
182 Mt. Elliott Ave. DETROIT, MICH.

Write today for  
descriptive lit-  
erature and  
prices.

**Uni-Lectric**  
GASOLINE-ELECTRIC UNIT  
LIGHTING SYSTEM



## "Get a RECEIPT"

YOU ARE SURE OF IT from the MERCHANT WHO USES A NATIONAL CASH REGISTER



### 3 Books on Boats and Engines Free

Issued by the world's largest manufacturer of Marine Motors. Telling where you can buy the kind of boat you want at the price you want to pay; and showing complete line of Gray 2 and 4 cycle Guaranteed Marine Motors including the new 4 cycle Model "D." Gray Model "D's" have made good in speed-boats, work-boats, cruisers and house-boats. Write for these three books today—they are free.

GRAY MOTOR CO., 198 Gray Motor Bldg., Detroit, Mich.

## A NEW WAY To Get Your Clothes Free

### Make Big Money During Spare Time

Something Different, bigger, more liberal than any offer ever made. Lower prices—better clothes—bigger cash profits. Express paid on everything.

### Double Pay

FREE clothes and cash besides. We don't ask you to use your cash profits for your own clothes. Ours is a new and better plan. An Extra Present with every order. Not a prize scheme. Choose what you want, work for it and get it besides your Cash Profits. Complete Outfit FREE, 50 real cloth samples, 50 Fashion Plates, inside wholesale prices. Get the big money. Your name on a post card brings everything FREE.

SPENCER MEAD CO., Dept. 270, Chicago



# POWER for YOU!

Power from within! Strength that is *more* than mere muscular strength—the strength of better health, abundant nerve force—the strength of the perfect man. Don't you want it? Nine people out of every ten are only *half alive!* How about yourself?

## All the Exhilarating Joys of Life Strength Youth

Do you feel just right? If you do not—if you haven't that vigorous "go ahead" feeling all the time—don't fail to send the coupon for full particulars about the White Cross Electric Vibrator. In vibration there exists many of the secrets of life. You now have an opportunity of seeing what vibration will do for you—how every nerve, every fibre in your whole body will fairly tingle. Try this remarkable instrument for yourself—test it. Now is the time for YOU to send for the free book, "Health and Beauty." Thousands have received it. You are invited to write for it, too.



### The White Cross Electric Vibrator

is the result of years of work and experiment. If you have your house wired for electricity, you connect it up as easily as an electric lamp; if not, we can supply you with models operated on their own batteries.

### Special Offer for a Limited Time

For a short time only we are making a remarkable Special Introductory Offer on the White Cross Electric Vibrator, in order to place at least one of these splendid instruments in every city, town, village in the country.

### Free Book Sign the coupon and mail it today. Get our splendid big

FREE book telling you all about the marvels of Vibration. Read what scientists say. Post yourself on what it will do for you. Learn all about the White Cross Electric Vibrator and our limited offer. No obligations at all—send the coupon or a post card or letter today.

Lindstrom, Smith Co.  
1100 South Wabash Avenue  
Dept. 1191, Chicago, Ill.

We also manufacture White Cross Electric Stoves, Irons, Hair Dryers, Electric Lamps, Electric Fans, Electric Automobile Horns, Electric Curling Irons, Heating Pads, Small Motors, etc. Dealers write.

Name.....

Address.....

My Electrical Dealer's Name is.....

LINDSTROM,  
SMITH CO.

1100 S. Wabash Avenue  
Dept. 1191, Chicago, Ill.

Without any obligations on my part, please send me, free and prepaid, your free book on Vibration, full particulars of the White Cross Vibrator and your Special Offer.

Please Mention Popular Mechanics

WE ARE HEADQUARTERS FOR

**ELECTRICAL GOODS and WIRELESS APPARATUS**

OUR NEW 224 pp. No. 7 CATALOG IS THE BEST ONE PUBLISHED

**EXPERIMENTERS**

THIS IS THE Experimenter's Reference Book

It's the latest edition of the famous Amco Catalogue, contains over 200 pages and is fully illustrated. Complete description and prices of the latest electrical and experimental apparatus—Storage Batteries, Rectifiers, Transformers, Induction Coils, Wireless Apparatus, Lamps, Flashlights, Motors, X-Rays, Books, Tools, Electric Railways, Steam Engines, Water Motors, Dynamos, Motors, Telephones, Electrical Supplies, Model Aeroplanes and Parts for building your own apparatus. 6c in stamps will bring you this wonderful book. Contains a complete list of Wireless Calls, gives Codes, Wiring Diagrams, tells how to put up an aerial and install apparatus, etc.

Best catalog of Wireless and Electrical Apparatus, etc., published. Send for this catalog right away. Our prices will save you money.

6c in stamps brings it by return mail.

**FUN WITH ELECTRICITY**

Here is a rare chance to get started right in your study of electricity. This wonderful outfit contains 55 page book of instructions and all the apparatus for performing 60 interesting and spectacular experiments which will give any boy a practical knowledge of electricity.

Price Only 50c. Postage 10c Extra

**FUN WITH MAGNETISM**

This outfit contains 12 page book of instructions and all the apparatus for performing 61 fascinating experiments. It will give you some new ideas about electricity and magnetism in such an interesting way you can't help remembering it. Price only 25c. Postage extra 5c

**LOTS OF FUN FOR BOYS!**

3 1/2 volt, 2 C. P. TUNGSTEN lamp, switch, socket, 20 ft. insulated wire and 3 cells of dry battery all ready to install. May be used to light a dark closet or hall.

Price only 60c. Postage extra 15c

**LITTLE GIANT MOTOR**

Is nearly 3 in. high. Runs at high speed on a single cell of battery. Very powerful and may be used to run small toys, etc. Just the motor every boy has been looking for. Sent postpaid for only 50c

**THE SIMPLEX TELEGRAPH OUTFIT**

An opportunity for every boy to learn to telegraph and to get up a line with his chum. This is a full sized telegraph set, consisting of a fine key and sounder, mounted on a polished base. Will work any distance. An excellent Field Telegraph for Boy Scouts. Price, 50c. Postage Extra. Wt. 2 lbs.

**UPRIGHT STEAM ENGINE**

A fine engine of the best materials. 9 in. high. The Right Engine for Any Boy, runs at high speed. Each engine tested at factory and fully warranted. Sent postpaid for only 50c

**SIMPLEX WIRELESS OUTFIT**

Every boy wants a wireless. Get in this interesting game and read the messages flying around you. This outfit is the greatest bargain ever offered. Consists of a large double slide tuner, a sensitive detector, condenser, telephone receiver and cord. Weight 3 lbs. Special Price, Complete, \$2.25. Postage Extra.



SEND 6 cents for our mammoth catalog

**ADAMS-MORGAN COMPANY** "The Experimenter's Supply House"  
25 Alvin Place UPPER MONTCLAIR, N. J.

**Building a Launch? You Need This Book**

It's the Callie Marine Motor Blue Book. It shows the most complete line of motors at the most economical prices in sizes ranging from 2 to 30 H.P. Every one is of highest grade, simple, sturdy, easy to operate, thoroughly guaranteed. This book has saved boat owners thousands of dollars.

8 H. P. \$150

Unit  
Plant

It will save you money. Get a copy. It's free.



The Callie  
Perfection  
Motor Co.  
1523 Callie St.  
Detroit,  
Mich.

**BUILD YOUR OWN MOTOR For Bicycle or Motor-Bob**

Send 25 cents (not stamps) for drawings and instructions and price list of finished parts. You can build it with few tools.

STEFFEY Motor, 5025 Brown St., Philadelphia, Pa.

**WIRELESS STATION ON PACIFIC COAST OF MEXICO**—To establish immediate and permanent wireless communication between the west coast of Mexico and all parts of the United States and western Canada, General Carranza has ordered the purchase in the United States of five powerful wireless plants, according to recent reports.

**WATKINS' SPECIAL MOTORS**

2 H. P. Single Cylinder . . . 30 lbs.  
4 H. P. Double Cylinder . . . 40 lbs.  
12 H. P. Four Cylinder . . . 160 lbs.

A strictly HIGH GRADE Motor that will give CONSTANT and EFFICIENT service. Especially adapted for CANOES and LIGHT BOATS. Aluminum base, copper water jacket, steel shaft, bronze bearings.

THE WATKINS MOTOR CO.  
837-839 West Sixth Street CINCINNATI, OHIO

**Toledo MARINE MOTORS**

"Nothing Cheap but the Price"

3 H. P. 1 cyl. complete	\$ 65.00
6 H. P. 1 " "	84.00
6 H. P. 2 " "	125.00
12 H. P. 2 " "	160.00
18 H. P. 3 " "	250.00

Fully guaranteed by a responsible concern. 2 cycle, 2 port, 3 1/2 x 5 1/2 and 4 1/2 x 4 1/2. Send for free catalog "C".

THE UNIVERSAL MACHINE CO., Pike Ave., Bowling Green, O.

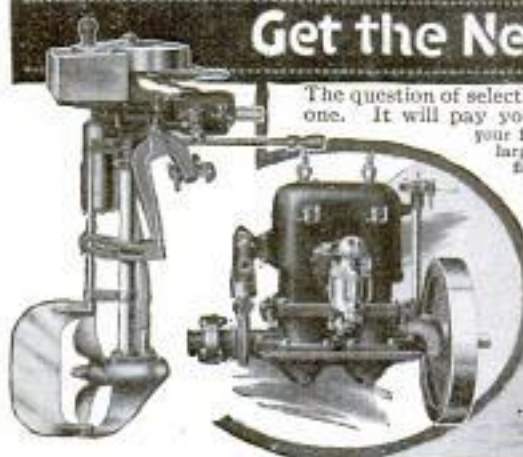
**Get the Newest LA Engine Book**

The question of selecting the right engine for that boat of yours is an important one. It will pay you well to get all the information possible before making your final decision, as the satisfaction you get from your outfit will depend largely upon the care you take in choosing your motor. You will find the new L-A engine book brim full of valuable hints and interesting engine information. It describes the complete line of L-A inboard and outboard motors for canoes, rowboats, pleasure boats, work boats, etc., and gives complete details of our liberal

**30 DAYS' TRIAL PLAN**

whereby you can have the privilege of proving out the quality of L-A Motors before making your final decision. Write for YOUR copy to-day.

**Lockwood-Ash Motor Co.**  
1320 Boston Av. Jackson, Mich.

1320 Boston Av. Jackson, Mich.



AN LA ENGINE FOR EVERY PURSE AND PURPOSE

Please Mention Popular Mechanics

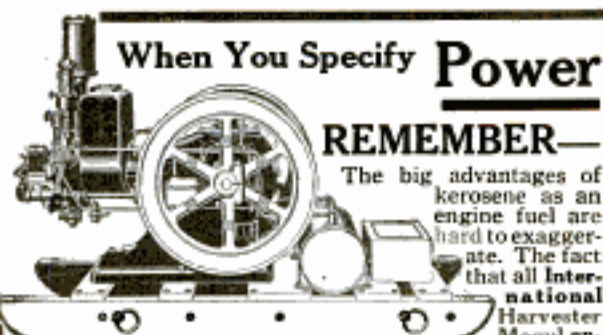

When You Specify **Power**

**REMEMBER—**

The big advantages of kerosene as an engine fuel are hard to exaggerate. The fact that all International Harvester Mogul engines burn low grade kerosene successfully has had much to do with their present popularity.

Kerosene is cheap—It is easy to get—It makes a noticeable reduction in insurance rates—Kerosene engine power has no stand-by loss—It is ready the instant you need it—Expense stops when the work stops—A Mogul kerosene engine is better, cheaper, safer than any other power. Remember the name—

## Mogul Kerosene Engine

Men who have had a wide experience in the use of power are all through with experimenting when they have once tried out a Mogul of the proper size. Let us send you catalogues and information regarding the right type of engine for you at the right price. Mogul sizes range from 1 to 50-H. P.

*Our specialty is—satisfactory power and the best of service before and after the sale. Drop us a line and we will prove it.*

**International Harvester Company of America**

(Incorporated)

16 Harvester Building

Chicago U S A



**TURN SPARE TIME TO DOLLARS**

You can be sole agent for the **REX VISIBLE STANDARD TYPEWRITER**

A brand new \$100 machine that you sell for \$37.50 and make BIG MONEY, without investment or experience. Unsurpassed merit, low price. Easy payments, 10-day free trial and 10-year guarantee will sell the REX for you. WRITE TODAY FOR PARTICULARS.

**REX TYPEWRITER CO., Dept. 27, 28 E. Jackson Blvd., CHICAGO**

## AGENTS Work With An Auto

Write Quick for **SPECIAL OFFER**

Agents are making tremendous success traveling by auto selling "The Easy Wringer Mop." Sell and deliver same time. Travel miles at our expense, easy, pleasantly, profitably. Easy sales. Make

**\$250 to \$500**  
A MONTH

You can do it. H. N. Brown's first order was \$1575. Over \$3500 Profit. Sells by Auto. I. C. Faulk sold 3778 first trial. \$2778 Profit. C. F. Lane orders 2,000 at once. \$1340 Profit. You are bound to win. No competition. Price low. Control big territory. We make it easy to cover ground and make money fast.

**Latest Model Auto Given**



**\$785** TOURING CAR

One of America's best known cars. Roadster or Touring Model. Low up-keep expense. Burns farther for the least money. Every agent can earn one. Not a contest. Given to every capable agent. Write quick for territory and particulars.

**U. S. MOP CO., 341 Main St., TOLEDO, OHIO**

# FREE to YOU

## FOR ONE WEEK



Delivered  
**FREE**  
to You  
Wherever  
You Live

## THE MARVELOUS ELECTRIC WASHING MACHINE

Yes, Madam, that is exactly what we mean. At our own expense—without a cent of cost or the least obligation to you—we want you to do a full week's washing with the Frantz Electric Washing Machine.

We are going to loan you, free, this marvelous Electric Washing Machine for one full week. We bear every expense. We even pay all delivery and express charges. This free loan will not cost you a penny. All you have to do is to use it to your heart's content—let it do all the washing for you for one full week—and do it easier and quicker than it has ever been done before.

### Without Cost to You

Simply sign and mail the Coupon below, or write us, and we will send you the full details of this wonderful free loan offer, and also our beautifully illustrated booklet. No strings are attached to this free loan offer. We want you to use the Frantz Electric Washing Machine for one whole week, just as though it were your own. Wash your clothing of all kinds, your linens, curtains, bedding, lingerie, or any other article that you wish. Put it to every test you can think of.

And then if at the end of one week's free trial, you are not more than delighted with the Frantz Electric Washing Machine, you may return it, or we will send for it, without a cent of cost or obligation on your part. But, if you decide that you simply cannot get along without it, then you may keep the washing machine and pay for it on

### Special Easy Monthly Payments

The Electric Washing Machine goes to you right from our factory or direct from our dealer if we have one in your town. First you get the free trial and then the easy monthly payments. And, remember you get the rock-bottom factory price—you do not pay a penny more because of this special Easy Monthly Payment Plan. We expect to be so swamped with Free Trial requests that we reserve the right to withdraw this offer after a reasonable length of time. So send at once for your Free Trial. Remember—absolutely no obligation to buy.

**MAIL THIS COUPON** Sign this coupon and mail it to us at once. The minute we hear from you we will mail you the full details of this great Free Trial offer and Easy Payment Plan. We will also send you free, the beautifully illustrated literature. Send coupon or write today—at once.

**The Frantz Premier Company**  
Dept. 1177, Cleveland, Ohio

### Sign This Coupon NOW!

**THE FRANTZ PREMIER COMPANY**  
Dept. 1177, Cleveland, Ohio

Without expense or obligation to me send full and complete details of your wonderful Free Trial and Easy Payment offer. Also your beautifully illustrated booklet.

Name .....

Address .....

Please Mention Popular Mechanics



# The Ultra Power "X"



Model 16-3  
Three Speed



PRICE  
**\$250** The Most Powerful  
Motorcycle in the World

*The Enormous Power of  
the Big X Twin Motor  
Multiplied by a Three  
Speed Gear of Autom-  
obile Type*

**A Mechanical Giant  
Under Perfect Control**

**COMPLETELY PERFECT—PERFECTLY COMPLETE**

Every detail that insures Power, Speed, Serviceability, Comfort and Safety developed to the highest degree of Mechanical Perfection.

One of Six Models at prices \$135.00 to \$280.00. Fully described in our new catalog. Write for it today.

*If you are interested in Light-Weights we have the winner of the world*

**Excelsior Motor Manufacturing & Supply Co.**  
3702 Cortland St., CHICAGO

**GARAGES \$14  
HEATER**

**Protect Your Car!**

and protect yourself. Keep your garage as warm as your home! No more shivering; no more numb hands. Order a "REO" GARAGE Gas Heater

Burns either natural or artificial gas. Insures your car against frozen radiator, etc. "REO" guaranteed safe. Exclusive Edwards Burner Construction and Flame Protector insure absolute safety. "REO" is 38 in. high, 12 in. wide. Compact and strong. Comes all ready to put into your garage. Order now. You'll be glad you did.

THE EDWARDS MANUFACTURING CO.  
323-329 Eggleston Ave. Cincinnati, Ohio

**Send In Your Order  
Act NOW! Today!**

\$14



**TOOTH-ACHE STOP** Stops the Pain & Stops the Tooth

Agents Wanted **PRICE 25 CENTS** 3 for 60 Cents  
Postpaid **ENOUGH TO STOP** 30 TOOTHACHES  
STOP  
Squeeze a little of this paste into hollow in the tooth and the **ACHE STOPS INSTANTLY**, then the paste hardens, forming an antiseptic stopper for the tooth, excluding the air and preventing a recurrence of the agony. **Guaranteed Absolutely Harmless**—will not spread and burn mouth. **Don't have it ready for the next bad attack.** A perfect godsend at two in the morning.  
**NATIONAL CHEMICAL CO., 7125 No. Clark Street, CHICAGO**



**POWERLIGHT**

Highest Award Inter. Exp. 335  
C. P.—20 Hrs. 1 qt. Kerosene or  
Gasoline. Read and sew with-  
out spectacles.

**Daylight's GREATEST COMPETITOR**

5 yr. Guarantee—20 styles—5 finishes.

Everybody buys—Sure sale when seen.

**RETAILS \$5, \$6 and \$9**

AGENTS—Contract exclusive territory.  
Big Profit—Samples Loaned.  
**POWERLIGHT CO., 543 Broadway, NEW YORK**



**AGENTS—The Million Dollar Hit!**

New, wonderful home invention, just introduced, yet million sales already recorded. Tremendous, rapid sales stagger country. Agents happy—banking enormous profits daily. Mighty opportunity for you to get the mighty dollar. Failure impossible. Experience unnecessary. Money rolls in first hour—\$10 to \$30 daily. Amazing cash records made. Walters received

**\$50.00 FOR 7 HOURS' WORK**

Never sold goods before, Arnold sold 160 in 2 days; Hagen 100 same time; Webb 10 per hour; O'Connell 25 first day. Hundreds like these. You, too, can have money in abundance. Grab's Scientific Shoe Cleaner sells itself—you take orders—that's all. Every family wants one on their doorstep. Replaces unsightly, unsanitary, crude door mat. **Automatically removes mud, dirt, snow from shoe in one operation.** Cleans sole, sides, heel. Works like magic—sells like sixty. Saves drudgery, time, money, shoes—saves carpets, floors. Mechanical wonder. Has 7 new patented features not found in any other scraper—10 steel blades—10 dirt outlets—twin adjustable and removable brushes—compound springs. Rotates for sweeping. Can't clog—practically self-cleaning. Hardly ever crumpled. Nothing else like it. Nothing so popular—so easy to sell. Selling price only \$1.00. You make half—100 per cent. Satisfaction guaranteed. Write quick for free catalog—exclusive agency. Better still, send order, naming territory. Investigate at once.

**SECURITY MFG. CO., Dept. 223, TOLEDO, OHIO**

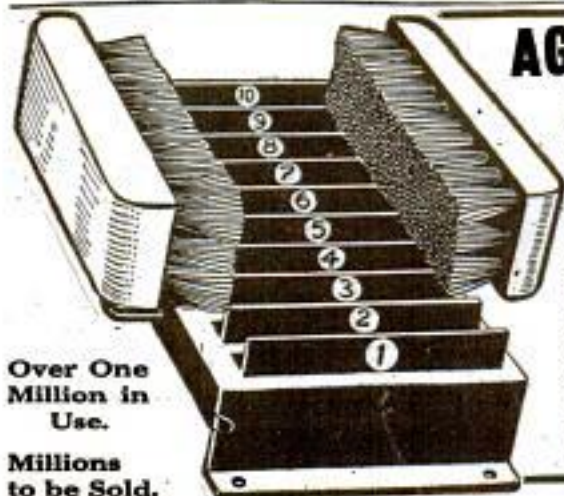

Over One  
Million in  
Use.  
Millions  
to be Sold.

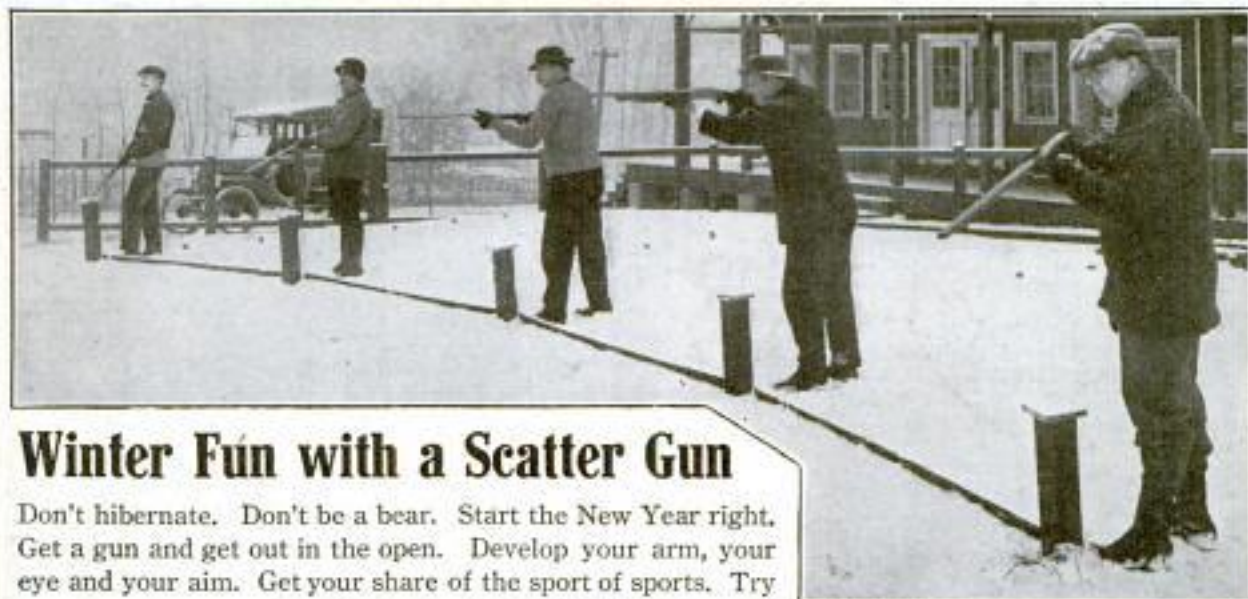

## Winter Fun with a Scatter Gun

Don't hibernate. Don't be a bear. Start the New Year right. Get a gun and get out in the open. Develop your arm, your eye and your aim. Get your share of the sport of sports. Try

## TRAPSHOOTING

Trapshooting is a real man's game filled with vigor, vim and exhilaration. Every target holds a challenge to your skill and judgment. And every shot just makes you crave for more. Join your local gun club now. Get in the game. If a club's not handy, get a **DU PONT** **HAND TRAP**

John B. Burnham says it's great practice for both experts and beginners and develops crack field shots. \$4.00 at your dealer's. If he can't supply you, we'll send it prepaid anywhere in the United States upon receipt of price.

Write for booklets—"The Sport Alluring" and "The Du Pont Hand Trap"

**E. I. DU PONT DE NEMOURS & COMPANY, WILMINGTON, DEL.**

**DAREDEVILS OF THE SPEEDWAY**

**FREE**, SIX MOUNTED, COLORED PHOTO ENGRAVURES of the World's greatest automobile racers—for home, den or garage. Send us 25c (coin or stamps) for a 3 months' trial subscription to the new, illustrated, valuable, helpful automobile magazine, and we will send you this entire set **ABSOLUTELY FREE**. SEND TODAY, as our supply is limited. Address: The American Chauffeur, 15 to 25 W. Sixth St., Cincinnati, O.

## U. S. "Chain Tread" Motorcycle Tire

All the Strength of the "Chain Tread" Automobile Tire.  
**UNITED STATES TIRE CO., New York City**

## OVERHAULED AND REBUILT MOTORCYCLES

At  $\frac{1}{3}$  to  $\frac{1}{2}$  **REGULAR PRICES**  
Some as Low as \$40



**FREE** Write today for price list and catalog.

We have the largest line of new and used motorcycles and supplies in the Country at the lowest prices. Every machine guaranteed. We handle parts and repairs for any machine on the market. Send us your machine to be overhauled. We exchange motorcycles, Motors and castings for airships and railway velocipedes.

**HARRY R. GEER CO.**  
888 McLaren Ave., St. Louis, Mo.

## It's The Fuel Cost That Counts Most

## ELLIS ENGINE KEROSENE

Give Perfect Service On The Cheapest

**9c A DAY**

is its fuel cost, 6c per H. P. for each 10 hours. A wonder for pumping, separating, churning, sawing, lighting and countless other jobs. Let us tell you more about this and other Ellis engines. 3 to 18 H. P., vertical and horizontal, single and double cylinders.

**30 Days' Trial—Freight Prepaid—Guaranteed 10 Years**

**ELLIS ENGINE CO., 2887 E. Grand Blvd., Detroit, Mich.**



**Free!**

Write for 1916 Book, Economy Facts. Sent postpaid, free.

This 1 1/2 H.P. "Ellis" has same cylinder capacity as many 2 1/2 H. P. Engines. Ellis patent fuel device guarantees perfect service on kerosene, distillate or other cheap oils. Starts without cranking, runs either way; crankshaft extends both sides; throttling governor adjustable while running.



## Fastest Boat in the World

Two Views—17-Footer

**\$45** Complete k. d. boat as described.

**\$95** Finished boat ready for motor.



## Big Boat Book Free

Showing over 100 designs. Cruisers—launches—sailboats—rowboats and canoes.

**BROOKS MFG. CO.**

8201 Rust Avenue  
Saginaw, Mich. U.S.A.

Utilize your spare time or make \$10 and up per day putting these boats together for your local trade. No skill required. We furnish the knock-down boat complete (best oak and cypress), everything cut to shape and fitted, with hardware and fittings. The k. d. prices quoted include everything except paint. This is a real business opportunity. We have started hundreds.

**BUILDER-AGENTS WANTED**

## 10 to 32 Miles With 4- to 25-H. P.

A comfortable family launch or a racer Semi-V bottom design—roomy, staunch and seaworthy. Becomes a stepless hydroplane with 12-h.p. or more. We furnish the finished boats, painted, varnished, with fittings and steering gear, already for the motor at the prices quoted. Get our prices with 4- to 25-h. p. motor installed ready to run.



Two Views—15-Footer

Complete k. d. boat..... **\$25**

Finished ready for motor **\$45**

With inboard or outboard motor installed **\$89**

**Lowest Price Boat in the World**



Write for  
**Manufacturer's  
Prices**



Save \$5—\$15 to \$40—get unbeatable quality—500 styles stoves and ranges—cash or easy payments, 30 days' trial, 360 days' approval test, \$100,000 guaranty. We pay freight and ship in 24 hours.

**Kalamazoo Stove Co.**  
Mfrs.  
Kalamazoo, Mich.

Ask for catalog  
No. 473

We also make  
**Malleable Steel Ranges**

**Book  
FREE**

**A Kalamazoo  
Direct to You**

SEWS THIS DOLLAR AWL FOR ANYTHING



1916  
MODEL

This Awl-U-Want is superior to all others. It is of immense value for sewing all kinds of leather, harness, bags, belts, shoes, etc. **THREADED DIRECT FROM THE REEL.** So simple a child can use it. Regular price \$1. For a limited time only we will mail it anywhere, with wanted thread, in a laminated folder. Handle curved and straight, and directions. For only 49¢ (postpaid 50¢). Write Headline Co., Thread Div., JOHNSON SMITH & CO., Dept. 23, 732 Dearborn St., CHICAGO

**49c**

Add 10¢ for postage  
**AGENTS WANTED**

I will send my 25c Book  
**Strong Arms**  
for 10c in stamps or coin

Illustrated with twenty full-page half-tone cuts showing exercises that will quickly develop, beautify and gain great strength in your shoulders, arms and hands, without any apparatus.

**PROF. ANTHONY BARKER**  
5642 Barker Building, 110 W. 42nd St., NEW YORK

For  
**MEN,  
WOMEN  
and  
CHILDREN**



**Sunshine Lamp**  
**300 Candle Power** **FREE**

**TO TRY IN YOUR OWN HOME.**

New unequalled combined table and hanging lamp. Turns night into day. Gives better light than gas, electricity or eighteen ordinary lamps at one-tenth the cost. Costs only one cent a night. For homes, stores, halls, churches. A child can carry it. Makes its own gas from common gasoline. No wick. No chimney. No dirt. No smoke. No odor. Absolutely safe. Guaranteed five years.

**Make \$30 to \$60 Every Week**

We loan you sample. No experience necessary. Everyone a possible customer. Exclusive territory free. We want one person in each locality to whom we can refer new customers. Take advantage of our Free Trial Offer.

**SUNSHINE SAFETY LAMP CO.,**

11 Factory Bldg.,

Kansas City, Mo.



## YOUR CHOICE OF THESE STEEL JAW VISE FINE POST DRILL **FREE**



To pay you for making a thorough test of the famous Luther Hummer Tool Grinder, we will give you either one of these two articles absolutely free. You merely agree to

use one of our Hummer Grinders for thirty days. You don't have to buy anything at all. We're willing to give you the premium outright, simply for the opportunity of showing you what a wonderful tool sharpener the Luther Hummer Grinder is.



## LUTHER HUMMER Tool Grinder

Handiest, lightest running, most accurate of foot-power tool sharpeners. Steel-shaft drive, dust-proof bearings, perfect lubrication. Puts keen edge on your dullest tools quick and easy. No water needed—can't draw temper—Dino-Gelt (artificial diamond) wheels. Patent tool rests give each tool proper bevel. Many special attachments.



Now Only  
**\$10.85**  
F.O.B. Milwaukee

### Write for Free Premium Today

Send us your dealer's name—and we will send to him for you the premium you choose and the Hummer Grinder. If not satisfied, return the Hummer Grinder after 30 days—or if you want to keep it, pay \$10.85 (special introductory price). The premium belongs to you—it's free for simply making the trial.

**LUTHER GRINDER MFG. CO.** 915 Point Street  
MILWAUKEE, WIS.

**MAZDA** Always etched on electric lamps to which MAZDA Service has been applied.

Burns 98% Air

## Make \$45 Weekly

Sell our marvelous new Portable Lamp. Better than gas or electricity, or 20 coal oil lamps. Costs less. Burns 98% air 2% fuel. Guaranteed 5 years.

### Sample on FREE Trial

You can prove at our expense that ours is the best and cheapest—that you can actually make \$45 or more weekly selling it. Territory FREE. Simply send name and address.

**J. B. HALL & CO.**  
804 Church Bldg. CHICAGO, ILL.



Burns 2% Fuel

## Waterman PORTO

1916 Model leads the world in flexibility of speed control. The New Reversing Propeller permits perfect speed adjustment for any boat for racing or trolling. Original outboard motor—11th year—32,000 in use. Guaranteed for life. 31 h.p. Weighs 65 lbs. Automobile carburetor; high tension fly-wheel magneto with dual ignition; removable bearings; solid bronze skeg; 10 1/2 inch reversing propeller. Steers by rudder from any part of boat. Water-cooled exhaust manifold; noiseless under-water exhaust; spun copper water jacket. Demand these essentials. If you want your money's worth. Write us to-day for free book showing full line. Our prices will surprise you.

**WATERMAN MOTOR CO., 230 ML.**  
Elliott Ave., Detroit, Mich.



Makes Any Boat A Motor Boat

# FREE to YOU

FOR

## 10 DAYS!

The World Famous

### Frantz Premier Electric Cleaner

Yes, Madam, that is exactly what we mean. We will send you one of our superb, brand new, easy gliding and deep cleaning Frantz Premier Electric Cleaners on 10 days' FREE Cleaning trial. We are going to loan you, free, this splendid cleaner for 10 whole days.

Remember, this free loan won't cost you a penny. We even pay all delivery charges. We bear every expense. All you have to do is to use it to your heart's content for all cleaning purposes about the house!

### Without Cost to You

Simply sign and mail the coupon below or write us and we will send you the full details of this wonderful free loan offer, and also our beautifully illustrated booklet. No strings are attached to this free loan offer. We want you to use the Frantz Premier for 10 full days just as though it were your own. Clean your carpets and your rugs with it. Try it on your furniture, mattresses and walls. Use it in all the nooks and corners. We want you to see for yourself how it picks up threads, lint and ravelings and every speck of dust and dirt.

And then at the end of the 10 days' free trial if you are not more than delighted with the cleaner, you may return it, or we will send for it, without a cent of cost or obligation on your part. But if you decide that you simply cannot get along without it, then you may keep the cleaner and pay for it on

### Special Easy Monthly Payments

The cleaner goes to you right from our factory, or direct from our dealer if we have one in your town. First you get the free trial and then the easy monthly payments. And, remember, you get the rock bottom factory price—you do not pay a penny more because of this special Easy Monthly Payment Plan.

We expect to be so swamped with Free Trial requests that we reserve the right to withdraw this offer after a reasonable length of time. So send at once for your Free Trial. Remember—absolutely no obligation to buy.

**MAIL THIS COUPON** Sign this coupon and mail it to us at once. The minute we hear from you we will mail you the full details of this great free trial offer and easy payment plan. We will also send you free, the beautifully illustrated literature. Send coupon or write today—at once.

**The Frantz Premier Company**  
Dept. 1176, Cleveland, Ohio

**Sign this Coupon NOW!**

**THE FRANTZ PREMIER COMPANY**  
Dept. 1176, Cleveland, Ohio

Without expense or obligation to me send full and complete details of your wonderful Free Trial and Easy Payment offer. Also your beautifully illustrated booklet.

Name .....

Address .....

## Oxy-Acetylene Welding and Cutting



Welding grates for acetylene purifying apparatus—  
240 welds per hour on 3/4 x 3/16 inch steel bars.

## Simplify and Improve Metal Manufacturing

Oxy-Acetylene welding is full of wonderful opportunities for practically every manufacturer of metal parts. It makes possible increased quality and decreased production costs.

Wherever two pieces of metal are to be joined, oxy-acetylene welding is probably the best and cheapest way—it is now in routine, every-day use by thousands of manufacturers, doing work possible by no other process, replacing riveted, threaded and brazed joints by better unions at less cost.

The oxy-acetylene process is simple. Any intelligent mechanic can learn it. We give full instructions with every outfit—also train your operators free of charge. Necessary equipment is not expensive. We furnish a thoroughly high grade welding apparatus for \$60, (Canada \$75); acetylene service at additional cost. Adaptable for oxy-acetylene cutting by addition of special cutting apparatus.

**Prest-O-Lite**  
PROCESS

Employs Prest-O-Lite Dissolved Acetylene (ready-made carbide gas) in portable cylinders. Used as conveniently as cylinders of oxygen. Saves large initial outlay and heavy depreciation of making crude acetylene in carbide generators. Perfectly dried, cleaned and purified—makes better welds and is cheaper to use.

### A Profitable Business Opportunity

Doing oxy-acetylene welding for others, presents a good opening for enterprising mechanics to make large legitimate profits quickly. Send for details.

Send for illustrated oxy-acetylene literature, full of helpful ideas for every one in the metal trades.

### The Prest-O-Lite Co., Inc.

The World's Largest Makers of Dissolved Acetylene  
Main Office and Factory: 816 Speedway, Indianapolis, Ind.  
Canadian Office and Factory: Merrifoot, Ontario  
53 Branches and Charging Plants



Please Mention Popular Mechanics

## Private Weather Bureau

IN EVERY HOME

Enables you to PREDICT  
THE WEATHER YOURSELF

A Reliable Barometer  
An Accurate Thermometer  
Actual Size 13 Inches High

Indispensable to the farmer, business man, professional man, automobilist, in fact, to everybody who should know in advance what the weather will be. Will save you money and time.



FORECASTS WEATHER  
**WEATHEROMETER**  
HOURS IN ADVANCE

**\$1.00 ONLY**  
REDUCED FROM \$3.00

Send us no money. Mail your order today and Weatherometer will be sent to you C. O. D. (10c extra). If you prefer you may enclose \$1.00 bill or money order with order. Satisfaction guaranteed.

WITHINGTON INSTRUMENT CO.  
5 South Wabash Avenue, Dept. 24, CHICAGO

## A New Year's Remembrance



### GREIDER'S FINE CATALOGUE

of pure bred poultry; 70 breeds illustrated and described, many in color. Perfect poultry guide—all facts. Low prices on stock and hatching eggs. Incubators and brooders. 23 years in business. You need this book. Send 10c for it—today.

B. H. GREIDER Box 19 RHEIMS, PA.

### WATCHES AND JEWELRY SENT FREE—

For inspection, at our risk. Did you see our offer in the November and December issues? Postal brings free catalog and special prices.

BARCLAY WATCH MFG'R'S Woolworth Bldg. NEW YORK

### Health? Take Turkish Bath at Home—Only 2 Cents



Physicians are abandoning drugs for this new treatment. If your mind or body is tired, open your pores and feel the rapid change in your condition, at cost of 2c a bath. The Robinson Bath Cabinet is the only scientifically constructed bath cabinet ever made for the home. Great \$2 Book Sent Free—"The Philosophy of Health and Beauty." Write today. Agents Wanted. ROBINSON MFG. CO. 850 Factory Bldg. TOLEDO, O.

### Knocked-Down Furniture Shipped in Sections At Less than Half the Retail Price

OVER 100 designs. Mission, Colonial and Flanders. Everything for the home, office or club. All of solid quartered oak. Any piece can be set up ready for use in 10 minutes. Our knocked-down sectional method saves factory space, packing cost and freight charges. Direct from the factory to you cuts out middlemen's profits. Satisfaction guaranteed. BIG FURNITURE BOOK FREE.

BROOKS MFG. CO.  
2701 East Ave. SAGINAW, MICH.

Originators of Knocked-Down Furniture. Largest plant of its kind in the world.



Extension  
48x72 in.

# Strawberries Are Ripe in FLORIDA

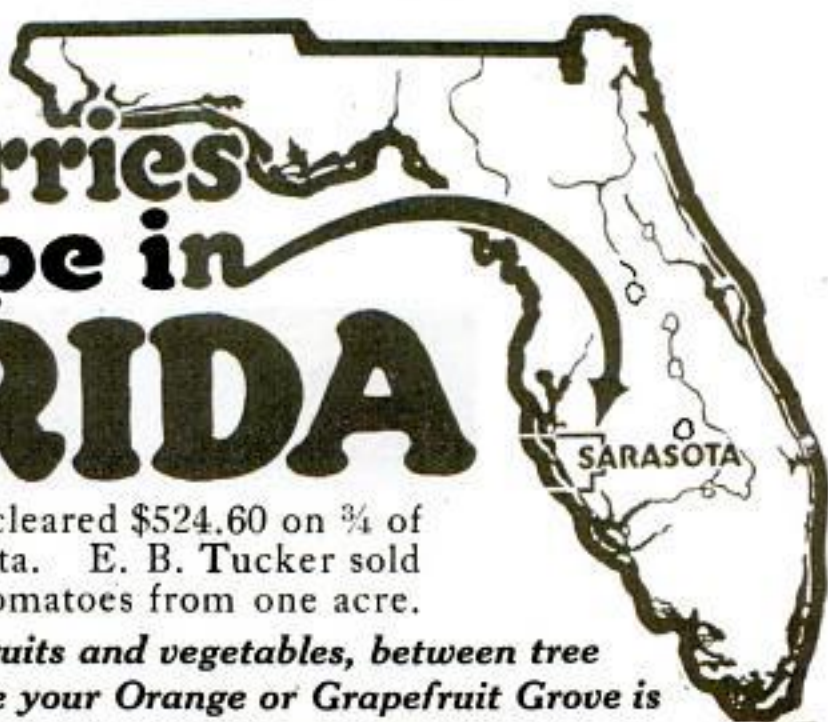

A. D. Albritton cleared \$524.60 on  $\frac{3}{4}$  of an acre at Sarasota. E. B. Tucker sold \$522 worth of Tomatoes from one acre.

*This is the way small fruits and vegetables, between tree rows, will pay you while your Orange or Grapefruit Grove is maturing. Then your income jumps to \$3,000, \$5,000 or more a year*

**Here's Your Chance** to trade January for June—a slim pay envelope for an income—your chance to get away from the grind and drudgery of uncongenial work—to trade blizzards for sunshine.

**Your Opportunity** to get land—rich combination land in the famous Sarasota Bay District, Florida. Land which will pay for itself faster than you have to pay for it.

**Not All Land** will grow vegetables and small fruits between the tree rows while waiting for the trees to bear, but Sarasota Combination land will.

**And You Have This Unusual Opportunity** to get a 10, 20 or 40-acre tract of this fertile Sarasota land on ten years' time.

**Ten Years to Pay—Think of It!** To take advantage of this opportunity means a change from a life of drudgery in a cold climate to a life of affluence and a real home amid oranges, sunshine and prosperity.

**Excellent Neighbors Are Already Here.** There are splendid schools, churches, lodges at hand and all that a modern town can offer. Big markets await you and the highest cash prices are paid. You are in daily touch with Northern and Eastern cities by rail and water transportation.

**In the Sarasota Bay District** there is abundant rainfall to mature all crops, but in addition anyone may have flowing artesian wells of pure, sweet water. These wells assure sufficient moisture in the event that the natural rainfall should happen to be insufficient when most needed.

**The Climate is Ideal**—mean annual temperature (21-year record) is 72.1 degrees. In recreation you will have, as a matter of course, what thousands annually pay dearly for.

**Be True to Yourself** and turn your thought into action. If you ever expect to attain independence now is the time to start. You don't know how great this opportunity really is, but you do owe it to yourself and those dependent upon you to find out.

**SARASOTA VENICE COMPANY**  
200 Pineapple Ave. SARASOTA, FLA.

**The Coupon** will bring you information, books and pictures that point the easy way to Florida and freedom. Act immediately, decisively, if you want to get in on this ten-years-to-pay opportunity.

**SARASOTA VENICE COMPANY,**  
200 Pineapple Ave., Sarasota, Florida  
Tell me all about Sarasota Combination Land  
and your Ten-Years-To-Pay Offer.

Name .....

Street Number .....

City..... State.....



## Opens the Furnace While you Sleep

Let the little "DRAFT-MAN" serve you. It will give you close regulation of your furnace during the day and open it for you in the morning before you wake up.

No more getting up on cold winter mornings to open up your furnace draft and get the house warm and comfortable. The little "DRAFT-MAN" will do this unpleasant job for you every morning without fail. Just set the time you want your furnace opened up and it does the rest. You can go to bed at night with perfect assurance that your rooms will be fine and warm when you get up. The little "DRAFT-MAN" is an absolutely reliable yet simple device with nothing to get out of order or need attention. The spring motor is self-winding, compact and durable. It has an Art Bronze case, and is a pleasing addition to the furnishings of any home. The little "DRAFT-MAN" can be installed in connection with any furnace by anyone in just a few minutes. It can be attached direct to the present furnace chains.

**\$7.50** gets the "DRAFT-MAN" complete with instructions for installing. Satisfaction guaranteed or money cheerfully refunded.

This is an especially attractive proposition for **AGENTS and DEALERS**

**STALKER FURNACE REGULATOR CO.**  
209 E. Liberty St., ANN ARBOR, MICH.



## Marvelous New Valveless RADIOSENE Wickless Lamp

Burns vaporized kerosene by means of mantle—newly invented process—first valveless, wickless kerosene lamp on the market. Gives more light than tungsten electric bulb, from cheapest, safest of fuels—100 worth of oil lasts an average week. Simple and reliable to use—perfectly safe, lighted or extinguished.

**\$7.50**

Radiosene rays called "scientific sunlight," next thing to nature's own—brilliant, steady and restful to the eyes. University professor asserts, "Tests proved Radiosene light to be free from red rays and to radiate 150 actual candlepower. The ideal light for any home."

**AGENTS—Big Money for You**  
Best proposition for hustling agents. Demonstration makes sure sales—fine chance for the right man to build up profitable business of his own. Write at once for terms and exclusive territory.

**SUPERIOR  
MANUFACTURING COMPANY**  
294 Second St.  
ANN ARBOR, MICHIGAN



**150  
CANDLE  
POWER  
OF WHITE  
BRILLIANT  
LIGHT**

—JUST PUBLISHED—

## Popular Mechanics

### Shop Notes for 1916

529 Easy Ways  
To Do Hard Things  
469 Illustrations  
224 Pages

Price 50c Postpaid

Reprinted from Popular Mechanics Magazine and comprising a series of 529 articles covering every department of mechanics with useful time and labor-saving kinks for all the trades. The following partial list of contents gives an indication of the wealth of material one will find in this book:

**POPULAR  
MECHANICS  
SHOP NOTES**



529 EASY WAYS  
TO DO HARD THINGS  
POPULAR MECHANICS CHICAGO

(Actual Size 6½ x 9½ in.)

Boat Dump—Automatic Siphon—Electric Door Lock—Gardener's Weeding Cart—Installation of Water-Heating Plant—Bandy Jack—Spark Plug Tester—Steam Water Heater—How to Make a Log Canoe—Chute for Fish to Pass Over Dam—Decarbonizer—Tire-Fluid Gun—Home Made Folding Bed—Portable Oxyacetylene Welding Outfit—Lining Up Shafting—Proper Fireplace Construction—Outdoor Fireplace—Small Crane for Wagon—Home Made Engine-Driven Tire Pump—Lift Pump—Concrete Mixer—Inexpensive Wood Pulleys—Iceless Refrigerator.

Complete series of Shop Notes consisting of 12 volumes \$6.00 prepaid or any single volume 50 cents postpaid.

**POPULAR MECHANICS BOOK DEPT.**  
6 N. Michigan Ave., CHICAGO

—Just Out—

## Amateur Mechanics No. 7

200 Articles  
211 Illustrations  
128 Pages  
Price 25c Postpd.

Those who take delight in building their own homemade contrivances will find in this new book a wealth of suggestions of interesting things to make. Each of its 200 articles tells completely how to construct some one thing. Everything described is either useful or ornamental. This book contains nothing found in any of the other numbers of the Amateur Mechanics series.

A few of the many practical things described:

Mile-O-View Camera—Houses Made of Poles—Houseboat—Pushmobile—Ice Glider—Electric Chime Clock—Bucket Ball Game—Musical Doorbell—Snowshoes—Child's Playhouse—Ice Boat and Catamaran—Poultry Coop—Coasting Bobbed—Candy Floss Machine—Snowball Maker—Lantern for Spot and Colored Lights—Skating Merry-Go-Round—Skiff—Steering Sled—Photographic Work Table—Skates Made of Wood—Water Meter—Foot Boats—Graining Tools—Roller Skates, etc.

The other numbers of Amateur Mechanics are equally interesting and will be sent postpaid at 25 cents each.

**POPULAR MECHANICS BOOK DEPT.**  
6 N. Michigan Ave., CHICAGO

Free  
Instruc-  
tion  
Book



10  
Days'  
FREE  
Trial

## Underwood Typewriter At Less than $\frac{1}{2}$ Manufacturer's Price YOU MAY RENT OR BUY

Every reader of Popular Mechanics should take advantage of this Supreme Opportunity to get a **Genuine Underwood Typewriter** at less than half Manufacturer's Price. Remember, you need not buy at once, but Rent an Underwood; then if you decide to purchase it, the rental you have paid will be applied on purchase price. Let us send you an

### Underwood Typewriter on 10 Days' Free Trial

If you are **not** thoroughly pleased with it, send it back at **our expense**—in no way will you be obligated. If satisfactory, you may rent it, and **every cent of the rental you have paid for six months will be applied on the purchase price.**

#### Easier Work—Extra Money

An Underwood Typewriter will serve the dual purpose of making your work easier, while at the same time opening an avenue to extra money.

Manuscripts will bring you from ten to twenty cents a sheet. Scholarly articles, human-interest stories and photoplay scenarios are in big demand now and bring big money. Typewritten manuscript in every case brings greater attention from publishers. They pay scant heed to long-hand manuscript.

You people who are looking for a way to earn extra money in your spare time can do so with a typewriter. The Underwood, as you know is the standard machine of the country and is easy to operate.

With our free instruction book sent with every machine it will take you only a few hours to learn the vital points and your speed after a little practice will surprise you. The many opportunities for this kind of work is right at hand. Get your start now and work will come even without solicitation.

#### You Can Get An Underwood Free

Our Agency Plan enables you to pay for a machine with commissions earned. No canvassing—No soliciting. Send coupon for full particulars of Underwood Offer No. 152.

Typewriter  
Emporium,  
Chicago

Without expense or obligation to me you may tell me all about your Underwood Offer No. 152.

### Typewriter Emporium, Chicago

*Largest Independent Typewriter Dealers in the World*

During 23 years of successful business we have sold and rented over 150,000 machines

Name.....

Address.....

Town.....State.....

## If you invest \$1 and receive \$2 in return are you not apt to call yourself lucky?

If you should buy a set of auger bits — 13 of them, 4-16 to 16-16 — put up in a nice canvas tool roll and find that you are in receipt of much more than you expected, you are surprised, pleased and considered wise. To be both wise and lucky send \$5.00 by express or money order at once and secure the finest, most perfect set of bits ever produced.

### THE CALDWELL "Z" TWIST AUGER BIT

The greatest labor-saving tool ever offered to the man who has a hole to bore—  
He'll finish it, no matter what the wood may be in one-half the time if he uses a "Z" Twist Bit.

### THE CALDWELL AUGER BIT CO., Lebanon, N. H.

Makers of CALDWELL "EFFICIENCY" TOOLS

Prices: 4- 5- 6-16, 30 cts; 7- 8- 9-16, 40 cts; 10- 11- 12-16, 50 cts; 13- 14-16, 60 cts; 15- 16-16, 65 cts. Sets, \$5.00

THIS IS OUR FIRST OFFER IN OUR "FACTORY TO FINANCIER" CAMPAIGN

### Get a Clean Shave with the "BALIHONE."

The newest and most up-to-date method of Sharpening Safety Razor and all kinds of Razor Blades, Surgical Instruments, Cutlery, Etc. **ORDER ONE TODAY.** Don't delay. Live proposition for hustling agents. See our ad on page 182 Dec. Popular Mechanics. Send for descriptive literature.

BAILEY RESILIENT HONE AND STROP CO., WILMETTE, ILL.

## DOMELRE

The Electric Ice Man will soon be standard equipment in all good American homes. Men of ability and capital who want a real monopoly in their territory are obtaining our exclusive perpetual sales contracts. (Get started on the ground floor of "The Next Great Business" by writing for our proposition today.)

Domestic - Electric - Refrigerator The Mechanical Refrigerator Company  
718 Fisher Building, Chicago  
Factory: Clybourn Avenue and Willow Street, Chicago, Ill.

### LITHOGRAPHIC MODELS IN COLORS

show and name every part of the following: Mallet Compound Locomotive—Atlantic Type Locomotive—Automobile—Steamship—Steam Engine—Steam Turbine—Dynamo—Gas Engine—Wireless Telegraph. Size 10x14 in. **PRICE 50c EACH. Set of Nine Models \$4.00 Postpaid.**  
POPULAR MECHANICS BOOK DEPT. 6 N. MICHIGAN AVE. CHICAGO

### 1000 Interesting Things FOR BOYS TO DO



are described in this  
greatest of all boys' books

## The Boy Mechanic VOL. II

A sequel to, but containing  
nothing found in Volume I.  
It gives complete directions  
for making those things  
every boy likes to build and  
experiment with in electric-  
ity, mechanics, wood-work-

ing, model work, indoor and outdoor sports, magic, tricks, arts and crafts work, etc., such as

Bobsleds—Snowshoes—Ice Boats—Ice Gliders—Boats—Camps—Fishing Tackle—Houses of Poles—Kites—Aerial Gliders—Motion-Picture Camera—Spot-Light Lantern—Mile-O-View Camera—Photographic Appliances—Games—Cyclemobile—Pushmobile—Flymobile—Roller Coaster—Ferris Wheel—Sunlight Flasher—Rood Furniture—Electrical Devices—Mechanical Contrivances and hundreds of equally interesting things.

180 Pages. 995 Illustrations  
Handsomely Bound in Cloth

Price \$1.50 Prepaid to Any Address

Popular Mechanics Book Dept.  
6 N. Michigan Ave., CHICAGO

### No Better Holiday Present for \$1.50

than a year's subscription to

## Popular Mechanics Magazine

containing nearly 4000 illustrations  
and 2000 pages of reading matter.

Much of it interests Everybody.  
Most of it interests Anybody.  
All of it interests Somebody.

Order through your newsdealer or address the  
publishers, POPULAR MECHANICS, CHICAGO

### A New 300 Page Book for Every Ford Owner, Dealer, Salesman and Repairman

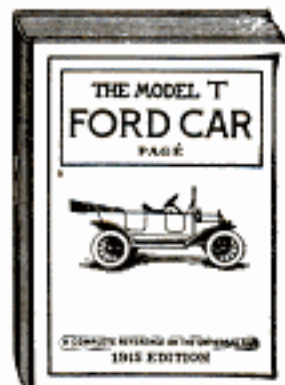

Deals Fully With  
Construction  
Operation  
Repair  
Over 100 Special Engravings  
Price \$1 Postpaid

This is the Most Complete and Practical Instruction Book ever published on the Ford Car. All parts of the Ford Model T Car are described and illustrated in a comprehensive manner—nothing is left for the reader to guess at. The construction is fully treated and Operating Principles made clear to everyone. Complete instructions for Driving and Repairing are given. Every detail is treated in a non-technical yet thorough manner. This book is written specially for Ford Drivers and Owners, by a recognized automobile engineering authority and an expert on the Ford, who has driven and repaired Ford Cars for a number of years. He writes for the average man in a practical way from actual knowledge. The illustrated chapter on Repairing and Overhauling alone, is worth many times the price of this book. Special description of book sent on request. Also

### A NEW FORD ENGINE CHART

makes location and correction of engine troubles easy. Size 25x38 in. PRICE 25c POSTPAID. Your money back if not satisfied.

Popular Mechanics Book Dept.  
6 N. Michigan Ave., CHICAGO

# No Money In Advance

## Sensational Bargains



### Seamless Brussels Rug Bargain

No. MK177. Magnificent extra heavy seamless Brussels rug in two sizes. Woven of selected yarns in a very attractive pattern. Colors: Tan, Red, Green and Brown harmoniously blended. Size 8 ft. 3 in. x 10 ft. 6 in. Price...\$12.74  
9x12 feet \$13.96 **\$1** Per Month



### 75c Per Month Dresser Bargain

No. MK180. Top of base 90 x 19 in. French bevel plate mirror 24 x 20 in., supported by strong standards. Top of mirror frame has neat carving. 2 small extended drawers at top of base, two full length drawers below. A real value at our price, \$9.68

This is an offer without an equal—a revelation of matchless liberality—the rarest money-saving opportunity ever opened to home makers. We want you to see for yourself, without advance payment, that any one of these is the grandest bargain ever before offered. Just pick out the bargain you want write it down in coupon below, write your name and address and mail coupon to us. We will ship it to you promptly. If it is not exactly what you want, return it at the end of 30 days at our freight expense both ways. If you are perfectly satisfied and decide to keep it, just pay for it in small monthly payments.

Only one of these items to each family can be sent at these amazing, heretofore unheard-of bargain terms. When you receive the Mammoth Hartman Catalog you can order as much or as little as you like all on easy credit terms.

### Hartman Will Trust You

Always keep this thought in mind: "HARTMAN WILL TRUST ME!" The Hartman Remarkable Credit Plan covers the nation like a network. From our tremendous organization in Chicago the Hartman lines of credit run straight and true to more than 1,500,000 typical homes—made happy by the help we lend.

HARTMAN Credit is REAL help. No quibble or question—no "red tape"—no interest to pay—no bothersome reference asked like others do—your every dealing with us is strictly confidential. Your credit is good with Hartman. USE IT! Trade with us for all your needs—and be SURE of satisfaction.

### Wonderful Bargain Catalog FREE

Filled from cover to cover with thousands of wonderful bargains in Home Furnishings, all sold on the Hartman Liberal Credit Plan, backed by the \$10,000,000 Hartman Guarantee. GET THIS GREAT MONEY-SAVER. Wonderfully done in many colors showing articles exactly as they look. Furniture, Carpets, Silverware, Clocks, Draperies, Paints, Roofing, etc.—everything needed in the home. We will send it to you—FREE—whether you buy direct from this page of "get-acquainted" offers or not. Mail coupon or postal asking for Catalog No. 89.

## HARTMAN

FURNITURE & CARPET CO.,  
3945 Wentworth Ave., Chicago, Ill.

### Rocker Bargain

No. MK176. Solid oak golden finish in choice design. Is upholstered with imitation Spanish brown leather on seat and back. Seat has four springs, stuffed with tow and cotton. Front and back posts are handsomely carved. Seat front plaited and back button tufted. Strong posts and runners. A real bargain at....\$3.57.



**50c** Per Month

### Solid Oak Dining Table Bargain

No. MK181. Beautiful solid oak dining table in Golden Oak or fumed finish. 44 in. top, extends to 6 ft.; 4 in.



**75c** Per Month

rim; heavy octagon pedestal fitted to 24 in. platform which rests upon 4 Colonial scroll legs. It is excellently finished throughout. This is an elegant dining table, one that will grace any dining room. A real bargain at our remarkably low price of only.....\$11.95

### "Wonder" Vacuum Sweeper

No. MK182. Noiseless fibre bearings and bellows lifting rods, steel frame dust bag, wide opening dust pan, pressed steel top, four drive wheels on brush, 3 bellows and 12 in. nozzle. Wheels flanged to avoid tire trouble. Nickel trimmed; fully guaranteed. Has brush adjustment—operated by foot. This is a vacuum sweeper that should be in every home. A wonderful bargain at this unheard-of price of only \$3.97 **50c** Per Month

### 5-Piece, 2-Inch Post Steel Bed Outfit

No. MK148. Elegant 2 in. continuous post steel bed with 3/4-in. fillers in artistic design, height head end 62 in.; link

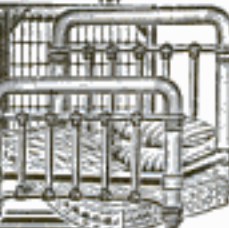

fabric, steel frame bed spring; cotton top, fibre filled mattress and two 4 1/2 lb. selected hen feather pillows 12x 20 in. All sizes, 3 ft.; 3 ft. 6 in.; 4 ft. or 4 ft. 6 in., full size. Colors: White, Pea Green or Vernis Martin. **75c** Per Month Price \$8.95



### Hartman's 3-Piece Library Set Bargain



**\$1.00** Per Month

No. MK184. Choice quality solid oak, fumed finish. Table top 36x24 in.; 2 roomy book ends, 7-in. connecting shelf. Panels at sides of book ends match panels on chairs. Chairs have heavy 2-in. front posts fitted to genuine quarter-sawn oak arms, 3 1/2 in. wide. Seats and backs upholstered with imitation Spanish leather over wood fibre and soft cotton jute, heavy steel springs. Complete set.....\$12.65

### Hartman Furniture and Carpet Co., 3945 Wentworth Ave., Chicago, Ill.

If only catalog is wanted place an X in this square   
If you wish any bargain shown on this page, fill in blank, write name and address in this coupon and mail.

Send me article No. .... (Fill in name and number)

If I keep it I will pay \$..... per month until full amount is paid as per terms and price quoted.

Name.....

Address.....

City.....State..... 88

## Mail Coupon Now





## GET ACQUAINTED WITH US ON THE NEWS-STANDS

**I**F you are a Man of Affairs, and would like to know what the world is thinking—if your time is limited, and you want a "Cook's Tour" through the realm of world thought—if a Monthly Review in Cartoon and Comment of Current Events appeals to you—if you want the viewpoint of other nations—if you would like to read history in the making in its most attractive form

GET A COPY OF

# CARTOONS MAGAZINE

(Published by H. H. WINDSOR, Publisher of Popular Mechanics Magazine)

It is the only magazine in the field mobilizing the pen-and-ink satirists from the four corners of the world, men who are fighting silent battles on their drawing boards.

So great has been the demand for back numbers of this periodical that several issues published early in the war have been exhausted. The file of *Cartoons Magazine* will be almost priceless a few years hence. It is a magazine for your library and reading table.

**25c A COPY**

**\$3.00 A YEAR**

**This Coupon** and \$3 brings it to you for a **Year**

CARTOONS MAGAZINE

6 N. Michigan Avenue, Chicago

Enclosed please find \$3.00, for which enter me for a year's subscription to your magazine.

Name.....

Street.....

City.....



BOARD  
ROOM

# Responsibility

## He Has It Because He Knows

You envy the man with the responsible job. You wish that you, too, might have some say in business affairs. You feel that you are just as capable as the other fellow. *But are you?*

The responsible man is a man who knows. That's why the big men call on him for advice. His special training enables him to answer a question without hesitation, while you—the *untrained* man—are compelled to "guess" or "look it up".

You can't expect to ever fill a responsible position without first preparing for it.

## Train For Responsibility

For nineteen years the *American School* has been training men and women for responsible, well-paying positions. The *American School* will give you the training you need to succeed in whatever occupation you select, no matter where you live or what you do. You don't have to give up your work—we train you at home, in your spare time.

Ambitious people everywhere have had their salaries raised as a direct result of the *American School's* help. Mark and mail the coupon and learn how *you* can succeed as they did. Finding out costs nothing—involves no obligation. So act today—send the coupon *now!*

# American School

of Correspondence, Chicago, U.S.A.

### Your Opportunity Coupon

Mark the position you want  
and mail the coupon now

- |                                |                           |
|--------------------------------|---------------------------|
| .... Electrical Engineer       | .... Lawyer               |
| .... Elec. Light & Power Supt. | .... Business Law         |
| .... Hydroelectric Engineer    | .... Business Manager     |
| .... Telephone Engineer        | .... Auditor              |
| .... Architect                 | .... Accountant           |
| .... Architectural Draftsman   | .... Cert'fd Public Acc't |
| .... Building Contractor       | .... Private Secretary    |
| .... Building Superintendent   | .... Stenographer         |
| .... Structural Engineer       | .... Bookkeeper           |
| .... Structural Draftsman      | .... Fire Ins. Inspector  |
| .... Mechanical Engineer       | .... Fire Ins. Adjuster   |
| .... Mechanical Draftsman      | .... Fire Ins. Expert     |
| .... Civil Engineer            | .... Sanitary Engineer    |
| .... Steam Engineer            | .... Plumber              |
| .... Shop Foreman              | .... Reclamation Eng.     |
| .... Shop Superintendent       | .... Textile Boss         |
| .... Sheet Metal Draftsman     | .... College Preparatory  |

We also prepare for civil service examinations in all engineering subjects

NAME .....

ADDRESS .....

Pop. Mech. 1-16

Please Mention Popular Mechanics

Copyrighted material



### The Dread of Dentistry is Pyorrhea

(Sometimes called Riggs Disease)

It is characterized (among other symptoms) by bleeding, discolored gums, receding gums, sensitive teeth, bad breath and finally loosening and dropping out of the teeth.

DO YOU KNOW that 90 per cent of the people have it in the first, second or third stage—

DO YOU KNOW what causes it or what a terrible menace it is to your health— You should know how to recognize Pyorrhea when you see it and how to prevent and overcome it.

SEND ME YOUR NAME and without obligation of any kind I will send you FREE my illustrated booklet about this most common but dreadful disease of the gums. Also testimonial letters from hundreds of people who have treated themselves at home avoiding pain, loss of time, expensive treatment and false teeth. *25 years' success.*

DR. F. W. WILLARD, A872, Powers Bldg., Chicago, Ill.

## AUTO GIVEN AWAY

We want representatives in every locality. No experience or capital necessary. Send us your name and address and by return mail we shall tell you how you can secure one of our new 1916 model 5-passenger touring cars free for demonstrating. Write today—do not delay—a postal card will do. Address

ECLIPSE MOTOR CAR CO. 851A Buhl Block  
DETROIT, MICH.



### PRICES SMASHED!

Write for the Greatest Incubator Bargain ever offered, on the most successful incubator ever built.

#### OLD RELIABLE INCUBATOR

34 years the standard—holds over 1200

First Premiums, awarded on superior merit.

Guaranteed successful in your hands or your money back in 60 days. Get

Free Poultry Book and my low price before you buy.

J. W. Myers, Pres.

Reliable Incubator & Brooder Co.  
Box B, 81, QUINCY, ILL.

# GODELL PRATT

## 1500 GOOD TOOLS

Our new catalog No. 12 shows over 1500 tools for carpenters, mechanics and householders. 80 of the tools, shown are new some of them absolutely different from anything else on the market.

A copy will be promptly mailed to you on request.

### Goodell-Pratt Company

Toolsmiths GREENFIELD, MASS., U. S. A.



GREATEST AND MOST UNIQUE FOR EVER DESIGNED.

Has quick-detachable tire; solid rim; leather strap; nickel buckle. Get one Absolutely Free by sending 25c (coin or stamp) for 3 months' trial subscription to the new, illustrated, valuable, helpful automobile magazine, SEND TODAY to The American Chieftain, 15-27 Sixth St., Cincinnati, O.

### NOVELTY AUTO WATCH

FOR FREE

## Free Book on WASHING

Tells how to get a good-sized washing done in an hour with the Thor Electric Washing Machine. Also tells how the Thor pays for itself by saving wear on clothes and cost of help. Write for this big 48-page book, fully illustrated. Sent absolutely free. And we will also tell you about the special offer we are making now.

Get this book and information now. Write Today  
HURLEY MACHINE CO., Dept. 1191, Chicago, Ill.

## AUTOMATIC CARD PRINTING IS EVER-LASTINGLY GOOD PAYING BUSINESS EVERYWHERE

WRITE TO-DAY FOR FREE BOOKLET OF OUR AUTOMATIC SELF-FEEDING PRINTING PRESS.  
S. B. FEUERSTEIN & CO. MANUFACTURERS 542 W. Jackson Blvd. CHICAGO, ILL.



Send for 1916 Catalogue.  
WESTFIELD MFG. CO.  
15 Lozier Ave., Westfield, Mass.

# DIAMONDS ON CREDIT

20% DOWN 10% MONTHLY

Let us send you any Diamond you may select from our catalogue so you may compare our values with those offered by other dealers; be convinced that our Importers' Prices offer you a great saving. We furnish a guarantee certificate with every Diamond and allow the full purchase price on all exchanges. We will send express prepaid any Diamond or other article, for examination and approval, you to be the sole judge as to whether you keep it or return it at our expense.

Write today for our Free catalogue de luxe No. 6, and see how easy it is for you to own and wear a beautiful Diamond  
L. W. SWEET & Co., Inc., 2 and 4 Maiden Lane, NEW YORK CITY





Your Choice of  
38 Styles

Any  
WING

Shipped on



# Four Weeks' Trial

Yes, we'll ship you on 4 weeks' absolutely free trial a Genuine highest grade Wing piano DIRECT from our own factory, *freight prepaid*. The most surprising—most amazing offer ever made. An offer that puts you on the same footing as the largest piano dealer—and at the very rock-bottom DIRECT wholesale factory price. Since 1868—for 47 years—we have been building Wing Pianos, renowned everywhere for their sweetness of tone and sterling merit—and we now make you this greatest of all offers on the Wing, guaranteed for 40 years.

We will allow you to use any Wing piano—your own choice of 38 superb new styles in any shade of mahogany, walnut or oak—in your own home for four full weeks at our expense. A Wing Upright, a Wing Grand or a wonderful Wing Player-Piano that plays all the greatest concert and opera selections (you can play it perfectly the first day without taking music lessons).

## No Money Down —Not a Cent of Freight

We ask no money down—no security—no deposit in your bank—no guarantee. Just choose any Wing from our large catalog. We employ no salesmen of any kind to visit and annoy you. We'll ship the instrument no money down—*freight prepaid*. While the piano is in your home use it just as if you owned it. Compare with description in the Wing catalog—but note the rock-bottom *direct-wholesale-factory price* is quoted in the personal letter to you. Play the piano—let your friends play it. Examine it carefully—thoroughly—inside and outside. Take music lessons on it if you like. Note the perfect bell-like tone, the remarkable easy regularity of the action, the deep resonance of the base, the timbre of the treble—note all this—then—

At the end of the 4 weeks' trial, if you wish, you may return the piano at our expense. We pay return freight to New York. Not a penny to pay for the pleasure of using the piano four weeks. No salesmen to influence you—you and you alone are to judge. Now write for the piano book (free).

## Valuable Book on Pianos—Free

### "The Book of Complete Information About Pianos"

The New York World says: "This is a book of educational interest everyone should own." Would you like to know all about pianos—how they are made, how to judge the fine points of quality and price in buying a piano? Then send the coupon for the piano book which we are sending FREE for the present. This book of 136 pages tells about materials, manufacture, assembling patented devices and what they do, all about soundboard, action, case, in fact every detail connected with a fine, high-grade piano. You will be astonished at the amount of information about piano quality and piano prices, and how to answer the arguments of piano salesmen. This magnificent 136 page book, a complete encyclopedia on the piano; the most complete and costly book ever published on the piano business; points you on the making of a piano from start to finish and how to judge the fine points of a piano. Now, then send the coupon. We will send you this book free and prepaid, provided you send the coupon at once. We will also send free our beautiful catalog showing new art styles and full explanation of our rock-bottom price on the Wing Piano. Send the coupon today.

**Wing & Son (Est. 1868)**

Dept. 1191 Wing Bldg., 9th Ave. and 13th St. New York, N.Y.

We will take your old organ or piano on the most liberal of all offers. Be sure to get our proposition before you sell or trade your old instrument. Do not overlook this opportunity.

Name.....

Address.....

Piano  
Book Coupon

Wing & Son

(Established 1868) Wing Bldg.,  
9th Avenue and 13th Street  
Dept. 1191 New York

Gentlemen: Please send me free and prepaid "The Book of Complete Information About Pianos," the complete encyclopedia of the piano. Also send full particulars of your Rock-Bottom offer on the Wing piano and catalog of latest art styles.



Please Mention Popular Mechanics



## Anticipating Telephone Needs

When a new subscriber is handed his telephone, there is given over to his use a share in the pole lines, underground conduits and cables, switchboards, exchange buildings, and in every other part of the complex mechanism of the telephone plant.

It is obvious that this equipment could not be installed for each new connection. It would mean constantly rebuilding the plant, with enormous expense and delay. Therefore, practically everything but the telephone instrument must be in place at the time service is demanded.

Consider what this involves. The telephone company must forecast the needs of the public. It must calculate increases in population in city and country.

It must figure the growth of business districts. It must estimate the number of possible telephone users and their approximate location everywhere.

The plant must be so designed that it may be added to in order to meet the estimated requirements of five, ten and even twenty years. And these additions must be ready in advance of the demand for them—as far in advance as it is economical to make them.

Thus, by constantly planning for the future and making expenditures for far-ahead requirements when they can be most advantageously made, the Bell System conserves the economic interest of the whole country while furnishing a telephone service which in its perfection is the model for all the world.



**AMERICAN TELEPHONE AND TELEGRAPH COMPANY  
AND ASSOCIATED COMPANIES**

*One Policy*

*One System*

*Universal Service*

*Please Mention Popular Mechanics*



Superb Brunswick  
**"Baby Grand"**  
 With Convertible Cushions  
 For All Carom and Pocket Games

## 33 Rollicking Billiard Games!

*Play Them at Home on The Brunswick*

# "BABY GRAND"

Play "Little Corporal" — it's *immense!* Play "Golf," "Cowboy," "Rotation" or "3-Ball Carom." It's no task to learn *any* game of carom or pocket billiards—the trick is to *win*.

These manly contests of skill and supremacy keep boys busy nights (at home) — they make men and women *young clear through*.

Play-time is filled with thrilling surprises, spectacular shots, and comical situations that engulf the whole party in laughter.

Right *NOW* — in winter — is the time to put a Brunswick in *your* home. Then, what matter how bleak the winter wind outdoors? — it can't chill the cheer in your cozy billiard room.

Write today for our de luxe book that gives full details. *It's free!*

### PAY 10c A DAY

Superb Brunswick Home Billiard Tables appeal to the expert as well as the novice because they are scientifically built. Fast, ever-level billiard beds and quick-acting Monarch cushions, the highest rated in the world. Choice woods richly inlaid and masterful cabinet work.

New low prices — only \$27 upward. Popular monthly payments — *as little as 10 cents a day*.

### No Extra Room Needed

"Baby Grand," "Convertibles" and new "Quick Demountables" come in a range of sizes to fit the space any home has. Brunswick "Grand," regulation size, made for homes with a special room for billiards.

### 30-Day Trial — Outfit Free

Try any Brunswick 30 days *free*. Complete high-class Playing Outfit given without extra cost — Balls, Cues, Rack, Markers, Expert Book of 33 games, etc.

Our handsome book, "Billiards — The Home Magnet," pictures these tables in realistic colors, gives prices and full details. *Sent free, postpaid. Write to-day.*

### Send This For Billiard Book FREE

The Brunswick-Balke-Collender Co. [493]  
 Dept. 25R, 623-633 S. Wabash Ave., Chicago

Without obligation to me, send free, postpaid, your billiard book in colors —

**"BILLIARDS — THE HOME MAGNET"**

Name .....

Address .....

# Williams'



## “Gentlemen—The Big Stick”

**H**ERE is the mightiest and yet the gentlest weapon that ever beat a stubborn beard into submission and left a smile of contentment in its wake.

It is built for men of action—ready to the hand, gentle to the skin and a steam roller to beard resistance.

A pull—and the top becomes a holder for the fingers. Dropping it back in the box after use is as natural as dropping it anywhere, and there it stays till tomorrow, protected from dust and germs.

Such, fellow shavers, is the Williams' Holder-Top Shaving Stick—a soap that comes down to you through three-quarters of a century without an impure

strain; a lather that feels like cream and carries moisture like a sponge, and a box that's as handy as a valet.

Try this super-soap tomorrow morning. It is no farther away than the nearest dealer.

### Stick, Powder, Cream, Liquid

Send 10 cents in stamps for a trial size of all four forms, and then decide which you prefer. Or send 4 cents in stamps for any one.



Address THE J. B. WILLIAMS COMPANY, Dept. A, Glastonbury, Conn.

*Add the finishing touch to your shave with Williams' Tale Powder  
Your choice of four odors, Violet, Carnation, Lilac, Rose*