

October

The Eye of The Submarine

15 Cents

PAGE 485

POPULAR MECHANICS MAGAZINE

WRITTEN SO YOU CAN UNDERSTAND IT

TRADE MARK

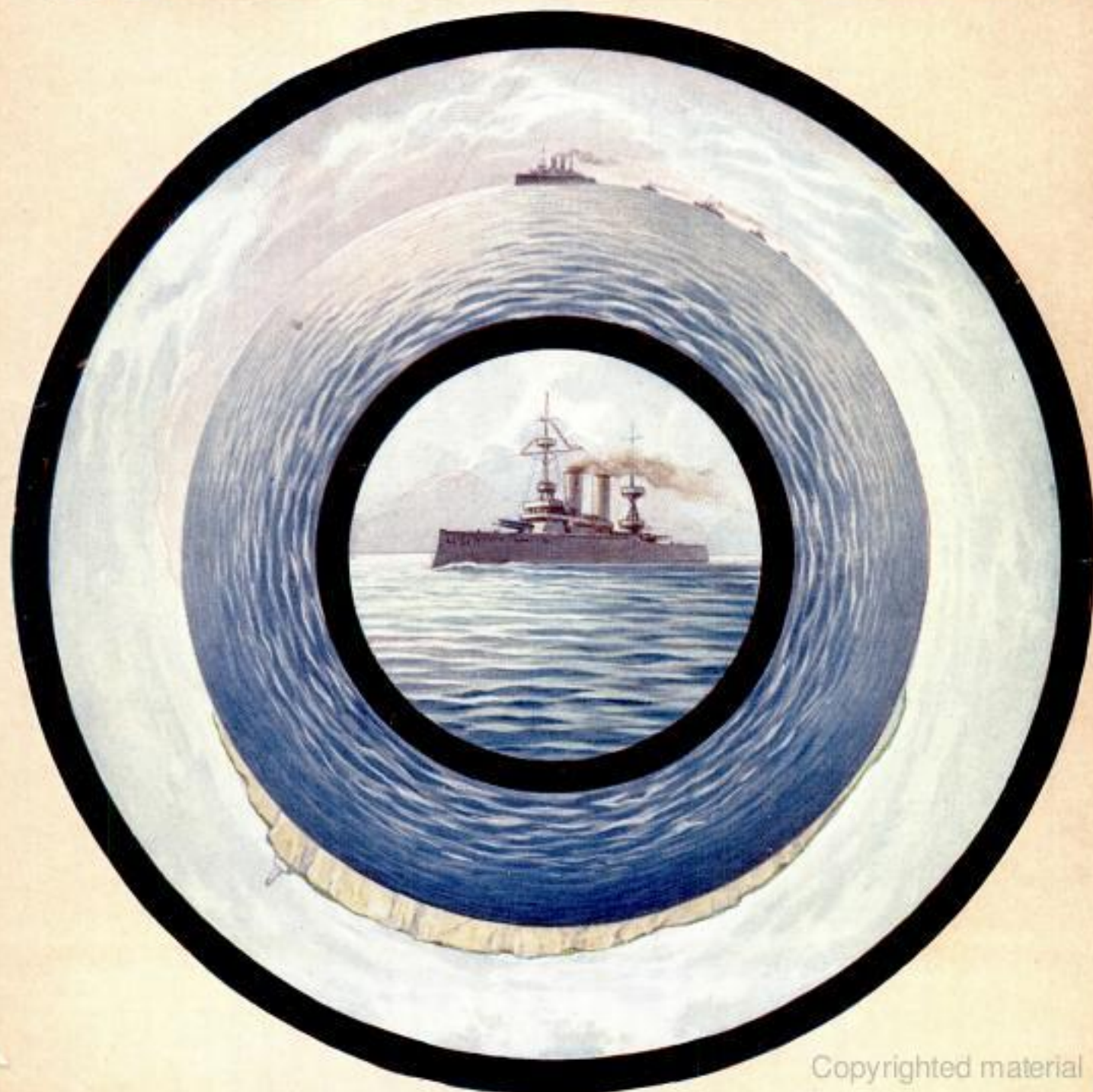

Copyrighted material

\$769 Buys the Material

\$2 Brings Complete Plans

"The Harris Way"

The New Modern Way to Build Your Home



Harris Home Design No. 181

Buy Now—Save 1/4 to 1/2—No Money Down

Every house backed by a \$10,000,000 Guarantee—shipped on approval—without the payment of one cent down—these are the simple terms of the "Harris Way."

Buy from us and reap the benefit of our 23 years' experience in planning, designing, and manufacturing. You keep all the in-between profits, because we MANUFACTURE and SHIP direct to you. Ours is the short-cut to big savings—we have saved big money for thousands of satisfied customers. Why not you? We take all the risk. Our FREE \$10,000.00 PLAN BOOK tells you our clear, straightforward proposition that every prospective home-owner should know. Send for it today.

Sensibly Ready-Cut—That Builds To Stay

You can purchase from us better material *cut-to-fit* "The Harris Way," at less than the cost than when ordinarily purchased in the old-fashioned way. We give you without charge the benefit of our powerful and accurate machinery. To you this means not only better material, but savings in labor, and time as well, and you know in building operations time is money. Ours is the way of no regrets. Our customers tell you their experience in our beautiful Plan Book.

THE DESIGN

This charming Harris Home is a bungalow of distinction—elegant and striking in appearance—any man would be proud to call it his home. Size: 27x41'6". Large living room across the front; 2 big bedrooms; numerous closets, spacious dining room, pantry, ice box room, and a large modern kitchen. There are over a hundred others in our FREE \$10,000.00 BOOK OF PLANS from which you may select. Get it and choose the ideal home of your dreams.

THE MATERIAL

Our absolute guarantee of every piece of sensibly cut-to-fit material is backed by \$10,000,000.00, because we manufacture our own lumber and millwork. For the outside of this Harris Home, we furnish clear, knotless finishing lumber, No. 1 dimension lumber. Red cedar or cypress shingles. Inside: perfectly manufactured clear flooring and beautiful doors; inside trim is thoroughly kiln-dried, clear, modern craftsman style; satin-finish hardware. Everything in keeping with the design.

Free Book of Plans We have spent thousands of dollars to produce this Book—yet we mail it FREE to prospective home builders. It contains more than 100 additional Harris Homes, Barns, Garages, illustrated, priced and showing floor plans. Do not attempt to build without first getting this Book. It contains much valuable information for you.

Free Plan Offer \$2.00 brings complete Blue Print Plans for this or any other Harris Home. Specifications and Material List tell exactly what is furnished with each Home. No guess work, but cold, convincing facts and figures. If plans do not suit, we refund you \$1.50. If you purchase material of us plans are FREE.



Design 185

Eight rooms, bath, large living rooms **\$867**



Design 171

Five rooms, bath, restful and pantry **\$669**



Design 182

Five rooms, bath, closets and pantry **\$564**



Design 193

Seven rooms, bath, sun parlor, sleeping porch **\$998**

MAIL THIS COUPON NOW!

HARRIS BROS. CO., Dept. V7.
Send me your \$10,000 Book of Plans.

Name _____

Address _____

Plumbing and Heating

You can easily install your own heating plant and plumbing material with the assistance of our free expert engineering service. We show you how to estimate by expense of installation.
Complete bathroom outfit, \$47.50.
Enamored bath-tubs as low as \$15.
Warm air heating plants, \$67.
Steam heating plants, \$88.
Hot water heating plants, \$85.
Mail the coupon. Ask for your copy of our new plumbing and heating book.

Quality Roofing Snaps

Our new Quality Roofing Book is full of practical information. Tells you the correct grade and style of material adapted to your particular purpose. It explains very clearly how to do your own roofing work. Everything explained by diagrams. Biggest values ever offered, in ready roofing, metal roofing, siding, ceilings, etc. Prices represent savings of from 1-3 to 5 in every instance. Mail coupon. Ask for FREE copy today.

HARRIS BROS. CO. 35th & Iron Sts. CHICAGO



© MISHKIN

38 West 59th. St.,
N.Y. April 22/15.

Victor Talking Machine Co.
Camden, New Jersey

Gentlemen:--

I would like to express
my delight at renewing my contract
with the Victor Talking Machine
Company for ten years more.

During my extensive travels I
have had such a vivid illustration
of the great work you are doing for
the world that it is with the
deepest feeling that I say I'm
proud to be a part of such a great
work, and that I may long enjoy
the privilege is the earnest wish
of

Yours very sincerely,

Anna Guck



Build Her a Little Greenhouse: Now

Plenty of time to beat old Winter to it, if you start soon. Do not consider any material but Wood—nor any wood but CYPRESS, "The Wood Eternal." Any responsible greenhouse manufacturer will tell you *why*. With metal sash-bars and concrete benches you must use fuel enough to keep the temperature fully 5 degrees higher than if you build of wood in order to keep your soil at a given warmth. Greenhouse use is the most severe test to which you can put wood; CYPRESS has no rival in meeting it.



Vol. 20 of the famous Cypress Pocket Library (never before advertised in this magazine) contains among many other items of special value, a Detailed Plan and Working Drawing, for a splendid little *practical* greenhouse (like picture at left) that *you can build yourself*. Don't miss this. Write tonight for Volume 20—also ask for Volume 3—all about greenhouses.

The John C. Moninger Company, Chicago, Greenhouse Builders, say:—"The greenhouses built by us of clear Cypress, free from sap, 21 years ago are being used today by their owners and the wood is perfectly preserved and *free of any decay or rot.*"

Let our "ALL-ROUND HELPS DEPARTMENT" help YOU. Our entire resources are at your service

SOUTHERN CYPRESS MANUFACTURERS' ASSOCIATION

1219 Hibernia Bank Building, New Orleans, La.; or 1219 Heard National Bank Building, Jacksonville, Fla.

INSIST ON CYPRESS AT YOUR LOCAL LUMBER DEALER'S. IF HE HASN'T IT—LET US KNOW QUICK

"FLAT GRAIN" CYPRESS for SUGI WORK

is preferred over the "curly" grain by many people of high artistic judgment because it

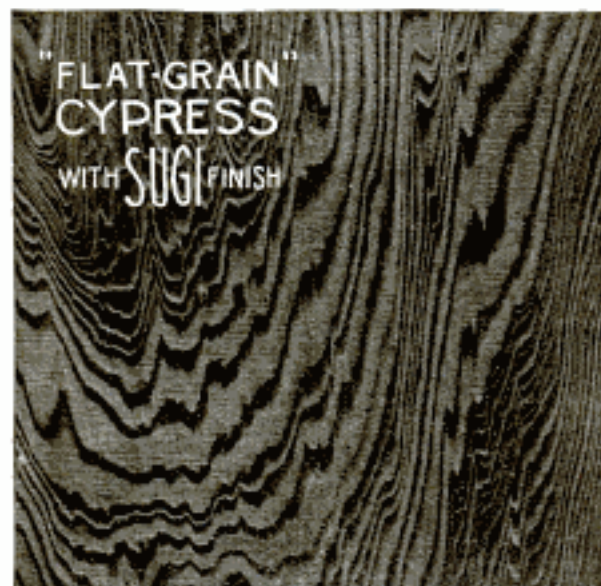

is so much simpler in effect. It undoubtedly is true that the super-convolute grain of the rarer examples of "curly" Cypress renders it wise to use it sparingly and only as the centers of panels or for small hand-made receptacles; it is so richly ornate as to tire the eye if shown in large areas. The "flat grain" as shown at the left, is a splendid relief when used in conjunction, and is in first demand by those amateur craftsmen who do the most "Sugi-ing" either for gifts or for their own homes. VOL. 26 of the famous Cypress Pocket Library tells all about the Sugi (Japanese Driftwood) effect which you can produce by simply scorching and brushing "a little piece of board," tells why it is successful only on "the Wood Eternal," and gives full directions and list of ideas of what to make.

VOL. 26 (FREE) CONTAINS 64 PAGES, INCLUDING 2 LARGE INSERTS IN INDIA TINT

Let our "ALL-AROUND HELPS DEPARTMENT" help YOU. Our entire resources are at your service with Reliable Counsel

SOUTHERN CYPRESS MANUFACTURERS' ASSOCIATION

1219 Hibernia Bank Building, New Orleans, La.; or 1219 Heard National Bank Building, Jacksonville, Fla.

INSIST ON CYPRESS AT YOUR LOCAL LUMBER DEALER'S. IF HE HASN'T IT—LET US KNOW IMMEDIATELY

Popular Mechanics Magazine

6 N. Michigan Avenue, Chicago, U. S. A.

EDITED BY H. H. WINDSOR

England: The International News Co.
5 Breams Bldg., Chancery Lane, London, E. C.

Australia:
The Australian News Co.

ISSUED MONTHLY

SUBSCRIPTION:

SINGLE COPY, 15 CENTS

In United States, and its possessions, Cuba and Mexico, per year, postpaid \$1.50
To Canada 1.75
To all other countries in the Postal Union 2.50

All subscriptions are discontinued at expiration. Please examine the date printed on your wrapper.

Entered as Second Class Matter Sept. 15, 1903, at the Post Office at Chicago, Illinois, under Act of March 3rd, 1879.

Entered as Second Class Matter at the Post Office Department, Canada.

Published monthly by POPULAR MECHANICS CO.

Copyright, 1915, by H. H. Windsor.

Copyright, in France.

Contents for October, 1915

Accident—Runaway Oil Car Collides with Passenger Train.....	486
Aeroplanes—Giant of German Aerial Corps.....	483
Aeroplane—Three Seat Tractor Plane Built for School Use.....	533
Aeroplanes, New Military Delivery to Army.....	575
Air Ducts, Flexible, for Tunnel Construction.....	534
Alaska, Large Sections Suited to Farming.....	512
Ambulance Surgeons, Young Women are Engaged as.....	582
Antiseptic Baths Given Steers on Ranches.....	577
Automobile—Drawer Seats Provided in Roadster.....	484
Automobile—"Gypsy Van," Luxurious, on Cross Country Tour.....	509
Automobile Lamp, New, Has Individual Battery.....	529
Automobiles—Self-Operating Jack Made for.....	530
Baby Inclosure, Lattice, Light and Flexible.....	545
Band Park, Slightly, Built in California City.....	542
Battleship Fleet Passes through Panama Canal.....	529
Bearings, Flexible Ring, Introduced in France.....	599
Bed, Child's, with Canopy Made of Spools.....	571
Bibs, Sanitary Paper, Made for Small Children.....	586
Boat Has Wings That Skim the Surface.....	481
Boston in Gala Dress for Governors' Visit.....	507
Building, Steel, Erected in Seven Hours.....	578
Burglar Alarm, Talking Machine Used as.....	599
Business Letters, Movement Toward Brevity in.....	569
Camera Specially Mounted for Surgical Purposes.....	549
Camping Ground, Municipal, for Visiting Motorists.....	502
Campus, Big Trees Preserved in Planning.....	560
Canal, Cape Cod, a Busy Waterway.....	540
Cars of New Design Built for Gotham Subways.....	560
Casket is Made of Glass Bound by Metal.....	508
Cavern, Deep Underground, Opened by Miners.....	578
Chair, Child's High, Built to Serve Also as Swing.....	577
Chimney, Floating Masonry, Sways in Strong Winds.....	545
Cigar Lighter and Cutter for Automobiles.....	595
Clock, Big, Triples Speed after Deluge of Rain.....	559
Clock, Skull is Case for, Given German Prince.....	542
Coast Survey Equipment to be Increased.....	594
Comment and Review, by H. H. Windsor:	
Better Times Here.....	537
Fire Department for Hire.....	538
Preparedness a Duty.....	535
"Safety First" "Eastland" Memorial.....	535
Scuttling American Ships.....	536
U. S. Dollar Becomes World's Standard.....	537
Concrete Piles, Pipes in Facilitate Jetting.....	539
Conveyor, Spiral Slide Used in Creamery.....	584
Cotton, "Half and Half," Government Warns Against.....	576
Cotton Used for Making Gearing.....	572
Counterbalanced Pole Needs No Steeplejack.....	592
Crocheting, Handy Spool Holder for.....	593
Current Motor Pump Made for Irrigation Uses.....	576
Dam, Gallipolis, Across Ohio River.....	500
Delivery Vehicle Built for Motor Car Bodies.....	599
Dirigibles, New Construction for.....	500
Dish Wiping Unnecessary with China Rack.....	532
Dogs Draw Wheel Chair for Crippled Man.....	488
Doll Baby with Two Faces of Different Expression.....	565
Drill Boat That Lifts Itself Out of Water.....	573
"Eastland," Ill Fated, Raising of.....	503
Eggs, Campaign to Lessen Loss in Handling.....	504
Electric Bus in Service at Bathing Beach.....	579
Electric Grinder, New Portable.....	510
Elevator Unloads Grain in Rapid Manner.....	543
Engine, New, Works on Gas and Steam.....	497
Eraser, New Ink, Uses Prepared Fiber.....	595
Excavation, Heavy, with Hydraulic Giant.....	531
Explosive, Carloads of Used in Single Blast.....	562
Eye-glass Mounting, Queer, Designed by Inventor.....	486
Farm Tractor Contest, Big, Held in Wheat Belt.....	489
Fender, New, for Motor Car, Neat in Appearance.....	534
Filing Papers and Pamphlets, Binding Clips for.....	593
Fire Department, Horns Clear Streets for.....	546
Fire Lighting Device for Coal Stoves.....	593
Fishing Stages on Coast of Newfoundland.....	564
Flagpole Mounting Lowers Pole for Repairs.....	590
Flies, Gallons of, Caught by Simple Trap.....	570
Flood Sweeps Canton, Drowning Hundreds.....	511
Flood, Erie, Death and Ruin Mark Path of.....	491
Fly Catching Syndicate Launched at Atlanta.....	502
Flying Trophy, Marine, Triumph of Wings is Theme of.....	498
Forest Lands Now Held for Actual Settlers.....	490
Forest Service, Farmers are Benefited by.....	532
Forests, Patrolling the, of the Far North.....	571
Forged Prints, Process for Detecting.....	598
Fuel Tank Far Removed from Gasoline Stove.....	590
Furnace Doorway Screen Made of Chains.....	545
Gas Pipes Welded with Oxyacetylene Flame.....	565
Geodetic Surveys, Building Towers for, by Harvey Fergusson.....	523
Gold to New York City, Britain Ships Millions in.....	501
Golf Balls, Simple Scrubbing Device for.....	512
Harvest, British, War Office Supplies Men for.....	576
Headlights, Humanlike Eyes are Fixed in Motor Car.....	543
Hogs, Team of, is Driven through City Streets.....	564

(Continued on Page 6)

Popular Mechanics offers no premiums; does not join in "clubbing offers," and employs no solicitors to secure subscriptions. It is for sale by nearly every newsdealer in the United States and Canada.

[Contents—Continued]

Hurricane Works Havoc along Gulf Coast.....	503	Traffic, Odd Signal Warns, of Lowered Arcs....	587
Hydroplane Meet, Western Craft Wins.....	502	Trench Tool, Combination Serves Many Func-	
Import of Beef, No Serious Menace Seen in.....	503	tions.....	549
Ladder, Folding, Orchard Forms Staging.....	508	Trouser Protector, Novel Devised for Bicycle...	574
Library, Harvard Memorial, Greatest of Its Kind	494	Turbine, Successful Gas, Made in Switzerland...	510
Lighthouse is Planned for Navassa Island.....	500	Ukuleles, Many Hawaiian, Now Used in States...	508
Locomotives, Miniature, Designed in Sugar.....	541	Umbrella, Wind Proof, Made with Special Ribs...	492
Locust Eggs are Now Used for Fertilizing Soil...	572	Unicycle Trick Rider Advertises Clients.....	490
Loom, Power, Made to Weave Oriental Rugs...	534	Valves, Motorcycle Engine, Lifted by Simple	
Lumber Shipment Travels 10,000 Miles.....	530	Tool.....	534
Macadam Streets Washed to Remove Dust.....	501	Vessel Lists Far to Port When Cargo Shifts....	579
Map, Large Tile, Railway System is Shown on...	591	War, European:	
Map, Official, of Gotham Streets is Drawn.....	586	Artillery, Concealed, Behind Allied Lines....	522
Medals, Law Stops Reproduction of Exposition...	534	Blind and Maimed Soldiers, With Europe's...	525
Medical Treatment, Free, for Iowa Children...	530	Churches, How Used in War Time.....	521
Military Instruction Experiment, Plattsburg...	498	Combating Poisoned Gas on Battle Fields....	513
Mining College, Gary Plan of Instruction Used at	500	Fleet Carries Water for Gallipoli Troops.....	512
Motorboats, Flotilla of, Recovers Torpedoes...	506	Galicia, Germany's Triumphant Army in.....	518
Motor Car Races, Night, Novel Speed Contests...	493	Glory of War, Striking Commentary on.....	514
Motor, Miniature Electric, Drives Dental Drill...	559	Hand Grenades and Bombs, Fighting with, in	
Motorcycle, Miniature, for City Streets.....	485	Battle Trenches.....	516
Motorcycle Sidecar Fixed for Stormy Weather...	586	Helmets, New, Protect French from Shrapnel...	520
Motorcycles, Loaded Moving Van Towed by....	501	Prisoners of War, Belligerents Exchange.....	523
Music, Teaching Children While at Play.....	527	Side Lights on, from German Viewpoint.....	519
Nail Bin, Revolving, Made with Many Com-		Wire Entanglements, Building and Razing...	515
partments.....	580	Wounded at Home and in the Field.....	525
Navy, Fours Years in the, by Louis E. Browne:		Wounded Soldiers' Life, Happy Phases of....	524
Part II—The Bluejacket on the Battleship....	551	War, Huge Size of Present, Shown by Statistics...	525
Novel and Practical Things for the Home....	506	War Munition Plant, Great, in Course of Erection	
Oil, Traction Engine Used to Warm Stiffened...	583	War Prisoners are Held in Canadian Fortress...	540
Pavements, Street, Plan for Lessening Cost of...	541	Watch, Sportsman's, with Compass in Crown....	482
Peat, Germans Using, as Insulating Material...	532	Water, Artesian, Assured for Odgen, Utah.....	582
Pen Point Extractor Made as Office Appliance...	570	Wireless, High Power, at San Francisco Fair...	534
Percolator, Curious, Made with Glass Vessels...	492	Wireless Mast, Extensible, for Submarines....	505
Periscope, Panoramic, Made for French Sub-		Wireless Wave Length and Intensity, Measuring	
marines.....	484	Yellowstone Park Now Open to Motor Cars....	500
Phonograph for Settling Family Quarrels....	486		
Phonograph Needle, Electric Bulb Used as....	585		
Photograph Gallery Runs without Attendant...	575		
Placer Machine, New, Works without Water....	585		
Poisonous Reptiles, Kit for Treating Bite of...	547		
Polo Ponies Commuters at San Francisco.....	569		
Popular Mechanics Read in Chinese Academy...	496		
Potash Salt, Feldspar Offers Store of.....	582		
Power Installation for Sailing Yachts, Novel...	548		
Prison, Arizona, Built in Mountain Side.....	544		
Radium Extracted Cheaply by Government Ex-			
perts.....	482		
Railroads, Elevated, Rebuilding New York's...	574		
Railway to Ice Free Arctic Port, Russia Builds...	497		
Railway, Most Northerly, Now Electrified....	580		
Railway Plans, Retracting, Found Unnecessary...	592		
Rations, Reserve, Carried by French Soldiers...	566		
Reading, Rapid, Taught by Simple Machine....	587		
Renting Agency, Municipal, Established at Milan	486		
Road, Contract for State, Given to Municipality...	592		
Road, New Federal, Assured to Yosemite Park...	582		
Rubber Pavement Used in London Street.....	539		
Rubbish Can, Three Compartment.....	587		
Saw, Single Unit Power, for Crate Making....	592		
Screwdriver Attachment for Difficult Work...	599		
Sea Shells, Thousands of, Form Elaborate Arcade	588		
Shipping, Merchant, What the War is Costing...	544		
Signpost Painters, Convenient Platform Used by...	559		
Skis, Where the Children Go to School on.....	548		
Sound Cabinet, Stage, Made in Form of Trunk...	508		
Stadium, Large Municipal, Built in Cañon....	589		
Steamship Service, Lake Boats Enter Ocean....	485		
Steering Mechanism, Dual, for Farm Tractor...	505		
Stilts Used by Pruners in Orange Groves....	496		
Stove, Odorless Portable, for Camping Purposes	504		
Stovepipe, Collapsible, for Camping Tent....	595		
Street Car, Articulated, Operated in Virginia			
City.....	533		
Street Car Crossing, Automatic Danger Signal at	540		
Street Car Made into Repair Shop.....	565		
Street Cars, Automatic Signal System for....	585		
Street, Model, Designed for Court Room Use...	527		
Sulphuric Acid, Industrial Importance of....	484		
Sunset, Mid-Ocean, Seen on Night Aerial Flight...	588		
Surface Measuring Device of Convenient Form...	493		
Tackle Case for Long Fishing Trips, Large Steel...	588		
Tailings Stacker Used in the Witwatersrand...	583		
Telephone Line, Railway, Crippled in Odd Way...	585		
Telephone Repair Truck Conveniently Arranged...	530		
Theater Chair, Convenience Embodied in....	541		
Tide Indicator, Electric, for Night Observation...	539		
Tile Ornaments Applied to Concrete Pillars...	545		
Traction Wheel of Binder Runs in Big Hoop....	492		

SHOP NOTES

Automobile Engine, Lubricating Tappets on....	612
Automobile Hoods, Rattling, To Stop Noise from	610
Automobile License Holder.....	620
Automobile, Repairing Torque Rod on.....	617
Barrel, To Empty, Gradually.....	603
Battery, Lead Storage, To Store When Not in	
Use.....	618
Boiler Plates, Depth Gauge to Measure Pits in..	602
Box Cover Fastened with Screws, Sealing.....	617
Brushes, Lettering, Care of.....	617
Cash Register Used as Adding Machine.....	610
Chair, To Shorten Legs of.....	619
Clamp Plates, Tool, Lifting Springs for.....	614
Clockface Decorations, Metallic Effect on.....	612
Copper, Lost Art of Hardening.....	616
Counterfeit Coin Detector.....	601
Cutters, Wide Milling, Distributing Oil to....	604
Dies, Tool to Remove Stock between Drilled	
Holes in.....	616
Drawer with Inclosed Shelf.....	609
Electric Foot Warmer.....	620
Electric Remote Control Switch.....	614
Eye Shade, Celluloid, Adjustable Fastener for...	613
Flywheel, Preventing, from Breaking Fastening	
Bolts.....	614
Gas Burner, Lengthening.....	610
Gas Engine Stops, To Open Ignition Circuit	
Automatically when.....	601
Gas Flame, Special Shaped, Making a.....	613
Home, Building a:	
Part VII—Plumbing, Heating, and Lighting...	605
Hook for Lifting Metal Plates.....	620
Lathe Feed, Longitudinal, Guide for.....	612
Lawn Cleaner and Sprinkler.....	603
Lime Mortar, How to Mix.....	604
Locks, Non-Take-Apart Cylinder, Fitting Keys to	604
Motorcycle, Running, with Acetylene Gas.....	602
Oil, Dynamo, Substitute for.....	601
Orchestra Music Racks, Reflecting Stage Scenes	
on.....	620
Pattern and Core Box for Small Air Chamber...	611
Pencil, Dual, for Draftsmen.....	619
Punch Press Operation as Substitute for Tapping	
Holes.....	608
Razor Strop Made of Old Leather Belt.....	603
Sand Roller, Exhaust Attachment for Dust from...	609
Siphon, Starting by Air Pressure.....	610
Swamp Shoe.....	601
Tire Economy.....	604

[Contents Continued on Page 8]



The Tower of Babel is Still Standing

Do you realize that 4000 years after this most wonderful of all towers was built by the ancients (according to the Book of Genesis about 2400 B. C.) its seven stages still rise high above the plains near the site of Babylon? Until a few years ago it had been known as the Mound of Birs Nimrud when Sir Henry Rawlinson discovered in one of the stages the inscribed cylinders which made the identification possible. This wonderful account is but one of the thousands of curiously interesting records and documents contained in the great work—

The Library of Original Sources

now for the first time available to the general public. By taking over the *entire unsold edition* from the publishers we secured it at an *absolutely unheard of bargain*. So now we can offer a few remaining sets to POPULAR MECHANICS readers at an

EXTRAORDINARY BARGAIN

FREE BOOK — thousands have written for our interesting FREE book of sample pages and list of curious "original records." Mail the coupon now and this book will be sent to you.

Send us the attached coupon AT ONCE, and we will tell you how to get the Library on EASY MONTHLY PAYMENTS, and mail you FREE a book of rare documents. Remember there are only a limited number of sets, so act quickly. Mail the coupon NOW. You assume no obligation. No salesman will call. The book is FREE.

THIS MARVELOUS WORK is revolutionizing modern thought. It's turning upside down old notions and ideas. It gives the authoritative, rock-bottom sources of our knowledge on ALL SUBJECTS OF HUMAN INTEREST from the earliest civilization down to today—the inside facts which the average person has never even heard of.

OVER 100 RESEARCH SPECIALISTS spent ten years gathering the contents of this great work. Ancient and remote and forgotten civilizations in all parts of the globe were uncovered, and age-buried hieroglyphics on monuments, tablets, sun-baked bricks and palimpsests yielded their secrets; untiring workers ransacked the hidden literature of every age, ancient, medieval and modern, to find the "original documents" that shaped the civilizations and influenced the thought and life of the world. Nothing like it has ever been attempted or thought of before. You'll be amazed at the wealth of information this unique library contains.

DO YOU KNOW that the old Egyptians 5000 B. C. had a Bible? Do you know that the Assyrian literature gives the story of the Creation? Do you know that books and newspapers were printed in Asia thousands of years before printing was invented by Gutenberg? Did YOU ever read Columbus' *personal log* of his great voyage? Do you know that there occurred in Medieval England the first great Socialistic protest? Do you know by what unique process Harvey demonstrated the circulation of the blood? Do you know who Machiavelli was or what world famous treatise he wrote?

YOU'LL FIND THEM ALL—and thousands of others equally as curious and important—in The Library of Original Sources. Every document is in the exact words of the original, translated; every contribution is from the actual eye-witness or person who took part; every idea is in the words of the thinker, investigator, discoverer or inventor.

JACK LONDON SAYS: "It is a whole library in itself. I certainly never could spare these books from my shelves."

10 sumptuous, massive volumes, bound in rich, black India sheepskin; full-page illustrations on India Vellum, pure silk headbands, printed in large, clear type on hand-made paper, gold tops—a triumph of the bookmaker's art.



MAIL THIS COUPON FOR FREE BOOK

10
15
P. M.

University
Research
Dept. G
Milwaukee, Wis.

Send me the FREE book of rare, original documents, showing curious inscriptions of the Ancients, and tell me of your easy payment offer. I assume no obligation, the book and all you send me is to be free, and no salesman is to call.

Name.....

Address.....

We Assist Students Getting Actual Driving Experience

YOU Can Learn AUTOMOBILE BUSINESS AT HOME During Your Spare Time by Mail with Dyke's New Idea Working Model Method

If we *prove* to you that we have started hundreds of others into the repair business and as chauffeurs—who had no previous experience and who knew no more about an auto than you do right now—you must admit we can do the same for you. Write me *today—now—and let me prove it.*

The Automobile Business is growing—more help needed and big pay. No other business offers such opportunities. It's easy to learn. An Auto Repairman is not a machinist—his work consists of adjustments and re-fitting worn parts, "knowing the principle," that's the thing. One of our students writes: "Before I started with your course I was a clerk at \$50 per month. After finishing I followed your instructions, started a repair shop and cleared \$122 the first month—pretty good for the first month." Let us show you this and many other letters.



Our book of testimonials, showing photos of students and their shops—free.

We will show you the way to start a repair shop of your own—or drive a car and make more than you are making now—we can give you this training during your spare time—with

DYKE'S NEW IDEA OF TEACHING BY MAIL WITH WORKING MODELS

On these models you get actual practice, see the actual operation and learn more than you could from the auto itself—it's easy and quick. You don't have to study hard with this system—we teach through the eye—a new idea. Mr. Dyke is the originator of the system of teaching by mail with models—therefore beware of imitators.

Our Employment Plan for Students

represents years of work to provide something that no other school had, namely, a way for the student to get started in the practical line of work.

Mr. Dyke has been identified as a pioneer inventor, supply man, etc., with the auto industry since its beginning. He originated the first auto supply co. and published the first book on autos in America. No other man with such experience is today teaching others.

FREE Mr. Dyke's 32-Page Booklet WRITE FOR IT—NOW!

It is interesting and instructive in itself. Learn how you can get all this training for only \$15. Fill out below or write a postal—but do it now.

Dyke's Correspondence School of Motoring
Box 196, Roe Bldg., St. Louis, Mo.

Send me your free 32-page booklet about your New Idea Working Model Course and testimonials and proofs. It is understood I am under no obligations in sending for this.

HOW TO GET INTO THE AUTO BUSINESS AND ITS OPPORTUNITIES

Name.....
Town.....
Street..... State.....

This school is a department of the firm A. L. Dyke, Publisher and Importer. Dyke's system is endorsed by leading motor authorities of the world.

SPECIAL INSTRUCTION on Six, Eight, Twelve Cylinder Engines. 1915 Electric Starting and Generating Systems.

(Contents—Continued from page 6)

Tool Holder for Machinery Blanking Dies.....	613
Typewriter Ribbon, To Determine Coloring Matter of.....	612
Waterproofing Waxed Finish.....	620

AMATEUR MECHANICS

Basket, Six Sided Waste Paper.....	627
Blowpipe for Gas.....	630
Box, Pasteboard, Shortening.....	631
Bromide Enlargements, Washing.....	630
Canoe, Paddling Your Own: Part II—The Knack of Handling the Paddle..	633
Gold, Surface Mining for: Part I—Panning for Gold.....	623
Lights in Gymnasium, Protecting.....	631
Miter Box, Bench Support for.....	630
Oiling Tool for Clocks.....	637
Pincushion, Durable.....	627
Plants, To Keep Worms Away from.....	627
Pump, Homemade Rotary.....	625
Scraper for Dishes.....	631
Shadowgraph of the Savior.....	627
Shelves, Easily Constructed Wall.....	622
Spout to Drain Tank Made of Paper.....	629
Table, Portable Folding Camp.....	626
Trick—Showing the Strength of a Giant.....	622
T-Squares, Making, by J. B. Murphy.....	621

PATENTS

Atomizer, New Type of.....	638
Automobile, Cushion Rim for.....	639
Automobile, Safety Attachment for.....	638
Camera, Focusing Hood for.....	639
Camshaft, New Drive for.....	638
Can Opener.....	638
Crutch with Ball Bearing Top.....	638
Knife Sharpener.....	638
Latch for Hoisting Hook.....	639
Motor, Current.....	639
Note Pad, Illuminated.....	638
Parachute Attachment for Aeroplane.....	639
Phonograph Needles, Holder for.....	638
Pole, Sectional, Joint for.....	639
Roller for Expanding Fabrics.....	639
Street Indicator for Elevated and Street Railway Cars.....	638
Swing, Rotating Lawn.....	638
Tongue for Horse Drawn Vehicle.....	639
Window Lock.....	639
Wrench, Pipe.....	639

Own a Business Be a Tree Expert

A big paying profession taught thoroughly by mail. Unlimited opportunities. Be independent. If \$25.00 to \$75.00 per week interest in YOU, write for our free booklet.

Wilmette School of Tree Dentistry, Dept. M, Wilmette, Ill.

LEARN WATCHMAKING

and become independent. Good-paying positions secured. Easy to learn. Send for FREE CATALOG.

ST. LOUIS WATCHMAKING SCHOOL, Dept. 5, ST. LOUIS, MO.

DON'T TAKE A COURSE IN MACHINE DRAFTING

until you've read my proposition. Practical, experienced Draftsman, regularly employed in large modern works, will teach a few men by mail. Best way to become a well-paid Draftsman. Special courses in Mathematics also. Instruments furnished. Rates very reasonable. Draftsman, 252 S. Corona St., Denver, Colo. Pay a part after in position.

J-M ASBESTOS ROOFINGS

Sometimes called "The Everlasting Roof." Investigate J-M Roof Registration always mindful of J-M Roofing Responsibility.

H. W. JOHNS-MANVILLE COMPANY

3186 New York and Every Large City

SPEAK A FOREIGN LANGUAGE!!!

The European war has created a great demand and unlimited opportunities for those who know Spanish, French, German or Italian. Now is the time to better your position or increase your business. You can learn quickly and easily, at home, during spare moments, by the

LANGUAGE-PHONE METHOD

And ROSENTHAL'S PRACTICAL LINGUISTRY

You listen to the living voice of a native professor pronounce the foreign language, over and over, until you know it. Our records fit all talking machines. Write for booklet, particulars of Free Trial. Easy payments.

The Language-Phone Method, 961 Putnam Bldg., 2 W. 49th St., N. Y.



Please Mention Popular Mechanics

NAPOLEON

LINCOLN

BISMARCK

GLADSTONE

GRANT

WASHINGTON



The Secret of Achievement— “Power of Will”

By Frank Channing Haddock, Ph.D., M.S.

**A Scientific Course of Will-Training Which Has Helped
Over 75,000 People—Sent Free without Deposit**

This great work provides a thorough course in Will-Training, consisting of 28 lessons. It reveals the secrets as to how great men train their wills into wonderful power.

All psychologists will testify that great men are not born with more gifts than others. They simply make something of their gifts, and others do not. They learn how to use their wills. We, on the contrary, allow the great powers we possess TO LIE DORMANT.

How to Develop Inflexible Will

It has long been known that the Will can be trained into wonderful power—like memory, or like any one of the senses—by intelligent exercise and use. The trouble with almost every one is that they do not use their wills. They carry out other people's wills, or drift along with circumstances.

If you held your arm in a sling for two years, the muscles would become powerless to lift a feather. That is exactly what happens, in most people, to the faculty we call “will-power.” Because we never use the Will, we finally become unable to use it. We degenerate into beings little more than slaves—unhappy, discontented, envious, hoping blindly that “some day”—without any effort—we will attain what we most want in life.

Helps Everybody

“Power of Will” provides the shake-up that ninety-nine out of every hundred people need. Men like Judge Ben B. Lindsey, Supreme Court Justice Parker, Wu Ting Fang, Ex-U. S. Chinese Ambassador, Lieutenant-Governor McKelvie of Nebraska, General Manager Christenson of Wells-Fargo Express Co., Assistant Postmaster-General Britt, Ernest Knaebel, Asst. Att’y-Gen’l of the U. S., E. St. Elmo Lewis, now Vice-Pres. Art Metal Cons. Co., Gov. Ferris of Michigan, are owners of this great work—and literally thousands of other men of action and ambition like them—read, use and praise “Power of Will.”

Its readers talk of it as of a Bible. It has made decisive men of action out of the most miserable “down-and-outs.” It has cured victims of drink and other vices. It has made big men bigger by showing them how to use their brains better. It is a goal to young and old alike. It has reawakened ambition in men and women who have been turned from their life purposes, and shown its students how to carry forward their ambition into consummation.

Send No Money—Examine Book First

The price of the book—although it is really a complete course in Will-Training—is only \$3.00. The publishers will gladly send a copy free, for five days' inspection. Send no money now. Merely mail the coupon below, enclosing your business card or giving a reference. If you decide to keep the book, send the money. If not, mail the book back. Tear out and fill out the coupon now, before you forget.

PELTON PUBLISHING CO.

510 Pelton Bldg.

MERIDEN, CONN.

What Readers Say

“I hand you \$3 in payment; from what I have already seen I believe I can get \$300 to \$30,000 worth of good out of it. Better still, I believe it worth more than money in any amount.”—C. D. Van Vechten, General Agent No. West Life Ins. Co., Cedar Rapids, Ia.

“Will-power is a compilation of mighty force. My first week's benefit in dollars is \$300.00—cost \$3.00; profit \$297.00.”—J. W. Heiland, 916 Tribune Bldg., Chicago.

“In my judgment ‘Power of Will’ is wonderful.”—Owen J. McCaughey, Secy. of Corp. Securities Co., St. Louis, Mo.

“The first thing I happened upon when I opened this book was ‘Some Diseases of the Imagination,’ and I tell you that chapter alone is worth ten times the price of the book. I wish such a volume had come into my possession 25 years ago.”—Thos. O'Connor, 270 Precita Ave., San Francisco, Cal.

“You could not buy it for one hundred times the amount I paid for it, if I knew I could not get another copy.”—R. E. Seay, Puscagoula, Miss.

We have hundreds of such testimonials on file.



POWER
OF
WILL

**Pelton
Pub. Co.
510 Pelton Bldg.
Meriden, Conn.**

Gentlemen: Please send me a copy of “Power of Will” on approval. I agree to remit \$3.00 or return the book in 5 days.

Name.....

Address.....

Partial List of Contents

The Law of Great Thinking.
The Four Factors on which it depends.

How to develop analytical power.
How to think “all around” any subject.

How to throw the mind into deliberate, controlled, productive thinking.

Detailed directions for Perfect Mind Concentration.

How to acquire the power of consecutive Thinking, Reasoning, Analysis.

How to acquire the skill of Creative Writing.

How to guard against errors in Thought.

How to drive from the mind all unwelcome thoughts.

How to follow any line of thought with keen, concentrated Power.

How to develop Reasoning Power.

How to handle the mind in Creative Thinking.

The secret of Building Mind Power.

How the Will is made to act.

How to test your Will.

How a Strong Will is Master of Body.

What creates Human Power.

The Six Principles of Will Training.

Define Methods for developing Will.

The NINETY-NINE METHODS for using Will-Power in the Conduct of Life.

Seven Principles of Drill in Mental, Physical, Personal Power.

FIFTY-ONE MAXIMS for Applied Power of Perception, Memory, Imagination, Self-Analysis, Control.

How to develop a strong, keen gaze.

How to concentrate the eye upon what is before you—object, person, printed page, work.

The First Principles for Success in contact with others.

How to keep the body well-poised.

How to open the Mind and Body for reception of incoming power.

The fifty-four Master rules in the control of others.

How to throw off Worry.

How to overcome the tyranny of the Nerves.

How to secure steady nerves.

How to maintain the Central Factors of Health.

The Law of Will-Power in Habits.

The Mental Attitude you must hold to impress people.

Fifteen Methods of Mastering Anger and Irritability.
Etc., Etc., Etc.

A complete list of contents would almost fill this page.



19 Jewel Burlington

The Master Timepiece—**adjusted** to positions—**adjusted** to the second—**adjusted** to isochronism.

Extra!

A Special Direct Offer

The Superb Burlington Watch now at the *direct* rock-bottom price—the same price that **even the wholesale jeweler** must pay—and in order to encourage everybody to secure this watch at once, pay this rock-bottom price, either for cash or \$2.50 a month on this great special offer. We send the watch on approval, prepaid. You risk absolutely nothing—you pay nothing, not one cent, unless you want this *exceptional* offer after seeing and thoroughly inspecting the watch. Read the coupon below.

**New Ideas in
Watch Cases
Block and Ribbon
Monograms
—Diamond Set—
Lodge—French
Art—Dragon.**

Watch Secrets

Explained In Our Book!

Burlington Watch Co.
19th Street and Marshall Blvd.
Dept. 1197, Chicago, Ill.
Please send me (without obligations and prepaid) your free book on watches, with full explanation of your cash or \$2.50 a month offer on the Burlington Watches.

Learn the inside facts about watch prices, and the many superior points of the Burlington over double-priced products. Just send the coupon or a letter or a postal. Get this offer while it lasts.

Name.....

Address.....

Burlington Watch Co.
19th St. & Marshall
Blvd. Dept. 1197
Chicago, Ill.

FREE Send for large Catalogue of Practical Mechanical Books FOR HOME STUDY

Best Books for Electricians, Telephone Men, Motion Picture Operators, Engineers, Railroad Men, Motormen, Draftsmen, Automobile Mechanics, Plumbers, Carpenters, Builders, Sign and Card Writers, also Bookkeepers and Civil Service Applicants.



F. J. DRAKE & CO., Dept. 8
1325 Michigan Ave., CHICAGO

This New Book Sent Prepaid
Cloth Binding \$1.00
Leather " 1.50

"The Power of Law Training"

WRITE today for our new 171 page free book "The Power of Law Training" It carries a vital and inspiring message to every ambitious man. If you know law, greater and bigger accomplishments are yours—in all lines of business as well as in the profession itself. Master minds of the law will train you.

Write Today for New 171 Page Book

No obligations. Your copy of "The Power of Law Training" is ready. You should read it. Write for it now. It's free.
American Correspondence School of Law, 1197 Manhattan Bldg., Chicago, Ill.

COPY THIS SKETCH

and let me see what you can do with it. Illustrators and cartoonists earn from \$20 to \$125 a week or more. My practical system of personal individual lessons by mail will develop your talent. Fifteen years' successful work for newspapers and magazines qualifies me to teach you. Send me your sketch of President Wilson with 4c in stamps and I will send you a test lesson plus a collection of drawings showing possibilities for you.

The Landon School of Illustrating and Cartooning
1433 Schofield Building, CLEVELAND, O.



BE A BANKER

Splendid opportunities. Pleasant work, short hours, all holidays off, yearly vacation with pay, good salary. Learn at home. Diploma in six months. Catalog free. EDGAR G. ALCOCK, Pres.
AMERICAN SCHOOL OF BANKING, 119 McLERE Bldg., COLUMBUS, OHIO

BE A DETECTIVE

Earn from \$150.00 to \$300.00 per month; travel over the world. Write C. T. LUDWIG, 133 Westover Bldg., Kansas City, Mo.



HERE YOU ARE, BOYS A medalion pin of Foxy Grandpa. Everyone will notice it on the lapel of your coat and try to get a closer look at it. All you have to do is press the bulb. Foxy Grandpa will finish the job by squirting a fine stream of water over the inquisitive one. Will squirt 20 feet. Greatest joke out. Order one today and fool your friends. Price 15c. Foxy Grandpa and Hooligan both for 25c. 5 for 50c or 1 doz. for \$1.00. A beautiful fountain pen free with every \$1.00 order.
AMERICAN SUPPLY CO., 918 Union St., St. Paul, Minn.

FREE "Linene" COLLAR
State size on postal and whether you want collar like cut or low turnover style.
REVERSIBLE COLLAR CO., Dept. U, Boston, Mass.

LAW STUDY at HOME

Become an LL.B.

The Only Law School of its Kind in America

Special and Exclusive Features

ONLY recognized resident law school in the United States conferring Degree of Bachelor of Laws LL.B.—by correspondence, strictly on the merits of its course. **ONLY** law school in U. S. conducting standard resident school and giving same instruction by mail. **ONLY** law school giving over 500 class-room lectures to its extension students. **ONLY** law school giving a full 3-year, University Law Course, by mail, having an actual faculty of over 30 prominent lawyers in active practice. **ONLY** law school in existence giving a Complete Course in Oratory and Public Speaking, in conjunction with its law course.

Our Degree LL.B.

We confer this Degree of Bachelor of Laws—LL.B.—only when the student has completed our full course with the necessary credits, to the satisfaction of the Faculty, exactly the same as in our resident school. This College is no "degree mill." Passing Bar Examination is not our standard for conferring this degree. Our degree stands for accomplishment, honor and distinction. It is worth working for, and a treasure to its possessor.



Direct From Class-Room to Student



From Lecture Room to Student
No Other Law School Can Use
This Illustration

chooses, take part of our course by mail and finish in our resident school where he will receive full credit for all work done by mail.

is the way we teach law. We are the only school doing this. Our system of teaching is interesting; not dry and dull like the average law course. Our system of conducting examinations is the most thorough, complete and expensive (to us) of any examinations ever given. A student can if he

Written Bar Guarantee

We give an absolute written guarantee to prepare our students to pass bar examinations.

The Hamilton College of Law is a regular, thoroughly recognized, bona-fide College of Law and NOT an "institute," "correspondence school," or a corporation selling sets of law books under the guise of teaching law.

This College occupies the entire third floor of the New Advertising Building where its large and commodious Class-rooms, Extensive Library and executive offices are located. School and Course Highly Endorsed and recommended by Government Officials, Business Men, Noted Lawyers, Graduates and Students.

FREE COMPLETE COURSE IN ORATORY AND PUBLIC SPEAKING

This course has been prepared and written by Prof. Oscar G. Christian, LL.M. (Master of Laws), the regular resident school professor in charge of this work. Knowing law, from a lawyer's standpoint, he has prepared this series of 26 lectures to meet all the requirements of the practicing attorney. This Course in Oratory and Public Speaking sells, individually, for \$30.00, but it is absolutely free to Hamilton College students.

Our Law Library

Consists of 24 volumes of Students Standard Text Books, two volumes bound together under one cover for convenience, making a total of 12 books. These law books were prepared at an enormous cost especially for the students of the Hamilton College of Law, by one of the largest and best law book publishers in

America. This is the only set of law text books ever prepared exclusively for students' use. We would be glad to have you submit these books to any lawyer or judge in the country and get his opinion regarding them.



What Our Students Say

These 12 Volumes are Free to Students

"No doubt you will be interested to hear that I was successful in the recent examination for admission to practice in our state."

R. S. A. Jr., Birmingham, Ala.

"You no doubt will be surprised to learn that I have been admitted to the Kentucky Bar. I made about 90% on this examination and was complimented very highly by the legal profession of my acquaintance."

C. D. M. Ky.

"About the 1st of May of this year, after I had been studying with your College for only 14 months, I successfully passed the Texas Bar Examination. I certainly intend to go ahead with the 3rd year. I think an LL. B. is quite worth while."

E. G. G., Supt. Public Instruction, Tex.

"As an officer of instruction in a large University permit me to say that I consider your course admirable in conception and well carried out in detail of practice."

E. G., N. Y.

"So enthusiastic and gratified am I over the progress made that I cannot refrain from writing you and expressing my appreciation."

S. J. L., A. B., M. A., Supt. Military Academy, Md.

"It gives me a good deal of pleasure to give you the result of my examination before the State Bar Commission. When I tell you that among those who ranked lower than I did were some college graduates, an attorney of another state, a former justice of the peace, and two who had done considerable work in an office under a good attorney, you will believe me when I say there is no school in the world, resident or otherwise, that will do as much for its students as the Hamilton College of Law."

N. C. W., Prof. Commercial Law,
..... High School of Commerce,

Full names, addresses and letters mailed with literature. We have hundreds of similar letters. Send Free Coupon Today and get our Handsomely Illustrated Prospectus. Gives you a clear understanding of the Profession of Law, and how we are successfully teaching it by correspondence. It may mean the turning point in YOUR career.

MAIL COUPON TODAY

HAMILTON COLLEGE OF LAW
200 Advertising Building, Chicago, Ill.

Gentlemen:—Kindly send me your Illustrated Prospectus and full particulars regarding your successful and exclusive method of teaching law by mail.

Name

Address

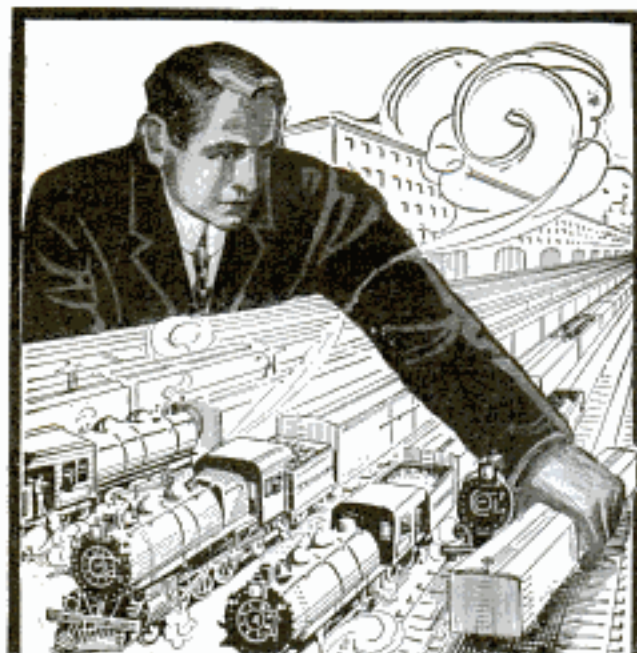

NEW JOBS NOW OPEN

Earn from \$35 to \$100 Weekly as a

TRAFFIC MANAGER

Modern transportation is a jungle of routes and rates calling for specialists who, like the pathfinders of old, have expert knowledge of the trails of traffic. How to route shipments to obtain shortest mileage and quickest deliveries and how to classify goods to obtain lowest rates are two vital factors in business competition. The man who knows how is so valuable to his employer that he commands respect and big remuneration.

Big Salaries Paid to Traffic Managers

Expert traffic managers command from \$2,500 to \$25,000 a year. Why not prepare yourself to fill one of these lucrative positions?

New and Uncrowded Profession

There are half a million LARGE SHIPPERS in the United States. Practically every one of them needs an expert traffic man, and this need is recognized as never before because of the recently enacted railroad rate laws and interstate commerce regulations. The demand for trained and efficient traffic men is many times greater than the supply. There's room for you.

Study Traffic and Interstate Commerce

Decide now to become a traffic man. Our Interstate Commerce Course enables you to study AT HOME, without leaving your occupation or sacrificing present income, and to become thoroughly versed and proficient in the strategy of shipping, including routes and classifications, interstate commerce rules and regulations, etc. The instruction is given by some of the biggest traffic managers in the country. The course is easy to grasp and thoroughly practical. Anyone with ordinary intelligence, with reasonable application, can master this new profession.

FREE PORTFOLIO Clip coupon below, sign and mail at once, and we will send you Free, postpaid, a handsome portfolio containing complete information concerning the opportunities and requirements of this attractive profession. Get posted at once. Clip coupon.

LA SALLE EXTENSION UNIVERSITY, Dept. C783, CHICAGO

COUPON

La Salle Extension University
Dept. C783, Chicago, Ill.

I am interested in the new profession—
Traffic Management. Please send me full information and Traffic Book, free of all cost.

Name

Occupation

Write Address on the Margin Plainly.

Please Mention Popular Mechanics

FREE PORTFOLIO



LEARN The AUTO BUSINESS

EARN A SPLENDID SALARY

Over 3000 graduates of our school are now receiving big salaries as Chauffeurs, Testers, Mechanical Experts, Demonstrators, etc., etc. There are greater opportunities now than ever before in the auto business—for properly trained men.

UP-TO-DATE TRAINING IN 4 WEEKS

Including expert instruction on latest starting and lighting systems, newest types of motors, etc., and repairing and driving high powered cars. 11 years of success—oldest and best established school west of New York. Tuition and board reasonable.

CALL OR WRITE US TODAY FOR CATALOG
Cleveland Automobile School, 2338 Euclid Ave., Cleveland, Ohio



TRAVELING MEN

EARN \$2,000 TO \$10,000 A YEAR

We will teach you to be a high grade salesman, in eight weeks at home and assure you definite proposition from a large number of reliable firms who offer our students opportunities to earn Big Pay while they are learning. No former experience required. Write today for particulars, list of hundreds of good openings and testimonials from hundreds of our students now earning \$100 to \$1000 a month. Address nearest Office, Dept. 507, NATIONAL SALESMEN'S TRAINING ASSN., Chicago New York San Francisco

GOVERNMENT POSITIONS

offer employment for life at a salary ranging from \$800 to \$1840 per year, with short hours under pleasant conditions and no fear of "lay-offs" or strikes. American citizens 18 or over are eligible. Our 64-page booklet contains list of positions, requirements, etc., and tells how you can prepare for "Exams" under the personal supervision of a former U. S. Civil Service Secretary-Examiner. Booklet is FREE, without obligation. Write today.

PATTERSON CIVIL SERVICE SCHOOL
110 Irving Place ROCHESTER, N. Y.

LEARN WATCH REPAIRING

Be a watchmaker—you can learn this profitable trade by correspondence in a few weeks in your own home by the DeSelms Chart System. After you complete the course you will know a watch from A to Z. You will know just what the matter is and how to repair one. When you graduate you will be a practical watchmaker and repairer and competent to fill any position. Positions for our graduates.

Ask for our Free Book. It explains our system and terms.
THE DeSELMS WATCH SCHOOL
23 Perry Street ATTICA, INDIANA

BE AN ILLUSTRATOR

Learn to draw. We will teach you by mail how to draw for magazines and newspapers

Send for Catalog

Learn to draw. We will teach you by mail how to draw for magazines and newspapers

112 Page Book, Chicago, Ill.



IF YOU STAMMER

attend no stammering school till you get my large FREE book and special rate. Largest and best school in the world curing by natural method. Write today.

Lee Wells Millard, Pres., North-Western School, Inc.
2317 Grand Avenue Milwaukee, Wis.

ARITHMETIC SELF-TAUGHT

A plain, easily-understood volume for all who have not had the opportunity of learning this subject thoroughly, or who have forgotten what they once learned. 257 Pages. Requires no teacher. This great little book sent postpaid for 60 CENTS. Stamps accepted.

GEO. A. ZELLER BOOK CO.
Est. 1876, 462 W. Belle Place ST. LOUIS, MO.

SPANGENBERG'S
PRACTICAL
ARITHMETIC
Self-Taught

You Need the FACTS in Electricity

To be a master man in the electrical profession you must have **exact** knowledge of electrical science. These books are the standard. They will pay for themselves many times over. Send for free examination to-day.

Electrical Knowledge Brings You Dollars

"The man who knows is the man who grows." The untrained man stays put, while the man who has the facts at his fingers' ends gets to the top. **Hawkins Electrical Guides** give you the knowledge that you need in a way you can understand.



The Most Complete Library of Electricity — Sent to YOU for FREE Examination

These books cover all branches of Electricity. They are authentic, up to the minute, complete. They contain no useless matter, only just such information as is needed. They are a complete course in Electrical Engineering. Look at the titles and note the wide range of subjects covered. The several thousand illustrations are profuse and remarkably clear. The books cost only \$1 per volume. They are a wonderful buy at this price, and they are the best Electrical books at any price. Don't take our word for their merits. Fill out the coupon to-day and the books will be sent you Absolutely FREE for your own examination. You have seven days' full use before you pay a cent.

Written by Practical Men for Practical Men

ing himself for advancement, for the wide awake man who is likely to be called on for work outside of his regular line, for the man who needs at his elbow, for ready reference, an accurate up-to-date work on electricity. You will find the books indispensable. An examination of them will convince you.

Handy Separate Volumes

Hawkins Electrical Guide is in separate volumes—which is especially handy for you. The binding is in flexible black leather with gold edge—very durable and attractive. The books are easy to handle and easy to read. They fit your pocket and your pocketbook as well.

There is no idle theory in Hawkins Electrical Guide. Every paragraph is written and illustrated to help you in the easiest, most practical way. The books are designed especially for the ambitious man who is training himself for advancement, for the wide awake man who is likely to be called on for work outside of his regular line, for the man who needs at his elbow, for ready reference, an accurate up-to-date work on electricity. You will find the books indispensable. An examination of them will convince you.

Read What Users Say

"I wish to say that I have been doing Electrical Work for 15 years, and have upwards of \$100 worth of Electrical books, but I consider the Hawkins Electrical Guides the best ever for the practical electrician."

—O. A. Armfield, Mulberry, Fla.

"The Hawkins Electrical Guides seem to me to be the best and most complete set of Electrical books that I have ever had the opportunity to find."

—T. J. Messinger, Columbus, Pa.

SHIPPED TO YOU FREE!

Send no money. Examine the books first. Decide for yourself that they are the most complete library of electricity ever published, and that you cannot afford to be without them. Every book is complete in itself. The price is only \$1 per copy, but the complete set is the best bargain. Settlement can be made at only \$1 per month. Eight numbers now ready.

Easy Payments Mail Coupon NOW

Accept this great offer now—today. Each page—every illustration will convince you of the big value we are offering. See the books first, then decide. If you decide to keep them you can make settlement at only \$1 monthly until paid for.

Just put your name and address on the coupon and send it to us at once. Absolutely no obligations of any kind. We will send the books for free examination. Convince yourself of their wonderful value. Do it to-day—NOW.

Send for free examination to-day—now.

FREE COUPON

THEO. AUDEL & CO.

Dept. PM, 72 Fifth Ave., NEW YORK

Please submit me for examination Hawkins Electrical Guides (Price \$1.00 each). Ship at once, prepaid, the first eight numbers; if satisfactory I agree to send you \$1.00 each month until paid.

Signature

Occupation

Business Address

Residence

Reference

THEO. AUDEL & CO. Dept. PM
72 Fifth Ave., New York

P.M. Oct.



PROF.
FREDERICK
W. FOOTE
Psychologist

Graduate of the University of Maine and of Bangor Theological Seminary. Scholarship graduate of Harvard University, where he studied Psychology under Prof. Hugo Muensterberg. Formerly associate in Psychology in the University of Minnesota.

Make Brain Power Tell

Vital Questions

1. For what goal are you aiming?
2. Are you satisfied with your present success?
3. Have you Power of Concentration?
4. Is Self-Control and Poise yours?
5. Do you desire to increase your Personal Power?
6. Would you like to develop a Master Mind?
7. Do you possess Mental-Control?

Concentration! Poise! Personal Power!

These Qualities are Results—the Results of Mental Control. Through my Scientific Mental Success Training Course I will personally teach you the positive laws which will enable you to so control your Brain Power that you will be Master of your Thinking and Acting.

PSYCHOLOGY

— which is the systematic study of mental laws — is the one great science by which you can obtain your goal. My method of teaching is unique. The facts are given to you in simple English — you cannot fail.

Write for my wonderful book to-day, it's FREE.

My Book Will Tell You HOW to Obtain This Power

FREE BOOK COUPON

Prof. Frederick W. Foote, President
Frederick Academy of Correspondence
30 N. Michigan Blvd., Chicago

Tell me how I can make BRAIN POWER TELL, in my SUCCESS Climb. Send me your free book, "Mental Mastery" and full particulars of your course in Scientific Mental Training. P.M. 19-15

Name

Address



LEARN TO PAINT SIGNS and SHOW CARDS

THERE'S MONEY IN IT

I'll teach you personally by mail. 16 years' successful teaching. Three courses: (1) Complete Lettering, Signs and Card Writing; (2) Show Card and Ticket Writing; (3) Lettering. It is a wonderful field for men and women. You can succeed—big. No limit to the window cards, sale cards, banners, and signs used by merchants and others. Gold lettering on glass and wood valuable feature of course. Teaches everything you need. This knowledge will help you wherever you are. Pay good, work fascinating, hours short.

Neal (Ohio) says, "Lessons easy to understand—anyone can easily learn." Schwartz (Del.) writes to say, "Yours is the only school that really teaches," and Tarbell (Ill.), "Price of course too cheap—best in existence." Get in on this big thing too. Your name and address brings full particulars.

THE DETROIT SCHOOL OF LETTERING
Chas. J. Strong, Founder, Dept. 210, Detroit, Mich.

Guarantee—
I guarantee to place my graduates in positions paying \$25.00 to \$175.00 when they have graduated and are competent. We have constantly more requests for men at good salaries than we can supply.

TYPEWRITE THE NEW WAY

80 to 100 Words a Minute GUARANTEED

Totally new system. Based on *Gymnastic Finger Training!* Brings amazing speed—perfect accuracy—BIG SALARIES. Easy for anyone. First day shows results. Learn while working. **48-Page Book Free** illustrates and explains all. Gives letters from hundreds with salaries **doubled and trebled**. A revelation as to **speed and salary** possible to typists. Postal will do, but write today—NOW.

Tulloss School of Typewriting, 190 College Hill, Springfield, O.

\$12500 to \$30000 a Month

Write at once. Most wonderful opportunity for the ambitious man. Railroads need hundreds of Signalmen—will pay Big Money.

Special Offer We will teach you *right at home* to be expert. Special offer if you write at once. Two big outfits free. **Write Today** for our free catalog and particulars of our big offer.

DEPARTMENT OF SIGNALING
1210 Wilson Ave., Room 9197, Ravenswood Station, CHICAGO

A GOOD POSITION

with **UNCLE SAM** is most desirable. Life positions, pleasant surroundings, good pay, steady work, short hours, promotions on merit. Both sexes. No political pull. Thousands of appointments yearly. Most thorough preparation \$5. Returned if not appointed. Full information and questions used by the Civil Service Commission free.

AMERICAN CIVIL SERVICE SCHOOL WASHINGTON, D. C.

MUSIC TAUGHT FREE AT YOUR HOME

Write Today for our booklet. It tells how to learn to play Piano, Organ, Violin, Mandolin, etc. Beginners or advanced pupils.

AMERICAN SCHOOL OF MUSIC, 50 Lakeside Bldg., Chicago, Ill.

DO NOT STAMMER

My book, "How to Stop Stammering"—a treatise on "Scientific Talking and Psychic Training." School and circular literature FREE. **M. L. HATFIELD, Prin. of The Pacific School for Stammerers, 1918 Grove St., OAKLAND, CAL.**

Learn Watchmaking At Home

You can learn by our modern and original system of instruction every part of the Watchmaker's Trade at home as good or better than at a shop. You can earn money while learning and secure a well paying position or start in business after completing our course of instruction. Good watchmakers are always in demand and earn from \$20 to \$35 per week. For particulars apply to the Wisconsin School of Watchmaking, 518th Bldg., Milwaukee, Wis.

SENT FREE



LAW

COURSE SENT FREE ON APPROVAL

Not one penny down. Get this greatest home-study course in law—consisting of a magnificent fourteen-volume law library, the most complete library of its kind in existence, and the first individual lessons; clear, comprehensive discussions of the law—in your hands positively free of charge, without any obligation whatever. We want you to see this course, examine it critically, put it to every test, compare it with other courses, before you even decide. Mail the coupon now—right now—to get the details of this startling offer—to find how you can, without risking a penny, get started right on your legal education.

Get Your Degree by Mail

No other school even dares to make an offer of this nature. They don't dare send out their courses in open competition with the LaSalle Extension University Course in Law.

We are authorized by the State of Illinois to confer on our graduates the degree of Bachelor of Laws (LL. B.). Our course prepares you to pass the bar examinations in any state. Should you fail to pass we guarantee to coach you without charge until you are successful.

In a recent Bar Examination at Lansing, Michigan, only six out of fourteen applicants for admission were successful and two of those who passed were LaSalle Students. Not one of the LaSalle students who entered the examination failed. Among the eight rejected, four were graduates of leading resident University Law Schools. These are some of the reasons why it pays us to send out our course on approval, without obligation. Satisfy yourself absolutely that this is the very best home-study law course offered by any school in the country before obligating yourself, before spending a penny.

Free Complete Course in Public Speaking prepared by Dr. Frederick B. Robinson, Professor of Public Speaking, College of City of N. Y., etc. No other course like it—Write Today for Special Limited Free Offer.

Mail Coupon—Offer Limited

Send no money. Just your name and address on the coupon below, and we will forward by return mail full particulars of our remarkable free on approval offer and our wonderful free book "Guide to the Law" showing how to study law at home. This is the first time in history that a University Home-Study Law Course has been offered on approval; our course is the only one that will stand this acid test. Moreover, if you act promptly we will save you more than half your tuition. We are doing it for advertising purposes only and the offer is subject to withdrawal in a short time, without notice. So act now. Get all the facts in your hands—NOW. Simply sign and mail the coupon.

LaSALLE EXTENSION UNIVERSITY, Dept. G781, Chicago, Ill.

Coupon Brings Details—Tear Off and Mail

LaSALLE EXTENSION UNIVERSITY, Dept. G781, Chicago, Ill.

Please send me full particulars of your free on approval, without obligation offer, showing also how I can secure Public Speaking Course free, and a copy of your free book "Guide to the Law."

Name _____

Address _____

Please Mention Popular Mechanics

Ridpath's History of the World At a Bargain



Weights
50
lbs.

2000 Pages
4000 Pictures

Free
We will mail
free a beautiful
46-page book-
let of 4 sample
pages from
Ridpath's his-
tory to all who
mail coupon.

We will name our special low price and easy terms only in direct letters to those mailing us the Coupon below. Tear off Coupon, write name and address plainly, and mail now before you forget it. The 46 Free Sample Pages will give you some idea of the splendid illustrations and wonderfully beautiful style in which the work is written. Thousands have already availed themselves of our offer and every purchaser is more than satisfied. Mail coupon now.

FREE COUPON

WESTERN NEWSPAPER ASSOCIATION 10-15
140 So. Dearborn St., Chicago, Ill.

Please mail your 46-page free sample booklet of Ridpath's History of the World, containing photogravures of Napoleon, Queen Elizabeth, Scrooges, Caesar and other great characters in history, and write me full particulars of your special offer to Popular Mechanics readers.

NAME.....

ADDRESS.....

"HELP WANTED"

-Uncle Sam.

**Railway Mail Clerks
Postoffice Clerks
City Mail Carriers
Clerks in Customs and Internal
Revenue Services**

Thousands of Appointments Coming

**\$800.00 to \$1800.00 a Year
for LIFE**

No "layoffs" without pay, because of strikes, wars, financial flarries or the whims of some petty boss. Excellent opportunities for quick advancement to Higher Government Positions. If you want immediate appointment, send TODAY for our schedule showing locations and dates of all Fall examinations. Any delay means the loss of just so much time in preparing yourself for examination.

SEND
COUPON
BELOW

FRANKLIN INSTITUTE
Dept. D104, ROCHESTER, N. Y.

This coupon, filled out as directed, entitles the sender to free sample questions; a free copy of our book, "Government Positions and How to Obtain Them," free list of positions now obtainable; and to consideration for Free Coaching for the examination here checked.

COUPON

..... Railway Mail Clerk (\$900 to \$1800) Customs Positions (\$800 to \$1500)
..... Postoffice Clerk (\$800 to \$1200) Internal Revenue (\$100 to \$1800)
..... Postoffice Carrier (\$800 to \$1200) Stenographer (\$800 to \$1500)
..... Rural Mail Carrier (\$500 to \$1200) Clerk in the Depart- ments at Washington (\$800 to \$1500)
..... Bookkeeper (\$900 to \$1800) Canadian Government Positions

Name.....

Address..... D104
Use this before you lose it. Write plainly.

Please Mention Popular Mechanics

SHORTHAND IN 30 DAYS

We absolutely guarantee to teach shorthand complete in only thirty days. You can learn in spare time in your own home, no matter where you live. No need to spend months as with old systems. Boyd's Syllable System is easy to learn—easy to write—easy to read. Simple. Practical. Speedy. Sure. No ruled lines—no positions—no shading as in other systems. No long lists of word signs to confuse. Only nine characters to learn and you have the entire English language at your absolute command. The best system for stenographers, private secretaries, newspaper reporters and railroad men. Lawyers, ministers, teachers, physicians, literary folk and business men and women may now learn shorthand for their own use. Does not take continual daily practice as with other systems. Our graduates hold high grade positions everywhere. Send today for booklets, testimonials, etc.

Chicago Correspondence Schools
969 Unity Bldg., CHICAGO, ILL.

LEARN THE JEWELRY TRADE

Splendid opportunities in the jewelry business. Good money, pleasant work. Learn this trade in the shortest, most direct, easiest way by the Drexler Extension System Correspondence Course. Practical instruction in simple, easily understood form makes you proficient and opens the way to a money-making business. Write today for free booklet which shows you how and why

The Drexler School, Sentinel Building, Milwaukee, Wis.

FEAR STAMMERERS!

Consult Foote, the trained expert Psychologist. If you have tried many other methods and failed know that you cannot fail if you place yourself in my hands—either for personal treatment or by correspondence. I have studied psychology in the greatest Universities in the World. It is now recognized that the trained Psychologist is the only one who can successfully treat stammering. Mine is the only scientific method of treatment which will permanently eradicate your "FEAR." Write for booklet, "The Cure of Stammering."

Prof. F. B. Foote, Michigan Boulevard Building, Chicago, Illinois

LEARN RAG TIME

Let me teach you Rag-Time Piano Playing by Mail. You learn easily—in just a few lessons, at home. My system is so simple you'll play a real ragtime piece at your 5th lesson. Whether you can play now, or not, I'll teach you to play anything in happy ragtime. "Money Back Guarantee." Write at once for special low terms and testimonials.

AXEL CHRISTENSEN, "Czar of Ragtime,"
Room 15, 526 So. Western Ave., Chicago, Ill.

DRAWING

Learn by mail in your own home. Cartooning, Newspaper, Magazine and Commercial Illustrating, also Water-Color and Oil Painting

Learn Drawing or Painting for profit and pleasure. We can develop your talent. This school has taught thousands. Free Scholarship Award—special limited offer. Your name and address brings you full explanation and our handsome illustrated Art Annual by return mail. Don't delay. Write today.

FINE ARTS INSTITUTE, Studio 217, Omaha, Neb.

Chicago Correspondence School of Law

Prepares Students at Home for the Bar. Four Courses of Study: College, Post-Graduate, Business Law and Bar Examination Review. Actual Daily Lessons by a recognized School that is approved by Bench and Bar.

Write today for FREE Catalog and Rules for Admission to the Bar.

520 Reaper Block, Chicago



LEARNED BY ALMOST ANYONE AT HOME SMALL COST

Send today 2c stamp for particulars and proof.
O. A. SMITH, Room D 129, 823 Bigelow St., PEORIA, ILL.

Wonderful

Elgin, Waltham or
Rockford Watch

BARGAINS

**No
Money
Down**

**Your
Credit
Good**

Why pay a fancy price for these world's standard watches when you can buy them of Hartman at sensational bargain prices on the most liberal credit terms ever made. Either ladies or gentlemen's, any design, size or number of jewels you want.

Each Watch Sold Guaranteed for Life

These watches have been long recognized as the world's leaders and they are so absolutely perfect in every respect that we do not hesitate to guarantee them—for life.

Repairs Free for All Time

Here is the crowning climax of our remarkable watch offer. We guarantee to make repairs on the watch you buy of us, free of charge for all time.

Sent on Approval

We send any watch shown on this page or in our big watch catalog on approval, all charges prepaid, without one penny in advance. Carry it for 30 days. If you are not then satisfied that it is the watch you've long wanted, return it to us at our expense. The trial costs you nothing. Only the mammoth house of Hartman with its enormous purchasing power of more than ten million dollars, can afford to sell these famous watches at these rock-bottom wholesale prices and on such liberal credit terms—as low as

50c Per Month

When you have decided to keep the watch you select, if you want to pay cash, you may, but it costs you nothing extra to take advantage of our easy credit terms. No references asked, no embarrassing questions, no mortgage, no security, no interest, no collectors.

FREE Hartman's Beautiful Watch Bargain Catalog

Handsome, full size illustrations in rich colors. Shows newest 10, 20, 25-year and permanent guaranteed cases, also solid gold cases with Inlay Enamel Monograms, Block and Ribbon Monograms, Lodge Emblems, Diamond Set and French Art Designs, open face or hunting cases, ladies' and gentlemen's sizes.

Ask for Jewelry Catalog No. 401-J.

HARTMAN'S

Jewelry Dept.
123-25 W. 39th St.,
Chicago, Ill.

Mail This Coupon

HARTMAN'S Jewelry Dept.

123-25 W. 39th St., Chicago, Ill.

Without obligating me to purchase, please send your Jewelry Catalog No. 401-J.

Name.....

Street and No.....

Town..... State.....

Please Mention Popular Mechanics

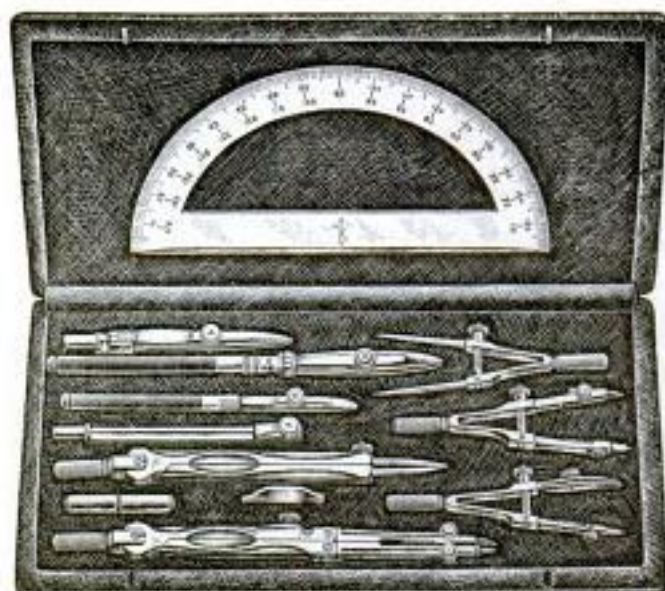

Because

I want ambitious men to become high salaried Draftsmen through my practical working training—therefore:

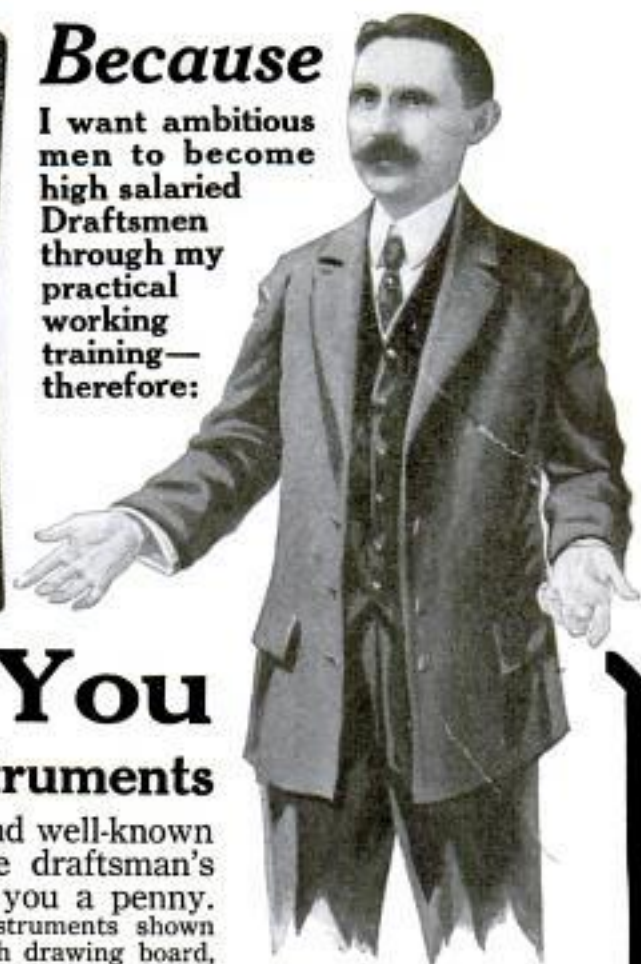

I Will Give You This Set of Drawing Instruments

The Chief Draftsman of a large and well-known company will give you this complete draftsman's outfit absolutely free. It does not cost you a penny. Besides these Imported regular draftsman's instruments shown here, I also give you absolutely free a 20x25 inch drawing board, a 24 inch T square, a draftsman's triangular rule, supply of drawing paper, 2 triangles and French curve, pencils and eraser, drawing thumb tacks, etc., in fact a complete and first class regular Draftsman's Working Outfit as soon as you enroll. This is just the same kind of an outfit I use myself. Genuine working instruments. You could not get this outfit for less than \$15. But now on this special offer, I will give it to you absolutely free.

And Train You For a \$200 Position

I am Chief Draftsman of an old and well known company. There is a constant demand for trained draftsmen all over the country and I will give you just the kind of training that will qualify you to hold one of these big paying positions. \$125 to \$200 a month straight salary is an ordinary pay for a good draftsman. I will give you just the kind of training that you need to hold one of these fine jobs, right in your own home during your spare time. Start earning money as soon as you are my personal student. I know the kind of training that you must have in order to get the highest salary—and that is just exactly the kind of training that I will give to you.

SPECIAL!

For a limited time I am making a special price offer in order to complete a new class ready to start. Send for free book at once, today.

During the last twenty years I have trained some of the highest paid men. Their success in the profession is well known. You can do as well—or better than they.

Send Me the Coupon For FREE New Book

Chief Draftsman Dobe

Engineer's Equipment Co.
Division 1197, CHICAGO, ILL.

Without any obligation to me whatsoever, please mail your book "Successful Draftsmanship," and full particulars of your liberal "Personal Instruction" offer to a few students. It is understood that I am obligated in no way whatever.



Put your name and address in the coupon or on a letter or postcard now and send to me at once for my new book "Successful Draftsmanship." Find out about the golden opportunities that await you in our profession. Find out how you can get just exactly the kind of training that you need to hold a position paying from \$125 to \$200 a month at once. Absolutely no obligations in getting the book. Just put your name and address on the coupon. But send it now—immediately while I am making this special offer.

CHIEF DRAFTSMAN DOBE
Div. 1197, Engineer's Equipment Co., Chicago

Name.....

Address.....

CLASSIFIED ADVERTISEMENTS

Advertisements in this section, 15 cents per word, each insertion, minimum 10 words, payable in advance. To insure ads being inserted under proper classified head in the November issue, copy must reach this office not later than October 1st.

AUTOMOBILES

CYLINDER Regrinding — First-class equipment, fifteen years' experience, and specializing in this work enables us to do high-grade work at lowest prices. We manufacture the "Neverleak" individual cast piston rings. Prices will interest you. Bridgeport Piston Ring Co., 346 Connecticut Ave., Bridgeport, Conn.

A WRITTEN guarantee for 5,000 miles without puncture. European Motorists are getting 10,000 miles out of their tires by increasing them about one-half inch in size. In eight months 20,000 American Motorists have followed their example. It's so easy that you can do it in your own garage in thirty minutes, no matter what condition your tires are in. Send for free catalog, sample and copy of guarantee. Colorado Tire & Leather Co., 1043 Tread Bldg., Denver, Colo.

1 RBO Runabout \$100. A. E. Pfitzenberger, 23 East Pike St., Covington, Ky.

SHOCK Absorbers: Bought 500 pairs, sell half price. Ford Junior, \$3.75. Pleasure Cars, \$12.50. Live agents wanted everywhere. Schultz, 1230 St. James St., Phila.

PUNCTURES can be avoided by using "Sure-Tite" in your tubes. \$1.25 per wheel. Agents wanted. Exclusive territory. George H. Monroe Co., Jamestown, N. Y.

\$1,500 **HAUPT** 53-horse, cross-country Roadster, Mile minute. Equipped \$550; photo. Schultz, 1230 St. James St., Phila.

AUTO Gasoline 3c a gallon. Sounds wonderful, but it's a fact, and what is better, your motor car will have "pep," "snap," power and speed as never before. Carbon evil eliminated. All these good things and more come when "Gas-Tonic" is added to ordinary Gasoline. Mileage increased 40%. Scientifically right. Quart can treat 200 gallons of gasoline. \$2 prepaid. Results guaranteed. Motorists enthusiastic wherever "Gas-Tonic" is tried. Circular and convincing details free. Great opportunity for live dealers and agents. White Mfg. Co., Dept. 112A, Cincinnati, Ohio.

FLEXIBLE Metal Automobile Tubing. Better than rubber. Inflates tires. Covers wires. As exhaust pipe, silences noise. Improves carburetors. Converts gasoline, oil, steam, etc. Protects speedometer shafting. Catalogue free. Breeze, Newark, N. J.

BOYS: Build a real auto of your own. Complete instructions and large drawings showing how to build this wonderful car, 25c. Ideal Book Shop, 3315M Belleplaine Ave., Chicago.

A NEW Automobile Book Free. Helpful Information for the Care of Automobiles is just off the press. It contains 72 pages of valuable information that every owner, garage, repairman and chauffeur should know. This book covers in simple, plain language every automobile and upkeep problem. It's a big money saver! First and only book of its kind ever compiled. Send us 25c in stamps or coin for a three month trial subscription to the American Chauffeur, the new leading technical automobile journal, and we will send you this book absolutely free. Write today, as the supply is very limited, and this offer is open only for a short time. American Chauffeur, 351 Butler Bldg., Cincinnati, O.

AUTOMOBILE Instruction—\$55.25. Four weeks' course. Best-equipped school in the country. Men enrolled from all parts of the U. S. Booklet P. M. on request. West Side Y. M. C. A., 318 West 57th Street, New York.

FOR Sale—\$9 H. P. White Auto Boiler and Engine, price, \$150.00. Send for photo. Lucas & Son, Bridgeport, Conn.

MAKE money selling "Little Hustler" \$285 auto truck. Stamp brings circular. Willis Auto Works, Canal Dorer, Ohio.

CYLINDER regrinding or reboring. Extra light pistons and perfect rings inserted. Accuracy guaranteed. Crankshaft grinding. Worn or broken parts duplicated. Prompt service. Everts Machine Co., 14 Hicks St., Hartford, Conn.

PAINT Your Car Yourself—Save \$25 to \$75 by doing the work at home with the Arsenal system. Our big free booklet "The Car Beautiful" tells how. Send for it today. Arsenal Varnish Co., Dept. P, Rock Island, Ill.

AUTOMOBILE SUPPLIES

110 VOLT, 60 cycle Single Phase Motors. New 1 HP. Wagner, \$65.00; 1/2 HP. General Electric, \$35; 1/12 HP. Fidelity, \$8; Examining Oven, \$10; New 3 HP. Watkins Marine Motor, \$35; 4 cylinder Cadillac Automobile Motor, \$100; Two Cylinder V Type Air Cooled Motors. Cycle Car 8 HP. Shaft Drive, no timer, \$25; Curtiss 6 HP. Shaft Drive, new, \$50; Curtiss 6 HP. Belt Drive, no timer, \$15; 10 HP. Stanley Steam Engine, \$10; Stanley Wheel Steering Gear, \$10; 22 inch Pratt and Whitney Drill, with counter shaft, \$35; Small Power Punch, \$5. Power Press, weight, 700 lbs., \$53; New Drop Hammer Base, 600 lbs., \$18; Drop Hammer Headweight, 85 lbs., \$5. Patterns for uplights, \$5; Low Tension Magnet, \$3; New Star Latho Chucks and Tools, 11x5, \$200; New Cycle Car, Running Gear with Tires, \$75. 30 Caliber Luger Carbine, \$20. Circular Saw Table, \$3. New Extension Arms for Ford Hand Brake Lever, \$1.50. Above goods sold for cash with the order only. B. F. Grant, Derby, Vt.

INTERSTATE Puncture Proof will stop all punctures and slow leaks immediately. Not a filler, or chemical in action, and cannot injure tire or tube. Costs only \$1.25 per tire—only a little more than one puncture would cost you. Endorsed by thousands of motorists. Send in your order today—we absolutely guarantee to refund your money if you're not satisfied. Interstate Puncture Proof Co., Denver, Colo.

ENGINES, Magneto, Parts, etc.—6-cyl. Acme \$150. 26-Hp. 30-Hp. Atlas \$85. 40-Hp. Overland \$90. 20-Hp. Thomas \$50. 35-Hp. Milwaukee \$75. B. K. Mea \$25. H. Presto \$10. Stronberg & Rayfield carbs \$10 up. Buick 13 parts for sale. Auto Salvage & Parts House, 1436 Wabash Ave., Chicago, Ill.

CONTINENTAL unit powerplant, 25-HP. with control levers, \$150; Timken axles, rear, \$25—front, \$3; steering gear, \$10; Warner transmission, \$25. Bongartz, 2742 Ave. D, Brooklyn, N. Y.

SPECIAL—\$5.00 Stewart Warner Signal Horns, \$2.49. Send for circular. W. E. Wandersee Co., 129 Gratiot Ave., Detroit, Mich.

PLACE your order now and secure the \$5.00 "Automatic Steam Vulcanizer" for \$2 prepaid. Circular on request. Halsey Mfg. Co., 320 Broadway, New York.

FOR Sale: Lower Half Crank Case, 1914 Model, Light Six Loader. Bargain. Address: F. G. Youker, Sistersville, W. Va.

AUTOMOBILE Polish; guaranteed not to stain. Absolutely dust-proof. For Autos, Pianos, Furniture and Metals. Price, 5¢ cents. Williams Co., North Powder, Ore.

AUTOMOBILE Water Pump Packing (soft metallic combination habbit, oil, graphite). Great improvement. Stops seeping, rusting, leakage. Reduces friction. Resists heat. Lasts years. Minute to install. Fits any pump. Give diameter shaft. Size packing. Best known car builder already using it. 75 cents per pump (cash with order), anywhere U. S. H. P. Young, 705 Great Northern Bldg., Chicago, Ill.

FREE Sample showing permanent repair made with Fixit. Fixit repairs tires and tubes without vulcanizing. No tools, hot hands. Costs less than 1/2¢ repair. Complete outfit, postpaid, 50 cents. J. P. Gorman Company, 47 West 42nd Street, New York.

1,000 **AGENTS** Wanted: Exclusive Territory: Repeat Proposition. "Gide"—Fuel for Increasing Efficiency of Gasoline Engines. Registered U. S. Patent Office No. 105,513. One Cent per Gallon, Eliminates Carbon Trouble. Increases Power and Mileage. Easy starting. Absolutely Non-injurious. Highly Indorsed. 100 Tablets One Dollar. Fred M. Giddings Mfr., 63 E. Simmons St., Galesburg, Illinois.

SPECIAL this month only. Guaranteed electric motor-driven auto horns, \$4.50. Complete line vibrator and hand horns. Geo. M. Studebaker, Jr., South Bend, Ind.

ANY magneto, coil, lighting and starting system repaired. Work guaranteed. Estimates cheerfully given. Pellet's Magneto Exchange, 1086 Michigan Avenue, Chicago, Illinois.

SAFETY First Electric Hand Lamp. Built for hard usage. The best the market offers. Price, \$1.50 delivered. Chas. Osterstock, 62 State St., Rochester, N. Y.

RETIFFERS for garages. All sizes. Charge one to eight batteries, \$12 upwards. American Battery Company, 1129 Fulton St., Chicago.

BATTERY charging dynamos earn big profits. Write us. Hobart Bros., Troy, Ohio.

AUTOMOBILE parts, piston rings, axle shafts, front and rear springs and gears for all makes of cars at cut prices. Specializing on parts for Ford and Maxwell Cars. Write for catalogue. Grossman Auto Parts Company, White Plains, N. Y.

PRONTO Spark Gap. Guaranteed to fire any spark-plug, broken porcelain, carboned, etc. Wonderful demonstration that sells. Liberal proposition to real salesmen. Sample set (four) \$3. Pronto Manufacturing Co., Omaha, Neb.

OUR Double-Tread Tires are Guaranteed (written) for 3,500 miles. Two tires in one. Big, strong, extra heavy. 30x3 1/2, \$7.00; 31x4, \$9.25; 30x4 1/2, \$12.00; 37x5, \$13.00. Big saving on other sizes also. Send for list now! State size and type rim. Max Liben & Company, 285B West 48th, New York.

VULCANIZER for shop. Bargain. Vanderpool's, Springfield, Ohio

MOUNT power vacuum cleaner on your auto. Buy parts, assemble. \$50 cost—earns \$15 daily. Vacuum Supply Co., Ann Arbor, Mich.

NEW Grease Gun—A half turn opens or closes entire side. Sufficient heavy grease, all the time, is positively necessary in Transmission and Differentials or a very inconvenient breakdown is possible. Grease them without soiling hands or clothing. Satisfaction guaranteed or money refunded. \$1.25 postpaid. Toomey Grease Gun Co., Edmore, N. D.

FORD ACCESSORIES

200-PAGE Ford Instruction Book, 100 Illustrations, Chart. For Owners, Dealers, Repairmen; \$1.50. Prepaid. Samuels Co., Box 328, Peoria, Ill.

SALESMAN with Ford Car to demonstrate and sell to dealers a new and necessary attachment for Fords. Exclusive or side line. Good commission. A. E. Reinhardt of Ashburn, Ga., selling it as a side line, made \$15 a day from the beginning. Sample attachment furnished. Address Room 926, 78 E. Madison St., Chicago.

BARGAIN—\$5.00 Stewart Warner Signal Horns, \$2.49. Send for circular. W. E. Wandersee Co., 129 Gratiot Ave., Detroit, Mich.

AGENTS and garages to handle accessory. Money-saver. Territory still open. Write at once. Duffy-Beamer Sales Co., 2101 Michigan Ave., Chicago.

DIFFERENTIAL ring gear, \$3.00, and any and all other parts for Ford cars at equally astonishing low prices. Write for bargain sheet. Grossman Auto Parts Company, White Plains, N. Y.

CYCLECAR MATERIAL

BUILD a Cyclecar. DeLuxe 2-cyl. 8 HP. "V" shaped motor, \$45.00; Badger 4-cyl. 2 1/2 x 3 1/2" motor, \$75.00; shaft drive rear axle complete, \$35.00; front axles with hubs complete, \$10.00; five passenger bodies (unupholstered), \$18.00; roadster bath tub bodies (upholstered), \$35.00; "V" shape radiator, brass, \$25.00; steering gears (worm gear type), \$8.00; wire wheels with bearings 28x5" fronts, \$1.50; wire wheels with pulleys, rears, \$2.00. Auto Parts Co., 737-39 W. Jackson Blvd., Chicago, Ill.

CYCLECAR Friction Transmissions. Aluminum disc, tarred fiber wheel. Roller bearings. Guaranteed. Cogswell Manufacturing Co., Hall St., Springfield, Mass.

MOTORCYCLES, BICYCLES & SUPPLIES

FOR Sale—1915 Three-speed Twin Harley-Davidson Electrically equipped with Harley steering. In first-class condition. Equipped with Jones speedometer seat on rear, light for speedometer and clock. Run less than 600 miles. Cost \$410; will sell for \$300 cash. E. K. Howard, Ogdenburg, N. Y.

WILL sell or trade 1915 Excelsior motorcycle. What have you got? J. G. Caskey, Empire, Ohio.

SLIGHTLY used 1913 Twin Excelsior fully equipped, \$110.00. David Stern Co., 1017 W. Madison St., Chicago, Ill.

BIG bargains in good motorcycles we have taken in exchange on new ones. Send for special bargain list. Shaw Mfg. Co., Galesburg, Kansas.

FOR Sale—H. P. Dayton Twin in All shape. Engine thoroughly overhauled, \$125. Indian twin, 1913 model, \$145. In first-class shape. John G. Nuebling, Reading, Pa.

INDIAN Twin \$150, or will exchange for 1913 Ford touring car and pay difference. Herbert Hooper, Higginsville, Mo.

1913 INDIAN Twin, \$100. Excellent condition. Arthur Freimuth, Crandon, Wis.

MUST sell my motorcycle and kodak. Luis, 175 1/2 Fargo, Buffalo, N. Y.

FOR Sale—M. M. Motorcycle, twin, clutch, speedy. \$100. Ray Hills, Blanchard, Iowa.

4-CYLINDER (P. N.) Motorcycle \$50; 6 hp. N. S. U. Motorcycle \$75; 4 hp. Merkel Motorcycle \$50; 4 hp. M. & M. Motorcycle \$50. Stenger, 902 Vine St., Cincinnati, Ohio.

INDIAN Twin, Clutch, Magneto, Cradle spring fork, overhauled, Fine condition, good tires. Bargain \$100, Box 255, Cleveland, Tenn.

MOTORCYCLE Bargains: Yale, \$35; Indian, \$35; Harley-Davidson, \$35; Reading-Standard, \$35; Excelsior Twin, \$45; Indian Twin, \$50; Flying Merkel Twin, \$45; Henderson 4-Cylinder, \$110. Write for free Big Bargain Sheet of over one hundred slightly used machines. W. E. Wandersee Co., 129 Gratiot Ave., Detroit, Mich. Largest motorcycle dealers in United States.

GENUINE Bargains in New and Used Motorcycles. Boyd P. Blakeman, Creighton, Nebr.

PIERCE 4, \$125, Pierce Single, \$75; both two-speeds; sidcar, \$20. H. Allen, Box 363, Winona, Minn.

TWIN 9-Hp. DeLuxe, magneto, tandem, speedy; a bargain, \$125. W. R. Jackson, 609 1/2 E. Washington, Springfield, Ill.

GASOLINE Railroad Speeder cheap. W. G. Abbott, Jeffersonville, Ind.

BARGAINS in motorcycle accessories. Spark Plugs, 15c; Grips, 25c pair; Leather Leggings, 95c pair; Goodyear Inner Tubes, 95c; Castings, \$4.95; Electric Horns, 95c; Saddles, \$2.45; Speedometers, \$7.85. Send for free Bargain Sheet. W. E. Wandersee Co., 129 Gratiot Ave., Detroit, Mich.

4 H. P. INDIAN Engine, carburetor and magneto, \$20. George French, Melrose Hds., Mass.

FOR Sale, Cheap—1914 Merkel motorcycle, twin cylinder, chain drive, \$85. Howard Cycle Co., Trenton, N. J.

CLOSING-OUT Sale used motorcycles. Lists free. All makes. Guaranteed. L. S. Chidester & Company, Ottumwa, Iowa.

BARGAINS—in motorcycles; guaranteed. 1914 Twin Excelsior \$115; 1913 Twin Excelsior, \$110; 1913 Excelsior, Three Speed, \$220. Sauffer Supply Company, Kansas City, Mo.

BARGAIN—Four-cylinder Henderson, 1914 model, perfect condition, Theodore Tong, Sherman, Texas.

1914 TWIN, Two-Speed Yale, fully equipped. Run 2,000 miles, \$135. 730 Main St., Davenport, Ia.

EXCHANGE Indian twin motorcycle and side car for Lathic H. W. Shank, 212 Fayette St., Cumberland, Md.

MOTORCYCLES, \$10-\$350. Typewriters, \$4-\$40. All makes. Payments, Knights, 3228 Locust, St. Louis, Mo.

WRITE for our money-making agency proposition on slightly used motorcycles. W. E. Wandersee Co., 129 Gratiot Ave., Detroit, Mich. Largest motorcycle dealers in United States.

AGENTS wanted for our line of second-hand motorcycles. Ask for list M80. Sterling Motor Co., Brockton, Mass.

\$50 TO \$150 buys the best motorcycles; every make and model in our large stock must be cleared. Half price. Send for list today. Brown Music Co., 9119 Commercial Ave., Chicago, Ill.

EASY terms on 1916 Eagle motorcycles. Get our proposition. M. Eagle Motorcycle Company, Brockton, Mass.

USED Motorcycles \$25 up. Yale Twin, \$50; Indian Twin, \$65; Harley Twin, \$95; Pierce Four, \$100. Best values in the country; get our list. Seiber & Hofhelus, Buffalo, N. Y.

DON'T buy a Bicycle Motor Attachment until you get our catalogue and prices. Shaw Mfg. Co., Dept. 27, Galesburg, Kansas.

WANT to sell your motorcycle? I have a method which has sold many. Write me today for free information. F. W. Johnson, Room 908, 73 E. Madison St., Chicago.

SEND for latest Bulletin of real Motorcycle Bargains, used and slightly used, all makes, models and prices; if you have \$25 and really want a powerful Motorcycle, send for this Bulletin; hundreds of machines at all prices, new ones on easy payments; tell us what you want and how much you can pay; we can fix you up. Peerless Motorcycle Co., Dorchester, Mass.

MOTORCYCLE cylinder reground, refitted with new piston, \$5. Irvin Depoy, Muncie, Ind.

BIG bargains in second-hand motorcycles, \$25 up. Indians, Harleys, Thors, Excelsiors and Merzels. Write for descriptions. Howard A. French & Co., Baltimore, Md.

SUPPLIES—Our big catalogue with prices lower than usual sent free to motorcycle owners. Mecca, Hammondsport, N. Y.

AERONAUTICS

MODEL Aeroplane (steel). Flies over 200 feet. Operated by cord, \$1 prepaid. Satisfaction guaranteed. Benjamin-Sellar Mfg. Co., 558 W. Quincy St., Chicago.

FOR Sale—Bleriot Monoplane, Curtiss Biplane, Cheap. W. Banning, Lorain, O.

MAN Carrying Aeroplane-kites. Give exhibition flights. Make \$200 a day. No skill needed. Price \$95. Write. Frank Orndorff, Mattoon, Ill.

BARGAIN 35-hp. Aeroplane Motor. Splendid condition. Write quick. Charles Kousch, Palestine, Ill.

CATALOG "H" off the press, most complete aeronautical catalog ever published, sent for 6 red stamps. Motor Catalog, 8c; propeller catalog, 6c. Heath Aerial Vehicle Co., Chicago.

FOR Sale—New One-Step Hydroplane Hull, 16 feet by 5 feet, with nickel-plated bronze fittings, \$100 f. o. b. Laconia. Address, Box 235, Laconia, N. H.

STANDARD Curtiss-Type Biplane, with 8-cyl. motor, complete with crates, \$275. Other bargains. Send for list. V. G. Gustafson, Joliet, Ill.

GAS Turbines, horsepower to the pound. Hundred horsepower turbines, \$525. Absolutely reliable, three years guaranteed. E. R. Holmes, 2214 Dime Bank Bldg., Detroit.

TURNBUCKLES: National Aero Varnish. National Aeroplane Company, Machinery Hall, Chicago.

FOR Sale—Two used aeroplane motors. 40 and 60 H. P. Prices right. Lock Box 473, Harlan, Iowa.

COMPLETE Plan, drawn to scale, with precise instructions for building 3-foot Model War Aeroplanes at the following prices: Bleriot, 15c; Nieuport, 25c; Taube, 25c; Curtiss Flying Boat, 25c; Curtiss Military Tractor, 25c; Wright, 25c; "Peoli," 25c; 48-hp. Model Supply Catalog, 5c. Ideal Aeroplane Co., 82 1/2 West Broadway, N. Y.

AVIATION Motors, all makes, up to 150 H. P., \$250 up. Complete aeroplanes, all types, \$500 up. State your needs. Aero Exchange, 38 Park Row, N. Y. C.

MODEL Aeroplanes—1c brings greatest handbook and catalog. Cheapest supplies. Walter Philips, 503 5th Ave., New York.

LIGHT Weight, Gasoline Engines, 2 1/2 hp. Guaranteed 1/2 H. P. The Weiss Co., Torrington, Conn.

BOOKS AND PERIODICALS

THE Addippler is a book of tables for calculating. Beats any machine. Costs \$5. An instruction chart, sold at cost, teaches the system. Costs 10c, stamps accepted. Chart is returnable for 10c. It is reasonably safe to fold this page over 10c and mail. Addippler Company, 116M Alpine Street, San Francisco.

COMPARATIVE Cancellation—Solves all Arithmetical and Geometrical Calculations with ease, accuracy and large saving of figures. 150 pages. Cloth bound. \$1 postpaid. Money back if dissatisfied. Herriek & Horton, Publishers, Princeton, Ill.

BOYS—10c brings large 9x12 boys' magazine one year. Canada 25c. Dandy stories, mechanics, stamps, electric. Youths' Magazine, 2653 Ogden Ave., Chicago.

AUTOMOBILE Troubles and how to remedy them. Cloth, \$1; leather, \$1.50. Many other practical and reliable mechanical books. Send for circular. Chas. C. Thompson Co., Dept. C, 591-599 Plymouth Ct., Chicago.

MY Book Cement contains directions for building beautiful homes, and for manufacturing many valuable articles from reinforced stone and woodfiber concrete. Price fifty cents postpaid. Peter De Lunde, Zion City, Ill.

BOOKS worth while: instructive and entertaining. Puzzles, Tricks, Novelties. Illustrated catalogue, 4c. Auburn Supply Co., Book Dept., 7817 Peoria St., Chicago.

AN Old-Time Blue-Back Spelling Book, with List of Old Books. Prepaid for 25 cents. Amos Poe, Books, No. 177, Evansville, Indiana.

CHAUFFEUR'S Blue Book of Practical Questions and Answers, 50c postpaid. W. E. Moody, Box 473, Rochester, N. Y.

All, 15c to 35c magazines 6c to 10c each. Bargain list mailed free. Economy Magazine Exchange, 315 Monon Building, Chicago.

LEARN Harmonica (mouth-organ). Complete self-instructor, 15c. G. Elsen, Owosso, Mich.

USED Books. All kinds. Bargains. Catalogue. Higene's, A-2441 Post, San Francisco.

FIFTEEN books on Tractor Engineering and Tractor Farming written by experts and published by the largest company of exclusive tractor builders in the world. Sent on 3 days free approval. No money to pay until you see the books and decide that you want them. This is a complete correspondence school course. Price for the set \$3.50 or 25c for each book. Master those books and you can run a tractor. Jobs are waiting everywhere for expert tractor engineers. Send name and address. Hart-Parr Co., Box M, Charles City, Iowa.

SEND ten cents for the liveliest outdoor magazine published. Hunter-Trader-Trapper, Box 29, Columbus, Ohio.

FOR Sale—Technical Books, shop-worn and slightly used. Send for list and prices to Box 235, Laconia, N. H.

AIRCRAFT, America's aeronautical authority. Illustrated, monthly. Two dollars per year. Send for sample. 37 East 28th St., New York.

BEST books 2c. Stamp brings catalogue. Duff, 2713 Mozart, Chicago.

EFFICIENCY and Success books. 25c Sample, 12c. Circulars free. Daniel Nestor, P.O.M., Jamaica, New York.

BOOKS—All kinds. Illustrated catalogue for stamp. Ideal Book Shop, 3315 Belleplaine Ave., Chicago.

SMALLEST Bible—Size postage stamp, 15c. Busy Print Shop, Asherville, N. C.

ENGINEERS' questions and answers for license, by Hobson, for twenty-five cents, postpaid. Send stamps. Kelly's Book Store, Philadelphia, Pa.

EDUCATIONAL AND INSTRUCTION

BRIEFHAND enables you to write as fast as the average stenographer, using longhand letters. Easy to learn, write, read. Simple, speedy, sure, clear, concise. Many testimonials. Complete self-teaching Manual containing 3,009 illustrations and many short-cuts, \$1.00. No other expense. Home study. Sample lesson free. Premier Briefhand School, Dept. 14, Washington, D. C.

LEARN to use a Gilson Slide Rule and solve any mathematical calculation with rapidity and accuracy. Price with complete instructions, 50c. Gilson Slide Rule Company, Niles, Michigan.

MECHANICAL Expert Teaching Drafting, modern machine work and die making. Lessons 53 cents, 12 lessons \$3. Bona Co., 267 E. 77 St., Cleveland, Ohio.

PERSONAL efficiency. Success helps for everybody. Literature free. Science Institute, Englewood, Chicago.

ARCASCOPE triangle does multiplication, division, trigonometry, geometry, mechanical drawing, plotting. Fifty cents. Agents wanted. Leishman Arcascope Company, Ogden, Utah.

POOR handwriting easily and quickly changed to good. Particulars free. Address D. B. Jones, Florence Station, Ky.

DETROIT Technical Institute offers courses university grade in Automobile, Chemical, Electrical, and Mechanical Engineering, Law, Accountancy, Business Administration, Pharmacy, Salesmanship, Advertising, Real Estate, Credits, and Watchmaking. Bulletin free. Address Director of Education, Room 311, Y. M. C. A., Detroit, Mich.

ARTIFICIAL Marble, Sanitary flooring, ornamental casting, concrete, plaster, papier-mache, interior decorations, garden furniture, statuary, life casting, elastic moulds, electro bronze depositing (immensely profitable work), complete instructions \$1; particulars, 260 illustrations free. Mahler, D-117 Russell St., Brooklyn, N. Y.

IRREGULAR handwriting changed to a rapid business style by mail. Journal free. P. B. Courtney, Box A 492, Detroit, Mich.

DYE Material (dry), for coloration of woods, artificial marble, cement, fabrics, inks, etc. Statuary, artificial marble outfits (following Mahler's instructions), moulds, models. Stamp for illustrated particulars. Roth, A-45 Frost St., Brooklyn, N. Y.

POSITIONS Guaranteed—Typewriters Furnished. Civil service, normal, academic, business, agricultural, English, drawing, engineering salesmanship, real estate and law courses by correspondence; tuition payable monthly. College Bulletin free. Address Carnegie College, Rogers, Ohio.

EIGHTEEN Ways to Make Money! Interesting, isn't it? If you are mechanically or electrically inclined don't fail to write for our free book, Efficiency Company, 164-A, East 16th St., New York.

TELEGRAPHY

TELEGRAPHY—Morse and Wireless—taught at home in half usual time. The Omnigraph Automatic Transmitter combined with sander or buzzer sends you messages, any speed, just as expert operator would. Used by U. S. Gov't to examine all applicants for licenses. Trifling cost. Catalog free. Omnigraph Mfg. Co., 41-G Cortlandt St., New York.

TELEGRAPHY—Morse and Wireless—also Station Agency taught. R. R. and Western Union wires and complete Marconi Wireless Station in school. Graduates assisted. Marconi Co. employs our wireless graduates. Low living expense—easily earned. Largest school—established 40 years. Investment \$25,000. Correspondence courses also. Catalog Free. Dodge's Institute, 15th St., Valparaiso, Ind.

TRADE SCHOOLS

ELECTRICITY, Plumbing, Bricklaying, Mechanical and Architectural Drafting taught by practical instruction. This is largest and best equipped practical school in America. Short time required and small expense. Positions secured. Earn expenses while learning. Write for big illustrated book. It's free. Come Trade School, Dept. 8197, Chicago.

LEARN Sign Painting and Card Writing. The only Practical School in Country. Sign Card School, Dept. A, 5th Ave., Chicago.

PAINTING, Decorating, Paper Hanging taught by actual practice. Free catalogue. Chicago School of Painting, 150 West Austin Ave., Chicago.

WIRELESS

WIRELESS telegraphy taught by mail. High-grade instruction. Complete. Catalog explains. New York Wireless School, 342 West 54th St., New York.

WE teach Wireless by Mail. Catalog tells how. National Radio School, 1401 You St., Washington, D. C.

PICTURES, POSTCARDS, PENNANTS

OUR Members Everywhere would like to exchange view postcards with you. Membership 10c (coin). Buckeye Club, Box 340-X, Cleveland, Ohio.

JOIN our postcard exchange. Results guaranteed. Membership, 15c. Popular Exchange, Windsor, N. C.

"FOUR" comic postals. Best ever. 3 samples, dime; 12 for quarter. All different. Burkhardt Co., Milbank, S. D.

FOUR real photographs of the Eastland for ten cents in coin. Lafbury Co., 305 North Fifth Ave., Chicago.

WE have the best line of pictures, books and novelties on the market. Send dime for good full-sized samples and illustrated catalogue. Williams Publishing Co., 721-C North Dearborn, Chicago.

FOURTEEN assorted college pennants, 50c; six classy. Fifteen assorted postcards, 15c. Sykes Specialties, Los Angeles.

PICTURES and Books. Samples and catalogue, 10c. Kay I. Co., Box 67, Ottawa, Ill.

CLEVER Mottos—Send 10c for sample set and no-talking selling plan. Paul Kuesthardt, Port Clinton, Ohio.

209 ILLUSTRATIONS Free. Beautiful art casts. Mahler, K-147 Russell St., Brooklyn, N. Y.

IF you really want to exchange postcards, try our splendid club. Lists circulate in many countries. Membership, 10c. Halcyon Club, Box 133, Erie, Pa.

MEMBERSHIP printed immediately, 10c. Pacific Card Exchange, Bryn Mawr, Wash.

CAMERAS AND PHOTO SUPPLIES

If you have a High-grade Camera, Lens or Kodak, and want to turn it into cash, write us today. State particulars, price, etc. We buy and trade, sell or exchange everything in Cameras from Vest Pocket to Graflex. Prompt, satisfactory service and a square deal to all. David Stern Co., 1047 W. Madison St., Chicago, Ill. In business since 1885.

REAL help for every Photographer. "Practical Photography" series of handbooks of everyday problems—clear, concise, comprehensive. Now ready: "The Secret of Exposure"; "Beginners' Troubles"; "How to Choose and Use a Lens"; "How to Make Prints in Color." Clothbound 50c each, paper 25c—at photo-supply dealers or Practical Photography, 430 Pope Bldg., Boston.

UNUSUAL trial offer for 10c. Send one roll of film, any size, 6 or 12 exposure (or film pack); we will develop film or pack and make a total of 6 pictures from the best negatives for 10c (slams). Beautiful 10-inch mounted enlargements 25c. Price list and sample print free upon request. Roanoke Cycle Company, Roanoke, Va.

4x5 PREMIO Camera and large outfit \$12.00. Model Works, Sallenville, Ohio.

ENLARGEMENTS, 15c, four times size your negative. Main Photo Co., Gross Hall Sta., Boston.

COLOR enlargements, 8x10 mounted, postpaid \$1.40. Send negatives. Photo Enlargers, Tomriver, N. J.

FOR Sale—Auto Graflex 4x5, Cooke Lens, f4.3, 4 plateholders, adapter. Perfect condition. Lists \$127. Bargain, Earl French, Sarnia, Canada.

ANY film developed, 5c. Prints, 3 1/2 x 5 1/2 and smaller, 2c. 24-hour service. National Photo Finishing Co., Dept. M, Omaha, Nebr.

HAVE you a Camera? Write for samples of my magazines, American Photography and Popular Photography, which tell you how to make better pictures and earn money. P. R. Fraprie, 130 Pope Bldg., Boston.

INSTRUCTIONS and formulas for Phosphorescent Photos, Disappearing Photos, Photos on Apples, Cloth, Chinaware, etc. Simple Enlarger, Trick Pictures, 25 in all, for 25c. Disappearing Photo Free with each order. Money-Back Basis. P. Benson, Stewartville, Minn.

SPOT cash for second-hand high-grade Motion Picture Cameras, Lenses, etc. Write today. David Stern Co., 1047 W. Madison St., Chicago, Ill.

SLIGHTLY used cameras at half prices. Geo. Olive, Willmar, Minn.

WONDERFUL Camera Bargains, \$22.50 Kodak \$15; \$22.50 Autographic Vest Pocket Kodak \$15; \$30 Premo \$11; \$25 Graphic \$12; \$101 Graflex \$63; \$137 Goetz Anastigmat \$65; \$13.50 Icarette \$10. Get list. Newark Photo Supply Co., 111 Washington Street, Newark, N. J.

FILMS developed, 10c; prints, 2c to 5c. A reputable Incorporated Company conducting largest existing plant. Price list and special offer. Enlargements our specialty. Chicago Photo Finishing Co., 34 W. Lake St., Dept. A, Chicago.

PHOTOGRAPHIC Retouching Taught; cheap course; learn at home. Y. & M. Retouching Co., Dept. M, Marshall, Mich.

AMATEURS, be in the flashlight yourself. Adams, 11 W. 33rd, Minneapolis, Minn.

TRIAL offer: Roll film developed, 5c. Prints from same, 2c. 8x10 enlargements, 25c. Sprauer, Hamilton, Ohio.

FOUR real photographs of the Eastland—valuable exposure meters for Graflex and other cameras—descriptive of the best Anstigmat Lens on earth, and the finest round-cornered roll-film camera made in America, all for ten cents in coin. Lafbury Co., 335 North Fifth Ave., Chicago.

KODAK Films Developed, 10c per roll, any size. Prompt attention given mail orders. Prints, 2 1/2 x 3 1/2, 3c. 4x5 to 3 1/2 x 5 1/2, 4c. J. M. Manning, Box B, 1062 Third Ave., New York City.

SECOND-HAND Lenses. All makes and sizes. Work just as well as new ones. Send for our bargain list. Hyatt's Photo Supply House, St. Louis, Mo.

HIGH Grade Amateur Finishing. We cater particularly to those who want good work, not cut prices. Send for price list D. L. M. Prince Co., 168 W. 4th St., Cincinnati, Ohio.

SAMPLE offer: one film roll (only) developed 5c; prints from same 2c each; to show high quality work. Moser & Son, 420 Arcade, Cincinnati, O.

WE buy, sell and exchange. Bargains in Microscopes, Telescopes, Binoculars, Cameras, etc. Bargain list sent. Kahn & Son, Opticians, No. 54 John St., New York. Established 62 years.

FILMS developed 5c, prints 3c, all sizes. Johnson's Studio, Oswego, N. Y.

BIG Money Saved on Photographic Lenses and Apparatus—goods exchanged; repairing done. Ralph J. Golsen, 65 East 46th St., Chicago, Department P.

FILMS developed 10c, all sizes. Prints 2 1/2 x 3 1/2, 3c; 2 1/2 x 4 1/2, 3 1/2 x 5 1/2, 3 1/2 x 4 1/2, 4c; Post Cards, 50c doz. Work guaranteed and returned 24 hours after receiving. Postpaid. Send negatives for samples. Girard's Commercial Photo Shop, Holyoke, Mass.

SAVE 40% on Photo Paper from factory, prepaid. "Instanto" has a sparkling quality no other gaslight paper possesses, quick printing develops easy. Money back guaranteed. Send 25c for 3 dozen postals or 4x6 size, price list and full directions. Photo Products Co., Dept. J, 6109 La Salle St., Chicago.

ROLL Film developed, 10c a roll. Packs 20c each; Prints, Brownies, 2c; 1a, 3x4, 3x3, and Post Cards, 3c each. Work returned next day. Postage paid. Kodak Film Finishing Co., 112 Merchants Station, St. Louis.

MOTION PICTURES

BIG Money Writing Moving-Picture Plays. Constant demand. Correspondence course; literary ability unnecessary. Write for free booklet, "How to Write Moving-Picture Plays." Universal Publishing Co., 200 Fergus Falls, Minnesota.

WRITE Moving-Picture Stories. Producers pay big money for photoplays. Interesting and fascinating. Experience unnecessary. Full particulars free. D. A. White Co., 1618 St. Paul Ave., Milwaukee.

PHOTO-Plays Wanted. Big prices paid. We show you how. Details free. Rex Publishers, Box 175D, Chicago.

WRITE Photoplays—Earn a big income. Our book tells how. Details free. Enterprise Co., PM-3548 Lowe Ave., Chicago.

MOTION Picture Machines Half Price. Bargain lists free. National Employment Company, Duluth, Minn.

MAKE \$50.00 clear nightly. We start you in the moving-picture business on the installment plan. No experience necessary. Write for free catalog. Monarch Film Service, Dept. F, Memphis, Tenn.

DYNAMOS specially for movie theatres. Payments \$5 monthly. Hobart Bros., Troy, Ohio.

BIG money writing Photo-plays; details free to beginners. No correspondence course. Producers League, 239 Wainwright, St. Louis.

MAKE big money writing moving picture plays. Previous experience, literary talent or correspondence course unnecessary. Free details and special offer. E-Z Scenario Co., 211 West 32d St., New York.

WRITE Moving-Picture Plays. Good prices. Devote all or spare time. No correspondence school. Details free. Atlas Publishing Co., 304, Cincinnati.

\$35 PROFIT Nightly—Moving Picture Business—small capital starts you, no experience needed. Teach you—furnish everything. Ralph J. Golsen, 65 E. 46th St., Chicago, Dept. M.

BUSINESS OPPORTUNITIES

A CARE-FREE Future—Be your own boss. Our free book shows how easily you can do what others are doing—have an easy, highly profitable and fascinating business of your own, manufacturing Extracts and Fruit Syrups at home. Big new field, tremendous profit. Capital and experience unnecessary. Thousands of gallons of these products used in every community. Investigate this. Send for free book—tells everything. Do it now. Roberts Product Co., 12 Roberts Bldg., Detroit, Mich.

MAIL-ORDER Dealers. Agents—Fastest selling leader known. Attractive prices in Gross Lots from Large Wholesale stock. Ingenious Selling plan. Unquestioned evidence. White Company, 459 West 26th Street, New York.

MAKE \$50 a month extra, reporting sales information. Dignified, fascinating, spare-time work. Send stamp for particulars. National Enterprise Association, 57 Revere St., Portland, Maine.

DRY Cleaning, scouring, spotting, pressing fully explained by practical expert. Complete book \$3.50. Star Cleaners and Dryers, Allentown, Pa.

QUALITY Paint 15c gal. Stamp brings particulars. Obetz, Hayesville, Ohio.

TEN Wonderful Sellers for mail dealers and beginners. Imprint circulars furnished. 15-5% profit. District Company, Box 1122, Washington, D. C.

BARGAINS! Bargains! Send for free magazine, 1,200 bargains. Farm lands, business chances; any kind, anywhere. Our services free to buyers. Western Sales Agency, Minneapolis, Minn.

DON'T be a drudge. Be independent. Have a business of your own. Enclose stamp for particulars. Sanitary Paint Co., 1073 East Main Street, Columbus, Ohio.

HUNDRED inventions for sale cheap. Cash or royalty. Gun sight; bottle opener, etc. Inventors' Association, City Hall Square, Washington, D. C.

WE start you in business. Furnish stock free which clears you \$2,000. Enormous profits; travel; independence. Write today. The Thomasi System, Box 793, Chicago, Ill.

OPEN Automobile Business of your own. Capital and experience unnecessary. Full instructions 25c. Automobile Exchange, Rochester, N. Y.

MEN—A business of your own; no canvassing, experience or capital needed. Information free. Address, The A. & S. Repair Shop, 149 Norman Ave., Desk K, Brooklyn, N. Y.

I PUBLISHED a wonderful magazine of money-making plans, ideas, suggestions and inspiration! It will show you how to make more money. Sample, 10c. Editor Booster Magazine, Northwestern Bldg., Chicago.

READ "Good Results"—Greatest Mail-Order Magazine published—two trial issues 10c. Good Results, 156P West Washington, Chicago.

MONEY Making Business Plans. Trade secrets, reliable formulas, beauty secrets, etc. Write Manager "Thrifty", 4212 Adams St., Chicago.

STOP here! Use your own brains in building up a mail-order business exclusively your own. Don't experiment with the old, worn-out schemes of the "outfit" promoter. We are offering something new and different. Ray & Co., Box 76-M, Oakland, Calif.

USE your spare time to build up a mail-order business of your own. We help you start for a share in profits. 27 opportunities. Particulars free. Opportunities Exchange, Buffalo, N. Y.

\$25,000—I MADE it in mail-order business. Had \$3 to start. I'll loan you \$3. Free Booklet tells how. A16, Scott, Cohoes, N. Y.

ARE you ambitious? Use your spare time to establish a paying mail-order business. Experience unnecessary. A remarkable opportunity now offered you; investigate it. Particulars free. Geo. Simpson, Wheeling, W. Va.

BRYAN Plastographed-Plastography instructions with formulas enable you to make life busts of your friends, portraying more delicate lines and shadows than photos or paintings. Very profitable work, easily learned; price \$1. A. Lincoln, Wilson or Victor Emmanuel mold free. School Plaques made to order. P. P. B. Spahr, York, Pa.

SPOT cash for second-hand high-grade cameras, lenses, Kodaks, microscopes, binoculars, etc. David Stern Co., 1017B W. Madison St., Chicago, Ill.

BIG Money in Extracts. Send \$1 for oil and formula which will make 27 ounces Orange Extract. W. N. Durant, Orange Grower, Covina, California.

20,000 FORMULAS, Recipes. 530p. volume, \$1. 3,000 valuable trade secrets, formulas, 368p. volume, 40c. 1,600 selected formulas, 110p. volume, 25c. All three, \$1.50. Satisfaction guaranteed. Ideal Book Shop, 3311-M, Belleplaine Ave., Chicago.

OWN a business. Co-operate with me evenings at home. Everything furnished. Don't worry about capital. Boyd H. Brown, Dept. K-10, Omaha, Neb.

WE will start you in the cleaning and dyeing business, excellent profits, little capital needed. Write for booklet, Ben-Voude System, Dept. C, Charlotte, N. C.

MAIL Order Beginners. Write for interesting literature. R. J. Sharock, 359 Aylesford Ave., Lexington, Ky.

MISTAKES are expensive—We have indispensable information for anyone in or about to start in the Mail Order Business. Be sure to investigate this before taking up any Mail Order Proposition. Premium Sales Co., 4309 E. Lincoln Ave., Chicago.

CANDY making a profitable and pleasing trade. Be your own employer. Our Candy Book tells how, 25c. Auburn Supply Co., Dept. 19, 7817 Peoria St., Chicago.

LEARN Dry Cleaning—Profitable, fascinating profession. Complete instructions, 25 cts. The Wiener Co., Madisonville, Ky.

YOU desire a profitable mail business. Golden opportunity for small capital. W. Mann & Co., 160 S. Warren Ave., Columbus, O.

FREE—50 Circulars advertising Copyright book; sells for 25c; profit 23c; enclose 4c. G. J. Myers, Codorus, Pa.

START Profitable Mail-Order Book Business. Catalogue and further information sent for stamp. Sheridan Company, 417 E. 151st St., New York.

WE start you in business, furnishing everything; men and women, \$20.00 to \$200.00 weekly operating our "New System Specialty Candy Factories" home or small room anywhere; no canvassing. Opportunity lifetime; booklet free. W. Ragsdale Co., East Orange, N. J.

"HIRE Yourself as Boss." Big corporation will back you in Money-Making Mail-Order Business selling Guaranteed Goods. Start spare time. Small capital. No canvassing. Wm. J. Dick, Mgr., Dept. B-10, 20 W. Lake St., Chicago.

OPERATE Mail-Order Book Business. Easiest, best paying line in Mail Order Field; everything furnished; folders, wholesale price lists, free. Rollins, Box 5272, Boston.

TWELVE Years Ago I started a small mail-order business at home in spare time with a few dollars capital. I wanted to make \$30 or \$40 a month, evenings. The net profits the first year averaged \$200 a week. Five years' work netted me \$50,000. I will show you how to start a small mail-order business. Send today for my proposition. It's interesting. No canvassing. Hencock, Box 867, Lockport, N. Y.

OPERATE Hahn's Premium Machine. The best seller for cigars and candy. J. Hahn, 1016 Germantown Ave., Phila.

ADVERTISE—20 words in 100 monthlies, \$1. Cape Agency, St. Louis.

PHOTO—Plays Wanted. Big prices paid. We show you how. Details free. Rex Publishers, Box 175F, Chicago.

I NEED branch managers for my world-wide mail-order business; operate from your own home in spare time; no canvassing or peddling; experience unnecessary; you should make \$50 weekly. Butler, 409 Facilities, Toledo, Ohio.

SILVERING Mirrors; guaranteed process; 150 formulas, 20c. Candy-making course, explains everything, guaranteed—25c. Ideal Book Shop, 3311-J, Belleplaine Ave., Chicago.

WE want new household and office specialties. Must be articles of high merit and new inventions. Honest merchandise only. Will need large quantities of suitable articles. Send description or sample. Hencock, Box 569, Lockport, N. Y.

MEN—If you want to make more money send 50c for plans. Thos. Morrow, Tyrone, Pa.

MIRROR silvering is a paying trade. We have best instructions, 25c. Auburn Supply Co., Dept. 19, 7817 Peoria St., Chicago.

24 BIG Manufacturing Opportunities open to You. Start at home. Spare time. Capital unnecessary. Complete Formulas and Instructions sent for dime. Gem Co., 1014 Breck, Louisville, Ky.

WE start you in the mail order business and show you how to succeed; attractive 64-page catalogue of 300 novelties, with your imprint; exceedingly reasonable; all goods wholesale. Send for my plan and particulars. Cunningham Co., Stamford, Conn.

BE your own manufacturer by sending 25 cents (coin) for 100 good commercial formulas. All good sellers. Conewango Manufacturing Co., Box 1109, Warren, Pa.

MEN—Learn to make my sparkling chipped glass name plates, house numbers, signs, etc.; make \$15 a day; write for my big free 32-page book, 45 fine illustrations, etc.; tells how. E. E. Palmer, Wooster, Ohio.

WANT Big Profits? Learn Tartaric Mirror Silvering. New process opens enormously profitable business. Particulars free. H. Barstow, 514 23rd Street, Oakland, Calif.

HERB Recipe Book and Herb Catalogue, 16c. Teaches how to make medicine from herbs for all diseases. Herb Gardens, Dept. 44, Hammond, Ind.

BUILD a \$5,000 business in two years. Let us start you in the collection business. No capital needed; big field. We teach secrets of collecting money; refer business to you. Write today for Free Pointers and new plan. American Collection Service, 101 State Street, Detroit, Mich.

"DOLLARS" yearly in your back yard. No ginseng, mushroom dope. New ideas never before published, particulars free. Metz, M, 315 East 89th St., New York.

INVENTORS: We develop and perfect inventions, make models, dies, tools. Metal stamping and special manufacturing. Gerding Bros., Lion Bldg., Cincinnati, O.

START in the Carpet or Clothes Cleaning Business Now. Thurman Vacuum Process unequalled for commercial cleaning. We show you how. Easily learned. Only \$125 capital needed to earn good income in towns of 2,000 and over. Write today. Thurman Vacuum Cleaner Co., manufacturers all types Vacuum Cleaners, Dept. H, St. Louis, U. S. A.

SAN-O-TEX, sanitary, fireproof floors for kitchens, pantries, theatres, hospitals, etc. Learn how to mix and spread and have an income of \$150 to \$300 monthly from kitchen floors alone. Instructions \$3. San-o-tex Company, Mechanic Street, Washington, Indiana.

INVENTIONS commercialized on cash and royalty basis. Inventors, manufacturers and agents write: Adam Fisher Mfg. Co., 61 Fisher Bldg., St. Louis, Mo.

MAKE Big Money Opening Safes and Setting Combinations. Wayne Strong, Box 1420, Los Angeles, Cal.

MEN and women for easy business. No interference with present position. Good money. Free information. F. Leonard Eager, Waterbury, Conn.

WOULD you like to own a good-paying Mail-Order Business? We have a line that gets repeat orders all the time. You can start in spare time; invest a dollar or two a week and soon own a nice business of your own. Particulars free. Nadico, 4313 Lincoln Ave., Chicago.

INDEPENDENCE and fortune quickly attained in the Manufacturing Mail Order business. I furnish Formulas, Manufacturing Processes and Trade Secrets in all lines. Sold under positive guarantee; 18 years' practical experience. Revision and improvement of Formulas and Processes—reduction of manufacturing cost—utilization of waste materials, etc., a specialty. Booklet, Formula List, and Valuable Information Free. W. L. Cummings, Ph. D., 127 Standard St., Syracuse, N. Y.

PATENTABLE ideas wanted—Send for 3 free books. R. B. Owen, 20 Owen Bldg., Washington, D. C.

WRITE Moving-Picture Plays. Good prices. Devote all or spare time. No correspondence school. Details free. Atlas Publishing Co., 3946, Cincinnati.

ADVERTISERS, Mail Dealers: Our 1915 Rate Book lists 2,600 Principal Publications, rates, circulation. Includes 30 Mail-Order Plans. Price 10c. Dearborn Advertising Agency, 210 Franklin Bldg., Chicago.

LEARN the Real Estate Business. Our complete instruction book teaches: Listing, Appraising, Management, Salesmanship, Insurance, Brokerage, Advertising, Renting Agency, Forms, etc. 121 subjects. Exceeds \$20.00 correspondence course. Buckeye cover, 75c. Silk cloth \$1.00 postpaid. Realty Book Company, 5982 Euclid Ave., Cleveland, Ohio.

LET the parcels post help you. Add (\$15 to \$25 weekly) to your present salary or income. Start during spare time and build up a permanent mail-order business of your own. We show you how and help you make good. No canvassing. Experience unnecessary. The Parcels Post makes success doubly sure. Our new ideas and up-to-date plans bring the money. No so-called "Course of Instruction" to sell. We give that free. Write today. Address Pease Mfg. Co., Inc., Dept. A, 70 Broadway, Buffalo, N. Y.

HOW to Operate a Mail Order Business. 30 Big Profit Plans and year's Mailing service sent for 10c. Mail Dealers' Wholesale House, 521 Franklin Bldg., Chicago.

BE Wise. Don't experiment in mail order. I can tell you how to succeed. B. Newham, Waukegan, Ill.

MANUFACTURERS, Promoters and Patent Buyers are invited to write us stating the line of invention in which they are interested, as we can supply their wants in any class of patents. Victor J. Erans & Co., 102 Ninth St., Washington, D. C.

STOP Here! Let me start you in a home business that will bring you money every day. Experience unnecessary. Spare time. No canvassing. I furnish everything. Send for proofs. Voorhies, Desk C. R., Omaha, Neb.

LEARN to collect money. Good income; quick results. Send for free booklet, "Skillful Collecting." Collectors' Association, Long Street, Newark, Ohio.

I WANT to send you proof of the wonderful pulling power of Popular Mechanics classified pages. What's your proposition? Write me today. F. W. Johnson, Classified Dept., Popular Mechanics Magazine, 6 N. Michigan Ave., Chicago.

PARTNERS WANTED

ADVERTISER holding guarantee of patentability U. S. A. for improved Electric Plug, desires immediate partner to finance patent fees. Half interest given. M. M., 9th Fl., 78 E. Madison St., Chicago.

BUSINESS FOR SALE

FOR Sale—Tire and Vulcanizing Business in Live Town. Will Show Fine Profit. Owner Leaving City. For Particulars Address H. H. Trebel, 316 Market Street, Hamilton, Ohio.

MAIL ORDER SUPPLIES

SELL Joker's Novelties! 16 samples, 10c. Chambers Works, Plainwell, Mich.

INCREASE your sales. Place your proposition before the readers of "Cartoons Magazine." 20,000 copies guaranteed every month. Classified rate 2c per word. Mail in a trial ad today. Cartoons Classified Dept., 78 E. Madison St., Chicago.

DUPLICATORS AND DEVICES

MALALANE Junior Duplicator \$1 post-paid. Has 2 duplicating pads 3 1/2 inches each. Ask booklet. Malalane, 1765 Southern Boulevard, New York.

MAKE your own duplicator for a few cents. Will last forever. Send 2c stamp for particulars. Desk 3, 594 Robinson Bldg., Racine, Wis.

OUR "Modern" Duplicator—Yours for \$2.40. No Glue or Gelatin. Always ready. All sizes. Free trial. 34,000 users. Standard for 15 years. Booklet free. Sole mfrs., J. E. Durkin & Beeves Co., 339 Fifth Ave., Pittsburgh, Pa.

FOR ADVERTISERS

ADVERTISE! Twenty words in 100 monthlies, \$1.00. Sample Magazine Free. Stanford Agency, Sebring, Ohio.

YOUR fifteen word advertisement in our \$12 magazine, reaching 20,000 boys, for 25c. Extra words 1c each. Youths' Magazine, Chicago.

BARGAIN—20-word ad, one insertion, 35,000 circulation and one year subscription, 25c; extra words, 1c. Digest, Grand Rapids, Mich.

YOUR advertisements placed in 36 different magazines for 3c per word; displayed, \$1.50 per inch; three times for price of two. List, particulars free. King's Magazine, Box 13-F, Little Silver, N. J.

PERSONAL

BROTHER—Accidentally discovered root cures tobacco habit. Gladly send particulars. F. Stokes, Mahawk, Florida.

FREE—Stop using Tobacco. Free. We will give free information how to conquer the habit easily and permanently. Results Guaranteed. Anti-Tobacco League, 618 Paxton Block, Omaha, Nebr.

AGENTS WANTED

AGENTS—Send for Free Sample "Fret-not." Enough for one washing. Be convinced you can do a whirlwind business. You can clear at least \$20 to \$100 weekly, according to spare or whole time. We want only live agents and give exclusive territory to men who can produce. You don't have to talk. If she doesn't buy at sight leave a sample. She will be looking for you long before you are able to make the rounds again. Free premiums for your customers. Our proposition is such a result getter that we can afford to give you all the samples you need. Credit given. Particulars free. Don't call. P. M. Mosler & Sons, 3213 Warren Ave., Chicago.

AGENTS—Snappiest household line on earth. Red hot sellers, steady repeaters. 100% profit. 250 light weight, fast selling, popular priced necessities. Agent's outfit free. Get busy—quick. Write today, postal will do. American Products Co., 5918 American Building, Cincinnati, O.

ESTABLISH yourself for life as a branch manager. With character and brains you need no capital if you act now. Everywhere in your city costly marble is ruined for lack of proper cleaners. Free from all acid, grit, grease, "Marbletome" is a revelation; cleanses, effluvia, enriches granite, onyx, porcelain, tiles, enamel, metal, wood-work. Homes consume plants; stores, banks, hotels, office buildings, galleons. You also can take big cleaning contracts. Write immediately for full particulars, A. Ryan, American Marble Cleaning Co., 158 E. 36th, New York.

AGENTS and Salesmen—Cavassers' Magazine, 48-page monthly, chock full of valuable information for cavassers and salesmen; tells how to buy from manufacturers, illustrates newly patented specialties, exposes "fakes," mail order schemes, and tells a hundred and one things hustling salesmen should know. Yearly subscription, \$1.00; special limited time rate, three months, 15c; six months, 25c. (No free copies.) Cavassers' Magazine, Dept. D, South Whitley, Indiana.

EVERY household on farm, in small town or suburbs, where oil lamps are used, needs and will buy the wonderful Aladdin Mantle Lamp. Burns common coal oil (Kerosene); gives a light five times as bright as electric. Awarded gold medal at San Francisco Exposition. One farmer cleared over \$500.00 in six weeks; hundreds with rigs earning \$100.00 to \$200.00 per month. No cash required. We furnish capital to reliable men. Write quick for wholesale prices, territory and sample lamp for free trial. Address nearest office. Mantle Lamp Co., 517 Aladdin Bldg., Chicago, Ill. Mantle Lamp Co., 517 Thermos Bldg., New York City.

AGENTS—Call on best people. Fast seller netting you \$2.00 on every sale. Send for particulars, Smith Mfg. Co., Bristol, Conn.

MEN and Women Agents: Money talks—how much are you making? If you are earning less than \$200 a month, no matter what your locality, you will positively be delighted with our Sentinel Burglar Alarm proposition. Many agents easily earn \$15.00 daily. Brand new invention. Sells quickly on sight to homes, offices. Patented. No competition. Free exclusive territory. Instantly attached any door knob. Impossible turn knob without ringing bell. No batteries, screws, nails. Handsomely nickel-plated. Retail \$1.00. Provides cheap burglar insurance. It's a big money maker. Let us prove why. If you mean business write today for liberal terms to agents. Marshall Dobbins & Co. Manufacturers, 1422 Marquette Bldg., Chicago.

WRITE quick. New, big paying territory just open. Take orders for guaranteed Planto Silk Hosiery and made-to-measure underwear. No capital or experience necessary. We teach you free. We pay all express. Big money and permanent business for men and women who write at once. Malloch Knitting Mills, Dept. 1197, Grand Rapids, Mich.

AGENTS wanted to sell back-saw blade cases in every factory and shop. Send 35c for sample. C. G. Pitkin & Co., Whitehall, Mich.

ACCEPT no agency until getting offer on Ho-Ho-Co Skin and Scalp Soap and Toilet Articles. Our plan new and different. Territory limited. Write today. Rothen, 212 N. 2nd, St. Louis, Mo.

AGENTS—Get particulars of the best Self-Heating Iron on the market. Low in price—absolutely practical. Three sales a day mean \$40 a week profit to you. Send postal today. C. Brown Mfg. Co., 4700 Brown Bldg., Cincinnati, O.

YOU can make big profits selling our Pure Aluminum Kitchen Utensils—Guaranteed for 20 years. Our specialties are not sold in stores, and they get the business for you. \$200,000 firm and liberal credit plan backs you. We have an attractive General Agency offer. Wm. J. Dick, Manager, Dept. B-21, 20 W. Lake St., Chicago.

LIVE Agents—Make big money. Particulars free. Sumner Co., D-3446, Augusta St., Chicago.

AGENTS coin money on Bid-of-Rats. Other big sellers. Berg & Beard, Inc., 61 Fleet Place, Brooklyn, N. Y.

WANTED—Agents to sell our Home Altar; great seller to Catholics. Inquire proposition. Novelty Altar Co., Stamford, Conn.

AGENTS are coining money selling our big 10c Packages of 20 Assorted Postal Cards, "5,000 Varieties." "Big Profits." Sell everywhere at sight. Sample Packages 10c. Particulars Free, Sullivan Card Co., 1234 Van Buren St., Chicago, Ill.

GET Money—I did; got \$301.27 in two weeks doing plating, writes M. L. Smith of Pennsylvania (used small outfit); start as Smith did; that's easy; hundreds already started, money coming in, goods going out. People everywhere have tableware, watches, jewelry, etc., for the "Gray Plating Man." Practical outfits, all sizes, heavy plate guaranteed. Pure Gold, Silver, Nickel. Metal Plating, latest process taught free quickly; experience unnecessary; secrets exposed. Own and boss a business that pays \$15 to \$50 weekly—you can. Write today. Gray & Co. Plating Works, 942 Gray Bldg., Cincinnati, O.

MAGIC Ink Eraser. No blade or acid. Removes ink like magic. Sells 25c. Sample 10c. Sell like bread in a famine. Fountain Pens, Aluminum Milk Bottle Corers, Gliding Casters and many agents' specialties. \$5 paid for each new agent whose combined orders amount to \$25. Quick selling specialties. Who knows good agents? S. Mfg. Co., Warren St., N. Y.

AGENTS—15% profit selling new Easy Wringer Mop. Every home buys. Martin sold 131 in 2 days. One man orders \$2,650 one month. Get details. U. S. Mop Co., 319 Main St., Toledo, Ohio.

I PROMISE any man or woman who will go out tomorrow and call at ten houses, at least two sales, which net \$1.80 apiece. Ten calls—\$3.60 for your day's work. It's that aluminum combination set that you are to offer—aluminum the women are crazy for, and at a price they go wild over. Experience in selling or not—doesn't matter. Drop a card and let me post you on my \$3.60 a day offer. Manager, Perfection Products, 1223 Westmoreland St., Philadelphia.

PORTRAIT Agents: Our goods will make you big profits. Delivery guaranteed. Receipts credited. Prompt shipments. Low prices. Send for latest catalogue and prices. Adam J. Kroll & Co., 692 Blue Island Ave., Chicago, Ill.

AGENTS with selling experience to sell direct to consumer, made-to-measure suits and overcoats, \$12.50 and \$16.50. If you want an independent business with Big Money, answer at once before territory is taken. Elegant outfits furnished. Midland Tailoring Co., 19 S. Fifth Ave., Chicago.

AGENTS—Men and women, newest invention. Wing Self Heating Flat Iron; guaranteed, sells everywhere. Women delighted. Write for particulars. Wing Mfg. Co., 1638 Fulton St., Chicago.

MARVELOUS—Expanding Cuff Button. New invention. Slip your cuffs up or down forearm without unbuttoning. Positively stay where you place them. Reduces laundry bills, combines utility with convenience. Practical. Agents coin money—season now ready. Endorsed everywhere. Exclusive territory. Public demands them. 100 per cent profit. Fill a positive want. Enclose stamps for full particulars. Flexo Cuff Links Co., Sheboygan, Wis.

AGENTS—Made to Measure Raincoats. Free coat, big commissions to good agents. Temple Raincoat Co., Box 400, Templeton, Mass.

TAILORING Agents Wanted. If \$10 to \$50 a week for your spare time interests you, write us quick for beautiful new sample outfit, 60 nifty fabrics, 32 swell styles, wholesale prices, measuring chart, tape line, etc., all free to you by return parcel post. We pay express charges and guarantee satisfaction on all our clothes. Your own suit special to show your friends, made to your measure and the finest you ever saw; new, nifty, stylish and first-class in every way. Write us quick. Even if you can't be our agent, get our proposition on a suit for yourself. Paragon Tailoring Company, Box 1014, Chicago.

DEPARTMENT Stores, jobber agents making money selling our high-grade magnifying glasses. Send for circular. Christian Schlicher Mfg. Co., 12 Bloomingdale Street, Rochester, N. Y.

AGENTS wanted to sell Non-Alcoholic Food Flavors, Perfumes, Toilet Articles, Soaps, Soft Drink Extracts, Household Necessities. 80% saving to consumer. Big Profits to Agent. Sample free. Credit given. Arthur N. Christy & Co., Dept. S, Newark, New York.

I WILL start you in mail order business if you handle my goods. Crest Co., 50 Atlantic City, N. J.

SOMETHING every man needs. Write Chas. Milton Co., Hermosa Beach, Calif.

MAKE and sell your own goods. Formulas by expert chemists. Manufacturing processes and trade secrets. Formula Catalog for stamp. B. Mystic Company, Washington, D. C.

AGENTS wishing to earn more money send for my catalogue of repeat order articles; particulars free. H. O. Abel, Box 134, Hanover, Pa.

THOUSANDS Government Jobs Open to Men and Women, \$45.00 to \$150.00 month. Write for list, Franklin Institute, Dept. B-22, Rochester, N. Y.

AGENTS—Here's a money maker. New, low-price Portable Oil Gas Stove, Light in weight, compact, practical. Every home a possible customer. Cooks, bakes, heats. Sells both in summer and winter. Write today for our Money Making Proposition. The World Mfg. Co., 6396 World Bldg., Cincinnati, O.

AGENTS—100% commission. Latest Auto Specialty. Every motorist a customer. Dept. F, Chase Specialty Company, Box 237, San Antonio, Texas.

GET in the \$75.00 a week class; our proposition will get you started right. One man made \$500.00 in one week. Stubbs Agency, Peckville, Penn.

GREATEST Check-protector with four disk necessities. Sample 50c. Sells \$1. Valmars, 261 Broadway, New York.

HEATLESS Trousers Press—Sell at 50c or \$1.00. Guaranteed to press trousers in 5 minutes without labor or heat. Big profits. Patented Goods Co., Dept. P, 5 Liberty St., Poughkeepsie, N. Y.

\$61.50 WEEKLY introducing and selling a new gas light burner for kerosene lamps. Beautiful light. No chimney. No mantle. Perfectly safe. Simple in construction. Nothing to get broken or out of order. Will not burn out. Durable. Will last for years. Low price. Easy to sell. 200 per cent profit. Experience not necessary. Sample free. Why not try one on your lamp? Beware of imitations. No branch offices. Lather Manufacturing Co., Dept. 104, Cincinnati, Ohio.

BIG Textile Mills will employ everywhere reliable people to take orders for dress fabrics, hosiery, underwear, sweaters, waists and skirts from samples. Factory prices. Spare or all time. No experience. Permanent. Many making over \$30.00 weekly. Steadfast Mills, 30 Bensen St., Cohoes, N. Y.

TREE Experts coin money. Send name for particulars. Pitts, Wilmette, Ill.

AGENTS, get propositions of all kinds. Send 10c for Registration, Zetka's Service Bureau, 1279 Mack Ave., Detroit, Mich.

\$1.00 EVERY hour. Easiest seller ever offered. McLaughlin writes: "Week's profit is \$42." Write today. Empire Supply Co., Niagara Falls, N. Y.

ENERGETIC man can make ten to twenty dollars daily selling our unsurpassed line of new specialties. Write today to Sales Manager, Box 418, Quincy, Ill.

AGENTS, both sexes, for Gem Wall Clothes Dryer, Big Profits, F. J. Mathies, 1202 Park Place, Brooklyn, N. Y.

ATTENTION! Clear \$30.00 weekly your round mauling music evenings. Why look farther? Send 10c for facts, proof and elegant new music to Wrbber Music Company, Boston, Massachusetts.

"JIFFY" Duplicator, \$3.00, Prints 1,000 postcards, etc.; 50% to agents. E. N. Fales, Chicago.

REAL live agents to start now selling Star and Handy Clothes Line Beels. Quick sellers. Big profits. Particulars free. Feeny Mfg. Co., C-192, Muncie, Ind.

PHOTO Pillow Tops, Portraits, Frames, Sheet Pictures, Photo Plates, Pennants. Rejects credited. Prompt Shipments; samples and catalogue free to agents, 30 days' credit. Jas. C. Bailey Co., Desk B-4, Chicago.

AGENTS Wanted—To advertise our goods by distributing free sample to consumer, 90 cents an hour. Write for full particulars Thomas Mfg. Co., 562 North St., Dayton, O.

BIGGEST money-maker out. Newly invented "Linedfinder and Copy Holder" for stenographers. Greatest time saver. Exclusive territory. Lingoide Mfg. Co., 160 N. 5th Ave., Chicago.

BIG money made installing alarm clock supports to control drafts on steam, hot water, hot air and natural gas heating outlets. Warm house in the morning. Use your own clock. Price, \$3.90. Alroy Mfg. Co., 1234 Harvard, Washington, D. C.

AGENTS for Silver polish; polishes 100 pieces silver or plate a minute. No rubbing. Very large profits; good repeater. Excellent side line. The Mahed Company, Newark, N. J.

MAKE your own Extracts and Perfumes. H. Lake Co., Adair, Ill.

AGENTS—Make money quick, easy, sure. Introducing our line of Coffee and Tea. You should make from \$10 to \$15 daily. Write for our selling plan. D. Abbott Coffee Company, Lynchburg, Va.

TWO cents gets proposition on Goodrich Rubber Telephone Ear Cushions. Every phone user a prospect. Effectually excludes all outside noises. Full outfit for fifty cents (returnable) and book on salesmanship. 100 to 150%. Franco Co., Majestic Bldg., Detroit, Mich.

200% PROFIT. You can't beat it. Sells everywhere. Free pocket sample. Our goods get the orders. Wm. J. Dick, Mgr., Dept. B-4, 20 W. Lake St., Chicago.

AGENTS—Just out. New Dollar Winner. "Wilson" One Hand Speed Wrench. Machinists, autoists, farmers, everybody, buys at sight. 100% profit. Make \$30 to \$50 weekly. Toledo Speed Wrench Co., Dept. 11, Toledo, Ohio.

GENERAL Agents Wanted in each locality to see the trade and put out sub-agents on a new patented device for inflating tires and registering air pressure. Motorists buy on sight, as its use guarantees greater mileage. Popular prices; three sizes. If you are willing to work hard you can make big money. First man that can measure up gets the agency—write now. Hansen Mfg. Co., 1213 Illuminating Bldg., Cleveland, Ohio.

AGENTS—Here is an article of merit. A patented ventilator for home, office and public buildings. Instantly installed without tools and adjusts to fit any window. Unlimited market. The Chapman Brothers Co., Box 20, Saybrook, Conn.

VACUUM Cleaner Men: You all know Hugro. Biggest Vacuum factory in world. Best and latest models. All styles. Blue bird indoor and outdoor clothes reels. Lowest factory prices. Hugro Mfg. Co., Warsaw, Indiana.

AGENTS Wanted—Agents make 500 per cent profit selling "Novelty Sign Cards." Merchants buy 10 to 100 on sight. 800 varieties. Catalogue free. Sullivan Co., 1234 Van Buren St., Chicago, Ill.

YOU can make big money selling electrical diamonds for the holidays. Send 10 cents for samples of scarfpin or ring. Our catalogue is a winner, send for it. Leon Wilder & Sons, 539 Broadway, New York.

AGENTS—Large Manufacturer wants reliable men, women, to sell guaranteed Hosiery, Underwear, Shirts, direct to homes. Write for free samples. Madison Mills, 588 Broadway, New York.

AGENTS—Steady Income. Large manufacturer of Handkerchiefs and Dress Goods, etc., wishes representative in each locality. Factory to consumer. Big profits, honest goods. Whole or spare time. Credit given. Send for particulars. Freeport Mfg. Co., 59 Main St., Brooklyn, N. Y.

BIG Money easily made selling Jules Folding Portable Electric Lamps, containing 10 ft. concealed extension cord automatically lengthened or shortened. Other features. Demonstration insures sales. Homes, Offices, Factories, Hospitals, Students. Rose-Strauss Co., 215 W. 48th, N. Y.

PERFECTION Pocket Adding Machine. Lightning seller. Agents wanted. Cincinnati Specialty Mfg. Co., Dept. R, Cincinnati, Ohio.

MEN and Women representatives to handle our specialties; a clean line, no trash. Seymour Specialty Company, Box 1477, Syracuse, N. Y.

AGENTS—Double your sales. Increase your profits. Let us show you the secrets of Agency Success. Particulars Free. Southwest Co., Box A1962, Los Angeles, Cal.

BRAND New Office Necessity. Sells seven out of ten. Profit 300 per cent. Particulars free. Sample 10c. Specialty Mfg. Co., 2 Lewis Block, Detroit, Mich.

\$10.00 FOR the inventor who can supply the ideas we need. Write for particulars. Patent News, Dept. 153, Washington, D. C.

DIAMOND Ring given for doing few hours' spare-time work. Write for particulars. Chas. Scheetz, 809 So. Ottawa, Joliet, Ill.

PEACE Postersettes, one book 1,250 \$1. Retail for \$3. War postcards, show cards, books, tricks, novelties, etc. Circulars free. Ward Pub. Co., Box 453, Chicago.

AGENTS: Everybody uses it; make \$10 per day. Particulars free. Totay, 6609 E. 15th St., Kansas City, Mo.

AGENTS—Salary or commission. Greatest seller yet. Every user pen and ink buys on sight. 200 to 500 per cent profit. One agent's sales \$620 in six days; another \$32 in two hours. Monroe Mfg. Co., X-6, La Crosse, Wis.

"GOLDINE" Sign Letters—1,000% profit. Sample free. Johnston Co., Quincy, Ill.

AGENTS—Something new that automobile owners buy. Big commission. Particulars free. Louis Henry, 3828 Yocum St., West Phila., Pa.

AGENTS—Everywhere, latest improved Self-Heating Flat Irons and Vacuum Sweepers. Sell easily and rapidly. Profits 100%. Particulars, American Sales & Novelty Mfg. Co., 1930 Diversey Parkway, Chicago.

AGENTS—Brand new specialty Aluminum Triplicate Sauce Pan with detachable handle. Cooks 3 different foods on one burner. Saves gas. Lasts lifetime. \$100 to \$300 per month easy. Send for our catalogue of 400 other specialties. American Aluminum Mfg. Co., Div. J. 19, Leomont, Ill.

MAN to advertise and solicit for Rogers' Guaranteed Silverware. Good salary and commission. A. A. Cline, 51 Copeland Building, Philadelphia, Pa.

I WANT agents for new proposition. Carl Milstead, Chatsworth, Ill.

ADJUSTABLE Ventilating Shade Fixture—Every home uses 6 to 24. 100% profit. Demonstration sells. Mounted sample set 50c prepaid. Write today. Shade Fixture Co., Cleveland, Ohio.

SELL Slot Machine Substitutes—make peanut cards. Mann, 1107 Independence Boulevard, Chicago.

"S-O-N" means agents' easiest ten-cent seller. Inquiries not answered unless accompanied by dime for sample. Harsh Mfg. Co., Indianapolis, Ind.

500 to 1,000% PROFIT. Postcard for particulars. Sommers, 516 N. Ohio Ave., Atlantic City, N. J.

\$70.00 IN Ten Days. Hedrik's profit with Rodolph's Curtain Rods. Sample, 10c. Rodolph's Manufacturer, 461 Northwestern Building, Chicago.

READ "Good Results"—Greatest Mail-Order Magazine published—two trial issues 10c. Good Results, 156-P West Washington, Chicago.

AGENTS—\$50 weekly; the only knife sharpener made on correct principle; wonderful seller; 157% profit; simple demonstration; no talking; general agents can make \$150 week; particulars free. 50c sample by mail, 25c. Thiele Co., 5 Austin Ave., Chicago.

YOU can make more money employing agents than by being one yourself. We show you how. We only make money when you make money. Write for particulars. Mumford & Larson, 334 Walker Building, Salt Lake City, Utah.

ELECTRIC and non-electric changeable window signs. Lowest prices. Mandeville, 67 West Schuyler Street, Oswego, N. Y.

SAFETY Seam Ripper. Rips fast; doesn't cut the cloth. Big profits. Quick seller. Sample 25c. E. Overholt, 1325 11th St., Washington, D. C.

"DECALCO" gold sign letters better everything. New, Sensational. Enormous profits. Sample free. Wadhams, 40 Broadway, Brooklyn, N. Y.

AGENTS, Demonstrators: Make big money. Remarkable household specialty; great seller; astonishing success. Write quick. Empire Supply Co., Jamestown, N. Y.

100% PROFIT selling new article, repeat orders; send 25c for sample. Blackstone, 153 Main St., Brockton, Mass.

BIG New York manufacturer wants ambitious representatives with at least \$15.00. Establish general agency and mail-order branch. Instructions guaranteeing success. Big repeater. Universal demand. Y. L. Modra, 24 E. 21st St., New York.

SOAP Agents—Our Vegetable Soap, Toilet Goods, Remedies, Flavorings, Excel—Outsell. Sample Free. F. A. Buchanan & Co., Dept. 54, St. Louis, Mo.

AGENTS Wanted—High-grade men only. We start you in business for yourself in your own town. No capital required. New Tungsten Nitrogen Lamp giving a very brilliant white light. Cuts electric bill in half. Write for restricted territory. E. Huber Co., 229 Taaffe Place, Brooklyn, N. Y.

NEW \$2.50 pocket adder. Sell 10 daily easy. Excellent profit. Everyone buys. No competition. K. Bassett, 5921 Indiana Ave., Chicago.

GENERAL Representatives with little capital for Jap 80k nonbreakable Gas Mantle; America's latest invention; throws greater light; outlives others; substantial income assured handling sub-agents and trade. Jules, 209 W. 48th, N. Y.

AGENTS Wanted—No matter who you are, or where you live, or what you do, right now before you turn the page, before you do another thing, send us your name and address so we can send you free our beautiful, heavy sample book, crowded with wonderful bargains in men's made to measure clothes, all the latest fabrics, advance styles, inside prices, measuring chart and everything needed to make \$5.00 to \$10.00 an hour in your spare time. Special offer on your own suit to advertise us. Don't miss this. We pay express and guarantee satisfaction. Send a postal now. American Woolen Mills Co., Dept. 1314, Chicago.

SHOCK Absorbers: Big money proposition selling automobile owners; cut prices. Schultz, 1330 St. James St., Phila.

AGENTS—Biggest hit ever! Eleven-piece Toilet Article Set, selling like blazes at \$1; with \$1 Carving Set Free! Enormous profits! Tremendous sensation! Experience unnecessary. Engle made \$51.00 first week. Write quick! Pierce Co., Dept. P, 996 Lake St., Chicago.

AGENTS: Investigate our new household specialty. Particulars free. Standard-A, 4 West 118th St., New York.

I MAKE \$2,000 yearly selling "Brightest" Gas Burners and "Perfect" Gas Lighters; splendid combination; easy sellers; enormous profits. Both samples, 15c. Get particulars. C. Lubow, 126 East 16th, New York.

OUR line of brushes is a winner. So is our proposition. We want live brush agents everywhere. United Brush Company, 622 W. Lake St., Chicago.

GET cash for names, information, ideas, formulas. Turn what you see, hear and know into money. Instructive booklet for stamp, Information System, 232 Marietta, Ohio.

LISTEN! Can you sell gasoline at one cent per gallon? If so, sell "Gas-Tonic." Gives 40% more gasoline mileage; eliminates carbon. Auto owners grabbing for it, \$10 a day easy. Helsey made \$25 first day. Act quick, man. Details free. White Mfg. Co., Dept. 112B, Cincinnati, O.

BIG Business for Agents—New clothes washing machine. Fits set or ordinary tubs. Sells for \$10, with big percentage of profit. Won medal Panama-Pacific Exposition. Just the thing for apartments. Write for proposition. Home Devices Corp., 213 Bush Terminal, Brooklyn, N. Y.

AGENTS Wanted—High grade photo finishing and photo novelties. Cross Photographic Co., St. Louis, Mo.

AGENTS—Make your own toilet preparations, household necessities, etc. 100 good formulas, 25 cents (coin). Conewango Manufacturing Co., Box 1100, Warren, Pa.

WILL pay \$25.00 to reliable agents to distribute 100 free packages of Lice Powder to poultry owners. Poultry Remedy Co., St. Paul, Minn.

SELL one for every auto. Sample, 10c. Hareus Mfg. Co., River Forest, Ill.

AGENTS, lady or gentleman, for patented paper dental specialties. Twenty-five cents for samples and proposition. F. G. Crane, Muskegon, Mich.

YOU Can Sell Our Custom Raincoats. Large profits and raincoat free. You invest nothing. Harvard Raincoat Co., Dept. P, Boston, Mass.

AGENTS who can make \$3,000 and more yearly. No others apply. Fuchs-Kelly Co., 38 Park Row, N. Y.

AGENTS Wanted to sell a household specialty—need in most every home; quick sales—big profits. Write today for proposition. Alpha Alcohol Utensil Co., 199 Hamilton St., Newark, New Jersey.

AGENTS Make \$50 weekly selling \$10 Starter and \$1.75 E. Z. Steerer for Ford Cars. Write Geo. H. Wilson, 992 North-western Bldg., Minneapolis, Minn.

WE want agents in the small towns and surrounding territories to introduce our gasoline lamps and mantles. Big money for the man who can sell. For catalogue and full particulars, address: Grand Rapids Novelty Co., 538 Woodlawn St., Grand Rapids, Mich.

AGENTS—Do you want something that sells rapidly, guarantees satisfaction and leaves a liberal profit for you? Sell our Oxy-Acetylene Welding and Cutting Outfits to garages, repair shops, etc. Big field. Write for attractive proposition. American Welding Co., 2724 Michigan Ave., Chicago.

SALESMEN for high-grade specialties. Demonstration invariably results in sale. Send for free descriptive booklet and terms. The Mountain Mfg. Co., Upper Montclair, N. J.

SIGN Letter Agents and Painters; 500% Profit Gold and Silver Sign Letters for Stores and Office Windows. Anyone can put on. Big demand. Free samples. Metallic Letter Co., 404 N. Clark St., Chicago.

ENDLESS Neckties—Something new, twelve ties in one; costs no more than old style; man made \$70 three days; woman made \$92 week; write for special agents' offer. Endless Necktie Mfg. Co., Dept. 10, Kansas City, Mo.

AGENTS—\$5 daily selling our Handy Tool, 12 articles in one. Lightning seller. Sample free. Thomas Mfg. Company, 762 North St., Dayton, Ohio.

JUST show them—The new adjustable floor and wall mops, dustless dusters and sanitary brushes sell themselves. Big line. Big profits. Agents write Silver-Chamberlin Co., Dept. M, Clayton, N. J.

EASY, pleasant work for Mechanics, Shop Men, Clerks, during spare hours, will add many dollars to their salaries. Also want persons who can give full time. Big wages assured. Novelty Cutlery Co., 67 Bar St., Canton, Ohio.

YOUNG Man, would you accept a tailor-made suit just for showing it to your friends? If you live in a town smaller than 10,000, write Banner Tailoring Co., Dept. 120, Chicago, and get beautiful samples, styles and a wonderful offer.

AGENTS—Here's a winner. The Midget Vest Pocket Garment Hanger—sells on sight. The most attractive proposition ever offered. 150% profit. No competition as article is fully protected by U. S. and foreign patents. Address: Dept. "M," The Silver Company, 171 Madison Ave., New York.

MEN and women earn up to \$3,000.00 yearly distributing Guaranteed Hosiery from mill to wearer. All or part time. Repeat orders insure permanent increasing business. No capital or experience needed. D. Parker Mills, 2733 No. 12th St., Phila., Pa.

INVENTIONS commercialized on cash and royalty basis. Inventors, Manufacturers and agents write: Adam Fisher Mfg. Co., 61 Fisher Bldg., St. Louis, Mo.

WANTED—Reliable Men and Women to place our Eggine in stores and appoint sub-agents. Takes the place of eggs in baking and cooking at less than 1c a dozen. Chas. Morrissey Co., 4463-5 Madison St., Chicago.

YOU are looking for more long green. You doubtless deserve it, and willing to work for it. Our soap and toilet article combinations have every ear-mark of being real coin getters, we can prove that they are. Write for convincing proofs. Davis Soap Works, M 64 Davis Bldg., Chicago.

FREE samples for men and women agents; double your money selling Delbare's Naptha Washing Tablets; washes clothes without rubbing; cleans floors, woodwork, pots, pans and dishes; polishes silverware; send for sample and particulars; not sold in stores. Manufactured and sold only by Naptha Washing Tablet Company, 716 So. Dearborn St., Chicago.

\$25.00 TO \$30.00 per week easily earned in your home town by representing reliable concern, selling their live line of household necessities. Exclusive rights granted. Apply at once. Dept. 29, Consumer's Direct Supply Co., 48 Hanover Street, Boston, Mass.

NEWEST wonder of the age! Silveron, the polish that silver-plates. Actually rubs on sterling silver. Used everywhere. Sells on sight. Repeat orders. Big profits. Protection. Secure now, introductory offer. Free sample. P. Carisa Co., 157 Cedar St., New York.

AGENTS: \$1,000 to \$3,000 yearly selling over eighty every-day articles to farmers. Pleasant, permanent business. Full instructions. Big chance. Write quick. Duoform Factories, Duoform Company, North Java, N. Y.

MONTAROMA, concentrated perfume of the mountains. Youth restoring, health giving invigorant. Sample 20 cents. Myrt. Strong, Ward, Colo.

\$1,000 PER Man per County. Strange invention startles world—agents amazed. Ten inexperienced men divide \$40,000. Korstad, a farmer, did \$2,200 in 14 days. Schleicher, a minister, \$195 first 12 hours. \$1,200 cold cash made, paid, banked by Stoneman in 30 days; \$15,000 to date. A hot or cold running water bath equipment for any home at only \$6.50. Self-heating. No plumbing or waterworks required. Investigate. Exclusive sale. Credit given. Send no money. Write letter or postal today. Allen Mfg. Co., 4137 Allen Bldg., Toledo, Ohio.

WINDOW Lettering Business. We start you free. Stalbrite Co., Dept. P, Long Island City, N. Y.

\$15.00 MADE first day by 13-year-old boy with Shomescope. Woman made \$8.00 first hour. Particulars free. Shomescope Mfg. Co., 523 W. 13th St., Kansas City, Mo.

GET into your own business. Cut loose from lay-offs, short hours and wage slavery. Our catchy soap and toilet combinations have put thousands on Prosperity Road. Tremendous saving to consumer—200% profit for you. Send postal quick for details. E. M. Davis Co., R64 Davis Bldg., Chicago.

SELL Dry Goods Remnants. Greatest bargains on earth. Remnant Store Co., Cincinnati, Ohio.

WE are the largest manufacturers of twisted Wire Brushes in America. Highest grade goods, best service, largest profits. Our new Auto Specials are winners. Send for catalog. Fuller Brush Company, Hartford, Conn.; Rock Island, Ill.

NEW 1915 Model—Send no money, just your name on a postal card, and learn by return mail how to get the best Vacuum Cleaner made, without costing you one cent. Shipped direct from factory, guaranteed for 5 years. Reliable, live agents wanted. The Warner Company, Dept. Z, Muncie, Indiana.

AGENTS—Sell the Primus, genuine Swedish wickless, coal-oil stoves. Smokeless, odorless. Twice the heat of gasoline at one-eighth the cost. No danger of explosion. Big profits. James Anderson & Sons, Sidney, Ohio, American distributors.

AGENTS make big money and become sales managers for our goods. Fast office sellers. Fine profits. Particulars and samples free. One Dip Pen Company, Dept. Z, Baltimore, Md.

READ the Agents Magazine and make more money. 2 issues 10c. Agent's Magazine, Chicago.

AGENTS—Air Cell Washing Machine. New, marvelous invention. Exceeds work of washers costing \$25.00 and up. Sells only \$1.00. No wonder every home buys. Exclusive territory free. Nearly 200% profit. Write today. Air Cell Washer Co., 3037 Detroit Ave., Toledo, Ohio.

AGENTS—Average \$5 to \$12 daily selling astonishing Aztec massage machine. New. Just patented. Different. No electricity or water power required. Nothing complicated. Affords exhilarating massage without cent expense. Lowest priced, but best outfit. Retail \$2.50 allowing you big end of the profit. Particulars and "beauty" folder free. Aztec Remedy Co., Dept. 132, Toledo, Ohio.

500% PROFIT selling our wonderful sign letters for office windows, store fronts and glass signs; resembles finest gold leaf; easily applied; samples free. Metallic Letter Co., 406 N. Clark St., Chicago.

AGENTS—Sell rich-looking imported 36x 68 Russ. \$1 each. Carter, Tenn., sold 115 in 4 days. Profit, \$57. You can do same. Write for sample offer selling plan; exclusive territory. Sample rug by parcel post prepaid, 98c. Condon, Importer, Stonington, Maine.

AGENTS make \$5 to \$10 a day on the start. Atkinson writes: "The best proposition I have found in my forty years' canvassing." Permanent work. Household necessity. Saving 80%. Write today for General or Local Agents terms. Free sample. C. H. Stuart & Co., 16 Union St., Newark, New York.

AGENTS—Stamping names on Pocket Key Protectors; sample Check with your name and address, 12c. Stamping Outfits, Emblem Checks, Check Fobs, Name Plates, Hart Mfg. Co., Desk 2, 393 Degraw St., Brooklyn, N. Y.

YOU can be your own boss with our Key Check Outfit. Good for \$5 a day stamping names on pocket key checks, fobs, etc. Sample check with your name and address, 15 cents. Pease Die Works, Dept. M, Winchester, N. H.

STOP Here! Let me start you in a home business that will bring you money every day. Experience unnecessary. Spare time. No canvassing. I furnish everything. Send for proofs. Voorhies, Desk C. R., Omaha, Neb.

BIG Profits for You! Manufacture Barley Crisp. New Confection. 5c package costs you 1c. Machine, instructions complete \$7.50 prepaid. Send 10c for samples. Barley Crisp Co., 1265 Broadway, San Francisco.

MAIL-ORDER Opportunities: 25 new Propositions. No competition! Make 95c profit on dollar order; complete outfit 10c. Mail Dealers Wholesale House, 521 Franklin Bldg., Chicago.

AGENTS make \$100 monthly selling our 300 handy household articles. Catalogue free. Scheff Company, Desplaines, Ill.

MEDALLIONS—300% profit. Make up your own goods and be independent. Catalogue free. Resag Co., 1205 Randolph St., Chicago.

YOU can make \$555 as our general or local agent. Household necessity; saves 80 per cent; permanent business; exclusive territory; salary or commission; free sample; credit. J. Pitkin, 113 Bechtel St., Newark, N. Y.

AGENTS of ability and high character wanted on a new household article. Over 100 per cent profit. Special selling plan that pulls results. Address Merritt & Brock, 59 to 69 Temple Place, Boston, Mass.

AGENCIES WANTED

WANT good articles exclusively. Our staff covers New York. Send particulars, samples. Valmars, 261 Broadway, New York.

MAN of good standing and large acquaintance desired to represent reliable concerns in Maine. Address W. Box 462, Portland, Maine.

SALESMEN WANTED

WANTED—An Agency that has three or four live-wire salesmen, to sell a chinaware assortment, direct from the manufacturer to the retail merchant. The biggest thing on earth for the money. Our big commissions will make you rich if you have the selling force. Answer, The E. H. Sebring China Co., Sebring, Ohio.

DANDRUFF. One Petron shampoo stops most cases for week or more. Nearly every man buys. Every buyer gets immediate results. Sample five applications, ten cents. Sanitary Methods Co., Desk "A," 122 Sycamore St., Milwaukee, Wis.

SALESMEN—We have some excellent territory open to salesmen of ability. This is a proposition that appeals to the best class of concerns. Sales are easy and your profits large. Write us today for catalogue P. M., covering the Schick All-Steel Paper Baler, Davenport Mfg. Company, Davenport, Iowa.

WANTED—Representatives everywhere. Exclusive territory. Gold sign letters for stores and office windows. Any one can put on. Write today for free sample. Mailing Letter Co., 405 N. Clark St., Chicago.

\$130 HAS been earned in 3 days by our representatives, some even better. Introducing our new advertising method which solves the advertising problem for merchants in smaller cities and towns. If you are or want to be a salesman I will show you how to build up a big profitable repeat business quick. Whole or part time. Big money if you set now. Write Salesmanager, Winslow Cabot Company, 66 Congress Bldg., Boston, Mass.

\$1,800 PER year and expenses, salary or commission, selling remarkable labor-saving invention to farmers and people who own cows. Experience unnecessary. Enormous demand. Nothing in market like it. Positions being filled fast all over country. If you want job for your locality, or traveling, write quick for particulars, free sample and salary proposition. DeKing Mfg. Co., Dept. 13-O, Chicago.

SPECIALTY Salesmen—Large Eastern organization manufacturing patented, popular-priced office efficiency devices wants representatives in unoccupied territory. Splendid proposition. Small capital. Cash or credit. Fine line "repeaters." Full protection. Ask for "Folder A5." Chelsea Mfg. Company, 111 Broadway, New York.

SALESMEN: Sell the patented Snuggit back-of-neck flat collar button to dealers. Mounted on beautiful counter display cards. Gold plated; lies flat; no bulge; tie slides easily; has no post or lever; cannot break; sells easily; liberal commission; exclusive territory. Sample and details positively free. Snuggit Company, Youngstown, Ohio.

SALESMEN: Pocket side line; new. Free proposition; all merchants in towns of 100-600 and under want it. Pays \$5.00 commission on each sale. No collecting, no risk to merchant. We take back unsold goods. Easiest, biggest paying side line ever offered. Canfield Mfg. Co., 208 Sigel St., Chicago.

SALESMEN Wanted—Salesmen and Manufacturers' Agents to represent us everywhere among the Superintendents, Engineers and Purchasing Agents of Manufacturing Plants. Four famous Federal Products—Pulley Facing, Roofing Cement, Metal Paints and Graphites. The Federal Graphite Mills, Cleveland, Ohio.

MY Check Protector the best. Send quarter for sample. Satisfaction guaranteed. Holt Sales Co., Atlanta, Ga.

SALESMAN. Sell beautiful 28x58 Artkraft felt rugs for \$13.50 per doz. Your profit, \$3 per doz. Kelso, Battle Creek, Mich., sold 30 doz. last week. His profit, \$98. Write for exclusive territory and selling plan. Prepaid sample, \$1.50, refunded on first order. H. Condon, Mgr., Stoughton, Maine.

WANTED—Side line salesmen calling upon hardware and general stores. National Production Co., 180-190 No. Market St., Chicago, Ill.

HELP-A-PHONE. Salesmen make \$100 weekly. Write Edward, 415 Beiden Ave., Chicago.

ADVERTISING Salesmen who wish to make a very profitable connection for 1916 should write us at once. Entirely new ideas to submit prospective customers. Competition eliminated. Exclusive designs, protected territory and liberal commission. The Hayes Lithographing Co., Lakerow Ave., Buffalo, N. Y.

SALESMEN—Get our plan for Monogramming Automobiles and Motorcycles by transfer method. Very large profits. Motorists' Accessories Co., Ashland, O.

SALESMEN—Make Big Money on our Convex Portraits 38c, Frames 35c, Glass 20c. Largest house in America. Est. 15 years. Samples Free. The Culver Co., Box 104, Westerville, O.

PERMANENT Income from sale of Transo (Transparent face) envelopes. Every business house a possible customer; Commission basis; local or traveling salesmen. Transo Paper Company, Chicago.

BIG Opportunity for Hustling Salesmen. Selling Sanbo Two-Compression Starters for Fords. \$14. Guaranteed to start. Great demand. Salesmen with Fords preferred. Write Sanbo Starter Co., Desk A, Rock Island, Ill.

SALESMEN: Acquainted with merchants. Large demand. Lib. comm. Pocket samples. Wirth Salesbook Co., Chicago.

WANTED—Hustlers to take orders for made-to-measure high-grade men's tailored suits from \$18.00 to \$22.00. Make \$25.00 to \$30.00 weekly. Elegant large book outfit free. Experience unnecessary. No pocket folder affair. Splendid opportunity to make money. Handy Dandy Line. Dept. 8, Sangamon St., Chicago.

GREAT opportunity for General Agents selling New Specialty to merchants. Retail \$5, \$13, \$15 each. Your profit 200%. No competition. Exclusive territory. Free samples. Sayers Co., 408 Wainwright, St. Louis, Mo.

HELP WANTED

MEN to erect Portable Automobile Garages and become our representative. Any one handy with tools and who can follow simple instructions can secure a good position in his own city. Write for full information. Address The Moeschl-Edwards Organizing Co., 16th Street, Covington, Ky.

USE your spare time to build up a mail-order business of your own. We help you start for a share in profits. 27 opportunities. Particulars free. Opportunities Exchange, Buffalo, N. Y.

WANTED—Man in your own territory. Salary of \$100.00 per month, traveling expenses and commission. Experience unnecessary. Write quick. R. D. Martel, 2309 Indiana Ave., Dept. B 8, Chicago.

HELP Wanted—U. S. government wants clerks. Men-women, 18 or over. \$70.00 month. Vacations. List of positions now obtainable free. Franklin Institute, Dept. B-21, Rochester, N. Y.

FIREMEN—Brakemen; \$100 monthly, experience unnecessary; hundreds needed by the best railroads everywhere. Particulars free. Railway Bureau, East St. Louis, Ill.

\$150.00 SALARY for 60 days' work paid man or woman in each town to distribute free circulars and take orders for White Ribbon Concentrated Flavoring. J. S. Ziegler Co., 7 P. East Harrison, Chicago.

MEN Wanted for Detective work. Also instructed by former U. S. Govt. Detective. Write J. Ganor, 2309 Calumet, Chicago.

\$18.00 WEEK. Become Chauffeurs. Earn while learning. Sample lessons free. Franklin Institute, Dept. B-202, Rochester, N. Y.

MEN Wanted to make Toy Soldiers, Indians, Cowboys, Nuremberg's industry. War stopped importation. Great demand. Greatest homework proposition. Big business in larger scale. Tools, experience unnecessary. We buy all the soldiers if not sold direct to stores. Flooded with orders for months ahead. Casting form outfit \$2.00 up. Interesting booklet, pattern sheet, payroll free. Toy Soldier Manufacturing, 32 Union Square, New York.

BE a Traffic Inspector—We Teach You. A New Profession. \$4 a Day to Start. Unlimited Opportunities for Travel and Advancement. Positions Now Open. Frontier Prep. School, Buffalo, N. Y.

GOVERNMENT Clerks Wanted. \$90.00 Month. Pull unnecessary. Common education sufficient. Vacations. Short hours. Rapid promotion. Write immediately for free list of positions now obtainable. Franklin Institute, Dept' B-21, Rochester, N. Y.

LEARN a Trade that pays well. Steady work. Billboard-Bulletin-Decorative-Pictorial and Theatrical Scene painting taught at your own home. No experience required. Send 4c stamps for catalog. Natl. Comm. Art School, Dept. A, 615 Omaha Natl., Omaha, Neb.

WANTED, Men 18 or Over, as Railway Mail Clerks. Sample examination questions free. Franklin Institute, Dept. B-21, Rochester, N. Y.

INVENTORS Wanted. Your ideas may mean fortune. Send sketch. Patents secured through new credit system. Book and advice free. Waters & Co., 4192 Warder Bldg., Wash., D. C.

I WANT a man of good character, aged from 20 to 60, for my special representative in his own section. No peddling or canvassing. High-class dignified work that you will like. Can make much more than you are now earning. If honest, ambitious and anxious to become independent for life, write today. McDonnell, Dept. 111, 1426 You St., Washington, D. C.

PLEASANT spare-time work; mailing circulars. Good pay. No scheme. Details free. Home Pub. Society, 48 N. 12th, Philadelphia.

WANTED—Circular Distributors, send 10c for Application Contract Sample Magazine. Oliver A. Barkley, Mount Pleasant, Pennsylvania.

THOUSANDS Government Jobs Open to Men and Women. \$65.00 to \$150.00 month. Write for list. Franklin Institute, Dept' B-21, Rochester, N. Y.

FIREMEN, Brakemen Wanted, all railroads; \$120 monthly. Experience unnecessary. Railway Association, Dept. 298, Brooklyn, N. Y.

GET a Government Job! See ad on page 12. Write now—today! Patterson Civil Service School, Rochester, N. Y.

PHOTO-Plays Wanted. Big prices paid. We show you how. Details free. Rex Publishers, Box 175E, Chicago.

OWN a business. Co-operate with me—evenings at home. Everything furnished. Don't worry about capital. Boyd H. Brown, Dept. K-10, Omaha, Neb.

WANTED—Men—Women. \$75.00 Month. List Government Jobs open—free. Franklin Institute, Dept' B-21, Rochester, N. Y.

A MONEY Proposition—Co-operate with me in a profit-sharing mail-order business. Will place trial advertisement, furnish printed matter, goods to all orders and divide the profits. Particulars. Desk 153, Hazen A. Horton, Tekonsha, Mich.

COMMERCIAL. Information Wanted: High-grade opportunity; no canvassing; spare time; confidential; good pay. Write for complete particulars. "Cico," Pmc, Evansville, Indiana.

SILVERING mirrors, Plating tableware, auto-brass. Home booklet plans free. Clarence Sprinkle, Dept. 28, Marion, Ind.

WANTED—Men to get members and establish lodges on commission basis for the Owls, South Bend, Indiana.

BECOME Detectives. Large salaries; easy work. Write Chief Wagner, 1243 Lexington Avenue, New York.

YOUR services are needed as Topographic Draftsman at excellent salary. You can learn from us soon. Get particulars, Columbia School of Drafting, McLachlen Bldg., Washington, D. C.

DISTRIBUTORS Wanted—Good pay; steady work; giving away packages Perfumed Borax Soap Powder with Soaps, etc. No capital or experience needed. S. Ward & Co., 218 Institute Pl., Chicago.

WRITE Moving-Picture Plays. Good prices. Devote all or spare time. No correspondence school. Details free. Atlas Publishing Co., 3045, Cincinnati.

MEN to refinish lighting fixtures, brass beds, etc. All or spare time. No capital or canvassing. Experience unnecessary. Information free. Geometal Co., Dept. G, Decatur, Ill.

STOP Here! Let me start you in a home business that will bring you money every day. Experience unnecessary. Spare time. No canvassing. I furnish everything. Send for profs. Voorhies, Desk C. R., Omaha, Neb.

BE a Detective—Earn from \$150.00 to \$300.00 per month. Travel over the world. Write C. T. Ludwig, 340 Westover Building, Kansas City, Mo.

WANTED—An Idea! Who can think of some simple thing to patent? Protect your ideas; they may bring you wealth. Write for "Needed Inventions" and "How to Get Your Patent and Your Money," Randolph & Co., Patent Attorneys, Dept. 144, Washington, D. C.

GO on the Stage, Vaudeville career offered you. Experience unnecessary. Managers endorse my method. Instructive vaudeville book free. Write today. Frederic LaBelle, Sta. 19, Jackson, Mich.

GOVERNMENT Examinations. Most thorough preparation, \$5; returned if not appointed; particulars free. American Civil Service School, Washington, D. C.

EARN \$20 weekly collecting names and information. What you see, hear and know is worth money. Send stamp for instructive booklet. Information System, 231 Marietta, Ohio.

WANTED

WANT good second-hand visible type-writer. Arthur Beld, Millersburg, Pa.

WANTED—Old Watch Cases. Douglas Bros., B'rechree, Mo.

WANTED—A first-class religious article to handle as side line. Novelty Altar Co., Stamford, Conn.

WANTED: Two good Cash Registers cheap. Chester Olson, Kewanee, Ill.

FOR SALE

15-LIGHT Acetylene Gas Plants, Generator, Fixtures, Chandellers, Pipe; cheaper than electricity; fully guaranteed; easily worth \$60; all complete for \$11.50. Write Daniel Zimmerman, Magley, Indiana.

OPERATORS' Bells \$10.00. Mills Floor Venders \$14.00 each, like new. Few others cheap to close out quick. Auto Vending Company, Minneapolis, Minn.

SLIGHTLY used transits and levels for sale; good bargains from \$75 to \$150. Strengthen Instrument Co., 205 Ozark Bldg., St. Louis, Mo.

FIELD and Marine, Day and Night Glasses, with beautiful case. 25-mile adjustment; \$30 value, only \$1.50. Money back if not satisfied. Well's Curiosity Shop, 20 S. Second St., Philadelphia, Pa.

FIELD Glasses, 9 power, case, strap, \$6.25 postpaid. Zehrbach & Cruikshank, Leipsic, Ohio.

VACUUM cleaner pumps and parts for assembling, save 15%. Vacuum Supply Co., Ann Arbor, Mich.

FOR SALE—Sixty latest style charcoal Flat-Irons, cheap. Chance to make \$100.00 easily. Box 370, New Bedford, Mass.

TENTS Cheap. Send for list. V. G. Gustafson, Joliet, Ill.

SALE OR EXCHANGE

M. R. P. is a "country-wide" trading service. Have you a farm, auto, gun, camera, etc. We can put you directly in touch with people who want what you have. Free pamphlet, Mathews-Ranch Publicity, 2d floor, Mallers Bldg., Chicago.

PATENT—Attractive: Hardware, Furniture, Implement Manufacturer. Want South Florida citrus land. Lock Box 1146, Manila, Philippine Islands.

Will trade Self-Heating Iron for printing, or what have you? Duhalaz, Hart Street, Providence, R. I.

VIEW Camera Outfit Field Glass to Exchange. Clayton Williams, Reed, Ky.

PATENT Chopping Knives. Will trade stock for iron pipe couplings or fittings. The A. & J. Mfg. Co., 359 W. Lake St., Chicago.

FLOUR & FEED MILLING MACHINERY

SPECIAL bargains in second hand Attrition mills, burr mills, crushers, corn shellers, bran dusters, dust collectors, purifiers, rolls, double, single, 2 and 3-pair high roller mills, sieve bolters, receiving separators, scouers, etc. Write for description and prices. Sprout, Waldron & Co., P. O. Box 129, Muncie, Pa.

ENGINE CASTINGS AND BLUE PRINTS

GASOLINE Engine Castings, with drawings. Cheap. Catalog for stamp. Novelty Manufacturing Co., 353 West 6th St., Cincinnati, Ohio.

MACHINERY, TOOLS AND SUPPLIES

18"x8" PRATT & WHITNEY planer, good order, \$175. Two large wood frame circular saw tables each \$20. Large Fay & Eagen jig saw with tilting table \$35. Three heavy punch presses, good order, \$75 each. 12 H. P. compound marine engine with fittings, A-1 condition, \$50. 6x8 Clayton Duplex air compressor, belt driven, \$80. 10x12 Norwalk steam driven compressor, 100 to 2400 lbs. capacity, \$300. Two 14"x5" engine lathes \$50 each. 2 Spindle Pratt & Whitney profiler, old style, but in good condition, \$100. Two 4-cylinder 18 H. P. air-cooled engines, each \$45. Send for better description. J. L. Lucas & Son, 5 Fox St., Bridgeport, Conn.

VISES for Sale. Have a limited stock of stationary-type blacksmith, pipe and machinists' vises. Below cost while they last. Puritan Machine Company, 55 Tenth Street, Detroit, Mich.

PULLEYS, Gears, Sprockets, Shafting, Hangers; see page 140. W. A. Jones Foundry & Machine Co., Chicago.

GLASS Cutter, improved type; cuts any thickness. Saves labor, time, money. Saves the hands. 10c. Smith & Hemenway Co., 1614 Chambers Street, New York City.

25-H. P. MARINE motor, \$45. Auto parts, etc. Send for bargain list. V. G. Gustafson, Joliet, Ill.

FOR Sale—New Power Hack Saw, capacity 4 in. by 4 in. \$15. New 10-inch Sensitive Bench Drill Press, drilling capacity 3/16 inch, \$15. Passman Bros., 28 So. Green Street, Chicago, Ill.

VACUUM Pumps and Cleaners, all sizes; complete outfits. Thurman Vacuum Cleaner Co., manufacturers, Dept. O, St. Louis, U. S. A.

VACUUM cleaner pumps, tools, etc., for stationary house or wagon outfit. Vacuum Supply Co., Ann Arbor, Mich.

HAVE for sale several sizes of lathes, milling machines, drill presses, punch presses, shapers, planers, boilers, steam engines, oil, gas and gasoline engines and wood-working machinery. Planner, 122 Water St., New York, N. Y.

ENGINE Lathe, swings 9 1/2 in., takes 25 in. between centers. Complete set gears cutting all size threads 3 in. to 40 in., \$13.50. Grammes & Sons, Allentown, Pa.

ENGINES, MOTORS AND DYNAMOS

ALTERNATING and direct current motors guaranteed for one year, at bargain prices. Sizes 1/30 h. p. upwards. General Electric, Fort Wayne, Wagner, Westinghouse, Emerson. Motors bought, exchanged, repaired. Send for new illustrated bargain list motors and supplies. Hyre Electric Co., 615-C, South Dearborn St., Chicago.

CORLISS Steam Engine for Sale. B. Wetherill & Co. Corliss engine, girder frame with bearing crank shaft, size 22x12, with 16"x28" cast-iron flywheel. Can be seen Keystone Leather Co., Camden, N. J.

LATHES and engines for sale. Send for list No. 31. Lucas & Son, Bridgeport, Conn.

GASOLINE Engines, 1/2 horsepower, \$15 complete. \$19 bare. Mustin Mfg. Co., Newport, Kentucky.

DYNAMOS, 50-Light \$60; 100-Light \$80; payments \$5 per month. Hobart Bros., Troy, Ohio.

TEN 3 H. P. 2-cylinder steam engines, each \$10.00. Send for photo. Lucas & Son, Bridgeport, Conn.

SAW Mills, Shingle Mills, Corn Mills, water wheels, hay presses, kerosene and steam engines, 25 and 14 hp. gasoline motor. DeLoach Mfg. Co., Box 511, Atlanta, Ga.

SMALL Dynamos and Motors—Low and standard voltages, half price. Write for new Special List, Johnston, Evans Ave., Ingram, Pa.

FOR Sale—20-H. P. Gasoline Engine. Machinery for Sternwheel Boat. H. E. Robinson, Plaquemine, La.

FOR Sale—2-H. P. Fairbanks-Morse gasoline engine; also 3x4 steam engine. P. O. Box 839, Riverhead, L. I., N. Y.

FOR Sale—Model B 2-H. P. Evinrude Detachable Rowboat Motor. Built-in Magneto, Maxim Silencer. Never used. Bargain, J. E. Pool, Silverville, W. Va.

AUTO Engine—40-H. P., V type, air-cooled; complete, \$40. Johnston, West End, Pittsburgh, Pa.

GOVERNORS, fans, jack shafts, etc., for motor engines when used as stationary. Circulars. Box 50, Taft, Calif.

REBUILT Engines—We have on hand a number of rebuilt "Buffalo" engines, guaranteed, at greatly reduced prices. Write for bargain list. Buffalo Gasoline Motor Co., 1203-1305 Niagara Street, Buffalo, N. Y.

GUNS, SPORTING GOODS, ETC.

PEERLESS famous combination spring exercisers with patented grip handles. Just the thing for athletes, business men, women, boys or girls. All the gymnasium advantages in your own home. Prices \$5 to \$1.00. Five styles, three tensions. Send for complete manufacturer's catalogue. Peerless Athletic Supply Co., 333 Pearl St., Brooklyn, N. Y.

FIREARMS—Old-time and modern. Buy, sell, exchange all sorts. Stephen Van Rensselaer, West Orange, New Jersey.

CEMENT

If you want the best information on cement and concrete construction, subscribe for Concrete-Cement Age. Leading cement and concrete monthly. Sample copy, 10 cents. Yearly subscription, \$1.50. Concrete-Cement Age, 135 Newberry Bldg., Detroit, Mich.

BLACKSMITHS

BLACKSMITHS, Listen! Wear the smile that won't come off, by doing hard jobs easy with Toy's Modern Methods on blacksmithing. Making all welds solid, tempering all tools to a standard with colored tempering charts. All for one dollar. Samples free. W. M. Toy, Sidney, Ohio.

ELECTRICAL

MAGNETO Generators (3 and 4 bar). Great thing for experimental purposes. Bell ringing and shocking machine, etc. Price \$3.50. Columbia Sales Agency, 643 Union Street, Columbia, Penna.

"BOY Electrician" Make Batteries, Dynamos, Motors, Electric Engine, Telephone, etc. 75 illustrations, 10c. Renew Dry Batteries, 3 guaranteed processes, 50c. Both, 25c. Ideal Book Shop, 3311-M Belleplaine Ave., Chicago.

TATTOOING Outfits, Electric and Hand. \$1 up. Roberts Company, 635 West Ave., Buffalo, N. Y.

STAMP COLLECTING

CHOOSE one. Sixty different Japanese, fifty Sweden, fifty Norway-Denmark, 205 foreign, 101 United States, fifty Asiatic, free. Remit 25c six months subscription McKel's Stamp Weekly, Boston, Mass.

FREE laundry packet to applicants for approval selections. Litten, Rock Island, Ill.

1,000 STAMPS from 40 countries 17c. Edward Lufbery, Wallingford, Conn.

OVER 300 Stamps, Album, Perforation gauge and interesting list 10c. Payn Stamp Co., 138 North Wellington St., Los Angeles, Calif.

STAMPS, 66 2/3% discount and premiums. Reference required. M. Place, Wrentham, Mass.

200 DIFFERENT foreign stamps for 12 cents. Head, 502 Park Place, Milwaukee, Wis.

STAMPS on approval at 60% to 80% discount. Leon Cass, Stroudsburg, Pa.

STAMPS Free! 50 different, including Russian War Charity Stamp. Send 4c postage, mention Gift P159, Bright & Son, 164 Strand, London, England.

STAMPS Exchanged. Trade your duplicates, plan 2c. Exchange St'p Co., 722 N. Linn St., Lancaster, Pa.

FREE! Send postal for our large bargain list of Sets, etc. Co-Operative Exchange, 1496 Bedford Ave., Brooklyn, N. Y.

CANADA Packet free. Many varieties, old issues, celebrations, etc. Postage 2c. Midland Stamp Company, Midland, Ontario.

I WANT to buy a good collection. Shalley, Linden Mills, Minneapolis, Minn.

WAR Tax Stamps used or unused. Postage approval. Reference necessary. Mrs. Oughtred, 28 Lincoln Ave., Montreal, Que.

STAMPS—50 different unused, 25c; 200 different foreign, 30c; Set Nyassa 1901 pictorial unused, 25c; Belgium Parcel Post, 8 rar., 7c; fine approvals, Graeme Tom, 2013 Palmer Ave., New Orleans, La.

STAMPS sent on approval at 75% discount. References required. Procents at 1/2 each. Emory Benoll, Hanover, Penna.

STAMPS—12 different from warring nations, 10c; 10 different foreign coins, 15c; 20 Belgian stamps, 10c. Lists free. Toledo Stamp Co., Toledo, Ohio.

FOREIGN Stamps Free; 52 different foreign, including China and Venezuela, to all who apply for our high grade approval sections. Send two-cent stamp for return postage. Edgewood Stamp Co., Dept. H, Milford, Conn.

25 DIFFERENT British Colonials to applicants for stamps on approval who send 2c postage. Nickles, 123 Florida Ave., Washington, D. C.

STAMPS—105 China, etc., stamp dictionary and list, 2c. Bullard, 87a, A, Boston.

STAMP Album with 538 Genuine Stamps, incl. Old Mexico, Malay (tiger), China (dragon), Tasmania (landscape), Jamaica (waterfalls), etc., 10c. 100 diff. Jap. N. Zid., etc., 5c. Big List, Coupons, etc., Free! We Buy Stamps. Hussman Stamp Co., St. Louis, Mo.

STAMPS, 100, all different, free. Postage 2c. Mention paper. Quaker Stamp Co., Toledo, Ohio.

24 VARIETIES Cuban stamps, 10 cents. List of 6,000 low-priced stamps free. Chambers Stamp Co., 111 P. Nassau St., New York City.

PACKET of 23 stamps; no two countries alike, 500 hinges. Set of \$1 and \$2 U. S. Rev., all for 5c. Mention paper. Miami Stamp Co., Toledo, Ohio.

RARE COINS

DID you know that the Exposition California gold tokens of 1915 are out, \$1.00, 50c, 25c sizes, and Alaska has New Gold tokens called one Pinch, $\frac{1}{2}$ Pinch, $\frac{3}{4}$ Pinch. Booklet for stamp. Coin Exchange, New Rochelle, N. Y.

MEXICO—Carranza or Villa currency, 100 Pesos, each 35c. Moore Coin Company, Commerce, Texas.

A COIN collection consisting of 1 large cent, $\frac{1}{2}$ cent, 1 2c piece, 1 bronze cent, 1 flying eagle cent, 1 three cent piece will be given for every 300 redeemable tobacco tags or coupons sent me, Bernard Pook, Box 17, Eaton, Ohio.

ALL for 30c, A California 25c gold token, a Columbia Nickel Coin Book and Lucky Seed. Selling list for stamp. C. J. Carey, New Rochelle, N. Y.

\$50.00 PAID for Dollar 1873 S. Mint; \$2.00 for 1904 Dollar, proof; \$7.00 for 1853 quarter, no arrows, etc. Many valuable coins in circulation. Watch your change. Look up your old money; you may have or get coins of premium value. Don't let a valuable coin slip away from you. Get Posted. Send only 4c. Get our Large Illustrated Coin Circular. It may mean large profits to you. You certainly have nothing to lose. Send Now to Numismatic Bank, Dept. H, Fort Worth, Texas.

\$4.25 EACH Paid for U. S. Flying Eagle Cents dated 1856. We pay cash premiums on hundreds of Old Coins. Send ten cents at once for New Illustrated Coin Value Book 4x7. It may mean your fortune. Clarke & Co., Coin Dealers, Box 15, Le Roy, N. Y.

FOR MEN

FOR Sale—40,000 pounds best leaf tobacco. Mail stamps for samples. Anton Warrin, Franklin, Ky.

TOWN Hall Cigars are now packed in boxes of 25 for 65 cents. A good 5 inch smoke, made of shor's which cannot be used for high priced cigars. You are therefore offered a cigar of extra quality at this remarkably low price. B. Reynolds, Distributor, 70 R. I. Ave., Washington, D. C.

MEN—Guaranteed safety razor and one blade, 25c, prepaid. Special introductory offer. Extra blades, 3 for 10c. Southern Supply Co., Bethen Building, Tampa, Fla.

FOR BOYS

BIG New Book for Boys—The Boy Mechanic, Vol. II.—Just out—A sequel to, but containing nothing found in Vol. I. Tells all about 1,000 interesting things to make and do. 480 Pages; 995 Illus., Cloth. Price, \$1.50 Postpaid. Send for descriptive circular. Popular Mechanics Book Dept., 6 N. Michigan Ave., Chicago.

FOR THE HOME

BUILD your own Fireless Cooker; worth \$7.50, cost 40c. Material obtainable anywhere. Complete drawings and instructions. 33c. Auburn Supply Company, Auburn, Alabama.

PIANOS AND MUSICAL INSTRUMENTS

VIOLIN (Paganini), good instrument, cash price \$85. F. Probst, Box 60, Linwood, Ont.

FINE Violins for quick sale. Low price. Easy payments. Sent on approval. Wilfred Munk, Watertown, N. Y.

MUSIC

RECORDS for Victrola, Columbia and Edison (disc or cylinder) Talking Machines. Edison Standard, 7c; Blue Amberol, 25c; Victrola, 15c; bought, sold and exchanged. Permanent Jewel Needle, \$1; Jewel point attachment for Victrola or Grafonola to play Edison disc records, \$2. Send for record list. Well's Curiosity Shop, 20 S. 2nd St., Philadelphia, Pa.

RAGTIME—Subscribe for "Christensen's Ragtime Review." Contains piano music, lessons in ragtime and theater piano playing. One dollar a year, or send 10 cents for sample copy. Axel Christensen, "Car of Ragtime," 542 Christensen Bldg., Chicago.

DANCE and Grand Opera Records for all makes of disc talking machines, 5c up. Write for list. Learn the new dances. Vernon Castle's illustrated book on Modern Dancing, \$1.50 value, 75c. Well's Curiosity Shop, 20 S. Second St., Philadelphia, Pa.

"FIGHT for the American Flag," latest patriotic song, and professional copy of "You Were, You Are, You'll Be," most wonderful love song ever written for 10c. Bauer Music Co., 145 East 34th St., New York.

"DREAMS," the greatest waltz ballad in years. For sale everywhere or direct from us, 10 cents. Marks-Goldsmith Co., Dept. 91, Washington, D. C.

DIAMONDS, WATCHES AND JEWELRY

DIAMOND La Vallieres, Snappy solid 12-carat gold La Vallieres, set with sparkling white genuine diamond and real pearl; 12-inch solid 10-carat gold chain. Actual retail value \$12.50. Our price \$3.00 with order and \$1.00 monthly for three months. Sent immediately upon receipt of order. Money immediately returned if dissatisfied for any reason whatever. Thomas Company, 2127 N. Park Ave., Philadelphia, Pa.

BUSINESS SERVICE

HOUSE to House distributing of circulars, booklets, samples, etc., in any city or town in Mass. Special distributing to Stationery, Grocery, Jewelry, Drug, Hardware stores, or tradesmen of any occupation within a fifty-mile radius of Boston. Hay State Distributing Service, 121 Mt. Auburn St., Cambridge, Mass., Room 17.

INCORPORATE. Our lawyers do the work, saving you time, annoyance and money in incorporating under the most liberal laws of Arizona. Laws and forms free. Southwestern Securities & Investment Co., Box D488, Phoenix, Ariz.

FORMULAS AND TRADE SECRETS

20,000 FORMULAS—Price \$1, postpaid; complete list 4c stamps. Edm. Bromley, Watervliet, N. Y.

100 MONEY-MAKING Formulas, 10c. Process Company, 415 Ft. Dearborn Building, Chicago.

1,650 FORMULAS 25c, resilver mirrors. Tattoo remover. Renew Dry Batteries. Make Printing Cuts 20c each. All 30c prepaid. Ideal Book Shop, 3311-M Belle-plaine Ave., Chicago.

\$1.00 CASH for best flashlight battery recipe. Otto Sengpiel, Seilman, Mo.

300 FORMULAS, Trade Secrets, Manufacturing Recipes, etc., three business plans for home manufacture, all for 25c. Formulary, Box 154, St. Paul, Minn.

ONE hundred commercial formulas for 25 cents (coins). All money makers. Coneywango Manufacturing Co., Box 1160, Warren, Pa.

HIGHGRADE formulas, all kinds, list for stamp. Information Bureau, 128 George St., Brooklyn.

GAMES AND ENTERTAINMENTS

MAGIC: We teach you to perform Tricks at home as good as the great professionals. Feature Acts in Mind Reading, Spiritualistic Work, Rope Ties, Escape Acts. Send for New Thumb Tie for stage work—7 Illustrations; complete directions, 50c. Catalogue 160 pages, greatest on earth, 10c. Chicago Magic Co., Dept. B, 72 W. Adams St., Chicago, Ill.

MAGIC Bargains! Handkerchief to Billiard Ball, 40c; Mysterious Rising Cards, 25c; Magician's Trick Cards, 30c; Vanishing and Reappearing Coin Trick, 25c; Multiplying Billiard Balls, 25c; Handkerchief Color Change, 25c; Excelsior Rope Tie, 15c; Blindfold Mind Reading, 15c. All above \$2.10 worth of tricks, only \$1.00 prepaid. Finest Illustrated Bargain Catalogue and Secret free. Magical Store, 1215 Nicollet Avenue, Minneapolis, Minn.

PLAYS, Vaudeville Sketches, Monologues, Dialogues, Speakers, Minstrel Material, Jokes, Recitations, Tableaux, Drills, Musical Pieces, Entertainments for all occasions. Make-up Goods. Large Catalog Free. T. S. Denison & Co., Dept. 11, Chicago.

CACHOO Sneeze Powder, Stink Bombs, Itching Powder, Trick Matches, Bear Charms, Bull-Charms, (new), 10c each. Agents wanted, Catalogue free. Empire Co., Olneyville, R. I.

500 WONDERFUL Magical bargains. Biggest list out. Free. Our Buffalo Green backs are perfection. Flashy roll, 10c. Gilmore, Morgan Park, Chicago.

"HAND 'Em a Lemon," New game. American Playing Cards, American Characters. Also play any old games. Easy money selling friends, 25 cents. Pleyte, 2445 Lisbon, Milwaukee.

GET This!!! Formula for Sneezing Powder. 7c. N. Zarlek, Frankfort, Indiana.

GREAT Magic Sale! Everything 25% off! Buy now—List Free. Douglas, Kiowa, Okla.

MAGIC Trick and "Magic News," 5c. Z. Israel, 440 East 148th, New York.

JOY 10-cent Book of 100 games, 100 tricks, 50 puzzles. Price 10 cents. Address Thomas May, Pilot Mount, Iowa.

MAGICIANS tricks, escapes, Ventriloquist and Punch Figures. All the latest. Prices low. Big catalog free. Magic Parlor, 192 Clifford, Providence, R. I.

PERPETUAL Motion—Automatic Power. Get this and fun begins—a laugh every time. Full explanation. Sent postpaid, 10c (two for 15c). Pesco Novelty Co., 315 Hale St., Pittsburgh, Pa.

BE a handcuff king. We teach you. Escape from handcuffs, boxes, ropes, etc. Secrets of 20 sensational escapes \$1. Particulars free. The Magician Co., Dept. A, Box 251, Detroit, Mich.

24 WAYS to Make Money and two issues of interesting magazine containing 55 valuable formulas, tricks, illusions and household hints, sent prepaid for 10c. C. Steenburgh, Box 191, St. Marys, Pa.

"MODERN Mysteries," the best magic book ever published. Anyone can become a magician. Fifty cents postpaid. Thurston Magic Company, Dept. PM, 3136 Emerson Ave., So., Minneapolis, Minn.

DISAPPEARING Card Trick and Chanlin Mustache. Both postpaid 10 cents. Ideal Supply Co., Box C-26, Arsenal Station, Pittsburgh, Pa.

TWO fifty-cent tricks, including catalogue, one dime. James Flynn, Leominster, Mass.

BE a Stage Cartoonist. Prof. Al Haffner, 726 N. 8th St., Philadelphia.

TRICKS, Puzzles, Jokes, Magic Goo's, Sensational Escapes, and Illusions, Big catalogue free. Oaks Magic Co., Dept. 254, Oshkosh, Wis.

TYPEWRITERS AND SUPPLIES

LARGEST Stock of Typewriters in America—All makes; Underwoods, Olivers, Remingtons, etc., one-fourth to one-half manufacturers' prices, \$15 up, rented anywhere, applying rent on price; free trial; installment payments if desired. Write for catalogue 70. Typewriter Emporium (Established 1892), 24-36 West Lake Street, Chicago, Illinois.

GOOD, serviceable typewriters \$7.50 and up. Post card brings list. First class ribbons any machine, 25c. Hub Typewriter Co., 285 Devonshire St., Boston.

(CONTINUED ON PAGE 162 BACK ADVERTISING SECTION)

**Act NOW Before
It Is Too Late**



MAIL THIS "BIG PAY ENVELOPE" COUPON—TODAY

- | | |
|---|---|
| <input type="checkbox"/> Machine Drafting | <input type="checkbox"/> Plan Reading |
| <input type="checkbox"/> Electrical Drafting | <input type="checkbox"/> Estimating |
| <input type="checkbox"/> Architectural Drafting | <input type="checkbox"/> Sheet Metal Drafting |
| <input type="checkbox"/> Structural Drafting | <input type="checkbox"/> Civil Engineering |
| <input type="checkbox"/> Builders' Course | <input type="checkbox"/> Surveying |

1050

Name

Address

Town

State

College or Home Study Course

**Complete \$45 Course
In Mechanical Drawing Includ-
ing Elegant \$15 Drawing Outfit**

FREE

Here is a wonderful opportunity for the fellow that looks ahead—that doesn't want to get in a rut. An unexcelled opportunity for ambitious young men. While this special offer lasts we will give in addition to the Free \$45 Course a complete \$15 Drawing outfit, making the most extraordinary free offer of \$60 given to you if you act quick.

**HERE'S
YOUR
CHANCE
TO LEARN**

DRAFTING

**MEN
WANTED
AT BIG
SALARIES**

It will cost you nothing to get full information; an inquiry will not obligate you in any way. Sign, tear and mail the coupon now. It is up to you and you alone whether you fit yourself for the big job—whether you draw the big pay. Let us make you a big earner. Prosperity and opportunity are here NOW. Fit yourself to grasp big things.



CHARLES W. MOREY
President of the College
Head of the firm of
Charles W. Morey & Co.,
Consulting Engineers.

STUDY AT HOME

Your Spare Hours Are Enough. This old established college has set aside a limited number of these free scholarships. This offer will be withdrawn when the allotted number has been used up. Hundreds of men are in daily attendance in the day and evening schools of the College. In your own home you can do the same work these men are doing and the same experts that teach them will teach you. These well known architects and engineers know exactly the practical training you need, and they train you—they prepare your instruction matter—your work is examined and approved by them.

EARN FROM \$3000 to \$5000 a YEAR

There is such a job for you if you have the training. The country is facing greater prosperity than it has ever before experienced. Far seeing men are preparing for booming times. The railroads, small factories, Big Business simply must make up the retrenchments of the last few years. Train your mind—be ready. All branches of

DRAFTING — ENGINEERING

CIVIL — ELECTRICAL — MECHANICAL — ARCHITECTURAL

are now calling for trained men. We can't fill all the applications we get. (Our employment bureau is free to all our graduates). Drafting is the bed-rock foundation of every engineering job. The structural plans for the great \$3,000,000 Cook County Hospital and many of the buildings, machinery and steel work now being constructed in Chicago, New York and other large cities were made by the engineering firm headed by Pres. Morey. And "Chicago Tech." students study and work with these live up-to-date plans of work in course of construction or recently constructed.

WE GIVE TWO ADVANTAGES OFFERED BY NO OTHER CORRESPONDENCE COURSE IN AMERICA

First—No other similar correspondence work in the World has a resident College or national reputation back of it nor a faculty of active experts actually engaged in municipal and corporation engineering work. Think what it means to you to have these men guide you in your own home to your big job. **Second**—Instead of purely theoretical work alone Chicago Tech. students study and work with live, up-to-date blue prints of work in actual construction. No old theoretical book plates to merely copy, no books to buy, just a straightforward, practical course, planned and taught by some of Chicago's most prominent architects and engineers, who are in constant charge of real work—big work. It costs you nothing to get full information. No obligation on you. Fill out coupon today.



E. OTTOMANN, Jr.
Consulting Engineer
Secretary of College



WM. T. HOOPER
Architect. Vice-Pres.
of College. Head of
Dept. Architecture.



M. M. CASE
Consulting Engineer
Head of Mechanical and
Electrical Depts.

CHICAGO TECHNICAL COLLEGE

1050 LAKE VIEW BUILDING, CHICAGO

HOW TO INCREASE YOUR LIVING POWER

How To Increase Health Promoting Power, Mind Power, Will Power and Pleasure Obtaining Power To An Unusual Degree Without Inconvenience, Apparatus, Drugs, Loss of Time or Study Through Conscious Evolution

The Story of "Conscious Evolution" and its Discoverer

By DONALD RICHARDSON

THE simple fact that the human body is built up of billions of cells, all resulting from the evolution of one original cell, is in itself interesting, but little more to the average person. The further declaration that health, life and pleasures of the body depend upon the condition of each individual cell compels notice.

When, however, along comes an individual who combines intimate scientific knowledge of the human cell with the discovery of the means to insure its health and develop unusual energy and potency—who by reason of study, experience and a certain genius, shows us how, without inconvenience, apparatus, drugs, study or loss of time, we can put unusual health and uncommon life into every one of our vast multitude of cells, thus giving the human body and mind the maximum of health, pleasure and power, and do this in a very perfectly natural, easy and practical way—then we are all attention.

A Great Secret of Life

This is the marvelous secret uncovered in a wonderful little book by Swoboda, a great pioneer in the realm of physiological science. Some day the complete history of "Conscious Evolution" and its discoverer will be recorded, with all its immense significance and far-reaching ramifications. This brief article can only sketch the rough outlines.

The story of Alois P. Swoboda is one of the romances of human history. As the discoverer of the origin and nature of the laws governing "conscious energy," and of a scientific system for applying those laws in a manner that has operated successfully in over two hundred thousand cases, Swoboda occupies a peculiar niche in earth's hall of fame. He did not merely write a great book, paint a great picture, invent some useful device, or win some particular battle. His fame is built on a far more substantial foundation. He is the wizard of the human body. He is the apostle of the greater, the successful life. Swoboda not only re-creates men and women; he makes them more powerful, capable, and happy than they were before. He advances them a tremendous way along the line of human development. The man himself—as well as his hosts of enthusiastic clients—is a most convincing example of the effectiveness of his methods. He has revolutionized the methods of energizing the body and mind.

The Swoboda System of Conscious Evolution Based on a Knowledge of all Sciences

Swoboda fairly radiates vitality, his whole being pulsating with unusual life and energy. And his mind is even more alert and active than his body; he is tireless. He discourses with learned fluency on the science of "Conscious Evolution," which embraces all other sciences entering with equal ease and facility on any phase of this all-important subject. Start him on his particular specialty—the development of human powers—and he pours out a veritable flood of illuminating exposition. Earnest and vehement, he rises to eloquence as he unfolds in his masterful manner the magnificent possibilities of man under the guidance of "conscious energy." You are impressed with the fact that you are in the presence of a remarkable personality, a superior product of the Swoboda system of body and personality building. Swoboda embodies in his own super-developed person the best proof of the correctness of his theories and of the success of his "Conscious Evolution."

The Aim of Conscious Evolution is Better Minds, Better Bodies, Better Health and More Intense Pleasures

Mr. Swoboda must not be classed with ordinary physiologists, physicians, faddists or with those whose aim is merely the development of muscle. Neither his philosophy nor his science is confined to such narrow limits. Swoboda's plan comprehends the complete development of the human being—increase of internal force, more body power, more brain power, mind power, and, in fact, greater capacity to live and enjoy in every way. He is primarily interested in those influences which make for a fuller and more potent life.

One cannot remain long in the presence of Swoboda without realizing that he is mentally and physically a superman. He makes you feel that you are only partially well, and vigorous and ambitious, only partially developed, that, in short, you are only half as alive as you must be if you wish to enjoy to the full the benefits of living—that you are leading an inferior life. No one can read his book without becoming conscious of his wonderful power and personality.

Swoboda is a Man Who is Centuries in Advance of His Time

His discovery of Conscious Evolution is itself of epochal importance. But its scientific and successful application is more wonderful still.

The feat of Franklin in drawing the electric spark from the clouds was a wonder of the time. Yet it took a hundred years to master the secret of that electric spark and harness the giant force of electricity to the uses of mankind. Swoboda not only discovered the marvelous secret and principle of Conscious Evolution, but applies it to individuals with results that are incalculable. Swoboda might, indeed, be called a specialist for the human race.

A single electric spark is of little importance. But intensify that spark and multiply it a billionfold, and you have the power, the heat and the dazzling lights of a great city. So with our cells, says Swoboda. Quicken one, and it makes little difference. But energize and intensify them all, and you have a "live-wire" human being, with mental and physical potency plus!—the Swoboda kind of body and mind.

What would happen to a business man who allowed half of his workmen to idle away at their machines, not only losing their own time and effort, but interfering with the producing power of the rest of the force? Yet that is exactly what the average human being does with the workers in his physiological factory. You have a most ingenious pleasure and power producing machine in your possession. The machine that means health or weakness, pleasure, happiness, success or failure, and yet you allow it to practically run itself, or erroneously believe that when this machine is ready to completely crumble that some physician possesses the magic power of restoring your health and life through the use of a drug. Far from securing health and pleasure, however, this resort to and belief in extraneous assistance really encourages physical and mental decay, because it weakens, by non-use and neglect, the body's natural resources, power, and means of recuperation.

The Human Body is a "War Machine"

The commander who goes into battle with an incapable army is handicapped at the start. The man who goes into the battle of life with his physiological forces far below par is foredoomed to at least partial failure. The great bulk of us are hardly drawing on our tremendous stores of energy and vitality. We are letting our cells grow stale and sluggish. Our human machine should be running in perfect condition in order that we may get the most out of it, before we can enjoy its full powers in complete and rounded fashion. Strengthen the vitality of these cells and you not only make the body more alive, but the brain more susceptible to new ideas from without, as well as greatly increase its own power to generate ideas. Many a man is getting a great deal of pleasure out of his mind, but nothing out of his body.

Ponce de Leon's fountain of youth died with him. Your fountain of youth will die with you. Each man's fountain of youth is within himself. Through Conscious Evolution only can you drink to the full of the fountain of youth.

Swoboda demonstrates that, no matter how old we may be, we can, through the conscious use of the principles of Evolution, make ourselves full-powered dynamos, with every part and wheel and power-belt

thoroughly in trim, working smoothly and at maximum capacity—100 per cent efficient.

If you believe you have developed to the highest degree your vitality, energy and powers of living and enjoying, you are, according to the Swoboda Standard, indeed mistaken. Conscious Evolution can lead you to a new and even greater realization of health, energy and pleasure.

More power, energy and life are the needs and will be the salvation of the present generation. The problem has always been how to get them. Eagerly we try each solution offered, swarming like the Athenians after every new thing. And yet the means lie right within us, as Swoboda clearly demonstrates.

Conscious Evolution is an antidote to old age in its every form and variety of conditions. It scientifically reduces excessive blood pressure, restores elasticity to arteries and turns the dial of physiological time in the direction of youth, efficiency, vitality and greater pleasure.

No one who is energized through Conscious Evolution will be subject to indigestion, intestinal sluggishness, nervous exhaustion, brain fag, sleeplessness, nervousness, or any functional difficulty of any character.

Swoboda Has Written a Wonderful Little Book

This book explains the Swoboda System of Conscious Evolution and the human body as it has never been explained before. It makes clear Swoboda's new theory of the mind and body. It startles, educates and enlightens. It tells how the cells build the body and how to organize them beyond the point where nature left off, for each one of us. It will give you a better understanding of yourself than you could obtain from a college course; the information which it imparts cannot be duplicated elsewhere at any price. It shows the unlimited possibilities through conscious evolution of the cells; it explains Swoboda's discoveries and what they are doing for thousands of men and women of every age and condition. It tells of the Dangers and After-effects of Exercise, and Conscious Deep Breathing. Swoboda's book shows how any one may possess unusual health and vitality.

You will cherish this book for having given you the first real understanding of your body and mind and for showing you how you may be able to attain greater pleasure and in every way a superior life.

Thousands have advanced themselves in every way through a better realization and conscious use of the principles of evolution which Swoboda discovered. It will open new avenues through which you may become successful in satisfying your most intense desires. It is not a dry treatise on physiology; on the contrary, it tells in a highly interesting and simple manner just what you need to know about the body and mind and the laws of their evolution.

Do not fail to take advantage of this opportunity to obtain a copy of this book while it is free. Address Alois P. Swoboda, 1331 Aeolian Bldg., New York City.

Since writing the above the writer has met a man who said: "Although I have been a close student of the body and mind all my life, and am a writer on the subject, Mr. Swoboda's book gave me a deeper conception of the body and mind than I have attained from years of study. Intellectual men and women must find his book of great interest. His theory of the body and mind was entirely new to me, and I believe that he is right."

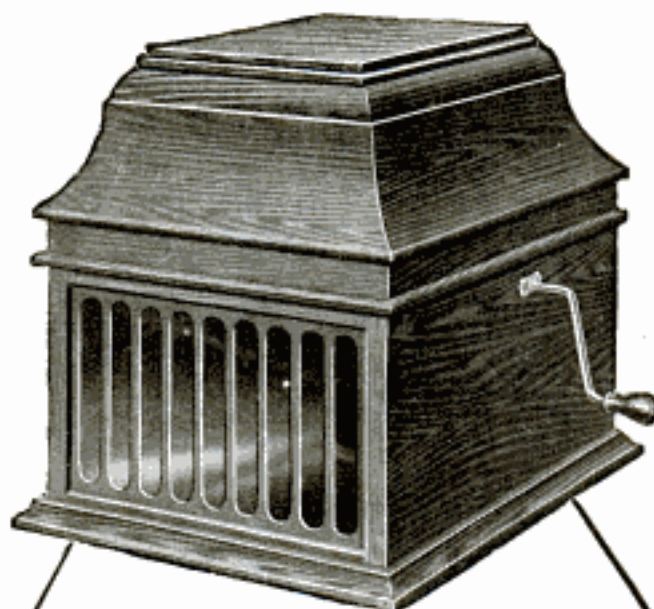

\$100

and You Keep This Superb New Edison

An astounding offer—the great New Edison with the new Diamond Stylus reproducer and your choice of all the brand new Diamond Amberol Records will be sent to you on free trial without a penny down. The finest, the best that money can buy at very very much less than the price at which imitations of the genuine Edison are offered—a rock-bottom offer direct from us.

Entertain Your Friends

Hear all the latest up-to-date song hits of the big cities. Laugh until the tears stream down your face from laughing at the funniest of minstrel shows. Entertain your family and your friends with everything from Grand Opera to Comic Vaudeville — then if you choose, send the outfit back to us at our expense.

Rock-Bottom Direct Offer

If you wish to keep Mr. Edison's superb new instrument, send us only \$1.00 after the free trial. Pay the balance on the easiest kind of monthly payments. Think of it — a \$1.00 payment, and a few dollars a month to get this brand new style outfit—the Diamond Stylus reproducer, the musical quality—the same Diamond Amberol Records—all the musical results of the highest price outfits—yes, the greatest value for \$1.00 down, balance on easiest monthly terms. Convince yourself — a free trial first! No money down, no C. O. D., not one cent to pay us unless you choose to keep the instrument.

Our New Edison Catalog Sent Free

To
F. K. Babson
Edison
Photograph Distributors
1197 Edison Blk.,
Chicago, Ill.

Your name and address on a postal or a letter (or just the coupon) is enough. No obligations in asking for the catalog. Get this offer — while this offer lasts. Fill out coupon today.

F. K. BABSON
Edison Photograph Distributors
1197 Edison Block
Chicago, Ill.

Canadian Office:
355 Portage Ave.,
Winnipeg,
Manitoba.

Name

Address

Learn to PAINT SIGNS and SHOW CARDS

I'll teach you personally by mail. 16 years' successful teaching. Big field for men and women. You can **Earn \$18.00 to \$45.00 a Week** Show (Ky.) says, "Your personal criticisms worth price of course." Write me for outlines of courses.

DETROIT SCHOOL OF LETTERING
Chas. J. Strom, Founder Dept. 210, Detroit, Mich.



MAGIC

We will send you two card tricks, very perplexing to onlookers, yet anyone can do them. Also booklets showing over 100 different Magic Tricks and Jokes. All for **10c.**

THE MAGIC SHOP, 52 North 13th Street, Phila., Pa.



LEARN PIANO TUNING AT HOME

My Patented Tune-a-Phone method makes it easy. Eliminates guess work. Anyone can learn. A. D. Pope, Texas, made \$80 first ten days. Course guaranteed as represented. Diploma granted. Write for free booklet, graduate's records, etc.

Wiles Bryant School of Piano Tuning, 450 East Bldg. Battle Creek, Michigan



Be an Artist AND DRAW for Magazines, Newspapers, Etc. Earn Big Money

All Branches of Art Taught BY MAIL or Local Classes. Write for illustrated booklet, terms and list of successful pupils.

ASSOCIATED ART STUDIOS, 2122 Flatiron Bldg., NEW YORK



GACHOO! Make the whole family "just sneeze their heads off" without knowing why, with **Cachoo**, the new long distance harmless snuff. Sent anywhere for 10c. 3 for 25c, 1 doz. and special premium for 90c. **AMERICAN SUPPLY CO., St. Paul, Minn.**



Place the 9 figures so the 2nd row is twice as much as top row and bottom row as much as top and 2nd row added together. All correct replies will receive 25 cents worth of our iron puzzles with catalog postpaid. Answers not correct will receive solution. Catalog of 200 puzzles and one of our leading 15c. products. All answers to enclose 10c. in stamps or coin to cover mailing, packing, etc.

WESTERN PUZZLE WORKS, St. Paul, Minn.

123
456
789

Every Boy His Own Toymaker

Greatest boys' book ever written. Tells how to make a Steam Engine, Telephone, Magic Lantern, Boats, Kites, Balloons, electrical and mechanical toys, traps, fishing tackle, 200 illustrations; also catalog of 150 puzzles, Kaller's Magic Ace Trick Card and "Houss & Tootle's" warbler and bird call all for only 10c. **WESTERN PUZZLE CO. ST. PAUL, MINN.**



DON'T TRY TO BE A CHAUFFEUR

or go to ANY SCHOOL to learn, or part with your hard earned dollars until you have read our valuable guide FIRST. It tells what you should PAY and what you should GET. Do not be deceived by schools which claim everything and give you nothing. **YOU CAN'T AFFORD TO SPEND ONE CENT TILL YOU GET OUR GUIDE.** It costs nothing and may save you many dollars. Write now for this FREE BOOK.

PRACTICAL AUTO SCHOOL, 68 Beaver St., New York

GET THIS BOOK FIRST.

JEWELRY ENGRAVING

We teach you, by our new and original method of instruction, this clean, fascinating and profitable business right at your home, and furnish you all tools needed absolutely free. Write for free book to the

WISCONSIN SCHOOL OF ENGRAVING, Strub Bldg., MILWAUKEE, WIS.

THIS COURSE MEANS MORE MONEY FOR YOU

Increase your income writing show cards. Big opportunity for ambitious men and women. Experience unnecessary. Our practical course teaches you quickly and explains the remarkable results obtained with Litholia Colors. Whatever your position, write for FREE BOOKLET now.

LITHOLIA COLOR CO.
\$21 to \$50 a week
1040 Flatiron Building NEW YORK





Learn a Paying Profession

that assures you a good income and position for life. For twenty years we have successfully taught

PHOTOGRAPHY

Photo-Engraving and Three-Color Work

Our graduates earn \$20 to \$50 a week. We assist them to secure these positions. Learn how you can become successful. Terms easy—living inexpensive. Write for catalogue—NOW!

ILLINOIS COLLEGE OF PHOTOGRAPHY, 999 Wabash Avenue, Effingham, Ill.

New York ELECTRICAL School

Gives you a complete training by actual practice. You get the knack of "HOW" together with the theory of "WHY" and the best business methods used in the World of Electrical Activity.

The N. Y. Electrical School is the pioneer and premier school of the "Learn by Doing" method. When you have completed this Course you shall be fully qualified to handle ALL branches of Electrical industry.

The equipment of this School is unequalled and up-to-the-minute. No preparation needed to become a "learner" in this school. You can start to learn on any day of any week throughout the whole year.

Visitors heartily welcomed. Send for catalogue.

44 West 17th St. New York City
N. Y. ELECTRICAL SCHOOL

LEWIS INSTITUTE

An Endowed Polytechnic School for Both Sexes. College Work in Mechanical and Electrical Engineering, and in Mechanic, Household, and Liberal Arts, leading to degree of B. S. High School Instruction in Science, Literature and Technology. Well equipped Shops and Laboratories. Day and Evening Sessions. Fall Term opens Sept. 14. For Bulletin, address, LEWIS INSTITUTE, Dept. 9, Madison and Reber Sts., CHICAGO

The University of Chicago

HOME STUDY

in addition to resident work, offers also instruction by correspondence.

For detailed information address

24th Year U. of C. (Div. 20) Chicago, Ill.



McCall Tower

EARN TELEGRAPH

Morse and Wireless—R. R. Accounting (Station Agency) taught. Splendid opportunities. Positions secured. Marconi Co. takes our wireless graduates. We own and exclusively occupy two large modern buildings equipped with R. R. and Western Union wires and complete \$5,000 Marconi Wireless Station. Largest School—established 40 years. Investment \$25,000. Endorsed by Railroad, Marconi and Western Union Officials. Expert, practical teachers. Low living expenses; easily earned if desired. Tuition low. Easy payments. Correspondence courses also. Catalogue Free.

Dodge's Telegraph, Ry. & Wireless Institute
5th Street, Valparaiso, Ind.



THINK! THEN ACT

Mechanical Draftsmen earn Big Wages. Complete course at home 4 MONTHS. Drawing Outfit Free. Terms Low. Ask for circular "P."

MODERN CORRESPONDENCE SCHOOL, Newark, N.J.



\$125 to \$300 A MONTH

Don't hesitate. Write to us at once and find out about this wonderful opportunity. Hundreds of Signal Men and Signal Engineers are needed right now. Are you able to accept one of these positions? Have you had the training that will enable you to forge ahead and earn big money? All the way from \$125 to \$300 per month. If not, you cannot afford to put off writing us. Send at once for our big book which tells you all about the wonderful new profession of Signal Engineering. After a short time you will be in a position to earn more money. By our plan you can become our Representative immediately. So don't wait. Write us today. Get this special offer NOW.

More Men Needed

The railroads are constantly looking for competent Signal Men and Signal Engineers. There are not enough men to fill the positions. Thousands and thousands of miles of tracks are to be equipped with automatic signals. More Signal Men are needed to superintend the work. Many new positions will be open and there are not enough men to take them. Besides a profession in which you can make a lot of money, Signal Engineering is the most fascinating work. So don't delay. Write today and find out about this wonderful opportunity.

Free Coupon

Just put your name and address on the free coupon and send it to us at once. You are under no obligations of any kind. We will send you the big new Signal Book which tells you all about this wonderful profession absolutely free. This book tells you how you can earn from \$125 to \$300 a month. Don't wait. Write today.

FREE BOOK COUPON

Dept. of Signaling
Room 1197, 1810 Wilson Ave.
Ravenswood Station, Chicago, Ill.

GENTLEMEN: Please send me absolutely free and prepaid your big new Signal book. It is distinctly understood that I assume no obligations of any kind.

Dept. of Signaling

Room 1197
1810 Wilson Ave.
Ravenswood Sta.
CHICAGO,
ILL.

Name

Address

Age.....Occupation.....

Please Mention Popular Mechanics

An Expert ACCOUNTANT

Holds a Job Like This

He is the Man Who Knows—
In Touch with Every Detail.



Could You
Fill This
Place?

He knows the Theory of Accounts, Practical Accounting, Cost Accounting, Auditing, Business Law, Organization, Management, etc.

Higher Accounting LEARN At Home By Mail

No need to leave your present occupation. You can thoroughly prepare yourself by the use of your spare time. The demand for qualified accountants is vastly in excess of the supply—not enough in the entire country to meet the needs of a single city like New York or Chicago. The opportunities are simply unlimited for well-trained men. Become an expert in the higher branches of this work. Get away from drudgery and poor pay. A little time and application will prepare you for the place higher up. The home of economic business efficiency is in the accounting department. The successful conduct of a business and the highest order of efficiency in all departments depend upon the constant supervision of the expert accountant. His services have become an absolute necessity. Many positions of this kind are paying over \$10,000 per annum. No line of work carries greater dignity or importance. Thousands of expert accountants have developed into executives of rare ability, all because of their training and intimate knowledge of economic principles and scientific methods. Decide today, now, that you will write and learn of the splendid course of training we offer; how you can become an expert accountant or a C. P. A. by the use of your spare time at home. Our facilities to teach you by correspondence are unexcelled. The course we offer has been prepared under the general supervision of

WILLIAM ARTHUR CHASE, LL. B., C. P. A.
President of the American Association of Certified
Public Accountant Examiners

Former Member of the Illinois State Board of Examiners in Accountancy, and
Author of "C. P. A. Examinations and How to Pass Them," which treatise forms
part of the text material furnished in this course.

Your instruction will be under the direction of experts who rank among the very highest. You can cover the complete course in *One Year*. No expense has been spared to make this the finest course of its kind in America. Let us tell you all about it. Write immediately for catalog and particulars describing our unique plan of instruction. All information is free. Send in the Coupon now. You will be surprised when you learn how easily you can prepare yourself for this profitable line of work.

Our Big Scholarship Offer

We are offering a limited number of reduced scholarships to those who, by occupation, make desirable students. Ambitious men will find our course a positive means to qualify for large incomes. Write today and learn of this limited scholarship offer.

Tell us your occupation and we will advise you promptly if eligible for one of these reduced-rate scholarships. Don't wait until the offer is withdrawn and it is too late. You may never have another opportunity like this. It will cost you nothing to inquire about this offer. Our handsome catalog and all particulars are free for the asking. Send for them now. Easy monthly payments within the reach of all.

LaSALLE
EXTENSION
UNIVERSITY,

Dept. H. 782
CHICAGO,
ILL.

Please Mention Popular Mechanics

LEARN IN 3 MONTHS TO EARN \$1300 TO \$4000 A YEAR

MECHANICAL DENTISTS DO IT—the demand is years ahead of the supply. Any man or woman can learn, no previous schooling or entrance examinations required. PROF. HODGE, the most ingenious and thorough mechanical dentist in America, instructs each student personally.

ESTAB. 1892

BODEE TRADE DENTAL SCHOOL

15-17 W. 44th St. NEW YORK CITY

The first and only school recognized by the Dental Profession. Not a correspondence school. Practical individual instruction on actual cases in our large laboratory; no book study. Tuition payable in moderate monthly installments; we assist you to positions. Students received at any date.
WRITE TODAY FOR CATALOG P

GOOD MEN WANTED

at once to learn the auto business. Big future for you or anyone who makes himself an auto expert. You learn here by doing the work yourself. Lifetime opportunity to learn the highest and most expensive auto work ever given. Omaha's NEW Auto Training College, one of the largest in the west, conducted by experienced Automobile men of Omaha, giving the highest and finest practical auto training work to be found anywhere. Experienced repairmen come and take to become experts, work. You get than you can at any shop, we have equipment, and instructors diploma that they don't even know. **College**
AUTO
\$900 to \$3,000 a Year, Salary or Bus. Profits in Repairshop or Garage, or as Salesman, Factory Testers, Chauffeurs, Repairsmen, Starter Experts or Garage Manager. If ever you are going to make a change to get into a higher paying and more pleasant line of work, DO IT NOW, the opportunities are the best now that they have ever been. Take our wonderful training course now until you are competent, and then go right into the automobile business from here. Positions now open needing capable men, and we want some good men at once to take up this work. Special \$50 course in Elec. Starting and Tractorwork FREE with regular course. Learn here in 6 wks. or more. Tuition small. Life scholarship. Work easy and interesting. Many make expenses while learning. Free catalog at once.
AMERICAN AUTO COLLEGE, 353 Auto Bldg., Omaha, Neb.

Practical Electrical Education

Our practical course in Electrical Science and Engineering trains you to get and keep the big-pay jobs. Enter at any time, no matter what your education. Advance as fast as you can master the work. Course combines theory with actual practice in all branches of Electrical Science. Individual instruction. Only practical training school of its kind in U. S. Endorsed by leading electrical employers past 10 years. Our trained students always in demand and well paid. Write for FREE ILLUSTRATED CATALOG. School of Engineering of Milwaukee, 213 5th Bldg., Milwaukee, Wis.



LANGUAGES Quickly Learned AT HOME by the Original

German—French—English—Italian—Spanish or any other language learned quickly and easily by the Cortina Method at home with Disk Cortina-Records. Write for free booklet today; easy payment plan.

CORTINA ACADEMY OF LANGUAGES
1610 Meera Bldg., 1600 Broadway,
Corner 48th Street, New York

CORTINA-PHONE

Taxidermy Book FREE



Write today

Stuff Beautiful Birds. Learn by mail to stuff and mount

all kinds of birds, animals, fish and game heads; make rugs, tan skins. Mount your own specimens and make money preserving for others. Men, women and boys learn easily and quickly. Success guaranteed or no tuition. Write today for our wonderful FREE book "How to Learn to Mount Birds and Animals. N.W. School of Taxidermy, 9197 Elwood Bldg. Omaha, Neb.

LEARN WATCHMAKING

Engraving and Jewelry Repairing. Practical specialists in charge of all instruction. Students trained for the best paying positions. Earn while learning. Our school is endorsed and recommended by leading jewelers. A few months will make you an expert. Positions secured for graduates. Demand for watchmakers greater than the supply. Write for free catalog.

CHICAGO SCHOOL OF WATCHMAKING, 63 E. Van Buren St., CHICAGO

LEARN ELECTRICITY**Mail Today****Earn \$100⁰⁰ to \$250⁰⁰ a Month**

Name.....

Thousands of trained men are needed in this great unlimited field of ELECTRICITY. We can train YOU for one of these big jobs that are NOW OPEN, paying \$100.00 a month and up. Experts teach you in a surprisingly short time. Not by correspondence or books, but under actual working conditions in our big shops. Tools and material furnished FREE.

Address.....

COYNE NATIONAL TRADE SCHOOLS**Men Wanted for These Trades****Electricity, Plumbing, Bricklaying, Motion Picture Operating, Mechanical Drawing**

We teach all these big paying trades by thorough practical methods and they are demanding more and more trained men EVERYWHERE to fill the big paying positions. As soon as you finish your course you can go right out and get a job paying \$6.00 to \$8.00 a day or go into business for yourself and make from \$3000.00 to \$7500.00 a year. Our School is open all the year. You can enter at any time. Day and evening sessions. The ages of our students range from 15 to 50 years. Many earn a part or all of their expenses while learning. We assist you in doing this. Drawing, Estimating and Plan Reading included in all courses. We assist our graduates to positions.

B. W. COOKE, Manager
Coyne National Trade Schools
Dept. 9197
39-51 E. Illinois St., Chicago, Ill.

Without cost or obligation on me, send me your "Trades Manual" and full particulars—**ALL FREE.**

**Learn by Doing**

THOUSANDS OF SUCCESSFUL GRADUATES

Learn In Short Time At Small Expense

In order to supply these trades with trained men we are charging a small tuition fee and this can be made in easy payments if desired. Remember, we furnish all equipment and tools free. All instruction is individual under the personal guidance of expert instructors of long experience in their particular field. This enables a man to master his trade thoroughly and quickly.

SEND COUPON FOR BIG FREE BOOK

Send the coupon today for your copy of this book. Take this step towards success. Let us tell you how you can master one of these big trades in a short time—make a bigger success than you ever dreamed of making. Mail the coupon today—now.

B. W. COOKE, Manager**COYNE NATIONAL TRADE SCHOOLS**39-51 E. Illinois Street
Dept. 9197, CHICAGO, ILL.

If you live in or near Chicago come over and go through our school's and see our students at work and how thoroughly they are taught.



WE OCCUPY ENTIRE BUILDING

Do You Like to Draw?
Cartoonists Are Well Paid

We will not give you any grand prize if you answer this ad. Nor will we claim to make you rich in a week. But if you are anxious to develop your talent with a successful cartoonist, so you can make money, send a copy of this picture, with 5¢ in stamps for portfolio of cartoons and sample lesson plate, and let us explain.

The W. L. Evans School of Cartooning
821 Leader Bldg., Cleveland, O.

**PRACTICAL ART**

Invest your spare time.

Learn call and sign writing, and lettering. Big growth of advertising makes constant demand for my graduates. I prove there is a big field. Earn a good salary or start in business. Earn while you learn. Cartoonists—learn to letter. It will help you. Course self paying. Work easy, pleasant. I personally correct all lessons. Write for free booklet, testimonials, etc.
Residing School of Lettering and Design, 730 Union Bldg., Cleveland, Ohio

LAW BOOK FREE

Be Sure to Get This 80-page Free Book Before You Enroll for Any Law Course No matter which school or which course you may be considering—no matter which method of instruction you may favor—be sure to read "How to Acquire a Legal Training" before you enroll. One of the greatest free books on law ever offered. Tells how to weigh and judge the claims of correspondence schools. Tells just what a law course should contain to give you the training absolutely necessary to succeed in the legal profession. Tells the easiest and best way to become a lawyer by studying at home, and explains all about the American School's simple method of home law instruction. Prepared by 56 of America's greatest legal authorities—25 more subjects and 50 more authors than any other correspondence law course.

FREE 13 Volume Law Library and 60 Text Books

With each course we furnish 60 new pocket size Text Books, 36 Case Books, and our big 13 volume Law Library. Written in plain, simple, easily understood language especially for correspondence instruction. Don't fail to investigate this wonderfully complete and practical course before taking up the study of law—send for your free book today. Just drop us a postal—there is no obligation—it is absolutely free for the coupon.

American School
of Correspondence, Chicago, U.S.A.

NAME.....

ADDRESS.....

FREE BOOK COUPON

Pop.
Mech.
10-15
A. S. of C.

Gentlemen:
Please send me your FREE Law Book, "How to Acquire a Legal Training," and full particulars regarding your wonderful new system of correspondence law instruction.

LEARN THE AUTOMOBILE BUSINESS BY ←

THE SWEENEY SYSTEM

OF PRACTICAL EXPERIENCE IN EIGHT WEEKS

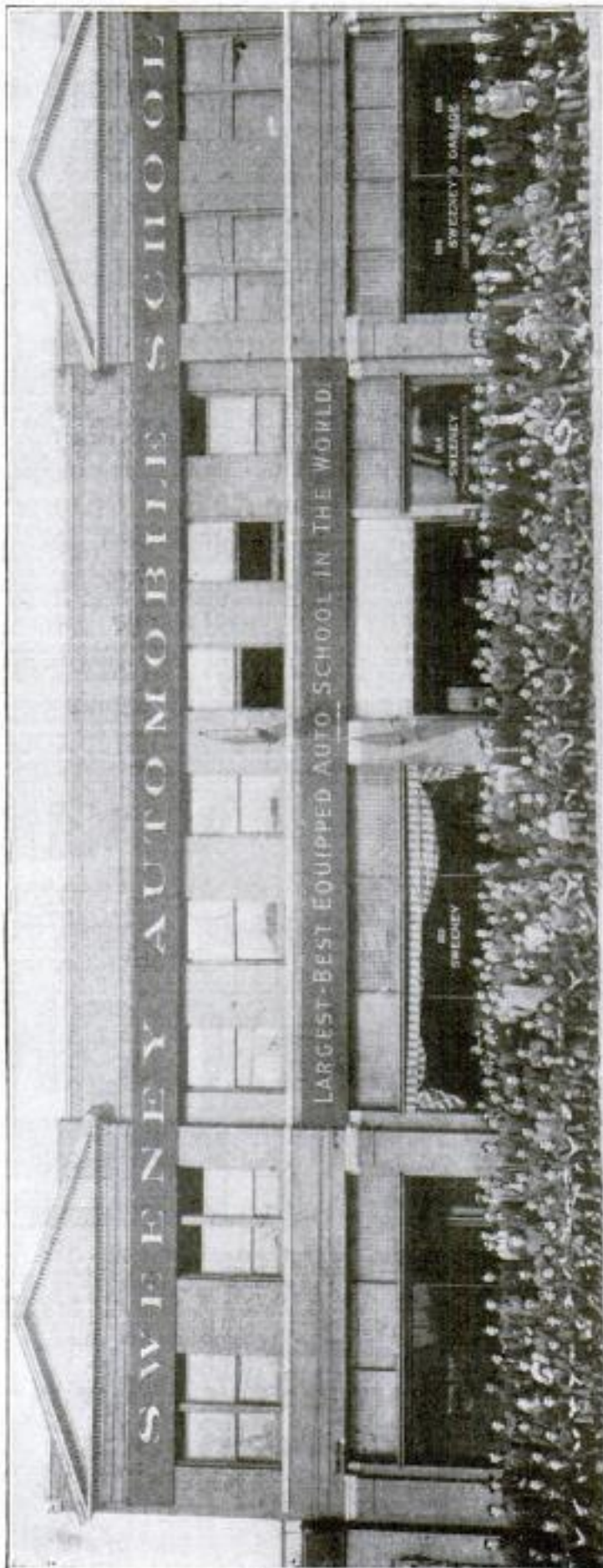

Students from 42 states. Class of January, 1915. Largest body of men that ever attended an automobile school

THAT there's money in the Automobile business for you is proven by the experience of thousands of successful graduates. If you want to make \$5 a day — earn from \$60 to \$150 a month — or own an independent business, the Sweeney System of practical instruction will fit you in 8 weeks to accomplish your aim.

There's only one place in the world to learn by the Sweeney System; and that is at the School of practical experience where you learn without text books and by doing the work with your own hands; and that's the Sweeney Automobile School of Kansas City, Mo. I want every young man mechanically inclined to send today for my big catalog. It costs me 50 cents, and is a complete encyclopedia on the subject. It is like a moving picture as the 123 actual photographs show men at work in every department, at every job. It explains the wonderful Sweeney System. I will send it free, to those who answer this announcement, together with a special advantageous offer. A \$50 Tractor Scholarship Free. Use Coupon Today—NOW.

The Sweeney System of Practical Auto Instruction

Twin Six Packard

is now universally recognized as the most thorough, practical and interesting course of automobile, gas engine instruction leading to certain and profitable **Employment**. It embraces every point worth knowing, including vulcanizing, brazing, oxy-acetylene welding, lathe work, machine shop practice, testing, driving, truck repairing, and operating, etc. **You Learn** by doing the work on **Real Cars** under the watchful eyes of skilled instructors.

I started seven years ago teaching a couple of young men in a little shop. I had one **BIG IDEA**. That was to teach them by practical experience. Not merely to TELL them how, but to SHOW them how and then have them do the work with their own hands, over and over until they could do it perfectly. And that is the **EASIEST WAY** to learn—because the right way is always the easiest.

I taught my young men how to do everything that any mechanic is ever called on to do about a car. Not merely to drive but to repair. Not merely to repair but if necessary to make his own tools. Everything from blacksmithing up. And then over and above that I taught them how to manage for themselves—how to make money in the business—how to run a garage, and so on.

Today I point to thousands of men who have made good under my system of practical instruction. I can point to what I claim is the biggest school of its kind in the world. The school with the most complete and best equipment obtainable. The school with 19 instructors. The school with pupils from almost every state in the Union and some from foreign countries. We still teach by "Practical Experience," you see what makes the wheels go round. We don't use books, we furnish free tools to the men and they learn by doing the work with their own hands under skilled instructors. I make them finished mechanics with a trade that's good for \$30 to \$150 a month or an independent business of their own.

Here's another thing: We've always been first in the field. We claim to be the first to teach traction engineering; all types of self-starters; stationary engineering; the first to develop FARM engineering and FARM mechanics. We were the first to operate a truck line. We claim to be the first and only school that owns an 8 cylinder Cadillac; the first and only school to buy a TWIN SIX PACKARD; the first to install all the elaborate and expensive machine shop equipment that the trained automobile man must know how to handle.

First in the Field

And now about my special offer. To advertise the school and also to give special training in a branch that is getting more important all the time, I will give a complete \$50 scholarship in **Traction Engineering** free with an enrollment for the regular automobile school course. Now, as you know, we not only have 5 tractors here but I have a big factory where we build the famous **Sweeney Iron Horse**. You are taught by men that know how. So this tractor scholarship means real value.

Do It Now

If you will sign and mail me the coupon attached or write me a postcard, I will send you my big free book and full details of this scholarship offer. This book will survey the whole field and the certificate will entitle you to the \$50 saving in case you enroll this fall. It will not obligate you in any way. As a matter of fact I won't take a cent of a man's money until he has personally inspected the school and has satisfied himself.

The book pictures the wonderful equipment of the Sweeney School. It shows how you are taught, shows the class of men you will associate with, portrays various phases of the automobile industry, explains how, when and where you begin to earn money, in a word is a complete encyclopedia of the subject. I don't urge you to send for it unless you really want it, but to every young man mechanically inclined I will be very glad indeed to mail it free, together with my regular magazine. Simply send name and address.



E. J. SWEENEY

President of the School,
Originator of the Sweeney
System.

CATALOG

Sweeney
AUTOMOBILE
SCHOOL

KANSAS CITY
MISSOURI

THE WORLD

Sweeney Auto School, 1100 E. 15th Street, Kansas City, Mo.

Send free and without obligation your catalog and tractor scholarship certificate.

Name.....

Address.....

Sweeney Auto School 1100 E. Kansas City, Mo.
15th St.

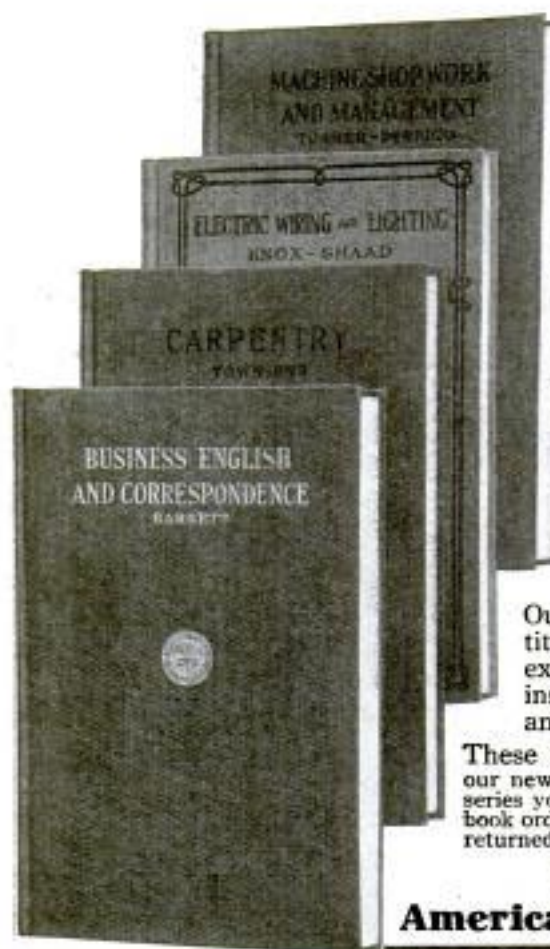

Handy Handbooks for Beginner and Expert

Applied Electrochemistry and Welding	\$1.50
Business English and Correspondence	1.00
Carpentry	1.50
Civil Engineering Specifications and Contracts	1.00
Electrical Measurements	1.00
Electrical Wiring and Lighting	1.00
Elevators—Hydraulic and Electric	1.50
Estimating	1.00
Machine Drawing	1.50
Motion Picture Work	3.00
Practical Lessons in Electricity	1.50
Reinforced Concrete	1.00
Steel Construction (Flexible Leather, Focket Size)	2.75
Strength of Materials	1.00

Our Practical Handbook Series now numbers 89 live, up-to-date titles. The authors are the biggest and best known engineering experts in America. Written especially for practical self-instruction—so clear that the beginner can understand them and so thorough that the expert can learn from them.

These books are sold at bookstores the world over. Send for our new catalog. If your dealer does not have the particular book of this series you want, ask him to order it for you or order it direct from us. Any book ordered direct will be shipped post paid on receipt of price, and may be returned after a five day examination if not suited to your needs in every way.

SOLD AT ALL BOOKSTORES

American Technical Society, Chicago, U. S. A.

Stop Forgetting!



Prof. Henry Dickson
America's foremost authority on Memory Training and Principal of the Dickson Memory School, Hearst Bldg., Chicago.

Forgetfulness—the Cause of Man's Inefficiency Perfect Memory—The Key To Success

A man's best possession is a perfect memory because the secret of business success depends quite as much upon a well developed ability to retain a vivid memory of perceptions and experiences as it does upon "bustle." In social life a good memory is the fundamental pre-requisite to brilliancy in conversation and the confidence of our acquaintances. Good memory is the stepping stone to responsible, honorable, high-salaried positions, and without the ability to remember you can never hope to make good. A good memory, however, is not a gift—peculiar to some few—it is the result of training—you can acquire it.

The Dickson Method of Memory Training Will Make YOU "Forget Proof"

Ten minutes a day of your spare time will give you this training and not interfere with your work in any way.

My course is not a theory, but a purely and absolutely scientific method of easy practical home lessons which anyone can readily understand and master. It is the result of many years of personal contact with thousands of students as their instructor in leading schools and colleges, searching their developing minds for means of strengthening their memories. My method of memory training enables you to classify impressions, ideas, names, facts and arguments without effort—trains you to think on your feet—to overcome self-consciousness and bashfulness. My system of memory training has transformed thousands of failures into successes—it will make you "forget proof."

De Luxe Book of Facts, "How to Remember," Absolutely Free

It explains clearly the course that has raised thousands of men from failure to great successes. My free book is the first step. Don't delay. Age, education, vocation or place of residence makes no difference.
Mail the Coupon or Postal today.

How to Get a Free Copy of This Valuable Book

"How to Speak in Public," De Luxe edition handsomely illustrated, richly bound. Is exactly suited to meet the needs of the man or woman who desires to be a successful public speaker. The price of this 1915 de luxe edition is \$2.00. Write today and learn how to obtain free copy.

Mail Coupon Before You Forget

Prof. HENRY DICKSON, Principal,
Dickson School of Memory,
705 Hearst Bldg., Chicago

Send me your Free Memory Test, Free Book "How to Remember," also full particulars how to obtain a free copy of Dickson's "How to Speak."

NAME.....

ADDRESS.....



Please Mention Popular Mechanics

ELECTRICAL men with training are always in demand. Having trained over 2000 young men in the past 22 years in the fundamentals of Applied Electricity, **The Bliss Electrical School**, with its well-equipped shops and laboratories, is peculiarly well qualified to give a condensed course in Electrical

ENGINEERING



including Mathematics, Steam and Gas Engines, Mechanical Drawing, Shop Work, and Theoretical and Practical Electricity, in all branches. Students construct dynamos, install wiring and test efficiency of electrical machinery. Course, with diploma, complete

IN ONE YEAR

For practical young men with limited time. 23rd year opens Sept. 22nd. Write for new catalog E. Special 6 months Evening Course in

"Wire and Wireless Operating"

opens November 15th, 1915. An

Exceptional Opportunity

to qualify as a

First-Class Commercial Operator

Write for Catalog W.

136 Takoma Avenue,

WASHINGTON, D. C.



WE TEACH YOU TO DRAW A GOOD SALARY

Most Art Schools merely teach you how to draw pictures—we teach you how to draw a good salary as well. **PRACTICAL and PERSONAL INSTRUCTION** Study during your spare time and learn *How to Make Pictures That Will Sell*. Artists earn from \$25 to \$150 a week. Send sample of your work for free criticism and 5 cents in stamps for illustrated catalog. Correspondence and local school.

WASHINGTON SCHOOL OF ART 911 F Street N. W. WASHINGTON, D. C.

Only Practical Auto School on the Pacific Coast

Fully equipped. Most modern methods. Expert instructors. Our course includes everything worth knowing about the auto business. No time limit. Hundreds of successful graduates. Room and board while learning. Assist graduates to positions. We guarantee satisfaction.

SPECIAL EXPOSITION RATES CATALOG FREE
NATIONAL SCHOOL OF ENGINEERING
2111 West 7th St. (Est. 1905) Los Angeles, California

DO YOU WANT MORE MONEY?

Learn the art of Sign & Showcard Writing. Branch of Advertising. Men and women make big money. Personal instruction and original methods (copyright) make you expert. **\$6.00 Per Day or More** is the union scale in Chicago and other towns. You can make even more on job work. I have a big business of your own. We show you how, and help you pay for your course. Particulars and booklet free. Explains everything. Write today. The School with a METHOD.

ILLINOIS SCHOOL OF LETTERING & DESIGN
Dept. B, 187 N. Clark Street Chicago, Illinois



OSCAR A. FORS
PRINCIPAL

EFFICIENCY

Your success depends upon your Personal Efficiency. Complete course \$4.00. Particulars.

MEAD COURSE IN PERSONAL EFFICIENCY
CEDAR RAPIDS, IOWA

ELOCUTION

Put Money in Your Purse

By Studying our Correspondence Course in Public Speaking, Dramatic Reading and Entertaining.

We offer you a complete course BY MAIL absolutely unique in matter and method. Hundreds of graduates now earning good money. Nothing finer for self-confidence, culture and popularity. Thoroughly practical. Excellent for Mothers to train children.

Send 4c stamp for Sample Illustrated Recitation.

THE MERRILL SCHOOL OF EXPRESSION

Dept. S, 1750 Woodward Avenue, DETROIT, MICH.

DRAFTSMEN WANTED



If you knew what a tremendous and ever-growing need there is for Draftsmen, if you knew what Draftsmanship offers you in the way of salary and opportunity for executive positions, power and money, if you realized how quickly, thoroughly and easily my personal instructions qualifies you to answer the call for Draftsmen you would not hesitate a minute in taking advantage of the opportunity that is now open to you. If you want the facts, the proofs, simply write to me and I will show you in black and white just what I can do for you and what I have done for others.

I Will Teach You

No special training or requirements needed. No need to take a minute from your regular work or sacrifice your pleasures. Give me a few minutes regularly of your spare time for a few months and I will teach you personally everything a successful Draftsman must know. I give you the training the big employers of Draftsmen in this country demand. Everything so plain and simple that you can grasp it at once. No matter who you are, or what work you are doing now, I will make you a competent Draftsman, one who can go out and step into a big paying job.

The Salaries Are Big

Look at the want ads of our metropolitan newspapers. See what a great number of Draftsmen are needed in comparison with any other profession. The demand now is bigger than ever before. Big positions paying \$2400 a year and more. Put yourself in line for the position of Chief Draftsman, Chief Engineer or Superintendent, or open an office and establish yourself in a business of your own.

My Special Tuition Offer

To a few more earnest students I offer my personal instructions on such small, easy payments that no matter how small your present salary you can take my course and scarcely miss the money. For prompt enrollment I am making an extra special offer of a free \$25.00 tuition credit. Mail coupon.

FREE! \$17.50 DRAFTSMAN'S OUTFIT

This magnificent set of Draftsman's Drawing Instruments, valued at \$17.50—the same as I used, goes to you absolutely free if you act at once. This free outfit is in itself a big step to your successful training. This outfit goes to you free in addition to the free \$25.00 tuition credit. But you must act promptly. The coupon or a post card brings you full particulars—also copy of my book on Draftsmanship, one of the most valuable ever published on the subject. Act now. Strike while the iron is hot.

Chief Engineer Cooke
Chicago Engineer Works
Dept. 10
455 Cass St.
Chicago, Ill.



Free Book Coupon

CHIEF ENGINEER COOKE
Dept. 10, 455 Cass St., Chicago, Ill.
Without obligation or cost to me, send prepaid your free book "The Road to Success" and particulars of your very extra special offer.

NAME.....

ADDRESS.....

Please Mention Popular Mechanics

YOU are needed NOW

YES, there's a good position waiting for you—will you get ready for it?

Yes, sir—you are needed to fill a good job. But you're not ready—you're not trained. You can't fill it now. But you can in six months if you study. Will you do it? **Will you get ready?** Big salaries don't grow on trees. They don't just happen. They go to men who get ready for them—who can fill to a T the jobs that pay big salaries. Do you know anything about electricity? Are you inclined that way? If not inclined, would a good salary make it interesting? We'll prepare you during your spare time.

Earn \$1,200 to \$3,000 a Year

as an Electrical Meter Engineer. When you're ready to fill a job—a job is ready for you. Listen! There are over 7,000,000 meters now in use. Another half million will be installed this year. Think of the men needed to install and keep them in order. Think of the engineers needed—who know meters and can direct the work. Meters are delicate—need constant adjusting.

Electric light companies lose thousands yearly on slow running and out-of-order meters. Can't get enough good men to keep them right. Fort Wayne Trained men quickly get good jobs—are quickly advanced—always ready for the bigger job of meter engineer. Our course teaches the theory of electricity; design, construction, operation, calibration care, and maintenance of all makes and types of electrical measuring instruments and meters. You'll know meters from A to Z—all kinds. No problem will stump you. Our students are successful. E. D. Henley, Ala. writes: "When I commenced your course was making \$65.00 a month testing meters. Soon I was able to take care of standardizing instruments and salary was raised to \$90. Special work brought it up to \$125." Martin Ekvigrud, Minn. writes: "My salary is now three times what I got when I started your course." Will you begin now? Will you get ready for a good steady position? We are ready to prepare you. Read our guarantee.

Write today for free booklet, "Electrical Meter Engineering". Address

FORT WAYNE CORRESPONDENCE SCHOOL
Dept. 190
FT. WAYNE, INDIANA

OUR GUARANTEE

We guarantee to furnish you with our complete course of instruction in Electrical Meter Engineering and train you without charge, other than tuition as specified in our Enrollment Blank, until you are qualified to accept a position paying from \$75 to \$200 a month. Furthermore, we guarantee to assist you in securing a high grade position after you receive your Diploma. We also guarantee to answer any questions regarding your school work, or daily work as well.

Get Into a Business that Pays Big Money

N. A. S.

Driving \$80 to \$125 a Month — Repairmen and Salesmen \$300 and Up!

Lots of driving and touring jobs now open in all large cities and good chances (if you are ambitious) to start a garage, do repairing, sell cars, etc. 400,000 more automobiles this year than last. Every small town in the country needs a Real Expert Auto Repairman. We teach you—and we do it right—the way you would like to learn. We put you to work into overalls, with tools, on all kinds of automobiles, in a real shop and garage. Plenty of actual driving and repairing. Our method is down-in-the-grease—and out-on-the-road. No time limit—you stay till you learn thoroughly and are perfectly satisfied. Here is a chance to "Double Your Pay." If you are out of work or dissatisfied with your present job, change now—Get into



THE COMING BUSINESS
NATIONAL AUTO SCHOOL 2625 Reading Rd., CINCINNATI, O.

Write your name and address on margin of this page, tear out and mail to us—we'll send you our catalog and full information.



YOUNG ARTIST EARNS \$200.00 IN FOUR DAYS

Commercial Artists practically trained by members of our faculty have earned \$100.00 in two days—often more.

High Authorities Endorse This Great Course
Earn from \$25.00 to \$75.00 per week. Become a Commercial Designer—uncrowded field—dignified profession. Learn to draw during your spare time by our home study method.

Easy to Learn—Easy to Apply

Send today for our beautiful catalog in colors. Also our folio of commercial illustrations. Free for the asking.

FEDERAL SCHOOL OF COMMERCIAL DESIGNING, Inc., 607 Warner Bldg., Minneapolis, Minn.



TRAFFIC

The Chain Connecting
Producer and Consumer



**Efficient Traffic Men Earn
From \$2,000 to \$40,000 Yearly**

Young Man, You Have As Much Brains As These High-Salaried Men. Your Brains Simply Require Proper Training

Heretofore Traffic Knowledge could be secured only through years of tedious experience. YOU can now easily acquire this highly profitable knowledge in a very few months, and EARN A BIG SALARY FOR LIFE through membership in the AMERICAN COMMERCE ASSOCIATION. Right now the railroads and shippers are in urgent need of 100,000 trained traffic men. There are 500,000 business concerns in the U. S.—50,000 of these pay freight bills of \$5,000 and over, yearly. Over 2,000 Million Dollars is paid as freight each year to 1,000 railroads. Transportation is the largest single business in the U. S. and employs over 4,000,000 men. Each day it grows bigger. It is the basis of commerce—the life-blood of business. It is interwoven through all the processes of commerce and industry. There is no "fixed" salary for efficient managers—YOU are worth just what you can earn. A number of Traffic Managers receive yearly salaries of \$25,000 to \$40,000. Thousands receive \$2,000 to \$5,000.

Your Salary in Five Years From Now

Don't envy the man higher up—climb up yourself. Your spare time is worth \$30 per hour—are you wasting it? Use these valuable hours in easily acquiring traffic knowledge. Don't stand still—climb! In five years you can be earning each week your present monthly salary. You can acquire this traffic knowledge in one year. Efficient traffic men receive what they are worth—there is hardly any limit. The AMERICAN COMMERCE ASSOCIATION is a national organization of Trained Traffic Men.

Traffic Knowledge Earns Big Salaries

The expert traffic man earns his own salary many times over. Transportation either makes or breaks a business. The right places are eager for the right men. Thousands of trained men are needed NOW in the traffic departments of railroads, express companies, and industrial concerns. It is easy to learn in a few months what required numerous experts a life time to learn through actual experience. The cost is less than you should be making in a few years in a single week.

Note These Opinions About the A. C. A.

Mr. H. G. Wilson, President of the National Industrial League: "Your Association is better equipped to advance the efficiency of traffic men than any other." Mr. A. T. Waterfall, Traffic Commissioner, Detroit, Mich.: "You are to be congratulated on this splendid and important work." Mr. F. A. Barber, Chief of Tariff Bureau, Wabash Railroad: "I do not see how anyone can help but be greatly benefited thereby." Let us send you copies of letters of approval received from dozens of America's foremost traffic men.

Get Ready to Earn \$200 to \$1,000 Monthly JOIN THE AMERICAN COMMERCE ASSOCIATION

Use your spare time in becoming a Traffic Expert. It costs little, is easy to learn, and the work is fascinating. You will enjoy big rewards all your life. You have the brains—fill them with "cashable" knowledge. Look ahead! The years are slipping by fast. Our practical method will make you efficient in a few months. You won't have to neglect your present duties. It is the biggest and best opportunity you have ever had. You will have the assistance of many of America's most prominent traffic men. Your success depends upon your taking advantage of the experiences, technical knowledge and co-operation of these men. After completing your course if you are not entirely satisfied with its value we will refund your money.

Ask For This Free Book Simply sign and mail the coupon and we will send you a FREE

COPY of "Opportunities Along The Trails of Traffic" by H. G. Wilson, President of the National Industrial Traffic League. It is intensely interesting and informative. We will also send you full information about becoming a member of the National Fraternity of Traffic Experts. Don't hesitate—act quickly! Clip, sign, and mail coupon—NOW!

American Commerce Association Dept. 21, "The Bakery" CHICAGO, ILL.

American
Commerce
Association
Dept. 21, "The Bakery"
Chicago, Ill.

Please send me, entirely
without charge or obligation,
H. G. Wilson's book, "Opportunities
Along the Trails of Traffic"—
also explain how your course in
Traffic Efficiency will train me to be-
come a traffic expert.

Name.....

Address.....

Age..... Occupation.....

City..... State.....



H. J. RAHE, President
Automobile Training School
Kansas City, Mo.

Men Wanted

To Fill Positions Paying
\$75 TO \$300
PER MONTH

Six weeks from the day you commence your studies in this great practical school, you will be able to repair any make of automobile and to drive any car on the market.

Prepare yourself to earn a salary of from \$75.00 to \$300.00 per month; or to go into business for yourself as a garage owner or automobile agent and make from \$2,000.00 to \$5,000.00 a year.

Graduates of this school are in demand. Many of our graduates are to be found in high-salaried positions in some of the largest automobile factories in the country. Many are in business for themselves and are making big money. Ask us to prove that the Automobile Training School of Kansas City, Mo., has more graduates holding responsible positions than all other automobile schools in the West combined.



No Books Used No Tools to Buy

The Automobile Training School has no illustrated books and offers no charts or correspondence courses. Our students receive individual practical instruction under practical conditions on up-to-date automobiles and motors from the best instructors that we can secure. This school, we claim, is the largest in the world, occupying three big buildings, operating two of the principal garages and repair shops in Kansas City. We claim to have more floor space, more instructors, more equipment than any other Automobile School in the United States.

\$50 Scholarship Free

As a very special inducement to enroll the full capacity of our school without delay, we are including with our regular automobile course, absolutely free of any charge, our big new combination in Tractor and Stationary Engineering. We will only offer a limited number of these free scholarships. If you wish to take advantage of this special offer, write today. We will send you free and postpaid, copy of our big sixty-page book, "How To Make Money In The Automobile Business"—filled with scores of illustrations from our school, and letters from successful graduates all over the world. Sign your name and address on the coupon below, and mail it now.

HENRY J. RAHE, President

Automobile Training School
1070 Locust St. KANSAS CITY, MO.

FREE SCHOLARSHIP AND BOOK COUPON.

Henry J. Rahe, Pres., AUTOMOBILE TRAINING SCHOOL, 1070 Locust St., Kansas City, Mo. Send me, free and postpaid, your big, 60-page illustrated book, also the free \$50.00 Scholarship Certificate covering Course in Tractor and Stationary Gas Engineering and Electric Starting and Lighting, as offered in your advertisement. This request does not obligate me in any way.

Name..... R. F. D.....
Postoffice..... County..... State.....

Please Mention Popular Mechanics

Young Man! Your greatest opportunity



Write
for
Book
Today
It's
FREE

To the man who wants to improve his condition in life—to increase his earning capacity—to get away from the monotony, grind, and low wages of ordinary occupations—to elevate his social standing, the new profession of Tree Surgery, which is not overcrowded, offers the young man of today his greatest opportunity. The Extension Course given by The Davey Institute of Tree Surgery will fit you to practice this profitable profession.

LEARN TREE SURGERY AND FRUIT GROWING BY MAIL

You can become proficient in this work without interfering with your present occupation. An hour or so a day will give you a training that will make your future bright and prosperous. The work of a Tree Surgeon is healthful, fascinating and remunerative. The call for men in this profession is far greater than the supply, and the demand is growing. There are positions open at good salary and opportunities everywhere to establish a paying business of your own. Why work for others at small pay when you can be your own boss? Write today for our book, "Adventures in Success." Read what others have done, and learn how easily and quickly you can improve your condition in life.

**THE DAVEY INSTITUTE
OF TREE SURGERY**
353 Oak St., Kent, Ohio

Mechanical Drawing

Learn to read and make drawings or become a Mechanical Draftsman. We teach successfully by mail. 50 cents each lesson; pay as you go. Our course is simple, practical and thorough. Genuine blue-ink lesson sheets. A different data sheet showing useful drawing and mechanical information sent with each lesson. All drawings and materials free. Ask for particulars or, better still, send 50 cents for first lesson and be convinced.

50 C.
Per
Lesson

ALBANY INSTITUTE OF MECHANICAL DRAWING
Lock Box 84, ALBANY, N. Y.

CIVIL SERVICE

positions are in all parts of the country. Good pay, steady work, life positions, congenial surroundings, promotions on merit, short hours, annual vacation and sick leave with pay. Many thousands appointed yearly. Both sexes. No political pull. Nearly 300,000 classified positions. Common school education sufficient. Full information and questions used by the Civil Service Commission free.

COLUMBIAN CORRESP. COLLEGE, Washington, D. C.

EARN A BIG SALARY

Make something of yourself. Get out of the common rut and be a live one. Learn an uncrowded trade—

TELEGRAPHY All our biggest railroad officials were first telegraph operators. Let us show you the way to success. We are official instructors for the Western Union Tel. Co. and the only school instructing Western Union employees. Largest attendance of any telegraph school. Also authorized school for U. S. Central Ry. Co. Agency course free. Practical instructors. Main line wire. Equipment furnished to care expenses if desired. Wireless course just added. Perfect equipment for instruction in wireless telegraphy. Start today. Jones School of Telegraphy, Dept. P. 305, So. La Salle St., Chicago

SHOW CARD WRITERS EARN \$80 TO \$200 A MONTH LEARN FREE!

We will furnish a thorough course in Show Card Writing and Lettering absolutely free to introduce our colors if you will purchase an assortment of Alpha Colors to use while practicing. Particulars for stamp.

ALPHA COLOR COMPANY, Inc., Dept. K, 81 East 125th St., N. Y. City

112 Words a Minute Without Looking!

NEW METHOD

The remarkable secret speed method of world's speed marvel leads to double salaries for stenographers and typists—creating thousands of new possibilities everywhere. Entirely different from all other methods—astonishing discovery. Now you can qualify to operate a typewriter at the amazing speed of 112 words a minute—step into a big position—

Be a Private Secretary

—the position all stenographers strive for—the position which offers quickest promotions and lucrative salaries. Thousands needed now. If you are a stenographer, master this wonderful speed method and double your salary.

Double Salaries

Stenographers, typists and everyone face unheard of possibilities. Former \$15-a-week stenographers now \$30. Employers now demand speed and accuracy. Operators with old-time methods turned away.



Learn at Home in Spare Time. Regardless of when you work at home, this is your opportunity to step into a big-salaried profession. Anyone can learn easily—quickly. Past experience in stenography or office work not needed. Salary increases long before you finish. Tuition payments to suit you.

START FREE Write now for free first lesson—send no money. This special offer may be withdrawn—act now. Success assured—entire course on trial. Learn how we send \$100.00 Typewriter free to new students. Write now for free details of our possibilities open everywhere if you master this method.

Shorthand If you wish to learn shorthand only, write for special offer on Bosworth Simplified Home Study Course—same system used by world's high-salaried experts.

BOSWORTH INSTITUTE, 1102 Bosworth Bldg., Chicago

\$100.00 Typewriter FREE While Learning

Be A Salesman
Earn \$20 to \$50 per week. We find positions for our graduates. Write for catalog and particulars.
Brown's Home-Study School, 100 Brown Bldg., Peoria, Illinois

LEARN TO WRITE ADVERTISEMENTS EARN \$25 to \$100 A WEEK

We can positively show you by mail How to increase your salary. BOOK MAILED FREE. PAGE-DAVIS CO., 112 Page Building Chicago, Ill., or 150 Nassau St., New York

Public Speaking Taught at Home



Write for our special public speaking offer. 15 minutes a day, spare time, will make you a powerful, convincing speaker. You can be at ease before any audience—enrich your vocabulary—increase your earning power—become more popular. We have trained hundreds of successful speakers by mail at home.

Special Offer—Write Now Send quick for details of our special limited offer. No obligation. But you must hurry. Write now.

Public Speaking Department
American Correspondence School of Law, 9197 Manhattan Bldg., Chicago, Ill.

Learn to Write

BEGIN TODAY
WRITE for my FREE BOOK

I can make a good penman of you at home during spare time. Write for my free book, "How to Become a Good Penman." It contains specimens and tells how others mastered penmanship by the Tamblin System. Your name will be elegantly written on a card if you enclose stamp to pay postage.

FREE BOOK Write for it Today

F. W. Tamblin, 418 Meyer Bldg. Kansas City, Mo.



This Inspiring Book Free To Ambitious Men

This intensely interesting and instructive 165-page book tells you how a knowledge of law will develop your natural ability and increase your earning capacity; how it has proved to be the stepping stone for thousands of men to power and achievement.

It tells you of the great and increasing demand for lawyers and how you can become one. It tells you why law trained men are now selected for most positions of responsibility in business, public life and social work—and how you can grasp these opportunities.

It shows you how you can become law trained without leaving your home or business by a method which includes the comprehensive features of the best resident law schools and is endorsed by distinguished men throughout the country in whose opinion you have the utmost confidence. Send for your copy of "The Law Trained Man," today.

Modern American Law Course and Service of Blackstone Institute

Blackstone Institute (including the Sprague Correspondence School of Law) was founded in 1899, and is by far the oldest and largest law school for non-resident instruction in the world.

We have successfully trained more than thirty thousand men and women in law. Among our graduates are the Governor of a State, United States Senators and Congressmen, State, County and City Officials, many Judges and thousands of successful Lawyers and business men everywhere. This notable record extending over twenty-five years is the most convincing evidence that we produce results—and it is results that count.

Chief Justice Ladd of the Supreme Court of Iowa, says: "Every person interested in the law will receive from Blackstone Institute an unusually excellent—in fact, the best, non-resident system of instruction."

Our Course and Service has been prepared especially for home study by eighty eminent judges and authorities, including: Chief Justice John B. Wislaw, LL. D., Sup. Court, Wis.; Hon. Geo. C. Holt, LL. D., ex-Judge U. S. Dist. Court, N. Y.; Hon. Paul B. Keetch, Ph. D., LL. B., U. S. Minister to China; Judge A. L. Sanborn, U. S. Dist. Court, Western Dist., Wis.; Dean O. H. Barker, College of Law, University of Ill.; Dean H. H. Ingersoll, College of Law, University of Tenn.

The Course is clearly written in simple non-technical language. It is practical, yet reads like an interesting story. Preliminary education is not necessary. You can read in spare time at home, and you will benefit from the day you start. Our Course and Service will prepare you on all subjects required in the bar examinations, as it has already done for thousands of others in your own state, and every other state in the Union. It will equip you to become a leader in business or public life—and to attain positions of honor and profit open only to law trained men.

Special Offer—Investigate FREE

The recent union of the Sprague Correspondence School of Law with Blackstone Institute and the resulting increase in our facilities enable us to make you a most important Special Offer. Investigate now by sending prepaid or letter, or clipping the coupon for our 165-page free book and full particulars. No cost or obligation.

Address, Extension Division 1257
Blackstone Institute
20 W. Jackson Blvd.,
Chicago, Ill.



Extension Division 1257
BLACKSTONE INSTITUTE,
20 W. Jackson Boulevard, Chicago, Ill.

Please send me your 165-page free book, "The Law Trained Man," and full particulars of your Law Course and service and Special Offer. No cost or obligation.

Name _____

Address _____

FREE BOOK COUPON

Please Mention Popular Mechanics

95000

Positions Like This
Are Waiting For
Trained Men At
\$1800 to \$4000
a Year



Why not fill one of them yourself?
We're talking facts now—not theories.
There's no vivid imagination behind these
words. You can prove them before you answer this
advertisement if you wish.

Trained Traffic Men in Demand Everywhere

Here's the proof. There are 500,000 shippers in the United States. 100,000 of them are big enough to employ individual traffic managers. There are now 3000 to 5000 traffic managers in the country. That leaves 95,000 shippers without a traffic manager to fill one of the most important positions in their entire organization; a man they need; a man that can save them money.

PREPARE NOW TO FILL ONE OF THESE SPLENDID POSITIONS

Thousands of shippers are coming to realize their need of an expert, trained traffic manager.

But the supply of trained men who know all the ropes doesn't begin to meet the demand.

Thousands upon thousands of men in America are in the wrong job; right perhaps, as far as the work is concerned, but wrong where the pay comes in. Few men can be contented in a job that doesn't pay well or offer a good chance for steady and sure advancement.

This is the day when far sighted ambitious men climb out of ruts and seek opportunities where the going is good.

To become a successful and highly paid traffic manager, just three things are essential. A common school
INTERSTATE TRAFFIC SCHOOL

education, intelligence and training. You don't have to have "special talent". It's a simple proposition of figures and knowledge. When you have mastered tariffs and freight rates you can land in a job paying at least \$1800 and if you get in with a big firm, where your services will save lots of money, you can earn as high as \$10,000.

This isn't theory—it's facts—cold facts. Ask any shipper you know if the trained traffic manager isn't one of the most important and well paid men in the shipper's service. Ask him if it wouldn't be a good thing for you to get into.

Then send for our free catalog. It tells who we are, what we teach and how we do it. We'll train you to earn \$1800 to \$4000 a year as a Traffic Manager.

Dept. 170 FT. WAYNE, INDIANA

Learn How to WRESTLE



In Your Own Home
By Mail

Yes, learn to become an expert wrestler right in your own home, by mail, from the greatest wrestler the world has ever known. Be an athlete, be strong, be healthy. Learn how to throw and handle big men with ease. Learn to defend yourself. All taught in our course of lessons, and illustrated with hundreds of charts and actual photographs by

Farmer Burns and Frank Gotch

Farmer Burns, "the grand old man of the mat," taught Frank Gotch, the present World's Champion, all he knows about wrestling, so Gotch says. He will now teach you Scientific Wrestling—Physical Culture—Jiu-Jitsu—Self Defense. Every man and boy in America, no difference what age, needs this wonderful course of lessons. Write today—your name, age and address on a postcard or letter brings you our free book absolutely free—no obligations of any kind. A splendid book on wrestling and physical culture. Write today stating your age.

Farmer Burns School of Wrestling 1197 Range Bldg., Omaha

This Wrestling Book FREE

You Can Earn a 5-Passenger, 28 H. P. BUSH TOURING CAR

self-starter, electric lights and the agency for your territory by qualifying through a course in Driving, Repairing and Selling Automobiles. An opportunity of a lifetime.

THE OFFER IS LIMITED. WRITE TO-DAY

Dept. 1017, BUSH MOTOR COLLEGE, Inc., J. H. Bush, Pres. Bush Bldg., Clark St. and Chicago Ave., CHICAGO, ILL.

STUDENTS ART MAGAZINE

for ARTISTS AND ART STUDENTS

12 issues for \$1.00
Publishes Cash Art Assignments, lessons and articles on Cartooning, Illustrating, Lettering, Designing and Chalk-Talking. Criticizes amateurs' work. Interesting, helpful, artistic, UNIQUE. It will please you. Money back if not satisfactory. 10c a copy, \$1 per year. Send \$1 NOW, stamps or bill, to

LOCKWOOD PUB. CO., Dept. 51, Kalamazoo, Mich.

WANTED

Railway Mail Clerks
\$900 to \$1800 a Year
(\$75 to \$150 a month)



Pleasant Work — Continually Traveling

FRANKLIN INSTITUTE (The Pathway to Plenty), Dept. D106, ROCHESTER, N. Y.

This coupon, filled out as directed, entitles the sender to free specimen questions; a free copy of our book, "Government Positions and How to Obtain Them," a list of Government positions now obtainable, and to consideration for Free Coaching for the examination here checked.

COUPON
 ..Railway Mail Clerk... (\$900 to \$1800) ..Customs Positions... (\$800 to \$1500)
 ..Bookkeeper... (\$900 to \$1800) ..Stenographer... (\$800 to \$1500)
 ..Postoffice Clerk... (\$800 to \$1200) ..Internal Revenue... (\$700 to \$1800)
 ..Postoffice Carrier... (\$800 to \$1200) ..Clerk in the Departments
 ..Rural Mail Carrier... (\$500 to \$1200) at Washington... (\$800 to \$1500)
 ..Auto Chauffeur... ..Canadian Gov't Positions.....

Name..... Address..... D106

Use this before you lose it.

Write plainly.

The Truth About Poultry



Get the Facts by Reading

The One-Man Poultry Plant

Successful Methods of Men on Farms or Small Acreage. Complete in twelve parts; printed in one volume.

By DR. N. W. SANBORN

REAL work, with real poultry, on a real New England Farm. This is a simple story of what has been done by a man, at forty-five years of age, town bred and city educated, getting out of practice of medicine, buying a small farm in the hill country, and making a success of the venture. Not only is the rearing of chicks and the management of adult fowl completely covered, but the interesting side issues of fruit growing, grain raising and the production of milk, that cannot be escaped on a real farm. You get rugged facts—rarely found in print. The truth about poultry as found in actual life on a one-man poultry farm.

You Can Do the Same, Book Tells How

OUR SPECIAL OFFER—The One-Man Poultry Plant, in twelve parts (book form), and the American Poultry Advocate, one year, for only 50 cts., book and Advocate, three years, for only \$1.00, if order is sent at once.

Our paper is handsomely illustrated, practical, progressive and up-to-date on poultry matters. Established 1892. 44 to 132 pages monthly. 50 cents a year. 3 months' trial 10 cents. Sample copy free. Catalogue of poultry literature free. Address

AMERICAN POULTRY ADVOCATE, 523 Hodgkins Bldg., Syracuse, N.Y.

AUTOMOBILE WATCH FOB

The neatest and most novel fob ever designed. Has a leather strap and nickel buckle. Wheel is made of Rubber and is an exact reproduction of an automobile wheel with a quick detachable tire which can be removed and put on in a "jiffy." We will mail you this novel watch fob

ABSOLUTELY FREE

If you will send us 25c in coin or stamps for a three months' trial subscription to the AMERICAN CHAUFFEUR AND AUTOMOBILE DIGEST, the new illustrated technical Automobile magazine, which is full of valuable, interesting, helpful Automobile information.

Send today, as our supply of Watch Fobs is limited. Address

THE AMERICAN CHAUFFEUR
261 Butler Bldg. CINCINNATI, OHIO

DO YOUR OWN SOLDERING

—and Save Money

Send 55 cents for
"Simple Soldering"
A BOOK of Instructions

SPON & CHAMBERLAIN
123 P.M. Liberty St., N.Y.



Please Mention Popular Mechanics

DIVISION SUPT \$3000 A YEAR
MAINT. ENGINEER \$2500 A YEAR
CIVIL ENGINEER \$3000 A YEAR
ASST. SUPERINTENDENT \$2500 A YEAR



Take Your Pick of These Jobs

Do you realize that all you need to fill a responsible, well-paid position is a little knowledge? The men who are holding down such jobs are no brighter than you, but they have the knowledge that enables them to direct you fellows who work with your hands instead of your brains.

Why not train your brain to make big money? You can do it in your spare time and in your own home. All the knowledge necessary to fit yourself for one of these big-paying jobs can be obtained from the American Technical Society's

Complete Cyclopedia of Civil Engineering

Contains 3,900 pages, 7x10 inches, 3,000 illustrations, full page plates, diagrams, etc.; hundreds of valuable tables and formulas; carefully cross-indexed for quick, easy reference. The books are substantially bound in half red morocco, gold stamped, and are printed in large clear type on special quality paper.

Important Subjects Covered

Plane Surveying—Plotting and Topography—Railroad Engineering—Statics—Strength of Materials—Roof Trusses—Cost Analysis in Relation to Engineering—Masonry and Reinforced Concrete—Steel Construction—Practical Problems in Construction—Bridge Engineering—Highway Construction—Hydraulics—Water Supply—Irrigation Engineering—Water Power Development—Sewers and Drains—Home Drainage and Sanitation—River and Harbor Improvements.

Sent Absolutely Free, Express Prepaid

The complete eight volumes, not a sample volume, will be sent, express prepaid, for seven days' free examination; returnable at our expense if they do not contain the information you want. If you keep the books, pay \$2.00 seven days after receipt and then \$2.00 a month until you have paid the special introductory price of \$24.80. The regular price of this great Cyclopedia is \$40.00.

Just fill in and mail the coupon. It won't cost you a cent to examine these books. We know they'll be worth many times their cost to you. Mail the coupon now and you will receive your set promptly.

Another Great Offer With every set is included a year's Consulting Membership, regular value \$12.00, entitling you to the free advice of a staff of expert Civil Engineers. This will give you practical help in handling your difficult problems. There will be no limit to this service. A single problem solved for you may be worth more than the first cost of the books.

American Technical Society, Chicago, U.S.A.



P. 31e,
10-15

A. T. S.

Please send Cyclopedia of Applied Electricity for seven days' examination. I will send \$2.00 within seven days and \$2.00 a month until I have paid \$24.80, or notify you and hold books subject to your order. Title not to pass until fully paid.

NAME.....

ADDRESS.....

As I have had no previous dealings with you, I refer you to

MICHIGAN STATE AUTO SCHOOL
 AUTO SCHOOL

Come to Detroit
 the automobile center
 and

LEARN THE AUTOMOBILE BUSINESS

Big opportunities every-
 where for Detroit-trained

Automobile Men. The business is
 interesting, pleasant, and a **Money Maker.**

Every locality needs ambitious men now to start
 garage and repair shops in down town and residence
 districts. Learn now, become competent and efficient.
 Opportunities are thick — chauffeurs are needed, garage
 men have more work than they can do.

Earn \$75 to \$300 a Month

This business is growing bigger all the time. We will teach you to handle any auto propo-
 sition. Our equipment is complete. Students actually build new cars from start to finish,
 getting regular factory training in assembling, block-testing, road-testing, etc. That's the Detroit
 way. All leading types of starting, lighting and ignition systems in operation. Learn to time
 motors, adjust carburetors, magnetos, valves, bearings, etc. Six-cylinder Lozier touring car used
 for road instruction. New 8-cylinder King chassis, the latest thing out, also part of our equipment.

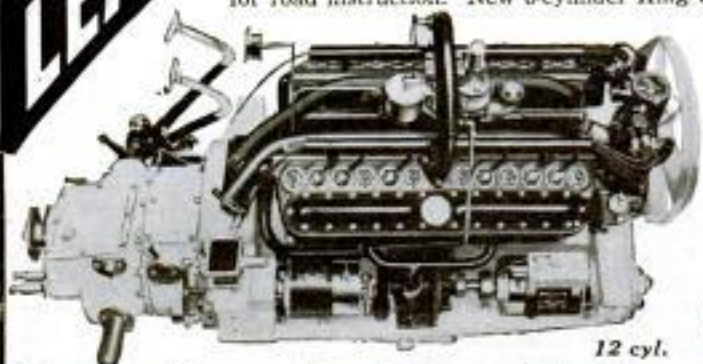

12 cyl.

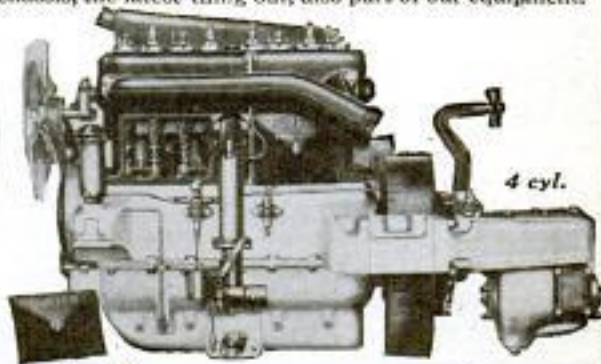

4 cyl.

Detroit is the Place to Learn

Start Any Time There are 44 auto factories in Detroit. Our students
 have the privilege of going through any or all of
 them, including Detroit electric service department, while taking our
 course. You can't get these advantages and opportunities anywhere else.
Detroit is the automobile center. Our students are in the midst of this
 activity. You make faster time here and you get **Practical instruction.**
Come to Detroit and learn the business right. Enter classes any
 time. Start the same day you arrive if you like.

Great Demand for Detroit Trained Men

Auto factories have been advertising nearly every day for months
 past for competent automobile mechanics, but can't get them. Garages
 throughout the country write us for men. We have had more calls for
 men than we have been able to fill. Why not fit yourself for one of
 these good paying positions?

Michigan State Auto School Students Are Competent to Fill Every Position and Make Good

La Farge, Wis., Feb. 6, 1915.

Prof. C. G. Arthur, Michigan State Auto School, Detroit, Mich.
 Dear Sir:— I am getting along just fine. A friend of mine, Mr. Slocin,
 and myself, have opened a garage in our home town, and we have been hav-
 ing all we could do. Thanks to what you have pounded into that old nut of
 mine, I have never been stuck yet. We have the agency for the Studebaker
 and Maxwell.
 Yours truly, (Signed) O. C. HILL.

Demand Greater Than Supply for Competent Men

GUARANTEE

We guarantee to
 quality you for a
 position as chauff-
 feur, repairman,
 tester, salesman,
 demonstrator or
 garage man pay-
 ing from \$75.00
 to \$300.00 in a
 short time or re-
 fund your money.
 We have constan-
 tly more re-
 quests for men, at
 \$1000 salaries, than
 we can supply.

Following Clipped from Daily Papers—All Parts of U. S.

Experienced motor mechanics, bearing scrapers,
 assemblers, repairmen; good wages, Henderson
 Motorcycle Co., 1158 Cass.

Chauffeur—Must be good driver, steady and reliable;
 one with knowledge of Pierce-Arrow cars preferred;
 no other but good mechanic need apply. Address Box
 B, No. 100 Free Press.

10 road testers, 20 garage repairmen, final assemblers,
 Maxwell Motor Co., Inc., Oakland Ave. Plant.

40 Drivers—Come ready to work. Maxwell Motor
 Co., Inc., Oakland Avenue Plant.

Write for Auto School News— it's free. Get full particulars. Or
 jump on the train and come to Detroit as hundreds have done.

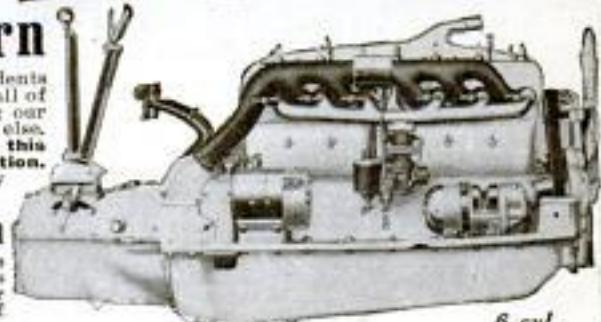

6 cyl.

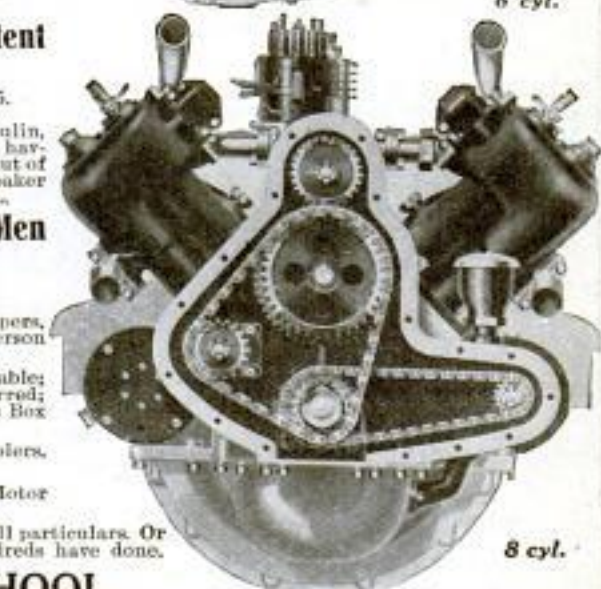

8 cyl.

THE MICHIGAN STATE AUTO SCHOOL

Dept. PM, 10 Selden Avenue

DETROIT, MICH.

These four motors are regular equipment in our block-test
 department and our road cars, with the exception of the 12 cyl.,
 which will be installed as soon as factory can make delivery.

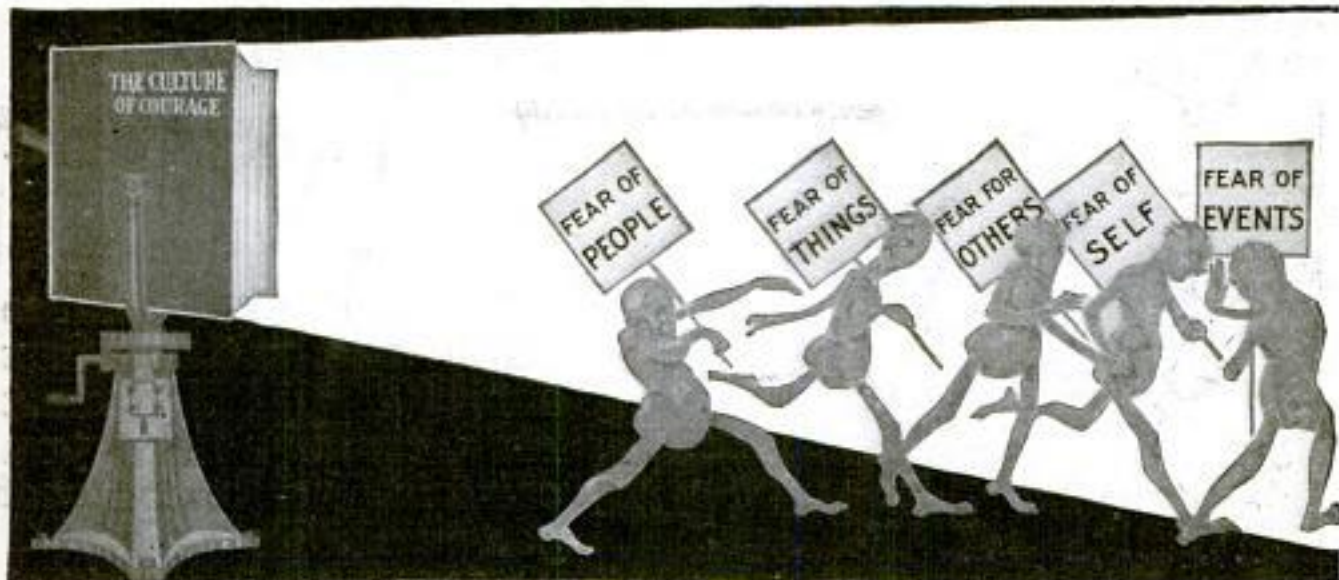

What This Book Teaches You

- How to overcome Timidity.
- How to conquer Bashfulness.
- How to have "nerve."
- How to demand "your own."
- How to face people you have always felt inferior to.
- How to develop Self-Confidence.
- How to deal with people on their own level.
- How to successfully face embarrassing situations.
- How to "rise to the occasion."
- How to be Forceful and Dominant.
- How to eliminate Nervousness in dealing with big men.
- How to act calmly and naturally on occasions that usually excited you.
- How to banish Fear, physical as well as mental.
- How to stop Worry.
- How to become a Man among Men.
- How to get rid of Superstition.
- How to face old age calmly.
- How to maintain poise in public.
- How to assert yourself in Business as well as in the Home.
- How to develop courage to swing big deals.
- How to dominate Circumstances.
- How to defy old time habits of Hesitation.
- How to insure a healthy, virile, intrepid grade of Brain.
- How to stir into electrical activity, latent leadership qualities, which Nature has tacked into the make-up of every normal man or woman.
- How to mass the myriad cell-forces of your Mind into a strong, daring, goal-gaining plan of conduct.
- How to break open the door to a new world of Thinking—rare in beauty, practical in application.
- How to blaze the way to unthought-of fields of self-expression.
- How to add to your physical buoyancy a tingle and zest hitherto missing.
- How to impress others with your poise, purpose and power.

A complete list of contents would almost fill this box.

Culture of Courage Scatters Your Fears!

Send No Money—Examine Book Free

Do you lack confidence in meeting other people? Are you conscious of another's personality and your own lack of it? Do you feel inferior to others? Are you superstitious about anything? Do you worry about your loved ones or about conditions? Are you afraid of approaching old age? Do you seem to be blinded by petty fears? Are you frightened in public? Are you afraid of your ability to "put things over"? Are you afraid to assert yourself in your home or in business? Do you fear the opinion of others? Have you the courage of your convictions? Do things that other men and women are doing seem impossible of accomplishment by you? Are you afraid to go in business for yourself or afraid to take the risks you used to? Are you able to brush aside all obstacles in order to arrive at your destination? Are you conscious of your power, self-confident and eager, demanding what you want, or do you stand cringing, hat in hand, and whine for it? If any of these subjects even touch on your condition "Culture of Courage" will prove a godsend!

Fear of self—fear of people—fear of the future—fear of things—fear for others (worry)—are what keep men and women down when they should and could be on top.

A Ghost-Scattering Searchlight

In "Culture of Courage" the author opens up into some of the most important problems of existence; he throws a ghost-scattering searchlight into the shadows that have scared people from rich fields of life; he tears away the straw-and-gossamer entanglements which have held men and women in subjection; he pulls off the imagination-created masks of various fears, superstitions and bugaboos which in all ages have paralyzed the brain's energies and constantly dinned into eager ears the failure slogans: "I'm afraid," "I dare not try," "I haven't the ability," etc.

This book will startle you, will awaken strains of thought that may easily change the entire course of your career, just as it has that of thousands of other men and women in all walks of life who have learned its wonderful back-bone building secrets.

"Culture of Courage"

by Frank Channing Haddock, Ph. D. This great work by the famous author of "Power of Will"—a scientist whose name ranks with James, Royce, and Bergson, is not an inspirational book which merely admonishes you to "destroy your Fears" and "Be Courageous." Instead, it is a practical course in *how* to overcome each particular kind of human fear, physical as well as mental, to which we are all subjected. It contains actual principles, rules, methods, and exercises which any one can easily follow and become ten times bigger—ten times more successful—ten times happier than you have ever dared hope.

Send No Money While published in book form "Culture of Courage" is a comprehensive system of courage-building and contains more material than many \$25 correspondence courses. It has 14 main divisions, and fills 460 pages. Beautifully bound in half-leather, gold top leaves, big readable print—yet the price is only \$3.00, and we are offering it for 5 days' examination without a penny from you in advance.

Send no money—merely mail the coupon enclosing your business card or giving a reference. If, after you have it in your own home, you feel you can afford not to own this wonderful guide to a broader life, to things worth while, send it back. The examination will not have cost you a penny. Tear out, fill in and mail the coupon right now before you turn this page, as this announcement may not appear in this magazine again.



460 pp.
Half Leather
Gold Top
Leaves

What Readers Say:

"In it I found rules, principles and regimes which make it worth its weight in gold to me."—District Attorney Goodwin, Oil City, Penn.

"It is a 'wonder.' The more one reads it, the more forceful ideas he can draw from this storehouse."—J. F. Ellis, Pres. Nat. School of Sales'p, Minneapolis, Minn.

"It is simply magnificent; I shall highly recommend it and wish everybody could read it."—L. J. Hall, Rochester, N.Y.

"It stands absolutely at the head of anything I have ever come across; Mr. Haddock is certainly a Master Mind. As a teacher, I can say that no greater good could come than the abolition from superstition this book brings about."—James Sermitwell, Reynoldsville, Pa.

"These books are a gold mine of 'energizing material' for the progressive mind."—A. A. Martin, M. D., Pierce, Neb.

"Enclosed is my check; send another copy."—W. H. Smith, Pres., Herring Hall, Marvin Safe Corp., New York.

"'Culture of Courage' is superb. It is clear, forceful, scientific, practical in every form and manner; ALIVE with the rich, the high, the ideal, the sublime. It's an inspiration from beginning to end. IT JUSTIFIES ALL CLAIMS."—F. Stanley Perera, Res. Master, Wesley College, Colombo, Ceylon.

"Enclosed is check for which send me another copy for one of my friends. Dr. Haddock's works are superior to anything I have ever read for the development of the individual. He is entirely in a class by himself."—Chas. E. Ward, D. C., Houston, Tex.

Pelton Pub. Co.
5101 Pelton Bldg.
Meriden, Conn.
Gentlemen: Please send me a copy of "Culture of Courage" on approval. I agree to remit \$3.00 or return the book in 5 days.

Pelton Pub. Co. 5101 Pelton Bldg. Meriden, Conn. Name.....
Address.....



YOU Can Be What You Want to Be

No one ever hit the bull's-eye without first aiming for it. You must first *resolve* before you can *win*. *You can be what you want to be.*

If you want a good position at the work you like best of all—if you want to earn more—if

you want to be in line for bigger things, the *American School* will tell you how to be just *what you want to be*. Check the position you want and mail the coupon now.

How the American School can help you

For over eighteen years the *American School* has been training men and women for responsible, well-paid positions. It has prepared thousands for entrance into the big resident colleges. It has trained even more in all branches of *Engineering, Business* and *Law*. The *American School* will give you the training you need to succeed in whatever occupation you select, no matter where you live or what you do. You don't have to give up your work—we train you at home, in your spare time.

Your Opportunity Coupon

Mark the position you want
and mail the coupon now

- | | |
|--------------------------------|---------------------------|
| Electrical Engineer | Lawyer |
| Elec. Light & Power Supt. | Business Law |
| Hydroelectric Engineer | Business Manager |
| Telephone Engineer | Auditor |
| Architect | Accountant |
| Architectural Draftsman | Cert'fd Public Acct' |
| Building Contractor | Private Secretary |
| Building Superintendent | Stenographer |
| Structural Engineer | Bookkeeper |
| Structural Draftsman | Fire Ins. Inspector |
| Mechanical Engineer | Fire Ins. Adjuster |
| Mechanical Draftsman | Fire Ins. Expert |
| Civil Engineer | Sanitary Engineer |
| Steam Engineer | Plumber |
| Shop Foreman | Reclamation Eng. |
| Shop Superintendent | Textile Boss |
| Sheet Metal Draftsman | College Preparatory |
- We also prepare for civil service examinations in all engineering subjects

Ambitious people everywhere have had their salaries raised as a direct result of the *American School's* help. Mark and mail the attached coupon and learn how *you* can succeed as they did. Finding out costs you nothing—involves no obligation. So—act today—send the coupon now.

No agent "will call on you." The *American School* does not employ agents or collectors to bother you in your home or at your work. We do all of our business as we teach—by correspondence. Mail the coupon and get the facts.

American School

of Correspondence, Chicago, U.S.A.

NAME

ADDRESS

Pop. Mech. 10-15

Please Mention Popular Mechanics



Apprentice Seamen in Sham Battle at Training Station

Winning Success in the Navy

FOUR YEARS' service in the United States Navy is an education. It is an education of a practical nature, fitting young men for successful careers.

☪ In the Navy trade schools are taught such trades as electrician, radio, carpenter, coppersmith, blacksmith, machinist, cook, baker, clerical work, nursing, pharmacy and numerous others. The training stations prepare recruits for the elementary duties of seamanship, and the classes on board ship instruct men in those school branches in which they are deficient, besides preparing them for advancement in rating. It is the aim of the Navy Department to assign every man to the work for which he is best fitted, and to help him strive for promotion.

☪ The pay begins with enlistment, and every recruit is furnished **free** with a complete outfit of uniform valued at \$60. Pay increases with advancement, and with re-enlistment. Promotion is open to petty officers, to warrant grades, and for those who work for it, to commissioned rank.

Investigate the Navy's offer. Write for the address of the Navy recruiting station nearest you, and learn all about the work, pay and advantages of naval service. Address Box 66

BUREAU OF NAVIGATION
NAVY DEPARTMENT **WASHINGTON, D. C.**

Keep Things Bright with JOHNSON'S PREPARED WAX

It cleans, polishes and finishes in one operation. It forms a thin, protecting film over varnish—adding years to its life. Every family has dozens of uses for Johnson's Prepared Wax—it is just as necessary around the house as soap. Keep a can always on hand for cleaning and polishing

The furniture, woodwork and floors

—In Your Home

The desks, filing cases, cabinets, etc.

—In Your Office

The body, hood and fenders of automobiles

—In Your Garage



JOHNSON'S PREPARED WAX

Is the standard polish for automobiles, electrics and limousines. It imparts a perfectly hard, dry, glasslike finish that

Will Not Gather Dust

It preserves the varnish and protects it from the weather. It is in paste form—clean and easy to use and economical—it prevents checking and

cracking—covers up small scratches and

"Sheds Water Like a Ducks' Back"

It keeps new cars bright and shiny for an indefinite time and makes old cars look as well as a coat of paint and varnish. A "wash" lasts twice as long on cars polished with Johnson's Prepared Wax. It is conveniently put up—always ready for use—no tools or brushes required—all you need is a cheese cloth rag. Use it to clean and polish

Floors	Piano	Golf Clubs
Linoleum	Furniture	Automobiles
Woodwork	Leather Goods	Gun Stocks, etc.

We shall be glad to send you gratis a copy of our beautiful new 25c color book "The Proper Treatment for Floors, Woodwork and Furniture."

S. C. JOHNSON & SON RACINE, WIS.
"The Wood Finishing Authorities"

S. C. JOHNSON & SON, Racine, Wis. P.A. 10

I enclose 10c for a trial can of Johnson's Prepared Wax—sufficient for polishing an automobile, several pieces of furniture, or a small floor. Also send booklet on home beautifying free.

Name.....

Address.....

City and State.....

Please Mention Popular Mechanics

Popular Mechanics Magazine

REGISTERED IN U. S. PATENT OFFICE

WRITTEN SO YOU CAN UNDERSTAND IT

Vol. 24

OCTOBER, 1915

No. 4

327

Boat Has Wings That Skim the Surface

THE latest development in racing motorboats is a craft capable of making from 60 to 80 miles an hour and equipped with wings that are designed to catch the water just as the wings of an aeroplane catch the air. This boat is 19 ft. 9 in. long and 12 ft. wide over-all, each of the wings being 3 ft. wide and the hull 6 ft. wide. It is equipped with a 250-hp. racing engine which ordinarily runs at 1,500 revolutions a minute and drives the propeller at 2,250 revolutions a minute, or one and a half times its own speed. One of the novel features of the boat is that the rudder is at the bow, while the helmsman sits at the stern. With this arrangement the boat is easily handled at any speed, one

effect of the bow rudder being that the boat, in making a turn, has a tendency to pivot around the rudder. This craft is apparently built specifically for high speeds. At less than 15 miles an hour the stern drags deeply, the bow point-

Brown & Dawson, Stamford, Conn.

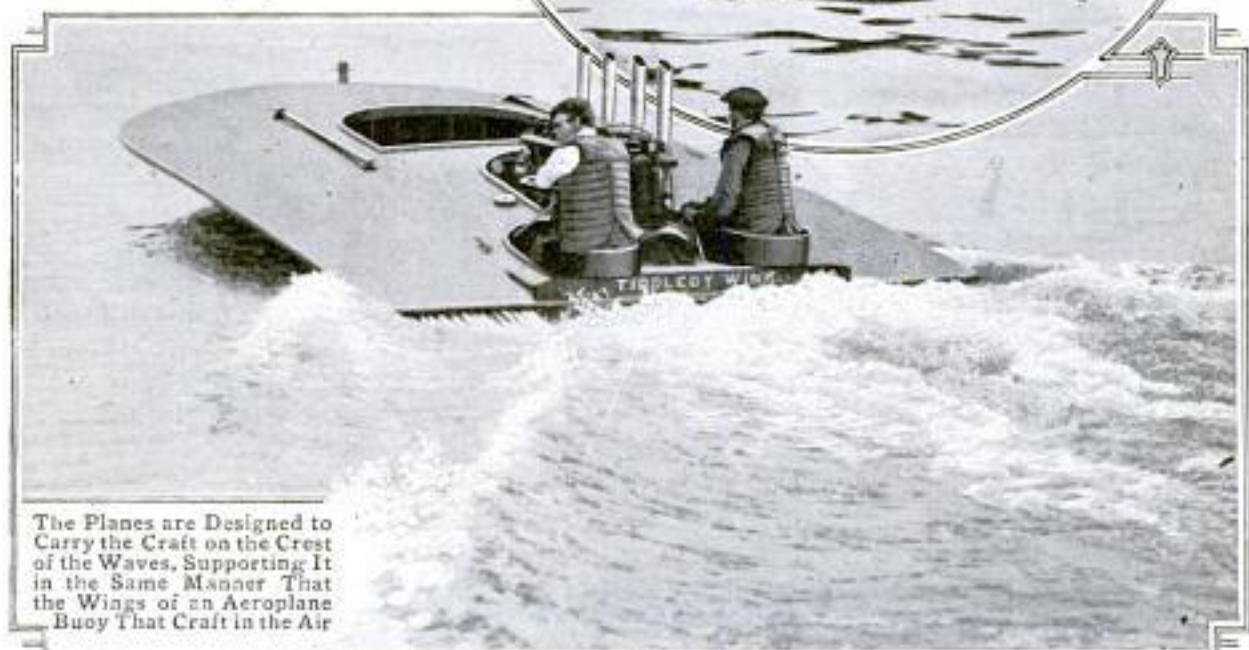
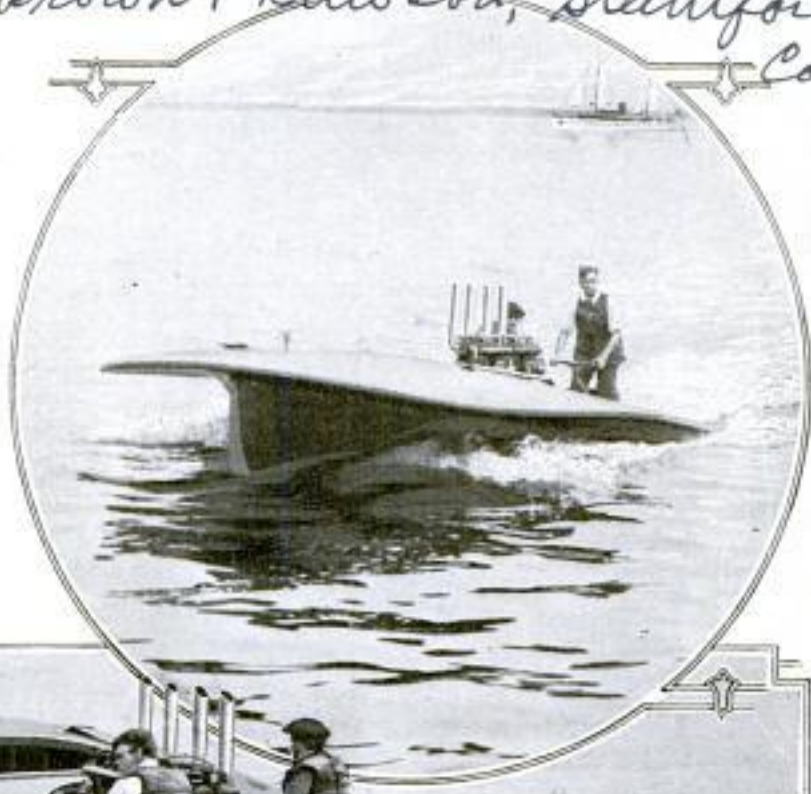

The Planes are Designed to Carry the Craft on the Crest of the Waves, Supporting It in the Same Manner That the Wings of an Aeroplane Buoy That Craft in the Air

COPYRIGHT, BROWN & DAWSON

Designed & Built for Chas. Chesbrough
of Northport, L. I., by A. E. Luders of
Luders Marine Construction Co., Stamford, Conn.

481

Copyrighted material

ing upward at an angle of about 20°. From this speed up to about 30 miles an hour the bow slowly lowers as the speed is increased. Above this speed the boat settles down, under the action of its propeller, to a level position and skims the surface evenly, the speed increasing perceptibly with each increase in the application of power.

SPORTSMAN'S WATCH BUILT WITH COMPASS IN-CROWN

Novel features are embodied in two inexpensive watches which are being introduced by an eastern maker. One of the instruments mounts a miniature compass in its crown, while the other



The Compass is Mounted Neatly in the Crown so That It does Not Detract from the Appearance of the Watch

holds a small cigar cutter in a similar position. Because of the manner in which these devices are mounted, they do not detract from the appearance of either timepiece. They are made in No. 14 size, thin model, with antique pendant and pull-out stem. Although the compass is small, it is adequate for ordinary needs on short hunting and fishing trips, and may also be used conveniently by motorists and cyclists.

RADIUM EXTRACTED CHEAPLY

BY GOVERNMENT EXPERTS 351

According to an official announcement, a new process for the extraction of radium from the carnotite ores of Colorado, which has been undertaken by the Bureau of Mines, is now being employed profitably on a manufacturing basis. The experimental work has passed and the results are far more gratifying than was even expected.

Metallic radium has been produced in the form of a bromide at a cost of \$36,050 a gram. The great importance of this may best be appreciated by comparing the figure with the ordinary prices for the substance, which have ranged between \$120,000 and \$160,000 a gram.

Slightly more than three grams of the metal have been obtained in the form of radium-barium sulphate. The ratio of this is more than one milligram of radium to a kilogram of the sulphate. Ten carnotite claims at Long Park, Col., which are owned by a steel company, have supplied the ore for the work. From these deposits 796 tons of ore, averaging two per cent uranium oxide, have been obtained.

Conversion of the radium-barium sulphates into chlorides and the refining of the radium is accomplished easily and without much loss. A concentrating plant has been erected at the mines and is now recovering material which was formerly wasted. Grinding and sampling machinery has been installed at Denver, where a radium-extraction plant has also been erected and is now in operation. The figures covering the last five carloads of ore, received prior to July 1, show that 90 per cent of the mineral was recovered. An announcement of the methods employed in mining and concentrating the ore and extracting the radium is to be made by the government in a short time.

Signs identifying points of interest, such as historical battle fields and prominent rivers, are being erected along the right of way of a southern railroad.

204

The E. Ingraham Co.,
Bristol, Conn.
See page 111-550
1911

GIANT WAR HAWK OF GERMAN AERIAL CORPS



WAR correspondents are describing the appearance in northern France of a German "battle aeroplane" of the dual-tractor, twin-engine type which has all but driven its enemy from the sky. This machine is a biplane of 70-ft. wing spread. It has two separate fuselages, in each of which is installed a 100-hp. motor, and between these an armored nacelle which mounts machine guns. It maintains a six-hour patrol safely out of firing range at a height varying between 4,000 and 8,000 ft. While awaiting the appearance of prey it sweeps the sky in broad circles. Then it swoops down like a hawk and gives battle. Observers assert that the machine is superior to any other yet developed.

C. J. Silver Motor Co., 1760 Broadway, New York City

DRAWER SEATS PROVIDED IN MOTOR ROADSTER

One of the new body designs for a roadster provides seating room for six persons. Four of the seats are purely

161



The Drawer Seats at the Sides are Pushed Out of View When Not in Use

auxiliary and are closed from view when not in use. Two drawer seats, one on each side of the machine, which may be pulled out over the runboards when desired, take care of a couple of passengers. This feature is especially convenient and odd. When not required, the side seats are pushed into the body out of sight. Space for two other persons is given in a cockpit constructed at the rear. When this room is not needed the space may be closed and, if wished, used for storage purposes. Both of the features are well worked out and do not impair the appearance of the car.

409

INDUSTRIAL IMPORTANCE OF SULPHURIC ACID

In recent years sulphuric acid has assumed such great importance in an industrial and commercial way that statistics showing the production are now given out annually by the United States Geological Survey. This material is probably used in a greater vari-

Booklet on Sulphur by U. S. Geological Survey.

ety of ways in the chemical arts than any other substance. The most important classes of industry in which the consumption of sulphuric acid is involved are the manufacture of fertilizers, the refining of petroleum products, the iron, steel, and coke industries, the manufacture of nitroglycerin, celluloid, and similar products, and in general metallurgical and chemical practice.

381 — La Nature

PANORAMIC PERISCOPE MADE FOR FRENCH SUBMARINES

France has at last developed a panoramic periscope which is capable of providing a commander of a submarine a constant and clear view of the horizon in all directions. The instrument, which is reliably stated to be successful, represents one of the most important inventions recently made for facilitating the operation of submersible vessels. Of late years much effort has been expended in perfecting a periscope of this character, but until now the results have been unsatisfactory.

One of the great handicaps imposed upon the operators of modern submarines has been the inability to see in more than one direction at a time. Only by turning a periscope, or encircling a "walk around," has it been possible to scan the whole horizon, and then not at a single glance as now.

At the top of the new instrument is an annular lens, the exterior of which has a spherical curvature while the interior is ellipsoidal. Images of everything discernible about the whole horizon are first refracted and then reflected down the tube. They are collected in a horizontal plane by a condenser set midway in the tube, and thrown upon a five-sided prism at the bottom which reflects the rays twice and projects them through binoculars. The view given the observer is circular; much the same in appearance as if he were looking at one side of a globe.

This describes one half of the instrument, which in reality is a double periscope. Immediately below the lens at the top of the tube is a second eye and

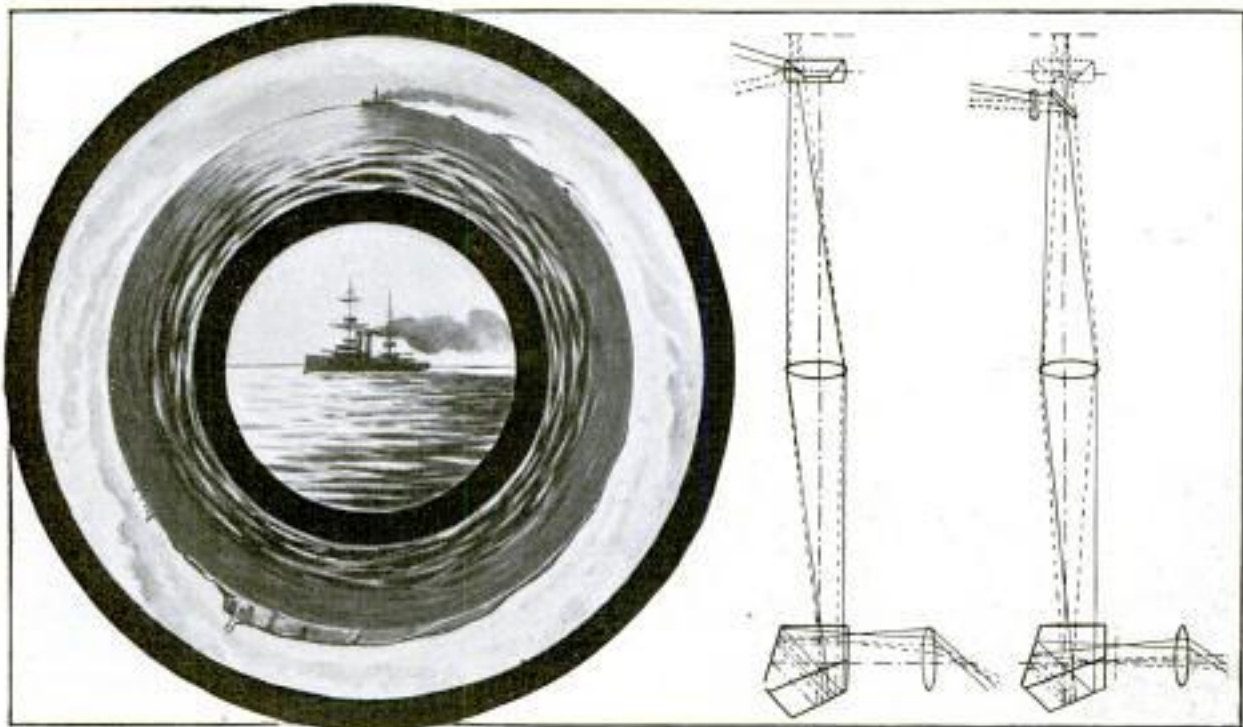

COURTESY OF LA NATURE

In the Center of the Panorama Appears the Image of a Ship upon Which the Eye of the Inner Periscope is Focused. In the First of the Diagrams the Full Lines Show the Refraction of Rays Admitted by the Annular Lens, While in the Other They Indicate the Path of Those Forming the Middle Image

this may be turned in any direction and focused on a specific object, just as an ordinary periscope may. The rays entering it pass down the tube in the same manner as the others, but without interfering with them. The image appears in the center of the panoramic picture and is greatly magnified in comparison with individual objects shown in the latter.

MINIATURE RUNABOUT BUILT FOR USE IN CITY STREETS

What is without doubt the most curious motor-driven vehicle that has yet made its appearance was recently demonstrated in the business streets of Baltimore. It is a diminutive adaptation of the motorcycle and not a great deal larger in size than many of the manually propelled conveyances driven on city sidewalks by small boys. The device is designed not as a plaything, but as a quick, ready means of transportation. A compact 2½-hp. motor, which drives the machine at a maximum speed of 25 miles an hour, is mounted at one side of the rear wheel. The fuel and oil tanks are embodied in the frame, and it is stated

that one gallon of gasoline will carry the cycle approximately 75 miles. To prevent mud and water from splashing onto the rider, the wheels are nearly incased in specially shaped mudguards. The machine is 4 ft. in length, 18 in. high, 9 in. wide, and weighs 45 lb. It is equipped with a "kick starter" and is controlled in a novel way. By moving the handlebars forward the speed is increased, while by drawing them all of the way back the clutch is disengaged, the engine throttled, and the brakes applied.

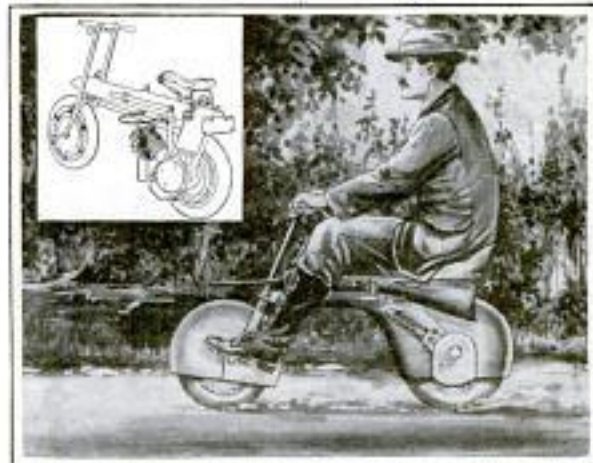

While Weighing Only 45 Pounds, the Little Machine Is Capable of Carrying a Weight of 300 Pounds at a Speed of 25 Miles an Hour

Libson Motor - 400
 No. 24 C
 1/8/17 -
 (Steen)

The Coalition Company, Inc.,
 Universal Machine Co.
 Industrial Bldg.
 Balt., Md. are the actual manufacturers.
 50 Church St.,
 New York City

Copyrighted material

The "Motor Auto" N.Y.C.
 Invention by Libson & Co. also known
 as the "Auto" - Reg. - Aug 1914 - 163-7170

9010
**QUEER EYEGLOSS MOUNTING
 DESIGNED BY INVENTOR**

In an effort to devise a means of mounting eyeglasses so as to avoid the skin irritation sometimes caused by the bows resting around the ears and the



The Glasses are Suspended before the Eyes from a Bandagelike Headgear

bridge pinching the nose, a Nebraska inventor has patented an odd plan for suspending the lenses before the eyes. While the arrangement cannot be called an attractive one so far as appearances are concerned, it may benefit certain persons who are compelled to wear glasses constantly and find the ordinary mountings objectionable. Large lenses, each having a straight edge on the inside so as to fit close to the nose, are secured at the top to an adjustable yoke. The terminals of this are fixed in a headgear, or cap. In this manner the weight of the glasses is supported above the nose, the lenses merely hanging in front of the eyes.

☞ Flying an American-made tractor bi-plane, Raymond V. Norris, carrying three passengers, recently reached an altitude of 8,300 ft. at Buffalo.

**MUNICIPAL RENTING AGENCY
 ESTABLISHED AT MILAN**

Modeled after the system in vogue at Paris, the authorities at Milan, Italy, have established a municipal renting bureau, the fundamental purpose of which is to enable a stricter supervision of sanitation conditions than has been possible in the past. The idea originated at a tuberculosis congress some time ago and a movement was immediately launched to crystallize it. When an owner lists his property with the municipal agency it is thoroughly inspected in regard to both cleanliness and location. A bulletin is issued periodically, giving the locations of various vacant apartments in the city. This is distributed free, and no charge is exacted for the service from the owner.

414
**PHONOGRAPH FOR SETTLING
 FAMILY QUARRELS**

From Daily paper
 A judge in Kansas City, Kans., proposes to use the phonograph in a novel way for settling family and neighborhood quarrels when they are brought into the police court. The phonograph is to be installed in the court room, and with it all the testimony will be recorded. After a few days all concerned will again be summoned and compelled to listen to the testimony, with the inflections of the voice and all interruptions faithfully reproduced. The judge believes that in the majority of cases the whole proceeding will then seem too petty to be carried farther.

396
**RUNAWAY OIL CAR COLLIDES
 WITH PASSENGER TRAIN**

Only battered, twisted metal and heaps of charcoal remained of a passenger train following a serious wreck which recently occurred near the Olinda oil fields in California. The disaster happened when a large tank car filled with petroleum broke loose, rolled down grade for five miles, rounded a curve at an estimated speed

Cont. Robert W. Phelps,
185 S. Ardmore Ave.,
POPULAR MECHANICS Los Angeles, Calif. 487



All That Remained of the Ill-Fated Passenger Train an Hour after the Collision Was a Snarl of Metal and a Long Heap of Ashes and Charred Wood. All but Two of Those Aboard Escaped Death

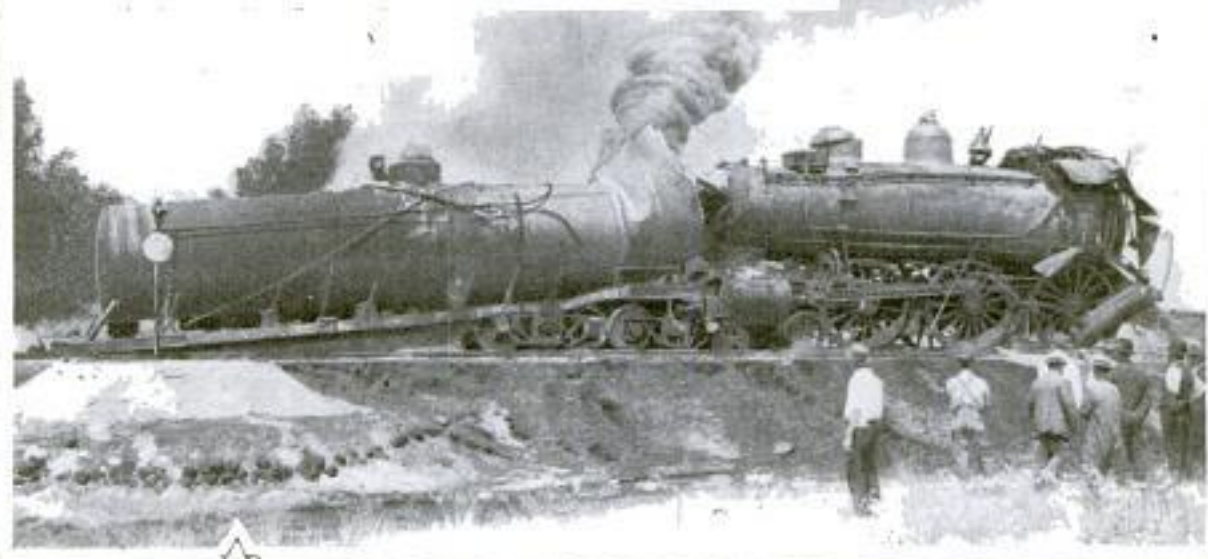

The Head of the Locomotive Pierced One End of the Tank Car, Causing a Sheet of Oil to Fall over the Whole Train. Below Is a Diagram Showing How the Accident Occurred

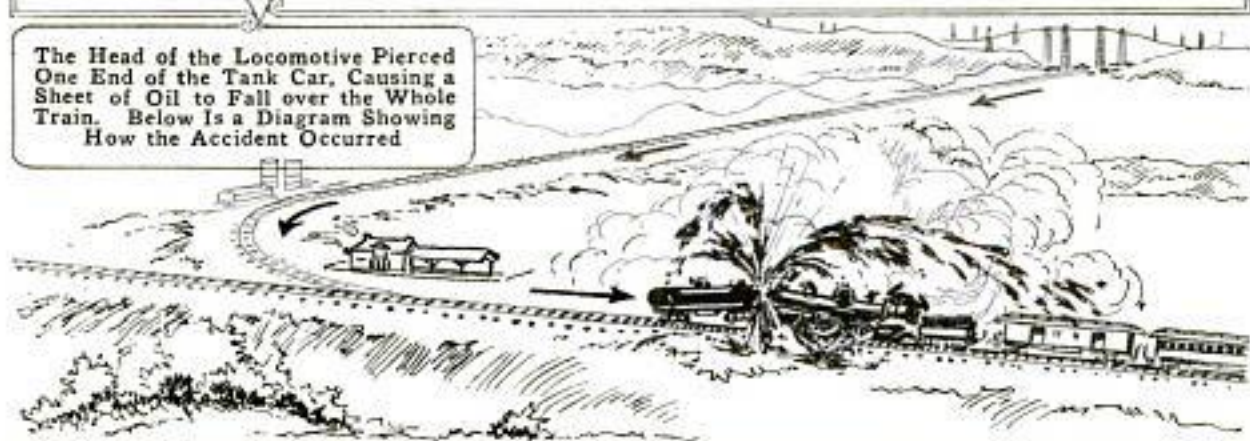

of 65 miles an hour and swung into the main line of a western railway just in time to crash, head-on, into a speeding passenger train. The impact caused the oil car and the locomotive to telescope, while the coaches at the rear were hurled back for some distance. A sheet of oil shot out of the smashed end of the tank, drenching the entire train. Almost instantly this was ignited by the heat from the engine's fire box, enveloping everything

in a cloud of flame and smoke. Fortunately the train was a local, carrying two coaches and a combination car, which were only partly filled. Because of this the casualty list was small.

During 1914, 172,296 tons of talc and soapstone were marketed. This was less by two per cent than the volume handled in 1913. The value of the production was \$1,865,087.

DOGS DRAW WHEEL CHAIR FOR CRIPPLED MAN

In order that he may make his way about the streets of the city unattended, a Pennsylvanian, who is



In This Chair the Man is Pulled about the City by His Dogs

permanently incapacitated physically, hitches a team of dogs to his wheel chair and drives in comparative ease. The vehicle is of the three-wheel type and is guided by a rod controlling the front wheel. The dogs are harnessed and placed on either side of the chair. Instead of attempting to drive them

with reins, he merely turns his tricycle in whatever direction he desires to proceed. The small brutes, alert to their duty, change their course as quickly as if their heads were pulled to one side or the other.

LAKE BOATS ENTER OCEAN STEAMSHIP SERVICE

Vessels for transatlantic and coastwise shipping have been in considerable demand since the opening of hostilities abroad. This has been responsible for the sale of a number of Great Lakes freighters to ocean steamship companies and the subsequent delivery of the ships at eastern ports. This has been done by taking the vessels through the Welland Canal, connecting lakes Erie and Ontario, and thence down the St. Lawrence River. The locks in the waterway, however, do not permit the passage of boats greater than 270 ft. in length, which has made it necessary in several instances to cut the freighters in two amidships and float the segments through separately. This was done with the "Matoa" recently, which has a length of 291 ft. The ship was cut apart at Port Huron, Mich., and the hull sealed with heavy bulkheads. The aft part of the vessel proceeded under its own steam as it was steered by a tug, while the bow section was towed. Concurrent with this four other ships were similarly prepared at Buffalo for the trip.

276

*9585
Herman Lieber,
338 Catharine St.
Philadelphia, Pa.*

*Cont: N. W. Patton,
% The Detroit News,
Detroit, Mich.*



Above: Rear View of the Forward Segment, Showing Bulkhead Construction

Right: Aft Section of the "Matoa" Making Ahead under Its Own Steam

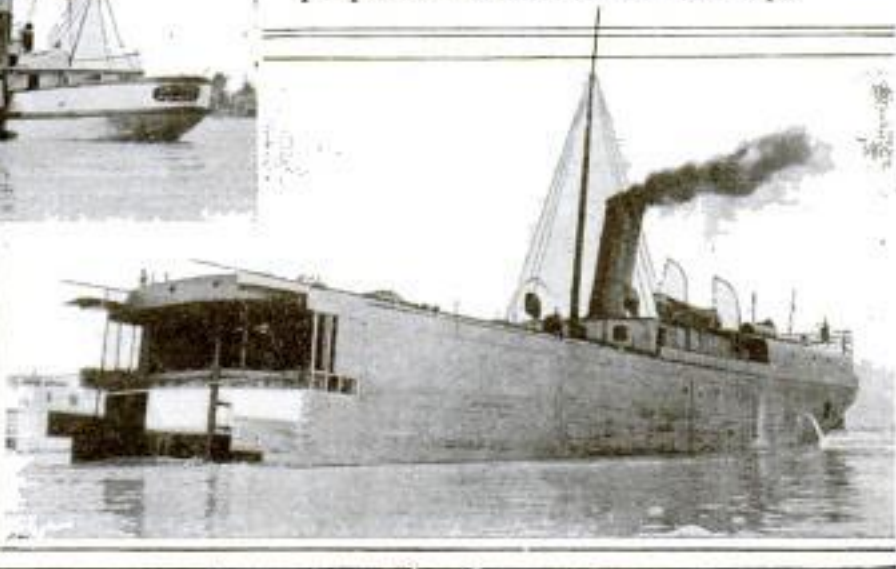

Cont: David Baxter,
410 East B Avenue,

POPULAR MECHANICS ⁴⁸⁹ Hutchinson,
Kansas

BIG FARM-TRACTOR CONTEST HELD IN WHEAT BELT



Above are Shown Two Types of Farm Tractors Which Took Part in the Kansas Contest



Long Line of Machines on Their Way to the Exhibition Grounds



All of the Tractors were Put through a Series of Severe Tests to Show Their Capabilities



379

Nearly 100 farm tractors of different types and sizes were entered in a power plowing and cultivating contest which was held in Kansas soon after the wheat harvest. The meet took place on a 1,000-acre tract of land adjacent to Hutchinson, where separate plots were measured off for the demonstration of each machine. These spaces were allotted in accordance with the size and potential capacity of the various tractors. The exhibition, which was on a much broader scale than any previously held in the wheat belt, was attended by thousands of grain men and agriculturists of the Southwest. The tests were made especially interesting because of the muddy condition of the ground, due to the incessant rains which had caused great trouble during

the harvest season. They were given an opportunity in this way to compare at first hand the abilities of various patterns of machines, determine which types were best suited to meet their specific requirements, and see what these respective tractors could accomplish in soft fields. The machines represented a wide range in horsepower, weight, and cost; light tractors intended to do the work of two horses, and large engines built to pull nearly a score of plows at one time, appearing side by side.

Contributions of tobacco sent from this country for the use of French soldiers must be directed to the minister of war, who will distribute it at his discretion.

TRICK RIDER OF UNICYCLE ADVERTISES CLIENTS

271 Giving spectacular riding exhibitions on a high-seated unicycle in one of the streets of San Francisco, is the occupation of a trick cyclist of that city. Ad-



How the Cyclist, Wearing the Uniform of a Ship's Officer, Advertised an Antiquated British Convict Vessel Exhibited at the Water Front

vertising local business and amusement concerns constitutes his source of income, and this he does by wearing a placard on his back while startling the crowds as he apparently narrowly escapes death traps in the rush of traffic. He swerves and turns, winding in and out through the jam of motor cars, trucks, and wagons with ease, but nevertheless to the constant concern of onlookers. One day he wears a dress suit and advertises some tailor shop, while the next day he may display an advertisement of a different nature.

FOREST LANDS NOW HELD FOR ACTUAL SETTLERS

411 To prevent timber speculators from interfering with the settlement of the land by real farmers, the government is now withholding from agricultural entry all heavily timbered land in the national forests, until after the timber has been cut off. In each case the land will be opened to entry as soon as this is done, and settlers will be able to acquire it from the government under the homestead laws instead of having to pay from \$40 to \$60 an acre to speculators. The serious situation that confronts the government in this connection is shown in the fact that in Oregon and Washington alone more than 3,000,000 acres of fertile logged-off land are lying idle, being held at prohibitive prices by owners who acquired it for the timber, while at the same time hundreds of settlers are seeking homes in the adjoining national forests. The care that is being taken in classifying and disposing of the forest lands is well illustrated in the Kootenai Valley in Montana. Here a large river winds for 150 miles through the national forest. The valley is heavily timbered, but except for detached sections along the river it is too rough or too thinly covered with soil to be valuable for agricultural purposes. Instead of opening the whole valley to settlement, the Forest Service has painstakingly surveyed every little river bottom, island, and bench that contains enough arable land to support a home, and only these will be subject to entry. In this way more than 300 small farms have been carved out of the Kootenai national forest, while the bulk of the valuable timber land has been preserved for the national government.

When a recently invented massage vibrator is used the machine does not touch the person under treatment. The apparatus slips over the back of one of the operator's hands, transferring its motion so that the flesh is kneaded by the fingers.

Cont. U. S. Rockwell, Berkeley, Calif.

Cyclist: Walter E. Nilsson.

Information Sheet sent out by Department of Agriculture.

392

International News Service

238 William St.

DEATH AND RUIN MARK PATH OF ERIE FLOOD

W. H. C.



Remains of Twenty-Sixth Street Culvert, Which for Some Time Held Back a Lake of Water. Subsequently It Burst, Turning the Flood Loose on the Town. In Five Minutes Water Rose Four Feet



This Street Car was Struck by a Wall of Water and Overturned at the Intersection of Eighteenth and French Streets. The Flood Cut a Path 28 Blocks Long through the Heart of the City



The Flood was Caused by a Cloudburst Which Came after Three Days' Rain. Mill Creek, Dividing the City, Was Already Out of Its Banks. Picture Shows Debris in Seventh Street

French Street, Which Suffered Severely. Nearly 2,000 Persons were Made Homeless and 100 Buildings Swept from Their Foundations. Many Casualties and Large Property Damage Resulted



Mfr. Regal Silver Manufacturing Co.,
 Silvermiths' Bldg. 1041 State Street, New Haven,
 125 Gladstone Lane, New York.

CURIOUS PERCOLATOR MADE WITH GLASS VESSELS

Application for patent rights has been made on a novel coffee percolator, the principal parts of which are de-



By Removing the Funnel and Strainer and Using the Bracket as a Handle, the Coffee may be Poured from the Flask

signed in glass. The device is as simple in construction as it is unusual in appearance. It consists essentially of a small-necked flask into which fits a glass funnel that holds a strainer.

These three parts are supported by a neat bracket, on the base of which is a place for an alcohol lamp. The required amount of water is poured into the flask, pulverized coffee placed in the funnel, and the small burner lighted. As the water becomes heated it rises into the funnel, coming in contact with the coffee. When all of the water has risen to the top the flame is extinguished, and the liquid allowed to filter back into the flask. The coffee is then ready to serve.

— 357

TRACTION WHEEL OF BINDER RUNS IN BIG HOOP

When continued rains soaked his wheat fields to the extent that it was almost impossible to drive a binder across them, an Iowa farmer devised a novel and very effective means of overcoming the difficulty. A substantial wooden wheel, 9 ft. in diameter and bound by steel wagon tires, was constructed and so mounted as to form a track for the bull wheel of the harvester, thus preventing the latter from becoming mired. The rim of the big drum was 15 in. in width, which was sufficient to support the weight of the binder in soft fields. The device served its purpose well and enabled the farmer to save his crop.

*Cont: Merg Maroni,
 of Sentinel-Post,
 Shenandoah, Iowa.*



The Large Hoop Forms a Track for the Bull Wheel and Prevents the Binder from Sinking into the Soft Ground

Invention of H. R. Hogsett, of that city

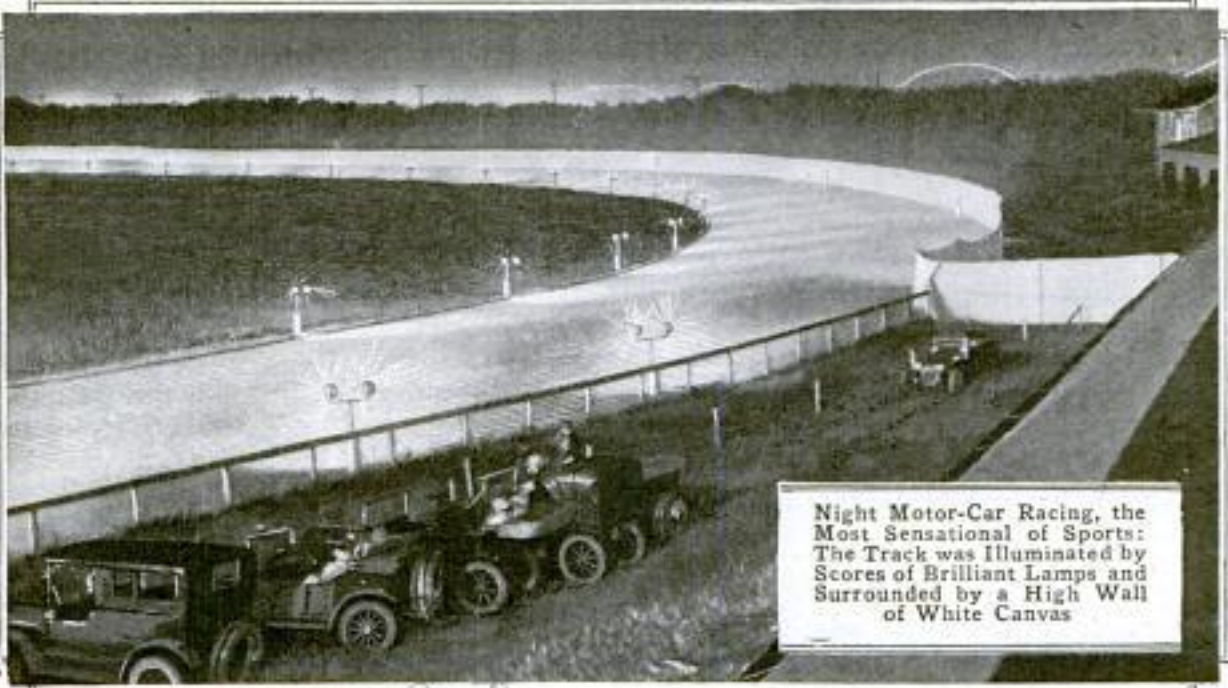

Archie
**NIGHT MOTOR-CAR RACES
 NOVEL SPEED CONTESTS**

373
 Motor-car racing at night under the glare of scores of powerful carbide lamps developed into a popular sport at the Brighton Beach track during the middle part of summer. A number of fast speed contests were run before large crowds which were attracted by the novelty of the events. By instituting a simple scheme of illumination, the one-mile course was lighted so that the spectators could see the racers at all times. This was accomplished by placing 185 dual-burner lamps, each capable of throwing a 12,000-cp. glow over a wide area, at frequent intervals. The outside of the track was margined with a 10-ft. white-canvas wall. Part of the lights were directed against this and others at the floor of the track. The cars in this way were silhouetted against the white background. Although the spectators were given an intensified impression of the speed, because of the black surroundings, the machines did rumble around the track in fast time, in one instance a lap being made in $49\frac{1}{5}$ seconds.

☐ Boiled sea water has been found by a French surgeon to be an excellent disinfectant for bullet wounds.

156
**SURFACE-MEASURING DEVICE
 OF CONVENIENT FORM**

To make easier the operation of measuring curved and irregular surfaces, a German inventor has constructed a mechanical device which is easily used and gives quite accurate results on certain kinds of work. It is provided with a wheel which, when



The Device is Especially Useful for Measuring Curved or Irregular Outlines, but may Also be Employed on Straight Lines as Shown Here

*German invention.
 Conl: Wm C. Tuttle, 69 Truck Street,
 San Francisco, Calif.*

*C. G. Moore, 32 Street,
 541 East Madison, Ind. - Promoter*

moved over a surface in the same way as a tracing wheel, actuates two dials; one of which records the distance in yards, feet, and fractions of inches, and the other according to the metric scale. It can be used wherever a tape or rule is employed, as well as various places where these agents are of little value.

WIND-PROOF UMBRELLA MADE WITH SPECIAL RIBS

Ordinary umbrellas are often practically worthless after being blown wrong side out by a strong gust of wind, which is not infrequent in heavy storms. Because of this a new type of construction has been adopted by an eastern maker, who has designed a wind-proof umbrella. This is fitted with specially shaped ribs which permit the umbrella to be turned inside out without straining the connecting



If Turned Inside Out This Umbrella may be Pulled Back into Position without Injury

parts enough to break them. It is stanchly enough made, however, to hold its own under ordinary circumstances. In case it is turned wrong side out it may be drawn back to normal position without difficulty and without injury.

HARVARD MEMORIAL LIBRARY GREATEST OF ITS KIND

One of the finest library buildings* possessed by any educational institution has lately been completed on the campus of Harvard University. It has been erected at a cost of approximately \$2,000,000 as a memorial to Harry Elkins Widener, of the class of '85, who lost his life in the "Titanic" tragedy. It is intended to be used not only by undergraduates and research students of the institution, but as a place of special study for students at large. The structure is a mother's tribute to her son's memory.

The library will be the official home of the Harvard Commission on Western History, a body which is collecting material intended partly for the future use of historians and students of American ancestry and progress. At the present time the building holds some 706,240 volumes and about 423,000 pamphlets, while with a number of special collections also included the number exceeds 1,800,000 titles.

In its capacity the building is only slightly less than the New York public library or the Congressional Library at Washington, it is stated. Sufficient shelving space is available, it is estimated, for approximately 2,200,000 volumes.

The exterior of the structure is square and finished in brick. Within the quadrangle formed by its walls is a well which furnishes sunlight on all sides of the memorial hall. The interior, for the most part, is finished in weathered, quartered oak. The halls have marble floors, while cork is laid in the principal rooms to deaden sound. In all there are 70 private study rooms for the exclusive use of professors, and 300 reading stalls for students.

CEarly in July a French airman destroyed an Austrian submarine in the Adriatic by dropping a bomb upon it. A similar feat was previously accomplished by German fliers, who sank a Russian undersea craft.

Mfr: Hulser Bros. & Daniel Co.,
 251 Church Street,
 New York City

9458



Above is Shown the Exterior
of the Harry Elkins Widener
Memorial Library at Harvard

Right: Beautiful
Memorial Fire-
place of Marble
Surmounted by
Portrait of
"Titanic" Victim

Below: Interior of the
Main Reading Room



STILTS USED BY PRUNERS IN ORANGE GROVES

Out in California an orange grower has found a practical use for stilts—one which is quite different from the ordi-



Using Stilts Instead of a Ladder While Pruning Orange Trees

nary function that small boys make them perform. During pruning season they are used instead of ladders for reaching the topmost branches of the fruit trees. It was observed that the continual shifting of stepladders consumed much of the workers' time. This prompted the suggestion that

stilts be substituted. Several pruners, who professed that they had been adept in the use of stilts in their younger days, were provided with the devices. After a small amount of practice they made excellent progress and were able to do considerably more work than they had been capable of doing while using ladders. When the pruning is being done part of the men work on stilts, taking care of the upper part of the trees, while the others remain on the ground.

— 205

POPULAR MECHANICS READ IN CHINESE ACADEMY

Popular Mechanics Magazine is in no sense intended as a textbook, yet this is the use which is being made of it in Soochow Academy, at Soochow, China. The members of the senior class use the magazine instead of the usual classics in the study of English. The reason given for this is twofold. The instructors have found that the pupils make better progress when matter is written in a simple, direct style, than they do when reading more involved literature such as that taught in our schools. On the other hand, modern mechanical progress is more or less unknown to the average Chinaman. So, in studying Popular Mechanics Magazine, the boys not only become acquainted with the language of the American home, but also with the current industrial and scientific achievements of the world.



Group of Senior-Class Boys of Soochow Academy, Where Popular Mechanics Magazine is Used as a Textbook in the Study of English

Cont. - E. R. Manzy.

Justin, Orange Co., Calif.

Cont: Roger Wolcott Soochow Academy

Marine Journal, July 10, 1915

NEW ENGINE WORKS ON GAS AND STEAM

331

A motor of novel type that has just been brought out is designed to use any fuel oil whatever, and combines some of the features of both the internal-combustion engine and the steam engine. It is adapted to marine, automobile, and stationary-power uses. In the operation of this engine the air is compressed in a chamber to itself and is then passed to a second chamber where it mixes with the atomized oil. When this mixture is ignited by the

electric spark, the resulting hot flame is utilized for forming a measured quantity of water into steam, a process that greatly reduces the temperature of the gases formed by the explosion. The steam and these gases then enter a cylinder much like that of a steam engine, where their expansive force furnishes the power for driving the piston. With this arrangement the speed of the engine is easily controlled by a throttle, in exactly the same man-

ner as that of a steam engine, while reversing is accomplished by the simple process of swinging the reversing lever. The engine can be started di-

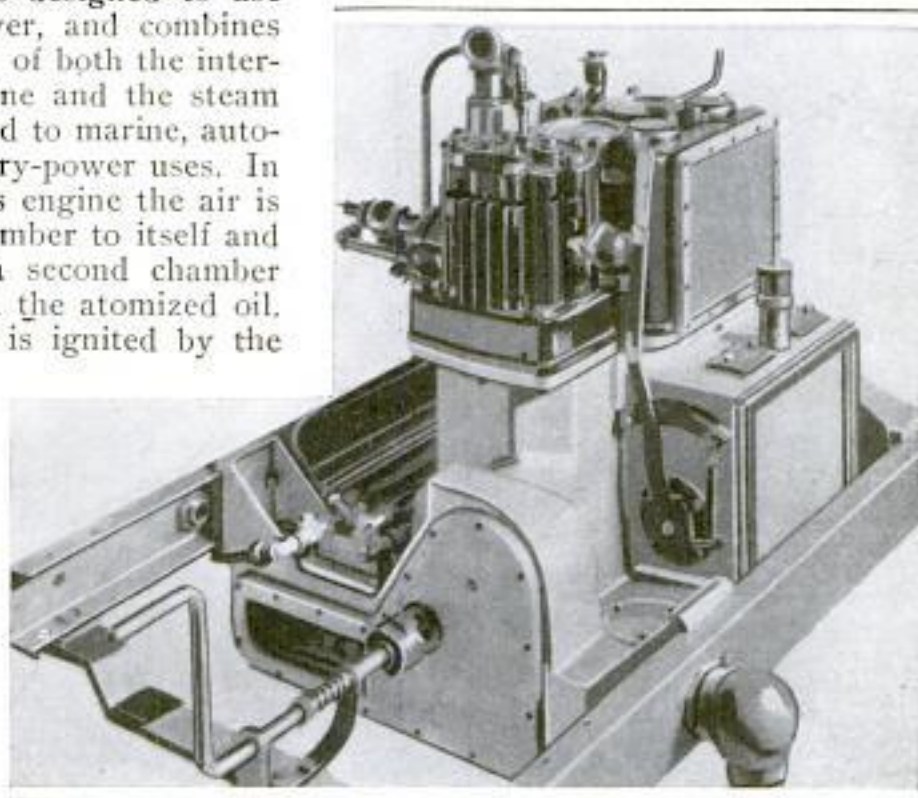

In This Motor Both Gas and Steam are Formed and are Used in Cylinders Like Those of a Steam Engine

rectly on oil without any previous heating. Since the gases for the entire engine are formed in one chamber, only one spark plug is required, whatever may be the number of cylinders.

Shipping Illustrated, Aug. 14, 1915

RUSSIA BUILDS RAILWAY TO ICE-FREE ARCTIC PORT

According to newspaper reports the double-track railway which Russia is building from Petrograd through Petrozavodsk to Kola and Ekaterina on the Arctic Ocean is now practically ready to be placed in operation. The purpose of the new line is to utilize an arctic port that can be kept open the year round. Ekaterina is located about 250 miles easterly from North Cape, the most northerly point of Europe. The mild winter climate of this port and the adjacent seas is due to the Gulf Stream which, after cross-

ing the Atlantic and striking the north coast of Norway, divides near North Cape, one arm flowing easterly along the coast of the Arctic Ocean and keeping the waters practically clear of ice to a point a few miles east of Ekaterina. While this port is open to navigation throughout the year, Archangel, located several hundred miles south and east at the southern end of the White Sea, is closed to navigation early in October and remains closed until some time in May. In view of the war, the importance of this new connection can hardly be overestimated, since it will give the Russians a direct and sure communication with the Atlantic.

TRIUMPH OF WINGS IS THEME OF MARINE FLYING TROPHY

To promote aerial navigation in America, a large silver trophy has been offered for over-water flying. It be-



COPYRIGHT, THEODORE E. STARR, INC.

The Triumph of the Flying Boat over Neptune and Boreas

comes the property of any recognized club whose members win it three consecutive years. The rules of each succeeding contest will be changed in accordance with the advancement made in aeronautics during the intervening periods.

The first stage of the competition will end October 31, this year. Its winner will be the one who flies the greatest distance over water during 10 hours of one day. The conditions governing the measurement of this distance prescribe that the airman who flies in a broken line will be penalized a certain part of the total for the advantage he obtains over those who drive in a straight line from the starting to the finishing places. An addition of

five points is made to the record of a pilot for each passenger he carries.

The trophy is emblematic of the victory of the flying boat over the dominion of Neptune, the ruler of the seas, and Boreas, the master of the winds. It shows a craft of this type escaping the outstretched arms of the elements personified. It is nearly four feet in height and is 2 ft. 7 in. in diameter.

THE PLATTSBURG MILITARY-INSTRUCTION EXPERIMENT 477

Several hundred prominent business and professional men of Boston, New York, Philadelphia, and other Atlantic-coast cities took part during August in one of the most interesting military experiments that has been undertaken in this country.

At Plattsburg, which is in the northern part of New York State, the men, most of them college graduates and all paying their own expenses, under the direction of Maj. Gen. Leonard Wood, were given a month's training in the manual of arms and practices of warfare. The purpose of this encampment, quite unique in America, was to give this body of citizenry an understanding of the fundamental principles of modern warfare and an insight into the business of the soldier. In the four-weeks' course was condensed what the average recruit would ordinarily be given in a year's time.

The men were put through as thorough a workout in field maneuvers, trench fighting, and drilling as the briefness of the time would permit. From sunrise until one o'clock in the afternoons they were kept on the go, while following this hour they were given exercises in signaling, map reading, and similar things, and heard lectures upon such subjects as bridge construction, trench warfare, and the installation and operation of electric lines in the field. The whole period was spent in hard work and a total absence of revelry. The experiment was based on the theory that college men and efficient business and professional experts are capable of a quicker response

Photo - - Theodore B. Starr, Inc.
Fifth Ave. & 47th St.
New York City

Flying
7/19/15



Instructing the
Plattsburg
Contingent of
Eastern Business
Men in the
Mechanism and
Proper Handling
of the Army
Rifle



Group of Khaki-Clad New
Yorkers and Bostonians being
Taught How to Advance
When under Fire of an Enemy



Training the Men in the
Manual of Arms: From Sun-
rise to One o'Clock Each Day
They were Put through Their
Paces, Maneuvering, Drill-
ing, and "Fighting"

REPRODUCED BY

UNDERWOOD & UNDERWOOD

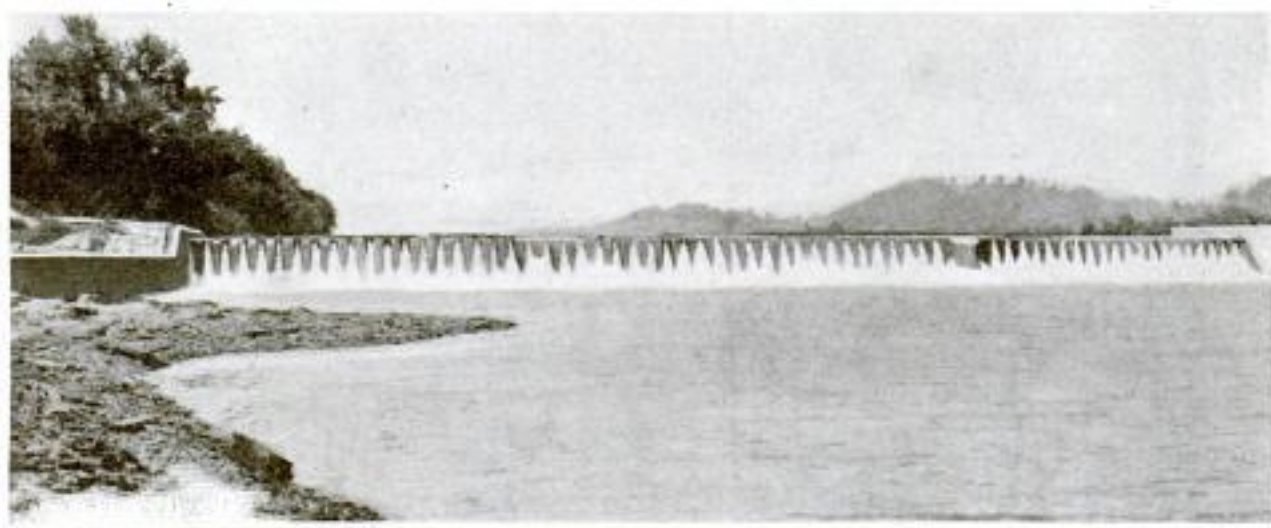

COPYRIGHT, LUPTON

The New Dam at Gallipolis, Ohio, One of More than 50 Dams Which

to military training than is the average raw recruit, and therefore able to absorb in a comparatively short time a really valuable understanding, so that in the event of necessity they could be whipped into shape to serve as officers for a volunteer army.

The success of the encampment has been exceptional. The result of the work has also attracted nation-wide attention and caused other sections of the country to fall in line for similar courses of instruction. Notable in this movement is Chicago. At the present writing a large number of prominent men in that city and surrounding points have signified their intention of attending an encampment to be held at Fort Sheridan, Ill., between September 20 and October 18. This course will be conducted like that in New York State.

484 YELLOWSTONE PARK NOW OPEN TO MOTOR CARS

After years of agitation the government has at last consented to open the Yellowstone National Park to motor cars. The official time for the opening was set for midnight of July 31, 1915, but by special arrangement cars were permitted to enter at Gardiner and go as far as the Mammoth Hot Springs Hotel so that they could start a tour of the park at sunrise the next day.

398 THE GALLIPOLIS DAM ACROSS THE OHIO RIVER

To provide a minimum depth of 9 ft. from Pittsburgh to Cairo, the government is gradually installing a series of dams along the Ohio River between these two points, and this construction, taken in connection with the other work that is being done for the improvement of navigation, constitutes one of the biggest jobs of river improvement ever attempted in this country. For completing this work, which is to make the Ohio River navigable at all stages of water, a total of over 50 dams will be required. The latest of these dams to be completed is the one at Gallipolis, Ohio, about 200 miles up the river from Cincinnati. In construction it is much like the dam at Fernbank, near Cincinnati, which was described in the October, 1911, number of this magazine. Both dams are of the wicket type, a construction which permits a practically unobstructed flow during high water, but which can be used for forming a navigable pool during low water. The Gallipolis dam has a lock big enough to handle the largest river steamers afloat, this lock being 110 ft. wide and 600 ft. long. The section of the dam adjacent to the lock is the navigable pass. This is 600 ft. long and is made up of wickets, or gates, which can be raised to form a

J. C. Lupton,
328 Second Ave., Gallipolis Ohio.

Motor Cars,
8/12/1915

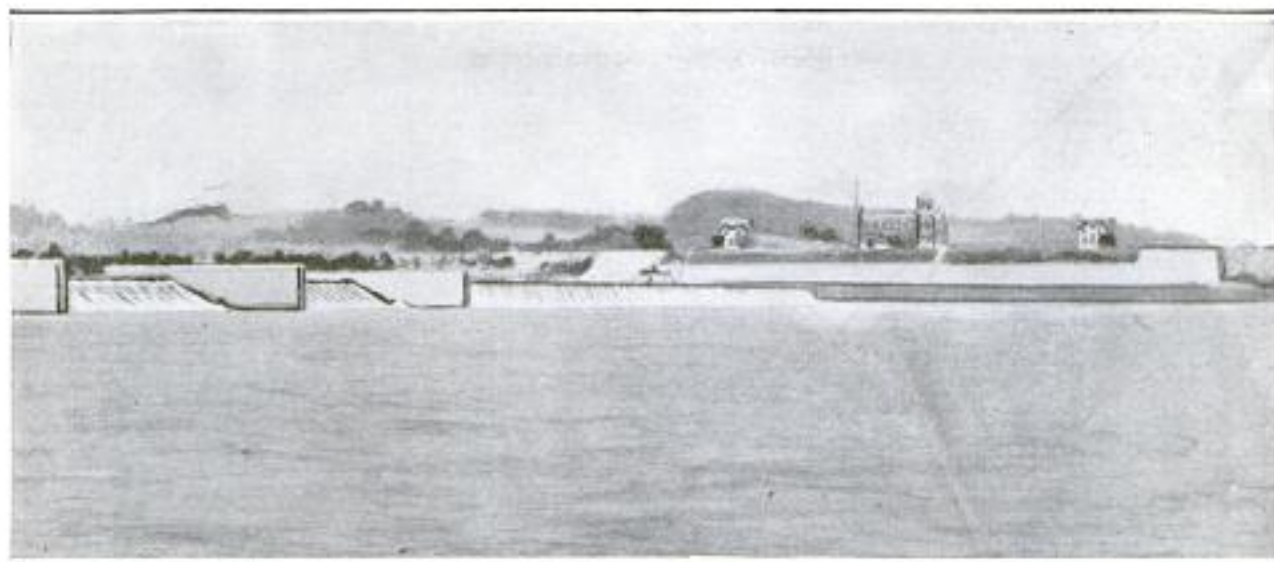

are to Make the Ohio River Navigable at All Stages of Water

dam or laid flat on the river bed. When raised, these wickets stand practically 17 ft. above the bottom of the river. Next to the navigable pass come two bear-trap dams, each 91 ft. long, the remainder of the river being closed by a second wicket section, 272 ft. long. During high water all these sections are laid flat on the river bed, leaving the river entirely clear, except

for the piers at the bear-trap dams. Under these conditions the river steamers use the navigable pass as a channel. When the water is at a low stage, the sections are raised and the steamers use the lock for passing the dam thus formed. The bear-trap dams serve as a spillway that can be easily raised or lowered to correspond to the amount of water passing down the river.



415 COPYRIGHT, UNDERWOOD & UNDERWOOD

BRITAIN SHIPS MILLIONS IN GOLD TO NEW YORK CITY

WHAT was without doubt the largest single consignment of gold ever transported across the Atlantic in one bottom was recently shipped from England to New York bankers. The treasure amounted to \$52,000,000, two-thirds of which was in gold and one-third in securities. It was carried in a battleship escorted by a flotilla of destroyers to Halifax, where an express company took it in charge. The above photograph shows the gold being carried under guard in 23 motor trucks to the subtreasury.

Underwood + Underwood,

*417 Fifth Ave.
N. Y. C.*

Copyrighted material

FLY-CATCHING SYNDICATE LAUNCHED AT ATLANTA

Fly trapping, strange as it may sound, has become a recognized business at Atlanta, Ga. In an attempt to

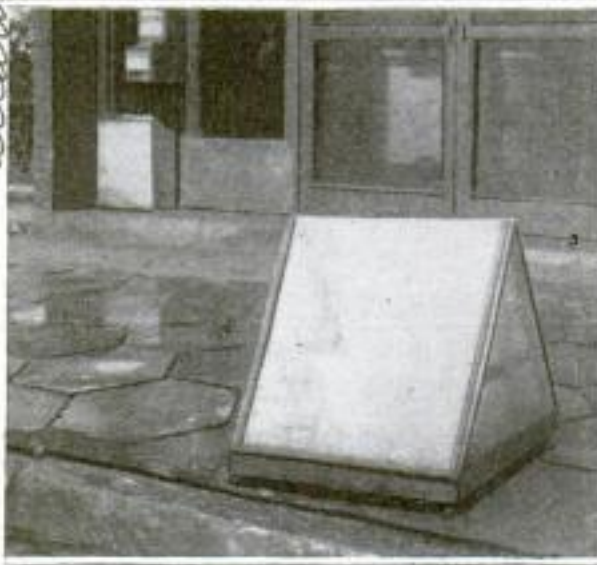

This Shows One of the Syndicate's Traps Set at the Curb on an Atlanta Street

rid the city of flies the municipal authorities have contracted with a fly-catching syndicate to pay a bounty of 25 cents a quart for the pests. As a result the firm has placed tent-shaped traps along some of the business thor-

oughfares and in other places, is maintaining them, and making periodical collections. It is stated that since the devices were installed each has been catching an average of three or four quarts of flies daily.

— 434

MUNICIPAL CAMPING GROUND FOR VISITING MOTORISTS

In one of the municipal parks of Denver, several acres of ground have been fenced and reserved as a camping place for motor tourists. The plan has met with such pronounced success that a permanent sewerage system is being installed. Motorists drive into the pretty wooden inclosure and are provided a clean, inviting place, safe from intrusion, where they may pitch a tent, build a fire, and remain as long as they desire to accept the city's hospitality. When their camp is established they may come and go as they wish, with the assurance that their personal belongings are being protected by guards. The ground is intended for tourists from other states who are making outings of their trips, and prefer camp life to the conveniences of hotels while in the city.

cont: Roger Wolcott,
335 S. Symmes Bldg.,
Denver, Col.

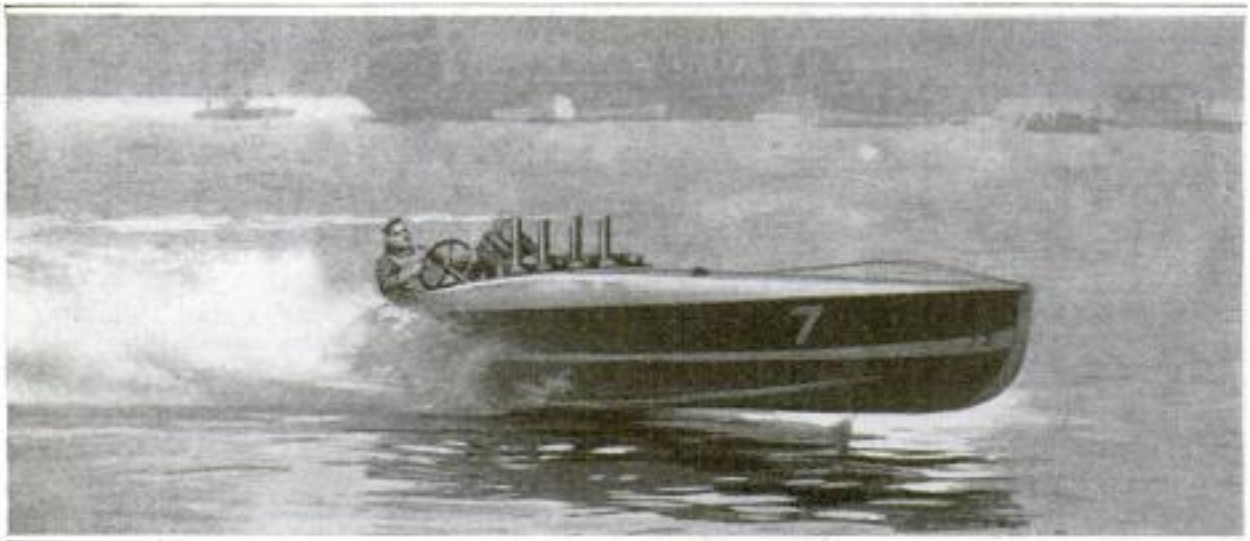

COPYRIGHT, UNDERWOOD & UNDERWOOD

WESTERN CRAFT WINS HYDROPLANE MEET

"MISS DETROIT," the speedy little hydroplane of a Detroit association, skimming over the water of Manhasset Bay, Long Island, during the recent contest for the gold challenger cup in which it captured the honors in the third and final race. The boat easily outdistanced its two rivals and covered the 30-mile course in 1 hour, 3 minutes, and 34 seconds.

Mae Kenzig, Barnes,
76 E Linden St.,
Atlanta, Ga.

J. E. King - 202 S. Winnetka Ave., Dallas.

Underwood & U. - 417 Fifth Ave., New York City.

HURRICANE WORKS HAVOC ALONG GULF COAST

476



COPYRIGHT UNDERWOOD & UNDERWOOD
Heavy Property Damage and Many Fatalities Were the Toll at Galveston. This Shows Ruins along the Sea Wall Boulevard. Monuments were Swept from the Sea Wall

COPYRIGHT UNDERWOOD & UNDERWOOD
Residence on the Beach at Fourteenth Street Wrecked by the Waves. It can Hardly be Estimated What would have Happened had the City Not had the Protection of the Sea Wall



One of the Freaks: Wreck of 200-Foot Schooner Which was Lifted over the Sea Wall and Hurlled Inland with Such Force That It Broke into Pieces



COPYRIGHT UNDERWOOD & UNDERWOOD
At Houston, Texas: The Wreck of One of the Oldest Brickyards in the State. Several Million Dollars' Damage was Worked in the City by the Hurricane

447

RAISING OF THE ILL-FATED "EASTLAND"

JUST three weeks after capsizing at its dock and carrying more than 800 picnickers to their death, the ill-fated steamship "Eastland," its hull patched and decks stripped, was raised out of the mud of the Chicago River and towed into the "north branch."

A number of perplexing situations confronted the engineers in charge of the salvaging. The majority of these were more exasperating than serious, however, and served principally to delay the final operation of righting the vessel. The question of supplying sufficient power to float the half-submerged ship did not prove so troublesome in the end as did much of the preliminary work, although this constituted one of the interesting phases of the undertaking.

It will be remembered that the vessel listed away from its berth and turned over on the port side, submerging about two-thirds of its beam. After as many of the bodies had been recovered as could be reached, the funnels, spars, and all other deck obstructions, were cut off by divers and sealed. While this was being done the openings which had been ripped in the starboard side of the ship, by rescuers with oxyacetylene torches, were patched. Much difficulty was experienced in closing the portholes and gangways on the under side, for these were obstructed by great piles of luggage, ship furniture, and debris. The closing of the hatches was not so difficult.

Before the water could be pumped out of the vessel it was necessary to seal and reinforce the aft bulkhead, which had been broken through in attempts to penetrate the interior. This work, which presented one of the trying problems, had to be done by divers. The entire partition, approximately 26 feet long and 9 feet high, when in normal position, was reinforced by 2 by 10-in. planks lapped one over the other. Another thickness of lumber was placed over this, the planks crossing the first ones. Canvas was subse-

quently stretched over the whole to prevent leakage. The sealing of this wall prevented an inrush of water from the stern of the boat when the centrifugal pumps were started to expel that in the main part of the hull. After a part of this had been pumped out, however, the tremendous pressure against the bulkhead threatened to cause it to collapse. It was apparent that elaborate bracing was required to forestall this, so divers were again sent beneath the water to do the work. Beams were extended diagonally between the bulkhead and the deck, much of the carpentering being done with the use of block and tackle and pneumatic instruments.

The shifting of the coal in the bow to the port side, and the leakage of some of the holes which had been inadequately sealed, were also matters which contributed to delay the work. The ballast tanks on both sides were filled in order to provide a rolling weight which would assist in righting the vessel and in balancing it when raised.

The "Favorite," a wrecking tug, was anchored at the bow of the "Eastland," while aft, near the stern, a large pontoon carrying a heavy hoisting apparatus was moored. Cables were extended entirely around the hull of the sunken ship from both of these vessels and secured to the starboard, or upturned, side. The forward cable was fastened to the iron standard streak and passed over a big sheave at the stern on the "Favorite." This line was then wound on a large winch. The aft cable reaching from the pontoon was fixed to the "chop" forward of the stern.

When everything was in readiness to attempt the actual righting of the vessel, both the "Favorite" and the pontoon were flooded until the tug was lowered 8½ ft. and the latter 9 ft. The weight of the "Eastland" is about 1,200 tons. Its boilers held approximately 40 tons of water and its hold a large quantity of coal, while a considerable amount of water also remained in the hull. This was the load which had to

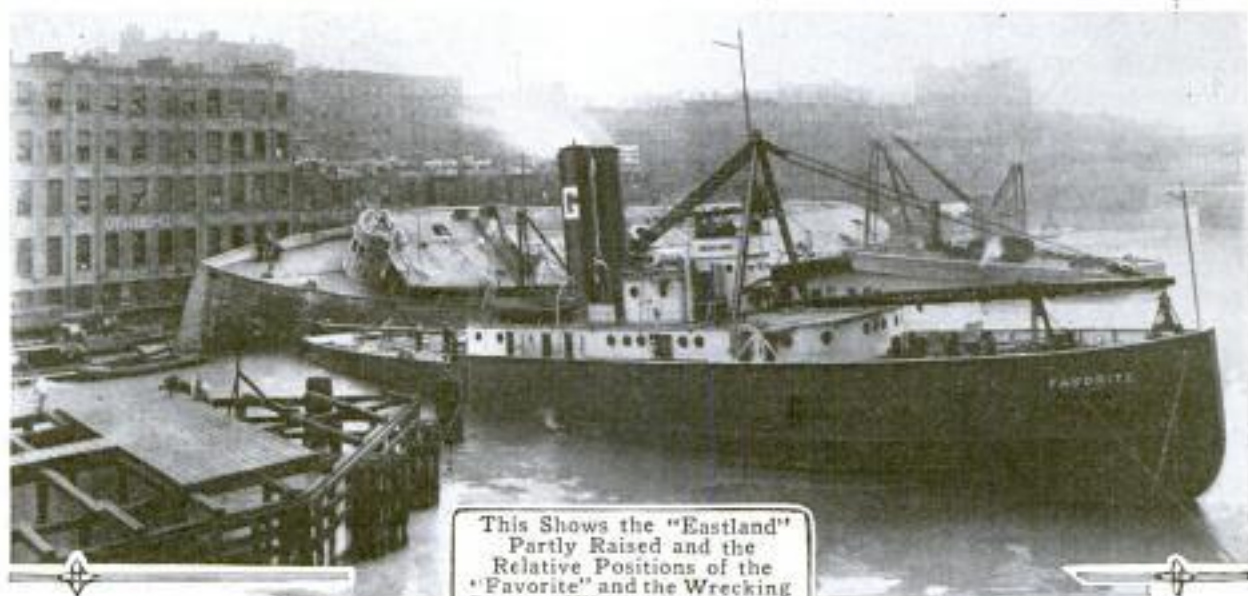

This Shows the "Eastland"
Partly Raised and the
Relative Positions of the
"Favorite" and the Wrecking
Pontoon Which Accomplished
the Work

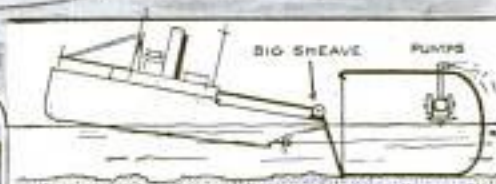
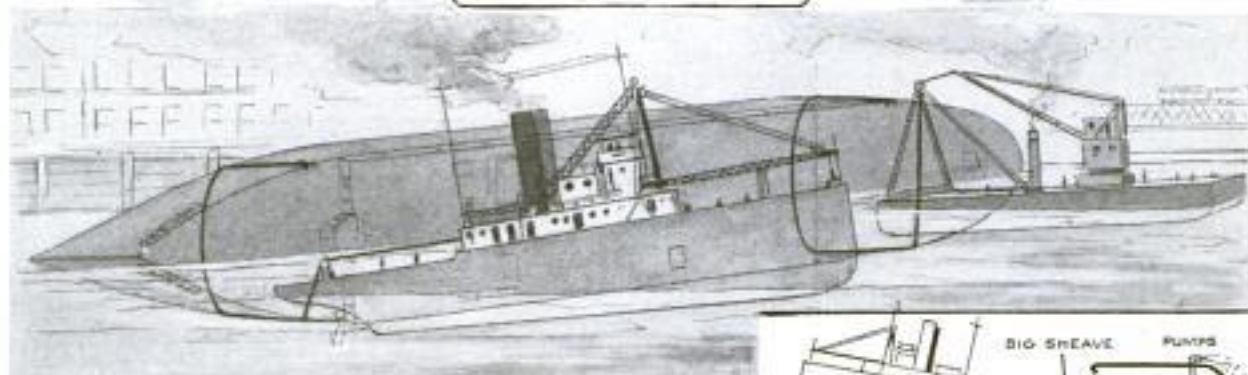

The Upper of the Above Diagrams
Illustrates the Manner in Which the
Cables were Run from the Tug and
Pontoon and Anchored on the Starboard
Side of the Half-Submerged Ship. The
Lower Drawing Indicates How the Cable
was Extended to the Winch Aboard the
"Favorite"



Bracing of the Aft
Bulkhead: The
Work was Done
under Water by
Divers



Towing the
"Death Ship"
from the Scene of
the Tragedy

be negotiated in order to keel the ship, which, it was estimated, would right itself upon being pulled to a 45° angle. When the engines had drawn up the cables until the tug and pontoon had been pulled as deeply into the water as was advisable, pumps were started exhausting the water from both. It was the added lifting power given by the natural buoyancy of these two vessels, coupled with the work of the en-

gines, that finally brought up the "Eastland."

Instead of righting itself at 45°, however, the death ship had to be pulled to approximately 70°. Before this point was reached the water was taken from the boilers and still more expelled from the hold. The ship was not completely trimmed, however, until the coal and wreckage, thrown to the port side, had been moved.

436 FLOTILLA OF MOTORBOATS RECOVERS TORPEDOES

Four stanch motorboats of a seaworthy, fast type form a fleet of torpedo chasers which is being used off Greenport, L. I., where marine projectiles are tested. The flotilla was built especially for this service. Each unit is constructed the same as its sister

and have heavily armored guards. The steering station is placed alongside of the helmsman, who is protected by a windshield and has full control of the boat.

Barbed wire, painted a foliage green to make it invisible, is being used for wire entanglements by the armies of Europe.

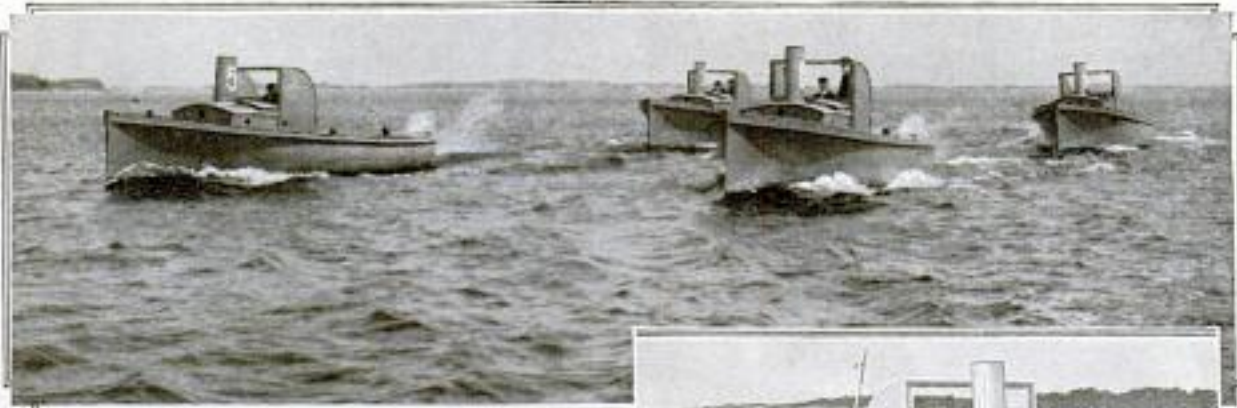

The Flotilla of Speedy Torpedo Chasers at Work on the Testing Course off Greenport: The Vessels Are Very Stanch and Able to Withstand Quite Rough Water

boats, so that the quartette is well mated for maneuvering in various formations. The work of testing torpedoes consists in firing them at various angles over a determined course. The "chasers" are distributed at different points to recover the missiles as they are shot out through the water, and return them to the firing station. The boats have been built to withstand a fairly heavy sea. At the same time each of them has a speed of 13 miles an hour. The over-all length is 40 ft.; the beam, 7 ft. 9 in., and the draft, 2 ft. 10 in. The craft are made of oak scantling and cedar planking,

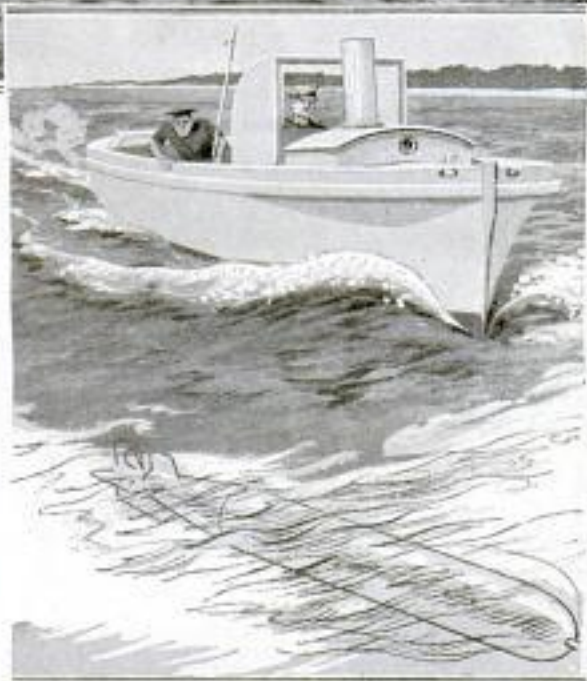

Chasing a Torpedo: These Little Launches Hunt the Marine Projectiles After They are Fired and Return Them to the Testing Station

Used by E. W. Bliss & Co.,
Greenport, N. Y.

Mfr - Greenport Basin & Construction Co.,
Greenport, N. Y.

BOSTON IN GALA DRESS FOR GOVERNORS' VISIT



Destroyers Passing
before Gubernatorial
Party aboard the
"Wyoming"



The Capitol
Decked in
Festive
Attire during
the Con-
ference of
State
Executives

DURING the annual conclave of state executives which was held this year at Boston, the Atlantic fleet and Massachusetts National Guard were reviewed. The party, as the guest of Secretary Josephus Daniels, was carried by the "Wyoming" from Charleston Navy Yard to a position off Boston Light. Following the review the flagship was "attacked" by a flotilla of destroyers. When the "enemy" was sighted the governors were given an exhibition of fast naval maneuvering under Admiral Fletcher, who stood on the bridge. Blank cartridges were fired at the approaching vessels, one of which dashed up within 3,000 yards of the ship and discharged a dummy torpedo that missed its mark by a few feet.

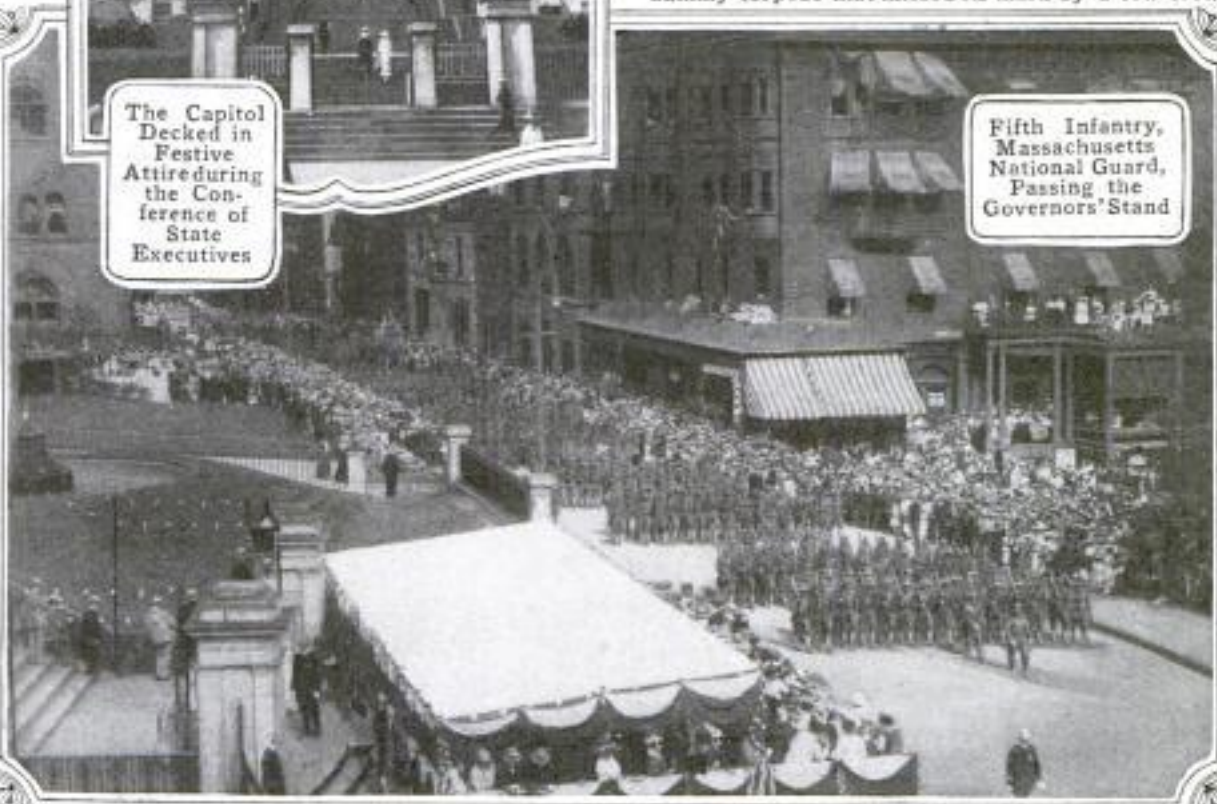

Fifth Infantry,
Massachusetts
National Guard,
Passing the
Governors' Stand

American Glass Casket Co.,
 Oklahoma City, Okla.
 Instrument made to order by and picture
 contributed by: N.C. Parrish, 191 Union Ave. N.,
 Portland, Oregon.

**STAGE SOUND CABINET MADE
IN FORM OF TRUNK**

For the use of a traveling theatrical company, a novel compressed-air and electric sound cabinet has been built,

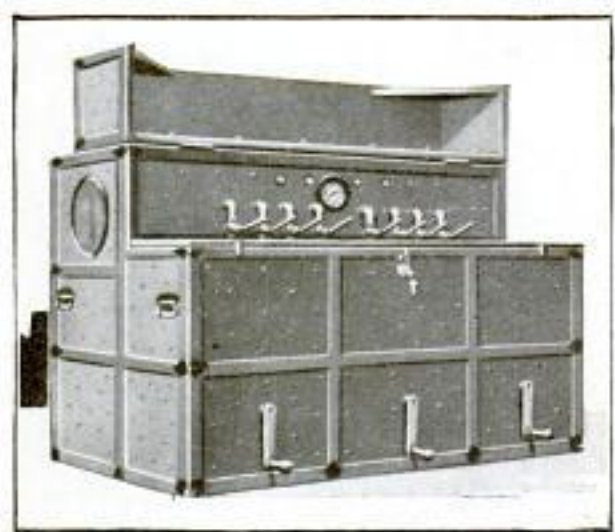

The Cranks Shown at the Front may be Removed Quickly and the Top Folded Down and Locked

which produces any one of a large number of different noise effects on the stage. It is constructed compactly in the form of a trunk which in a moment's time may be closed and locked preparatory for shipment. It is especially valuable for a troupe playing a

some by electricity. With it the characteristic noises of a motor car, a locomotive exhaust, air-brake release, safety valve, railway-engine whistles, boat whistles, fire-engine whistle, siren, sawmill, wind, water, train bell, cow bell, telephone bell, electric house bell, buzzer, dining-room bell, and a telegraph instrument may be made. A second trunk contains an air compressor which furnishes the air power.

**CASKET IS MADE OF GLASS
BOUND BY METAL 401**

Made of two pieces which are bound together by heavy metal bands, a glass casket has been invented which will soon be introduced for burial purposes. This serves both as a coffin and vault, as it requires no protection against the chemical action of the earth. When closed it is hermetically sealed and is proof against both air and water. The two sections are molded in heavy glass, which gives the casket great strength. Its general form is the same, practically, as that of other burial receptacles. The chief point advanced in its favor is its obvious qualities of durability. The casket is to be made

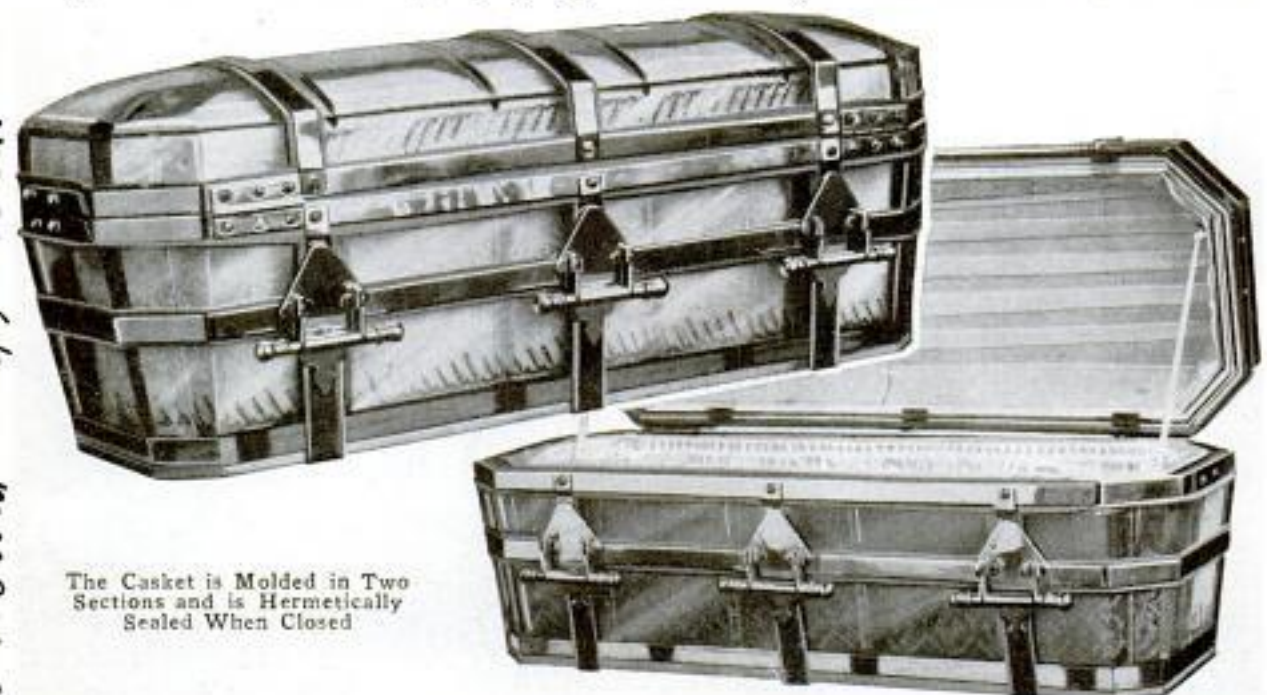

The Casket is Molded in Two Sections and is Hermetically Sealed When Closed

long repertory. Inside of it are several different instruments, some of which are operated by air pressure,

in various sizes and grades. The cost will vary largely according to the quality of the trimmings.



Huge Touring Van with Top in Folded Position

Starting on the Transcontinental Tour in One of the Most Elaborate Prairie Schooners That Ever Headed for the Plains

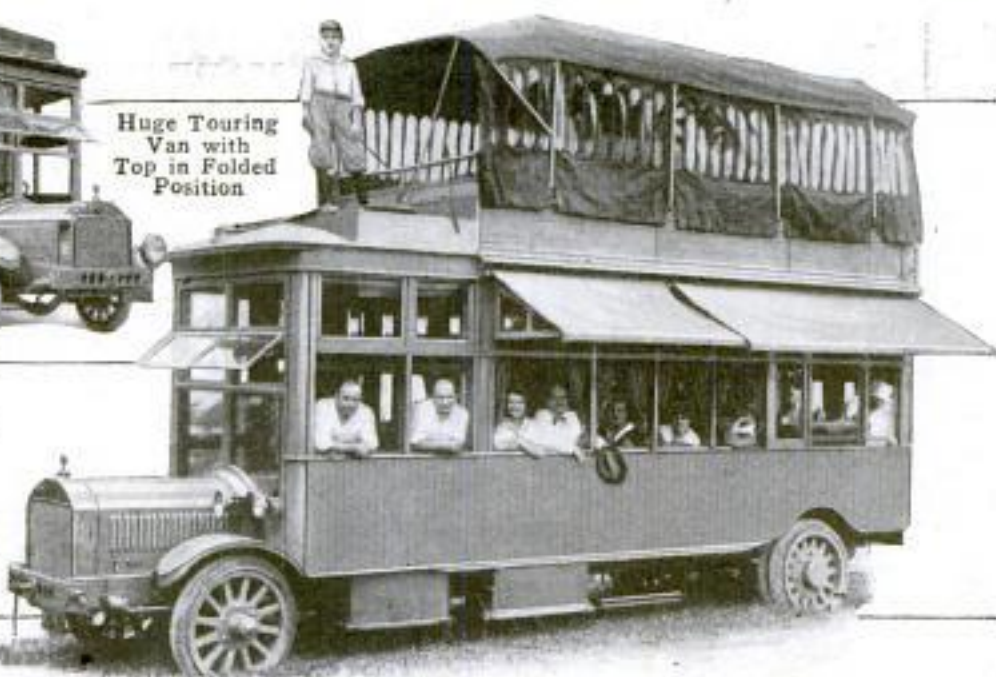

454

Travelling Auto

LUXURIOUS BIG "GYPSY VAN" ON CROSS-COUNTRY TOUR

What is probably the most elaborate prairie schooner that ever started on a transcontinental trip in this country, recently left Long Island bound for San Francisco with a party of nine persons. It is a large, double-decked, richly appointed motor bus which was built especially for this tour by a New York financier.

The interior of the car is 21 ft. in length, 7½ ft. wide, and 6½ ft. high. The space is divided into three compartments. The first of these is occupied by two chauffeurs and is a roomy vestibule which almost in a moment's time may be converted into a very comfortable bedchamber. Back of this is the main room, some 10 feet in length. The arrangement of this is much like that of a Pullman car. During the daytime it is used as a living room, while at night, with its six berths made up, it offers nearly the same conveniences as are afforded on a well-equipped overland express. There are electric lights, hot and cold running water, shower baths, and other similar accommodations. The room is fitted with upholstered furniture, has a library and writing desk, boasts a talking machine, and is shaded by broad

awnings. Back of this compartment is an electric kitchen in which is built a compact refrigerator.

The top of the "schooner" is reached by steps leading from the rear compartment. It is covered with a collapsible top and is used as a dining room. It is fitted with lockers, and also offers sleeping facilities. A motorcycle is carried here for emergency purposes.

The car is equipped with a six-cylinder, 60-hp. motor. It was built especially for the bus, and has nine forward and three reverse speeds. A folding bridge is carried for emergencies.

MEASURING WIRELESS WAVE LENGTH AND INTENSITY

For the purpose of measuring the logarithmic decrement, or the reduction of intensity and the diminution of wave length of vibrations emitted by a wireless transmitter, a direct-reading instrument has been developed which is now being used by the radio-inspection service of the Bureau of Navigation. The government regulations concerning the operation of wireless stations are rigid and it was to facilitate the work of ascertaining whether they are observed that the invention of this apparatus was prompted. The Federal rulings are of importance because by

Cont: Mrs. Stuart Moby Coleman, 1223 -- 12 St. N. W. Washington, D. C.

sending out single-frequency oscillations from a station a more selective receiving equipment may be employed. This enables sharp tuning and lessens interference from other plants.

This Compact Instrument is Used by Government Radio Inspectors for Measuring Intensity of Wireless Impulses and Their Lengths

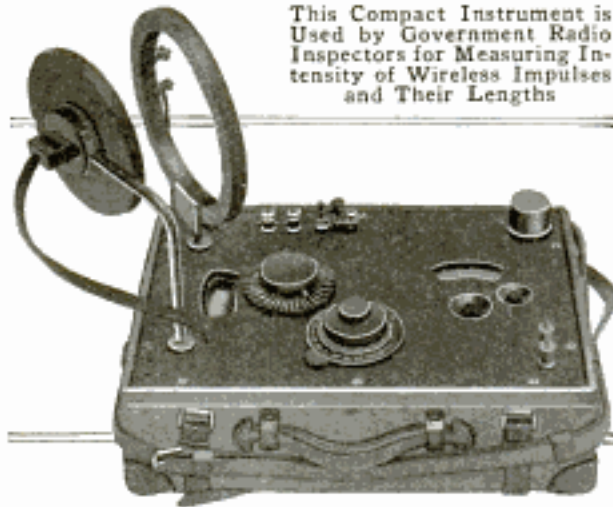

The decimeter, in simpler terms a decrease meter, enables measurements of variations in intensity to be made quickly and accurately. Instead of its being necessary to do the work according to laboratory methods, it is with this instrument possible to go aboard a ship, where conditions make the former method of measurement difficult, and do the work readily.

NEW PORTABLE ELECTRIC GRINDER 179

A portable electric grinder adapted for grinding centers, reamers, cutters, and dies, has been invented and placed on the market. This grinder weighs only 5½ lb., operates at 10,000 revolutions a minute and is capable of grinding holes up to

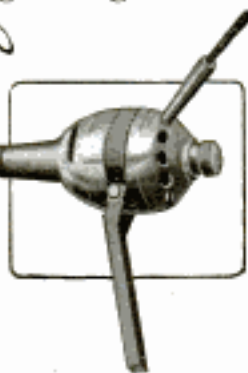

in. in depth. An arm is provided for supporting it from the slide rest of a lathe, and it can be used both for external and internal work. The grinder is driven by a ¼-hp. motor which operates on either alternating or direct current.

Electrical World,
June 19-1915

SUCCESSFUL GAS TURBINE MADE IN SWITZERLAND

The development of the gas turbine to a state of practical efficiency is reported to have been accomplished at Baden, Switzerland, where experiments have been under way for a considerable time. Since a gas turbine occupies only one-third the space required for a gas engine and weighs only about one-fourth as much, its importance can hardly be overestimated, especially in its application to aeroplanes and dirigibles. This was fully realized before the outbreak of the war, and the first successful use of the turbine is likely to be in connection with aircraft used in military service.

In this turbine a number of bottle-shaped explosion chambers are arranged radially with reference to the shaft, so that the gases resulting from the explosion in each chamber strike against the turbine blades. Air and gas in measured quantities are forced into each chamber in turn, a spraying apparatus being used when gasoline or other volatile liquid fuel is used. This charge is fired by an electric spark, and at the right instant the valve in the nozzle of the explosion chamber opens, and the full force of the expanding gases is brought to bear against the turbine blades. When the force of the explosion has been spent, a blast of air is forced through the chamber for the purpose of scavenging. It is planned to use the exhaust gases for raising steam in a small boiler, the steam thus produced being used to drive the air and gas pumps. The making of turbine blades that will stand the destructive effect of the hot gases, the greatest difficulty heretofore experienced in making a gas turbine, is said to have been entirely overcome in the making of this turbine. The turbine will probably be used immediately with military aircraft, but it is not likely that it will be exploited in a commercial way until after the readjustment of industry following the end of the war.

Taken from "The Iron Age" 7/22/15 p 185
 Developed at works of the Brown-Boveri & Co
 Baders,
 Switzerland.

460



© UNDERWOOD & UNDERWOOD
 Street Scene in Canton, China, during the July Deluge Which Rendered Thousands of Inhabitants Homeless and Claimed the Lives of Many Others



① UNDERWOOD & UNDERWOOD
 The Raft Supports the Bodies of Victims Recovered from the Water, Which in Some Places Rose to a Depth of 15 Feet. Incendiary Fires Added to Suffering



The Flood Was One of the Worst That has Ever Visited Canton. Hundreds of Shops in the Principal Streets were Ruined. Volunteer Guards and Soldiers Had Difficulty in Coping with Organized Bands of Thieves Who Looted and Burned as They Went

Underwood + Underwood.

334
SIMPLE SCRUBBING DEVICE
FOR GOLF BALLS

For cleaning golf balls which are grass-stained or dirt-covered, a convenient little machine has been de-

"CHEROKEE BALL WASH ER"



By Turning the Handle a Few Times the Ball is Given a Thorough Scrubbing Which Removes the Dirt and Grass Stain

signed which is intended to be mounted on a tee box where it is available for the use of players. It consists of a hemispherical case holding three circular brushes, so mounted that they may be revolved rapidly by turning a crank, which is fixed at one side. The bowl is filled with soapy water, a ball is placed within it and in contact with the bristles, and the cover closed. A few turns of the handle are sufficient to do the work.

482 FLEET CARRIES WATER FOR
GALLIPOLI TROOPS

One of the hardest problems for the British and French forces operating on the Gallipoli Peninsula is that of obtaining an adequate supply of water suitable for drinking. There is little water to be found on the peninsula, and what there is, is in most cases too badly polluted to be used. As a result it is necessary to transport the water long distances by sea, some of it coming from Greece and the Ægean

From "Daily News"
Islands, but the most of it being brought from distant places like Malta and Egypt. An enormous fleet of tank ships and barges is constantly engaged in this work. Usually the water is unloaded in the crudest manner. When the sea is calm ordinary ship's boats are scrubbed thoroughly, towed alongside and filled to the gunwales with the fresh water. These boats are towed ashore, and the water is bailed out with buckets and carried to the front in enormous Greek wine casks lashed to mule carts. At the front the British use steel-armored water carts, while the French engineers have built underground cisterns each capable of holding 1,000 gal. These tanks are protected by bomb-proof coverings.

488
LARGE SECTIONS OF ALASKA
SUITED TO FARMING

As the result of a survey carried out by the Department of Agriculture, covering the climate, soil, and other conditions bearing on the possibility of agricultural development in Alaska, it has been found that there are millions of acres of land in that far northern country that are climatically and topographically suited to farming. These farming lands are all located in certain plainlike valleys, which have a mild summer climate, long hours of summer daylight, and a good quality of soil. In some sections of the territory food products in considerable quantities and of many kinds are already being raised. Farmers, however, are compelled to live under pioneer conditions, and this situation will probably continue for some years to come. Good roads are scarce, and settlement is practically limited to the regions of mining camps which at present furnish practically the only market for farm products.

Work on the first of a series of locks and weirs that will make the river Murray in southern Australia navigable and will supply irrigation for about 1,500,000 acres of land was begun in June, 1915.

Information Sheet issued
by U. S. Agricultural Dept.

COMBATING POISONED GAS ON BATTLE FIELDS



Red Cross Workers behind the German Lines Resuscitating Unconscious Soldiers Who have Succumbed to the Heavy Gases



Charging Allied Trenches under Cover of Gas Cloud



In an Advanced French Trench: A Sentry is Sounding a Gong to Warn the Soldiers of the Approach of an Asphyxiating-Gas Cloud and the Necessity to Don Respirators

Equipped with Field Apparatus for Reviving Gas Victims and Protected against Asphyxiation by a Respiratory Mask



STRIKING COMMENTARY ON THE GLORY OF WAR



The Effect of German Artillery Fire upon a Cabin on the Eastern Front Which was Occupied by Russian Troops. A Bursting Shell Practically Wrecked the Dwelling and Killed the Men, the Bodies of Several of Whom are to be Seen in the Debris

BUILDING AND RAZING WIRE ENTANGLEMENTS



An Improved
Barbed-Wire
Factory in
Germany
Where Rus-
sian Prisoners
are Kept at
Work



Italians Clearing
Corada Pass of Bar-
ricades by Driving
Wild Cattle through
Them

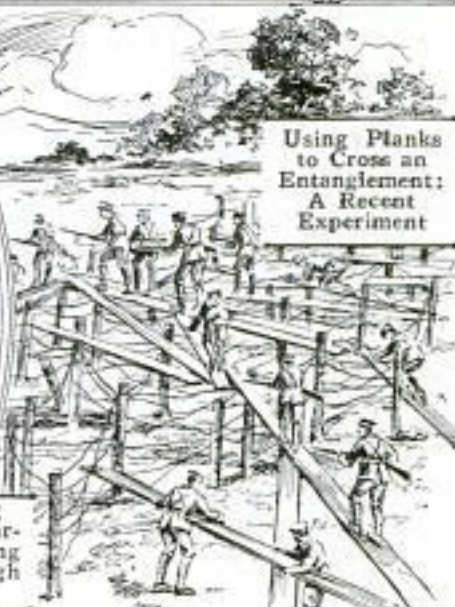

Using Planks
to Cross an
Entanglement:
A Recent
Experiment

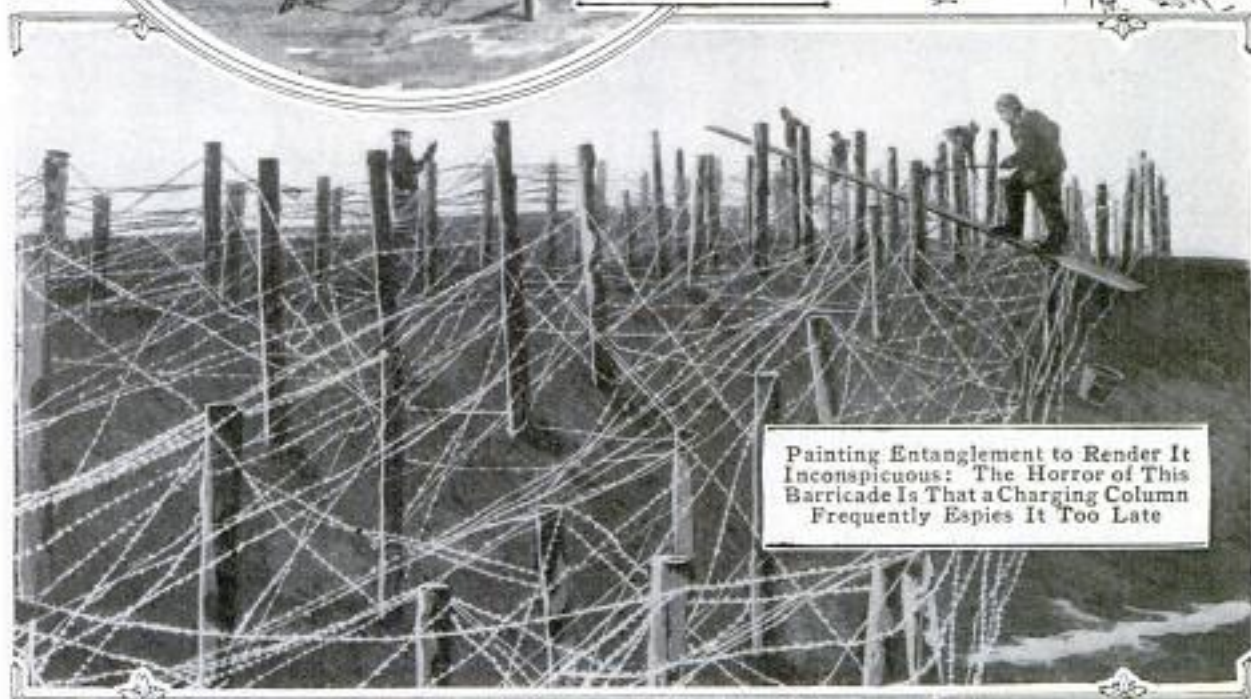

Painting Entanglement to Render It
Inconspicuous: The Horror of This
Barricade Is That a Charging Column
Frequently Espies It Too Late

FIGHTING AT CLOSE RANGE WITH HAND GRENADES



The Use of Periscopes in Connection with Rifles Is a New Development in Trench Warfare Peculiar to Modern Fighting. This Shows How French Soldiers Are Able to Snipe Off the Enemy without Exposing Any Part of Their Bodies to a Return Fire. The Rifles are Supplied with Auxiliary Stocks and Periscopes Which Allow the Soldiers Using Them to Remain Completely Out of Sight While Shooting



Bracelet Igniting Device: At Close Range a Hand Grenade Is More Destructive than a Rifle



This Shows Some of the Types of Hand Grenades Now in Use. The Bomblike Device of the English is Popularly Known as the Bracelet Grenade

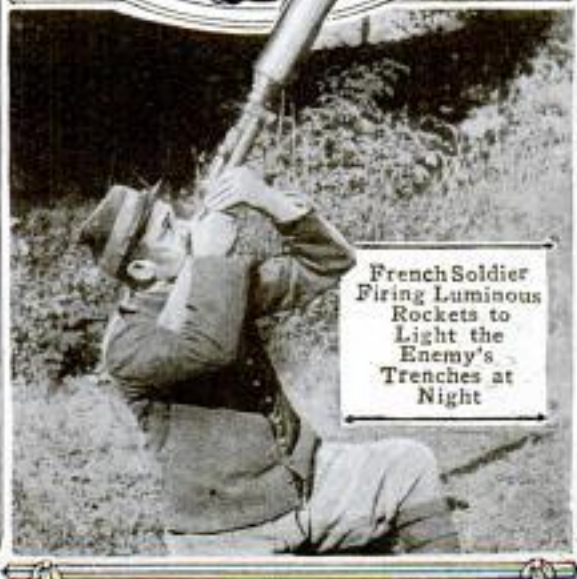

French Soldier Firing Luminous Rockets to Light the Enemy's Trenches at Night

AND BOMBS IN THE BATTLE TRENCHES OF EUROPE

In Many Sections of the War Zone Enemy Intrenchments Are Only a Few Rods Apart. This Cramped Condition has Made Hand Grenades and Various Forms of Trench Bombs Very Important Agents of Human Destruction. Some of the Former Devices Are Spherical in Shape and No Larger than Baseballs. This Type Usually Explodes upon Contact and, Like Others, Is Growsomely Effective at Times



COPYRIGHT, UNDERWOOD & UNDERWOOD



Racket Throwing Device: The Fuse Here is Ignited before Throwing the Grenade



Odd Form of Trench Bomb Employed by the French against Strongly Fortified Intrenchments



Potato-Masher Type of Grenade: Soldiers Carry These Strapped to Their Belts

PHOTO COPYRIGHT, UNDERWOOD & UNDERWOOD

GERMANY'S TRIUMPHANT ARMY IN GALICIA



Russian Dead
Strewn behind
Improvised Breast-
works Hastily
Thrown Up with
Lumber Taken from
the Ruins of a
Bombarded House
at the Rear



Pack Horses
Loaded with
Booty Captured
by the German
Forces



The Victors Inspecting the Spoils:
This Shows Some of the Equipment
and Ammunition to Which the
Germans Fell Heir after the Russians'
Last Stand in Western Galicia

SIDE LIGHTS ON WAR FROM GERMAN VIEWPOINT



German Sentry on Raft Patrolling Shore Line in Flanders While Exposed to the View of Snipers

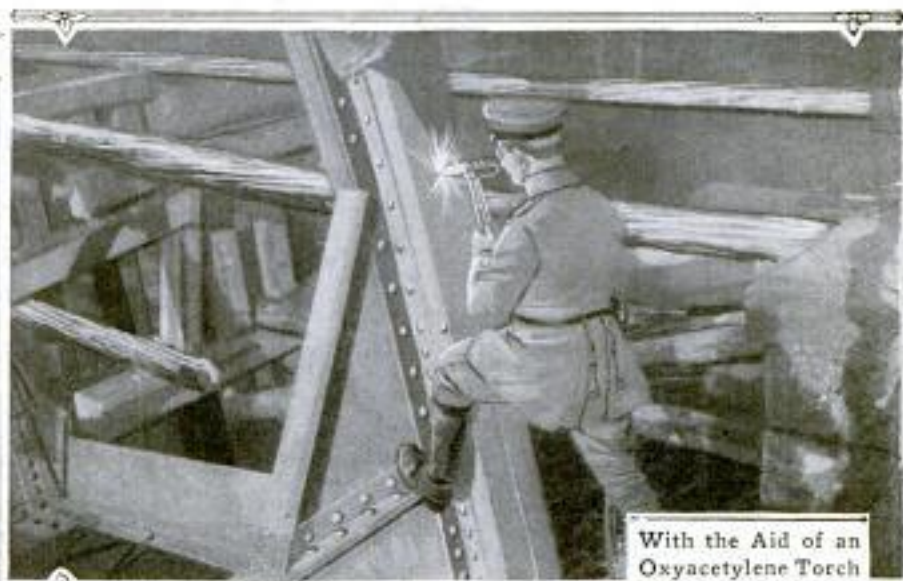

With the Aid of an Oxyacetylene Torch This German Officer is Cutting the Steel Supports of a Bridge in Order to Hamper the Enemy



Two Members of a Pioneer Corps of the Kaiser's Forces Decked in Their River Togs. It Is the Duty of These Men to Go Ahead of a Column and Reconstruct Wrecked Bridges and Restore Other Avenues of Communication. The Buoyant Uniforms Allow Them to Sit in the Water and Move About

NEW HELMETS PROTECT FRENCH FROM SHRAPNEL



At the Left is shown One of the Old Ironsides of Cromwell's Time. The Helmet Worn by This 17th Century Soldier has been Employed as a Pattern for the New French Helmet Adopted Recently for Use on the Firing Line as a Protection against Shrapnel and Spent Fragments of Shells. It is Made of Thin Chrome Steel and Weighs 21 Ounces



France Provided Many of Its Men with Metal Headgear Which Were Worn with Their Kepis Until the New Gray-Blue Helmets could be Supplied. Several of the Soldiers Occupying This Trench are Fitted with These

HOW CHURCHES ARE USED DURING WAR TIME

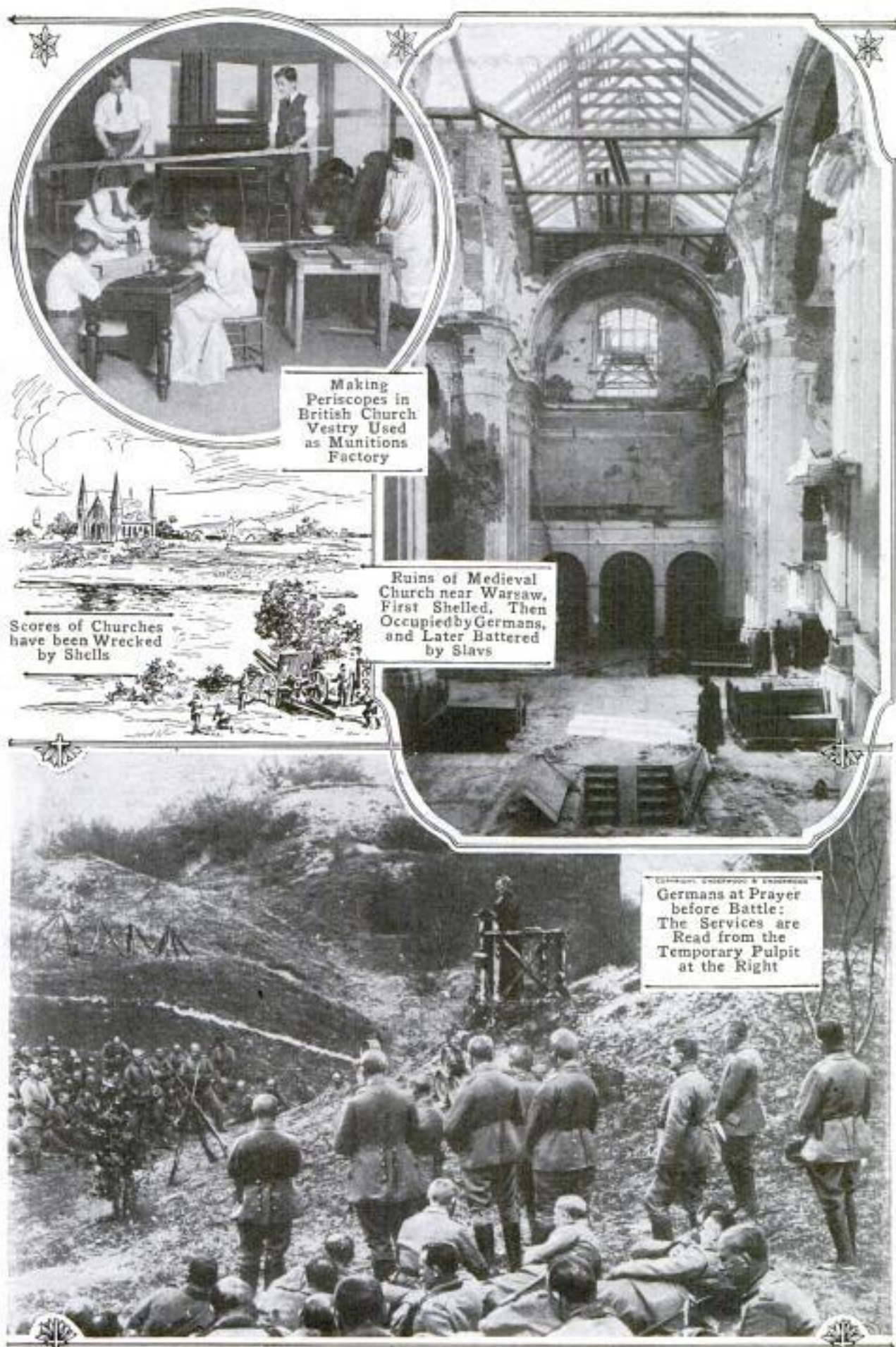

Making
Periscopes in
British Church
Vestry Used
as Munitions
Factory

Ruins of Medieval
Church near Warsaw,
First Shelled, Then
Occupied by Germans,
and Later Battered
by Slavs

Scores of Churches
have been Wrecked
by Shells

Germans at Prayer
before Battle:
The Services are
Read from the
Temporary Pulpit
at the Right

CONCEALED ARTILLERY BEHIND ALLIED LINES



COPYRIGHT UNDERWOOD & UNDERWOOD
Heavy French Siege Gun Hidden by Brush from German Aerial Scouts. When an Aeroplane Approaches the Crew Hides in the Dugout

Russian Guard Artillerymen Wheeling Field Piece About Preparatory for Action



COPYRIGHT INTERNATIONAL NEWS SERVICE
Well Secluded Beneath a Heavy Railway Arch, This Servian Battery is Bombarding an Austrian Position in Comparative Safety

BELLIGERENTS EXCHANGE PRISONERS OF WAR

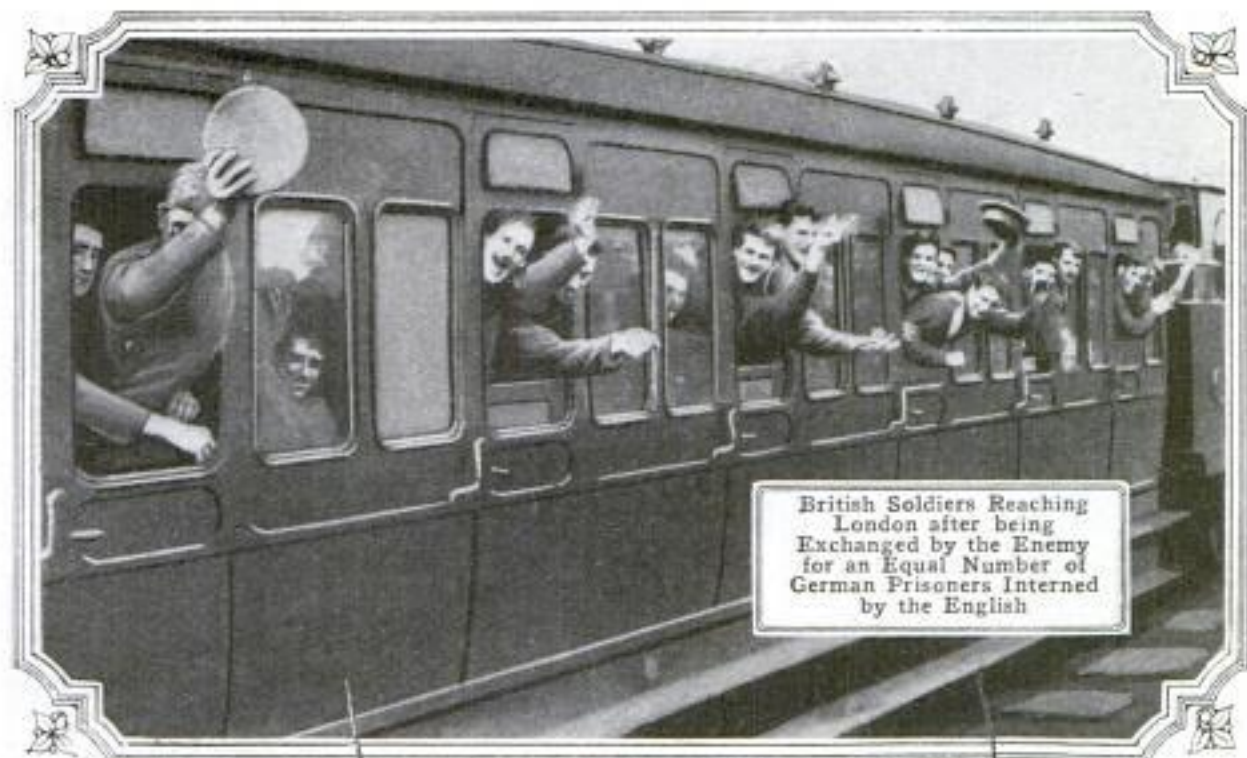

This Dutch Steamer, the "Oranje-Nassau," has been Used in Transferring Men between the British Isles and Holland, Which Country has Served as a Clearing House in the Exchange of War Prisoners



HAPPY PHASES OF THE WOUNDED SOLDIER'S LIFE



Copyright
 UNDERWOOD & UNDERWOOD
 These French
 Soldiers, in
 Charge of
 Trained Nurses,
 are Suffering
 from Serious
 Wounds, but
 Smiling. They
 are Awaiting a
 Train Starting
 toward France



Maimed Soldiers in a
 Berlin Hospital For-
 getting Their Wounds
 While Enjoying an Ent-
 ertainment Produced
 in an Assembly Hall
 COPYRIGHT PRESS ILLUSTRATING



Offering
 Felicitations to the
 Bride and Groom, the
 Former a Canadian
 Girl Who Crossed the
 Atlantic to Wed Her
 Fiancé in a British
 Hospital

WITH EUROPE'S BLIND AND MAIMED SOLDIERS



Convalescent Germans Making a Chessboard for Diversion



Building Artificial Limbs for Maimed Soldiers



This Photograph was Taken at Vincennes and Shows General Lienard Making the First Awards of the New French War Medal



Blind British Soldiers at a Regent's Park Home are being Coached as Oarsmen. Recently They Engaged in a Series of Remarkable Races

WITH THE WOUNDED AT HOME AND IN THE FIELD



Copyright International News Service
Crippled Italian Soldiers being wheeled through the Streets of Rome in Litters Fitted with Shades Which Shield Them from the Sun

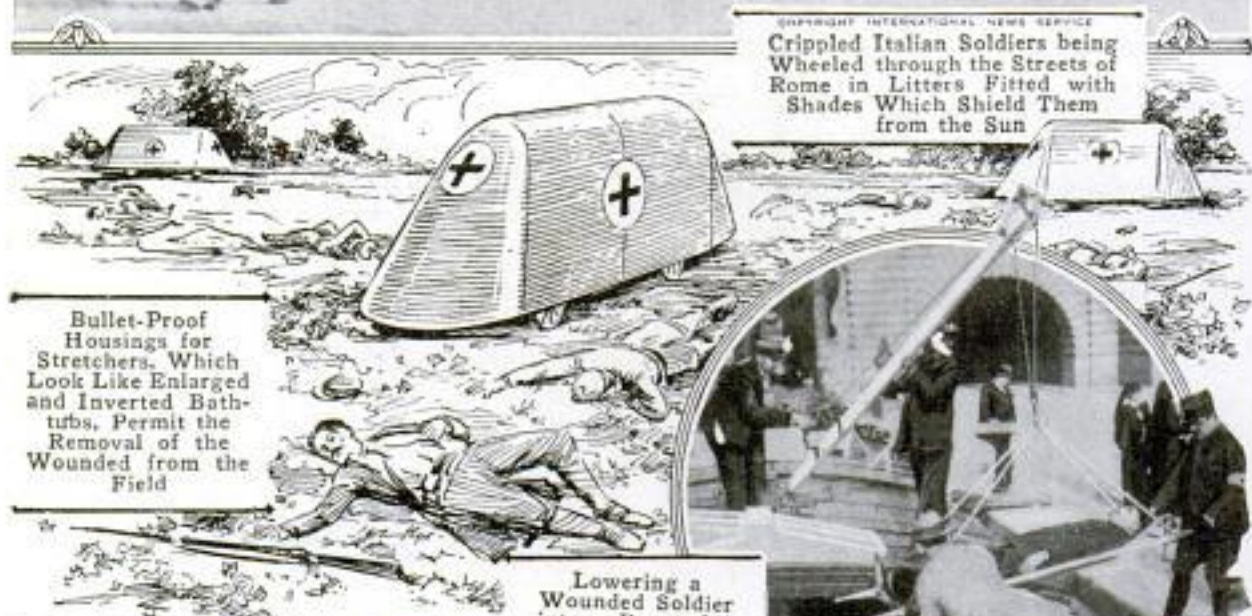

Bullet-Proof Housings for Stretchers. Which Look Like Enlarged and Inverted Bath-tubs, Permit the Removal of the Wounded from the Field

Lowering a Wounded Soldier into a Barge for Transportation to a Hospital Base



The Ambulance Corps of All Belligerent Armies have Found Dogs Very Valuable for Locating Seriously Wounded Soldiers. This Shows a Group of Animals Used by the Germans

Cont: J. L. Grall
84 W. South Water St.
Chicago. POPULAR MECHANICS

TEACHING CHILDREN MUSIC WHILE AT PLAY

By the invention of a simple apparatus, an Indiana music instructor has devised a means of teaching sight reading to children which makes the study a pastime rather than a dull, irksome exercise much to be avoided. The device consists of a large chart which is lined with parallel grooves in which the various characters, such as semibreve, minim, crotchet, tie, hold, and staccato marks, may be inserted. These characters are marked in black on small, white-enameled metal pieces which are fitted in the lines. With these a child follows the instructions of its teacher and builds up the staffs in whatever manner directed, placing a clef at the left margin and putting the different marks where they properly belong. Since there is a wide

range of grooves, a staff may be extended in compass above or below as required. Experience has shown that the average child looks upon this exercise more as a means of amusement than an unpleasant task, and is rarely

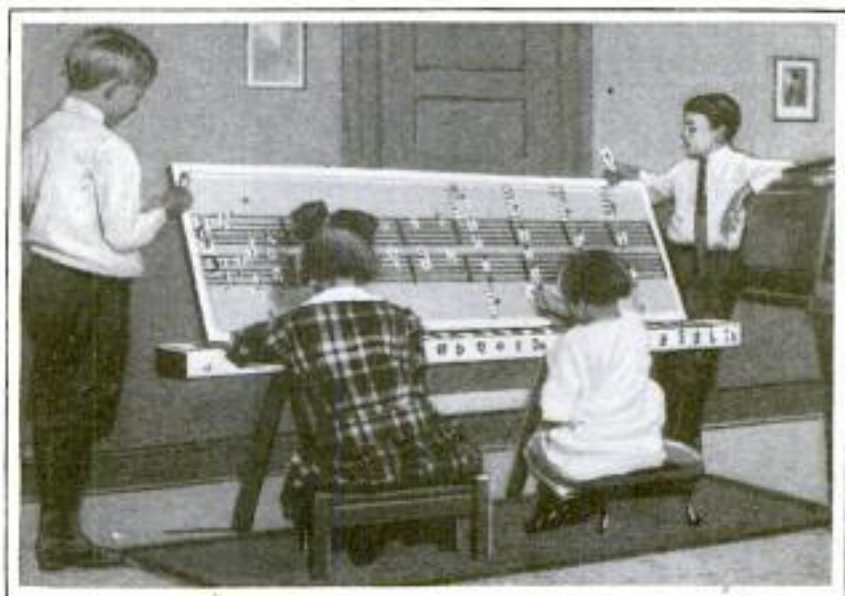

Making Sight-Reading Exercises a Pastime for Children by Utilizing a Device on Which a Staff may be Built with Enamel Characters

averse to continuing music lessons. It is claimed that the method helps a child to grasp the rudiments of music more readily than ordinary methods.

Cont: Low Strohm, Hall of Records, Los Angeles, Calif. MODEL STREET DESIGNED FOR COURT-ROOM USES

In order to facilitate the work of attorneys and witnesses in street-car claim cases brought before him for trial, a superior-court judge of Los Angeles County, Cal., has installed a horizontal blackboard in his chambers to make it possible for the jurors to be given graphic descriptions of the various phases of different accidents. The board is constructed according to a set scale and made to represent a typical street and intersection. The car tracks are drawn in accordance with conditions presented in any specific case which is being heard.

Miniature street cars and automobiles are provided with it, so that almost any kind of a collision or accident may be illustrated readily. The cars are made of wood in the proper dimensions to represent both those of the surface traction and interurban lines, while a card placed on each model carries information pertaining to the size, weight, and

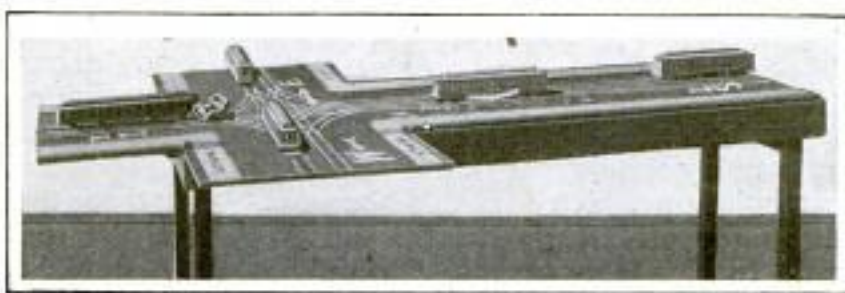

In This Instance the Board is being Used to Illustrate a Collision between a Traction Car and a Roadster

equipment of the individual car it represents.

Invented by Judge Curtis D. Webber,
Superior Court of Los Angeles, Ca.

Winona Lake Assembly, Indiana
Winona Lake

9961

BUILDING THE TOWERS FOR GEODETIC SURVEYS

By HARVEY FERGUSSON

Box 3782, Washington, D. C.

A department of the government little known to the layman, but one of wide and adventurous activities, is the Coast and Geodetic Survey. Geodesy may be described as surveying in seven-

the geodesist works in the open country instead of on a piece of paper; he deals with triangles the sides of which may be from 10 to nearly 200 miles in length; and a peculiarity of his work is that the longer he makes the sides of his triangles the more accurate will be the result. The necessity for making observations at great distances presents a difficult problem in engineering, for the geodesist must elevate himself and his instruments to such a height that he can see above all obstructions.

In a mountainous country the problem is simple, as peaks form natural points for observation. The longest observation on record was made between Mt. Helena and Mt. Shasta, in California, a distance of about 190 miles. In level country the geodesist must devise means for lifting himself to a height of from 60 to 150 ft. above the ground, and at this elevation he must have a platform steady enough to make delicate observations possible. This necessity has led to the development of some novel structures by the geodesists who are carrying the primary triangulation system into wild country. In the dense spruce forests of the Olympic Peninsula, for example, a tower strong enough to withstand the heavy winds and giving an elevation of 145 ft. for the instrument was made by bending and binding together three spruce trees that towered above their neighbors. The close-growing branches made a natural ladder by which the observer reached his lofty platform. By using powerful acetylene lamps at night and heliostopes, or sun-flashing mirrors, during the day, signals were sent and received over distances of from 10 to 40 miles. Another tower was built in a spruce forest simply by cross-bracing three trees, each of which was about a yard in diameter at the base and about 18 inches at the level of the platform, which was 150 ft. above the ground.

On the Canadian boundary survey it was found necessary to build towers, as the trees growing along the line were



This 145-Foot Tower was Built by Binding Together Three Tall Spruce Trees

The Top of This Lone Tree Supported a Platform on Which the Geodesists' Instruments were Mounted While Carrying a Survey through a Forest

league boots. It consists in covering the country with great lines of primary triangulation which serve as the foundation for practically all the surveys made by this department. Triangulation is based on the well-known principle by which, with one side and two of the angles of a triangle known, the other two sides can be calculated. But

Mfr.
 Peck Engineering & Mfg. Co.,
 230 Mill St.,
 Rochester, N. Y.

POPULAR MECHANICS

NEW AUTOMOBILE LAMP HAS
 INDIVIDUAL BATTERY 9555

not large enough to be used as they stood. A serviceable tower, 75 ft. high, was built from poles cut in the vicinity. In this, as in all towers built without the use of standing trees, there is an inner tripod that supports the instrument and an outer four-sided tower that holds the platform on which the observer stands. This insures the necessary stability for the instrument. These towers are strongly built, with their bases deeply anchored in the ground, and many of them have withstood windstorms that were little short of hurricanes.

333

BATTLESHIP FLEET PASSES THROUGH PANAMA CANAL

The first battleships to use the Panama Canal were the "Missouri," "Ohio," and "Wisconsin," of the United States Navy, which passed through the canal on their way to San Francisco July 16, 1915. This battleship fleet, of which the "Missouri" was the flagship, was engaged in the service of transporting the cadets from the Naval Academy at Annapolis, Md., to the Panama-Pacific Exposition. The entire canal, including the section affected by the Cucaracha slide, was traversed without difficulty.

An electric lamp that is supplied with current by its own individual battery is one of the latest features in automobile equipment. This lamp is carried on a bracket similar to that used with an oil lamp, and no wiring is necessary. The battery used is the No. 6 dry cell commonly used for general automobile purposes. Used intermittently, the lamp will burn from 50 to 100 hours, according to the condition of the battery, while the battery is easily and quickly replaced when exhausted. The light is turned on and off by a button conveniently placed on the side of the lamp.



The "Missouri" in the West Chamber of the Locks at Pedro Miguel. This Battleship, accompanied by the "Ohio" and "Wisconsin," was the first to pass through the Panama Canal.

International News Service
 238 William St.
 N. Y. C.

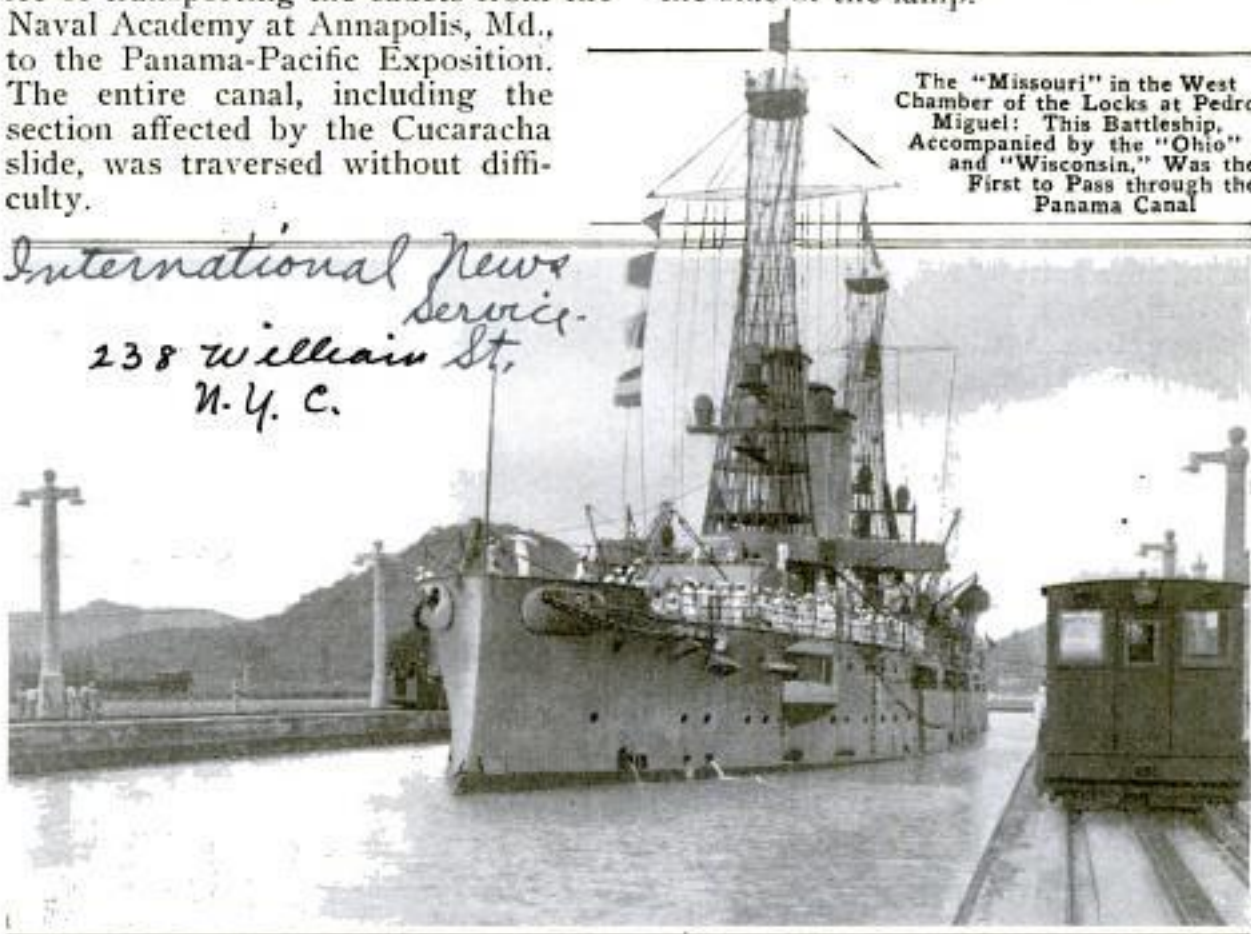

SELF-OPERATING JACK MADE FOR MOTOR-CAR PURPOSES

For use in a motor-car garage, a self-operating jack is being made which is particularly convenient for the owner

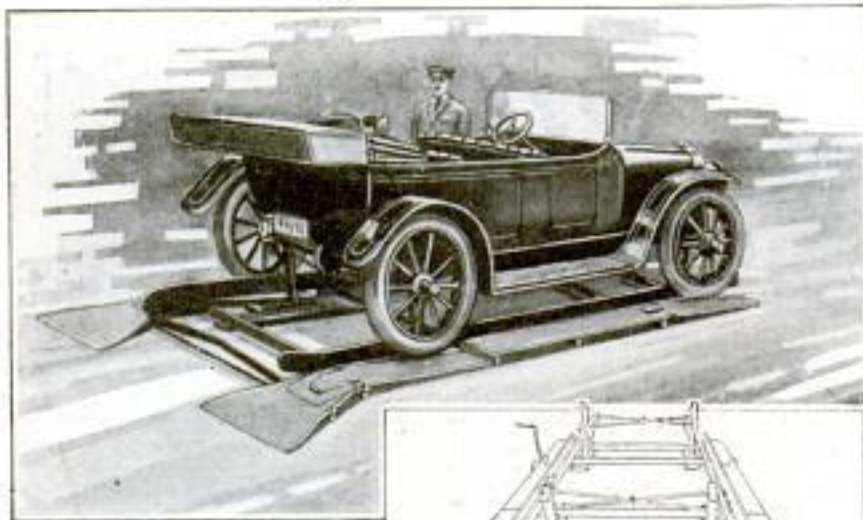

By Backing the Machine off the Platform the Traps are Reset and the Jacks Righted

who does his own repair work. The device is built with a metal framework, on two sides of which are board tracks fitted with spring traps. Rubber-cushioned arms support the front and rear axles of a machine. At the proper instant, when a car is driven upon the apparatus, the four traps in the guide boards are sprung, allowing the wheels to drop slightly and the machine to push onto the tilted supports. This operation is done without requiring any work on the part of the chauffeur other than that of driving the car. To remove a machine from the jack, pressure is first applied to a foot pedal which lowers the supports so that the car rests on its wheels and is able to back off the platform. The traps are reset and the jacks righted automatically.

ⒸThe best quality of rice available in United States markets is grown in Arkansas, it is said. Although this industry is not an old one in that state, last year 96,318 acres were given over to it.

FREE MEDICAL TREATMENT FOR IOWA CHILDREN

In accordance with a law now in effect in Iowa, children under the age of 16 years, who are suffering from some

curable malady or deformity, upon the order of a district-court judge may be given free medical and surgical treatment as well as hospital care at the medical college of the state university. The statute prohibits that any child thus cared for, however, be made an object of experimentation. This service is extended only to those whose parents are financially unable to bear the expense of having treatment rendered in the usual way.

If the court so dictates, a child may be accompanied to the university by a parent or appointed companion with all expenses paid by the commonwealth. Under the terms of the law it is illegal to treat any ailment other than is specifically prescribed by the judge, who bases his instructions upon a written report presented by an examining physician under his direction.

— 407

LUMBER SHIPMENT TRAVELS TEN THOUSAND MILES

Although the distance between the two points "as the crow flies" is only 1,400 miles, a cargo of Douglas fir that has been shipped from British Columbia to Port Nelson on Hudson Bay, where it will be used in the construction of docks, will be required to make a journey of nearly 10,000 miles to reach its destination. The shipment is to be taken all the way by water, the route lying through the Panama Canal, up the Atlantic coast and into Hudson Bay through Hudson Strait.

American Automobili Automobiles Jack Co.,
Nicksville, Ohio.

"Journal of American Medical Assoc." 6/17/15
"Daily Consular & Trade Reports"

Cour: Horace M. Engle.

Box 157, Marietta, Pa.

9121

POPULAR MECHANICS

531

HEAVY EXCAVATION WITH THE HYDRAULIC GIANT



Using Hydraulic Giant for Stripping the Earth from Mineral Deposits at a Mine in Canada: This Machine Throws a Five-Inch Jet under a Pressure of 200 Pounds to the Square Inch

depends on the impact of the water, and for this reason the force exerted is a factor both of the size of the jet and the pressure under which the water is supplied. When a jet of water is thrown at high velocity from one of these machines it has many of the qualities of a hard, rigid bar. In tests made to determine the hardness of jets produced by heavy pressure, attempts to cut through the jet with a sword have simply resulted in the break-

Washing the dirt and boulders out of the way with a jet of water thrown at high velocity from a hydraulic giant is now recognized as one of the most efficient methods for stripping the earth from mineral deposits as well as for many other kinds of heavy excavation. The hydraulic giant consists simply of a tapering metal tube, or nozzle, usually from six to eight feet long, to which water is supplied under heavy pressure. It is so mounted that it can be swung both horizontally and vertically, a feature that makes it possible to direct the jet at any point in a big area. The work done by the hydraulic giant

ing of the blade. In actual practice the head may vary from a hundred feet to several thousand feet, or the equivalent pressure may be supplied by means of pumps. The hydraulic giant used at the Nipissing mine in the Cobalt field in Ontario, Canada, shown in the illustrations, throws a 5-in. stream. It works under a pressure of 200 lb. to the square inch, equivalent to a head of 460 ft., the water being supplied by two centrifugal pumps.

Approximately 250,000,000 incandescent lamps were manufactured in this country during 1914.

* See *Henderson Register* / *Giant (Hydraulic)*
See *Thomas* 50

DISH WIPING UNNECESSARY WITH CHINA RACK

For household use, a dish-drying rack is being introduced which is intended to eliminate entirely the ordinary pro-



This China Rack is Intended to Make Dish Wiping an Unnecessary Procedure

cedure of wiping china after it has been washed and thoroughly rinsed. The drier is made of white-enameled wood and is designed to be fixed to the wall immediately above the draining board of a kitchen sink. It provides an individual space for each piece of china so that the danger of breakage is materially lessened. As the dishes are washed and sterilized with hot water, which frees them from traces of soap, they are placed in the rack and allowed to dry of their own accord. After about ten minutes, providing the rinsing has been done properly, the china will be found clean and free from lint, which is frequently present when dishes are wiped.

¶ No employe in the buffet service of one eastern railway company had a contagious disease when recently examined.

FARMERS ARE BENEFITED BY FOREST SERVICE 353

One of the principal reasons that agricultural development has been slow in remote regions adjacent to some of the Federal forest reserves has been the lack of good roads. Many of the farmers in these localities are settlers doing pioneering work under as difficult conditions as have ever been encountered in this country. Because of this situation, the government is attempting to lend its assistance in the work of upbuilding these districts so as to open up large areas of land for cultivation. Some of the individual forest reservations are giving a revenue of as much as \$100,000 annually, and one-fourth of the receipts are contributed to the counties in which the timbered areas exist, for the construction of roads and the establishment and maintenance of schools. In some cases, however, the forests are not yet earning. Because of this, a plan is being advocated which contemplates asking Congress for an advance of money in anticipation of the forests' future receipts. In addition to its other work the Forest Service has built, up to the present, 2,300 miles of roads in the reservations, 21,000 miles of trails, nearly 600 bridges, and 18,000 miles of telephone lines.

GERMANS USING PEAT AS AN INSULATING MATERIAL 413

Compressed and formed into sheets, peat is now being extensively used in Germany as an insulating material in place of cork, which has become practically unobtainable as a result of the war. The sheets are made in varying thicknesses and are used in the same way as cork sheets. As an insulation against heat and cold the peat has about the same efficiency as cork. As a sound-proofing material it is said to be far superior to any other substance, tests having shown that its efficiency for this purpose is about seven times that of cork.

"Technische Monatshefte
Exchange"

Sanitary Dish Drier Company,
 P.O. Box 576 - Chicago, Ill.
 Kan. Cy. No. 29
 Detroit, Mich. 339 B. Higdon Av. Holyoke, Mass.

Information Sheet.
 Forest Service.

Car operated by Virginia Railway + Power Co.,
Richmond, Va.

Chas. C. Johnson, Asst. to General Mgr. of above Co.
supplied information.

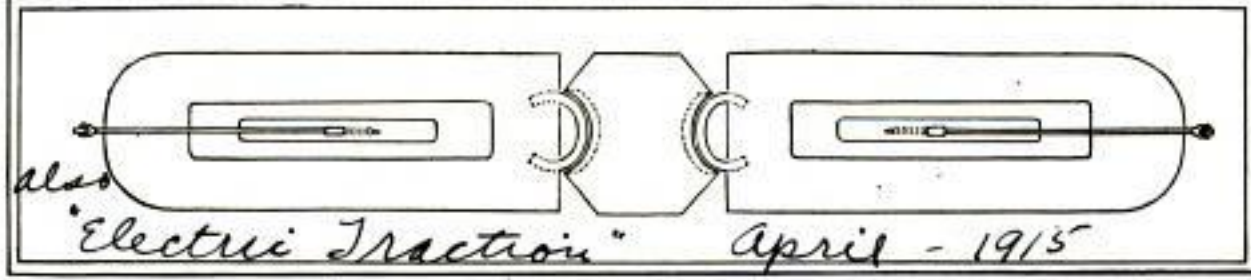
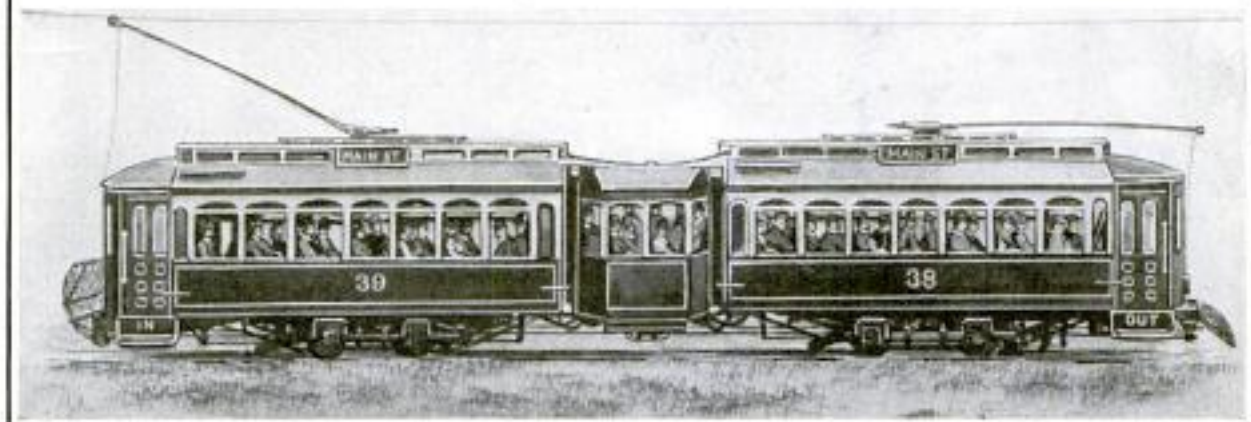

also "Electric Traction" April - 1915

The General Appearance of the Hyphenated Car is Shown by the Cut, While the Diagram Below Indicates the Manner in Which the Intermediate Compartment is Mounted in Order to Allow the Negotiation of Curves

ARTICULATED CAR OPERATED 145 IN VIRGINIA CITY

To avoid the necessity of discarding a number of single-truck carriers, a surface-traction company at Richmond, Va., has adopted a plan of joining two cars by building a small compartment between them after removing the adjacent platforms. Virtually the result is a hyphenated vehicle, somewhat odd in appearance but nevertheless serviceable and considerably better on rough track than single-truck equipment. A means has been worked out for preventing the oscillation of the center compartment, the weight of which is borne by both cars.

THREE-SEAT TRACTOR PLANE BUILT FOR SCHOOL USE 245

Pleasing lines are incorporated in a new tractor biplane which has been built for an aviation school at North Island, San Diego, Cal. It mounts a 60-hp. motor which is capable of giving the craft a speed of 65 miles an hour when it is carrying three persons, and sufficient fuel to last two hours. It may be throttled down to 30 miles an hour with safety. With a full load it is able to climb at a rate of 400 ft. a minute. The machine is quite similar to one type of craft which has recently been delivered at the army aeronautic station in California.



New Tractor Designed and Built for a California Flying School

Cont: S. Edward Bamhart,
Hotel Oliver, San Diego, Calif.

423

NEW FENDER FOR MOTOR CAR IS NEAT IN APPEARANCE

One of the chief difficulties which has stood in the way of developing a



practical fender for motor cars, the question of lightness, has apparently been overcome by the invention of a combination bumper and pick-up basket. When the device is in normal position, the connecting rods clamped to the springs and abutting against the front axle, its appearance is quite like that of an ordinary bumper, for which it serves. By pressing a button fixed to the steering wheel of a car, however, one set of the arms instantly drops, the bar parts and a large canvas pocket, which extends from within 2 in. of the ground to the top of the mudguards, is shot out in front of the machine. This is said to be capable of picking up a pedestrian and carrying him safely until the car can be brought to a stop. Its operation is controlled just as easily as is that of a siren. The device is said to have shown merit in tests.

HIGH-POWER WIRELESS AT SAN FRANCISCO FAIR

One of the most interesting features of the government's wireless exhibit at the Panama-Pacific Exposition is a sound-magnifying receiver through which the time signals from the Mare Island Naval Observatory, on San Pablo Bay, are rendered sufficiently audible to permit visitors to set their watches by them at a distance of 30 ft. from the apparatus. It is also reported that signals have recently been received from the Eilvese station in Germany.

Radio Service
Bulletin

FLEXIBLE AIR DUCTS FOR TUNNEL CONSTRUCTION

A decided innovation in tunnel ventilation has been introduced in the sewer work now in progress in St. Louis, where flexible air ducts made of rubberized fabric are being employed in place of the usual galvanized-iron, or other metallic, ducts. The principal advantage in the use of this kind of tubing is that it is easily installed as the work progresses, and can be rolled up and taken out of the way when a blast is to be fired and then re-extended quickly. It is made in 100-ft. lengths, which are equipped with special couplings. A 24-in. tube carries the air down the shaft and from this point 16-in. tubes lead to the headings, each about 1,600 ft. distant from the shaft. The rubberized fabric is both air-tight and water-tight, and the makers believe that the tubing can be used to advantage as a temporary water conduit in many instances.

MOTORCYCLE ENGINE VALVES LIFTED BY SIMPLE TOOL

Fashioned somewhat after the form of a pair of heavy tweezers, a convenient instrument has been introduced for the use of motorcyclists in removing engine valves. It does away with the trouble commonly encountered when it becomes necessary to lift a valve from the heated chamber of a motor, an operation which frequently results in burned finger tips. The knurled ends of the tool spread apart when the bowed spring is pressed together. So, in using it, the instrument is inserted into the slot in the valve head, pressed with the fingers, and then withdrawn, bringing the movable parts of the valve with it.



Motor Cycle Illustrated

A. S. Safety Fender Co., Broad + Race Sts.,
Abbott Bldg., Philadelphia, Pa.

Inventor: Samuel Blagov
Philadelphia, Pa.

Engineering News,
7/22/15

9992

424

Motor Cycle Illustrated
The Motor Company, Milwaukee, Wis.

COMMENT AND REVIEW

AT this writing the sorrow of the "Eastland" disaster is rapidly fading into history, while the usual investigations by various city, county, and Federal officials are progressing. Various causes will be set forth as more or less contributory, but the simple verdict of "overloading" will include all the others. Owners and managers, by reason of immunity from accident in the past, naturally grow impatient at restrictions imposed, and use every means to load to maximum capacity. A maximum load on either a man or machine is just a little more than prudence will suggest, as it removes that margin, though small, which furnishes the factor of safety.

*"Safety
First"
"Eastland"
Memorial*

The other Chicago calamity, the fire in the Iroquois theater a few years ago, also claimed chiefly as its victims women and children. That disaster so awakened the sluggish public that today scarcely a theater throughout the entire United States but has been made either safe or far less dangerous as a result.

The most imaginative novelist could scarcely have had the temerity to weave in fiction what actually took place in the case of the "Eastland," so unusual were the conditions and so startling the effect. Monuments in stone and a memorial of some benevolent character will commemorate the event, but the best memorial would be that which will make a repetition impossible, and safeguard the public for all time to come.



THE employment of so many plants on munitions of war and the incident training of thousands of men to the work is an asset to this country of very great importance. For while other nations, even smaller than our own, have encouraged and fostered such plants, we have drifted along in dreamy indifference to what the balance of the world were doing. That the day is at hand in which we must awake and strengthen our arms both at sea and on land, is already generally realized. The voice of the jingo is hushed and that of the pacifist—well-meaning but easy-going

*Preparedness
a Duty*

—is stilled in the presence of a responsibility more vast than any which has confronted this nation since old Liberty Bell rang out the glad news.

Our state of unpreparedness is absolutely pitiful, and can be mentioned with perfect frankness, for while the mass of our own people know little and appreciate less our lack in every essential, the war archives of every foreign country are bulging with records of what we have not. The submarine of 1915 and the 42-centimeter gun give us something very definite with which to compare ourselves, and the comparison is appalling. An effective standing army between the Atlantic and Pacific of barely double the police force of New York City, to guard 5,000 miles of seacoast and the richest country in the world, does not suggest that sagacity and forethought on which we

have prided ourselves. Both our navy and army, what we have of each, are excellent; we are justly proud of them, but a single fire engine cannot put out a big conflagration.

America, the birthplace of the aeroplane and submarine, still uses the one chiefly as a circus entertainment, and of the other has a mere handful, and those of short cruising radius and doubtful reliability.

A kind Providence has spared us thus far, but we must not tempt fate a moment longer, and in the provision of an adequate defense—for we have no desire or occasion to aggress—the most remote farmer a hundred miles from the nearest railroad is equally interested with the city dweller on an exposed coast.

Congress does not always appropriate the funds at command in a way the most commendable, nevertheless the President and the next Congress should have the unanimous support of the entire country, as we awake from our Rip Van Winkle sleep and come down to the real problems and responsibilities which have been gathering with the advent of the twentieth century.



IF an enemy had succeeded in driving the American Flag from the high seas only a fraction as effectively as our lawmakers have legally done, the whole nation would be aroused and in arms. Apparently no effort has been neglected to make the burden of flying the American Flag as heavy as possible.

*Scuttling
American
Ships*

As a result the Pacific Mail S. S. Co. will very soon withdraw its ships from the trans-Pacific trade; and when the Great Northern does the same, as its vessels are unprofitable, there will remain no American trans-Pacific line, and this vast oceanway will be left to Japan to claim and use. That Japan will not be slow to seize the opportunity goes without saying, for Japan subsidizes the ships that fly her flag, while the United States refuses a dollar of encouragement and imposes restrictions and requirements which are in effect a practical prohibition.

Even the Great Lakes are not immune; for when the idiotic La Follette act takes effect next November, the American Flag will come down from a forest of mastheads, not to fly again until the law is changed. Labor unions are credited with the conception of the La Follette bill, which was heralded as an act "to promote the welfare of American seamen," but which in its results will promote thousands of sailors out of a job. The Interstate Commerce Commission has also lent a helping hand, and the lake steamers of railroad lines will have to tie up. Inasmuch as these lines have not been particularly profitable under fairly good conditions in the past, it is not to be expected navigation companies will spring up and clamor to buy these ships. With the close of navigation on the Great Lakes next December, the American Flag will be practically exterminated on the inland seas. The boats will almost certainly be sold to other countries.

What a fine thing it all is; what a grand accomplishment; how proud we all should be to have made it almost a misdemeanor to fly

our own flag, and to have thrown so many obstacles against its being flown from the masthead that an owner and captain stand a mighty good chance of going to jail every time they do it! While almost every other nation which has even a few miles of seacoast is striving in every way to encourage its marine, we, with the largest available seacoast on earth, have apparently neglected nothing to exterminate the little marine we had. This country will pay a costly penalty one of these days, and will reap in humiliation and dismay the bitter harvest which shortsighted and misguided politicians have sown for us.



BUSINESS conditions are certainly beginning to show improvement, although the taking up of long-unused tools is gradual. Many lines of manufacture are yet either idle or working at low ebb, while those capable of turning out any sort of war supplies are running at high speed. Millions of dollars even are being spent for new plants in which to fill war orders. In this connection it is interesting to watch the movement of the so-called war stocks, prices of which have gone soaring. The man of moderate means, however, will do well to let these stocks alone and confine himself to the purchase of any one of scores of reliable securities which, while they do not promise a king's ransom in a minute, have a worthy record for good management and fair returns, and can be bought at prices lower than in years. The war stocks are a rich man's game, which may return extraordinary profits for several years, but are more likely to disappoint the inexperienced.

*Better
Times
Here*

Prosperity is certainly peeping through the clouds, and there is every evidence that better times are rapidly approaching. Billions of dollars in harvests and billions more in war orders are pouring gold into Columbia's lap as never in our history. Already the steel industry—that reliable business barometer—is pointing toward "good," and the railroads, that other large and sympathetic factor, are reporting increasing earnings and are beginning to buy supplies. The main thing to keep in mind is a reasonable degree of prudence in permanent investment as production becomes taxed to its limit with the temptation to overbuild.



DURING the past year Europe has purchased from us a billion dollars' worth of supplies, chiefly foodstuffs and munitions of war. We in turn have absorbed many millions of our own bonds and stocks which have been sent here for sale. Patriotism and the opportunity to purchase bonds of their own government at favorable prices have caused foreign capitalists to give up our securities, many of which had been held abroad for 20 years. That prices of our securities have been so well maintained is, of course, highly gratifying. There will doubtless be millions more to follow in the next twelve months.

*U. S. Dollar
Becomes
World's
Standard*

On the other hand, the United States Dollar is now the standard measure of value throughout the world, and the only unit which is not below par. When business transactions in South America are discussed in terms of dollars instead of pounds or marks, a great advance has been made toward the day when the financial center of the world shall be in the United States; but when that day arrives, its sun will flash the light of freedom from our flag on every sea and in a hundred ports, with a navy which will assure to every American that same courteous respect which is afforded every Englishman.



AT last it is beginning to dawn upon us that the man whose carelessness and stinginess permits his building to catch fire and burn, incidentally causing loss to any number of innocent bystanders, is a pest and should be treated as such. As has been urged in these pages more than once, we should copy the long-established practice in Great Britain and on the Continent, and impose a penalty on the man whose building has a fire, instead of rewarding him with fat fire-insurance policies, which put an actual premium on the largest possible loss and damage by fire and

water. On the other side, when the fire department is called, the man with a fire pays a good round sum for the services of the firemen and equipment. Instead of a thrill at being the basic cause of a brilliant setting for a moving picture, with brightly painted ladder trucks and resplendent steamers, and a few score of the bravest, in motor trucks, dashing to the rescue, there is consternation at the prospective bill, for the more that come the bigger the charge will be.

Where a good part of the prospective insurance money is consumed in advance by the bill the fire department will collect for their professional visit, a fire loses much of its charm. A city levies charges for the water it supplies for domestic purposes, and why not for water pumped to put out fires? The fact is, a score of things are charged for by cities which are not a fraction as logical as to charge for the use of the fire department.

New York and Boston have already announced their tariff charges for fire service of one steamer up, and other cities should promptly do the same. A very large percentage of fires would never have occurred if some one had used reasonable care, and nothing will stimulate greater care so much as having to pay for what is now free as air.

H. H. WINDSOR

August 10, 1915

*Fire
Department
for Hire*

Cont.- Geo. A. Oberauer, 921 Smith St., Buffalo.

Foundation of POPULAR MECHANICS

539

Buffalo's new Lehigh Valley Dep. Station

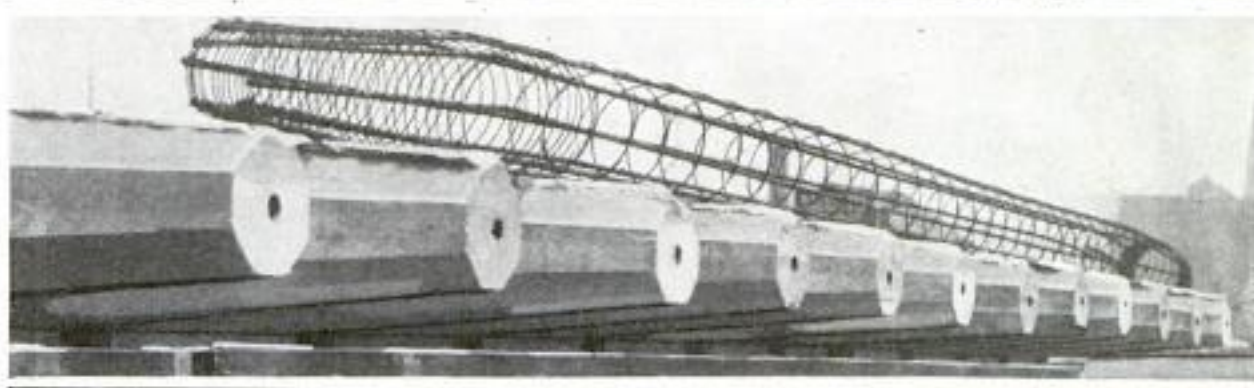

Concrete Piles with Jetting Pipes Incorporated within Them and Reinforcing Skeleton Used in Their Construction

213

PIPES IN CONCRETE PILES FACILITATE JETTING

Reinforced-concrete piling is being employed to provide a base for the foundation of a large railway station to be erected near the water front, at Buffalo, N. Y. The general form of these monoliths is similar to that of those ordinarily used for such purposes. An interesting feature in their construction, however, is the provision which has been made for jetting them into place. In molding each pile a long section of pipe, having an elbow at one end, was incorporated. This extends longitudinally through the middle of the pillar, one end opening flush with the bottom and the other coming out at right angles about three feet from the top. In sinking one of these piles a connection is made with the upper end of the pipe and the water is pumped through under heavy pressure. The force of this digs a hole for the monolith, which settles gradually into

place. The work is more easily done and better results are attained this way than by jetting with an auxiliary pipe at one side of a pile.

308

— *Electrical World*
ELECTRIC TIDE INDICATOR
FOR NIGHT OBSERVATION *June 4/15*

For the purpose of registering the state of the tide at night in connection with dredging operations, a British firm is making use of an interesting electrical gauge. A timber dolphin, placed about a half mile from shore, carries the apparatus, which partly consists of a compact, automatic electric-light plant that supplies current to five lamps of different colors. A float, fixed in a standpipe under the dolphin, controls a number of switches. The rise and fall of the tide operates these, causing different lamps to be illuminated according to a prescribed code. The level from naught to 19.5 ft. is indicated by the colored-light combinations.

Mfr: *Gent & Co., Ltd.*
Faraday Works,
Leicester, England

Copyrighted material

**AUTOMATIC DANGER SIGNAL
AT STREET-CAR CROSSING**

**CAPE COD CANAL A BUSY
WATERWAY**

*cont: George Paterson,
22 Lincoln Street,
Detroit, Mich.*

In order to warn motorists and others of the approach of traction cars at an inter-



section of two narrow streets where the view is obstructed by buildings, fences, and trees, an electric signal of rather novel appearance has been put in use. At the top of an iron post, which also carries the street signs, is mounted a propeller-shaped member which oscillates whenever a car nears the crossing. At night a sign beneath this signal arm bearing the word "Danger" is illuminated in red.

It is estimated that the average life of a British officer after he

reaches the firing line is only 23 days. A cavalry horse lasts about ten days and an automobile a month.

An idea of the value of the Cape Cod Canal to shipping is given in the fact that more than 2,500 vessels have passed through this waterway since it was opened in the summer of 1914, each of these vessels saving something like 70 miles of travel and avoiding the dangerous route around Cape Cod. One of the largest of these vessels was the "Tenbergen," a Dutch steamer of 3,826 tons. Many government vessels have passed through the canal, among these being the submarines "K-5" and "K-6," which made the trip from Boston to Newport at an average rate of 11 miles an hour. Only 45 minutes was required by the two submarines in making the passage through the canal.

**WAR PRISONERS ARE HELD
IN CANADIAN FORTRESS**

Fort Henry, an obsolete Canadian fortification adjacent to Kingston, Ont., is being used as a place of internment for some 200 German and Austrian prisoners. Hundreds of aliens within the confines of the Dominion have comparative freedom, but those who either have refused to agree to the terms of parole, or are looked upon as dangerous persons to be at large during war time, are kept under guard. The men held at Fort Henry entertain themselves by playing football and baseball on a compound surrounded by the inner walls of the structure.



Approximately 200 Germans and Austrians are Held Prisoners in This Old Fortification near Kingston, Ontario

*Army & Navy Journal
8/7/15*

*Robson Black, 33 Broadway Ave,
Ottawa, Canada.*

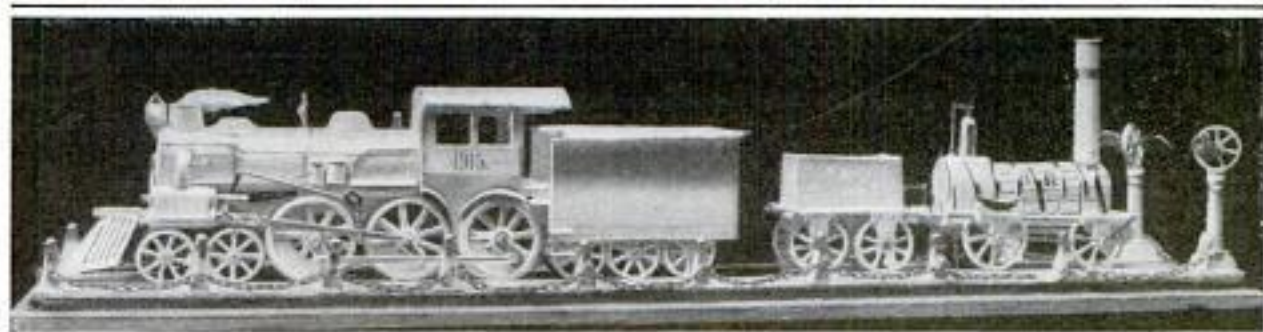

Old and New Types of Railway Locomotives Molded in Sugar by Hand

One nationality plays against the other and much rivalry is displayed. The fortification was built in 1836 and is typical of those guarding the boundary. Although it mounts a number of guns, it is considered, like many of the others, absolutely worthless for defense purposes.

**MINIATURE RAILWAY ENGINES
DESIGNED IN SUGAR**

326

Small replicas of a modern express locomotive and a diminutive, antiquated, wood-burning engine of pioneer railroad days, have been made of sugar by the chef of an Atlantic City hostelry. All of the molding was done by hand with remarkable artfulness, considering the character of the material used. The miniature models, which have been set end to end and placed on display, measure approximately eight feet in length.

8898

**CONVENIENCE IS EMBODIED
IN NEW THEATER CHAIR**

One of the most annoying features of the usual seating arrangement in

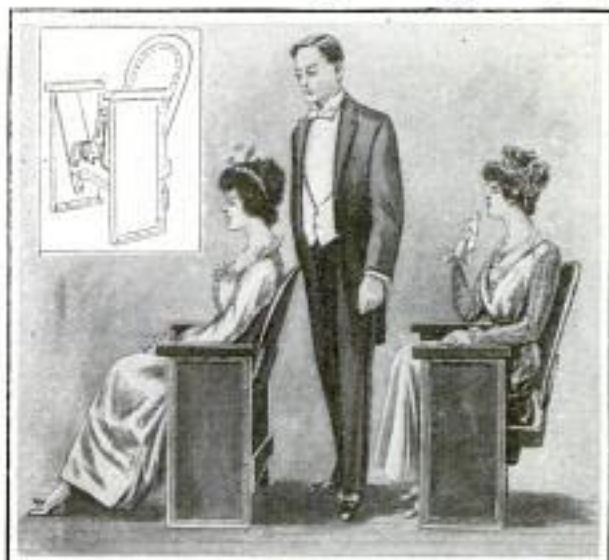

With Slight Exertion the Seat may be Moved Back so as to Provide Plenty of Space for a Person to Pass without Crowding

theaters has been at least partly overcome by the invention of a new type of chair. This enables a person to pass in

**PLAN FOR LESSENING COST
OF STREET PAVEMENTS**

310

Interesting results have marked recent efforts, made at the University of Oklahoma, to devise a means of effecting a saving in the expense of constructing street pavements. It has been found that the cost of laying a concrete base can be cut approximately 50 cents a square yard by making a thinner spread than is customary and strengthening it with a light reinforcement. Laboratory tests of a severe character have shown that a 3-in. concrete slab reinforced with rectangular-mesh hog fencing, which can be procured for from three to five cents a square yard, is almost equal in strength to a 6-in. unreinforced slab of like linear dimensions. Approximately, concrete costs from 15 to 20 cents a square yard for each inch of thickness. Thus the saving which may be derived, by lessening the thickness by half and adding five cents worth of hog fencing to each square yard, is apparent. According to the director of the university's engineering school, the plan, if followed, would not merely give results as satisfactory as those obtained by the usual form of construction, but undoubtedly greatly better ones would be secured.

"Engineering Record" 6/5/15-

Cord: Harper B. Smith, 173 S. Kentucky Ave. Atlantic City, N.J.

Inventor: Kable, Finner, S. Seattle Wash.

The Auditorium Chair, Co.
861 Empire Bldg.
Seattle Wash.

Copyrighted material

front of the occupants of aisle seats, when going to or from an inside chair, without particularly disturbing them. At the same time the seats are placed as closely together as is customary. It is mounted in a fixed support in such a way that it may be moved back several inches by moderately pushing with

the feet against the floor. This may be done almost without exertion, just as a rocking chair may be tilted back naturally. The result is that a passage way is quickly provided and the necessity of a long row of persons rising in order to allow others to crowd past them, is eliminated.

305 SKULL IS CASE FOR CLOCK GIVEN GERMAN PRINCE

Although its appearance is not such as could be called pleasing, a clock of both curious and significant design

"Mesa Revuelta"



Skull Clock of the Prussian Crown Prince, Colonel of the "Death Hussars"

has been patterned for the crown prince of Prussia. The case consists of a human skull mounted on cross-

bones. The hours and minutes are shown by large numerals displayed in the eye sockets. It was a recent gift to the prince by his consort. The appropriateness of the design is apparent when it is remembered that the prince is colonel of the "Death Hussars."

SIGHTLY BAND PARK BUILT IN CALIFORNIA CITY 153

At Redlands, Cal., an open-air concert park has been laid out in an attractive manner. It is built much in the form of a large bowl, beautified by palm trees and encircled by a broad cement walk at the street level. The floor, which is covered with gravel, slopes gradually toward the middle, where a cement bandstand has been constructed. The seats are typical of those which are coming into general use in parks and public places along the coast. They are especially sightly and made with concrete center and end pieces which support heavy planks. A narrow grass terrace surrounding the park is cut at intervals by broad cement steps leading to the aisles.



The Ground was Excavated to Allow the Floor to Slope Gradually from the Street Level to the Middle of the Park, Where the Band Stand has been Erected

This Shows the Great Concrete Structure as It was Nearing Completion

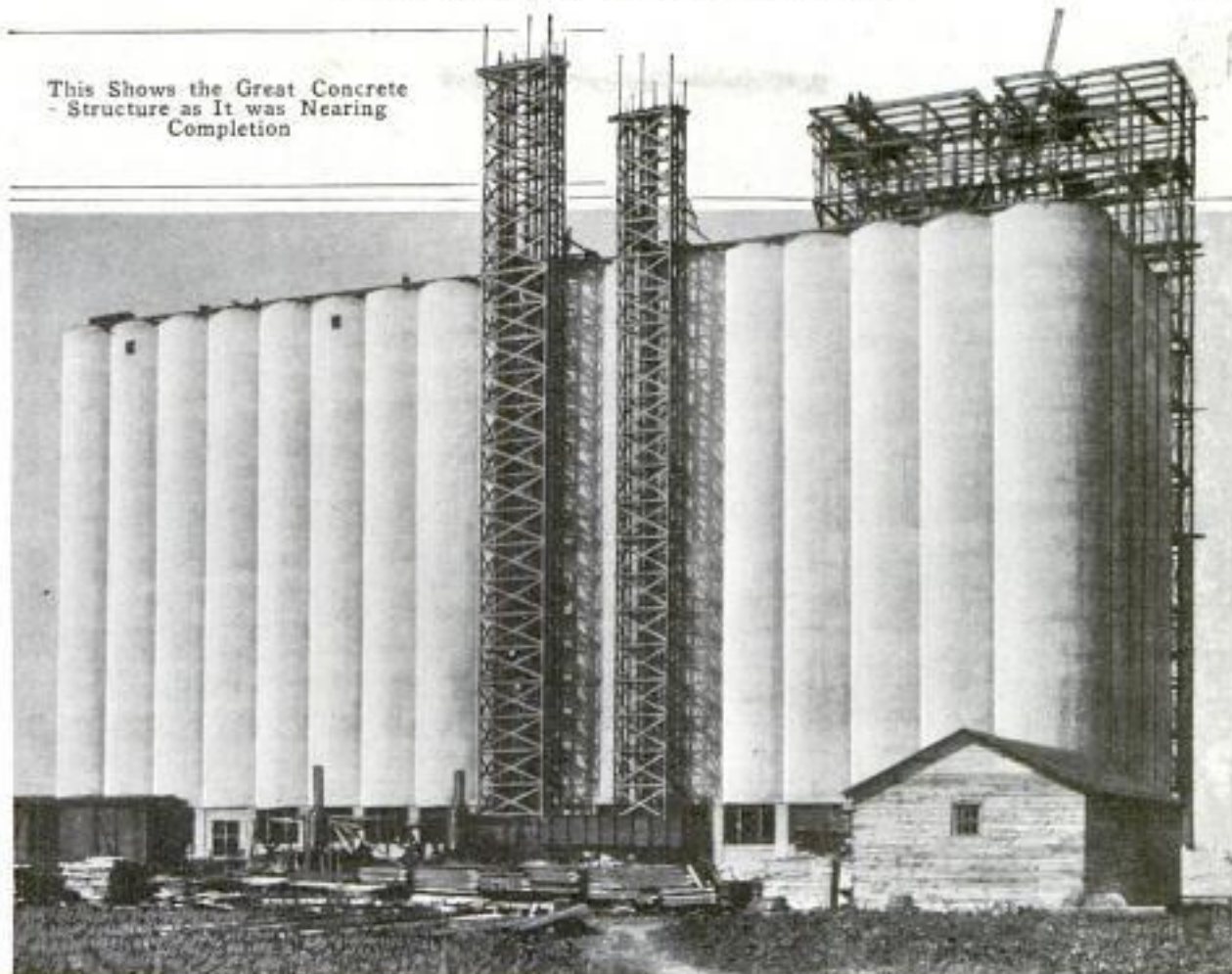

ELEVATOR UNLOADS GRAIN IN RAPID MANNER

26/ On the river front at Buffalo, N. Y., a concrete grain elevator with a 1,050,000-bu. capacity has been erected which has unusually good facilities for loading and unloading both cars and steamers. When work is in full swing, it is possible to unload the largest grain boat sailing the Great Lakes in approximately 10 hours' time. The capacity of the unloading cars is about 40,000 bushels an hour. It is also said to be possible at this elevator to load a like quantity of grain into freight cars and about 20,000 bushels into ships and canal boats, an hour. The dock is 811 ft. in length, which provides adequate space for berthing two large boats, or possibly three small ones. Trackage is also provided in adjacent yards for approximately 1,400 cars. Although the capacity of this elevator is not exceptional, its loading facilities exceed those of many lake plants.

2/2 Auto Access
HUMANLIKE EYES ARE FIXED IN MOTOR-CAR HEADLIGHTS

For advertising purposes a Los Angeles company has installed a pair of electric eyes in the headlights of one of its motor cars. These are made to

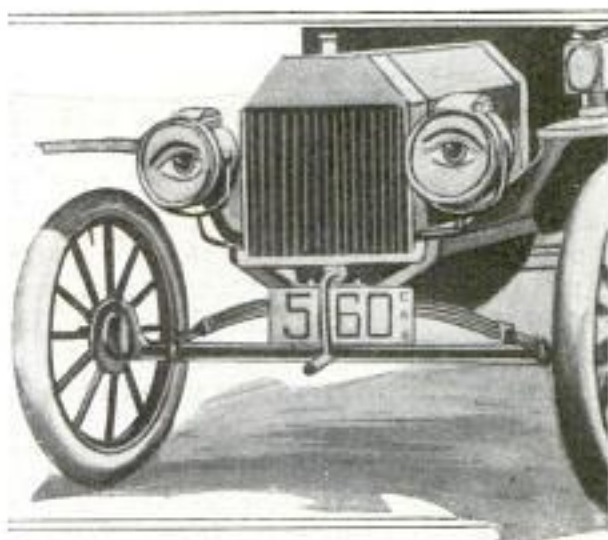

Eyes in the Headlights are Opened and Closed Electrically

Weaver Roof Co.,
 Los Angeles, Calif.

A. S. Burtis, 339 E. 2nd St.,
 Los Angeles, Calif.

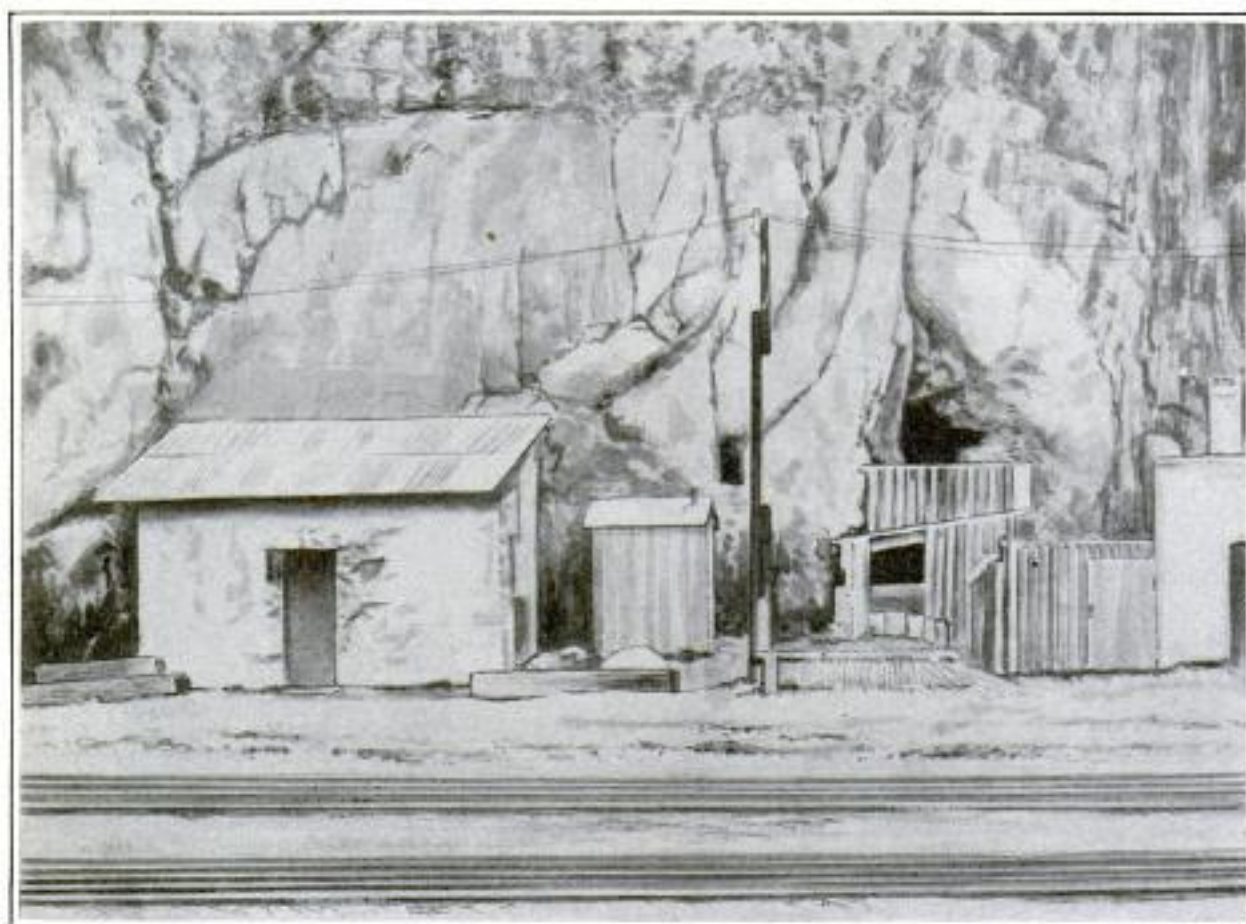

Dingy County Jail in Rock-Walled Mountain at Arizona Town

*H. E. Zimmerman,
Mt. Morris, Ill.*

represent human eyes and completely cover the glass panes shielding the reflectors. By means of a push button fixed to the steering wheel, the driver of the machine is able to cause them to open and close slowly. The novelty has attracted considerable attention.

"The Engineer" 8/6/15
WHAT THE WAR IS COSTING
437 MERCHANT SHIPPING

During the first eleven months of the war approximately two per cent of the world's shipping, estimated on the basis of tonnage, was wiped out. When the war broke out the world's merchant tonnage of all classes was about 48,000,000 gross tons, of which 20,431,534 tons was British and 5,082,061 tons German. Without taking into account the ships held or captured by an enemy, 511 ships aggregating 915,457 tons were eliminated prior to July 1, 1915. During this period the British alone lost 327 vessels having an aggregate tonnage of 609,934 tons.

ARIZONA PRISON IS BUILT IN
MOUNTAIN SIDE 9944

What is undoubtedly as forbidding-looking a prison as is supported by any community, and one which also is more or less curious, is that maintained by Graham County in Arizona, at Clifton, the seat. It is properly a cave, partly artificial, which extends through rock formations parallel with the outside of the mountain in which it is situated. It is divided into compartments which are supplied with bar-covered holes blasted through the rock wall to admit light and air. The entrance of the underground prison is closed by a small masonry structure which is occupied by the sheriff and his staff, and separated from the cell rooms by steel gates. The jail windows are so high above the floor that escape from the place, without assistance from the outside, is made next to impossible. One might pass the prison many times without becoming aware of its existence.

247

FLOATING MASONRY CHIMNEY SWAYS IN STRONG WINDS

After 34 years of service a floating masonry chimney, 204 ft. in height, which rises beside a factory building at Frankfort Junction, Pa., and sways freely during heavy winds, is still in a good state of preservation. At the time of its erection the engineer having the work in charge discovered that a vein of quicksand extended beneath the point where the foundation for the stack was to be laid. He met the difficulty by casting a solid block of concrete, 30 ft. square and 5 ft. thick, and employing it as a floating bed for the heavy masonry. Curiously, when the stack swings in the wind it always moves slowly in a north and south direction. It has not suffered a serious departure from the vertical.

Schlichter Gute Cordage Co.
Frankfort Junction Pa.

FURNACE DOORWAY SCREEN MADE OF CHAINS

To prevent an excessive volume of cold air from entering a furnace and cooling its brickwork and crown sheet-

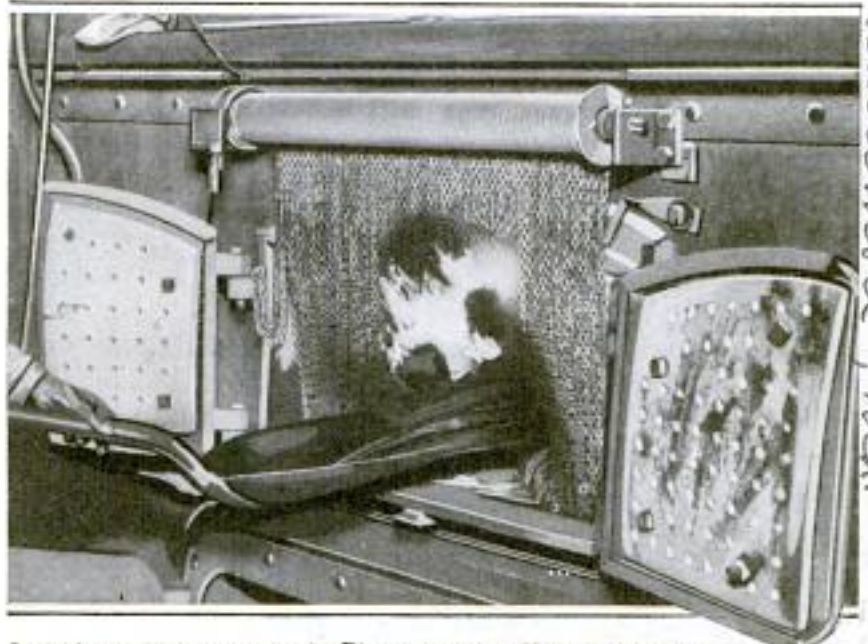

One of the Chain Screens in Place, Showing How It Protects a Furnace Opening While Not Obstructing the View of the Fireman

Mfrs: E. J. Cold Company, Baltimore, Md.

TILE ORNAMENTS APPLIED TO CONCRETE PILLARS

Tile ornaments applied to the faces of concrete pillars are the latest feature in building decoration in southern California. Each ornament is made up of small tile of various colors assembled to form an attractive design, and is usually about 12 inches wide and 18 inches high. The ornament is applied after the pillar is completed by means of liquid cement.



42
Abern Marple,
322 Boynton St.,
Tropics Calif.

ing when the fire is being stoked, or the door opened for other purposes, a chain screen has been invented which covers the aperture. It is made of steel chains of uniform lengths attached to a cylinder that is secured on brackets fixed across the top of the furnace opening. When the device is to be used the drum is unwound like a curtain roller, allowing the chains to fall evenly across the doorway, screening it and checking the entrance of too much cold air and the escape of heat. Aside from its economical feature, the chain door protects the fireman by shielding him from intense temperatures. It is intended to be used with practically all kinds of furnaces.

LATTICE BABY INCLOSURE LIGHT AND FLEXIBLE

Designed so that it may be used in a number of different ways, a collapsible fencing has been invented which performs a serviceable function for those who have small children to raise. It is made of light, horizontal slats and

divided into eight sections, all being flexibly connected. When used on a lawn, for instance, it may be set to form an octagonal corral, inside of

HUGE SIZE OF PRESENT WAR SHOWN BY STATISTICS 225

Figures which show in a striking manner the titanic proportions of the European war have recently been compiled in Germany. According to these statistics there are some 21,770,000 men engaged in the land and sea operations. Of this number it is estimated that 12,820,000 are enlisted on the side of the allies, and 8,950,000 on that of Germany, Austria, and Turkey. The population of the two hostile alliances is approximately 800,000,000 for the former, as against 150,000,000 for the latter.

The daily expense of the conflict at the present time is computed to aggregate approximately \$42,250,000, while the amount expended prior to last April is set at \$10,000,000,000. Excluding Italy from consideration, the annual cost of such a war would exceed \$15,000,000,000. If this amount were represented in German 1,000-mark bank notes placed one on top of the other, the stack, it is estimated, would extend to a height of about 20,000 feet, or approximately 400 yards less than four miles.

HORNS CLEAR STREETS FOR FIRE DEPARTMENT 73

To provide a quick and reliable means of clearing the streets for the fire department, the city of Pittsfield, Mass., has installed electric siren horns above the fire-alarm boxes along the principal thoroughfares. The horns are connected with each other by an independent circuit and are also connected with the regular fire-alarm circuit in such a manner that when an alarm is turned in from any box, the horn above that box and all those between the box and the central station will start blowing and will continue to blow until the apparatus is replaced in inoperative position, or the current is switched off at the central station. Forming part of the mechanism of the ordinary fire-alarm box is a wheel that bears against a contact bar, and through this contact

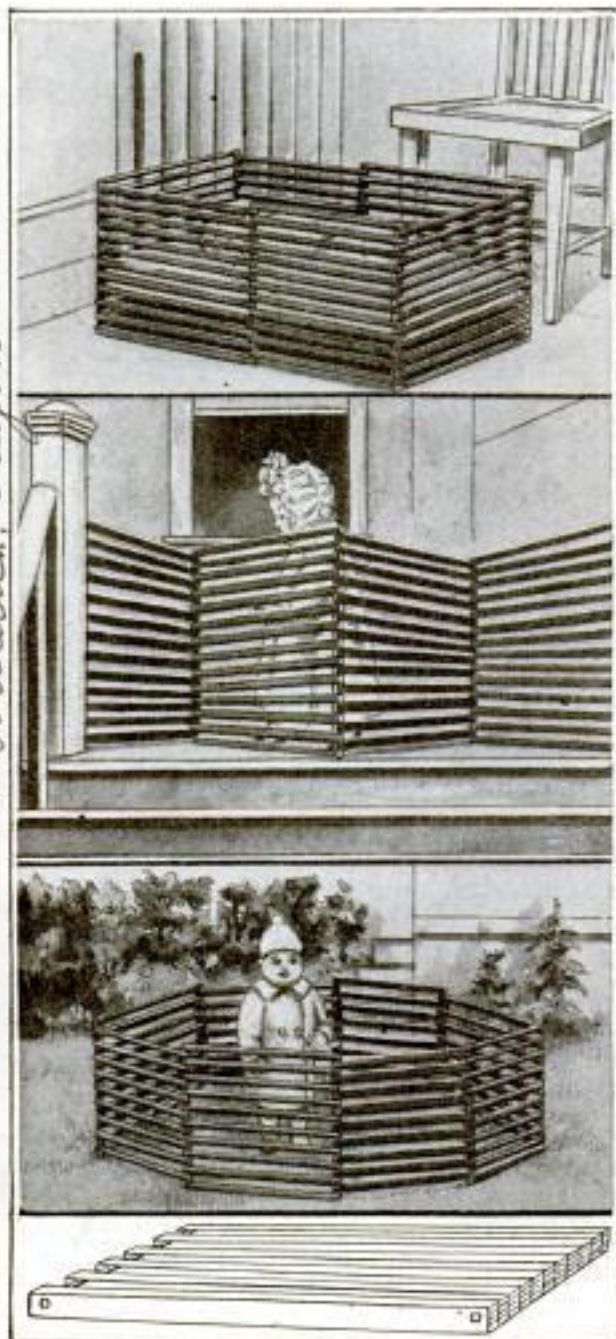

The Flexibly Jointed Latticework may be Used in Many Ways to Protect a Baby from being Injured When Left Alone

which a baby is in no danger of being hurt if left alone. The device may be straightened out and set across a porch entrance to safeguard a child from falling down a series of steps, or it may be used to guard a grate. When folded it is only 2 ft. long, 21 in. high, and 3 in. thick, and may easily be carried in a trunk when traveling.

Boardman Mfg. Co.
84 N. Broadway, Portland, Oregon.

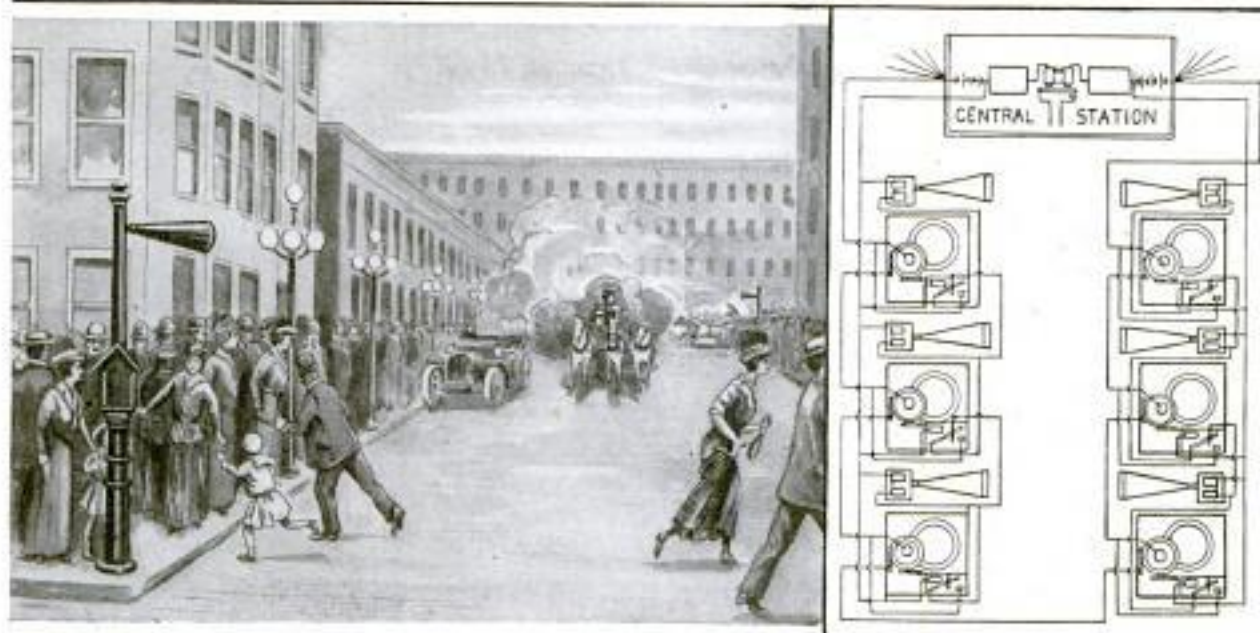

How the Streets of Pittsfield, Mass., are Cleared for the Fire Department by Electric Siren Horns; Electric Connection of Horns with Central Station Shown by Diagram at Right

electric current flows constantly. When an alarm is turned in this wheel makes one revolution. On the rim of the wheel are notches that break the circuit in a certain series, and in this way the number of the box is signaled through the action of a whistle magnet located in the central station. For operating the horns this wheel is provided with a lug which, as the wheel revolves, contacts with a second bar, closing a circuit that energizes a magnet located within the box. Through the action of this magnet a drop bar is released and the free end falls on a stud, closing a circuit that sets the horns to blowing. With the apparatus in this position there is nothing to prevent additional alarms from being turned in from the same box. The drop bar is restored to its original position by an attendant.

I make

KIT FOR TREATING BITE OF POISONOUS REPTILES

A handy pocket kit for travelers and hunters, that contains the means for the immediate treatment of the bite of the rattlesnake or tarantula or the sting of the scorpion, has been placed on the market by a California druggist. The case in which the drugs are carried is made of nickelplated metal and is of

such a size as to fit in the upper vest pocket. The outfit contains a hypodermic syringe, bottles in which are sterilized water and permanganate of potash, and other antidotes for injection in the wound; tablets for internal use for stimulating the action of the heart, and a ligature. The drugs are said to be such as are used for treat-

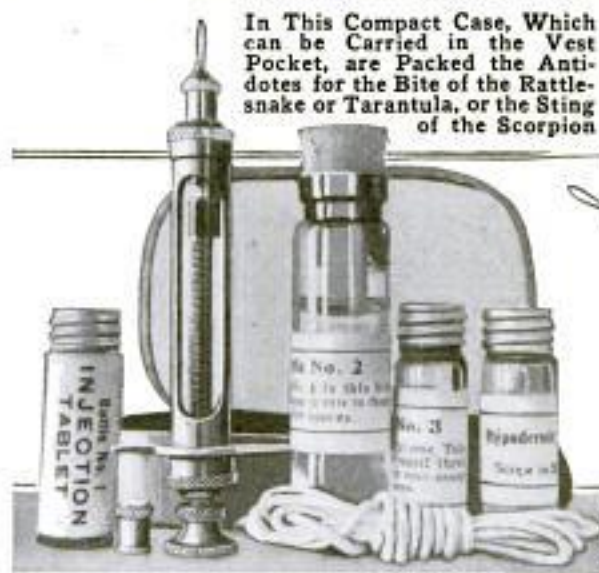

In This Compact Case, Which can be Carried in the Vest Pocket, are Packed the Antidotes for the Bite of the Rattlesnake or Tarantula, or the Sting of the Scorpion

ment by the best physicians. On the inner side of the lid of the case are full directions for using the remedies.

Large numbers of American motor cycles are being shipped abroad for military purposes. One domestic company has an order for 3,000 machines.

*cont: J. Bassett, 2768 Columbia St., San Diego, Calif.
Mfr: Monarch Drug Co. Inc., San Diego, Calif.*

WHERE THE CHILDREN GO TO SCHOOL ON SKIS

Florence L. Clark, Bozeman, Mont.

The children of the hay ranchers who live in the highest altitudes of the Gal-

practically the whole of the school year. With the exception of a few weeks in summer, the mountain trails leading from the cabin homes to the schoolhouse among the pines are covered with snow, and much of the time the snow is so deep that the children can touch the telephone lines. The trails are kept marked continually by willow twigs stuck in the snow, these being renewed after each snowstorm. The children have been taught to throw themselves face down on the snow and to lie still until the blast has passed as a protection against



Montana Children Who Go to School the Greater Part of the Year on Skis

latin National Forest in western Montana go to school on skis during

the winds that sometimes sweep suddenly down from the mountain peaks.

NOVEL POWER INSTALLATION FOR SAILING YACHTS

For use on a sailing yacht, an auxiliary power plant has been designed which may be installed without requir-

ing either internal or external alterations of the vessel. The plan is being used successfully on an English craft and is apparently both economical and efficient. In this particular case, a 35-hp. internal-combustion engine is installed on the deck and concealed by a teak case. A reinforced rubber hose, fitted with a weight and suction rose at one end, extends overboard and supplies a continuous circulation of water for cooling the motor, while a flexible copper tubing carries off the exhaust gases. The propeller shaft is installed in outboard fashion at the side of the vessel, extending from the deck into the water. It is incased in a tube and connected at the deck end

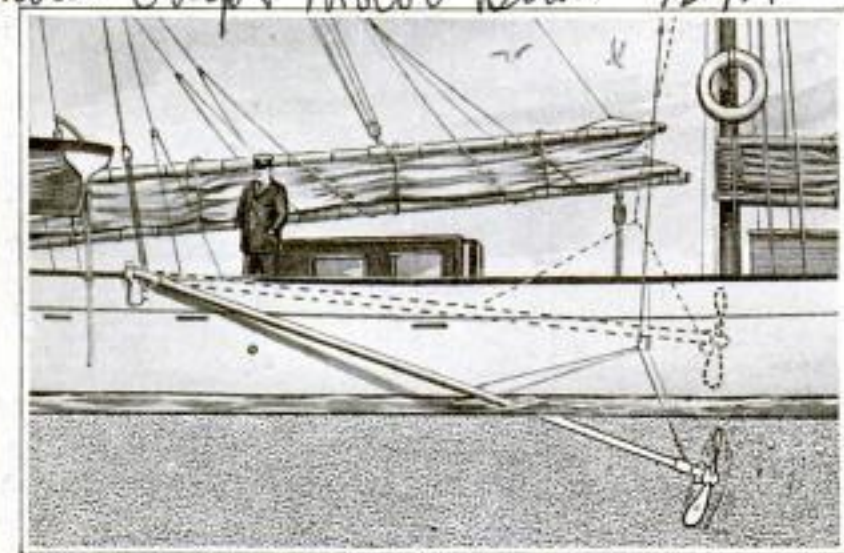

By Extending the Propulsion Shaft over One Side of the Yacht, Alterations are Avoided

275

to a cross shaft reaching from the engine. This latter shaft is supplied with a universal joint, while the gear casing is mounted on a swivel bracket over the side of the vessel. The propeller shaft may readily be raised from the water or lowered into it as desired. The yacht on which this installation has been made is the "Arminel," a 74-ft. craft with a 10-ft. draft. With a three-blade, 31-in. propeller the motor drives the vessel at a rate of about seven miles an hour.

CAMERA SPECIALLY MOUNTED FOR SURGICAL PURPOSES

To simplify the work of taking photographs of important surgical operations performed in a Michigan sanitarium, an ingenious plan has been adopted which obviates the difficulty encountered when adequate facilities are lacking. A stereoscopic camera has been mounted on a vertical rod extending down from a chandelier immediately above the operating table. The lens is permanently focused so that preliminary adjustments are not required before making an exposure. A plate is always kept in the instrument and when a surgeon wishes to have a picture taken an attendant merely presses the bulb and the work is done.

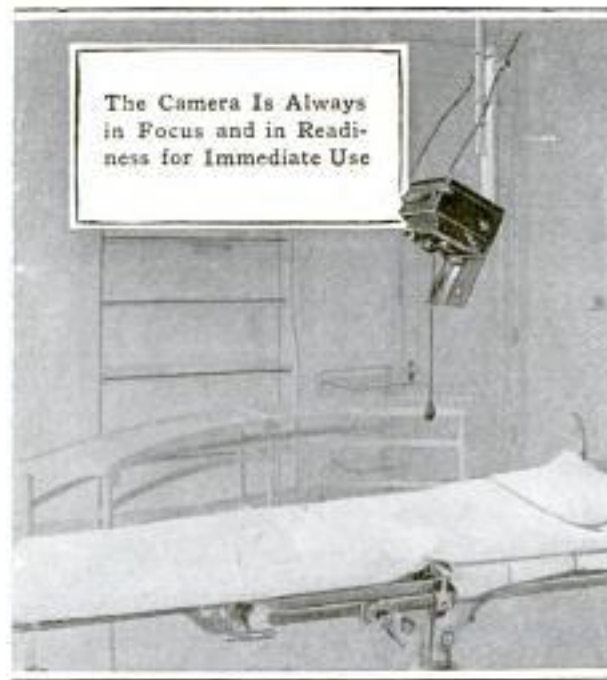

COMBINATION TRENCH TOOL SERVES MANY FUNCTIONS

Several different implements are embodied in a combination intrenching tool which has been devised by a Cin-



The Intrenching Tool and Several of the Ways in Which It may be Used

cinnati inventor. It is slightly less than three feet in length and is not excessively heavy. At one end is a detachable trench shovel that is held securely in place by means of a large thumbscrew. By removing this, the steel plate may be utilized as an abdomen shield, or as a head protection when firing from a prostrate position before "digging in." A substantial saw is fixed in the handle like a blade of a pocketknife. When the shovel is removed this may be unfolded and used freely. At the opposite end of the tool is an ax and adz. When not in use, according to the inventor's idea, the device would be carried assembled and strapped to a soldier's belt.

Correspondents report that Germany is using a transparent material made of cellulose and acetic acid as a covering for aeroplane wings which renders the machine practically invisible at a height of 3,000 feet.

cont: Roe S. Eastman, The Times-Star, Cincinnati, Ohio.
 Inventor: F. Stiney, 115 W. Elder St., Cincinnati, Ohio.

218
 Anton Samoil, Battle Creek, Mich.
 cont:

168 Construction

TELEPHONE REPAIR TRUCK
CONVENIENTLY ARRANGED

In order to save the time ordinarily wasted by linemen in searching for their tools and materials, a telephone

truck is provided on the opposite side. At the rear are compartments for telephone instruments, a folding ladder, and rolls of wire. The machine is designed to hold an adequate supply of material for an average day's work and is intended to be restocked each night.

371

GARY PLAN OF INSTRUCTION
USED AT MINING COLLEGE

Through an application of the fundamental principles governing the Gary, Ind., system of education, the College of Mines of the University of Arizona is accomplishing a very interesting work.

The institution is situated in the midst of one of the greatest mining regions in the United States, which makes the plan of combining theory and practice possible. Three days of each week the students devote their time to laboratory and class work, while the remaining days are spent in the large mills, mines and smelters situated at different points in the surrounding territory. Cyanidation is

studied at Pearce, Tombstone, and Wickenburg, where at each place a different application of the process is employed. Practical instruction in smelting is given in plants at Douglas, Hayden, and Globe, while mining itself is studied at Bisbee, Ray, Globe, and Miami, where in the

hundreds of miles of underground works many technical problems of mining engineering are encountered. Ore dressing and similar subjects are taken up at some of these same points. The plan has been found to be of great value to the student, for he not only lives in the atmosphere of the industry, but is brought into contact with successful miners and is also able to specialize in problems peculiar to different companies, thus making himself valuable when his college training is finished.

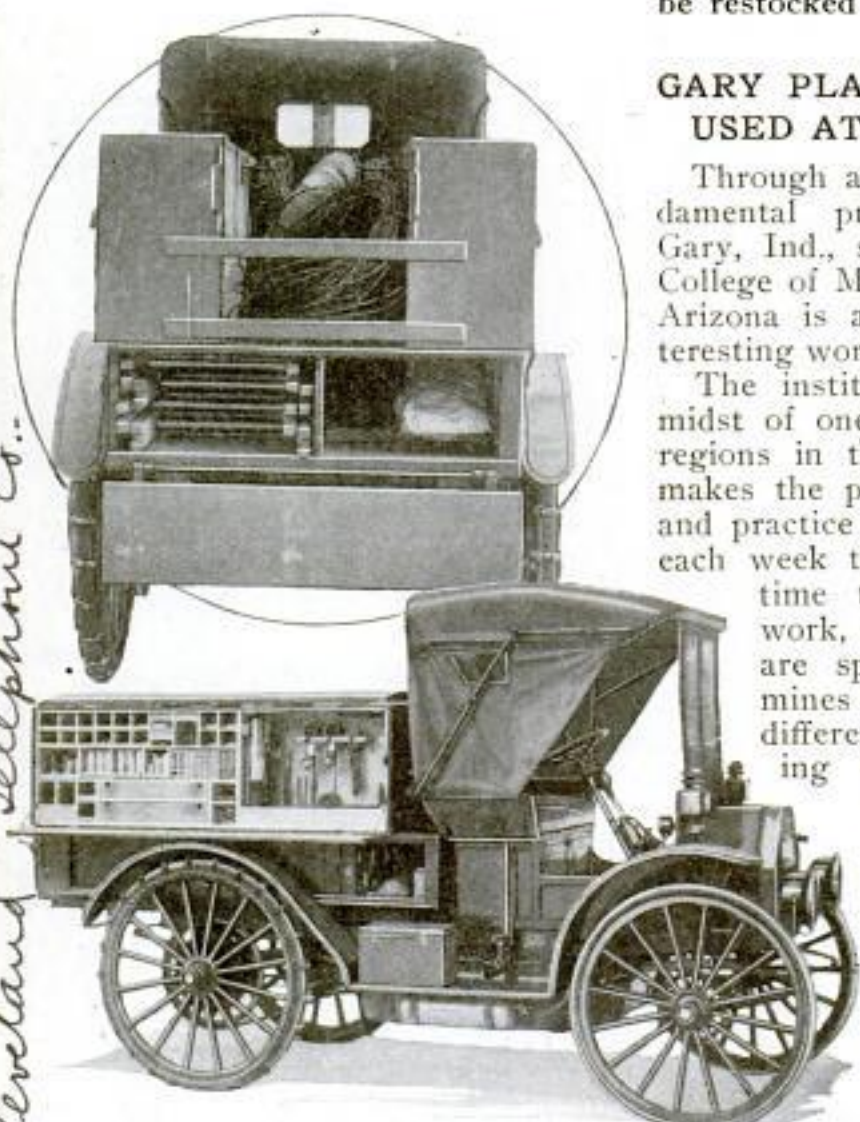

Compartments are Provided for Everything, so Time is Not Lost in Searching for Materials and Tools

Used by company at Cleveland, Ohio, has constructed a repair truck with a specially designed body. This is divided into a series of compartments which offer individual spaces in which to carry the supplies and tools needed on average work. It is arranged as conveniently as a kitchen cabinet, and permits ready access to everything carried. Things most frequently needed are arranged in compartments on the right side of the machine, while spaces for rubber coats, boots, linemen's spurs, lanterns, torches, and similar things, are pro-

Cont: A. J. Spangler, 1305 W. 85 St. Cleveland, Ohio.

Cleveland Telephone Co.

University of Arizona



FOUR YEARS

in the

NAVY

PART II

THE BLUEJACKET ON
THE BATTLESHIP

by

LOUIS E. BROWNE

ON shipboard, reveille is at 5 a. m., when the master-at-arms—a battleship's policeman—"turns out" all bluejackets except those on watch during the night. An oaken barrel stave, whacked against the bottom of a sailor's hammock is the navy's alarm clock. In warm weather, many men sleep in the open air. A hammock contains a mattress and two heavy blankets—the sailor uses neither pajamas nor sheets. In the daytime, hammocks are rolled up and stowed in the nettings below decks. Warm, fresh water is portioned out in buckets and the men flock to the wash rooms and sheltered corners of the open deck to bathe. Many use the salt-water shower baths.

Decks are wet down, sanded and scrubbed; bright work is cleaned and, as each man has a small portion of the ship to keep clean, everything is ship-shape by 7:30, when breakfast consisting of cereal, meat, potatoes, fruit, hot bread, and coffee is served.

The galley and bakeshop, where all food is prepared, are above decks and open to the air on all sides. Ten men sit at a table, which when not in use is folded and suspended overhead. One "mess cook," or waiter, is provided for each table. The men may purchase delicacies such as pickles, jam, and cookies from the ship's canteen.

At 9:15 all go to quarters, when officers inspect their divisions. For 20 minutes all perform physical drill, which is followed by a wild run about the decks. Then the men don work clothes and go to drill. In turrets, on the signal bridge, and on decks they strive for perfection. No athletic team

in the work is more highly trained than a big-gun crew. Five times a minute, a 1,000-lb. projectile and powder is sent to the turret from the magazine and loaded into the rifle. The drill prepares men for target practice, which is preparation for war. Success brings prize money to the crew. Target practice is to the navy what the world's series is to baseball. Gunnery and engineering competition in the navy has created a fine service spirit. Each crew strives to outdo the others.

There are signal, collision, fire, general-quarters, first-aid drills, and many others. Morning drills are over at 11:30, when the smoking lamp for the crew is lighted. Fifteen minutes later the boatswain pipes mess gear, when the tables are set for dinner—the big meal of the day—which includes soup, chicken or meat, two potatoes, salad, dessert, and coffee. This meal is over at 12:30, when the bugler sounds "school call." Men anxious for promotion gather in the crew's library and under officer instructors study grammar, arithmetic, spelling, and technical subjects. Textbooks of all sorts are handy. Probably 175 men out of a battleship's crew of 900 take advantage of the service's educational offerings. Afternoon drills are over at 3:30, when the bluejacket's time becomes his own. Supper is at six o'clock. Hammocks are swung at 7:30, and all must be retired by "taps," at nine.

Bluejackets scrub and wash their own clothes, hammocks, and bedding. Because of the difficulty of making fresh water from salt water, the men must use sea water.

The day is divided into six parts called watches. Each man is on duty either on the bridge, in the fire room, or on deck about two watches out of the six. The cooks and bakers stand watch about nine hours straight but have "all night in." A sailor has his rest uninterrupted but one night out of four.

Leisure time never hangs heavy upon a bluejacket's hands. He can always stretch full length upon the deck in the sun and "cork off." Cards, checkers, backgammon, and other games, are popular. Boxing is the sailorman's favorite sport, and there is hardly a bluejacket who does not believe himself to be a "white hope." All crews own their own piano, piano player, or phonograph. These, with glee clubs and quartettes, furnish constant entertainment.

Every large ship has a band which plays at noon and during the dinner hour. All bluejackets are adepts at the tango and other fancy dances. At night a large screen is often stretched on the quarter-deck and the ship's motion-picture machine is set up for an hour's entertainment. Each ship crew owns a couple of dozen films which are exchanged with other ships of the fleet.

When in port, ships give smokers to the crews of other ships. Such a treat must always be returned. A stage is erected at the extreme end of the quarter-deck. The rails and masts are brightly illuminated with electric-light bulbs; the officers of the two ships are seated nearest the stage and then in a solid mass come the crews, stretching as far forward as the mainmast. The program is varied—officers often taking part. Singing, glee-club music, dancing, and jokes of which the commanding officer, the admiral, and the younger officers are usually the butts, precede the boxing matches, which are the features. First comes the battle royal. Four men are blindfolded and with tin cups in one hand and pillow-like boxing gloves on the other, take corners in a regulation prize ring. At the word "go" they must advance to

the center, tapping the tin cup on the deck. When they locate one another, by the tapping, they punch—more often missing the mark by several feet than hitting. The winner, the man who remains in the ring longest, gets a prize. Six-round sparring bouts follow.

A race is the big event of the navy. Every ship has a highly trained crew of 10 men upon whom the bluejackets will bet their last dollar. Specially constructed cutters, used as race boats, are fitted with rolling seats and movable ballast. In the center of the cage mast of a battleship there are big cleist weights at which the race-boat crew pulls for two hours every day. In port the crew pulls in the boat. The crew has a training table. The race covers usually two to five miles of open water. During its progress the men flock to the tops and upper works. Excitement runs high, and a battleship's crew will sometimes wager a pool of \$40,000 on its race boat. There are many racing trophies worth trying for, the chief of which is the Battenburg Cup now held by the "Florida."

A lifeboat crew works in an element of chance. When a man falls overboard a marine sentry drops the automatic buoy into the water. The man swims to it. At night it spouts fire—in the daytime dense smoke. The bugler calls away the lifeboat, a flag is hoisted at the fore, and at night a gun is fired. The crew of six men and a coxswain, always standing by, can launch its boat in less than a minute. Lifeboat drills are a regular feature and are held frequently.

A battleship has all sorts of athletic teams—baseball, football, basketball, and track. During the season the teams from various ships hold series for the championship of the fleet. The navy introduced baseball in China. They play wherever they happen to be—Cuba, India, or South America. Coaches are secured from the naval academy and young officers play upon teams with the men.

Many players join the big leagues after leaving the service.

HOW THE SHIP AND ITS CREW ARE KEPT CLEAN

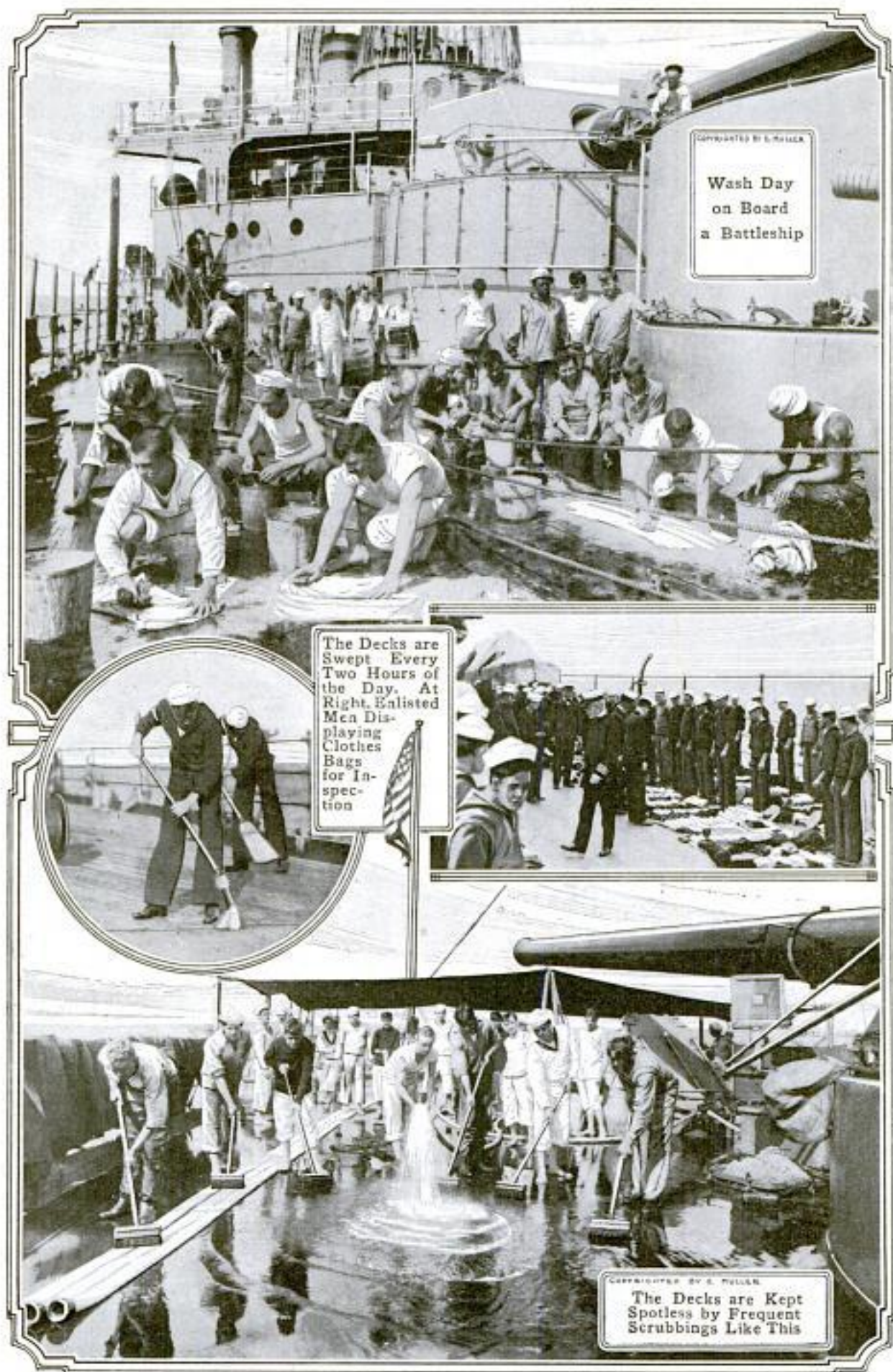

THE DRILLS THAT MAKE THE ENLISTED MEN

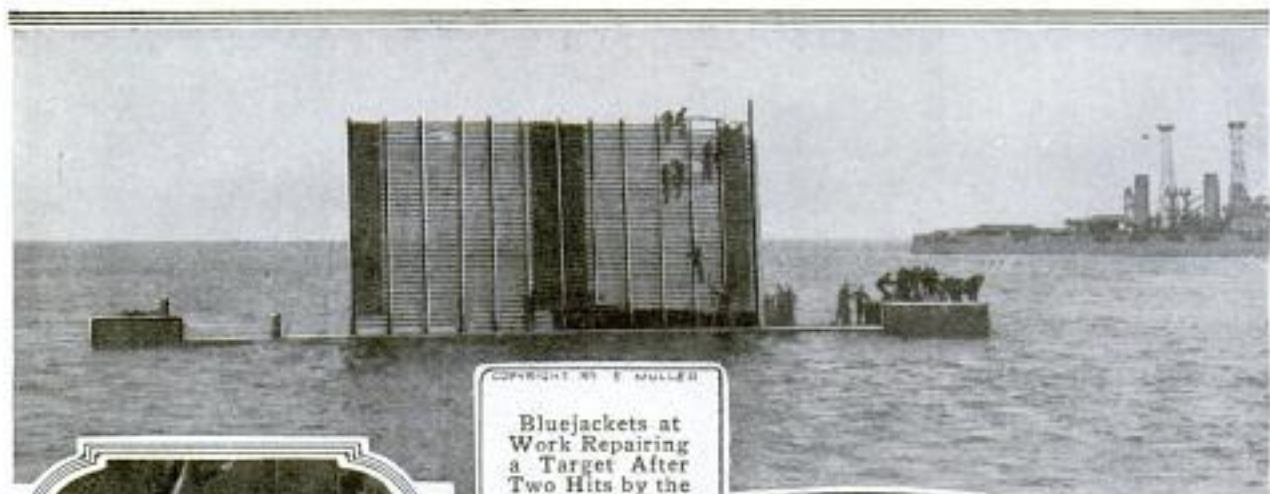

COPYRIGHT BY E. MULLER

Bluejackets at Work Repairing a Target After Two Hits by the "Utah." The Picture Below Shows the Deck of the "Arkansas" with Bluejackets at Their Daily Exercise



UNITED STATES GOVERNMENT INTERNATIONAL NEWS SERVICE



UNITED STATES GOVERNMENT INTERNATIONAL NEWS SERVICE

A Drill in Knotting and Splicing, on the Forecastle Deck of a Battleship. Painting the Hull of the "Wyoming," at Left: The Men Work on Small Scaffolds Slung from the Deck and the Paint is Applied by the Pneumatic Process



UNITED STATES GOVERNMENT INTERNATIONAL NEWS SERVICE
Deck of Cruiser "Chester," When Stationed at Tampico, Prepared for Trouble

PROFICIENT IN SEAMANSHIP AND FIGHTING

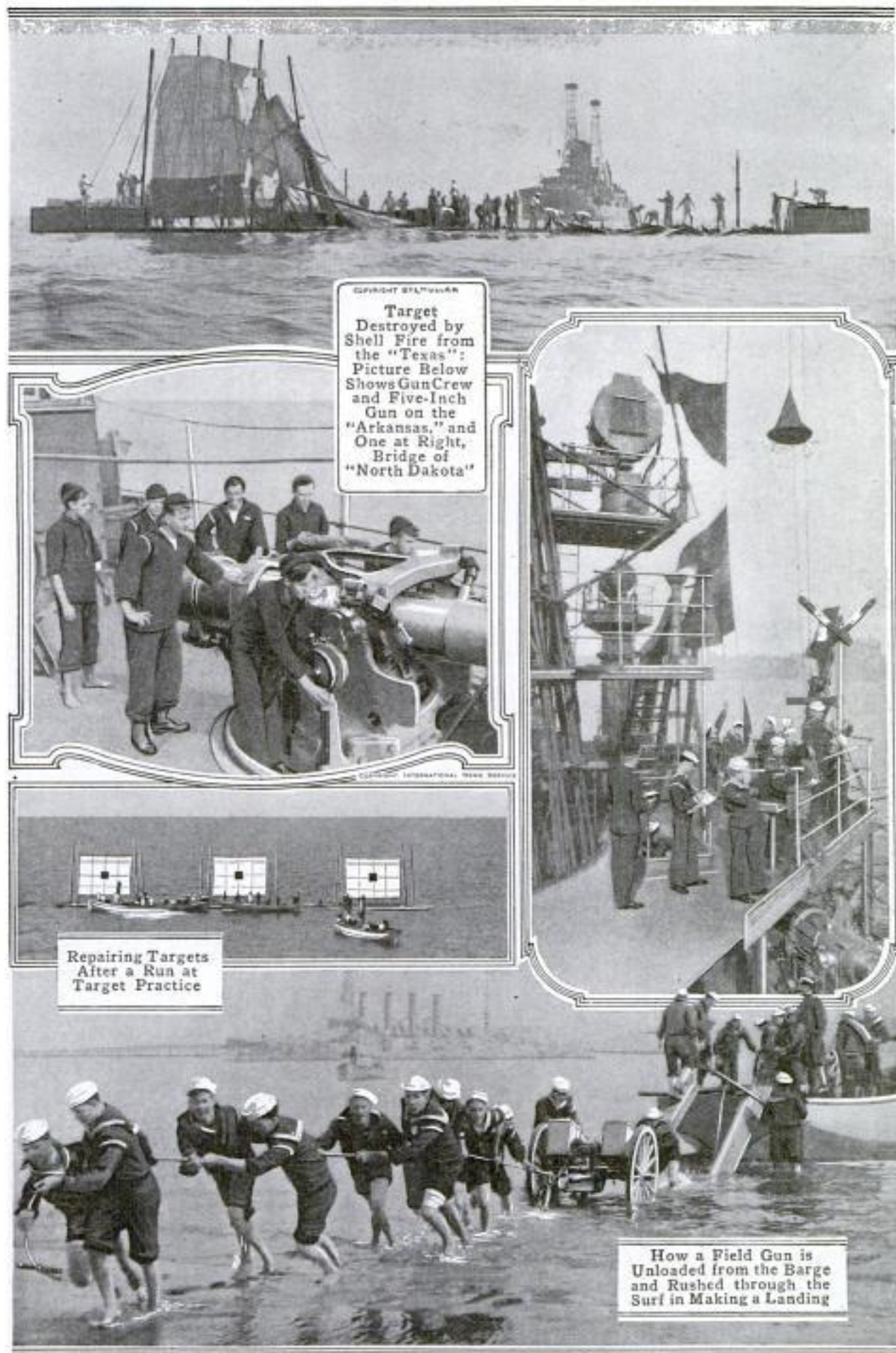

COPYRIGHT BY TULLOCH

Target Destroyed by Shell Fire from the "Texas": Picture Below Shows Gun Crew and Five-Inch Gun on the "Arkansas," and One at Right, Bridge of "North Dakota"

Repairing Targets After a Run at Target Practice

How a Field Gun is Unloaded from the Barge and Rushed through the Surf in Making a Landing

HOW THE "MESS" IS PREPARED AND SERVED



Following Reveille, which is sounded at 5 a. m., the Bluejackets are kept busy putting the ship in order until 7:30. When breakfast is served. The picture at the left shows the kind of tables and benches used; while the one below shows the Bluejackets at breakfast. Ten men eat at each table.

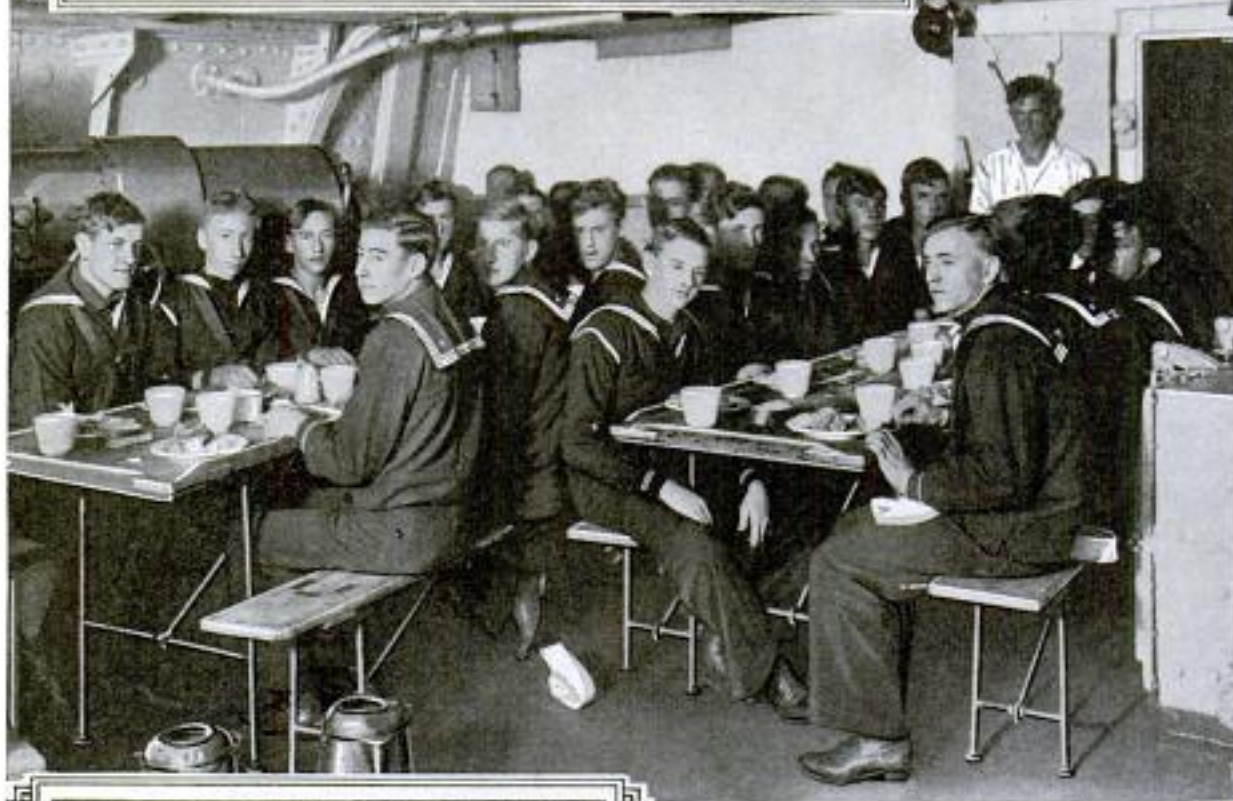

The Galley and Bakeshop, where all food is prepared, are located above deck and are open to the air on all sides. At the right is shown a Thanksgiving dinner ready to be taken from the ovens, while the picture above shows Bluejackets at work peeling onions for the next day's hash.

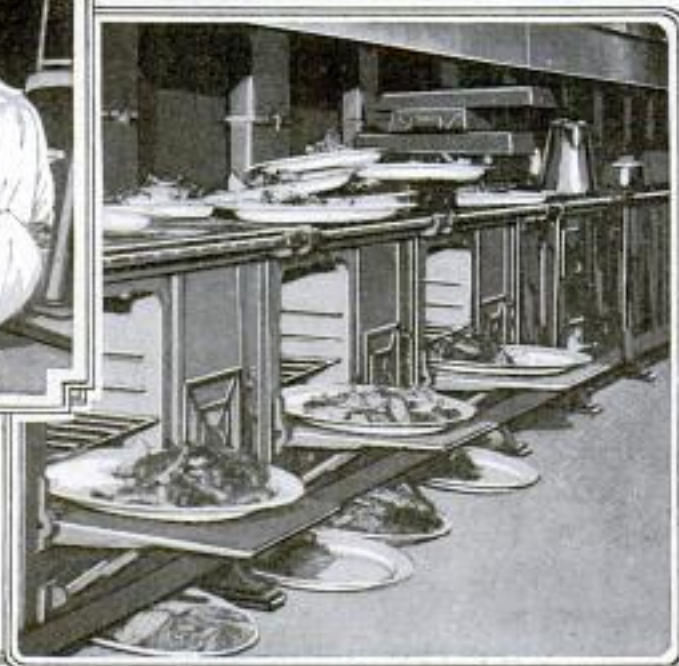

SCHOOL WORK AND DISCIPLINARY BARRACKS



COPYRIGHT,
F. H. NOWELL

When an Enlisted Man Commits an Offense That Merits Severe Punishment but Is Not Serious Enough to Warrant a Prison Sentence He is Sent to the Disciplinary Barracks. Here, in an Attempt to Mold Him into a Better Man Before He is Returned to the Service, He is Sent to School and is Subjected to Constant Drills. This Picture Shows a Squad at the Puget Sound Disciplinary Barracks Drilling with a Torpedo-Defense Gun

Below: Squad at the Disciplinary Barracks Drilling in the "Hollow Square," a Formation of Vital Importance When a Small Body of Troops is Attacked from All Sides. The Picture at the Right Shows a Class in Arithmetic on Board the Battleship "Tennessee." School Work Forms Part of the Daily Routine for the Enlisted Men during the First Two Years of Enlistment

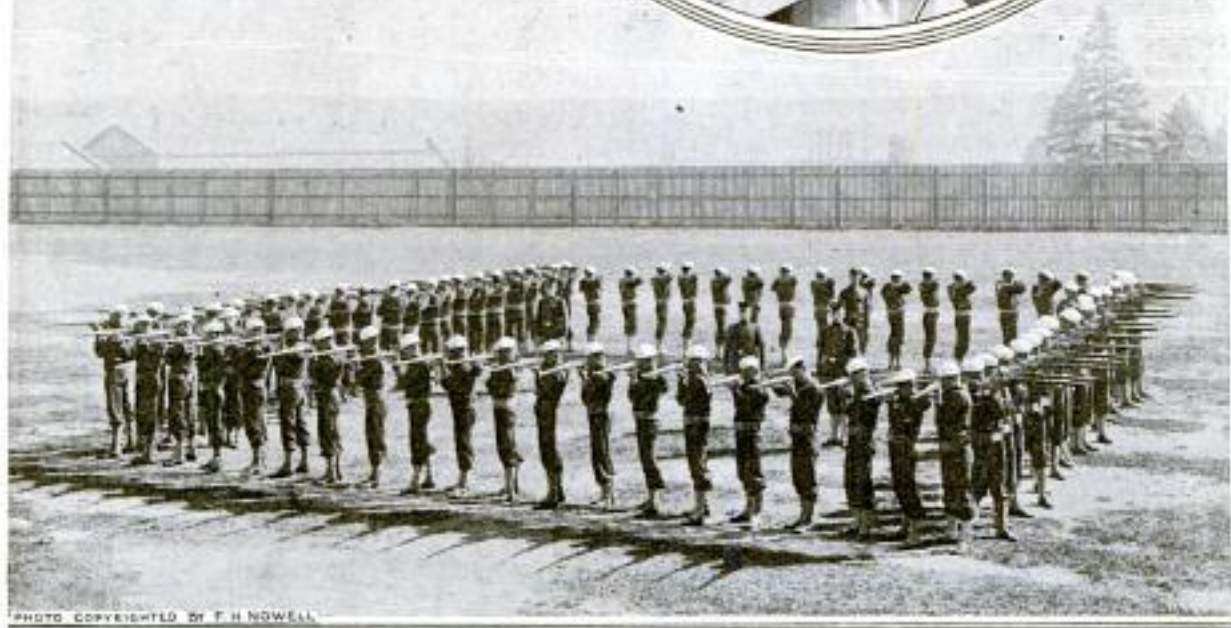

PHOTO COPYRIGHTED BY F. H. NOWELL

WHAT THE ENLISTED MAN DOES WHEN OFF DUTY



The Bluejacket Has Access to Literature of All Types

Many of the Battleships are Provided with Pool Tables: The One Shown at the Right is Installed on the Gun Deck of the "Wyoming"



Racing Crew of the Dreadnaught "Florida" Returning to the Ship after Winning the Battenburg Cup in a Hotly Contested Race



Above:
"Good Night"
Below: Going Ashore
Right: "Stag"
Dance on the Deck



217

9723

**MOVEMENT TOWARD BREVITY
IN BUSINESS LETTERS**

According to advices from the American ambassador at Berlin, many commercial houses in Germany are abolishing the practice of employing "unnecessary terms of politeness" in their business correspondence. Introductory phrases such as "Gentlemen," "Dear Sir," and "Sir," as well as "Yours truly" and similar concluding terms, are being dropped. Certain companies go so far as to attach printed slips to their letters explaining, "Following the example of other firms, I also omit from my business letters the unnecessary terms of politeness, as well as assurances of self-evident esteem. I request that you reciprocate in your correspondence with me."

**CONVENIENT PLATFORM USED
BY SIGNPOST PAINTERS**

In repainting warning signs at crossings along a railroad right of way, a portable platform is used instead of ladders and scaffolds by employes of an eastern company. It is approximately eight feet in length and is secured to a signpost by a simple wedging arrangement. The flooring is built on an arm, one end of which is extended so as to fit about three sides of a square post. When this is put in place a heavy bolt is pushed through holes in the two steel-reinforced planks, and the platform is raised to the desired height. A wedge is then driven between the bolt and the post, holding the device firmly in place.



**MINIATURE ELECTRIC MOTOR
DRIVES DENTAL DRILL**

One of the smallest electric motors that has ever been developed for general commercial purposes is being used in connection with a dental drill of new design. The purpose of the drill is to replace the bulky apparatus commonly used. The motor, which weighs only 5 1/4 oz., has a diameter of 1 1/4 in. and a length of 1 3/4 in. It normally operates at a speed of 15,000 revolutions a minute and may be driven by either an alternating or direct current. A control switch which may be operated conveniently by a finger is mounted on the motor. While it has been built particularly for dental purposes, it may also be used wherever a self-contained, hand-held and controlled power device is needed for driving a light instrument.

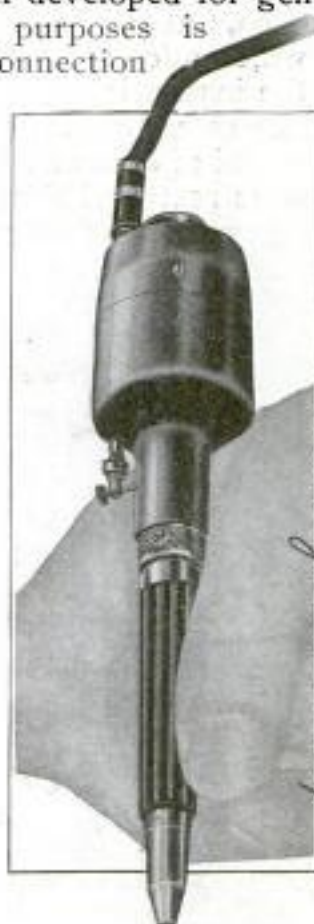

**BIG CLOCK TRIPLES SPEED
AFTER DELUGE OF RAIN**

Following a heavy rain at Springfield, Mass., recently, a large clock in the municipal building developed uncommon speed in the downward trip of the big hand from 6 to 6:30 p. m. In moving from the hour to the half-hour points on the dial the indicator covered the distance in approximately 10 minutes. Investigation disclosed that the hand, which is hollow, had been filled with water during the storm. This additional weight was the cause of the trouble.

Wally Concellan's Report
6/30/15
151
1801 East 93rd Street,
Cleveland, Ohio

Mfr: Shelton Electric Co.
30 East 42 Street
New York City

Henry H. Bessie's
24 Commonwealth Ave.
Boston, Mass.

BIG TREES ARE PRESERVED IN PLANNING CAMPUS

76 In designing the campus of the Throop College of Technology at Pasadena, Cal., the architects devised a plan which allows the various buildings of the institution to be grouped symmetrically without necessitating the removal of even one of some 40 large oak trees scattered about the grounds. As a result, the new campus, when com-

pleted, will have the advantage of being shaded by full-grown trees at the outset, while from a landscaping viewpoint the arrangement fortunately will be as harmonious as if the buildings had first been built and the grounds then planted with young trees.

In designing the structures, which are of Spanish architecture and grouped to form a large court, airy arcades and broad, overhanging eaves have been provided along the front sides so that the students will be able to pass between the various buildings without inconvenience during the rainy season. The central building, which houses the administration offices and is now in use, has a large dome. Instead of allowing the space beneath this, which is excellently lighted, to be wasted, the place has been utilized for the college library. Bookshelves are placed around the wall and an octagonal study table set in the middle of the room.

⊕ Glass containers for screws, nails, hinges, and other small supplies are coming into general use in the workshops of London.

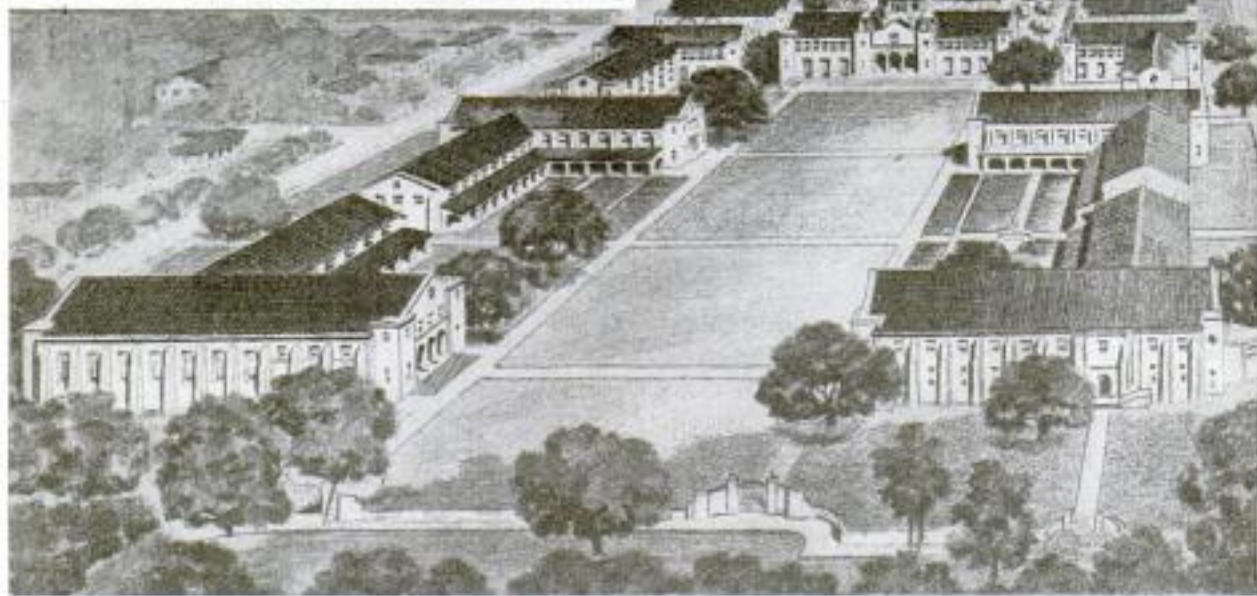

Instead of Allowing the Space Beneath the Dome to be Wasted, the Circular Room has been Devoted to the College Library. The Lower View Shows How the Buildings were Planned to Preserve 40 Oak Trees

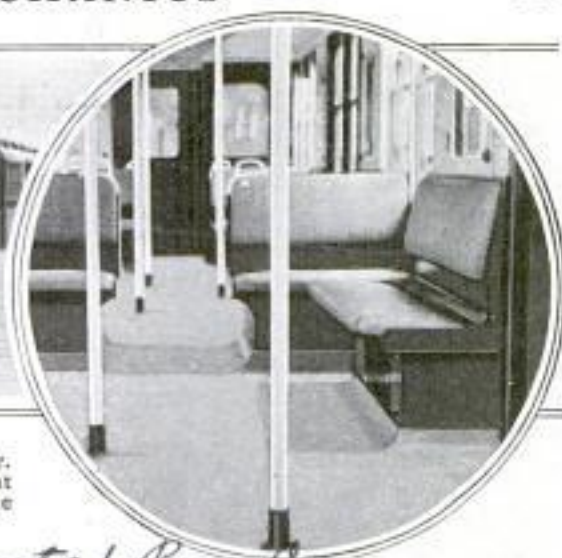
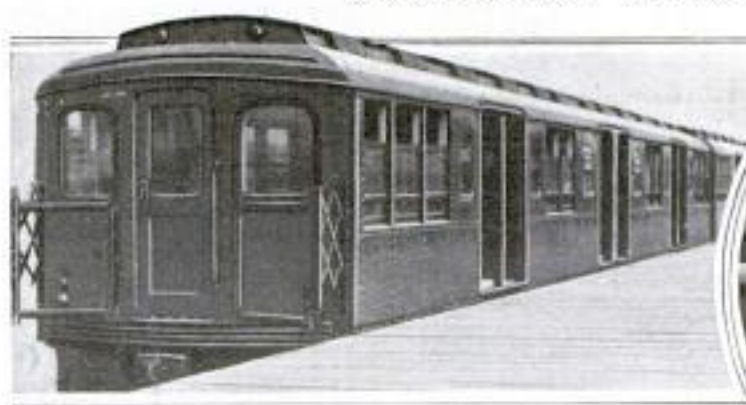

Three Double Doors are Arranged on Each Side of a Car. The Right-Hand View Shows the Design of the New Seat Which has been Adopted; Cement Floors and White Enamel Make the Cars Easy to Clean

Used by New York Consolidated Ry. Co.
CARS OF NEW DESIGN BUILT
FOR GOTHAM SUBWAYS

183 Cars larger and better than those heretofore operated and embodying various features for safety, comfort, and sanitation, are being placed in service in the New York subways. They are of steel construction and built a foot wider and 16 ft. longer than former cars, providing seating capacity for 78 persons and auxiliary accommodations for a score more.

The interior of the cars is finished in white enamel. The floor is made of a cement composition which allows it to be flushed and thoroughly washed at the end of a run. Posts replace the proverbial straps, while the seats are especially designed for comfort. In making these, the measurements of a large number of persons were taken in order to determine a pattern which would best suit the requirements of the average New Yorker.

Platforms have been eliminated. Three double doors, facilitating the loading and unloading, are arranged on each side. These are operated electrically and controlled by a guard stationed at the middle entrance. A train cannot be started until each door is closed and locked, at which time the motorman is signaled automatically. An emergency lighting system, receiving current from storage batteries, is put in operation when contact with the third rail is broken or the regular power temporarily cut off.

So as to stop the trains more uni-

formly, two brake shoes are used on each wheel. The braking power is regulated proportionately to the passenger load. The power can be cut off and the air brakes applied by a guard in any car, should an emergency arise. The operating lever on the controller is so built that a train stops in case a motorman for any reason takes his hand from it.

118
MACADAM STREETS WASHED TO REMOVE DUST

Ordinary sprinkling failed in allaying the dust on the macadamized thoroughfares of Dundas, Ont., and, instead of having them oiled, the municipal fire department was assigned the task of thoroughly washing them. The streets were followed from end to end, and heavy streams of water played



Firemen Washing the Macadam Streets of Ontario Town to Remove the Dust

Cont: R. Dymond, Box 129, Dundas, Ont., Canada

upon them until the silt had been deposited in the gutters, or carried into the sewers. Although much of the surface material, which might have been saved by a binder of some kind, was in this way wasted, the roads nevertheless were cleaned.

SINGLE-UNIT POWER SAW FOR CRATE MAKING

Designed especially for installation in shipping rooms, a self-contained,



The Saw may be Suspended from an Overhead Beam and Used in Limited Space

power swing saw has been devised which is intended for cutting crating materials, and doing similar work. The compactness of the apparatus enables it to be fitted to an overhead beam in some out-of-the-way corner, when working space is cramped. It is made in a single unit with an electric motor

mounted at the top of the cast-iron saw frame. The arm of this latter member mounts a rotary saw and guard at its lower end and is encircled by the driving belt leading from the motor. The device is counterbalanced so that it automatically returns to its normal position and cuts off the current when not in use.

POLO-PONIES COMMUTERS AT SAN FRANCISCO

Commuter service between the polo grounds and San Mateo was established for the ponies taking part in the tournament held recently at San Francisco. This was made necessary because adequate room and facilities were lacking at the grounds for the care of all of the animals participating in the event. At San Mateo, 20 miles away, the accommodations were available, however, and this led to the practice of shipping the ponies back and forth night and morning. For this purpose an all-steel car, divided into individual stalls, was used.

CARLOADS OF EXPLOSIVE USED IN SINGLE BLAST

What is believed to have been the greatest single blast that has ever been fired, was touched off recently at the quarry of a Pacific coast cement works. Fifty-eight tons of explosive was used to loosen approximately 400,000 tons of rock on the face of a hill.

Instead of planting the powder in ordinary drill holes, it was placed by tunneling through from the rear of the

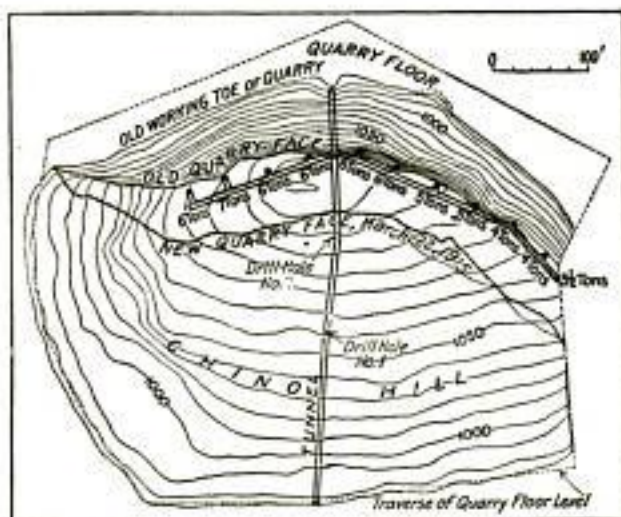

COURTESY OF ENGINEERING NEWS

Manner in Which a Quarry was Mined with 58 Tons of Explosive, Which was Fired in One Blast

hill and extending drifts on either side of the main bore to parallel the face of the quarry. The various mines were

10
The Revs-Kaetker Electric Co.,
610 Baymiller St., Cincinnati, Ohio.

W. W. Cook,
327 Mc Donough St., Brooklyn, N.Y.

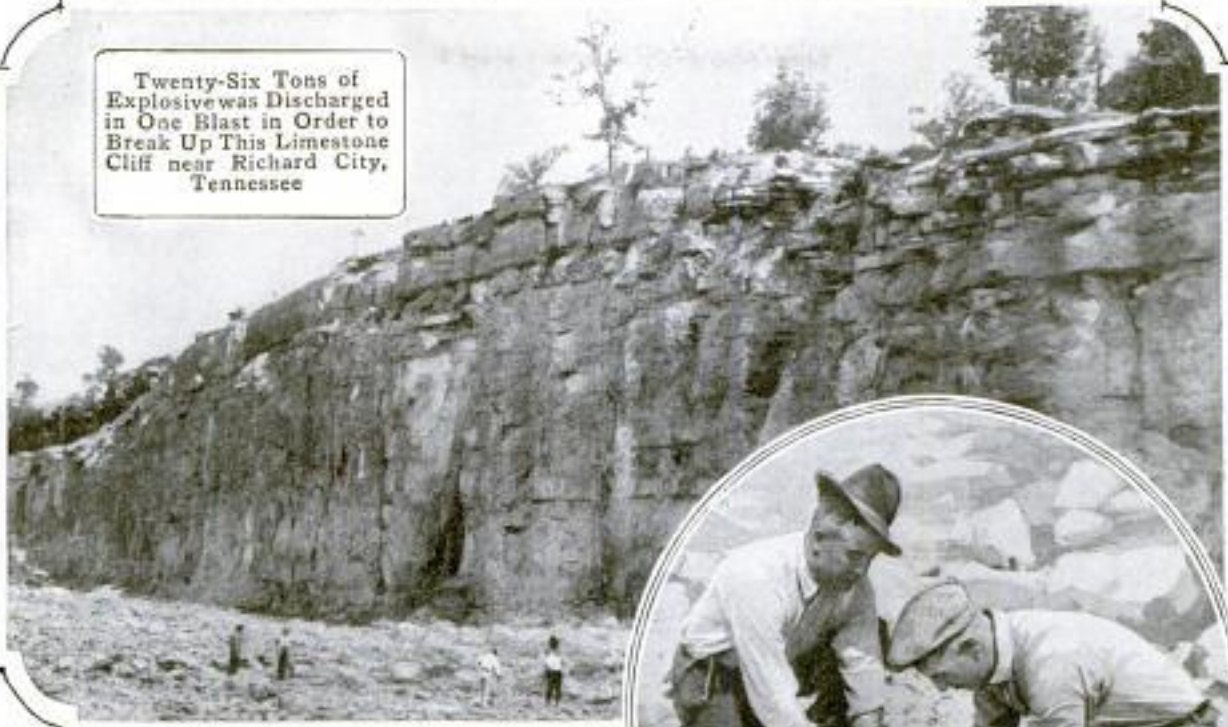

Twenty-Six Tons of Explosive was Discharged in One Blast in Order to Break Up This Limestone Cliff near Richard City, Tennessee



Laying the Fuse to Touch Off Simultaneously 54 Charges of Explosive

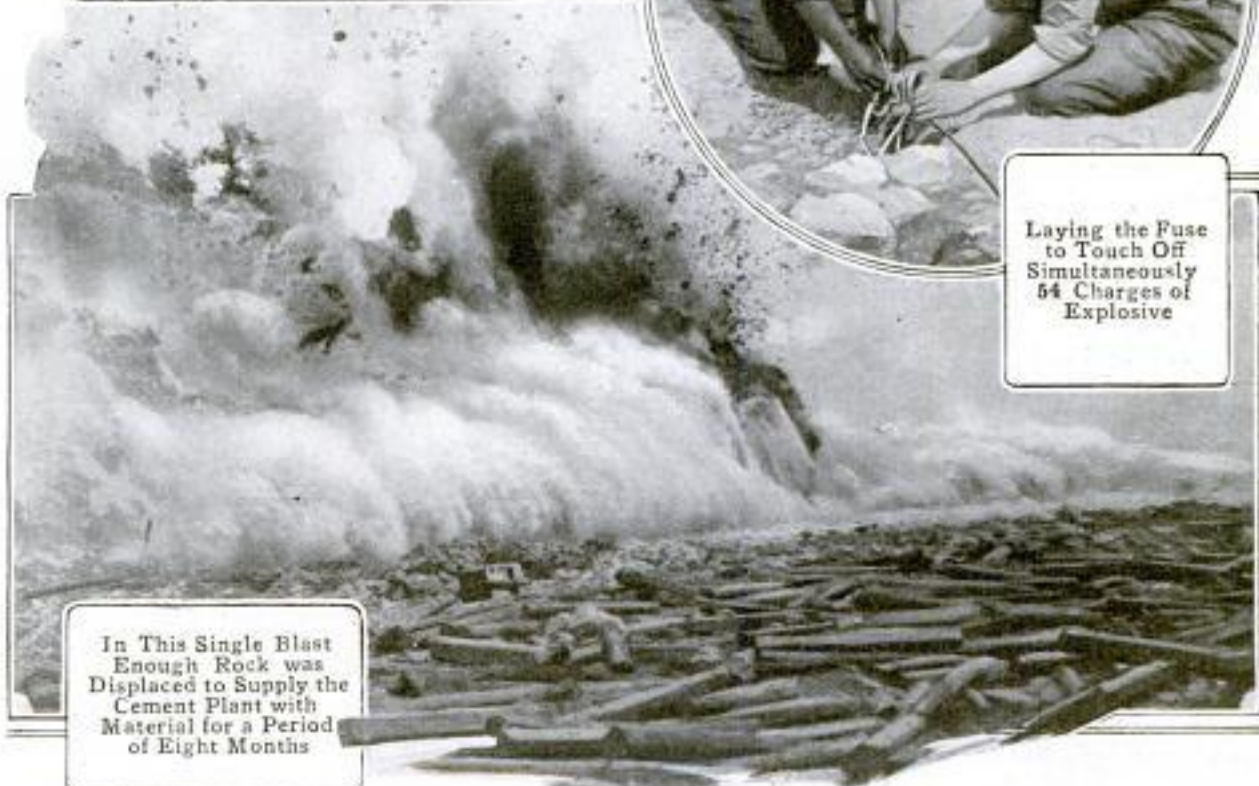

In This Single Blast Enough Rock was Displaced to Supply the Cement Plant with Material for a Period of Eight Months

then placed at intervals of a number of yards along the drifts, the individual charges varying in size from $3\frac{1}{2}$ to 7 tons each. Contrary to what might have been expected, there was little vibration and noise attending the discharge.

Another blast, thought to have been second only to the aforementioned one, was set off by a cement company at

Richard City, Tenn., in order to break up a large limestone cliff which was being worked. There, 26 tons of explosive was employed and approximately 300,000 tons of rock—enough to keep the plant supplied for eight months—opened up. In this instance, however, 54 drill holes, each about 100 ft. in depth, were bored into the cliff to receive the charges.



Fishing Stages on the Shore
of a Small Bay on
Newfoundland's Coast

FISHING STAGES ON COAST OF NEWFOUNDLAND

Along the rugged coast of Newfoundland, where the rock cliffs verge upon the perpendicular, it is not an infrequent sight to see an extensive latticework of fishing stages. These frameworks, made principally of poles

and in many instances appearing crude in construction, are provided in order that incoming fishermen may have places on which to throw their catches when they draw up their boats. Above the stages there are ordinarily a number of small shacks where fish are cleaned, prepared for shipment, and packed for export.

TEAM OF HOGS IS DRIVEN THROUGH CITY STREETS

As curious a turnout as has probably ever been seen on any thoroughfare, a four-hog team drawing a light wagon, recently attracted attention when it appeared in one of the business streets

at Lewiston, Ida., during the course of a celebration. The odd draft animals were well fitted in specially made harness and hitched in the same manner as are horses. As an added touch of the unusual, the hogs are not of the common breed, but have uncloven hoofs shaped like those of a mule. In other particulars, however, they are quite of the ordinary appearance. It is said that the animals are well trained and drive nicely, although intermittently they are apt to do considerable squealing, to the amusement of the crowds.

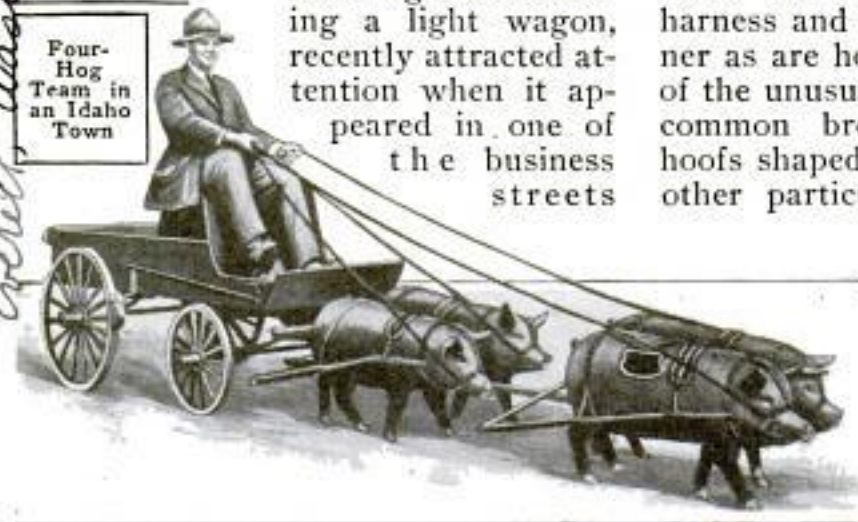

Four-Hog
Team in
an Idaho
Town

*Mrs. Janet M. Cummings,
75th Avenue, New York City.*

*Cont: Chas. E. Wilder,
1232 Hoyt Avenue,
Evanston, Wash.*

Leonard Y. Painter,
La Grange, Mo.

**RAILWAY TELEPHONE LINE
CRIPPLED IN ODD WAY**

103

As an illustration of the ease with which a telephone line may be disabled by the carelessness of its user, a circuit operated in connection with a railway block system in an Iowa town was recently crippled by two pins. The wires extended down a wall at one side of the station agent's desk. He was in the habit of using the insulation on these as a pin cushion. Unwittingly he stuck a pin in a block-line wire and another in a ground wire. The heads of the two pins touched. This naturally grounded the current. Division linemen, after considerable delay, finally found the trouble source.

**STREET CAR MADE INTO
REPAIR SHOP**

After having outlived its usefulness in the transportation world, a street



Carl: Hinton Gilmore,
Battle Creek, Mich.

**DOLL BABY WITH TWO FACES
OF DIFFERENT EXPRESSION**

65

Two dolls are virtually provided in one by an ingenious plan lately worked out by a New York woman inventor. The head of the doll is made with two faces, one on each side. A heavy wig is so attached that it may be turned to

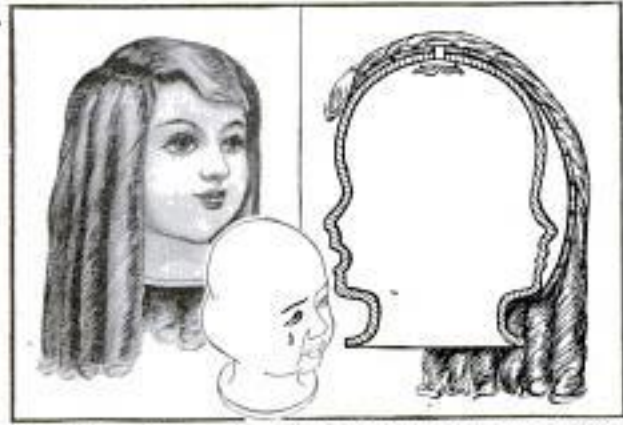

One Face Shows the Doll Crying While the Other Countenance Is Placid

expose either of the faces while covering the other. The expression is different in each case.

Mary C. Rausch,
White Plains, N.Y.

car has been dismantled from its trucks and installed as a repair shop on one of the principal streets of Battle Creek, Mich. The interior is fitted up in such a way as to provide plenty of room for working, and at the same time presents an inviting appearance to customers. The unusual appearance of the quaint shop with its novel signs and its flower garden serves as an effective advertisement for the owner's business.

— 49

**GAS PIPES WELDED WITH
OXYACETYLENE FLAME**

By using the oxyacetylene flame, with soft-steel wire as the welding material, the joints of 4,000 ft. of 4-in. gas main recently laid in a city in North Carolina were so successfully welded that the joints are not only gas-tight but are as strong as the pipe itself. The pipe was sent to the site with the ends beveled and ready for welding. In one afternoon 15 leakless joints were made with only one torch, the apparatus being moved about 20 feet after each weld. It was found that the joints could be welded faster and better in the trench than at the ground

level, as the torch appeared to draw an excess of oxygen from the air when exposed to the wind with the result



Welding the Joints of a Gas Main by Means of the Oxyacetylene Torch, with Soft-Steel Wire as the Welding Material

that there was a tendency to burn the welding material. The wire used was No. 8 gauge, and about $3\frac{1}{2}$ feet was required for each joint.

RESERVE RATIONS CARRIED BY FRENCH SOLDIERS

Every soldier in the French army carries emergency rations which are not to be used except in case of absolute necessity. So far, the commissary service has worked with the regularity of a clock, and the troops, it is said, have never once had to fall back on their reserve supplies. The problem of providing food punctually day after day for thousands of men scattered

over a wide territory, some of them changing their positions frequently, requires an almost perfect-working organization. Each day food is distributed for use on the following day, and this is done at specified railway points from which the provisions are carried to the front by wagon. When there are no railways available, motor cars are used in the place of trains. Should neither trains nor motor cars arrive, the forces would fall back on their reserve rations.

OFFICIAL MAP OF GOTHAM STREETS IS DRAWN

For the first time a comprehensive and accurate official map of New York City's streets and outlying territory is available. Aside from the area within the corporate limits, it covers the territory adjacent in Jersey, Westchester County, and Long Island. It is uncolored, making it possible for the several municipal departments, for which it is primarily intended, to emphasize their respective fields of activity. It is drawn to a scale of 2,000 ft. to the inch and in its finished form is 8 ft. square.

Great pains were taken to assure minute accuracy. The original drawings were made on a heavy paper, to the scale of 600 ft. to the inch, which from humidity and temperature changes showed variations in length ranging between .012 in. and .017 in. to the foot, which is much less than the similar changes in tracing cloth. Twenty-one of these sheets, each 8.01 ft. by 3.53 ft., were employed. In making certain tracings from other charts, glass-top tables, illuminated from beneath by three powerful electric lamps, were used, enabling the draftsmen to trace through two thicknesses of paper without difficulty. Small electrically driven disk erasers were employed in making all the necessary alterations, and it was found that the erased surfaces were indistinguishable from the original wherever these devices were used. The exact widths of the thousands of streets are shown. To accomplish this an instrument which made it possible to

The Prest. O-Lite Co., Inc.,
800 Spaulding, Indianapolis, Ind.

Army & Navy Journal,
3/6/15

9519

W. M. Murphy, 288 Broadway, N. Y. C.

POPULAR MECHANICS

567

"Engineering Record" May 22, 1915

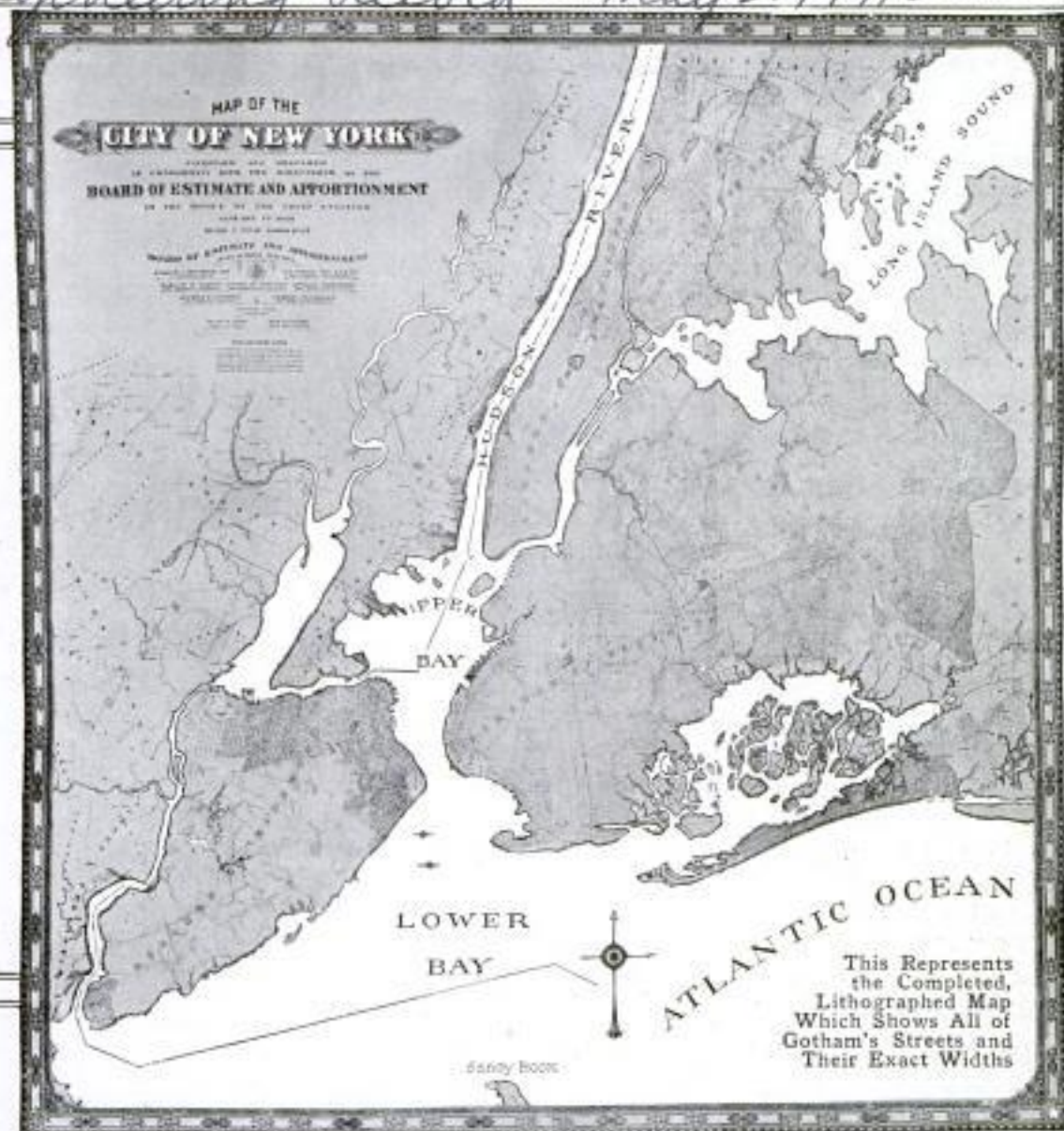

Cont: Karl Stefan,
Norfolk, Nebr.

draw both margins of a thoroughfare simultaneously was devised.

A platform finished like the surface of a drafting table and 27 ft. by 28 ft. in dimension, was provided for joining the various sheets making up the complete map. Since each section of the chart was divided into even minutes of both latitude and longitude, the assembling and matching was materially facilitated.

THOUSANDS OF SEA SHELLS FORM ELABORATE ARCADE

9958 After spending several years collecting sea shells, a resident of Jacksonville, Fla., has constructed an ornate arcade about his home which is one of the sights of the town. Surmounting the arched columns, an elaborate, heavy design has been worked out, through which climbing vines are entwined. The appearance of the structure, which serves to screen the grounds from the street and add to the privacy of the place, is quite out of the ordinary, although it may not conform to many persons' sense of what is attractive.

DUAL STEERING MECHANISM FOR FARM TRACTOR 9

For general farm purposes a power tractor has been constructed which is provided with two separate steering arrangements. One of these is operated by means of two levers which control a transmission mechanism that allows the driving wheels to be propelled in opposite directions. This enables the tractor to turn in very close quarters and makes it an easy matter for the operator to send it into what otherwise would be awkward places when plowing is being done. The mechanism responsible for this function is very simple. Two friction disks are mounted several inches apart and parallel with each other. A shaft carrying two cone clutches, one facing the other, passes between them. The use of one lever thrusts one of the cones against the edges of the disks, driving them in opposite directions. The engagement of the other clutch reverses these directions. Thus either of the wheels, when this transmission plan is used, may be driven in either a forward or backward direction and opposite to

William H. Watson,
Morton, Pa.



It Required Several Years' Time to Collect the Shells Used in Erecting This Ornate Structure

Inventors: J. A. Colwell }
 Albert Kennedy } Norfolk, Nebr.
 5/25/12-13
 Albion-Dover Co. Marshall Blvd, Chicago
 7100

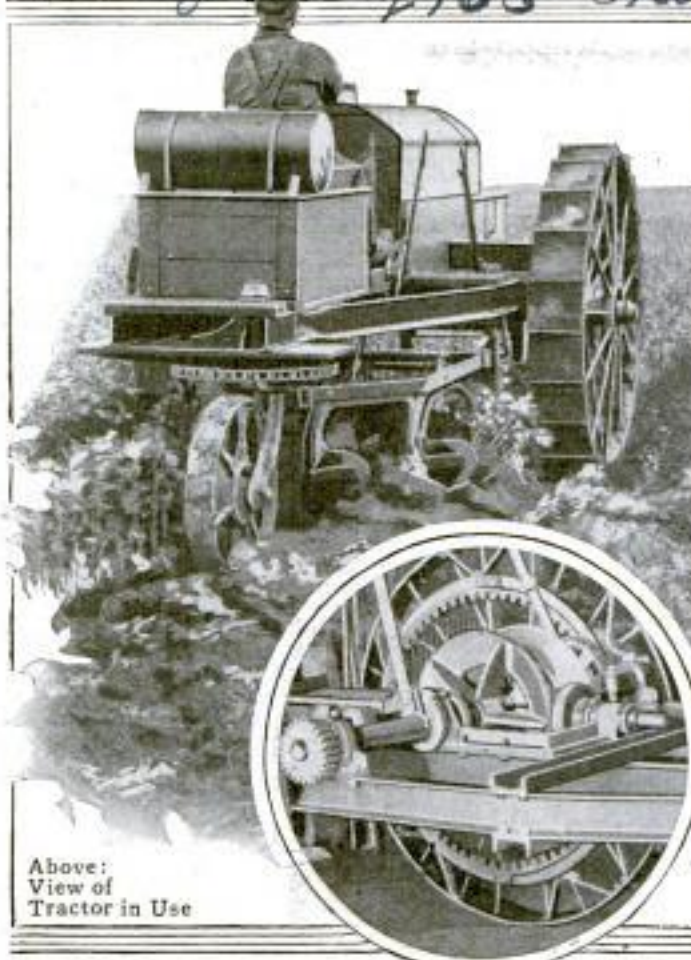

Above:
View of
Tractor in Use

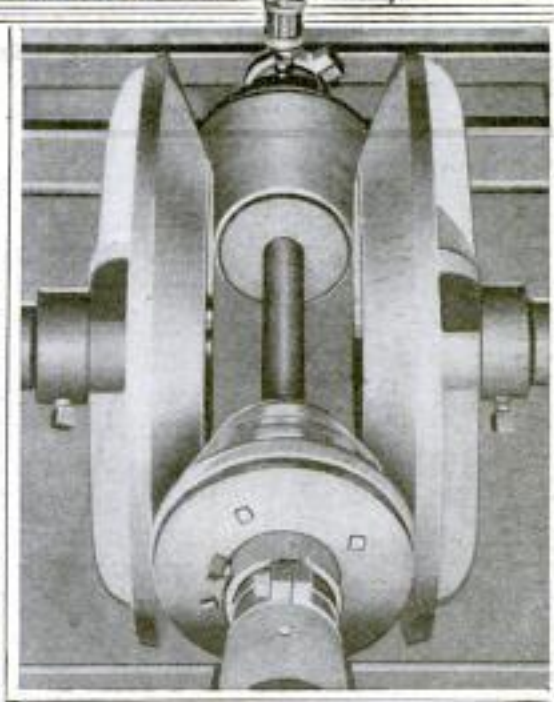

This Gives an
Idea of the
Arrangement
of the
Transmission
Set and the Way It is
Mounted in Relation to
the Driving Wheels of the Machine

the direction traveled by the other. The second steering apparatus is similar to that of a motor car—an ordinary steering column. This is used for all ordinary purposes.

**MANY HAWAIIAN UKULELES
NOW USED IN STATES**

Few musical instruments have ever come so quickly into popular favor in this country as has the Hawaiian ukulele during the last three or four years. It is estimated that in 1914 alone between 20,000 and 25,000 of these small instruments were purchased, probably 90 per cent of which were sold along the Pacific coast, where they are becoming quite commonly used.

A very large proportion of the ukuleles sold here are not imported, as is commonly believed, but are manufactured in a mid-western city, where probably as many of them are made as in Hawaii. There are also a few individual makers in California who are

engaged in building instruments to supply the local demand.

In appearance the ukulele is similar to the Spanish guitar, although smaller in size. It has four strings and is intended for the accompaniment of other instruments or the voice. It has a soft, melodious tone that brings out the weird romance of the island songs.

A.W. Simon, Los Angeles



This Ukulele Maker has Abandoned Violin Work Because of the Great Demand Which has been Created for the Small Hawaiian Instrument

*Harmony Co. 1744 N. Lawrence St. } Chicago
 Regal Musical Instrument Co.
 3211 Grand Av.
 Globe Mfg Co., St. Charles, Ill.*

39
 Mrs. Anna Meyers
 4013 Berendic Ave.
 Los Angeles, Calif.

Mfr: The Kohlhaas Company, 31 W. Lake St., Chicago, Ill.
J. R. Schmidt, 3557 St. Charles Place, Hyde Park, Cincinnati, Ohio.

"Office Appliances"
POPULAR MECHANICS

PEN-POINT EXTRACTOR MADE AS OFFICE APPLIANCE

For removing worn-out pen points from their holders without staining the fingers with ink, a convenient device has been introduced which is intended to be attached to a wall or a side of a desk. It is made of metal somewhat in the form of a box



and is provided with a hinged door which serves as a gripping agent. By inserting a point in this and pulling, a pen may be readily removed.

and is provided with a hinged door which serves as a gripping agent. By inserting a point in this and pulling, a pen may be readily removed.

GALLONS OF FLIES CAUGHT BY SIMPLE TRAP *231*

With a homemade sugar-barrel trap, a Cincinnati man recently succeeded in catching 43 lb. of flies in less than a week. A device similar to the one used by him may be made easily, and when employed, will materially lessen the number of flies around a house.

In constructing the trap, both ends of an ordinary barrel are removed. A screen cone about 18 inches in height is fitted in the inside of this with its outer edge securely tacked to the rim. The tip of the cone is cut off, leaving an opening approximately an inch

in diameter. Screening is fastened to a hoop and used to cover the barrel, which should be supported two or three inches from the ground on short legs. This constitutes the trap.

The bait may be sugar or some other sweet which will attract the flies but not make their wings sticky. This is put in a tray placed on the floor or ground immediately beneath the cone. After eating, the flies, attracted by the light above them, will rise through the cone and enter the barrel, from which they cannot escape. When it is time to empty the trap a small amount of boiling water should be poured over the flies.

Ammunition and firearms exported from the United States during the 10 months ended last May were valued at \$37,000,000, according to an authoritative statement issued recently at Washington.



After Using the Trap Six Days, This Tubful of Flies was Removed

cont:



One of the Steamboats Engaged in Fire-Patrol Service on the Peace River in Canada

The Railways are Constantly Patrolled by Men on Velocipedes with Equipment for Extinguishing Fires



91
PATROLLING THE FORESTS OF THE FAR NORTH

The forests of the northern sections of Canada that are suitable for settlement are now being carefully guarded against fire by the Dominion government. Patrols are maintained on land, particularly along the lines of the few railways, and the Peace and Mackenzie rivers are regularly patrolled by steamboats equipped for fire fighting. In sections where railways have not been built the rivers of the North are practically the only avenues of travel and the danger from fire is almost entirely confined to the woods along their banks, since a camp fire or a careless smoker may easily start a serious blaze. The steamers used in the work are propelled by rear paddle wheels and are of shallow draft. Because of the bitterly cold winds encountered during a large part of the navigation season they are entirely housed in, with the exception of the forward deck. The mounted police is charged with fire-patrol duties, and along the railways are patrolmen who follow up the trains on velocipedes, prepared to extinguish small blazes or, if necessary, to summon help from the nearest station. Each railway patrolman is equipped with two pails, two shovels, and blankets, in addition to his personal equipment.

ⒸThe superdreadnaught "Texas" is the first American warship to be equipped with a laundry and drying room.

CHILD'S BED WITH CANOPY
 9483 MADE OF SPOOLS

During his leisure hours an Ohio man has constructed a novel bed for a child by using a few boards and a number of spools. Although it is more of a curiosity than a practical piece of furniture, it

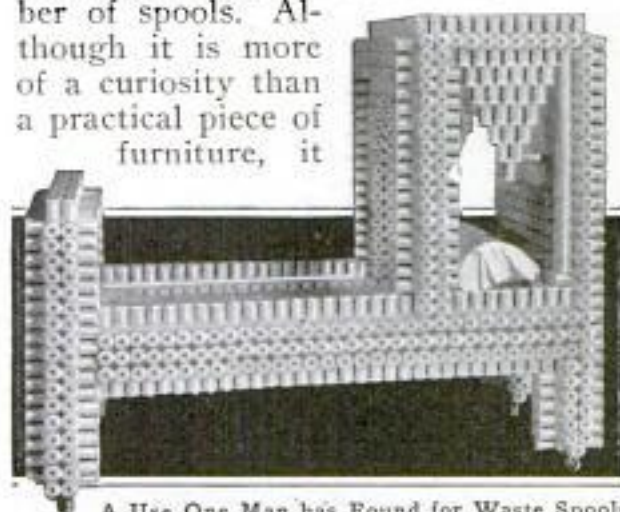

A Use One Man has Found for Waste Spools

is nevertheless substantially built and serves its purpose adequately. The spools are arranged in parallel rows, covering the bedstead and its canopy completely and giving a very ornate appearance. It is slightly more than three feet in length and about 30 inches in height at the head, a size which would also allow its use as a doll's bed.

Made by resident of Camp Washington, suburb of Cincinnati

Felix J. Roth, Keam Ave. Grandale, Cincinnati, Ohio.

COTTON USED FOR MAKING GEARING

78

Pinions made of cotton, highly compressed and held between two steel side plates, or shrouds, are coming into

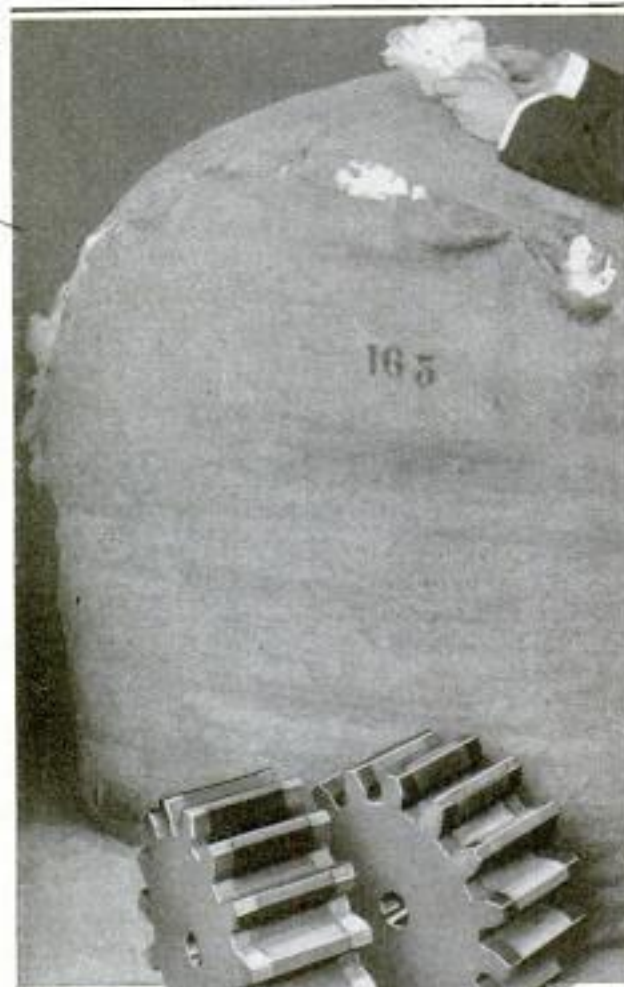

The Cotton in the 165-Pound Bale Shown in the Used in Making

Background was All These Two Pinions

wide use on account of their wearing qualities as well as their noiselessness in operation. Like rawhide and other nonmetallic pinions, they are run in mesh with metallic gears. The teeth are elastic but strong enough to be used wherever cast iron can be used. They are not injured by oil, water, or changes in temperature, and are immune against attacks of rats or mice. In making the pinions the cotton is first compressed by heavy hydraulic pressure and the resulting blanks are treated with oil by the vacuum process. After the shrouds are applied they are then machined in the same way as a

metallic pinion. Some idea of the amount of compression required in the cotton is given in the illustration showing a 165-lb. cotton bale used in making two pinions each a trifle more than 14 in. in diameter.

LOCUST EGGS ARE NOW USED FOR FERTILIZING SOIL

372

Locust eggs are being used to enrich the soil in Sicily and other parts of the Mediterranean country where these insects are very prolific. Tons of the eggs are gathered annually and treated with sulphuric acid and lime, after which the resulting material is used for fertilizing purposes. Experiments have shown it to be especially good as a food for olive trees. The locust is one of the most serious pests encountered in a great part of the Old World. On the island of Cyprus a bounty is paid for the egg cases and at a certain season hundreds of men and women are engaged in searching for them. They are long cylindrical masses enveloped in a glutinous secretion and deposited in holes excavated in the ground by the females. Several thousand tons of the eggs, it is estimated, are laid yearly, during periods when the migrations are heavy, on different islands. As early as 1881 attempts were made to exterminate the pests by searching for and destroying their eggs, and in that year some 1,300 tons of them were collected in Cyprus alone.

DRILL BOAT THAT LIFTS ITSELF OUT OF WATER

180

At the Lake Ontario end of the Welland ship canal, where there is no natural harbor and all work in connection with the new harbor is exposed to the full force of the lake storms, a drill boat that can be raised four or five feet above the waves when required was used in making the rock soundings. The boat consists of twin hulls rigidly connected, over which is laid a platform for the drilling outfit, steam boiler, four hoisting engines, and capstans and crabs required for handling the boat.

Made by General Electric Company.
Schenectady, N. Y.

Refer pinions to
F. H. Gale 6/23

V. D. Johnson, P. O. Box 695,
Berlin, Ont., Canada

Drill Boat Used in Making the Soundings at the Lake Ontario End of the Welland Ship Canal, Where All Work in Connection with the New Harbor was Exposed to the Full Force of Lake Storms

When Raised above the Waves the Drill Boat Rested on Four Spuds, One Located at Each Corner; the Lifting was Done by a Wire-Rope System Worked by Four 10-Horsepower Steam Crabs

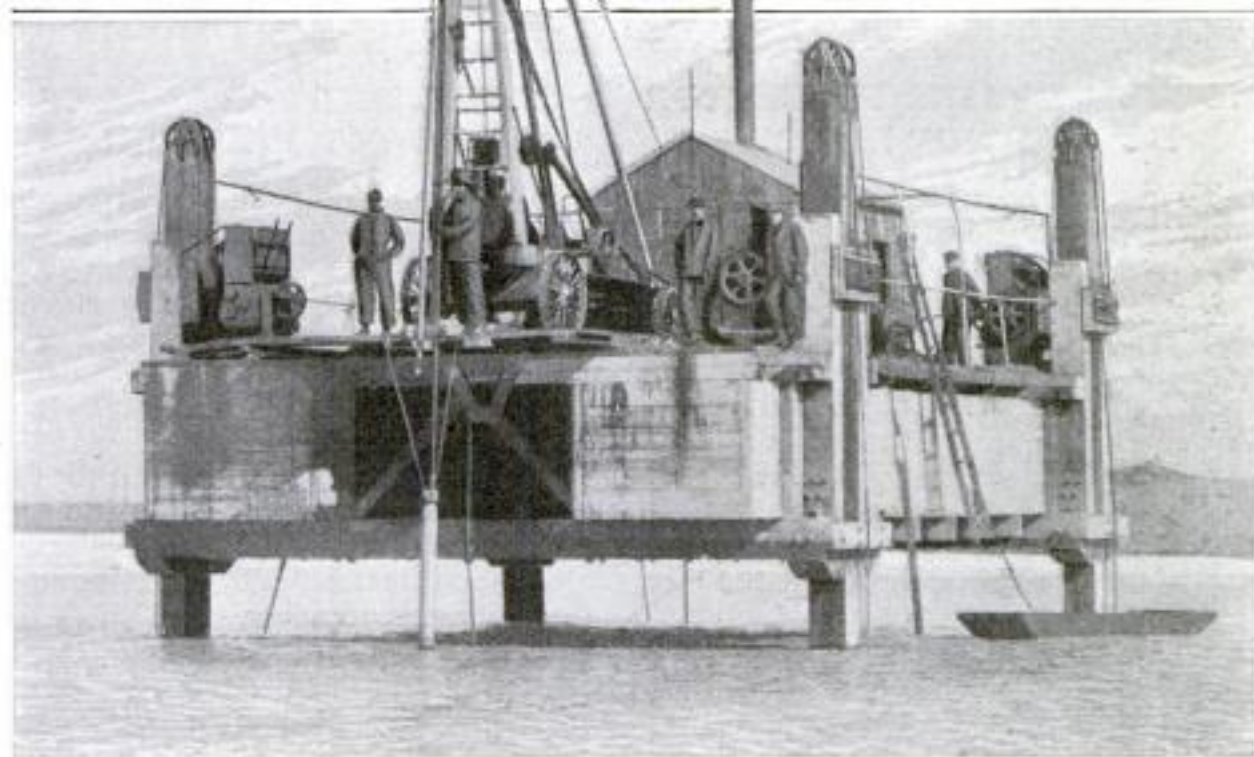
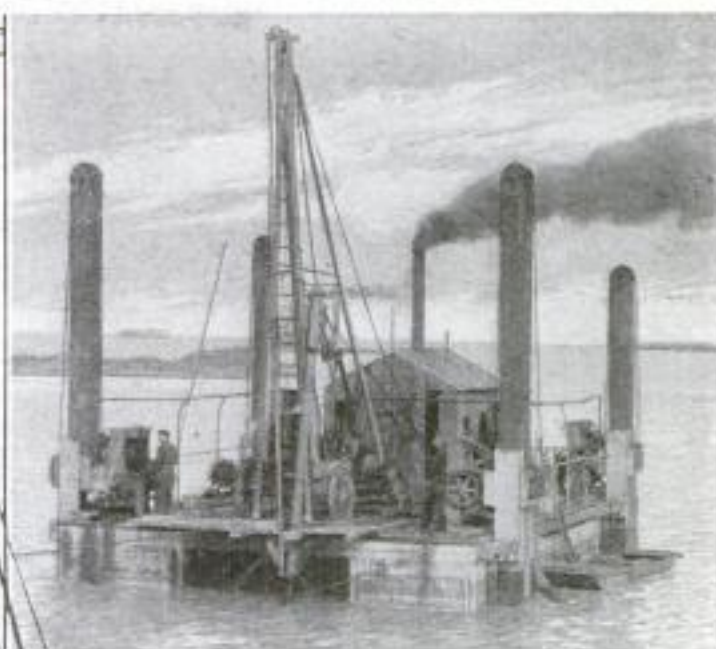

At each corner of the boat is a heavy spud working in guides, and when the boat is to be lifted these spuds are brought to a bearing on the bottom of the lake and the boat is raised by means of a wire-rope system worked by four 10-hp. double steam crabs. The raising rope is led from the top drum of the steam crab over a sheave at the top of the spud, to a sheave on the guide, and

then to an anchorage on the boat. The spuds are kept clear of the lake bottom when the boat is afloat by ropes that pass through sheaves fixed to the bases of the spuds. These ropes are operated by the lower drums of the crabs, the two drums being so adjusted as to keep both ropes taut at all times. This boat has been successfully used for pile driving as well as for drilling.

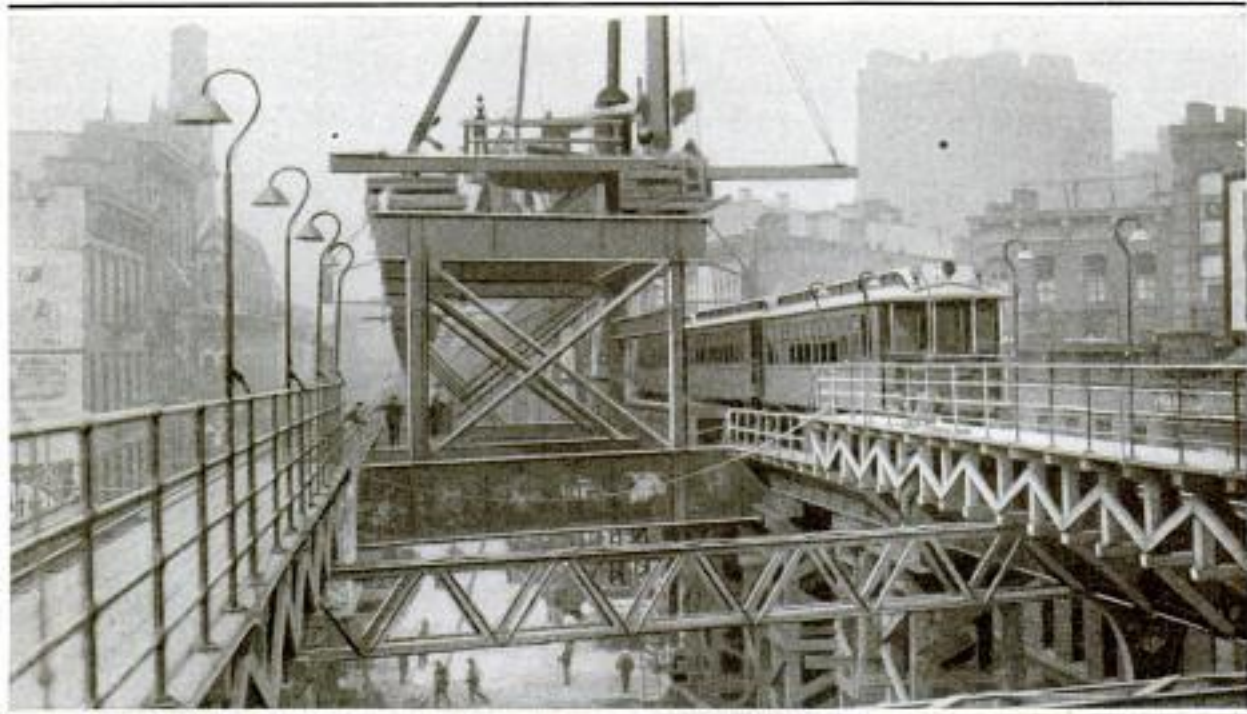

How the Third Track for the New York Elevated-Railway System is being Built as a Second Story between the Existing Tracks without Interference with Traffic

NOVEL TROUSER PROTECTOR DEvised FOR BICYCLE

To avoid the necessity of wearing trouser guards when riding a bicycle, a North Carolina man has devised a disk protector which is designed to be attached to the right side of the fore sprocket. It is made of metal in about the size of a standard phonograph record. The plate covers the gear and enough of the chain to prevent the bottom or cuff of a trouser leg from becoming entangled or soiled by oil or graphite.

Although somewhat odd in appearance at first sight, the device does not particularly detract from the looks of a cycle on which it is used. It may be readily attached to any ordinary wheel.



REBUILDING NEW YORK'S ELEVATED RAILROADS

In the rebuilding and enlarging of almost the entire elevated-railroad system of New York City a difficult piece of engineering work is being carried out practically without interference with the hundreds of trains that operate daily over the structures. The work is estimated to cost about \$10,000,000 and consists in converting the lines into two-story tracks. The elevated roads were built originally as two-track lines. When it became necessary to provide a third track for express trains it was found that while there was room for the additional track there was not sufficient space for the island express stations. This has made it necessary to build the express tracks above the local tracks, involving, as a general thing, the remodeling of the entire elevated structure. In carrying out this work of construction on the busiest elevated railroad in the world without serious interference with traffic, rapid and well-organized teamwork is required on the part of the men. So adept have the ironworkers become that they can hoist a 10-ton girder from the street, drop it into place, and have

cont. Lester L. Sargent, 700 -- 9th St., Washington, D.C.

Inventor: Adolphus O. Davis, Wilson, N. Car.

W. Scott Williams, 116 Waverly Place, New York City.

148

United Vending Machine Co., Inc.
Dept 3, 840 E. 93rd St.
Cleveland, O.
See apl 1914 p 180 apl's

the riveting under way within a space of three minutes. At one point on the Second Avenue line it was necessary to raise the entire structure seven feet. This was accomplished without stopping a single train.

Calif.

— 243

NEW MILITARY AEROPLANES DELIVERED TO ARMY

Eight tractors of the new Curtiss military type were recently delivered at the army aeronautic station at San Diego, Cal. This not only represents the largest order for machines that has ever been filled for the government by one designer, but also the largest shipment that has been received at a government aerial station at one time. The new machines are graceful in appearance and have shapely streamline bodies. Each is equipped with a 100-hp. domestic motor rated to give the craft a speed of approximately 70 miles an hour. The wings have a spread of 37 ft. and are braced for heavy work and hard usage. Each machine is designed to carry a pilot and observer and a sufficient store of fuel for a six-hour flight. In the opinion of the war department, as previously expressed, the craft compare throughout very favorably with most of the reconnaissance machines that are now used by various armies in the European war.

*S. Edwards Barnhart,
Hotel Olive, San Diego*

PHOTOGRAPH GALLERY RUNS WITHOUT ATTENDANT

For concession purposes at summer amusement parks, and similar places, an automatic camera has been constructed which takes tintype pictures of its customers with the same mechanical precision with which other types of vending machines deal out peanuts and gum after a coin is inserted. The operation of the device is purely mechanical. It is only necessary for the subject to deposit a dime and seat himself before the lens. The apparatus is built on a short platform with the camera placed at one end and a chair and background fixed at the other. By glancing into a finder, the subject assures himself that his posture is becoming and then drops a dime in a slot. As soon as this is done, an arc is illuminated



*Alan D. Witherspoon,
5424 East View Park,
Chicago, Ill.
Fox Apples, C*

Aside from Making Good Speed for a Biplane, the Craft is Built to Withstand Heavy Strain

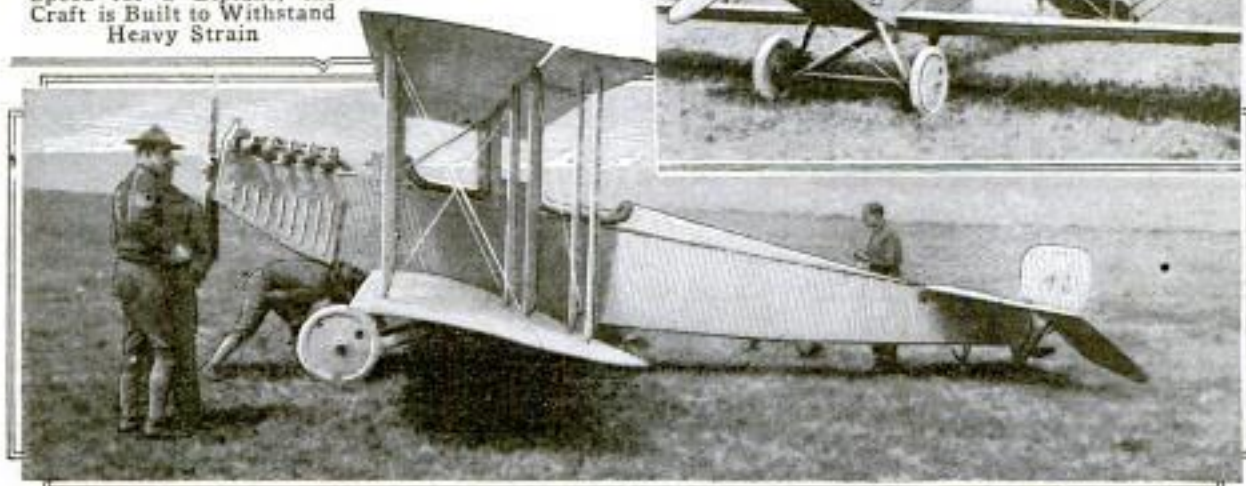

The Side View of the Machine Gives a Good Idea of Its Streamline Effect and the Character of the Rudder and Elevators Used

236
Christian Science Monitor
WAR OFFICE SUPPLIES MEN
FOR BRITISH HARVEST *7/9/15*

which throws a strong light over his countenance. Subsequently the shutter opens and closes. In another minute the tintype, fresh from the chemicals and mounted in a circular brass frame, issues through an aperture at one side of the machine. It is then placed on an electric drier for a minute to evaporate the moisture.

CURRENT-MOTOR PUMP MADE FOR IRRIGATING USES

Designed chiefly for irrigating purposes, a current motor has been built by a Montana inventor which in recent tests has shown itself capable of pumping approximately one cubic foot of water a second to a height of 27 ft. This amount of work is about equal to that of a 3½-hp. gasoline motor. The apparatus is



This Current Motor, Which Operates Practically without Expense, Is Capable of Irrigating About 100 Acres of Land

constructed on a floating platform which is moored in the current of a river. The expense of its operation practically amounts to nothing, while its maintenance consists of merely a low upkeep charge. The amount of water it pumps is sufficient to irrigate about 100 acres of land.

In response to appeals made by the board of agriculture and fisheries, the British army council has agreed to furlough a limited number of new soldiers for a fortnight and permit them to assist in the hay harvest. English farmers have faced a serious problem because of the dearth of labor, and this means is being taken to cope with the situation. Agriculturists who wish to employ soldiers in this capacity make their applications to the board-of-trade labor exchanges, which forward the requests to the military authorities. It is only when suitable labor cannot be otherwise obtained in a specific locality that soldiers are supplied for this purpose. It is also stipulated that each soldier shall be paid \$1 a day for his services, if he provides his own board and lodging.

GOVERNMENT WARNS AGAINST "HALF AND HALF" COTTON

A warning against the so-called "half and half" cotton has been issued by the United States Department of Agriculture, being particularly directed to the cotton growers of Oklahoma, Texas, and Arkansas, where much of this cotton is being grown as a result of an active campaign carried on in the past two or three years. Tests made by the department show that "half and half" cotton does not maintain a high yield of lint per acre, and that the lint is of poor quality, irregular, and very short. Much of the lint examined was found to be less than 7/8 in. in length, which is the minimum length acceptable under contracts for future delivery.

8863
Conf: H. H. Liscum, in Sept 1912-313
Lyell & Bellings Journal
Bellings Mont.
Refer to E. Jas. H. Martin (Inventor)
Springfield, Mo.

Information Sheet
Dept. of Agriculture

Combination Swing & High Chair Co.,
 Box 423,
 POPULAR MECHANICS La Porte, 577 Ind.

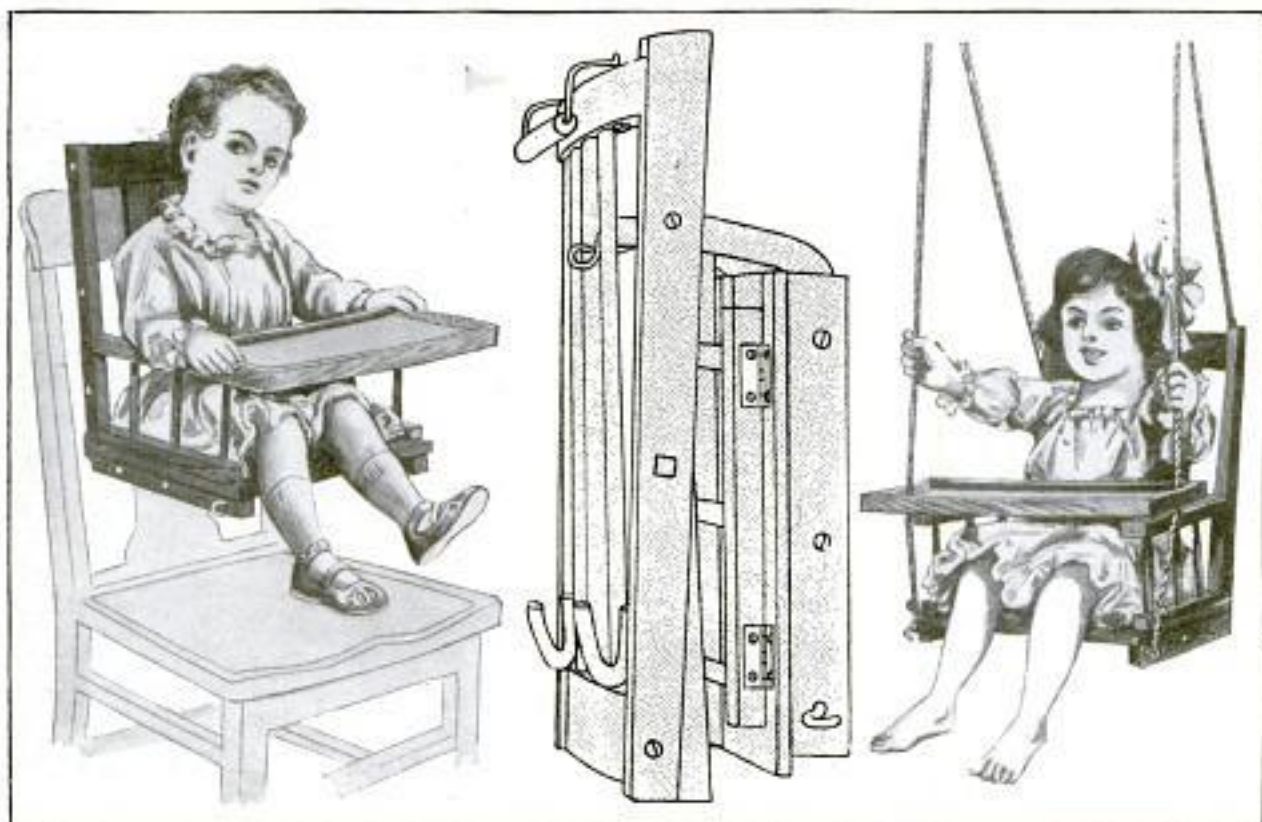

When the Chair is Not Needed It may be Folded and Stored in a Small Space

CHILD'S HIGH CHAIR BUILT TO SERVE ALSO AS SWING

190 Several convenient points are embodied in a child's combination swing and high chair which has lately been brought out. Besides serving two different functions, the device has the added advantage of being collapsible. It is fitted with rubber-covered grips which enable it to be fastened to the back of an ordinary dining chair and used as a high chair at a table. Places for fastening ropes are also provided so that in a few minutes' time it may be converted into a swing suitable for use on a porch or lawn, or within doors if desired. The plate tray remains in place in both instances and serves to hold the child safely in the chair.

Ⓒ Much of the sand used in the construction of the new subways in New York is beach sand obtained practically free of charge from the holds of ships which, owing to war conditions, have made the western trip across the Atlantic carrying only sand ballast.

ANTISEPTIC BATHS GIVEN STEERS ON RANCHES

21 On well-regulated stock ranches facilities are usually provided for bathing the cattle in germicide periodically in order to kill disease-bearing vermin. One of the ways of doing this is to



Bathing Steers Is a Regular Operation on This Wyoming Ranch

Cow: W. A. Du Buy, Clearwater, Va.
 on ranch of C. N. Zetter, Clearwater, Va.
 Wyo

build a deep, rectangular tank between two corrals. When this is filled with an effective solution the steers are driven into it at one end and made to swim to the pen at the other extremity. On such occasions attendants alongside push the animals' heads beneath the water so that all parts of their bodies, including the insides of their ears, are reached by the germicide.

256

DEEP UNDERGROUND CAVERN IS OPENED BY MINERS

While sinking a shaft for a gold mine in southern Nevada, some 11 miles from the famous Tonopah camp, a vast subterranean cavern was uncovered recently in a most unexpected manner. The claim is a new one. At 50 ft. below the surface the drills passed into a soft-rock formation which caused the workers to express surprise. After the last blast had been fired the muckers were lowered down the shaft until the end of the derrick rope was reached. It was then found that the

explosion had uncovered a great pit extending far into the earth. The blast had made the shaft bottomless.

Subsequent examinations of the place were made, but although men were lowered for a distance of several hundred feet they were unable to reach the bottom. Rocks which became dislodged, slipped into the chasm and fell through space silently, giving back no echoes. The atmosphere in the cavern appears to be pure. A candle will burn freely in it, but the flame occasionally flickers, which indicates that some place there are openings through which the air is able to circulate.

The surface of the rock bears evidence of having been burned. This is responsible, partly, for the theory that the miners have broken into a cross fissure caused by the shrinkage of the earth following the cooling of a volcano. Tests of the incrustment on the walls are reported to have shown that it is almost pure carbonate of lime, indicating that the volcanic rock formation overlies lime beds.

STEEL BUILDING ERECTED IN SEVEN HOURS

Record time was made recently by a Syracuse, N. Y., contractor in erecting

it was expedient that all possible haste be exercised in raising a new building.

The material for the structure was on the ground at eight o'clock on the morning the work commenced. At 4:15 o'clock that afternoon, after an hour had been allowed for the workers to lunch, the building was completed and turned over to its owners.



This Photograph was Taken at 8:15 in the Morning, a Quarter of an Hour After the Work had been Started



Here the Building is Shown as It Appeared Exactly Four Hours Later, When 32 Men Were at Work

a steel-frame building to be used as a workshop by a local copper company. Fire destroyed the plant formerly operated by the firm and

Below: The Steamship "Seward" Lashed to Its Dock at Cordova, Alaska, After It had been Towed from Off Prince William Sound. The Insert Shows the Vessel Listing Far to Port After Its Heavy Cargo had Shifted

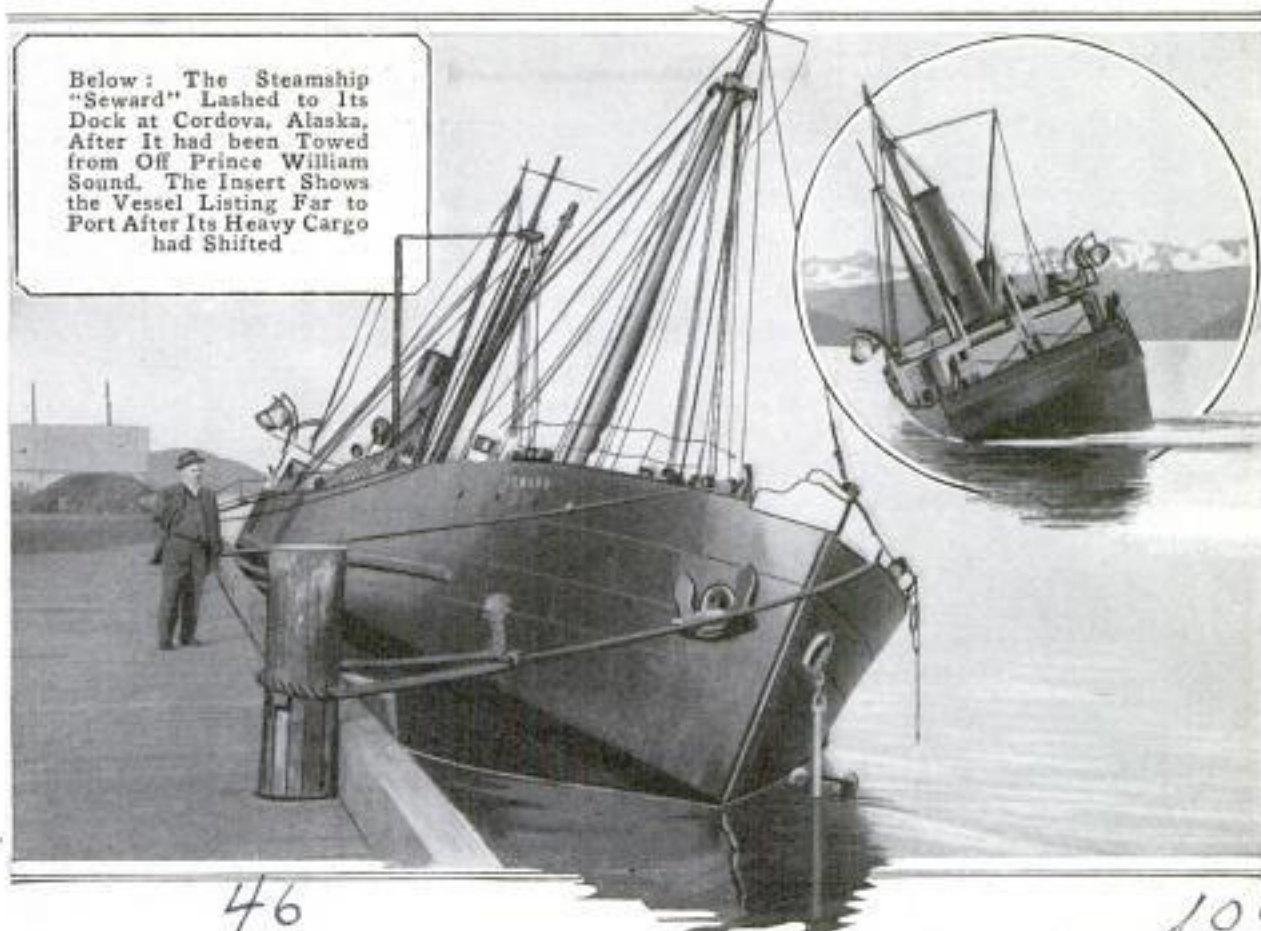

46

104

VESEL LISTS FAR TO PORT WHEN CARGO SHIFTS

ELECTRIC BUS IN SERVICE AT BATHING BEACH

While steaming off Prince William Sound recently with a 4,000-ton cargo of copper ore, the freighter "Seward," bound from Cordova, Alaska, to Tacoma, Wash., suddenly listed nearly 30° to port and became unmanageable. The trouble was caused by a shifting of the heavy cargo. There was no opportunity for remedying the condition at sea and immediate assistance was needed to save the vessel from capsizing. An "S O S" call brought another vessel to the scene which towed the disabled steamer back to the Alaskan port, where a part of its cargo was transferred to a second ship. It is believed that had the accident happened farther out at sea the "Seward" would have gone to the bottom.

One of the curious vehicles in service at Ocean Park, Cal., is an electric bus with which sight-seers are transported from point to point along the beach. Power is supplied by a storage battery and the bus operates on the



Electric Bus Used for Transporting Sight-Seeers from Point to Point along the Beach at Ocean Park, California

concrete sidewalk that parallels the beach. The length of the run made the bus is a trifle more than a mile.

With German and Austrian toys shut out as a result of the war, American toy makers are finding a growing market for their wares in the countries of the Orient.

comb. H. A. D. No. Cordova, Alaska.

comb. Alan D. Witzkowski 5424 East View Park. Cheung, Ill.

REVOLVING NAIL BIN MADE WITH MANY COMPARTMENTS

To facilitate the handling of nails and bolts in retail hardware stores, a sectional bin has been devised which has



The Bin Is Particularly Convenient because Its Capacity Allows It to Hold a Large Assortment of Nails and Bolts

a number of convenient features for the dealer. It is made in different sizes, the largest of which has five sections and 50 separate compartments, each holding more than 50 lb. of nails. The sections are conical in shape, made of metal, divided by substantial partitions, and provided with scalloped edges to prevent the contents from spilling. These members are placed one above the other on a vertical shafting and are mounted on ball bearings so that they may be revolved easily. Suspended from a rotary arm mounted at the top of the center tubing are scales.

¶ Largely as a result of the awakening in shipping circles brought about in this country by the European war, there are now building in American shipyards over 48 seagoing steamers, 23 tank ships, nine colliers, and a considerable number of smaller craft.

MOST NORTHERLY RAILWAY IS NOW ELECTRIFIED

In connection with the prospective building of a government railway in Alaska, it is of interest to note the results which have been gained by the electrification of a section of the Swedish State Railways which is used for the transportation of iron ore. The road is the most northerly line in the world, starting at a point nearly 87 miles north of the polar circle. It is used to carry ore mined near Kiruna to the Norwegian frontier. The power station is 155 miles distant from the terminus of the branch. A single-phase current of 80,000 volts is carried by overhead transmission lines to substations along the way. It is claimed that this system of operation has increased the train capacity of the line 40 per cent and the speed 50 per cent over steam operation.

LARGE MUNICIPAL STADIUM BUILT IN CANON

What is undoubtedly the finest municipal stadium in this country has recently been completed at San Diego, Cal. It is beautifully situated in a natural cañon in full view of the bay, which is approximately a mile distant.

Twenty-five tiers of concrete seats, which furnish accommodations for approximately 30,000 persons, encircle a tablelike athletic field, 621 ft. in length and 287 ft. broad, which is skirted by a quarter-mile track. The top row of seats is 39 ft. above the arena and is margined by a broad walk from which access is given to the several entrances. The ground at this point is level and extends, back for some distance, providing ample parking space for hundreds of motor cars and giving their occupants an excellent view of the field.

Closing the front end of the amphitheater, without obstructing the sight of the ocean or cutting off the cool breeze from it, is a long colonnade of massive pillars forming a heavy portico in front of which extends a semicircu-

The Eclipse Manufacturing Co., Wellston, Ohio

65

Geo. Bassett, 2768 Columbia St.,
San Diego, Calif. 581

POPULAR MECHANICS



General View of Athletic Field. Far in Background Is the Ocean



Front of Amphitheater and Hills between Which It is Built



lar structure, the graceful lines of which give the approach to the stadium a most pleasing appearance. In the court thus formed is a space for basketball, tennis, and handball courts, while the room available in the structure itself is occupied by dressing rooms and lockers for the participants in athletic meets.

In dedicating the stadium recently a nine-hour program consisting of infantry and cavalry drills, football, baseball, and basketball games, track events, and field contests was held.

CA book containing 100 coupons, each good for an hour's free repairing or overhauling, is being issued to the purchaser of each car by an automobile company in Detroit, Mich.



Above Is One of the Several Artistic Ticket Offices Such as Are Located at Various Points about the Broad Walk. Steps Below Lead from Side of Colonnade to the Seats



YOUNG WOMEN ARE ENGAGED AS AMBULANCE SURGEONS

Two young women graduates of an eastern medical college were recently



These Young Women are Taking Men's Places as Ambulance Surgeons for a New York Hospital

placed on the staff of ambulance surgeons at a New York hospital. The district in which they operate is one of the poorest in the city and likewise one where emergency calls are more or less continuous. Since in work of this kind it is not always possible to determine in advance just what conditions will be encountered on a call, the girls are handling a hard branch of work and one which in nearly all cities is taken care of solely by men.

NEW FEDERAL ROAD ASSURED TO YOSEMITE PARK

Projection of a new road extending from western Nevada to the Yosemite National Park has been undertaken by the government. Purchase was made some time ago, by popular subscription, of the Tioga road, long ago abandoned, which reached from the eastern slope of the Sierra Nevada range through the park. In turn it was presented to the government and accepted. It is now announced that this will be rebuilt.

ARTESIAN WATER ASSURED FOR OGDEN, UTAH

Sixteen artesian wells with an aggregate flow of about 9,000,000 gallons of pure water daily, have been drilled in the Ogden Valley adjacent to Huntsville, and will hereafter supply Ogden, Utah. The depths from which the water is taken vary from 110 to 147 feet. A pipe line had previously been laid through the Ogden cañon for the purpose of tapping some of the near-by mountain streams, and it will only be necessary to make an extension to this in order to carry the water into the city. The wells have been sunk within a radius of less than 250 feet of each other, and as new bores have been made the flow of the old ones has not been decreased. The entire work, including the property purchased by the city, when completed will have cost less than \$150,000, it is believed.

FELDSPAR OFFERS STORE OF POTASH SALT

By employing a new chemical process which is now being tried, it is believed that potash can be obtained from feldspar economically enough to make production of the salt commercially possible at normal prices. Five parts of powdered feldspar are mixed with one part of powdered quicklime and treated with a solution of calcium chloride. The latter acts with the lime to the formation of an oxychloride cement which binds the powder in lumps. These are fed into a kiln, where, under high temperature, the potassium is freed from its union with the silica and unites with chlorine. The muriate thus formed is soluble in water and by a

Paper by E.W. Coggeshall before National Lime Assoc.

International News Service
238 William St.
N.Y.C.

Cont: E. B. Seaberg
Ogden, Utah

"Engineering News"
6/3/15

"Engineering News"
6/17/15

leaching process a 10-per-cent solution of potassium chloride is said to be obtained.

9250

TAILINGS STACKER USED IN THE WITWATERSRAND

About 25,000,000 tons of gold ore is hoisted out of the mines of the Witwatersrand in South Africa every year, and the disposal of the tailings, as the refuse rock is called after it has been crushed to a sand and the gold extracted by the cyanide-of-potassium process, constitutes one of the biggest problems in the operation of some of the mines. As a general thing gold mines are located in mountainous country, and the tailings can be dumped in almost any quantity down a mountain side, but in the Witwatersrand the country is flat and special methods must be used to prevent the mine and mill from being buried. In the type of tailings conveyor and stacker most commonly used, an inclined steel structure, supported on steel towers, carries a cableway equipped with buckets with which the tailings are carried and dumped in a pile at some distance from the mill. The pile eventually grows to enormous size, and most of the steel structure is buried and lost. These tailings piles are a striking feature of the Witwatersrand, but a great nuisance as well, as in the dry season the wind carries the sand over the whole countryside, unless the pile is covered with some such substance as salt, which absorbs enough moisture to prevent the material from being blown away. In some cases the problem is solved by running the tailings back into worked-out portions of the mine.



TRACTION ENGINE USED TO WARM STIFFENED OIL

When the crude oil in a tank car received at a Canadian city in midwinter could not be made to flow on account of the stiffening effect of the



Traction Engine Used for Warming Crude Oil That had been Stiffened by the Cold

intense cold it was easily thawed and softened by steam supplied from an ordinary traction engine. The whistle of the engine was removed and in its place an iron pipe was inserted. This was connected by an intermediate pipe with a pipe projecting from the side of the car and leading into the tank. Steam was then raised in the traction

Tailings Stacker at a Mine in the Witwatersrand with a Pile of Tailings Just Started

Ray Dymond,
Box 129, Dundas, Ont. Canada.

Cont: A.L. Kellogg, Grantwood, N.J.

engine and as soon as the pressure had reached the required degree the valve in the projecting pipe was opened and the steam was allowed to enter the tank. This process was kept up until all the oil had been softened and drawn from the tank.

9900
**SPIRAL-SLIDE CONVEYOR
USED IN CREAMERY**

At a creamery establishment in Los Angeles, a spiral chute is employed for conveying empty milk cans from the

**LAW STOPS REPRODUCTION
OF EXPOSITION MEDALS** 7/8/15

According to recent advices from Washington the photographing or reproducing of medals and diplomas awarded to exhibitors at the Panama-Pacific Exposition is prohibited. This situation arises from the fact that the work on them was done in Federal mints and by the Department of Engraving and Printing, which thus brings them under the statutes prohibiting the reproduction of United States coins and securities. Congressional action is necessary before the medals can be legally photographed.

**POWER LOOM MADE TO
WEAVE ORIENTAL RUGS** 9514

de Feb 1910-2346
After many failures in the attempt to develop a machine capable of weaving oriental rugs, a successful power loom for this purpose has at last been constructed. It is able to produce a rug in a single day which would require a year's labor on a hand loom. As for the rug itself, it is claimed the work is so ingeniously done that close scrutiny by even an expert is required to distinguish between it and one made by hand.

One of the principal differences between oriental and domestic rugs is that in the former the short pieces of yarn forming the pile are knotted to the warp threads, instead of merely being looped around them. It is partly this which makes the oriental rug both more expensive and durable than common ones. To build a machine which could successfully tie this knot has in the past been the chief obstacle confronted by inventors, for in making the knot a hand weaver uses five different finger motions. The knots tied by the new machine, however, of which there are more than a million in a large-sized rug, are said to be exactly the same, so far as appearance is concerned, as the real Persian, or Sehna, knot.

With this loom it is possible to produce very durable and artistic rugs much more reasonably than they can

*Albert Warple,
322 Boynton St., Tropico, Calif.*

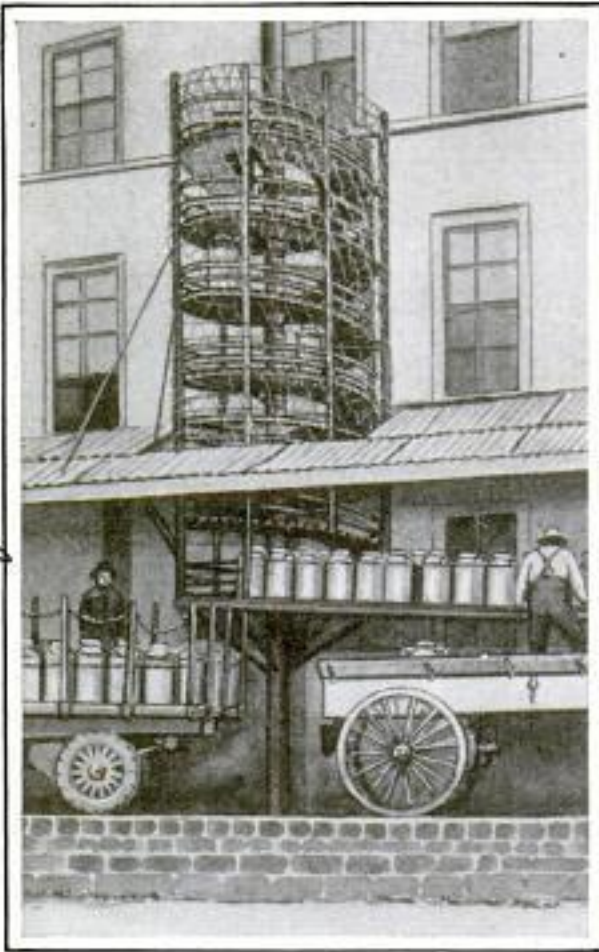

This Shows How the Cans Are Shot from the Spiral onto a Second Chute Which, When Inclined, Allows Them to Slide into a Wagon

third floor of the building to a loading platform near the ground. The device has been constructed in order to effect a time saving in handling the receptacles. The chute, on which the cans slide in an upright position to the wagons waiting below, is inclosed in a wire netting so that it may easily be cleaned and is subjected to the sun's rays during a certain period each day.

Warc was personally directed by the late Nazan Cesterlyan and carried

Geo. F. Worts, 627 W. 113 St., New York City.

POPULAR MECHANICS

585

United States Persian Carpet Co. *

"Mirhali Rugs"
 400 Fifth Ave. New York City
 Mirhali H. Co. Ltd. New York

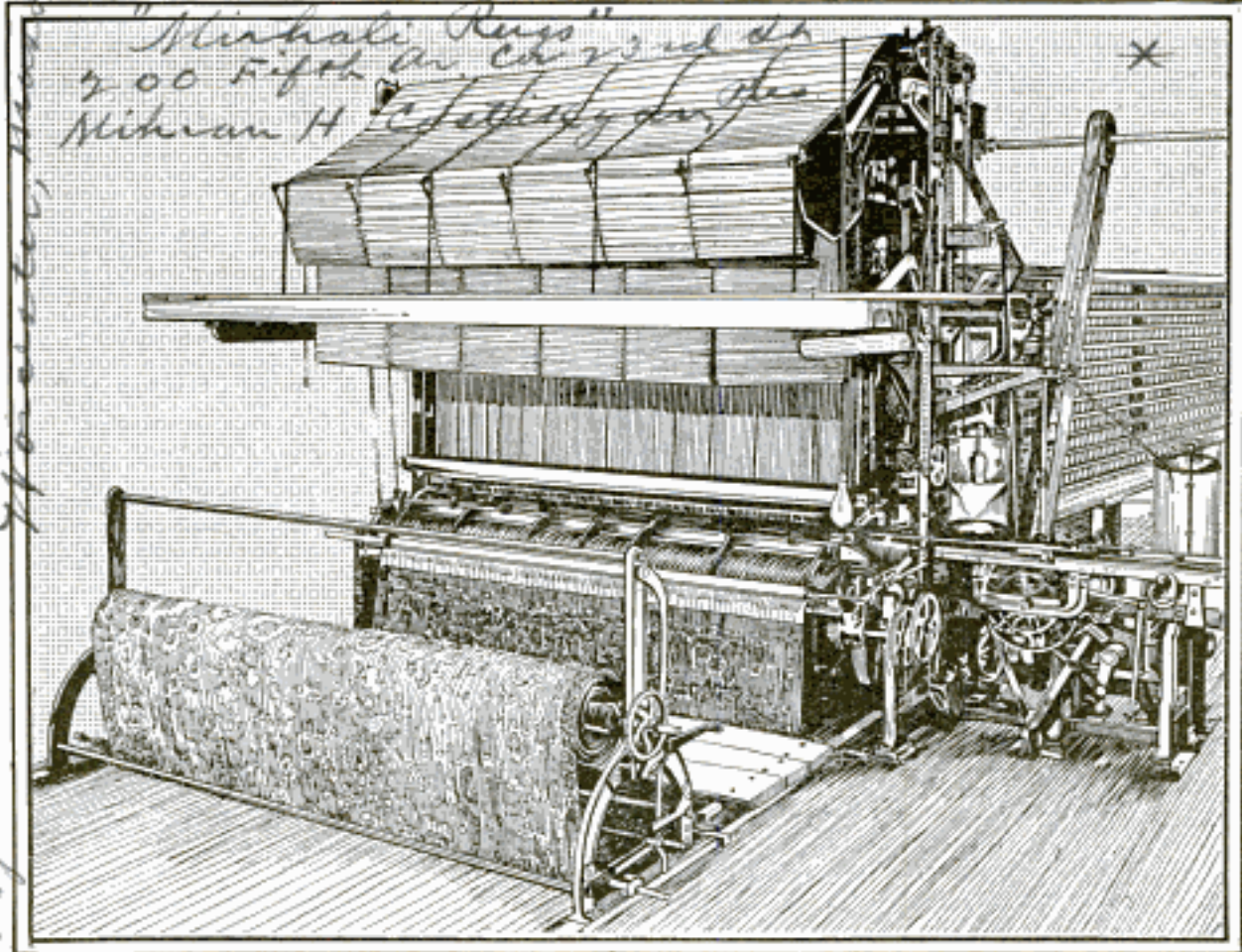

Rugs Which from the Point of Workmanship can Hardly be Told from Those of Oriental Weaving, are Made on This Power Loom

be imported. An additional advantage, from the consumer's point of view, is that the machine-made rugs are fresh and new and therefore more lasting than many of the popular-grade hand-made rugs.

Only one man is required in operating the power loom. The wool is introduced at the rear of the machine and guided by Jacquard cards in which the design is cut. Long rods controlling the various yarn feeders drop into the perforations and actuate a mechanism which knots the wool to the warp threads. Any pattern may be woven in this way and as many duplicates made as are desired.

Insanity patients at an Illinois institution are to play golf. A nine-hole course is being laid out for their use. The experiment is based on the belief that moderate outdoor exercise in many instances is a very valuable means of strengthening unbalanced minds.

AUTOMATIC SIGNAL SYSTEM

FOR STREET CARS 9956

At St. Louis a new signaling system for motormen has been tried out on surface-traction cars provided with inclosed vestibules at the back, which not only makes rear-step accidents next to impossible, but also lessens the work of conductors and allows them to direct more of their attention to collecting fares and issuing transfers. A small electric lamp is mounted in the forward vestibule in front of the motorman where it is readily seen by him. The wiring is arranged so that the light is automatically extinguished when the conductor closes the rear doors. Until these are entirely closed, however, the light continues burning. This relieves the conductor of the necessity of pulling a bell rope and also makes it impossible for a signal to be given prematurely, providing the doors are not opened after once being closed.

Financial backing: Coatsygan & Co. 130th St. New York
 Looms embodying this invention have been constructed by
 Crompton & Knowles Loom Works
 Worcester, Mass.

Paper N. 20 hits
 United Railway's Bulletin
 St. Louis
 Mo.

James K. Dalckianian
 K. H. Dalckianian & Sons,
 2214 Broadway, New York
 Oriental Rugs

Copyrighted material

MOTORCYCLE SIDECAR FIXED FOR STORMY WEATHER

To make the sidecar attachment of a motorcycle serviceable in disagreeable weather, a neatly fitted top with watertight curtains has made its appearance.

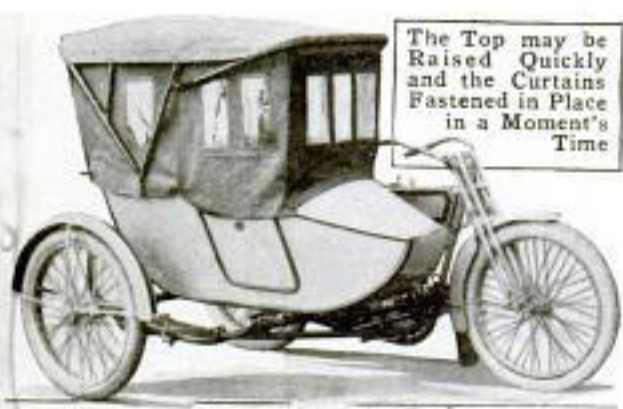

9683

The drops are provided with mica windows and fasten snugly about the body. When caught in a storm, or when facing cold winter winds, the sidecar passenger is as well protected as if occupying a well-appointed motor car.

SANITARY PAPER BIBS MADE FOR SMALL CHILDREN

Intended for the use of babies and young children, a paper bib has been introduced which may be thrown away after once being soiled. It is neat and crisp in appearance and replaces the usual linen napkin. The face of the bib is absorbent and the back waterproof. It is inexpensive and serves to lessen the size of a family washing.

358

NEW PLACER MACHINE WORKS WITHOUT WATER

A machine for concentrating the gold and valuable sulphides without the use of water is now being introduced in some of the placer mines of the West. This machine consists of a table top, on which the actual work of separation is done, together with such auxiliary parts as a screen, pressure fan, and machinery for oscillating the table. The table is in effect a shallow box of approximately tri-

angular shape, with a slight slope lengthwise toward the point and a sharp slope sidewise. The surface is formed with a series of grooves running longitudinally of the table, each about 1/4 in. in depth and width, and equipped with small perforations along the sides. A toggle mechanism gives the table a reciprocating motion, the backward stroke being much quicker than the forward stroke, so

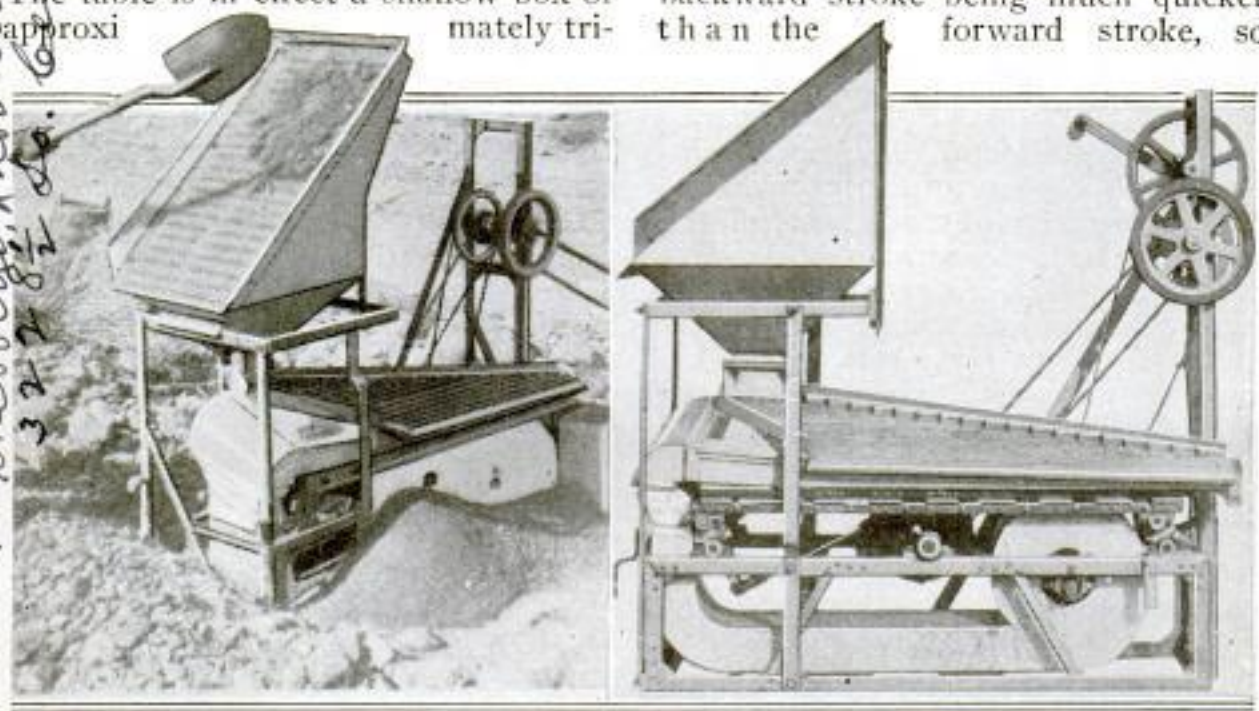

Placer-Working Machine That Uses Air Instead of Water in Separating the Valuable and Worthless Materials

191
Cook: Herbert A. McGraw, 825 W. 178 St. = N.Y.C.
Inventor: W.H. Stebbins, 200 Angles, Calif. (Mining engineer)
327 8 1/2 St. Central Park

Wm. J. & Crane, Milwaukee, Wis.
Michl.

W. J. McHale,
516 -- 12 Ave. S. E.
Minneapolis, Minn.
587
19577

that any bit of material held in the grooves is gradually moved toward the point. Mounted above the table is a hopper, and above this is an inclined screen. The material is cast onto this screen, which removes the larger stones and prevents them from reaching the table, while the smaller material falls through the screen and hopper to the table. Here it spreads out and as the table is oscillated the lighter and worthless portions are shaken off over the side while the heavy portions such as gold and sulphide settle into the grooves and are gradually shaken to the end and deposited in a receptacle. This action is assisted by the fan, which forces air under light pressure through the perforations into the mass of material and keeps it in a loose condition.

THREE-COMPARTMENT RUBBISH CAN

Intended especially for use in cities where the health ordinances prohibit the mixing of garbage and ashes and necessitate the maintenance of separate disposal receptacles, a three-compartment, ventilated rubbish container for household purposes has been designed by a Cincinnati inventor. It is made throughout of metal and is not at all unlike a camp stove so far as appearances are concerned. The refuse is held in metal boxes which fit into the compartments. Separate covers on the top of the device allow the deposit of the waste materials, while side doors are provided for the removal of the cans. A small box built on one side offers a place for disposing of waste paper.



80

ODD SIGNAL WARNS TRAFFIC OF LOWERED ARCS

As a means of safeguarding against accidents occurring when street arcs are lowered at intersections, a lighting company at Minneapolis uses portable signal standards to warn drivers and lessen chances of collisions. One of these devices consists of a light, substantial tripod supporting an upright rod which carries two signal flags set at right angles to each other. These, like the rest of the contrivance, are made of metal. Each bears a large red spot on a white ground, enabling it to be seen for some distance. When an inspector wishes to clean or insert fresh carbons in a lamp, he places the signal in the street at the point where the arc will hang when lowered.



RAPID READING IS TAUGHT BY SIMPLE MACHINE

For the purpose of assisting persons who read slowly to cultivate the habit of assimilating the contents of a printed page or column with greater rapidity than is their custom, a Boston professor of psychology has developed an interesting machine which schools one in the proper way of reading. It is of simple construction, and in experiments has been found to produce good results.

Near the top of a reading board is an oblong slot which is only wide enough to display one line of printed matter to the reader. A newspaper clipping of single-column measure is inserted at the back of the board and engaged between two rollers, which draw it up-

Designed & used by
Prof. of Psychology at the
Boston Normal School
Caleb A. Scott.

Made by Minneapolis General Electric Co.

James Kilgus,
The Traveler, Boston, Mass.

Wm. Alex J. Roeh,
Healme Ave., Woodville,
Cincinnati, Ohio.

ward one line at a time as a crank, fixed in the base, is turned. By means of an auxiliary device, only one-half of a line is shown at a time. A metal

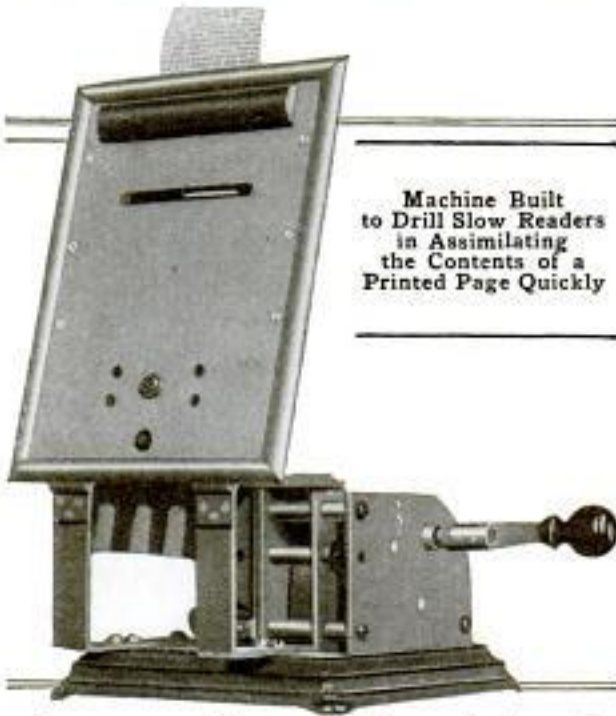

Machine Built to Drill Slow Readers in Assimilating the Contents of a Printed Page Quickly

piece covers first one side and then the other of the opening, exposing the first words of a line for a fraction of a second and then veiling them while the other part is uncovered.

A person with normal eyesight and mental faculties should be able to read approximately 300 words of light matter a minute. A great many persons do not read thus rapidly, however, because they have acquired a habit of pausing and looking back at words instead of moving their eyes only once in scanning a line. It has been shown that a slow reader gains from 50 to 100 words a minute after practicing with the machine.

ELECTRIC-LIGHT BULB USED AS PHONOGRAPH NEEDLE

Quite an ingenious, although a somewhat ludicrous, substitute for a phonograph needle was discovered recently by a number of bluejackets at the United States naval station at Guantanamo Bay, Cuba. A group of the sailors had ordered a talking machine from the States. When it arrived they were chagrined. There was an abund-

ance of records but not a needle to be found. They were bemoaning their plight when a sailor climbed on deck carrying a number of electric-light bulbs. Out of curiosity he started the phonograph and pressed the tip of one of the lamps against a record. The sound of a popular song rang out clearly. For days the machine was played in this way.

LARGE STEEL TACKLE CASE FOR LONG FISHING TRIPS

Providing ample space for carrying all the accessories required on an extended expedition, a steel tackle box has been brought out for fishermen which is built in a convenient form. It is designed especially for sportsmen who desire to carry a full equipage and keep it assembled in one case. It is slightly more than 24 in. in length, 9 in. high, and 6 in. wide, and affords adequate room for a number of disjointed poles of standard size. The bottom space is sufficiently roomy to accommodate landing nets, gaff hooks, hats, a raincoat, a flask, bottled bait, and similar things. The box is fitted with two metal trays, each of which is divided into small compartments. The upper of these receives small flies, leaders,

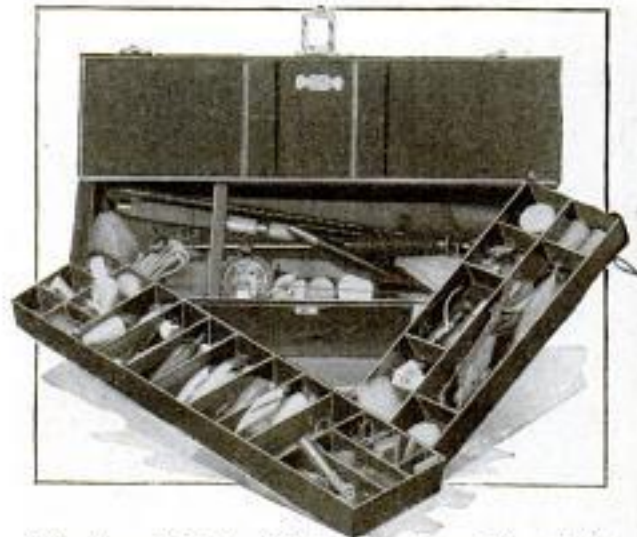

The Case is Made with Double Seams Electrically Welded and Reinforced

wobblers, and wooden minnows, while the lower one provides space for tackle, various sizes of reels, large minnows, and other equipment.

Kennedy Mfg. Co. 14 E. Jackson Blvd., Chicago

210

Ralph W. Larson, U.S.S. Decola, Naval Station, Guantanamo Bay, Cuba

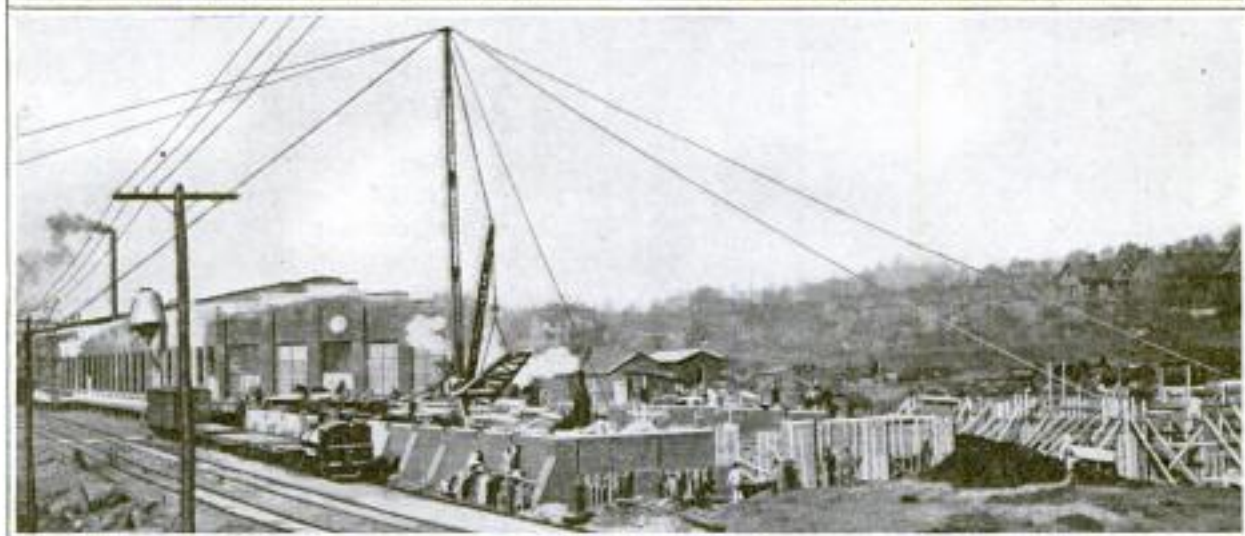

Large Arms and Ammunition Plant at Bridgeport, Connecticut, Where Scores of Buildings Are Still in the Course of Construction

**GREAT WAR-MUNITION PLANT
 IN COURSE OF ERECTION**

280 Europe's unprecedented demands for munitions of war have caused the hurried construction of a number of large ammunition and arms plants in the East, and the enlargement of others. One of these is at Bridgeport, Conn., where scores of factory buildings have been erected by one corporation on a site embracing some 102 acres of land. Substantial structures, already completed, if placed end to end would stretch a number of miles in length. These have been built since the opening of hostilities abroad. Much attention has been directed at this plant of late because of the recent outbreak of labor trouble there, concurrent with attempts to wreck the Capitol at Washington and destroy vessels sailing for Great Britain. The disturbances, which were attributed to the activities of German agents, for a period threatened to seriously cripple operations at the factory by tying up construction work.

**RUBBER PAVEMENT IN USE
 IN LONDON STREET 9853**

Rubber is being experimented with at London as a surfacing material for pavements, and aside from providing a perfectly noiseless, resilient, and non-skidding roadway it appears to possess good wearing qualities. A stretch of this pavement has been in use in the Old Kent Road for nearly a year and has been subjected to a traffic that amounts to approximately 90 tons to the square foot each hour in every twenty-four. It is built up with wood blocks finished with a cushion surface of rubber that is secured firmly in place by dovetailing. So far the roadway bears no noticeable indication of wear or injury, it is said, while a wood-block pavement adjacent to it, which has been subjected to a like traffic during the same period, has lost 1/2 in. in thickness. The use of rubber in this capacity is purely experimental, and whatever merit it may have remains to be proved.

Rubber Traders Association
 1 Oxford Court, Cannon St., London E.C.

A. Bonnin, Secy.
 Metropolitan Board of Works, London, Eng.

"The Valor World"
 Daily Telegraph

Cowt: J. E. Houlihan, Albert Lea, Merin.

Sale by: ⁵⁹⁰ Albert Lea Gas Light Co, Albert Lea, Merin.
POPULAR MECHANICS

FUEL TANK FAR REMOVED FROM GASOLINE STOVE

Because of well-defined fears, many persons have an inherent aversion to danger. In an attempt to engineer around this recognized feeling and thereby open a larger commercial field for stoves of this kind, an inventor has developed a gasoline range which receives its fuel under pressure through a small, hollow copper wire, allowing the gas tank to be kept as far from the stove as may be desired by any user. It has essentially the appearance of a gas range and eliminates the common objection of having a gasoline tank supported above, or adjacent to, its burners. Because of the small size of the feed wire it would be almost impossible for more than a teaspoonful of gasoline to be in the stove.

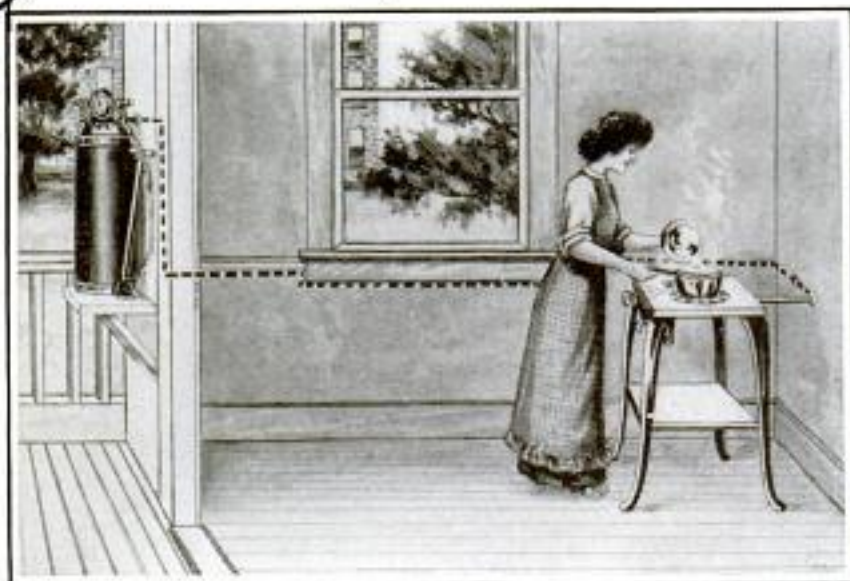

The Gasoline Tank may be Kept a Hundred Feet from a House if so Desired

the use of gasoline stoves, and suffer inconvenience rather than subject themselves to what they consider to be

small size of the feed wire it would be almost impossible for more than a teaspoonful of gasoline to be in the stove.

184 DELIVERY VEHICLE BUILT FOR MOTOR-CAR BODIES

For delivering motor-car bodies to assembling plants, a Detroit manufacturing company has developed a truck and trailer for its own use which is divided into 10 open-end compartments. Two touring or roadster bodies can be carried in double-decked compartments back of the driver's seat on the truck, while similar spaces are provided for eight others on the trailer. The upper-deck flooring is built in sections and secured to angle irons bolted to the sides of the partitions.

This arrangement makes it possible to remove the upper shelvings and furnish adequate space for limousine bodies. Sufficient room is allowed between the truck and its trailer to permit the driver to make as sharp turns as may be necessary.

CA recently patented watch crystal, said to be unbreakable, consists of a disk made of celluloid or other elastic transparent material, and sprung into an undercut groove in the watch bezel.

By Removing the Upper Shelvings, Sufficient Space is Provided in the Compartments for Limousine Bodies

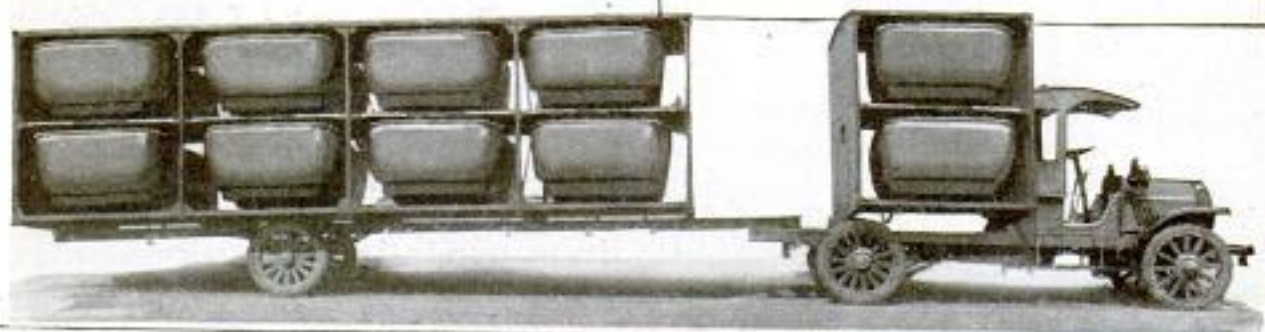

Fisher Body Co., Detroit, Mich.

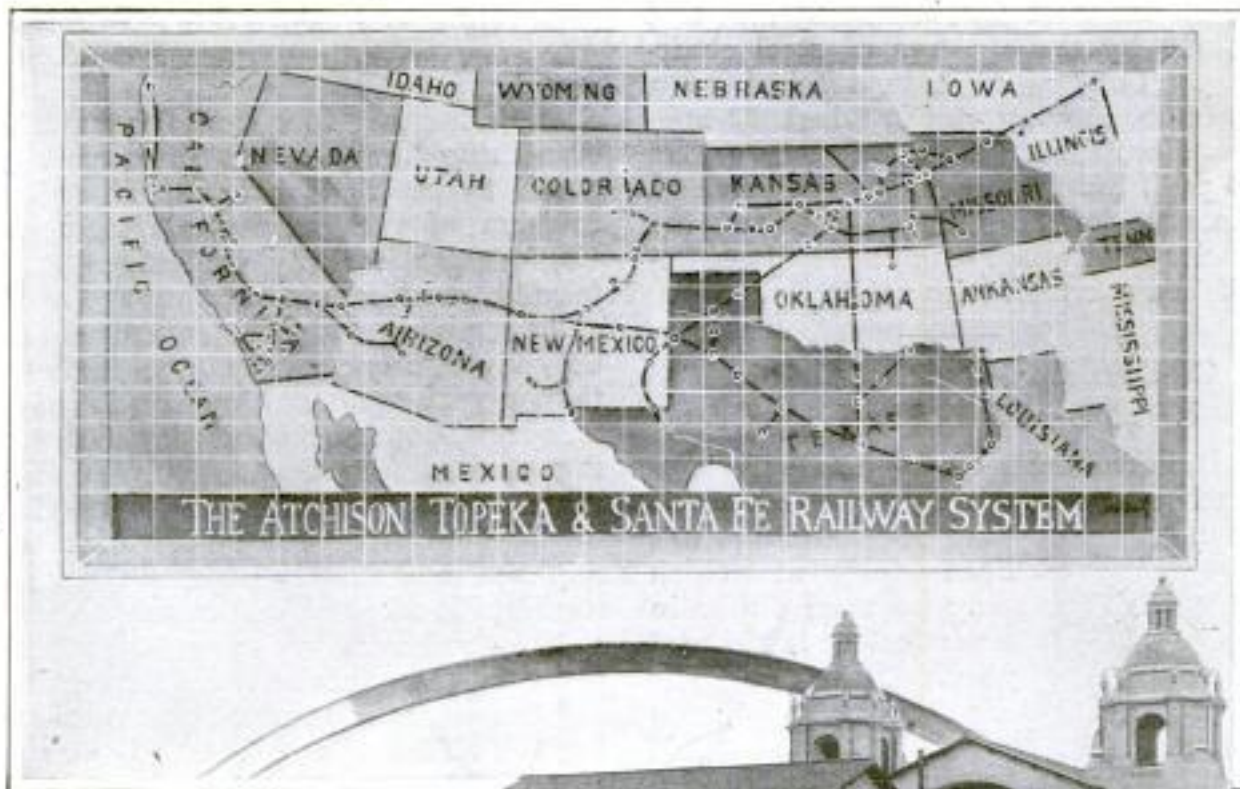

The Tile Railway Map Shown Above is Fixed to One of the Walls of the Patio at the New San Diego Station Pictured Below



9968
RAILWAY SYSTEM IS SHOWN ON LARGE TILE MAP

On one of the court walls of the Santa Fe Railway station at San Diego, Cal., is a colored map made of tile which shows the various lines of the system. It is approximately 14 ft. by 7 ft. in size and is composed of some 360 separate pieces of specially designed tile. The various states from Lake Michigan west to the Pacific coast which are traversed by the railway are outlined in colors and the points representing their principal cities marked with small incandescent bulbs which are illuminated at night. The station, which was lately completed, is of Spanish colonial architecture and finished in plaster. One of the features of this structure is its patio, 150 ft. in depth, which is surrounded by heavy columns and provided with a massive, triple-arch entrance. The court forms an airing place for travelers waiting for trains.

LOADED MOVING VAN TOWED BY MOTORCYCLES 9490

As a means of demonstrating the pulling power of their engines, two motorcycles were recently harnessed together and made to perform quite a striking feat at Bridgeport, Conn. The



Sixty-Two Men Packed the Wagon, Which was Drawn 28 Miles

*James H. Burroughs,
 866 State St.
 Bridgeport, Conn.*

machines were placed side by side and joined by three pieces of steel shafting. They were then hitched to a 2,600-lb. moving van in which 62 men were crowded. With this heavy load to pull, the motorcycles were driven a distance of 28 miles. Both of the cycles were stock machines and accomplished the task with ease.

— 9306 —

COUNTERBALANCED POLE NEEDS NO STEEPLEJACK

Built so that it may be easily lowered when repairing or painting is required, a flagstaff for buildings has been designed which may be used either in a vertical or horizontal position, as occasion dictates. The pole is pivotally mounted between two heavy uprights which form its support, and is counterbalanced by weights at the base. The supporting brackets are mounted on steel beams placed at a height which brings the axis of the staff level with the top of the fire wall of a building. This enables the pole to be used horizontally. When work is to be done on it, the pole is swung backward. It is made both of steel and wood, and in sizes up to 50 feet.

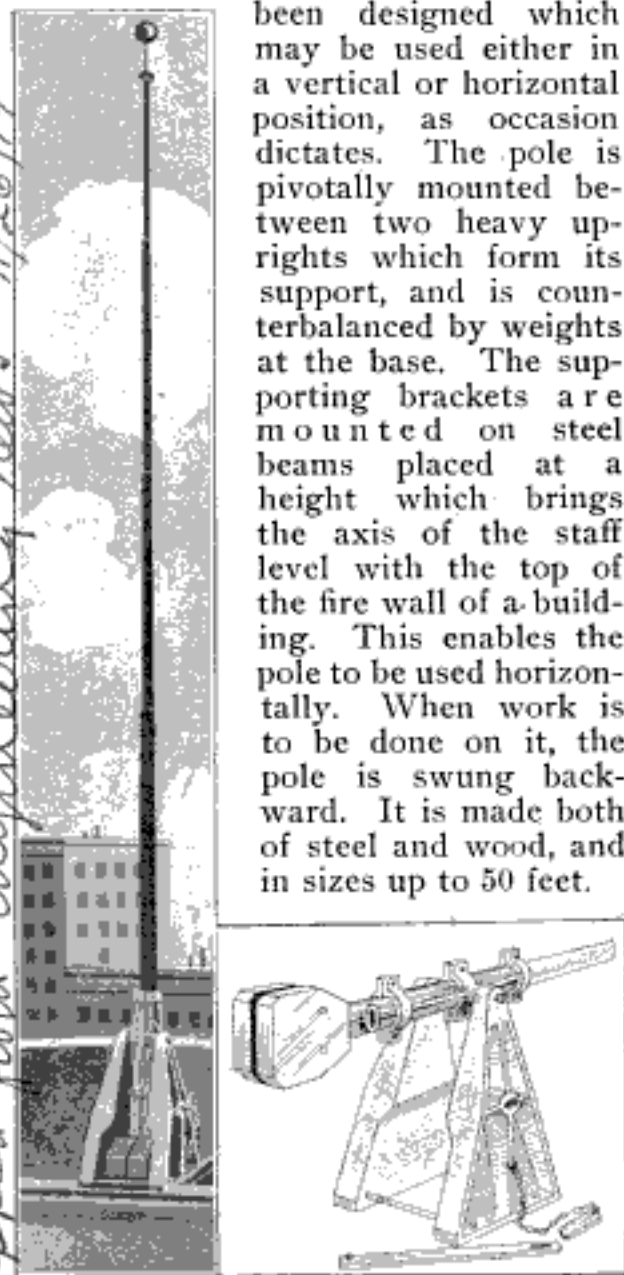

The Pole is Held Securely in a Vertical Position by a Locking Bar That Passes through It and the Standards

Engineering Record

RETRACING RAILWAY PLANS IS FOUND UNNECESSARY

5/29/14

In attempting to escape the expense of making new tracings of maps and plans to be filed with the valuation division of the Interstate Commerce Commission, railway companies have found a quick means of doing the work and complying with the demands which they vigorously protested against more than a year ago. A blueprint is made on special paper from an original drawing to be reproduced. This is then placed, face down, on a smooth gelatin surface with the result that the material immediately beneath the tracing lines is affected and caused to rise. When the blueprint is removed an ink roller is passed over the gelatin, inking the fine raised lines, but not touching the rest of the surface. A piece of tracing cloth is then pressed lightly on this mat. When removed, the impression on the cloth is an exact duplicate of the original tracing.

Engineering Record

CONTRACT FOR STATE ROAD GIVEN TO MUNICIPALITY

6/5/18

The town of Southampton, L. I., has appeared in the rôle of a road builder. It has been awarded a \$113,000 contract for the construction of a state highway between its limits and Quogue. The situation is an interesting one, but is not without precedent. The municipal corporation placed its bid for the work in competition with private contracting companies, setting the lowest figure, and winning. One of the reasons that led the city to undertake the project is that the work will provide employment for many of its unengaged laborers. Southampton also controls some of the best gravel beds in that vicinity.

Announcement has been made by the Federal Horticultural Board that an attempt will be made this winter to inspect and certify Christmas "greens" cut in districts infested by the gypsy moth, so as to allow shipments of clean stock to be made.

Inventor: Elmer E. Carr, 237 Insurance Exchange Bldg. - Chicago.
 Clipped from "Engineering News" 11/26/14

Year Book (1914) Dept. of Agriculture

232

8543

**NO SERIOUS MENACE SEEN
IN IMPORT OF BEEF**

During the last 15 years the beef-export trade of Argentina has made a remarkable development. An investigation of that country's meat production, especially from the standpoint of its effect upon the domestic industry, has recently been completed by the Department of Agriculture. The conclusion reached by the Federal men is that the rapid advance of the republic's beef-shipping business has been brought about by the sharp decline in the surplus production in this country. Although approximately 154,000,000 pounds of meat, of which 140,000,000 lb. was refrigerated beef, was imported from Argentina during the year ended Sept. 1, 1914, the Bureau of Animal Industry does not consider that native producers need fear the effect of this competition for some time to come. On the other hand, it is believed that there will be a beneficial effect arising from a demand for breeding animals. At the present time Argentina ranks next to Australia in the number of sheep, and fourth in cattle.

**HANDY SPOOL HOLDER FOR
CROCHETING 6476**

A handy little device for holding the spool of floss or cotton while doing crochet work, recently brought out in France, consists of a small metal disk with a central loop of wire attached by a swivel hook to a bracelet. The wire loop opens easily to pass through the hole in the core of the ball of thread, the disk keeping the ball from slipping off. Thus the ball is always safe, and close to hand, while it interferes in no wise with the freedom of the hand or arm.



**FIRE-LIGHTING DEVICE MADE
FOR COAL STOVES**

Designed to be used in stoves, furnaces, and other heating apparatus, a fire-kindling device has been invented

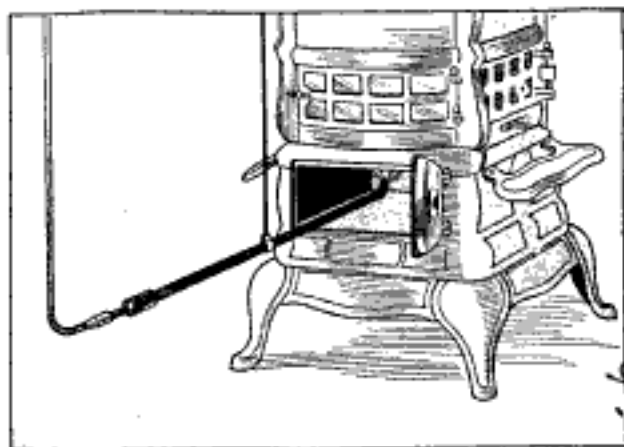

Gas Torch Which Starts a Furnace Fire Quickly without the Use of Kindling

which eliminates much of the trouble of rebuilding a fire which has burned out during the night. The lighter is arranged much on the style of a gas torch. It consists of a pipe of convenient length, at one end of which is a gas burner and at the other end a nipple to which a rubber hose may be connected. When it is desired to start a fire or prevent one from dying out this burner is lighted and the torch placed beneath the furnace grate in such a position that the gas flame comes in contact with the coal and ignites it. During the spring and early summer when a light fire is needed for a couple of hours each morning to take the chill out of the rooms of a house, several bricks may be placed in the fire bowl of a furnace and gas heat used exclusively.

**BINDER CLIPS FOR FILING
PAPERS AND PAMPHLETS**

For securely binding loose papers, a series of pamphlets, or similar things preparatory to filing them, a steel spring clasp has been invented, which, once set in place, maintains a firm grip on whatever it holds. For heavy service such as binding several volumes of a magazine, the grip is made U-shaped

J. M. Buckley, (Inventor & Manufacturer)
1611 Beacon Blvd.
Kansas City, Mo.

8205

with a broad mouth, while for clasping letters, papers, or clippings, it is triangular. The jaws are drawn apart with specially designed pliers which operate by a ratchet action. On the flat side, or back, of the binder are "L. E. B."

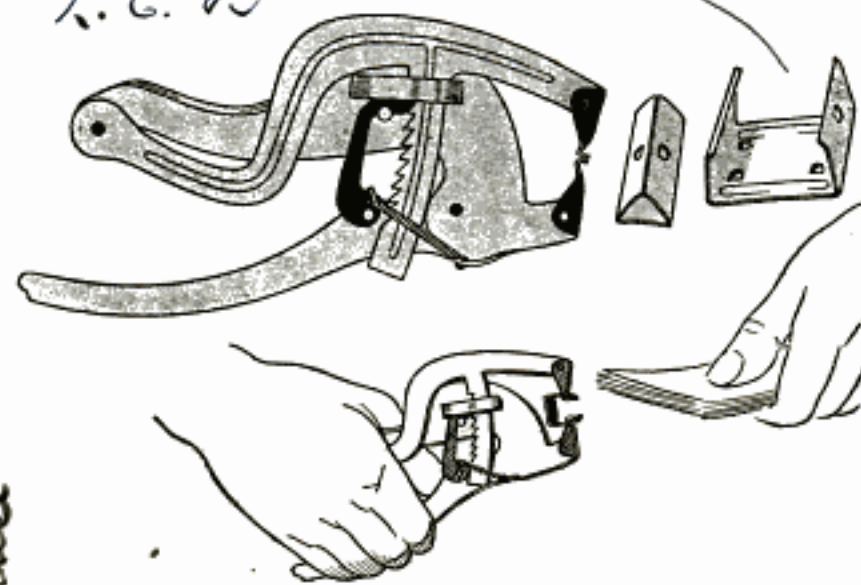

Steel Binders and the Pliers Used in Opening Them

small clamps for the insertion of an index card. Once in place, the grip can only be removed by using the pliers.

9074 —
ODORLESS PORTABLE STOVE FOR CAMPING PURPOSES

Designed particularly for the use of motor tourists and campers, a small portable stove has been brought out in France which may be carried very conveniently and without any danger of injuring, through the leakage of oil or odors, anything which may be packed with it.

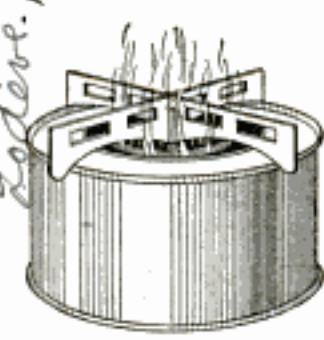

The fuel, which is in the form of a paste of solidified alcohol, is contained in a cylindrical box that forms the base of the stove. When ignited the material burns with an intense heat, but is neither explosive nor productive of strong odors. When the flame is extinguished the paste again solidifies.

for sale by quincaillerie of
 Georges Heuserot
 39 rue de Clignancourt
 "all dealers" Paris

COAST-SURVEY EQUIPMENT TO BE INCREASED

For new vessels to be used by the Coast and Geodetic Survey in charting the coasts of the United States, Alaska, the Philippines, Hawaii, Guam, and Porto Rico, the secretary of commerce has asked for an appropriation of \$500,000. The importance of the work is shown by the fact that a wire-drag party organized on the Atlantic coast in 1906 has, in the succeeding eight years, found 3,300 rocks with less water over them than was shown on the navigation charts, and that 393 of these were distinct menaces to navigation. On a 41-mile stretch

in Alaskan waters, 14 uncharted pinnacle rocks were found by the same method. In the last 11 years, 30 wrecks, with a loss of 61 lives and \$2,000,000 worth of property, have occurred on the Alaskan coast alone on account of the badly charted waters.

187
CAMPAIGN TO LESSEN LOSS IN HANDLING EGGS

In an effort to reduce the tremendous annual loss of eggs due to needless breakage, and other causes, the Department of Agriculture recently equipped an egg and poultry demonstration car and sent it through the Southwest, inaugurating an educational campaign aimed at farmers, retailers, and shippers. Representatives of the Bureau of Chemistry undertook to show simple ways in which material savings might be effected by the exercise of care and intelligence.

In addition to demonstrating the proper methods of refrigeration, candling, handling, packing, and transporting of eggs, special effort was made to induce farmers to candle and grade

"Marine Journal"

187

Information taken from book issued by U.S. agric. Dept.

Francis P. Mann - 12 Boulevard Arago, Paris, France.
 Société Française des Produits "Cof" Solèr.

"Motor Age"

C. F. Harwood, Boston, Mass

eggs before going to market, and then dispose of them according to their quality, rather than in bulk at a set price. The difference in the keeping qualities of fertile and infertile eggs was another point emphasized. The advantage of gathering eggs immediately after they are laid and storing them in cold places was also demonstrated.

7540

NEW INK ERASER USES PREPARED FIBER

In a new ink eraser that has just made its appearance on the market the work of removing the ink is done by a compact bundle of prepared fibers carried in an aluminum holder.

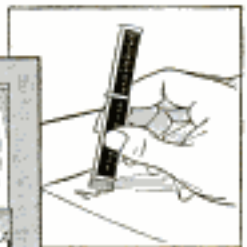

The holder is so made that the fibers are easily fed down as required by wear, or other conditions. The eraser is designed to be used for ink of any kind, and if rightly employed will not seriously mar the finish of paper.

8425

COLLAPSIBLE STOVEPIPE FOR CAMPING TENT

Intended for use in tents, a collapsible stovepipe has been devised which may be folded into a compact space and carried by campers without inconvenience. It is composed of a series of telescoping sections which nest one within the other when the pipe is not in service. One of these segments is provided with an insulating jacket to protect the canvas, through which it passes, from excessive heat. This same member is also supplied with a fastening device by means of which the pipe may be secured to the tent pole or some other fixed object adjacent to the roof of the tent.



CIGAR LIGHTER AND CUTTER FOR AUTOMOBILES

A combined electric cigar lighter and cutter has been brought out for use on motor cars. The cutter is operated by a button that projects from the side of the case, and the act of pressing this button turns on the current and sets the lighter going. When the button is released the current is automatically turned off.



8644

EXTENSIBLE WIRELESS MAST FOR SUBMARINES

An extensible mast for wireless operation that may be folded down on the deck so that it does not interfere with the operation of the vessel when submerged has been brought out by a German company for use on submarines. The mast consists of two parts, the upper part being made to slide on the lower part. The upper part is raised or lowered by means of lines running over pulleys, as shown, and operated by a crank arm within the submarine. The lower part of the mast is carried on bearings and may be raised to a vertical position or laid flat on the deck by means of a worm gear which meshes with a quadrant fixed to the base of the mast, and which is also operated by a crank arm within the submarine.

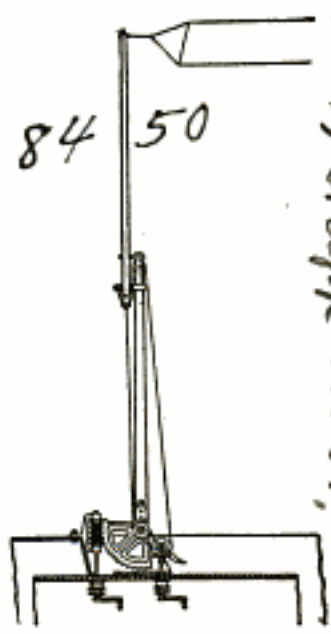

8450

Continental Mfg. Co.
302 Kansas City Life Bldg.
Kansas City, Mo.

Patented: Thomas M. Hopkins,
Denver, Colo.

Clipping from foreign paper - Mr. Mann
Friedl, Knapp N. S., Essen, Germany.

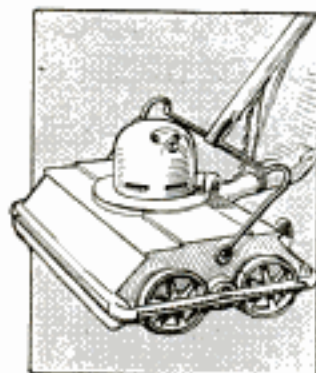
NOVEL AND PRACTICAL THINGS
FOR THE HOMEVacuum Attachment for
Carpet Sweeper

is intended to be attached to an ordinary carpet sweeper. Twelve-inch nozzles are fitted in front and back of the rotary brush, the motor is mounted on

Convenient Book Rest
for an Armchair

Designed particularly for use in a private library, a neat metal book rest is being made which may be fastened to an arm of a chair and adjusted to whatever angle best suits a reader. The supporting bracket is also pivoted to the clamp so that the rack may be turned freely.

Electric Flatiron with
Headlight

a new electric flatiron is a 4-cp. lamp fitted with a small reflector which throws light directly onto the board. The chief convenience of this is obvious. Aside from the major function, however, the lamp serves as a pilot light and is especially serviceable when used

²⁸⁶
OPERATED by a compactly housed electric motor, an ingenious vacuum-cleaning device has been invented which

top of the sweeper, and a dust bag is secured to the handle. By making the installation, a vacuum sweeper capable of removing both dust and lint from a carpet or rug is provided at moderate cost.

Mounted on the fore bracket of the handle on

in a room having only one outlet, or socket.

To prevent the soiling of one's fingers when asparagus is eaten, a holder has

been designed which need not arouse a person's self-consciousness when it is used. Three rings attached to folding prongs allow for the insertion of the thumb and two forefingers of the right hand.

Neatly Designed Asparagus
Holder

For sharpening carving knives, when it is necessary, at a table, and doing the work both

Sharpening Device for
Carving Knives

quickly and satisfactorily, a convenient device has been introduced to take the place of the ordinary "steel," which a novice often experiences difficulty in using. It is provided with a pair of beveled steel wheels be-

tween which a knife blade is drawn once or twice.

Intended for travelers, a toothbrush with a folding handle is so designed that the bristles are incased when not in use. The end of the handle is enlarged and hollowed, enabling it to fit securely over the brush when folded down.

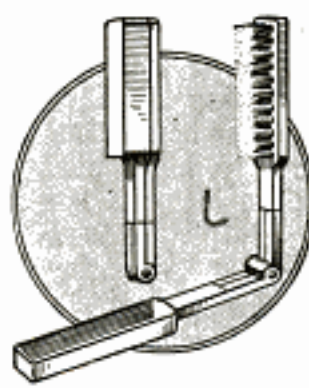
Folding Toothbrush for
Use of Tourists

Designed as a silent alarm, suitable for use by deaf persons, a wrist watch which is capable of awakening a person without disturbing the other occupants of a house, has been introduced. It has concentric dials, the inner of which is used for setting the alarm. A small-sized cord that encircles the wrist or ankle, when the watch is strapped in place, tightens at a predetermined time and awakens the sleeper. The device performs an especially convenient function when traveling.

To protect a baby from rain, dust, and chill breezes, a windshield has been designed for use on perambulators. It is made of celluloid and is held in position by detachable upright pieces. When these are removed the shield may be rolled and tied neatly at the front of the carriage.

Serving either as an auxiliary heater for spring

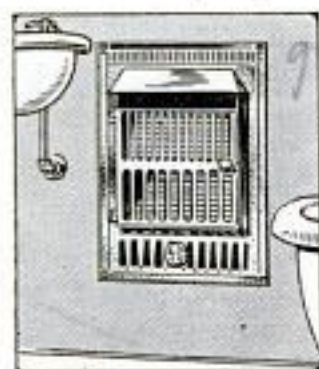

Gas Heater for Bathroom Purposes

or fall use, or as a permanent one, a gas wall radiator is made which is serviceable in a bathroom. It is set approximately a foot and a half above the floor and has the appearance of being a hot-air register. It has a



Wrist Watch That Serves as Alarm Clock



Windshield Protects Baby from Exposure

corrugated copper reflector and a deflector which radiate the heat and give

a pleasing lighting effect.

Invisible door hinges have been invented. They are made up of a number of leaves, mounted on friction bearings, which move in or out of a door and casing as the former is opened or closed. It is only when a door is open that the hinges can be seen.

A spring hook for hats and coats is made which remains flush with the wall when not in service. The chief advantage of the device is that it may be used in places where ordinary hooks are unsightly. When an article is removed, the hook rises to a vertical position of its own accord.

Patent rights have been allowed an eastern inventor who has devised an adjustable muzzle for dogs. It is made so that in a moment's time it may be fitted to the face of an animal. Most muzzles are rigid and made after one set pattern, which frequently means that a dog is forced to wear an ill-fitting contrivance which is a source of constant irritation.

Business interests have appealed to the postmaster-general of Great Britain urging penny postage with France, Belgium, and other allied nations.



Hinges Are Invisible When Door is Closed



Sightly Hook for Coats and Hats

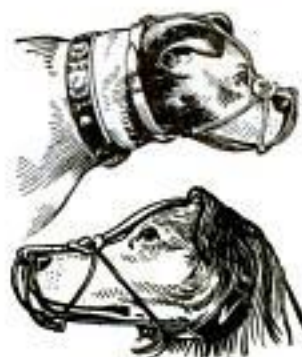

This Muzzle may be Adjusted to Fit Any Dog

FOLDING ORCHARD LADDER FORMS STAGING

A combination ladder, stepladder, and scaffolding has been invented which is intended particularly to be



used in orchards for fruit picking. When a staging is wanted, the device may be extended in such a manner that a platform 6 ft. in

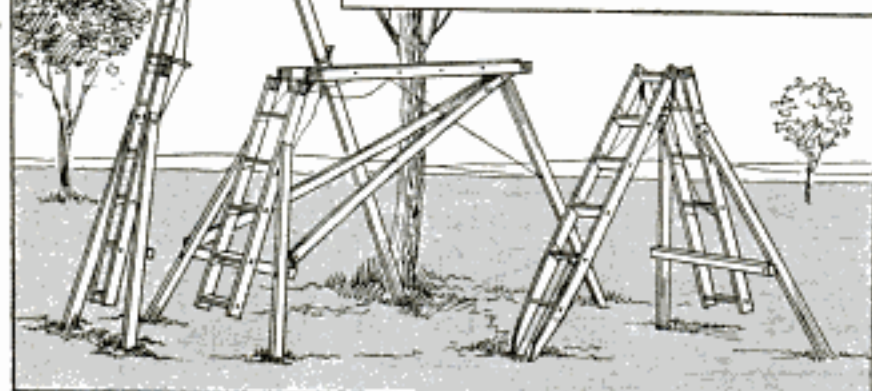

This Shows Three Different Ways in Which the Ladder may be Extended and Used

length is provided at a height of 6 ft. from the ground. When it is necessary to reach the top of a tree, a simple adjustment provides a 12-ft. ladder. When not in use, or when being transported, the apparatus folds so that it is 6 ft. long, 14 in. wide and 9 in. deep.

MID-OCEAN SUNSET IS SEEN ON NIGHT AERIAL FLIGHT

In a recent night flight over San Francisco, an airman climbed to an altitude of approximately 6,000 ft. in a biplane and witnessed a mid-Pacific sunset in the vicinity of the Hawaiian Islands. At 8:45 o'clock he lifted from the ground and made the climb in about 15 minutes, reaching the vantage point an hour and a half after the sun had set at San Francisco. He clearly saw the sun dropping low across the sea, while California, below him, was in darkness.

The feat, although a most interesting one, was in no way contrary to what was to be expected. The sun travels at a rate of one-fourth of one degree a minute. In 1 hour and 30 minutes this would amount to 22.5°. Honolulu, roughly speaking, is 28° west of San Francisco, which gives an idea of the position

at which the sun was setting when the airman saw it. From a height of one mile it would be possible for a person to see a Honolulu sunset from the Pacific Coast, although in this instance it was not yet twilight in the Hawaiian group.

PROCESS FOR DETECTING FORGED PRINTS

For detecting forgeries of engravings and other prints, a new process has been invented and patented that makes it possible to detect the slightest deviations of a suspected print from one known to be genuine. In carrying out this process a transparency of the genuine print is made by a photographic process on a reduced scale, and from this a second transparency, approximately the size of the original, is made. This transparency is a positive, the light and dark lines and spaces corresponding to the light

and dark lines and spaces of the original. A small transparency on the same scale as the first one made of



When the Negative Transparency of the Suspected Print is Projected on the Positive of the Genuine Print, the Entire Area will Appear to Be Black Only in Case the Suspected Print Is Genuine

Taken from Patents Office Specifications

Inventor: H. M. Pilkington,
Arden, L.I., N.Y.

Copyrighted material

Mfr: Wenatchee Woodworking Mill, Wenatchee, Wash.

Mfr:

9759

Coul: Arch Macdonald; 280 Fee St. Oakland, Calif.

the genuine print is made of the suspected print, but this transparency is made as a negative. With the camera carefully adjusted for the correct enlargement, this transparency is then projected on the large transparency of the genuine print. If the suspected print is genuine, the dark lines and spaces of the projected image will exactly fill the light lines and spaces of the transparency, with the result that the entire transparency will appear to be black. If there is any variation between the two, as is almost certain to be the case even though the suspected print has been made by a photographic process, the two images will fail to fit at some points, and at these points the light will shine through. Owing to the unavoidable variations in lenses it is essential that the same lens be used throughout the process.

cabinet and extends over the edge of the record, supporting the needle so that it does not come in contact with

Pat 1111190 - Sept 22 1914
Pat. 527,706 1919

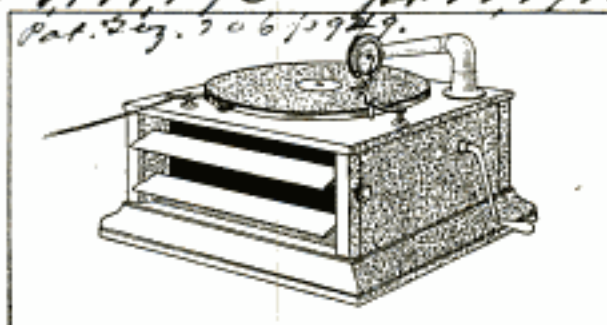

By Means of a Simple Attachment This Phonograph is Used as a Burglar Alarm

the disk. On the circumference of the turntable is screwed a small metal knob, while a string attached to the releasing lever is extended to the door or window which it is wished to guard. By raising the window, for instance, the string is pulled, releasing the turntable and allowing it to revolve. As it turns once around, the small projecting member on its rim strikes a trigger bar on the arm supporting the needle and knocks it to one side, allowing the needle to drop onto the record. A special record that will shout a warning such as "Help! Burglars!" should be used. While arousing a household it will also frighten away the prowler.

Societe des Etablissements, Mallevet & Reun, Lezins, France.

La Technique Moderne 4/14
FLEXIBLE-RING BEARINGS
INTRODUCED IN FRANCE

Rings, or tores, have been introduced by a French inventor to replace balls in bearings, and are claimed by him to embody several points which give his plan an advantage over the other. The flexibility of the rings, he asserts, eliminates trouble in case slightly different diameters are used together, which in the instance of balls would cause wear on the larger ones and immediately increase friction. It is also possible to arrange the rings so that they have an initial tension and become to some extent shock-absorbing.

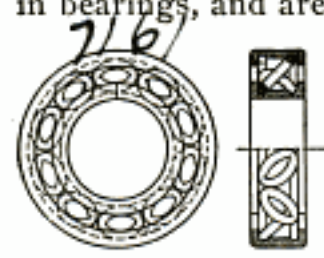

How used U.S.
TALKING MACHINE UTILIZED AS BURGLAR ALARM

By constructing a simple attachment which when fitted to a phonograph allows it to be started automatically, a Chicago inventor has devised a means of employing a talking machine as a burglar alarm. A horizontal arm is pivoted to the top of the

7995
SCREWDRIVER ATTACHMENT FOR DIFFICULT WORK

A screwdriver attachment which has recently been invented is designed to be used in close places where it is difficult to employ the ordinary type of tool. The

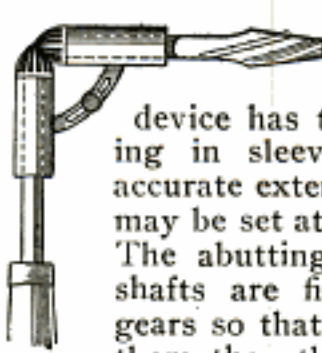

device has two shafts, operating in sleeves provided with accurate extensions so that they may be set at any angle desired. The abutting ends of the two shafts are fitted with beveled gears so that by turning one of them the other is also rotated. One of these members is shaped to receive certain types of screwdriver handles, while the opposite end of the other shaft terminates in a screw-engaging bit.

9112

cont: H. Ray Martin, 513 -- 8 St., N. E., Washington.

Inventor: J. V. Muldrow, 320 W. Palmetto St., Florence, S. Car.

FLAGPOLE MOUNTING LOWERS POLE FOR REPAIRS

The 40-ft. flagpole surmounting the fire-escape tower of a new hotel in New York City has been made so that

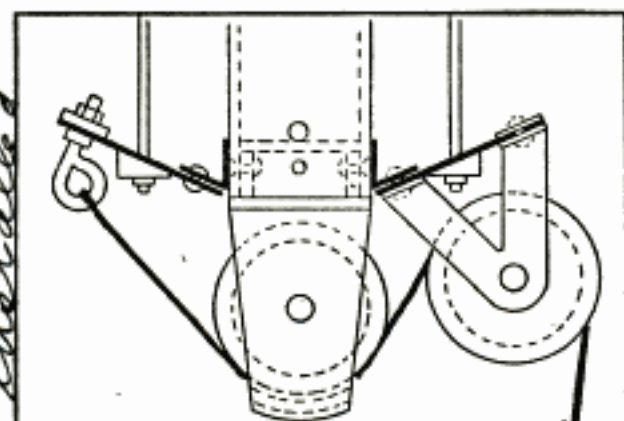

The Flagpole Slides Vertically in Two Steel Spiders and is Raised or Lowered by the Cable

it can be lowered into a hollow core at the top of the tower, making any part easily accessible from the roof and avoiding dependence on steeple jacks when the pole is to be painted or repaired. The pole is made up of sections of heavy cast-iron pipe and slides in two framed steel spiders, one of which is fixed in the roof framing, and the other a sufficient distance below to give the pole rigidity when it is raised. It is handled by a $\frac{1}{2}$ -in. cable that is attached to an eyebolt in one side of the spider, passes under a

sheave at the bottom of the pole, then over a sheave in the opposite side of the spider, and drops down within reach of the stairway below. When in raised position, the pole is held securely by a 1-in. pin that passes through the pole and bears against the sides of the opening in the lower spider.

LIGHTHOUSE IS PLANNED FOR NAVASSA ISLAND

Specifications have been completed by the Department of Commerce preparatory to the construction of a lighthouse on Navassa Island, a small, barren rock in the Windward Passage between Haiti and Jamaica in the West Indies. The point is owned by the government and the establishment of a light station there has been requested by navigators for some time, particularly those who ship through the Panama Canal. A tall, cylindrical tower is to be built of reinforced concrete on ground 250 ft. above sea level. The illuminating apparatus will consist of two four-sided lenses mounted parallel with each other on a mercury float and provided with lamps giving an aggregate of 56,000 cp. The focal plane of the lantern will be 402 ft. above the water and its range approximately 31 miles.

Information Sheet.
Dept. of Commerce.

"Technische Monatshefte" April 1914 NEW CONSTRUCTION FOR DIRIGIBLES

A dirigible airship of a new type is made up of series of elongated bal-

lonets arranged in line from the forward end to the stern, and in addition to these, there is a spherical ballonnet occupying the tapered space at each end of the craft. The framework, like that of a Zeppelin, is made of light trellised metal work.

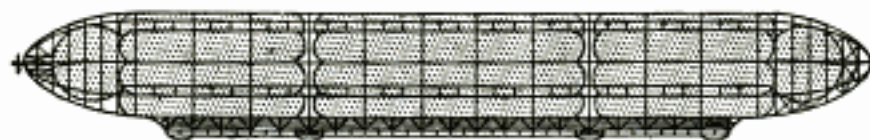

This Airship is Made Up of Elongated Ballonets Running Longitudinally of the Craft and Arranged Radially around a Central Cylindrical Framework

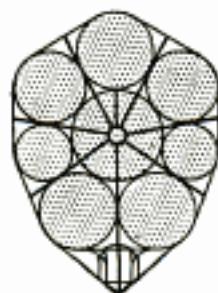

lonets running longitudinally of the craft and arranged radially around a central cylindrical framework. In the entire airship

There is an especial demand in Norway for electrically driven vehicles, due to good roads and low power rates.

Inventor Ing. Zenger
Take built by a person in Solin

Engineering Record, 2/22/14, p. 200
5th Av. New York
Designed & supervised by Francis S. Swales, architect Hotel Vancouver, in which it was installed

206

7172

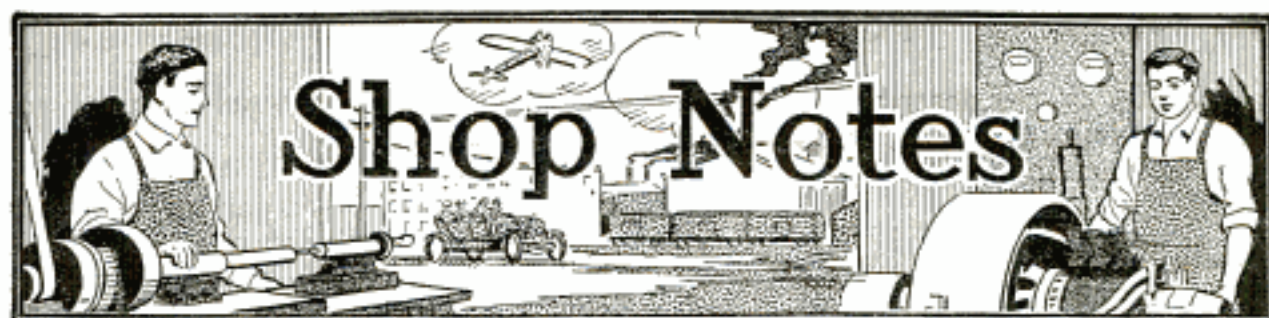

Shop Notes

Substitute for Dynamo Oil

One night I found that I had so little dynamo oil left that a burned-out bearing would be the result if the machine were run much longer. A diligent search was of no avail, and nothing but some kerosene could be found. In the medicine chest there was a large bottle of vaseline. Taking quite a bit of this, I placed it in a tin cup and heated it till it melted, then poured some of the kerosene in it and allowed it to cool. In cooling it hardened, and by adding more kerosene, I made it the consistency of thick cream. The oil cups were filled with this grease, and it gave good results.—Contributed by E. A. Gardener, Rochester, N. Y.

A Swamp Shoe

The frame is made of narrow strips of wood, the center piece being somewhat wider than the others, or a trifle wider than a shoe sole, to which a toe strap is attached. The frame is then covered on the under side with sheet metal. Such a device is a boon to duck hunters

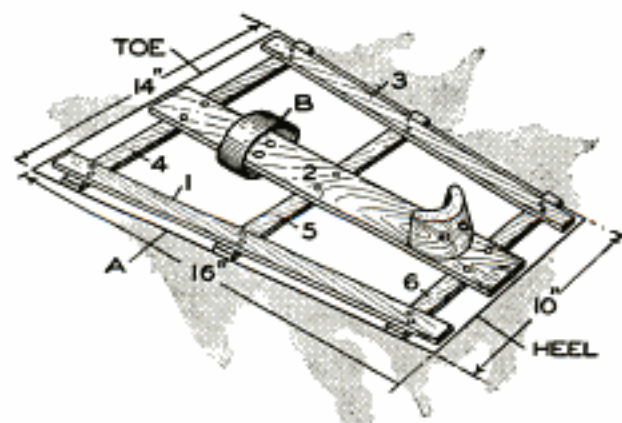

The Shoe Is Similar to a Snowshoe, and is Used to Walk in Swamps

and others that may need to travel over swamp land.—Contributed by J. C. Noble, Toronto, Can.

A Counterfeit-Coin Detector

Genuine coins will not break and are exceedingly hard to bend. Owing to this characteristic composition it is

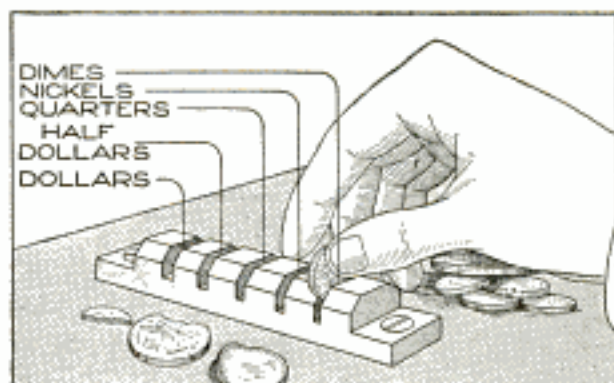

A Genuine Coin will Not Break, and It Is Exceedingly Hard to Bend

easy to provide a detector to test out the coins that appear to be counterfeit. Such a detector can be made of a piece of brass, 4 in. long and $\frac{5}{8}$ in. square. Cut off at each end a piece, $\frac{1}{2}$ in. long by $\frac{3}{8}$ in., as shown, and drill holes for screws to fasten it to a desk or other convenient place. Cut five slots about $\frac{1}{2}$ in. apart, $\frac{3}{8}$ in. deep and a trifle wider than the coins, for a nickel, dime, quarter, half, and a dollar. To use, insert the coin in the proper slot and press forward. If the coin is a counterfeit it will easily bend or snap in two.—Contributed by Maurice Baudier, New Orleans, La.

To Open Ignition Circuit Automatically When Gas Engine Stops

Considerable difficulty is experienced in the operation of gas engines with a make-and-break ignition circuit in having a run-down or discharged battery caused by the engine stopping where the sparking contacts are touching and the attendant failing to open the battery circuit. It is the object of the

automatic device described to prevent such a thing happening, and its operation, in brief, is as follows: The wiring

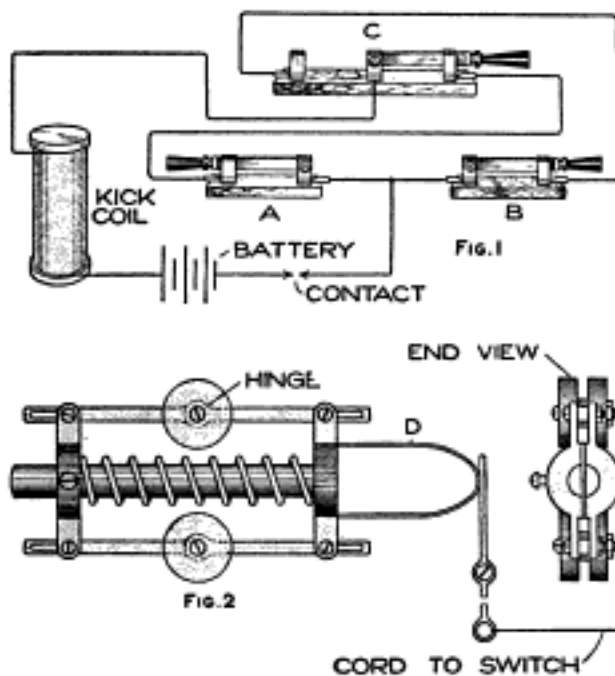

A Governor to Operate Switches in an Ignition Circuit When a Gas Engine Stops

of the ignition circuit is shown diagrammatically in Fig. 1. The two switches A and B are single-pole pull switches; that is, they are operated by pulling a small chain or cord, alternate pulls opening and closing the circuit. The switch C is a single-blade, double-throw type.

A special governor, similar to the one shown in Fig. 2, serves to operate the two switches A and B, Fig. 1. When the governor is revolving, the V-shaped piece D moves to the left and thus loosens the tension on the cord connected to the switches. When the engine stops the switches are both operated, so that if one was originally closed and the other open, the switch C will need be changed in order to close the ignition circuit again. The construction of the governor is not given in detail on account of the wide variation in requirements, but the one illustrated will work quite satisfactorily if properly constructed.

⌘The flanges, or washers, used on an emery-wheel arbor should have a slight concave to their face.

Running Motorcycle with Acetylene Gas

Gas in tanks used for lighting purposes on motorcycles can be used to advantage, in cases of emergency, to run the motor when the gasoline gives out. A piece of $\frac{1}{4}$ -in. rubber hose, such as is used for connecting up gas lamps, should be carried in the tool kit, a piece about 3 ft. long being sufficient. When it is necessary to use the gas from the tank for running the engine, disconnect the gasoline-feed pipe from the carburetor and attach the rubber hose from the lighting tank. Remove the small needle valve which is attached to the float to give the gas a free passage. It will be necessary to alter the air adjustment slightly.—Contributed by A. Dane, Pottstown, Pennsylvania.

Depth Gauge to Measure Pits in Boiler Plates

In the inspection of boilers for conditions of sheets, the discovery of pitted portions is not uncommon. In reports of boiler conditions, the depths of such pits must be exactly recorded. In making many of these report sketches, one inspector makes use of a very handy pocket depth gauge with which it is possible to ascertain quickly the depth of the sheet to which the metal has been corroded. The body of the gauge is simply a piece of $\frac{1}{2}$ -in. round steel, about $\frac{3}{4}$ in. long. The thumbscrew and needle attachment are easily fitted in drilled holes. The il-

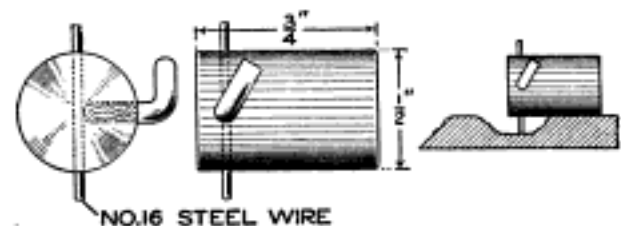

Depth Gauge Made of a Small Rod and Wire to Measure Pits in Boiler Plates

lustration of the gauge shows its application clearly.

Such measurements can be taken with a scale and a piece of wire, but wire is not always easy to find, and a

long scale cannot be used as a straightedge in many places. The gauge is something easily carried in the pocket, and can be used in almost any place on a boiler where a sheet pit is liable to occur.—Contributed by F. W. Bentley, Missouri Valley, Iowa.

To Empty a Barrel Gradually

The sketch shows a labor-saving method of emptying a barrel of powdered, or granular, material where the emptying is to be done slowly. Instead of taking out the material by scoops in order to fill it gradually into a machine hopper, for instance, the workman quickly upends the headless barrel and works it over toward the edge of the platform and the material flows to the hopper. As the barrel settles down it must be rocked

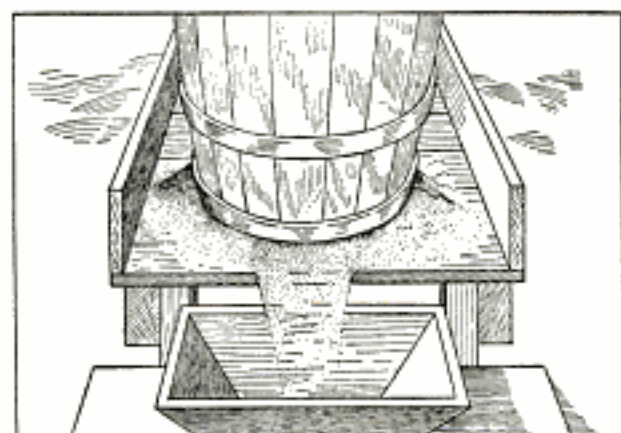

An Overturned Barrel on a Table, or Platform, will Permit Its Contents to Run Out Slowly

slightly so as to keep the material flowing. When empty, there is a small amount on the platform to be scooped into the hopper.—Contributed by J. J. O'Brien, Buffalo, N. Y.

Lawn Cleaner and Sprinkler

Caretakers of a large acreage surrounding a capitol building found it difficult to keep the lawn clear of leaves that fall from the large elm trees in autumn with the use of the ordinary hand rake. One of the men devised a special apparatus to serve as a rake and sprinkler combined. This is shown in the illustration and consists of an iron-pipe nozzle bent to direct the stream of

water parallel with the ground. The jet of water drives the leaves ahead of it and clears an acre in a short time,



The Hose Nozzle Serves a Double Purpose, That of Sprinkling and Removing the Leaves

leaving the lawn clean and well sprinkled.—Contributed by B. O. Darrow, Sacramento, Cal.

Razor Strop Made of an Old Leather Belt

Owing to the continual stretching and smoothing over the pulley face, a section of an old leather belt makes an excellent razor strop. Soak it in oil for a time and remove the grit, then equip it with a metal tip, fastened with small rivets and drilled with a hole for slipping on a swivel snap. This snap

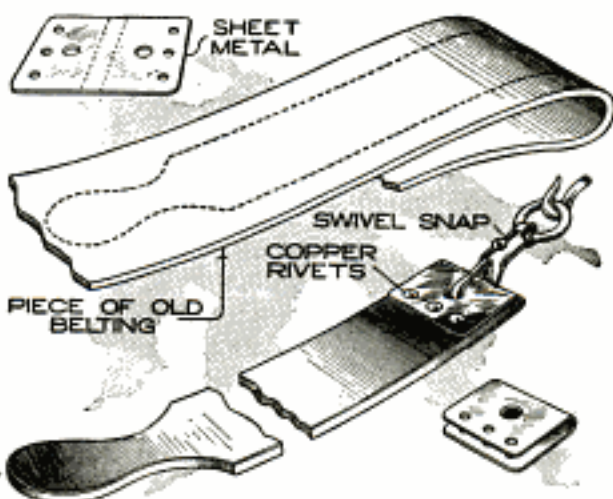

A Piece of Old Leather Belt Fitted Up for Use as a Razor Strop

makes it reversible. Rub polishing rouge on the rough side for putting on the edge, and leave the smooth side as it is for finishing.

Fitting Keys to Non-Take-Apart Cylinder Locks

With a hacksaw, cut the metal on the line A down to the rim, and bend the small strip back, as shown by the dotted lines. This will expose the plunger-pin holes. Remove the springs and plunger pins, then the cylinder plug can be easily removed. A key can be fitted by using the same pins and springs. In assembling, be sure that the strip of metal, which holds the pins and springs in place, is bent back in its original position and soldered. A tumbler-pin cylinder lock is burglar-proof and cannot be picked or operated by a skeleton key.—Contributed by William J. Tolson, Lyons, Iowa.



Tire Economy

Many old tire shoes are sold for old rubber while they still have much service in them, and some owners, who are not economical, buy protectors when an old tire could be used for the same purpose. Tires generally blow out or wear out on the tread, or road surface, long before the sides show the slightest abrasion. If the old tire, about to be sold for junk, is cut all around, as shown in the sketch, to remove the bead, it forms an outer protector, or cover, that will protect some tire already on the car which is showing signs of failure in the near future. By placing a bad spot of the cover on a good section of the tire two weak places will not be in line. Two such old tires put to-

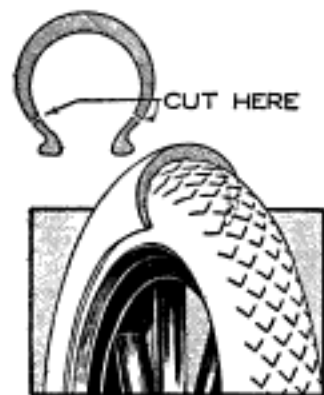

gether will last a considerable length of time.

To apply the cover, deflate the tire or remove it from the rim altogether. The latter is the easiest way, even though two persons are required and a couple of tire tools. Anyone who has applied such a cover will have no doubt of its staying on when inflated.

Distributing Oil to Wide Milling Cutters

When using a wide cutter on a milling machine, the ordinary single spout from the oil bucket directs the oil to only one place on the cutter, frequently leaving the other parts without sufficient lubrication.

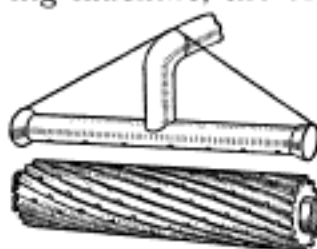

To overcome this, an oil distributor can be made from a piece of small tubing, with holes drilled for the desired number of spouts. One hole should be provided in the center to admit the spout of the oil receptacle. The ends of the tube are plugged up with corks, or wood, and the device is held in place by a wire fastened to each of its ends, and suspended from the nozzle.—Contributed by G. Jaques, Chicago, Ill.

How to Mix Lime Mortar

In mixing mortar a stronger batter will be had by adding some lime to the water used for making the mixture. A mixture consisting of 3 parts of fine sand, 4 parts of coarse sand, 1 part of old slaked lime, and some water, will make a good mortar. The very best, however, is made when the lime has been slaked and buried in the ground for some weeks, or even months. The mixed mortar can be buried, and it will prove fully as strong as cement, besides being like butter in applying it on the surface. Freshly made mortar is short and hard to apply.—Contributed by A. Kelly, Malvern, Pa.

BUILDING A HOME

By Geo. M. Petersen

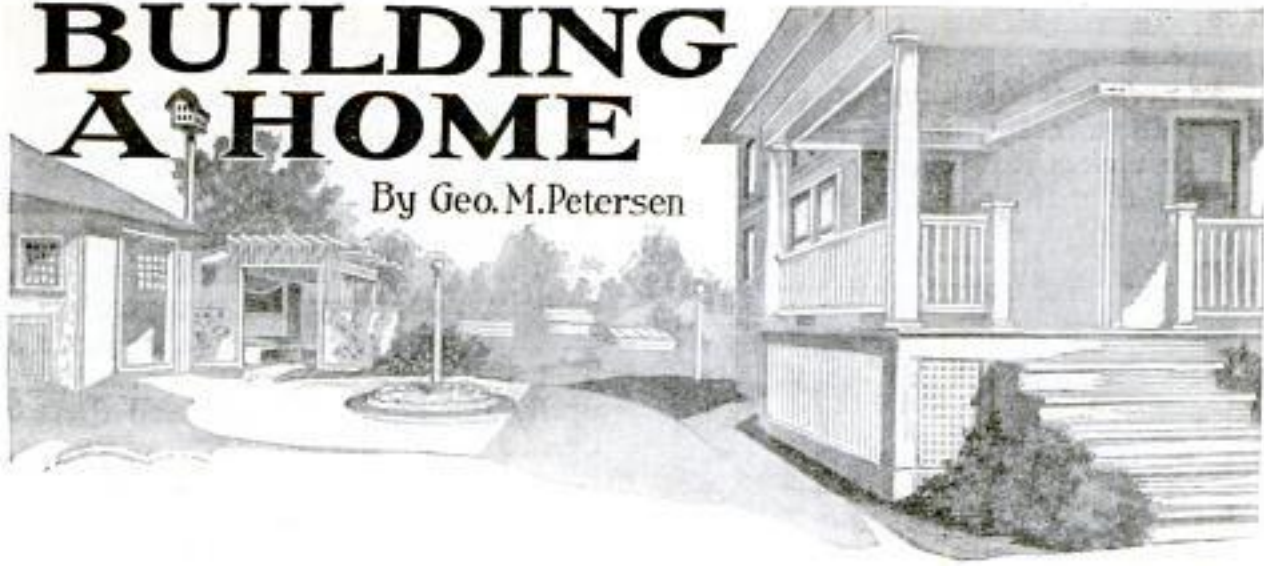

PART VII—Plumbing, Heating, and Lighting

THE average person when inspecting a home, or, in fact, a building of any kind, often neglects to a certain extent the plumbing, heating, and lighting items. In reality these branches of building construction are as important as anything that goes to make a complete job.

Plumbing

The plumbing in the average home is often improperly laid out both in point of convenience and sanitation. For example, the average kitchen sink is set far too low to make it easy for a woman of ordinary height to wash the dishes, or do other similar work, without straining her back. This feature can be readily overcome if the plumber is instructed before work is started as to the height at which the sink is to be placed.

While considering sinks it may be well to mention the subject of drain boards. While the old-fashioned maple drain board requires considerable attention and work to keep it clean and bright, it is, nevertheless, a great help in saving the china from being broken. The enameled-iron drain boards are much more sanitary but very hard on china and glassware if the housekeeper is the least bit careless. The enamel, too, is quite easily cracked, and nothing looks worse than a white-enamel drain board showing the black iron below in spots. Many housewives that have

enameled drain boards use in connection with them a wire basket to place the dishes in, and this system is all right providing no soap or soapy water is on the drain board. The soap makes the basket slide easily into the sink.

The location of the sink in the kitchen is another important feature which is often overlooked until it is too late. The sink should be in a light place, preferably with the light coming from the left, but should never be directly in front of a window, as it is harmful to have the light falling di-



The Sink should be Located in a Light Place with the Light Coming from the Left

rectly into the eyes, and besides, the frost and cold in the winter is very apt to freeze the water pipes. The standard size of a kitchen sink is 30 in. long by 20 in. wide, and of the drain board, 24 in. long by 20 in. wide. It is necessary to see that proper space has been allowed for these fixtures.

In laying out the bathroom, the aver-

age architect or plumber places the bathtub directly under the window, which makes it necessary for a person to lean over the tub to open or close it.

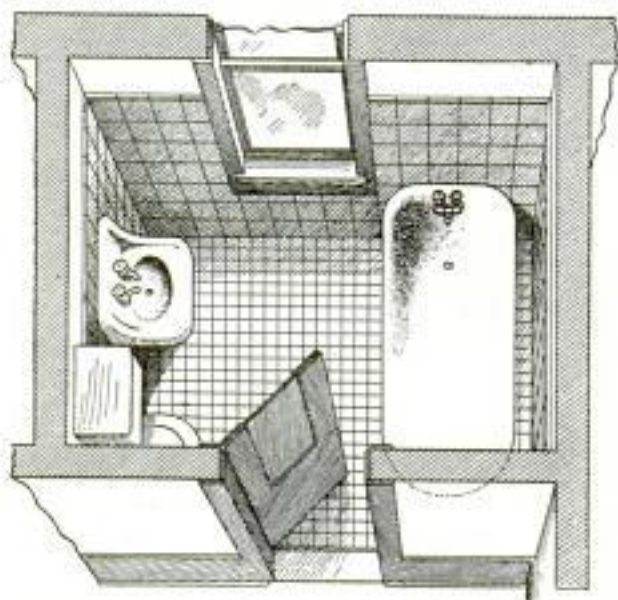

Proper Location of the Bathtub, Lavatory, and Toilet in a Small Bathroom

This is due to the fact that the average bathroom in modern houses is so small that it is often difficult to know how to work in the fixtures.

It is a good plan to take the advice of an expert, and locate the bathtub where it will not be in the way of the window. A bathroom should never be less than 7 ft. by 7 ft.—49 sq. ft. of floor space—or its equivalent, with a width never less than 5 ft. Bathtubs range in length from 4 ft. to 6 ft. by 6-in. steps. This means the over-all outside dimension and allows for exposed pipes. Nothing is more annoying to the owner than to have the plumber report that a partition must be moved a little to allow for the setting of the tub. If this is the architect's mistake, the owner will have to pay the expense.

Another point to remember in bathtubs is the width of 30 in., over-all. The owner must see to it before the rough plumbing is put in, that there will be room enough between the toilet and lavatory and the tub to allow free passage. Tubs should be set at least 6 in. from the walls for cleaning the floor and wainscoting behind them.

The position of the toilet is preferably back of the door so that when the door

is left open the toilet is not in view. The standard lavatory is 20 in. by 24 in., and this fixture should have at least a 10-in. back with a 6-in. apron, all cast in one piece. Bear in mind that there are three grades of enameled ironware, namely, nonguarantee, two-year guarantee, and five-year guarantee articles. The last-mentioned articles are naturally the highest-priced, and there is quite a difference in the cost of five and two-year guarantee fixtures, while the difference in cost between the two-year guarantee and nonguarantee is very small. Most plumbers will not use the nonguarantee ware, as they are compelled to buy it in the crate and cannot inspect it before the purchase. It is a well-known fact among plumbers and contractors that if an enameled-iron fixture is going to "go bad" it will show up within three or four months after the fixture is set, and for that reason it is a waste of money and time to put in a five-year guaranteed article. Of course, the guarantee on the article is simply against imperfections in either the enameled surface or the iron, and while the manufacturer will replace the article, he will not stand for the cost of delivery or the cost of taking out the old fixture and putting in the new, and this is the main reason why plumbers hesitate to change fixtures even though they are guaranteed.

The location of the laundry trays is preferably in the rear of the basement where unobstructed light from the back yard will make artificial light unnecessary. Laundry trays are known as one, two, and three-part trays. They are made from slate and from concrete, the latter being as serviceable as the former and the price considerably less. The three-part tray is the one most used and measures 24 in. by 72 in.

The rules and regulations of the board of health in the larger cities require that all sewer pipe placed under the basement floor should be of extra-heavy cast iron. Sewers run outside of the foundation may be vitrified-clay tile, and this tile, when laid with cemented joints, is far superior to the cast-iron pipe. This is partly

due to the fact that iron collects the grease which comes from the various fixtures and will eventually clog up to a certain degree, thereby hindering the refuse material from passing through freely to the sewer. In placing a sewer pipe under a basement floor, it is usually laid near the surface and often the floor breaks down, or is undermined by it. In outlying districts of a city the sewer trunks are usually not placed deep enough in the earth, and an iron pipe placed under the basement floor will not have the proper pitch to the house sewer to carry the sewage away quickly. When the trunk sewer is high, it is sometimes well to place the laundry trays in the kitchen, thereby keeping the sewer up at a higher level at the house than would be possible if they were placed in the basement. It is sometimes necessary in a large building to siphon the sewage out into the trunk sewer. When the sewer is low enough, floor drains should be placed in the basement so that it can be flushed once or twice a year and cleaned. A drain should also be placed at the laundry trays so that any surface water that accumulates will run off.

Heating

The three systems of heating in common use are hot air, steam, and hot water. The first-mentioned system, while the oldest of the three, is quite satisfactory when properly installed and operated. There are two kinds of hot-air heating furnaces, one being the built-in kind and the other known as the portable type. A portable furnace is one that can be readily moved, if necessary, without taking out brick walls and the like. The better class of portable furnace is known as the tubular, and this type is almost as expensive as a hot-water furnace. With the regular portable type, the cold air is drawn from outdoors and circulates around the fire pot, which is heated by the coals on the grate. With the tubular furnace, however, the operation is slightly different in that the air is drawn in and circulated through the tubes and heated as it passes through them; the operation

being very similar to that of the tubular boiler in which the water is circulated through tubes and goes out heated to the boiling point. Some of the points

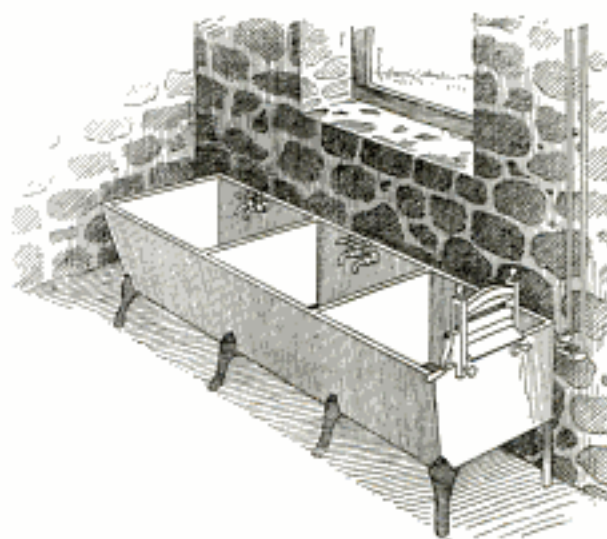

A Three-Part Laundry Tray Set Up in the Rear Part of the Basement

to be watched to get satisfactory results from a hot-air plant are to get the cold-air box on the prevailing-wind side of the house; to locate the furnace as near the center of the house as possible, and to set it as low as possible so that there will be no horizontal runs of pipe, or if they must be horizontal, that they will be as short as possible, as heat will rise readily, but will not flow through a horizontal flue without being forced. In preparing the foundation for a portable furnace, do not dig a pit and set the furnace in it, as the basement dampness will settle to the lower point and eventually rust out the iron jacket.

Hot-air furnaces must have some attention, and three of the most essential things are to provide plenty of fresh air, to keep the water tank filled, and to remove the ashes from under the grate. If there is an insufficient amount of fresh air the furnace will not have enough pressure to force the heat through the registers at the farthest points from the furnace. If the water box is not kept full, the air in the house will become dry, causing damage to the furniture as well as being unhealthful.

There is a great difference of opinion as to which is the better heat, steam or hot water. Steam heat works similar to

the old base-burner stove, and an even temperature cannot be steadily obtained. This is due to the fact that when the steam is up and circulates through the pipes at a high temperature,

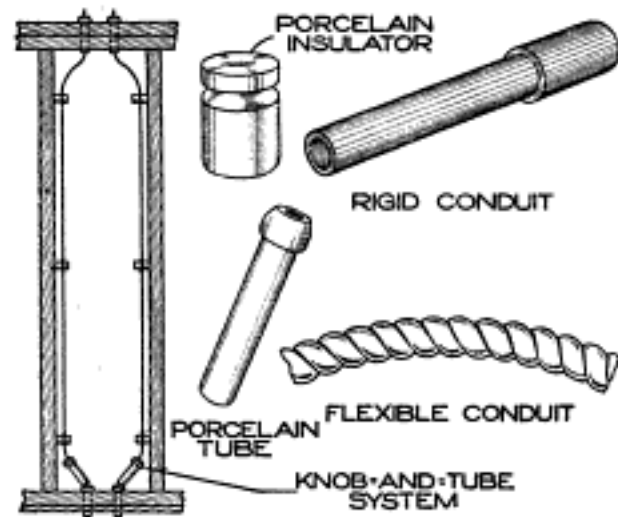

The Usual Installation of Electric Wiring is Known as the Knob-and-Tube System

the radiators get intensely hot, but when the register is shut off, the steam rapidly condenses and the radiator chills. This condensed steam is also responsible for the annoying hammering sound which is often heard in a steam-heating system. Buildings may be heated very quickly with steam, as the heat is so intense, but it chills as rapidly.

With a hot-water plant, the water is in continual circulation just as long as there is any heat in it, and while the temperature of the water never rises to the point of steam, it is a steady heat circulating through the pipes, and the disagreeable pounding sound is never heard in such a system. The piping of a hot-water plant must be larger than that of a steam plant, but it is a damper heat and does not shrink and warp the furniture as does steam or hot air.

Lighting

There are three common systems of electric wiring. The cheapest and most commonly used is known as the knob-and-tube system, in which the wires are run on porcelain knobs between the joists and in porcelain tubes through partitions. The others are the flexible and rigid-conduit systems. Rigid conduit is simply an iron pipe with a baked

coat of enamel both on the interior and exterior. The wires are carried from the conduit and brought through outlet boxes. Rigid conduit is often used in the basement of a house which is wired elsewhere with the knob-and-tube system. The flexible system is used for fixtures, and for wiring old houses where it is impossible to get knob-and-tube work in without destroying the floors and plaster. Under these circumstances the wires are often run in circular casings consisting of a canvas covering treated with insulating compound.

To save future annoyance be sure that the lights in the house are properly located and are of sufficient size. The location of fixtures in bedrooms should be on the side wall where the dressing table will be placed, and not closer than 5 ft. apart and about 4½ ft. from the floor. All side-wall outlets should be what is known as combination fixtures, gas and electric. Kitchens should have a combination light over the sink and a ceiling light over the stove, or in the center of the room. Living rooms should have a center outlet and from two to eight combination side-wall outlets. Bathrooms should have one side-wall outlet on each side of the medicine cabinet, which is usually placed over the lavatory. The lighting scheme for the dining room should be similar to that of the living room, except that the candlepower of the lights should not be so great.

Punch-Press Operation as a Substitute for Tapping Holes

Very frequently large quantities of a standard thin sheet-metal part must be threaded to hold a screw, and the general practice is to draw the metal and tap it as shown in Fig. 1. Obviously, in addition to the press operation of drawing the shoulder, comes the cost of the tapping operation.

A superior method to this is shown in Fig. 2. This is actually a substitute for the tapping operation, and is done in a punch press, together with any other regular press operations. Two

tongues of the metal are projected outward, as shown at A, and separated slightly, as at B. The projecting edges are hollowed out, corresponding to a circle whose diameter is that of the pitch diameter of the screw to be used. The screw, in being driven through, will engage with these tongue edges, which adapt themselves to the pitch of the screw, acting as one complete thread.

Although there is only one thread, it has the advantage that the tighter the screw is forced the firmer will be the grip of the tongues on the thread, owing to the resulting inward draw of these tongues. By experiment it has been found that on small-size screws, up to about 10-32, it is impossible to strip the nut before breaking the screw.

It is evident that this arrangement can be used successfully wherever the thickness of the metal is slightly smaller than the pitch of the screw, and in certain classes of work it is more

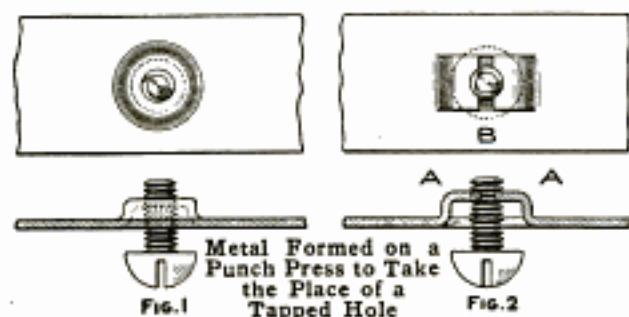

convenient than other means. It eliminates a tapping operation and allows other press operations at the same time of the punch-press tapping operation.

Drawer with an Inclosed Shelf

In deep drawers, particularly those used in a buffet or dresser, the space may be made more useful if a shelf is inserted in the manner shown in the sketch. This represents a drawer which I fixed with a shelf. The drawer was in a buffet and very deep, but it could only be used for table covers. The small things, such as napkins and table mats, could not be put in the same drawer for the reason that in taking out a tablecloth the piles would become mixed. By putting in the

shelf, however, these small pieces could be put on three sides of the drawer, and the tablecloths could be

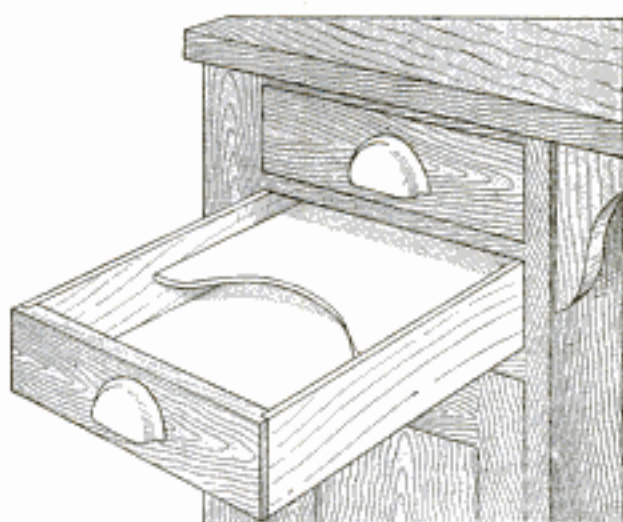

A Shelf Put in a Buffet Drawer to Make a Place for the Small Linen

put in and removed without disturbing the piles of napkins.—Contributed by Irving M. Hayward, Brooklyn, New York.

Exhaust Attachment for Dust from a Sand Roller

Workmen using a sand roller in a lathe will be in a great measure relieved from the dust if projections are fastened to the face of the cone pulley to form wings like those of a fan. The wings can be cut from sheet metal, bent at right angles to form blades. These are fastened to the pulley face with screws. They will act the same as an exhaust fan in drawing the dust and throwing

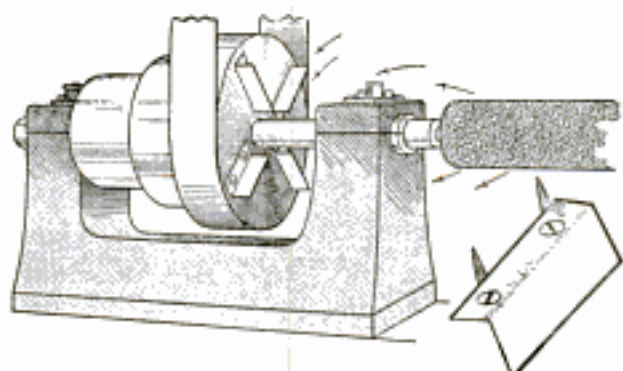

The Wings Attached to the Cone Pulley Draw the Dust and Throw It Away from the Operator

it away from the operator. The blades can be removed when not in use.—Contributed by C. M. Graham, Waterloo, Iowa.

To Stop Noise of Rattling Automobile Hoods

The constant vibration of an automobile causes such parts as the hood to become loose, noisy, and rattling. This noise can be stopped in the following manner: The noise usually occurs at the point where the hood rests against the hood sill, which is bolted to the vehicle frame. A small strip of steel, $\frac{1}{16}$ in. thick and about $\frac{3}{8}$ in. wide, is bent into the shape shown so that, when the hood is down and in the right position, the strip rests snugly on the hood sill. Two strips on each side of the hood will be sufficient.

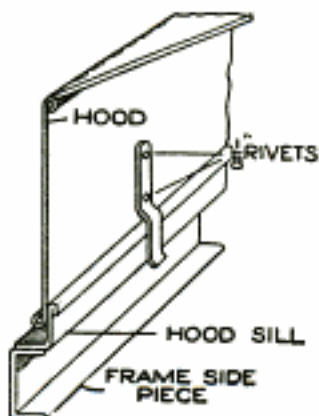

Starting a Siphon by Air Pressure

A siphon that is absolutely safe to use in handling acids or other corrosive or harmful liquids, because it is started by blowing, can be made as follows: A suitable length of glass tubing of fairly large diameter—say, $\frac{1}{2}$ to $\frac{3}{4}$ in. for ordinary laboratory use—is provided with tight-fitting rubber stoppers at both ends, one having two perforations and the other a very small one. In the two-holed stopper are inserted one short, slightly bent piece of glass tubing extending just below the stopper, and a U-shaped tube, both about $\frac{1}{8}$ in. in diameter. The inner arm of the U-tube reaches near the end of the wide tube, and the outside arm below it, as shown. When this device is inserted in the vessel containing the

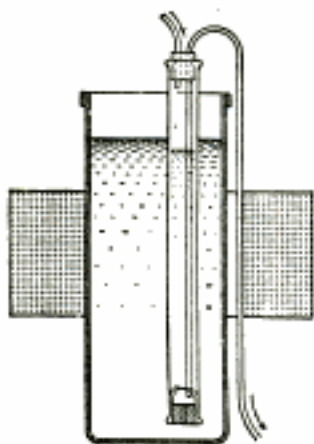

liquid to be siphoned, the liquid seeks its level inside and outside of the large tube, and by blowing through the short small tube an air pressure is created in the wide tube which forces the liquid out through the U-tube, because all of it cannot pass back into the liquid container through the small perforation in the bottom stopper of the siphon. When once started, the device, of course, works automatically like an ordinary siphon.

Lengthening a Gas Burner

While assisting a gas fitter to build up some sections of brass tubing with burners, we found one piece a trifle too short. No other piece being at hand, I cut a section from a gas burner, the part below the line AB in the sketch, and filed the upper portion of it so as to fit into the lower section of another burner. This section was screwed on the tube and the burner slipped over it and soldered, as there were no threads on the cut-off section. The tube being covered with an imitation candle, the repair could not be seen.—Contributed by James M. Kane, Doylestown, Pa.

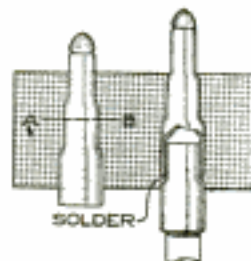

A Cash Register Used as an Adding Machine

A person having a number of long columns to add but no adding machine, used his cash register as a substitute. By pushing the keys and opening and shutting the drawer in the usual way each horizontal line of figures was registered, and the totaling mechanism showed the sum correctly. As it was impossible to register \$100 on the machine at one operation, the large amounts were split and made in two counts. Aside from being rather noisy, the substitute adding machine was a decided success.

Pattern and Core Box for a Small Air Chamber

Small air chambers of a form similar to the one illustrated in Fig. 1 are quickly and easily made if the half pieces are glued up solid. Two pieces of 2-in. stock are used for each half pattern.

The stock is prepared for the lathe in the usual way by jointing the halves and inserting the dowels. Enough extra stock is allowed at each end for the screws that are to hold the halves together. In Fig. 2 is shown the piece for the body of the chamber, all prepared for turning. It will be noticed that the ends have been cut on the band saw to the radii. These should be about $\frac{1}{8}$ in., full, of the finished size on each end.

The largest diameter is first turned to size, then the neck, or smaller diame-

ter, is finished to templet. This templet is made to just clear the end spud, and the lines for the fillet and

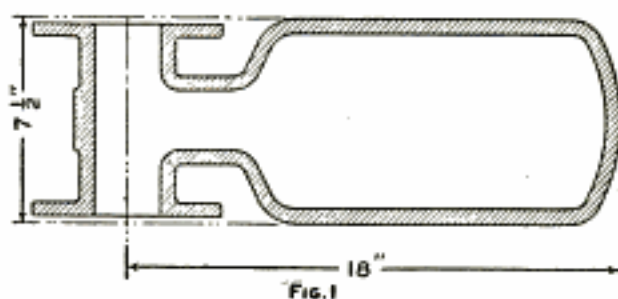

Fig. 1
Drawing of an Air Chamber from Which a Pattern-maker Forms a Pattern and a Core Box

the neck end should be laid out on it, as it is used for finishing both ends.

The cross branch on the end is made with the flanges gained or checked into the prints. In Fig. 3 is shown the method of connecting or fastening the two parts with a lap joint. The lap is cut into the neck about $\frac{3}{4}$ in. in thick-

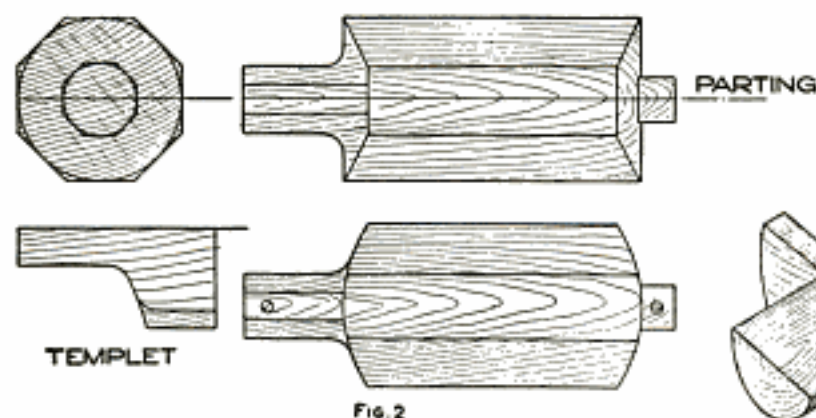

Fig. 2

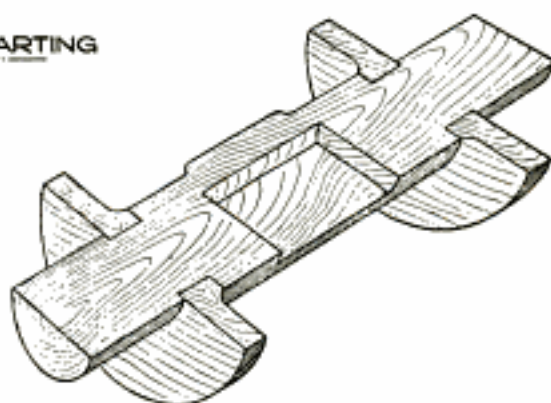

Fig. 3

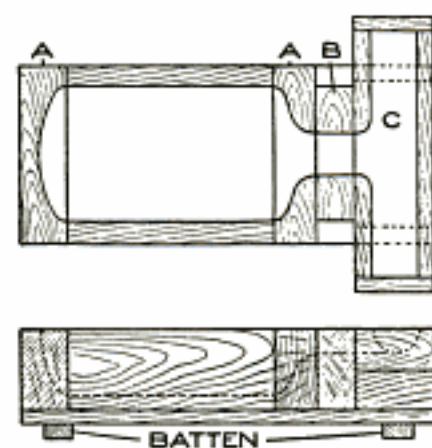

Fig. 4

Main Body for the Pattern before Turning It Up, and Templet for a Guide in Shaping the Ends; Manner of Attaching the Cross-Branch End, and the Construction of the Core Box

ter, is finished. The rest is then moved to the top, or crown, end, and the spud on the end with the screw in it is turned to, say, 2 in. in diameter. The

ness, and a recess is routed out of the cross branch to receive it. This makes a very strong joint, and when fastened with glue and screws, it is not apt to

become loose with the rapping in the mold.

The core box, Fig. 4, is made up of five pieces, fastened to a bottom board. The pieces marked A are turned in halves on a faceplate, B and C are worked out with the core-box plane. The piece B is fastened with glue and screws to one of the pieces marked A, and the large round corner is worked off to a templet. Two pieces of stock are fastened to the bottom board to raise the piece C to the same level as the other pieces.—Contributed by J. A. Shelly, Brooklyn, N. Y.

Guide for Longitudinal Lathe Feed

An ordinary 12-in. flexible-steel scale fastened to the bed of a lathe makes a good guide for the longitudinal feed.

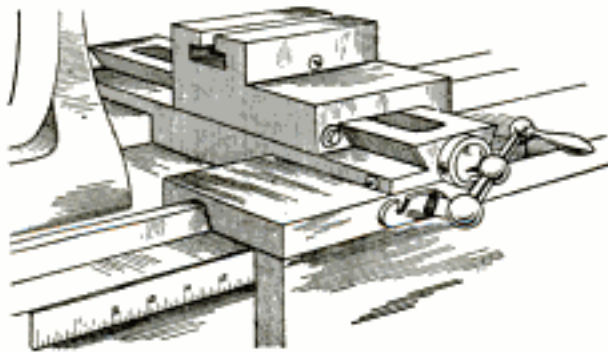

Steel Scale Fastened to a Lathe Bed, to Provide a Guide for the Longitudinal Feed

This is a very handy device for roughing out work and is easily applied. In my case, I have placed the scale on the front of the bed, and the carriage passes over it, but it can be placed on top of the bed if desired.—Contributed by A. E. Holiday, Union City, Conn.

Metallic Effect on Clockface Decorations

In repainting the ornaments on an old clockface, I found that the metallic luster shining through the color had been secured by first laying a piece of metal leaf, silver or gold, on the surface and in the exact shape of the ornament. In the case mentioned it was a sea shell. The desired effect was secured by glazing it lightly or heavily with the proper colors.

To Determine the Coloring Matter of a Typewriter Ribbon

There are two kinds of typewriter ribbon, one that gives an indelible record and one that does not. The color used for the former has a true carbon base, while the latter is made with aniline colors. To distinguish the two, soak a corner, or piece, of the ribbon in very hot alcohol, scrape off a little of the coloring matter and smear it on a piece of white blotting paper. The smear will widen on the blotting paper as the alcohol is soaked up by it, and if this spot is colored all the way to the edge, the color used is aniline, that is, the ribbon is of the cheaper grade that does not produce an indelible record, while, if the size of the original smear is simply surrounded by an uncolored edge of wet, it is a sure sign that the ribbon is made with genuine carbon color. The reason is that aniline black is dissolved by the alcohol, while true carbon black is not.

Lubricating Tappets on an Automobile Engine

The existence of friction in a gasoline engine, or, in fact, any machine, necessarily means a loss of power, particularly at such an important point as the valve tappet. In order to minimize the friction at this point it is well to drill four reasonably large holes in the tappet guide, as shown in the sketch. This will allow the lubricating oil in the crank case to find its way more readily to the tappets. It is well to slightly countersink these holes for the purpose of allowing the oil to reach the inside of the guide readily.

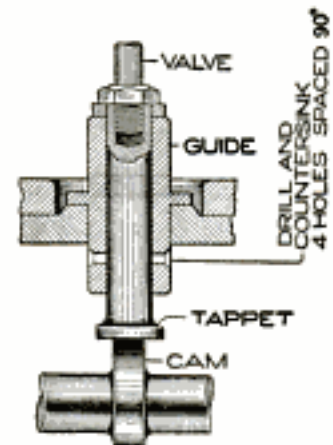

Making a Special-Shaped Gas Flame

Anyone who has attempted to temper small tools, or bend pieces of steel, knows how difficult it is to get a uniform heat without overheating. The most satisfactory solution is to make a special gas stove in the manner illustrated, which will not require much time in the construction. Cut out a small block of wood, 1 in. thick, and hollow out a small channel of the desired shape with a knife. Bore a $\frac{1}{4}$ -in. hole in one end and connect the channel by means of a second hole drilled in a vertical direction. Force a short piece of brass tubing into the end hole for the gas connection, and then cut out a piece of tin or sheet metal large enough to cover the top. Lay out the desired curve on this in a position directly over the curved channel in the block. Prick, or drill, a series of pin-

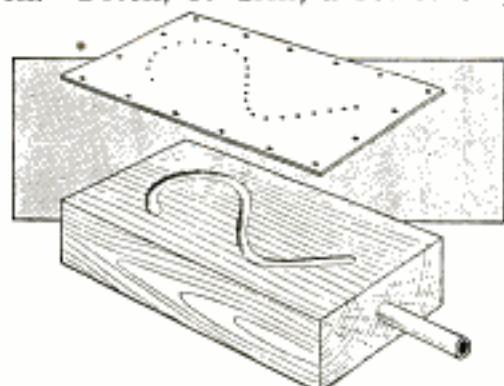

A Gas Stove That Produces a Special-Shaped Flame to Temper Pieces of Bent Steel

holes in the metal along the curved line, making the holes about $\frac{1}{4}$ in. apart, and then tack it firmly to the block. If the gas can be arranged to pick up a little air as it passes into the stove, in the same manner as this is done in the ordinary gas range, the flame will be free from carbon.—Contributed by John D. Adams, Phoenix, Arizona.

Adjustable Fastener for Celluloid Eye Shade

The head strap of a celluloid eye shade is usually held with a brass paper fastener which often breaks when no fasteners are at hand. A much better way is to use a very small bone or com-

position collar button secured with an elastic rubber washer slipped over the

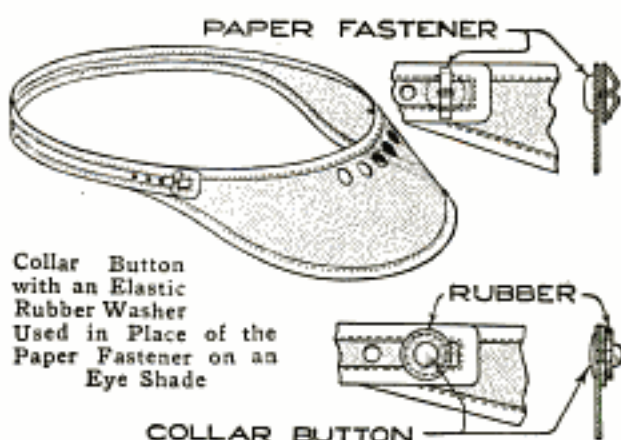

head. This method admits quick adjustment of the shade and is not at all clumsy.

Tool Holder for Machining Blanking Dies

The illustration shows a holder and tools especially designed for use in machining blanking dies. The holder can be adjusted to accommodate the return stroke of the shaper and can be used to get any desired shape by forging the proper tools.

The holder A is held firmly to the swivel block B by means of a clamping screw, C. The cutting tool D passes through the hole E where it is clamped with the screw F. Various tools, like those shown at G, can be forged to meet requirements. The tools are forged from $\frac{3}{8}$ -in. drill rod, and the screw C

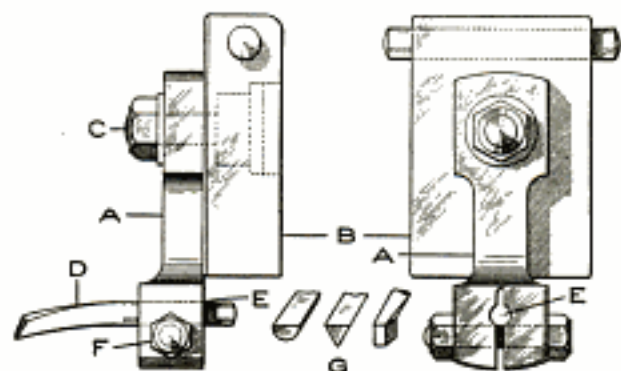

Adjustable Tool Holder Attached to the Shaper Head Block for Shaping Blanking Dies

and holder A made of machine steel. The screw F is a stock-size, $\frac{3}{8}$ -16, cap screw with a nut.—Contributed by George F. Kuhne, E. Rutherford, N. J.

Lifting Springs for Tool-Clamp Plates

The tool holder, or clamp plates, on heavy lathes cause considerable trouble by dropping down when the heavy tool

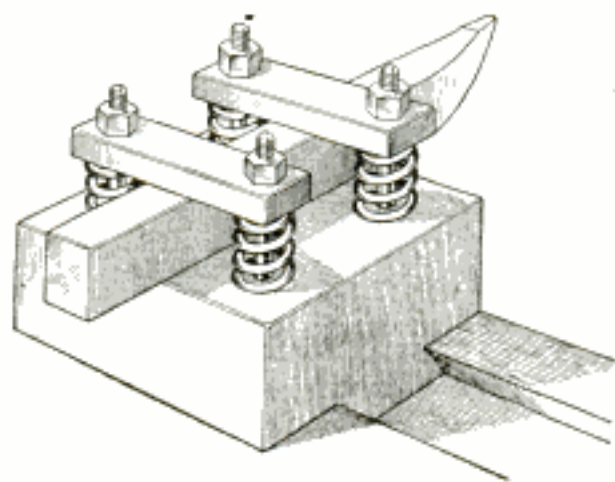

The Coil Springs Placed on the Bolts under the Plates Keep Them Up

is drawn out for sharpening or change of cutting edge. The sketch shows how a number of comparatively heavy steel-wire springs can be utilized to raise the strips free of the tool and hold them up out of the way as soon as the nuts are loosened. Much loss of time and injury to fingers will be avoided by the springs on any tool-holding arrangement of this kind.

Preventing Flywheel from Breaking Fastening Bolts

It happens quite frequently that the bolts connecting the flywheel to the crankshaft flange shear off, due to their carrying an excessive strain. To prevent trouble of this nature, I inserted

a small drive collar on each alternate bolt of the six which were used. The flywheel and crankshaft were counter-bored, and the three collars were securely pressed into them when the bolt nuts were tightened up. In this manner the three collars did the greatest part of the work, and therefore the bolts were relieved to a great extent.—Contributed by Adolph Kline, New York City.



An Electric Remote-Control Switch

The remote-control switch described will be found very serviceable when it is desired to control electrical circuits from one or more points that may be quite a distance apart, or that may be in different buildings, or on different floors of the same building. The switch mechanism consists of two electromagnets, each operating a separate armature, and so connected that they may be energized independently by merely pressing one of two push buttons located at the points from which it is desired to control the switch. One of these magnets is called a closing magnet, because its armature, when drawn up, closes the main electrical circuit, and the other is called the opening magnet, because the electrical switch is opened when its armature is drawn up. A sketch from which the electrical and mechanical operation of the switch may be understood is shown in Fig. 1. The armatures of both magnets are pivoted at one end, and a spring is attached to each at the hinge which tends to hold them away from their respective cores. A V-shaped piece of metal, A, is attached to the free end of the armature of the closing magnet, which serves to connect the two springs B and C when the armature is drawn up against the core of the magnet. The two springs B and C form the terminals of the electric circuit which the switch is to control. A specially shaped piece of metal, D, is fastened to the free end of the armature of the opening magnet, which serves as a double latch for the armature of the closing magnet. If the armature of the opening magnet is drawn up, the armature of the closing magnet will move under the action of the spring away from its core until the free end strikes the end of the piece D, and the connection between the springs B and C will be broken. When the armature of the closing magnet is drawn over against its core, its free end moves beyond the bend in the piece D, the armature of the opening magnet moves by the spring away from its core, and the

See sketch on file from Patent Office. D. Kline, New York City. 139/28/15

armature of the closing magnet is held in its energizing position even though there is no current through the winding of the magnet. The springs B and C then remain in electrical connection until the armature of the opening magnet is drawn up by sending a current through the winding of the magnet.

The current operating the magnets may be furnished by several dry cells connected in a common wire so that the same cells serve for both magnets. The connections of the pairs of push buttons are as shown, and there may be as many combinations as desired. One of the great advantages of the switch is the ease with which the control circuits may be installed, no greater precautions being required than in the ordinary bell circuit. The pair of push buttons located at any point may be painted, one white and the other black, which will serve as an indication for the control of the magnets, the dark one representing an open circuit and the light one the closed circuit.

The construction of the switch is as follows: Two spools are made with iron cores, and heads, or ends, of thin fiber insulation, similar in form and dimensions to the one shown in Fig. 2. One end of each of these spools is tapped to accommodate a $\frac{1}{8}$ -in. machine screw. Wind each of these spools full of No. 26 gauge cotton-covered copper wire, and bring the ends out through the small holes drilled in the fiber ends. A layer of suitable insulating material

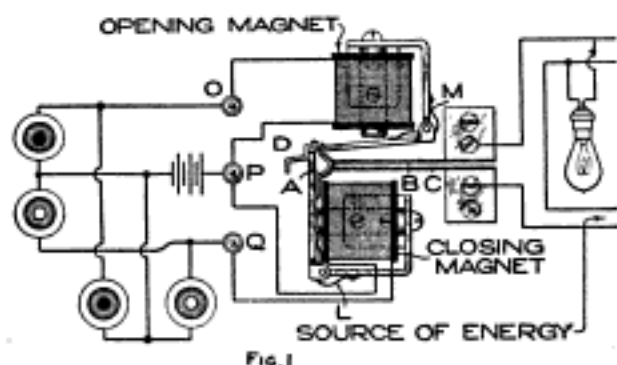

Diagrammatic Arrangement of the Opening and Closing Magnets to Control a Current at a Distance

should be placed outside of each of these spools so as to provide a good mechanical protection. Cut from sheet iron, $\frac{1}{16}$

in. thick, two pieces, as shown in Fig. 3. These pieces are to form the support for the coils and the armatures, and at the same time serve to complete the

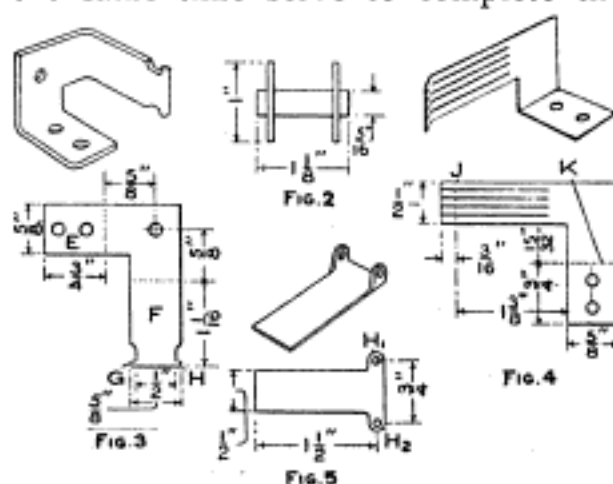

Details of the Parts for Constructing the Switch to be Operated on a Battery Circuit

magnetic circuits of the coils and thus increase their pulling force on the armatures. In each of these pieces three $\frac{1}{8}$ -in. holes are drilled, as shown, and the projections E and F bent up along the dotted lines until they are at right angles to the main part of the piece. The two small projections G and H are to form part of the hinge for the armature, and they should be filed round to make pins $\frac{1}{16}$ in. in diameter.

The two springs indicated by B and C, in Fig. 1, are made from sheet brass, about $\frac{1}{64}$ in. in thickness and cut to the shape shown in Fig. 4. Drill two holes in each piece, $\frac{1}{8}$ in. in diameter, for use in mounting them on a base. There are four slots cut in each piece to form five narrow springs. The ends of these springs to the left of the dotted line J are bent up on one piece, and those on the other piece are bent down, until they are at an angle of 45 deg. to the main part of each piece. The extension below the dotted line K is bent up and down, respectively, for the two pieces.

The armatures should be cut from sheet iron, about $\frac{1}{32}$ in. thick, to the form shown in Fig. 5. The projections are drilled with a $\frac{1}{16}$ -in. drill. Before completing the armatures the coils and springs B and C must be mounted on a suitable base, such as a piece of slate. The location of the parts is shown in

Fig. 1. A thin piece of brass, $\frac{5}{8}$ in. long and $\frac{1}{4}$ in. wide, is cut and bent to the shape shown at A. This piece is attached to the end of the armature of the closing magnet, but is insulated from it. A very light spring should be attached to the ends of each of the supports for the armatures, as shown at L and M. The strength and shape of these springs should be such that they will hold the armature away from the core of the magnets, regardless of the position in which the switch may be placed. The armature is then mounted in position by bending the two extensions over at right angles to the main part so that they will fit on the two projections G and H shown in Fig. 3.

Rivet a thin piece of sheet brass to the free end of the armature of the opening magnet. This piece is about $\frac{3}{4}$ in. long and $\frac{1}{8}$ in. wide. The armature of the opening magnet is fastened in place by bending the two extensions

over as in the case of the armature of the closing magnet. The opening magnet is mounted in place on the base so that its armature and the piece of brass attached connect as previously described.

The three small terminals O, P, and Q are mounted on the base and the windings connected to them as indicated. The small bolts used in mounting the springs B and C may serve as terminals for the circuit which the switch is to control. A suitable covering, preferably of metal, should be made and fastened in position over the switch in such a manner that it may be easily removed. Holes are drilled through the base near the connecting terminals of the switch, through which the wire may pass and thus not interfere with the cover in any way. Two additional holes are drilled through the base, in a suitable place, through which the mounting screws, or bolts, for the switch may pass.

Tool to Remove Stock between Drilled Holes in Dies

In making a die it is often necessary to remove a part of the metal by drilling holes close together on the line of separation, then chiseling out the metal between the holes. The tool illustrated is quite convenient for remov-

ing this metal. It is made of tool steel with the body a sliding fit in the holes drilled; then a side cutter is formed to extend into the next hole with a cutting edge on one end. It is only necessary to drive the tool through the holes.—Contributed by Chas. C. Davies, Washington, D. C.

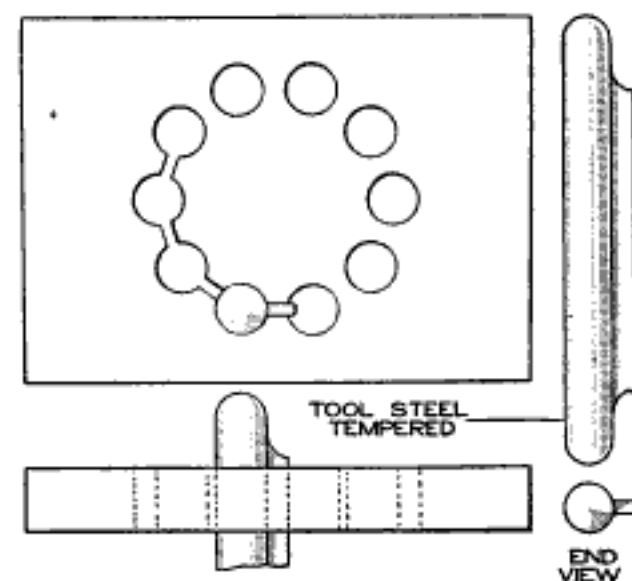

The Extending Part on the Side of the Tool Removes the Metal between the Holes

The Lost Art of Hardening Copper

The hardening of copper by the ancients has never been proven, although many statements have been made to that effect. The supposedly hardened copper implements are made merely of alloys of copper and tin. Often the lost art of hardening copper is bewailed as a real loss to the people of today, but the uses to which hardened copper could be put are not many. Its use for tools is only a myth, for with the price of copper many times that of steel no one would buy the former even if it were as durable. Copper and brass are made much harder, or stiffer, by drawing, pressing, and hammering. Rods, bars, and wire are

regularly listed as "soft" and "hard." The term hard, for copper, does not imply a quality to be compared with similarly designated products of the iron and steel trade.

Quite frequently copper may be found that is really hard, so hard that it cannot be filed. In overhauling the canopy switches of trolley-car switches of the jackknife type the contact members have been found to be as hard as glass, sometimes for a length of 1 in. These switches are located over the motorman's head and in conjunction with fuses were, and are still, used on the older-type cars, and smaller ones for the same combined purposes as the circuit breakers with which all modern trolley cars are equipped. Seemingly, the only way to account for the hardened area of the contacts is that the cars had been run with the switches barely closed and that continued arcing had set up a fusion that had produced this result. In all of the cases noted, the blades had not gone so far as to interfere with the working of the switches. In no case had the switches been taken out solely for repairs to them.

Repairing a Torque Rod on an Automobile

A tubular torque rod on an automobile was broken as shown in the sketch. It was repaired as follows: Both sections of the broken rod were removed, and a piece of round drill rod was forced part way into the large portion A, after which an additional piece of tubing, B, was forced over the torque rod on the outside. The other portion

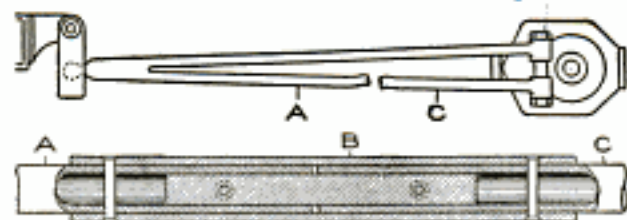

Torque Rod of an Automobile Repaired with a Rod and Tube Riveted in Place

of the torque rod C was then forced into position, and the joint made permanent with four rivets.

The Care of Lettering Brushes

Lettering brushes after being used should be cleaned out and wrapped with paper to keep the hairs straight. Many

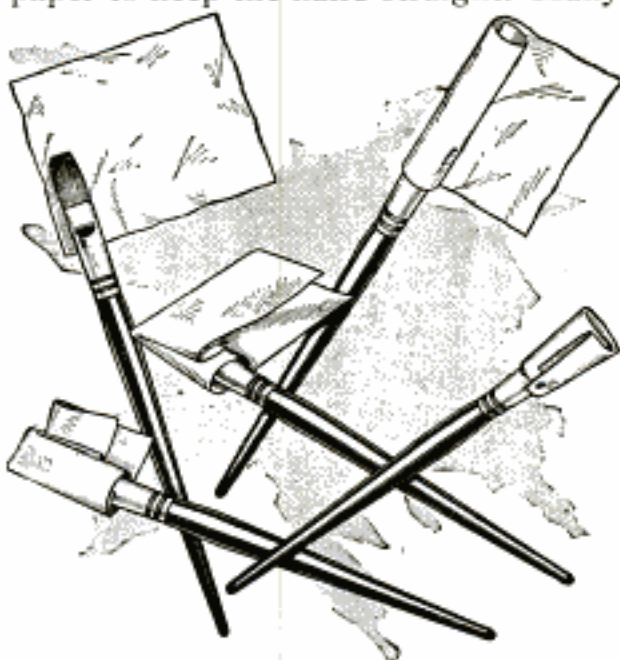

Wrapping a Paintbrush without the Use of a String, to Keep the Hairs Straight

painters, when out of a job, wrap the brushes in paper and put them in a pail of oil, the paper keeping the hair straight, and the oil preventing them from hardening. The manner of wrapping the brushes without the use of a string or rubber band is shown in the illustration.—Contributed by Wm. A. Temple, Fort Dodge, Iowa.

Sealing a Box Cover Fastened with Screws

Recently I received a shotgun packed in a pine-wood box, the cover being secured with wood screws and the screw heads set in a counterbore, whereupon the depressions had been filled with sealing wax to prevent tampering with the contents. I have received a great many valuable guns for repairs, and this was the first one placed in a package secured in this manner.—Contributed by M. E. Duggan, Kenosha, Wis.



To Store a Lead Storage Battery When Not in Use

One of two methods is usually employed in putting a storage battery away for the winter, one known as "dry storage," and the other as "wet storage." The condition of the battery and the length of time it is to be out of service are the principal factors governing the selection of the method to be used. If the battery is in good condition and there is no real necessity for dismantling it on account of needed repairs, the wet storage is the preferable method, provided the battery is not to be out of service for more than about twelve months. On the other hand, if the battery is in such condition that repairs are, or soon will be, required, or if it is necessary to store it for more than a year, the dry method is the better.

The battery should be carefully examined, paying particular attention to the condition of the plates, separators, and the amount of sediment in the bottom of the containing jars. If the plates are found in good condition, and there is very little sediment in the bottom of the jars, the battery may be given an equalizing charge, and then placed in storage where it will be free from dust and dirt. The equalizing charge is a low-rate overcharge, continued until there is no increase in specific gravity of the electrolyte in any of the cells. Should the gravity in any of the cells exceed 1,300 during this charge, some of the electrolyte should be drawn off and distilled water added to reduce the gravity. After the electrolyte in all the cells has reached a constant gravity, and no change has been noted for three or four hours, proper corrections being made in the gravity readings for any change in temperature, the charge may be considered complete. The gravity in all the cells should then be adjusted to a value between 1,270 and 1,280 by removing some of the electrolyte and adding water, or 1,300-acid, as may be required. It often happens that only one or two cells may require a prolonged charge, in which case it is al-

ways best to disconnect them from the others and charge them separately.

While the battery is in storage, the loss through evaporation should be replaced periodically by adding pure water so that the plates are covered to a depth of at least $\frac{1}{2}$ in. About every three or four months, the battery should be given a charge, using half the normal finishing rate recommended by the makers, until the cells have gassed continuously for at least three hours. If any of the cells fail to gas, they should be examined and the trouble corrected. If the examination of the battery indicates a poor condition of the plates and a large amount of sediment in the bottom of the jars—it should be at least $\frac{3}{8}$ in. from the lower edge of the plates—it must be dismantled and placed in dry storage as follows: First make a sketch of all the connections and mark all terminals and their polarity. Next remove all connections between cells, and by means of a putty knife, take off the covers. The covers must be thoroughly cleaned by placing them in hot water, which will melt any of the sealing compound adhering to them, and clean off the acid. The hot water will soften the covers, and these, to be kept straight, should be placed in a pile and a weight put on top of them.

The plates are then carefully removed from the jars, and the separators between them taken out by parting the lower ends slightly. The separators are then washed, dried, and tied in bundles.

The positive and negative groups of plates are then separated, which will permit of a more careful examination. When the positive plates show a great deal of wear, they must be scrapped. If not thrown away, all loose particles adhering to them are removed with a smooth paddle. If the active material of the negative plates is swollen beyond the surface of the grid, it should be pressed back into position before the plates dry. This can be done by placing boards of suitable thickness between the plates and clamping them in a vise. The acid is then carefully

poured out of the jars to keep it as clean as possible; then the sediment in the bottom is removed, and the jars are thoroughly washed. The acid is kept, to treat the negative plates. The positive groups of plates are combined in pairs and placed in the jars, and are then ready for the storage.

The negative groups of plates are also placed together in pairs, put in the remaining jars, covered with the acid and allowed to remain about six hours. The acid is then removed and the jars with the plates stored.

When it is desired to put the battery back in service, the positive and negative groups of plates are reassembled and the separators placed between them. Place the elements in the jars and fill with acid of a specific gravity of 1,250 so that the plates are covered $\frac{1}{2}$ in. Connect the cells in series, and put the battery on charge at the regular finishing rate. After charging for a few minutes, note the voltage of each cell and make a record of these readings. Each cell should record about two volts, and those not showing this voltage are more than likely to be connected backward, which should be remedied. The cells are then closed and the connections made permanent.

When the cells begin to gas freely, the charging rate should be reduced to half the normal finishing rate, or less, if the temperature of the electrolyte exceeds 110 deg. F. Continue the charge until the gravity of all cells has become constant for a continuous period of 10 hours, but do not allow it to exceed 1,300. After the charge is complete, adjust the acid in the cells to a value of 1,270 to 1,280.

A Dual Pencil for Draftsmen

For the draftsman who desires to save time in drawing uniform parallel lines, for lettering and other purposes, the dual pencil shown in the illustration will be found exceedingly useful. It is made by cutting away the sides of two pencils until the lead is just exposed and joining them face to face by means of a ferrule from an old pen-

holder. This ferrule should be short so as to allow the necessary degree of flexibility. If one is not available a tight wrapping of string, or wire, at



Two Pencils Joined Together with Ferrule on Upper Ends, and Sliding Wedge to Draw Parallel Lines

the top answers the purpose almost as well. A small wood or cardboard wedge inserted between the pencils permits the easy adjustment of the points by sliding it up and down.—Contributed by Morris G. Miller, New Rochelle, N. Y.

To Shorten the Legs of a Chair

Usually when the legs of a chair or stool are sawn off carelessly one, or all of them, will rest on the floor like that shown at A. The cut should always be made parallel with the floor and not with the seat. To insure correctness, place the chair on a level surface and mark each leg all the way around with a pencil resting on a block which is slid around the leg, as shown at B. In this

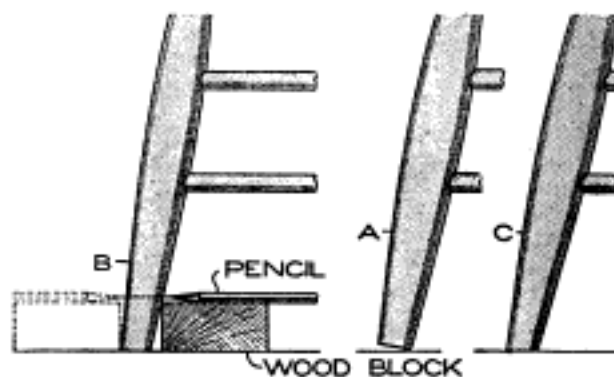

Marking a Chair Leg so That It can be Cut Off to Rest Level on the Floor

manner a proper guide line is made for the saw, and when cut, the leg will rest on the floor, as shown at C.

An Electric Foot Warmer

The hot brick, or slate slab, can be easily supplanted by an electric stove where electrical energy is available. It is only necessary to procure a large

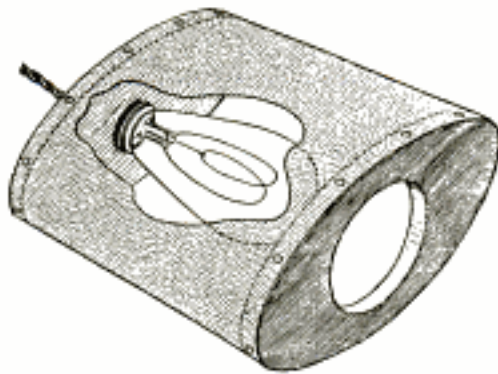

A Large Incandescent Electric Globe Constitutes the Heating Element in the Tin-Can Body

fruit can, about 1-gal. size, and remove both ends, being careful not to disturb the seam where the ends of the body are joined. This part of the can is then pressed into an oval shape and crosspieces of wood are fastened into the open ends. A large-size incandescent electric globe is then introduced in this covering and fastened so it will be in the center. This is connected to a lamp cord with a plug at the opposite end, the cord being long enough to reach and connect with a lamp socket.

Hook for Lifting Metal Plates

Steel plates are usually stored in a horizontal position, and when worked in a press, punch, or shear, they are carried in this position. The illustra-

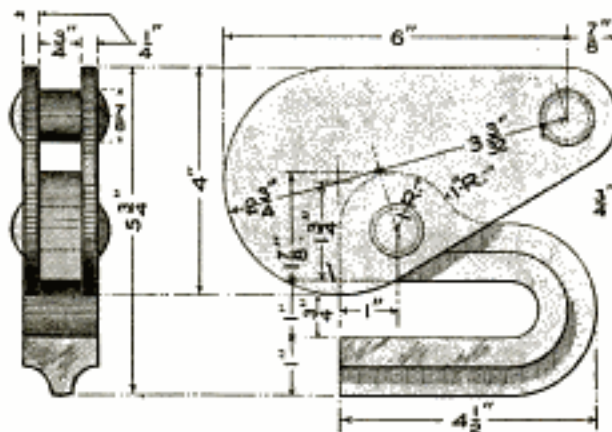

Hook to Grip the Edge of a Plate for Lifting It with a Crane

tion shows a hook, of which three are used, for lifting each plate with the crane. The opening in the hook part will admit plates up to $\frac{3}{4}$ in. in thickness. A link is attached to the end of the eccentric piece for attaching the chain of the crane. These hooks will grip the metal tightly and there is no danger of dropping the plate.—Contributed by Joseph K. Long, Renovo, Pennsylvania.

Reflecting Stage Scenes on Orchestra Music Racks

Orchestra leaders and players for moving-picture shows will find it worth while to rig up a set of mirrors to reflect the play on the stage so that it is not necessary to look up. If a large mirror is placed just back of the orchestra, and a smaller mirror set close to the music rack, they will reflect the scene close to where the music is read. The mirrors can be easily set to reflect at the proper angle.—Contributed by Roy Douglas, Terre Haute, Indiana.

An Automobile-License Holder

Almost all states require the driver of an automobile to have a license and to carry it at all times while driving. If this paper is carried in the pocket loosely it will soon become worn or possibly lost. The best way to carry the license is in the small holder used for pencils. Remove the pencil, make the license into a small roll and put it in the holder. Fasten the chain to the key ring, and the license will be ever ready and clean.

Waterproofing a Waxed Finish

A waxed finish may be effectually protected against water, or other form of moisture, by applying the following coating: Zanzibar copal varnish, boiled linseed oil, and spirits of turpentine; six parts of each, by weight. Mix these well together. This protective coating will not affect the appearance of the wax finish or change it in any way.

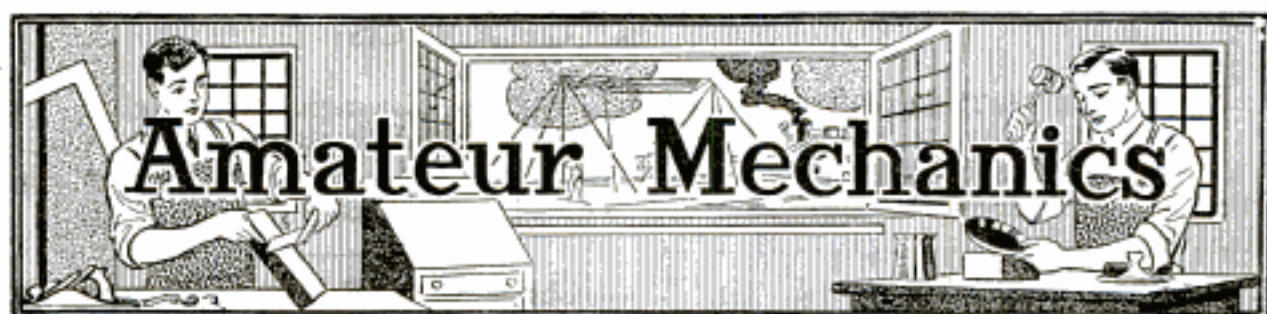

Making T-Squares

By J. B. MURPHY

THE making of a single article of any kind presents a distinct problem in itself, but the production of a large number of the same article must be done in a different way, if efficiency and uniformity in the product are desirable qualities. Taking, for instance, the making of a large number of T-squares, the material is not made up in the same manner as for one. Where a number of these instruments was required, they were made as follows, with no other equipment than bench tools and a band saw. The squares were made of mahogany having both stock and blade edged with maple. The blades were fastened to the stock with five $\frac{3}{8}$ -in. button-head screws.

The material for the heads and the

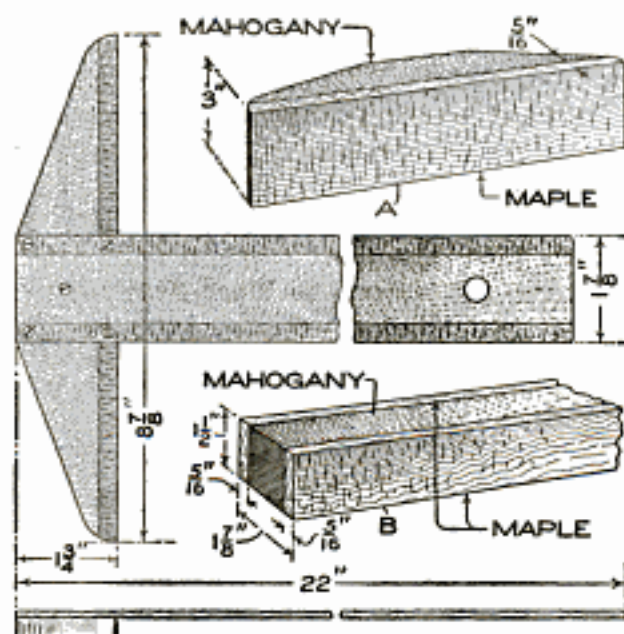

Dimensions for a T-Square of Which a Number were to be Made in Duplicate

blades was glued up and finished to the sizes given at A and B. The material was cut to gauge lines on the band saw, the blades being a scant $\frac{1}{8}$ in. in thick-

ness, and the stocks, $\frac{3}{8}$ in. Two of each were cut from each prepared piece, first from one side and then from

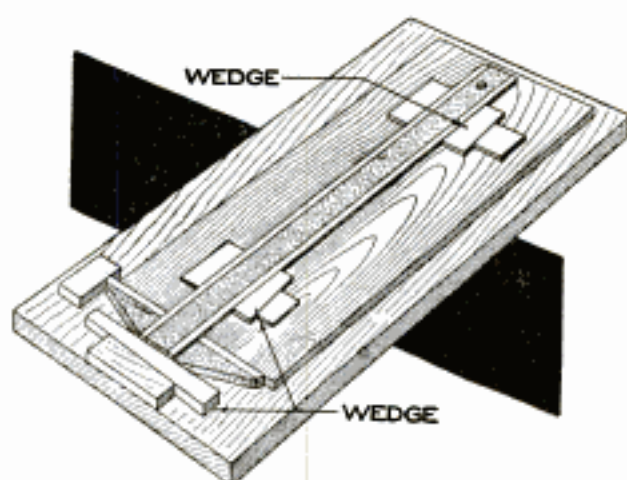

Stock and Blade Material for Making the Parts, and the Jig for Assembling

the other. They were then faced off on both sides, and two more pieces cut. With careful cutting, six blades and six stocks were made from each piece. This left one side of each piece to be planed after sawing. The holes for the screws were drilled with a small hand drill.

For assembling, a jig was made by nailing a piece of stock, $\frac{3}{8}$ in. thick, to a straight drawing board. One end of the piece was planed straight and true before it was fastened in place. Stops were provided to locate the stock and hold the blade square with it. Wedges were used to keep both stock and blade against the stops while the screws were inserted. The wedges were not driven with a hammer, but pushed in firmly with the fingers.

☞ Insert a scratch awl in common hard soap for hardening, and it will need no drawing after the plunge.

Easily Constructed Wall Shelves

All that is necessary to make and support the simple set of wall shelves, shown in the illustration, is lumber for

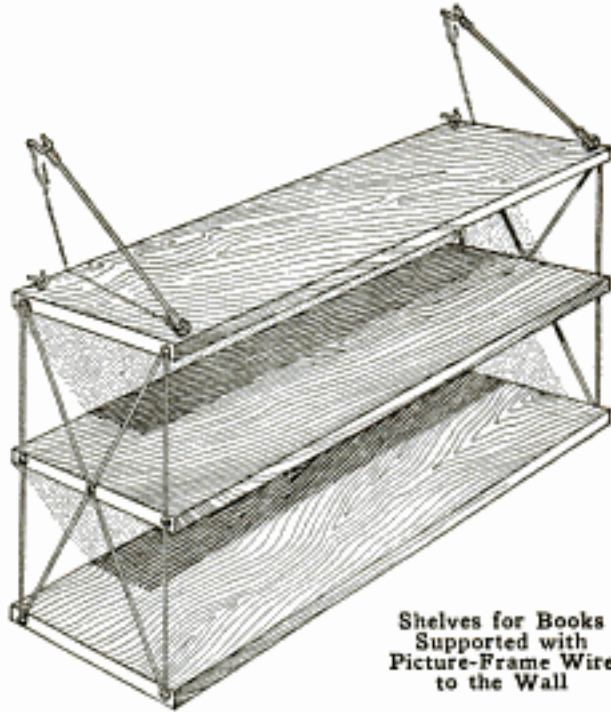

Shelves for Books Supported with Picture-Frame Wire to the Wall

the shelves, four screw eyes, four screw hooks, sufficient picture-frame wire to form the braces and supports, and wood screws for attaching the wire. On the top side of the upper shelf are fastened the four screw eyes, two near the wall edge and the others near the outer edge. To support the upper shelf four screw hooks are used; two placed in the wall and spaced to match the set of screw eyes nearest the wall, the others being placed above the first and connected to the outer set of screw eyes with the wire, thereby forming strong inclined

supports. The remaining shelves can be hung to suit by the supporting wires, which are fastened with screws to the end of each shelf.

Showing the Strength of a Giant

This trick is not so well known as it might be, although for a while it was quite a popular drawing attraction for circus side shows and other amusement places. It is one of the favorite Hindu tricks. The performer passes for examination two pieces of rope 10 ft. long. In one end of each rope a large ring is fastened. Taking a ring in each hand the performer commands three or four men at each end of the rope to take hold of it and at a signal they pull as hard as possible. They pull until they are exhausted as in a tug of war, but the performer only appears a trifle exerted and finds no difficulty in holding the men.

The secret is in the use of a piece of flexible wire, which passes up the right sleeve of the performer, across the back and down the left sleeve, lying just inside of the coat sleeve. At the ends of the wire are small hooks. When about to perform this trick the performer puts on a pair of gloves. The gloves are slit in the palms to allow the hooks to pass through. The hooks are covered with cloth, colored to match the gloves. An essential point to remember in performing the trick is to keep the fingers well around the rings to prevent the ropes from dropping in case of a slack-up on the tension.

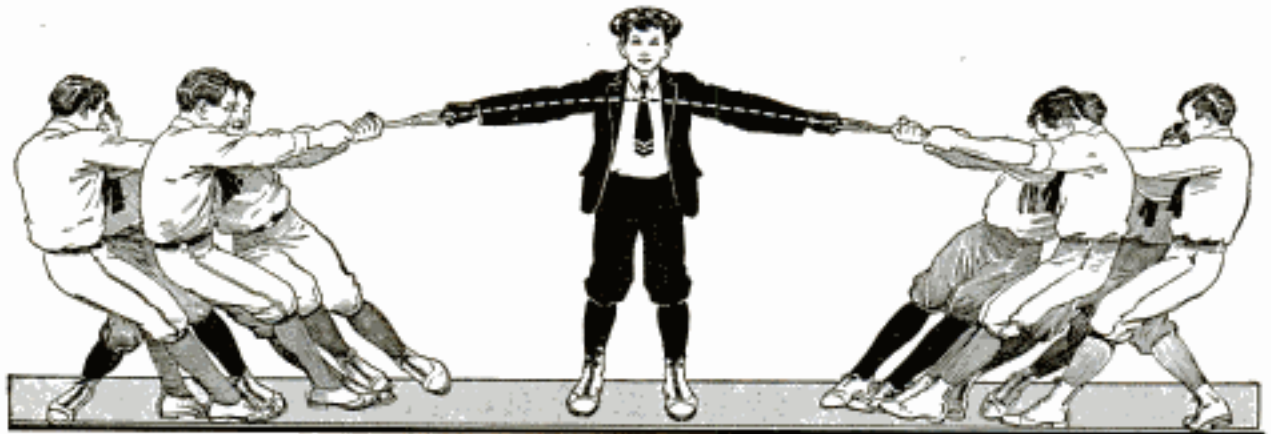

The Performer Seems to Hold the Ones Pulling on the Ropes without Any Effort. Producing an Effect That cannot be Readily Understood, and Making an Excellent Trick for the Lawn Party

*Barrofield
Calif*

SURFACE MINING *for* GOLD

BY W. M. MILLS

CONDITIONS

of life are such that opportunities for new experiences and pastimes present themselves continually to the adventuresome person. Even during the short summer vacations, the time set aside for idleness and pleasure may often result in profit combined with pleasure, if surroundings and possibilities are considered. Quite a few people plan their vacations and outings in places and surroundings where they may not only enjoy the rest from their regular labors, but even pay their way as

they go from the results of pastime investigations or experiences. New ideas may be the means of eventually getting into more interesting lines of work. People planning their vacations in the mountains, especially in ore-bearing regions, may wisely look around and possibly come across some "find" that may change the rest of their career. In view of such an opportunity, it may be well to give some of the general, yet useful, points in gold mining and the assay, or determination of value, of such ore.

First of all, a prospector's outfit is necessary. In any camping, or out-



PART I—

Panning for Gold

A Regular Camp is Set Up and Then Preliminary Panning is Systematically Followed Out Until Traces of Color are Found; Then the Prospecting Proceeds Upward and Back into the Hills

door living, a simple outfit must be provided if considerable traveling is to be done. Some means of transportation must be figured on; if by stream, then a boat is necessary; if by land, a horse or donkey should be used, unless several members compose the party, in which case each one can share the necessary burden. It is important to figure on emergencies; therefore, even in warm climates, it may be necessary to have several blankets. If possible a small "A" tent should be taken along. All necessary cooking utensils should be provided, besides a supply of flour, sugar, bacon, salt, baking powder, and coffee, sufficient to last longer than the planned trip. Meat and fish probably can be procured on the trip and need not be taken along. The necessary tools are: Ax, pick, shovel, pan, hammer, three or four rock drills of assorted lengths, blasting powder or dynamite, fuse, and a gun. It sometimes is desirable to assay the gold on the spot, necessitating the assay outfit, mentioned later on.

New discoveries of gold-bearing lands are made from time to time and in unthought-of places. A great deal of valuable ore can be recovered from so-called "tailings," or scrap, of discon-



Separating the Gold and Mercury by Heating the Amalgam in an Iron Retort

tinued mining properties. In gold mining, especially in "placer," or hydraulic, separation of ore and soil, valuable deposits may still be frequently found around worked-out properties, or entirely new discoveries made. The chances of finding "pay dirt," or gold ore, in a gold country, whether in the hills or on the desert, as in southern California, are best if a regular system of prospecting is followed. This work should begin generally in the lower areas and be followed up through the draws, or cañons, to the hills and mountains. The reason for this is that the gold which was originally in the rocky strata of the mountains, has, through the effect of surface washing, or erosion, been released from the quartz lodes, or ledges, and carried downward by the waters to the lower stretches. Here it has been deposited in past ages, and remains there until discovered.

It is the hope of every miner and prospector to discover a quartz ledge which carries gold. This is usually not accomplished without first having followed up some slight clew of "color," or trace of gold, which may have been found in the low washes, or draws, leading up to the hills. This find of "color," or gold trace, is made by what is known as "panning" the dirt at the bottom of the draws as the prospecting proceeds upward and backward to the hills. Panning, or

horning, is the first and simplest of all the means employed by the prospectors in the search for gold. A pan, about the shape of a frying pan, with sloping sides is the best for this purpose. The dirt to be examined is placed in the pan, and enough water is added to move it freely. The pan is then given a whirling motion, and is slightly tipped so the lighter dirt will wash over the side. This operation is continued until all the fine silt and sand is removed, leaving only the heavy material. The remainder is then carefully examined for "color," or fine gold, by holding it in the bright light and watching it closely, as it takes but very little of the yellow dirt to make the find valuable.

If signs of pay dirt, or color, are discovered, close search should be made for the ledge of quartz from which the color has come. If this ledge is found, it should be examined with great care, both at the surface, or "grass roots," and beneath the surface, for signs of gold. In the southern country, especially in California, these lodes, or ledges, have a tendency to strike nearly north and south. If the searcher has been fortunate enough to find the gold ledge, it is next necessary to assay samples; in other words, to determine the value of the ore. This can be done as explained later on in the article, or if no conveniences and tools are handy, the sample may be sent to a reliable assayer and the exact value of the ore per ton thus determined.

Having discovered a ledge of gold-bearing ore, the next question is that of the expense of mining the ore, sending it to a mill, and separating the gold from the rock. It frequently occurs that a good find, be it of gold or other ore, may be so situated with regard to transportation facilities and necessary supplies for mining operations that the expense of getting the gold is greater than the actual value of the bullion. Necessities, as fuel and water for boiler plants, may render an otherwise valuable ledge worthless for the time being. Usually, in a rough mountain

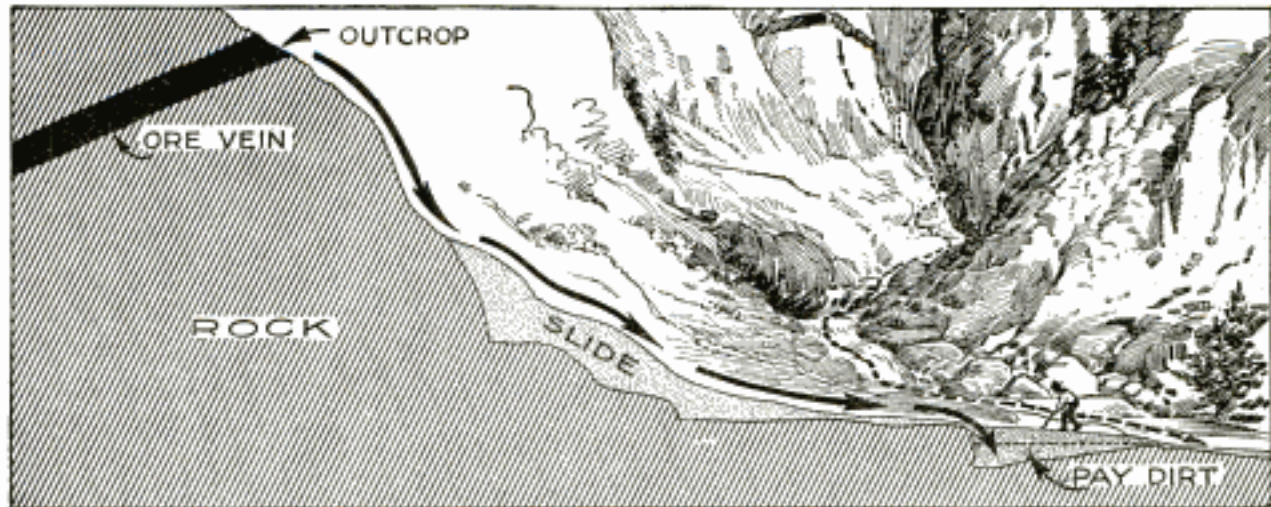

When Placer Gold is Found, It Is Necessary to Use a Sluice Box and Run the Gravel and Pay Dirt over Riffles to Catch the Gold

country, the lack of facilities for transporting the ore from mine to mill is the greatest obstacle to the development of a mine.

The simplest method of mining gold is through what is known as "placer," or hydraulic, mining on a small scale. It is usually carried on along waterways, rivers or creeks, wherever water is to be had in abundance. Often, however, such mining is found to be profitable along ancient waterways, or in the beds of dried-up streams and in what are known as "river gravels." In the course of the decay and wearing away of the ancient rocks which carried gold, the rivers and streams became natural concentrators, or collectors, by carrying away the lighter portions of the soil and decayed rock, and depositing the gold—which is 19 times heavier than water—in the river bottoms, where it is found at the present time. Gold itself is so indestructible that it will lie in the bed of a stream for ages, and when removed, will still be found the same bright metal it was originally. Placer gold is usually found in nuggets and requires but little refining. The gold being so readily detected in placer mining, this is naturally the most popular way of searching for it. A few nuggets found by placer mining may be worth more than the gold which can be separated from tons of gold-bearing ore. The transportation difficulties are overcome; for, as long as but a small amount need be

carried, no trouble will be found in taking it to the refining mill. Gold, when sought after in placer mining, may usually be found in the lowest part of the river bed, due to its weight being greater than that of gravel. Of any number of assay samples, those taken from above the immediate bedrock will be found the richest. A placer locality is identified by the accumulation of rounded river stones and boulders, possibly cemented together, and appearing as either a rolling surface or, perhaps, as low, rounded hills. Such gravels may often be covered with a layer of lava which is of later deposit.

Having located a stream with conditions right for placer work, preliminary panning should be followed until colors are found, and followed up to a find of placer gold. It is then necessary to use a sluice box, and run the pay dirt and gravel over "riffles" to catch the gold. The riffles can be made of various materials; the general idea in their construction is to form some slight obstruction to the passage of the water and gravel in the sluice box. This sudden retarding of the flow will cause the heavy gold to drop down in pockets, or openings, in the riffles. Many different devices are made use of, as the gold may be coarse and in nuggets, or even as fine as flour. As a rule, mercury will assist greatly in catching the valuable ore, since mercury has a very strong affinity for gold

and will readily amalgamate with it. A good illustration of this action can be obtained by placing a gold ring, or other gold article, in mercury; it will immediately amalgamate with the gold, forming a coat of mercury over it, which either must wear off or be removed by heat or chemicals. Valuable deposits of gold are often found mixed with a black iron ore, frequently called "black dirt," which not only tends to prevent amalgamation but, in the preliminary panning, increases the difficulties of discovering the gold. This ore, when found, is usually concentrated, or refined, for its gold-bearing portion and then sent to a refining mill. If the sluice boxes and riffles with mercury pools are used, the gold may frequently be obtained pure by retort-

ing the amalgam. This operation is shown in the illustration. The amalgam is put in an iron retort which is gently heated. The mercury vaporizes and passes out through a tube, connecting the top of the closed retort with a water-filled receptacle, where the vapor is condensed to liquid mercury which may be used over again. The gold can then be easily removed from the retort. After removing the bulk of amalgam from the riffles, the residue may be obtained by burning the riffles, if they are made of reeds, or cloth. Part of the gold will drop out and can be recovered; the remainder is then thoroughly amalgamated and later separated into its parts, gold and mercury, in the retort, as described.

A Portable Folding Camp Table

Camp or lawn tables are usually bunglesome bits of furniture to carry from place to place, and for this reason I constructed one to fold and present the appearance of a thin sample case. When folded it is 30 in. long, 24 in. wide, and 3 in. thick, and as a

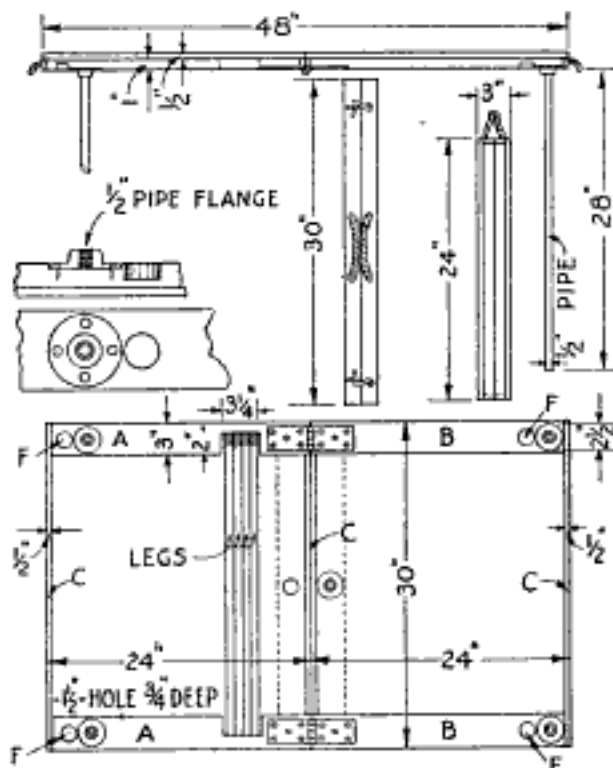

The Camp Table When Folded Ready for Carrying Resembles a Tin Sample Case

table it has a top 4 ft. long and 30 in. wide, and is 29½ in. high. The parts necessary, outside of the lumber, are a pair of hinges, four ½-in. pipe flanges, and four pieces of ½-in. pipe, 28 in. long, with threads on one end of each piece.

Two strips of wood, 23 in. long, 3 in. wide, and 1 in. thick, A and B, are connected at each end by strips, 23 in. long, 1 in. wide, and ½ in. thick, C. On these frames are placed the ½-in. thick boards forming the table top. The hinges that join the two parts of the table should be recessed so the table, when folded up, will resemble a thin carrying case. The pipe flanges are placed on the strips A and B in such a way that they will not interfere when the table is closed. On the parts B they may be located touching the outer end strip C. On the other strips, A, they should be placed a distance from the strip C corresponding to one-half the diameter of the entire flange plus one-half the outside diameter of the boss. This will allow the bosses of opposite halves to just clear each other. In fastening to the table, the flanges should be recessed so that only the bosses extend beyond the surface of the wood. Holes, F, should be located and drilled in the strips A and

B, corresponding in position, diameter, and depth to the flange bosses, thus allowing the table to be shut up tight, the bosses fitting into the holes. The strips A are cut out sufficiently so the table legs can be placed in the position shown. Tablecloths, napkins, and other light material, may likewise be carried between the folded parts of the table. Any convenient carrying handle may be provided, and the table locked when closed by means of hooks and staples. Should the table be made to larger proportions requiring extra supports in the center, one or more legs may be added by first putting in crosspieces, shown by the dotted lines, then placing the flanges so they will miss each other and fold into holes bored to receive the bosses as before.—Contributed by F. M. Arnold, St. Elmo, Tenn.

A Durable Pincushion

The pincushion is not merely cheap, but satisfactory in every way for my office desk. It is made of a cake of white soap covered with tissue paper, the paper being fastened neatly in place with pins. Into this I stick the pins that are constantly needed for use at the desk. The pins stick in easily, remain firm and do not rust. The paper can readily be renewed when soiled.—Contributed by L. Alberta Norrell, Marietta, Ga.

To Keep Worms Away from Plants

Old screen wire, or new, can be used to good advantage over plants, such as cabbage and tomatoes, to keep out worms. To use the wire, form it into cones of sufficient size to cover the plant until it gets a hardy growth. In some instances the wire screen has protected plants from the frost. The base of the cone is pushed into the earth about the plant.

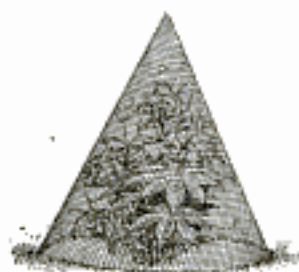

Shadowgraph of the Savior

The sketch would appear to be the work of a cubist, but instead it is a shadowgraph which will produce an



In a Strong Light the Paper Cut Out Produces an Excellent Shadowgraph of the Christ

almost perfect representation of the Savior. The exterior lines must be trimmed, the spaces cut out and then held in such a manner that a shadow will be cast. The result will be the face of the Crucified thrown upon the wall.—Contributed by John F. McCune, Ellicottville, N. Y.

Six-Sided Waste-Paper Basket

To construct the hexagonal waste-basket, shown in the sketch, it is necessary to have the following material:

- 6 side pieces, $\frac{3}{8}$ by $4\frac{1}{2}$ by 12 in.
- 1 base, $\frac{3}{8}$ by $8\frac{1}{2}$ by $8\frac{1}{2}$ in.
- 12 round-head wood screws.
- 6 strips of leather lace, about 10 in. long.

The bottom is laid off with a pair of dividers, first drawing a $4\frac{1}{4}$ -in.-radius circle, and then using the same setting to step off around the circle, thereby getting six equal spaces which are connected to form sides each $4\frac{1}{4}$ in. long.

These are then cut and planed to size. The sides are squared up to a size, $4\frac{1}{2}$ in. wide by 12 in. long, and the design is laid out on them. The edges of the

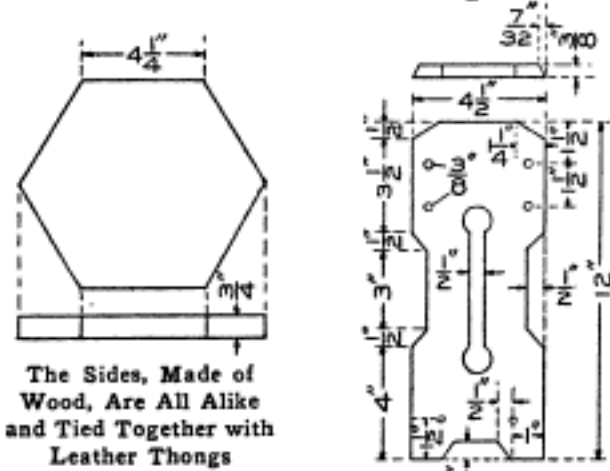

boards are beveled off to fit around the base. A line is drawn on the inner side, $\frac{7}{32}$ in. from the edge and parallel with it. If the board is then trimmed from the outer corner to the line, the correct bevel will be obtained very closely. The

sides are then cut to the design. If no scroll saw is handy, the internal design may be cut out with an auger bit and keyhole saw. After all the pieces have been fitted, they are assembled and fastened to the base with the wood screws.

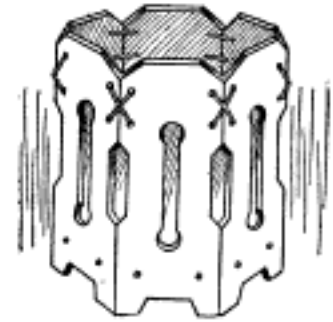

The best finish can be given the basket if it is sandpapered and stained or varnished, as desired, before permanently assembling it. The sides, at the top, are held together by leather laces. Strips of brass, or copper, may be used to good effect instead of the lace. If desired, two metal handles or rings may be fastened to opposite boards with lace or screws.—Contributed by James Gaffney, Chicago.

Homemade Rotary Pump

In order to drive reciprocating pumps from a revolving pulley, a special power head must be provided, equipped with gears, crank, and bearings. Rotary pumps, besides avoiding the necessity of any such arrangement for driving them, are valveless and

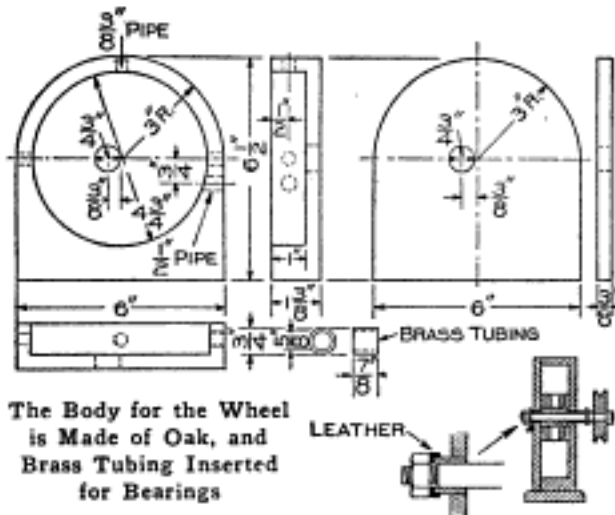

more compact, and therefore especially adapted to confined places and laboratories. The illustrated pump can be

easily made from wood and fittings that are readily obtainable.

For the body of the pump, a piece of sound hard wood, 6 by $6\frac{1}{2}$ in. and $1\frac{3}{8}$ in. thick, should be provided. This is faced off and turned in a lathe, a central hole being cut out, $4\frac{3}{4}$ in. in diameter by 1 in. deep. The center of this recess should be found, and a $\frac{3}{4}$ -in. hole for the bearing laid off and drilled, with its center $\frac{3}{8}$ in. to the left of the recess center, on the horizontal center line of the recess, as shown. A $\frac{3}{8}$ -in. thick cover should be provided, having the same exterior outline, and likewise drilled for a $\frac{3}{4}$ -in. hole. For the inlet connection of the body, a hole should be drilled and tapped for a $\frac{1}{2}$ -in. pipe thread, $\frac{3}{4}$ in. below the center line of the circular recess, and $\frac{1}{2}$ in. in from the open side. An outlet should be drilled and tapped for a $\frac{3}{8}$ -in. pipe connection through the top, and in line with the center of the body. In order to permit all water in the upper part of the pump to escape, a groove should be cut in the circular face, starting at the outlet and passing

down to a point near the horizontal center line of the body.

The rotor, or paddle wheel, consists of a 4-in. circular disk provided with four $\frac{3}{8}$ -in. slots, equally spaced. In these are fitted vanes, or paddles, held in position bearing against the inner circular face of the body, by means of spiral springs. Two $\frac{5}{16}$ -in. holes in each vane serve not only as guides for the springs, but also permit the use of a greater length for the same. The upper edges of the vanes are rounded off to provide an easier sliding movement around the circular face. The rotor is carefully bored to fit a $\frac{5}{8}$ -in. brass shaft, and fastened to it by means of machine screws, fitted through the ends of the slots. Brass bearings for the shaft are tightly fitted into the $\frac{3}{4}$ -in. openings of the body and cover. The shaft is turned down and threaded at each end for $\frac{3}{8}$ -in. standard nuts. Rubber or leather washers, placed over the shaft at each end, are pressed against the bearings by the adjusting nuts, thereby preventing any leakage. The driving pulley is held in place on the long end of the shaft, between the adjusting nut and a locknut. Before assembling the pump, the body is fastened to a suitable base, and all wooden parts are thoroughly shellacked and varnished, inside and out, to prevent the absorption of moisture. In order

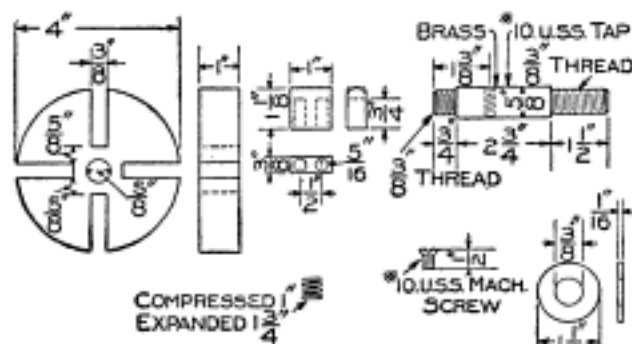

Detail of the Parts for the Wheel Which Consist Mostly of Wood and Brass

to provide a slight end clearance for the rotor, a paper packing ring should be placed between the cover and body when these are fastened together.

In operating the pump, water is forced out continuously by the blades in the upper part of the body. Any

escape from this part, except through the outlet, is prevented on one side by the ascending vane which has last passed the inlet; and on the other side

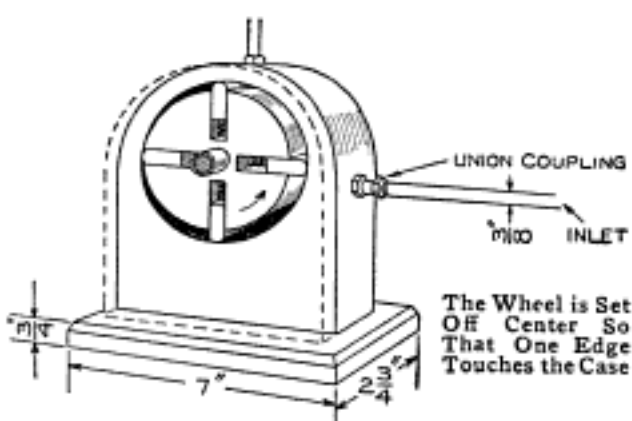

by the sliding contact existing between rotor and body. The vanes in the lower part first produce a slight vacuum until that space connects with the inlet opening, when it fills up with water, which is carried along into the upper section of the pump and there escapes; this cycle of operations is repeated continuously. It is best to have the supply water above the inlet of the pump, insuring its operation, as slight leaks or inaccuracies of rotor and body may admit sufficient air to spoil the vacuum, and prevent the suction of the pump.—Contributed by Adolph Kline, Newark, N. J.

Spout to Drain a Tank Made of Paper

Often one has need for a spout of small size for draining a tank, or some similar use. I had occasion to use one while draining a tank and proceeded to look around for something to serve the purpose. I finally took the cover of a cardboard suit box and rolled it up to make a spout of the desired size. It was then tied with a piece of twine and propped up in the desired position. After draining the tank several times, the water had soaked through a very little bit, only enough to wet the cardboard, but it did not soak through, or drip out, on the sides. I have found that such a spout will last for several hours, working as well at the last as it did at first.—Contributed by Jack F. Meredith, Pittsburgh, Pa.

Washing Bromide Enlargements

The difficulty of washing bromide enlargements of the larger sizes has always made the amateur hesitate to un-

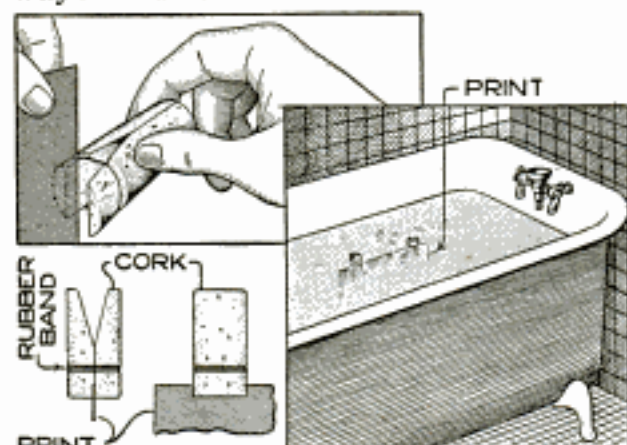

The Cork Clips Hold the Bromide Print in the Water in a Vertical Position

dertake much of this kind of work. The developing and fixing can be done with comparative ease, because of the facility with which the print can be kept moving in a tray that is smaller in size than the print itself, but washing is such a long process that one's patience is exhausted before the hypo is completely eliminated. Continuous handling of a print for 30 minutes is tedious work. This objection can be overcome in the simplest and most efficacious manner, as follows:

Procure some large corks of the best quality and in each cut a groove completely around it, near one end, to serve as a retainer for a rubber band; then cut the cork lengthwise through the center, and cut a wedge-shaped piece from the center toward the end opposite the one where the groove was cut for the rubber band. After placing a band in the groove of the proper size the combination will work similarly to an old-fashioned spring clothespin.

If two of these are snapped on the edge of a bromide print, this can be dropped into a bathtub or laundry tub for washing. The corks will cause the print to float vertically in the running water. By this means a number of prints can be washed at a time without any danger of their sticking together or becoming wrinkled or cracked in the bath.—Contributed by T. B. Lambert, Chicago.

Bench Support for a Miter Box

To make the most effective use of a miter box, it must be fastened solidly to a base, but if fastened to the workbench top it is in the way when not in use, and it is a nuisance to fasten and unfasten the box every time it is used. To avoid the changing, I mounted the miter box on two pieces of 1 by 3-in. stock, about 2 ft. long. These pieces were placed on the bench top, at right angles to the front edge and with their centers as far apart as the two pairs of legs on the box. The box was placed on the front end of the pieces, with the back parallel to the front of the bench, at right angles to the pieces, and was fastened to them with screws. The other end of each piece was fastened to the bench top with a hinge.

This fastened the miter box firmly to the bench top, but in such a way that I could tip it up and back against the wall, or other support, where it was out of the way but ready for use immediately. To stiffen the frame, I placed a cross brace between the two pieces, making it in the form of the letter H.—Contributed by L. C. Burke, Madison, Wisconsin.

A Blowpipe for Gas

Every experimenter who has a gas connection within convenient distance of the workbench should provide a 4 or 5-ft. length of $\frac{1}{4}$ -in. rubber tubing, terminating in a brass tube through which air may be blown in order that a clear blue flame may be available for either hard or soft soldering. The brass tube should be 4 or 5 in. long and fitted at one end with a removable nozzle having a $\frac{1}{16}$ -in. hole in it. A hole is then drilled in the side and a



piece of smaller brass tubing, bent as shown in the sketch, is soldered in place for the air supply. A piece of soft-rubber tubing about 1 ft. long is then provided and one end slipped over

the projecting end of the air pipe and the other fitted to a hard-rubber, or amber, mouthpiece. By regulating the gas supply and blowing to the proper degree, a pencil of blue flame may be produced, anywhere from 1 to 4 in. long. For heating large surfaces, the nozzle tip should be removed.

This method of soldering not only makes a better connection than the usual copper, but is instantly available and does not disarrange the several pieces where, as is often the case, it is not practicable to pin or hold them in place.

Scraper for Dishes

Housekeepers will find the scraper shown to be silent and more rapid than a knife for cleaning dishes. It consists of a handle cut from a piece of straight-grained wood, with a kerf sawed in the wide end to a depth of $\frac{3}{4}$ in., into which a piece of sheet rubber is inserted. The rubber may be cut from an old bicycle-tire casing and is fastened with two or three brads driven through the handle. The ends of the brads are bent over or riveted.



A Dish Scraper Made of a Piece of Rubber Inserted in a Wood Handle

The edge of the rubber should be made straight.—Contributed by H. S. Craig, Rushford, Minn.

Protecting Lights in a Gymnasium

A public-school auditorium was used for playing basket ball, and the lights were protected as shown. Wire wastebaskets were fastened to pieces of board, which in turn were nailed to the ceiling around each lamp. As it was desired to provide a way to ventilate the room, an opening was cut in each board around the lamp base, providing fan-shaped cut-outs covered with galvanized metal of the same design, to

make a way to open and shut the ventilator. The air passed up into an attic. The goals, which were old black-

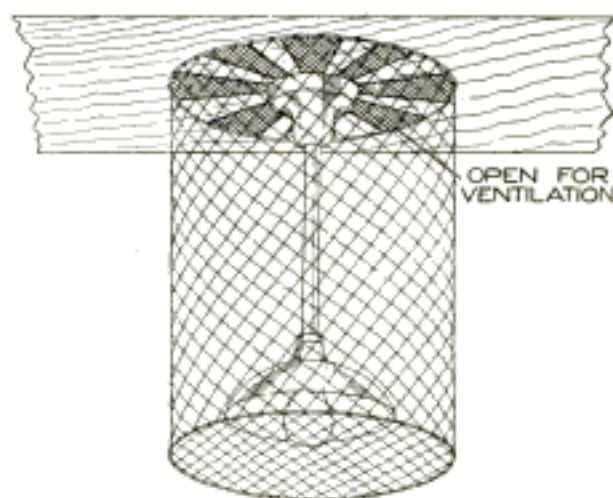

Wire Wastebasket Fastened around a Light to Protect It for Basket-Ball Games

boards, were fastened between the posts that supported the ceiling. Two iron rods, one above the other, were clamped with bolts to the posts, and the boards were bolted to the rods.—Contributed by Frank C. Svacha, McKees Rocks, Pa.

Shortening a Pasteboard Box

If a pasteboard box happens to be too long for a special purpose it can be shortened as shown. The sides are cut down to the bottom and the end removed. The bottom is then bent up on a line between the places where the

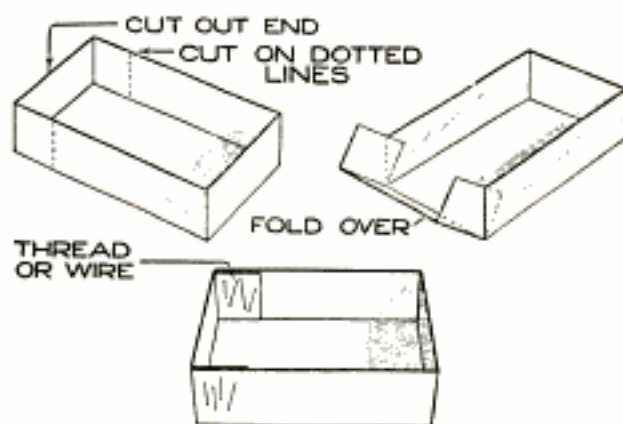

Shortening a Box by Bending Up the Bottom after Removing the End and Cutting Down the Sides

sides were cut down, to form a new end for the box. The joining parts are then held with a thread or wire fasteners.

Am. M.
Vill. p. 888

Padding Your Own Canoe

by
Stillman Taylor



PART II—The Knack of Handling the Paddle

THE knack of paddling a canoe as the majority of amateurs paddle is quickly learned, but to handle a paddle as the expert woodsman and the Indian wield it requires not a little practice and experience. In the birch-bark and canvas-covered craft, used by the guides of Maine and Canada, there are no seats, and the stern paddler kneels with his back against the rear thwart, while the bow paddler usually kneels with his back against the second thwart from the bow. However, the builders of modern canoes furnish a seat for each paddler, and while it is more comfortable to use them, it is better to take the kneeling position, which brings the weight lower in the canoe, as it is safer, and the paddler is better able to control his craft. Again, the use of the seat makes it impossible for the paddler to put much of his body into the stroke, and he propels the craft largely through the muscles of his arms and shoulders. But when paddling from the knees they are spread out to brace the body firmly, and the back resting against the thwart enables the paddler to use his back and thigh muscles to drive his craft ahead with much less exertion and waste of energy than when sitting erect. Of course, the kneeling position is a source of discomfort at first, but after a little practice it will be easy to keep the position for several hours.

The stroke of the paddle is made with the body motionless, one hand grasping the shaft of the paddle and the other holding it a short distance above the blade. The paddle is now carried forward, dipped into the water in front, Fig. 1, A and B, and carried downward past the paddler's body, Fig. 2, A and B, and the stroke is finished in the rear, Fig. 3, A and B. The paddle is recovered by turning the wrist so that the blade is turned edgewise as it is swung through the air to begin the second stroke. The swing of the paddle should be smooth from the beginning to the finish of the stroke, that is, free from undue jerkiness, but the long and slow sweep of the paddle is amateurish, pure and simple. The canoe men of the North woods do not use this stroke, but prefer a shorter stroke, quick recovery of the blade, and the "accent" of the stroke is much the same as that the expert axman uses when felling a tree. Therefore one's energy should be concentrated upon the first part of the stroke, easing up quickly as soon as the blade is opposite the body, and finishing the stroke smartly as it is carried backward. The driving power of the paddle diminishes rapidly as the blade is carried backward, and if the full force of the stroke is continued with a long backward sweep, a way of most amateurs, much energy is wasted, since it adds nothing to the forward momentum

of the canoe, but rather retards it, by forcing down the stern, and also causes the craft to drag more water after it. For a short afternoon paddle almost any kind of a stroke will suffice to drive the canoe ahead, but upon long trips, or when head winds and rough water are encountered, the quick, short stroke will save both time and muscle. The long sweeping stroke of the summer idler will probably average about 26 to 30 strokes per minute, while the North-woods guide and Indian will



FIG. 1-A

dip their blades almost twice as often, a fair cruising average being about 45 strokes per minute. Short strokes, with the accent at the beginning of the stroke, will push the canoe faster and with less effort, and the paddler has better control over his craft.

The bow paddler usually does nothing more than keep up a regular stroke and watch for rocks and obstructions, but if he is a good hand at the paddle he can do much to steer the canoe. For example, take the usual bow stroke, made by dipping the paddle quite close and ahead of the canoe. The force of the stroke thus made forces the bow in the opposite direction, and the man in the stern will be called upon to use more energy in steering. In contrast to this faulty handling of the paddle, the experienced bowman will begin his stroke by dipping his pad-

dle well out from the bow and pulling it toward him at a greater angle, which keeps the canoe moving straight ahead without swinging to one side, and the energy of both paddlers is used in driving the craft steadily ahead. When paddling in tortuous and rocky streams it is the bow paddler's duty to watch out for rocks and snags, and he should always be prepared to "draw" the canoe whenever it is necessary to clear an obstruction or assist the stern paddler to shoot the canoe around an abrupt bend. To do this is simple enough, since in "drawing," the man at the bow merely reaches his paddle

out at arm's length over the side and pulls the bow in that direction, while the stern paddler simply paddles straight ahead.

The stern paddler is the helmsman of the canoe, and while he can keep his craft on a straight course by



FIG. 2-A



FIG. 3-A



FIG. 1-B



FIG. 2-B

The Stroke of the Paddle is Made with the Body Motionless, One Hand Grasping the Shaft of the Paddle and the Other Holding It a Short Distance above the Blade



FIG. 3-B

trailing his paddle at the end of each stroke and using it like a rudder, it can only be done when a long, slow stroke is used. To save time and muscle, the experienced stern paddler always finishes his stroke with an outward push and a turn of the wrist, which offsets the swing of the bow and keeps the canoe on a straight course with much less effort than when trailing the paddle astern. Paddling from the stern is often considered difficult, but one soon masters it by a little experience.

Paddling in Open and White Water

When traveling in the open waters of large lakes where heavy winds and seas are commonly encountered, paddling should always be done on the knees, and the canoeist's own experience and judgment must be called upon to meet constantly changing conditions of the wind and water. To cross a broad stretch of wind-swept water where whitecaps are running high, means a long, hard fight, and the stern paddler must be ever alert to ease the canoe through breaking crests and shift his balance whenever the necessity arises. When paddling in rough water, many canoeists make the mistake of driving their craft too hard, consequently the canoe will "pound" when it reaches the trough of the sea, and much unnecessary spray is sent flying aboard. Of course, in rough water some spray is certain to come over the rail, but if the craft is well balanced by stowing the camp duffle so that the canoe floats on



Dangerous for the Novice,
but Experts Win Races
in This Position

an even keel, it will, with proper handling, weather a pretty stiff gale. When paddling against a heavy sea and wind, the regular stroke must be altered and modified, and the man in the stern may often balance his craft by holding his paddle in the water while a particular high comber sweeps by. Short and clean strokes are essential for handling the canoe in a heavy sea, and while the skillful canoeist can handle his craft in the trough of the sea when the need arises, it is hazardous for the novice to attempt it. In heavy weather, it is a good thing to keep one paddle in the water while the other is in the air, hence the experienced canoeist will—unconsciously perhaps—alternate or "split" strokes with his bowman.

When paddling against a heavy sea and wind, the regular stroke must be altered and modified, and the man in the stern may often balance his craft by holding his paddle in the water while a particular high comber sweeps by.

When paddling against a heavy sea and wind, the regular stroke must be altered and modified, and the man in the stern may often balance his craft by holding his paddle in the water while a particular high comber sweeps by.

To paddle, head on, into heavy seas is slow and tiresome work, and most canoeists find it easier to take the seas on the quarter, and the stern paddler must be ever on the lookout, nursing his craft over the big ones and often turning his bow into the largest combers. To be sure, the canoe will plunge more or less and yaw about, but the stern paddler merely checks this side spin, since he cannot prevent it entirely and drive his craft onward at the same time. When running before the wind, it is only necessary to keep the canoe balanced or "trimmed" to keep things dry. Here the bow paddler has the best of it; his sole duty is to keep paddling steadily ahead, while the balancing and handling of the canoe rests with the man in the stern. This point is well worth remembering, for to keep the canoe right side up when shooting rapids or when bucking heavy seas on a lake, the bow paddler must stick to his seat. He can, from his position in the bow, quickly note rocks or other obstructions and pass the word to his partner, who from his point of advantage can likewise better size up the effect of a high wave upon the craft. Probably more capsizes have resulted through the bowman's mistaken efforts to balance the canoe by leaning to one side, or attempting to dodge the spray in rough-water paddling, than through the inability of the stern paddler to handle his craft.

Running a rapid stream in a canoe is replete with excitement, but it is likewise a dangerous bit of fun for the inexperienced canoeist who has not fully mastered the handling of his craft. When running rapids where the water is fairly deep, the use of the paddle is the better way, providing both paddlers kneel in the bottom of the canoe. Unknown streams are naturally the most dangerous, although the veteran canoeist can "size" up the character of the stream at the first glance, that is, the trained eye of the woodsman will read the bottom of the river by the indications on the surface; depth of water, strength of current, swirl caused by submerged rocks, and many other de-

tails are evident to him. To the novice these signs mean but little. If the current flow is from three to four miles per hour, rocks or submerged logs, 4 or 5 in. below the surface, will show very little, but in a 10-mile or swifter current obstructions 12 or even 18 in. below the surface will throw up swirling ripples, and in a very rocky stream with much water flowing, rocks 3 or 4 ft. below will throw up waves of good size. Again, waves are caused by swift water striking the comparatively quiet water of a deep pool and the canoeist should be able to determine the difference between them in order to know what part of the stretch is dangerous and that which may be run in safety.

The waves in a rapid stream are altogether unlike the rolling waves of the open lake, in that the crests follow one another closely and the canoe cannot rise, but plunges through the curling crests. Rocks on the surface are easily avoided, as they split the current, and it is only necessary to steer the craft to one side to pass them safely. The one chief thing to do when shooting the rapids is to keep the canoe on an even keel and the bow into the current, and when it is necessary to change channels, the craft must be shot diagonally across the fast water. To keep the canoe under perfect control in white water, it must be propelled faster than the current flows, and the force of the stream must not strike one side of the bow with greater force than it exerts on the other side. When a canoe swings around in the current, the power of the paddles will be unable to cope with the more powerful current, which quickly swings it broadside and one is struggling in the water in the next instant.

On a long canoe trip where much rapid water must be run, a "setting pole" should be reckoned a necessity. The pole may be a stout sapling, 10 ft. long, cut by the stream side, but an iron shoe, or spike, about 3 in. long, with an iron band or ferrule, should be carried in the kit, the iron spike being simply driven in the end of the green pole. The pole may be used to good advantage when running down shallow rapids, the

man in the bow kneeling and using his paddle to help steer while his partner stands in the stern and wields the pole.



The Double Blade Is Often Useful When Paddling Single-Handed on a Broad Reach of Wind-Swept Water

When traveling up shallow and swift streams, the setting pole is absolutely necessary, and while at first it is an awkward implement to handle, a little practice will enable the canoeist to pole his craft with very little more effort than is required to paddle it. The use of the pole necessitates a standing position, but this is neither risky nor difficult for any canoeist who understands the knack of balancing a canoe, and none but an experienced canoeist has any business in swift, white water. The setting pole is gripped with the left hand near the top, with the right hand held stationary about 2 ft. lower, and as the canoe travels past the pole, firmly planted on the river bottom, the poler leans forward and makes use of his weight and strength to give a quick push. The pole is again shoved forward as quickly as possible, that the craft may lose as little headway as possible, and a new grip secured for the next push. After a little experience with the pole, the canoeist will find it an easy matter to swing his craft across the current and avoid rocks and other obstructions as easily as when paddling. When contemplating a long trip up a stream where the water is heavy and the current swift, the use of two poles will make the work easier. Both persons should pole from the

same side, the man in the bow doing the steering while the stern man adds his straight-ahead push to force the canoe upstream.

The Track Line

The average wilderness stream of the North has enough "tight" places which



judgment tells the traveler to avoid by making a detour by land rather than risk a capsize and a possible loss of the outfit. To "tote" the outfit overland means more or less hard work, and as every canoeist will avoid portaging if there is a fair chance of getting the canoe through a bad stretch of water, the tracking line will come in handy very often. The usual ring in the bow of the canoe is far too flimsy for hauling the loaded craft, and sufficient length of stout rope should be carried along to pass through the painter eye, and then carried aft and half-hitched to the first and second thwarts. One man can pull the canoe up a swift stream by walking along the bank while his partner takes up the opposite side and steers the craft away from rocks by using a stern line. With a heavily loaded canoe in very swift and shallow water, both men must often wade, and a tump line rigged up as a breast or shoulder strap will make it easier work for the man at the bow line.

Paddling a Canoe Single-Handed

The open, or Canadian-model, canoe is, of course, handled more easily and

with better speed with two paddlers, but there are occasions when the canoe is used single-handed. When out for a few hours' paddle, the canoeist usually balances the craft by sitting on the bow seat—or kneels on the bottom with his back against the bow-seat brace—and using the stern for the bow. This brings the paddler's weight nearer the center and keeps the canoe better balanced than when paddling from the stern with the bow high in the air. However, when the canoe is loaded, many canoeists stow their camp duffle forward and paddle from the stern, the weight of the outfit keeping the craft on an even keel. This answers well enough for smooth-water going, but when the water is rough, or a stretch of rapids is run single-handed, the stern position is by no means a good one, since the craft is more difficult to control, and much more strength is required to drive it forward. The Indian manner of paddling a canoe alone is the only correct one, for he always sits amidships—kneeling in the center—and if a load is carried, it is placed in front and back of him so that the craft is balanced on an even keel. Consequently the canoe draws less water and can be paddled faster with the same effort, while the paddler has the craft under perfect control. But the experienced line paddler does not kneel in the center, he moves out until his body is close to the gunwale. This makes the craft heel at a decided angle, it is true, but this position makes for better speed, because it enables the paddle to be held almost vertical, and the more nearly perpendicular the paddle is swung the more efficient will be the stroke.

In using the double blade, the paddler dips first on one side, then on the other, and to make the blades travel through the air with the least resistance, it is customary to set them at right angles to each other. The motion is really a push and pull, the shaft of the paddle being rotated in the hands so that the blade will enter the water with the full breadth facing the canoeist. Rubber cups, to catch the drip as the paddle rises in the air when making

the stroke, are sometimes used by novices, but these are unnecessary if the paddles are set at right angles, and the paddler will bend his wrist a trifle to throw the drip ahead and to one side. At the beginning, the novice will very likely throw a little water in the canoe, but a little practice will soon master the knack.

Care and Repair of the Canoe

The canvas-covered cedar canoe will stand a vast amount of hard service, but it should not be dragged over the ground or over the boarding of the landing float, neither should it be so placed that any strain will come amidships while the ends are well supported. When storing for the winter, keep it under cover, resting bottom side down on a floor, or turn it bottom side up and support it with boxes, or other standards, at the center as well as at the ends. While unused at the camp, turn it bottom side up on the bank. Birch bark must be kept out of the sun, and the paint of canvas-covered canoes will last longer if kept in the shade. When the paint becomes rough, sandpaper it down smooth, and give it a couple of coats of canoe paint. When the paint is worn off and exposes the canvas, give the bare cloth a couple of coats of shellac before painting.

Oiling Tool for Clocks

Jewelers use a little tool for oiling clocks and watches that could be used profitably by others for the same and similar work. It consists of a steel wire, bluntly pointed on the end and set into a wood handle. Very often the only thing that is the matter with a clock which does not keep good time, is that it is dirty and dry. If this is the case, any person handy with tools can fix it at practically no cost. Remove the works, which are usually held with four screws, from the case, immerse them in kerosene and allow them to stand for a few minutes, then remove and drain. This will clean out the dirt.

The oiling tool is dipped in light oil

A repair kit should be taken along on all long trips, consisting of a small can of white lead, a can of orange shel-



Padding should be Done on the Knees When Traveling Where High Winds and Seas are Encountered

lac, and a sheet of oiled silk. For small cuts in the canvas, a coat or two of shellac will suffice, but for bad gashes, cut off the loose threads of canvas and rub on a little white lead under the raised portion near the hole and on the surface, cut a patch of the oiled silk to cover it, and paste it in position. When the lead is dry, give it a couple of coats of shellac. For making quick repairs, a roll of electrician's tape will come in handy. The birch canoe is quickly repaired in the same manner as suggested for the canvas-covered craft, and as the shellac is waterproof and dries quickly, all ordinary repairs may be made by the stream side with but little loss of time.

and a drop applied to each bearing. Replace the works in the case and the job is finished. A reliable jeweler will charge very little for this work, but the more crafty ones may ask a good price for this "mysterious" process. If the works are not dirty, apply the oil with the tool. Anyone who has tried to oil a clock with an ordinary spout oilcan



The Tool will Pick Up a Drop of Oil and Deposit It Where Wanted

knows the futility of the attempt. The object of the tool is to pick up and carry a drop of oil and deposit it where wanted. A can, a feather, or a match will do, but any one of them is apt to carry dirt, flood the dry part, or smear up nonmoving parts.

INTERESTING NEW PATENTS

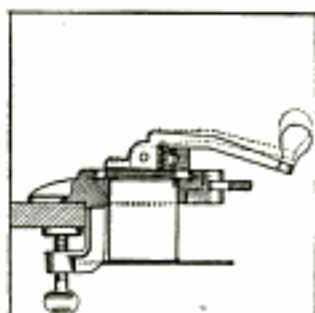

Fig. 1

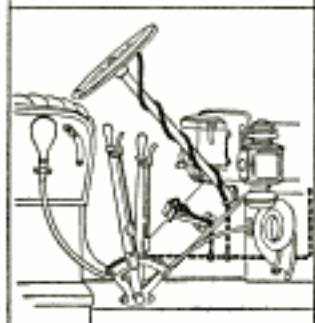

Fig. 3



Fig. 5



Fig. 7



Fig. 9

CAN OPENER (Fig. 1)—One of the features of this can opener is that it may be clamped in fixed position to the edge of the table. It is equipped with two jaws for holding the can, one of these jaws being movable so that any size of can is easily clamped in place. Working over the jaws is a rotating head operated by a handle, and mounted in this head is an adjustable knife for cutting the tin. In using, the knife is adjusted to the can and is sunk into the tin by depressing the handle. The head is then rotated, with the result that the top of the can is cut out.

ROTATING LAWN SWING (Fig. 2)—The platform is mounted to swing free on a stationary shaft, at the top of which is a table and circular handrail. The passengers rotate the platform simply by pulling on the handrail. The table and handrail are provided with a clutch with which they are fixed to the shaft.

SAFETY ATTACHMENT FOR AUTOMOBILE (Fig. 3)—The object of this invention is to make it impossible for the car to move unless the driver is in his seat with his hands on the steering wheel and with the pedals depressed. This is accomplished by a series of circuit breakers that control the ignition. The car cannot be cranked or the self-starter operated unless the speed lever is in neutral position.

ILLUMINATED NOTE PAD (Fig. 4)—Mounted on the end of the pad is a cylindrical case carrying a small electric lamp for illuminating the paper, current being supplied by a battery placed within the case. The light is turned off and on by means of a push button.

CRUTCH WITH BALL-BEARING TOP (Fig. 5)—The top of the crutch is made up of two metal segments between which are $\frac{1}{8}$ -in. steel balls. With this antifriction bearing the top segment moves freely, adjusting itself to the changing angles of the crutch so that there is little or no wear on the clothing.

NEW TYPE OF ATOMIZER (Fig. 6)—It is the evident purpose of this invention to provide a durable substitute for the rubber bulb commonly used with atomizers. The principal feature of the device is an air pump mounted in the chamber containing the liquid. The pump is equipped with a coil spring that returns it automatically to its original position each time it is released.

STREET INDICATOR FOR ELEVATED AND STREET-RAILWAY CARS (Fig. 7)—This indicator consists of a case in which are mounted a series of pivoted shutters bearing the names of the stations or streets in their proper order. The shutters are all carried on the same pivot, the arrangement being such that when a shutter drops, swinging into the receptacle at the side of the case, it uncovers the shutter bearing the name of the next station or street. The shutters are released electrically by push buttons placed in convenient reach of the motorman. When the car reaches the end of the line all the shutters are returned to their original position by means of a lever at the bottom of the case.

NEW DRIVE FOR CAMSHAFT (Fig. 8)—Mounted on the end of the camshaft is a mechanical device having four radial slots and known as the Maltese cross. Pins carried on the flywheel of the engine engage the slots in succession and rotate the camshaft at the required intervals.

KNIFE SHARPENER (Fig. 9)—The sharpener is operated by the handles, which are worked like the handles of a pair of shears. One of the handles is rigidly fixed to the frame, while the other is pivoted and drives the sharpening disk through a crankshaft and gearing.

HOLDER FOR PHONOGRAPH NEEDLES (Fig. 10)—This device consists simply of a strip of permeable material in which the needles are stuck



Fig. 2



Fig. 4



Fig. 6

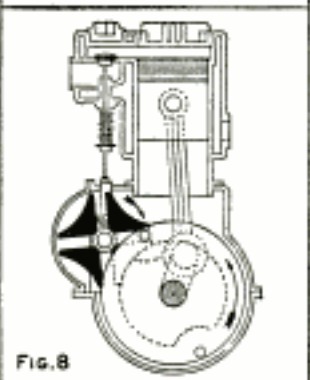

Fig. 8

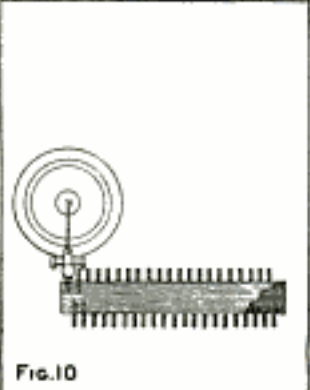

Fig. 10

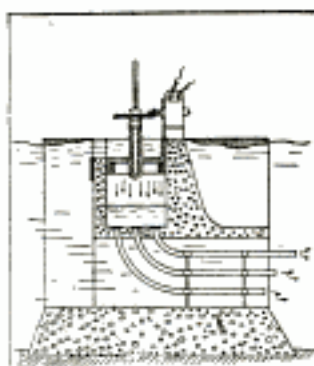

Fig. 11

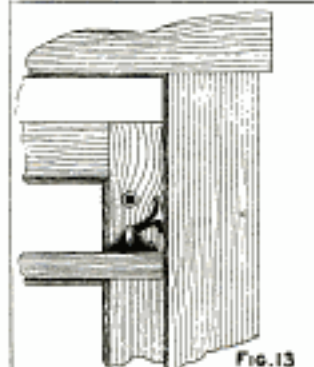

Fig. 13

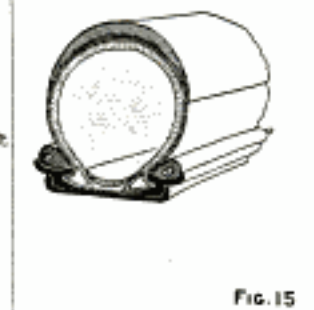

Fig. 15

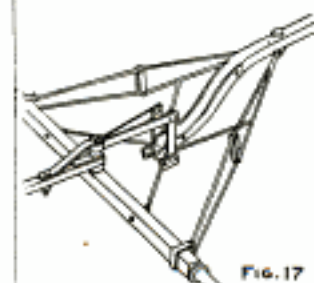

Fig. 17

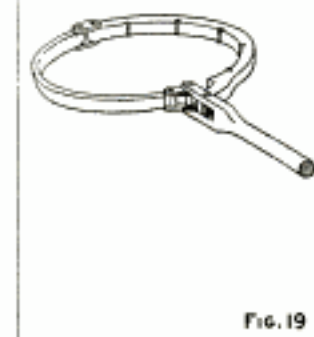

Fig. 19

point first. The needles are spaced such a distance apart that they can be inserted in the needle holder of the sound box without being touched by the hand.

CURRENT MOTOR (Fig. 11)—This motor, designed to be installed in a river current or tideway, consists of a turbine working on a vertical axis and mounted in a casing that is entirely closed except for openings through which the water enters and leaves. The entire apparatus is placed below the surface of the water and the turbine is protected from floating debris by a perforated horizontal plate. The water enters through the perforations, passes through the turbine and then out through pipes leading downstream.

PARACHUTE ATTACHMENT FOR AEROPLANE (Fig. 12)—Two parachutes, one on each side of the vertical axis of the machine, are attached to a series of rods mounted on the top plane and are so arranged that they are held in folded position when not in use. They are released by a lever or other control. The parachutes have sliding connections with the rods and are provided with springs so that they expand quickly when released.

WINDOW LOCK (Fig. 13)—This lock, which is intended to be mounted on the top of the lower sash, has a pivoted arm provided with a saw-tooth face which prevents the sash from being raised when the latch is in operative position. Passing through the body of the lock is a plunger designed to engage sockets in the upper sash and lock the two sashes together.

ROLLER FOR EXPANDING FABRICS (Fig. 14)—This device consists of three rollers working on a bent shaft, and is designed for taking wrinkles and puckers out of a piece of fabric by stretching it transversely. The rollers are mounted on ball bearings and are made to work in unison by intermeshing teeth formed at the ends.

CUSHION RIM FOR AUTOMOBILE (Fig. 15)—A rubber ring is stretched around the wheel on each edge of the rim in such position as to give support to the sides of the tire and keep it from coming in contact with the metal, the idea being to prevent the cutting of the tire when the car is taking a turn at high speed or when the tire is flat or under-inflated.

JOINT FOR SECTIONAL POLE (Fig. 16)—The end of one section is equipped with a central longitudinal sleeve from which radiate four kerfs, or double metallic walls, forming deep slots. The end of the other section is equipped with a central post from which radiate four blades, the post being designed to fit closely into the sleeve and the blades into the slots of the opposite section. The idea is to provide a strong joint for sectional tent or flagpoles that will permit the sections to be easily jointed together or taken apart.

TONGUE FOR HORSE-DRAWN VEHICLE (Fig. 17)—This tongue is braced to the front axle by a system of diagonal rods so that there is no lateral swing. The rear end of the tongue is supported on a yoke that projects forward from the bolster, the arrangement being such that while the tongue is free to move vertically, only a small part of its weight is carried on the necks of the horses.

FOCUSING HOOD FOR CAMERA (Fig. 18)—Intended as a substitute for the cloth ordinarily used by photographers, this hood is permanently attached to the camera and is equipped with an eye-piece. The hood is flexible and can be drawn out to any position required in focusing.

PIPE WRENCH (Fig. 19)—The gripping hand is made in two sections or jaws which are hinged together. One of the jaws is pivoted to the handle while the other is connected to it by a link, so that a pull on the handle tightens the jaws around the pipe.

LATCH FOR HOISTING HOOK (Fig. 20)—When the load is on, the latch is drawn closely against the hook. With the load resting on any support the pivot connecting the hook and latch is raised and the latch is drawn clear of the hook.

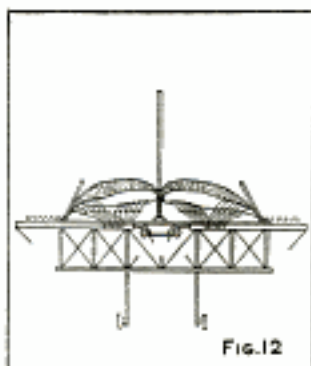

Fig. 12

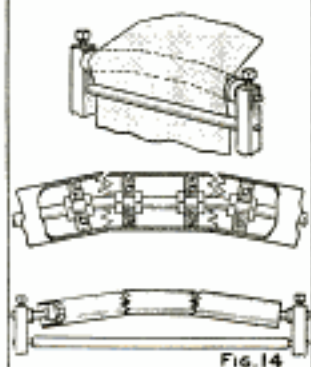

Fig. 14



Fig. 16

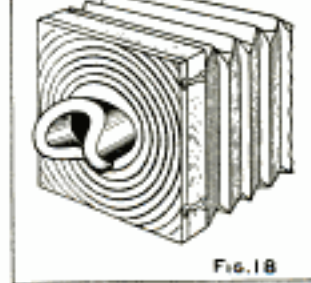

Fig. 18

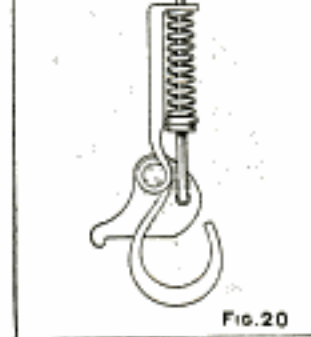

Fig. 20

295

FRAME COTTAGE WITH STUCCO EXTERIOR



Thos. J. Berley,
Architect,
Philadelphia

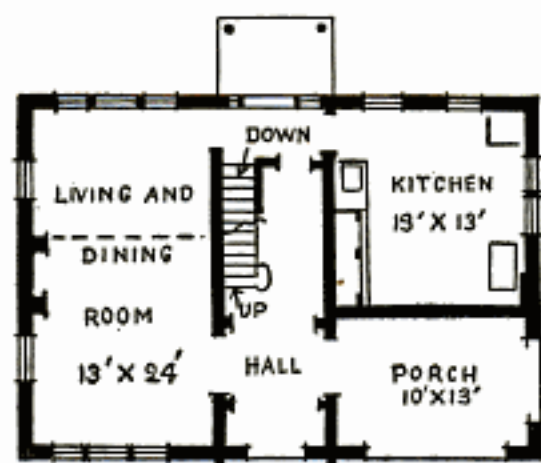

First-Floor Plan

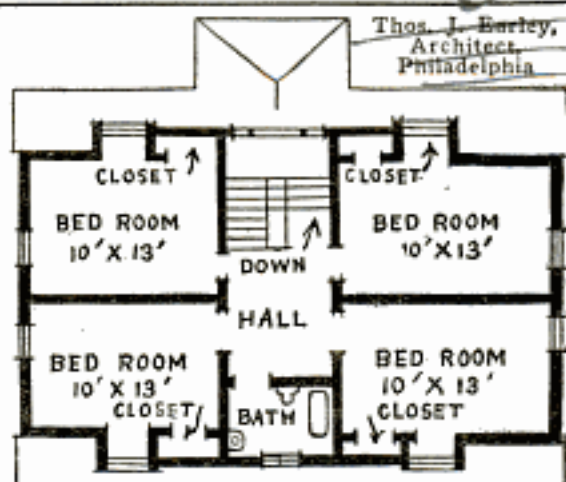

Second-Floor Plan

THIS quaint cottage with its attractively arranged interior is an adaptation of the early American farmhouse to modern needs. While providing ample space for the second-story rooms, this type of construction is an economical one owing to the elimination of all but the gable walls above second-floor level. The cottage is of frame construction plastered on the outside with cement stucco, and is provided with a shingle roof. The exterior woodwork is of white pine painted white. The cost of the house complete was \$2,725. The principal feature of the interior is the hallways, one on each floor, extending from the front to the rear, and the arrangement by which each room opens into a hallway. Spaces at the sides of the dormer windows are utilized in providing a closet for each of the second-story bedrooms. A novel feature of the plan is the location of the entry to the kitchen under the landing of the stairway leading to the second floor. The equipment includes a hot-air heating plant.

IN accordance with the editorial policy of this magazine never to accept compensation in any form for what appears in our reading pages, and also to avoid all appearance of doing so, we are obliged to omit the name of the maker or the seller of any article described. This information, however, is kept on file and will be furnished free, by addressing Bureau of Information, Popular Mechanics Magazine, Chicago. [Editor.]

Aladdin Furnace

Pipeless **\$47.50** Pipeless



Costs Less than a Base Burner Have you a heating problem? Are you planning on a new heating system for your home? Do you want to install a furnace complete at a lower price than you could buy a regular hard coal stove? The Aladdin Furnace solves the problem. Think of it—a complete furnace for \$47.50. And one that will heat your entire home to an even temperature. No pipes or any other appliances, unnecessary to tear up the house to put in—you can install it yourself in your own home in 24 hours, ready for use.

Heats Entire House

In our "Aladdin" pipeless furnace, we are offering the very latest departure in warm air heating. The principle is positive. Cold air is taken thru the base of the jacket and is forced upward thru a large 14x20 inch register placed directly over the furnace. Thru this register, the hot air passes with great force to the ceiling and circulates from there to all rooms. The warm air will be so evenly distributed that you will find a variation of less than three degrees between the room where the register is placed and the room farthest away from same, providing, of course, that doors connecting these rooms are left open to give a free circulation.

Install It Yourself

To give an idea of how simple an operation it is to install one of the "Aladdin," we show a cross section view of our house, "The Portlan," with the furnace installed. We call your attention to the fact that there are no large warm air pipes to destroy the usefulness of the basement, no wall pipes or fittings to be installed. In fact, any man who is so inclined, can install this furnace, do all of the work himself, and the whole operation should not take more than four or five hours. You take no chance when you order an "Aladdin." Absolutely guaranteed.

Furniture, Bathrooms, Fixtures, Etc.

The Aladdin Merchandise Catalog is a buying Guide for Furniture, Plumbing, Heating, Paints, Hardware, etc. Prices Unmatchable. Your copy will be mailed you free on request. Send for it today.



North American Construction Co.

968 Aladdin Ave. Bay City, Mich.

5000
Bargains
in Aladdin
Merchandise
Catalog.
Send
for
It.

North American Construction Co., 968 Aladdin Ave., Bay City, Mich.
Send me Aladdin Catalog of Merchandise No. 130.
Send me full information on the Aladdin Furnace.

Name.....
Street.....
City.....
State.....

BO MECCANO

Building These TOYS

MECCANO Engineering is real Engineering in miniature. You can build anything with MECCANO—can duplicate any machine or structure you have ever seen. Can build large, strong models, or small, complicated ones; models that operate like

MECCANO Shows You What Real Engineering Is

You build just like a real Engineer, using miniature steel beams, girders, angle irons, rods, wheels, gears, nuts and bolts. MECCANO is the greatest toy ever invented for boys—it's an education in mechanics and engineering. The original building toy that builds mechanically correct models. The MECCANO-wise boy knows real engineering; he learns as he builds with MECCANO—and he has a heap of fun at the same time.

The number of models you can build with MECCANO is unlimited. You can build all those in our big Manual of Instruction, all those in any other Manual—and can keep right on building as long as you can think of anything to build.

The number of parts you get in an erecting outfit isn't what counts. How many ways can you use each part?

That's what counts! MECCANO has more interchangeable parts than any other builder. You can use the same parts in more different ways; for more different things. That's why MECCANO builds 10,000 models.

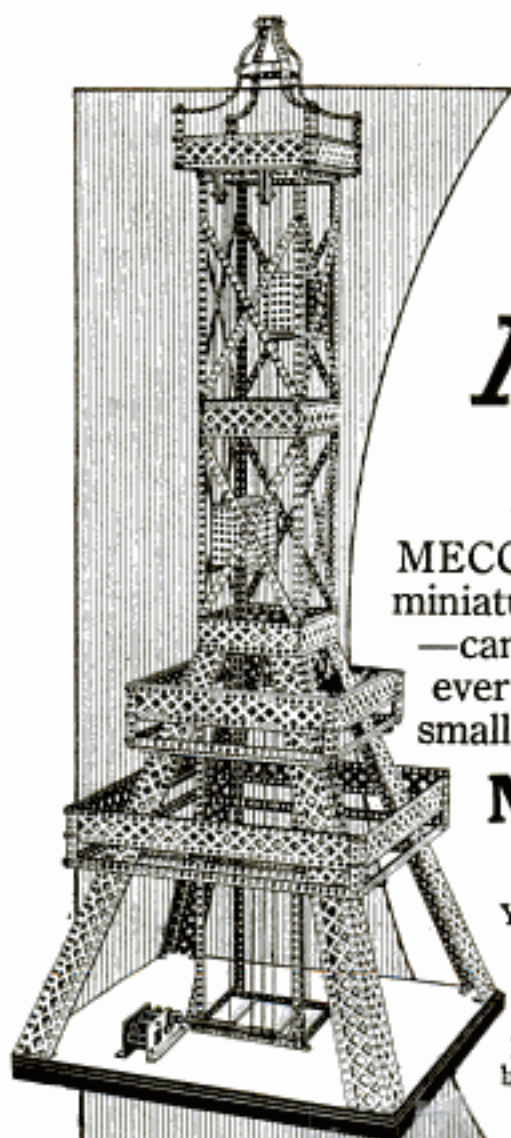

Boys—

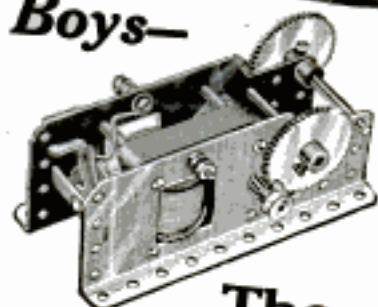

The MECCANO Electric Motor

Operates models like real machinery. Direct shaft and interchangeable gear wheel drive—positive and powerful. Two or three dry batteries run it. It's a real electric engine—the most powerful toy motor made. Above motor, with starting, stopping and reversing lever, included in Outfit No. 3X (\$7.50). Sold separately, with extra gears, for \$3.00. Same motor, without control lever and with fewer gears, included in outfits No. 1X (\$3.00) and No. 2X (\$5.00). Sold separately for \$1.50.

MECCANO Girder Strip

Builds big models quicker, better and stronger; see Eiffel Tower shown above. Made in 2 sizes: 5½" long, 35c per half dozen; 12½" long, 50c per half dozen. Both included in Inventor's Accessory Outfit.



MECCANO Spring Motor

Will run an Automobile, an Elevator, a Pile Driver and many other models. Has a powerful spring, direct shaft and gear wheel drive, reversing lever and starting and stopping brake. Builds into any MECCANO model. Given FREE with Outfits Nos. 4, 5 and 6. Sold separately for \$2.00.

YES

Engineering

Greatest Fun for BOYS

real machinery; that are true to correct engineering principles. High towers, strong Drawbridges, Cranes of every kind, Automobiles, Aeroplanes, Steamships, Submarines, all kinds of machinery; thousands of things all different can be built with MECCANO.

MECCANO Builds 10,000 Models

10,000 models were entered in our last prize contest. It is this greater inter-change-ability of all the parts that makes MECCANO so much better; it is why MECCANO builds so many more models. Each MECCANO part has the MECCANO Equidistant Holes—that's what makes them interchangeable! Get MECCANO-wise! Find out all about MECCANO. You'll find MECCANO Engineering the greatest fun you ever had. Stop in the toy department and see the MECCANO outfits, and all the new parts that make MECCANO the leading building toy. Pick the outfit you're going to get!

\$1,000.00 Prize Contest

Get an entry blank at the Toy Department and win a prize in the 1915-16 Contest. Get MECCANO-wise!



Add to Your MECCANO

Get this Inventor's Accessory Outfit. Contains all this year's new parts; Girder Strips; Sprocket Wheels and Chain; $\frac{1}{2}$ " and 2" Pulleys; large Gear Wheels; Healds for Weaving Machine; and other parts. Can be used with any MECCANO Outfit. **\$2**

MECCANO Outfits With Motor As Low as \$3.00

Sold in Toy Departments

Outfit No. 0.....	\$ 1.00
Outfit No. 1.....	2.00
Outfit No. 1X with Electric Motor.....	3.00
Outfit No. 2.....	4.00
Outfit No. 2X with Electric Motor.....	5.00
Outfit No. 3.....	6.00
Outfit No. 3X with Electric Motor.....	7.50
Outfit No. 4—Spring Motor Free.....	10.00
Others at \$14.00, \$18.00, \$36.00	

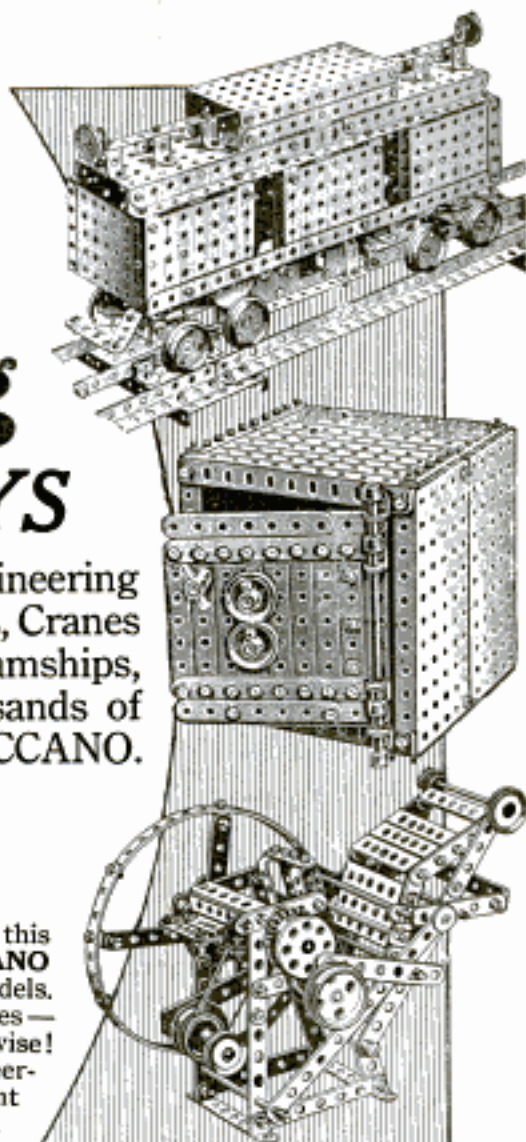

FRANK HORNBY
THE BOY WHO MADE
\$1,000,000
WITH A TOY

This Boys' Book FREE

It's a dandy story about a fight for success. Interesting; tells just how this boy won out. 144 pages, size $3\frac{1}{2}$ " x $5\frac{1}{2}$ ", cloth bound, illustrated. Tell five boys about MECCANO. Tell them in your own way; send their names and addresses with 4c in stamps for postage and the book is yours. **Get yours today!**

Frank Hornby

PRESIDENT

MECCANO CO.
Room 15, Masonic Hall
West 23rd Street New York City

Announcing the 1916 HENDERSON FOUR

THE NEW 1916 HENDERSON FOUR-CYLINDER MOTORCYCLES ARE NOW READY FOR DELIVERY

These new models will continue Henderson leadership. You may now buy a Henderson—a greater, more efficient, more comfortable Henderson—in two models, single speed and two speed, for \$265 and \$295 respectively.

Engineers agree that the multi-cylinder motor is the motor of the future as well as the present.

Now here at last is your opportunity to buy a four-cylinder motorcycle—with the constant, smooth-flowing power that only such an engine can give—at a price only slightly more than that of the old-fashioned twin-cylinder type.

And remember—in spite of the big reduction in price you are getting genuine four-cylinder Hendersons with all that the name Henderson implies plus numerous important improvements and refinements.

Write for our beautiful advance folder giving complete information on all improvements and refinements.

**SINGLE SPEED
MODEL**

\$265⁰⁰

**HENDERSON MOTORCYCLE COMPANY
1160 Cass Avenue, DETROIT, MICHIGAN**

**TWO SPEED
MODEL**

\$295⁰⁰

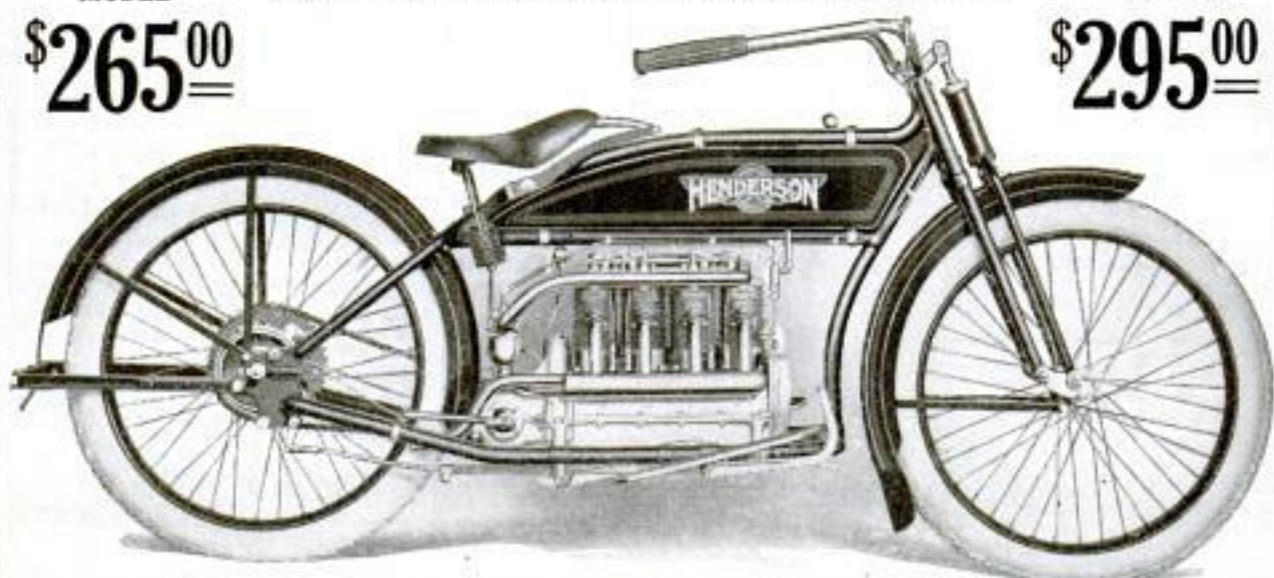

Some 1916 Henderson Improvements

Kick starter of simple and positive design.

Foot operated clutch in addition to usual hand lever.

Mechanical force feed oiler—Hand oil pump.

Cylinder displacement now 61 cubic inches, qualifying for all contests held under rules of Federation of American Motorcyclists.

New design fork rocker arm, increasing comfort.

Neat chain and clutch guard, preventing oil from splashing rider or machine.

Handle bars wider and lower.

Improved saddle design—positive full floating action.

Increased gasoline and oil capacity in tanks.

Larger exhaust and manifold pipes.

Please Mention Popular Mechanics

Copyrighted material



Salesmen—
Get Your
Name on



This Door With the Frantz Premier

Important positions await successful salesmen of the Frantz Premier Electric Cleaner. Some of these will be as Branch Managers in the big cities. Others will be as Department Heads at our home Office.

We seek men who want to grow—and grow with us in increasing sales of the Frantz Premier Electric Cleaner.

If you are now working for a small wage and want to *earn more*, you can do it the Frantz Way.

No matter what you are now doing—so long as you are ambitious and feel that you have selling ability—you are the man we want.

We Work With You

And you will not be left alone to do it all. Our advertising in the leading magazines and newspapers makes sales for you.

We are the largest concern in America making Electric Cleaners.

The Frantz Premier represents today's finality.

It weighs but 9 pounds—costs but \$25—and does all that the most expensive and complex machine will do.

Over 100,000 homes already use the Frantz Premier—millions of others await it.

Get the
Book—

“A
Career
with the
Frantz
Premier”

What Some Have Done

A salesman who started in Chicago in December, 1914, soon averaged \$350 a month. He is now City Manager of the Chicago Branch.

A cigar clerk, earning \$15 a week, has averaged \$160 a month the Frantz Way. In some months he has made as high as \$325.00.

This man's brother, also a clerk, at \$18 a week, has since averaged \$175.00 a month the Frantz Way.

Another man who came to us as salesman on February 15th of this year has since been made manager of the Indianapolis branch. We will

give these names—and others—on request.

Your Opportunity

And here is *your* opportunity to win a career with the Frantz Premier. Learn how. If you are really ambitious and sincere, write today. You'll be glad you did. A real opportunity awaits you.

THE FRANTZ PREMIER COMPANY

1119 Power Avenue, Cleveland, O., U. S. A.

The Premier Vacuum Cleaner Company, Ltd., Toronto, Canada.

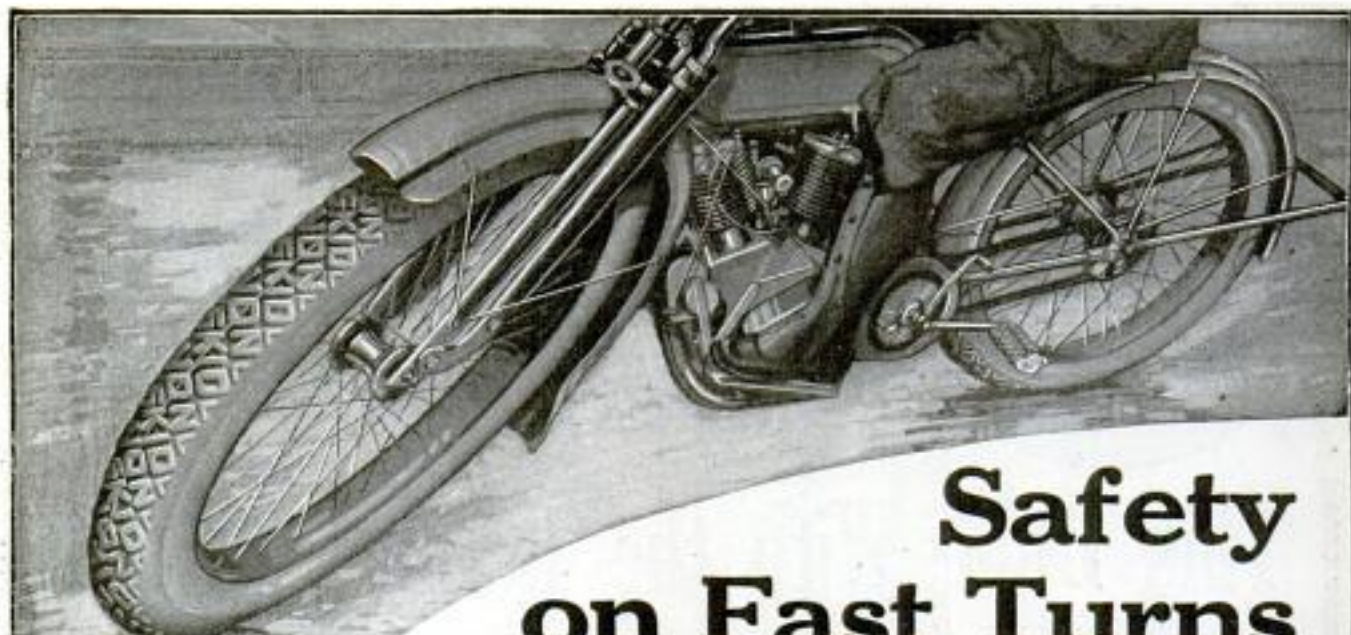

Safety on Fast Turns

The motorcyclist takes the turns with confidence when Firestone Non-Skid Tires are gripping the road.

Then on the straightaway, he opens the throttle and "burns up the road" without thought of his tires.

The heavy pure rubber treads with the extra thickness of the raised letters take the wear, and insulate fabric and inner tube from the heat.

Firestone Motorcycle Tires

are built with Firestone accuracy to meet every tire requirement of the motorcycle.

High speed and the varying angle of the wheels from the perpendicular are provided for in their design.

Firestone reputation for quality, won by actual performance on motor cars, has already extended to Firestone Tires for motorcycles by proving that they give—"Most Miles per Dollar."

Firestone Tire and Rubber Company

"America's Largest Exclusive Tire and Rim Makers"

Akron, Ohio—Branches and Dealers Everywhere

Please Mention Popular Mechanics

"100 Miles for 10¢"

Everybody Rides It—A Mount for the Masses

"God made the country, but man made the towns." Just a few miles beyond the sweltering streets and stuffy city flats lie the broad acres of all outdoors. The fresh pure country air means new blood, new zest and health that all the doctors in the world can't give you. The Miami Power Bicycle gives you country trips, not as a rare thing to be looked forward to for weeks—but every pleasant day of the year.

Ride it to and from work. It's cheaper and more pleasant than street cars. In the evening steer your Miami straight for the country and let the rushing air wash the cobwebs from your tired brain. Get that glorious ozone of the open fields into your system. Then you'll understand why the farmer can always look trouble in the face and laugh in its teeth. No matter what your income you can afford the

Miami
Reg. U.S. Pat. Off.
Power Bicycle

Model 15 Flat belt and idler, magneto ignition, pedal starter. Wt. with tank filled about 119 lbs. Price **\$125**

Model 16 Chain drive, two speed, foot boards, clutch, magneto ignition and kick starter. Wt. 125 lbs. Price **\$140**

It costs you little more than a good bicycle and runs 115 miles on a gallon of gasoline. Not a motorcycle, but a strong bicycle with the power built right into it. Has a speed of 25 miles per hour, fast enough for all sane purposes, but not so fast as to be dangerous. Light enough so that it can be easily handled, but heavy enough to hold the road at all speeds.

Safe, silent, clean. So simple in design that you don't require an expert garage man to show you how to run it. Operates as smoothly as an ordinary bicycle. Runs as quietly as a sewing machine. Tire expense practically as low as on an ordinary bicycle.

Ask your dealer for free demonstration or write us for illustrated catalog and interesting special proposition.

We also make the Flying Merkel motorcycle and bicycle; also Racycle, Miami, and Hudson bicycles. Catalogs free.

Dealers and Agents

It will pay you to investigate our new special proposition.

THE MIAMI CYCLE & MFG. CO.
134 Mobile Ave.
Middletown,
Ohio

The
Miami
Cycle &
Mfg. Co.
134
Mobile Ave.,
Middletown,
Ohio

Without obligating me please send me your new catalog of the Miami Power Bicycle.

Please Mention Popular Mechanics

SAXON ROADSTER

\$395

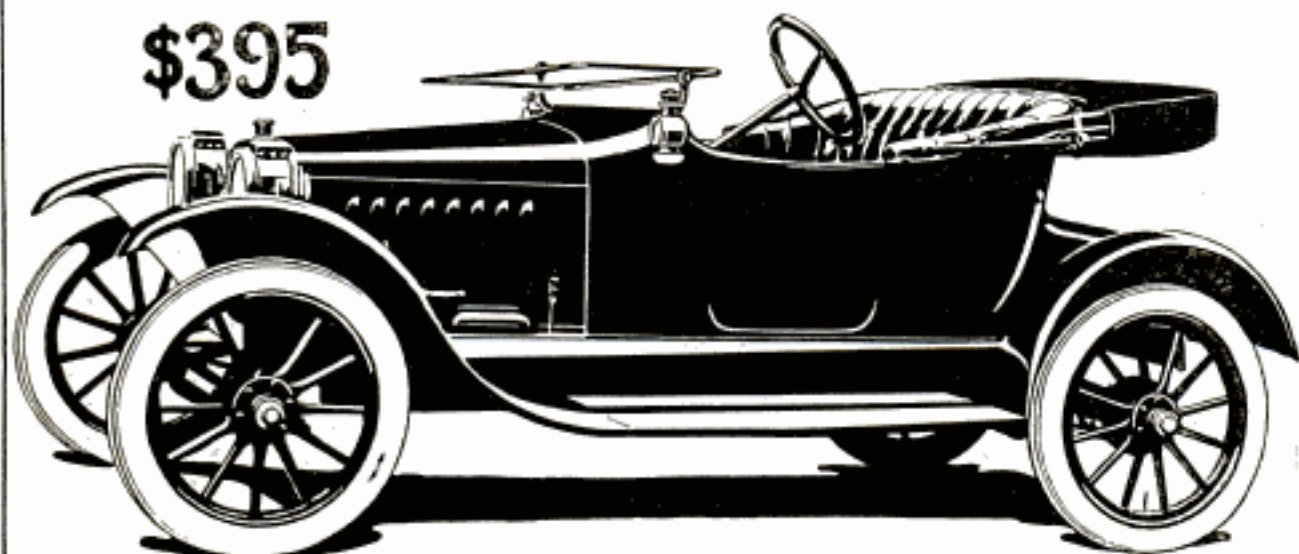

Don't Waste Time Walking

Your time is worth money—and the Saxon Roadster enables you to go from place to place quickly and cheaply—multiplies the number of things you can accomplish in a day. In this sense it is not a luxury but a sound business investment with real profit earning power.

The Saxon Roadster costs only \$395 and stays good for years because it is well designed and honestly built. It costs little to run—you can get 30 miles on a gallon of gasoline and 100 to 150 miles on a quart of oil.

In design and construction Saxon Roadster is absolutely modern and up-to-date—powerful high speed motor; sliding gear transmission; dry plate clutch; Timken axles; vanadium steel cantilever springs; honeycomb radiator; genuine streamline



body; roomy and comfortable. No other car under \$400 gives you these modern features. (Electric starting and lighting, \$50 extra).

Every man who is mechanically inclined—which means every reader of Popular Mechanics—ought to have a Saxon Roadster. Any Saxon dealer will show you why Saxon is the finest two-passenger value yet produced.

Saxon dealers are everywhere. See one nearest you and have a Saxon ride.

Saxon Roadster \$395

Saxon "Six" \$785

Saxon Motor Company, Detroit

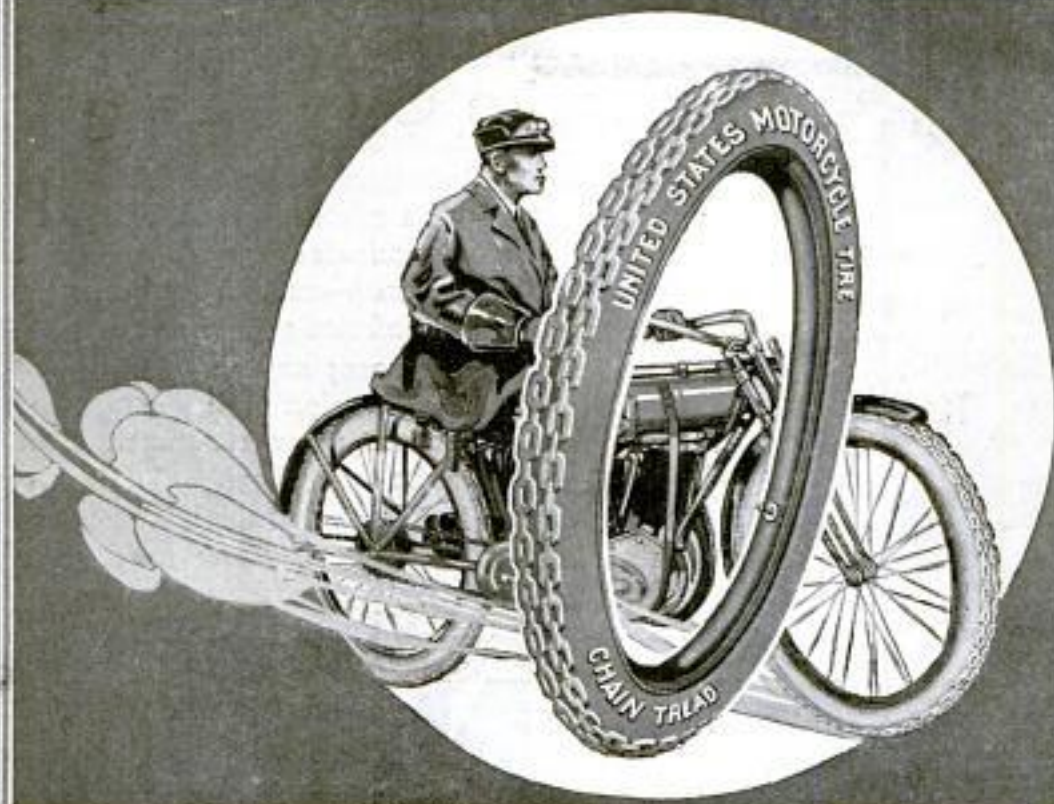

Approved by Motorcycle Experts

THE "Chain Tread" Tire for automobiles is standard equipment on many of the leading makes of cars. The most prominent makes of motorcycles are also equipped with the "Chain Tread" Tire.

The "Chain Tread" Tire for motorcycles has the same heavy service construction, the same wear-resisting rubber and fabric, and the same practical anti-skid tread, as the "Chain Tread" automobile tire.

Profit by the experience of the keen automobile and motorcycle manufacturers, who are increasing the prestige of their products by equipping the machines they make with "Chain Tread" Tires. You can buy "Chain Tread" Tires from good dealers everywhere.

United States Tires

Made by the Largest Rubber Company
in the World



Please Mention Popular Mechanics



Places like this make Criminals

Society trains criminals as carefully as it does lawyers or doctors—and graduates more of them. There will always be criminals as long as the training schools of crime exist—rum holes, prisons, opium joints and gang-infested street corners.

Any criminal is a menace; anyone—you—may be his victim. What protection have you? The law? It punishes but rarely prevents crime. The Police? They cannot be everywhere.

Between you and the criminal there is but one certain barrier—your own readiness to defend yourself and your family against felonious aggression. In the

IVER JOHNSON

Safety Automatic REVOLVER

are combined, at a reasonable cost, accuracy, dependability and absolute safety. In unskilled or nervous hands it is safe—it cannot be accidentally discharged—you can Hammer the Hammer.

\$6 to \$8 at Hardware and Sporting Goods Stores

Send for our 84-page book which tells all about Iver Johnson Revolvers, Shot Guns, Bicycles and Motorcycles.

**IVER JOHNSON'S ARMS
& CYCLE WORKS**

307 River St., Fitchburg, Mass
89 Chambers St., New York
717 Market St., San Francisco

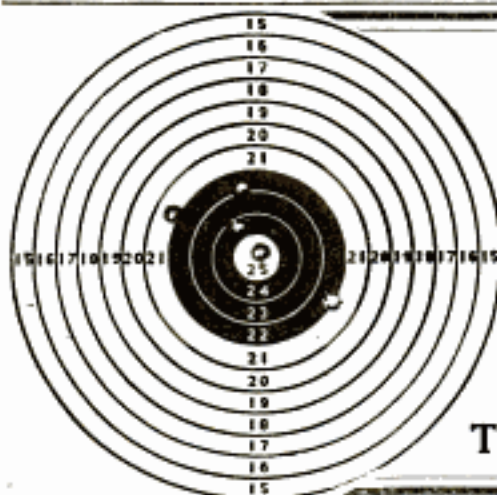

Spot Shot Rifle Target

PATENT PENDING

This target enables you to spot or see the position of shot instantaneously, by permitting light to shine through bullet holes. It has revolutionized indoor rifle shooting. Endorsed by military and expert riflemen. Operated by electricity. Interest increased many 100%. Only target made that permits the shooter to see his shot from firing line. Drop us a line and we will show you how to start a club in your city without cost. Circulars fully describe target. If you are interested in rifle shooting to any degree, write us.

The Reed Mfg. Co., Box 202, Springfield, Ohio

Please Mention Popular Mechanics

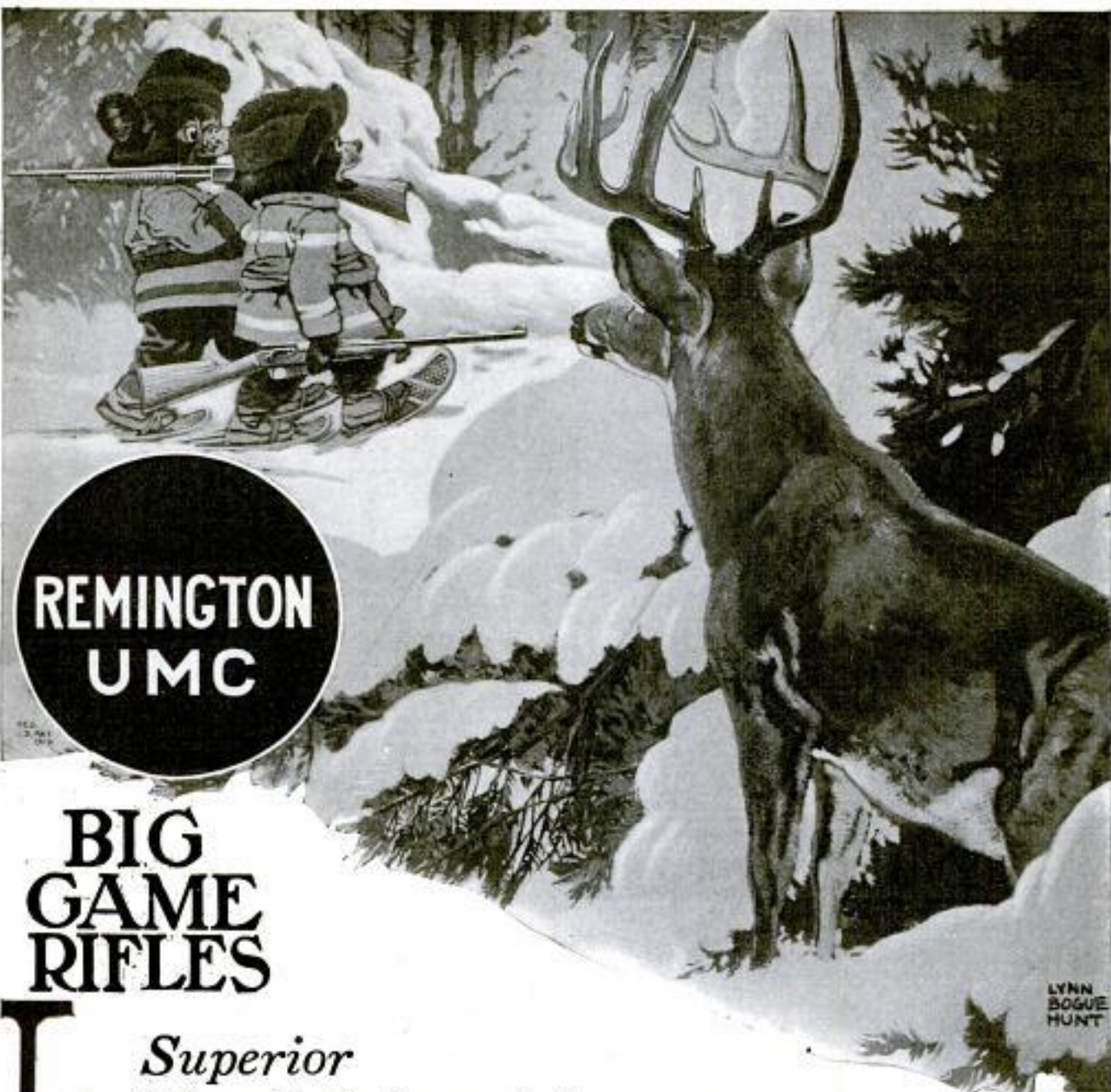

REMINGTON
UMC

BIG GAME RIFLES

*Superior
in "Hang," Action and Accuracy*

AS SOON as Sportsmen got to asking *Why* and *How* about rifles, Remington-UMC High Power Rifles came into their own.

To-day Remington-UMC High Power Big Game Rifles are in demand more than ever—by the leading crack shots and by the great body of Sportsmen, who are quite as able to tell a good gun when they see it perform as any professional expert.

The Remington-UMC dealer in your community—he's the man to go to for these rifles. He makes it a point to show the guns that his best customers want.

Ask to see Remington-UMC *High Power Slide Action Repeaters*, six shots, solid breech, hammerless, safe. *Autoloading Rifles*—Five shots, simply press trigger for each shot. Solid breech, hammerless, positive safety device.

REMINGTON ARMS-UNION METALLIC CARTRIDGE CO.
WOOLWORTH BLDG. (233 Broadway) NEW YORK CITY

Please Mention Popular Mechanics

2c a Week Pays Wash Bill!

Electricity or Water-Power Does the Work

Write for
FREE Book

Just a "Twist of the Wrist" Starts or Stops the Machine!

The 1900 Motor Washers are now at work in thousands of homes. They are doing the work formerly done by women, at a cost of 2c a week for power! Saving thousands upon thousands of dollars in wash bills. Saving worlds of wash-day troubles. Leaving the women free to do other work while the machines are doing the washing.

The 1900 Motor Washer

Washes a Tubful in Six Minutes!

1900 Water Motor Washer
Can be connected with
any water tap instantly



Handles Heavy Blankets or Dainty Laces

The outfit consists of the famous 1900 Washer with either Electric Motor or Water Motor. You turn on the power as easily as you turn on the light, and back and forth goes the tub, washing the clothes for dear life. Then, turn a lever, and the washer does the wringing. All so simple and easy that it is mere child's play.

A Self-Working Wringer Sent With Every Washer!

The motor runs the wringer. We guarantee the perfect working of both. No extra charge for wringer, which is one of the finest made. **Write for FREE BOOK and 30 Days' FREE TRIAL OFFER!** Don't doubt! Don't say it can't be done. The free book proves that it can. But we do not ask you to take our word for it. We offer to send a 1900 Motor Washer on absolute Free Trial for an entire month to any responsible person. Not a cent of security—nor a promise to buy. Just your word that you will give it a test. We even agree to pay the freight, and will take it back if it fails to do all we claim for it. A postal card with your name and address sent to us today will bring you the book free by return mail. All correspondence should be addressed to



Doing the wringing with
1900 Electric Motor Washer

1900 WASHER CO., 6200 Court St., BINGHAMTON, N. Y.

OIL IF YOU LIVE IN CANADA, WRITE TO THE CANADIAN WASHER CO., 355 YONGE ST., TORONTO, CANADA.

(23)

TYPEWRITERS ALL MAKES ALL PRICES

Look at these bargains! Typewriters Rebuilt in our own Factories, and guaranteed for one year.

- | | |
|---------------------------|----------------------|
| Remingtons \$30 to \$55 | Smiths \$18 to \$40 |
| Underwoods \$35 to \$60 | Royals \$25 to \$45 |
| L. C. Smiths \$30 to \$50 | Olivers \$20 to \$35 |

We have others, of course. Send for catalog describing them, and address of nearest branch office.

American Writing Machine Co., Inc., 345 Broadway, N. Y.



TYPEWRITERS ALL MAKES

Prices \$15.00 up. SOLD or RENTED ANYWHERE at 1/2 to 1/3 MANUFACTURERS' PRICES, allowing RENTAL TO APPLY ON PRICE. Free Trial. Installment payments if desired. Write for Catalog L.

TYPEWRITER EMPORIUM, 24-26 W. Lake St., Chicago, Ill.

"The Engine Ahead!"

That's what every one is calling the 1916 Ellis—the strongest, sturdiest, simplest engine made.

ELLIS ENGINE

1 1/2 to 18 H. P. Sold on 30 days' FREE TRIAL. Interesting book — "ENGINE FACTS" — mailed FREE. Don't miss it. Full of things you ought to know.

ELLIS ENGINE COMPANY
2828 E. Grand Blvd., Detroit, Mich.



"Vulcan" Ink Pencils

RED OR BLACK

Inexpensive and Durable. Unequaled for general writing

ONLY Non-Leakable moderate price INK PENCIL made



ORDER TODAY

EXTRA SIZE 8 INC. EACH ONLY \$1.25

2 SIZES 4 IN & 5 1/2 INC.

AGENTS TERRITORY OPEN
J.C. ULLRICH & CO. 27 THAMES ST. NEW YORK

A "MIDGET" Emblem of Your Order

has an added dignity thru its uniqueness of size, retaining withal, its individuality in point of detail of design. Inserted at point of lapel and tightly screwed.

In Solid Gold only, 50c

- | | |
|------------------------|-----------------------|
| 1. Woodmen of World | 11. Keystone Masonic |
| 2. Maj. Follows | 12. P. M. |
| 3. Roymen | 13. Men's Bible Class |
| 4. Knights Columbus | 14. Jr. O. American |
| 5. Modern Woodmen | 15. Mechanics |
| 6. Masonic | 16. Knights Pythias |
| 7. Hall & Cane Masonic | 17. Knights Templar |
| 8. Skirins | 18. Noons |
| 9. Trowel Masonic | 19. P. O. Eagles |
| 10. Slipper Masonic | 20. Grotto Masonic |

20-21 Old Glory and the Bell

PHILADELPHIA BADGE CO.
174 N. 8th St. Philadelphia, Pa.



THIS \$3300 MODEL KING TALKING MACHINE \$10.98 1 YR. To Pay

Entertain! Enjoy the luxury of finest music—operas—monologs—minstrels, etc. Own the latest hornless King machine. Sweetest, clearest tone. Handiest, simplest to operate. We give you

FREE 30 DAYS TRIAL

This rich, \$325 model King machine sent with six records for 4 weeks of entertainment in your home. Return at our expense if not delighted. Write for latest record list and "year to pay" trial plan.

King Co., Dept. 44, 2011 Ogden Ave., Chicago, Ill.



SUPERIOR SINCE 1904

OVER 100,000 IN USE

Mostly sold through recommendation. For Personal Desk or General Office. It checks mental calculations. Buy through your stationer.

Write for 10-Day Trial Offer
E. Gardner & A.N. Co., 143 Duane St., New York

Agents Wanted

Golden Gem PORTABLE Adding Machine \$10

Multiplicates - Subtracts

Please Mention Popular Mechanics

Hartman Big Heater Bargain No. MJ141. New model Hartman "Regent" Hot Blast Heating Stove, cold rolled steel plate, cast iron fire pot, strong base. Swing cover, reflector, side columns, urn, foot rails, screw drafts, front base strip and front base legs nicked. Body is 16 inches in diameter. Stands 56 inches high over all. Price **\$12.65**



Steel Range Bargain No. MJ 146.

"Regent" complete with high warming closet. Leg base, oven 18x18x11 inches. Duplex grates, six hole top, oven thermometer, improved blue system;



steel base. **\$1 Per Month** With or without contact type reservoir. If you would buy this range elsewhere it would cost you a great deal more than the low price we ask. Price with-out reservoir **\$24.75** **\$1.75 Per Month** **\$2 Per Month** Price with reservoir **\$26.65**

Solid Oak Kitchen Cabinet

No. MJ149. Sanitary "Comfort" Kitchen Cabinet of solid oak. Base has white wood table top, 41x26 inches, smoothly sanded; handy bread board; cutlery drawer and large utility drawer. Large roomy cupboard. Top has large china cupboard with 2 art glass doors; metal floor bin, 45 pound capacity; removable sifter; spice drawer; open cereal cupboard. Rich golden shade, 67 in. high. A wonderful opportunity to secure a remarkable labor-saving device for little money and on easy terms. You will be proud to own it. Price **\$10.95**



5-Piece 2-Inch Post Steel Bed Outfit Bargain No. MJ148.

Complete bed outfit, consisting of elegant 2-inch Continuous Post Steel Bed with 3/4-inch fillers in artistic design height head end 52 inches; link fabric, steel frame bed spring; cotton top, fibre filled mattress and two 4 1/2-pound selected hen feather pillows

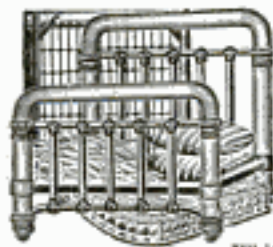

18x25 ins., which are soft and elastic and covered with striped ticking. Bed outfit comes in all sizes: 3 ft., 3 feet, 6 inches; 4 feet, 6 inches, full size. Colors: White, Pea Green or Vernis Martin. A remarkable bargain at our very low price. Complete **\$8.98** **75c Month**

No Money In Advance

To prove to you that the Hartman prices are lowest and credit terms most liberal, we extend to you this unparalleled "get-acquainted" offer and invite you to order any one of the items advertised on this page without sending any money in advance. However, we can afford to send only one item to each family at these terms. When you get our mammoth catalog, order any amount—make small monthly payments to suit your convenience.

Our \$10,000,000 Purchasing Power Makes

Bargains Worth While

The Hartman plan of considering no sale complete until you have received the articles selected and after 30 days' use in your own home find them all we claim, makes ordering from us more satisfactory than a visit to the largest stores. **Every Hartman bargain sells on its own merit.** We allow no one to undersell us. Read our guarantee. It is without question the broadest and most satisfactory ever made.

Pick out one of the articles shown here—one that you want right now—today—and let us send it to you—Hartman will trust you.

No Reference Required

We ask no references or embarrassing questions. No mortgage, no interest, no collectors, no red tape of any kind. Everything strictly confidential. It is the fairest, squarest, most practical, most helpful credit ever offered. It has enabled millions to beautify their homes—let it do the same thing for you.

FREE Hartman's Mammoth Bargain Catalog

Over 10,000 of the most stupendous bargains you ever saw. Everything needed for the home—Household Furnishings—Rugs and Carpets, Silverware, Jewelry, etc. Many pages in colors.

Ask for Catalog No. 86

HARTMAN Furniture and Carpet Co.,
3945 Wentworth Ave., Chicago, Ill.

Solid Oak Rocker Bargain

No. MJ145. Large, roomy Rocker. Solid oak genuine quarter-sawned arms, rich golden finish. Manufactured Spanish brown leather upholstery on seat and back. Slip seat has six springs, stuffed with tow and cotton. Elegantly carved posts. Seat front and upper panel of back button tufted, 39 inches high, seat 18x19 1/2 inches. Price **\$3.58**



50c Per Month

Dresser, made of American quartered bevel plate mirror, 24 x 30 inches in size, supported by strong standards, 2 small drawers at top of base, 2 full length drawers, each fitted with wooden drawer pulls. Heavy plank top and Colonial front posts. Price **\$8.98**

Colonial Dresser No. MJ 143.

A wonderful offering in a beautiful Colonial hardwood with rich oak finish. French

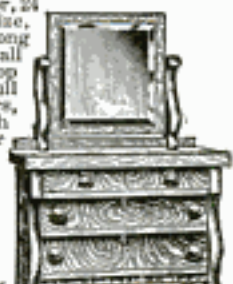

75c Per Month

Solid Oak Writing Desk

No. MJ150. A remarkable value surpassing anything at this price. 44 in.

high, 30 in. wide, 16 in. deep. Solid oak sides, quarter-sawned oak front; golden oak or fumed oak finish. The desk compartment has drop lid, lock, pigeon holes and shelves. Full width drawer and two-door book cabinet below; lattice work over glass doors; spring catches. Wonderful bargain Price **\$8.49**

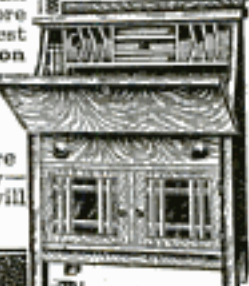

75c Per Month

border. Has rich coloring of tan green, brown and red. Will give lasting service. Size 9 x 12 feet. Price..... **\$11.35** **75c Per Month**
Size 8 ft. 3 in. x 10 ft. 6 in. Price **\$9.89** **75c Per Month**

Brussels Rug

No. MJ147. Woven of excellent worsted yarns in a scroll and floral pattern with medallion center and harmonizing



\$1 Per Month

3-Piece Solid Oak Library Set

No. MJ144. Upholstered with manufactured Spanish brown leather. Table solidly constructed with square edge top 34x24 in.; panels match those on backs of chairs. Solid comfort armchair and luxurious rocker or have cleverly arranged backs; center panel upholstered. Spring seats expertly filled and upholstered. Quartered oak arms, strong front posts. Fumed finish. Price **\$11.89**



75c Per Month

HARTMAN WILL TRUST YOU



APPLIED ELECTRICITY

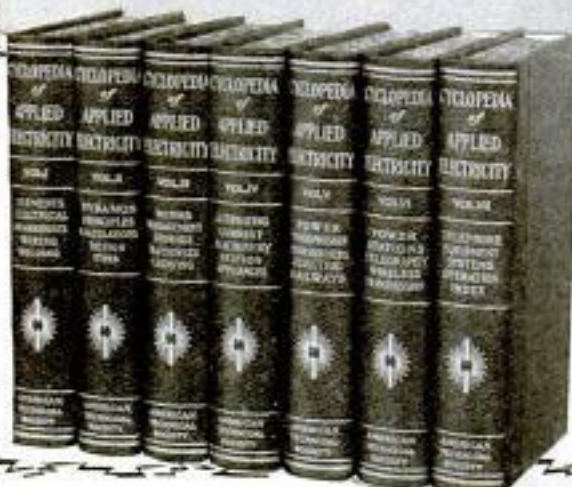

Only 50c a Week

Send today for your set of the greatest electrical reference library ever published. The new edition, just off the press, is recognized by big men in the electrical field as the most practical work of its kind. Covers completely the generation and use of electricity for power, light, transportation and communication, the construction and operation of dynamos and motors, central station engineering and telephone work, as well as wireless telegraphy and telephony and land and submarine telegraphy. Valuable alike to the beginner and expert.

The seven big volumes, written by thirty-two famous experts, contain 3,500 pages and 3,000 illustrations, full page plates, diagrams, simple explanations, etc., with hundreds of valuable facts and figures. Substantially bound in half red morocco, gold stamped.

Sent Absolutely Free

To prove to you that these books will help you in your own work every day, we'll trust you for seven days before you spend one penny. Simply fill in and mail the coupon below, and your set will be sent you immediately, express prepaid. Keep the books an entire week. Give them the hardest test you possibly can. They must make good with you or we take them back without question or annoyance. Despite the fact that the new edition is greatly enlarged, the price remains the same—\$35. Those, however, who take advantage of this great offer now are entitled to the special introductory price of \$19.00, payable in monthly installments of \$2 each. So don't delay, but send in the coupon now.

Read These Subjects Carefully

Elements of Electricity—Electrical Measurements—Underwriter's Requirements—Theory, Calculation, Design and Construction of Direct Current Generators and Motors—Types of Generators and Motors—Management of Dynamo-Electric Machinery—Electric Lighting—Alternating Current Machinery—Power Transmission—Electric Railways—Self-Propelled Railway Cars—Power Stations—Switchboards and Switching—Storage Batteries—Applied Electro-chemistry—Electric Elevators—Electric Welding and Heating—Wire and Wireless Telegraphy.

Free \$12.00 Consulting Membership

Our staff of 22 electrical experts answer every question you want to ask on electrical subjects absolutely free for a full year to every holder of a set of these books. This privilege has always cost \$12.00 and men tell us it is worth twice that amount in settling one problem alone. You get this service free if you buy the books after examination. This means \$10.00 saved if you act now. Send the coupon carefully. Then fill it out and mail today. The books will reach you promptly—express paid by us. After seven days send us \$2.00; otherwise, notify us for their return. Don't wait. You take no chances whatever. It costs nothing to inspect and you are nothing out if you do not care to buy. Mail the coupon today.

Free Coupon

Worth \$15.20 to You

American Technical Society

Please send me Cyclopaedia of Applied Electricity for seven days' free examination. If I keep the books will send \$2.00 within seven days and \$2.00 a month until \$19.00 has been paid, when \$35 books and \$12 consulting membership will be mine. Otherwise will notify you and hold books subject to your order. Title not to pass until fully paid. Pop. Mech. 10-15.

NAME

ADDRESS

As I have had no previous dealings with you, I refer you to

AMERICAN TECHNICAL SOCIETY

Chicago U. S. A.

Please Mention Popular Mechanics

Genuine Imported English Serge Made-to-Order \$14.50!



Think of it! A genuine imported English serge suit, made to your measure, for only \$14.50. Pay \$4.50 now and the balance in one or two months. Your credit is good.

On Credit!

You do not pay a cent unless you are delighted with the suit after it has been made up for you. Tailor made—Imported English serge—\$14.50.

Write for our style book and samples at once. No obligations. Get posted on the greatest high-class clothing offer ever made. Write quick for these samples, so that you can measure yourself and order your suit—and have it next week.

The Greatest High-Class Clothing Offer Ever Made!

This offer is positively limited. These imported serges are the very latest English weave—the newest thing in serges—a splendid, fashionable material. Your suit will be made up by expert tailors in any of the latest styles you select.

Don't miss this chance. It's a real opportunity. Remember this is a very special offer, made for the purpose of showing new customers the remarkable values we give. You pay no commissions for merchants' or salesmen's salaries. You buy direct, and save all profits.

Write Today! For free, colored style book and samples of serge and other materials for suits and overcoats. We can have your suit ready in ten days. Send for booklet and free imported samples.

BABSON BROS., Dept. 1197, 19th St., Chicago



FORD RACERS

REBUILD YOUR FORD CAR
Sketches, specifications, and instructions. Prepaid for twenty-five cents. T. M. Co. Dept. A, Box 212, Woodford, Maine



ALORRA DIAMONDS

SPARKLE LIKE THE GENUINE—AT 1-40 THE COST
SOLID GOLD RINGS
—stand acid, fire and expert examination. See them before paying. Any style ring, pin or stud. Catalog FREE. The Alorra Co., Dept. A7, 140 S. Dearborn St., Chicago



AGENTS \$10 to \$20 PER DAY!

New Pure Aluminum Hot Water Bottle—will outwear 100 Rubber ones. Lasts a lifetime. Low price makes quick sales. Write for sample and large catalog of 400 other Specials.
AMERICAN ALUMINUM MFG. CO.
Div. B. M. LEMONT, ILL.



SEVEN MODELS

Singles, Twins
Two Speed
Chain and
Belt Drive

ALWAYS MAKES GOOD Write for Catalog
EXCELSIOR MOTOR MFG. & SUPPLY CO., 3702 Cortland St., CHICAGO

Freedom
with Fit
Comfort
with
Style



HERE'S a horsehide glove—designed for driving or work, and made as carefully in details as the finest kid. Easy, yet not "baggy," and slips on and off in a jiffy. Allows finger-freedom (almost like bare hands) with perfect fit and style.

Hansen Dan Patch Glove

cannot scuff, harden, crack or peel, and gives far greater wear than the best kid glove. Cheaper in the end than a dozen flimsy makeshifts. Over 500 styles.

Send for Free Book of Gloves

At your dealer's or write for information

O. C. Hansen Mfg. Company

291a Milwaukee St.

Milwaukee, Wisconsin

The bayonet derives its name from the city of Bayonne, France, where it was first manufactured.

Agents \$60 WEEKLY

Robinson Folding Bath Tub. Big seller. Costs little, no plumbing, little water. Weight 15 pounds, folds into small roll. Full length built, far better than tin tubs. Guaranteed 10 years. \$10 a day easily made. Write for free tub offer. Robinson Cabinet Mfg. Co., 351 Factory Bldg., Toledo, O.

GENERATORS

6 volts, 10 amperes, \$8.50. 8 volts, 10 amperes, \$10.00

For charging storage batteries, plating, operating wireless coils, lighting outfits, etc. Can be attached to automobile or motor boat. Our smaller sizes of dynamo motors make ideal machines for experimenting, lighting, etc. As motors they will operate heavy models, emergency wheels and other useful appliances.

18 watt dynamo-motor, \$3.00 24 watt dynamo-motor, \$3.81

40 watt dynamo-motor, \$5.25

Send 2 cent stamp for catalog of wireless apparatus, trains, electrical supplies, novelties, tools and books.

Loomis Electric Company, 1429 N. Artesian Ave., Chicago, Ill.



I will send my 25c book
Improve Your Face
for 10c, stamps or coin



This book contains a complete course of instructions in Physical Culture for the face

More than 90,000 persons are following these instructions today. They will do more to build beauty than all the paint and powder in the world, for they get right at the root of your facial defects and overcome them.

Not simple or silly. Just Physical Culture applied to facial muscles; common sense, that's all. If you want to improve your looks, send 10c for this book to-day, at once, while it's on your mind.

PROF. ANTHONY BARKER
5641 Barker Bldg., 110 W. 42nd St., N. Y. C.

Write

for This Free
**Washing
Book**



Great big book. Many pictures of actual washings. Tells how to save wear on clothes, how to save money, how to make washday easy—yes, really easy. Absolutely free for the asking. Send coupon today.

One Hour For a Wash!



Only an hour, Madam, to do a good-sized family washing. That's all, if you have a Thor Electric Home Washing Machine. Not a rub to wash finest linens or heaviest clothes. Does all the wringing, too. All you do is to press a button. Madam, learn all about this NEW washday marvel. Send coupon today.

The Thor

The machine which puts a wash-woman in your home each Monday at a cost of 2c. And your clothes are washed clean and white as snow. A special offer is on right now. We want to tell you all about it.

Mail This Free
**Special
Coupon offer!**

Hurley Machine Co.
29 So. Clinton Street
Dept. 1197 Chicago
147 W. 42nd St., New York

You may send the free washing book. Also full information about the special offer you are making now.

This coupon brings our 48-page book and all the good news about the better way of washing. Do not fail to mail the coupon for this book right now. It costs you nothing. We will tell you also about the big special offer we are making.

Name.....

Address.....

Hurley Machine Co.
29 So. Clinton St.
Dept. 1197
Chicago, Illinois
147 W. 42nd St.
New York, N. Y.

Name of Electric Dealer

Please Mention Popular Mechanics

"I've Read of Gold Mines" —

"I'VE read of gold mines, but yours is the first I have ever seen." That's what a patron said to J. J. Williams when he saw his Ten-Pinnet Alleys piling up profits. You can make a double profit from Ten-Pinnet, "world's greatest bowling game." Besides owning your own business, be our local representative and enjoy big commissions on sales in your territory.

Automatic Bowling—New and Fascinating!

Everybody plays Ten-Pinnet—men, women, children. Marvelous automatic feature makes your receipts nearly all net profit. No up-keep expense—no pin-boys—just someone to take in money. Alleys 38 to 50 feet long—easily installed in any room.

Valuable Premiums



to increase the interest of bowlers—we furnish coupons. An Ohio operator: "I am having great success. My place looks like a fair at times. Could use more alleys and may enlarge." You can start on small investment—easy terms. Write today for catalog and agent's prices.

The Ten-Pinnet Company

34 Van Buren Street,

Indianapolis, Ind.



Be The Auto Top Expert IN YOUR TERRITORY Earn \$10 AND MORE Per Day

Our copyrighted measurement charts and patent-applied-for system of making Auto Tops saves buyers nearly half the cost. Wherever introduced it controls the Auto Top business because low prices, perfect fit and high grade material get the orders. We will give live, hustling men exclusive territory to take orders and attach tops. You can learn how in a few hours and make \$10 per day at the start. Under our system you have no competition. Our low prices and samples get the order every time and we guarantee satisfaction. Our national advertising brings you customers. As your business grows hire help and spend your time getting orders. Thousands of tops, worn by hard summer's use, must be replaced. This is your opportunity, the biggest offered any man where no capital is required—only \$5.75 temporary deposit for necessary working tools, which is returned under stated conditions. Write now, today for catalog, samples and full information free.

AUTO SPECIALTY FACTORY

1008 Spring Street

CINCINNATI, OHIO

The average number of persons to a dwelling in New York City is sixteen.

SOME CAR! BOYS! Send for Booklet Today



The Lad's Car

Send 20c today for Booklet, telling how to build this automobile. Complete instructions and descriptions of parts and sizes, illustrated with diagrams, blue print, cuts made from photographs, and price list of parts.

SPECIAL INDUCEMENT to first boy in your town
Niagara Motor Car Corp'n, Dept. A, Niagara Falls, N. Y.

SEBASTIAN LATHES HIGH QUALITY LOW PRICES

If you delight in good tools you will delight in Sebastian Lathes. For 25 years we have built lathes, and lathes only, employing skilled labor always, and improving equipment and machinery every year. Sebastian Lathes are

STANDARD FOR QUALITY—LOW IN PRICE

They are accurate, economical, simple and durable. Many re-orders and voluntary letters from users of Sebastian Lathes prove this. The Sebastian reputation is back of every Sebastian Lathe. You are judge and jury when you buy a lathe. We are not satisfied until you are. Look over the complete line in our new catalog. It shows Lathes for general repair work, garage and automobile work, etc.

When you buy a lathe, say "Sebastian"

ADDRESS (FOR THE CATALOG)

THE SEBASTIAN LATHE COMPANY, 107 Culvert St., Cincinnati, Ohio

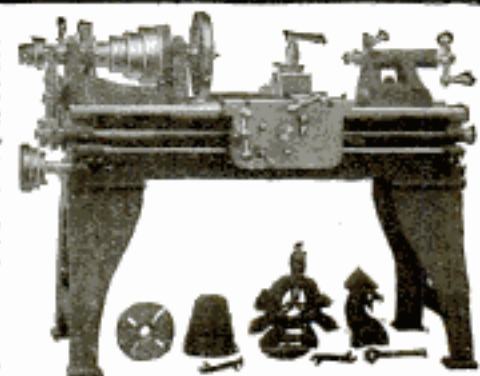

ONLY FROM **BASCH** CAN YOU GET GENUINE PERFECT CUT DIAMONDS

WORLD'S
LOWEST
PRICE

\$ **97.50**
Per Carat

DIRECT FROM
IMPORTER
TO YOU

And Here's the Reason:

We import direct from the European diamond cutters and sell direct to you. No middlemen's profits included in our extraordinary low import price of \$97.50 per carat. Retail value \$150.00 per carat. We save you 35%.

WE SHIP FOR YOUR FREE EXAMINATION —SEND NO MONEY

Here's the popular **Basch Plan**. Select any article from our catalogue or from this page. We ship your selection for your free inspection—entirely at our expense and risk—without obligating you in any way. We invite you to examine and compare our goods without it costing you one cent. If you don't say the article is the greatest value you have ever seen, simply have it returned at our expense.

L1
Mounting \$3.75
Add to cost of
Diamond

1/8 c.	\$ 8.25
1/4 c.	17.50
1/2 c.	45.00
3/4 c.	67.50
1 c.	97.50

L2
1 Diamond \$3.95

L3
3 Diamonds \$8.75

L4
1 Dia.
2 Pearls \$3.95

L5
Solid Gold
1 Dia. \$1.00

L6
1/2 c. Diamond
Compl. \$52.00

L7
1 c. Diamond
Compl. \$103.00

L8
5/8 c. Diamond
Compl. \$62.25

L9
1/8-3/64 c. Dia.
Special \$5.95

L10
3/8 c. Dia.
Compl. \$35.75

L11
Solid Gold Dia. Set
Special \$1.75 per pair

A WRITTEN MONEY-BACK GUARANTEE FOR YOU!

It protects you against disappointment or loss. A written legal contract to refund in cash full price less 10% should you for any reason wish to return your diamond any time within a year. Also allows full price in exchange at any time. Contains written statement of carat weight, quality and value of the diamond. "See that your diamond is Basch guaranteed."

Send for Your Copy of the Basch Diamond Book De Luxe FREE!

We will forward you postpaid, a copy of this beautiful book upon receipt of your name and address. It is complete, valuable and authori-

The Popular New Friendship Bracelet

Start your sisters, girl friends, relatives, etc. with a friendship bracelet. Solid sterling silver links only 15c each. (Retail value 25c). Black silk velvet band free with each link you buy for your different friends. The links are worn on the velvet band until you have enough links to encircle the wrist; then send us the complete set of links and we connect them with Sterling Silver Fasteners for 25 cents. The Friendship Bracelet is then complete and makes a very attractive permanent piece of jewelry. Mailing charges prepaid. Remit in any form convenient to you.



L. BASCH & CO.
Dept. K2470 STATE AND QUINCY STS.
CHICAGO, U. S. A.

tative. Contains facts written by life-long experts which enable you to buy your diamonds and jewelry safely. Thousands of illustrations of diamonds, watches, platinum and gold jewelry, silverware, cut glass, etc.—all priced to you at remarkably low figures. See this book before making your purchase—you will appreciate our money saving prices. Mail coupon or write us a letter or postcard for your free copy.
NOW!

FREE DIAMOND BOOK COUPON
Please mail me FREE, without obligating me, Basch Diamond Book DeLuxe.

Name.....
Address.....

L. BASCH & CO.
Dept. K2470
State & Quincy Sts.,
CHICAGO,
U. S. A.

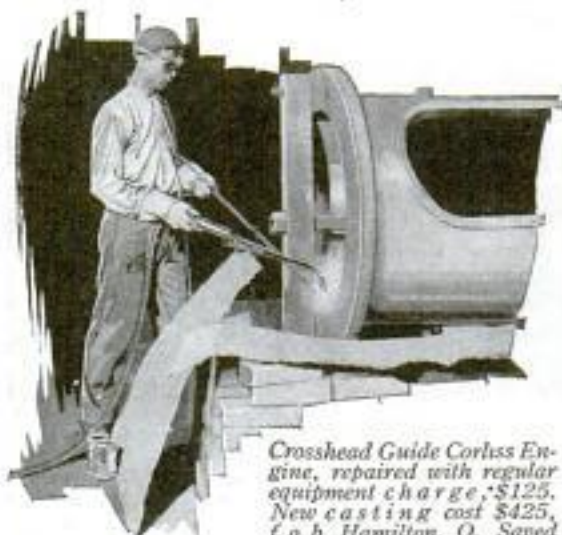

Crosshead Guide Corless Engine, repaired with regular equipment charge, \$125. New casting cost \$425, f.o.b. Hamilton, O. Saved three weeks' delay.

Investigate Savings Made by Oxy-Acetylene Welding

Don't follow wasteful, expensive and tedious methods—remember that "wherever two pieces of metal are to be joined, you will find a profitable use for Prest-O-Lite Oxy-Acetylene Welding." Investigate the savings you can make in metal manufacturing, construction and repair work. Other manufacturers, garage and shop owners are getting the benefits in economy, efficiency and quality that only this process can give. Are you?

Cost of equipment needed is low. Operation is simple, and easily learned. Often just one repair, made "on the spot," more than pays for all necessary apparatus. We furnish a thoroughly high-grade welding outfit for \$60. The average user will also need gas cylinders at an additional cost and about \$10 worth of welding supplies. Truck and special cutting equipment at extra cost.

Process in Easy Reach Through PREST-O-LITE Dissolved Acetylene (Ready-made Carbide Gas)

Prest-O-Lite Acetylene Service is permanent and universal, furnishes the highest grade of Dissolved Acetylene in portable cylinders and is used as conveniently as you use cylinders of oxygen. Saves the large initial outlay and heavy depreciation, trouble and inconvenience of making crude Acetylene in carbide generators. Besides, Prest-O-Lite Dissolved Acetylene is perfectly dried, cleaned and purified—makes better welds and is cheaper to use.

If you use Acetylene for ANY purpose, you should have full details of this unparalleled service.

Start Now—Get Full Details

Send for literature that shows what you can do in your shop, the savings you can make. Your name and address on the margin of this page will bring it to you.

The Prest-O-Lite Co., Inc.
The World's Largest Makers of Dissolved Acetylene
816 Speedway Indianapolis, Ind.

53 direct factory branches and charging plants in principal industrial centers.



One of 38 Styles.

4 Weeks' Trial

Choice of 38 Styles

Yes, we will ship you on four weeks'

absolutely free trial, direct from our own factory, your choice of 38 new styles of the highest-grade Wing Piano or Player Piano. No obligations—no C.O.D.—no security.

No Money Down—Not a Cent of Freight
Use it and enjoy it four full weeks; then, if you wish, ship it back at our expense. You alone are the judge. You will be amazed at our rock-bottom, direct price on the superb Wing, guaranteed 40 years. Easy monthly payments or cash. **WRITE TODAY.**

Valuable Book—FREE "The Book of Complete Information About Pianos" sent free and post-paid. Valuable 128-page book. Tells how to judge pianos. Beautiful art catalog also sent and particulars of great Free Shipment Offer. Write today.

Wing & Son (Est. 1868), Wing Bldg., 9th Ave. & 13th St., Dept. 1197, New York

This 64-Page Free Catalog Saves You 25 to 50% on Furniture

Come-Packt Furniture, sold direct from factory to home on a year's trial, saves you 25 to 50%. Home Furnishing Department helps you make best selections. Money-Back Guarantee. Write for Catalog today.

COME-PACKT FURNITURE CO.
1001 Fernwood Ave. Toledo, Ohio



WEAR

Trade Mark Registered

B.V.D. U.S. Patent Office and Foreign Countries

UNDERWEAR

An investigation of fusible-tin boiler plugs by the Bureau of Standards has been completed, and the bureau believes that there can now be no excuse for boiler explosions from imperfect plugs if its findings are followed, that is, to use tin to 99.9 per cent purity and free from zinc.

\$12500 to \$30000 a Month



Write at once. Most wonderful opportunity for the ambitious man. Railroads need hundreds of Signal men—will pay Big Money.

Special Offer We will teach you right at home to be expert. Special offer if you write at once. Two big outfits free. **Write Today** for our free catalog and particulars of our big offer.

DEPARTMENT OF SIGNALING

1810 Wilson Ave., Room 9197, Ravenswood Station, CHICAGO

OVER 70 YEARS' EXPERIENCE

PATENTS

TRADE MARKS
DESIGNS
COPYRIGHTS, &c.

Anyone sending a sketch and description may quickly ascertain our opinion free whether an invention is probably patentable. Communications strictly confidential. **HANDBOOK on Patents** sent free. Oldest agency for securing patents. Patents taken through Munn & Co. receive special notice, without charge, in the

Scientific American.

A handsomely illustrated weekly. Largest circulation of any scientific journal. Terms, \$3 a year; four months, \$1. Sold by all newsdealers.

MUNN & CO. 672 Woolworth Bldg., NEW YORK

Washington Office, 625 F St., Washington, D. C.

Please Mention Popular Mechanics

Our \$10,000 Plan Book Has at Least ONE Plan That Will Exactly Suit You!

SEND FOR IT TODAY!

The houses illustrated in this advertisement are but three out of over 100 shown in our big \$10,000 Plan Book. Full details—photographs—floor plans—color schemes—wholesale prices. Despite its cost, we will send this book **Free** to home builders. Simply send 10c for postage and packing. Get your copy. Contains hundreds of ideas, space-saving plans, new wrinkles, home suggestions that a woman will appreciate, and all facts about our famous "mill-direct-to-you" selling plans. Send 10c for postage—Now!

Plan 104

\$707

Plan 194

\$1106

Plan 100

\$782

Buy Your House Wholesale
Save \$200 to \$500 or More

Shipped to You Anywhere
Safe Delivery and Satisfaction
Guaranteed or Money Back!

You take no risk dealing with us. Three strong banks and over 100,000 delighted customers vouch for us. Customers everywhere—all bought by mail. Save 25% to 50% on your home. Highest quality; lowest, wholesale prices. Money back if you are not absolutely satisfied; you to be the sole judge. Dollars saved on the bill for every nickle of freight. Makes no difference where you live; we ship anywhere. We sell no "knock-down" houses—simply supply material wholesale for substantial permanent homes. Cozy bungalows—stately dwellings—comfortable cottages. Distinctive houses with class to them. Also "Ready-Made" Houses—"we saw them, you nail them." All waste of time and material eliminated. Great savings. No "extras"; no "come-backs." Send for "Guaranteed Right" estimate on your needs; costs keep within figures. Estimates free. Tell us what you want.

Send For Our 5000 Bargain Catalog

Contains 156 pages of money-savers. Everything for building—Lumber, Millwork, Screens, Builders' Hardware—over 5000 price and quality making bargains. All shipped anywhere—large or small orders. Book **FREE** on request. Send now! **USE THE COUPON!**

Gordon-Van Tine Co., 782 Federal Street,
Davenport, Iowa
In Business Over Half a Century 1865-1915

GORDON-VAN TINE CO.,
782 Federal St., Davenport, Ia.

In sending for Plan Book, enclose 10 cents for postage and mailing. You will receive the books by return mail.

Gentlemen—Please send the books checked below:

Building Material (Lumber, Millwork, Hardware, Paints, etc.) Plan Book

Name.....

Address.....

Occupation.....

Please Mention Popular Mechanics



Height 72 inches
Width 48 1/2 inches
Depth 24 1/2 inches

Brooks Mfg. Co. 2710 Brooks Ave.
SAGINAW, MICH.
Largest plant of its kind in the world

Something New

A Combination Wardrobe and Chest of Genuine Tennessee Red Cedar

\$26⁵⁰ Freight Prepaid
East of the Rockies; equalized beyond

Save Half Your Furniture Cost

We make everything for the home, office or club in Mission, Colonial or Flanders design—all of solid quarter-sawn oak—your choice of finish.

We can furnish the wardrobe or chest in quartered oak at the same price.



Length 49 inches
Height 20 inches
Width 22 inches **Price \$10.50**

Private Weather Bureau

IN EVERY HOME

**A Reliable Barometer
An Accurate Thermometer**
Actual Size 13 inches High

Indispensable to the farmer, business man, professional man, automobile list, in fact, to everybody who should know in advance what the weather will be. Will save you money and time.

WEATHEROMETER
FORECASTS WEATHER
HOURS IN ADVANCE

\$1.00 ONLY — Reduced from \$3.00
Send us no money. Mail your order today and Weatherometer will be sent to you C. O. D. (10c extra). If you prefer you may enclose \$1.00 bill or money order with order. Satisfaction guaranteed.

WITHINGTON INSTRUMENT CO.
5 South Wabash Avenue, Dept. 24, CHICAGO



Perfection Sleeping Bag With Pneumatic Mattress

These evenly-soft air mattresses may be used on damp ground with perfect safety—they are non-absorbent. And they are absolutely sanitary, with no place for dust or vermin to collect. Easily deflated and inflated—may be rolled into a small light bundle and easily carried in and out of the house. **Last indefinitely.** Invaluable for motor, yachting and camping trips. Endorsed by the Federal Government.

Write for Catalog and endorsements—today
PNEUMATIC MFG. CO. 536 17th Street
BROOKLYN, N. Y.



The United States is the greatest producer, the greatest exporter, the greatest importer, and the greatest consumer of tobacco in the world. The production of leaf of all sorts averages over 1,000,000,000 lb. a year. Considerably more than one-third of the production is exported. Tobacco exports exceed in value such items as cotton manufactures, electrical machinery, paper and paper products, and leather and leather manufactures.

GO INTO THE MOVING PICTURE BUSINESS

Make Money Fast! Be Your Own Boss!
\$30 to \$50 PER NIGHT CLEAR
No Experience Needed
We furnish you with machine, film, curtain and complete outfit ready to go to work with. **Get Easy Payment Plan.**
Write Now for Our **LARGE FREE CATALOGUE**
MONARCH FILM SERVICE
228 Union Ave., Dept. N, Memphis, Tenn.

QUICK MONEY
Growing Mushrooms

How to really make big money in mushrooms, is fully explained in the wonderful book, "The Truth About Mushrooms." Everything explained from A to Z, at first hand, from the greatest practical authority in America. Add \$10 to \$20 a week to your income. Demand exceeds supply. Grow in cellars, sheds, boxes, etc. Small capital to start. Profits bigger and quicker. Anyone can do it. Women and children, too. Now is the best time. Send for **FREE** book of information.
Bureau of Mushroom Industry, Dept. 124, 1342 N. Clark St., Chicago

3 1/3 c a Day

now boys a dazzling Lachmite Gem. Their brilliance is eternal—they stand fire and acid tests and cut glass like diamonds. Cost but one-third as much. **Set in solid gold.** The newest designs. Sold on **Free Trial.** See our new jewelry book.
Write for Big Jewelry Book Your name and address is enough. No obligations whatever. Write today—now.
HAROLD LACHMAN COMPANY
12 N. Michigan Avenue, Dept. 9127 Chicago, Ill.

Please Mention Popular Mechanics



ENGINE QUALITY HIGHER PRICES LOWER

Engine quality means *earning* capacity. High earning capacity means *high* quality. Low *first* cost (engine price) and low *after* cost (cost of fuel and up-keep) — both of these factors together, when they give you steady, dependable, continuous operation at fuel load — these things mean *high earning capacity* — high quality. Add to this low money-cost (price and operating cost), the matter of convenience — engine easy to understand and manage, easy and quick to start without cranking — and you come to the highest point of high engine quality.

It is just this kind of high quality, that has made successful, for over 28 years (almost ever since there have been any gasoline engines), my well-known, fuel saving

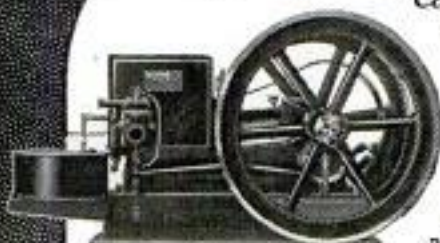

Gasoline and Naphtha Engine — Stationary Sizes: 2, 3, 4, 6, 8, 12, 16 and 22 H-P. Shown mounted on iron sub-base.

WITTE ENGINES

GASOLINE, GAS, KEROSENE, AND DISTILLATE

WITTE Engine — On Skids
Sizes: 2, 3, 4, 6, 8 and 12 H-P.
Kerosene or Gasoline.

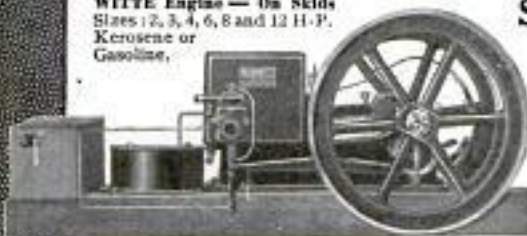

Sold Direct from Maker to User

If you knew my engine quality, as well as many thousands of my old customers, you would believe, just as they believe and freely say, "You can't buy any better engines for any price, and none as good for the low WITTE price." My engines are now made to deliver 30% to 50% surplus power, according to size, over the regular rating, and to operate on 15% to 30% less fuel per H-P. delivered in the belt or at the brake. Yet with these important advantages, the price is lower than ever, averaging for stationary engines

Less than \$17.50 per Horse-Power. Steel mounted portables now average less than \$22.00 per H-P. and complete engine saw-rigs proportionally low. To know, fully, what these figures mean in real engine value, you should send at once for my new

EASY-TO-UNDERSTAND ENGINE BOOK — FREE

This book shows in detail, how to judge engines, as to construction, low cost and easy operation, and which sizes are most suitable for the various kinds of work for which any kind of engine can be used to advantage. Until you read my book, you will not fully know just how much quality your engine money can and should buy. Let me show you my offer before you arrange to try any engine. Write to-day, to my office nearest to you.

ED. H. WITTE, WITTE ENGINE WORKS

1741 Oakland Ave., KANSAS CITY, MO.
174 Empire Bldg., PITTSBURGH, PA.

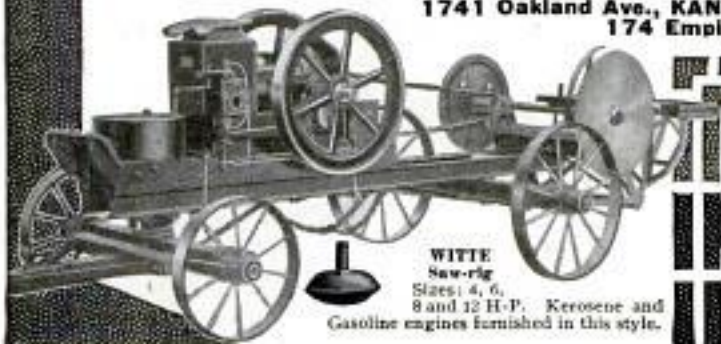

WITTE Saw-rig
Sizes: 4, 6, 8 and 12 H-P. Kerosene and Gasoline engines furnished in this style.

Latest WITTE Prices

5-Year Guarantee on Efficiency and Durability

CASH OR EASY TERMS
(F. O. B. Factory)

Stationary

2 H-P.,	\$34.95
3 H-P.,	52.45
4 H-P.,	69.75
6 H-P.,	97.75
8 H-P.,	139.65
12 H-P.,	197.00
16 H-P.,	279.70
22 H-P.,	359.80

Portable

2 H-P.,	\$39.95
3 H-P.,	60.50
4 H-P.,	82.75
6 H-P.,	127.75
8 H-P.,	174.65
12 H-P.,	237.00
16 H-P.,	329.70
22 H-P.,	412.30

Saw-Rigs

4 H-P.,	\$124.25
6 H-P.,	152.25
8 H-P.,	202.15
12 H-P.,	267.00



ED. H. WITTE, WITTE ENGINE WORKS,
1741 Oakland Ave., Kansas City, Mo.
174 Empire Bldg., Pittsburgh, Pa.

Without cost to me, and with no obligation on my part, I should like to receive your latest and finest Engine Book, and to investigate your New Liberal Selling Plan.

Name

Address

Please Mention Popular Mechanics

Have a Rifle of Your Own!

Enjoy the charm of the woods and fields—shoot woodchucks, crows, hawks, and other pests—practice snap-shooting on targets in mid-air—and shooting at the mark. *It's wonderful sport!*

Marlin

.22 Calibre Repeater

—the *right* gun for small game, for snap-shooting and shooting at the mark. It is *remarkably accurate*; has plenty of range and power; gives *quick repeat shots*; and the ammunition is so cheap you can shoot all day long at slight expense.

New Hammerless Model \$12.50

Model No. 32. Hammerless—and built right! The pistol grip stock has a real pistol grip and the greater "drop" that experienced shooters like so well. The quick adjustable *Wind-Gauge* rear and *Ivory Bead* front are "extra quality" sights—

the best ever furnished on any .22 repeater.

The *Take Down* is simpler and quicker than any other—the rifle more convenient to carry and easier to keep clean. The *safety slide button* is placed right—just under your thumb. The *Solid Steel Top* protects your face and eyes from defective cartridges; the *Side Ejection* throws shells away from you.

15 Shots; with full magazine 25 shots. *Four other Marlin .22 repeaters* give choice of *lever or pump* action with visible hammer. All five models handle .22 short, .22 long, .22 long-rifle cartridges.

Buy the right gun!—Send three stamps for 140-page catalog of repeating rifles and shotguns.

The Marlin Firearms Co.
65 Willow St., New Haven, Conn.

Model
No. 32
\$12.50

Please Mention Popular Mechanics

Valuable Book of INFORMATION FREE

to Ford owners interested in reducing operating costs and increasing the comforts and pleasures of Family Motoring by the world's greatest

EFFICIENCY SPECIALISTS
for
Ford
cars

Copyright, 1915

K.C. Auto
Supply
Co.

1501 Grand
AVENUE

Kansas City, Mo.



Fine appearing, easy \$75 to erect GARAGE

Price is for 10ft. x 12ft. size, 12ft. x 15ft. and 12ft. x 18ft. National Garages at proportionate prices—either with gable or hip roofs. National Garages come complete in sections, painted in one coat, with roofing and all hardware included. No extras to buy—no special tools or skill required to put up or take down. Simplicity of erection, splendid appearance and substantial construction outweighs any further price consideration with National Garage owners. Send for free catalog of the National line.

National Lumber Mfg. Co.
27 Shawnee St. DAYTON, OHIO

The cultivated grapefruit no longer grows in clusters like huge bunches of grapes as it did in the uncultivated state. For this reason the Department of Agriculture has decided that the old name has become misleading, and the fruit will henceforth be called "pomelo" in its literature.

A "BRIDAL" GIFT WITH EVERY IMPERIAL RANGE

Simply send name and address. This reserves your delightful premium. Learn the facts of Imperial Ranges—Heat retaining Stone Oven Bottom, Odor Hood, Ash Sifter, all exclusive features. Save \$10 to \$25. Direct from factory. 30 days' Free Trial. Cash or Credit. Write now for catalog and facts about YOUR premium. THE IMPERIAL STEEL RANGE COMPANY 269 Detroit Street CLEVELAND, OHIO



3 YEARS TO PAY

Meister Piano 30 days free trial in your own home

\$1 A WEEK or \$5 A MONTH Price \$175.00

No cash payment down. No interest—no extras. Piano stool and scarf free.

ROTHSCHILD & COMPANY
Dept. 16L CHICAGO, ILL.



Runs on Alcohol

At Cost of Less than 1/2¢ an Hour

anywhere without electricity, springs or batteries. Superb construction. 12-inch blades. Adjustable roller bearing. Reliable. A proved comfort. Prompt delivery. The original and only Lake Breeze Motor manufactured according to the design of the inventor and under his direct and personal supervision.

Keep Cool

\$15 Cash with Order

Lake Breeze Motor, 122 N. Jefferson St., Chicago





Strolling and Rolling with Riz La Croix

Your cigarettes will always be pleasant company if you roll them in Riz La Croix "papers"—famous the world over for superior *quality* that insures entire satisfaction in every requirement.

RIZ LA

(Pronounced: REE-LAH-KROY)

FAMOUS CIGARETTE PAPERS

Roll easily, shape up perfectly, hold shape and don't burst—because they combine lightness and thinness with great textile strength.

Absolutely tasteless—no "paper-taste" in the smoke—because their combustion is complete. Naturally adhesive—don't unroll in smoking—because made of best flax-linen, a pure vegetable product.



5^c

FREE

Two interesting, illustrated Booklets— one about RIZ LA CROIX Cigarette Papers, the other showing how to "Roll Your Own" cigarettes— sent anywhere in U. S. on request. Address The American Tobacco Company, Room 1184, 484 Broome Street, N. Y.

Please Mention Popular Mechanics



GOERZ LENSES CAMERAS

Speedy! But not too Speedy for a Goerz

When "first-time" pictures are imperative—when you must depend on your camera, not on the sun or weather—use Goerz Lenses and Cameras.

Speed plus absolute reliability make Goerz Cameras and Lenses indispensable to the professional—to the amateur who demands maximum depth of field and sharp definition from edge to edge.

Don't you want the "Goerz kind" of pictures? Your dealer has Goerz goods. The new tariff makes prices lower—don't forget that!

Booklet free—Specify which—"Lenses" or "Cameras"
C. P. GOERZ OPTICAL CO.
323C East 34th St. NEW YORK CITY

No Money In Advance

**This Marvelous Camera
ON FREE TRIAL!**



Only 10,000 of these marvelous, instantaneous picture-taking and making cameras to be sent out absolutely on approval without a penny in advance just to prove that it is the most wonderful invention—the camera sensation of the age. Just think of it—the Mandel-ette takes and makes finished pictures

INSTANTLY!

You press the button, drop card in developer and in one minute take out a perfect, finished post card photo $2\frac{1}{2} \times 3\frac{1}{2}$ inches in size. Camera, itself, is about $4\frac{1}{2} \times 5 \times 7$ inches. Loads in daylight, 16 to 50 post cards at one time. No Films—No Plates—No Dark Room. It is instantaneous photography. Universal focus lens produces sharp pictures at all distances. Pictures develop and print automatically. Can't overdevelop; results amazing.

We Trust You

We will send you the complete Mandel-ette outfit absolutely on approval, no references required, and give you 10 days to test it. If not satisfactory return at our expense. If you keep it simply pay \$1 when you get camera and \$1 per month until our special price of only \$5 is paid. No experience required. Plain instructions and everything complete with outfit so you can begin taking pictures the moment it arrives. We guarantee that even a child can operate it. Send coupon for camera.

— THE CHICAGO FERROTYPY COMPANY —
Desk 163 Ferrotypy Bldg., Chicago, Ill.

Send me one complete Mandel-ette Camera outfit including supply of post cards and instructions. I agree to pay \$1 when I get the camera, and if satisfied keep it and pay you \$1 a month until your special price of \$5 is paid. Otherwise I will return it at the end of 10 days.

Name.....

Address.....

Please Mention Popular Mechanics



BOOK of BUNGALOWS

The pick of 1,000 practical and distinctive Bungalows, with plans, etc., actually built for from \$400.00 to \$4,000.00, all contained in my **BUNGALOW BOOK De Luxe Edition** **100** Postpaid
The largest exclusive Bungalow book ever published I will send this to anyone anywhere for \$1.00 postpaid. This book contains 112 pages, showing exterior and interior views, floor plans, size of rooms, actual cost of construction, and valuable points and suggestions on Bungalow building written by an expert. Before you build, send for this book. Money back if not satisfactory. Send check, money order or stamps. A smaller book for 50 cents.

JUD YOH0, The Bungalow Craftsman, 53 Bungalow Bldg., SEATTLE, WASH.

Ironing Made Easy



You will save time, labor, health, money, and get better ironing if you use the

SIMPLEX IRONER
THE BEST IRONER

Operated by hand or power. Heated at nominal expense. Made in 8 sizes—\$25 and up. Soon saves its cost. Easy payments if desired. Write for FREE Catalog, "Ironing Hints" Booklet, and 30 Days' FREE Trial Offer. Established 10 years.

AMERICAN IRONING MACHINE CO., 532 — 168 N. Michigan Ave., CHICAGO

IF IT ISN'T
AN EASTMAN
IT ISN'T A KODAK

GROWTH OF HAWAIIAN RAILWAYS—Twenty years ago there were $23\frac{1}{2}$ miles of track on Oahu Island; today 127 miles with 22 locomotives, 44 passenger cars and 520 freight cars, are in existence. The gross earnings of the road 20 years ago were \$120,000; now they are \$1,300,000. Then 79,000 passengers were carried yearly, while in 1914 about 1,140,000 passengers were transported.

THIS BUNGALOW \$900 CAN BE BUILT FOR

This and many others in my new book, Building Plans for Modern Homes, will save you hundreds of dollars. One of the most complete and comprehensive books of plans ever published by any architect. Fifth edition just off the press. Two hundred and fifty floor plans and photographs of bungalows, etc., costing from \$200 up; gives sizes and cost to build. Sent postpaid for \$1.00



FREDERICK H. GOWING
ARCHITECT

18 Tremont St., BOSTON, MASS.

Send Us Your

Old Carpets We Dye Them and Weave Velvety Rugs

Beautiful new rugs in plain, fancy or Oriental patterns—any color you want, any size—totally different and far superior to other rugs woven from old carpets.

Rugs, \$1.00 and Up

Reversible, seamless, soft, bright, durable rugs, guaranteed to wear 10 years. Money back if not satisfied. Every order completed in three days.

You Save 1-2

Your old carpets are worth money, no matter how badly worn.

Free Write for book of designs in color, our liberal freight payment offer and full information.
Olson Rug Co., Dept. C34, 48 LaSalle St., CHICAGO, ILL.



7 CENTS A DAY Buys This Standard Visible Oliver Typewriter

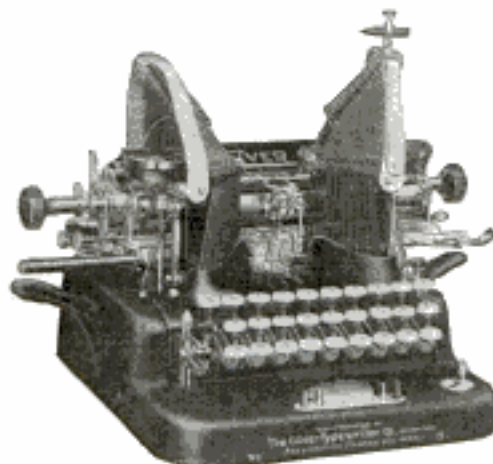

Much Less than Half Price FREE Trial—10-Year Guarantee

This is the best typewriter offer ever made. The typewriter is the genuine model No. 5 Standard Visible Oliver with complete, brand-new equipment. Perfect machines only. Not shop worn, not damaged, not inferior. Back spacer and tabulator—no features lacking. Warranted to be the equal in quality of any other \$100 typewriter.

This offer is not on some ancient style of blind typewriter, but on an up-to-date, standard, visible machine, the same kind of typewriter that many thousands of the world's best business firms are today using.

Oliver Points:

Nearly one-half million Olivers have been sold. Its record has never been equaled. It is easily "The Favorite."

Its simple efficiency, lightness and durability place it in a class ahead of all others; writing always in sight; writes in many different colors without changing the ribbon. Has the universal keyboard, back spacer, tabulator, ruling device, disappearing indicator. The type is beautiful; it is so hard that nothing can mar it. It outwears type found on other machines.

It is the lightest of all the standard typewriters. It is the only practical, portable typewriter. It has the lightest key action. Its speed is unlimited. It has the patented "U" shaped type bar which insures perfect alignment of the letters. One can write on ruled lines with it or it can be used to draw lines. It makes an efficient billing machine as well as correspondence machine.

The downward stroke of the type bar gives greater power. The Oliver is nearly always chosen for manifolding—some firms write as many as 20 copies at one writing. It does any practical thing which any typewriter can do.

It has the fewest parts. It requires the least adjustments. There is nothing to wear out. We guarantee it for 10 years.

While it is the choice of the experts, it is so simple in its design that anyone can learn to write on it in 10 minutes' time.

Sensational Reduction

Many thousands of purchasers paid \$100.00 for typewriters of this model. They were satisfied that at that price they were getting the best value that the market afforded.

Now, without any reduction in quality and with brand new standard equipment, our price to you is but \$39.80—a saving of over half, and we give you over a year in which to pay.

Our Offer Is This

Send the coupon and we will forward one of these typewriters with complete equipment on five days' trial. We will ship it by express. When it arrives you leave \$3.80 with the express agent to be held while you try the typewriter.

If you do not find it to be the best typewriter that you ever examined, satisfactory in every respect, the best value offered anywhere, then you simply return it to the express agent, who will give you back the \$3.80 and return the typewriter to us at our expense.

If you decide to keep it, the express agent will forward the \$3.80 to us and it will be deducted from the \$39.80 price, leaving a balance of \$36.00, which you can pay at the rate of \$2.00 per month, the first monthly payment not being due until one month after date of delivery.

There are no interest charges, no red tape, no salesmen, no collectors, no bother. The simple coupon is all we require.

The typewriter we will send you will be delivered in the original package as put up in the factory of the manufacturer, perfect in every detail.

Send the coupon today. Make sure of getting this bargain, as we will only supply 100 typewriters at this price.

United States Typewriter Exchange
Dept. 306, All Light Bldg., CHICAGO, ILL.

Trial Order Coupon

United States Typewriter Exchange
Dept. 306, All Light Bldg., CHICAGO, ILL.

You may send me a No. 5 Oliver Typewriter on approval. When it arrives I will leave with the express agent \$3.80 with the understanding that if I do not wish to keep the typewriter the \$3.80 will be returned to me by the express agent when I return the typewriter to him within five days from the date I receive it.

Otherwise I will keep the typewriter and the \$3.80 will be forwarded to you to apply on your special purchase price of \$39.80, and I will pay the balance of \$36.00 in 18 consecutive monthly installments of \$2.00 each, commencing one month from date of delivery.

The title of the Oliver Typewriter remaining in you until it is totally paid for.

Name.....

Address.....

References.....

(327)

"Little Guard"
the **Torrey**

*gives a quick, smooth,
clean shave*

Here's a *real* safety guard razor, shaves in the only correct way, cuts close, doesn't rough the skin.

\$2

Like all **Torrey** razors, this new safety has the perfect shaving edge. Hold like any other *real* razor—it's two-thirds size. Has reversible safety guard.

If your dealer hasn't Torrey razors, write us; we'll tell you where to get them. Ask for Free Booklet, "How to Shave."

The new Torrey Honing Strop has no equal

THE J. R. TORREY RAZOR COMPANY
Dept. P, Worcester, Mass.

BEACON BURNER FREE
FITS YOUR OLD LAMP

100 Candle Power Incandescent pure white light from (kerosene) coal oil. Beats either gas or electricity.

COSTS ONLY 1 CENT FOR 6 HOURS

We want one person in each locality to whom we can refer new customers. Take advantage of our Special Offer to secure a Beacon Burner **FREE**. Write today. **AGENTS WANTED.**

HOME SUPPLY CO., 111 Home Bldg., Kansas City, Mo.

BUY PLUMBING and HEATING SUPPLIES
at **WHOLESALE** Will Save You **30%**

Don't pay retail prices. Full stock on hand for prompt shipment. Send for free catalog.

B. P. KAROL, 800-802 South Kedzie Ave., CHICAGO

The "BEST" LIGHT

A soft, luminous light, which casts no shadow. Brighter than electricity or acetylene. Makes and burns its own gas. Costs 2c a week. No dirt, smoke nor odor. Over 200 styles, ranging from 100 to 2000 candle power. Absolutely guaranteed. Write for illustrated catalog.

AGENTS WANTED EVERYWHERE
THE BEST LIGHT CO.
324 E. 5th St., Canton, O.

OWN A BUSINESS WE WILL HELP YOU.

"I made \$88.16 first three days," writes Mr. Reed, of Ohio. Mr. Woodward earns \$170 a month. Mr. M. L. Smith turned out \$301 in two weeks. Rev. Crawford made \$7.00 first day. See what they have done, judge what you can do.

LET US START YOU
in Gold, Silver, Nickel and metal plating. Prof. Gray's new electro machine plates on watches, jewelry, tableware, and metal goods. Prof. Gray's New Royal Immersion Process latest method. Goods come out instantly with fine, brilliant, beautiful thick plate, guaranteed three to ten years. No polishing or grinding. Every family, hotel and restaurant want goods plated.

PLATERS HAVE ALL THEY CAN DO

People bring it. You can hire boys to do the plating as we do. Men and women gather work for small per cent. Work is fine—no way to do it better. No experience required, we teach you. Recipes, Formulas, Trade Secrets Free. Outfits ready for work when received. Materials cost about ten cents to do \$1.00 worth of plating. Our new plan, testimonials, circulars and **SAMPLE FREE**. Don't wait. Send us your Address anyway.

GRAY & CO., PLATING WORKS
856 Gray Building CINCINNATI, OHIO

Sunshine Lamp FREE!
300 Candle Power

To Try in Your Own Home
Turns night into day. Gives better light than gas, electricity or 18 ordinary lamps at one tenth the cost. For Homes, Stores, Halls, Churches. A child can carry it. Makes its own light from common gasoline. Absolutely SAFE.

COSTS 1 CENT A NIGHT

We want one person in each locality to whom we can refer new customers. Take advantage of our **SPECIAL FREE TRIAL OFFER**. Agents Wanted.

SUNSHINE SAFETY LAMP CO.
616 Factory Bldg. Kansas City, Mo.

KRUPP'S BURGLAR-PROOF SAFE—It is reported that the Krupp works have just turned out a steel safe that will put all burglars to shame, being made of a steel of such resistance that it withstands all methods of attack and tools known at present. At one test of a plate of this steel, a 2-in. hole, 1.4 in. deep, was made in the plate, but for this not less than 476 gal. of acetylene

Small Engines

Our illustrated book tells all about our wonderful small engines in $\frac{1}{2}$, 1 and $1\frac{1}{2}$ H. P.

SIEVERKROPP STARTER
SIX SEAT STARTER FOR FORD CARS
Shipped on trial. Send stamp for Booklet and Special Offer

Sieverkropp Engine Co., 1224 18th St., Racine, Wis.

FREE to Hunters and Trappers

Fine Taxidermy Book Now Free! 120p. with hundreds of photos of mounted birds and animals. Learn this profession. Save your trophies. Decorate your home and den. Great value to sportsmen.

Learn to Stuff Birds animals, game birds, tan furs, make rugs and robes. Quickly learned by men and boys. Big Profits from spare time. Intensely interesting. **INVESTIGATE!** Write Today for Free Book. Only a few free—no rush.

Northwestern School of Taxidermy, 1197 Elwood Bldg., Omaha, Neb.

FITS-UR-POT **FITS ANY COFFEE POT**

Just out. Going with a rush. Every home a prospect. Converts any pot into percolator. Makes better coffee—saves third to half. Aluminum. Quick sales.

Profits \$24 to \$36 a Week

Most percolators cost \$3 to \$5. **FITS-UR-POT** sells for \$1. Practical—absolutely new. Our free premiums stimulate sales. Write quick for agency.

Standard Spinning & Stamping Company
110 Smead Ave. Toledo, Ohio

AGENTS WANTED

Not One Cent To Pay For Three Months

Here is the engine offer that eclipses all others. Think of it—not one cent to pay for three months! How absolutely perfect this engine must be in every particular—how absolutely sure we must be that it will positively make good under all conditions when we say:

Use this engine on your own work. Don't send us a cent of your money until, from your own experience with it, you are absolutely sure it is the engine you want. If it isn't, send it back at our expense. If it is, you may use it for three whole months before you make even the first payment and then pay the balance in 6, 9 and 12 months—giving you

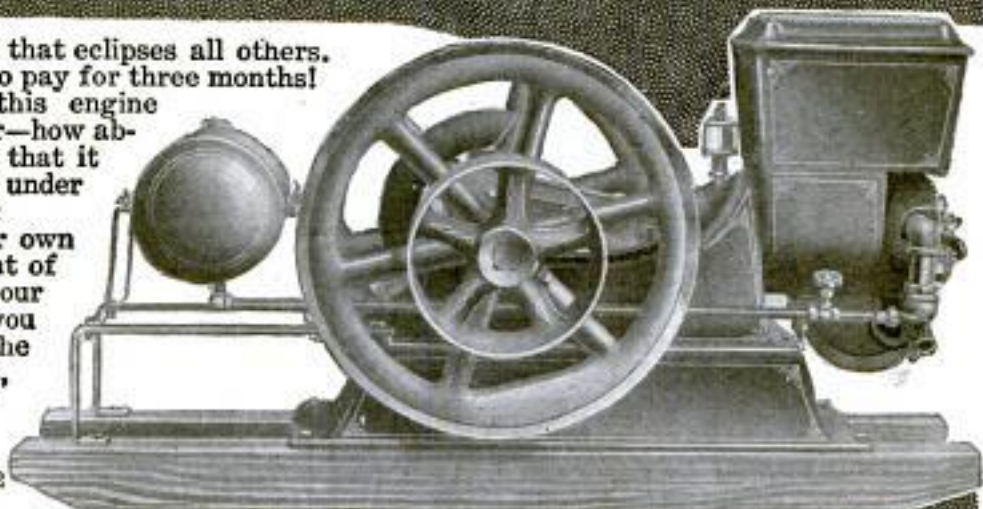

MAJESTIC STATIONARY ENGINE
Sizes 2, 3, 5, 7, 9 and
14 Horsepower

A Year To Pay Without Interest

There's a guarantee of quality the like of which has never been heard before.

The Majestic is such an amazing triumph of engine construction that we will gladly send any size to suit your needs so that you, by testing it out on your own place, may prove our claims at our risk.

No Money In Advance

Only the great House of Hartman with its enormous \$10,000,000 capital can afford to sell an engine at the remarkable bargain price of the Majestic, back it up with a strong guarantee and extend such liberal credit terms—the most liberal ever conceived.

The Great Majestic Engines Gasoline, Kerosene, Naphtha, Gas

The Majestic is the "happy medium"—neither too heavy nor too light. Has fewer number of parts—a marvel of simplicity. Perfectly balanced—just the right weight for the power it is designed to develop—no excessive friction.

The Majestic must not be confused with old-style, over-heavy type of gasoline engines which are made after patterns designed years ago and which consume enormous amounts of fuel and are, therefore, expensive to operate. Neither is the Majestic of the opposite extreme type, that are so light they literally jerk and tear themselves to pieces when running at high speed or under a heavy load.

The Majestic is the simplest, most durable, most powerful for its H.P. rating and most economical-to-operate gasoline engine ever made.

Big improvements in all vital parts—and the most wonderful automatic mixer ever put on a gasoline engine.

All Majestics are horizontal, 4-cycle type, open jacket, hopper cooled. No over-heating of parts or sticking of valves. Very little water needed for cooling. Convenient, compact, easy to run.

YOUR CREDIT IS GOOD

If you need power, no matter where you live, this offer is for you. No bank deposit—no references—no mortgage—no embarrassing questions—no collectors—no red tape. You may pay all cash if you prefer. It costs you not one penny extra to take advantage of Hartman's most liberal credit terms.

FREE Engine Book The most valuable, most interesting book of engines ever published. Tells all about the wonderful Majestic, how made, and why it is the biggest engine value in America today. Tells how to pick out the size and style engine best suited for your needs and explains the famous Hartman selling plan. Mail Coupon for Engine Catalog No. 86-E

The Hartman Co.,
3945 LaSalle St., Chicago, Ill.

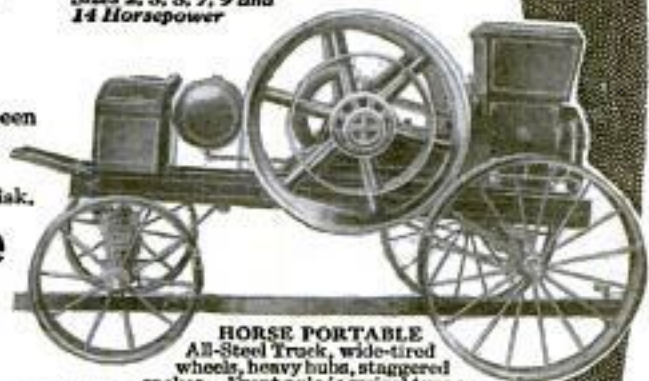

HORSE PORTABLE

All-Steel Truck, wide-tired wheels, heavy hubs, staggered spokes. Front axle is swivel type so made that wheels, passing over obstructions, do not disturb level of engine. 6, 7, 9 and 14 H.P., mounted this style.



PORTABLE
WOOD SAW

Table slides on wheels, cannot sag or get out of alignment. Outfit shipped complete, ready for work. 6, 7, 9 and 14 H.P., mounted this style.

**FREE Engine Book
COUPON**

THE HARTMAN COMPANY,
3945 LaSalle St., Chicago, Ill.

Without obligating me, send your Engine Catalog No. 86-E and particulars of selling plan.

Name.....

Address
P. O. Box.....
or R. F. D.

Town..... State.....

Please Mention Popular Mechanics

TAILOR MADE TO ORDER 6 MONTHS TO PAY



Be the swellest dresser in your set. Wear clothes that virtually breathe class. Take six months to pay for them. Get acquainted with America's greatest price-smashing tailoring house. See how our tremendous buying power gives us the pick of the world's finest fabrics at lowest prices known. Our catalog will astound you. Write for it.

Save Half!

Think of it! **\$25 tailored-to-your-order Suits and Overcoats only \$15 from us; \$35 values only \$18, etc.** Don't buy ready-mades and pay double our price. Don't pay other tailors two or three times as much as we charge. Don't buy clothes that can't be guaranteed to the limit. We must make good clothes to uphold our reputation.

Only \$2.30 Per Month!

No need to sacrifice the advantage of made-to-order clothes. So easy to pay our way that you won't miss the money. We trust you. No references required. No red tape. No delay. No collectors. No extra charge for the credit. Absolutely rock-bottom prices.

BEWARE

of the houses advertising "made-to-measure" clothes who don't dare to back up their claims. Don't be fooled into accepting altered-to-fit ready-mades as made-to-order clothes. Deal with the house that believes in quality and fairness.

\$1,000 Reward To anyone who proves that we do not make all our garments absolutely tailor-made to your own individual order and measurements. There's our sensational offer. Don't confuse us with the ordinary run of so-called tailoring houses. We're different. See our money-back guarantee in our catalog.

DeLuxe Book of Style FREE!

Just off the press—our wonderful Book of 1916 Fall and Winter Fashions. Most advanced and exclusive styles—the choicest designs from the world's greatest style centers. The cream of the greatest mills. Write for it today. Post cards brings it free together with full particulars of the most sensational offer ever made in the history of high class tailoring. Write now!

STANLEY-ROGERS CO., 544 S. Clark St., Chicago, Ill.

Here's a New Business



Reproduce Photographs of persons and scenes upon watch caps, dials, china, etc. Work easily done. Knowledge of photography not necessary. TRIAL OUTFIT with directions, \$2 postpaid—Contains enough material to make at least 15 reproductions that you should sell from \$1.50 to \$2.50 each. ORDER TODAY. Satisfaction Guaranteed.

AMERICAN ARTS & CRAFTS COMPANY, BOSTON, MASS.

BARODA DIAMONDS

FLASH LIKE THE GENUINE—AT 1-50 THE COST
SOLID GOLD MOUNTINGS. Stand acid test and expert examination. See them first, then pay. Catalog FREE. Patent Ring Gauge included for 5 two-cent stamps. The Baroda Co., Dept. 95, 1458 Grand Ave., Chicago



Cut Your Own Hair

Save Time and Money

It is now possible for you to cut your own hair—to cut it just as efficiently as the barber, in less time and with less expense, if you have a MASONSON'S

SAFETY HAIR CUTTER

The only device of its kind on the market—works like a comb, no clipping. Just the thing you've needed. Send \$1 today. Or write for further information.

Dealers—A sensational seller—sells on sight. Easy work, lots of profit. Write us for our money-making proposition.
AMERICAN SAFETY HAIR CUTTER CO.
103 Bindley Power Building PITTSBURGH, PA.



Write Today - See New Styles 1916 Prices

GET the 1916 wholesale price offer from Kalamazoo on 500 styles

and sizes of best quality stoves and ranges. Mail postal or letter today for

New Catalog and "Recipes FREE in Rhyme"

Cash or easy payments—30 days' trial—year's test. We pay freight and ship within 24 hours. \$100,000 bank bond guaranty. Write today.

Ask for Catalog 473

Kalamazoo Stove Co., Mfrs.
Kalamazoo, Michigan

Stoves, ranges, gas stoves, furnaces, white enameled metal kitchen cabinets and tables, 4 catalogs—please say which you want.

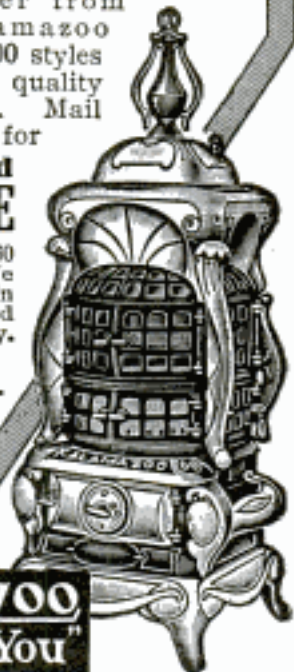

"A Kalamazoo Direct to You"

and 534 gal. of oxygen were used and the time consumed was one and one-quarter hours. In order to produce a hole large enough to admit the hand, 2,642 gal. of oxygen and 2,378 gal. of acetylene would be needed, while the performance of this work would require six hours. It is evident, therefore, that burglars will never succeed in melting open a safe made from the new steel. The steel is very hard and cannot be bored, so that the holes for the screws and rivets must be made at the start. The new material does not lose its hardness by annealing.



CLASS PINS



FACTORY TO YOU

Made to your special order, any style or material. Write to-day for free catalog of 1915 designs. Special offer, either style of pins here illustrated with any equal number of letters and figures, with one or two colors of best hard enamel. SILVER PLATE, \$.15 each, \$1.50 per dozen; STERLING SILVER, \$.30 each, \$3.00 per dozen; GOLD PLATE, \$.35 each, \$3.50 per dozen; SOLID GOLD, \$1.50 each, \$15.00 per dozen.
BASTIAN BROG. CO., 825 BASTIAN BLDG., ROCHESTER, N. Y.

Champion Racer



MODEL AEROPLANES

Send 2c postage for Complete handbook of Models and Supplies.

WADING RIVER MFG. CO.
WADING RIVER, N. Y.

Our set contains this and 9 other drawings, with instructions for building \$1.00



Amazing Profits In Mushrooms

Anybody can add \$8 to \$40 per week to their income, in spare time, entire year growing mushrooms in cellars, sheds, barns, boxes, etc. I tell you where to sell, at highest prices.

Free Illustrated Instruction Booklet

HIRAM BARTON
Desk 2, 329 W. 48th St., New York

Agents! 500% Profit

\$25.00 to \$50.00 a week that's what our agents are making selling our new metallic sign letters for office windows, store windows and glass signs. For a quick, easy money making proposition for agents, salesmen and sign painters, there is nothing to equal the selling and putting up of our new metallic letters and numbers. There is no experience necessary to put up these signs. Anyone can succeed and make money right from the start. We will send you full particulars and you will see how easy it is to make money in this business. One agent says: "Have already put up 14 signs in this little burg and more in sight. Your letters are the best thing I have seen in years. Will soon be in a position to buy in 5000 lots." Another says: "I am getting all the work I can do and the letters have given entire satisfaction everywhere." We are daily receiving such letters from agents who have started in the sign letter business. This is the only field that is not overcrowded. There is a big demand for window and glass signs in every town. You can sell to nearby trade or travel from town to town all over the country as you please. We would be pleased to send you a free sample and full particulars.

WRITE TODAY. ADDRESS

The Metallic Sign Letter Co.
407 N. Clark Street, CHICAGO, U. S. A.

GARGOYLE



Mobiloils

A grade for each type of motor

BIG CHANCE FOR AGENTS



You can earn **BIG MONEY**

most complete line of guaranteed transparent handle Razors with Photo, Name and Lodge Emblem of cutlery. Write today for catalogue and terms. Cutlery Co., 554 W. Lake St., Dept. 209, Chicago, Ill.

Better Hearing

Write today for our 15 day trial offer of the New 1915 Thin Receiver Model Mears Ear Phone. It has eight adjustments of 12 sounds in each.

96 Degrees of Sound

The complete range of tone for the human ear is covered. It is the final perfection of an efficient substitute for the natural hearing organs. Instrument hardly noticeable.

Write for Free Book Write today for valuable book on deafness sent free. It explains our low direct prices to you. No middle-man's profit—15-day free trial offer. If you are a sufferer from deafness—if you have a deaf friend don't fail to write for this book. Mears Ear Phone Co., Dept. 1197, 45 W. 34th St., New York City



FISH'S "HOME MAKER'S"

BOOK—FREE

WRITE for our wonderful 292-page book, "The Home Maker." It's filled with 4,985 useful and ornamental articles for the home. Tells you how to furnish and beautify your home—how to buy anything you want on credit with a whole year to pay—without fuss, bother or publicity. A book of honest values at amazingly low prices. Below are hints of our offerings. Write for the Book today. Order direct from this ad if you like and send only first payment.

RICH UP-HOLSTERED ROCKER



\$8.45
75 cents Cash
75c a Month
No. F-247

A massive, luxurious, overstuffed Rocker, high-grade in construction and workmanship. Seat, back and arms are carefully upholstered and covered in black Royal Leather or Spanish Supreme Leather. (Style which is wanted.) Seat is upholstered over extra heavy braced steel springs. Back and front are neatly ruffled.

Iris Wonder Oak Heater



No. A-238—13 in. Firepot
Price \$6.95
No. A-239—15 in. Firepot
Price \$8.80
50c Cash 50c a Month

Strong and durable in construction, handsome in appearance, economical in fuel consumption. Burns any kind of fuel. Has heavy cast iron fire pot and castings; screw draft register, body of sheet steel. Beautiful nickel trimmings.

Washing Machine Bargain



Price \$7.35
50 Cents Cash
50 Cents a Month
No. A-237

The Wonder Rotary is the most practical washing machine ever offered at so low a price. Saves health and labor. Cleans finest fabrics without slightest danger of injury. Body made of Louisiana Red Cypress bound with steel bands and corrugated on inside. Ball bearing mechanism—light, easy running.

30 Days' FREE TRIAL

We give you a month in which to prove the goods we sell you. If dissatisfied we refund first payment and pay transportation both ways. We take all of the risk, giving you a YEAR TO PAY. Enjoy your furniture while paying for it.

DEPT 173
FISH'S FURNITURE CO.
CHICAGO

A YEAR TO PAY

Please Mention Popular Mechanics

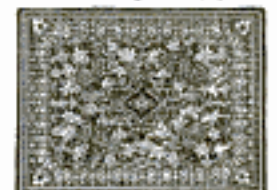

Tapestry Brussels Rug
Price Size 9x12 ft. \$10.45
No. A-242 75 cents a month
Wonderful value. Closely and firmly woven of fine, selected yarns, with firm, heavy back. Beautiful floral and oriental patterns in rich, artistic, non-fading color combinations of tan, green and red. State whether floral or oriental pattern is wanted and what colors you like best.

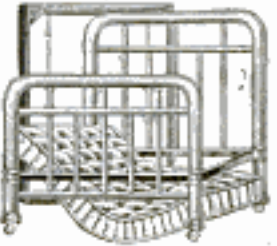

IRON BED OUTFIT
Price \$8.85 75c Cash
No. A-243
Consists of Handmade continuous track bed, woven wire spring and full 4 1/2 lb. cotton top mattress.



Washing Machine Bargain
Price \$7.35
50 Cents Cash
50 Cents a Month
No. A-237

The Wonder Rotary is the most practical washing machine ever offered at so low a price. Saves health and labor. Cleans finest fabrics without slightest danger of injury. Body made of Louisiana Red Cypress bound with steel bands and corrugated on inside. Ball bearing mechanism—light, easy running.

30 Days' FREE TRIAL
We give you a month in which to prove the goods we sell you. If dissatisfied we refund first payment and pay transportation both ways. We take all of the risk, giving you a YEAR TO PAY. Enjoy your furniture while paying for it.

DEPT 173
FISH'S FURNITURE CO.
CHICAGO

WRITE FOR BOOK TODAY

Crippled Children

This boy was born with Club Feet. When three years old his father brought him to this Sanitarium and his feet were permanently straightened, as is shown in the picture.

In 1907 the boy developed Potts Disease, which, as is generally known, is a progressive, destructive disease of the spinal bones, usually tubercular, always deforming and frequently causing paralysis. He was then barely able to walk. Because of his father's experience with us in the treatment of his feet he brought the boy here for the treatment of Potts Disease and today he is a strong, well, happy boy. Look at the photograph; read his father's letter, dated Dec. 20th, 1914.

"Lloyd is now the picture of health. Am thankful that I knew of the McLain Sanitarium for it surely saved our boy's life. I will be pleased to answer any inquiries in regard to the treatment. You may publish this if you wish, as I cannot say enough in favor of the McLain Sanitarium.—H. J. Dowd, Spirit Lake, Iowa.

Write to Mr. Dowd and ask any questions. He will answer.

For thirty years this Institution has successfully treated

DEFORMITIES

Including all Spinal Troubles, Hip Disease, Infantile Paralysis, Club Feet, Bow Legs, Knock Knees, Wry Neck, etc., especially as found in children and young adults. Write for our book, "Deformities and Paralysis"; also book containing testimonials from practically every state. 84m.ires.



The McLain Orthopedic Sanitarium
902 Aubert Avenue ST. LOUIS, MO.

STOP USING A TRUSS

Do Away With Steel And Rubber Bands

FREE TRIAL



Inner surface is made adhesive to secure the PLAPAO-PAD firmly to the body, keeping the PLAPAO continually applied and the pad from slipping. No straps, buckles or springs attached. Soft as velvet—easy to apply.

It's the Non-Slipping, yet Non-Rigid Pad and What is Within It That Counts

PATD APRIL 6 1909

FREE to 5,000 Truss Sufferers

To the first 5,000 Sufferers who write, I will send, ABSOLUTELY FREE, a sufficient quantity of the Plapao to positively convince them that this is the only logical, common-sense way of treating rupture. Plapao is a highly astringent medication placed within the Plapao-Pad and being absorbed through the skin, creates a wonderful feeling of relief and at the same time tends to strengthen the weakened muscles and thus permanently close the rupture opening. The process of recovery is natural, so you'll have no use for a truss—you can throw it away forever! Old and young have testified under oath that the Plapao-Pads cured their rupture—many of them long-standing, aggravated cases—without delay from work. Patent allowed in U. S. and foreign countries. Awarded Gold Medal at Rome and Grand Prix at Paris.

Send No Money—for a sufficient quantity of the Plapao is sent without charge to enable you to give it a thorough test; you pay nothing for this trial now or ever. Write for it and full information today. Address Plapao Laboratories, Block 1427 St. Louis, Mo.

"I Would Not Part with It for \$10,000"

So writes an enthusiastic, grateful customer. "Worth its weight in gold," says another. In like manner testify over 100,000 people who have worn it.

The Natural Body Brace

For MEN and WOMEN.

Develops erect, graceful figure, overcomes WEAKNESS and AILMENTS of Women & Men.

Brings womanly beauty and manly strength, restful relief, ability to work and enjoy life.

Banishes All These Troubles

Does away with the strain and pain of standing and walking; replaces and supports misplaced internal organs; reduces enlarged abdomen; straightens and strengthens the back; corrects stooping shoulders; develops lungs, chest and bust; relieves backache and nervousness. Comfortable and easy to wear.

Wear It 30 Days Free at Our Expense

Write today for illustrated booklet, measurement blank, etc., and read our very liberal proposition.

HOWARD C. RASH, Pres. Natural Body Brace Co.
223 Rash Building SALINA, KANSAS



We are Under Govt. Bond

Water power in Switzerland is utilized to such an extent that in some towns not an ounce of coal is burned, power, light, and heat being furnished by hydroelectric plants.

Deafness



Perfect hearing is now being restored in every condition of deafness or defective hearing from causes such as

Relaxed or Sunken Drums, Roaring or Hissing Sounds, Perforated, Partially Destroyed Drums, etc.

Wilson Common-Sense Ear Drums

"Little Wireless Phones for the Ears"—require no medicine but effectively replace what is lacking or defective in the natural drums. They are simple devices, which the wearer easily fits into the ears where they are invisible. Soft, safe and comfortable to wear at all times.

Write today for our 168 page FREE book on DEAFNESS, giving you full particulars and plenty of testimonials.

WILSON EAR DRUM CO., Incorporated
101 Inter-Southern Building LOUISVILLE, KY.

NO MORE BALD HEADS



When our VACUUM CAP is used a few minutes daily. We accept no pay until you have tried the Cap 60 days and are satisfied. The Vacuum Cap is an appliance that draws the blood to the Hair Roots and starts a new healthy crop of hair. It stops Dandruff, stops the hair from falling out. Bought by Doctors and men who

know that it is the only reasonable HAIR GROWER known to science. No Drugs Used. Write for application blank, testimonials, and booklet on "HAIR," sent sealed in plain envelope, FREE.

THE MODERN VACUUM CAP CO.
W. 559 BARCLAY, DENVER, COLO.

Please Mention Popular Mechanics



Tobacco Habit BANISHED

in 48 to 72 Hours



No Desire After First Dose

Trying to quit the tobacco habit unaided is a losing fight against heavy odds, and means a serious shock to your nervous system. So don't try it! Make the tobacco habit quit you. It will quit you if you will just take Tobacco Redeemer according to directions.

It doesn't make a particle of difference whether you've been a user of tobacco for a single month or for 50 years, or how much you use, or in what form you use it. Whether you smoke cigars, cigarettes, pipe, chew plug or fine cut or use snuff Tobacco Redeemer will positively remove all craving for tobacco in any form in from 48 to 72 hours. Your tobacco craving will begin to decrease after the very first dose—there's no long waiting for results.

Tobacco Redeemer is absolutely harmless and contains no habit-forming drugs of any kind—the most marvelously quick and thoroughly reliable remedy for the tobacco habit the world has ever known.

Not a Substitute

Tobacco Redeemer is in no sense a substitute for tobacco, but is a radical, efficient treatment. After finishing the treatment you have absolutely no desire to use tobacco again or to continue the use of the remedy. It quiets the nerves, and will make you feel better in every way. If you really want to quit the tobacco habit—get rid of it so completely that when you see others using it, it will not awaken the slightest desire in you—you should at once begin a course of Tobacco Redeemer treatment for the habit.

Results Absolutely Guaranteed

A single trial will convince the most skeptical. Our legal, binding, money-back guarantee goes with each full treatment. If Tobacco Redeemer fails to banish the tobacco habit when taken according to the plain and easy directions, your money will be cheerfully refunded upon demand.

Let Us Send You Convincing Proof

If you're a slave of the tobacco habit and want to find a sure, quick way of quitting "for keeps" you owe it to yourself and to your family to mail the coupon below or send your name and address on a postal and receive our free booklet on the deadly effect of tobacco on the human system, and positive proof that Tobacco Redeemer will quickly free you from the habit.

Newell Pharmacal Company
Dept. 300, St. Louis, Mo.



Mail Coupon NOW for FREE Booklet

NEWELL PHARMACAL CO.,
Dept. 300, St. Louis, Mo.

Please send, without obligating me in any way, your free booklet regarding the tobacco habit and proof that Tobacco Redeemer will positively free me from the tobacco habit.

Name

Street and No.

Town State

Please Mention Popular Mechanics



Smith & Wesson Automatic

Doubly safe

Protection against intruders and unintentional discharge



Get your dealer to show you the special features of the Smith & Wesson Automatic.

Booklet on request.

SMITH & WESSON
814 Stockbridge St., Springfield, Mass.

Every Smith & Wesson is the Best of its kind



MOTORCYCLES \$25 to \$175

All reliable makes. Some as good as new. Write today for full particulars and catalog. We repair and exchange motorcycles.

HARRY R. GERR CO., 699 McLaren Ave., St. Louis, Mo.

Save Half ON PLAYER PIANO ROLLS

Enjoy the best, full-score music, yet save 45c to 50c on the dollar, get quicker delivery and choice of **OVER 2000 SELECTIONS** (classic, popular, etc.) Arrangement of our rolls celebrated. Materials of highest quality.

90-Page Catalog FREE

Shows convincingly how to get truly desirable (88-note) player-music at **GENUINE** half prices.

S. H. CONSUMERS MUSIC CO., Sta. H., BUFFALO, N. Y.

Argo Standard

Standard tread, 4-cylinder motor; full streamline body; a wonder at the price.

Roadster
\$385

f.o.b. factory

Touring Car
\$435

f.o.b. factory

Electric lighting and starting system, \$60 additional
Not only the most but the best that such a price has ever bought.

ARGO MOTOR COMPANY, Inc.
614 Main St. JACKSON, MICHIGAN

MAKE YOUR BIKE A MOTORCYCLE

at a small cost, by using our attachable outfit. Fits any Bicycle. Easily attached. No special tools required.

"Used His Four Years"

Harry A. Hyatt, of Boreas River, New York, writes: "About four years ago I received my motor attachment, and wish to say that I am satisfied with it in every way, for it has certainly given me good service. Anyone wanting a motorcycle or attachment, I would recommend them to the Shaw Manufacturing Co."

FREE BOOK Write today for bargain list and free booklet, fully describing the SHAW Bicycle Motor Attachment. Motorcycles all makes, new and second-hand, \$35.00 up.

SHAW MANUFACTURING CO.
Dept. 6 GALESBURG, KANSAS



\$4.00 SEISS

Powerful, Commanding, Warning Signal. Operated by touch of hand, either right or left—for short blast or long, continuous sound, same as a Motor-Driven Horn.

THE SEISS MFG. CO.
439 Dorr St., TOLEDO, O.

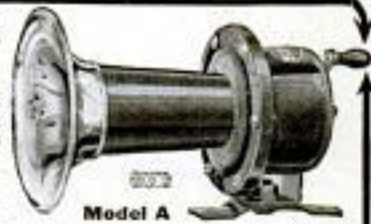

Convert Your Bicycle into a Motor-Cycle

Motor fits any wheel. **BEST, MOST RELIABLE.** Best hill climber. More **STEFFEYS** in use than all others. Stamp for circulars. STEFFEY MFG. CO., 5007 Brown Street, PHILA., PA.

EXPLOSION-PROOF ELECTRIC MOTORS FOR MINES—A recent technical paper issued by the Bureau of Mines gives the details of construction of a permissible explosion-proof electric motor for use in mines where a spark might ignite inflammable gases or dust.

5 H. P.

1915 Peerless Motorcycle



with Free Engine, Bosch Magneto, together with the best there is in Motorcycle construction. Power, Speed, Silence, Endurance, and those wearing qualities so essential for low cost of maintenance.
5 MILES FOR ONE CENT
Agents Wanted—Liberal Discount!

PEERLESS MOTORCYCLE CO., 179 Hunting Ave., BOSTON, MASS.

1915 Harley-Davidson

Winner of the International Grand Prize Race at Venice, California, April 4th.



Complete description of various models can be obtained from any dealer or catalog will be mailed on request.

HARLEY-DAVIDSON MOTOR COMPANY
Producers of High Grade Motorcycles for Fourteen Years
431 B Street Milwaukee, Wisconsin

Garage \$69.50

10x12feet "Steelcote" Edwards ready-to-use garage, \$69.50 complete. Factory price. Fireproof. Portable. Quickly set up. All styles and sizes of garages and portable buildings. Send postal for illustrated catalog.

THE EDWARDS MFG. CO.
320-370 Eggleston Ave., Cincinnati, O.





Be a Tizard Tire Doctor

Enter the best-paying trade—tire repairing, 10,000,000 tires in service—thousands being sold each day. Demand for tire doctors growing—some one must look after the tires in YOUR locality—will YOU be the man to reap the enormous profits?

**MAKE \$40 TO \$70 A WEEK
BEGIN NOW**

Get out of the wage class—OWN your business—make BIG money. No matter how small you start, a vast opportunity awaits you. The automobile industry is growing each day—demand for tire repairmen far exceeds the supply—so repair prices remain HIGH. Make \$2,500 to \$4,000 a year—grasp the opportunity before your neighbor beats you to it.

THE TIZARD IMPROVED STEAM VULCANIZER

is a big-capacity plant, yet costs but a few cents a day to run. It vulcanizes SIX inner tubes and THREE casings at one time. Is equipped with work-bench, two tire racks, tools, etc.—it's complete, ready to produce the minute installed and the price is low.

Our Help-You-Plan Assures Success When you buy a Tizard Vulcanizer, you get business insurance. With the machine, we give you FREE, business letterheads and envelopes printed with your firm name, merchandising plans, service data, co-operation, which will insure you SUCCESS. We furnish also for starting you out, business cards, follow-up system, price list folders—a system of advertising to bring you the business. In short, we co-operate with you and stand back of you.

WRITE FOR OUR BEAUTIFULLY ILLUSTRATED BOOKLET

and learn about this wonderful business. This handsome book reads like a story—it's an education itself. Tells how rubber is gathered in the Brazilian jungles, how manufactured and made into tires. It describes and pictures various tire injuries and best methods of repair. Let us tell you about our new help-you-plan—nothing like it elsewhere. Send the coupon—a letter or postal will do as well—and DO IT NOW, while the opportunity in your territory is waiting.

Tizard Manufacturing Company, Dept. 207, Omaha, Neb.

Tizard
Mfg. Co.,
Dept. 207,
Omaha,
Nebraska

Please send free
and prepaid your il-
lustrated book and de-
tails of your HELP-
ME
plan.

Send This Coupon Today

which, according to tests made by the bureau, meets the requirements of a safe motor. This motor is to be used as a standard with which other motors, sent to the bureau for testing, will be compared in passing on their permissibility.

Indian Motorcycles
One, two and three
speed Gears with
cradle spring frame.
Send for catalog.
HENDEE MFG. CO., 711 State Street, SPRINGFIELD, MASS.

GO INTO THE MOVING PICTURE BUSINESS

Write For
FREE Catalog



On
Our Easy Payment Plan

Make \$20 to \$50 per
night

With our Moving Picture Outfit
We sell everything—Films, too.

Moving Picture Sales Co.
Dept. 2 540 Plymouth Place, Chicago, Ill.

High Grade Violins 30 Days' Free Trial

Your choice from a large and carefully graded stock of representative instruments from the leading foreign violin makers.

Strictly hand made and of superior type, these violins are far superior to the average old violins sold at four times the price.

Write Today. Don't fail to send your name and address today for the superb Lewis catalog sent free and postpaid. Of value to everyone interested in high grade instruments. Learn how you can have your choice of these superb instruments on a free trial in your home. Write today.

Wm. Lewis & Son (1922) Dept. 1197, 225 S. Wabash Ave. Chicago

OUR SPECIALTIES: Imported wood-turnings and tools for violin makers.

ENGINE BUYERS! BE UP-TO-DATE

Why be satisfied with an old-fashioned, out-of-date engine when you can get a 1916 Ellis—"the engine ahead"—on a 30-day Free Trial and with a 19-year guaranty? Delivers full power on cheap kerosene; always on the job; never has to be petted or coaxed. 1½ to 18 h.p. Interesting booklet, "Engine Facts," FREE. Don't miss it.

ELLIS ENGINE COMPANY, 2830 E. Grand Blvd., DETROIT, MICH.



36278 \$150. 36034 \$45. 36030 \$25. 36184 \$100.

EIGHT MONTHS TO PAY

BEAUTIFUL DIAMOND
SENT ON APPROVAL—NO MONEY DOWN

No obligation: pay as you can. Order any diamond from our catalogue: when received, if not absolutely satisfactory, return it. Otherwise keep it and pay 20% of the price, and only 10% per month thereafter. Ten per cent. discount for all cash. A binding guarantee as to quality with each diamond. Exchangeable at any time at an increase of 7 1-2% more than you paid. SEND FOR FREE CATALOGUE DELUXE 8. Contains over one thousand photographs of rings, pins, diamonds, and other precious stones.

L. W. SWEET & CO., Inc. 2 and 4 MAIDEN LANE NEW YORK CITY

36043 \$100. 36055 \$300. 36211 \$90. 36080 \$100.

36254 \$50. 36226 \$25. 36071 \$55.

Patents

**Trade Marks and
Copyrights Secured
or Fee Returned**

Special Offer—Free Search of Patent Office Records

Send us a model or sketch and description of your invention, and we will make a *Free Search* of the *Patent Office Records* to ascertain if it is patentable. If we report the invention patentable, we will guarantee to obtain a patent or return our fee, and furnish a certificate of patentability backed by a bonded contract to that effect.

This Certificate of Patentability will protect the inventor and serve as proof of the invention until the case can be filed in the U. S. Patent Office.

Obtaining Assistance for Inventors

Our certificate is of great assistance to inventors who require financial aid to obtain patents.

Our Five Books Mailed Free

(SEE COUPON BELOW)

to any address. Send for these books—the finest publications ever issued for free distribution.

How to Obtain a Patent

Our illustrated eighty-page Guide Book is a book of reference for inventors, and contains 100 mechanical movements illustrated and described.

Money in Patents

Tells how to invent for profit, and gives history of successful inventions.

What to Invent

Contains a valuable **LIST OF INVENTIONS WANTED** and suggestions concerning profitable fields of invention; also information regarding prizes offered for inventions, among which is

Prize of One Million Dollars

offered for one invention, and \$10,000 for others.

Patents That Pay

Contains letters from our clients who have built up profitable enterprises founded upon patents procured by us; also endorsements from prominent inventors, manufacturers, Senators, Congressmen, Governors, etc.

We Advertise Our Clients'

Inventions Free

In a list of Sunday newspapers with two million circulation, in manufacturers' journals and in the *World's Progress*. Sample Copy Free. We save you time and money in securing patents. After the patent is granted we assist you **TO SELL YOUR PATENT.**

Foreign Patents

WE HAVE DIRECT AGENCIES IN ALL THE PRINCIPAL FOREIGN COUNTRIES and secure **FOREIGN PATENTS** in the shortest possible **TIME** and at the **LOWEST COST.** Write for our Illustrated Guide Book on Foreign Patents, sent free to any address.

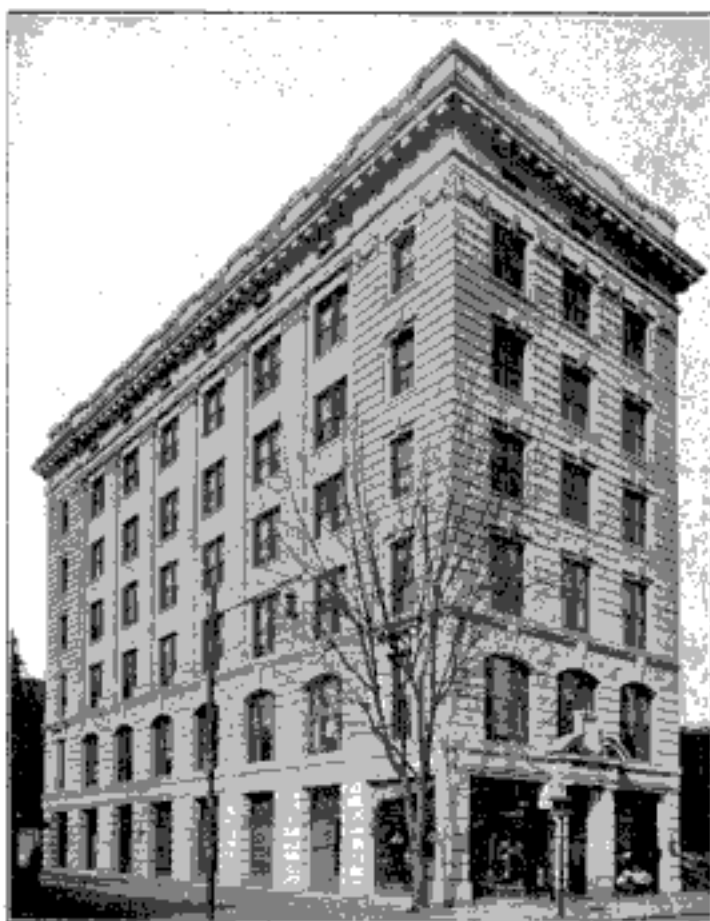

VICTOR BUILDING

Our new \$200,000 building opposite U. S. Patent Office
SPECIALLY ERECTED by us for OUR own use

WANTED NEW IDEAS

Send for **LIST OF PATENT BUYERS** who consult us when purchasing patents. Contains requests from **MANUFACTURERS, MAIL ORDER HOUSES** and **PROMOTERS** for patents secured by us, and suggestions as to **New Ideas** they wish to purchase. We invite manufacturers and promoters to address our Sales Department regarding the purchase or leasing of a number of meritorious patents secured by us.

REFERENCES

Second National Bank, Washington, D. C.; Union Savings Bank, Washington, D. C.; Chamber of Commerce, Washington, D. C.; Pitner Gasoline Lighting Co., Chicago, Ill.; R. G. Dun & Co., Washington, D. C.; Smethport Glass Co., Smethport, Pa.; The Melvin Gauge and Signal Co., Scranton, Pa.; M. Winter Lumber Co., Sheboygan, Wis.; National Savings and Trust Co., Washington, D. C.

FREE COUPON!

VICTOR J. EVANS & CO., Patent Attorneys

NEW YORK OFFICES: 189-191 Broadway

PHILADELPHIA OFFICES: 1429 Chestnut St.

Main Offices: 765 Ninth St., N. W., WASHINGTON, D. C.

GENTLEMEN: Please send me **FREE OF CHARGE** your **FIVE** Books as described above.

NAME..... ADDRESS.....

WANTED IDEAS



Inquiries from Manufacturers and Other Buyers of Patents
Who Are Looking for Good Ideas

Protected by Owen Patents

Are constantly being received. Hundreds of ideas are wanted—a market exists for them to-day. YOURS may be one of them. Send for my free books and see for yourself—read the requests for inventions protected by me. Many are simple. You can help supply this demand.

As soon as my clients' rights are protected I aid in every practicable way, without charge, to sell. Their applications are advertised free—their patents are called to the attention of the proper prospective buyers—every necessary thing is done. Get my booklets and see.

THESE ARE FREE

You will incur no obligation by writing me. A simple request will bring them to you—the finest, most reliable and instructive patent books published. A postal will do.

"Successful Patents"—a 72 page guide book, tells how to proceed; describes my advantageous business methods; gives references, testimonials, etc.
"Stepping Stones"—gives hundreds of hints of inventions wanted; articles from interviews of noted authorities; tells the truth about prizes for inventions.
"Patent Promotion"—tells you how to sell; why some inventors fail; discusses the value of your idea; how I aid my clients; manufacturing aids furnished you; recent successful patents, etc.

You will also be sent from time to time, as new inventions are wanted, full information concerning them. Only in this way can you keep up to date.

Write for These To-day—Advice costs nothing. All communications confidential. I secure patents or receive no compensation. Your work will receive my personal supervision—but my fees are no higher than others.

Results Speak Loudest—But Here Are Some References

Columbia National Bank,
Washington, D. C.
National Lockfile Co.,
Washington, D. C.
The Carnahan Press,
Washington, D. C.
Lightning Gun & Cycle Works,
Oklahoma City, Okla.
Antholene Mfg. Co.,
Hutchinson, Kans.

National Hack Co.,
61 Hannover St.,
Boston, Mass.
The G. J. Loftus Co.,
13 Spring Common,
Youngstown, Ohio
Whitehead Hosiery Mills,
Burlington, N. C.
Dickinson Mfg. Co.,
Des Moines, Iowa.

A LARGE NUMBER OF OTHERS IN MY BOOKLETS.

RICHARD B. OWEN 9-303 OWEN BLDG.
WASHINGTON, D. C.

Inventors submitting their inventions to me are protected in a tangible manner until their applications are filed.



Search of Records

Send sketch or model of your invention for free search of Patent Office Records and report on patentability.

PATENTS SECURED OR FEE RETURNED

Latest and Most Complete Patent Book Ever Published for Free Distribution

WRITE FOR IT

Compare My SERVICE and TERMS with Those of Any First Class Attorney

Send Sketch, Photograph, or Model of your invention for an ACTUAL SEARCH of the Records of the Patent Office and report as to patentability — FREE. I give every detail of every case my closest personal attention and do not entrust your interests to assistants. Impartial advice on your ideas. I help you sell your patent. Terms moderate. My 90-page book tells what inventors should know before they apply for a patent.

GEORGE P. KIMMEL, Patent Lawyer, 200 Barrister Bldg. Washington, D. C.

Money in Patents

Manufacturers are always looking for inventions. All patentable ideas should be protected by a patent. (By a Registered United States Patent Attorney.)

The great majority of money making inventions are thought of by persons, I will term amateur inventors, and nearly always are some very small or simple thing, for the reason that a large invention takes too much time and money for the average person to produce.

I have inquiries from all over the country, in which manufacturers and business houses are looking for patents in every line of industry. Owing to these inquiries I am about to put inventors in direct touch with manufacturers who want patents, and thereby find a ready sale for their invention, which, for results, is far more practicable than any other mode of assistance to inventors.

A book "How to get your patent and make your profits thereon," which contains general patent information, is free and I would be very glad to have you write me for a copy of it.

MANSELL F. MILLS

Registered United States Patent Attorney

244 Commercial National Bank Building, WASHINGTON, D. C.

PATENTS AND TRADE MARKS

LANCASTER & ALLWINE



201 OURAY BLDG., WASHINGTON, D. C.
BOOK INVENTIONS—PATENTING & PROMOTING FREE

Our co-operation with an Inventor is, FIRST, to help him establish his rights before he discloses the idea to ANY attorney; SECOND, to give a frank opinion whether it will pay to patent his idea, based upon our extensive knowledge of manufacturers' wants and facilities; THIRD, to obtain for him a patent which is in reality a valuable monopoly; FOURTH, to advise and assist him in the marketing by outright sale, territorial grants, obtaining royalty, or independent manufacturing of the invention; and FIFTH, aiding him to so profit by conferring with manufacturers, investors or distributors of machines. Before sending a sketch to anyone, sign, witness, and deposit in our fireproof vault our document

EVIDENCE OF CONCEPTION

—AND PROTECT YOUR RIGHTS—

PATENTS C. L. PARKER
Formerly Member Examining Corps, U. S. Patent Office
PATENT LAWYER
210 MCGILL BLDG.
WASHINGTON, D. C.

Patents, Trade Marks, Copyrights, Patent Litigation

Handbook for Inventors, "Protecting, Exploiting and Selling Inventions" sent free upon request.

A Fortune to the Inventor

who reads and heeds it, is the possible worth of the book we send for 6 cents postage. Write us at once.
E. S. & A. B. LACEY, Dept. Y, WASHINGTON, D. C.

PATENTS THAT PROTECT and PAY

Advice free. Terms reasonable. Highest references. Best results.

Send sketch or model for FREE examination and opinion.

BONDED and recommended Patent Lawyer in the Rand-McNally Directory of Bankers and Attorneys Published by Rand-McNally & Co., Chicago, Ill. Recommended Patent Attorney in the Bankers Register and special list of selected lawyers published by the Credit Company, Pontiac Building, Chicago, Sharp & Allman's Directory of Lawyers and Bankers of Philadelphia, Martindale's American Legal Directory of New York City, and the Con. P. Curran Directory of Bankers and Lawyers of St. Louis.

ALL BUSINESS GIVEN PROMPT AND PROPER ATTENTION

A large list of strong recommendations furnished free

WATSON E. COLEMAN, Patent Lawyer, 624 F St., N.W., Washington, D.C.

Wanted—Ideas Inventors! Send for these Remarkable FREE BOOKS, Today

Complete and full information about patents, everything the inventor or manufacturer should know, has been included in these books. Never before has such an inexhaustible fund of valuable information been at the inventor's disposal. Regardless of the fact that the compilation of this information cost us thousands of dollars, we will send to all interested persons, any or all of these books, entirely without charge or obligation.

"Millions In Patents"

This volume, 192 pages, tells the story of the romance of invention. The brain of the inventor is the magician that has made the ancient fairy tales come true. Millions have been paid for a hook, fortunes have come from a toy. Read "Millions in Patents," and you will realize that this country and all the nations of the world are ready to enrich you beyond your wildest dreams if you can contribute one useful or amusing thing.

"What Is a Trademark?"

It is not an exaggeration to say that billions of dollars have been made out of trademarks, labels and copyrights. He who can fashion a trademark or design a label which will make a product stand out above all similar products, is indisputably a genius for whose brains the world offers almost unlimited money.

"Foreign Patents"

A good invention is bought not by one country but by the world. "Foreign Patents" shows you how the inventor may be paid by other countries and other peoples, as well as by this nation, for his ideas and his inventions. It explains how we, through our representatives in the capitals of the world, maintain for your benefit an endless chain of opportunities which, if you take advantage of them, will girdle the earth and make of your product an agent that may bring back to you rich rewards.

"Inventions Needed"

This book, 256 pages, lays before you a description of the active and profitable field of invention. It tells you the inventions the world needs today, the devices manufacturers are seeking for their business, the ideas for which the public will pay big money. It gives great men's ideas of the most important things needed in inventions now. Science is the key to wealth, and this key can be turned best by the inventor. This book tells you why.

"How to Get Your Patent and Your Money"

The man who invents needs the co-operation of the man who invests. This book, 132 pages, is a guide to the inventor. It describes, according to the teachings of our experience and the lessons of men made rich by patents, how the inventor may secure money, the right amount of money, for the device which his brain has constructed. If you have invented something and desire to learn what it will cost you to get your patent and what you must do to find your market, read this book.

"Special Bulletin of Patent Buyers"

This bulletin, 64 pages, contains copies of hundreds of letters from wealthy men who are seeking to purchase patents. Next to the idea of the invention itself, the most valuable thing to the inventor is a hint of where there is a man ready to buy the invention or to finance the inventor so that his device can be readily marketed. We act as intermediary, without one cent of charge, between the man who invents and the man who invests.

We Secure Reliable Patents, Trade Marks,
Copyrights, On Most Liberal Terms
Ever Offered

Send Model or Sketch and Description of
your invention for Free Search of
the United States Patents

Rejected and Difficult Cases are Our Specialty

RANDOLPH & CO.
600 F St., N. W., Washington, D.C.

RANDOLPH & CO.,
WASHINGTON, D. C.

Gentlemen: Please send me, without obligation on my part, the books indicated on margin of this coupon. (Write on margin of coupon, names of books desired.)

NAME.....

STREET.....

CITY.....

STATE.....



PATENT YOUR IDEAS

There is a Constant Demand for Good Inventions

THOUSANDS of the biggest money-making inventions have been the "little" things that have made people wonder why they were never thought of before.

"What to Invent" and "How to Obtain a Patent"

These Books Sent FREE

If you have an invention send us a sketch, photograph or model of it. We will give you a report as to its patentability absolutely free. Send for our book "What to Invent"—containing hundreds of valuable suggestions. We are recognized authorities on patent matters and have helped hundreds to find a market for their ideas. We can prove it. If you wish to sell your patent we will advertise it in manufacturers' journals at our expense.

Don't Wait—Find Out NOW! Your idea will never do you any good if some one else patents it ahead of you. Act quick! You reap the profit. Let the others wish they had.

Advice FREE—All Matters Confidential

Send rough drawing or model of your invention for our opinion as to its patentability. We will guard it carefully and report quickly. You are under no obligations to proceed further. Our free books are the best publications written for the man who has an idea to patent, or who is of an inventive turn of mind. They show just how to proceed with your idea and tell of hundreds of things to invent.

If you have an invention send us a sketch of it for report and ask for the books at the same time.

CHANDLEE & CHANDLEE, REGISTERED ATTORNEYS 969 F Street, Washington, D. C.
(Combined with H. Ellis Chandler & Co.)

PATENTS THAT PAY. 2 BOOKS **FREE** **100,000** MADE BY OUR CLIENTS
Protect Your Idea
Send data (model) for Search
E. E. Vrooman & Co., 871 F St., Wash., D. C.

INVENTORS!—"Let Us Be Your Factory"



We manufacture Special Machinery, Patented Metal Specialties of all kinds, Electric Articles, Hardware, Contract Manufacturing, Development, Sample Work. You get the advantage of our splendid equipment, up-to-date methods and wide experience. **We Do It All.** Tools, Dies, Stampings, Lathe, Screw Machine Work, Milling Machine Work, Metal Spinnings, Metal Drawings, Castings, Plating of all kinds, Enameling, Japanning, Tinning, Galvanizing, Wood and Metal Patterns, Drafting, Designing, Blue-print Work. Send sample for expert advice. **Our 25c book free,** containing tables and valuable information. **Write for it today.** Address **THE EAGLE MFG. CO., 1603 Blue Rock St., CINCINNATI, O.**

AGENTS \$6 A DAY

Should be easily made selling our Concentrated Non-Alcoholic Food Flavors, Soaps, Perfumes and Toilet Preparations. Over 100 kinds, put up in collapsible tubes. Ten times the strength of bottle extracts. Every home in city or country is a possible customer. Entirely new. Quick sellers. Good repeaters. Not sold in stores. No competition. 100 per cent profit to agents. Little or no capital required. Elegant sample case for workers. Start now while it's new. Write today—a post card will do—for full particulars **FREE**



AMERICAN PRODUCTS CO., 3952 Third St., CINCINNATI, O.

With the active entrance of Italy into the conflict, more than six-sevenths of the population of Europe and over four-fifths of its territory are directly involved in the great war.

PATENTS Secured Through Credit System.
Free search. Send sketch. Booklet and "How To Sell Your Patent" FREE.
WATERS & CO., 4102 Warder Bldg., Wash., D. C.

Send for **FREE BOOK** { **WHAT TO INVENT**
WHAT NOT TO INVENT
HOW TO SELL YOUR PATENT
Copies of nearest Patents and report in every case without charge
H. L. WOODWARD, 9th and G Sts., WASHINGTON, D. C.



MECHANICAL SUPPLIES AND MATERIAL of all kinds.
EXPERIMENTAL AND LIGHT MACHINE WORK to order.
132 MILK STREET, BOSTON



BRASS GEARS

Cut by an entirely new process. The most accurate made and at prices that cannot be equalled by others. Every gear has a hub, center painted ebony black, edges turned true, highest grade red brass, and much heavier than others. We carry the largest stock in the world and every gear listed is always shipped on date of order.

SEND FOR CATALOGUE
CHICAGO STOCK GEAR WORKS
16 S. FIFTH AV. Chicago

Active Powers of Inventive Genius



INVENTORS Our Brain Belongs to You. Our Ideas Are Free of Charge.

All we want in return is to build your model, special machinery, dies, tools and jigs to manufacture sheet metal goods, etc. We are expert mechanics, over thirty years' experience and have one of the best equipped shops in the country. Ask for Booklet No. 17. Consultation free. Experimental work strictly confidential.

A. Naecke & Son, J. Urman, L. Heldrich, Prop's
236-242 S. 9th St., Philadelphia, Pa.

Some Boy

In Your Town

—some boy is going to prove himself the best marksman. Will you be that boy? Fifty valuable prizes will be awarded to the fifty winners of the Grand National King Marksmanship Contest which will be held November 8 to 13 (inclusive). Every boy 16 years of age or under can take part—and it costs nothing to participate. Your dealer can tell you all about the Contest and supply you with a free target. If he shouldn't be able to, just send us a postal with his name and address and we will forward targets and information to him. Write for our illustrated booklet A.

THE MARKHAM AIR RIFLE CO.
Plymouth, Mich.

Pacific Coast Office
Phil B. Bekeart, 717 Market St., San Francisco, Cal.
Southern Representatives
Sand & Hulfish, 11 Hansa Haus, Baltimore, Md.



(12)

On a precision scale in the U. S. Bureau of Standards, anything from a fly's wing to a 50-lb. piece of steel can be weighed with perfect accuracy.

WHITE FLAME

BURNERS make your old kerosene lamps and lanterns give a brilliant white light better than electricity or gas. Doubles your light. Saves oil. **NO MANTLE TO BREAK.** Guaranteed Safe and Reliable. Delights every user. Send now for complete sample postpaid 25¢, stamps or coin. 3 for \$1. **MONEY BACK IF NOT SATISFACTORY.** Live Representatives Wanted. Exclusive Territory.

WHITE FLAME LIGHT CO., 68 Clark Bldg., Grand Rapids, Mich.



Every Man
Wants One
**Slide-Stroke
Stropper**

puts perfect edge on any razor, old style or safety. Blade moves up and down—strop moves back and forth, producing true diagonal stroke from heel to toe. Sure, quick, steady seller. Write for particulars and territory now. **SAMUEL KANNER, 556 Broadway, NEW YORK CITY**

KEROSENE Gas Lamps

**BRIGHT AS THE SUN
Simple as a Candle**

A Flood of Shadowless Light

For all kinds of lighting.
300 to 1000 Candle Power
from Common Coal Oil.



BRILLIANT GAS LAMP COMPANY 1009S, S. Wabash Ave., Chicago, Ill.



NEW 1915 EDITION AUTOMOBILE ENGINEERING

No matter what type of motor vehicle you are interested in. No matter what standard make of auto, motor car, motorcycle or motor boat you want to know about.

Here is your opportunity to get a brand new library covering every motor subject. Here is your chance to secure the latest, most practical, most authoritative set of books ever written on automobile and motor engineering at an extremely low, inside price.

If you want help in solving the knotty points you bump up against every day, this set of books is just what you are looking for. If you want to become a Gas Engine expert, this great 5 volume cyclopedia, written by the biggest men in the business, is the standard text book for you.

\$25.00 Set Now \$14.80—\$2.00 a Month

This auto library contains 2,000 pages, with 1,900 illustrations that make technical points as simple as A-B-C; full page plates that literally pick the mechanism to pieces before your very eyes; drawings and diagrams that show the working of all the principles employed in the various types of motors. Bound in half red morocco, gold stamped. These five volumes are a most remarkable value at the regular price. Yet we offer a limited number of sets at a special introductory price of \$14.80—payable \$2 a month.

SHIPPED FREE Test these books before you buy. You don't buy a motor until you have tried it out. Buy books the same way. We send the full 5 volumes to you, express prepaid, for 7 days' free examination. Use them a whole week free. See if they don't help you work out the problems that come up in your garage or repair shop. If the books are what you want, send us \$2. Otherwise we'll take them back, paying the express both ways ourselves.

Subjects Covered

Explosion Motors—Gasoline Car Features—Ignition Systems—Lighting Systems—Electric Starters—Types of Automobiles—Electric Pleasure Cars—Storage Cells—Electric Motors—Care and Operation of Electrics—Automobile Driving—Road Troubles—Private Garages—Repairs—Electric Delivery Wagons—Electric Trucks—Gasoline Delivery Wagons—Trucks—Taxicabs—Tractors—Trailers—Road Trains—Traction Engines—Maintenance and Costs—Steam Cars—Motorcycles—Cyclecars—Light Cars—Motor Boats—Glossary.

FREE !! \$12.00 Consulting Membership

We give you absolutely free our \$12 consulting membership. This privilege puts our whole staff of experts at your service for a whole year without cost to you. Ask them any motor question you want. They will give you practical help. The solution of a single problem might easily be worth more than what you pay for the books—you get this service free.

The moment you see the books you will realize that you need them. There is no limit to the good they can do you every day. It costs you nothing to look them over, to use them for a whole week. You run no risk, you incur no obligation. The books come back at our expense if you say so.

Send in the coupon now—today.

**AMERICAN
TECHNICAL
SOCIETY**
Chicago, U. S. A.

FREE COUPON

Worth \$10.20 to You

American Technical Society
Chicago, U. S. A.

Please send me Cyclopedia of Automobile Engineering for 7 days' free examination. If I decide to buy, will send \$2 in 7 days and balance \$2 a month until \$14.80 has been paid, when \$25 books and \$12 consulting membership will be mine free. Otherwise will notify you and hold books subject to your order. Title not to pass until fully paid. Pop. Mech. 10-15

NAME

ADDRESS

As I have had no previous dealings with you, I refer you to

Please Mention Popular Mechanics



300 Candle Power of Light AT A COST OF 1/8c PER HOUR

The Kerosene table lamp has one inverted mantle and **MAKES and BURNS ITS OWN GAS FROM COMMON KEROSENE or COAL OIL.** It gives a bright and steady white light **TEN TIMES** as **BRILLIANT** as an ordinary kerosene wick lamp

THE "QUICKLIT" Gasoline table lamp can be **LIT WITH AN ORDINARY MATCH, LIKE CITY GAS.**
Both styles equipped with automatic cleaning needle.

No smoke, no smell, no wicks to trim. A splendid proposition for dealers

LIVE AGENTS WANTED Write today for further particulars, also complete illustrated catalog describing the above kerosene and gasoline lamps and hollow wire systems.

THE NAGEL-CHASE MFG. CO., 152-160 East Erie St., CHICAGO, ILL., U.S.A.
The largest manufacturers of artificial lighting devices in the world.



DO YOU HAVE KNIVES TO GRIND, SILVER TO POLISH, SMALL TOOLS TO OPERATE, WASHING MACHINES OR WRINGERS TO RUN? LET THE RED DEVIL

DO YOUR WORK

Attached to any water faucet will develop up to 3 Horse Power according to size of pipe and water pressure. Only perfect small motor made. Improved bucket wheel construction.

6 in. Motor for Mechanics and Tradesmen. Washing Machine, 1/2 H. P., on 1/2 in. pipe, 80 lbs. water pressure; 1 H. P., on 3/4 in. pipe, 2 in. pipe. Net price \$5, cash with order.

No. 1492—4 in. Motor for grinding, polishing, fans, sewing machines; for Doctors, Dentists, Druggists, etc., with emery, buffing wheel, silver polish and pulley, \$3.

No. 1493—4 in. Motor and pulley only \$2.50, cash with order.

Money back for any reason. Order your motor from dealer or from us. Send your water pressure and size of supply pipe. Active Agents wanted. Catalog free.

Only Motor to do this work



DIVINE WATER MOTOR CO. DEPT P. UTICA, N.Y.



South Bend Lathes

For the Machine and Repair Shop

11 inch Lathe Complete,	\$100.00
12 inch Lathe Complete,	125.00
13 inch Lathe Complete,	165.00
14 inch Lathe Complete,	200.00
16 inch Lathe Complete,	250.00
18 inch Lathe Complete,	300.00

How to Run a Lathe

A 50 cent book for 10 cents. Postpaid, stamps accepted

Straight or Gap Beds. Send for free catalog giving prices on entire line. SOUTH BEND MACHINE TOOL CO. 423 Madison St., South Bend, Ind.

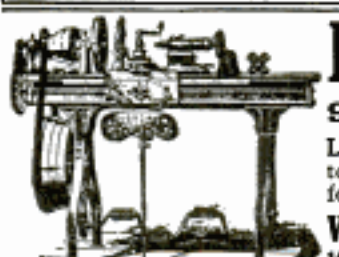

LATHES

9 to 18-inch Swing

List price \$75 and up according to size. When ready to buy send for Lathe Catalog and prices.

W. F. & John Barnes Co. 100 Ruby Street, ROCKFORD, ILL.



A complete line of appliances for the transmission of Power. Anything from a bolt to a complete mill or factory outfit. Send for catalogue. Largest Manufacturers of Pulleys in the country. 1400 W. North Ave. CHICAGO

W. A. Jones Foundry & Machine Co. CHICAGO

MAKING PORCELAIN CRUCIBLES IN THE UNITED STATES—Up to the present time, practically all the porcelain crucibles and dishes used in chemical laboratories throughout the country have been imported from Germany. Two years ago the Clay Products Section of the Bureau of Standards undertook to ascertain whether or not American materials were suitable for the manufacture of this porcelain. The investigation developed that clays existed in this country from which



CRESCENT WOOD WORKING MACHINERY

always pleases particular users. Send for catalog today. Band Saws, Jointers, Saw Tables, Planers, Planers and Matchers, Hollow Chisel Mortiser, Variety Wood Worker, Universal Wood Worker, Swing Cut Off Saw, Shaper, Bench Jointers.

The Crescent Machine Co., 93 Columbia St., Leontonia, Ohio



MOTOR DRIVEN BENCH SAW

Saws Wood and Soft Metals
Indispensable and most economical. For shop or private use. Full description and circular on request.

H. G. CRANE Cypress St., Brookline, Mass.

Pay as You Wish

We'll send you a genuine Lachnite for you to wear for 10 full days. If you can tell it from a real diamond send it back at our expense. Costs but 1.50th as much. If you decide to keep it pay only a few cents a month. Write for catalog.

Genuine Lachnite Gems keep their dazzling fire forever. Set in solid gold, cut by world renowned diamond cutters. Will stand fire and acid tests. All kinds of jewelry at extraordinary low prices. Easy payments. **WRITE TODAY.** H. Lachman Co., 12N. Michigan Av., Chicago Dept. 1197



Water Pumps Water

with a Rife Ram. Plenty of it for every purpose about your farm and country home—day and night, winter and summer, without fuel, labor, freezing or repairs. The

RIFE RAM

is operated by any small stream having a fall of three feet or more and a supply of three or more gallons per minute. Fills high elevated tanks or operates air pressure system. Easy to install. First cost the only cost. Always on the job; over 11,000 in daily use. Tell us your water supply conditions. Ask for free estimate and catalog. Now is the time to install. Write today.

RIFE ENGINE CO., 3131 Trinity Building, NEW YORK

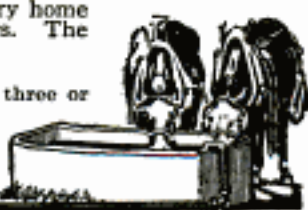



75c

will bring you postpaid to any part of the United States this ratchet tap holder and our new pocket catalog

Goodell-Pratt 1500 Good Tools

This tool is for rapidly tapping or reaming small holes, or for any other work of this character. The ratchet which is either right or left hand is operated by turning the knurled shell nearest to the handle. The chuck has a capacity up to $\frac{1}{4}$ inch. Every mechanic has lots of use for one of these. Get yours now.

Goodell-Pratt Company
Toolsmiths
GREENFIELD, MASS., U. S. A.



Portable Cases

FOR TOOL MAKERS
AND MACHINISTS

Twelve styles, felt lined drawers, solid brass trimmings, best of material, beautiful finish, low prices, satisfaction guaranteed. Ask for booklet of cases built for service.

The Pilliod Lumber Co.
SWANTON, OHIO

BILLINGS & SPENCER

TOOLS

Special Kits
for
Ford Cars
HARTFORD, CT.

Wrenches
Pliers
Sc. Drivers
Hammers
Ratchets
Wrench Kits
Tool Kits

The Acetylene Blow Torch Prest-O-Torch

Costs less to buy than a
good gasoline blow torch
and costs less to use.

In all soldering and brazing, the Prest-O-Torch avoids the delays and uncertainties of gasoline outfits. Provides a concentrated, intense flame that doesn't blow out even in a high wind. Needs no attention whatever. Used with handy sizes of Prest-O-Lite cylinders—ready-made gas, instantly available.

Style "A" sells for 75c. Used with the small MC size Prest-O-Lite. Will braze up to $\frac{3}{8}$ inch round rod. This outfit can be fitted with handle and hook for added convenience in bench and overhead work. Style "C" Prest-O-Torch is recommended for large work. Will braze up to $\frac{1}{2}$ inch round rod. Sells for \$2.25. For use with the larger sizes of Prest-O-Lites.

Write for special literature and learn where you can see the Prest-O-Torch in operation.

The Prest-O-Lite Co., Inc. 816 Speedway, Indianapolis, Ind.
Exclusive Agents Everywhere

Learn Electricity! Learn Plumbing! Learn Bricklaying!

Unlimited possibilities for gaining wealth and future independence in all of these trades. They pay \$5 to \$8 a day right from the start and any one of them offers exceptional opportunities for starting a business of your own on very small capital. The same is true of

Mechanical Drawing and Moving Picture Operating

Two new, big-paying occupations that are now demanding more and more trained men everywhere. You can earn

\$100 to \$250 a Month

We give you thorough, practical training—no needless theory—you learn with actual tools in your own hands under expert instruction instead of from books. No experience and no special education required. Just a willingness to learn and we'll make you an expert in a surprisingly short time. You can enter at any time. The ages of our students are from 15 to 50 years.

MEN WANTED

right now for all of these trades. That's why we are now making special inducements in the way of a very small tuition on easy payments if you like, agree to assist you in earning your way through school and also help to place you in a good paying position when you graduate. At this biggest and most successful of all trade schools everything has been arranged for the benefit and convenience of our students. Day or night classes as you prefer, and we even furnish

Tools Free as well as all other necessary equipment for your work
Mail Coupon NOW!

Don't put it off. This is a matter of vital importance to you. Get full particulars of the wonderful opportunities this remarkable school affords. No obligation—everything free. Mail coupon today while our Special Offer is still open.

Coyne Nat'l
Trade
Schools



WE OCCUPY ENTIRE BUILDING
Tear off, fill out and mail

B. W. Cooke, Director, Coyne National Trade Schools
39-51 E. Illinois St., Dept. 1197, Chicago, Ill.

Gentlemen: Without any obligations on me whatsoever, please send me your school catalog and full particulars of this offer to men—All Free.

NAME

ADDRESS



Hundreds of
COYNE
GRADUATES
are holding
big positions,
many have their
own business—
they are always
in demand.
Mail coupon
today and
learn how easy
it is to
become a
"Coyne
Success"



One of the Largest Squares Ever Made—

Blade 72" long, beam 30" long, weight about 90 lbs. It was the work of experts to make the blade perfectly true and set it squarely in the beam. Such big tools are constructed occasionally, on order, for large manufacturers or government works. It is the careful work which we constantly put on our regular line of squares and other tools that has cultivated the skill and built the reputation for handling these difficult jobs. That is also the reason that

From Largest to Smallest All Brown & Sharpe Tools Can Be Relied On

And there is great variety to select from; for instance, in the line of squares there are 7 styles, and over 30 sizes. Among so many different tools in our regular line, there are several that you probably need now, if you are a machinist, tool-maker, draftsman, or metal worker. Better look over the tools now; you will find them in the leading hardware stores.

The B. & S. line includes Rules, Micrometers, Scales, Squares, Verniers, Protractors, Gauges, Indicators, Calipers and Dividers, and many other tools. Step in and ask the hardware dealer for free catalog No. 26 or write us for copy.



BROWN & SHARPE MFG. CO.
PROVIDENCE, R. I.

Rent This Level 9 Months — Then It's Yours BUILDERS and CONTRACTORS

High price and cash payments are eliminated. For the first time it is possible to obtain a high grade Level on terms so easy that you can not afford to be without one.

Convertible Level

Besides its use as a Level, it can also be used for running straight lines, getting angles, taking vertical sights, etc., for which ordinarily a Transit is required.



For more than fifty years Aloc's surveying instruments have been recognized as standard instruments. This Level is offered to you with an absolute guarantee that is backed by a ten day free trial offer.

FULL PARTICULARS and details of our extraordinary selling plan will be sent on request.

A. S. Aloe Co., 515 Olive St., St. Louis, Mo.



KEEN KUTTER Tools and Cutlery

Made by
Men Who
Know, for
Men Who
Know

such wares could be made, but owing to impurities in the clay the ware was defective in color. Recently, the Clay Products Section has developed a method of purifying the clay, which makes possible the manufacture of ware of good color, a detail important not only in this particular ware but in all white wares. While the process is yet

The Wrench of a Thousand Sizes



Universal Adjustable Wrench—a dozen wrenches in one. Instantly adjusted to grip objects of all sizes and shapes. Indispensable for the MECHANIC, CHAUFFEUR and for HOUSEHOLD purposes. From your dealer, or direct from us, \$1.00 postpaid. LIVE AGENTS Wanted

THE COLYTT LABORATORIES, 567 West Washington, CHICAGO, ILL.

LUTHER HUMMER TOOL GRINDER Sharpens All Tools Quickly

Get free booklet about this light-running, swift-sharpening, foot-power grinder. Won't draw temper. No water needed. Steel shaft drive, dust-proof parts, perfect lubrication, "handiest ever" tool rest. Write for particulars.

LUTHER GRINDER MFG. CO.
800 Point St. MILWAUKEE, WIS.



"Red Devil"
Plier
No. 50
6 in.

A High Grade Mechanics' Tool

The Standard Electricians'
Plier the World Over

Known and used wherever good tools are known for all kinds of practical and experimental electrical work. Handles scientifically shaped and grip like a vise. Tested cutting edges. Polished head, gun-metal finished handles.

Sample "RED DEVIL" No. 50—6 in. postpaid for 75c.
Booklet of Mechanics' Tools on request.

SMITH & HEMENWAY CO., Inc.
161 Chambers St., NEW YORK CITY



Tool Cases for Toolmakers and Machinists

Keep your tools orderly arranged in a Gerstner Portable Tool Case. There's a place for every tool in one of the felt lined drawers. Every up-to-date mechanic needs one and you'll find our Cases the best built, neatest and most practical on the market. We guarantee to please or refund all money. Write for our free booklet

Gerstner & Sons

Mfrs. of Mechanic's High Grade Tool Cases
808 Columbia St., DAYTON, OHIO



WILSON'S One Hand Speed WRENCH

Just Out

Quick and Self-Adjusting. No slack or lost motion. Will not strip or slip.

A Necessity Around Complicated Machinery and in Hard-to-get-at Places. Indispensable in the factory, shop, garage and home. Wouldn't sell mine for five dollars if I could not get another," says Mack.

Endorsed by Machinists, Engineers, Plumbers, Chauffeurs

Drop forged from strong, selected steel. All parts thoroughly tempered. Worth the money even without new patented speed feature. Price only \$1.00. Money back if not entirely satisfied. Order today. Descriptive circular free.

THE TOLEDO SPEED WRENCH CO.

Dept. 12, Toledo, Ohio

AGENTS The first man in your locality will "clean up." Hurry! Make \$30 to \$50 weekly. Sell at sight. It's a sure winner. Don't fail to get our proposition. Write today.

Just Press the Hump and SLIDE THE JAW

Newest tool out. Handy, useful, convenient. Quickly and easily adjusted (with one hand) to any size opening by thumb-pressure at jaw-base. Can be used also in regular manner. Holds tightly and firmly. Guaranteed. Don't be without one.

Handiest Tool in Its Class

somewhat in the experimental stage, it is probable that in a short time all varieties of such ware will be made in this country.

TIME IS MONEY

GASOLINE SOLDERING IRON BLOW-TORCH

Address Dept. 1, Emmelmann Bros. Mfg. Co., Indianapolis, Ind., U.S.A.

Duplicate Keys for all Pin Tumbler Locks can be made in a minute with **The Harrison M. I. P. Key Filing Machine**

Indispensable for Machinists, Building Superintendents, Hardware and Repair Shops, Locksmiths, Carpenters, Electricians, Garages, etc. Anyone can make a perfect duplicate key without injuring the original. Every machine unconditionally guaranteed. Money refunded if not entirely satisfactory. Price \$2.00 net. Send us P. O. order or N. Y. draft and receive the complete machine by return Parcel Post. Special diamond shaped files for angular keys 35c each or 4 for \$1.00. Send for circular.

HARRISON & COMPANY, 81 NEW ST., NEW YORK

MENDS EVERYTHING

New Metal Solder, in paste form, stops all leaks. Ready for instant use.

SOLDERALL

Latest necessity for use in home and shop. Indispensable for automobilists. Excellent for wiring. Price 25c. Blow torch, 75c. Sold separately or complete outfit sent postpaid for a dollar. Dealers write for prices. **SOLDERALL CO., 143(C) Liberty St., N.Y.**

THE AWL YOU WANT

See That Reel **The Awl For All**

Is the genuine MYERS \$1.00 "Lock Stitch" Sewing Awl with the exclusive feature. See thread reel in front of handle under the finger tips. Natural tension. Sews heavy or light material, diamond point, full grooved needles used to protect the thread when sewing. **C. A. MYERS COMPANY, 6339 University Ave., Chicago, Illinois**

Stanley Tools



Stanley Combination Hafts Nos. 305

Very handy little tools, as they are well made, strong, and fit easily in the pocket. The illustration shows same about two-fifths actual size.

With each Haft, 12 tools are furnished as follows: 1 each Chisel, Reamer, Scratch Awl, Screw Driver, Tack Puller, Belt Awl, and 6 Brad Awls assorted. All are hardened and tempered and the tips are polished. They are approximately 1 1/2 inches long.

Price .60 Each Sent Postage Prepaid Upon Receipt of Price

STANLEY RULE & LEVEL CO.
NEW BRITAIN, CONN. U.S.A.

Use the Coupon



OSTER MATCHLESS RATCHET DIE-STOCK

"Pipe-threading with the hard work left out" — that's the Matchless. The narrow receding dies let only a few teeth cut at a time, making the "pull" easy. The Matchless swings in a 14-inch circle, and threads pipe 5 inches from wall. Two sizes, 1" to 2" and 2 1/2" to 4".

Ask for Catalog

The Oster Mfg. Co.,
2100 East 61st St.,
Cleveland,
Ohio

Please send catalog to

Name.....

Occupation.....

Address.....

City..... State..... (2100-10)

"Yankee" Bench Drill with Automatic Friction-and-Ratchet Feed

This LEVER controls the Feed. In horizontal position, the Ratchet-feed operates continuously and uniformly, until thrown off by contact of lever with knock-off, at extreme down or up position. Friction-feed moves the drill quickly to or from the work.

Speed Shifter. On No. 1005. This pin moved to proper notch, controls speed fast or slow, or locks drill for removing or inserting of drilling tools in chuck. Change for slow or fast can be made with drill in work.

Three-Jaw Chuck. Tool-steel, hardened. Holds round shank drills absolutely centered.

This nut holds table bracket in position. Table is adjustable to different heights.

Knock-off throws the lever, when set for Ratchet Feed.

Lower Knock-off for throwing lever on downward movement. Prevents jamming.

Slow Speed. These inside gears drive the spindle to one revolution of crank.

Fast Speed. These outer gears drive 3 1/2 revolutions of spindle to one revolution of crank.

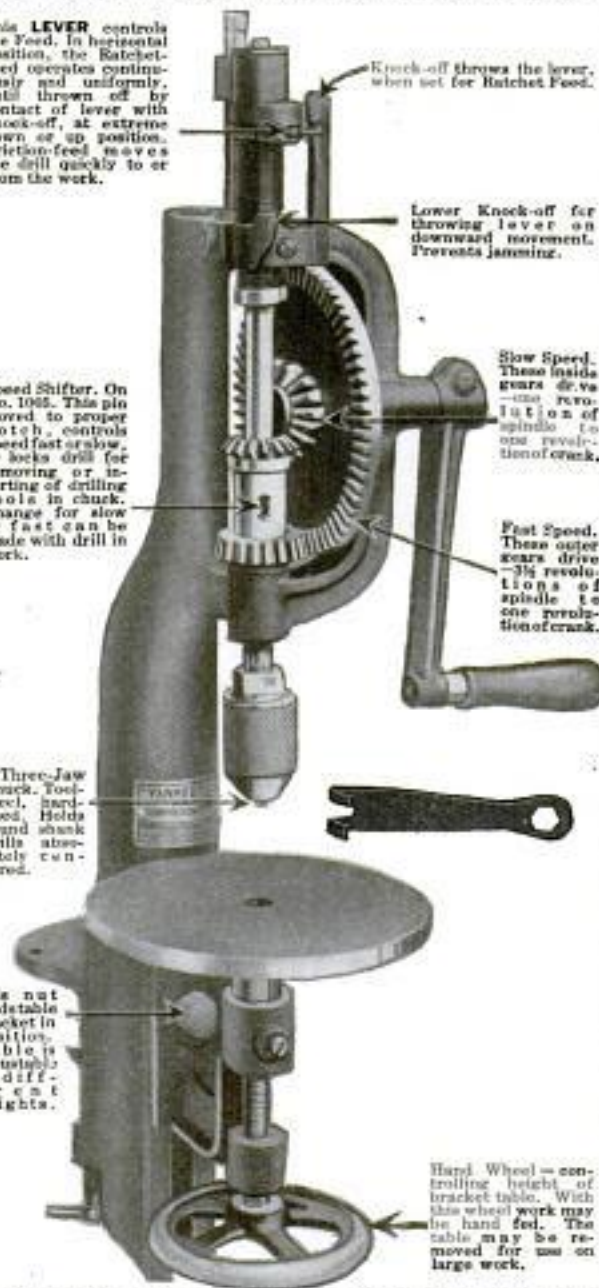

Hand Wheel - controlling height of bracket table. With this wheel work may be hand fed. The table may be removed for use on large work.

Saves drills, gives more speed, has larger capacity than any other bench drill. Absolutely accident proof, can't jam or strip the threads, or break the gear teeth. Automatic, uniform feed for large and small drills.

No. 1005 - Height 28" - Holds drills up to 3/4" diam. Two speeds.
No. 1003 - Height 18 1/4" - Holds drills up to 1/4" diam. One speed.



"Yankee" Vise No. 990

To hold small work on "Yankee" Bench Drill Table. Swivel, steel jaw for taper work 2 1/2 in. open; without swivel jaw 3 in. Can be attached to work bench.

YOUR DEALER CAN SUPPLY YOU—

"Yankee" Tool Book for mechanics and handymen and "Yankee" Tools in the Garage for motorists. FREE.

North Bros. Mfg. Co., Philadelphia

"YANKEE" TOOLS

Make Better Mechanics

Don't Scrape—Shave!

Put 3-in-One on the strop before sharpening your razor! Also draw razor edge between thumb and finger, moistened with

3-in-One oil

This will keep razor so keen that you'll never gouge your face or fail of a smooth shave. Don't scoff.

Try it.

3-in-One is sold in drug, hardware, sporting goods and general stores.

A 1 oz. bottle, 10c; 3 oz. 25c; 8 oz. (3/4 pt.), 50c. Also in Handy Oil Cans, 3 1/2 oz. 25c. If your dealer hasn't Handy Oil Cans, we will send one full of 3-in-One for 30c.

FREE—A generous sample of 3-in-One and the 3-in-One Dictionary.

THREE-IN-ONE OIL CO.

42 CNR. Broadway
New York



The biggest monolithic shaft of polished stone in America is the battle monument at West Point. It is 41 1/2 ft. high. The famous granite columns of the Cathedral of St. John the Divine are each composed of two parts, and while the marble columns for the Lincoln Memorial in Washington are to be the largest of their kind in the world, having a height of 46 ft. and weighing 35 tons each, they are made up of 12 blocks.

SEARIGHT Compound Lever Mechanics' Snips

cut 16 gauge metal at the point with one hand. The cutting power of these snips is three times that of the common straight snip. They are Drop Forged from Crucible Tool Steel.



Size: 7, 8, 10, 12 & 14 in. long
Prices: \$1.00, \$1.50, \$2.25
\$3.00, \$3.50 Forged

BARTLETT MANUFACTURING CO.
22 East Lafayette Ave., DETROIT, MICH.

MILLERS FALLS TOOLS

Braces
Drills

Hack Saws
Mitre Boxes

Do Better Work and Last Longer

Write for catalog showing complete line

MILLERS FALLS CO., Millers Falls, Mass.



TOOL CASES

For Up-to-Date TOOLMAKERS and MACHINISTS

We carry the finest and most complete line of mechanics' toolcases and tools in the country. We guarantee to please you or refund money. Write for free catalogue.

J. M. WATERSTON

177 Jefferson Ave., E. Detroit, Mich.

57 Prizes for Boys In Si-monds' 1000 Things Made of Wood Contest

First prize, \$30 cabinet of carpenters' tools; second prize, a handy kit of saws; third prize, a 24" hand saw; fourth prize, a coping saw; and 150 honorable mentions; for the boys who either at home or in school can make during the next two months with carpenters' tools of any make the most useful or ingenious thing.

The principal material must be wood. String, cloth, metal, etc., may be used only in the smaller details such as handles, hinges and other trimmings. Objects in any of the following classes will be entitled to compete: porch furniture, kitchen furnishings, library furnishings, bedroom furnishings, business office furnishings, real boats and canoes, camp equipment, other useful objects, things useful in outdoor games, things for the wild birds, things for indoor pets, things for domestic animals, things for poultry, things useful in the garden, things useful in winter, doll furniture, playthings for little children, toy boats, toys with wheels, hobby horses, things useful in entertainments, gymnasium equipment, chemical and physical apparatus, electrical devices.

We offer the three series of prizes in order to interest boys in learning how to use tools, as well as to increase an interest in manual training all over the country. We believe that the salvation of the country depends to a large degree upon the ability of its citizens not only to work with their brains, but to work with their hands, and the purpose of this contest is to stimulate an interest in the proper use of tools, to reward those who show originality in making useful things, and to further the growth and development of the manual training school.

In order that the contest may be open to all there are three divisions. One for boys who attend manual training, industrial, technical, or trade schools of high school grade or higher; another for boys who are in the elementary grades under special teaching or supervision; and a third set of prizes for boys not in school, but working at home or elsewhere without the aid of a teacher.

All who desire to compete should send to the Simonds Manufacturing Company for free specification labels which must accompany all work submitted. Only photographs, perspective sketches or complete sets of working drawings should be sent. Address Dept. No. 11.

Simonds Manufacturing Co.
"THE SAW MAKERS"
5 Factories Fitchburg, Mass. 11 Branches

SEWS THIS DOLLAR AWL FOR ANYTHING
Makes a perfect lockstitch



1916 MODEL Engraving cut to show position of thread in handle

49c Add 6c for postage AGENTS WANTED

This Automatic Awl is superior to all others. It is of immense value for repairing all kinds of leather, harness, bags, belts, shoes, etc. **THREADED DIRECT FROM THE REEL.** So simple a child can use it. Regular price \$1. For a limited time only we will mail it anywhere, with waxed Thread, two Diamond Point Needles (curved and straight), and directions, for **Only 49c** (postpaid 56c). Extra Needles 6c, Thread 10c. **JOHNSON SMITH & CO., Dept. 10, 78 S. Dearborn St., CHICAGO**

ELLS ENGINE 30 Days' Free Trial and 10-year guaranty on the



new 1916 models—the simplest, strongest and most economical engines ever built. More power from coal oil than some engines get out of gasoline. "The engine ahead." 1 1/2 to 18 H.P. Interesting booklet, "Engine Facts" FREE. Expert advice on how to get the most out of your engine FREE. Write Davis—our engine man—he's a practical farmer as well as a mechanic.

Ells Engine Company, 2832 E. Grand Blvd., Detroit, Mich.

WHY WELD

When you can do better work in one-fourth the time — at one-fourth the price — by using the latest great discovery

So-Luminum
The Aluminum Solder

No welding. No oxidation. No flux necessary. Runs at extremely low temperature. Easily applied with gasoline torch, twice as strong and much harder than aluminum — never

breaks at soldered point. **Convince Yourself by Trying It.** Tested, used by Internat'l Motor, Locomobile, Packard, Stanley, Pierce Arrow, Brewster, Demarest, Studebaker, Simplex, — Aeroplane Mfgs., and U.S. Navy. **Write for booklet 1.**

\$3.50 per lb. Sample stick (1/2 pound) \$1.50 net cash.

SO-LUMINUM MFG. AND ENGINEERING CO., Inc.
Sole Manufacturers and distributors

United States Rubber Co. Bldg., 1790 Broadway, New York

SPECIAL

ONLY \$12.75



Standard of the World. Endorsed by Government and Railway Officials. Harris-Goar's enlarged easy credit plan enables you to own one of these superb Elgin Watches now.

17-Jewel Elgin!

Now, during this Special Sale, is the time to buy this elegant 17-Jewel Elgin. Thoroughly factory tested, fitted in a beautiful Gold Strata case, factory stamped and guaranteed 25 years, hand engraved, plain polished or with your own monogram, and our startling offer is to send you this celebrated 1916 Model free of charge for your inspection and approval.

No Money Down

Because we want to prove to you that the great volume of our business actually enables us to do better by you than any other watch or diamond house in the world and that on this particular watch, we save you nearly half, for it sells regularly at \$20 to \$22, while our

Special Price is only \$12.75

We don't want you to send one cent. Not a penny. Merely give us your full name and address that we may send you this superb 17-Jewel Elgin on approval, and if after you receive it and want to keep it, then we ask you to pay us the small sum of

Only \$2 a Month But, if after you have worn it 30 days free and don't want to keep it, send it back at our expense. You assume no risk whatever. You do not buy or pay one cent until we have placed the watch right in your own hands for your own decision. We want no security, no interest, no red tape — just common honesty among men.

3 Fine Books FREE!

Mr. HARRIS wants to send you his three latest BOOKS FREE — one the story of "THE DIAMOND," its discovery, where and how mined, cut and marketed, the other "FACTS VS BUNCS" or all about the watch business, both at home and abroad; also our Big Free Illustrated WATCH AND DIAMOND BOOK. Write today — Do it now!

HARRIS-GOAR CO. Department 1751
Kansas City, Mo.

The House that Sells More Elgin Watches than Any Other Firm in the World.

Please Mention Popular Mechanics

PETE SAYS:
 "There's as Much Difference
 in Sharpening Stones as there
 is in Tools"



THERE are
 some tools
 that fall down
 on the job,



there are others that give service—it's the same with sharpening stones, there are some that merely rub the edge on the tool, that fill and won't hold their shape and then there are

Carborundum Sharpening Stones

Clean and quick-cutting, positively uniform and they won't glaze if properly used. They hold their shape, show long life, always ready for work. ¶ There is nothing harder, sharper or faster-cutting than Carborundum.

*Your hardware dealer can supply you
 or order direct*

THE CARBORUNDUM COMPANY
 NIAGARA FALLS, N. Y.



AETNA-IZE Protect yourself and your family in case of sickness or accident. \$50 a week, and as high as \$10,000 for death. Write for particulars.

AETNA LIFE INSURANCE COMPANY
 Drawer 1341 Dept. PM. 10-15 Hartford, Conn.

FARM VIM MARINE ENGINES

Get a VIM Engine and save money. VIM Midget 1 1/2 H.P. Farm Motor shown below does all the chores—churning, washing, pumping, separating, spraying, etc. Women operate easily. No complicated parts. Weighs only 15 lbs. Water cooled, automatic lubrication. Comes ready to run. Guaranteed. Full line marine engines 5 to 27 H.P.; 1, 2 and 3 cyl.; Speed, pressure and heavy duty types. Gasoline or kerosene. Double ignition. Non-backfiring. Strong, simple, accessible—absolutely dependable. Built for a lifetime. The boat-builder's stand-by, the boat-owner's pride. When writing for catalogs, please mention whether interested in stationary or marine engines, or both. Ask for attractive agency offer. The Vim Motor Company, 619 Water St., Sandusky, Ohio



SELF-SHARPENER FOR SAFETY RAZORS

Insert safety blade (any but Durham Duplex), turn handle few times. Hones and sharpens one operation; keen cutting edge like new. Sent anywhere for \$3. Money-back guarantee. **AGENTS WANTED.** CIRCULAR P ON REQUEST.

IN. MFG. CO., 1 W. Broadway, New York

Auto Gasoline 3¢ a Gallon

Sounds wonderful, but it's a fact; and what is better, your motor car will have "pep," "snap," power and speed as never before. Carbon evil eliminated. All these good things and more come when **GASO-TONIC** is added to ordinary Gasoline. Mileage increased 40%. Scientifically right. Quart can treats 200 gallons of gasoline, \$2 prepaid. Results guaranteed. Motorists enthusiastic wherever **GASO-TONIC** is tried. Circular and convincing details free. Great opportunity for live dealers. **WHITE MFG. CO., Dept. 112, CINCINNATI, OHIO** and agents.

"When brush meets Brush, it's the Whiting-Adams Vulcan Rubber Cemented that wins"

All Brush Users Find WHITING-ADAMS

TRADE **VULCAN** MARK

RUBBER CEMENTED

BRUSHES

Perfect in Construction, Superior in Quality, Everlasting in wear. Always Suit—Never Fail

Send for illustrated literature telling about Whiting-Adams Brushes

Manufactured by

JOHN L. WHITING-J. J. ADAMS CO.

BOSTON, U. S. A.

Brush Manufacturers for Over One Hundred Years

Whiting-Adams Brushes Awarded Gold Medal, the highest award at Panama-Pacific Exposition, 1915



HERMAN'S US ARMY SHOES



Army Surgeons devoted years to perfecting this shoe. It allows natural freedom to the toes while setting snug at the heel and will not chafe, bind, pinch or blister the tenderest feet under severe tests of climate and service. Every U. S. Soldier, most militiamen and thousands of civilians wear the **Foot-Easing Munson Last** Efficiency-Building Every Sportsman ought to wear it. Ask your dealer or send to us for catalog and testimonials. The price is **\$4.50 a pair**, sent prepaid and **guaranteed satisfactory.**

JOS. M. HERMAN SHOE CO.
160 Lincoln St., Dept. 56, Boston, Mass.

Made-to-Measure

EXPRESS PREPAID \$2.75

Pants cut in the latest style. Made to your individual measure. Fit, workmanship and wear guaranteed.

No Extra Charge

for peg tops, no matter how extreme you order them.

Agents A good live hustler in every town to take orders for our **Wanted celebrated** made-to-measure clothes. Samples of all latest materials **FREE.**

We Pay Big Money

to our agents everywhere. Turn your spare time into cash by taking orders for our stylish clothes. Write today for beautiful **FREE** outfit.

THE PROGRESS TAILORING CO.
Dept. 107, CHICAGO, ILL.



The wealth of the United States has increased from about \$1,750,000,000 to about \$150,000,000,000, or almost 8,500 per cent in the last 100 years. In the same time the population increased about 1,125 per cent.



WOULD YOU

show this standard high grade fully visible typewriter to your friends and let them see wherein it **excels any other \$100 typewriter**, if by doing this and rendering other small assistance, you could easily earn one to keep as your own. Then by

post card or letter to us simply say "Mail Particulars."
Woodstock Typewriter Co., Box 015, Woodstock, Ill.

Drink Pure Water

Perfect health demands it. Disease lurks in impure water. Insure purity by installing a

Bohner Self-Cleansing Filter

Gives you constant supply of crystal water, pure as ozone. Inexpensive. Anyone can install without tools. Lasts a lifetime. Full particulars on request.

Bohner Mfg. Co. 1009S. So. Wabash Av. CHICAGO, ILL.



Guaranteed to give satisfaction or money back if returned in 15 days.

AGENTS WANTED

Salt Mackerel

CODFISH, FRESH LOBSTER

FOR THE CONSUMER

NOT THE DEALER



FOR YOUR OWN TABLE

FAMILIES who are fond of **FISH** can be supplied **DIRECT** from **GLOUCESTER, MASS.**, by the **FRANK E. DAVIS COMPANY**, with newly caught **KEEPABLE OCEAN FISH** choicer than any inland dealer could possibly furnish.

We sell **ONLY TO THE CONSUMER DIRECT** sending by **EXPRESS RIGHT TO YOUR HOME**. We **PREPAY** express on all orders east of Kansas. Our fish are pure, appetizing and economical and we want **YOU** to try some, payment subject to your approval.

SALT MACKEREL, fat, meaty, juicy fish, are delicious for breakfast. They are freshly packed in brine and will not spoil on your hands.

CODFISH, as we salt it, is white, boneless and ready for instant use. It makes a substantial meal, a fine change from meat, at a much lower cost.

FRESH LOBSTER is the best thing known for salads. Right fresh from the water, our lobsters simply are boiled and packed in **PARCHMENT-LINED CANS**. They come to you as the purest and safest lobsters you can buy and the meat is as crisp and natural as if you took it from the shell yourself.

FRIED CLAMS is a relishable, hearty dish, that your whole family will enjoy. No other flavor is just like that of clams, whether fried or in a chowder.

FRESH MACKEREL, perfect for frying, **SHRIMP** to cream on toast, **CRABMEAT** for Newburg or deviled, **SALMON** ready to serve, **SARDINES** of all kinds, **TUNNY** for salad, **SANDWICH FILLINGS** and every good thing packed here or abroad you can get direct from us and keep right on your pantry shelf for regular or emergency use.

With every order we send **BOOK OF RECIPES** for preparing all our products. *Write for it.*

Our list tells how each kind of fish is put up, with the delivered price, so you can choose just what you will enjoy most. Send the coupon for it now.

Let Gloucester be your Fish Market and Davis be your Fishman.

FRANK E. DAVIS CO. 28 Central Wharf, Gloucester, Mass.

Please send me your latest Fish Price List.

Name..... Street..... City..... State.....



MOVING EYES SCARF PIN 25c

2 fiery brilliants, in vibrating mountings set into the eye sockets of a heavy gold plated head pin. Marvelous effect produced by continual motion of the sparkling gems. 3 styles: **Skull, Bulldog and Owl Head**. Sample postpaid 25c to advertise our new jewelry catalogue.

ARKENAU CO., Dept. J. 524 45th St., Brooklyn, N. Y.

Hand Forged
Razor Steel
Blades. No. 57

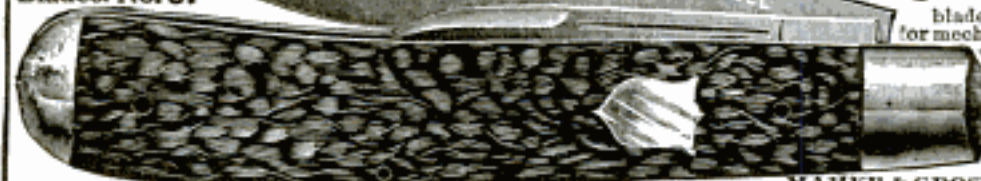

This \$2 **KNIFE** 83¢

DIRECT AT FACTORY PRICE

Handy shaped blade makes this knife best for mechanics, sportsmen and farmers; light but strong; resharpened easily. Stag handle, German silver finish; blades file tested, hand forged from razor steel and warranted. Sample 83c, 3 for \$2 postpaid. Choicest pearl \$2 each.

Send for our 80 Page List and "How to use a Razor" **FREE**

MAHER & GROSH CO., 106 A. St., Toledo, Ohio.

30 Days Free Trial

BESSEMER

KEROSENE ENGINE

How about that engine? If your old gasoline engine is too expensive, replace it with a Bessemer—a real Kerosene engine—and it will pay for itself in fuel saved. Write for the facts and 30-day free trial today—every day you delay costs you money. Sizes 2, 4, 6, 8 and 10 H. P. Also direct connected to pumps, hoists, air compressors, electric lighting plants, saws, farm machinery, etc. Try a Bessemer Kerosene Engine 30 days and we know you'll like it so well you'll buy it. Details in Catalog "K," free.

BESSEMER OIL ENGINE recommended where power from 15 to 200 H. P. is required. Burns crude and fuel oil and runs at about $\frac{1}{2}$ to $\frac{3}{4}$ cost of gasoline. Now being used in irrigation, flour mills, factories, lighting plants. This engine is revolutionizing the power question. Get the facts by writing for Catalog "O."

THE BESSEMER GAS ENGINE CO., 121 Lincoln Ave., Grove City, Pa.



LOWEST FUEL COST



This Man Knew!

"I realized," said a certain manufacturer who has just re-equipped his plant with engine power, "that nothing about my place means so much to me as reliability of power. Things must go right—I must be able to depend on things running smoothly without delays and stoppages, or I lose money fast. Anything less than absolutely the best to be had in quality is false economy. I know that from experience." This man's plant now runs on

International Harvester Oil Engine Power

Any man, whether large or small user of power, who looks till he finds the right engine, who studies most carefully all details of engines on the market, inevitably buys an I H C engine—Titan or Mogul. No engines last longer, run more steadily, deliver more power—are more uniformly satisfactory than International Harvester engines. They are built in all styles, in sizes up to 50 H. P., run on any one of a half dozen different fuels, built for any particular need—your need.

International Harvester engines—Titan and Mogul—are worth knowing about. Write for a catalogue, showing an interesting array of special features, and we will tell you where you can see the engine.

International Harvester Company of America

(Incorporated)

16 Harvester Building

Chicago U S A

2-Cylinder Cushman Engines Very Steady Power

For all work requiring steadiness of speed, Cushman Light Weight Engines are pre-eminent. They are today recognized as the leading American light weight, high efficiency, all-purpose engines, challenging comparison in **minimum weight per horsepower, reduced friction, quality of material and workmanship and cost of operation.** 8 H. P. 2-cylinder weighs only 320 lbs.—larger sizes up to 20 H. P. proportionately. 4 H. P. single cylinder only 100 lbs. No heavy bases or large fly-wheels.

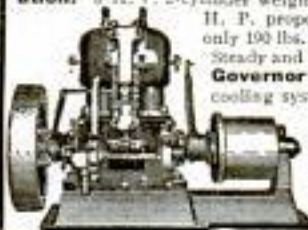

Steady and quiet, because of sensitive **Throttle Governor** and perfect balance. Forced water cooling system. **Run at any speed.** Schebler Carburetor and Friction Clutch Pulley. **Not a cheap engine,** but cheap in the long run. Ask for Engine Book

CUSHMAN MOTOR WORKS
882 N. 21st St., Lincoln, Neb.

1c IS WORTH DOLLARS



when you invest that 1c in a postal card to us. Here are a few of the good things in it for YOU—

1½ H.P., \$24.75	5 H.P., \$87.50
2 H.P., 28.75	6 H.P., 96.75
3 H.P., 33.90	8 H.P., 135.50
4 H.P., 68.90	10 H.P., 179.90
	12½ H.P., \$214.90

We guarantee against repairs forever
OTTAWA MFG. CO., 2033 King St., Ottawa, Kans.



RELIABLE POWER

Nearly 100,000 Galloway engines in daily use. Large bore, long stroke, heavy weight. Built for hard, continuous engine-users' satisfaction. All sizes, prices, styles. Modern design, few parts. Best materials, skilled labor. Posters not overrated. Sold direct. Engine book free. Postal gets it. Investigate before you buy, compare value we give and you'll have no other. Address

Wm. Galloway Co., Box 965 Waterloo, Iowa

9875
7750
3950
3475
2675

The Push of a Button

Starts This Electric Light Plant

It is practically automatic, and is particularly adapted for farm and country homes. Gives 24-hour service. Capacity 40 lights.

Mor-Lite

is a compact unit, consisting of Dynamo, Gasoline Engine and Switchboard, all connected up on one base ready to run. Storage batteries fully charged ready for service. May we tell you more about this automatic outfit?

Fairbanks, Morse & Co.

Chicago

New York

San Francisco

and other principal cities.

(449-4N)



DIAMONDS-WATCHES ON CREDIT

MEN'S 12 SIZE THIN MODEL WATCH, 17 JEWELS, ADJUSTED
 Illinois, Elgin, Hampden or Waltham movement. Warranted accurate. Finest gold strain case, guaranteed 25 years; engraved, engine turned or plain polished. **Special Sale Price, \$18.95.** Eighty per cent of all men's Watches sold are these Thin Models. Give us your name and address, and we'll send you this splendid accurate 17-Jewel Adjusted Watch, all charges prepaid.

On Approval—No Money Down
 If you keep it, pay only **\$2.00 A MONTH**
 If you don't want to keep it, return at our expense.

These Diamond Rings are the famous Loftis "Perfection" 6-prong 14c solid gold mounting. Very fine brilliant diamonds. CREDIT TERMS: One-fifth down, balance divided into 8 equal amounts, payable monthly. Write for free Catalog, containing over 2,000 illustrations of Diamonds, Watches, Jewelry, etc. It tells all about our easy credit plan.

LOFTIS BROS. & CO., National Credit Jewelers
 Dept. E894 —100 to 108 North State Street, Chicago, Ill.
 Stores in: CHICAGO PITTSBURGH ST. LOUIS OMAHA

No. N75

The Best Gift of All



2 H.P. MARINE MOTOR \$29.95

30 Days Trial

Positively the highest grade. Best materials. Best workmanship. Simplest design. Easy to operate and install. Guaranteed for life.

Sold Only Direct to Users

thus reducing sales expense. This saving coupled with our quantity production and tremendous buying power enables us to furnish you a No. 1 motor at a fraction of the price others charge. Sizes range from 2 to 30 H.P. Furnished to run on gasoline or kerosene. Send for catalog "A."

American Engine Company
 605 Boston St.
 Detroit, Michigan



Let Him Design Your Boat

FREE

This man is America's foremost small boat designer. He is Ed Townsend, designer of "Silver Heels," the famous 16-foot hydroplane with which a 16-year-old boy won nine Jersey Coast races out of nine entries. This boat is powered with an 8 H. P. Caille Unit Plant. So harmonious is this combination of motor and boat that we purchased the original "Silver Heels" plans from Mr. Townsend. Now we offer a set of "Silver Heels" blue prints FREE with each Caille 8 H. P. Unit Power Plant. Investigate this offer before planning your next year's boat. Also ask for our 1916 Marine Engine book No. 24 showing Caille motors from 2 to 30 H. P.

THE CAILLE PERFECTION MOTOR CO.
 1523 Caille Street DETROIT, MICH.



WATKINS' SPECIAL MOTORS

3 H. P. Single Cylinder . . . 30 lbs.
 6 H. P. Double Cylinder . . . 40 lbs.
 12 H. P. Four Cylinder . . . 100 lbs.

A strictly HIGH GRADE Motor that will give CONSTANT and EFFICIENT service. Especially adapted for CANOES and LIGHT BOATS. Aluminum base, copper water jacket, steel shaft, bronze bearings.

THE WATKINS MOTOR CO.
 837-839 West Sixth Street CINCINNATI, OHIO

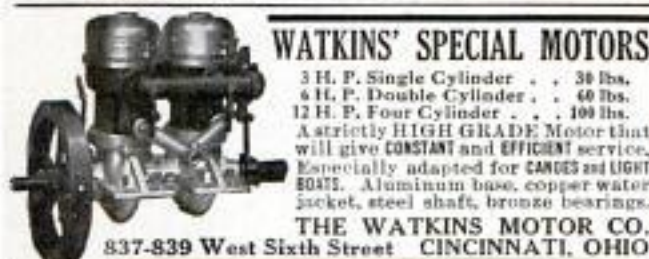

Toledo MARINE MOTORS

NONE BETTER

"Nothing Cheap but the Price"

3 H. P. 1 cyl. complete	\$ 65.00
6 H. P. 1 " "	84.00
6 H. P. 2 " "	125.00
12 H. P. 2 " "	160.00
18 H. P. 3 " "	250.00

Fully guaranteed by a responsible concern. 2 cycle. 2 port. 2 1/2" x 3 1/2" and 4 1/2" x 4 1/2". Send for free catalog "C."

THE UNIVERSAL MACHINE CO., Pike Ave., Bowling Green, O.

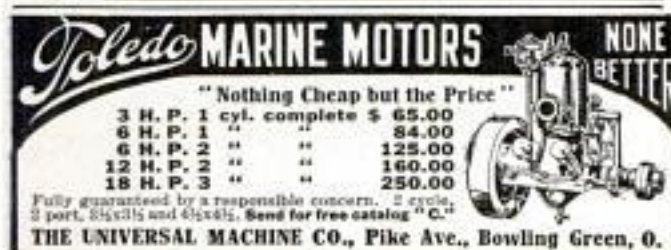

GET THIS CATALOG FULL OF VALUABLE INFORMATION TO EVERY BOAT OWNER ON

RACING PROPELLER WHEELS, REVERSE GEARS AND MARINE ACCESSORIES

LARGE CATALOG FREE. SEND TODAY

MICHIGAN WHEEL CO.
 1129 MONROE AVE., GRAND RAPIDS, MICH.



KERMATH Marine Engines

"America's Standard 4 Cycle Marine Motor"

4 Cycle, 4 Cylinder, 12 to 30 H.P. Highest quality. Silent operation. No vibration. Controls like the finest Motor Car engine. Extremely economical on fuel. Used as standard equipment by over 60 per cent. of the world's leading boat builders. Catalog on request. \$180 to \$300 depending on equipment.

KERMATH MFD. CO. Dept. P, Detroit, Mich.



THE MOTOR-BOB

Dept. 1, BUFFALO, N. Y.

BOYS, YOU CAN BUILD A REAL LITTLE AUTO LIKE THIS!

Send a quarter for a set of our plans and instructions, with a large working drawing and price list of parts. They make it easy for you.



LIONEL STRONGFORT

Health and Strength Institute, Dept. S105, Atlantic City, N. J.

DEAR STRONGFORT: I am interested in my Physical Welfare and wish to read your book, "Intelligence in Physical and Health Culture"; I enclose 3c. to cover postage. Also please write me a personal and confidential letter regarding the subjects which I have checked X. I enclose 10c. for each subject for expenses.

.... Thinness Round Shoulders
.... Nervousness Rupture
.... Indigestion Alcohol
.... Constipation Tobacco, or other
.... Flat Chest Bad Habits and
.... Catarrh Weaknesses
.... Lung Trouble Poor Memory
.... Increased Height Muscular Development
.... General Health Great Strength

Name

Street

City

For twenty years "the strongest man in the world" and its most successful Physical Culture and Health Instructor, **LIONEL STRONGFORT** gives each inquiry his personal attention. **Strongfortism Spells Success.**



Please Mention Popular Mechanics

THE ELECTRO IMPORTING CO. NEW YORK CAT No 15

'EVERYTHING FOR THE EXPERIMENTER'
CATALOG No 15

1st Edition
1915
250,000

1st Edition
1915
250,000



Copyright, 1915, by E. I. Co., N. Y.

DOWNTOWN RETAIL STORE: 69 WEST BROADWAY, NEW YORK

"THE LIVEST CATALOG IN AMERICA"

ACCEPT THIS GREAT BOOK FREE! The above is a full size view of our 275 page Cyclo-pedia catalog weighing half a pound and containing 658 illustrations. It contains a Treatise on Wireless, and a world of information on electricity and wireless and experiments in both; a complete list of all wireless stations in U. S. and their call letters; Morse, Continental and Navy code chart. Fully describes and illustrates greatest assortment of wireless telegraph supplies in the country. Spark coils, Geissler Tubes, X-Ray Tubes, compasses, high frequency apparatus, electrical alarm thermometers, all kinds of batteries (storage, wet and dry) voltmeters, ammeters, flash lamps, flashlights, auto lamps, Xmas tree outfits, lighting plants and supplies, dynamos, motors, fans, toy motors, transformers, rheostats, electric trains, nickel and copper-plating outfits, parlor projectors, telephone receivers, Tesla coils, Transformers, Medical Coils, static machines, electric whistles, switches, cords, wires, table lamps and heating apparatus. Immense assortment of tools, raw materials, parts and supplies. **Most complete scientific book catalog in America,** watches, photographic apparatus, microscopes, telescopes, phonographs, printing presses, steam engines, air rifles, sporting goods, pocket knives, building outfits, etc., etc. **2000 articles in all, everyone illustrated and described all at the lowest prices in America.** You can't afford to be without this catalog; send 4c in stamps or coin (to cover postage) for a copy today.

THE ELECTRO IMPORTING CO., 233A Fulton St., New York City

Write your name and address in the margin below and mail with 4c today

Complete Wireless Sending and Receiving Station \$10¹⁰

Receives hundreds of miles.

Sends 8 to 20 miles.

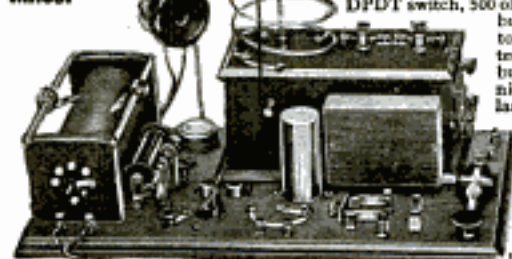

This remarkable station consists of a guaranteed 1 1/2 in. spark coil, machine turned fluted spark gap, our 1501 key, a flat plate condenser, assembled in an oak case, a large capacity helix, DPDT switch, 500 ohm potentiometer, buzzer and switch to tell if your 2 detectors are working, buzzer battery in nicked case, tubular condenser, bare wire wound double slide tuner, number 30 silk wire wound large 6 capacity loading coil that allows you to get Arlington and long wave stations.

Send stamps for our large catalog "P" of remarkable values. If possible call and see our stock. **THE HANDEL ELECT. CO., 138-140 Centre St., NEW YORK**

Here's Health and Power—Vim and Vigor



Do you want them? Strength that is more than mere muscular strength. The strength of better health, abundant nerve force. The strength of keen relish. Write and find out what vibration will do for you. Nine out of ten people are only half alive. How about yourself? Do you feel just right? If you haven't that vigorous "go ahead" feeling all the time,

don't fail to send the free coupon today for our big new book that will tell you all about

THE WHITE CROSS ELECTRIC VIBRATOR



Our Combination Outfits give you three of the greatest curative agents—Vibration, Faradic and Galvanic electricity. We will send this wonderful machine to you on free trial. See it—try it—feel its health-giving vibrations for yourself.

Vibration Is Life

In vibration there exists many of the secrets of life. The safest, surest and quickest way to recover normal health is by scientific manipulation of the organs affected and in this way stimulating them to perform their duties, whether it be those of digestion, respiration, circulation, or the nervous system. The rich, red blood will be sent coursing through every vein and artery. Write today—now—for our free book.



Send the Free Coupon

Just your name and address on the free coupon or a letter or a post card is enough. We will send you absolutely free and prepaid, our new book, "Health and Beauty." It's free. No obligations of any kind. Write today—at once.

Lindstrom, Smith Company
1100-1110 South Wabash Avenue
Dept. 1197 Chicago, Illinois

We also manufacture White Cross Electric Stoves, Irons, Hair Dryers, Electric Lamps, Electric Fans, Electric Automobile Horns, Electric Curling Irons, Heating Pads, Small Motors, etc., etc. Dealers write.

Name.....

Address.....

My Electrical Dealer's Name is.....

Lindstrom, Smith Co.

1100 S. Wabash Ave.
Dept. 1197 Chicago

Please send me, absolutely free and prepaid, your new book, "Health and Beauty" and full particulars about the White Cross Electric Vibrator. I assume no obligation of any kind.

"The Electrical Experimenter"

The big electrical Magazine for those who dabble in electricity and Wireless. Chuck full of experiments. Intensely interesting. Monthly prices of \$5.00 for best experiments. Amateur Electricians, Wireless News, Latest Patents 100 articles, 100 to 150 illus. Read the great serial: "Baron Munchhausen's New Scientific Adventures" \$1.00 a year.

Send 10¢ for 3 issues

Electrical Experimenter 234 Fulton Street, N. Y.
10c a copy at News-stands

A census of motorcycles in the United States has been made by the Office of Public Roads, which shows that there were 152,945 vehicles of this class registered in 1914.

ELECTRIC LIGHT PLANTS Complete gasoline engine, dynamo, switchboard and storage battery \$240.
Agents wanted. American Battery Co., 1139 Fulton St. Chicago (Estab. 1889.)

ELECTRIC HOME, FARM and STORE LIGHT PLANTS. LIGHTS, DYNAMOS, MOTORS, ENGINES. Fan Motors, Storage & Medical Batteries, Rectifiers, Bells, Bells, Bicycle, Carriage & Auto Lights, Massage, Ozone & M. P. Machines. MOTION PICTURE THEATRE Permanent and Traveling Equipments. Big Opportunity. Catalog 3 cts. OHIO ELECTRIC WORKS, CLEVELAND, OHIO

ELECTRICITY
BOYS—Send today for our new 128-page catalog of everything electrical. Motors, Dynamos, Flashlights, Lamps, Coils, Batteries, Transformers, Magnet and Resistance Wires, Telegraph Outfits, Miniature Electrical Railways and Parts. Catalog with coupon sent only for 6c in stamps or coin. No postals answered.
VOLTAMP ELECTRIC MFG. CO. Voltamp Block, BALTIMORE, MD.

DUCK'S BIG 320 PAGE Electrical and Wireless Catalog

Mailed on receipt of 8c in stamps or coin which may be deducted on first dollar purchase. Great cost of catalog and low prices prohibit distribution otherwise.

WHAT THIS BIG CATALOG CONTAINS

- | | |
|---|---|
| 125 pp. Wireless Apparatus for Commercial and Experimental use; | 10 pp. Ammeters & Voltmeters; |
| 10 pp. Raw Material; | 25 pp. Electrical and Mechanical Books; |
| 5 pp. Transformers; | 2 pp. Fans; |
| 8 pp. Storage Batteries; | 12 pp. Telephone Equipment; |
| 15 pp. Telegraph Insts.; | 6 pp. Heating Appliances; |
| 43 pp. Motors and Dynamos; | 10 pp. Auto Accessories; |
| 10 pp. Miniature Lamps; | 13 pp. Victrolas, on our Easy Payment Purchase Plan; (No Down Payment). |
| 8 pp. Flashlights; | 30 pp. General Electrical Supplies. |
| 5 pp. Massage Vibrators; | |
| 10 pp. Miniature Railways; | |
| 5 pp. Lighting Plants; | |

THE WILLIAM B. DUCK COMPANY, Arcade Bldg., TOLEDO, OHIO



Play Billiards at Home!

Under our easy payment plan, the expense is scarcely noticeable.
You will be surprised to find how easily you can own a

BURROWES

Billiard and Pool Table

No special room is needed. The Burrowes Table can be set on your dining-room or library table, or mounted on its own legs or folding stand, and quickly set aside when not in use. Burrowes Tables are splendidly made and correct in every detail. The rubber cushions are the Burrowes Regis High-Speed Cushions. Great experts say there is nothing better. The most expert shots, calling for skill of the highest order, can be executed with the utmost precision. Sizes range up to 4½x9 ft. [standard].

The Cost is Trifling

A few cents a day (far less than it costs to play in a public poolroom) will soon make you the owner of a handsome Burrowes Table. You can play on the Table while paying for it. Why not own your Table and play with family and friends in the home atmosphere instead of spending a greater amount, with nothing to show for it, for rental of a public table?

E. T. BURROWES CO., 160 Spring Street, Portland, Me.

Please send catalog of Billiard Table offers.

Name

Address

FREE TRIAL—

NO RED TAPE

On receipt of first installment we will ship Table. Play on it one week. If unsatisfactory return it, and on its receipt we will refund your deposit. This insures you a free trial. Write today or mail the attached coupon.

We make the world-famous Burrowes Rustless Screens and Folding Card-Tables



**\$1.00
DOWN**

Terms are very easy—\$1 or more down (depending upon size and style selected), and a small amount each month. Prices from \$15 up. CUES, BALLS, ETC., FREE.

THE AMERICAN MODEL BUILDER

WRITE FOR CATALOG

The American Mechanical Toy Co.
403 E. First Street DAYTON, OHIO

BRANDES WIRELESS RECEIVERS

EXTREMELY SENSITIVE

Light in weight. Built for service.
Send stamp for catalogue "P." It fully describes all our headsets.

C. BRANDES, INC.

32 Union Square NEW YORK



The operation of the Panama Canal for the first eight months shows an excess of 10 per cent of expenditures over receipts.

Old Stamps Wanted FOR CASH. We buy rare or old stamps of any country, also old or large stamp collections, old letter files (from 1843 to 1870) of private individuals or old business or banking firms. **PREMIUM LIST 10c.** Address **C. E. HUSSMAN STAMP COMPANY, Dept. M. O., St. Louis, Mo.**

Build a WAR Aeroplane

"Ideal" accurate Scale Drawings and knocked down parts will enable you to EASILY build 3 Ft. Flying Models of those Aeroplanes now used in the European War. Students of Aeronautics, everyone with an inquiring turn of mind, should construct one of these fascinating Models.

Prices of 3 Ft. Scale Drawings:
Curtiss Flying Boat 25c Heriot Monoplane 15c
Curtiss Military Tractor 25c Taube Monoplane.... 25c
" Hydroaeroplane 35c Wright Biplane... 25c
Nieuport M'A' plane 25c Cerril Peoli Racer 25c
Complete Set of Eight, \$1.60 postpaid
Just Out 1916 catalog of Model Aeroplanes and Supplies, 62 pages. Postpaid 6c.
Ideal Aeroplane & Supply Co., 82-88 West Broadway, New York



Send for a Copy of Our New Manual No. 2

Its pages give simple formulas for calculating the natural period of an antenna; capacity of a receiving or transmitting condenser; spark frequency of rotary spark gaps; tables for calculating the correct amount of wire for the construction of magnets and tuning coils; tables for ascertaining the spark lengths of different voltages; the Federal regulations regarding the restrictions of wave lengths for amateur stations; instructions for the installation, maintenance and operation of wireless stations; directions for learning the code, working diagrams and a complete list of up-to-date wireless instruments and accessories, together with other features of interest to the amateur or professional wireless enthusiast.

Containing as it does a fund of valuable information not generally contained in a catalogue, it approaches nearer a text book in the fascinating field of wireless telegraphy. It is printed on good stock with a heavy paper cover in two colors. No expense has been spared to make it accurate and reliable. We make a charge of 10c for it which amount will be allowed on an order amounting to \$1 or more.

No Wireless Experimenter Should be Without the *Mesco Wireless Manual*

Send for Our Pocket Catalog P.28

It will contain over 200 pages, with over 1,000 illustrations, describing in plain, clear language all about Bells, Push Buttons, Batteries, Telephone and Telegraph Material, Electric Toys, Burglar and Fire Alarm Contrivances, Electric Call Bells, Electric Alarm Clocks, Medical Batteries, Motor Boat Horns, Electrically Heated Apparatus, Battery Gauges, Wireless Telegraph Instruments, Ignition Supplies, Etc.

It Means Money Saved to You to Have Our Manual and Our Catalog When You Want to Buy

Manhattan Electrical Supply Co. New York 17 Park Place Chicago 114 So. 5th Av. St. Louis 1106 Pine St. San Francisco 604 Mission St.



1/3 SAVED Buy Direct From MANUFACTURER
J. Hardin Co., J. J. Lane, Pres.

N^o 1 \$9.60 N^o 2 \$15.50 N^o 3 \$12.90

FREE BOOK

Install Your Own Plumbing and Heating

Get our catalog No. 69A—contains complete heating plants, heating goods of every description, bathroom outfits, sinks, roughing-in goods, pipe fittings, valves, etc., water pressure systems and lighting plants. In fact, absolutely everything in high-grade plumbing and heating supplies **exclusively** at wholesale prices. Any handy man can install our goods with our free easy installing plans. \$400,000 plants behind our guarantee. **WRITE TODAY.**

No. 4526 00-99
J. HARDIN CO. 40 years at 4533-43 CHICAGO
 Cottage Grove Ave.

MONEY IN MUSHROOMS

Make \$20 a Week and Over Growing Mushrooms at Home

Quickly and easily raised in cellars, stables, sheds, caves, boxes, etc., all the year. Crop sells for \$0.50 to \$1.00 a lb. Only small space needed. Previous experience or capital not necessary. Costs little to start, large profits; markets waiting. We can show you how, by using our spawn and simple directions, to make big money at this fascinating occupation. We are

We guarantee our spawn absolutely.

Our long experience at your service.

an old and reliable concern; stand back of our spawn and help our customers to success. We teach you our methods free and tell you how and where to sell your crop. **SEND TODAY** for our large illustrated, 32 page free booklet and learn this great business.

NAT'L SPAWN & MUSHROOM CO., Dept. 17, BOSTON, MASS.

A NEW WAY To Get Your Clothes Free

Make Big Money During Spare Time

Something Different, bigger, more liberal than any offer ever made. Lower prices—better clothes—bigger cash profits. Express paid on everything.

Double Pay

FREE clothes and cash besides. We don't ask you to use your cash profits for your own clothes. Ours is a new and better plan.

An Extra Present with every order. Not a prize scheme. Choose what you want, work for it and get it besides your Cash Profits. Complete Outfit FREE, 56 real cloth samples, 50 Fashion Plates. Inside wholesale prices. Get the big money. Your name on a post card brings everything FREE.

SPENCER MEAD CO., Dept. 607, Chicago

A good shave is a "running start" on a good day. Good lather means *real* comfort.

Colgate's Shaving Lather

Stick—Powder—Cream

Plentiful—luxurious—lasting. Softening—soothing—sanitary. Send 4 cts. for trial size of your favorite method.

COLGATE & CO., Dept. 81, 199 FULTON ST., N. Y.

Go Into MOVING PICTURE BUSINESS

Small Capital Starts You

on our easy payment plan. Begin now and get your share. We sell everything. Write TODAY.

Atlas Moving Picture Co.
 Dept. 40 525 S. Dearborn St., Chicago

Our Catalog FREE. Show you how to earn \$25 to \$50 per day

The Burlington Smashes

Mail the Coupon TODAY for Free WatchBook

All Watch Competition

Look!



19 Ruby and Sapphire Jewels—

Adjusted to the second—

Adjusted to temperature—

Adjusted to isochronism—

25-year gold strata case—

Genuine Montgomery Railroad Dial—

New Ideas in Thin Cases.

Every fighting vessel in the U. S. Navy has the Burlington Watch aboard. This includes every torpedo boat—every submarine as well as the big Dreadnaughts.

\$2.50

Only 2 A Month

And all of this for \$3.50—only \$3.50 per month—a great reduction in watch price—direct to you—positively the exact prices the wholesale dealer would have to pay. We do not care to quote these prices here, but write—write before you buy. Think of the high-grade, guaranteed watch we offer here at such a remarkable price. Indeed, the days of exorbitant watch prices have passed.

See It First!

You don't pay a cent to anybody until you see the watch. We won't let you buy a Burlington watch without seeing it. Look at the splendid beauty of the watch itself. Thin model, handsomely shaped—aristocratic in every line. Then look at the works! There you see the pinnacle of watchmaking. You understand how this wonder timepiece is adjusted to the **very second!**

Free Watch Book

Get the Burlington Watch Book by sending this coupon now. You will know a lot more about watch buying when you read it. You will be able to "steer clear" of the double-priced watches which are no better. Send coupon today for the book and our offer.

Free Watch Book Coupon

Burlington Watch Co.
 19th St. and Marshall Blvd.
 Dept. 9197 Chicago, Ill.

Please send me (without obligations and prepaid) your free book on watches with full explanation of your cash or \$2.50 a month offer on the Burlington Watch.

Burlington Watch Co.

19th St. & Marshall Blvd., Dept. 9197
 Chicago

Name.....

Address.....

Please Mention Popular Mechanics

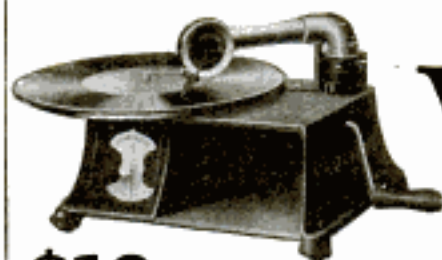

Now Every Home Can Have A Vanophone=\$12

A Wonderful Player at a Wonderful Price

\$12 Here's the crowning achievement among musical instruments. A phonograph with unique and novel features of refinement, with a volume and purity of tone unsurpassed by any other higher-priced talking machine. The music profession stands amazed at its perfection of reproductive quality. The Vanophone is beautifully enameled in black and gold. The powerful motor is sure, smooth, and absolutely noiseless. Has the exclusive automatic brake. Yet it weighs only 12 pounds. Its range of enjoyment is greater than any other, for home, club, dances, house parties and outings. Plays 10 or 12 in. disc records.

Beautiful FREE Book Explains All — Get Your Copy TODAY

Don't buy a phonograph till you have seen this marvelous Vanophone. We tell you all in a beautiful illustrated book. Tells you how harsh, rasping sounds have been overcome in this newest musical creation. No longer need to pay huge prices. The Vanophone is just what you have been looking for. You should have it. Every Vanophone is *guaranteed* or your money refunded.

But be your own judge. Write for FREE book—write now, before you forget it.

DEALERS—Thousands of dealers are cashing in on the tremendous popularity of the Vanophone. Druggists, Stationers, Hardware Dealers, Merchants should write at once. We send you complete proposition with your prices and profits. Put the Vanophone on your selling staff. Write us today. Address Dept. 28

THE GARFORD MANUFACTURING COMPANY, Elyria, Ohio

Manufacturers of the Highest Grade Telephone Equipment in the World

Boston Garter

Vulcan Grip

Three Popular Styles:

**NEVERBIND
CORD and
PAD**

GEO. FROST CO.
MAKERS
BOSTON



Silk 50¢
Lisle 25¢



AGENTS!

Here is Your Chance to make money by saving money for others. Our new discovery, **EGGINE** Powder, takes the place of Eggs in baking and cooking at less than 9¢ a doz. A 25¢ package equals 3 doz. An absolutely Pure Food Product fully guaranteed. Derived principally from milk and corn. Convenient, economical and always fresh. Satisfaction certain, thus steady customers. Send 10¢ for trial package and terms postpaid.

CHAS. T. MORRISSEY & CO.
4414 Madison St. CHICAGO, ILL.



NEW SCIENTIFIC WONDER!

MARVEL X-RAY BOYS! A REAL CURIOSITY Apparently shows bones in your fingers. You see through fabrics. Even the flesh turns transparent, revealing the bones. Lasts lifetime. Always ready for use. Get one today. Price, 10 cents; 3 for 25 cents. **NUIDEA CO., Dept. 3, 524 45th St., Brooklyn, N.Y.**

AGENTS—Make \$100 to \$300



per month easy selling our new **Triplicate Sauce Pan**. Cooking utensil for 3 different foods on one burner. **400 Specialties**—all **Whirlwind** sellers. Write quick for exclusive territory and large catalogue. **AMERICAN ALUMINUM MFG. CO.**
Div. 5 61 LEMONT, ILL.

DIAMONDS ON CREDIT

Whether for personal use, or as a gift, nothing can compare with a Diamond, if it be of pure quality.

Lyon Diamonds are absolutely free from flaws or imperfections and of the rich Blue-white color. Every honest person is offered our liberal terms of

20% Down and 10% A Month

With every Diamond we furnish a Guarantee Certificate attesting the quality and value, and providing for exchange at full purchase price. Send for Catalog No. 3, showing splendid line of Watches, Jewelry and Silverware. Goods sent prepaid for inspection, subject to approval. 10% Discount Allowed for Cash.

J. M. LYON & CO., Est'd. 1843 **71-73 NASSAU STREET**
NEW YORK CITY, U. S. A.



Draftsmanship for YOU!

Send the Coupon and See What It Means

Are you holding a job that is distasteful to you? Are you wrestling with the problem of small wages and no future? Have you a job today that you are not sure you are going to have tomorrow? Are you ambitious for big things, for big earnings, for independence? Then write to me and I will show you what Draftsmanship holds out to you. Yes, I will prove entirely at my expense that I can qualify you right in your own home, in your spare time, for all the things that are at the command of the Draftsman.

A Big Salary—A Real Future

Look at the want ads of our metropolitan newspapers. See what a great number of Draftsmen are needed in comparison with any other profession. The marvelous growth of modern industries and the marked building activity all over the country have created a bigger demand than ever before for the Draftsman. This is the "Construction Age"—the epoch of a new page in every field of scientific and mechanical endeavor. The need for the Draftsman's services has expanded accordingly. Their value has been remarkably enhanced. Big positions paying \$2400 a year and more—positions that will put you in line for the place of Chief Draftsman, Chief Engineer or Superintendent. Give me a few minutes regularly of your spare time for a few months and I will put you into a field of real opportunity. Keep your present position and earn while you learn.

\$17.50 Draftsman's Outfit FREE

This magnificent set of Draftsman's Drawing Instruments, valued at \$17.50—the same as I use, goes to you absolutely free if you act at once. This free outfit is in itself a big step to your successful training. This outfit goes to you free in addition to the free \$25.00 tuition credit. But you must act promptly. The coupon or a post card brings you full particulars—also copy of my book on Draftsmanship, one of the most valuable ever published on the subject. Act now. Strike while the iron is hot.

Chief Engineer Cooke, Chicago Engineer Works
Dept. 10A 455 Cass St. Chicago, Ill.



THIS SUPERB OUTFIT FREE

CHIEF ENGINEER COOKE
Dept. 10A, 455 Cass St., Chicago, Ill.
Without obligation or cost to me send prepaid your free book "The Road to Success" and particulars of your very extra special offer.

NAME.....

ADDRESS.....



My Special Tuition Offer!

You don't have to let the question of ready money stand between you and this opportunity. If you are really ambitious, I offer you my personal instructions on such small easy payments, that no matter how small your present salary is you will scarcely miss the money. For prompt enrollment I am making an extra special offer of a free \$25.00 tuition credit. I am the only expert Draftsman giving his personal instructions in such small payments.

Wear It a Week At Our Expense

We will send you a genuine Italian jewel set in solid gold for a whole week's free trial. Compare it with a diamond, in brilliance, hardness and beauty. If you can tell the difference, send it back. Write today for New Jewelry Book. See illustrations of the exquisite gems. No obligations. The book is FREE. 1197 Ward Building CHICAGO, ILLINOIS



Typewriters

-- All Ekco, Factory Rebuilt by the famous "Young Process"; look like new, guaranteed like new. Our big business insure "Square Deal" and permits lowest cash prices -- \$10 and up; also machines rented -- or sold on time. No matter what your requirements are, we can best serve you. Write and see - NOW.

YOUNG TYPEWRITER CO. Dept. 253 CHICAGO

BUY YOUR FURNACE \$10 DOWN \$10 A MONTH



Our monthly payment plan of selling direct saves you the dealer's profits and charges for installation. The

JAHANT FURNACE

with the patented "Down Draft System" is best for residences, schools, hotels, churches, etc., because it delivers plenty of heat wherever and whenever desired at a saving of 1/3 to 1/2 in fuel bills. Install the JAHANT yourself. We send complete outfit, freight prepaid with special plans, detailed instructions and all necessary tools for installation. Satisfaction guaranteed or money refunded.

WRITE FOR FREE ILLUSTRATED BOOK
THE JAHANT HEATING CO.

200 Steiner Avenue AKRON, OHIO

Save 1/3 to 1/2 on Fuel Bills

Don't Throw Away Your Worn Tires

You can get 5,000 miles MORE service out of them

For over three years European motorists have been getting from 10,000 to 15,000 miles out of their tires by "half-soling" them with Steel Studded Treads.

In eight months 20,000 American motorists have followed their example and are saving \$50 to \$200 a year in their tire expense.

We Deliver Free Without a cent deposit, prepay the express and allow you to be the judge. Durable Treads double the life of your tires and are sold under a signed guarantee for 5,000 miles without puncture. Applied in your own garage in thirty minutes.

Special Discount offered to motorists in new territory on first shipment direct from factory. Don't take any more chances with your tires. Mail the coupon Today and find out how to get 5,000 more miles out of them.

COLORADO TIRE & LEATHER CO.

107 Tread Bldg., Denver, Colo., Dept. J7, Box 228, Chicago
710 Woolworth Bldg., New York

Gentlemen:—Please send me without obligation, full information, sample and guarantee.

Name.....

Address.....

My Tire Sizes are.....

Please Mention Popular Mechanics

Boys—Here's Fun

FREE BIG CATALOG

ASK DAD FOR ONE

Write Quick for Catalog

YOU'LL have barrels of fun with a Lionel electric locomotive, Pullmans, freight cars, switches, semaphores, electric lights, track, etc. Make the trains scoot around with touch of your finger—just like the big railroads. Run 'em on batteries or from electricity in your house with a Lionel transformer.

250,000 BOYS OWN THEM—Join us—a quarter million of happy boys. **Write Quick for New Boy's Catalog**

LIONEL TOYS ELECTRIC are safe—no shocks. They resist hard, rough usage because they're steel—not Cast Iron—and won't break. Are highest grade of material throughout but *not high priced*. Unconditionally guaranteed. Finished handsomely in rich, harmonious, non-chipping colors and gold. Models are faithful reproductions of originals seen on our prominent railroads. Locomotives, cars, etc., can be bought made up into trains—outfits—or separately as one's pocketbook dictates.

Do it right away. I've written this new catalog specially for YOU and crammed it full of pictures. No big words in it—you'll understand them all. New photos tell you why you'll have such a dandy good time with Lionel Trains.

Section of Lionel rail free Most toy dealers, electrical stores and department stores sell Lionel Toys. If you'll go to your toy dealer, find out if he sells Lionel Trains, and tell me when you write for catalog—I'll include a special section of rail—free.

BE SURE TO ADDRESS DEPT. 46
THE LIONEL MFG. CO.

 DEPT. 46
52 East 21st Street
NEW YORK CITY

J. LIONEL COWEN,

 A Friend of Boys
President

LIONEL TOYS ELECTRIC

Rapid

AUTO PEN

SPEED and UNIFORM LETTERING GUARANTEED

The Perfect **SINGLE STROKE** medium for Lettering Price Tickets, Show Cards, Etc.

Manufactured in 76 sizes and styles. Special introductory offer—6 pens and 2 shades Lettering Ink, with complete instructions, prepaid \$1.00. Catalog free.

THE NEWTON AUTOMATIC LETTERING PEN CO.
Dept. A, PONTIAC, MICH., U. S. A.

"Interlox"

SAVES TIME, TEMPER AND TROUBLE

MASTER SLIDE RULE
The Only Interlocking Rule made—and the Only one whereby inside measurements of doors, windows, etc., can be taken rapidly and accurately. Also superior to all others for outside measurements of walls, ceilings, etc. If your hardware dealer hasn't this Rule, send us his name and 15c per foot (in any length from 2 to 8 ft.) and it will be sent prepaid.

Liberal Proposition for Dealers and Agents

DAHL MFG. CO., 51P E. 42nd St., NEW YORK

When You Build

please bear in mind that there is still plenty of

WHITE PINE

Send for our free booklet, "WHITE PINE IN HOME-BUILDING"

WHITE PINE BUREAU

1626 Merchants' Bank Bldg. ST. PAUL, MINN.

Sterling "Double Duty Davenport"

Considered the Best Davenport-Bed on the Market

Combines latest style attractive 5-foot Davenport with large, comfortable 6-foot-3 inch bed. Simple construction. **Easy to operate.** No iron projections or ragged edges to injure occupant or tear bed clothes. Thick mattress and bed clothing can be folded into the spring construction. Has special strong steel frame. High grade springs, entirely separate from seat cushions. **Equally as comfortable on edge of bed as in center.** Seat and back handsomely upholstered in leather.

 (OPEN)
Send Today for
Our Big Free Catalog

A Necessity in Apartments, Suites, Small Houses and Flats

Always comfortable, safe and sanitary. Never gets out of order. Perfectly made of highest grade materials by expert workers in our large factory under best conditions and system. Large line to select from.

Save 30 to 50% — Buy Direct from Maker

30 years' experience enables us to offer better quality at lower prices. Don't fail to send for free catalog giving full description and prices of our complete line, including Living Room, Library, and Dining Room pieces.

THE STERLING FURNITURE CO., 5010 Sterling Bldg., TOLEDO, OHIO
Not a Mail-Order House — We Are Manufacturers

 Takes Up Less Room
When Closed Than Others

Boys Say,
"IT'S GREAT!"

ERECTOR

Fun! Development of skill in engineering and building construction! A chance to win a prize! That's what your boy gets when you buy him Erector.

Boys—I know what you like. I made Erector girders with interlocking edges so you could build bigger, stronger and more models. No other construction toy has girders exactly like structural steel which build strong, square columns.



The Toy Like Structural Steel

Powerful Motor With most sets I give the Erector motor free—the most powerful toy motor made. It runs your models, such as derricks, machine shops, inclined railroads, etc. It's great fun!

Dealers everywhere sell Erector, \$1 to \$25. You'll especially like Set No. 4 at \$5; contains 571 parts and motor, builds over 250 models and is packed in handsome oak cabinet.

Free Book and Boy's Magazine \$3000 Prize Contest

Free Book (full of pictures of Erector models) and a free copy of my boys' magazine, Erector Tips which tells all about the 307 valuable prizes I give the boys who build the best models.

Write now for the Free Book and magazine; please give dealer's name.

A. C. GILBERT, President
THE MYSTO MANUFACTURING COMPANY
104 Fox St., New Haven, Conn.



TANGOPHONE

Plays any of the latest melodies. Good music for either song or dance. Anybody can play one. Made of metal, will last for years. SWEET—MELODIOUS—HARMONIZING

Surprise your friends with your great musical ability. 10c postpaid, also big new catalogue.

ARDEE CO., Box 500, Stamford, Conn.



GOOD AGENTS

Wide awake, energetic Men can secure protected Territory to sell our portable Lamps, Lighting Systems and our 250 C. P. Inc. Gasoline Lanterns, which are positively the simplest and most practical gasoline devices on the market. We challenge competition, Your Chance. Territory is being rapidly taken. If you want a good, steady income, write to us TODAY.

INTERNATIONAL LIGHT NOVELTY & SPECIALTY CO.
426 So. Clinton St., Dept. 76, CHICAGO, ILL.



WAVECURL

Imparts beautiful wavy curls however luscious your hair is. One testimonial says: "My hair soon became a mass of wavy curls." For either ladies or gentlemen. Send 15c stamps or coin. Dept. 16, WAVECURL CO., ST. PAUL, MINN.

CORONA

FOLDING TYPEWRITER
CORONA TYPEWRITER CO., Inc., BROTON, N. Y.

Weights 6 lbs. Occupies little space. Durable, efficient. Costs but \$50. Write for booklet No. 13. New York: 141 West 42nd Street

"Board Me 30 Days" An Engine's Own Story

I am an amazing light feeder. I don't need high test gasoline. Ordinary cheap coal oil, kerosene or distillate suits me just as well; and I don't need much of it either. There are six brothers of us all very strong for our size. I'm 1½ H. P. and my biggest brother is

18 H. P. Some of us are vertical, and some horizontal; some have one cylinder and some two.

We do all sorts of work; we're no trouble to start; and we'll run 24 hours a day if you want us to. There are many attractive features in our family. We run fast or slow; we run very, very steady; we don't jump around; we run electric light plants, pumps, shop machinery, farm machinery, anything and everything. We are working now all over the United States and Canada, and in 32 foreign lands. We have to behave well to make good.

I can get "out on bail" to do your work for 30 days without cost to you. Work me as hard as you like; overwork me if you want to. If I don't deliver the goods, send me home without feeling sorry for me. One of my bigger brothers will come on the same terms if you would rather have him.

There's a free book "Engine Facts" that tells all about us; how we are made, what we can do, and how little it costs to get one of us for "keeps." And it tells lots of other things about engines. Write for your free copy to

Ellis Engine Company, 2826 E. Grand Blvd., Detroit, Mich.

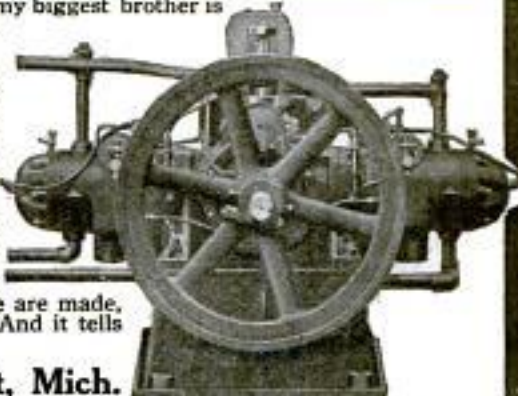

HEADLIGHT (Union Made) OVERALLS

"A
smile of
satisfaction
with every
pair"

Look for this ticket



Our Money-Back Offer

Guaranteed the best overalls you ever bought—of money refunded after 30 days' wear.

Larned, Carter & Co., Detroit

World's Greatest Overall Makers

Factories: Detroit and Post Huron, Mich.
St. Louis, Mo., San Francisco, Cal.
Canadian Factory: Sarnia, Ont. (4)

Please Mention Popular Mechanics

ADJUST-A-LITE

Brings Light Just
Where You Want It

Needed in every home, office, shop, factory—in fact everywhere that electric current is used for lighting. Can be carried in traveling bag—weighs 20 oz. including stand and shade. Quickly attached to Bed, Dresser, Piano, Chair, Desk or any place desired.

Ten Foot Cord Rolls Up in
Casing When Not in Use

Nothing to adjust. Nothing to get out of order. Fits any electric socket—comes ready for use. Lights from any current. Burns any make Lamp. Finest material in Nickel or Brush Brass Finish. Descriptive circular sent free. Price complete \$3.50.

Big Money for Agents

This is by far the handiest adjustable light on the market. It sells on merit. Write for our liberal terms that give agents a chance for big profits.



International Automatic
Utilities Co.

312 Old Colony Bldg.
CHICAGO



10 Days Free Trial



Play on the violin of your choice—and test it for 10 days before you decide to buy. Send it back at our expense or pay for it at the rate of only a few cents a day.

Rare Old
Violin Cir-
cular Free

The products of the leading violin makers of the world are yours to choose from—Ferry, Esader, Ullmer, Heberlein, Fiedler, Wurlitzer, etc.

Write Today for Special Circular. No obligations. Get full details of our offer direct to you. Write today.

The Rudolph Wurlitzer Company, Dept. 1197
8. Wabash Avenue, Chicago, Ill. 4th Street, Cincinnati, Ohio

WURLITZER

We supply
the
U. S. Govt.



THINK of a detachable bicycle Motor that you can attach to any bicycle in 5 minutes and ride at any speed up to 25 miles an hour—100 to 125 miles on one gallon of gasoline. Thoroughly practical—simple and economical. Full control from one small thumb lever attached to the handle bars of the bicycle. Descriptive literature on request.

A. O. SMITH COMPANY
Motorwheel Division 127
MILWAUKEE, WISCONSIN

30 DAYS FREE TRIAL



Total cost only

\$7.50 By
Our

7 MONTHS TIME
Purchase
Plan

to prove to you that this magnificent Royal has the SWEETEST, PUREST, LOUDEST and CLEAREST TONE—

to prove to you that it is as large and handsome as the trust machines that sell at \$25.00—

to prove to you that it has the strongest motor, the best reproducer and tone arm and the most ingenious devices to start, stop and control the music.

Shipped with a supply of 10-inch double disc records of your selection, so you can enjoy the finest entertainments for one whole month. Return the outfit

AT OUR EXPENSE

if for any reason you do not wish to keep it. Drop a postal for our big list of unsolicited testimonials, record book and other literature—all Free.

Central Distributing House
Dept. F 41 6101-11 May St., CHICAGO

Electric Light for Your Home

This newly invented system enables every rural home to make their own electric current; operates from one to fifty lights; and will drive small electric iron, electric iron, toaster, etc. Everything complete in one compact unit; no batteries or switchboard. Uses standard lamps and fixtures that any dealer can supply. Nothing to watch but the small, high-speed gasoline motor, which requires slight attention once a week.

The ideal electric lighting system for country homes. Nothing like it ever sold before. Costs less than other systems to buy and to operate. Will last for years.

WATERMAN MOTOR COMPANY
182 Mt. Elliott Ave. DETROIT, MICH.

Write today for descriptive literature and prices.

Uni-Lectric
GASOLINE-ELECTRIC UNIT
LIGHTING SYSTEM



250 WATT "WIRELESS" TRANSFORMER \$9.00

CLOSED-CORE TYPE SELF CONTAINED 14000 VOLTS 3 DIFFERENT POWERS Shipping Weight 20 Lbs.

Send 2¢ stamp for catalogue of Wireless Supplies, folders, etc. Winger's Telegraph Code Charts free with \$2 orders; otherwise 20 cts. each. Furnished in "station" or "pocket" sizes. Continental or Morse code; please state which, otherwise Continental "pocket" size will be sent. Winger Electric & Mfg. Co., 711 So. Dearborn St., Chicago, Ill.

Ford Owners

The Steer-erR will automatically steer your Ford straight—and without nerve strain, too. Stops wobbling of steering wheel. Price only \$3.75. Your dealer will put a Steer-erR on your car for a 10-day free trial; or if you have no dealer, write us for the same proposition. WALKER MFG. CO., 1511 Michigan Ave., Chicago

EVINRUDE

Detachable Rowboat and Canoe Motors attached in a few minutes to any kind of boat, make it a power boat. Can be carried anywhere. Automatic Reverse, Built-in Magneto, Maxim Silencer. Illustrated Catalog free.

EVINRUDE MOTOR CO.
31 Evinrude Block, Milwaukee, Wis., U. S. A.



\$628.80 Brings this Beauty



Sterling System Built Homes

Palatial 8-room STERLING Home—all materials complete—and all lumber cut-to-fit, saving 1/2 carpenter cost—four closets—modern in every detail—can be erected in 24 days. Price \$628.80 cash; balance on 2 years' credit. Total price, only \$1042.00.

WRITE FOR CATALOG

Send Postal for Book showing the Famous Fifty Sterling Homes—cottages, bungalows, two-story dwellings. Prices, \$206.50 to \$2500. We can save you big money—write!

INTERNATIONAL MILL & TIMBER CO.
Q10, Bay City, Mich.

Save 1/2 on Diamonds

Watches  Jewelry

Our Customers' letters continually prove this.

A FIRM of over 60 years of unquestioned integrity is offering special diamond bargains right now. Exquisite gems which you can secure at prices you should not overlook. Read below the indisputable reasons that make these attractive prices possible. Then write for latest bulletin. Just issued.

We are diamond bankers. We loaned money to the former owners of the fine diamonds we now offer. The loans have not been paid. So we must sell the diamonds at a fraction of their proper value. You get the benefit.

Diamonds of the finest grade—beautiful, scintillating blue white gems—fully 50% below the normal figure. And fully guaranteed. Don't miss these great bargains. Write—write today for the latest bulletin.

Diamond Banking

Our business as diamond bankers enables us not only to quote you amazing low prices, but it also enables us to get hold of the very choicest gems—diamonds which were selected originally by purchasers only after long study and investigation. We have often offered stones which cost originally more than \$100 for \$49 or less. You should write at once for the new bulletin with complete descriptions and prices—now ready to mail.

You can have a beautiful guaranteed perfect cut quality, blue white gem, 1/2-3/4, 1/64 karat in a lady's ring for only \$44.50 with a further loan of \$60 guaranteed. Try to match it for \$100.

A Belcher set with a 1-3/16 karat, blue white, perfect cut gem, will cost you but \$145.40 and we guarantee a \$200 loan should you need it. Just try to match it at \$250.

A Cluster—one of the most exquisite settings we have ever seen—is offered for only \$21.50, only because we loaned money on it. Try to match at \$50. In appreciation, a precious 1 1/2 ct. solitaire. Hundreds of sparkling unpaid loan bargains are illustrated in our latest bulletin. Write for it now.

Free Examination

The DeRoy Money-Back Guarantees

provide for Everything as offered; Exact weight to smallest fraction; Quality, color, etc. Exchange at full price; Exact cash loans.

We will send prepaid the gem or the watch of your choice on approval. See it and examine it for yourself. Compare it with any other you ever have seen—satisfy yourself that the price we are making you represents a most remarkable achievement even for a 60 year old house as large as ours—over \$700,000 behind us. If not satisfied with article after examining it, return at our expense.



Send the Coupon

For Latest Bargain Bulletin

Fill out the coupon and mail

it now—or send letter or post card

and get our big new bargain bulletin

absolutely free. No obligations of

any kind. Read our prices—then

decide yourself. See the exquisite

illustrations of the superb dia-

monds, watches, etc., you have

to select from. Write now.

Jos. DeRoy & Sons

Only opposite Post Office

197 DeRoy Building,

Pittsburgh, Pa.

Reference by permis-

sion—Farmers Dep.

Nat. Bank, Marine

Nat. Bank or any

Pittsburgh daily

Newspaper.

Jos. DeRoy & Sons
197 DeRoy Bldg.
Pittsburgh, Pa.

Gentlemen:—Please send me absolutely free and prepaid your new Bargain Bulletin of diamonds, watches and other jewelry. It is distinctly understood that I assume no obligations of any kind.

Name.....

Address.....

Please Mention Popular Mechanics



**STARRETT
TOOLS**

Accuracy

INSPECTION in modern factories has become so rigid that the accuracy of workmanship is measured to the thousandth of an inch.

Every high-grade mechanic prizes his Starrett Tools because he knows they are standard throughout the world. He knows his skill aided by these instruments makes him an accurate workman and that Starrett Tools are almost an insurance against idleness, for manufacturers know that the best workmen use the best tools.

Starrett Tools

include 2100 styles and sizes of fine instruments—steel rules, tapes, squares, levels, hack saws, calipers and dividers, micrometers, gauges, speed indicators and many others.

For sale at leading hardware stores. Send for Free Catalog No. 20 A. P.

THE L. S. STARRETT CO.
"The World's Greatest
Tool Makers"
Athol - - Mass.
New York Chicago
London

The L. S. Starrett Company
Makers of the Standard Tools
BY AUTHORITY
MEMBER OF
THE TOOL SOCIETY
NEW YORK U.S.A.

Please Mention Popular Mechanics



**JUST OUT!
FALL STYLE BOOK
40 CLOTH SAMPLES**

MADE TO ORDER
CLOTHES FOR MEN

FALL AND WINTER
CLOTHING

GLEN ROCK WOOLEN CO.
219 MAIN ST., SOMERVILLE, N. J.

\$10 to \$22

**Buy a Glen Rock Suit
or Overcoat and Save
\$8.00 or More.**

Send for our Men's Fall Style Book and 40 samples of cloth patterns. You select the style and cloth sample which you like best. Write your measurements in order-blank which we furnish. You can't go wrong. You can't lose on the Glen Rock plan.

Every garment is guaranteed not only to fit perfectly, but to keep its perfect shape permanently. Glen Rock garments are noted for the excellence of cloth, trimmings, cutting and tailoring. Signed guarantee attached to every made-to-order garment. The first step to save \$8.00 is to send today for New 1915 Style Book and 40 Cloth Samples—FREE.

GLEN ROCK WOOLEN CO.
J. E. Griggs, Treas. & Gen. Mgr. 219 Main St., Somerville, N. J.

FINE OLD VIOLINS

**On Easy Payments
30 Days Free Trial**



allowed, no matter where you live. If not more than pleased with our values return violin **AT OUR EXPENSE**—and no harm done. Ability to play the violin brings social and financial success. Get a violin with a rich, mellow tone and it will create in you a desire to master it.

**Free! Magnificent
Album-Catalog**

containing portraits of the world's greatest violinists since Paganini's time, a half-tone of "Stradivarius in His Workshop," and the romantic story of The King of Musical Instruments. A postal brings all to you FREE—no obligations.

CREMONA VIOLIN SHOP
Dept. B541 CHICAGO

There Are Water Wells All Around You To Be Drilled

Get a Star Drilling Machine, and as soon as it becomes known, you will learn of contracts all around you waiting to be closed up. One job suggests another, and so your business will grow like a snow ball rolling down hill.

Star Drilling Machines

Portable—Steam or Gasoline

One Star owner cleans up \$2,000 per year. Another started penniless three years ago and now owns \$4,000 worth of machines, a home worth \$5,500 and a \$3,000 bank account. Write us if you would like to get into the well-drilling business. Free booklet tells how we help you make money.

Star Drilling Machine Co.
506 Washington St., Akron, O.



WONDER LIGHT OUTFIT

Lots of Fun for Boys!
25 volt, 2 C. P. TUNGSTEN lamp, switch, socket, 20 ft. insulated wire and 3 coils of dry battery all ready to install. May be used to light a dark closet or hall.

PRICE ONLY 60c. Post. Extra 15c

LITTLE GIANT MOTOR
Is nearly 3 in. high. Runs at high speed on a single coil of battery. Very powerful and may be used to run small toys, etc. Just the motor every boy has been looking for.

Sent postpaid for only 50c

THE SIMPLEX TELEGRAPH OUTFIT

An opportunity for every boy to learn to telegraph and to put up a line with his class. This is a full sized telegraph set, consisting of a fine key and condenser, mounted on a polished base. Will work any distance. An excellent Field Telegraph for Boy Scouts.

Price, 98c. Postage Extra. Wt. 2 lbs.



EXPERIMENTERS

THIS IS THE Experimenter's Reference Book

It's the latest edition of the famous **Anso Catalogue**, contains over 200 pages and is fully illustrated. Complete description and prices of the latest electrical and experimental apparatus—Storage Batteries, Rectifiers, Transformers, Induction Coils, Wireless Apparatus, Lamps, Flashlights, Meters, X-Rays, Boats, Electric Railways, Steam Engines, Water Motors, Dynamos, Motors, Telegraphs, Telephones, Electrical Supplies, Model Aeroplanes and Parts for building your own apparatus. 6c in stamps will bring you this wonderful book. Contains a complete list of Wireless Calls, gives Codes, Wiring Diagrams, tells how to put up an aerial and install apparatus, etc.

Best catalog of Wireless and Electrical Apparatus, etc., published. Send for this catalog right away. Our prices will save you money.

Put an Electric Headlight on Your Bicycle

Every boy wants a practical electric headlight for his bicycle. **NO MATCHES—NO OIL—NO BOTHER.** Shows a powerful beam of light 200 ft. ahead. Burns 50 hours on one battery. Has powerful silver plated reflector and magnifying glass 4 inches in diameter. May be adjusted in any position. Comes complete with tungsten bulb, cord, battery case, etc.



PRICE ONLY \$1.75
A FINE CANOE LIGHT



Adams - Morgan Company "The Experimenter's Supply House"
Dept. M UPPER MONTCLAIR, N. J.

Mammoth Jubilee Book Free

Picturing 5152 Home Things

Get your book while the edition lasts.

SPIEGEL, MAY, STERN CO., 1401 W. 35th St., Chicago



Be the First in Your Club

School, City or Town, to wear this pure, all wool sweater, double collar and cuffs. Your choice in colors. This jersey was selected by 10,000 of my customers for last season. Your chum will recommend it. My 1915-1916 catalogue is now ready. Write me and learn my offer for your club's order. Popular Prices, Best Grade Sporting Goods—Football, Basketball, Baseball, Tennis, Golf, etc. WRITE ME NOW.

JACK SHANNON CO., Dept. 46, 54 E. Monroe St., Chicago

Waterman PORTO

1915 Model has reversing propeller, high tension magnet and unrestricted speed control. 3 H. P. Wt., 65 lbs. Sold direct from factory to you, freight paid. Original outboard motor—10th year—30,000 in use. Guaranteed for life. Fits any shape stern. Has automobile carburetor, removable bearings, solid bronze skeg protecting 10 1/2 in. propeller. Steers by rudder from any part of the boat. Water cooled exhaust manifold; wireless underwater exhaust; spin copper water jacket. Demand these essentials if you want your money's worth. Write today for free book showing both outboard and inboard engines. Our prices will surprise you.

WATERMAN MOTOR CO.
230 Mt. Elliott Ave., Detroit, Mich.



Makes Any Boat A Motor Boat

STEAM ENGINEERING



This \$35 Set—Now \$19.80

Here's your chance to own the famous **Steam Engineering Library**, written by 27 of the biggest and best known engineering experts in America, at a simply phenomenal price. The regular \$35 Edition for a short time at \$19.80 complete—\$2.00 a month.

This great work covers completely the construction and operation of stationary, locomotive and marine engines and boilers; the use of gas and gasoline engines for power and locomotion; the transformation of steam and gas power into electricity for power and light; the application of steam and gas power to the special uses of refrigeration, compressed air, etc.

Seven big, handsome books; bound in half red morocco, gold stamped; 3,300 pages; 2,500 absorbing illustrations, full page plates, diagrams, etc.; hundreds of valuable tables and formulas; cross-indexed so that you can get at any subject instantly, at this astounding introductory price.

SHIPPED FREE Look this entire set over for a whole week FREE. See if it really does fit in with your needs. Then decide whether or not you want to keep it. And don't send us any money until you decide. We'll ship the set absolutely free, express paid by us. See coupon below.

These Subjects Covered

Construction of Boilers—Boiler Accessories—Fuel Economizers—Mechanical Stokers—Pumps—Steam Engines—Indicators—Valve Gears—Steam Turbines—Gas and Oil Engines—Fuels—Locomotive Boilers and Engines—The Air-Brake—Hydraulic and Electric Elevators—Marine Boilers—Marine Engines—Heating and Ventilating—Compressed Air Machinery—Refrigeration—Ammonia Machines—Direct Current Dynamos and Motors—Management of Dynamos and Motors—Power Stations.

FREE!! \$12.00 Consulting Membership

Our big board of consulting experts, men actively engaged with engineering departments of prominent Chicago concerns, will answer any question or solve any problem you have for a whole year absolutely free when you own these books. This privilege alone sells for \$12.00, but you get it free if you keep the books.

SEND THE COUPON

Send no money. Merely send us this coupon. Books will be shipped at once, express paid. Study them a whole week. Then make up your mind. If you keep them, pay the special price—\$19.80—at the rate of only \$2.00 a month. But first see the books. The coupon brings them quickly. Mail it today. You take no risk, for we take the set back if you say so, and you are not out a penny.

FREE COUPON

Worth \$15.20 to You
American Technical Society:

Please send me 7 volume set Cyclopedia of Steam Engineering for seven days' free examination. If I decide to buy, will send \$2.00 in seven days and balance \$2.00 a month until \$19.80 has been paid, when \$35.00 books and \$12.00 consulting membership will be mine free. Otherwise will notify you and hold books subject to your order. Title not to pass until fully paid.

Pop. Mech. 10-15

NAME.....
ADDRESS.....
As I have had no previous dealings with you, I refer you to

Please Mention Popular Mechanics

(CONTINUED FROM PAGE 28 FRONT ADVERTISING SECTION)

TYPEWRITERS, all makes, factory-rebuilt by famous "Young Process." Look like new, wear like new, guaranteed like new. Our big business insure "Square Deal" and permits lowest cash prices—\$10 and up. Also, machines rented or sold on time. No matter what your needs are, we can best serve you. Write and see—now. Young Typewriter Company, Dept. 229, Chicago.

PRICES on all Slightly Used Late-Model Typewriters cut from \$100 to from \$30 to \$50 cash; mail course free; for price list and "monthly payment plan," address Carnegie College Co., Rogers, Ohio.

MAILING LISTS

FREE to business men, copy of our comprehensive "Silent Salesman." Contains over 2,000 different classifications of Mailing Lists with number and price of each list, and information every business man needs. Accept this free offer. Trade Circular Addressing Co., G 164 1/2 W. Adams, Chicago.

PRINTING, ENGRAVING AND MULTIGRAPHING

QUALITY Printing Prepaid—500 either envelopes, noteheads, cards, statements, \$1.25, 1,000 \$1.85; 1,000 envelope slips, \$1, 1,000 6x9 circulars, \$1.75. 500 linen-finish letterheads or envelopes, \$1.75; 1,000, \$3. Printing prepaid. Imitation typewritten letters. Stamp brings samples. Model Company, Manchester, Iowa.

BOND Letterheads, 100 each, large and small size, and 100 envelopes. All printed and prepaid for \$1. Write for samples. Fanco Press, 410 N. 7th Street, St. Louis.

4,000 GUMMED labels printed in two colors, 1 1/2x2 1/4. \$1. Label Shop, New Haven, Conn.

150 **HAMMERMILL** Bond Letterheads and 150 envelopes printed to order, \$1 prepaid. Samples free. Andrew Bros, Corona, N. Y.

BARGAIN—Buffum Automatic Card Press, \$105. Progressive Printery, Port Clinton, Ohio.

QUICK, Artistic printing; colors, engraving, cuts. Low prices. Guarantee with work. Catalog for stamp. Westall Rapid Printery, Worcester, Mass.

ENVELOPES, Billheads, Noteheads, 1,000 \$1.50. Samples free. Specialty: circulars, booklets. Jukes, 129 Fifth, Philadelphia.

1,000 **BOND** Letterheads, 8 1/2x11, \$1.00. Samples free. Burton Bros., Louisville, Ky.

1,000 **TYPEWRITER** Imitation Letters, \$3.00. Stamoule, 23 Duane Street, New York.

LETTERHEADS — 1,000, \$2.30; 2,000, \$3.50; 5,000, \$7.50; good grade bond paper, 16 pound; others charge more for same quality; samples free. Girard Job Shop, Dept. 5-1, Girard, Kansas.

1,000 **CIRCULARS** 4 1/2x6 printed, 200 words, prepaid \$1.40. Samples. National Printing Co., 917 S. Lafayette St., South Bend, Ind.

1,000 8x6 **CIRCULARS**, 100 Words, 8c. Postpaid, Chas. Walter, Lancaster, Ohio.

HEADQUARTERS for Printing Presses and Supplies. Lowest prices. List for stamp. Popular Bargains, Richland, Pa.

250 **EACH**—Bond Letterheads and Envelopes, \$1.50. Hoyt Brothers, Pittsfield, N. H.

MULTIGRAPHED Letters, complete—beating black, body purple, 25 lines copy, 1,000, \$3.50; 500, \$2.35; 250, \$1.75. Quick delivery, perfect work. Samples free. Franklin Letter Press, Waukegan, Ill.

ENVELOPE Slips, 3 1/4x6, 163 words, 1,000, \$1.00; 3,000, \$2.00, 5,000, \$3.00. Evans Press, 21 No. Main, Concord, N. H.

50 **CALLING** Cards, 1c. 25 Envelopes, 10c. F. Shephard, Rome, N. Y.

GUMMED labels; 1,000, 60c, 40 pp. catalogue, 2c. Mac Taggart, 1235 Arch. Phila., Pa.

250 **EACH**, letterheads, envelopes, \$1.25. Samples free. News, Thayer, Kansas.

250 **BOND** Letterheads and 250 Envelopes neatly printed, \$1.75, prepaid. Elegant samples free. Wolverine Press, 37 Harrison, Detroit, Mich.

HAMMERMILL Bond Letterheads and Envelopes, 100 of each, and 100 white wove return envelopes, \$1.00 postpaid. Samples Free. Toledo Press, Box 184C, Toledo, Ohio.

ILLUSTRATE your printing; Cuts from photographs 85c. We print anything. Samples free. Commercial Press, Batavia, Ohio.

1,000 **CARDS** Printed, delivered, \$1.30. Harley, 1731x, Esterpe, New Orleans.

MULTIGRAPH Letters, Letterheads—1,000 complete, \$3. Letters purple, heads black. Samples for stamp. Perfection Letter Company, Muncie, Indiana.

ADVERTISERS—Here's your opportunity. 25 word classified ad inserted in "Cartoons Magazine" for 50c; one inch display ad \$1.25. 20,000 copies guaranteed. Send in your ad for the next issue. Cartoons Classified Dept., 78 E. Madison St., Chicago.

PRINTING Outfits—Presses, type, supplies, type novelties. Send stamp for catalogue. Model Press, York, Penna.

GOOD Printing at low prices. 1,000 good letterheads, envelopes, cards, billheads, labels, circulars. \$2.50. Samples free. Catalogues, booklets, and circulars our specialty. Ernest L. Fantus Co., 523 S. Dearborn St., Chicago.

SAFETY BLADES SHARPENED

SAFETY razors sharpened; two cents each. Guaranteed. Blade box free. Electro Shaving Co., 134 Shelby St., Detroit, Mich.

PATENT ATTORNEYS

DON'T lose your rights to patent protection. Before proceeding further send for our blank form, Evidence of Conception, to be signed and witnessed. Book, instructions and advice free. Lancaster & Allwine, 221 Oursay Bldg., Washington, D. C.

PATENTS secured through Credit System. Free search. Send sketch. Booklet free. Waters & Company, 4192 Warder Building, Washington, D. C.

PATENT your invention without delay; it may bring riches. Attorney's fee payable when patent allowed. Reliable service for reliable inventors. No misleading statements to induce useless applications. Correspondence solicited. Jaynes & Jaynes, 655 Kellogg, Washington, D. C.

PATENTABLE Ideas Sold. Ten dollars upwards. Write for free circular, "One Hundred Patentable Ideas." "The truth about patents." Inventor's Association, 456 Louisiana Avenue, Washington, D. C.

PATENT Applications prepared, \$10. Why pay more? Best protection, quickest service. \$19,000 prize. Patent News, Dept. 152, Washington, D. C.

PATENT your invention. It may make your fortune. I secure valuable protective patents. Full information on request. Lester Sargent, 500 7th St., Wash., D. C.

PATENTS secured promptly. Personal attention. Edward W. Kibbey, Patent Attorney, 503 Victor Bldg., Washington, D. C.

PATENT your invention. \$10,000 offered for inventions wanted. Booklet and Opinion free. Milo B. Stevens & Co., Established 1864, 685 F St., Washington; 353 Monadnock Block, Chicago.

PATENT what you invent. It may be valuable. Write me. No attorney's fee until patent is allowed. Estab. 1882. "Inventor's Guide" free. Franklin H. Hough, 522 Loan & Trust Bldg., Washington, D. C.

THE Patentome is free. An education in obtaining patents. Established 1865. Anderson & Son, Attorneys, 707 7th St., Washington, D. C.

"**PATENTS** and Patent Possibilities" is a 72-page treatise which tells all about patents, what to invent and where to sell it. It gives honest advice to inventors, and is full of valuable and interesting information. Write for it today! It is free. H. S. Hill, 905 McLaehlen Bldg., Washington, D. C.

PATENTS of highest order secured for modest fees; information free. Burton T. Doyle, Attorney, Washington, D. C.

INVENTORS will receive prompt attention and advice from Edwin S. Clarkson, Patent Lawyer, 505 Victor Bldg., Washington, D. C. Established 1890.

PATENTS, Trade Marks, Information and advice free. William C. Linton, 633-4 F Street N. W., Washington, D. C.

PATENTS secured or fee returned. Send sketch for free search. Latest and most complete patent book ever published for free distribution. George P. Kimmel, attorney, 212 Barrister Bldg., Washington, D. C.

PATENTS—100 mechanical movements, 50 perpetual motions. Free. Send 10 cents postage for mailing. F. G. Dieterich & Co., 40 Oursay Bldg., Washington, D. C.

PATENTABLE Ideas Wanted—Send for 3 free books. R. B. Owen, 30 Owen Bldg., Wash., D. C.

PATENTS Secured—Take advantage of my personal experience; send sketch or model. Get my free book containing 200 mechanical movements. W. N. Roach, Jr., 950 McGill Bldg., Washington, D. C.

PATENTS—Trade-Marks. Send for my free book, "How To Get Them." It's full of information you should know. Joshua R. H. Potts, 3 Dearborn St., Chicago; 929 Chestnut St., Philadelphia; 805 G. St., Washington.

PATENTS explained in my free books, telling what you should know—what to invent—what not to invent—how to sell your patent, etc. Write today, H. L. Woodward, 902 G St., Washington, D. C.

PROTECTIVE patents procured promptly. 112 page blue book on patents sent on request. Trade-marks registered. Robb & Robb, 211-215 Southern Bldg., Washington, D. C.

PATENTS—Herbert Jenner, patent attorney and mechanical expert, 606 F St., Washington, D. C. I report free of charge if a patent can be had and its exact cost. Send for circular.

WANTED—New Ideas. Write for List of Inventions Wanted. \$1,000,000 in prizes offered for inventions. Our Four Books sent free upon request. Victor J. Evans & Co., 166 Ninth St., Washington, D. C.

PATENTS—Send sketch for free search and report. Books on patents and book of reference letters sent free. John S. Duffie & Co., 610 F St., Washington, D. C.

PATENTS build fortunes for you. Our free booklets tell how; what to invent, how to choose an attorney. Write today. D. Swift, 317 Seventh St., Washington, D. C. Established 1889.

PATENTS That Pay. Proof given. Two wonderful guide books free. E. E. Vrooman & Co., 871 F St., Washington, D. C.

C. L. PARKER, Ex-member Examining Corps, Patent Office. Patent Attorney, 910 G St., Washington, D. C. Inventor's handbook. "Protecting, Exploiting and Selling Inventions," sent free upon request.

PATENTS that protect and pay. Advice and books free. Rates reasonable—highest references; best results. Watson E. Coleman, Patent Lawyer, 624 F St., N. W., Washington, D. C.

NO Attorney fees until patent allowed. Send sketch for free report. Books free. Frank Fuller, Washington, D. C.

TRADE MARKS, COPYRIGHTS, ETC.

TRADEMARKS registered; all countries; protect your trade name or symbol, it is your business reputation; terms low; literature free. Sanders, 7 Webster Building, Chicago, Ill.

COPYRIGHTS procured; all countries; protect your literary, dramatic, musical, etc., works; terms low. Sanders, 7 Webster Building, Chicago, Ill.

FOR INVENTORS

WE furnish money to market meritorious patented articles, also sales plans and service. Describe in first letter what you have patented. National Advertising Company, Milwaukee, 412 Colby-Abbot Bldg.

WE desire to purchase meritorious patents or ideas for household or office specialties, either for cash or a royalty basis. Marshall Dobbin & Company, 1422 Marquette Bldg., Chicago, Ill.

INVENTORS—Let me advise you on your invention before spending money on patents. Also machines designed, ideas developed. Terms reasonable. D. Bushnell, M. E., 145 Arnett, Rochester, N. Y.

INVENTORS: Hiseox's Books will keep you "inventing" things that have been done before. Circulars free. Engineering Books, Box 243, Goshen, Ind.

PATENTS and Patentable Ideas Sold. Best location and facilities. Fuller Company, 500 5th Avenue, New York.

DRAWINGS made for inventors. Consulting Engineer, PM-3249 Seminary Ave., Chicago.

INVENTIONS—Patenting and Promoting. A book containing practical advice and directions for inventors and manufacturers. Book, instruction and advice free. Lancaster & Allwine, 221 Ouray Bldg., Washington, D. C.

PATENT specification and drawing prepared \$10. Send sketch. Free particulars. Seyer Company, 1160 New York Ave., Washington.

INVENTORS, attention! Patents sold on commission basis. Cash and per cent of profits our specialty. Write us for quick results. B. G. Martin & Co., 1609 Harris Trust Bldg., Chicago.

SECRETS and original ideas safely developed. We advise, plan, develop and execute original ideas in strict confidence. We are specialists in appliances and apparatus for reducing operating costs. We design, build or improve experimental machinery, dies, tools, etc., for manufacturers and inventors. Confide in us and we will respect your rights. Farrand Engineering Company, 44 No. 4th Street, Philadelphia, Pa.

INVENTOR'S Guide. One of the best books printed. Illustrated. Sent Free. E. B. McBath, 737 8th St., Washington, D. C.

INVENTIONS commercialized on cash and royalty basis. Inventors, manufacturers and agents write: Adam Fisher Mfg. Co., 61 Fisher Bldg., St. Louis, Mo.

WANTED—Models. Tools and Light Special Machinery to build. We have the Experienced Mechanics and Facilities to build perfect Working Models. Accurate, reliable and confidential work of every description. Regal Model & Tool Works, Chicago.

SELL your patent through the Patent Publicity Company, Browning Building, New York City. Particulars free.

MECHANICAL engineer expert on manufacturing methods and designer of special machinery, will develop your ideas and inventions into commercially practical form. Albert S. Kux, 105 W. Monroe St., Chicago.

PATENTABLE Ideas Wanted—Send for 3 free books. R. B. Owen, 30 Owen Bldg., Wash., D. C.

HAVE You an Idea? If so, you should protect it by a patent. Send us a model or sketch for free opinion as to patentability. Write for our Four Books sent free to any address. Victor J. Evans & Co., 157 Ninth St., Washington, D. C.

INVENTORS! Send to postage for Hand-some Book on Patents and List of Inventions Wanted. Sanders, 7 Webster Building, Chicago.

PATENTS, Trade-Marks and Copyrights. Our handbook on patents will be sent free on request. All patents secured through us are described without cost to the patentee in the Scientific American. Munn & Co., Patent Attorneys, 672 Woolworth Bldg., N. Y. Washington, D. C., office, 625 F St.

WIRE goods all kinds made to order. Cooley, 553 W. Monroe, Chicago.

INVENTORS! My patent made a fortune. Particulars free. Let me sell yours. Eugene Pearl, 423 Union Square, New York.

HAVE you a Patent to sell? You'll be interested in my proposition. Write now for free particulars. F. W. Johnson, 6 N. Michigan Ave., Chicago.

WANTED—An Idea! Who can think of some simple thing to patent? Protect your ideas; they may bring you wealth. Write for "Needed Inventions" and "How to Get Your Patent and Your Money." Randolph & Co., Patent Attorneys, 629 F St., Washington, D. C.

PATENTS without advance attorney's fees. Send sketch for free report. Books free. Frank Fuller, Washington, D. C.

INVENTIONS MARKED

INVENTIONS Marketed. This company's principal business is to develop for the market original and patented products of its own Laboratories. Its Sales Department will consider outside patented inventions. Send copy of patent with stamps for return. McCormick Laboratories, McCormick Manufacturing Company, Dayton, Ohio.

PATENTS FOR SALE

RESPONSIBLE party with means, buy outright or manufacture on royalty, small, inconspicuous, effective device; attaches to doors, windows; sounds alarm, lights room automatically; costs 1.3c to manufacture. Investigate. Harrison, Goldfield, Colorado.

SUITCASE handle. New practical device. Investigate. R. L. Stephens, 637 Lehmeyer St., Huntington, Ind.

PATENTS for Sale—"No Hook" garment fastener, made of wire, similar to hook-and-eye, but better. Also Rubber Vacuum Sticker for holding advertising posters, etc. in show windows; sticks to glass or other smooth surface; used instead of gummed paper stickers. J. P. Everitt, Sayre, Pa.

WILL sell Patents, American. Foreign just allowed. Automobile accessory. New. Prevents accidents. William A. Gilday, 5422 Irving St., Philadelphia, Pa.

PATENT—No. 1,040,922. Outright or Royalty. Household necessity of proven merit. M. R. Evans, 1853 Jefferson, Kansas City, Mo.

NEW Draftsmen's Protractor. Equals high-grade \$6.00 instruments; costs under 40c to make; can retail for \$2.00. Fine mail order article. Van Buskirk, Hodges Bldg., Detroit.

FOR Sale—Patent on novelty of great service to housekeepers. Chas. R. Pettes, Lakota, N. D.

FOR Sale—Patent No. 1,117,932, an improvement in putty production. Can be made very cheaply. Address, William W. Watson, Weir, Miss.

MECHANICAL Dictionary. Defines with crank; for children; model; price, W. H. Robinson, 1324 Newtown St., Paris, Ky.

PATENT for Sale—On account of change in business I am obliged to offer for sale a half interest in patent No. 1,111,209, which is for a new and improved life preserver, composed of a body harness with pneumatic rubber bags attached to same. Please address P. A. Pludowski, Gardner, Mass., P. O. Box 168.

FOR Sale—Outright or Royalty, a newly patented Sheet Metal Partition, U. S. A. and Canadian rights. Easily constructed and cheaply manufactured; can be made in all widths; full particulars. Chas. W. Sanders, 1808 Cook St., Victoria, B. C.

FOR Sale—U. S. Patent No. 1,015,833. System of hot-water heating by the force circulation. Best offer for cash, royalty, or trade for a new automobile. D. Pepsa, 19 Wanda Ave., H. P., Detroit, Mich.

PATENT for Sale. \$150; foot-operated Electric Switch for Electrically horn. Write for circulars. John Helstrom, Seabright, N. J.

SASH Lock. Patented 1907. Perfect substitute for sash weights or "window sticks." Millions needed. Circular free. G. G. Adamson, Crider, Ky.

PATENT for Sale—U. S. No. 1,136,826; Canadian No. 163,491; in Combination Pocket Tool. Herman Komelnska, 1091-15 St., San Francisco, Calif.

FOR Sale—United States and Canada patent, for folding fishtrap and Bel pot-umstatter, 961 Falls St., Bronx, N. Y.

\$909 BLYS outright new patent, vending device for restaurants, big opportunities, no competition. Harry Blythe, 2901 Union, San Francisco, Calif.

METAL Specialty, of merit; for dental office. B. M. Umboltz, Salina, Kansas.

PATENT for Sale—Cutlery Cleaner; will retail for 10c. Write for circulars. J. Helstrom, Seabright, N. J.

FOR Sale or Royalty—Patent on auger; borer holes for telephone poles; a winner. John O. Nelson, Onida, S. Dak.

FOR Sale—The Peerless Lock Nut; has stood the test. J. M. Bong, 3417 Cherry St., Milwaukee, Wis.

PATENT For Sale: 1,144,489, Barrel Cover Latch. Advice and two Patent Books free. E. E. Vrooman & Co., Washington, D. C.

INFANT'S Nursing Outfit; American, Foreign rights. Market millions yearly. Box 9, Spring City, Pa.

SMALL, compact, speed-reducing gear for any high-speed power. Simple in construction and very practical. Will sell outright or royalty. John Neff, P. O. Box 381, Honolulu, T. H.

PATENT Buyers are invited to address our sales department for information on any class of Patents they wish to purchase or lease on a royalty. We have secured a number of valuable patents in all lines of invention. Mail Order, Department Store and Household Novelties a specialty. Victor J. Evans & Co., 160 Ninth St., Washington, D. C.

GINSENG

GINSENG and golden seal roots and seed for planting; ginseng culture 10c; golden seal, estimate \$6,000 an acre. Booklet giving my experience, 10c. W. N. Long, Florence, Ky.

GINSENG—Two-year cultivated assorted plants, \$8.00 M. Wagner, Warsaw, Ohio.

GINSENG seeds, \$1 thousand; planting instructions free. Specialty Farm, Rockford, Minn.

MODELS AND MODEL SUPPLIES

FREE catalogue of model supplies. Castings, metal specialties on contract. North Chicago Tool Works, 15 Grove Ave., North Chicago, Ill.

PRODUCE of Results: Inventions developed, Models, Experimental Work, anything special in metal to order, novelties, spinning, forging, castings in any material, electrical devices, patterns of all kinds, plating, general manufacturing, designing, special tools, punches and dies, stampings. Send drawings or sample. Expert information free. John's Machine & Stamping Works, Dept. C, Cleveland, Ohio.

WE make models dies, metal novelties, stamping, etc., reasonable. Star Novelty Co., 4 Nicholson Place, St. Louis, Mo.

WE develop and perfect working models for inventors. Light machinery building, scientific experiment work. Dies made and stamping done. Modern Die & Tool Company, 70 Ship St., Providence, R. I.

MODELS, dies, and manufacturing for inventors, by builders of "Tools That Work." La Croix Tool Co., 214 N. 21st St., St. Louis, Mo.

MODELS made for inventors; general machine work; designing and perfecting; developing automatic devices and machinery. In a position to do all kinds of light tool and machine work. Prices reasonable; estimates cheerfully given. Ideal Machine Works, 62 Ann Street, New York City.

WE make working models for inventors; also dies and stamping of specialties, and carry a complete stock of brass gears and model supplies. Send for catalogue. The Pierce Model Works, 3405 Pierce Ave., Chicago, Ill.

SPECIAL Electrical and Mechanical devices built to order. Models, Tools, Dies. Benj. Levi, 357 West Broadway, N. Y. City.

MANUFACTURING

WANTED—To manufacture: Good new metal specialty. We have enormous mfg. and selling organization. What have you? Hugro Mfg. Co., Warsaw, Ind.

EXPERIMENTAL work of highest workmanship. Also machine parts of all kinds. Let me quote you. R. M. Hanson, 18 E. King's St., Chicago, Ill.

CLEVELAND Specialty and Manufacturing Company, Cleveland, Ohio, design or make special articles to order. Inventions developed.

LET Our factory be Your factory. Metal specialties developed and correctly manufactured. L. B. Nelson Mfg. Co., Peoria, Ill.

WIRE, wire goods and springs. Thomas Hamilton, 4538 N. Broad St., Phila., Pa.

WIRE Goods, all kinds, made to order. Cooley Mfg. Co., 553 W. Monroe St., Chicago.

REAL ESTATE AND FARM LANDS

SOUTHERN lands are low in price but high in productive value, make two to four crops a year and give largest profits in grain, vegetables, fruits, live stock and dairying. Unsurpassed climate, good markets. Southern Progress is on the Southern Railway. Publications on request. M. V. Richards, Commissioner, Room 64, Southern Railway, Washington, D. C.

PROFITABLE little farms in valley of Virginia, 5 and 10 acre tracts, \$250 and up. Good fruit and farming country. Send for literature now. F. La Baume, Agri. Agt., N. & W. Ry., 250 Arcade Bldg., Roanoke, Va.

MONEY-MAKING Farms throughout 15 Eastern States; one acre to 1,000 acres, \$10 per acre up; many with lives-ock and tools included; big illustrated catalogue free. E. A. Strout Farm Agency, Station 3943, 47 W. 34th St., New York.

VISIT San Joaquin Valley, California, this year. See the Expositions, too!!! Low fares for great World's Expositions at San Francisco-San Diego enable you to see wondrously fertile San Joaquin Valley as well as "Santa Fe." Look into this Promised Land of the Homeseeker now. Combine education, enjoyment and exploration. For free literature write C. L. Seagraves, Gen. Colonization Agent, AT&SF Ry., 1869 Ry. Exchange, Chicago.

BARGAIN—Fine little dairy farm, 61 acres, on river; Minneapolis, 20 miles; \$85 per acre. Buildings worth \$2,500. Terms. Washburn, 2741 Portland Ave., Minneapolis.

FLORIDA Opportunity—During the past year, which has been one of financial depression, panics, hard times and scarce money, we have sold to bankers, doctors, brokers, investment experts, lawyers and the choicest class of business men, about 17,000 acres of first-class orange, grapefruit and Natal hay land in Lake County, Fla.; this in spite of the fact that other companies in Florida have been doing little or nothing in the selling line. There is a reason why we have been able to do this and the reason is—the land. Let us show you as those who have bought have already been shown. Lake County Land Owners' Association, No. 93 Lake Ave., Fruitland Park, Florida.

WANTED: To hear direct from owner of good farm or unimproved land for sale. C. C. Buckingham, Houston, Texas.

CALIFORNIA Land, \$1 acre cash, balance entire purchase, 99 cents a month per acre; immediate possession given; no taxes; no interest; Merced County; 5-acre tracts up; clear; ready to plow; gravity irrigation \$1 acre per annum. Particulars, maps free. Sterenson Colony, 783 Market St., San Francisco.

WHEAT Land—160, 243, 320, 640 acre tracts, \$12.50 acre; some terms. One crop will pay price. A. J. Simonson, 214 Cooper Bldg., Denver, Colo.

BEARING Fig and Orange Orchards for sale in Southeastern Texas Gulf Coast. All these orchards are in best condition, located near town and railway station, and near preserving plants. For all information write to the owners, Theo. F. Koch & Co., 807 Transportation Building, Chicago, Ill.

CALIFORNIA Indian Land Sale, \$4 per acre. Residence unnecessary. Particulars, R. Carson Co., San Francisco.

I HAVE a successful way of selling farms and farm lands. Write me for free particulars. No obligation whatever. E. J. Zimmer, 925 Tower Bldg., Chicago.

BARGAINS in wheat and alfalfa land. Write Elmer Hager, New Ulysses, Kansas.

FAIRBANKS Garden and Poultry Farms, 10 and 20-acre tracts. Monthly payments. Right at station and on Shell Road. Only 40 minutes from Houston. Fine land. Write for information. Commercial Investment Company, 491 Commercial Bank Bldg., Houston, Texas.

SELL your property quickly for cash, no matter where located. Don't pay big commissions. Particulars free. Real Estate Salesman Co., Desk B, Lincoln, Neb.

FARMS for sale or exchange anywhere in the U. S. or Canada, direct from the owners. State where you want to locate. Information free. American Investment Association, 37 Palace Bldg., Minneapolis, Minn.

DOGS, BIRDS, POULTRY, PETS

GOLDFISH—Rare specimens, artistic aquariums, waterplants. Circular free. Pioneer Goldfish Hatchery, Racine, Wis.

All kinds of dogs—Descriptive book. Black tongue and mange cure included, 10 cents. Bunker Hill Kennels, Colfax, N. C.

FOR Sale—Two good coon hounds; also two well started. H. Buss, Upper Alton, Ill. Route 1.

RAISE Belgian Hares for us, big profits. We furnish stock and pay you \$2 each, also Gavis, Mink, Skunk, Fox, Squabs, Frogs, etc. Two booklets and contract for dime. Particulars Free, The Belgian Hare, Box 37, Holmes Park, Mo.

PURE-BRED Fox Hounds, suitable for fox, wolves, coon, skunk, opossum, mink and rabbits, trained and untrained. Ten days' trial allowed. J. E. Adams, Herrick, Ill.

BEAGLES—Rabbit, Fox Hounds, Setters, Pointers, Coon, Skunk, Squirrel, Bear, Deer, Wolf Hounds, Ferrets. Catalogue 10c. Brown's Kennels, York, Pa.

MISCELLANEOUS

DECORATE your suitcase. Six gummed hotel labels from all parts of United States, ten cents. Elbert Hall, Fitchburg, Mass.

INDIAN Baskets, Relics. Price free. G. Gilham, Highland Springs, Cal.

EGG-O-LENE (Eggrine or Re-Plac-O), the New Absolutely Real Egg Substitute. With my formulas and information it's easy to manufacture this and all my other New, Original, Reliable Formulas and Trade Secrets—Shoe Polishes, Automobile Specialties, Food Products, Flavorings, Beverages, Soaps, Fine Toilet Specialties. Stamp brings latest lists and free information regarding any product. H. Liscomb Miller, Manufacturers' Chemist—Tampa, Florida.

\$2.50 POCKET Adder. Send for circular. Bassett, 5921-L, Indiana Ave., Chicago.

BIG Mail Free. Your name listed once, 35,000 circulation and magazine one year 10c. Digest, Grand Rapids, Mich.

GET It Instantly. The Baf-File chart locates instantly tools, machine parts, stock in trade, catalogues, correspondence, books, etc. Self-explained. Simple. Reliable. Endorsed. Sent postpaid \$1. Baf-File Co., Washington, D. C.

HOW to make Printing Cuts cheaply, 150 selected formulas, 20c. Ideal Book Shop, 3311-M, Belleplaine Ave., Chicago.

ELECTRIC Machines—guaranteed—all makes—discounts 20 to 50%—send for literature—mention makes wanted. Morton, 1129 Olive St., St. Louis, Mo.

TATTOOING Machines. My Perfection Machine, \$8.00. Positively the finest machine on the market. Guaranteed. The Star Machine \$2.50. Catalogue of supplies. Send stamps if you mean business. Prof. J. Barber, 79½ Brush St., Detroit, Mich.

PAPER Bibs for the kiddies—absorbent face, waterproof back—sanitary, convenient and attractive. Fifty by mail postpaid for 25c. F. G. Crane, Muskegon, Mich.

CUTS anybody can make. Simple Etching Process, \$1. Particulars, specimens, for stamp. M. Day, Windfall, Ind.

GRANDFATHER'S Clock Works, \$5. Slightly shop-worn, quantity limited, others with chimes, all prices; also several nice Grandfather's Clock-cases, exceptional bargains. Clock Company, 1673 Ruffner St., Philadelphia, Pa.

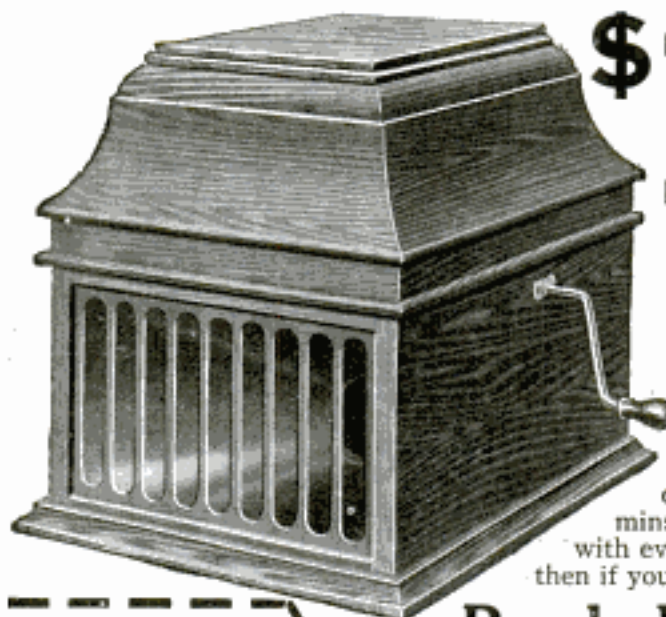

\$1.00 And You Keep This Superb New Edison

The great New Edison with the new Diamond Stylus reproducer and your choice of all the brand new Diamond Amberol Records will be sent to you on **free trial** without a penny down.

Entertain Your Friends

Hear all the latest up-to-date song hits of the big cities. Laugh until the tears stream down your face from laughing at the funniest of minstrel shows. Entertain your family and your friends with everything from Grand Opera to Comic Vaudeville—then if you choose, send the outfit back to us at our expense.

Rock-Bottom Direct Offer

Think of it—a \$1.00 payment, and a few dollars a month to get this brand new style outfit—the Diamond Stylus reproducer, the musical quality—the same Diamond Amberol Records—all the musical results of the highest price outfits—yes, the greatest value for \$1.00 down, balance on **easiest monthly terms**. Convince yourself—a free trial first! No money down, no C. O. D., not one cent to pay us unless you choose to keep the instrument.

Our New Edison Catalog Sent Free

Your name and address on a postal or a letter (or just the coupon) is enough. No obligations in asking for the catalog. Get this offer—while this offer lasts. Fill out coupon today.

F. K. BABSON, Edison Phonograph Distributors, 9197 Edison Block, Chicago, Ill.
Canadian Office: 355 Portage Ave., Winnipeg, Manitoba

To F. K. BABSON
Edison Phonograph Distributors
9197 Edison Blk., Chicago, Ill.

Gentlemen: Please send me your New Edison Catalog and full particulars of your free trial offer on the new model Edison Phonograph.

Name.....

Address.....

PREST-O-LITE

for
MOTORCYCLES

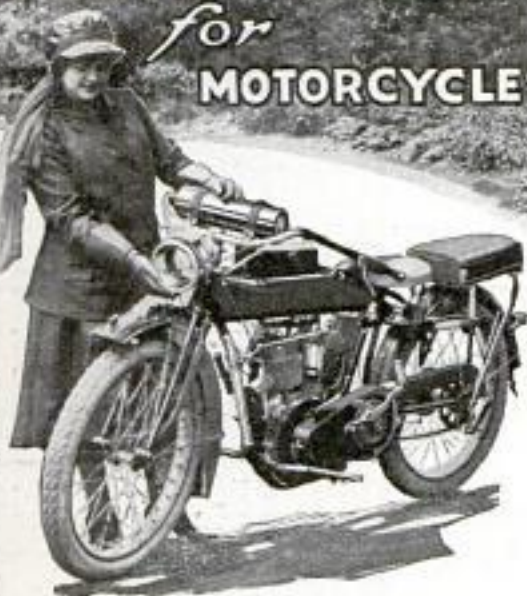

Economical Efficient and Brilliant Light

Prest-O-Lite gives perfect riding light—it is as sturdy as your motorcycle itself. It stands the jolts, needs no attention you yourself cannot give. Practical, simple, and trouble-proof.

Considering its simplicity and freedom from trouble, it is at once the most convenient and the most economical lighting system for motorcycles.

Complete Equipment for Regular Service

Nearly all dealers make this typical equipment combination: "Prest-O-Lite, a lamp, and a mechanical horn." Costs less to buy and less to use.

Your name and address on the margin of this page will bring complete information on motorcycle lighting. Get our valuable free book. Write today.

The Prest-O-Lite Co., Inc.

The World's Largest Makers of Dissolved Acetylene
265 Speedway Indianapolis, Indiana
Prest-O-Lite Exchange Agencies Everywhere

Square Deal
Miller
Says—

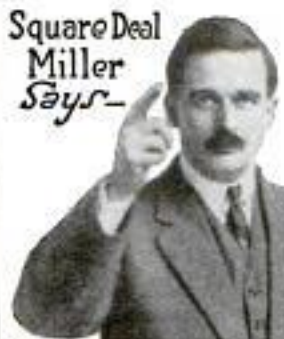

1916 Models Now Ready!

Any Watch You
Want
On Credit



**Waltham
Hamilton
Howard
Elgin**
Illinois, Rockford

All Are 1916 Models.

And I am the first man in the country to offer the **NEW 1916 MODELS** of America's best known watches. I have them all, the latest products of the world's most famous factories, and watches are by no means all. You can get too, the very latest style mountings for **Diamonds**, and the most up-to-date pieces of exquisite **Jewelry**. Whether you buy for cash or credit, the prices are right.

NO MONEY DOWN \$2.75 A MONTH

GIFT SPECIAL
NO A.I.

I Smash the Terms!

My Square Deal methods—my high grade, well known merchandise, my liberal policies, right prices, lowest terms, have earned me my title—"Terms Smashing Miller." No catalog published offers such remarkable values, such smashing terms, as our brand new **1916 Free Book**.

30 Day Free Trial

No Money Down Express Paid in Advance By Me

That is the test that tells. Suppose you want a watch? Any make, any grade, any size, any case. I have it for you—just the watch that you want—a **1916 Model**—NO MONEY DOWN, Express Prepaid. You can try any one of America's best known timepieces for 30 days. **A Free Trial, a Full Month to Carry It in Your Pocket.**

No References Demanded—An Open Account

The same credit you get from your grocer liberally and cheerfully given. Arrangements are made for an Open Account as soon as you write. No red tape, no publicity, notes, nor collectors. Every transaction strictly confidential.

Send This Today For Watch & Diamond Book

Send me your name and address at once so I can mail you, free and postpaid, the most beautiful catalog of its kind ever printed. I want you to see the **New 1916 Models** of America's best known watches. The book is a gem. It illustrates all makes of valuable **Watches, Elegant Genuine Diamonds**, and a vast assortment of **Beautiful Jewelry**, all on the easiest and most liberal terms.

Write today and get a letter from me that will make you a friend of mine from the start.

SQUARE DEAL Miller, Pres., Miller-Hoefler Co.
499 MILLER BUILDING
DETROIT, MICH.

SQUARE DEAL MILLER, Pres.
499 MILLER BLDG.
DETROIT, MICH.

Dear Sir: Please send me, without cost or obligation, your Big Book on all makes of High Grade Watches, the **1916 Models**, Genuine Diamonds and Jewelry and full information on your Easy Payment, No Money Down and 30 Day Trial Plan.

Name _____

Address _____

\$100 For Helpful INFORMATION

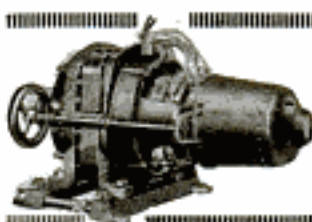

We explain below our plan for paying for intelligent information that will help us enlarge our market for the

KIMBLE Adjustable Speed—Alternating Current MOTOR

For the first time in industrial history a motor has been created that gives absolute control of speeds with alternating current and at the same time holds any and every speed through all load changes. It is a single phase motor that can be attached to any phase of a polyphase circuit.

There are thousands of people wishing for such a motor. We want you to help us find who those people are, and we'll pay you for your help, by offering prizes for the letters containing the most valuable information as follows:

Best letter	- -	\$25.00
Second best	- -	15.00
Third best	- -	10.00
Five next best	- -	5.00 each
25 next best	- -	1.00 each

Awards will be made by a committee of the officers and directors of this company, solely on the practical value to us of the information given.

We also want local representatives in territory not already assigned, and hope to be able to find many such from among the ones who compete for the above prizes, judging the fitness of the man by the intelligence and grasp of conditions which he shows in his letter.

HOW TO COMPETE

Write at once and ask for some of our Bulletins and one of our Instruction Sheets, so that you may know exactly what kind of information we want.

Then get busy and ask questions of managers, engineers, and superintendents of plants; makers and sellers of machinery; managers of central stations and others, and write down what you learn, in a letter, as long or short as you like.

Motor sizes are $\frac{1}{2}$ — $\frac{3}{4}$ — 1 — $1\frac{1}{2}$ — 2 — $2\frac{1}{2}$ H. P. 110 or 220 volts—all cycles.

Contest Closes Nov. 10, 1915



KIMBLE ELECTRIC COMPANY
2401 W. Erie St., Chicago, Ill.

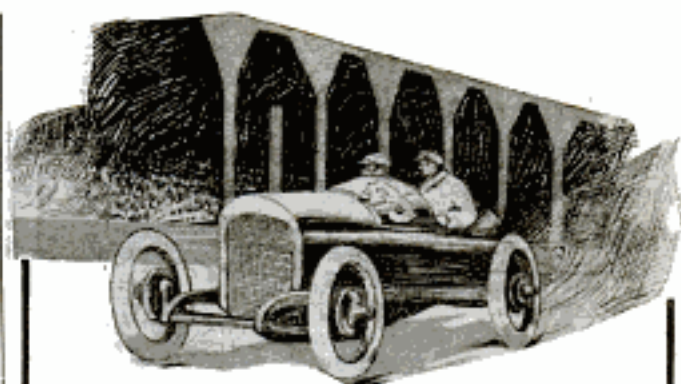

The Test of Speed

High speed—the most grueling test of a spark plug—has helped to develop Champion Reliability.

Every separate Champion type has been exhaustively tried out under racing conditions in the motor it is built to serve.

We have subjected Champions to a flow of sparks, far more rapid and constant than you will ever develop in your car.

This is merely one of the methods we have adopted to assure you perfect spark plug service under all conditions.

Champion
X for Ford Cars

Special $\frac{1}{2}$ inch, 75 cents

Since 1911 all new Ford cars have been equipped at the factory with this plug. When you replace the spark plugs in your Ford, follow the example of the Ford Engineers. Specify Champion X.



Caution The Champion X plug should be used only on Ford cars. There is a special Champion plug for every type of car.

Heavy Duty Motorcycle

This motorcycle plug is made in one piece and cannot leak. It is of extra heavy and durable construction.

The Champion Guarantee

Complete satisfaction to the user—free repair, replacement or money back.



Champion Spark Plug Company
406 Avondale Ave. Toledo, Ohio

SPECIAL!**GENUINE DIAMONDS BLUE WHITE Perfect Cut****1/4 Carat**

14K. Tiffany Style Solitaire ring, this month only \$17.75; set with full 1/4 carat blue white perfect cut diamond, \$35 value; our import price only \$17.25



Small Sizes as low as \$50 per C

Nowhere else can you get fine Blue White perfect cut Diamonds for only \$88 per carat, small sizes down to \$50 per carat. Expert comparison proves their value fully \$150 per carat. Direct importing system does it. You save the difference in cash. No middlemen get it. Your only opportunity to buy direct from importer.

\$88

Per Carat

Simply write for our Book. It's FREE. And setting. No references needed.

SEND NO MONEY IN ADVANCE! See our enormous assortment. Then tell us your choice of diamond. We'll ship, at our expense; allow you to examine and test them in any way. You will not be asked or obliged to buy.

The Only Bankable, Legal Money-Back Guarantee

Issued only by us. Permits you to return any diamond bought from us through any bank in America, or direct to us; and you'll get cash refund by return mail. Besides it guarantees full value if you exchange at any time! And it legally certifies the carat weight, color any money-value.

DeLuxe Book of Diamonds, FREE! First to show 1916 styles. Most remarkably book of diamond facts, inside methods used by experts, ever compiled. A postal brings it free by return mail. Mail it now! **BARNARD & CO., Dept. 5C, N. W. Cor. Michigan Ave. & Adams St., Chicago**

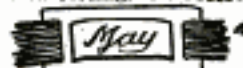

Friendship bracelet links. Sterling silver, initials or name engraved. Free. 10c
14K. Solid Gold Girl's ring. Sizes up to 6. Set with perfect cut blue white genuine diamond. \$30 value, \$2.88



Special September Price

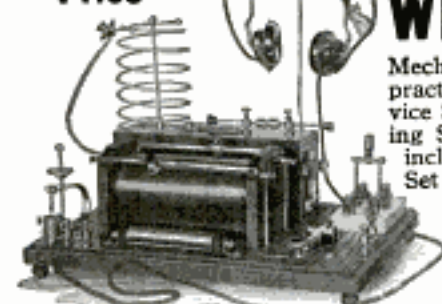

Regular Price \$20. Our Special Price for September only

FREE! FREE! FREE!

Receives up to 500 miles. Cannot be purchased elsewhere for less than \$6.00. We will make you a present of it. No work necessary—no strings to our offer. Write for full particulars and blank for ordering a station. 152 page catalogue A10 for 6 cts. stamps.

NICHOLS ELECTRIC CO.
1-3 West Broadway, New York

GET BEST WIRELESS

Mechanically perfect; a practical, ready-for-service Sending and Receiving Station; all complete including 2000 Ohm Head Set; sending up to 20 miles; receiving up to 2000; nothing better in this class ever constructed.

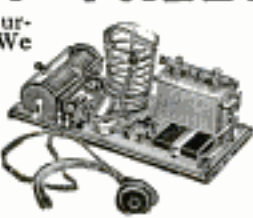
\$14.00**AKRON Independent Lighting Systems**

Supply gasoline under pressure through hollow wire to lamps all over the house, and to gasoline stove. Our system is absolutely safe.

Sheds a soft, steady, brilliant, white light of high candle power. Makes the home attractive and reading a greater pleasure. Better and cheaper than any other illumination.

Complete line of "Akron" portable and street lamps, and lanterns. Latest types; latest improvements; safe and simple construction; 15 years of success.

AGENTS WANTED in unoccupied territory. Handy demonstration outfit. Our proposition to live hostlers cannot be beat. Write quick for catalog and terms.

AKRON GAS LAMP CO.
622 South Main St., AKRON, OHIO



This Blue Serge Suit Tailored To Your Measure \$15



Thousands of men the country over are wearing Bernard-Hewitt line tailored-to-measure clothes. They like our tailoring—also the money we save them. We want to number you, too, among our regular customers—so secure your first order we will line your suit with a regular \$4 SATIN LINING WITHOUT EXTRA CHARGE and pay all shipping charges. We guarantee to please you in style, fit, workmanship and fabric or you don't pay us one cent. Send for our NEW Spring Catalogue—70 Samples FREE—Contains generous samples of plain and fancy suitings (prices \$15 to \$27.50) tells about our new system of tailoring—cutting direct through no agents or dealers—also quotes lowest prices on men's furnishings, hats and shoes. Write NOW **BERNARD-HEWITT CO., Desk D2A, 564 West Monroe Street, CHICAGO**

UNION Tool Chests

Over 15 Different Styles and Sizes

Plain or Quartered Oak or Leatherette covered.

Design, material and workmanship of the best.

Let Us Save Your Tools and Money

If dealer does not carry, we have a special offer that will interest you. You cannot afford to go without a Union. Chest guaranteed to meet your entire approval or money back.

WRITE TODAY—CATALOG FREE

UNION TOOL CHEST WORKS
22 Railroad St. Rochester, N. Y.



The Green Automatic

ADD TO YOUR INCOME With little effort you can make \$5 to \$10 a day

"AMERICAN" Sharpener

The "AMERICAN" is the only machine on the market (barring none) that sharpens, hones, and stropps razors, sharpens all kinds safety razor blades, scissors, clippers, pocket knives, surgical instruments, etc. No previous experience required. REMEMBER THE GREEN AUTOMATIC is one of our latest conceptions, it Sharpens, Hones, and Stropps each and every blade, all in one operation; it finishes from four to six blades per minute. Write for free booklet.



AMERICAN SHARPENING MACHINE CO., (Inc.) Dept. 10, 184 W. Washington St., CHICAGO



Try This Way to Save
Time in Your Office.

Western Electric Inter-phones

can be bought, two in a package, with wiring material and directions, all ready to attach to your present bell or buzzer wires.

When you have Western Electric Inter-phones, you can telephone your clerk or office boy for what you want without waiting for him to come to you first and wasting your time and his.

Inquire of your electrical dealer, or send check or money order for \$8.75 to our Department 55-AW for one of these outfits.

WESTERN ELECTRIC COMPANY

463 West Street, New York
500 South Clinton Street, Chicago
Offices in all principal cities



Please Mention Popular Mechanics

The Cheapest Power on Earth



for any machine capable of being run by hand, is this **Stewart Little Major Engine, 1/2 horse power.**

With battery, \$27.50; with high tension magneto, \$37.50.

The simplest, strongest and most practical big little engine ever offered. It operates for a full ten-hour work day on less than a half gallon of gasoline.

Just the thing to run a small press, washing machine, bone cutter, lathe, drills, small saw, cream separator, ice cream freezer, spraying outfit, pump, feed mill, etc. Stewart Engines in 1/2, 3 or 3 horse power sizes.

Order to-day or write for catalogue.
CHICAGO FLEXIBLE SHAFT CO.
105 N. La Salle St., Chicago, Ill.

A MARVELOUSLY PRACTICAL COMBINED Tool is this **Stewart Handy Worker**

Comprises on one base a vise up to 4 1/2 inches; width of jaw, 4 inches; powerful pipe vise up to 1 1/2 inch pipe; a strong, sturdy anvil; cutting hardie; drill press with two speeds; corundum grinding wheel, 5 inches x 1 inch, operated at 3 speeds, etc.

Weights, boxed, 90 pounds; complete, f. o. b. Chicago, \$12.50 only.

A complete workshop. Order one or write for booklet.



Chicago Flexible Shaft Company

105 N. La Salle St.

Chicago, Illinois

Save the Dealer's Profit



Why pay fancy prices when you can buy any of our 6 models, 1 1/2 to 12 H. P., and save 20 to 25 per cent. Try 30 days at our risk before you buy. Every motor guaranteed for one year. Write for our catalog today.

LOCKWOOD-ASH MOTOR COMPANY
1036 Barton Avenue, Jackson, Michigan



THEY NEED YOU

If you know Telegraphy, Wireless or Commercial. Teach yourself at home in half usual time and at trifling cost with the wonderful Automatic Transmitter. The **Omnigraph** sends unlimited Morse or Continental messages, at any speed, just as an expert operator would. Adopted by U. S. Gov't. 4 styles. Catalog FREE.

OMNIGRAPH MFG. CO.
39-B Cortlandt St. NEW YORK



BUILD YOUR OWN GRANDFATHER'S CLOCK

WITH OUR HELP

We furnish blue prints, finishing material and instructions. Buy the works, dial, weights and pendulum from us at surprisingly low prices. You make a fine profit building artistic clocks for your friends. Complete works, \$5.00. Others with chimes at all prices. Ask for attractive free offer.

CLOCK COMPANY
1673 Ruffin St., PHILADELPHIA, PA.





DEAF?
**"I
 Now
 Hear
 Clearly"**

Mr. Garrett Brown (photo above) is but one of the 200,000 deaf people whom the Acousticon has enabled to hear clearly and usefully. This makes us feel so certain of its efficiency, that we will gladly send to every deaf person, simply on request, our new

1916 ACOUSTICON FOR FREE TRIAL

No Deposit—No Expense

Just say that you are deaf and will try the Acousticon, and the trial will not cost you one cent, as we even pay delivery charges.

WARNING! There is no good reason why every one should not make as liberal a trial offer as we do, so do not send money for any instrument for the deaf until you have tried it.

We most sincerely state that we do not want one cent of your money if you cannot hear; that's the reason we want you to try the Acousticon first and convince yourself—you alone to decide. Just write today for your absolutely free trial and interesting particulars.

GENERAL ACOUSTIC CO., 1307 Candler Bldg., NEW YORK
 Toronto, Ont., Royal Bank Bldg.

30 Days FREE TRIAL

and freight prepaid on the new 1916 "RANGER" bicycle. Write at once and get our big catalog and special offers before buying.

Marvelous improvements. Extraordinary values in our 1916 price offers. You cannot afford to buy without getting our latest propositions. WRITE TODAY.

Boys, be a "Rider Agent" and make big money taking orders for bicycles and supplies. Get our liberal terms on a sample to introduce the new "RANGER."

Tires, equipment, sundries and everything in the bicycle line half usual prices. Auto. and Motorcycle Supplies.

MEAD CYCLE CO., DEPT. 6108 CHICAGO



ACORN UNI-LITE FREE

Turns night into day. 300 candle power. Carry as a lantern—use anywhere as a lamp. Weather proof. Kerosene or gasoline. For house, barn, garage, camp and around the farm. Write for big free offer. Special opportunity to farmers, stockmen and motorists. Agents make big money. Write tonight. Acorn Brass Mfg. Co., 808 Lam Bldg., Chicago

NEVERBREAK ALL STEEL SAW VISES
 PATENTED
 CLIPPER TOOL CO.
 BUFFALO, N. Y.



A Steel Saw Vise That Won't Break Only 50c each (postpaid)

Used by thousands of carpenters and builders—needed wherever a saw is used.

Two sizes: No. 57—wt. 1 1/2 lbs., length jaw 9 1/2"—50c
 No. 67—wt. 1 3/4 lbs., rubber jaws 10" long, 75c

If your dealer can't supply you, we can. Order today, mentioning dealer's name and address.

DEALERS: Write for our unusual proposition.
 CLIPPER TOOL CO., 284 Mills St., BUFFALO, N. Y.



Indiana Storage and Accessories Co.
 Indianapolis, Ind.

"A Fenestra Booster"

"YOU can say for me that Fenestra Solid Steel Windows are ideal for garage construction. I find my men work faster and accomplish more with less effort in our new building than they did before. Our garage is evenly heated and the gas and smoke never bother us because of the excellent ventilation. The saving in light bills is considerable. I will be glad to recommend your sash for this type of building anywhere."

H. J. Defrees, owner of the Indiana Storage and Accessories Company at Indianapolis, is a Fenestra Booster because he found

Fenestra
 SOLID STEEL WINDOWS

"REG. U.S. PAT. OFF."

as installed in his garage had all the advantages we said they had.

You will be just as enthusiastic as Mr. Defrees if you use fireproof Fenestra in the garage you are going to build. You can get these windows in standard sizes at the same price you would pay for wood sash.

Our pamphlet, "Suppose This Were Your Garage," gives all details. Let us send it to you free, or fill out the coupon for estimate of cost.

Detroit Steel Products Co.
 Dept. J-6 Detroit, Mich.

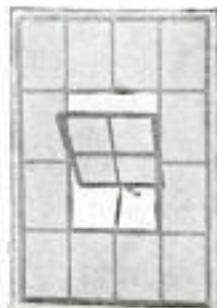

Standard FENESTRA horizontally pivoted. Ventilator operated by automatic gravity cone latch and stay operator, equipped with external adjustable lant.

Detroit Steel Products Co., Department J-6

Gentlemen: Without obligation to me please send estimate based on following data:

Kind of building

Chief building material.....

WINDOW OPENINGS

No.....Size.....No.....Size.....

No.....Size.....No.....Size.....

I want them ventilated [] Unventilated []

Per cent of ventilation desired.....

I attach blue prints [] Sketches []

Name

Address.....

Please Mention Popular Mechanics

BOYS! BUILD THINGS!

THIS BIG NEW BOOK

Vol. II — **THE BOY MECHANIC** — Vol. II

Tells All About 1000 Interesting Things To Make and Do

A SEQUEL TO, BUT CONTAINING NOTHING FOUND IN VOLUME I



480 PAGES (6 $\frac{3}{4}$ x9 $\frac{3}{4}$ in.) — 995 ILLS. — CLOTH — PRICE \$1.50

HOW TO MAKE

Bobbeds — Snowshoes — Ice Boats — Ice Gliders — Boats — Camps — Fishing Tackle — Houses of Poles — Kites — Aerial Gliders — Motion-Picture Camera — Spot-Light Lantern — Mile-O-View Camera — Photographic Appliances — Indoor Games — Tricks — Cyclemobile — Pushmobile — Flymobile — Roller Coaster — Ferris Wheel — Sunlight Flasher — Reed Furniture — Electrical Devices — Mechanical Contrivances — Art-Craft Work and hundreds of equally interesting things.

SENT POSTPAID UPON RECEIPT OF PRICE BY PUBLISHERS

POPULAR MECHANICS BOOK DEPT., 6 NORTH MICHIGAN AVE., CHICAGO



I Built this
Plant With
My Profits



I Want to Start Energetic Men

In A Permanent Profitable Business

A Business Like Mine—All of Your Own Repair and Retread Auto Tires—No Experience Needed

Listen to this if you want **success, wealth and power**—if you have nerve, ambition and energy and are waiting for your opportunity to get into a big paying business of your own. I started in the tire repair business about six years ago. There were mighty few automobiles then as compared to today. The automobile industry just about got under way. **Your chances to win now are ten to one better than mine.** This is the biggest year in the automobile business. Stop working for others. Get into business for yourself. Get the big end of the money instead of the small. I will show you how to gain independence, happiness, riches, if you will write me at once.

Make \$3,000 This Year to Start

One Million New Autos to be Made. This Gives You the Chance

Think of it. **One million new automobiles will be made in this country this year.** One concern alone plans to make over half the entire country's production. There are now nearly 900,000 Fords alone in use and they are being turned out at the rate of over 1,000 a day. **Think what a chance this gives you in the tire repair business.**

Punctures and Blow Outs Are Common

Every automobile means four tires to mend. **Over 4,000,000 tires will need repairing besides the millions already in use.** There is no business under the sun that offers such wonderful opportunities. And now you can get into it **easy.** Yes Sir. You can make \$3,000 a year to start. Many men with Haywood equipments are averaging that the year round. Many are making more. **Johnson, Texas, writes: "I have made as high as \$18 a day in this business."** I will gladly send you more proof of success when you write. The demand for tire repairing and retreading is already ahead of the supply, and 4,000,000 more tires will be added to that demand this year. **Be the first in your town with a new Haywood equipment.** Mends tires the best and quickest. Does the work

at the biggest net profits to you. **Retreading, vulcanizing and repairing of tires saves motorists money,** so business comes easy. Old autoists and the one million new autoists will be eager to give you their business.

Tires to Mend the Whole Year Round

Autos are used both winter and summer. **No seasons to tide over, without any work.** Money comes in from one year's end to another, continually growing bigger and better, making you rich, prosperous and contented.

Haywood Tire Repair Plants

are all complete in the finest detail. Nothing omitted to make them a winner. **Experience is absolutely unnecessary.** Just a little mechanical turn and follow directions is all that's required. The investment is small. **One machine will give you the start.** That's the way I did it. Business grows fast from this beginning. You will soon need another machine and then another. The first thing you know, you will be running a big shop—**You're a Real Manufacturer—and a Success.**

This Is Your Opportunity

There was never a better one for any man anywhere. Why not make the most of it while the chance is before you? **Why keep tied down,** shackled to the whims and purse strings of bosses? Why don't you hold the bag and make the big money? I built the business you see at the top of this page, the business I want to start you in. It's well worth your while to investigate. This coupon or post card will bring you complete information.

MAIL THE
COUPON TODAY



Get All the Facts From This FREE BOOK

The biggest year in the automobile business has just started. Learn all the secrets of this proposition. **The Free book gives all details.** Tells all about tires and how to repair them. Shows outfits in use. Tells stories of successes from men who grasped their opportunity. It's really an important message that every ambitious man should read. Just send your name and address only.

Use the coupon, a letter or postcard, but do it at once.

M. E. HAYWOOD, Pres.
**HAYWOOD TIRE &
EQUIPMENT COMPANY**
980 Capitol Ave.
INDIANAPOLIS, IND.

**FREE
COUPON**

M. E. HAYWOOD, Pres.
HAYWOOD TIRE & EQUIPMENT CO.
980 Capitol Ave., Indianapolis, Ind.

Dear Sir:— You can send me your book and full particulars about your tire repairing device. This, of course, without any obligation on my part.

NAME.....

ADDRESS.....



Build Models that Work! STRUCTO Does It More Parts—More Models

These are the exclusive features that have won boys to STRUCTO. No other make can give them to you. STRUCTO gears, wheels and pulleys are die cast. They cannot get out of mesh and they run smoothly. The shafting is all key-seated—preventing slipping of gears. Then there are more parts and more sizes—all non-rusting. These are features you should demand. You can get them only in STRUCTO.

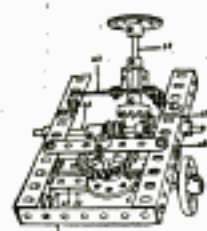
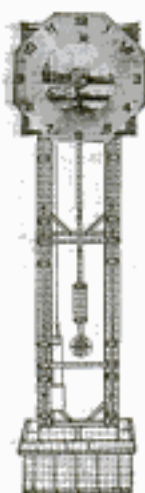

145 Models and a Million Combinations

You can build anything you want now—big suspension bridges, battleships, locomotives, aeroplanes, machine shops, fire trucks, derricks, etc., etc. These models really work. That's because of the exclusive STRUCTO features. We have made everything perfectly simple for you. Old and young alike are fascinated with STRUCTO.

Powerful Electric Motor FREE

Boys' dreams have at last come true—STRUCTO models work just like big machinery. With all STRUCTO outfits for five dollars or over you get a powerful electric motor free. It is equipped with standard shafting and gears, which are interchangeable to suit power and speed desired.

Die Cast Gears Key Seated Shafting



This Attractive Book FREE

Write for it NOW

This book gives a complete description of Structo parts and shows sample models of bridges, derricks, monoplane, battleships, clock, locomotive, etc. We will send you a copy Free for the asking.



Dealers. Thousands of boys are clamoring for STRUCTO. If you do not handle this quick seller, write us today for complete dealers' proposition. Address Dept. A.

STRUCTO MFG. COMPANY, Freeport, Ill.

Made in U. S. A.

(1)

Wonderful New Kerosene Light

Burns Vapor
Saves Oil

Beats Electric
or Gasoline



Awarded
Gold Medal
at World's
Exposition
San
Francisco

Scientists
say its
White Light
is nearest
to daylight
in color

10-Days FREE TRIAL

SEND NO MONEY, WE PREPAY CHARGES

We don't ask you to pay us a cent until you have used this wonderful modern light in your own home ten days—we even prepay transportation charges. You may return it at our expense if not perfectly satisfied after putting it to every possible test for 10 nights. You can't possibly lose a cent. We want to prove to you that it makes an ordinary oil lamp look like a candle; beats electric, gasoline or acetylene. Lights and is put out like old oil lamp. Tests at 38 leading Universities and Government Bureau of Standards show that it

BURNS 50 HOURS ON 1 GALLON

common coal oil (kerosene) and gives more than twice as much light as the best round wick open flame lamps. No odor, smoke or noise, simple, clean, no pressure, won't explode. Children run it. Several million people already enjoying this powerful, white steady light nearest to sunlight. Guaranteed.

\$1000.00 Will Be Given

to the person who shows us an oil lamp equal to the new ALADDIN (details of offer given in our circular.) Would we dare make such a challenge if there was the slightest doubt as to the merits of the ALADDIN?

Men Make \$50 to \$300 per Month With Rigs or Autos Delivering

the ALADDIN on our easy plan. No previous experience necessary. Practically every farm home and small town home will buy after trying. One farmer who had never sold anything in his life before writes: "I sold 51 lamps the first seven days." Another says: "I disposed of 34 lamps out of 31 calls." Thousands who are coining money endorse the ALADDIN just as strongly.

No Money Required

We furnish capital to reliable men to get started. Ask for our distributor's plan, and learn how to make big money in unoccupied territory. Sample Lamp sent for 10 days FREE Trial.

We want one user in each locality to whom we can refer customers. Be the first and get our special introductory offer, under which you get your own lamp free for showing it to a few neighbors and sending in their orders. Write quick for our 10-Day Absolutely Free Trial. Just say, "Show me how I can get a strong white light from kerosene oil, without risking a cent." Address nearest office.

MANTLE LAMP CO., 375 Aladdin Building

Largest Kerosene (Coal Oil) Mantle Lamp House in the World
Portland, Ore., Chicago, New York City, Montreal or Winnipeg, Can.

EDISON DAY

OCTOBER 21st

Edison's Dream Comes True



EDISON MAZDA LAMPS

In Millions of Homes, the Country O'er

—the fullest appreciation of Edison's invention of the incandescent lamp is now based on the bright, white brilliance of its successor of the present day —the EDISON MAZDA LAMP.

Three times as economical to operate as your old-style carbon lamps, your greatest saving comes when you put EDISON MAZDAS in every socket.

Make your home radiant with the three times greater brilliance of EDISON MAZDA. Your lighting company or nearest Edison agent will gladly help you choose sizes best suited to your needs.

EDISON DAY—October 21st—is the 36th anniversary of the invention of the incandescent lamp. Thirty-six years' experience in lamp making is summed up in the EDISON MAZDA LAMP of today.



EDISON LAMP WORKS
OF GENERAL ELECTRIC COMPANY

General Sales Office, Harrison, N.J.

Agencies Everywhere

5676

Please Mention Popular Mechanics

Copyrighted material

Tell Your Storekeeper

You Want

Butter-Kist Pop Corn

TELL him how hundreds of high class stores now have this sensational Butter-Kist Pop Corn Machine.

Folks stand spellbound and watch the miraculous way it runs itself.

Look for the Butter-Kist Popper in your neighborhood. See how it feeds the raw corn from the hopper; watch the kernels swell, jump and burst into big, fluffy white flakes—crisp, crackling and clean—untouched by hands and piping hot! See how this marvelous machine butters each morsel evenly with pure creamery butter—more dexterous than human fingers. You never tasted such a tantalizing treat as BUTTER-KIST. Folks walk blocks to get it.

MERCHANTS! Net Profits Up to \$3120 Yearly, Many Actually More

This beautiful BUTTER-KIST Corn Popper is reaping a year-round harvest of spot-cash sales for high class department, drug and fruit stores, picture theatres, restaurants, cigar stands, etc. Brings new customers—increases store profits.

Small confectioner sells \$5 to \$16 BUTTER-KIST daily. One installed last Winter took in \$2080.65 the first 5 months. Many making \$25 to \$60 clear per week.

Hundreds of records prove that BUTTER-KIST Corn Popper earns 5 times as much profit as anything else in the store for space occupied. Earning capacity variable from 75c to \$4 per hour. 70c profit out of every \$1 in sales.

Superbly Built—Runs Itself

No stock to carry—no watching. Stands anywhere—occupies only 26x32 inches—just move a chair and you have room for it.

Handsome and attractive—beautifies your store. Superbly built with plate glass, and mahogany or oak or white enamel cabinet. Metal parts highly polished and nickelled.

Pay From Your Sales

A payment of \$150 puts the BUTTER-KIST Corn Popper in your store—all privileges included. After that it quickly pays for itself.

Dealers! Write for "The Little Gold Mine," FREE

This valuable new book gives facts, photographs, figures that prove profits, and full details. Sent free, postpaid. Write at once—every day gained means big money to you.

Holcomb & Hoke Mfg. Co.

1736 Van Buren Street Indianapolis, Ind.

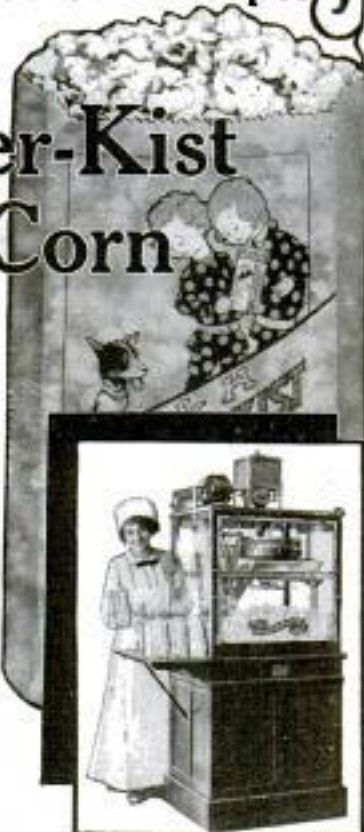

This Instructive Automobile Book FREE

HELPFUL INFORMATION for the care of Automobiles

What Do You Know About Your Car?

Can you make the repairs that save little bills now, big bills later on? Can you get everything out of your car that the manufacturer put into it? Do you know how to cut your tire cost by taking care of your tires?

Learn Your Car! Let us send you this book—"Helpful Information"—FREE. It tells you, in simple terms, all you need to know to take care of any emergency, make any repairs. Helps you know where trouble is, and to correct it. Covers every automobile problem. Complete in every detail. YOU cannot get a book like it for money. We give it to you FREE, with three months' subscription to *The American Chauffeur*. This offer is made for a limited time to introduce to you *The American Chauffeur*, one of the best magazines in the automobile field. Each issue contains valuable information. Send 25c in stamps or coin, and send it at once. The edition is limited, and offer will soon be withdrawn.

The American Chauffeur, 351 Blair Bldg., Cincinnati, Ohio.



STANWELD Cold Drawn Seamless Steel TUBING

Lightest, smoothest, strongest Steel Tubing made. World's largest manufacturers of bicycles, motorcycles and automobiles use it exclusively. Send for Folder "A."

THE STANDARD WELDING COMPANY
Main Office and Factory CLEVELAND, OHIO

Sharpen Your Safety Blades With a Stag Sharpener \$1 POST PAID

The only one of its kind. Note wheel in holder! Sets blade always at proper angle. Simple, Easy to use; Sharpens any safety razor blade. GUARANTEED. Will last a lifetime. Highest Awards at Panama-Pacific Exposition. Complete nickel plated holder, barber's hone and strap in neat case, \$1.00. Money back if dissatisfied.

The Stag Company, 38 South State St., Chicago, Ill.



Agents and Dealers Wanted



REDEMOTORS

GREATEST SMALL GAS ENGINES

These small engines are now accepted as the logical power for light machinery. For running Washing Machines, Cream Separators, Churns, Pumps, Coffee Mills, Railway Velocipedes, Boys' Autos, Boats, Electric Dynamos, etc., they have no rival. Thousands in use in all parts of the world. Run on gasoline, kerosene, alcohol or on city gas, natural gas or blaugas. 1 hp., 1/2 hp. and 3/4 hp. Get Catalog J.

ELGIN WHEEL & ENGINE CO., ELGIN, ILLINOIS

CARTOONS MAGAZINE

this month carries on the great continued story of the world war and the world movement. More than 200 cartoons representing public opinion in the United States, Great Britain, Germany, France, Japan, Spain and Italy, with editorial comment from the most authoritative sources, make a fascinating chapter of History.

Ask your newsdealer for a copy, or send for sample copy to 6 N. Michigan Ave., Chicago

\$3.00 a year. 25c on newsstands.

DENBY $\frac{3}{4}$ ton Truck \$890

With body as shown. Top, panel body or starting and lighting system may be obtained if desired at moderate extra expense.

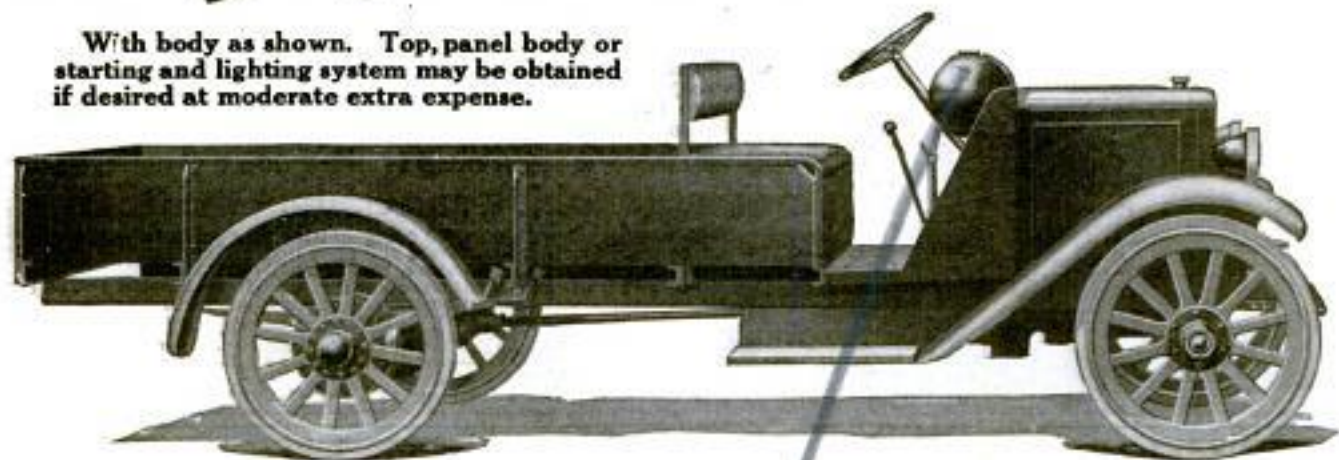

Don't Be a "Neighborhood Business" Any Longer

The growth of ninety per cent of the smaller business establishments is directly restricted by the limited field they are able to serve. Motor-haulage will increase the size of their "neighborhood." But they must be equipped to take full advantage of it in a sales sense. That is why we are announcing in connection with latest Denby model,

The Denby Business-Building and Sales-Efficiency Service

What It Is

This service—an exclusive Denby feature—embodies a year's course, under the direction of experts, in everything that has to do with increasing sales, adding new customers, building business.

There are thirty-six lessons, divided into quarterly periods of nine lessons each. The best experts obtainable have been employed in their preparation.

The driver of the truck—the man who comes in closest contact with customers, and who sees many that seldom come to the store—is the logical person to take the course.

But it is free to any person nominated by the owner of a Denby truck. And it means an efficient salesman added to your force.

\$3000 in Rewards

We have appropriated \$3000 to be awarded to the students who show progress. \$1000 of this will be paid November 1, 1916, to the person who has exhibited the greatest aptitude, whether he shall have taken the whole course at that time, or only part of it.

\$2000 additional will be paid in subsidiary awards during the year.

The judges, whose decisions shall be final, are:

GARVIN DENBY,
President, Denby Motor Truck Company

J. WALTER DRAKE,
President, Hupp Motor Car Company

CARL S. VON POETTGEN,
Advertising Counsel

Larger Units, Too

While this Service was inaugurated principally to aid the small merchant, it is open to the purchaser of any Denby model.

The larger units maintain the supremacy which, in little over a year, have placed the Denby in the front rank of commercial motor-vehicles, and have made necessary the purchase of a greatly enlarged factory.

The internal-gear axle—which has made obsolete all other forms of drive—is a feature of all models.

Denby trucks are built by a thoroughly experienced organization with years of success behind it.

The prices of the larger units are:

Type B—1-ton . . . \$1475

Type D—1½ tons . . . 1685

Type E—2 tons . . . 1985

Write for particulars of the type you are interested in, and of the exclusive Denby service that helps to solve the problem of "making it pay."

Denby Motor Truck Company, 403 Holbrook Ave., Detroit, Mich.

Please Mention Popular Mechanics

5¢ A DAY BUYS A GIBSON



OPEN—A splendid, permanent teaching and business opportunity to the right teacher—either sex.

Tilted neck permits high bridge with extension string holder, securing increased string pressure and higness of tone never before realized. Reinforced non-warpable neck—elevated guard-plate and finger rest. Easy action. Adjustable string bearing at bridge overcomes sharpening of heavier strings in upper positions.

Big Money Teaching and Selling the Gibson

Become a teacher—we show you how. Splendid opportunities for mandolin and guitar teachers—either sex, in every locality, for private and class instruction, and the sale of Gibsons. The Gibson has "made" many a teacher, professionally and financially. U. A. Templeton, Sioux City, Iowa, writes: "If it were not for the Gibson I would not be a teacher. I consider that you started me in business." F. Marshall Bell, Flint, Mich., writes: "I have sold \$1000 worth of your goods since last year." **The Gibson is used and endorsed by Wm. Plich, Jr., Providence, R. I., star soloist for Victor Talking Machine Co. Since today, if a teacher, become our agent, do business on our capital. Seek territory. We help sell. Agent's territory protected. You make the profits. We pay the advertising. Pay for goods when sold; return made not sold. Try our "50¢ Hunt" Catalog and Thematic list free. Write promptly, positions pending.**

GIBSON MANDOLIN GUITAR CO., 170 Harrison Court, KALAMAZOO, MICH.

KEITH'S \$1 Offer

1st—A 100-page number of Keith's Magazine, a special number devoted to Bungalows.

2nd—A big book containing up-to-date designs for 140 Bungalows and Cottages.

3rd—A six month's subscription to the well known and leading authority for home builders, Keith's Magazine, \$2 a year, 20c copy.

ALL THE ABOVE, SPECIAL \$1.00
KEITH'S, 778 McKnight Bldg., MINNEAPOLIS, MINN.



Easy
to
Put
On

The
Roof that
Stays and Pays!

Hard
to
Wear
Out

THERE'S one roof the elements can't get the better of—one roof that won't fly off or wear out in a hurry—one roof that stays and PAYS. It is an

EDWARDS Metal Roof

Costs less in the first place. Easier to lay than a wood shingle roof—a man with hammer does it all. Lasts five times as long. Always tight—that's because of the patented interlocking device and "Tighttite" process. No raw edges. No spots to rust or rot. Each sheet completely dipped in molten metal. Covers all edges as well as sides.

Other Advantages And a \$10,000 Guarantee Bond insures you against lightning loss.

All styles and sizes. Edwards Metal Roofing comes in handy sheets all ready to lay. Goes on with hammer and nails—Then your roof is on for good! It will pay you to write for Bureau Catalog No. 1930. Give size of roof for complete estimate of cost. Write today—now—while prices are still down.

THE EDWARDS MFG. CO. 1000-1030 Lock St. CINCINNATI, OHIO

You're
Guar-
anteed
Against
Lightning
Loss

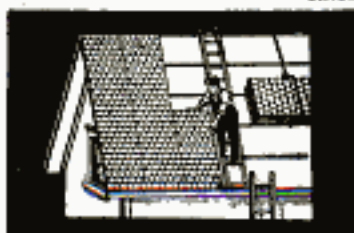

Absol-
utely
Weather-
tight
in All
Seasons

Every Southern Land Owner

should have our 1915-16 Nursery Catalog of Grapefruit, Orange, Lime, Peach and Plum Trees.

If you want the highest grade guaranteed nursery stock do not fail to write for our latest FREE catalog. It gives you much valuable information regarding preparing land, setting and caring for trees. Every tree guaranteed to grow and true to name.

THE C. E. THOMAS NURSERIES
Zack and Florida Ave. TAMPA, FLORIDA

INCREASE YOUR INCOME

during spare time. Start profitable Mail Order business at home. We supply everything. Write for particulars **NADICO, 4309 Lincoln Ave., CHICAGO, ILL.**

1916 Model **RIDE a RANGER**

bicycles and know you have the best. Buy a machine you can prove before accepting.

DELIVERED FREE ON APPROVAL and 30 days' trial. No expense to you if you do not wish to keep it. **LOW FACTORY COST**, great improvements and values never before equalled in our 1916 models.

WRITE TODAY for our big catalog showing our complete line of 1916 bicycles, TIRES, sundries and parts, and learn the wonderful new offers and terms we will give you. Auto and Motorcycle Supplies at factory to user prices. Do not buy until you know what we can do for you.

MEAD CYCLE CO. DEPT. 8104 CHICAGO

NEW TOP for \$10 Your Old Ford \$10

Make your Ford look like new by putting our Slip Roof Outfit over the old top frame. This outfit consists of new rubber roof, back curtain, back stays and quarters. Furnished complete with tacks, etc., ever put on and guaranteed to fit. **One-Man Repair Top \$25.** Above tops and outfits fit 1913-14-15-16 Ford touring cars. State year when ordering.

CLEVELAND TOP CO., 3102 Franklin Ave., Cleveland, Ohio

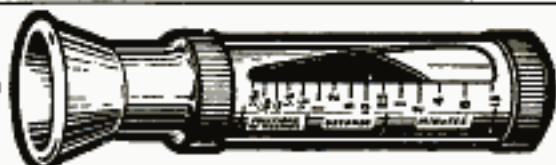

Do You Photograph? The TRILUX Exposure Meter

tells instantly, accurately and easily the correct time for all exposures indoors and out

All timing guesswork is eliminated. Shows instantly, on plainly marked scale, time for exposure; used with any film or shutter. Can't get out of order. No sensitive paper. No larger than a roll of film—weighs less than three ounces. Neatly finished, in gunmetal and nickel. Use the Trilux and never lose a film. At your dealer's or postpaid, \$2.00. Money back if not satisfied. Send for catalogue. **Trilux Photo Co., 1491C Marquette Bldg., Chicago, Ill.**

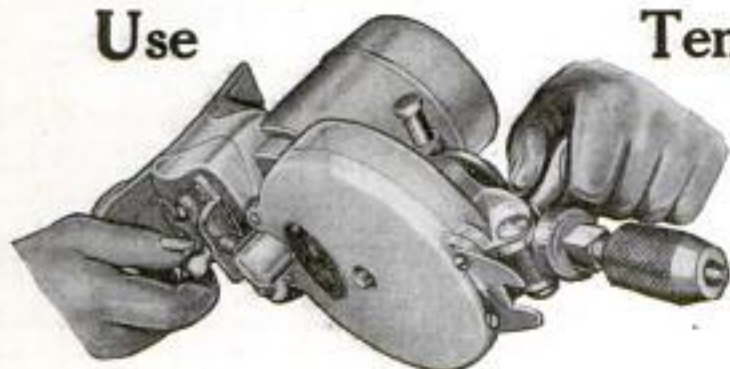
TEMCO**Automobile
and Garage
Necessities****Use****Temco**

Electric Portable Tools

for drilling in iron, steel or wood, tapping, sharpening tools, reamers, cutters and grinding dies and lathe centers.

Get Quick Results and Double Efficiency

Do away with that tiring hand work. Temco Tools cost but little while operating and stop all expense when not in use. Carry them anywhere in the shop or factory. Connect them to your drop light and you have the most modern equipment—equipment that saves you time and labor and brings quick results.

Compact in Design—Easy to Operate

An operator will appreciate a handy tool like Model B Drill. The weight is so well distributed and it is so compact in design that the drill is well balanced when held in the hands. Easy to operate because the switch is always accessible, right where you want it—near the handle. You do not have to release your hold on the drill to start, stop or reverse the motor.

Reverse the Motor When the Drill Sticks

No matter whether the motor is running at full speed or not—it instantly reverses. The same switch starts, stops and reverses the motor and is always under your thumb when you hold the drill naturally for work. The Motor will not burn out.

Let us show you how a Temco Tool will take care of your needs. We have different models for varied requirements. Ask your dealer for a catalog on Temco Tools. Study the advantages offered. Apply the features to your particular work.

If your dealer cannot supply you with Temco Tools or literature, write direct to the factory and we will see you are supplied.

The Temco Electric Motor Company

Main Office—Factory 119 Sugar Street, LEIPSIC, OHIO



TEMCO Shock
Absorbers
For FORD Cars
Complete Set of 4 \$ **15**



TEMCO Improved
Master Vibrator
For FORD Cars \$ **12.50**

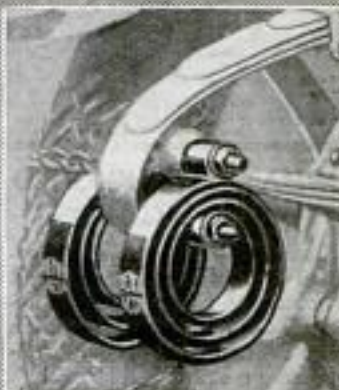

TEMCO-ALTA
Universal
Shock Absorber
For All Cars
Complete Rear Set \$ **12**



The Picture of Health

And they used to be so thin, underweight, pale and tired looking. Now they are plump, properly proportioned, contented, capable and resourceful — their bodies well nourished and clothed with the proper amount of solid, healthy flesh.

A good physique can only come from health, properly fortified by a normal, natural supply of firm flesh and muscular tissue.

A product like Sargol for the needs of people who are thin, underweight and undeveloped is necessary. It will not of itself make fat, but mixes with the food you eat for the purpose of preparing the fats, sugars, starches and muscle building protein of your meals into a rich, ripe, flesh and weight producing condition that your blood can readily assimilate and distribute throughout your body.

SARGOL

works on the theory that most of the fat and tissue building elements of food pass through the thin person's body as waste. That to stop this waste and encourage proper food assimilation means the creation of millions of new flesh-forming cells and the rounding out and developing of the body to proper, normal weight and proportions.

Sargol either will or will not increase *your* weight and the only way you can ever know is to try it.

Let Us Prove What Sargol Can Do For You

Let us send you a regular 50-cent package of Sargol free for your own use. Take one tiny tablet with every meal and watch results. With the package we will send you valuable information on the nutrition and assimilation of food and the testimony of many who report successful use of Sargol. Address

THE SARGOL COMPANY

849-K HERALD BUILDING

BINGHAMTON, N. Y.

WHAT YOU SHOULD WEIGH

The following table of Normal Weights for both men and women will enable you to decide how badly you fall beneath the average that proper development demands.

Height	Men	Women
5 ft. 0 in.	121	113
5 ft. 1 in.	124	116
5 ft. 2 in.	129	121
5 ft. 3 in.	135	127
5 ft. 4 in.	139	131
5 ft. 5 in.	145	138
5 ft. 6 in.	149	141
5 ft. 7 in.	156	148
5 ft. 8 in.	161	153
5 ft. 9 in.	166	158
5 ft. 10 in.	171	163
5 ft. 11 in.	176	168
6 ft.	182	174

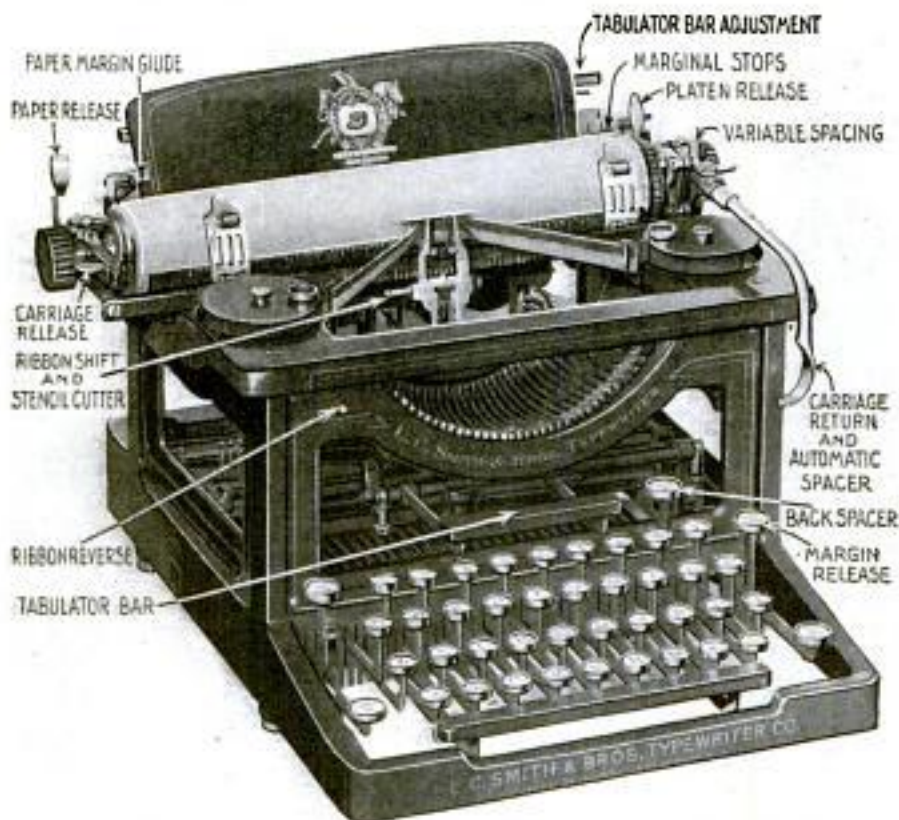

TYPEWRITER SENSATION

Free TRIAL—Use As You Pay

Only \$2.50 a month until the low total price of \$48.80 is paid, and the machine is yours

This is absolutely the most generous typewriter offer ever made. Do not rent a machine when you can pay \$2.50 a month and own one. Think of it—Buying a \$100.00 machine for \$48.80. Cash price, \$45.45. Never before has anything like this been attempted.

Standard Visible **L. C. Smith**

Perfect machines, not damaged or shop worn. Standard size, Keyboard of Standard Universal arrangement writing 84 characters — universally used in teaching the touch system. The entire line of writing completely visible at all times, has the tabulator, the two color ribbon with automatic reverse, the Back Spacer, Ball Bearing type bars, Ball Bearing shift action, the carriage runs on Ball Bearings, in fact every late style feature and modern operating convenience. Comes to you with everything complete, tools, cover, operating book and instructions, ribbon, practice paper—nothing extra to buy. You cannot imagine the perfection of this beautiful reconstructed Ball Bearing typewriter until you have seen it. I have sold several thousands of these perfect latest style Model No. 2 typewriters at this bargain price and every one of these thousands of satisfied customers had this beautiful, strictly up-to-date, visible machine on five days' free trial, before deciding to buy it. I will send it to you f. o. b. Chicago for five days' free trial on receipt of your request, without obligation of any kind on your part to purchase. It will sell itself, but if you are not satisfied this is the greatest typewriter bargain you ever saw, you can return it at my expense — but — you won't want to return it after you try it — you cannot equal this wonderful value anywhere.

You Take No Risk—Put In Your Order Now

When the typewriter arrives deposit with the express agent \$8.80 and take the machine for five days' trial. If you are convinced that it is the best typewriter you ever saw, keep it and send me \$2.50 a month until our bargain price of \$48.80 is paid. If you don't want it, return it to the express agent, he will return your \$8.80 and return the typewriter to me. I will pay the return express charges. This machine is guaranteed just as if you paid \$100.00 for it. It is standard. Over one hundred thousand people own and use these typewriters and think them the best ever manufactured.

The supply at this price is very limited, the price will probably be raised when my next advertisement appears, so don't delay. Fill in the coupon today—mail to me—the typewriter will be shipped promptly. There is no red tape. I employ no solicitors—no collectors—no chattel mortgage. I deal direct with you — by mail only. It is simply understood that I retain title to the machine until the full \$48.80 is paid. You cannot lose. It is the greatest typewriter opportunity you will ever have.

Get the coupon in the mail today — sure

HARRY A. SMITH, 231 N. Fifth Ave., CHICAGO

H. A. SMITH
231 N. Fifth Ave.
CHICAGO, ILL.

Ship me a No. 2 L. C. Smith F. O. B. Chicago, as described in this advertisement. I will pay you the \$40.00 balance of the SPECIAL \$48.80 purchase price, at the rate of \$2.50 per month. The title to remain in you until fully paid for. It is understood that I have five days in which to examine and try the typewriter. If I choose not to keep it I will carefully repack it and return it to the express agent. It is understood that you give the standard guarantee for one year.

Name

Address

Pop. Mech. Oct.

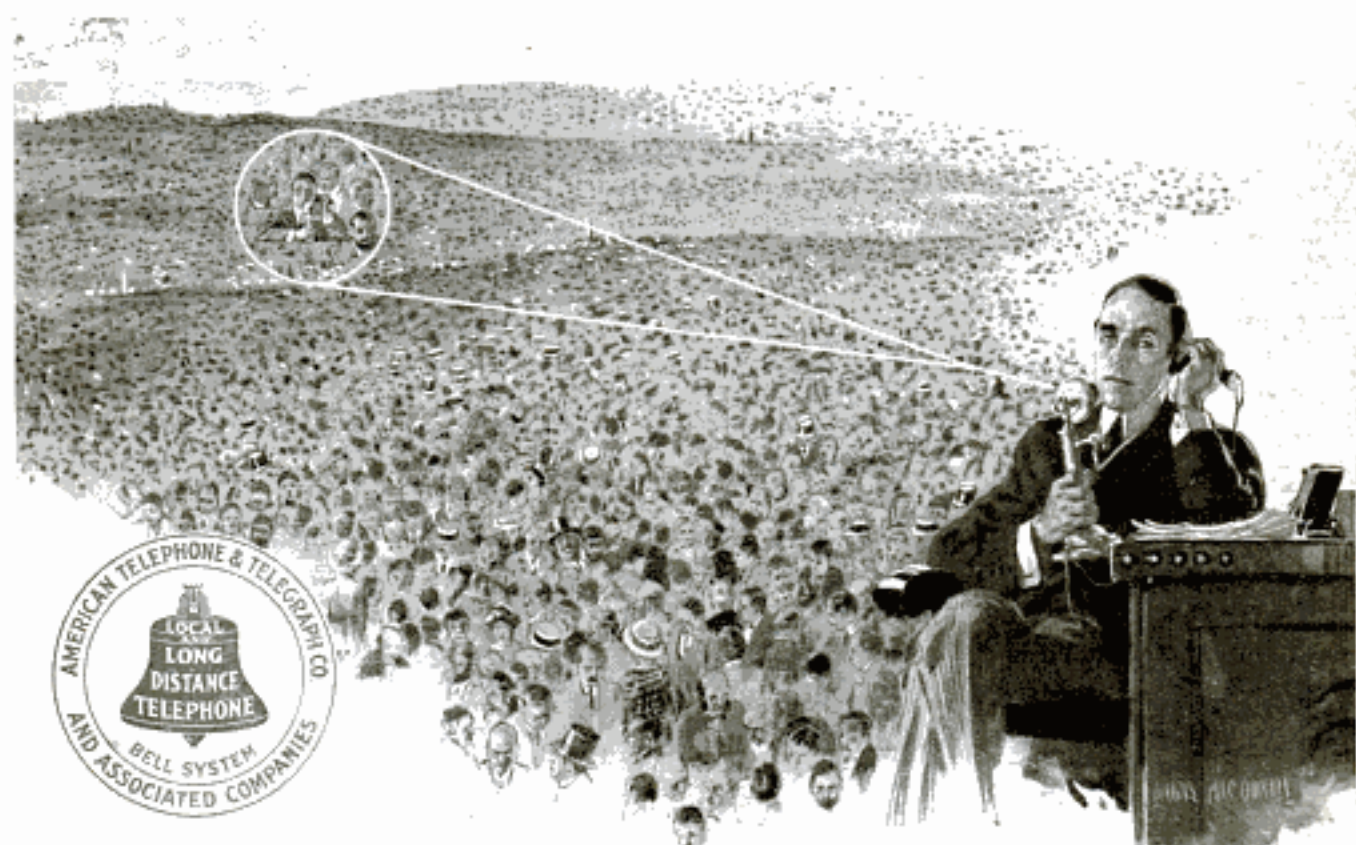

The Man in the Multitude

That the human voice may be transmitted across our continent by telephone is the marvel of this age of wonders. Yet the full significance of the achievement is not realized if it is considered strictly as a coast-to-coast connection.

The Transcontinental Line not only bridges the country from east to west, but, by having finally overcome the great barrier of distance, it has removed the last limitation of telephone communication between all the people of the nation.

This means that the voice can be sent not only from New York to San Francisco, but from *anywhere* to *anywhere*—even from *any one* to *any one*—in the United States.

Wherever you are, it is possible to reach any one of our hundred million population. You can single out from this vast throng any particular individual with whom you desire to speak.

To bring this about, the Bell System has spent years and millions, extending its lines everywhere, anticipating the ultimate triumph. It has had the foresight and the courage to unite this great country, community by community, into one telephone neighborhood.

With success achieved by the Transcontinental Line, the established Bell highways make you, wherever you are, the near neighbor of your farthest-away fellow citizen.

**AMERICAN TELEPHONE AND TELEGRAPH COMPANY
AND ASSOCIATED COMPANIES**

One Policy

One System

Universal Service

10 20 30 40 50

This is to Hail a Real Brunswick Home Billiard Table at \$27

Due to a Great Discovery—The Light-Weight, Ever-Level Astralite Billiard Bed

Rainy days, winter days, evenings after work is done—let the gay family gather round this scientific Carom and Pocket Billiard Table that you can set up in a jiffy or put aside when not in use.

For billiards is king of indoor sports—and nowadays reigns supreme in thousands of homes. A game brimming over with mirth and manly skill. It stirs the blood, sets old-age at a distance and makes your home the most enchanting place on earth for growing boys and girls!

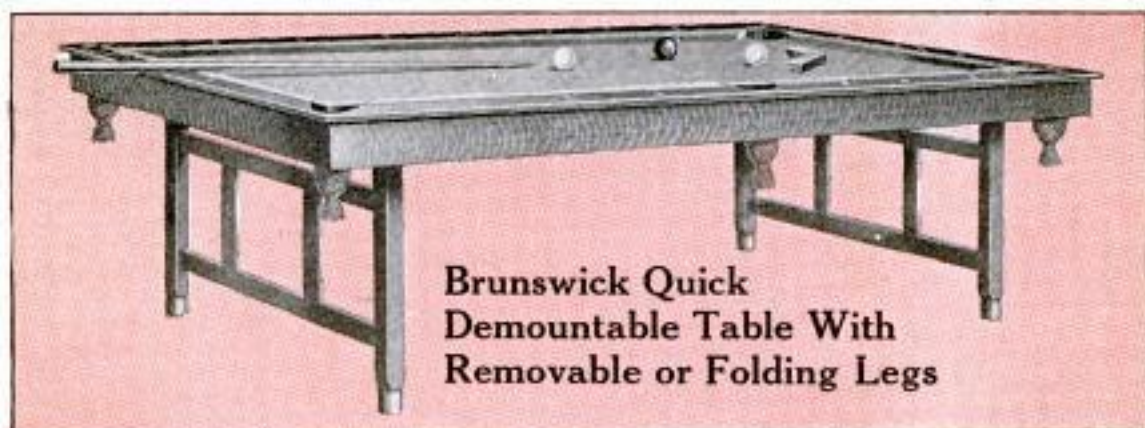

**Brunswick Quick
Demountable Table With
Removable or Folding Legs**

Brunswick Home Carom and Pocket Billiard Tables are made of rare and beautiful woods. Not flimsy toys—but scientific tables with ever-level bed—accuracy! life! and speed!

The "GRAND," "BABY GRAND" and "CONVERTIBLE" Brunswicks have long been conceded the finest and fastest home tables in the world.

And now comes the Brunswick Quick Demountable—at \$27 upward—made by the same skilled men and methods. This table requires no spare room whatever. The demountable construction and the new sizes adapt it to fit in any home. No maker has ever produced one like it. The reason is this:

Astralite Bed—Monarch Cushion

The bed and the cushion are the two most vital parts of any billiard table. Genuine Vermont slate is used for the bed in all our other lines. This is far too heavy for a Demountable table, yet common wood billiard beds work loose and warp. Metal dents and rusts.

So our experts, after many trials, developed with the aid of science this new construction—called Astralite.

It combines light weight with the playing qualities of slate and the Brunswick Quick Demountable is the only table made that has it.

No other tables but Brunswicks have genuine Monarch Cushions, conceded by experts to be the liveliest and most durable known.

Playing Outfit FREE

No matter what size or style you select, we give a **high-class** Playing Outfit without extra cost—Balls, Cues, Rack, Markers, Spirit Level, Cue Clamps, Tips, expert book, "How to Play," etc.

Free Trial—Then 10c a Day!

Our plan lets you try a Brunswick **right in your own home for 30 days free!** Then you can pay as you play—terms as low as \$5 down, **10 cents a day!**

Full details, prices and tables all shown in our handsomely colored book, "Billiards—The Home Magnet." The coupon brings it postpaid free. Don't put off—send it **NOW**—while these valuable books last.

Mail for Billiard Book FREE

THE BRUNSWICK-BALKE-COLLENDER CO.

Dept. 18K, 623-633 S. Wabash Ave., CHICAGO

Send free, your colored book
"Billiards—The Home Magnet,"
and tell about your 30 day trial offer.

Name.....
Address.....

Williams' Shaving Soap

A Signal Success

From the days of the wooden frigate to the modern super-dread-nought this one word

Williams'

has successfully held its place as the keyword in the shaver's code.

The Holder-Top Stick—"You hold the Holder and the Holder holds the Stick"—is proving a signal success throughout the ranks of men who shave.

Four other forms of the same good quality: Williams' Shaving Stick in hinged-top, nicked box, Williams' Shaving Powder, Williams' Shaving Cream and Williams' Liquid Shaving Soap.

A sample of any kind sent for 4 cents in stamps.

Address
**The J. B. WILLIAMS
COMPANY**
Dept. A
Glastonbury, Conn.



**Williams'
PATENTED
Holder-
Top
Shaving
Stick**